

# SIEMENS

## SIMATIC

### WinCC Comfort/Advanced V12.0 SP1

#### System Manual

System overview of STEP 7 and WinCC	1
Readme	2
Installation	3
Migrating projects and programs	4
First steps	5
Introduction to the TIA Portal	6
Editing projects	7
Editing devices and networks	8
Programming the PLC	9
Visualizing processes (Comfort/Advanced)	10
Using technology functions	11
Using online and diagnostics functions	12
Hardware documentation	13

Printout of the online help

## Legal information

### Warning notice system

This manual contains notices you have to observe in order to ensure your personal safety, as well as to prevent damage to property. The notices referring to your personal safety are highlighted in the manual by a safety alert symbol, notices referring only to property damage have no safety alert symbol. These notices shown below are graded according to the degree of danger.

<b>⚠ DANGER</b>
indicates that death or severe personal injury <b>will</b> result if proper precautions are not taken.
<b>⚠ WARNING</b>
indicates that death or severe personal injury <b>may</b> result if proper precautions are not taken.
<b>⚠ CAUTION</b>
indicates that minor personal injury can result if proper precautions are not taken.
<b>NOTICE</b>
indicates that property damage can result if proper precautions are not taken.

If more than one degree of danger is present, the warning notice representing the highest degree of danger will be used. A notice warning of injury to persons with a safety alert symbol may also include a warning relating to property damage.

### Qualified Personnel

The product/system described in this documentation may be operated only by **personnel qualified** for the specific task in accordance with the relevant documentation, in particular its warning notices and safety instructions. Qualified personnel are those who, based on their training and experience, are capable of identifying risks and avoiding potential hazards when working with these products/systems.

### Proper use of Siemens products

Note the following:

<b>⚠ WARNING</b>
Siemens products may only be used for the applications described in the catalog and in the relevant technical documentation. If products and components from other manufacturers are used, these must be recommended or approved by Siemens. Proper transport, storage, installation, assembly, commissioning, operation and maintenance are required to ensure that the products operate safely and without any problems. The permissible ambient conditions must be complied with. The information in the relevant documentation must be observed.

### Trademarks

All names identified by ® are registered trademarks of Siemens AG. The remaining trademarks in this publication may be trademarks whose use by third parties for their own purposes could violate the rights of the owner.

### Disclaimer of Liability

We have reviewed the contents of this publication to ensure consistency with the hardware and software described. Since variance cannot be precluded entirely, we cannot guarantee full consistency. However, the information in this publication is reviewed regularly and any necessary corrections are included in subsequent editions.

# Table of contents

<b>1</b>	<b>System overview of STEP 7 and WinCC.....</b>	<b>29</b>
1.1	Scaling of STEP 7 and WinCC.....	29
1.2	Options for STEP 7 Engineering System.....	31
1.3	Options for WinCC Engineering and Runtime systems.....	32
<b>2</b>	<b>Readme.....</b>	<b>35</b>
2.1	General notes.....	35
2.1.1	General notes.....	35
2.1.2	Notes on the installation.....	39
2.2	STEP 7 Basic.....	41
2.2.1	Security information.....	41
2.2.2	Notes on use.....	42
2.2.3	Editing devices and networks.....	44
2.2.3.1	General information on devices and networks.....	44
2.2.3.2	Use of modules on the S7-1200.....	44
2.2.3.3	Replacing ET 200S positioning modules.....	45
2.2.3.4	CP 343-2 on SIMATIC S7 Embedded Controller EC31-RTX.....	46
2.2.3.5	Notes on online and diagnostics.....	46
2.2.3.6	Network components.....	47
2.2.4	Programming a PLC.....	48
2.2.4.1	General notes on PLC programming.....	48
2.2.4.2	Instructions.....	49
2.2.4.3	Testing the user program.....	50
2.2.5	Technological functions.....	51
2.2.5.1	Notes on technological functions.....	51
2.3	WinCC Advanced.....	52
2.3.1	Security information.....	52
2.3.2	Notes on use.....	55
2.3.3	Migration.....	57
2.3.4	Special considerations for Windows 7.....	60
2.3.5	Engineering System.....	61
2.3.5.1	Screens and Screen Objects.....	61
2.3.5.2	Tags and connections.....	66
2.3.5.3	Alarm system and alarm displays.....	68
2.3.5.4	System functions and scripts.....	68
2.3.5.5	Recipes.....	70
2.3.5.6	User administration.....	71
2.3.5.7	Communication.....	71
2.3.6	Compiling and loading.....	75
2.3.7	Runtime.....	77
2.3.7.1	Notes on operation in Runtime.....	77
2.3.7.2	Notes on operation of panels in Runtime.....	78
2.3.7.3	Notes on operation of Runtime Advanced.....	79
2.3.8	HMI devices.....	79

2.3.8.1	Notes on HMI devices.....	79
<b>3</b>	<b>Installation.....</b>	<b>83</b>
3.1	System requirements for installation.....	83
3.1.1	Notes on licenses.....	83
3.1.2	Notes on the system requirements.....	84
3.1.3	System requirements STEP 7 Basic.....	85
3.1.3.1	Licensing of STEP 7.....	85
3.1.3.2	Handling licenses and license keys.....	86
3.1.3.3	Software and hardware requirements STEP 7.....	88
3.1.4	System requirement for WinCC Advanced.....	91
3.1.4.1	Software and hardware requirements.....	91
3.1.4.2	Parallel installation.....	95
3.1.4.3	Add-ons.....	96
3.1.4.4	Licenses and Powerpacks.....	98
3.2	Installation log.....	106
3.3	Starting installation.....	107
3.4	Installing Support Packages.....	109
3.5	Displaying the installed software.....	110
3.6	Modifying or updating installed products.....	111
3.7	Repairing installed products.....	113
3.8	Starting to uninstall.....	115
3.9	Installing and uninstalling the migration tool.....	117
3.9.1	System requirements.....	117
3.9.2	Installing the migration tool.....	117
3.9.3	Uninstalling the migration tool.....	118
<b>4</b>	<b>Migrating projects and programs.....</b>	<b>119</b>
4.1	Migrating projects in a TIA portal project.....	119
4.1.1	Migration of projects with the TIA Portal.....	119
4.1.2	Preparing projects with the migration tool.....	120
4.1.2.1	Migrating projects with the migration tool.....	120
4.1.2.2	Calling the migration tool.....	122
4.1.2.3	Creating a migration file.....	122
4.1.3	Migrating projects.....	123
4.1.4	Displaying the history of the migration.....	124
4.1.5	Display migration log.....	125
4.1.6	Migrating WinCC flexible projects (Advanced).....	126
4.1.6.1	Principles (WinCC flexible).....	126
4.1.6.2	Migrating engineering data (WinCC flexible).....	132
4.1.6.3	Migrating runtime data (WinCC flexible).....	153
4.1.6.4	Migrating integrated projects (WinCC flexible).....	156
4.1.6.5	Reference (WinCC flexible).....	159
4.1.7	Migrating integrated projects.....	175
4.1.7.1	Migrating an integrated project.....	175
4.1.7.2	Post-editing integrated projects.....	176
4.1.7.3	Converting unspecified CPUs into specified CPUs.....	178
4.1.7.4	Creating an integrated HMI connection.....	179

---

4.1.7.5	Re-linking HMI tags.....	181
4.1.7.6	Deleting an unspecified connection.....	182
4.2	Programming recommendations.....	183
4.2.1	The new S7-1500 CPU functions at a glance.....	183
4.2.2	Symbolic addressing.....	185
4.2.3	Using IEC timers and counters.....	187
4.2.4	Flexibly using enable output ENO.....	188
4.2.5	Using MOVE instructions in STL.....	190
4.2.6	Implementing array access with a variable index.....	192
4.2.7	Using PLC data types (UDT).....	194
<b>5</b>	<b>First steps.....</b>	<b>197</b>
5.1	Getting Started Documentation.....	197
<b>6</b>	<b>Introduction to the TIA Portal.....</b>	<b>199</b>
6.1	User interface and operation.....	199
6.1.1	Starting, setting and exiting the TIA Portal.....	199
6.1.1.1	Starting and exiting the TIA Portal.....	199
6.1.1.2	Overview of the program settings.....	199
6.1.1.3	Overview of the script and text editor settings.....	201
6.1.1.4	Overview of the print settings.....	202
6.1.1.5	Changing the settings.....	203
6.1.2	Layout of the user interface.....	203
6.1.2.1	Views.....	203
6.1.2.2	Portal view.....	204
6.1.2.3	Project view.....	205
6.1.2.4	Library view.....	207
6.1.2.5	Project tree.....	208
6.1.2.6	Work area.....	211
6.1.2.7	Inspector window.....	219
6.1.2.8	Task cards.....	221
6.1.2.9	Reference projects.....	223
6.1.2.10	Details view.....	225
6.1.2.11	Overview window.....	226
6.1.2.12	User interface layout.....	230
6.1.3	Keyboard operation in the TIA Portal.....	234
6.1.3.1	Operating the TIA Portal with the keyboard.....	234
6.1.3.2	Displaying an overview of all keyboard shortcuts.....	234
6.1.3.3	Basic functions of the TIA Portal.....	234
6.1.3.4	Using project-related functions.....	236
6.1.3.5	Arranging windows.....	236
6.1.3.6	Navigating through the program interface.....	237
6.1.3.7	Customizing editors.....	238
6.1.3.8	Editing objects.....	240
6.1.3.9	Text editing.....	241
6.1.3.10	Editing tables.....	242
6.1.3.11	Using online functions.....	243
6.1.3.12	Using the on-screen keyboard.....	244
6.1.4	Special features specific to the operating system.....	244
6.1.4.1	Influence of user rights.....	244
6.1.4.2	Expanding user rights.....	245

6.2	Help on the information system.....	247
6.2.1	General remarks on the information system.....	247
6.2.2	Opening the Help system.....	250
6.2.3	Searching the Help system for keywords.....	250
6.2.4	Full-text searches.....	250
6.2.5	Using favorites.....	251
6.2.6	Printing help topics.....	252
6.2.7	Configuring the display of tooltips and tooltip cascades.....	253
6.2.8	Safety Guidelines.....	253
6.2.9	Assembling customized documentation.....	255
<b>7</b>	<b>Editing projects.....</b>	<b>257</b>
7.1	The basics of projects.....	257
7.2	Using logs.....	258
7.3	Creating and managing projects.....	259
7.3.1	Creating a new project.....	259
7.3.2	Opening projects.....	259
7.3.3	Notes on compatibility.....	260
7.3.4	Upgrading projects.....	262
7.3.5	Displaying properties of the project.....	263
7.3.6	Saving projects.....	264
7.3.7	Closing projects.....	265
7.3.8	Deleting projects.....	265
7.3.9	Working with multi-language projects.....	266
7.3.9.1	Project text basics.....	266
7.3.9.2	Select project languages.....	268
7.3.9.3	Setting the editing language.....	268
7.3.9.4	Translating all project texts in tabular form.....	269
7.3.9.5	Translating text associated with individual objects.....	269
7.3.9.6	Translating texts using reference texts.....	270
7.3.9.7	Exporting and importing project texts.....	271
7.3.9.8	Application examples for multilanguage projects.....	273
7.3.10	Archiving and retrieving projects.....	274
7.3.10.1	Working with project archives.....	274
7.3.10.2	Archiving projects.....	275
7.3.10.3	Retrieving projects.....	276
7.4	Using reference projects.....	277
7.4.1	Basics of reference projects.....	277
7.4.2	Opening and closing a reference project.....	277
7.4.3	Comparing reference projects.....	278
7.5	Editing project data.....	280
7.5.1	Compiling and loading project data.....	280
7.5.1.1	Compiling project data.....	280
7.5.1.2	Downloading project data.....	281
7.5.2	Comparing project data.....	286
7.5.2.1	Basics of project data comparison.....	286
7.5.2.2	Carrying out an online/offline comparison.....	287
7.5.2.3	Carrying out offline/offline comparisons.....	287
7.5.2.4	Using the comparison editor.....	288
7.5.3	Protecting project data.....	298

7.5.3.1	Protection concept for project data.....	298
7.5.3.2	Revoking access rights for devices.....	299
7.5.4	Printing project contents.....	299
7.5.4.1	Printing project documentation.....	299
7.5.4.2	Printing module labels.....	319
7.6	Undoing and redoing actions.....	324
7.6.1	Basics of undoing and redoing actions.....	324
7.6.2	Undoing an action.....	325
7.6.3	Redoing an action.....	326
7.7	Finding and replacing in projects.....	328
7.7.1	Information on the search function.....	328
7.7.2	Search and replace.....	328
7.8	Working with text lists.....	331
7.8.1	Text lists.....	331
7.8.2	Creating user-defined text lists.....	332
7.8.3	Editing user-defined text lists.....	333
7.8.4	Editing system-defined text lists.....	333
7.9	Using memory cards.....	335
7.9.1	Basics about memory cards.....	335
7.9.2	Adding a user-defined card reader.....	335
7.9.3	Accessing memory cards.....	336
7.9.4	Displaying properties of memory cards.....	337
7.10	Using libraries.....	338
7.10.1	Library basics.....	338
7.10.2	Using the "Libraries" task card.....	339
7.10.2.1	Overview of the "Libraries" task card.....	339
7.10.2.2	Using the element view.....	342
7.10.3	Using the library view.....	343
7.10.3.1	Overview of the library view.....	343
7.10.3.2	Opening and closing the library view.....	345
7.10.4	Using library management.....	346
7.10.4.1	Overview of the library management.....	346
7.10.4.2	Opening library management.....	348
7.10.5	Using global libraries.....	348
7.10.5.1	Creating a global library.....	348
7.10.5.2	Opening a global library.....	349
7.10.5.3	Upgrading libraries from older versions.....	350
7.10.5.4	Displaying properties of global libraries.....	351
7.10.5.5	Displaying logs of global libraries.....	352
7.10.5.6	Saving a global library.....	352
7.10.5.7	Closing a global library.....	353
7.10.5.8	Deleting a global library.....	354
7.10.5.9	Archiving and disabling global libraries.....	354
7.10.6	Creating folders in a library.....	357
7.10.7	Using master copies.....	357
7.10.7.1	Basics on master copies.....	357
7.10.7.2	Adding master copies.....	358
7.10.7.3	Filtering master copies.....	359
7.10.7.4	Using master copies.....	360
7.10.8	Using types and their versions.....	361

7.10.8.1	Basics on types.....	361
7.10.8.2	State of type versions.....	362
7.10.8.3	Displaying a released type version.....	363
7.10.8.4	Displaying properties of a type or version.....	364
7.10.8.5	Working with types in the project library.....	365
7.10.8.6	Working with types in global libraries.....	376
7.10.9	Editing library elements.....	380
7.10.10	Updating a library with the contents of another library.....	381
7.10.11	Harmonizing names and path structure.....	383
7.10.12	Clean up library.....	384
7.10.13	Comparing library elements.....	385
7.11	Using cross-references.....	387
7.11.1	Using cross-references.....	387
7.12	Simulating devices.....	388
7.12.1	Simulation of devices.....	388
7.12.2	Starting the simulation.....	388
<b>8</b>	<b>Editing devices and networks.....</b>	<b>389</b>
8.1	Configuring devices and networks.....	389
8.1.1	Hardware and network editor.....	389
8.1.1.1	Overview of hardware and network editor.....	389
8.1.1.2	Network view.....	391
8.1.1.3	Device view.....	393
8.1.1.4	Topology view.....	396
8.1.1.5	Printing hardware and network configurations.....	399
8.1.1.6	Activating the page break preview for printout.....	400
8.1.1.7	Changing the print options.....	401
8.1.1.8	Inspector window .....	401
8.1.1.9	Hardware catalog.....	403
8.1.1.10	Information on hardware components.....	404
8.1.1.11	Enabling product support.....	405
8.1.1.12	Keyboard operation: Navigation in the editor.....	406
8.1.1.13	Keyboard operation: Editing objects.....	407
8.1.2	Configuring devices.....	408
8.1.2.1	Basics.....	408
8.1.2.2	Configuring individual devices.....	417
8.1.3	Configure networks.....	432
8.1.3.1	Networking devices.....	432
8.1.3.2	Communication via connections.....	450
8.1.3.3	Displaying and configuring topology.....	509
8.1.3.4	Industrial Ethernet Security.....	525
8.1.4	Creating configurations.....	635
8.1.4.1	Information about the web server.....	635
8.1.4.2	Things you should know about PROFIBUS DP operating modes.....	636
8.1.4.3	Configuring automation systems.....	637
8.1.4.4	S7-1200 CM/CP.....	674
8.1.4.5	IPv6 protocol.....	687
8.1.4.6	SCALANCE X, W and M.....	687
8.1.4.7	Configuring PROFIBUS DP.....	771
8.1.4.8	Configurations for PROFINET IO.....	795
8.1.4.9	Bus coupling with PN/PN coupler.....	823



8.1.4.10	Integrating external tools.....	824
8.1.4.11	Loading a configuration.....	826
8.1.5	Displaying alarms.....	829
8.1.5.1	Overview of the alarm display.....	829
8.1.5.2	Archive view.....	830
8.1.5.3	Layout of the alarms in the archive view.....	830
8.1.5.4	Receiving alarms.....	830
8.1.5.5	Export archive.....	831
8.1.5.6	Clear archive.....	831
8.1.5.7	"Active alarms" view.....	832
8.1.5.8	Layout of the alarms in the "Active alarms" view.....	832
8.1.5.9	Status of the alarms.....	832
8.1.5.10	Acknowledging alarms.....	833
8.1.5.11	Ignoring alarms.....	833
8.1.5.12	Keyboard commands in the alarm display.....	834
8.1.6	Additional information on configurations.....	834
8.1.6.1	Functional description of S7-1200 CPUs.....	834
8.1.6.2	Distributed I/O.....	906
8.2	Device and network diagnostics.....	960
8.2.1	Hardware diagnostics.....	960
8.2.1.1	Overview of hardware diagnostics.....	960
8.2.1.2	Showing non-editable and current values of configurable module properties.....	970
8.2.1.3	Showing the current values of dynamic modules properties.....	977
8.2.1.4	Checking a module for defects.....	981
8.2.1.5	Changing the properties of a module or the programming device/PC.....	988
8.2.1.6	Diagnostics in STOP mode.....	1003
8.2.1.7	Online accesses in the Online and Diagnostics view.....	1006
8.2.1.8	Checking PROFIBUS DP subnets for faults.....	1009
8.2.2	Connection diagnostics.....	1012
8.2.2.1	Overview of connection diagnostics.....	1012
8.2.2.2	Displaying the connection status using icons.....	1013
8.2.2.3	Detailed connection diagnostics.....	1014
<b>9</b>	<b>Programming the PLC.....</b>	<b>1019</b>
9.1	Creating a user program.....	1019
9.1.1	Programming basics.....	1019
9.1.1.1	Operating system and user program.....	1019
9.1.1.2	Blocks in the user program.....	1020
9.1.1.3	Block calls.....	1032
9.1.1.4	Using and addressing operands.....	1049
9.1.1.5	Data types.....	1077
9.1.1.6	Program flow control.....	1167
9.1.2	Declaring PLC tags.....	1172
9.1.2.1	Overview of PLC tag tables.....	1172
9.1.2.2	Structure of the PLC tag tables.....	1173
9.1.2.3	Rules for PLC tags.....	1175
9.1.2.4	Creating and managing PLC tag tables.....	1178
9.1.2.5	Declaring PLC tags.....	1180
9.1.2.6	Grouping PLC tags for inputs and outputs in structures.....	1184
9.1.2.7	Declaring symbolic constants.....	1187
9.1.2.8	Editing properties.....	1189
9.1.2.9	Monitoring of PLC tags.....	1192

9.1.2.10	Editing PLC tag tables.....	1192
9.1.3	Creating and managing blocks.....	1196
9.1.3.1	Creating blocks.....	1196
9.1.3.2	Specifying block properties.....	1208
9.1.3.3	Managing blocks.....	1214
9.1.4	Programming blocks.....	1219
9.1.4.1	Program editor.....	1219
9.1.4.2	Programming code blocks.....	1239
9.1.4.3	Programming data blocks.....	1382
9.1.4.4	Programming PLC data types.....	1409
9.1.4.5	Using external source files.....	1418
9.1.5	Comparing PLC programs.....	1423
9.1.5.1	Basic information on comparing PLC programs.....	1423
9.1.5.2	Comparing blocks.....	1427
9.1.5.3	Comparing PLC tags.....	1435
9.1.5.4	Comparing PLC data types.....	1436
9.1.6	Compiling and downloading blocks.....	1438
9.1.6.1	Compiling blocks.....	1438
9.1.6.2	Downloading blocks.....	1442
9.1.7	Protecting blocks.....	1453
9.1.7.1	Protecting blocks.....	1453
9.1.7.2	Setting up and removing block copy protection.....	1455
9.1.7.3	Setting up block know-how protection.....	1456
9.1.7.4	Opening know-how protected blocks.....	1457
9.1.7.5	Printing know-how protected blocks.....	1457
9.1.7.6	Changing a password.....	1459
9.1.7.7	Removing block know-how protection.....	1459
9.2	Displaying program information.....	1461
9.2.1	Overview of available program information.....	1461
9.2.2	Displaying an assignment list.....	1462
9.2.2.1	Introduction to the assignment list.....	1462
9.2.2.2	Layout of the assignment list.....	1463
9.2.2.3	Symbols in the assignment list.....	1464
9.2.2.4	Displaying an assignment list.....	1465
9.2.2.5	Setting the view options for the assignment list.....	1465
9.2.2.6	Filter options in the assignment list.....	1466
9.2.2.7	Defining filters for assignment list.....	1467
9.2.2.8	Filtering an assignment list.....	1468
9.2.2.9	Defining retentive memory areas for bit memories.....	1469
9.2.2.10	Enabling the display of retentive bit memories.....	1469
9.2.3	Displaying the call structure.....	1470
9.2.3.1	Introduction to the call structure.....	1470
9.2.3.2	Symbols in the call structure.....	1472
9.2.3.3	Layout of the call structure.....	1473
9.2.3.4	Displaying the call structure.....	1473
9.2.3.5	Setting the view options for the call structure.....	1474
9.2.3.6	Introducing the consistency check in the call structure.....	1475
9.2.3.7	Checking block consistency in the call structure.....	1475
9.2.4	Displaying the dependency structure.....	1476
9.2.4.1	Introduction to the dependency structure.....	1476
9.2.4.2	Layout of the dependency structure.....	1477
9.2.4.3	Symbols in the dependency structure.....	1478

---

9.2.4.4	Displaying the dependency structure.....	1479
9.2.4.5	Setting the view options for the dependency structure.....	1479
9.2.4.6	Introducing the consistency check in the dependency structure.....	1480
9.2.4.7	Checking block consistency in the dependency structure.....	1481
9.2.5	Displaying CPU resources.....	1481
9.2.5.1	Introducing resources.....	1481
9.2.5.2	Layout of the "Resources" tab.....	1483
9.2.5.3	Displaying resources.....	1484
9.2.5.4	Selecting the maximum load memory available.....	1485
9.3	Displaying cross-references.....	1486
9.3.1	General information about cross references.....	1486
9.3.2	Structure of the cross-reference list.....	1486
9.3.3	Displaying the cross-reference list.....	1488
9.3.4	Displaying cross-references in the Inspector window.....	1489
9.4	Testing the user program.....	1491
9.4.1	Basics of testing the user program.....	1491
9.4.2	Testing with program status.....	1492
9.4.2.1	Introduction to testing with program status.....	1492
9.4.2.2	Switching test with program status on/off.....	1493
9.4.2.3	Editing blocks during the program test.....	1494
9.4.2.4	Modifying tags in the program status.....	1495
9.4.2.5	Switching display formats in the program status.....	1495
9.4.2.6	Examples of program status display.....	1496
9.4.3	Testing with the watch table.....	1499
9.4.3.1	Introduction to testing with the watch table.....	1499
9.4.3.2	Layout of the watch table.....	1500
9.4.3.3	Basic mode and expanded mode in the watch table.....	1501
9.4.3.4	Icons in the watch table.....	1502
9.4.3.5	Creating and editing watch tables.....	1503
9.4.3.6	Entering tags in the watch table.....	1505
9.4.3.7	Monitoring tags in the watch table.....	1512
9.4.3.8	Modifying tags in the watch table.....	1517
9.4.4	Testing with the force table.....	1524
9.4.4.1	Introduction for testing with the force table.....	1524
9.4.4.2	Safety precautions when forcing tags.....	1526
9.4.4.3	Layout of the force table.....	1526
9.4.4.4	Basic mode and expanded mode in the force table.....	1527
9.4.4.5	Icons in the force table.....	1528
9.4.4.6	Open and edit force table.....	1529
9.4.4.7	Entering tags in the force table.....	1530
9.4.4.8	Monitoring tags in the force table.....	1536
9.4.4.9	Forcing tags in the force table.....	1539
9.4.4.10	Stop forcing tags.....	1546
9.5	Using global project functions.....	1549
9.5.1	Importing and exporting.....	1549
9.5.1.1	Basics for importing and exporting.....	1549
9.5.1.2	Format of the export file.....	1549
9.5.1.3	Exporting PLC tags.....	1550
9.5.1.4	Importing PLC tags.....	1551
9.6	Programming examples.....	1552

9.6.1	LAD programming examples.....	1552
9.6.1.1	Example of controlling a conveyor belt .....	1552
9.6.1.2	Example of detecting the direction of a conveyor belt.....	1553
9.6.1.3	Example of detecting the fill level of a storage area .....	1554
9.6.1.4	Example of controlling room temperature.....	1557
9.6.2	FBD programming examples.....	1559
9.6.2.1	Example of controlling a conveyor belt .....	1559
9.6.2.2	Example of detecting the direction of a conveyor belt.....	1560
9.6.2.3	Example of detecting the fill level of a storage area .....	1561
9.6.2.4	Example of controlling room temperature.....	1564
9.6.3	STL programming examples.....	1566
9.6.3.1	Example: Bit logic instructions.....	1566
9.6.3.2	Example of detecting the direction of a conveyor belt.....	1568
9.6.3.3	Example of detecting the fill level of a storage area .....	1569
9.6.3.4	Example of calculating an equation.....	1571
9.6.3.5	Example: Word logic instructions.....	1572
9.6.3.6	Example of a step sequence.....	1574
9.6.4	SCL programming examples.....	1576
9.6.4.1	Example: Bit logic instructions.....	1576
9.6.4.2	Example of detecting the direction of a conveyor belt.....	1578
9.6.4.3	Example of detecting the fill level of a storage area .....	1579
9.7	References.....	1582
9.7.1	General parameters of the instructions.....	1582
9.7.1.1	Meaning of the parameters REQ, RET_VAL and BUSY with asynchronous instructions.....	1582
9.7.1.2	Evaluating errors with output parameter RET_VAL.....	1584
9.7.2	Basic instructions.....	1588
9.7.2.1	LAD.....	1588
9.7.2.2	FBD.....	1835
9.7.2.3	SCL.....	2093
9.7.3	Extended instructions.....	2281
9.7.3.1	Date and time-of-day.....	2281
9.7.3.2	String + Char.....	2294
9.7.3.3	Process image.....	2315
9.7.3.4	Distributed I/O.....	2321
9.7.3.5	PROFInergy.....	2391
9.7.3.6	Module parameter assignment.....	2431
9.7.3.7	Interrupts.....	2441
9.7.3.8	Alarms.....	2470
9.7.3.9	Diagnostics.....	2475
9.7.3.10	Pulse.....	2506
9.7.3.11	Recipes and data logging.....	2507
9.7.3.12	Data block functions.....	2533
9.7.3.13	Addressing.....	2542
9.7.4	Technology.....	2556
9.7.4.1	S7-1200 Motion Control.....	2556
9.7.4.2	High-speed counters.....	2588
9.7.4.3	PID Control.....	2591
9.7.5	Communication.....	2699
9.7.5.1	Communications processor.....	2699
9.7.5.2	S7 communication.....	2826
9.7.5.3	Open User Communication.....	2843
9.7.5.4	Web server.....	2920

9.7.5.5	TeleService.....	2922
<b>10</b>	<b>Visualizing processes (Comfort/Advanced).....</b>	<b>2931</b>
10.1	Creating screens.....	2931
10.1.1	Basics.....	2931
10.1.1.1	Screen basics.....	2931
10.1.1.2	Device-specific functional scope of screens.....	2933
10.1.1.3	Elements and basic settings.....	2935
10.1.1.4	Working with screens.....	2937
10.1.1.5	Working with templates.....	2941
10.1.2	Working with objects.....	2947
10.1.2.1	Overview of objects.....	2947
10.1.2.2	Overview of objects.....	2950
10.1.2.3	Options for Editing Objects.....	2953
10.1.2.4	Inserting an object.....	2954
10.1.2.5	Deleting an Object.....	2956
10.1.2.6	Positioning an object.....	2957
10.1.2.7	Resizing an object.....	2958
10.1.2.8	Aligning objects.....	2960
10.1.2.9	Moving an object forward or backward.....	2962
10.1.2.10	Show objects outside the screen area.....	2963
10.1.2.11	Rotating objects.....	2963
10.1.2.12	Flipping objects.....	2965
10.1.2.13	Flashing.....	2966
10.1.2.14	Designing an object.....	2966
10.1.2.15	Inserting multiple objects of the same type (stamping tool).....	2967
10.1.2.16	Selecting multiple objects.....	2969
10.1.2.17	Repositioning and resizing multiple objects.....	2971
10.1.2.18	Managing My Controls.....	2972
10.1.2.19	External graphics.....	2974
10.1.2.20	Managing external graphics.....	2975
10.1.2.21	Storing an external image in the graphics library.....	2977
10.1.2.22	Working with object groups.....	2979
10.1.2.23	Configuring the keyboard access.....	2985
10.1.2.24	Examples.....	2988
10.1.3	Working with text lists and graphics lists.....	2991
10.1.3.1	Working with text lists.....	2991
10.1.3.2	Working with graphics lists.....	2999
10.1.4	Dynamizing screens.....	3007
10.1.4.1	Basics on dynamizing screens.....	3007
10.1.4.2	Basics on dynamizing screens.....	3007
10.1.4.3	Dynamization in the inspector window.....	3008
10.1.4.4	Dynamization in the inspector window.....	3010
10.1.4.5	Dynamization with animations.....	3012
10.1.4.6	Dynamization in the property list.....	3024
10.1.4.7	Dynamize with system functions.....	3028
10.1.5	Working with function keys.....	3030
10.1.5.1	Working with function keys.....	3030
10.1.5.2	Assigning function keys globally.....	3032
10.1.5.3	Local assignment of function keys.....	3033
10.1.5.4	Assigning a function key to a function.....	3035
10.1.5.5	Assigning operator authorization for a function key.....	3036

10.1.5.6	Assigning a function key to a graphic.....	3037
10.1.5.7	Configuring LED tags.....	3039
10.1.5.8	Example: Using function keys for screen navigation.....	3041
10.1.6	Working with layers.....	3042
10.1.6.1	Basics on working with layers.....	3042
10.1.6.2	Moving objects between layers.....	3044
10.1.6.3	Setting the active layer.....	3044
10.1.6.4	Show and hide layers.....	3046
10.1.6.5	Renaming layers.....	3047
10.1.7	Working with faceplates.....	3049
10.1.7.1	Basics on faceplates.....	3049
10.1.7.2	Faceplate editor.....	3051
10.1.7.3	Creating and managing faceplates.....	3054
10.1.7.4	Dynamizing faceplates.....	3069
10.1.7.5	Examples of faceplates.....	3070
10.1.8	Indicator and control objects.....	3077
10.1.8.1	Device-Specific Nature of the Objects.....	3077
10.1.8.2	Objects.....	3086
10.1.9	Configuring screen navigation.....	3162
10.1.9.1	Basics on screen navigation.....	3162
10.1.9.2	Assigning button with screen change.....	3163
10.1.9.3	Assigning screen change to function key.....	3164
10.2	Working with Tags.....	3166
10.2.1	Basics.....	3166
10.2.1.1	Basics of tags.....	3166
10.2.1.2	Overview of HMI tag tables.....	3167
10.2.1.3	External tags.....	3169
10.2.1.4	Addressing external tags.....	3170
10.2.1.5	Internal Tags.....	3172
10.2.2	Working with Tags.....	3173
10.2.2.1	Creating tags.....	3173
10.2.2.2	Editing tags.....	3177
10.2.2.3	Configuring Tags.....	3183
10.2.3	Working with arrays.....	3201
10.2.3.1	Basics on arrays.....	3201
10.2.3.2	Creating array tags.....	3203
10.2.3.3	Examples of arrays.....	3204
10.2.4	Working with user data types.....	3204
10.2.4.1	Basics on user data types.....	3204
10.2.4.2	Creating a user data type.....	3206
10.2.4.3	Creating user data type elements.....	3208
10.2.4.4	Managing versions of user data types.....	3209
10.2.4.5	Creating tags with a user data type data type.....	3210
10.2.5	Working with cycles.....	3212
10.2.5.1	Cycle basics.....	3212
10.2.5.2	Defining cycles.....	3213
10.2.6	Logging tags.....	3214
10.2.6.1	Basic principles for data logging.....	3214
10.2.6.2	Data logging in Runtime Advanced and Panels.....	3215
10.2.7	Displaying Tags.....	3235
10.2.7.1	Displaying tags with Basic Panels.....	3235
10.2.7.2	Displaying tags with Runtime Advanced and Panels.....	3237

---

10.3	Working with alarms.....	3245
10.3.1	Basics.....	3245
10.3.1.1	Alarm Logging in WinCC.....	3245
10.3.1.2	Alarm Logging in WinCC.....	3246
10.3.1.3	Alarm Procedures.....	3247
10.3.1.4	Alarm states.....	3252
10.3.1.5	Alarm classes.....	3253
10.3.1.6	Acknowledgement.....	3256
10.3.1.7	Alarm groups.....	3259
10.3.1.8	Alarm number.....	3259
10.3.2	Working with Alarms .....	3260
10.3.2.1	Alarm components and properties.....	3260
10.3.2.2	Configuring Alarms.....	3261
10.3.2.3	Configuring the Outputting of Alarms.....	3283
10.3.2.4	Acknowledging alarms.....	3300
10.3.2.5	Configuring alarm buffer overflow.....	3303
10.3.3	Logging Alarms.....	3304
10.3.3.1	Alarm Logging Basics.....	3304
10.3.3.2	Storage locations for log files.....	3306
10.3.3.3	Creating an alarm log.....	3308
10.3.3.4	Logging Alarms.....	3312
10.3.3.5	Configuring an alarm view for logged alarms.....	3313
10.3.3.6	Direct access to the ODBC log database.....	3314
10.3.3.7	Setting up the ODBC data source.....	3315
10.3.3.8	Configuring a checksum for a log.....	3315
10.3.3.9	Evaluating the checksum of log data.....	3317
10.3.3.10	Log response to language switching in runtime.....	3318
10.3.3.11	Managing logging behavior when Runtime starts.....	3319
10.3.3.12	Controlling the Logging in relation to the Fill Level.....	3320
10.3.4	Using Alarms in Runtime.....	3321
10.3.4.1	Alarms in Runtime.....	3321
10.3.4.2	Alarms in Runtime.....	3323
10.3.4.3	Using the Alarm Window or Alarm View.....	3325
10.3.4.4	Using the Simple Alarm Window, Alarm View.....	3328
10.3.4.5	Using the Alarm Indicator.....	3331
10.3.4.6	Acknowledging alarms.....	3332
10.3.4.7	Filtering Alarms .....	3333
10.3.5	Reference.....	3334
10.3.5.1	System functions for alarms.....	3334
10.3.5.2	Alarm events.....	3335
10.3.5.3	System functions for logs.....	3336
10.3.5.4	Structure of *.csv files that contain alarms.....	3336
10.3.5.5	System events.....	3338
10.3.6	Configuring system diagnostics.....	3371
10.3.6.1	System diagnostics basics.....	3371
10.3.6.2	System diagnostics views.....	3372
10.3.6.3	Basic Panel basics.....	3376
10.3.6.4	Configuring system diagnostics objects.....	3379
10.4	Working with logs.....	3388
10.4.1	Working with logs for Runtime Advanced and Panels.....	3388
10.4.1.1	Log Basics.....	3388

10.4.1.2	Properties of Logs.....	3388
10.5	Working with recipes.....	3391
10.5.1	Basics.....	3391
10.5.1.1	Definition and applications.....	3391
10.5.1.2	Examples for using recipes.....	3393
10.5.1.3	Recipe structure.....	3393
10.5.1.4	Display of recipes.....	3395
10.5.1.5	Transferring recipe data records.....	3397
10.5.1.6	Configuration of recipes.....	3400
10.5.1.7	Special features of some devices.....	3401
10.5.1.8	Synchronization of recipe data records with the PLC.....	3403
10.5.1.9	"Recipes" editor.....	3404
10.5.2	Displaying and Editing Recipes in Runtime.....	3407
10.5.2.1	Recipe screen and recipe view.....	3407
10.5.2.2	Simple recipe view.....	3407
10.5.2.3	Configuration options of the simple recipe view.....	3409
10.5.2.4	Advanced recipe view.....	3412
10.5.2.5	Configuration options of the advanced recipe view.....	3413
10.5.2.6	Response of the recipe view in Runtime.....	3415
10.5.2.7	Basics on the recipe screen.....	3416
10.5.3	Configuring Recipes.....	3418
10.5.3.1	General configuration procedure.....	3418
10.5.3.2	Creating and Editing Recipes.....	3419
10.5.3.3	Configuring the display of recipes.....	3427
10.5.3.4	Importing recipes into the configuration and exporting them.....	3433
10.5.4	Using Recipes in Runtime.....	3436
10.5.4.1	Simple recipe view.....	3436
10.5.4.2	Advanced recipe view.....	3442
10.5.4.3	Exporting and importing recipe data records.....	3449
10.5.4.4	Reactions to modifications of the recipe structure.....	3450
10.5.5	Examples.....	3451
10.5.5.1	Example of creating a recipe.....	3451
10.5.5.2	Example of configuring a recipe screen.....	3453
10.5.5.3	Scenario for Entering Recipe Data Records in Runtime.....	3455
10.5.5.4	Scenario for a manual production sequence.....	3456
10.5.5.5	Scenario for an Automatic Production Sequence.....	3458
10.6	Working with reports.....	3460
10.6.1	Basics.....	3460
10.6.1.1	Reports.....	3460
10.6.1.2	Structure of reports.....	3461
10.6.2	Working with reports.....	3463
10.6.2.1	Creating reports.....	3463
10.6.2.2	Printing reports.....	3468
10.6.2.3	Working with objects.....	3469
10.6.3	Operation in Runtime.....	3484
10.6.3.1	Printing reports.....	3484
10.6.4	Objects in reports.....	3484
10.6.4.1	Audit report.....	3484
10.6.4.2	Date/time field.....	3485
10.6.4.3	I/O field.....	3486
10.6.4.4	Graphic view.....	3488



---

10.6.4.5	Graphic I/O field.....	3489
10.6.4.6	Alarm report.....	3489
10.6.4.7	Recipe report.....	3492
10.6.4.8	Page number.....	3493
10.6.4.9	Symbolic I/O field.....	3494
10.6.4.10	Text field.....	3494
10.7	Configuring user administration.....	3496
10.7.1	Field of application of the user administration.....	3496
10.7.2	Form of the user administration.....	3496
10.7.3	Basics.....	3497
10.7.3.1	Users.....	3497
10.7.3.2	Users work area.....	3498
10.7.3.3	User groups.....	3499
10.7.3.4	User groups work area.....	3499
10.7.3.5	Settings for the user administration.....	3500
10.7.3.6	Settings for the user administration.....	3502
10.7.4	Building up and structuring a user administration.....	3504
10.7.4.1	Basics of user administration.....	3504
10.7.4.2	Administering users for Runtime .....	3505
10.7.4.3	Managing users on the server.....	3511
10.7.4.4	Administering users in Runtime.....	3516
10.7.4.5	Configuring access protection.....	3528
10.7.5	Reference.....	3529
10.7.5.1	Objects with access protection.....	3529
10.7.5.2	Objects with access protection.....	3530
10.7.5.3	Default user groups and authorizations.....	3530
10.7.6	Examples.....	3531
10.7.6.1	Example: Configuring a button with logon dialog box.....	3531
10.7.6.2	Example: Logging the logon and logoff events.....	3532
10.7.6.3	Example of a user administration.....	3533
10.8	Working with system functions and Runtime scripting.....	3541
10.8.1	Basics.....	3541
10.8.1.1	Runtime scripting.....	3541
10.8.1.2	System functions.....	3542
10.8.1.3	User-defined functions.....	3544
10.8.2	Working with function lists.....	3545
10.8.2.1	Basics of the function list.....	3545
10.8.2.2	Properties of a function list.....	3546
10.8.2.3	Configuring a function list.....	3547
10.8.2.4	Editing a function list.....	3549
10.8.3	Working with user-defined VB functions.....	3550
10.8.3.1	"Scripts" editor.....	3550
10.8.3.2	Access to HMI tags.....	3552
10.8.3.3	Access to objects.....	3553
10.8.3.4	Calling system functions.....	3554
10.8.3.5	Calling user-defined VB functions.....	3555
10.8.3.6	Transfer and return of values in VBS.....	3557
10.8.3.7	Create customized VB functions.....	3558
10.8.3.8	Testing the syntax of customized functions.....	3560
10.8.3.9	Renaming customized VB functions.....	3561
10.8.3.10	Executing customized VB functions.....	3561

10.8.3.11	Protecting user-defined functions.....	3562
10.8.4	Debugging user-defined VB functions.....	3564
10.8.4.1	Debugging user-defined VB functions.....	3564
10.8.4.2	Integrating the Debugger.....	3567
10.8.4.3	Starting and stopping the debugger.....	3572
10.8.5	Runtime behavior in Runtime.....	3573
10.8.5.1	Executing a function list in Runtime.....	3573
10.8.5.2	Executing user-defined functions in Runtime.....	3573
10.8.5.3	Processing sequence for user-defined functions and system functions.....	3574
10.8.5.4	Making object properties dynamic in Runtime.....	3576
10.8.6	Examples.....	3577
10.8.6.1	Example: Converting Fahrenheit into degrees Celsius.....	3577
10.8.6.2	Example: Converting inches into meters.....	3579
10.8.6.3	Example: Changing the operating mode on the HMI device with the current display.....	3581
10.8.7	Reference.....	3583
10.8.7.1	Function list.....	3583
10.8.7.2	Events.....	3775
10.8.7.3	VB scripts.....	3798
10.9	Mobile Wireless.....	4864
10.9.1	Field of application of the Mobile Panel Wireless.....	4864
10.9.2	How does the transponder system work?.....	4865
10.9.3	How does the RFID system work?.....	4867
10.9.4	Configuring the Mobile Panel V2 for fail-safe operation.....	4869
10.9.4.1	Configuration overview.....	4869
10.9.4.2	Creating PLC for fail-safe operation.....	4870
10.9.4.3	Installing a general station description (GSD).....	4871
10.9.4.4	Creating a module from the GSD file.....	4871
10.9.4.5	Creating a connection between a module and the PLC.....	4874
10.9.4.6	Creating Mobile Panel.....	4875
10.9.5	Basics.....	4876
10.9.5.1	Zones.....	4876
10.9.5.2	Zones working area.....	4876
10.9.5.3	Effective ranges.....	4877
10.9.5.4	Effective ranges working area.....	4878
10.9.5.5	Effective ranges (RFID).....	4880
10.9.5.6	Work area for effective ranges (RFID).....	4880
10.9.6	Working with zones.....	4882
10.9.6.1	Configuring a zone.....	4882
10.9.6.2	Displaying the screen on entering a zone.....	4883
10.9.6.3	Displaying an object in relation to the zone.....	4884
10.9.7	Working with effective ranges.....	4885
10.9.7.1	Overview.....	4885
10.9.7.2	Configure effective range.....	4886
10.9.7.3	Configuring the effective range name.....	4887
10.9.7.4	Configuring additional Mobile Wireless objects.....	4888
10.9.8	Working with effective ranges (RFID).....	4888
10.9.8.1	Overview.....	4888
10.9.8.2	Configuring effective range (RFID).....	4889
10.9.8.3	Configuring the effective range name (RFID).....	4890
10.9.9	Reference.....	4891
10.9.9.1	PROFIsafe address.....	4891
10.9.9.2	Power Management.....	4892

---

10.9.9.3	Zone ID / connection point ID.....	4893
10.10	Planning tasks.....	4894
10.10.1	Field of application of the Scheduler.....	4894
10.10.2	Working with tasks and triggers.....	4895
10.10.3	Basics.....	4896
10.10.3.1	Work area of the "Scheduler" editor.....	4896
10.10.3.2	Function list.....	4897
10.10.3.3	Function list.....	4897
10.10.3.4	Triggers.....	4898
10.10.4	Planning jobs.....	4900
10.10.4.1	Planning tasks with acyclic triggers.....	4900
10.10.4.2	Planning tasks with cyclic triggers .....	4902
10.10.4.3	Planning tasks with event triggers .....	4903
10.10.4.4	Administer task.....	4904
10.10.5	Examples.....	4904
10.10.5.1	Example: Terminating Runtime every day.....	4904
10.10.5.2	Example: Update user following change of user.....	4905
10.10.5.3	Example: Changing the starting point of a job in Runtime.....	4906
10.11	Communicating with PLCs.....	4911
10.11.1	Basics of communication.....	4911
10.11.1.1	Communication between devices.....	4911
10.11.1.2	Devices and networks in the automation system.....	4912
10.11.1.3	Data exchange using tags.....	4917
10.11.1.4	Data exchange using area pointers.....	4918
10.11.1.5	Communication drivers.....	4918
10.11.2	Editors for communication.....	4919
10.11.2.1	"Devices & networks" editor.....	4919
10.11.2.2	Network view.....	4920
10.11.2.3	Network data.....	4923
10.11.2.4	Diagnostics of online connections.....	4925
10.11.2.5	Device view.....	4926
10.11.2.6	Topology view.....	4928
10.11.2.7	Inspector window .....	4930
10.11.2.8	Hardware catalog .....	4932
10.11.2.9	Information on hardware components.....	4934
10.11.3	Networks and connections.....	4935
10.11.3.1	SIMATIC communication networks.....	4935
10.11.3.2	Configuring networks and connections.....	4940
10.11.4	Data exchange.....	4948
10.11.4.1	Data exchange using tags.....	4948
10.11.4.2	Data exchange using area pointers.....	4954
10.11.5	Device dependency.....	4960
10.11.5.1	Basic Panel.....	4960
10.11.5.2	Panel.....	4963
10.11.5.3	Comfort Panel.....	4967
10.11.5.4	Multi Panel.....	4971
10.11.5.5	Mobile Panel.....	4973
10.11.5.6	PC systems.....	4977
10.11.5.7	Parallel communication .....	4979
10.11.6	Communicating with SIMATIC S7 1500.....	4980
10.11.6.1	Communication with SIMATIC S7 1500.....	4980

10.11.6.2	Communication via PROFINET.....	4981
10.11.6.3	Communication via PROFIBUS.....	4999
10.11.6.4	Data exchange.....	5011
10.11.6.5	Performance features of communication.....	5031
10.11.6.6	Configuring connections in the "Connections" editor.....	5032
10.11.6.7	Configuring connections in the "Connections" editor.....	5039
10.11.6.8	Configuring time synchronization.....	5044
10.11.7	Communicating with SIMATIC S7 1200.....	5047
10.11.7.1	Communication with SIMATIC S7 1200.....	5047
10.11.7.2	Communication via PROFINET.....	5048
10.11.7.3	Communication via PROFIBUS.....	5069
10.11.7.4	Data exchange.....	5084
10.11.7.5	Performance features of communication.....	5106
10.11.7.6	Creating connections in the "Connections" editor.....	5108
10.11.7.7	Time synchronization.....	5117
10.11.8	Communicating with SIMATIC S7 300/400.....	5120
10.11.8.1	Communication with SIMATIC S7 300/400.....	5120
10.11.8.2	Communication via PROFINET.....	5121
10.11.8.3	Communication via PROFIBUS.....	5141
10.11.8.4	Communication via MPI.....	5155
10.11.8.5	Data exchange.....	5167
10.11.8.6	Performance features of communication.....	5187
10.11.8.7	Creating connections in the "Connections" editor.....	5188
10.11.9	Communicating with SIMATIC S7 200.....	5200
10.11.9.1	Communication with SIMATIC S7 200.....	5200
10.11.9.2	Creating a connection to SIMATIC S7 200.....	5200
10.11.9.3	Parameters for the connection.....	5202
10.11.9.4	Data exchange.....	5210
10.11.9.5	Performance features of communication.....	5229
10.11.10	Communicating with SIMATIC LOGO!.....	5230
10.11.10.1	Communication with SIMATIC LOGO!.....	5230
10.11.10.2	Creating a connection to SIMATIC LOGO!.....	5231
10.11.10.3	Connection parameters.....	5232
10.11.10.4	Data exchange.....	5236
10.11.10.5	Performance features of communication.....	5241
10.11.11	Configuring direct keys.....	5241
10.11.11.1	Direct keys.....	5241
10.11.11.2	Changing the operating mode of the HMI device.....	5242
10.11.11.3	Configuring direct keys.....	5243
10.11.11.4	PROFINET IO direct keys.....	5245
10.11.11.5	PROFIBUS DP direct keys.....	5262
10.11.12	Communication via SIMATIC HMI HTTP.....	5280
10.11.12.1	Basic information on SIMATIC HMI HTTP.....	5280
10.11.12.2	Configuring a connection via SIMATIC HMI HTTP.....	5282
10.11.12.3	Performance features of communication.....	5295
10.11.13	Communication via OPC.....	5296
10.11.13.1	Communication via OPC.....	5296
10.11.13.2	Configuring a connection via OPC.....	5296
10.11.13.3	Performance features of communication.....	5298
10.11.14	Communication via routing.....	5300
10.11.14.1	Communication via routing.....	5300
10.11.14.2	Example for communication via routing.....	5302

10.11.14.3	Configuring communication via routing.....	5304
10.11.15	PROFINET IO and IRT.....	5305
10.11.15.1	PROFINET IO.....	5305
10.11.15.2	IRT communication.....	5307
10.11.15.3	Configuring the HMI device as IO device.....	5310
10.11.15.4	Parameters for PROFINET IO and IRT.....	5311
10.11.15.5	Performance characteristics of PROFINET IO and IRT.....	5313
10.11.16	Media redundancy.....	5314
10.11.16.1	Restrictions with media redundancy.....	5314
10.11.16.2	Media redundancy.....	5315
10.11.16.3	Media Redundancy Protocol (MRP).....	5316
10.11.16.4	Configuring media redundancy for HMI devices .....	5317
10.11.16.5	Parameters for media redundancy.....	5319
10.11.16.6	Managing MRP domains.....	5320
10.11.17	Communication with other PLCs.....	5322
10.11.17.1	Communication with other PLCs.....	5322
10.11.17.2	Distinctive features when configuring.....	5323
10.11.17.3	Parallel communication .....	5323
10.11.17.4	Communication drivers.....	5325
10.11.17.5	Data exchange using area pointers.....	5446
10.11.18	Special features of WinAC MP.....	5461
10.11.18.1	WinAC MP basics.....	5461
10.11.18.2	Communication options with WinAC MP.....	5463
10.11.18.3	Standard procedure for communication with WinAC MP.....	5467
10.11.18.4	Configuring the WinAC MP communications driver.....	5468
10.11.18.5	Transferring WinAC MP to the HMI device.....	5479
10.11.18.6	Transferring authorization to the HMI device.....	5484
10.11.18.7	WinAC MP system library.....	5485
10.12	Using global functions.....	5486
10.12.1	HMI device wizard basics.....	5486
10.12.2	HMI device wizard basics.....	5487
10.12.3	Working with libraries.....	5488
10.12.3.1	Basics on libraries.....	5488
10.12.3.2	Overview of the library view.....	5490
10.12.3.3	Copy templates and types.....	5492
10.12.3.4	Libraries in WinCC.....	5493
10.12.3.5	Managing libraries.....	5494
10.12.3.6	Managing objects in a library.....	5499
10.12.3.7	Using types and their versions.....	5503
10.12.4	Importing and exporting project data.....	5506
10.12.4.1	Importing and exporting project data.....	5506
10.12.4.2	Importing and exporting recipes.....	5508
10.12.4.3	Importing and exporting alarms.....	5512
10.12.4.4	Importing and exporting tags.....	5519
10.12.4.5	Importing and exporting text lists.....	5525
10.12.5	Using cross-references.....	5529
10.12.5.1	General information about cross references.....	5529
10.12.5.2	Displaying the cross-reference list.....	5529
10.12.5.3	Structure of the cross-reference list.....	5530
10.12.5.4	Displaying cross-references in the Inspector window.....	5531
10.12.6	Managing languages.....	5533
10.12.6.1	Languages in WinCC.....	5533

10.12.6.2	Language settings in the operating system.....	5534
10.12.6.3	Operating system settings for Asian languages.....	5535
10.12.6.4	Setting project languages.....	5536
10.12.6.5	Creating one project in multiple languages.....	5539
10.12.6.6	Using language-specific graphics.....	5547
10.12.6.7	Languages in runtime.....	5551
10.12.6.8	Example of multilingual configuration.....	5558
10.12.7	Replacing devices.....	5561
10.12.7.1	Basics.....	5561
10.12.7.2	Device-specific functions.....	5562
10.12.7.3	Adjust screens to the new device.....	5567
10.12.7.4	Example: Replacing devices.....	5572
10.12.8	Copying between devices and editors.....	5576
10.12.8.1	Basics.....	5576
10.12.8.2	Copy and paste.....	5579
10.12.8.3	Copying between different RT and ES versions.....	5583
10.12.9	Using WinCC version compatibility.....	5585
10.12.9.1	Basics on version compatibility.....	5585
10.12.9.2	Editing projects of a previous WinCC version.....	5587
10.12.9.3	Upgrading projects.....	5588
10.12.9.4	Changing between device versions.....	5589
10.12.9.5	Changing the device version.....	5590
10.12.10	Viewing memory card data.....	5591
10.12.10.1	Basics.....	5591
10.12.10.2	Working with backups.....	5591
10.12.10.3	Working with HMI device images.....	5594
10.13	Compiling and loading.....	5599
10.13.1	Compiling and loading projects.....	5599
10.13.1.1	Overview of compiling and loading projects.....	5599
10.13.1.2	Compiling a project.....	5601
10.13.1.3	Loading projects.....	5602
10.13.1.4	Runtime start.....	5615
10.13.2	Simulating projects.....	5617
10.13.2.1	Simulation basics.....	5617
10.13.2.2	WinCC Runtime Advanced simulation.....	5618
10.13.2.3	Simulating a project.....	5619
10.13.2.4	Simulating a screen.....	5621
10.13.2.5	Working with the tag simulator.....	5621
10.13.2.6	Simulation restrictions.....	5623
10.13.2.7	Start debugger.....	5623
10.13.3	Servicing the HMI device.....	5624
10.13.3.1	Overview of HMI device maintenance (Basic Panels).....	5624
10.13.3.2	Overview of HMI device maintenance tasks (Basic Panels).....	5625
10.13.3.3	ProSave.....	5626
10.13.3.4	Backup of HMI data.....	5626
10.13.3.5	Backing up and restoring data of the HMI device.....	5628
10.13.3.6	Updating the operating system.....	5629
10.13.3.7	Updating the operating system on the HMI device.....	5630
10.13.3.8	Transferring license keys.....	5632
10.13.3.9	Managing licenses.....	5632
10.13.3.10	Installing and uninstalling an option.....	5634
10.13.4	Reference.....	5635

---

10.13.4.1	Error messages during the download of projects.....	5635
10.13.4.2	Adapting the project for another HMI device.....	5636
10.13.4.3	Establishing a connection to the HMI device.....	5638
10.14	Operating in Runtime.....	5639
10.14.1	Basics.....	5639
10.14.1.1	Overview.....	5639
10.14.1.2	System behavior.....	5640
10.14.2	Commissioning projects.....	5644
10.14.2.1	Runtime Advanced and Panels.....	5644
10.14.2.2	Settings for Runtime Advanced and Panels.....	5644
10.14.2.3	Loading a project.....	5647
10.14.2.4	Testing a project.....	5648
10.14.2.5	Backup and restoring projects.....	5649
10.14.2.6	Starting the project.....	5651
10.14.3	Operating projects.....	5651
10.14.3.1	Setting the project language.....	5651
10.14.3.2	Operating recipes.....	5652
10.14.3.3	Operating alarms.....	5681
10.14.3.4	Basics.....	5691
10.14.3.5	Project security.....	5708
10.15	Performance features.....	5727
10.15.1	Engineering system.....	5727
10.15.2	Basic Panel.....	5729
10.15.3	Panel.....	5732
10.15.4	Mobile Panel.....	5736
10.15.5	Multi Panel.....	5740
10.15.6	Comfort Panel.....	5744
10.15.7	WinCC Runtime Advanced.....	5749
10.15.8	General technical specifications.....	5752
10.15.8.1	Recommended printers.....	5752
10.15.8.2	Printing via print server.....	5753
10.15.8.3	Memory requirement of recipes.....	5754
10.15.8.4	Memory requirements of recipes for Basic Panels, OP 77A, and TP 177A.....	5755
10.16	Options.....	5757
10.16.1	Following GMP with Audit.....	5757
10.16.1.1	Basics.....	5757
10.16.1.2	Enabling GMP compliant configuration.....	5761
10.16.1.3	Using the Audit trail.....	5763
10.16.1.4	Configuring audit functions.....	5784
10.16.1.5	Performance features of GMP relevant configuration.....	5798
10.16.2	Sm@rt Options.....	5799
10.16.2.1	Basics.....	5799
10.16.2.2	Remote control via Sm@rtServer.....	5829
10.16.2.3	E-mail notification from runtime.....	5840
10.16.2.4	Display integrated Service-Pages.....	5844
10.16.2.5	Access via SIMATIC HMI HTTP Protocol.....	5856
10.16.2.6	Connection to the Office-world.....	5864
10.17	Interfaces.....	5869
10.17.1	Customer controls.....	5869
10.17.1.1	Overview.....	5869

10.17.1.2	Interfaces.....	5871
10.17.1.3	Demo project.....	5873
10.17.1.4	Creating and testing customer controls.....	5874
10.17.1.5	Reference.....	5883
10.17.2	OPC.....	5892
10.17.2.1	Basics.....	5892
10.17.2.2	Configuring an OPC server.....	5895
10.17.2.3	Configuring an OPC client.....	5897
10.17.2.4	Reference.....	5902
10.18	Migration to WinCC V12.....	5905
10.18.1	Overview of migration to WinCC V12.....	5905
10.18.2	WinCC flexible.....	5905
10.18.2.1	Libraries.....	5905
10.18.2.2	Screens and templates.....	5907
10.18.2.3	Scripts in faceplates.....	5909
10.18.2.4	Synchronization of recipes.....	5910
<b>11</b>	<b>Using technology functions.....</b>	<b>5913</b>
11.1	PID control.....	5913
11.1.1	Principles for control.....	5913
11.1.1.1	Controlled system and actuators.....	5913
11.1.1.2	Controlled systems.....	5914
11.1.1.3	Characteristic values of the control section.....	5916
11.1.1.4	Pulse controller.....	5918
11.1.1.5	Response to setpoint changes and disturbances.....	5922
11.1.1.6	Control Response at Different Feedback Structures.....	5923
11.1.1.7	Selection of the controller structure for specified controlled systems.....	5931
11.1.1.8	PID parameter settings.....	5932
11.1.2	Configuring a software controller.....	5932
11.1.2.1	Overview of software controller.....	5932
11.1.2.2	Steps for the configuration of a software controller.....	5934
11.1.2.3	Add technology objects.....	5934
11.1.2.4	Configure technology objects.....	5935
11.1.2.5	Call instruction in the user program.....	5936
11.1.2.6	Downloading technology objects to device.....	5937
11.1.2.7	Commissioning software controller.....	5938
11.1.2.8	Save optimized PID parameter in the project.....	5939
11.1.2.9	Comparing values.....	5939
11.1.2.10	Display instance DB of a technology object.....	5942
11.1.3	Using PID_Compact.....	5942
11.1.3.1	Technology object PID_Compact.....	5942
11.1.3.2	PID_Compact V2.....	5943
11.1.3.3	PID_Compact V1.....	5959
11.1.4	Using PID_3Step.....	5974
11.1.4.1	Technology object PID_3Step.....	5974
11.1.4.2	PID_3Step V2.....	5975
11.1.4.3	PID_3Step V1.....	5991
11.2	Using S7-1200 Motion Control.....	6008
11.2.1	Introduction.....	6008
11.2.1.1	Motion functionality of the CPU S7-1200.....	6008
11.2.1.2	Hardware components for motion control.....	6009



11.2.2	Basics for working with S7-1200 Motion Control.....	6012
11.2.2.1	CPU outputs relevant for motion control.....	6012
11.2.2.2	How the pulse interface works.....	6013
11.2.2.3	Relationship between the travel direction and voltage level at the direction output.....	6015
11.2.2.4	Hardware and software limit switches.....	6016
11.2.2.5	Jerk limit.....	6017
11.2.2.6	Homing.....	6018
11.2.3	Guidelines on use of motion control.....	6019
11.2.4	Overview of versions.....	6019
11.2.5	Techology object axis.....	6022
11.2.5.1	Integration of the axis technology object.....	6022
11.2.5.2	Tools of the axis technology object.....	6024
11.2.5.3	Add technological object Axis.....	6026
11.2.5.4	Configuring the axis technology object.....	6027
11.2.6	Technology object command table.....	6050
11.2.6.1	Use of the command table technology object.....	6050
11.2.6.2	Command table technology object tools.....	6050
11.2.6.3	Adding the technological object command table.....	6051
11.2.6.4	Configuring the command table technology object.....	6052
11.2.7	Download to CPU.....	6068
11.2.8	Commissioning the axis - Axis control panel.....	6069
11.2.9	Programming.....	6072
11.2.9.1	Overview of the Motion Control statements.....	6072
11.2.9.2	Creating a user program.....	6073
11.2.9.3	Programming notes.....	6076
11.2.9.4	Behavior of the Motion Control commands after POWER OFF and restart.....	6078
11.2.9.5	Monitoring active commands.....	6078
11.2.9.6	Error displays of the Motion Control statements.....	6090
11.2.10	Axis - Diagnostics.....	6091
11.2.10.1	Status and error bits.....	6091
11.2.10.2	Motion status.....	6093
11.2.10.3	Dynamics settings.....	6094
11.2.11	Working with watch tables.....	6094
11.2.12	Appendix.....	6095
11.2.12.1	Using multiple axes with the same PTO.....	6095
11.2.12.2	Using multiple drives with the same PTO.....	6099
11.2.12.3	Tracking jobs from higher priority classes (execution levels).....	6100
11.2.12.4	Special cases for use of software limit switches.....	6102
11.2.12.5	Reducing velocity for a short positioning duration.....	6109
11.2.12.6	Dynamic adjustment of start/stop velocity.....	6109
11.2.12.7	List of ErrorIDs and ErrorInfos (technology objects as of V2.0).....	6109
11.2.12.8	Tag of the Axis technology object.....	6118
11.2.12.9	Command table technology object tag.....	6133
11.2.12.10	Documentation for functions from previous versions.....	6134
<b>12</b>	<b>Using online and diagnostics functions.....</b>	<b>6143</b>
12.1	Displaying accessible devices.....	6143
12.2	Changing the device configuration online.....	6145
12.3	Connecting devices online.....	6146
12.3.1	General information about online mode.....	6146
12.3.2	View in online mode.....	6147

12.3.3	Establishing and canceling an online connection.....	6148
12.3.4	Connecting online with several devices.....	6150
12.3.5	Disconnecting online connections of multiple devices.....	6151
12.4	Backing up the software and hardware configuration of a device.....	6152
12.4.1	Creating a backup of a device.....	6152
12.4.2	Backing up a device configuration.....	6153
12.4.3	Restoring the software and hardware configuration of a device.....	6153
12.5	Configuring the PG/PC interface.....	6155
12.5.1	Online access.....	6155
12.5.2	Basics of assigning parameters for the PG/PC interface.....	6157
12.5.3	Displaying and modifying interface properties.....	6157
12.5.4	Adding interfaces.....	6158
12.5.5	Setting parameters for the Ethernet interface.....	6158
12.5.5.1	Setting parameters for the Industrial Ethernet interface.....	6158
12.5.5.2	Displaying operating system parameters.....	6159
12.5.5.3	Connecting the PG/PC interface to a subnet.....	6160
12.5.5.4	Setting parameters for the Ethernet interface.....	6160
12.5.5.5	Assigning a temporary IP address.....	6161
12.5.5.6	Managing temporary IP addresses.....	6162
12.5.5.7	Resetting the TCP/IP configuration.....	6162
12.5.6	Setting parameters for the MPI and PROFIBUS interfaces.....	6163
12.5.6.1	Setting parameters for the MPI and PROFIBUS interfaces.....	6163
12.5.6.2	Setting MPI or PROFIBUS interface parameters automatically.....	6164
12.5.6.3	Setting parameters for the MPI interface.....	6164
12.5.6.4	Setting parameters for the PROFIBUS interface.....	6166
12.5.6.5	Overview of the bus parameters for PROFIBUS.....	6169
12.5.6.6	Resetting the MPI or PROFIBUS configuration.....	6170
12.6	Using the trace and logic analyzer function.....	6171
	Preface.....	6171
12.6.1	Description.....	6172
12.6.1.1	Supported hardware.....	6172
12.6.1.2	Recording of measured values with the trace function.....	6172
12.6.1.3	Trace configuration, recording and measurement.....	6173
12.6.1.4	Data storage.....	6174
12.6.2	Software user interface.....	6175
12.6.2.1	Project navigator.....	6177
12.6.2.2	Working area.....	6177
12.6.2.3	Device-specific area.....	6185
12.6.3	Operation.....	6185
12.6.3.1	Quick start.....	6185
12.6.3.2	Using the trace function - overview.....	6190
12.6.3.3	Calling the trace editor.....	6190
12.6.3.4	Trace handling.....	6191
12.6.3.5	Signal table.....	6195
12.6.3.6	Curve diagram.....	6196
12.6.4	Devices.....	6197
12.6.4.1	S7-1200/1500 CPUs.....	6197
12.7	Establishing a remote connection with TeleService.....	6211
12.7.1	Basics of working with TeleService.....	6211
12.7.1.1	Introduction to TeleService.....	6211

12.7.1.2	TeleService functionality.....	6212
12.7.1.3	Telephone book at TeleService.....	6212
12.7.2	Working with the phone book.....	6213
12.7.2.1	Basics on working with the phone book.....	6213
12.7.2.2	Structure of the phone book.....	6214
12.7.2.3	Symbols in the phone book.....	6215
12.7.2.4	Manage phone book.....	6215
12.7.3	Remote connections as dial-up connections.....	6221
12.7.3.1	Basics for establishing a dial-up connection.....	6221
12.7.3.2	Telephone networks and modems.....	6222
12.7.3.3	Access protection for dial-up connections.....	6225
12.7.3.4	TS adapter MPI.....	6230
12.7.3.5	TS adapter IE.....	6237
12.7.3.6	Establishing a dial-up connection to a remote system.....	6243
12.7.4	Remote VPN connections.....	6245
12.7.4.1	Basics for establishing a VPN connection.....	6245
12.7.4.2	Basics of CA certificates.....	6246
12.7.4.3	Installing CA certificates for VPN connections.....	6248
12.7.4.4	Deleting CA certificates for VPN connections.....	6251
12.7.4.5	Establishing a VPN connection to a remote system.....	6251
12.7.4.6	TS Adapter IE Advanced.....	6253
12.7.5	CPU controlled TeleService remote connections .....	6258
12.7.5.1	Overview of CPU controlled remote connections.....	6258
12.7.5.2	Establishing a connection from and to remote systems (PG-AS-remote coupling).....	6259
12.7.5.3	Data exchange between remote systems (AS-AS-remote coupling).....	6260
12.7.5.4	Send SMS from a system.....	6262
12.7.5.5	Send an email from a system.....	6263
12.7.6	Notes on troubleshooting.....	6266
12.7.6.1	General information on troubleshooting for modem problems.....	6266
12.7.6.2	Recording a log file for the modem.....	6266
12.7.6.3	Dial-up connection to the TS Adapter is not established.....	6267
12.7.6.4	Dial-up connection from the TS Adapter is not established.....	6268
12.7.6.5	Modem connection is interrupted.....	6269
12.7.6.6	Checklist for troubleshooting the modem.....	6270
12.7.6.7	Modem alarms.....	6270
12.7.6.8	Possible error messages with VPN connections.....	6271
<b>13</b>	<b>Hardware documentation.....</b>	<b>6273</b>
13.1	General information on the hardware documentation.....	6273
13.2	HMI.....	6274
13.2.1	Basic Panels.....	6274
13.2.1.1	Basic Panels.....	6274
13.2.2	Panels.....	6274
13.2.2.1	Panels of the 70 series.....	6274
13.2.2.2	Panels of the 170 series.....	6274
13.2.2.3	Panels of the 270 series.....	6274
13.2.3	Comfort Panels.....	6274
13.2.3.1	Comfort Panels.....	6274
13.2.4	Multi Panels.....	6275
13.2.4.1	170 series.....	6275
13.2.4.2	270 series.....	6275
13.2.4.3	370 series.....	6275

13.2.5	Mobile Panels.....	6275
13.2.5.1	170 series.....	6275
13.2.5.2	270 series.....	6275
13.2.6	Key Panels.....	6275
13.2.6.1	Key Panels.....	6275
13.2.6.2	Push Button Panels.....	6276
13.2.7	WinAC for Multi Panels.....	6276
13.2.7.1	WinAC for Multi Panels.....	6276
13.3	PLC.....	6277
13.3.1	SIMATIC S7-1200.....	6277
13.3.1.1	CPU.....	6277
13.3.1.2	Signal boards (6ES7 2xx-xxx30-0XB0).....	6278
13.3.1.3	CB 1241 (6ES7 241-1CH30-1XB0).....	6278
13.3.1.4	BB 1297 (6ES7 297-0AX30-0XA0).....	6278
13.3.1.5	Digital input modules (6ES7 221-1Bx30-0XB0).....	6279
13.3.1.6	Digital output modules (6ES7 222-1xx30-0XB0).....	6279
13.3.1.7	Digital input and output modules (6ES7 223-1xx30-0XB0).....	6279
13.3.1.8	Analog input modules (6ES7 231-xxx30-0XB0).....	6280
13.3.1.9	Analog output modules (6ES7 234-4Hx30-0XB0).....	6280
13.3.1.10	Analog input and output module (6ES7 234-4HE30-0XB0).....	6280
13.3.1.11	Communications modules.....	6281
13.3.1.12	Technology modules.....	6283
13.4	Distributed I/O.....	6284
13.4.1	ET 200MP.....	6284
13.4.1.1	Interface modules.....	6284
13.4.2	ET 200SP.....	6284
13.4.2.1	Interface modules.....	6284
13.4.2.2	Digital input modules.....	6287
13.4.2.3	Digital output modules.....	6288
13.4.2.4	Analog input modules.....	6289
13.4.2.5	Analog output modules.....	6290
13.4.2.6	Communication modules.....	6291
13.4.2.7	Special modules.....	6291
13.4.2.8	Technology modules.....	6291
<b>Index</b> .....		<b>6293</b>

## System overview of STEP 7 and WinCC

### 1.1 Scaling of STEP 7 and WinCC

#### Scope of performance of the products

The following graphic shows the scope of performance of the individual products of STEP 7 and WinCC:

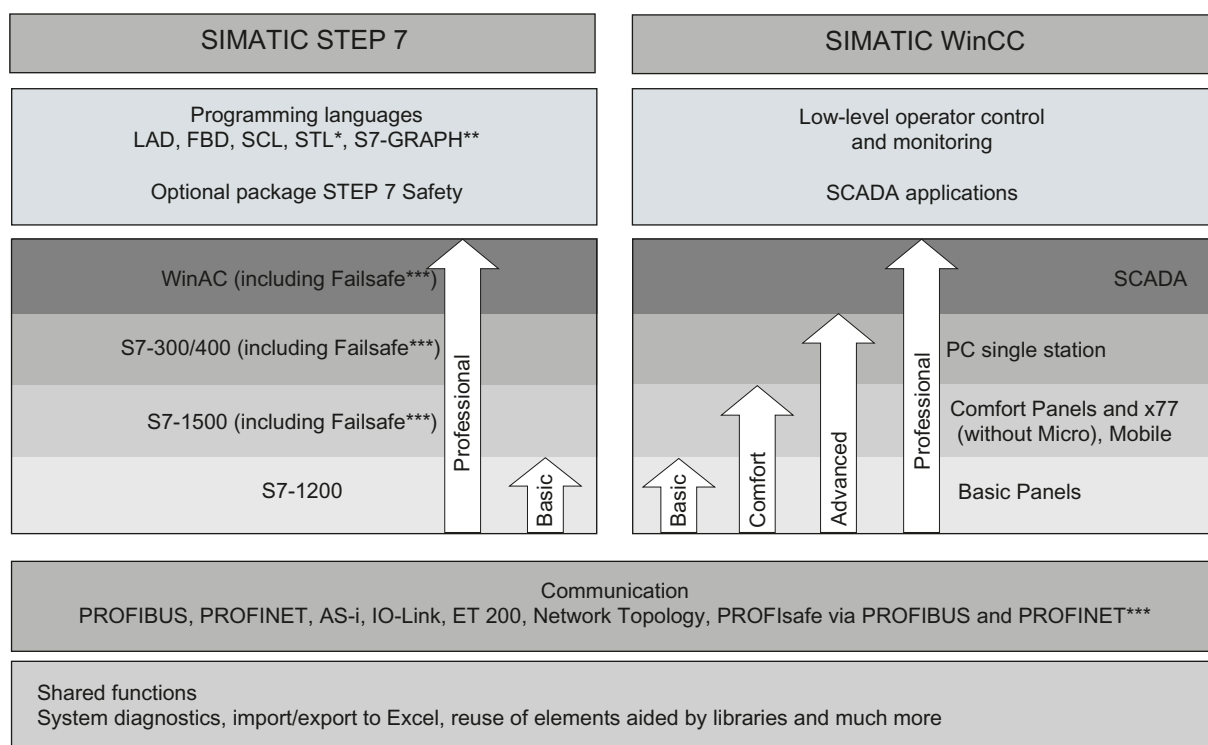

\* Only with Professional for S7-300/400/WinAC and S7-1500  
 \*\* Only with Professional for S7-300/400/WinAC  
 \*\*\* With installed optional package "STEP 7 Safety"

#### STEP 7

STEP 7 (TIA Portal) is the engineering software for configuring the SIMATIC S7-1200, S7-1500, S7-300/400 and WinAC controller families. STEP 7 (TIA Portal) is available in two editions, depending on the configurable controller families:

- STEP 7 Basic for configuring the S7-1200
- STEP 7 Professional for configuring S7-1200, S7-1500, S7-300/400 and WinAC

## WinCC

WinCC (TIA Portal) is an engineering software for configuring SIMATIC Panels, SIMATIC Industrial PCs, and Standard PCs with the WinCC Runtime Advanced or the SCADA System WinCC Runtime Professional visualization software.

WinCC (TIA Portal) is available in four editions, depending on the configurable operator control systems:

- WinCC Basic for configuring Basic Panels  
WinCC Basic is included with every STEP 7 Basic and STEP 7 Professional product.
- WinCC Comfort for configuring all panels (including Comfort Panels, Mobile Panels)
- WinCC Advanced for configuring all panels and PCs with the WinCC Runtime Advanced visualization software  
WinCC Runtime Advanced is a visualization software for PC-based single-station systems. WinCC Runtime Advanced can be purchased with licenses for 128, 512, 2k, 4k as well as 8k PowerTags (tags with a process interface).
- WinCC Professional for configuring panels and PCs with WinCC Runtime Advanced or SCADA System WinCC Runtime Professional. WinCC Professional is available in the following editions: WinCC Professional for 512 and 4096 PowerTags as well as "WinCC Professional max. PowerTags".  
WinCC Runtime Professional is a SCADA system for structuring a configuration ranging from single-station systems to multi-station systems including standard clients or web clients. WinCC Runtime Professional can be purchased with licenses for 128, 512, 2k, 4k, 8k, and 64k PowerTags (tags with a process interface).

With WinCC (TIA Portal), it is also possible to configure a SINUMERIK PC with WinCC Runtime Advanced or WinCC Runtime Professional and HMI devices with SINUMERIK HMI Pro sl RT or SINUMERIK Operate WinCC RT Basic.

## **1.2 Options for STEP 7 Engineering System**

### **Additional STEP 7 products**

For applications with increased safety requirements, STEP 7 Professional can be extended with the STEP 7 Safety option.

When using the STEP 7 Safety option, you can configure failsafe I/O and safety programs for F-CPU's in LAD and FBD.

## 1.3 Options for WinCC Engineering and Runtime systems

SIMATIC Panels as well as WinCC Runtime Advanced and WinCC Runtime Professional contain all essential functions for operator control and monitoring of machines or plants. Additional options allow you to extend the functionality in some cases to increase the range of available tasks.

### Options for Comfort Panels, Mobile Panels, Multi Panels

The following possible extensions are available for Comfort Panels, Mobile Panels, and Multi Panels:

- WinCC SmartServer (remote operation)
- WinCC Audit (audit trail and electronic signature for regulated applications)

---

#### Note

In contrast to WinCC flexible 2008, functions from the WinCC flexible /Sm@rtService, WinCC flexible /Sm@rtAccess options as well as the WinCC flexible /OPC Server option are incorporated into the basic functionality.

---

### Options for WinCC Runtime Advanced

The following possible extensions are available for WinCC Runtime Advanced:

- WinCC SmartServer (remote operation)
- WinCC Recipes (recipe system)
- WinCC Logging (logging of process values and alarms)
- WinCC Audit (audit trail for regulated applications)

---

#### Note

In contrast to WinCC flexible 2008, functions from the WinCC flexible /Sm@rtService, WinCC flexible /Sm@rtAccess options as well as the WinCC flexible /OPC Server option are incorporated into the basic functionality.

---

### Options for WinCC Runtime Professional

The following possible extensions are available for WinCC Runtime Professional:

- WinCC Client (standard client for structuring multi-station systems)
- WinCC Server (supplements WinCC Runtime to include server functionality)
- WinCC Recipes (recipe system, formerly WinCC /UserArchives)
- WinCC WebNavigator (Web-based operator control and monitoring)
- WinCC DataMonitor (display and evaluation of process states and historical data)



---

**Note**

In contrast to WinCC V7, functions from the WinCC /OPC-Server and WinCC /ConnectivityPack options are incorporated into the basic functionality. Likewise, the basic functionality includes the Runtime API from WinCC /ODK.

---

Beyond the Runtime options, WinCC Runtime Advanced and WinCC Runtime Professional can be enhanced with customer-specific controls. To develop controls, the WinCC ControlDevelopment option is required.



# Readme

## 2.1 General notes

### 2.1.1 General notes

The information in this readme file supersedes statements made in other documents.

Read the following notes carefully because they include important information for installation and use. Read these notes prior to installation.

### Functions for S7-1200 as of firmware version V4

In the information system for the TIA Portal V12 SP1, functions are documented for S7-1200 as of firmware version V4 which are not yet available in the software.

### Online operation in hibernate mode

We recommend that you do not use the two options "Hibernate" and "Sleep" in online operation; if you do, communication problems could occur. If necessary, adapt the computer's energy options.

### Opening a project for the first time in TIA Portal V12 SP1

If you are opening your project for the first time in TIA Portal V12 SP1, right-click on the CPUs used in the project view and then select "Compile > Software (rebuild all blocks)" from the shortcut menu.

### Installing new .Net versions or .Net service packs

- Close the TIA Portal before installing a new .Net version or a new .Net service pack on your programming device/PC.
- Restart the TIA Portal only after successful installation of the new .Net version or the new .Net service pack.

### Opening a project in TIA Portal V11

When you open a version V11 project in TIA Portal version 12, you can add components that were subsequently supplied for the version V11 within the context of a Hardware Support Package (HSP) to the project. The project is then still compatible with TIA Portal version 11. If you now open this project in TIA Portal version 11, but this TIA Portal application has not been upgraded with the corresponding HSP, the respective component will not be supported in the project.

### Notes on handling

- If a project in the list of projects last used is located on a network drive that is not connected, you may experience delays when opening the "Project" menu.
- When you insert a CPU, you may need to wait for some time if the project editor is open at the same time. This generally takes longer when you insert the first CPU in a newly created project. To be able to continue working more quickly, you should close the project editor before inserting a CPU.
- The alarm "Application is not responding" may appear in Windows 7 with functions that take a long time to run (loading the CPU for example). If this occurs, wait until the function has correctly finished.
- If you have installed a Microsoft mouse with IntelliPoint, you may find that it superimposes components over the buttons of the title bar. If this is the case, uninstall the IntelliPoint software from Microsoft.
- Enabling the "Virtual Desktop" options with NVIDIA graphics cards can cause problems. In this case, disable the "nView virtual desktop manager" of your NVIDIA graphics driver.

### Using the TIA Portal via a remote desktop

In principle, it is possible to use the TIA Portal via a remote desktop connection. During configuration, you should, however, avoid disconnecting the connection to the desktop client. In rare cases, this can lead to the software user interface being blocked.

If you experience this blockage, follow these steps on the desktop client.

1. Open the Windows Task-Manager and close the "rdpclip.exe" process.
2. Type in "rdpclip.exe" in the command prompt to restart the process.

Note that the current content of the clipboard will be lost. You can, however, then continue configuration as usual. To be on the safe side, you should restart the TIA Portal at the next opportunity.

### Opening the TIA Portal multiple times

If you are running several applications of the TIA Portal and they continually become active in turn, you can briefly switch to another application or use the key combination <ALT+Tab> to solve the problem.

### Note on SD cards

The SD cards have been formatted and set up by Siemens for use with S7-1200 and S7-1500 modules. This format must not be overwritten; otherwise, the card will no longer be accepted by the modules. Formatting with Windows tools is therefore not permitted.

### Behavior in case of open force job

Note that active force jobs is retained even after you have loaded a new project to the SD card. This means you should first delete the active force job before you remove an SD card from the CPU and before you overwrite the card in the PC with a new project. If you use an SD card with unknown content, you should format the SD card before the next download.

### Warnings on memory space with Windows XP (32-bit)

When you work with Windows XP (32-bit) for a long time, a memory space warning may appear which prompts you to save the current project and restart the TIA Portal. This can occur frequently in the case of an operating system with integrated graphics hardware. Disabling the graphics hardware acceleration may reduce the number of warnings. You can find the setting for this by clicking on the desktop and selecting "Properties > Settings > Advanced > Troubleshoot" by means of the right mouse button. In this dialog, move the "Hardware acceleration" slider to the far left (setting "None") and apply this setting.

### Problems while shutting down Windows XP

If you experience problems shutting down the computer, make sure that the TIA Portal has closed completely.

1. In the shortcut menu, select the Task Manager from the shortcut menu on the Taskbar.
2. If you see the process "Siemens.Automation.ObjectFrame.FileStorage.Server.exe" in the "Processes" tab, wait until this process has closed.
3. Then you can shut down the computer.

### Subnet addressing for CP 1613 and CP 1623

CP 1613 and CP 1623 are communication modules with microprocessor. To ensure secure management of communication links, these are processed on the module. The protocol stack in your PC is used for diagnostic purposes (SNMP, DCP). To allow both protocol stacks (i.e. CP 1613/23 Firmware and CP 1613/23 NDIS access) access to the same partners, is recommended to place both stacks of a module in the same subnet.

### Editing a device IP address

Do not use the address range from 192.168.x.241 to 192.168.x.250 when editing a device IP address. If necessary, this address range is automatically assigned by the system to a programming device. Depending on the subnet mask, this applies also for all network classes.

### Migrating projects with the TIA Portal

After the migration of hardware configurations and program blocks from earlier automation solutions, first check the functionality of the migrated project before you use it in productive operation.

### Working with TeleService

The TS Adapter IE Advanced is not available yet at the start of delivery of the TIA Portal V12 SP1. Remote connections can only be configured as VPN connections with the TIA Portal V12 SP1 after the start of delivery of the TS Adapter IE Advanced.

## 2.1 General notes

### Working with automatically synchronized network drives

Automatic synchronization after a network interruption can result in current (local) project data being stored as a "backup" on the network drive through user interactions. This could cause outdated project data to be loaded from the network drive when opening the project. For this reason, we do not recommend that you store TIA Portal projects on synchronized network drives.

If, however, you do work on synchronized drives, you can continue working locally in the event of a network interruption. In this case, you must always ensure that the TIA Portal application is closed while data is synchronized. The synchronization itself must be implemented in such a way that the current (local) project data replaces the project data on the network drive.

### Entry of decimal places

With certain Windows language settings, it may occur that the entry of values with a comma as decimal place is not recognized (entering "1,23" leads to an error). Instead, use the international format ("1.23").

### Access protection for memory cards in USB card readers

By improving the security mechanisms for online access and engineering of S7-1500 CPUs, the data storage on memory cards has been changed. For this reason, this version of STEP 7 cannot evaluate the passwords of the configured protection level when reading project data from memory cards that is accessed via a USB card reader. The changed behavior affects the memory cards for CPUs of the S7-1200/1500 series. Therefore, use physical safeguards to protect critical project data on memory cards for these devices.

---

#### Note

This restriction is not related to online access to devices or the know-how protection of program blocks.

---

### Screen display

After long periods of work, it can happen in the case of certain computer configurations with Windows XP that parts of the TIA Portal interface are no longer updated. Reducing the graphic hardware acceleration can correct this problem. You can find the setting for this by clicking on the desktop and selecting "Properties > Settings > Advanced > Troubleshoot" by means of the right mouse button. In this dialog, move the "Hardware acceleration" slider to the far left (setting "None") and apply this setting.

### Information on the TIA Portal in online support

Overview of the most relevant technical information and solutions for the TIA Portal in the industry online support.

Internet link: [Auto-Hotspot](#)

All information on service and support in the industry online support:

Internet link: [Auto-Hotspot](#)

Here, you can also subscribe to the newsletter that provides you with latest information relating to your products.

### Starting the TIA Portal

When you start the TIA Portal, Windows attempts to update the Certificate Revocation List (CRL) of "windowsupdate.com".

If no Internet connection is available and there are multiple DNS servers, a timeout may occur during the start of the TIA Portal.

### FAQs on the TIA Portal

FAQs on the TIA Portal are available at <http://support.automation.siemens.com>.

## 2.1.2 Notes on the installation

### Contents

Information that could not be included in the online help and important information about product characteristics.

### Using the same versions of TIA Portal products

The TIA Portal products STEP 7 (incl. PLCSIM), WinCC and Startdrive must be upgraded to the same version (V12 SP1). If the versions are different, you will no longer be able to start the TIA Portal. Even uninstalling a product will not restore an operational status. Please ensure that you have the service packs for these products to hand before you start the installation. You can download the service packs from the Internet under <http://support.automation.siemens.com> (<http://support.automation.siemens.com/WW/llisapi.dll?aktprim=99&lang=en&referer=%2fWW%2f&func=cslib.csinfo2&siteid=csius&extranet=standard&viewreg=WW&groupid=4000002>).

### Target directory of the installation

Do not use any UNICODE characters (for example, Chinese characters) in the installation path.

### Use of antivirus programs

During the installation, read and write access to already installed files is necessary. Some antivirus programs block this access. We therefore recommend that you disable antivirus programs during the installation of the TIA Portal and enable them again afterwards.

### Installation of STEP 7 Basic V12 and STEP 7 Professional V12 under Windows XP with Turkish regional and language options

Installation of STEP 7 Basic V12 and STEP 7 Professional V12 under Windows XP may be aborted if the regional and language options are set to Turkish. In this case change the regional and language options from Turkish to English or German.

1. Open the Control Panel under Windows with one of the following commands:
  - "Start > Control Panel" (Start menu under Windows XP)
  - "Start > Settings > Control Panel" (classic start menu)
2. Open the "Regional and Language Options".
3. Select the "Regional Options" tab.
4. Under "Standards and formats" select "German" or "English" in the drop-down list.
5. Click "Apply" and confirm with OK.
6. Restart your PC for the setting to become active. Now you can continue with the installation of STEP 7 Basic V12 and STEP 7 Professional V12.
7. After installation, you can revert the regional and language settings (as described in steps 1 to 4) to Turkish.

### Compatibility with V11

An empty V11.0.2.5 project with the name "TIA\_Portal\_Project\_V11.0.2.5.ap11" is installed in the installation directory under ..\Portal V12\SampleProjects in order to allow TIA Portal V12 to be opened in compatibility mode V11. This project must be copied to a local directory with full access before it can be used. For more information on this, refer to FAQ ID 66027369.

### Installation of Startdrive V12

A prerequisite for the installation of Startdrive V12 is that STEP 7 V12 is installed beforehand.

### Installation of the SIMATIC USB driver under Windows server 2003 R2 StdE SP2

An operating system alarm relating to the SIMATIC USB driver is issued on the operating system Windows Server 2003 R2 StdE SP2. This alarm must be acknowledged with "Yes" as soon as possible after the alarm has been issued. The alarm may be in the background and therefore may not be immediately visible. After a certain period of time, the setup continues with the next component. The SIMATIC USB drivers are then not installed and cannot be used.



## 2.2 STEP 7 Basic

### 2.2.1 Security information

#### Upgrades and updates

Siemens provides automation and drive products with industrial security functions that support the secure operation of plants or machines. They are an important component in a holistic industrial security concept. With this in mind, our products undergo continuous development. We therefore recommend that you keep yourself informed with respect to our product updates. Please find further information and newsletters on this subject at:

<http://support.automation.siemens.com> (<http://support.automation.siemens.com/WWW/llisapi.dll?aktprim=99&lang=en&referer=%2fWWW%2f&func=cslib.csinfo2&siteid=csius&extranet=standard&viewreg=WW&groupid=4000002>)

To ensure the secure operation of a plant or machine it is also necessary to take suitable preventive action (e.g. cell protection concept) and to integrate the automation and drive components into a state-of-the-art holistic industrial security concept for the entire plant or machine. Any third-party products that may be in use must also be taken into account. Please find further information at:

<http://www.siemens.com/industrialsecurity> (<http://www.industry.siemens.com/topics/global/en/industrial-security/Pages/Default.aspx>)

#### Network settings

The following tables show the network settings of each product you need to analyze the network security and to configure external firewalls:

STEP 7 Basic					
Name	Port number	Transport protocol	Direction	Function	Description
ALM	4410*	TCP	Inbound/ outbound	License service	This service provides the complete functionality for software licenses and is used by both the Automation License Manager as well as all license-related software products.
RFC 1006	102	TCP	Outbound	S7 communication	Communication to the S7 controller via Ethernet/PROFINET for programming and diagnostic purposes.
DCP	---	Ethernet	Outbound	PROFINET	The DCP protocol (Discovery and Basic Configuration Protocol) is used by PROFINET and provides the basic functionality for locating and configuring PROFINET devices.

2.2 STEP 7 Basic

STEP 7 Basic					
SNMP	161	UDP	Outbound	PROFINET	The SNMP client functionality is used by STEP 7 to read status information from PROFINET devices.
* Default port that can be changed by user configuration					

WinCC ES Basic (without simulation)					
Name	Port number	Transport protocol	Direction	Function	Description
ALM	4410*	TCP	Inbound/ outbound	License service	This service provides the complete functionality for software licenses and is used by both the Automation License Manager as well as all license-related software products.
HMI Load	1033	TCP	Outbound	HMI Load (RT Basic)	This service is used to transmit images and configuration data to Basic Panels.
* Default port that can be changed by user configuration					

Simulation RT Basic					
Name	Port number	Transport protocol	Direction	Function	Description
HMI Load	1033	TCP	Inbound	HMI Load (RT Basic)	This service is used to transmit images and configuration data to Basic Panels.
Ethernet/ IP	44818	TCP	Outbound	Ethernet/IP channel	The Ethernet/IP protocol is used for connections to Allen Bradley PLCs.
	2222	UDP	Inbound	Ethernet/IP channel	The Ethernet/IP protocol is used for connections to Allen Bradley PLCs.
Modbus TCP	502	TCP	Outbound	Modbus TCP channel	The Modbus TCP protocol is used for connections to Schneider PLCs.
RFC 1006	102	TCP	Outbound	S7 channel	Communication to the S7 controller via Ethernet/PROFINET
Mitsubishi MC	5002	TCP	Outbound	Mitsubishi MC channel	The Mitsubishi protocol is used for connections to Mitsubishi PLCs.

2.2.2 Notes on use

Contents

Information that could not be included in the online help and important information about product characteristics.

## Online operation

The simultaneous online operation of STEP 7 V5.5 or earlier and STEP 7 Basic V12 has not been approved.

## Simultaneous online connections on an S7-1200 CPU

It is not possible to establish an online connection from multiple TIA Portal instances simultaneously to the same S7-1200 CPU.

## Configuring and assigning module parameters

You will find an overview of the modules that can be configured and assigned parameters with STEP 7 Basic V12 at <http://support.automation.siemens.com> (<http://support.automation.siemens.com/WW/view/en/28919804/133000>).

## Removing/inserting the memory card

After removing or inserting a memory card, always perform a memory reset on the CPU in order to restore the CPU to a functional condition.

## Removing and inserting Ethernet modules

If Ethernet modules are removed and re-inserted during operation, you must boot the PC; otherwise, the "Accessible devices" functionality in STEP 7 or NCM PC will not display all devices. While the PC boots, Ethernet modules must be activated.

## Notes on the information system

The following function has already been described in the information system, but is not available in STEP 7 Basic V12 SP1:

- Loading hardware configurations from the target system to the PG/PC.

## Comparing project data

The comparison functions (online/offline, offline/offline) currently do not take hardware into consideration.

## Loading project data with TIA Portal V11 and V12 (S7-1200)

If you load the project data of an S7-1200 CPU with the TIA Portal V12, you can no longer use TIA Portal V11 to access this data. To do this, first restore the factory settings of the CPU. Read the additional information on this in the online help under "How to reset a CPU to factory settings".

### Activating ENO enable output

As of STEP 7 TIA Portal V12.0, the ENO enable output is disabled by default in the programming languages LAD and FBD and the ENO parameter is shown grayed out. If needed, you can activate the enable output and thereby specifically control the instructions for which you want to have error evaluation.

To activate the ENO enable output of an instruction, follow these steps:

1. In your program, right-click the instruction for which you want to activate the ENO enable output.
2. Select the "Generate ENO" command from the shortcut menu.  
The ENO value is generated for the instruction and the color of the ENO parameter changes from gray to black.  
Additional instructions are inserted with the enable output.

### Compatibility

The device configuration and program of an S7-1200 CPU must always be configured with the same STEP 7 version. Usually, the TIA Portal makes sure that no version conflicts occur by outputting appropriate notifications during loading to the device.

This automatic verification is not possible with S7-1200 CPUs with firmware version V1.x. In this case, users themselves must ensure that no version conflicts occur.

## 2.2.3 Editing devices and networks

### 2.2.3.1 General information on devices and networks

#### Contents

Currently, there is no general information available on devices and networks.

### 2.2.3.2 Use of modules on the S7-1200

#### Contents

Information that could not be included in the online help and important information about product characteristics.

## Use of modules on the S7-1200

The modules listed below are not supported on the S7-1200.

Family	Module	Order number
S7-300 FMs	SM 338	6ES7 338-4BC01-0AB0
	FM 350-1	6ES7 350-1AH03-0AE0
	FM 350-2	6ES7 350-2AH00-0AE0, 6ES7 350-2AH01-0AE0
	FM 351	6ES7 351-1AH01-0AE0, 6ES7 351-1AH02-0AE0
	FM 352	6ES7 352-1AH02-0AE0
	FM 355 S	6ES7 355-1VH10-0AE0
	FM 355 C	6ES7 355-0VH10-0AE0
	FM 355-2 C	6ES7 355-2CH00-0AE0
	FM 355-2 S	6ES7 355-2SH00-0AE0
S7-300 PtP-CP	CP 340	6ES7 340-1AH02-0AE0, 6ES7 340-1BH02-0AE0, 6ES7 340-1CH02-0AE0
	CP 341	6ES7 341-1AH01-0AE0, 6ES7 341-1AH02-0AE0, 6ES7 341-1BH01-0AE0, 6ES7 341-1BH02-0AE0, 6ES7 341-1CH01-0AE0, 6ES7 341-1CH02-0AE0
Network component	Diagnostics repeater	6ES7 972-0AB01-0XA0
ET 200S	1 Count 24 V	6ES7 138-4DA04-0AB0
	1 Count 5 V	6ES7 138-4DE02-0AB0
	1 Step 5 V	6ES7 138-4DC00-0AB0, 6ES7 138-4DC01-0AB0
	2 pulses	6ES7 138-4DD00-0AB0, 6ES7 138-4DD01-0AB0
	1 SI	6ES7 138-4DF01-0AB0
	1 SI Modbus	6ES7 138-4DF11-0AB0
	1 SSI	6ES7 138-4DB02-0AB0, 6ES7 138-4DB03-0AB0
	1 Pos Universal	6ES7 138-4DL00-0AB0
	SIWAREX	7MH4910-0AA01, 7MH4912-0AA01, 7MH4920-0AA01
ET 200M	SIWAREX	7MH4 900-2AA01, 7MH4 900-3AA01, 7MH4 950-1AA01, 7MH4 950-2AA01

### 2.2.3.3 Replacing ET 200S positioning modules

#### Contents

Information that could not be included in the online help and important information about product characteristics.

#### Replacing ET 200S positioning modules

This information relates to the positioning module "1 Step 5V" (6ES7 138-4DC00-0AB0) from a project which was created with TIA Portal V11.0. When replacing these modules from the TIA Portal V11.0 with a new version of these modules, the parameter settings are reset to the default values.

This is the case with one of the following procedures:

- Replace the positioning module 6ES7 138-4DC00-0AB0 with its successor module 6ES7 138-4DC01-0AB0 by means of a device exchange.
- Updating the module version using the appropriate button in the device properties in the Inspector window.

#### 2.2.3.4 CP 343-2 on SIMATIC S7 Embedded Controller EC31-RTX

##### Contents

Information that could not be included in the online help and important information about product characteristics.

#### CP 343-2 on SIMATIC S7 Embedded Controller EC31-RTX

The module AS-Interface CP 343-2 (order no.: 6GK7 343-2AH01) can be inserted in an expansion rack of the SIMATIC S7 Embedded Controller EC31-RTX (order no.: 6ES7 677-1DDxx-0BB0), but the CP 343-2 cannot be operated with the EC31-RTX.

#### 2.2.3.5 Notes on online and diagnostics

##### Contents

Information that could not be included in the online help and important information about product characteristics.

#### Hardware detection followed by online connection

When the "Online > Hardware detection" command is performed for an unspecified CPU, the online configuration is not loaded from the CPU. If you do not load the configuration resulting from the hardware detection to the CPU, the device and network views will always show a difference between the offline and online configurations. It will appear that there are different configurations in the online and diagnostic views, although the MLFBs are identical in the actual CPU and the offline CPU.

### 2.2.3.6 Network components

#### Network components

#### CP 1242-7

#### Copying the CP 1242-7 into another project

If you copy a CP 1242-7 from one project into another project, the following parameters in the parameter group "CP identification" are changed on the target station:

- Project number of the CP
- Station number of the CP

#### Download to device

Only use the "Download to device" function with the CP 1242-7 via a TeleService connection as follows:

1. Select the CP in STEP 7.
2. Select the "Online" > "Download to device" menu.
3. In the "Extended download" dialog that appears, select the TeleService interface.
4. Download the project data from the "Extended download" dialog.

#### Upload from device

The function "Upload from device" is not supported by the CP 1242-7.

#### SCALANCE X

#### SCALANCE XR500 as IO device: "Compile" and "Download to device"

With a SCALANCE XR500 configured as a PROFINET IO device and assigned to an IO controller, the functions "Compile" and "Download to device" only download the data to the switch that can also be configured in Web Based Management (WBM) (layer 2, layer 3, system, security).

If you want to use the "Compile" or "Download to device" functions for the PROFINET IO device data of the XR500, first select the assigned IO controller.

### Using a link aggregation in an MSTP instance

If you want to use a link aggregation in an MSTP instance, follow the steps below during configuration:

1. Create a link aggregation in "Layer 2" > "Link Aggregation".
2. Create an MSTP instance in "Layer 2" > "MSTP" > "MST General".
3. Configure the link aggregation in "Layer 2" > "MSTP" > "MST Port".

### Automatic activation of MRP in redundant topologies

If you connect SCALANCE X switches with redundant network structures in the topology view, MRP is activated automatically on the switches involved.

If there is an existing configuration with other redundancy mechanisms, such as MSTP, this is automatically deactivated.

## 2.2.4 Programming a PLC

### 2.2.4.1 General notes on PLC programming

#### Contents

Information that could not be included in the online help and important information about product characteristics.

#### Loading inconsistent programs to a device

In TIA Portal, it is not possible to download inconsistent programs to a device without a consistency check. During the loading process, all blocks of the program are implicitly checked and are compiled again in the event of inconsistencies. If, however, there are programs on your CPU which were loaded with earlier versions of STEP 7, these programs could demonstrate inconsistencies.

In this case, note the following:

If you load an inconsistent program from a device, you will not be able to load the program unchanged to the device afterwards, because a consistency check always takes place during the loading process and existing inconsistencies are corrected.

#### Process image of PTO/PWM outputs

Do not use PTO/PWM outputs in the process image (for example, for access in the user program, for online functions or in HMI). The update rate of the process image is much slower than the rate of the signal changes. The display in the process image therefore does not reflect the signal flow.



### Monitoring blocks in LAD and FBD

If the start of the current path is outside the visible range, it may not be possible to determine the input value. In this case, the current path is shown grayed out.

### Avoid using PLC data types generated by the system in libraries

Some instructions generate their own PLC data types during instancing which are saved in the "PLC data types" project folder. However, you should not use these system-generated PLC data types in any library, because they may be recreated by the system at any time and may result in an unfavorable system behavior.

### Using global data blocks in assignments

It is not possible to assign the contents of a global data block to a structurally identical data block, e.g. using a move box.

### Conversion of know-how protected blocks from V10.5

The program must be compiled after conversion from previous STEP 7 versions (e.g., STEP 7 V10.5). If you are using know-how protected blocks, you are prompted to enter the password.

## 2.2.4.2 Instructions

### Contents

Information that could not be included in the online help and important information about product characteristics.

### Use of instructions (S7-1200)

If a parameter-specific error occurs with instructions which represent a system function (SFC) or system function block (SFB), no error code is output at parameter RET\_VAL. RET\_VAL is invalid in this case. You have a number of different options for responding to these errors, depending on the CPU used.

### Instruction "TRCV\_C: Receive data via Ethernet"

Contrary to the information provided in the online help, the communication connection is terminated immediately, and not after sending data, when the CONT parameter is set to the value "0".

### Instruction "T\_CONFIG: Configure interface"

The CPU is restarted after you have executed the "Configure interface" instruction in order to change an IP parameter. The CPU goes to STOP mode, a warm restart is carried out and the CPU starts up again (RUN mode). Make sure that the control process is in a secure operating mode after the CPU has been restarted following execution of the "Configure interface"

instruction. Uncontrolled operation can result in serious material damage or personal injury due to malfunctions or programming errors, for example. Non-retentive data could be lost.

Parameters ERROR and STATUS

ERROR	STATUS (DW#16#..)	ERR_LOC	Explanation
0	00000000	0	After the instruction has been executed successfully, the STATUS parameter "00000000" does not return any value.

### Instruction "GET\_DIAG: Read diagnostics information"

MODE 3 at the MODE parameter is not supported by the S7-1200 CPU.

### Using instructions with parameters of type VARIANT in code blocks with different access types (S7-1200)

Code blocks (FBs/FCs) and data blocks (DBs) can be created with different access types ("standard" and "optimized"). In code blocks, you can call any instructions. Certain instructions (for example, "WRIT\_DBL" and "READ\_DBL") use pointers of type VARIANT at input and output parameters to address data blocks.

Ensure that you do not use these instructions in programs in which code blocks of different access types are called reciprocally. This could cause the following to occur:

- A structure from a standard data block is directly or indirectly passed to an optimized code block, which forwards this structure directly or indirectly to one of the blocks mentioned above.
- The reverse scenario, whereby a structure from an optimized code block is directly or indirectly passed to a standard data block, which forwards this structure directly or indirectly to one of the blocks mentioned above.

#### 2.2.4.3 Testing the user program

##### Testing with the watch table

##### Contents

Information that could not be included in the online help and important information about product characteristics.

##### Multiple access to the same CPU

Access to a CPU from a PG/PC is permitted only when a TIA Portal is open. Multiple access to the same CPU is not permitted and can lead to errors.

## Loading data blocks during an active control job

---

### Note

Loading changed data blocks during an active control job can result in unforeseen operating states. The control job continues to control the specified address, although the address allocation may have changed in the data block. Complete active control jobs before loading data blocks.

---

## Testing programs converted from STEP 7 V10.5.

To monitor and test a program converted from STEP 7 V10.5, you have to first compile and load with STEP 7 V11.0.

## "Enable peripheral outputs" function

In TIA Portal V12.0, the function "Enable peripheral outputs" is not available for CPUs from the S7-1500 series.

This function can only be carried out with an S7-300, S7-400 or S7-1200 CPU in TIA Portal V12.0.

## Testing with the force table

## Contents

Information that could not be included in the online help and important information about product characteristics.

## Forcing tags for direct I/O access

If you use direct I/O access for an S7-300 CPU in your user program, forcing this I/O address is not permitted.

## Example

If I/O access to the address "IB0:P" takes place in the user program, it is not permitted to force the following I/O address areas: IO.0:P, IB0:P, IW0:P and ID0:P.

## 2.2.5 Technological functions

### 2.2.5.1 Notes on technological functions

There are no notes about the technology functions.

## 2.3 WinCC Advanced

### 2.3.1 Security information

#### Security information

Siemens provides automation and drive products with industrial security functions that support the secure operation of plants or machines. They are an important component in a holistic industrial security concept. With this in mind, our products undergo continuous development. We therefore recommend that you keep yourself informed with respect to our product updates. Please find further information and newsletters on this subject at:

<http://support.automation.siemens.com> (<http://support.automation.siemens.com>)

To ensure the secure operation of a plant or machine it is also necessary to take suitable preventive action (e.g. cell protection concept) and to integrate the automation and drive components into a state-of-the-art holistic industrial security concept for the entire plant or machine. Any third-party products that may be in use must also be taken into account. Please find further information at:

<http://www.siemens.com/industrialsecurity> (<http://support.automation.siemens.com>)

#### Passwords

Various passwords are set by default in WinCC. For security reasons, you should change these passwords.

- The default password for the Sm@rtServer and for the integrated Web server is "100".
- For the user "Administrator", the default password is "administrator".

#### Integrated Web server

It is always possible on a PC to access HTML pages in Runtime, even though the option "HTML pages" is disabled. Setup always installs the standard pages of the Web Server on the PC. Assign an administrator password to prevent unauthorized access to the pages.

#### Communication via Ethernet

In Ethernet-based communication, end users themselves are responsible for the security of their data network. The proper functioning of the device cannot be guaranteed in all circumstances; targeted attacks, for example, can lead to overload of the device.

#### Ending Runtime automatically

If automatic transfer is enabled on the HMI device and a transfer is started on the configuration PC, the running project is automatically stopped.

The HMI device then switches autonomously to "Transfer" mode.

After the commissioning phase, disable the automatic transfer function to prevent the HMI device from switching inadvertently to transfer mode.

Transfer mode can cause undesired reactions in the system.

To block access to the transfer settings and thus avoid unauthorized changes, assign a password in the Control Panel.

## Network settings

The following tables show the network settings of each product which you need in order to analyze the network security and for the configuration of external firewalls:

WinCC Advanced (without simulation)					
Name	Port number	Transport protocol	Direction	Function	Description
ALM	4410*	TCP	Inbound, Outbound	License service	This service provides the complete functionality for software licenses and is used by both the Automation License Manager as well as all license-related software products.
HMI Load	1033	TCP	Outbound	HMI Load (RT Basic)	This service is used to transmit images and configuration data to Basic Panels.
HMI Load	2308	TCP	Outbound	HMI Load (RT Advanced)	This service is used to transmit images and configuration data to Panels.

\* Default port that can be changed by user configuration

WinCC Simulation for Basic Panels					
Name	Port number	Transport protocol	Direction	Function	Description
HMI Load	1033	TCP	Inbound	HMI Load (RT Basic)	This service is used to transmit images and configuration data to Basic Panels.
EtherNet/IP	44818	TCP	Outbound	Ethernet/IP channel	The Ethernet/IP protocol is used for connections to Allen Bradley PLCs.
	2222	UDP	Inbound	Ethernet/IP channel	The Ethernet/IP protocol is used for connections to Allen Bradley PLCs.
Modbus TCP	502	TCP	Outbound	Modbus TCP channel	The Modbus TCP protocol is used for connections to Schneider PLCs.
RFC 1006	102	TCP	Outbound	S7 channel	Communication with the S7 controller via Ethernet/PROFINET
Mitsubishi MC	5002	TCP	Outbound	Mitsubishi MC channel	The Mitsubishi protocol is used for connections to Mitsubishi PLCs.

WinCC Simulation for Panels and Runtime Advanced					
Name	Port number	Transport protocol	Direction	Function	Description
DCP	---	Ethernet	Outbound	PROFINET	The DCP protocol (Discovery and Basic Configuration Protocol) is used by PROFINET and provides the basic functionality for locating and configuring PROFINET devices.
LLDP	---	Ethernet	Inbound, Outbound	PROFINET	The LLDP protocol (Link Layer Discover Protocol) is used by PROFINET for topology detection.
SMTP	25	TCP	Outbound	SMTP Communication	This service is used by WinCC Runtime Advanced to send e-mails.
HTTP	80*	TCP	Inbound	Sm@rtServer	The Web server is only available when Sm@rtService is activated. The used port may differ depending on automatically selected settings.
RFC 1006	102	TCP	Outbound	S7 channel	Communication with the S7 controller via Ethernet/PROFINET
NTP	123	UDP	Outbound	Time-of-day synchronization	The NTP protocol (Network Time Protocol) is used for time-of-day synchronization in IP-based networks.
SNMP	161	UDP	Outbound	PROFINET	The SNMP client functionality is used by STEP 7 to read status information from PROFINET devices.
HMI Load	2308	TCP	Outbound	HMI Load (RT Advanced)	This service is used to transmit images and configuration data to Panels.
HTTPS	443*	TCP	Inbound	Sm@rtServer	The Web server with HTTPS protocol is only available when Sm@rtService is activated. The used port may differ depending on automatically selected settings.
VNC server	5900*	TCP	Inbound	Sm@rtServer	This service is only available when Sm@rtService is activated.
	5800*	TCP	Inbound	Sm@rtServer	This service is only available when Sm@rtService is activated.
VNC client	5500	TCP	Outbound	Sm@rtServer	This service is only available when Sm@rtService is activated.

\* Default port that can be changed by user configuration

**See also**

<http://www.siemens.com/industrialsecurity> (<http://www.industry.siemens.com/topics/global/en/industrial-security/Pages/Default.aspx>)

## 2.3.2 Notes on use

### Contents

Information that could not be included in the online help and important information about product features.

### Copying HMI devices with HMI connections

If you copy an HMI device with HMI connections to a PLC, the HMI connection in the new HMI device is not automatically connected to an existing PLC with the same name. This applies to copying within a project as well as copying across projects.

To access the PLC tag via HMI tag in the new HMI device, you have to complete the HMI configuration immediately after copying. Proceed as follows:

1. Open the "Devices & Networks" editor.
2. Connect the new HMI device to the desired network.
3. Open the connection table.
4. Select the HMI connection of the new HMI device.
5. Select the desired PLC under "Partner".

If you compile the new HMI device or connect additional PLC tags in between copying the HMI device and completing the connection, there may be some instances in which an additional HMI connection to the same PLC is created. This is especially true if you connect HMI tags with DB array elements.

### Device replacement

After an HMI device has been replaced, you should check the appearance of the configured screens. Changing the size of the display may result in changes to the position and appearance of screen objects, e.g. recipe view and alarm view.

### Device replacement - communication

If an HMI device is replaced, error messages of the type "... is not supported in the new configuration and will therefore be removed" may be generated. These alarms refer to configured connections of the device and are triggered, for example, if the HMI devices have a different number of interfaces. These connections are marked red after a device replacement. If you would like to continue to use these connections, you have change the configuration of the connection. Proceed as follows:

1. Open the "Devices and Networks" editor.
2. Click "Network" in the toolbar of the network view.
3. Network the interface of the HMI device with the interface of the CPU.
4. Click in the table area of the network view on the "Connections" table.

5. Select the connection marked red.
6. Enter the new interface under "Properties > General > Interface" in the Inspector window.

### Specifying the time of modification in the overview window

The times of modification displayed in the overview window only refer to changes to the object itself. Changes to subordinate objects, e.g. screen objects in a screen, do not cause the time of the last change to the screen to change in the overview window.

### HMI device wizard

When you create a device with a color display using the HMI device wizard, the graphics of the navigation buttons may be displayed in black and white. This error only occurs, however, if the new device is created with the same name as a device with a monochrome display which has been deleted in the meantime.

You can avoid this error by always deleting the associated graphics in the Graphics collection whenever you delete a device from the project.

### Objects with object references in the project library

Two copying methods can be used in WinCC flexible.

- With "simple copy" a WinCC flexible screen including an IO field, for example is copied. Only the object name of a tag configured on the IO field is copied, as this is a reference.
- With "copy", a screen, an IO field contained there and a tag configured on the IO field together with its properties are copied.

These two methods can also be used for storing an object in a library. Project libraries and the objects contained there are migrated during migration and can be used in WinCC.

In WinCC, however, only one copying method is available. With regard to tags, it functions like "simple copy" in WinCC flexible. With regard to graphics, graphics lists and text lists, it functions like "copy" in WinCC flexible.

If you stored objects with references to tags in a library in WinCC flexible, you must reconfigure the referenced objects when using them in WinCC.

### Reports with Asian character sets on Windows CE devices

If Asian characters sets are displayed in an illegible manner in a report on a Windows CE device, you must change the character sets for the objects in the report. It is sufficient to change to a different character set and then reset the original character set.

### License transfer via S7USB

You always need to run WinCC to transfer a license to a panel via S7USB.



### Transferring licenses to a panel on 64-bit operating systems

If you are running a 64-bit operating system and the "Edit > Connect target systems > Connect HMI device" menu command is not available in Automation License Manager, open command line input and run the following command with administrator rights:

```
"%WINDIR%\system32\RegSvr32.exe" "%CommonProgramFiles%\siemens\AlmPanelPlugin\ALMPanelParam.dll"
```

### Installation sequence for Startdrive

When you install Startdrive on a PC, adhere to the following installation sequence:

- Install STEP7 V12.0.
- Install Startdrive.

### SIMOTION

SIMOTION is not supported with WinCC V12 SP1.

### Security settings during installation

When you install WinCC V12, security settings are changed in your operating system.

The security settings in question are listed during the installation.

You must confirm the changes to the security settings.

If you make changes to your operating system after the installation, the changes to the security settings made by the installation of the TIA Portal could be changed.

You can restore the changes to the security settings made by the installation of the TIA Portal:

"Start > All Programs > Siemens Automation > Security Controller > Restore settings"

### SQL instance of WinCC V12

If you have installed a WinCC V11 product and you wish to install a WinCC V12 product, you must uninstall all WinCC V11 products and the WinCC instance of SQL Server 2005 one after the other before the installation.

A new WinCC SQL 2008 instance is installed with the installation of WinCC V12.

## 2.3.3 Migration

### Contents

Information that could not be included in the online help and important information about product features.

### Changing the names of alarm classes

In contrast to WinCC flexible, the names of the predefined alarm classes are not dependent on the user interface language currently in use. During migration, the names of the alarm classes are assigned as follows:

WinCC flexible	WinCC
Error	Errors
System	System
Warnings	Warnings

The display names of the alarm classes can be changed as necessary after migration.

### Project languages in WinCC

WinCC V12 does not support all project languages that were available in WinCC flexible, such as Arabic. If you receive an empty project as the result of your migration, you may want to check the set editing language. Do not set the project languages that are not supported as editing language in the source project. Proceed as follows:

1. Open the project with WinCC flexible.
2. Change the editing language to English, for example.
3. Save the project.
4. Restart the migration.

### Objects with object references in the project library

Two copying methods can be used in WinCC flexible.

- With "simple copy", a WinCC flexible screen including an IO field, for example, is copied. Only the object name of a tag configured on the IO field is copied, as this is a reference.
- With "copy", a screen, an IO field contained there and a tag configured on the IO field together with its properties are copied.

These two methods can also be used for storing an object in a library. Project libraries and the objects contained there are migrated during migration and can be used in WinCC.

In WinCC, however, only one copying method is available. It functions like "simple copy" in WinCC flexible.

If you have stored objects with references to other objects in a library in WinCC flexible, you must reconfigure the referenced objects when using them in WinCC.

### Migrating an integrated project with ProTool objects

The "PROTOOL option package(s) missing in STEP 7" error message output during migration of a WinCC flexible project that is integrated in STEP 7 indicates that WinCC flexible 2008 SP3 is installed on your system. Moreover, the project still contains objects that were configured using ProTool. Do not open the project with WinCC flexible 2008 SP3! Proceed as follows to migrate the project:

1. Copy the project to a computer on which WinCC flexible 2008 SP2 and STEP 7 are installed.
2. Open the project in the SIMATIC Manager.
3. Remove all ProTool objects from the project.
4. Execute the "Save as" command in the "File" menu.
5. Activate the option "With reorganization" in the "Save project as" dialog.
6. Click OK.
7. Copy the project back to the original computer.
8. Restart the migration.

### Migrating a WinCC V7 project with "Chinese (Taiwan)" Runtime language

If your WinCC is installed with support for the "Chinese" user interface language, the texts and report layouts of the "Chinese (Taiwan)" Runtime language will not be included when you migrate WinCC V7 projects. Migrate such projects using the Migration Tool, or a PC that contains a WinCC setup without "Chinese" user interface language.

### Progress bar

As long as the progress bar still shows a value of 100 %, the software is still busy running remaining tasks such as the closing of references. The software will not respond to user input while this status is given.

### Principle

When you open a V11 project with a V12 version, it will no longer be possible to open this project with an older version afterwards.

### Managing third-party ActiveX controls

The migration also supports third-party ActiveX controls. However, the controls must be registered in the operating system. If an ActiveX control is not registered, migration is canceled.

If you save a project with the migration tool and perform the migration yourself on another PC, the controls must also be registered on this PC.

### Language switching in RT

Upgrading the project from V11 to V12 and migration of WinCC V7.0 SP3 to V12:

If you have used a script to program a language change to Chinese (PRC) in V11 or V7.0 SP3 with LCID, language switching to Chinese (PRC) in runtime no longer works after upgrading or migrating.

Change the LCID in script from "1028" to "2052".

### Migrating integrated projects with alarm views

An alarm view is enabled with all alarm classes in an integrated project. The alarm classes are disabled during migration of the project.

Once the migration of the project is completed, check the settings in the alarm view.

Enable the require alarm classes in the Inspector window of the alarm view if needed under "Properties > General".

### Migrating projects from WinCC V7

We recommend a 64-bit operating system for the migration of extensive projects from WinCC V7.0 SP3.

### See also

Object support during migration

## 2.3.4 Special considerations for Windows 7

### Contents

Information that could not be included in the online help and important information about product characteristics.

### Permission for the starting Runtime

To start WinCC Runtime Professional or WinCC Runtime Advanced, a user must be a member of the automatically created group, "Siemens TIA Engineer".

### Working with standard user rights

If you are working with standard user rights in Windows 7, "User Account Control (UAC)" cannot be disabled.

The "User Account Control" is enabled in Windows 7 by default.

For more information on the "User Account Control, refer to the online help for Windows 7.

### Slow response from the screen keyboard and SmartServer

The following programs may start and respond very slowly under Windows 7 and Windows 2008 servers:

- Microsoft OSK screen keyboard and HMI TouchInputPC
- SmartServer: <Ctrl+Alt+Del> shortcut in the logon dialog

The delay is caused by the callback for the Internet certificate validation.

Remedy:

You can find the following files on the product DVD under:  
Support\Windows7\CRL\_Check or CD\_RT\ Support\Windows7\CRL\_Check\:

- DisableCRLCheck\_LocalSystem.cmd
  - DisableCRLCheck\_CurrentUser.cmd
1. Run the "DisableCRLCheck\_LocalSystem.cmd" file with administrator rights. Select the command "Run as administrator" from the shortcut menu of the file.
  2. Reboot the PC.

If the problem persists, follow these steps:

1. Double-click the file and run the "DisableCRLCheck\_CurrentUser.cmd" file with user rights.
2. Reboot the PC.

---

**Note**

The callback for the certificate validation is disabled for all users or PCs. To restore the original state, perform the following files:

- RestoreDefaults\_LocalSystem.cmd
- RestoreDefaults\_CurrentUser.cmd

You can find the files in the following directory of product DVD:

- Support\Windows7\CRL\_Check or CD\_RT\Support\Windows7\CRL\_Check\
- 

## On-screen keyboard

Once you have opened the TIA Portal, you can no longer call the on-screen keyboard.

To call the on-screen keyboard in Windows, use the following command: "Start > All Programs > Accessories > Ease of access > On-screen keyboard".

## 2.3.5 Engineering System

### 2.3.5.1 Screens and Screen Objects

## Contents

Information that could not be included in the online help and important information about product features.

## Text format of output fields in alarm text

It is not possible to underline tags and text list entries.

### Copying display objects between two projects or two devices

In Project\_1 configure an alarm window in the Global Screen, for example. You copy the alarm window and paste it in the Global Screen in Project\_2.

The enabled alarm classes are partly not enabled in the alarm window after pasting.

This behavior applies to the following display objects:

- Alarm window
- Alarm indicator
- Alarm view

### Representation of the cross-references in the Inspector window

The Inspector window displays objects used by a screen object in the "About > Cross-reference" tab.

A screen is open and an object selected. You are using an HMI tag at the object as process tag.

The object and the linked HMI tag are displayed in the cross-references. All locations of use of the object and the HMI tags are listed.

If the HMI tag is interconnected with a PLC tag or a DB tag, then the locations of use of the interconnected PLC tag or DB tag will be displayed.

### Event names in case of alarms in the "Info" tab of the Inspector window

In some alarms of the Inspector window the event names in the "Info" tab will deviate from the names in the "Properties" tab.

Name in the "Properties" tab of the Inspector window	Name in the "Info" tab of the Inspector window
Cleared	ClearScreen
Loaded	GenerateScreen
Enable	Activate
Change	Change
When a dialog is opened	ONMODALBEGIN
When a dialog is closed	ONMODALEND
User change	PASSWORD
Screen change	SCREEN
Disable	Deactivate
Press	Press
Outgoing	Going
Incoming	Coming
Limit "high limit error" violated	AboveUpperLimit
Limit "low limit error" violated	BelowLowerLimit
Click	Click
Loop-In-Alarm	LoopInAlarm

Name in the "Properties" tab of the Inspector window	Name in the "Info" tab of the Inspector window
Release	Release
Alarm buffer overflow	OVERFLOW
Acknowledge	Acknowledgement
Runtime stop	Shutdown
Press key	KeyDown
Release key	KeyUp
Switch ON	SwitchOn
Switch OFF	SwitchOff
Value change	Change value

### Dynamization of object properties in a group

The dynamization of properties for all objects of the group which have these properties is not possible in a group. In WinCC V12, the properties of the objects belong to a group can only be dynamized for each object itself.

### Illegible characters in Runtime Professional

With Runtime Professional, only characters belonging to the language area which is defined with the operating system setting "Language for non-Unicode programs" can be displayed on the target system. Texts with characters from other language areas can, however, also be configured in the project.

Illegible characters may occur in the Engineering System with the objects text field, symbolic I/O field, gauge and slider if the settings in the operating system relating to "Language for non-Unicode programs" do not match the selected editing language and the objects are displayed in a different design than "WinCC Classic". The characters are displayed correctly in the Inspector window and the "Project texts" editor.

Therefore, first check in the Control Panel under "Regional and Language Options > Advanced" whether the setting for "Language for non-Unicode programs" is the same as the editing language. Otherwise, you can check or change the correct texts in the Inspector window or the "Project texts" editor.

### Faceplates

Faceplates cannot be rotated or mirrored.

### Persistence with display objects in WinCC Runtime Professional

The objects f(t)-trend view, f(x)-trend view, alarm view, recipe view, table view and value table have settings for the persistence of online configurations. If you have configured "Persistence" for "Online configuration" and "Keep changes" for "Reaction to screen change", you can make changes to the configuration dialogs in runtime which will be retained after a screen change and after runtime is exited.

However, online configurations for the settings mentioned cause changes to the configuration of the objects in the Engineering System to only be applied in Runtime if you recompile the device with the command "Compile > Software (rebuild all)".

### Basic Panels, OP73, OP77A and TP177A: Displaying texts in runtime

The default font selected in the "Runtime settings > Languages & font" editor has an effect on the display of texts in runtime.

Text entries may be truncated if you selected an unfavorable font size or style.

This setting possibly has an effect on the following text entries:

- Tooltips
- long alarm text
- text in the dialogs

### Tab sequence in screens with faceplates

If you configured a tab sequence in screens with faceplates in WinCC V12 or WinCC V12 SP1, you should check the tab sequence of these screens in WinCC V12 SP2. The tab sequence may have been changed in both the screen and the faceplate.

### Tag prefix of a screen window in WinCC Runtime Professional

The objects of the "Controls" palette do not support the tag prefix that can be configured for a screen window.

### I/O field with "decimal" display format and format pattern without "s" prefix

You have linked a process tag to an I/O field. The I/O field is assigned the "decimal" display format.

You may select a signed or an unsigned display format.

A "Format pattern" setting without "s", e.g. "999" has the following effects:

1. You cannot set negative values using the I/O field in Runtime.
2. If the tag assumes a negative value, the I/O field generates a two's complement and a corrupted positive value is output.

### Trend view on Basic Panels

The trend view buttons are not displayed on Basic Panels. You can operate the trend view using the function keys of the HMI device that are assigned corresponding system functions.

### Displaying controls in protocols

A project with WinCC V11 SP2 with Update 4 or earlier is upgraded to WinCC V12.

In this process, it may happen that archive data is not displayed in controls for protocols.



The following controls are affected:

- f(t) trend view
- f(x) trend view
- Table view

Remedial measures for f(t) trend view and f(x) trend view

1. In the control, select "Properties > Properties > General > Display > Online".
2. Recompile your project.
3. Load the project onto your HMI device.

Remedial measures for Table view:

1. In the control, select "Properties > Properties > General > Upon opening screen > Start update".
2. Recompile your project.
3. Load the project onto your HMI device.

### Grouping of screen objects

When you group screen objects in WinCC, performance problems can arise in WinCC in the case of large nesting depths.

### Status/Force

The "Status/Force" screen object is enabled for the following controllers:

- SIMATIC S7-300
- SIMATIC S7-400

### ActiveX and .NET controls

ActiveX and .NET controls are always positioned in the foreground in runtime.

The configuration of ActiveX and .NET controls on levels is not supported.

### Frame line of rectangles

In a WinCC V7 project, you have configured a rectangle with the settings "Line weight = 1" and "Draw insider border = yes".

You then migrate the WinCC V7 project to WinCC V12. To have the rectangle displayed correctly, proceed as follows.

1. Open the Inspector window of the rectangle.
2. Open the property list.
3. Disable "Widen border line inwards".

## Graphics in faceplates

You have added a graphic display in a faceplate and defined the "Graphic" property as the interface of the faceplate. The "Graphic" property can now be made dynamic using the interface of the faceplate instance.

Use the following notation to address the property with a screen via a script:  
"..\\..\\screen name".

## Assigning dynamic properties to instances of a faceplate type in a group

You can assign dynamic properties to instances of a faceplate type in an object group. The properties of an instance are also displayed as properties of a group. The individual dynamization processes with tags, scripts or animations of a group are not displayed in Runtime.

## System diagnostics indicator for RT Advanced

You can find the library object "Diagnostics indicator" in the library "Buttons and Switches > DiagnosticsButtons (Comfort Panels)". The object can also be used for devices with RT Advanced.

## Preview in screen window

You use your own designs with shadow for screen objects. They can display the screen objects in a screen window.

The shadows of the screen objects are not displayed in the preview of the screen window. The response occurs only in the Engineering System. It is displayed correctly in Runtime.

### 2.3.5.2 Tags and connections

#### Contents

Information that could not be included in the online help and important information about product features.

#### Tag names

HMI tag names may not start with the character @.

#### Display of deleted array elements at location of use of HMI tags

The locations of use of HMI tags, such as the process value of IO fields, are usually indicated by the tag name. If the element of an array tag is used, then the tag name will be extended by the index of the array element indicated in brackets.

If a used tag is no longer included in the project, then the tag name will still be displayed at the location of use. The field will be displayed with a red background to indicate the missing tag. If a used array element or the array tag is no longer present, then only the index of the array element will be displayed in brackets. The tag name will not be displayed. The field is

highlighted in red. You can no longer identify the name of the associated array tag based on the location of use in this instance.

If you do not know which array tag was linked to this location of use, then it may be necessary to link the array element once again.

If a tag or array tag was created based on a reference, then the selected reference will be closed automatically.

If an HMI tag is connected with an array element of a PLC tag and the PLC tag does no longer exist in the project, then the same behavior will take place in the "HMI tags" editor.

### Array tags as list entry of multiplex tags

You can use the array tags of the Char data type just like the tags of the String data type.

The use of an array tag of the Char data type as list entry of a multiplex tag in the "HMI tags" editor is not supported.

### Multiplexing tags on a Basic Panel

If you multiplex a tag with an external tag on a Basic Panel, the address is read from the PLC in runtime during the first read cycle. The value of the address read is not available until the second read cycle.

### Runtime Advanced and Panels: Importing array elements and structure elements

Array tags and structure tags are always imported in full with all elements. The elements of the array tags and structure tags are not filled further during import.

A new tag is created if the name of a tag corresponds to the name of an array or structure element in the import file.

Example:

The import file contains an array tag called "Otto" with 10 array elements. The array elements are then called Otto[1], Otto[2], for example.

If the import file contains a tag called "Otto[1]", the first element of the array tag will not be filled. Instead, a new tag will be created in the Engineering System.

### Local ID of HMI connections

You cannot edit the "Local ID" value in the HMI connection properties. You need the local ID, for example, for communication by way of AR\_SEND. To enable usage of the "Local ID" for communication, proceed as follows:

1. Open the network view in the "Devices & Networks" editor.
2. Click "Connections".
3. Select an S7 connection.
4. Select the "Add new connection" command in the shortcut menu of the PLC.
5. Click on the interface.

6. Specify the "Local ID (hex)".
7. Click "Add" and then "Close".
8. Select "Properties > General" from the partner area of the Inspector window and enter the IP address of the HMI device for the new connection.
9. Configure the necessary raw data tags for communication in the HMI device.

### Tags with the DTL data type

Tags that use the "DTL" data type element by element, can only be used as read-only.

### 2.3.5.3 Alarm system and alarm displays

#### Contents

Information that could not be included in the online help and important information about product properties.

#### Displaying special characters in alarm texts

When configuring alarm texts, a fixed character set is used in the Engineering System. This character set allows you to use numerous special characters in alarm texts.

Language-dependent fonts are used in runtime to display the texts, for example MS PGothic, SimSun. The fonts used in runtime do not support all special characters. As a result, some special characters are not displayed in runtime.

#### Use of multiplex tags in output boxes with alarm texts

It is also possible to use multiplex tags in the output boxes of alarm texts in the engineering system. During runtime, this leads to an incorrect display of the alarm, because the use of multiplex tags is not supported by the basic panels.

#### Parameters in user alarms

Contrary to the information in the online help, it is not possible to configure parameters for user alarms.

The menu command "Properties > Properties > Alarm parameters" is not available in the Inspector window.

### 2.3.5.4 System functions and scripts

#### Contents

Information that could not be included in the online help and important information about product features.

## SmartTag object in user-defined VB functions for Runtime Professional

With the "SmartTags reads values from the cache" setting, values are read from the process image (cache) instead of directly from the controller.

The SmartTag object can also read values directly from the controller. However, you can then expect a substantially higher communication load between the HMI device and the controller.

## Runtime error on startup on TP 277 and OP 277

At the start of the runtime on a TP 277 or OP 277, the error "Global unknown error with VBScript: 'Expected statement' in script ..." can be reported.

This error is triggered on devices with the Windows CE 3.0 operating system by user functions of the following type:

```
Sub VBFunction_1()  
With HmiRuntime.Screens("Screen_1").ScreenItems("Button_1")  
    .backcolor = vbred  
    .visible = not .visible  
End With  
End Sub
```

If the error occurs, you need to re-program the user function as follows:

```
Sub VBFunction_1()  
    HmiRuntime.Screens("Screen_1").ScreenItems("Button_1").backcolor = vbred  
    HmiRuntime.Screens("Screen_1").ScreenItems("Button_1").visible = not .visible  
End Sub
```

## Hiding warnings for scripts

Activate "Runtime settings > General > Settings > Also start with faulty scripts".

As a result, Runtime is started irrespective of faulty scripts. In addition, script warnings will not be displayed during a complete compilation

## System function "GetPLCMode"

Contrary to the information in the online help, the following description applies to the system function "GetPLCMode".

### Description

Evaluates the current mode of the connected PLC.

The system function "GetPLCMode" can only be configured for the following PLCs:

- SIMATIC S7 1200
- SIMATIC S7 1500

**Use in the function list**

GetPLCMode (connection, mode)

**Use in user-defined functions**

GetPLCMode (connection, mode)

**Parameter**

**Connection**

Connection of PLC and HMI device.

**Mode**

Evaluates the mode of the connected PLC.

8: RUN = The PLC program is being executed.

4: STOP = The PLC program has been interrupted.

Select a suitable user variable for the evaluation.

**Scripts for service projects**

Since no interactive user is usually logged in service projects, C scripts and VB scripts lead to problems in the following cases:

- When the scripts require interaction, for example, operator input.
- When the scripts show message boxes.

There is no common data area for C scripting in service mode. Thus, for example, no global C variables can be exchanged between the "Scheduler" and "Screens".

**2.3.5.5 Recipes**

**Contents**

Information that could not be included in the online help and important information about product features.

**Arrays in recipe elements**

If you have configured both an array as well as the elements of this array for recipe elements of a recipe, the loading of data records aborts with the following error message: "290055: Import of data records aborted with error"

Use either the array or just the array elements for recipe elements of a single recipe.

### 2.3.5.6 User administration

#### Contents

Information that could not be included in the online help and important information about product characteristics.

### SIMATIC Logon for WinCC Runtime Advanced and Panels

When you use SIMATIC Logon to manage access to a panel or a device with WinCC Runtime Advanced, you must note that the characters [/] and [\] cannot be used in the names of Windows user groups or Windows users.

### 2.3.5.7 Communication

#### Contents

Information that could not be included in the online help and important information about product features.

### Connection interruptions with Mitsubishi PLCs

After multiple connection interruptions, a situation may arise where all the connection resources of the Mitsubishi PLC are in use and the connection can no longer be established. It is recommended to check these connection resources in the PLC program of the PLC and also to enable them again.

### Area pointer "Date/time" or "Date/time PLC"

If you use the area pointer "Date/time" or "Date/time PLC" in communication with an S7-1200, you must use "DTL" data type in the configuration of the PLC.

### Accuracy of the "DTL" data type

The "DTL" data type supports time information down to the nanosecond range. Because panels only support time information down to the millisecond, you may encounter the following restrictions when using the area pointers:

- Area pointer "Date/time"  
For the transmission of time information from a panel to the PLC, the smallest unit of time is 1 millisecond. The value range from microseconds to nanoseconds of the "DTL" data type is filled with zeros.
- Area pointer "Date/time PLC"  
For the transmission of time information from a PLC to a panel, the range from microseconds to nanoseconds is ignored. The time information is processed on the panel down to milliseconds.

### Limited number of possible HMI connections

An error message is displayed during compilation of a device indicating that the configuration of the HMI connection in the "Devices & Networks" editor is invalid. The reason may be that the maximum number of possible connections of the HMI device or PLC has been exceeded.

Check the maximum number of available connections. Consult the device manuals of the devices you are using.

### Routed communication with S7 300/400

Communication from connection partners in various different subnets can be routed via the following connections: PROFINET, PROFIBUS, MPI.

### Using PROFINET IO with panel HMI devices

When using PROFINET IO to connect the direct keys and LEDs of HMI devices to the PLC, you can define an offset for the address area of the inputs and outputs during configuration in HW Config.

The following restriction applies when you use a PROFINET IO-capable CPU of the 400 series with one of the HMI devices listed below:

The offset for the start of the address area of the inputs cannot be bigger than the offset for the start of the address area of the outputs.

The restriction applies to the following HMI devices:

- OP 177B
- OP 277
- Mobile Panel 177

For the configuration of the address parameters, open the PLC with the CPU of the 400 series in HW Config. Select the HMI device connected via PROFINET IO in the station window of HW Config. A table with the properties of the HMI device is displayed at the bottom of the station window in the detail view. Select the line containing the addresses of the HMI device in the table and open the object properties using the shortcut menu.

Select the "Addresses" tab in the "Object properties" dialog. Configure the offset for the inputs under "Inputs > Start". Configure the offset for the outputs under "Outputs > Start".

### Exceeding value ranges with Mitsubishi MC and Mitsubishi FX

With some data types, the Mitsubishi MC and Mitsubishi FX communication drivers do not check whether the value of a recipe tag exceeds the value range of the PLC tags. The data types affected are:

- 4-bit block
- 12-bit block
- 20-bit block
- 24-bit block
- 28-bit block



## Coordination area pointer in an OPC connection

In principle, the coordination area pointer can be used eight times in an OPC connection. If you have configured an OPC connection and automatically create another OPC connection using "Add", the coordination area pointer is only displayed once in the newly created connection. In this case, you should change the communication driver of the connection. If you then set OPC again as the communication driver, the area pointer coordination can again be used eight times.

## Communication resources: SIMATIC S7 1200

The SIMATIC S7 1200 controller provides six communication resources for HMI communication.

The number of HMI connections that you can actually configure depends on the HMI devices that you connect with the SIMATIC S7 1200.

- One HMI Panel occupies one communication resource per connection.
- One RT Advanced occupies one communication resource per connection.

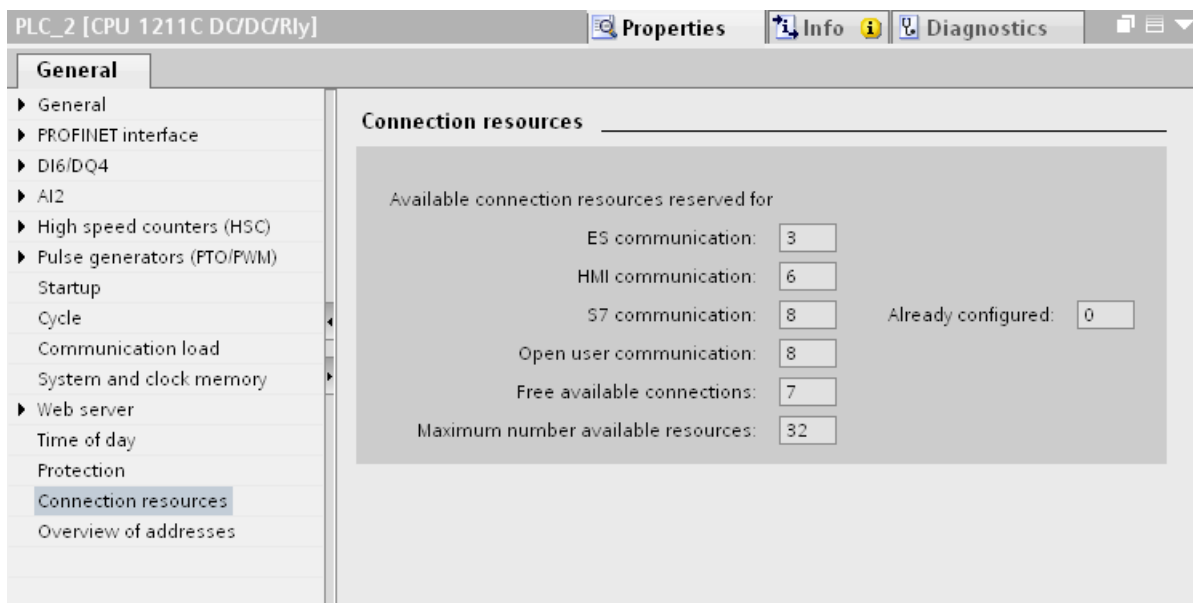

## RT Advanced communication via Station Manager (SIMATIC NET) with an S7 1200

For routed communication of a SIMATIC S7 1200 with a PC with WinCC RT Advanced, the following restrictions apply for the PC:

- Windows 7: Only with installed SIMATIC NET 8.1
- Windows XP: Communication via Station Manager (SIMATIC NET) is not supported

These restrictions also apply if you are using WinAC MP or Station Manager. Connections with the help of the Station Manager of Runtime Advanced are always treated as routed connections.

### Communication between S7-1200 and a multi panel

Communication between an S7-1200 and a multi panel with the "WinAC MP" option installed via ProSave is not possible. The HMI devices affected are:

- SIMATIC MP 177 6" Touch
- SIMATIC MP 277 8" Touch
- SIMATIC MP 277 8" Key
- SIMATIC MP 277 10" Touch
- SIMATIC MP 277 10" Key
- SIMATIC MP 377 12" Touch
- SIMATIC MP 377 12" Key
- SIMATIC MP 377 15" Touch
- SIMATIC MP 377 19" Touch

### HMI connections in WinCC V12

HMI connections to SIMATIC S7-1200 PLCs with firmware version lower than V2.0 cannot be made in WinCC V12.

### Connections via PROFIBUS DP

When a connection between a PLC and an HMI device via PROFIBUS DP is interrupted and then re-established, sporadically all other PROFIBUS DP connections in the communication network are interrupted and re-established.

De-energize the disconnected station before reconnecting it.

### "Set the IP suite (address) of the PLC in the Control Panel" with SIMATIC S7-1200 V1

The function "Set the IP suite (address) of the PLC in the Control Panel" has not been approved for the following PLCs:

- SIMATIC S7-1200 V1

### Switching a connection

A connection may be interrupted when it is switched from a HMI device control panel to a SIMATIC S7-300/400, SIMATIC S7-1500 or SIMATIC S7-1200.

Note the following settings in the SIMATIC S7 1500 or SIMATIC S7 1200 controllers:

- Absolute addressing of tags
- The "Disable PUT-GET communication" option must be selected
- The "Complete protection" protection level may not be set

## 2.3.6 Compiling and loading

### Contents

Information that could not be included in the online help and important information about product features.

### Compiling and loading

If internal errors or warnings occur during compiling, compile the complete project using the command "Compile > Software (rebuild all)" in the shortcut menu of the HMI device.

Before you start productive operation with your project, compile the entire project using the "Compile > Software (rebuild all)" command from the shortcut menu of the HMI device.

If you are using HMI tags that are connected to the control tags in your project, compile all modified blocks with the command "Compile > Software" in the shortcut menu before you compile the HMI device.

### Saving the WinCC project

If you save a project in WinCC using the "Save As..." command, this has no effect on the name of the Runtime projects generated for the devices. If you do not adapt the destination path of the devices in the "Extended download to device" dialog, the Runtime projects on the target devices will be overwritten.

### Settings for update of operating system

If you select the command "Online > HMI device maintenance > Update operating system" from WinCC, you cannot change the settings such as the type of PG/PC interface or baud rate. The settings used during the last download are always used.

To make changes to the settings, open the "Extended download" dialog using the "Online > Extended download to device" command and change the settings. When you click the "Load" button the changed settings are saved.

Alternatively, you can perform an update of the operating system with changed settings with ProSave. You start ProSave via the Windows Start menu "Siemens Automation > Options and Tools > HMI Tools > SIMATIC ProSave".

### Incorrect installation of ProSave

If you receive an error message during installation of ProSave when loading data to a target device or maintenance of an HMI device, then you cannot remedy this error using the repair function of setup. Remove ProSave via the Control Panel. Then start setup and install the "ProSave" component again.

### Checking the address parameters

During compilation of an HMI device in the project tree with the command "Compile > Software" in the shortcut menu, the address parameters of the HMI device, such as the IP address, will

not be checked. If you want to ensure that the address parameters are checked as well, you will have to compile the HMI device in the "Devices & Networks" editor of the toolbar.

### **Error message when downloading data to the PLC**

A panel and a PLC are connected and communicating with other.

If a tag is accessed while downloading data from the panel to the PLC, an error message is displayed on the panel.

### **Delayed reaction in the "Extended download to device" dialog**

If the settings in the "Extended download to device" dialog for "Type of the PG/PC interface" and "PG/PC interface" do not match the settings on the HMI device, this can result in the application not responding for up to a minute.

### **Extended download with an S7-1200 and a Comfort Panel**

An S7-1200 PLC and a Comfort Panel are located in the same physical network as the PG/PC. You open the "Extended download to device" dialog for the Comfort Panel.

If you activate the option "Show all accessible devices", it may occur that the application stops responding.

### **OP77A, OP73, TP177A: Loading projects**

When loading a project to an HMI device, it can happen that Runtime is not automatically ended, even though "Remote Transfers" is activated in the Panel.

If this happens, stop Runtime and manually set the transfer mode on the HMI device.

### **Loading a SIMATIC HMI application to a PC station**

The following circumstances can lead to an error message during the first load of a SIMATIC PC station:

- A SIMATIC HMI application is configured in a PC station in the project
  - WinCC Runtime Advanced
  - WinCC Runtime Professional
  - WinCC Standby
  - or WinCC Client
- The property "S7RTM is installed" is activated.

Before you load a SIMATIC PC station for the first time, select the configured device HMI\_RT (WinCC...) in the project tree. Open the "Extended download to device" dialog and select the appropriate interface and parameter settings. Click "Load".

You then load the PC station as normal.

## Project transfer via USB

If you have connected more than one HMI device via USB to your configuration PC, project transfer is only possible to the last connected device.

## Delta download capability

If you make changes to a UDT, is the capability to perform a delta download of the Runtime Professional project lost.

Compile the full project again.

## Opening project files

When you run "HmiIIRTm.exe", a dialog opens asking if you want to open the project file (.fwc).

The following options are available to you:

- "Yes": A dialog opens allowing you to select a project file (.fwc).
- "No": The dialog closes.

## 2.3.7 Runtime

### 2.3.7.1 Notes on operation in Runtime

#### Contents

Information that could not be included in the online help and important information about product features.

#### Special characters in the user view

Special characters, such as / " § \$ % & ' ? , are not permitted when entering a name or the password in the user view.

#### Language behavior - Layout of on-screen keyboard

The layout of the on-screen keyboard is not switched when the runtime language changes.

#### Tag values exceed the maximum length

You enter a character string in a string tag via an I/O field. If the character string exceeds the configured number of tags, the character string will be shortened to the configured length.

#### Empty message texts

Runtime is running with a project. The project is saved on a network drive.

In the event of interruptions to the network drive connection, Runtime may attempt to load message texts from the network drive.

In the event of disconnection, the alarm window or the alarm view remains empty.

To avoid this, copy the project to a local drive before the starting the project in Runtime.

### Complete download in Service mode

If you need to perform a "complete download" to the OS in Service mode from the engineering station, Runtime automatically stops and then starts again.

The project is then no longer in Service mode.

In this state, the power supply is interrupted and WinCC Runtime no longer starts automatically on the OS.

Remedy:

1. Switch the project manually to Service mode after you have performed the "complete download".
2. Close the project manually.
3. Activate Service mode.
4. Start Runtime again using the surrogate icon in the taskbar.

### 2.3.7.2 Notes on operation of panels in Runtime

#### Contents

Information that could not be included in the online help and important information about product features.

#### Using the mouse wheel in Runtime

The use of the mouse wheel in Runtime is not supported on all panels.

#### Basic Panels: Connections to S7-1200 and S7-1500 with Backup/Restore

If you use the "Backup/Restore" function, a maximum of two connections from Basic Panels to the controllers are possible at any given time.

- SIMATIC S7-1200
- SIMATIC S7-1500

#### Basic Panels: Backup on the memory card of the PLC

Create the backup file "A.psb" on the memory card of the PLC. An error, for example a connection break, occurs when creating the backup.

This will create a corrupt file on the memory card of the PLC. Such a file has "~\$" as prefix.

Delete the file with the prefix "~\$" if you want to save a backup again under the same name "A.psb".

### Basic Panels: Panel Data Storage and S7-1500F

The "Panel Data Storage" PDS function cannot be used on Basic Panels in conjunction with S7-1500F when the password for the protection level "Full access incl. fail-safe" is used.

### Upgrading Basic Panels to WinCC V12

Before you upgrade Basic Panels from version V11 to version V12, transfer the image of the V11 SP2 Update 5 or higher to the devices.

In the "SIMATIC ProSave [OS Update]" dialog, select the setting "Reset to factory settings".

In this way, you always start a functional update of the image.

Affected devices:

- KP300 Basic mono PN,
- KP400 Basic color PN
- and KTP400 Basic color PN.

### 2.3.7.3 Notes on operation of Runtime Advanced

#### Contents

Information that could not be included in the online help and important information about product characteristics.

#### .Net-Controls in Runtime

If you have incorporated a .Net Control in your project as "Specific .Net-Control", you have to copy the files belonging to these controls to the installation directory of WinCC Runtime, e.g. "C:\ProgramFiles\Siemens\Automation\WinCC RT Advanced". Otherwise, the control cannot be loaded in Runtime.

### 2.3.8 HMI devices

#### 2.3.8.1 Notes on HMI devices

#### Contents

Information that could not be included in the online help and important information about product characteristics.

If the PC goes into standby or hibernate mode while the transfer is in progress, the panel status after interruption of the transfer is not defined.

### Multi-key operation

Unintentional actions can be triggered by multi-key operation:

- When you are using a key device, you cannot press more than two function keys at the same time.
- When you are using a touch device, a standard PC or a panel PC, you can only press one function key or button at the same time.

### TS Adapter with Ethernet interface

If an HMI device is connected via Ethernet and a TS adapter, it can not be reset to factory settings.

### Simulation of the Basic Panels

Use an output field in an alarm text to output an external tag. The content of the output field will always be displayed with "0" during simulation.

### Simulation with real PLC connection

The access point used by the simulation is independent from the settings of the Engineering System and can only be altered in the Control Panel with the "Setting PG/PC Interface" tool. If the PLC connection is terminated right after the start of the simulation with alarm 140001, you should check the access point used by the simulation with "Setting PG/PC Interface".

1. Double-click "Setting PG/PC Interface" in the Control Panel. A dialog opens.
2. Select "S7ONLINE" in the "Access point of application" field as standard for HMI.
3. Select the interface in the "Interface Parameter Assignment Used" area.
4. Exit the dialog "Setting PG/PC Interface" with OK

### Loading of projects without recipe data records

You are using recipes in a project. You transfer the project to a Basic Panel without recipe data records.

You may encounter inconsistencies if you have altered the structure of the recipe in the Engineering System and the device already held recipe data records.

Check the consistency of the data records in this case. The device will not issue a note for all structural changes.

### Floating point numbers on MP 277, MP 377, TP 177B 4" and CP4

Only floating point numbers in the range from  $10^{-293}$  ...  $10^{+307}$  are displayed correctly on the HMI devices MP 277, MP 377, TP 177B 4" and CP4. If the tag value is outside this range, it is displayed as 0.



## USB device driver under Windows XP

If a configuration PC with Windows XP and a Comfort Panel are connected via USB, the S7-USB driver may be reinstalled when the HMI device is restarted. The device settings may in this case not be restored.

## Mobile Panels V2

If you use Mobile Panels V2 in a project, it is not possible to open the project with WinCC V11 SP1. This affects projects with the following devices:

- Mobile Panel 277F IWLAN (RFID Tag)
- Mobile Panel 277F IWLAN V2
- Mobile Panel 277 IWLAN V2

## "Zone ID/Connection point ID" tag of a Mobile Panel 277 IWLAN V2

The tag used for the "Zone ID/Connection point ID" must be of data type INT for Mobile Panel 277 IWLAN V2 devices. Adapt this data type if necessary when migrating a project.

## HMI devices with operating system Windows CE 5.0 or higher

Owing to a modified client-server communication security setting, the time difference between the HMI device (client) and PC (server) must not exceed 1 day. If you back up recipe data from the HMI device on a network drive, for example, make sure that the time is set correctly on the PC (server) and the HMI device (client).

## HMI devices with high communication load

S7 Diagnostics should be enabled if a Panel is assigned many connections to PLCs or other HMI devices. Otherwise, you will risk overload on the Panel.

## Device replacement in the Engineering System

In the Engineering System, you replace a device with configured LED keys with a device without LED keys. Runtime start fails after you have transferred the project data to the device.

For this reason, delete the LED key configuration before you replace the device.

## Restrictions for the HMI device, MP 377 15" Touch daylight readable

The following functions are not supported in WinCC V12 for the MP 377 15" Touch daylight readable HMI device:

- Option: Sm@rtServer
- System function: SetAndGetBrightness
- Direct keys

### Upgrading Basic Panels to WinCC V12

Before you upgrade Basic Panels from version V11 to version V12, transfer the image of the V11 SP2 Update 5 or higher to the devices.

In the "SIMATIC ProSave [OS Update]" dialog, select the setting "Reset to factory settings".

In this way, you always start a functional update of the image.

Affected devices:

- KP300 Basic mono PN
- KP400 Basic color PN
- KTP400 Basic color PN

### Connection switch in the Control Panel with Basic Panels

If you use the "Override protected connection information" function, the following restriction applies:

You cannot perform a connection switch in the Control Panel of a Basic Panel from a PLC without a protection level to a PLC with a "Complete protection" level.

# Installation

## 3.1 System requirements for installation

### 3.1.1 Notes on licenses

#### Availability of licenses

The licenses for the products of the TIA Portal are usually supplied on the installation data medium and installed automatically by the Automation Licence Manager during the installation process of the TIA Portal.

Before you uninstall the TIA Portal, you must transfer and back up the licenses still required. Use the Automation License Manager for this purpose.

#### Provision of the Automation License Manager

The Automation License Manager is supplied on the installation data medium and is transferred automatically during the installation process.

If you remove the TIA Portal, the Automation License Manager remains installed on your system.

#### Working with the Automation License Manager

The Automation License Manager is a product of Siemens AG, which is used for handling license keys (technical representatives of licenses).

Software products that require license keys for operation, such as the TIA-Portal, register the required license key automatically with the Automation License Manager. If the Automation License Manager finds a valid license key for this software, the software can be used according to the license usage terms associated with this license key.

---

#### Note

For additional information on how to manage your licenses with the Automation License Manager, refer to the documentation supplied with the Automation License Manager.

---

### *3.1 System requirements for installation*

#### **See also**

- Notes on the system requirements (Page 84)
- Starting installation (Page 107)
- Displaying the installed software (Page 110)
- Modifying or updating installed products (Page 111)
- Repairing installed products (Page 113)
- Starting to uninstall (Page 115)
- Installation log (Page 106)

### **3.1.2 Notes on the system requirements**

#### **System requirements for individual products**

The system requirements may differ depending on the products you want to install. You should therefore check the individual system requirements of your products.

If you want to install several products, make sure that your system meets the demands of the product with the highest requirements.

#### **Displaying PDF files**

To be able to read the supplied PDF files, you require a PDF reader that is compatible with PDF 1.7 e.g. Adobe (R) Reader version 9.

#### **Displaying the Welcome Tour**

You require the Adobe (R) Reader as of version 9 to start the Welcome Tour for the TIA portal.

#### **See also**

- Notes on licenses (Page 83)
- Starting installation (Page 107)
- Displaying the installed software (Page 110)
- Modifying or updating installed products (Page 111)
- Repairing installed products (Page 113)
- Starting to uninstall (Page 115)

### 3.1.3 System requirements STEP 7 Basic

#### 3.1.3.1 Licensing of STEP 7

##### Introduction

You require a License Key to license the following STEP 7 editions:

- STEP 7 Basic
- STEP 7 Professional

You can install the corresponding License Key when you are installing STEP 7 or transfer it using the Automation License Manager after the installation has been completed.

##### Licenses for STEP 7

The following licenses with the corresponding license keys are available:

- STEP 7 Basic
- STEP 7 Professional
- STEP 7 Professional Combo

##### Validity of license keys for older versions of STEP 7

With a valid License Key for V12.x of STEP 7 Professional and STEP 7 Professional Combo, you can also operate older versions of STEP 7 without restrictions. The following table provides more detailed information about this:

Edition	License	Valid for
STEP 7 Basic V12.x	STEP 7 Basic	<ul style="list-style-type: none"> <li>• STEP 7 Basic V12.x</li> </ul>
STEP 7 Professional V12.x	STEP 7 Professional	<ul style="list-style-type: none"> <li>• STEP 7 Basic V10.5</li> <li>• STEP 7 Basic V11.0</li> <li>• STEP 7 Professional V11.0</li> </ul>
STEP 7 Professional V12.x	STEP 7 Professional Combo	<ul style="list-style-type: none"> <li>• STEP 7 Basic V10.5</li> <li>• STEP 7 Basic V11.0</li> <li>• STEP 7 Professional V11.0</li> </ul>

##### Starting without a valid license key

If you start an edition of STEP 7 without a valid License Key, the system alerts you that you are working in non-licensed mode. You have the one-time option of activating a Trial License. However, this license is valid for a limited period only and expires after 21 days.

When the Trial License expires, the following scenarios can occur:

### 3.1 System requirements for installation

- STEP 7 has never been licensed on the PC in question:
  - Operations requiring a license can no longer be performed in STEP 7.
- STEP 7 was already licensed on the PC in question:
  - A window requiring acknowledgment presents an alert for non-licensed mode every 10 minutes and for every action requiring a license.

#### License requirements for simulation

You do not require additional licenses when you use the menu command "Online > Simulation" to start the simulation in STEP 7.

If the following conditions are met, the appropriate licenses for the edition of STEP 7 you have installed are also required for the simulation.

- The engineering station is connected to a PLC.
- The connection to the PLC is configured and active.

#### See also

Handling licenses and license keys (Page 86)

#### 3.1.3.2 Handling licenses and license keys

##### Introduction

In each case, you require a valid License Key to use STEP 7 Basic and STEP 7 Professional.

##### Installing license keys

When you install STEP 7 Basic, the License Key is installed automatically during setup. When you install STEP 7 Professional you will be prompted at the end of the setup to transfer the license from the supplied storage medium to your PC.

If you want to install additional License Keys, you have to use the Automation License Manager to do this.

When you install a license, the associated license key is removed from the license key storage location.

<b>NOTICE</b>
<b>Destruction of license keys by copying</b>
It is not possible to copy a License Key. The copy protection prevents the license keys from being copied. If you attempt to copy a License Key this will be destroyed.

## Uninstalling license keys

License keys are always uninstalled using the Automation License Manager. You uninstall a License Key in the following cases:

- When backing up data.
- If you no longer require the license.

You can then use a valid license on another PC or HMI device.

## Data backup

When backing up data on the HMI device or creating a backup during device replacement, remove the License Keys on the HMI device. To do this, open the Automation License Manager and back up the uninstalled license key to another storage location.

### NOTICE

#### Destruction of license keys on PCs

Start by removing all license keys in the following situations:

- Before you format the hard disk.
- Before you compress the hard disk.
- Before you restore the hard disk.
- Before you start an optimization program that moves fixed blocks.
- Before you install a new operating system.

Read the description of Automation License Manager ("Start > Siemens Automation > Documentation"). Observe all warnings and notices.

On PC-based HMI devices and on non-PC-based HMI devices where Automation License Manager is used, the license key storage location may contain multiple license keys. This capability means you can store multiple licenses of the same type at one location. Save all license keys of an HMI device to the same storage location.

### NOTICE

Always keep the original storage location of the license keys.

## Invalid license after time zone change

The installed license no longer functions in the following case.

- If you change the time zone on a PC as follows:  
From a time based on a complete hour to a time not based on a complete hour.  
**Example:** You change the time zone from GMT +3:00 to GMT +3:30.

To avoid this inconvenience, uninstall the license key using the Automation License Manager under the time zone setting that was set when the license key was installed.

This behavior does not apply to the Trial License.

### Defective license

A license is defective in the following cases:

- If the license key is no longer accessible at the storage location.
- If the license key disappears during its transfer to the destination drive.

You can use the Automation License Manager to repair the defective license. To do this, use the "Restore" function or the "Restore wizard" of the Automation License Manager. To perform this restore operation you must contact Customer Support.

You can find more detailed information on the Internet: <http://support.automation.siemens.com> (<http://support.automation.siemens.com/WW/llisapi.dll?aktprim=99&lang=en&referer=%2fWW%2f&func=cslib.csinfo2&siteid=csius&extranet=standard&viewreg=WW&groupid=4000002>)

### See also

Licensing of STEP 7 (Page 85)

### 3.1.3.3 Software and hardware requirements STEP 7

#### System requirements for installation

The following table shows the minimum software and hardware requirements for installation of the "SIMATIC STEP 7 Basic" software package:

Hardware/software	Requirement
Processor	2.0 GHZ CORE 2 DUO
RAM	1 GB (Windows XP) 2 GB (Windows 7)
Free hard disk space	2 GB on system drive "C:"



Hardware/software	Requirement
Operating systems *	<p><b>Windows XP (32-bit)</b></p> <ul style="list-style-type: none"> <li>• Windows XP Home SP3</li> <li>• Windows XP Professional SP3</li> </ul> <p><b>Windows 7 (32-bit)</b></p> <ul style="list-style-type: none"> <li>• Windows 7 Home Premium</li> <li>• Windows 7 Home Premium SP1</li> <li>• Windows 7 Professional</li> <li>• Windows 7 Professional SP1</li> <li>• Windows 7 Enterprise</li> <li>• Windows 7 Enterprise SP1</li> <li>• Windows 7 Ultimate</li> <li>• Windows 7 Ultimate SP1</li> </ul> <p><b>Windows 7 (64-bit)</b></p> <ul style="list-style-type: none"> <li>• Windows 7 Home Premium</li> <li>• Windows 7 Home Premium SP1</li> <li>• Windows 7 Professional</li> <li>• Windows 7 Professional SP1</li> <li>• Windows 7 Enterprise</li> <li>• Windows 7 Enterprise SP1</li> <li>• Windows 7 Ultimate</li> <li>• Windows 7 Ultimate SP1</li> </ul>
Graphics card	32 MB RAM 24-bit color depth
Screen resolution	1024 x 768
Network	10Mbit/s Ethernet or faster
Optical drive	DVD-ROM

\* For more detailed information on operating systems, refer to the help on Microsoft Windows or the Microsoft homepage.

## Recommended hardware

The following table shows the recommended hardware for the operation of STEP 7.

Hardware	Requirement
Computer	SIMATIC FIELD PG M2 PREMIUM (or similar PC)
Processor	2.2 GHZ CORE 2 DUO (T7500)
RAM	1X2GB DDR2 RAM
Hard disk	250GB S-ATA HDD
Monitor	15" SXGA+ DISPLAY (1400 X 1050)
Optical drive	DL MULTISTANDARD DVD RW

### 3.1 System requirements for installation

#### Supported virtualization platforms

You can install the "SIMATIC STEP 7 Basic" software package on a virtual machine. To do this, use one of the following virtualization platforms:

- VMware vSphere Hypervisor (ESXi) 5
- VMware Workstation 8
- VMware Player 4
- Microsoft Windows Server 2008 R2 SP1 Hyper-V

These virtualization platforms can use the following operating systems as host operating system:

- Windows 7 Professional/Ultimate/Enterprise (32-bit)
- Windows 7 Professional/Ultimate/Enterprise (32-bit)
- Windows Server 2008 R2 (64-bit)

You can use the following host operating systems to install "SIMATIC STEP 7 Basic" within the selected virtualization platform:

- Windows 7 Professional/Ultimate/Enterprise (32-bit)
- Windows 7 Professional/Ultimate/Enterprise (64-bit)

---

#### Note

- The same hardware requirements apply to the host operating system as for the respective TIA products.
  - The plant operator must ensure that sufficient system resources are available for the host operating systems.
  - The hardware certified by the manufacturers is recommended for the use of HyperV server and ESXi.
  - When you use Microsoft Hyper-V, accessible stations cannot be displayed.
- 

#### Supported security programs

The following security programs are compatible with "SIMATIC STEP 7 Basic":

- Antivirus programs:
  - Symantec Endpoint Protection 12.1
  - Trend Micro Office Scan Corporate Edition 10.6
  - McAfee VirusScan Enterprise 8.8
- Encryption software:
  - Microsoft Bitlocker
  - Utimaco SafeGuard Easy 4.2
- Host-based Intrusion Detection System:
  - McAfee Application Control 6.0

## 3.1.4 System requirement for WinCC Advanced

### 3.1.4.1 Software and hardware requirements

#### Introduction

Specific requirements for the operating system and software configuration must be met for the installation.

---

#### Note

WinCC is generally authorized for use in a domain or workgroup.

However, be aware that domain group policies and restrictions of the domain may hinder the installation. In this happens, remove the computer from the domain prior to installing Microsoft Message Queuing, Microsoft SQL Server and WinCC. Log onto the computer in question locally with administrative rights. Then perform the installation. After successful installation, you can enter the WinCC computer back into the domain. If the domain group policies and restrictions of the domain do not impede the installation, the computer need not be removed from the domain during the installation.

Be aware that domain group policies and restrictions of the domain may also hinder operation. If you cannot avoid these restrictions, run the WinCC computer in a workgroup.

Consult with the domain administrator if needed.

---

#### Installation requirements

The following table shows the minimum software and hardware requirements that have to be met for the installation of the "SIMATIC WinCC Advanced" software package:

Hardware/software	Requirement
Processor type	2.0 GHz Core 2 Duo processor
RAM	1 GB (Windows XP) 2 GB (Windows 7; Windows Server)
Free hard disk space	2 GB on system drive "C:"

3.1 System requirements for installation

Hardware/software	Requirement
Operating systems *	<p><b>Windows XP</b></p> <ul style="list-style-type: none"> <li>Windows XP Professional SP3</li> </ul> <p><b>Windows 7 (32 bit)</b></p> <ul style="list-style-type: none"> <li>Windows 7 Professional</li> <li>Windows 7 Professional SP1</li> <li>Windows 7 Enterprise</li> <li>Windows 7 Enterprise SP1</li> <li>Windows 7 Ultimate</li> <li>Windows 7 Ultimate SP1</li> </ul> <p><b>Windows 7 (64 bit)</b></p> <ul style="list-style-type: none"> <li>Windows 7 Professional</li> <li>Windows 7 Professional SP1</li> <li>Windows 7 Enterprise</li> <li>Windows 7 Enterprise SP1</li> <li>Windows 7 Ultimate SP1</li> </ul> <p><b>Windows Server (32 bit)</b></p> <ul style="list-style-type: none"> <li>Windows Server 2003 R2 Standard Edition SP2</li> <li>Windows Server 2008 R2 Standard Edition SP2</li> </ul> <p><b>Windows Server (64 bit)</b></p> <ul style="list-style-type: none"> <li>Windows Server 2008 R2 Standard Edition</li> <li>Windows Server 2008 R2 Standard Edition SP1</li> </ul>
Graphics card	<p>32 MB RAM</p> <p>24-bit color depth</p>
Screen resolution	1024x768
Network	Ethernet 10 Mbps or faster
Optical drive	DVD-ROM
Software	<p>Microsoft .Net Framework 3.5 SP1</p> <p>Microsoft Windows Message Queuing</p>

\* For additional information on operating systems, refer to the help on Microsoft Windows or the Microsoft homepage.

Simultaneously opening multiple instances of WinCC on a configuration PC can also increase the hardware capacity required.

**Note**

**"Aero Glass Style" of Microsoft Windows 7**

A powerful graphics card is required for "Aero Glass Style". It requires DirectX9 capabilities and 128 MB of dedicated graphics memory.

The performance of the architecture of the graphics system can significantly influence the performance of WinCC.

## Recommended hardware

The following table shows the recommended hardware for the operation of SIMATIC WinCC.

Hardware	Requirement
Computer	SIMATIC FIELD PG M2 PREMIUM
Processor	2.2 GHZ CORE 2 DUO (T7500)
RAM	1X2GB DDR2 RAM
Hard disk	250GB S-ATA HDD
Monitor	15" SXGA+ DISPLAY (1400 X 1050)
Optical drive	DL MULTISTANDARD DVD RW

## Supported virtualization platforms

You can install the "SIMATIC WinCC Comfort" and "SIMATIC WinCC Advanced" software package on a virtual machine. To do this, use one of the following virtualization platforms:

- VMware vSphere Hypervisor (ESXi) 5
- VMware Workstation 8
- VMware Player 4
- Microsoft Windows Server 2008 R2 SP1 Hyper-V

These virtualization platforms can use the following operating systems as the host operating system:

- Windows 7 Professional/Ultimate/Enterprise (32-bit)
- Windows 7 Professional/Ultimate/Enterprise (32-bit)
- Windows Server 2008 R2 (64-bit)

You can use the following host operating systems to install "SIMATIC STEP 7 Basic" in the selected virtualization platform:

- Windows 7 Professional/Ultimate/Enterprise (32-bit)
- Windows 7 Professional/Ultimate/Enterprise (64-bit)

---

### Note

- The same hardware requirements apply to the host operating system as to the respective TIA products.
  - The plant operator must ensure that sufficient system resources are available for the host operating systems.
  - The hardware certified by the manufacturers is recommended for the use of HyperV server and ESXi.
-

### 3.1 System requirements for installation

#### Supported security programs

The following security programs are compatible with "SIMATIC WinCC Comfort" and "SIMATIC WinCC Advanced".

- Antivirus programs:
  - Symantec Endpoint Protection 12.1
  - Trend Micro Office Scan Corporate Edition 10.6
  - McAfee VirusScan Enterprise 8.8
- Encryption software:
  - Microsoft Bitlocker
  - Utimaco SafeGuard Easy 4.2
- Host-based Intrusion Detection System:
  - McAfee Application Control 6.0

#### Installing Microsoft .Net Framework

.Net Framework 3.5 SP1 is included on the installation medium. The installation routine determines if .Net Framework is already installed at the beginning of the installation. If .Net Framework is not installed, you are prompted with a dialog to perform the installation. When you confirm the prompt for installation, .Net Framework is installed. You need to reboot the computer after installing .Net Framework. If you do not install .Net Framework, the installation of WinCC Runtime Professional is aborted.

#### Installing Microsoft Windows Message Queuing in Windows XP

You can install the Windows Message Queuing component from the Windows Control Panel.

Click Start > Control Panel. Double-click "Add or remove software", the "Add or remove software" dialog opens. In the "Add or Remove Programs" dialog, click "Add or Remove Windows Components". The Windows Components Wizard opens. Select the "Message Queuing" component in the Windows Components Wizard. Click "Next", the "Message Queuing" component is installed.

#### Installing Microsoft Windows Message Queuing in Windows 7

You can install the Windows Message Queuing component from the Windows Control Panel.

Click Start > Control Panel. Click "Programs" and the "Programs" dialog opens. Under the "Programs and Features" section, click "Turn Windows features on or off". The "Windows Features" dialog opens. In the "Windows Features" dialog, select the "Microsoft Message Queue Server" feature. Click "OK" to enable the "Microsoft Message Queue Server".

## Online help for Windows 7 / Windows Server 2008

Windows 7 and Windows Server 2008 no longer support all online help formats by default. With WinCC, these online help formats are used in the following cases:

- Calling WinCC Direct Help
- Calling the WinCC Information System from the WinCC editors or via the Direct Help links

To be able to continue opening WinCC Direct Help, the following components are installed during the installation of WinCC:

- Microsoft Help Engine

You can also call the WinCC Information System under Windows 7 and Windows Server 2008 from the Windows Start menu or from the installation folder.

To call the WinCC Information System from the WinCC editors or via the Direct Help links, some changes have to be made to the operating system. You can find more information on this in the section "More information for advanced users" of Microsoft Support article "917607": <http://support.microsoft.com/kb/917607> (<http://support.microsoft.com/kb/917607>)

## See also

Options for WinCC Engineering and Runtime systems (Page 96)

Licensing of WinCC Engineering System (Page 98)

### 3.1.4.2 Parallel installation

#### Parallel installations in TIA portal V12

You will be prevented from starting the TIA Portal if you perform a non-permitted parallel installation of STEP 7 and WinCC. The following parallel installations are permitted in the TIA portal:

- STEP 7 V12 and WinCC V12

A dialog opens during installation to inform you of any inconsistencies in your parallel installation. The following parallel installations are permitted:

- WinCC V12 and RT Advanced V12
- WinCC V12 and RT Professional V12

The Engineering System and Runtime must always be of the same version after an installation.

#### Parallel installation of WinCC V12 and other SIMATIC products

Parallel installation of WinCC V12 and versions of WinCC flexible prior to WinCC flexible 2008 is not allowed.

Parallel installation of WinCC V12 with versions of WinCC prior to WinCC V7.0 SP2 is not allowed. Parallel installation of WinCC V12 with WinCC V7.0 SP2 or WinCC V7.0 SP3 is only allowed with:

### 3.1 System requirements for installation

- WinCC V12 Basic
- WinCC V12 Runtime Advanced

#### Parallel use

If the term "Combo" appears in the name or license key of the software after installation, the use of the following products/versions is permitted in accordance with paragraph 1.6 of the General Terms and Conditions (see also setup text):

- With "WinCC V12 Comfort Combo" license: WinCC flexible 2008 Standard
- With "WinCC V12 Advanced Combo" license: WinCC flexible 2008 Advanced

#### 3.1.4.3 Add-ons

##### Options for WinCC Engineering and Runtime systems

SIMATIC Panels as well as WinCC Runtime Advanced and WinCC Runtime Professional contain all essential functions for operator control and monitoring of machines or plants. Additional add-ons allow you to extend the functionality in some cases to increase the range of available tasks.

##### Add-ons for Comfort Panels, Mobile Panels, Multi Panels

The following add-ons are available for Comfort Panels, Mobile Panels, and Multi Panels:

- WinCC SmartServer (remote operation)
- WinCC Audit (audit trail and electronic signature for regulated applications)

---

##### Note

In contrast to WinCC flexible 2008, functions from the WinCC flexible /Sm@rtService, WinCC flexible /Sm@rtAccess add-ons as well as the WinCC flexible /OPC Server add-on are incorporated into the basic functionality.

---

##### Add-ons for WinCC Runtime Advanced

The following add-ons are available for WinCC Runtime Advanced:

- WinCC SmartServer (remote operation)
- WinCC Recipes (recipe system)



- WinCC Logging (logging of process values and alarms)
- WinCC Audit (audit trail for regulated applications)

---

**Note**

In contrast to WinCC flexible 2008, functions from the WinCC flexible /Sm@rtService, WinCC flexible /Sm@rtAccess add-ons as well as the WinCC flexible /OPC Server add-on are incorporated into the basic functionality.

---

## Add-ons for WinCC Runtime Professional

WinCC Runtime Professional contains the following components, which you can activate with the appropriate license:

- WinCC Server (supplements WinCC Runtime to include server functionality)
- WinCC Recipes (recipe system, formerly WinCC /UserArchives)
- WinCC Logging (logging system, previously WinCC/TagLogging)

You can select and install the following add-ons in the installation dialog:

- WinCC Client (standard client for building multiple-station systems)
- WinCC WebNavigator (Web-based operator control and monitoring)
- WinCC DataMonitor (display and evaluation of process states and historical data)

---

**Note**

In contrast to WinCC V7, functions from the WinCC / OPC Server add-ons have been incorporated into the basic functionality. Likewise, the basic functionality includes the Runtime API from WinCC /ODK.

---

In addition to the Runtime add-ons, you can also expand WinCC Runtime Professional with custom controls. The WinCC ControlDevelopment add-on is required to develop controls.

## See also

Software and hardware requirements (Page 91)

Installing and uninstalling options (Page 97)

## Installing and uninstalling options

### Introduction

Some add-ons are included in standard WinCC installation and are installed automatically.

During the installation of WinCC Engineering System, the following add-ons are available for you to select for installation:

### 3.1 System requirements for installation

- Simulation for WinCC Runtime Advanced

During the installation of WinCC Runtime Advanced, the following add-ons are available for you to select for installation:

- OPC XML Gateway
- WinCC Audit Viewer

You must enable all the necessary add-ons for use.

---

#### Note

Each add-on requires a license. You activate an add-on by installing the appropriate license key.

---

### Add-ons for non-PC-based HMI devices

The required Runtime add-ons are installed on the HMI device as follows:

- During the transfer of the project to the HMI device  
Add-ons that are no longer required are removed automatically.
- With ProSave

### Procedure - activating add-ons

To activate an add-on for use, install the appropriate license key using the Automation License Manager.

In order to backup the license key of an add-on or use it on a different configuration PC or HMI device, you must uninstall this license key using the Automation License Manager.

---

#### Note

When no valid license key is installed on a PC with WinCC Runtime, Runtime runs in Demo mode.

---

### See also

Options for WinCC Engineering and Runtime systems (Page 96)

### 3.1.4.4 Licenses and Powerpacks

#### Licensing of WinCC Engineering System

You require a license key for the following:

- WinCC Engineering System, for example, WinCC Professional
- Add-ons for WinCC Engineering System

You can install the license key during the installation of WinCC. You transfer the licenses for WinCC add-ons after installation with the Automation License Manager.

### Starting without a valid license key

If you start WinCC without a valid license, the system alerts you that you are working in non-licensed mode. You have the option of activating a one-time trial license. Trial licenses for Engineering editions WinCC Basic, Comfort, Advanced und Professional expire after 21 days.

When the trial license expires, the following scenarios can occur:

- WinCC was never licensed on the PC in question.
  - Operations requiring a license can no longer be performed in WinCC.
- WinCC was already licensed on the PC in question.
  - An alert for non-licensed mode is presented every 10 minutes and for every action requiring a license by a window requiring acknowledgment.

### License requirements for simulation

When you want to start simulation in WinCC using the menu command "Online > Simulation > With tag simulator", you do not need licenses for WinCC Runtime or licensed-based add-ons.

If the following conditions are met, you also need the appropriate licenses for the simulation of WinCC Runtime and license-based add-ons:

- The engineering station is connected to a PLC.
- The connection to the PLC is configured and active.

You start the simulation with the "Online > Simulation > Start" menu command.

### See also

Software and hardware requirements (Page 91)

Licensing WinCC Runtime on PC-based HMI devices (Page 99)

Licensing of HMI devices (Page 100)

Working with license keys (Page 101)

Powerpack (Page 104)

Installing a Powerpack (Page 105)

### Licensing WinCC Runtime on PC-based HMI devices

With PC-based HMI devices, you require a license key for the following:

- WinCC Runtime with 128 tags, for example.
- WinCC add-ons

### 3.1 System requirements for installation

You can install the license key for WinCC Runtime during the installation of WinCC. You transfer the licenses for WinCC add-ons after installation with the Automation License Manager.

---

#### Note

Only the Certificate of License for WinCC Runtime V12 authorizes operation of WinCC Runtime V12.

---

The appropriate new license is required to license WinCC Runtime.

You can upgrade the runtime licenses of WinCC flexible 2008 and WinCC V7 with an upgrade to WinCC Runtime V12.

Productive operation of the software is only allowed with a valid Certificate of License that matches the version listed on it.

#### Non-licensed mode

WinCC Runtime and the Runtime add-ons can be used freely without license. An alert for non-licensed mode is presented every 10 minutes by a window requiring acknowledgment.

#### See also

Licensing of WinCC Engineering System (Page 98)

#### Licensing of HMI devices

Non-PC-based HMI devices are always equipped to maximum capacity. A license key is not required for runtime operation.

A license is required for each add-on for non-PC-based HMI devices. The license key of the respective license always activates one instance for use.

#### License key

To be able to license non-PC-based HMI devices with license keys, you require the "SIMATIC HMI License Manager Panel Plug-in" add-on.

WinCC Setup installs this add-on by default. You can open the License Manager Panel plug-in in the Automation License Manager with the menu command "Edit > Connect Target System > Connect HMI Device".

If WinCC is not installed, an installation of ProSave 7.2 or higher is required.

---

#### Note

Further information about handling the licenses can be found in the Automation License Manager help.

---

**Note**

Verify that the current release of the operating system is installed on the HMI device before you start licensing. If necessary, update the operating system using ProSave.

**Data backup****NOTICE****Destruction of license keys on non-PC-based HMI devices**

Installed license keys and authorizations are destroyed by the backup/restore processes on the HMI devices listed below.

- 270 series
- 370 series

Carry out the following before beginning restoring:

- Use the Automation License Manager and ProSave to check whether license keys are installed on the HMI device.
- Remove any license keys present on the HMI device.  
After restoring has been carried out, re-install the license keys on the HMI device.

**Non-licensed mode**

Runtime add-ons can also be used without a license without restriction. An alert for non-licensed mode is presented every 10 minutes by a window requiring acknowledgment.

**See also**

Licensing of WinCC Engineering System (Page 98)

**Working with license keys****Introduction**

Install a license key in the following situations:

- To use the WinCC Engineering System
- To use add-ons for the WinCC Engineering System
- To operate WinCC Runtime
- To use add-ons for WinCC Runtime on PC-based HMI devices
- To use add-ons on non-PC-based HMI Devices

To uninstall a license key in the following cases:

3.1 System requirements for installation

- When backing up data
- If you no longer require the license

You can then use this license on another PC or HMI device.

When you install a license, the associated license key is removed from the license key storage location.

---

**Note**

A license key cannot be copied. The copy protection employed prevents the license keys from being copied.

---

**Data backup**

Remove the license keys on the HMI device when backing up data on the HMI device and when creating a backup during device replacement.

You use the Automation License Manager to back up license keys of a HMI device to the storage area of the license key.

**NOTICE**

**Destruction of license keys on non-PC-based HMI devices**

Installed license keys are destroyed by backup/restore processes on the HMI devices listed below.

- 270 series
- 370 series

Carry out the following before beginning restoring:

- Use the Automation License Manager and ProSave to check whether license keys are on the HMI device.
- Remove any license keys present on the HMI device.  
After restoring has been carried out, re-install the license keys on the HMI device.

**NOTICE**

**Destruction of license keys on PCs**

Start by removing all license keys in the following situations:

- Before you format the hard disk
- Before you compress the hard disk
- Before you restore the hard disk
- Starting an optimization program that moves fixed blocks
- Installing a new operating system

Read the description of Automation License Manager ("Start > Simatic Automation > Documentation"). Observe all warnings and notices.

The license key storage location on PC-based HMI devices and on non-PC-based HMI devices where Automation License Manager is used may contain multiple license keys. This capability means you can store multiple licenses of the same type at one location. Save all license keys of the HMI device to the same storage location.

**NOTICE**

Always keep the original storage location of the license keys.

**Invalid license after time zone change**

The installed license no longer functions in the following case.

- If you change the time zone on a WinCC PC as follows:
  - From a time based on a complete hour to a time not based on a complete hour.  
Example: You change the time zone from GMT +3:00 to GMT +3:30.

To avoid this inconvenience, uninstall the license key under the time zone setting that was set when the license key was installed.

Example:

You have installed the license key with a time zone setting based on a full hour. Then also uninstall the license key with a time zone setting based on a full hour.

This behavior does not apply to the trial license.

**Defective license**

A license is defective in the following cases:

- If the license key is no longer accessible at the storage area.
- If the license key disappears during its transfer to the destination drive.

You can use the Automation License Manager to repair the defective license. Use the "Restore" function or the "Restore Wizard" of the Automation License Manager for this purpose. Contact Customer Support in order to restore the license. For additional information see: <http://support.automation.siemens.com>

**Note**

The runtime software can also be operated without errors if the license is missing or defective. The system alerts you at brief intervals that you are working in non-licensed mode.

**NOTICE**

If you start WinCC Engineering System without a valid license key, the system alerts you that you are working in non-licensed mode. You have the one-time option of activating a trial license. The trial license expires after 21 days.

When the trial license expires, the following scenarios can occur:

- WinCC was never licensed on the PC in question.  
WinCC can no longer be started.
- WinCC was already licensed on the PC in question.  
WinCC cannot be started. An alert for non-licensed mode is presented every 10 minutes by a window requiring acknowledgment.

**See also**

Licensing of WinCC Engineering System (Page 98)

**Powerpack**

**Introduction**

The following upgrades are possible with a Powerpack:

- From a smaller to a larger edition of WinCC Engineering System
- On a runtime system with greater quantity structure

A Powerpack also includes a special license using which you can at any time activate a higher level of WinCC for use.

**Engineering system**

You have WinCC Comfort, for example. You can use the "SIMATIC WinCC Advanced Powerpack WinCC Comfort -> WinCC Advanced V12" Powerpack to activate WinCC Advanced for use.

**Runtime**

You own WinCC Runtime Advanced with 128 tags, for example. You can use the "SIMATIC WinCC Runtime Advanced Powerpack 128 PowerTags -> 512 PowerTags V12" Powerpack to increase the capacity from 128 to 512 tags.

You own WinCC Runtime Advanced with 128 tags, for example. You can use the "SIMATIC WinCC Runtime Professional Powerpack Runtime Advanced 128 PowerTags -> Runtime Professional 128 PowerTags V12" Powerpack to activate WinCC Runtime Professional with 128 tags for use.

**See also**

Licensing of WinCC Engineering System (Page 98)



## **Installing a Powerpack**

### **Introduction**

Install a Powerpack by transferring the corresponding license key. The Powerpack license key replaces the license key of an existing installation.

### **Requirement**

- The conditions described in the "System requirements" chapter must be fulfilled.
- WinCC has been installed.
- The license key for the license for which you have purchased a Powerpack is available on the PC.

### **Installing a Powerpack**

1. Open the Automation License Manager.
2. Select the license key.
3. Select "License Key > Upgrade" in the menu.

### **Result**

The Powerpack license key replaces the former license key. You cannot reverse this process.

### **See also**

Licensing of WinCC Engineering System (Page 98)

## 3.2 Installation log

### Function of the installation log

The progress during the following installation processes is logged in a file:

- Installing products
- Modifying or updating already installed products
- Repairing an existing installation
- Uninstalling products

If errors occur during the installation process or warnings are issued, these can be evaluated with the help of the log file. You can do this yourself or contact product support.

### Installation logs storage location

The log file is the most recent file with the file extension ".log" and the name of which that starts with "SIA".

The location of the log file is stored in the environment variable "%autinstlog%". You can enter this environment variable in the address bar of Windows Explorer to open the folder with the log files. Alternatively, you can navigate to the corresponding directory by entering "CD %autinstlog%" in the command line.

The location depends on the operating system, e.g. "C:\Documents and Settings\All Users\Application Data\Siemens\Automation\Logfiles\Setup" in the English version of Windows XP.

### Setup\_Report (CAB file)

To make it easier to provide Product Support with all necessary files, an archive file that contains the installation log and all other required files is saved in CAB format. This archive can be found at "%autinstlog%\Reports\Setup\_report.cab". Send this CAB file to Product Support if you need assistance with installation. With this information, Product Support can determine whether the installation was executed properly. CAB files that were generated during earlier installation processes are saved with a date ID in the "Reports" directory.

### See also

Notes on licenses (Page 83)

Starting installation (Page 107)

Installing Support Packages (Page 109)

Displaying the installed software (Page 110)

Modifying or updating installed products (Page 111)

Repairing installed products (Page 113)

Starting to uninstall (Page 115)

## 3.3 Starting installation

### Introduction

Software packages are installed automatically by the setup program. The setup program starts once the installation medium has been inserted in the drive.

### Requirement

- Hardware and software of the programming device or PC meet the system requirements.
- You have administrator privileges on your computer.
- All running programs are closed.

### Procedure

To install the software packages, follow these steps:

1. Insert the installation medium in the relevant drive.  
The setup program starts automatically unless you have disabled Autostart on the programming device or PC.
2. If the setup program does not start up automatically, start it manually by double-clicking the "Start.exe" file.  
The dialog for selecting the setup language opens.
3. Choose the language in which you want the setup program dialogs to be displayed.
4. To read the information on the product and installation, click the "Read Notes" or "Installation Notes" button.  
The help file containing the notes opens.
5. Once you have read the notes, close the help file and click the "Next" button.  
The dialog for selecting the product languages opens.
6. Select the languages for the product user interface, and click the "Next" button.

---

#### Note

"English" is always installed as the basic product language.

---

The dialog for selecting the product configuration opens.

7. Select the products you want to install:
  - If you wish to install the program in a minimal configuration, click on the "Minimal" button.
  - If you wish to install the program in a typical configuration, click on the "Typical" button.
  - If you wish to personally select the products to be installed, click on the "User-defined" button. Then select the check boxes for the products you wish to install.
8. If you want to create a shortcut on the desktop, select the "Create desktop shortcut" check box.
9. Click the "Browse" button if you want to change the target directory for the installation. Note that the length of the installation path must not exceed 89 characters.

### 3.3 Starting installation

10. Click the "Next" button.  
The dialog for the license terms opens.
11. To continue the installation, read and accept all license agreements and click "Next".  
If changes to the security and permissions settings are required in order to install the TIA Portal, the security settings dialog opens.
12. To continue the installation, accept the changes to the security and permissions settings, and click the "Next" button.  
The next dialog displays an overview of the installation settings.
13. Check the selected installation settings. If you want to make any changes, click the "Back" button until you reach the point in the dialog where you want to make changes. Once you have completed the desired changes, return to the overview by clicking on "Next".
14. Click the "Install" button.  
Installation is started.

---

**Note**

If no license key is found during installation, you have the chance to transfer it to your PC. If you skip the license transfer, you can register it later with the Automation License Manager.

Following installation, you will receive a message indicating whether the installation was successful.

---

15. It may be necessary to restart the computer. If this is the case, select the "Yes, restart my computer now." option button. Then click "Restart".
16. If the computer does not reboot, click "Exit".

### Result

The TIA Portal along with the products and licenses you have ordered and the Automation License Manager have been installed on your computer.

### See also

- Installation log (Page 106)
- Notes on the system requirements (Page 84)
- Notes on licenses (Page 83)
- Displaying the installed software (Page 110)
- Modifying or updating installed products (Page 111)
- Repairing installed products (Page 113)
- Starting to uninstall (Page 115)

## 3.4 Installing Support Packages

You can install subsequent support packages, for example, hardware support packages, in the TIA Portal.

---

**Note**

Support packages for STEP7 V5.4 or V5.5 cannot be used.

---

### Procedure

To install a Support Package, follow these steps:

1. Click "Support packages" in the "Options" menu.  
The "Detailed information" dialog opens. A table lists all support packages from the directory that you selected as the storage location for support packages in the settings.
2. If you want to install a support package that is not in the list, you have the following options:
  - If the support package is already on your computer, you can add it to the list by selecting "Add from the file system".
  - If you add a support package from the "Service & Support" page on the Internet, first you download it by selecting "Download from the Internet". Then you can add it from the file system.
3. Select the support package that you want to install.
4. Click "Install."
5. Close and then restart the TIA Portal.

### See also

Installation log (Page 106)

## 3.5 Displaying the installed software

You can find out which software is installed at any time. In addition, you can display more information on the installed software.

### Procedure

To display an overview of the software installed, follow these steps:

1. Click "Installed software" in the "Help" menu.  
The "Installed software" dialog opens. You will see the installed software products in the dialog. Expand the entries to see which version is installed in each case.
2. If you would like to display additional information on the installed automation software, click the link on the "Detailed information about installed software" dialog.  
The "Detailed information" dialog opens.
3. Chose the topic you want more information about in the area navigation.

### See also

Notes on the system requirements (Page 84)

Notes on licenses (Page 83)

Starting installation (Page 107)

Modifying or updating installed products (Page 111)

Repairing installed products (Page 113)

Starting to uninstall (Page 115)

Installation log (Page 106)

## 3.6 Modifying or updating installed products

You have the option to modify installed products using the setup program or to update to a new version.

### Requirement

- Hardware and software of the programming device or PC meet the system requirements.
- You have administrator privileges on your computer.
- All running programs are closed.

### Procedure

To modify or update installed products, follow these steps:

1. Insert the installation medium in the relevant drive.  
The setup program starts automatically unless you have disabled Autostart on the programming device or PC.
2. If the setup program does not start up automatically, start it manually by double-clicking the "Start.exe" file.  
The dialog for selecting the setup language opens.
3. Choose the language in which you want the setup program dialogs to be displayed.
4. To read the information on the product and installation, click the "Read Notes" or "Installation Notes" button.  
The help file containing the notes opens.
5. Once you have read the notes, close the help file and click the "Next" button.  
The dialog for selecting the installation variant opens.
6. Select the "Modify/Upgrade" option button and click the "Next" button.  
The dialog for selecting the product languages opens.
7. Select the check boxes of the product languages that you want to install. You can remove previously installed product languages by clearing the corresponding check boxes.

---

#### Note

Note that the product language "English" cannot be removed.

---

8. Click the "Next" button.  
The dialog for selecting the product configuration opens.
9. Select the check boxes of the components that you want to install. You can remove previously installed components by clearing the corresponding check boxes.

10. Click the "Next" button.

---

**Note**

Note that you cannot change the target directory because the existing installation is being modified.

---

If changes to the security and permissions settings are required in order to install the TIA Portal, the security settings dialog opens.

11. To continue the installation, accept the changes to the security and permissions settings, and click the "Next" button.

The next dialog displays an overview of the installation settings.

12. Click the "Modify" button.

This starts the installation of the additional components.

---

**Note**

Following installation, you will receive a message indicating whether the existing installation was successfully changed.

---

13. It may be necessary to restart the computer. If this is the case, select the "Yes, restart my computer now." option button. Then click "Restart".

14. If the computer does not reboot, click "Exit".

## Result

The existing installation has been modified on your computer.

## See also

Notes on the system requirements (Page 84)

Notes on licenses (Page 83)

Starting installation (Page 107)

Displaying the installed software (Page 110)

Repairing installed products (Page 113)

Starting to uninstall (Page 115)

Installation log (Page 106)



## 3.7 Repairing installed products

You have the option to repair installed products by completely reinstalling them using the setup program.

### Requirement

- Hardware and software of the programming device or PC meet the system requirements.
- You have administrator privileges on your computer.
- All running programs are closed.

### Procedure

To repair installed products, follow these steps:

1. Insert the installation medium in the relevant drive.  
The setup program starts automatically unless you have disabled Autostart on the programming device or PC.
2. If the setup program does not start up automatically, start it manually by double-clicking the "Start.exe" file.  
The dialog for selecting the setup language opens.
3. Choose the language in which you want the setup program dialogs to be displayed.
4. To read the information on the product and installation, click the "Read Notes" or "Installation Notes" button.  
The help file containing the notes opens.
5. Once you have read the notes, close the help file and click the "Next" button.  
The dialog for selecting the installation variant opens.
6. Select the "Repair" option button, and click the "Next" button.  
The next dialog displays an overview of the installation settings.
7. Click the "Repair" button.  
This starts the repair of the existing installation.

---

#### Note

Following installation, you will receive a message indicating whether the existing installation was successfully repaired.

---

8. It may be necessary to restart the computer. If this is the case, select the "Yes, restart my computer now." option button. Then click "Restart".
9. If the computer does not reboot, click "Exit".

### Result

The installed products have been reinstalled.

**See also**

Notes on the system requirements (Page 84)

Notes on licenses (Page 83)

Starting installation (Page 107)

Displaying the installed software (Page 110)

Modifying or updating installed products (Page 111)

Starting to uninstall (Page 115)

Installation log (Page 106)

## 3.8 Starting to uninstall

### Introduction

Software packages are removed automatically by the setup program. Once started, the setup program guides you step-by-step through the entire removal procedure.

You have two options for removing:

- Removing selected components via the Control Panel
- Removing a product using the installation medium

---

#### Note

The Automation License Manager will not be removed automatically when you remove the software packages, because it is used for the administration of several license keys for products supplied by Siemens AG.

---

### Removing selected components via the Control Panel

To remove selected software packages, follow these steps:

1. Open the Control Panel with "Start > Settings > Control Panel".
2. Double click on "Add or Remove Programs" in the control panel.  
The "Add or Remove Programs" dialog opens.
3. Select the software package to be removed in the dialog "Add or Remove Programs", and click "Remove".  
The dialog for selecting the setup language opens.
4. Select the language in which you want the dialogs of the setup program to be displayed and click "Next".  
The dialog for selecting the products you want to remove opens.
5. Select the check boxes for the products that you want to remove and click "Next".  
The next dialog displays an overview of the installation settings.
6. Check the list with the products to be removed. If you want to make any changes, click the "Back" button.
7. Click the "Uninstall" button.  
Removal begins.
8. It may be necessary to restart the computer. If this is the case, select the "Yes, restart my computer now." option button. Then click "Restart".
9. If the computer does not reboot, click "Exit".

### Removing a product using the installation medium

To remove all software packages, follow these steps:

1. Insert the installation medium in the relevant drive.  
The setup program starts automatically unless you have disabled Autostart on the programming device or PC.
2. If the setup program does not start up automatically, start it manually by double-clicking the "Start.exe" file.  
The dialog for selecting the setup language opens.
3. Choose the language in which you want the setup program dialogs to be displayed.
4. To read the information on the product and installation, click "Read product information" or "Read installation notes".  
The help file containing the notes opens.
5. Once you have read the notes, close the help file and click the "Next" button.  
The dialog for selecting the installation variant opens.
6. Select the "Uninstall" option button and click the "Next" button.  
The next dialog displays an overview of the installation settings.
7. Click the "Uninstall" button.  
Removal begins.
8. It may be necessary to restart the computer. If this is the case, select the "Yes, restart my computer now." option button. Then click "Restart".
9. If the computer does not reboot, click "Exit".

### See also

Installation log (Page 106)

Notes on the system requirements (Page 84)

Notes on licenses (Page 83)

Starting installation (Page 107)

Displaying the installed software (Page 110)

Modifying or updating installed products (Page 111)

Repairing installed products (Page 113)

## 3.9 Installing and uninstalling the migration tool

### 3.9.1 System requirements

#### System requirements for the migration tool

The following system requirements apply to the use of the migration tool:

- All products used to create the source project must be installed. The following products are supported:
  - WinCC flexible 2008 SP2 and SP3
  - WinCC V7.0 SP3
  - STEP 7 V5.5
  - Integrated projects from STEP 7 V5.5 and the WinCC products listed above
  - SINUMERIK
  - STARTER and Startdrives
  - SIMOTION SCOUT V4.4  
You need the SCOUT Migration Tool PlugIn V4.4 to migrate SIMOTION SCOUT V4.4 projects.
- All optional packages needed to process the STEP 7 project are installed. For example, all HSPs for the devices used in the source project are required.

### 3.9.2 Installing the migration tool

#### Distribution of the migration tool

You can find the migration tool in the "Support" directory on the installation DVD of the TIA Portal. Alternatively, it can be downloaded from the Service & Support area of the Siemens website. For some products, (such as SIMATIC Failsafe or SIMOTION) additional plug-ins are required for the migration tool. These plug-ins can also be downloaded from the Service & Support page or installed from the installation DVD of the specific products.

Normally, the migration tool is installed without the TIA Portal. Because the TIA Portal has its own integrated migration function, a separate installation of the migration tool is not necessary.

## Procedure

To install the migration tool, proceed as follows:

1. Download the installation DVD from the Service & Support area of the Siemens website or use the installation file from the "Support" directory of the installation DVD of the TIA portal to perform the installation.
2. Run the installation file.  
The setup program for the migration tool will open.
3. First, select the language in which the setup should be displayed and click the "Next" button.  
The page for selecting the software language is displayed.
4. Since the migration tool is provided exclusively in English, you cannot choose any other language for the installation. Therefore, click "Next" to proceed to the next step.  
The page for selecting the product is displayed.
5. The migration tool consists solely of a software component. Therefore, the migration tool is already selected.  
To create a Desktop icon for starting the migration tool, select the check box "Create Desktop icon". Then click the "Next" button.  
The page for confirming the licensing terms is shown.
6. Click on an entry in the list of license terms to read the selected license term. If you agree with all license terms, select the check box "I accept the terms of the displayed license agreement". Then click the "Next" button.  
An overview of the installation is displayed.
7. Click the "Install" button.  
The installation is performed with the displayed settings.

### 3.9.3 Uninstalling the migration tool

The migration tool can be removed using the Control Panel.

## Procedure

To remove the migration tool, follow these steps:

1. Open the Control Panel.
2. Double click on "Add or Remove Programs" in the Control Panel.  
The "Add or Remove Programs" dialog opens.
3. Select the entry for the migration tool in the "Add or Remove Programs" dialog, and click the "Remove" button.  
A security prompt appears.
4. Click the "Uninstall" button to confirm this prompt.  
The migration tool will be removed.

# Migrating projects and programs

## 4.1 Migrating projects in a TIA portal project

### 4.1.1 Migration of projects with the TIA Portal

#### Migration of existing projects

You can migrate projects from earlier automation solutions to the TIA Portal. Each time you migrate, a new project is created for the migrated data with which you can then work. Any TIA Portal projects already open are closed first.

The migration is then displayed in the table of the project history. From there, you have access to the migration log that is created automatically for the migration.

#### Supported products for migration

The chapter "System overview STEP 7 and WinCC" includes information on the products that are available for the TIA Portal. In principle, all products listed there are supported by the TIA Portal during migration.

Any additional requirements that must be met depend on the initial products that were used and the currently installed products. For more information on the migration options for your products, you can, for example, refer to the Service & Support Internet pages and the documentation of your software products.

See also: Scaling of STEP 7 and WinCC (Page 29)

#### Procedure during migration

The migration process is divided into the following basic steps:

##### 1. Preparing the initial project

If the software for editing the initial project is not or not fully installed on the programming device/PC with the TIA Portal, or if the initial project is an integrated project, the initial project must first be converted into a migration file. To do this, install the migration tool on a programming device/PC on which the required software for editing the initial project is installed. Then, use the migration tool to convert the initial project, and copy the file to the programming device/PC on which the TIA Portal is installed. You can omit this step if the initial project and its associated software are on the same programming device/PC as the TIA Portal, and if the initial project is not an integrated project.

##### 2. Performing migration

Perform the actual migration within the TIA Portal. For the migration, either specify as source the migration file which you have created with the migration tool or specify the initial project when all required software has been installed.

#### 4.1 Migrating projects in a TIA portal project

##### 3. Checking the migration log

A migration log is created for each migration. It contains information about modified project parts. You can call the log under "Shared files > Logs" in the project tree or in the project history. After completion of the migration, the migration log will be displayed in the TIA Portal. Check the log following completion of the migration.

If the migration failed, an XML file is created as a log under "Logs" in the project directory. You can use any XML editor to open this log and view the reasons why the migration failed.

##### 4. Correcting the migrated project

Because the configurations of the initial project may not always be completely compatible with the TIA Portal, not all configurations are transferred in identical form in the migrated project. You should therefore work through the points in the migration log systematically.

If you have not included the hardware configuration in the migration, you also have to convert the unspecified devices to the appropriate hardware.

#### Including the hardware configuration in the migration

By default, only the software parts of the project are included in the migration. An unspecified device is generated in the migrated project for the devices contained in the initial project. The hardware and network configurations and the connection are not migrated. You can convert the unspecified devices into suitable devices after the migration and create any network configurations and connections manually.

If you are certain that the hardware used in the initial project has a corresponding equivalent in the TIA Portal, you can include the hardware configuration in the migration. In this case, both the hardware configuration and the software are migrated.

#### See also

Display migration log (Page 125)

Scaling of STEP 7 and WinCC (Page 29)

### 4.1.2 Preparing projects with the migration tool

#### 4.1.2.1 Migrating projects with the migration tool

##### Preparation for migration

In many cases, a project that you wish to migrate will not be located on the same programming device/PC on which the latest version of the TIA Portal is installed. Therefore, the initial project must first be converted to a compatible format for the migration. The same applies to integrated projects.

After creation of the migration file, you copy the migration file to the programming device/PC on which the current version of the TIA Portal is installed. In the TIA Portal, enter the migration file as source for the migration. You can now create a project in the current file format of the TIA Portal.



## **Procedure for migration with the migration tool**

The following steps are necessary to prepare a migration with the migration tool:

1. Install the migration tool on the programming device/PC where the source project is located. To do this, download the installation file from the Service & Support area of the Siemens website or install the migration tool from the setup DVD of the TIA Portal.
2. Start the migration tool and use it to convert the source project into the migration file format with file extension ".am12".  
For this step, make sure that all software needed to process the source project is installed on the programming device/PC. This also includes all necessary service packs, hardware support packages and all expansion software that is needed to process the initial project. If individual products are not installed it may not be possible to perform the migration or the migration may be incomplete.
3. Copy the migration file to the target system on which a current version of the TIA Portal is installed.  
Note that the target system must have been installed with all software needed to configure the complete set of devices contained in the migration.
4. Perform the migration within the TIA Portal, and specify the migration file with the extension ".am12" as the source.
5. Once migration is complete, check the migration log and systematically work through the information provided there for the newly created project. Read the information in the Inspector window with special care after the first compilation of the configuration.

## **Including the hardware configuration in the migration**

By default, only the software parts of the project are included in the migration. An unspecified device is generated in the migrated project for the devices contained in the initial project. The hardware and network configurations and the connection are not migrated. You can convert the unspecified devices into suitable devices after the migration and create any network configurations and connections manually.

If you are certain that the hardware used in the initial project has a corresponding equivalent in the TIA Portal, you can include the hardware configuration in the migration. In this case, both the hardware configuration and the software are migrated.

## **See also**

Migration of projects with the TIA Portal (Page 119)

Migrating projects (Page 123)

Calling the migration tool (Page 122)

Creating a migration file (Page 122)

### 4.1.2.2 Calling the migration tool

#### Starting the migration tool

During the installation, a "Migration to TIA Portal V12" shortcut is created as standard in the Start menu under "Siemens Automation > Migration Tool". Click this shortcut.

Alternatively, you can call the migration tool directly in Windows Explorer. The migration tool is saved to the following default folder during installation: "C:\Program Files\Siemens\Automation\Portal V12\bin". To start the migration tool, click the "Siemens.Automation.MigrationApplication.exe" file in this directory.

#### See also

Creating a migration file (Page 122)

### 4.1.2.3 Creating a migration file

The section below describes how you can use the migration tool to convert the initial project into a migration file that can be read by the TIA Portal. Following conversion, this file is transferred to the target system and migrated there.

You can specify whether the migration file should contain the entire project, including the complete hardware configuration and the associated software, or whether you want to migrate the software only.

#### Requirement

- The suitable, original software with a valid license is installed for all configurations used in the initial project.
- The initial project is not provided with access protection.
- The initial project must be consistent, otherwise problem-free migration cannot be assured.

#### Procedure

To create the migration file, follow these steps:

1. Choose the path of the source file for the migration in the "Storage Location (Path)" field.
2. Specify which project parts are to be migrated:
  - Select the "Include HW and Network data during the migration" check box to migrate not only the software but also the complete hardware parts and the network configuration of the project.
  - Select the "Copy SCADA runtime data" check box if you also want to migrate the runtime data, such as alarm archives, tag archives and user archives, in addition to the data of the engineering system.
3. Choose the path and the file name for the migration file in the "Intermediate file".
4. Click the "Migrate" button.

**Result:**

A migration file is created. Finally, copy this file to the target system and migrate this file in the TIA Portal.

**See also**

Migrating projects (Page 123)

Calling the migration tool (Page 122)

Migrating projects with the migration tool (Page 120)

### 4.1.3 Migrating projects

**Requirement**

- A converted file in the format ".am12" is already available or the original software with a valid license is installed for all configurations used in the initial project.
- The initial project is not provided with access protection.
- The initial project must be consistent, otherwise problem-free migration cannot be assured.

Read the additional information on the requirements in the help for the respective products installed.

---

**Note**

**System hibernation during the migration**

While a migration is running, the system should not be changed to the standby or hibernate mode. Otherwise the migration will be aborted.

---

**Procedure**

To migrate a project, follow these steps:

1. Select the "Migrate project" command in the "Project" menu.  
The "Migrate project" dialog opens.
2. Specify the path and the file name for the project to be migrated in the "Source path" field.  
Choose either a project in the ".am12" migration format or in the format of the initial project.
3. To include the hardware configuration in the migration, select the "Include hardware configuration" check box.  
If you have selected a migration file that was created with the migration tool, the check box cannot be selected. In this case, you must specify if you wish to include the hardware configuration in the migration before the conversion with the migration tool .

*4.1 Migrating projects in a TIA portal project*

4. Select the "Copy WinCC Runtime Professional data" check box, if you also want to migrate the runtime data, such as alarm archives, tag archives and user archives, in addition to the data of the engineering system.  
If you have selected a migration file that was created with the migration tool, the check box cannot be selected. In this case, you must specify if you wish to include the SCADA runtime data in the migration before the conversion with the migration tool .
5. Choose a name for the new project in the "Project name" box.
6. Choose a path in the "Target path" box where the new project will be created.
7. Enter your name or the name of another person responsible for the project in the "Author" field.
8. Enter a comment in the "Comment" box, if you require one.
9. Click "Migrate".

**Result**

The initial project is converted and a message appears after conversion is complete. The newly created project is then opened in the project view and the migration log is opened in the TIA Portal.

Even if the migration failed, a project directory is created and a migration log in the form of an XML file is generated in this directory. The completion message that appears after the migration contains a link to this XML file. Click the link to open the XML file. Alternatively, you can find the XML file in the project directory under "\Logs".

**See also**

Post-editing integrated projects (Page 176)

Display migration log (Page 125)

Using logs (Page 258)

Migrating projects with the migration tool (Page 120)

Creating a migration file (Page 122)

**4.1.4 Displaying the history of the migration**

If a project was created by migration, the migration will be listed in the table of the project history. You can open the migration log in the table. The time of the migration is also shown.

## Procedure

To display the migration in an overview table, follow these steps:

1. Select the open project in the project tree.
2. Select "Properties" in the shortcut menu of the project.  
The dialog with the properties of the project opens.
3. Select the "Project history" group in the area navigation.  
The overview table is displayed.

## See also

Displaying properties of the project (Page 263)

### 4.1.5 Display migration log

A log is created for each successful migration. The log contains the following information:

- Migrated objects
- Modifications to objects made during migration
- Errors that occurred during migration
- In certain cases a link to more help with specific events.  
In this case, click the question mark to obtain more help.

## Procedure

To display the log file of the migration, follow these steps:

1. Open the "Common data > Logs" folder in the project tree.
2. Double-click the desired log in the list.  
The contents of the log are displayed in the work area.

## See also

Migration of projects with the TIA Portal (Page 119)

Using logs (Page 258)

## **4.1.6 Migrating WinCC flexible projects (Advanced)**

### **4.1.6.1 Principles (WinCC flexible)**

#### **Migration (WinCC flexible)**

##### **Introduction**

You can continue to use projects in WinCC from WinCC flexible. The following versions of WinCC flexible are supported:

- WinCC flexible 2008 SP2
- WinCC flexible 2008 SP3

The following sections describe the HMI devices that are supported and the required basic conditions for a successful migration.

Projects from ProTool Pro and earlier WinCC flexible versions cannot be migrated directly to WinCC. If you want to continue using such projects in WinCC, you have to migrate these to a supported version of WinCC flexible first and change the HMI device type.

If the project to be migrated contains components of a supported option package, the option package must be installed for successful migration to WinCC. If the option package is not installed, migration is canceled. This concerns the following option packages:

- SINUMERIK

The following option packages are not supported by the migration:

- ProAgent
- Open Platform Program - OPP

##### **See also**

Migrating projects from WinCC flexible (WinCC flexible) (Page 129)

Compiling and loading a migrated project (WinCC flexible) (Page 131)

Supported HMI devices (WinCC flexible) (Page 132)

Migration of connections (WinCC flexible) (Page 140)

Migration of tags (WinCC flexible) (Page 144)

Migration of runtime data (WinCC flexible) (Page 153)

Migration of integrated projects (WinCC flexible) (Page 156)

## Migration principles (WinCC flexible)

### Introduction

In the migration the project data are converted from a WinCC flexible project into the new data format of WinCC. The data will not be evaluated to see if they are consistent in the project you want to migrate. If errors or warnings are output in a source project during compilation, these will not be resolved as part of the migration. This means you should be able to compile the project without errors prior to migration. Note the scope of a project during migration. The features of WinCC apply for migration. For additional information refer to the online help in chapter "Process visualization > Performance features > Engineering System".

### Unique object names

The objects are clearly identified by the folders in which they are contained in WinCC flexible. Screen objects in groups are clearly identified by the group name.

In WinCC, an object name must be unique within an HMI device. The name of screen objects must be unique within a screen.

The uniqueness of the name is verified during migration. If a name is not unique according to the new rule, the object in question will be renamed. A renamed object will receive the suffix "#Mign", where "n" stands for a sequential number.

---

#### Note

##### Changed OPC DA server name

If you have configured an OPC-DA server in the WinCC flexible project, the OPC-DA server is no longer available under the old name after migration.

In the migrated project, change the name of the OPC-DA server to the following value for the OPC clients concerned: "OPC.SimaticHMI.CoRtHmiRTm".

---

### Points to note when renaming tags

If you have structured tags in folders in WinCC flexible, the name of the tag will be formed during migration from the folder name and the tag name. The names of the folders and tags are separated by the character \. The name of the tag after migration is then, for example: Plant1\Line3\Tag17.

If the name would otherwise be longer than 128 characters after migration, the name is formed by the character string #mig, a consecutive number, the character # and the tag name from WinCC flexible, for example #mig2#Tag17.

If you dynamically compose tag names in scripts, you must check the tags whose names were changed during migration with "#mig".

## **Affected objects**

The following objects are renamed if necessary:

- Screens
- Faceplates
- Screen objects
- Graphics
- Recipes
- Structures
- Structural elements
- Alarm logs
- Tags
- Data logs
- Connections

## **Cancelling migration**

The migration is cancelled in the following cases:

- If the project to be migrated is opened in the engineering system or in Runtime.
- If not enough memory space is available on the hard disk to create a copy for migration of the project.
- If the migration cannot address the project database due to problems with the installed SQL-Server.
- If the migration cannot address the project database due to missing user authorization.
- If you select the "\*.hmi" file for the migration in an integrated project. You must select the "\*.s7" file for the migration in an integrated project.
- If the project was created with a version not supported by the migration.

## **Saving the project in the migration format**

You do not have to execute the migration of a WinCC flexible project completely on the PC on which the project is available. You can prepare the migration by saving the project in the migration format. The migration tool is available for saving a WinCC flexible project in the migration format. The migration tool exports the engineering data from the WinCC flexible project and saves the data in the migration format "\*.AM11".

For the actual migration, copy the data in the migration format to a PC on which the TIA-Portal is installed.

For more detailed information, please refer to the migration tool documentation.



## **Migrating projects from WinCC flexible (WinCC flexible)**

### **Introduction**

When you migrate a project, data from a WinCC flexible project is loaded into a new project for WinCC. A new project is therefore created automatically for project migration. You cannot migrate to an existing project.

The migration can be started in both the Portal view and the Project view.

You should only migrate a project in a newly started TIA portal.

Information on the migration of an integrated project can be found in the section Migration of integrated projects (WinCC flexible) (Page 156).

If you only want to save the project in migration format, you can use the migration tool. See Migration principles (WinCC flexible) (Page 127) for additional information.

### **Requirement**

- A project from WinCC flexible is available.
- The project is not open in WinCC flexible.

### Procedure

Migrate a project in the Portal view as follows:

1. Select the action "Start > Migrate Project".

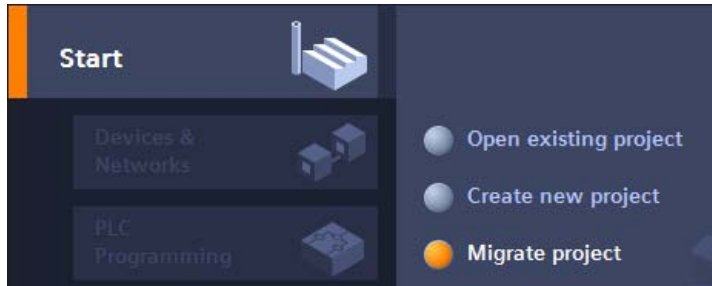

2. In the "Source path" box, navigate to the project you want to migrate.

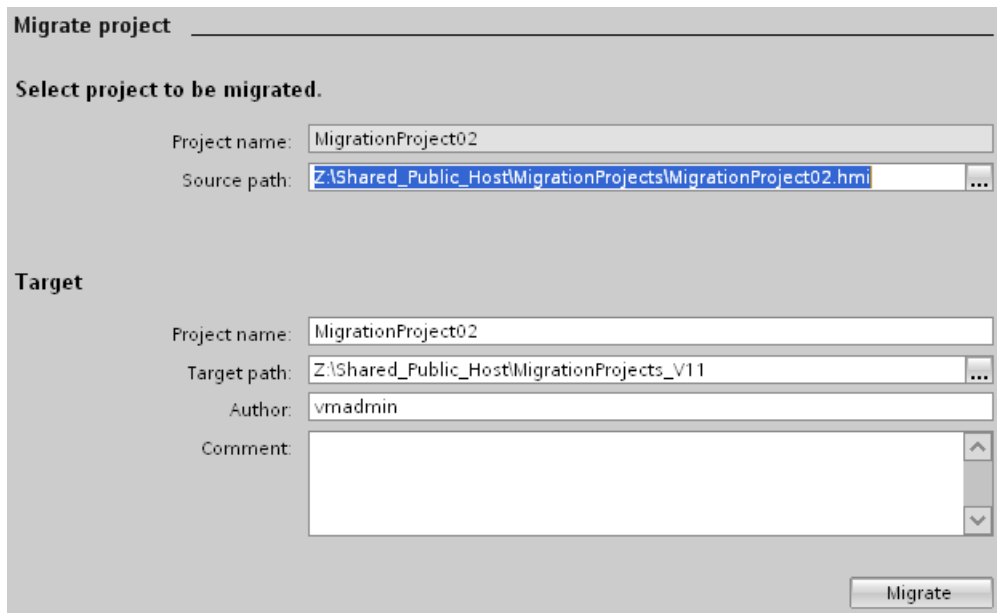

3. Select the WinCC flexible project file "\*.hmi".
4. Change the information for the project to be created, if necessary. For example, change the project name or project path. The data to be migrated is created in the new project.
5. Click "Migrate".
  - A new project is created and migration of the data is started:
    - The Project view opens.
    - The progress of the migration is shown in a migration window.
    - Warnings and errors about the migration process are displayed in the Inspector window under "Info > General".
    - All information about the migration is saved in a log file.
    - The project is saved and a message displayed upon completion of the migration. The message contains a link that you can use to open the log.

When migration is complete, you will find a newly created device for each migrated HMI device in the project tree. These devices contain the migrated data, such as screens, alarms and tags.

### **Opening the migration log at a later point in time**

The migration log is saved together with the migrated project. You can view the log at a later point in time. Open the log as follows:

1. Open the "Common data > Logs" folder in the project tree. It contains the logs of all previously performed migrations.
2. Double-click the required migration log.  
The log is opened.

### **See also**

Migration (WinCC flexible) (Page 126)

Migration of integrated projects (WinCC flexible) (Page 156)

Migration principles (WinCC flexible) (Page 127)

### **Compiling and loading a migrated project (WinCC flexible)**

#### **Compiling a migrated project**

Once you have successfully migrated a WinCC flexible project, you need to recompile it before loading it to the HMI device. The project will only compile successfully if it was capable of error-free compiling prior to migration.

If errors occur during compilation of the migrated project, they have to be eliminated.

Once compiling is successfully completed, load the project to the HMI device.

#### **Settings for download to the HMI device**

The settings for loading the HMI device are not included in the migration. Once you have migrated the project, you must configure the settings for loading.

Select the HMI device in the project tree and select "Loading in device > Software (complete loading)" from the shortcut menu. The dialog "Advanced Loading" is opened. Configure the required settings for the interface. Click the "Load" button. The project is recompiled and the dialog "Load preview" is opened.

Expand the "Overwrite" entry and verify the settings for the following options:

- Would you like to overwrite the existing user administration data from this device
- Would you like to overwrite the existing recipe data on HMI system

Configure the options as you want to use them in the project in the future. Subsequently, load the project to the HMI device.

## See also

Migration (WinCC flexible) (Page 126)

### 4.1.6.2 Migrating engineering data (WinCC flexible)

#### HMI devices (WinCC flexible)

#### Supported HMI devices (WinCC flexible)

##### Introduction

When migrating projects from WinCC flexible you must bear in mind that WinCC does not support all HMI devices. You have to distinguish between the following cases:

- HMI device is supported by WinCC.  
The project is migrated 1:1 and gets the same HMI device after migration as before migration.
- The HMI device is replaced by a compatible successor model.  
The project is migrated. The migration replaces the HMI device with a compatible successor model. See HMI device change as a result of migration (WinCC flexible) (Page 134) for additional information.
- HMI device is not supported.  
If your WinCC flexible project contains an HMI device that is not supported by WinCC, the migration process is cancelled. To migrate the project, you must change the HMI device in WinCC flexible to a HMI device type supported by WinCC.

The following HMI device types are supported both by WinCC flexible and WinCC:

##### Basic Panels

- KTP400 Basic mono PN
- KTP400 Basic mono PN Portrait
- KTP600 Basic DP
- KTP600 Basic DP Portrait
- KTP600 Basic PN
- KTP600 Basic PN Portrait
- KTP600 Basic mono PN
- KTP600 Basic mono PN Portrait
- KTP1000 Basic DP
- KTP1000 Basic PN
- TP1500 Basic PN

## **Mobile Panels**

- Mobile Panel 177 6" DP
- Mobile Panel 177 6" PN
- Mobile Panel 277 8"
- Mobile Panel 277 8" IWLAN V2
- Mobile Panel 277F 8" IWLAN V2
- Mobile Panel 277F 8" IWLAN (RFID Tag)
- Mobile Panel 277 10"

## **Panels**

- OP 73
- OP 77A
- OP 77B
- OP 177B 6" mono
- OP 177B 6" color PN/DP
- TP 177B 4" color PN/DP
- TP 177A
- TP 177A Portrait
- TP 177B 6" mono DP
- TP 177B 6" color PN/DP
- OP 277 6"
- TP 277 6"

## **Multi Panels**

- MP 177 6" Touch
- MP 277 8" Key
- MP 277 8" Touch
- MP 277 10" Key
- MP 277 10" Touch
- MP 377 12" Key
- MP 377 12" Touch
- MP 377 15" Touch
- MP 377 15" Touch daylight readable
- MP 377 19" Touch

## **Sinumerik PC**

- OP 010 Key
- OP 012 Key
- OP 015 Key
- OP 015A Key
- TP 015A Touch+Key

## **HMI applications**

- WinCC flexible Runtime

WinCC only supports the functions provided by these HMI device types.

Other functions which are not migrated because of the restricted device selection are documented in the following sections.

## **Adaptations before migration**

If the HMI device was changed to an HMI device with a different screen size in the project to be migrated, you must recompile and save the project in WinCC flexible before the migration. The compilation process will adjust the size of the screens and screen elements.

## **See also**

Migration (WinCC flexible) (Page 126)

HMI device change as a result of migration (WinCC flexible) (Page 134)

Configuration change after HMI device change (WinCC flexible) (Page 137)

Migration of connections (WinCC flexible) (Page 140)

## **HMI device change as a result of migration (WinCC flexible)**

### **Introduction**

WinCC flexible supports some HMI devices which are discontinued in the future. These HMI devices are no longer supported by WinCC. When migrating a WinCC flexible project, an HMI device that is not supported is replaced by a compatible successor device.

Only the HMI device type is changed during the migration. HMI device-specific data are not changed by the migration.

Inconsistencies in the project may occur due to a change in the HMI device. In a project which was compilable before the migration, errors may occur in the project compilation after changing the HMI device. E.g. because the changed HMI device supports different memory media to the previous HMI device.

## HMI device change by the migration

The following table provides information about which successors replace the HMI devices that are not supported.

Unsupported HMI devices	Successors
C7-635 6" Key	MP 177 6" Touch
C7-635 6" Touch	MP 177 6" Touch
C7-636 6" Key	MP 177 6" Touch
C7-636 10" Touch	MP 277 10" Touch
HT 8	PCU50.3 -C (resolution: 640*480)
Mobile Panel 170 6"	Mobile Panel 177 6" DP
Mobile Panel 277 8" IWLAN	Mobile Panel 277 8" IWLAN V2
Mobile Panel 277F 8" IWLAN	Mobile Panel 277F 8" IWLAN V2
OP010 Key	PCU50.3B -C (resolution: 640*480)
OP012 Key	PCU50.3B -C (resolution: 800*600)
OP015 Key	PCU50.3B -C (resolution: 1024*768)
OP 08T	PCU50.3 -C (resolution: 640*480)
OP 73micro	OP 73
OP 170B 6" mono	OP 177B 6" color PN/DP
OP 270 6"	OP 277 6"
OP 270 10"	MP 277 10" Key
TP015A Touch Key	PCU50.3B (resolution: 1024*768)
TP 170A 6"	TP 177A 6"
TP 170B 6" mono	TP 177B 6" color PN/DP
TP 170B 6" color	TP 177B 6" color PN/DP
TP 170micro 6"	TP 177A
TP 177micro 6"	TP 177A
TP 270 6"	TP 277 6"
TP 270 10"	MP 277 10" Touch
MP 270 6" Touch	TP 277 6"
MP 270 10" Key	MP 277 10" Key
MP 270 10" Touch	MP 277 10" Touch
MP 370 12" Key	MP 377 12" Key
MP 370 12" Touch	MP 377 12" Touch
MP 370 15" Touch	MP 377 15" Touch
PC 477 12" Key	PC 477B 12" Key PB
PC 477 12" Touch	PC 477B 12" Touch PB
PC 477 15" Key	PC 477B 15" Key PB
PC 477 15" Touch	PC 477B 15" Touch PB
PC 477 19" Touch	PC 477B 19" Touch PB
PC 577 12" Key	IPC 577C 12" Key PB
PC 577 12" Touch	IPC 577C 12" Touch PB
PC 577 15" Key	IPC 577C 15" Key PB

Unsupported HMI devices	Successors
PC 577 15" Touch	IPC 577C 15" Touch PB
PC 577 19" Touch	IPC 577C 19" Touch PB
PC 670 10" Key	HMI IPC677C 12" Key PB
PC 670 12" Key	PC 677B 12" Key PB
PC 670 12" Touch	PC 677B 12" Touch PB
PC 670 15" Key	PC 677B 15" Key PB
PC 670 15" Touch	PC 677B 15" Touch PB
PC 677 12" Key	PC 677B 12" Key PB
PC 677 12" Touch	PC 677B 12" Touch PB
PC 677 15" Key	PC 677B 15" Key PB
PC 677 15" Touch	PC 677B 15" Touch PB
PC 677 17" Touch	PC 677B 17" Touch PB
PC 677 19" Touch	PC 677B 19" Touch PB
PC 870 12" Key	HMI IPC677C 12" Key PB
PC 870 15" Key	HMI IPC677C 15" Key PB
PC 870 15" Touch	HMI IPC677C 15" Touch PB
PC 877 12" Key	HMI IPC677C 12" Key PB
PC 877 15" Key	HMI IPC677C 15" Key PB
PC 877 15" Touch	HMI IPC677C 15" Touch PB
PC 877 19" Touch	HMI IPC677C 19" Touch PB
PC IL 70 12" Touch	HMI IPC577C 12" Touch PB
PC IL 70 15" Touch	HMI IPC577C 15" Touch PB
PC IL 77 12" Touch	HMI IPC577C 12" Touch PB
PC IL 77 15" Touch	HMI IPC577C 15" Touch PB
PC IL 77 19" Touch	HMI IPC577C 19" Touch PB
PC IL 77 12" Key	HMI IPC577C 12" Key PB
PC IL 77 15" Key	HMI IPC577C 15" Key PB
P012T Touch	IPC 677C 12" Touch PB (if a P350 is connected)
P012T Touch	IPC 477C 12" Touch PB (if a P320 is connected)

### HMI device change by the user

If a project contains an HMI device that is not supported by WinCC and no compatible successor model exists, the migration is cancelled. If you want to migrate the project, you must change the HMI device to WinCC yourself before the migration. Use an HMI device which is supported both by WinCC flexible and WinCC for this.

### See also

Supported HMI devices (WinCC flexible) (Page 132)



## Configuration change after HMI device change (WinCC flexible)

---

### Note

If you migrate a project with embedded screens, this can result in the project file becoming larger than the old project file.

---

## HMI device replacement by the migration

If the migration makes an HMI device replacement, it replaces the existing HMI device with a compatible successor model. The successor models are further developed and therefore more efficient than their predecessors. The new models therefore support all the properties of their predecessors. Therefore only a little rework is to be expected on the project due to the HMI device replacement.

## HMI device replacement by the user

if you change an HMI device yourself before the migration, you must ensure that the HMI device used supports all properties which are used in the project. Compile the project after the HMI device replacement in WinCC flexible. The project must be perfectly compilable before the migration. Then migrate the project to WinCC.

## See also

Supported HMI devices (WinCC flexible) (Page 132)

## Object support during migration (WinCC flexible)

### Introduction

When migrating projects from WinCC flexible, all configuration data involving an HMI device supported by WinCC will be migrated. Basically, all object types and functions that are available and can be mapped to the new project environment will be fully migrated.

Some global object types are not migrated, for example, dictionaries and global libraries.

## Supported object types

The following object types are supported for migration:

- Animations
- Audit settings
- Audit reports
- Scheduler
- User administration
- Area pointer

*4.1 Migrating projects in a TIA portal project*

- Faceplates
- Screens
- Screen template
- Data types
- Function lists
- Graphics lists
- Display and operating elements  
Migration supports all display and operating elements available on the supported HMI devices.
- Alarms
- Alarm classes
- Alarm groups
- Project library
- Project languages
- Reports
- Recipes
- Runtime languages
- Runtime scripting
- Sm@rtAccess/Sm@rtService
- Structures
- System events
- System functions
- Texts
- Text lists
- Tags
- Connections
- Effective ranges
- Zones
- Cycles

**Unsupported object types**

The following object types are not supported by migration:

- Global libraries
- Dictionaries
- Project versions
- Change log

## Mapping of the screen navigation

WinCC does not support the screen navigation from WinCC flexible. The data of the screen hierarchy from WinCC flexible are not migrated. To map the functionality of a screen navigation from WinCC flexible, the navigation buttons are migrated to the button available in WinCC. The system functions migrated to the "ActivateScreen" system function are migrated to the "Click" event of the respective button. The following system functions used in WinCC flexible are not available for the screen navigation in WinCC:

- ActivateRootScreen
- ActivateLeftScreen
- ActivateRightScreen
- ActivateParentScreen
- ActivateFirstChildScreen

These system functions are migrated to the "ActivateScreen" system function. The "Screen name" parameter is taken from the data of the screen hierarchy. If one of the named system functions is called from a screen which is not contained in the screen hierarchy, the "ActivateScreen" function is created without parameters. You must configure the desired screen to this system function after the migration.

## Tab sequence in pictures with faceplates

In pictures with faceplates, the tab sequence is changed in both the screen and the faceplate as a result of the migration.

## Migration of the screen template

WinCC offers an extended concept for working with screen templates. WinCC offers a global screen and several templates for each device. During migration of a template from WinCC flexible, the objects contained there and the properties configured in the template are migrated to the extended concept of the screen templates of WinCC.

The following objects are migrated to the "global screen" of WinCC:

- Alarm window
- Alarm indicator
- Help indicator
- Function keys of HMI devices with function keys

All other objects and properties are migrated to a template of WinCC.

The connection of the objects and properties to the respective template is automatically adapted.

## See also

Changes of values of object properties by the migration (WinCC flexible) (Page 140)

## Changes of values of object properties by the migration (WinCC flexible)

### Introduction

The standardization of object properties from WinCC V7 and WinCC flexible requires changes to the object properties during the migration process. The migration calculates the changes in such a way that the representation of the objects after migration is the same as prior to migration. Changes made during migration result in different units of measurements and values in the configuration for some object properties.

### Migrating the font settings of an object

In WinCC V7 and WinCC flexible, the unit of measurement "point" is used to denote the size of the fonts used for an object. In WinCC, the unit of measurement "pixel" is used to denote the size of the fonts used for an object. During migration, the font size is converted accordingly to ensure that the representation of the font is the same size at zoom level 100%. The different units of measurement result in changes to the numerical values for the font sizes after migration.

**Example:**

Font style before migration	Font style after migration
Arial 10 points	Arial 13 pixels
Arial 16 points	Arial 21 pixels
Tahoma 10 points	Tahoma 13 pixels
Tahoma 16 points	Tahoma 21 pixels

### Migration of object margins

In WinCC flexible, some objects permit the entry of values <0 and >127 for setup of the object margins for the configuration of the representation. In WinCC, the range of values for object margins is limited to values between 0 and 127. The migration changes values <0 to the value "0" and values >127 to the value "127".

### See also

Object support during migration (WinCC flexible) (Page 137)

## Connections (WinCC flexible)

### Migration of connections (WinCC flexible)

#### Introduction

If you migrate a project in which a supported communication driver is used, this driver is used further in WinCC. Objects which communicate via this driver are migrated 1:1. No rework is necessary.

Not all communication drivers which are available in WinCC flexible are supported in WinCC. If an unsupported driver is used in the project to be migrated, there are two possible scenarios:

1. A compatible spare driver is available for the used driver.
2. No compatible spare driver is available for the used driver.

### Compatible spare driver is available

If a driver is available in WinCC which addresses the used PLC or a compatible PLC, the driver is automatically replaced during the migration.

You get an appropriate warning if the used driver is replaced.

In this case, check whether all the external tags and area pointers are valid after the migration by means of the migration report.

If the used driver is replaced, all the connection parameters are reset to the standard values. The CPU type is adapted to the appropriate PLC. The properties of the connected tags and area pointers are not changed.

### Compatible spare driver is not available

If no driver is available in WinCC which addresses the used PLC or a compatible PLC, the configured connection is not migrated. All external tags which were connected to the PLC by this driver are converted into internal tags. External tag properties are lost in the conversion, e.g. the address in the PLC. All changes to the tags are recorded in the migration report.

You must reconnect the tags with the PLC after the migration and configuring of a connection.

You get an appropriate warning if the driver is not migrated.

### Converting the communication driver

The following tables show the mapping of communication drivers from WinCC flexible to WinCC.

### Supported communication drivers

WinCC flexible	WinCC
Allen Bradley DF1	Allen Bradley DF1
Mitsubishi FX	Mitsubishi FX
Modicon MODBUS	Modicon MODBUS RTU
Modicon MODBUS TCP/IP	Modicon MODBUS TCP/IP
Omron Hostlink/Multilink	Omron HostLink
OPC	OPC
SIMATIC HMI HTTP Protocol	SIMATIC HMI HTTP Protocol
SIMATIC S7 200	SIMATIC S7 200
SIMATIC S7 300/400	SIMATIC S7 300/400

### Compatible communication drivers

WinCC flexible	WinCC
Allen Bradley DH485	Allen Bradley DF1
Allen Bradley E/IP C.Logix	Allen Bradley EtherNet/IP
Mitsubishi Protocol 4	Mitsubishi MC TCP/IP

### Not supported communication drivers

WinCC flexible	WinCC
GE Fanuc SNP	Not supported
ISAC	Not supported
LG GLOFA-GM	Not supported
SIMATIC 500/505 DP	Not supported
SIMATIC 500/505 serial	Not supported
SIMATIC S5 AS511	Not supported
SIMATIC S5 DP	Not supported
Telemecanique Uni-Telway	Not supported

### See also

- Migration (WinCC flexible) (Page 126)
- Supported HMI devices (WinCC flexible) (Page 132)
- Adapting configuration for non-migrated connection (WinCC flexible) (Page 142)
- Migration of area pointers (WinCC flexible) (Page 143)
- Migration of tags (WinCC flexible) (Page 144)

### Adapting configuration for non-migrated connection (WinCC flexible)

#### Introduction

If a connection cannot be migrated you have the following options:

- Change the configuration in WinCC flexible before the migration
- Change the configuration after the migration

#### Change a connection before the migration

If the communication driver selected for the connection is not supported by the migration, you must select a driver which is supported by the migration. The HMI device must also support the selected communication driver.

If no suitable driver is available for the used HMI device, you must use a suitable HMI device. Then adapt the configuration in WinCC flexible and recompile the project. Migrate the project after successful adaptation and compiling. The connection is then also migrated.

### **Changing a connection before the migration**

If you migrate a WinCC flexible project in which the connection is not migrated, all external tags of this connection are mapped to internal tags. You receive an appropriate entry in the migration protocol for every tag concerned.

You must configure a new connection after the migration. For this connection you select a communication driver which supports the used HMI device. If no suitable driver is available for the used HMI device, you must use a suitable HMI device.

If you have configured the new connection, you must reconnect all tags which were mapped to internal tags before the migration. Open the migration report to make reconfiguration easier. Reconfigure the tags according to the log entry.

If the project contained area pointers, you must also reconfigure these. You will also find corresponding entries for the area pointers in the migration log.

See the section *Migrating projects from WinCC flexible (WinCC flexible)* (Page 129) for further information about the migration log.

### **See also**

*Migrating projects from WinCC flexible (WinCC flexible)* (Page 129)

*Migration of connections (WinCC flexible)* (Page 140)

## **Migration of area pointers (WinCC flexible)**

### **Introduction**

The migration of area pointers depends on the used communication driver.

- If the used communication driver is supported by the migration, area pointers from WinCC flexible are taken over unchanged in the migration.
- if the used communication driver is not supported by the migration, area pointers are not migrated.

### **Migration of the area pointers**

If the connection used by the area pointers is fully migrated, the area pointers are also fully migrated. The parameters of the area pointers are taken over unchanged.

If you replace the communication driver of the connection before the migration, check whether all the parameters of the area pointers are still valid after the migration.

If the connection used by the area pointer is not migrated, the area pointers are not migrated either. See *Adapting configuration for non-migrated connection (WinCC flexible)* (Page 142) for additional information.

## See also

Adapting configuration for non-migrated connection (WinCC flexible) (Page 142)

Migration of connections (WinCC flexible) (Page 140)

## Migration of tags (WinCC flexible)

### Introduction

You need to make some special considerations when migrating tags. The following aspects should be distinguished:

- Migrating data types of tags
- Migrating internal tags
- Migrating external tags
- Tag names
- Tag limits

### Migrating data types

WinCC features some other data types and uses different data type names than WinCC flexible. When migrating a relevant tag, the data type from WinCC flexible is mapped to the corresponding data type in WinCC. See Migration of data types (WinCC flexible) (Page 159) for additional information.

### Migrating internal tags

Internal tags are always migrated completely. Only the data type names and tag names may change due to migration.

### Migrating external tags

If the connection used by the external tags is migrated, the external tags are also fully migrated. The migration of external tags depends on whether the used communication driver is supported by the migration. See Migration of connections (WinCC flexible) (Page 140) for additional information.

If the connection used by the external tags is not migrated, the external tags are not migrated either. The external tags are then mapped to internal tags. You must configure a new connection and reconnect the tags with the tags of the PLC after the migration.

### Migrating names of tags

In WinCC flexible, tags located in different folders can have the same name. In WinCC, the tag name must be unique on the configured HMI device. This means that tags with the same name from different folders will be renamed during migration. See Migration principles (WinCC flexible) (Page 127) for additional information.



## **See also**

- Migration of data types (WinCC flexible) (Page 159)
- Migration of connections (WinCC flexible) (Page 140)
- Migration principles (WinCC flexible) (Page 127)
- Migration (WinCC flexible) (Page 126)
- Migration of alarm classes and alarm groups (WinCC flexible) (Page 146)
- Migration of scripts (WinCC flexible) (Page 148)
- Migration of language-specific content (WinCC flexible) (Page 150)
- Migration of libraries (WinCC flexible) (Page 152)

## **Migration of structures**

In WinCC V12, the "StringChar" data type is not supported in HMI user data types.

If you have used this data type in a structure in a WinCC flexible project, an invalid element is created by the migration in the HMI user data type.

After migration , you must re-work this user data type in WinCC and enable the user data type.

At the same time, check the offset of the following elements and any existing interconnections between a faceplate and the elements of the user data type. Adapt the elements if required.

## **Migration of logs**

### **Storage location of logs**

WinCC flexible allowed you to store logs in a database which was automatically set up upon WinCC flexible installation ("System-defined data source" setting). This option is not available in WinCC.

If you have used this setting in your WinCC flexible project, it will be changed to "User-defined name of data source" during migration. Before you can store logs in a database, you must configure an ODBC data source in the Windows control panel and configure the name of the user data source specified there as the "name of the data source" in the log in WinCC.

## Migration of alarm classes and alarm groups (WinCC flexible)

### Changing the names of alarm classes

In contrast to WinCC flexible, the names of the predefined alarm classes are not dependent on the user interface language currently in use. During migration, the names of the alarm classes are assigned as follows:

WinCC flexible	WinCC
Error	Alarms
System	System
Warnings	Events

The names of the alarm classes can be changed as necessary after migration.

### Migrating alarm groups

Migration will migrate only those alarm groups actually in use.

Alarm groups with an ID from 1-31 will be migrated 1:1.

A corresponding alarm group is created in WinCC for each alarm class in the system. These alarm groups created by the system are assigned IDs beginning with the number 32 and consecutively incremented. The 4 pre-defined message classes in every WinCC project are automatically given IDs 32-35 by their alarm groups. Additionally created alarm group and an additional ID is assigned to each user-defined alarm class. Therefore, the IDs for alarms groups with IDs > 31 may be changed after migration. This step also changes the assignment of the alarm group names to the IDs.

Example:

In the example, you can see the assignment of the IDs in WinCC for the migration.

Alarm groups	ID in WinCC flexible	ID in WinCC	
Alarm group 1-16	1-16	1-16	Default for alarm groups from system alarms
Alarm group 17-31	17-31	17-31	Custom alarm groups
		32-35	Default in WinCC for alarm groups of predefined alarm classes.
Alarm group 32	32	36	Changed assignment of ID to alarm group in WinCC
Alarm group 33	33	37	Changed assignment of ID to alarm group in WinCC

Also note:

When migrating alarm groups that supposedly have the same group name, the migration adapts the name. This occurs, for example, when a group name contains a space at the end of the name. The migration deletes all existing spaces at the end of names. If two groups obtained the same group names due to this deletion, the migration adds the suffix "# Mign" to the group name of the following alarm groups, where "n" stands for a sequential number.

Example:

The following alarm groups exist in WinCC flexible:

"AlarmGroup\_18"

"AlarmGroup\_18 " - group name contains one space

"AlarmGroup\_18 " - group name contains two spaces

"AlarmGroup\_18" is the alarm group with the highest number.

Result after migration:

"AlarmGroup\_18"

"AlarmGroup\_18#Mig1"

"AlarmGroup\_18#Mig1.1"

### Changing the names of alarm classes

In contrast to WinCC flexible, the names of the predefined alarm classes are not dependent on the user interface language currently in use. During migration, the names of the alarm classes are assigned as follows:

WinCC flexible	WinCC
Error	Errors
System	System
Warnings	Warnings

The names of the alarm classes can be changed as necessary after migration.

### Display of ALARM\_S messages and SIMATIC SFM messages

In WinCC flexible you can activate the display classes for ALARM\_S messages in integrated projects. In WinCC flexible, you activate the display of SIMATIC SFM messages via a separate setting. The separate setting for activating the display of SIMATIC SFM messages is not required in WinCC. You control the display of SIMATIC SFM messages, and also the display of ALARM\_S messages in WinCC only by activating the corresponding display class.

The changed concept may cause the display of messages to change following migration.

If all the display classes for ALARM\_S messages are activated and the display of SIMATIC SFM messages is deactivated in the WinCC flexible project, ALARM\_S messages and SIMATIC SFM messages are displayed following migration.

To ensure that only ALARM\_S messages are displayed following migration, you have to assign the SIMATIC SFM messages to an unused display class after migration to STEP 7. You then have to deactivate this display class in WinCC.

If all the display classes for ALARM\_S messages are deactivated and the display of SIMATIC SFM messages is activated in the WinCC flexible project, ALARM\_S messages and SIMATIC SFM messages are not displayed following migration.

4.1 Migrating projects in a TIA portal project

To ensure that only SIMATIC SFM messages are displayed following migration, you have to assign the SIMATIC SFM messages to an unused display class after migration to STEP 7. You then have to activate this display class in WinCC.

The display class is dependent on the settings in STEP 7. The default setting for SIMATIC SFM messages in Step 7 is the display class "0". To activate the display in WinCC, the display class "0" must be activated.

You activate the display class in WinCC in the Runtime settings of the respective HMI device in the "Messages" category.

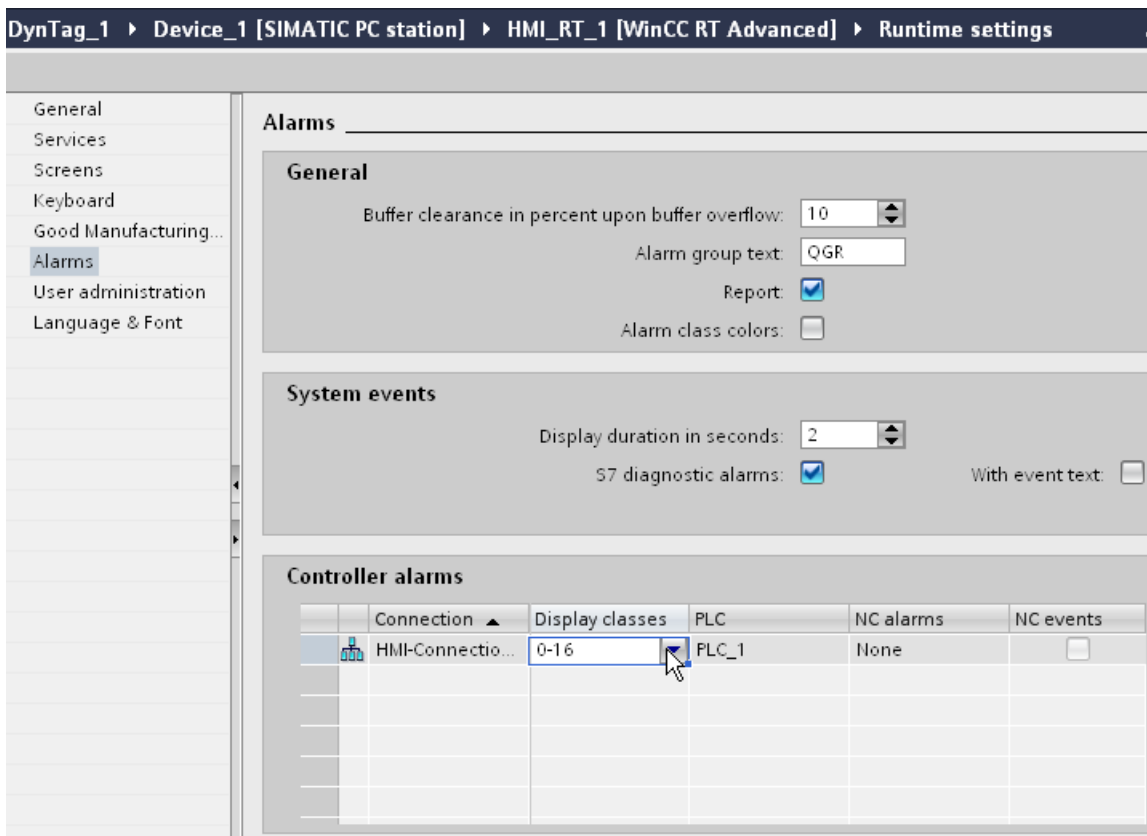

See also

Migration of tags (WinCC flexible) (Page 144)

Migration of scripts (WinCC flexible)

Introduction

The migration supports VB-scripts which were created in WinCC flexible. For a VB-script to be migrated successfully it must be functional in WinCC flexible first.

**Note****Script errors**

The most efficient way to locate scripting errors in the course of the initial test run after migration is to use an installed Script Debugger and the diagnostics controls.

**Migration of a VB script**

A script is analyzed in the migration and adapted to the system behavior of WinCC if necessary. The following is adapted:

- System functions which have changed their names are renamed.  
This concerns the following system functions:

Function name in WinCC flexible	Function name in WinCC
IncreaseValue	IncreaseTag
DecreaseValue	DecreaseTag
SetValue	SetTag

- The access to tags as parameters of system functions is adapted to the system behavior of WinCC. In WinCC scripts are no longer transformed as in WinCC flexible. The scripts are executed directly as a source code. Therefore the stricter rules for the VBS syntax apply. A tag call is always migrated with inverted commas. If several parameter types are allowed for a system function, these are migrated with the keyword "SmartTags".

Example 1:

The value of the "temperature" tag should be incremented by the value "1".

Valid expressions in WinCC flexible:

IncreaseValue temperature, 1

IncreaseValue "temperature", 1

IncreaseValue SmartTags("temperature"), 1

Valid expression in WinCC:

IncreaseTag "temperature", 1

Example 2:

You use a system function on which several parameters are allowed. The value of the "temperature" tag should be incremented by the value of the "heatcontrol" tag.

Valid expression for WinCC flexible:

IncreaseValue "temperature", "heatcontrol"

Valid expression for WinCC:

IncreaseTag "temperature", SmartTags("heatcontrol")

- Objects renamed by the migration are also renamed in the script when using in a script. See the section Migration principles (WinCC flexible) for further information about the renaming objects. You only have to observe the following rules when renaming objects: If you address objects whose names are dynamically generated by the script with the help of a script, the object names in the script can not be automatically changed by the migration. In such a case, you have to correct the generation of the object names in the script after migration.

## See also

Migration of tags (WinCC flexible) (Page 144)

## Migration of language-specific content (WinCC flexible)

### Introduction

WinCC offers the same options for configuring projects in different languages as those available in WinCC flexible. All languages supported by WinCC are included in the migration of a project.

### Migrating language-dependent content

The following language-dependent content is migrated:

- Project languages
- Project texts
- Fonts for display in runtime
- Language-dependent graphics

You need to consider the following when migrating language-dependent content:

- The operating system on the PC performing the migration must support the project languages used in the project.
- The fonts used for runtime display must be installed on the PC performing the migration.
- Dictionaries are not supported by the migration.

### Editing language of integrated projects following migration

During migration of an integrated project, the project components to be migrated from STEP 7 and WinCC flexible also bring their respective settings for the editing language. In WinCC there is only one editing language for all project components. Migration activates for the migrated project the editing language which was set in STEP 7 prior to migration. If this setting is not the same as the setting from WinCC flexible, the configured texts are no longer visible in WinCC. No text is displayed at the usage locations, or only the entry "Text" can be seen. To make the texts visible, you must change the editing language. Click the "Tasks" taskcard at

the right-hand edge of the TIA portal and select the correct editing language in the "Language & Resources" area.

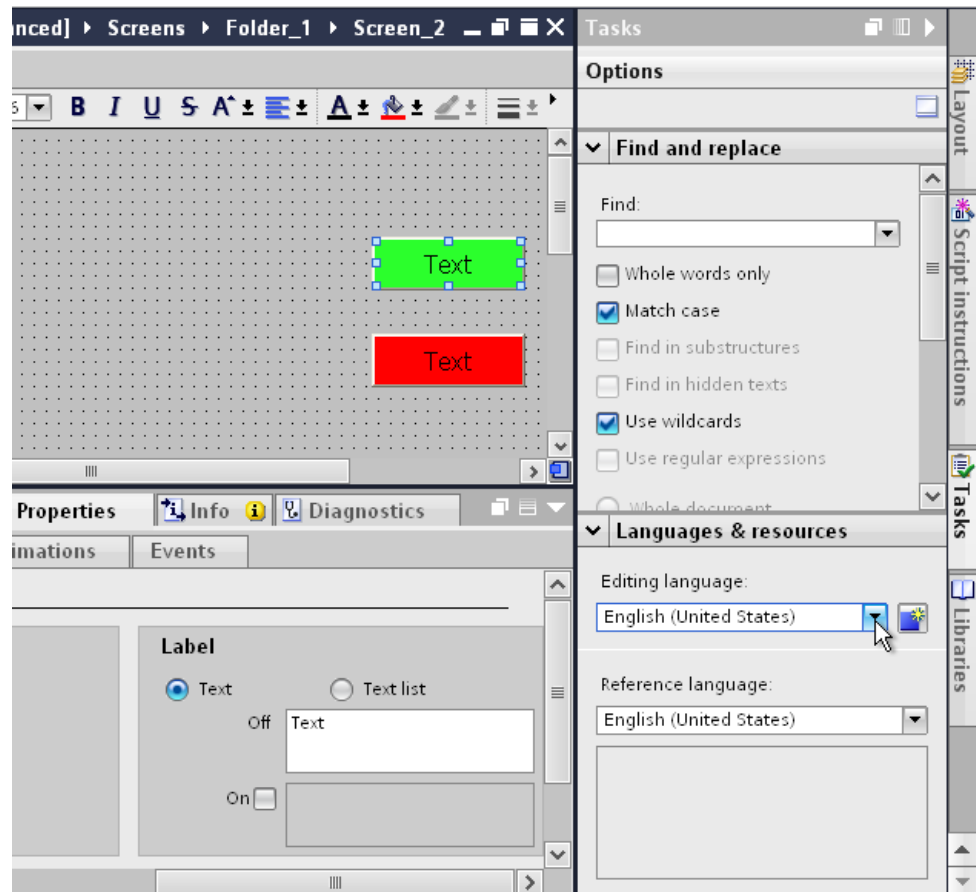

## Unsupported languages

The migration of language-dependent content depends on whether or not WinCC supports the respective language.

If a project only contains project languages not supported by WinCC, the project will not be migrated.

If a project contains supported and unsupported project languages, only the supported languages will be migrated. The editing language and reference language are set to a supported language.

The following languages are not supported by WinCC:

- Arabic
- Hebrew
- Dhivehi
- Gujarati
- Kannada

*4.1 Migrating projects in a TIA portal project*

- Tamil
- Telugu
- Urdu
- Punjabi
- Persian
- Syrian

**See also**

Migration of tags (WinCC flexible) (Page 144)

**Migration of libraries (WinCC flexible)**

**Introduction**

You need to consider two different cases when migrating from libraries:

1. Migrating a project library
2. Migrating a global library

**Migrating a project library**

A project library is stored together with the project data in the project file. For this reason, a project library is migrated with the same restrictions as the project data.

**Migrating a global library**

Global libraries are not supported by the migration. The library objects used in the project will be migrated, however. The library objects are copied when used in the project and then no longer have a connection to the library.

To migrate a global library, you must copy or move the objects contained in the library to the project library. The objects are then included in the migration. In WinCC, you move the migrated objects to a new global library that is created. You can copy or move both individual objects or entire library categories.

**See also**

Migration of tags (WinCC flexible) (Page 144)



### 4.1.6.3 Migrating runtime data (WinCC flexible)

#### Migration of runtime data (WinCC flexible)

##### Introduction

Only the configuration data are migrated by the migration when migrating a project. The runtime data are not affected. You need to update the runtime data following migration.

The runtime data consists of the following:

- Runtime project  
The runtime project contains the compiled project data.
- Recipe data and user administration  
The recipe data and user administration are data that can be changed in runtime.
- Log data  
The data of tag logs and alarm logs are acquired and logged in runtime.

##### Migrating recipe data and user administration

If the recipe data and user administration were changed in runtime, you need to back up this information from the HMI device before you load the migrated project.

Depending on the used HMI device, you have different options for saving the above data.

If the HMI device supports external memory media and the recipe data are saved there, the data remain on the memory medium. External memory media are for example StorageCard or a network drive. You use the data again after the migration. The user administration is not saved on an external memory medium so you have to save these data, e.g. with ProSave.

If the recipe data are saved in the internal memory of the HMI device, save these data on an external memory medium. Use ProSave to save the recipe data. If you have already configured appropriate system functions in your project, use the system functions. The following system functions are available for the recipe data:

- "ExportDataRecords" for the backup
- "ImportDataRecords" for the restore

You update the runtime project by compiling the project in WinCC again and loading it to the HMI device.

After you have loaded the migrated project on the HMI device, restore the recipe data and the user administration to the HMI device.

##### See also

Migration (WinCC flexible) (Page 126)

Backing up recipe data and user administration (WinCC flexible) (Page 154)

Restoring recipe data and user administration (WinCC flexible) (Page 155)

## **Backing up recipe data and user administration (WinCC flexible)**

### **Introduction**

To continue using the recipe data and user administration in a migrated project, you first need to back up this data from the HMI device. Then load the data into the migrated WinCC project. Use ProSave to back up the data.

### **Requirement**

- The WinCC flexible project is running on the HMI device in Runtime.
- The HMI device is connected to a PC on which ProSave is installed.

### **Procedure**

Proceed as follows to back up the recipe data and user administration:

1. Start ProSave.
2. Select the device type and the connection parameters in the "General" tab.
3. Open the "Backup" tab.
4. Select the "Recipes from the device memory" entry in the "Data type" box.  
Do not select "Complete backup" because otherwise you will not be able to select separately when restoring the recipe data.
5. Navigate to the desired location in the "Save as" box and click "Start Backup".  
The recipe data are saved.
6. Select "User administration" in the "Data type" box and click "Start Backup".  
The user administration is saved.

For additional information refer to the online help for ProSave.

### **Alternative procedure**

ProSave is automatically installed with WinCC flexible. The entire functional range of ProSave is available on the configuration PC within WinCC flexible via the menu command "Project > Transfer".

Alternatively, you can back up the recipe data and user administration via the ProSave integrated in WinCC flexible. Start WinCC flexible and select the menu command "Project > Transfer > Backup". Back up the recipe data and user administration as described in steps 4-6.

### **See also**

Migration of runtime data (WinCC flexible) (Page 153)

## Restoring recipe data and user administration (WinCC flexible)

### Introduction

To continue using saved recipe data and user administration after the migration, you first need to compile the migrated project and load it to the HMI device. You can then transfer the saved data to the HMI device. Use ProSave to restore the data.

### Requirement

- The migrated project has been transferred to the HMI device and is running in runtime.
- The HMI device is connected to a PC on which ProSave is installed.

### Procedure

Proceed as follows to load the saved recipe data and user administration to the HMI device:

1. Start ProSave.
2. Select the device type and the connection parameters in the "General" tab.
3. Open the "Restore" tab.
4. Navigate to the location of the saved recipe data in the "Opening..." box and select the file.
5. Click "Start Restore".  
The recipe data will be transferred to the HMI device..
6. Repeat steps 4-5 to restore the user administration.  
The user administration will be transferred to the HMI device.

For additional information refer to the online help for ProSave.

### Alternative procedure

ProSave is automatically installed with WinCC. The entire functional range of ProSave is available on the configuration PC within WinCC flexible via the menu command "Project > Transfer".

You can also restore the recipe data and user administration via the ProSave integrated in WinCC. Start WinCC and select the menu command "Online > Device maintenance > Restore". Restore the recipe data and user administration as described in steps 4-6.

### See also

Migration of runtime data (WinCC flexible) (Page 153)

## Backing up log data (WinCC flexible)

### Introduction

If an HMI device supports external memory media and the log data are saved there, the data remain on the memory medium. External memory media are for example StorageCard or a network drive. If a log is saved on an external memory medium, the migrated project accesses this storage location again after the migration. In this case the log data must not be backed up.

### Backing up log data

If you want to back up the log data externally before the migration, you have the following options:

- Backup with the "ArchiveLogFile".  
If you have already configured the "ArchiveLogFile" function in the WinCC flexible project, use this function to back up the data.
- Copy the log files by Copy&Paste with the Windows Explorer to an external memory medium or network drive.

### See also

Migration of runtime data (WinCC flexible) (Page 153)

#### 4.1.6.4 Migrating integrated projects (WinCC flexible)

### Migration of integrated projects (WinCC flexible)

#### Introduction

The controllers and HMI devices contained in a project integrated in STEP 7 are linked together by the configuration. The configuration data of WinCC flexible and STEP 7 are also connected. When an integrated project is migrated, the complete project will be migrated with components from WinCC flexible and STEP 7. The connections remain intact.

---

#### Note

It is advisable to compile and save an integrated project in WinCC flexible before you migrate it. You can be sure that the data in WinCC flexible and STEP 7 is synchronized if compilation was completed without errors.

---

### Migrating an integrated project

When migrating an integrated project, the same requirements apply for the WinCC flexible component as those for the migration of a non-integrated WinCC flexible project. The objects

and properties contained in the WinCC flexible component must be supported by WinCC, for example, the HMI device or the communication driver. The "Online" property must be activated on the configured connection. A connection with deactivated "Online" property is not migrated.

In addition to the requirements for the WinCC flexible component, there are also requirements for the STEP 7 component of the integrated project. The objects and properties contained in the STEP 7 V5.4 SP5 or V5.5 component must be supported in STEP 7. For detailed information, refer to the documentation for STEP 7.

To fully migrate an integrated project and then edit it, the following components must be installed on the PC performing the migration:

- STEP 7 V5.4 SP5 or STEP 7 V5.5
- WinCC flexible 2008 SP2 or WinCC flexible 2008 SP3
- STEP 7

If you only want to save the project in migration format, you can use the migration tool. See *Migration principles (WinCC flexible) (Page 127)* for additional information.

An integrated project is always fully migrated. If you only want to migrate the WinCC flexible project it contains, you need to separate it from the STEP 7 project before the migration. To separate the project from the integrated form, open the project in STEP 7 V5.4 SP5 or V5.5. Open the WinCC flexible project in the SIMATIC Manager. The project is opened with WinCC flexible. In WinCC flexible, select the menu command "Project > Copy project from STEP 7". WinCC flexible saves a non-integrated copy of the project.

## See also

*Migration (WinCC flexible) (Page 126)*

*Migrating integrated project (WinCC flexible) (Page 157)*

*Migration principles (WinCC flexible) (Page 127)*

## Migrating integrated project (WinCC flexible)

### Introduction

When migrating an integrated project, the components from both the WinCC flexible project and the STEP 7 project will be migrated. This means you need to select the project file with the file extension "\*.s7p" for migration. During migration, the data is copied from the existing project and migrated to a new project. You cannot migrate to an existing project.

The migration can be started in both the Portal view and the Project view.

You should only migrate a project in a newly started TIA portal.

If you only want to save the project in migration format, you can use the migration tool. See *Migration principles (WinCC flexible) (Page 127)* for additional information.

### Requirement

- STEP 7 V5.4 SP5 or STEP 7 V5.5 and all add-on packages used are installed.
- STEP 7 and all add-on packages used are installed.
- The TIA portal is newly started.
- No project is open in WinCC.
- An integrated project is available.
- The integrated project is not open.

### Procedure

Proceed as follows to migrate an integrated project in the Portal view:

1. Select the action "Start > Migrate Project".

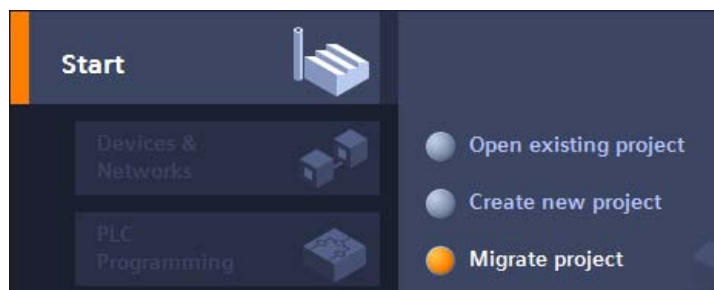

2. In the "Source path" box, navigate to the project you want to migrate.

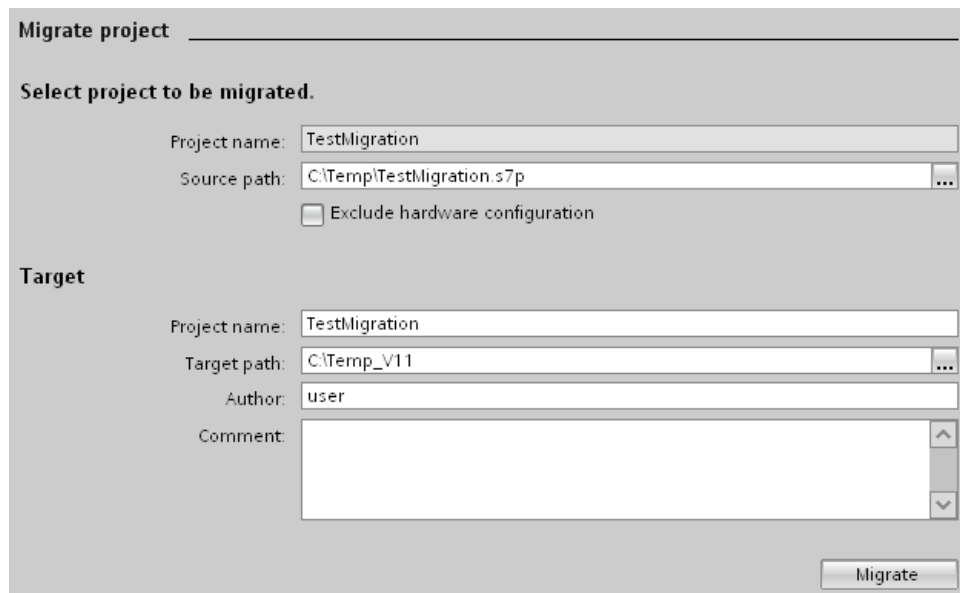

3. Select the "\*.s7p" project file.
4. Change the information for the project to be created, if necessary. For example, change the project name or project path. The data to be migrated is created in the new project.
5. To migrate the project without hardware configuration, activate "Exclude hardware configuration".

6. Click "Migrate".  
A new project is created and migration of the data is started:
  - The Project view opens.
  - The progress of the migration is shown in a migration window.
  - Warnings and errors about the migration process are displayed in the Inspector window under "Info > General".
  - All information about the migration is saved in a log file.
  - A message is displayed upon completion of the migration. The message contains a link that you can use to open the log.
7. Once migration is completed, save the project.

Once the migration is complete, you will find a newly created device for each migrated HMI device and controller in the project tree. These devices include the migrated data.

### Opening the migration log at a later point in time

The migration log is saved together with the migrated project. You can view the log at a later point in time. Open the log as follows:

1. Open "Shared data > Logs" in the project navigation.
2. Double-click the log file. The migration log opens.

### See also

Migration of integrated projects (WinCC flexible) (Page 156)

Migration principles (WinCC flexible) (Page 127)

#### 4.1.6.5 Reference (WinCC flexible)

### Migration of data types (WinCC flexible)

#### Introduction

To harmonize the data types used by PLCs and HMI systems, some data types of the internal HMI tags are renamed. The naming takes place in accordance with IEC conventions. Because only the names change, there are no changes to the internal tags for the configuration.

The following table describes the mapping of the internal data types from WinCC flexible to the data types in WinCC.

### **Migrating internal data types**

The internal data types are mapped as follows during migration:

<b>Internal data types WinCC flexible</b>	<b>Internal data types WinCC</b>
Bool	Bool
Char	SInt
Byte	USInt
Int	Int
UInt	UInt
Long	DInt
ULong	UDInt
Float	Real
Double	LReal
String	WString
DateTime	DateTime

### **Migrating external data types**

See the following pages for how to map the available communication drivers.



**See also**

- Migrating data types of Allen-Bradley DF1 (WinCC flexible) (Page 161)
- Migrating data types of Allen-Bradley DF485 (WinCC flexible) (Page 162)
- Migrating data types of Allen-Bradley Ethernet IP (WinCC flexible) (Page 162)
- Migrating data types of GE Fanuc SNP (WinCC flexible) (Page 163)
- Migrating data types of LG GLOFA GM (WinCC flexible) (Page 163)
- Migrating data types of Mitsubishi FX (WinCC flexible) (Page 164)
- Migrating data types of Mitsubishi Protocol 4 (WinCC flexible) (Page 165)
- Migrating data types of Modicon Modbus (WinCC flexible) (Page 165)
- Migrating data types of Modicon Modbus TCP/IP (WinCC flexible) (Page 166)
- Migrating data types of Omron Hostlink/Multilink (WinCC flexible) (Page 166)
- Migrating data types of OPC (WinCC flexible) (Page 167)
- Migrating data types of SIMATIC 500/505 DP (WinCC flexible) (Page 168)
- Migrating data types of SIMATIC 500/505 serial (WinCC flexible) (Page 168)
- Migrating data types of SIMATIC HMI HTTP Protocol (WinCC flexible) (Page 169)
- Migrating data types of SIMATIC S5 AS511 (WinCC flexible) (Page 169)
- Migrating data types of SIMATIC S5 DP (WinCC flexible) (Page 170)
- Migrating data types of SIMATIC S7 200 (WinCC flexible) (Page 171)
- Migrating data types of SIMATIC S7 300/400 (WinCC flexible) (Page 171)
- Migrating data types of Telemecanique Uni-Telway (WinCC flexible) (Page 174)

**Migrating data types of Allen-Bradley DF1 (WinCC flexible)**

**Migrating data types Allen-Bradley DF1**

The data types of the Allen-Bradley DF1 communication driver are mapped as follows in the migration to WinCC:

Data type in WinCC flexible	Data type in WinCC
ASCII	ASCII
BCD4	UInt
BCD8	UDInt
Bit	Bool
Int	Int
Long	DInt
Real	Real
UInt	UInt
ULong	UDInt

**See also**

Migration of data types (WinCC flexible) (Page 159)

**Migrating data types of Allen-Bradley DF485 (WinCC flexible)**

**Migrating data types Allen-Bradley DH485**

The Allen-Bradley DH485 communication driver is not supported by WinCC, it is replaced by the Allen-Bradley DF1 driver. The data types of the Allen-Bradley DH485 communication driver are mapped as follows in the migration to WinCC:

Data type in WinCC flexible	Data type in WinCC
ASCII	ASCII
Bit	Bool
Int	Int
Long	DInt
Real	Real
UInt	UInt
ULong	UDInt

**See also**

Migration of data types (WinCC flexible) (Page 159)

**Migrating data types of Allen-Bradley Ethernet IP (WinCC flexible)**

**Migrating data types Allen-Bradley Ethernet IP**

The data types of the Allen-Bradley Ethernet IP communication driver are mapped as follows in the migration to WinCC:

Data type in WinCC flexible	Data type in WinCC
Bool	Bool
DInt	DInt
Int	Int
Real	Real
SInt	SInt
String	String
UDInt	UDInt
UInt	UInt
USInt	USInt

**See also**

Migration of data types (WinCC flexible) (Page 159)

**Migrating data types of GE Fanuc SNP (WinCC flexible)****Migrating data types GE Fanuc SNP**

The GE Fanuc SNP communication driver is not supported by WinCC, the data types are mapped to the internal data types of WinCC. The data types of the GE Fanuc SNP communication driver are mapped as follows in the migration to WinCC:

Data type in WinCC flexible	Data type in WinCC
BCD4	UInt
BCD8	UDInt
Bit	Bool
Byte	USInt
DInt	DInt
Word	UInt
Int	Int
Real	Real
UInt	UInt
DWord	UDInt

**See also**

Migration of data types (WinCC flexible) (Page 159)

**Migrating data types of LG GLOFA GM (WinCC flexible)****Migrating data types LG GLOFA GM**

The LG GLOFA GM communication driver is not supported by WinCC, the data types are mapped to the internal data types of WinCC. The data types of the LG GLOFA GM communication driver are mapped as follows in the migration to WinCC:

Data type in WinCC flexible	Data type in WinCC
Bool	Bool
Byte	USInt
DInt	DInt
DWord	UDInt
Int	Int
SInt	SInt
String	WString

Data type in WinCC flexible	Data type in WinCC
Time	UDInt
UDInt	UDInt
UInt	UInt
USInt	USInt
Word	UInt

**See also**

Migration of data types (WinCC flexible) (Page 159)

**Migrating data types of Mitsubishi FX (WinCC flexible)**

**Migrating data types Mitsubishi FX**

The data types of the Mitsubishi FX communication driver are mapped as follows in the migration to WinCC:

Data type in WinCC flexible	Data type in WinCC
12 Bit Block	12-Bit Block
16 Bit Block	16-Bit Block
20 Bit Block	20-Bit Block
24 Bit Block	24-Bit Block
28 Bit Block	28-Bit Block
32 Bit Block	32-Bit Block
4 Bit Block	4-Bit Block
8 Bit Block	8-Bit Block
Bit	Bool
Double	DWord
IEEE-Float	Real
String	String
Word	Word

**See also**

Migration of data types (WinCC flexible) (Page 159)

## Migrating data types of Mitsubishi Protocol 4 (WinCC flexible)

### Migrating data types Mitsubishi Protocol 4

The Mitsubishi Protocol 4 communication driver is not supported by WinCC, it is replaced by the Mitsubishi MC TCP/IP driver. The data types of the Mitsubishi Protocol 4 communication driver are mapped as follows in the migration to WinCC:

Data type in WinCC flexible	Data type in WinCC
4 Bit Block	4-Bit Block
8 Bit Block	8-Bit Block
12 Bit Block	12-Bit Block
16 Bit Block	16-Bit Block
20 Bit Block	20-Bit Block
24 Bit Block	24-Bit Block
28 Bit Block	28-Bit Block
32 Bit Block	32-Bit Block
Bit	Bool
DInt	DInt
DWord	DWord
Int	Int
Real	Real
String	String
Word	Word

### See also

Migration of data types (WinCC flexible) (Page 159)

## Migrating data types of Modicon Modbus (WinCC flexible)

### Migrating data types Modicon Modbus

The Modicon Modbus communication driver is not supported by WinCC, it is replaced by the Modicon Modbus RTU driver. The data types of the Modicon Modbus communication driver are mapped as follows in the migration to WinCC:

Data type in WinCC flexible	Data type in WinCC
+/-Double	+/- Double
+/-Int	+/- Int
16 Bit Group	16 Bit Group
ASCII	ASCII
Bit	Bit
Double	Double

4.1 Migrating projects in a TIA portal project

Data type in WinCC flexible	Data type in WinCC
Float	Float
Int	Int

See also

Migration of data types (WinCC flexible) (Page 159)

Migrating data types of Modicon Modbus TCP/IP (WinCC flexible)

Migrating data types Modicon Modbus TCP/IP

The data types of the Modicon Modbus TCP/IP communication driver are mapped as follows in the migration to WinCC:

Data type in WinCC flexible	Data type in WinCC
+/-Double	+/- Double
+/-Int	+/- Int
16 Bit Group	16 Bit Group
ASCII	ASCII
Bit	Bit
Double	Double
Float	Float
Int	Int

See also

Migration of data types (WinCC flexible) (Page 159)

Migrating data types of Omron Hostlink/Multilink (WinCC flexible)

Migrating data types Omron Hostlink/Multilink

The Omron Hostlink/Multilink communication driver is not supported by WinCC, it is replaced by the Omron Host Link driver. The data types of the Omron Hostlink/Multilink communication driver are mapped as follows in the migration to WinCC:

Data type in WinCC flexible	Data type in WinCC
+/-DEC	Int
+/-LDEC	DInt
ASCII	String
BIN	Bool
BYTE	Byte

Data type in WinCC flexible	Data type in WinCC
DEC	UInt
IEEE	Real
LDEC	UDInt

**See also**

Migration of data types (WinCC flexible) (Page 159)

**Migrating data types of OPC (WinCC flexible)**

**Migrating data types OPC**

The data types of the OPC communication driver are mapped as follows in the migration to WinCC:

Data type in WinCC flexible	Data type in WinCC
Bool	VT_BOOL
Byte	VT_UI1
Char	VT_I1
Date	VT_DATE
Double	VT_R8
DWord	VT_UI4
Float	VT_R4
Long	VT_I4
Short	VT_I2
String	VT_BSTR
Word	VT_UI2

**See also**

Migration of data types (WinCC flexible) (Page 159)

### Migrating data types of SIMATIC 500/505 DP (WinCC flexible)

#### Migrating data types SIMATIC 500/505 DP

The SIMATIC 500/505 DP communication driver is not supported by WinCC, the data types are mapped to the internal data types of WinCC. The data types of the SIMATIC 500/505 DP communication driver are mapped as follows in the migration to WinCC:

Data type in WinCC flexible	Data type in WinCC
+/-Double	DInt
+/-Int	Int
ASCII	WString
Bit	Bool
Double	UDInt
Int	UInt
Real	Real

#### See also

Migration of data types (WinCC flexible) (Page 159)

### Migrating data types of SIMATIC 500/505 serial (WinCC flexible)

#### Migrating data types SIMATIC 500/505 seriell

The SIMATIC 500/505 seriell communication driver is not supported by WinCC, the data types are mapped to the internal data types of WinCC. The data types of the SIMATIC 500/505 seriell communication driver are mapped as follows in the migration to WinCC:

Data type in WinCC flexible	Data type in WinCC
+/-Double	DInt
+/-Int	Int
ASCII	WString
Bit	Bool
Double	UDInt
Int	UInt
Real	Real

#### See also

Migration of data types (WinCC flexible) (Page 159)



## Migrating data types of SIMATIC HMI HTTP Protocol (WinCC flexible)

### Migrating data types SIMATIC HMI HTTP Protocol

The data types of the SIMATIC HMI HTTP Protocol communication driver are mapped as follows in the migration to WinCC:

Data type in WinCC flexible	Data type in WinCC
Bool	Bool
Byte	USInt
Char	SInt
DateTime	DateTime
Double	LReal
Float	Real
Int	Int
Long	DInt
String	WString
UInt	UInt
ULong	UDInt

### See also

Migration of data types (WinCC flexible) (Page 159)

## Migrating data types of SIMATIC S5 AS511 (WinCC flexible)

### Migrating data types SIMATIC S5 AS511

The SIMATIC S5 AS511 communication driver is not supported by WinCC, the data types are mapped to the internal data types of WinCC. The data types of the SIMATIC S5 AS511 communication driver are mapped as follows in the migration to WinCC:

Data type in WinCC flexible	Data type in WinCC
Bit in D	Bool
Bit in W	Bool
DF	DInt
DH	UDInt
KC	WString
KF	Int
KG	Real
KH	UInt
KM	UInt
KT	UDInt

Data type in WinCC flexible	Data type in WinCC
KY	UInt
KZ	UInt

**See also**

Migration of data types (WinCC flexible) (Page 159)

**Migrating data types of SIMATIC S5 DP (WinCC flexible)**

**Migrating data types SIMATIC S5 DP**

The SIMATIC S5 DP communication driver is not supported by WinCC, the data types are mapped to the internal data types of WinCC. The data types of the SIMATIC S5 DP communication driver are mapped as follows in the migration to WinCC:

Data type in WinCC flexible	Data type in WinCC
Bit in D	Bool
Bit in W	Bool
DF	DInt
DH	UDInt
KC	WString
KF	Int
KG	Real
KH	UInt
KM	UInt
KT	UDInt
KY	UInt
KZ	UInt

**See also**

Migration of data types (WinCC flexible) (Page 159)

## Migrating data types of SIMATIC S7 200 (WinCC flexible)

### Migrating data types SIMATIC S7 200

The data types of the SIMATIC S7 200 communication driver are mapped as follows in the migration to WinCC:

Data type in WinCC flexible	Data type in WinCC
Bool	Bool
Byte	Byte
Char	Char
DInt	DInt
DWord	DWord
Int	Int
Real	Real
StringChar	StringChar
Timer	Timer
Word	Word

### See also

Migration of data types (WinCC flexible) (Page 159)

## Migrating data types of SIMATIC S7 300/400 (WinCC flexible)

### Migrating data types SIMATIC S7 300/400

The data types of the SIMATIC S7 300/400 communication driver are mapped as follows in the migration to WinCC:

Data type in WinCC flexible	Data type in WinCC
Bool	Bool
Byte	Byte
Char	see below
Counter	see below
Date	Date
Date and Time	Date_And_Time
DInt	DInt
DWord	DWord
Int	Int
Real	Real
String	String
StringChar	see below
Time	Time

Data type in WinCC flexible	Data type in WinCC
Time of Day	Time_Of_Day
Timer	see below
Word	Word

### Special considerations for some data types

There are special considerations to be made when migrating external tags that contain data types of a SIMATIC S7-300/400 PLC.

### Mapping of the S7 data type "Char"

The S7 data type "Char" is a data type for mapping characters according to the specification. However, since this data type is often used for reading and writing numerical values, it is mapped in WinCC to the S7 data type "Byte". If this should be the case during migration, an alarm will appear in the output window.

If the S7 data type "Char" is used for numerical values and negative numbers were configured at the point of use, the result is an error in mapping to the S7 data type "Byte". The S7 data type "Byte" cannot map any negative numbers. You have to adapt the configuration accordingly to correct the error. Use a signed data type, such as the data type "Int", for processing positive and negative numerical values.

If the S7 data type "Char" is used for mapping characters, you must change the configuration after migration. To represent characters, use the data type "String".

When an integrated project is migrated, the data type "Char" in WinCC is also migrated to the data type "Byte". With a connected PLC tag, the data type "Char" remains "Char". As a result of changing the data type of the HMI tag, symbolic addressing of the tags in question is not migrated. After migration, the tags are interconnected by absolute addresses and continue to work. If you want to restore symbolic addressing, you have to change the configuration accordingly after the migration.

### Mapping an array of the S7 data type "Char"

An array of the S7 data type "Char" is mapped to an array of the data type "Byte" during migration.

If an array of the S7 data type "Char" is used for numerical values and negative numbers were configured at the point of use, the result is an error in mapping to an array of the S7 data type "Byte". The S7 data type "Byte" cannot map any negative numbers. You have to adapt the configuration accordingly to correct the error. Use a signed data type, such as the data type "Int", for processing positive and negative numerical values.

### Mapping of the S7 data type "Counter"

An external tag with the S7 data type "Counter" with counter address is mapped to the S7 data type "Counter". The address will be retained.

If an external tag with the S7 data type "Counter" addresses a data block or a bit memory address, it is mapped to the S7 data type "Word". The address will be retained. The migration sets the coding to "SimaticBCDCounter".

The S7 data type "Counter" has a value range of 0-999. When supplied by the S7 data type "Word" the value range may be exceeded on the PLC side. Ensure that you are observing the value range.

Example:

#### WinCC flexible

Tag	S7 data type	Address	Comment
Counter_Actual_Value	Counter	C10	BCD coded counter value
Counter_Setpoint_Value	Counter	DB10.DBW200	BCD coded counter value
Counter_Setpoint_Value#2	Counter	MW20	BCD coded counter value

#### WinCC

Tag	S7 data type	Address	Coding	Comment
Counter_Actual_Value	Counter	%C10	<Standard>	BCD coded counter value
Counter_Setpoint_Value	Word	%DB10.%DBW200	SimaticBCDCounter	BCD coded counter value
Counter_Setpoint_Value#2	Word	%MW20	SimaticBCDCounter	BCD coded counter value

### Mapping of the data type "StringChar"

In WinCC there is no corresponding data type to which the "StringChar" data type can be mapped. Mapping in WinCC depends on the property "Length" of the S7 data type.

A tag of the "StringChar" data type with the "Length" property > 1 is migrated to an array of the S7 data type "Char". The length of the array corresponds to the length of the originally configured data type "StringChar".

If the property "Length" = 1, the data type in WinCC is migrated to an array of the S7 data type "Char" with length = 1. The expression for an array with an element is "Array[0 ..0] of Char".

### Mapping of the S7 data type "Timer"

An external tag with the S7 data type "Timer" with timer address is mapped to the S7 data type "Timer". The address will be retained.

If an external tag with the S7 data type "Timer" addresses a data block or a bit memory address, it is mapped to the S7 data type "S5 Time". The address will be retained.

Example:

#### WinCC flexible

Tag	S7 data type	Address	Comment
Timer_Actual_Value	Timer	T10	BCD coded timer value
Timer_Setpoint_Value	Timer	DB10.DBW200	BCD coded timer value
Timer_Setpoint_Value#2	Timer	MW20	BCD coded timer value

**WinCC**

Tag	S7 data type	Address	Comment
Timer_Actual_Value	Timer	%T10	BCD coded timer value
Timer_Setpoint_Value	S5Time	%DB10.%DBW200	BCD coded timer value
Timer_Setpoint_Value#2	S5Time	%MW20	BCD coded timer value

**See also**

Migration of data types (WinCC flexible) (Page 159)

**Migrating data types of Telemecanique Uni-Telway (WinCC flexible)**

**Migrating data types Telemecanique Uni-Telway**

The Telemecanique Uni-Telway communication driver is not supported by WinCC, the data types are mapped to the internal data types of WinCC. The data types of the Telemecanique Uni-Telway communication driver are mapped as follows in the migration to WinCC:

Data type in WinCC flexible	Data type in WinCC
+/-Int	Int
+/-Long	DInt
ASCII	WString
Bool	Bool
Float	Real
Int	UInt
Long	UDInt

**See also**

Migration of data types (WinCC flexible) (Page 159)

## **4.1.7 Migrating integrated projects**

### **4.1.7.1 Migrating an integrated project**

#### **Introduction**

When an integrated project is migrated, the complete project will be migrated with components from WinCC and STEP 7. Configured connections between control and visualization remain intact.

#### **Migrating an integrated project**

When migrating an integrated project, the same requirements apply for the STEP 7 component as those for migration of a non-integrated STEP 7 project. The objects and properties contained in the WinCC component must also be supported in WinCC (TIA Portal). For detailed information, refer to the documentation for WinCC.

Also note that the initial project must be compiled before the migration.

To fully migrate an integrated project, the following components must be installed on the PG/PC performing the migration:

- STEP 7 V5.4 SP5 or STEP 7 V5.5
- WinCC V7.0 SP3 or WinCC Flexible 2008 SP2 and SP3

To be able to fully post-edit an integrated project, the following components must be installed on the PC for post-editing:

- STEP 7 Professional V12 SP1
- WinCC Basic, WinCC Comfort/Advanced or WinCC Professional, depending on the components used

#### **Using the migration tool**

It is necessary to use the migration tool under the following circumstances:

- The initial project is not located on the same PG/PC as the installation of the TIA Portal.
- SCADA devices are included in the initial project. These can only be migrated with the migration tool.
- WinCC Professional V12 and STEP 7 with WinCC V7.0 SP3 cannot be installed on the same PG / PC. Therefore, integrated projects with WinCC V7.0 SP3 parts must be prepared for migration with the migration tool.

#### **Migration of the STEP 7 part of an integrated project**

An integrated project is always fully migrated. Individual components cannot be migrated on their own. You can only migrate the included STEP 7 project alone, if you have previously deleted all HMI stations in the SIMATIC stations in the SIMATIC Manager and then recompiled the project in NetPro.

#### *4.1 Migrating projects in a TIA portal project*

Alternatively, you can open the project in an installation of STEP 7 V5.4 SP5 or V5.5 without an installation of WinCC. Then, save the project again and select the "Reorganize" function during saving. The WinCC parts are then automatically removed when the copy is saved.

You can then migrate the STEP 7 project without the WinCC project.

### **Migration of an integrated project with the hardware configuration**

In integrated projects, HMI devices are migrated even if the hardware configuration is not included in the migration. The STEP 7 part of the hardware configuration, including network configurations, and connections and interrupts, is migrated only if you include the hardware configuration in the migration. Otherwise, unspecified modules will be created for the STEP 7 devices and you will need to convert them into suitable modules after the migration.

HMI modules that are plugged into a PC station are converted to a separate Station during the migration. If you perform the migration without including the hardware configuration, the migrated project then contains a non-specified SIMATIC PC Station and a SIMATIC PC Station with the HMI devices. References to HMI devices are not imported during migration. When the hardware configuration is included, the migrated project contains two separate stations: the HMI Station and the PC Station.

### **Storage location of an integrated WinCC project**

If you migrate an integrated project, the HMI part of it must be on the same PG/PC as the STEP 7 part of the project. If the HMI part is on a different PG, then only the STEP 7 part will be migrated.

### **Unsupported objects**

The following components are not supported for migration:

- STEP 7 multiproject  
A STEP 7 multiproject cannot be migrated. Migration will be canceled.
- Central Archive Server - CAS  
If a CAS is part of an integrated project, then the migration will be carried out but the CAS data will not be migrated.

### **See also**

Post-editing integrated projects (Page 176)

#### **4.1.7.2 Post-editing integrated projects**

If you have migrated an integrated project without hardware configuration, unspecified CPUs are used instead of the CPUs of the original project. Since no connection can exist between an unspecified CPU and an HMI device, connections from the source project are also imported only unspecified.

The following figure shows the state after a Migration without hardware configuration in an example project:



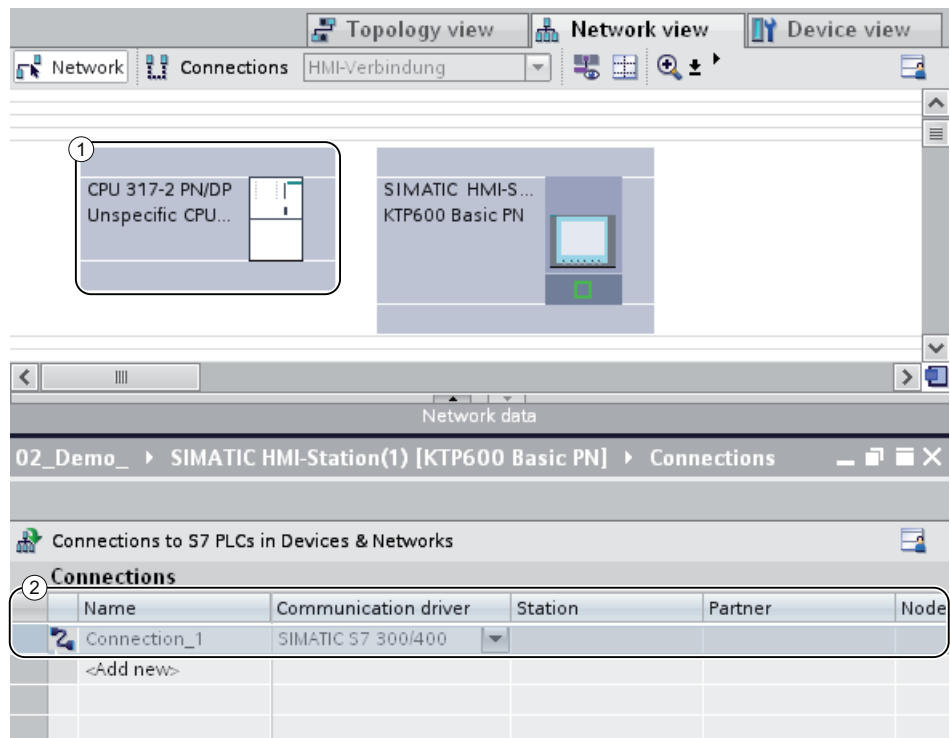

- ① The original CPU 317-2 PN/DP was replaced with an unspecified CPU during migration.
- ② The link between the CPU and HMI device is also unspecified and must be renewed.

## Procedure

To continue to use an integrated project after the migration, follow these steps:

1. Convert the unspecified devices into suitable devices again.
2. Restore the integrated HMI connection between the HMI device and the PLC.
3. Connect all HMI tags to the newly created integrated connection.
4. Restore the connection between HMI tags and PLC tags.
5. Delete the non-integrated HMI connection.

In the following chapters a sample project is used to describe the individual steps in more detail.

## See also

Converting unspecified CPUs into specified CPUs (Page 178)

Creating an integrated HMI connection (Page 179)

Re-linking HMI tags (Page 181)

Deleting an unspecified connection (Page 182)

### 4.1.7.3 Converting unspecified CPUs into specified CPUs

The first step after the migration without hardware configuration is the conversion of the unspecified CPUs into specified CPUs. Unspecified CPUs are placeholders for certain CPUs from the hardware catalog that are not currently known. You can define general parameters and home the CPUs already in the user program. However, the project is not fully functional until the unspecified CPU has been specified.

#### Specifying a CPU using module replacement

To use module replacement to specify an unspecified CPU, follow these steps:

1. Select the unspecified CPU in the network or device view.
2. Select the "Replace device" command in the shortcut menu.

The "Replace device" dialog opens.

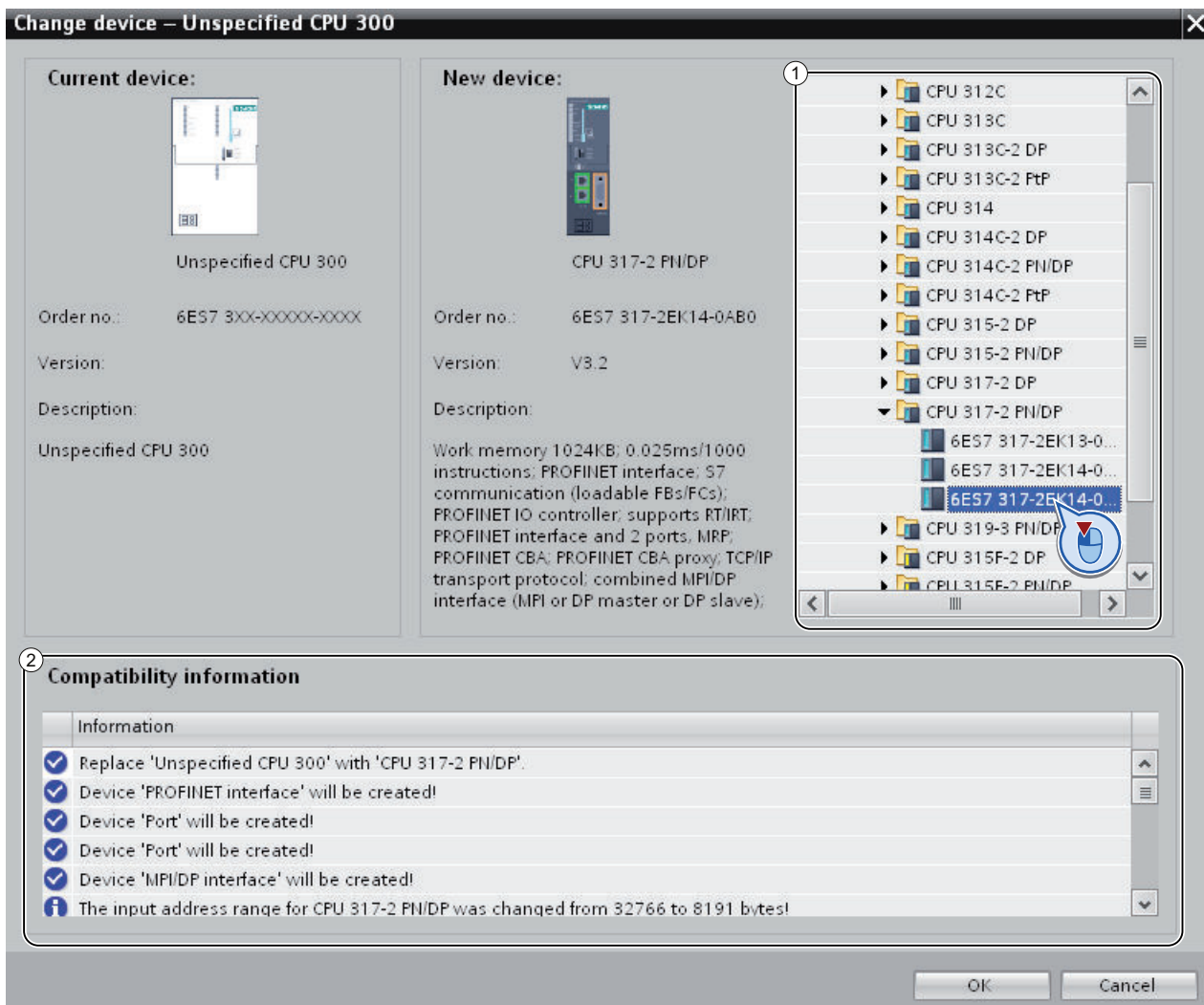

3. Under "New device" in the tree structure, select the module with which you want to replace the unspecified CPU. (Area 1)  
"Compatibility information" provides you with information on the extent to which the selected CPU is compatible with the configuration in source project. (Area 2)
4. Click "OK".
5. Perform the above-described steps for all unspecified CPUs.

## See also

Creating an integrated HMI connection (Page 179)

### 4.1.7.4 Creating an integrated HMI connection

After you have specified the unspecified CPU, establish the connection to the HMI-device.

## Procedure

To create a connection graphically, follow these steps:

1. On the toolbar, click the "Connections" icon. This activates connection mode.

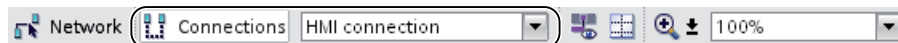

2. Select the connection type "HMI connection" in the adjacent drop-down list.  
The network view highlights in color all CPUs and HMI devices that can be used for an HMI connection.
3. You can now have the connection path automatically determined, or explicitly select a connection path via specific interfaces:
  - Allow connection path to be automatically determined  
Select the source CPU for a connection. Drag the mouse to the target components. Confirm the connection endpoint with another mouse click.  
Alternatively: While holding down the shift button, select the target components and with the right mouse button select the "Add new connection" command.
  - Selecting an explicit connection path from interface to interface  
Click on the subnet interface in the device for which you want to create a connection. Hold down the mouse button, drag the cursor to the relevant interface in the target device and then release the mouse button.

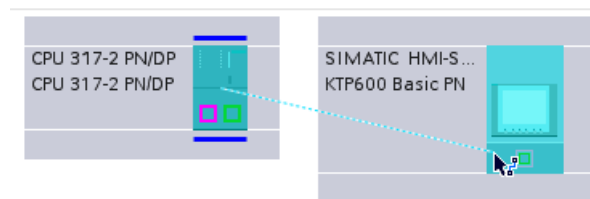

Result

The following figure shows the state after the integrated connection has been created:

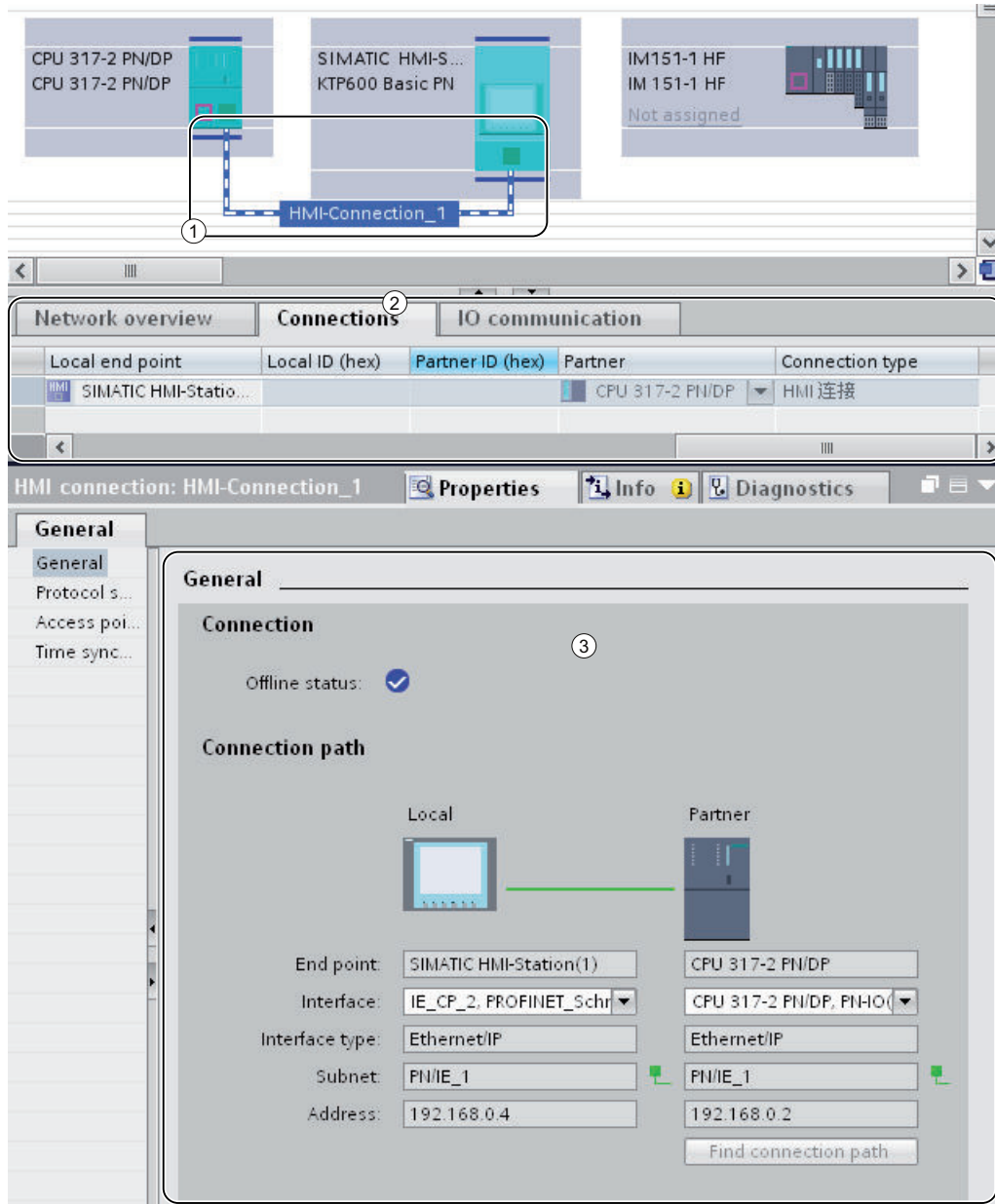

- ① An integrated HMI connection is created and highlighted in the network view.
- ② The connection is shown in the connection table of the components.
- ③ The connection can be edited in the connection properties.

See also

Re-linking HMI tags (Page 181)

### 4.1.7.5 Re-linking HMI tags

When you have created a new HMI connection between the CPU and HMI device, you have to assign the existing HMI tags to the new connection. Perform the following steps for each line in the relevant tag table.

#### Procedure

To re-link HMI tags, follow these steps:

1. In the project tree, navigate to the HMI tags and double-click the relevant tag table to show this in the work area.  
The tag table opens.

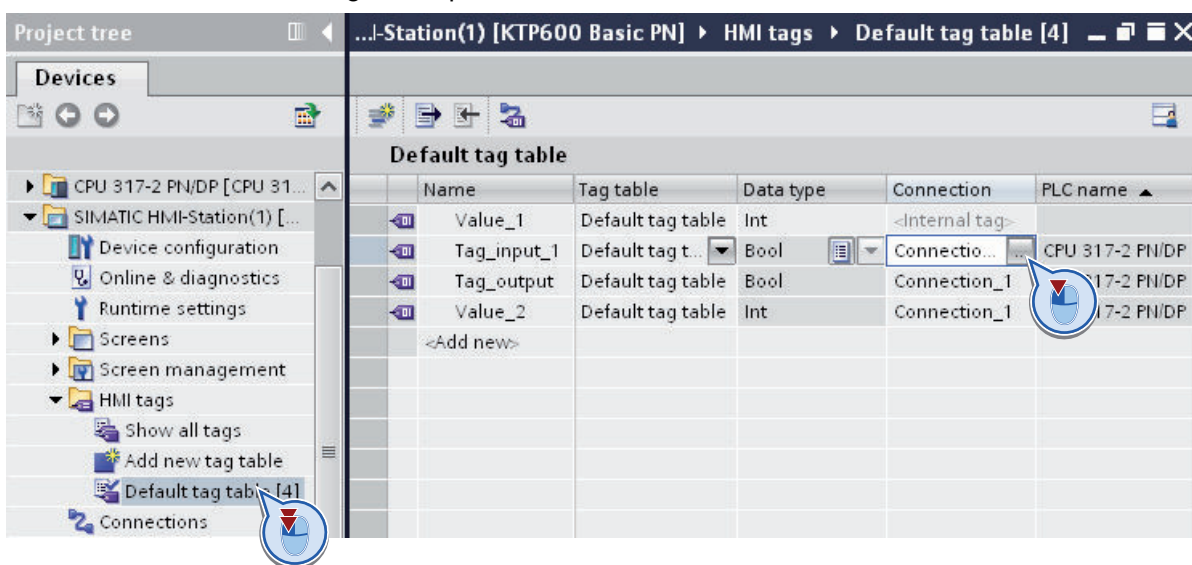

2. Click the " ..." button in the "Connection" column.  
A dialog box for selecting the connection opens.
3. Select the newly established HMI connection.

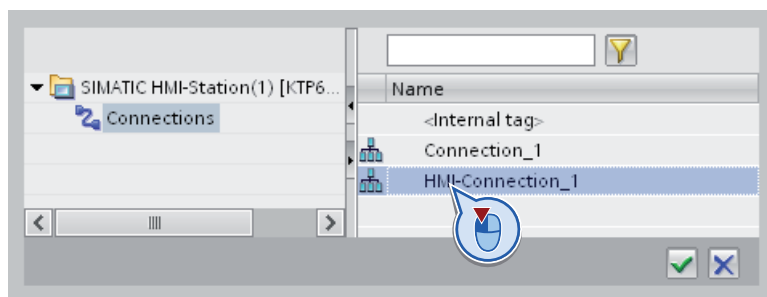

4. Click the "✓" button to apply the selected connection.
5. On the toolbar, click the "Re-connect PLC tag" button.

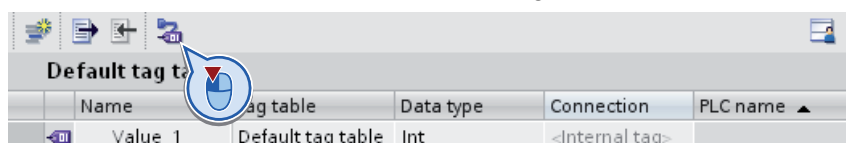

See also

Deleting an unspecified connection (Page 182)

4.1.7.6 Deleting an unspecified connection

Finally, you can remove unspecified connections that still remain from the source project.

Procedure

To delete unspecified connections, follow these steps:

1. In the project tree, open the HMI device and double-click the "Connections" entry. The connection table opens.

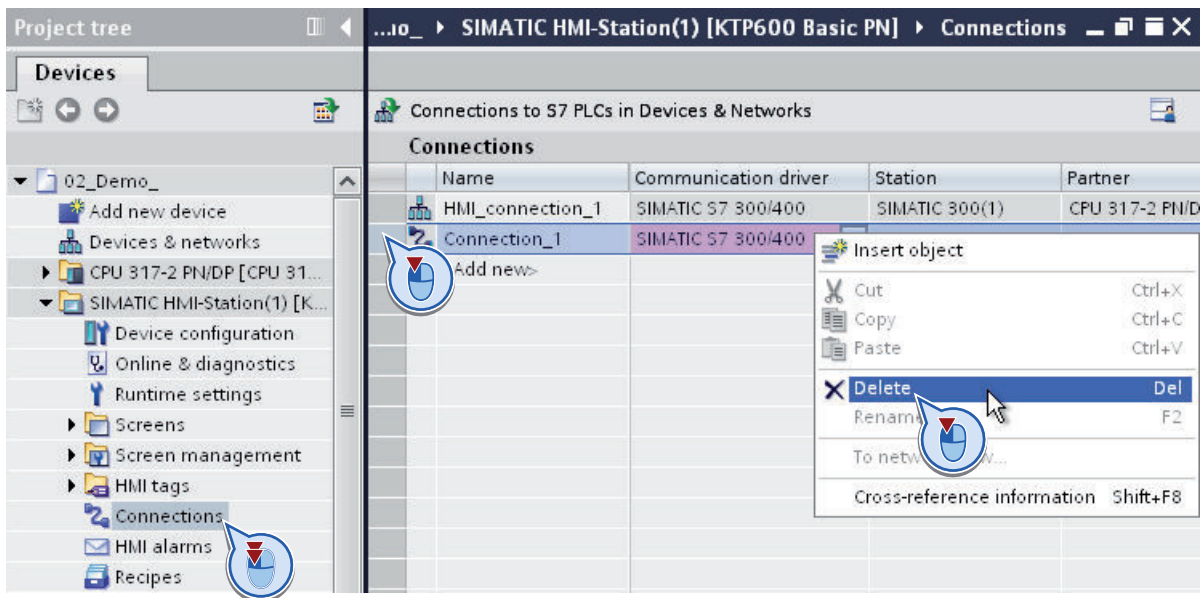

2. Select the row with the old connection in the table.
3. Select the "Delete" command in the shortcut menu of the connection line.
4. Perform the above-described steps for all unspecified connections of the source project.

## 4.2 Programming recommendations

### 4.2.1 The new S7-1500 CPU functions at a glance

#### Higher performance

The S7-1500 represents a CPU series that provides much higher performance than the CPUs of the S7-300/400 series. When programming with STEP 7 V5.x, you were probably used to working with programming methods such as absolute addressing to achieve higher performance from the CPU and leaner program code.

Due to the high performance that the S7-1500 provides, these programming methods are made obsolete.

In the paragraphs below we would like to introduce some new programming options of the S7-1500.

#### Universal symbolism

The S7-1500 allows you to use the symbolism throughout the entire project. Using the auto-complete function, you are given context-dependent support for programming with symbols within the programming editors. The data elements, for example those in a data block, are assigned only a symbolic name in the declaration but no fixed address within the data block. This allows you to fully exploit the high performance of the S7-1500 when accessing these data elements. The absolute addresses of operands need not be known and access errors are avoided.





Your program code will be clearer due to the symbolism and you have to comment less. All points of use are automatically updated when a correction is made to the symbolism.

An example of the use of universal symbols is available at: Symbolic addressing (Page 185)

#### Optimized block access

With optimized block access, the declared data elements are arranged automatically in the available memory area of the block in a way that makes optimal use of its capacity. The data is structured and saved in way that is optimal for the CPU used. The storage is left to the system. The data elements are assigned only a symbolic name in the declaration by which the

tag within the block can be addressed. This allows you to increase the performance of the CPU. Access errors, from the HMI, for example, are not possible.

Comparison of block accesses Standard < > Optimized		<b>SIEMENS</b>
	Standard block access (S7-1200/1500 compatible with S7-300/400)	Optimized block access (S7-1200/1500 only)
Data management	You can address tags using both symbolic (memory-optimized) and absolute (user-defined) addresses.	The system manages and optimizes the data storage. This results in optimal use of the memory capacity.
Performance	 The access to a CPU of the S7-1200/1500 series does not always occur as fast as possible because the data storage can be inefficient due to absolute addressing.	 The access always occurs as fast as possible because the data storage is optimized by the system and no fixed addresses are assigned.
Susceptibility to errors	 Absolute addressing (e.g., from HMI or when indirect addressing is used) can lead to inconsistencies after a change to the fixed address.	 Access errors, e.g., from HMI or when indirect addressing is used, are not possible because the access is symbolic.
Retentivity	Valid for all tags of a data block	Valid for individual tags
<b>Recommendation:</b> To achieve the best-possible performance, the combining of different block access types within your program is not recommended.		

You can find additional information on blocks with optimized access under "See also".

### New data types

The new data types LWORD, LINT, ULINT, LTIME, LTOD, LDT and the array (32-bit limit) offer much higher calculation accuracy when using mathematical functions. In the area of implicit and explicit data type conversion, you have more options in comparison to the CPUs of the S7-300/400 series.

You can find additional information on the new data types under "See also".

### PLC data types

PLC data types (UDT) are data structures that you define and that can be used multiple times within the program. The structure of a PLC data type is made up of several components, each of which can contain different data types. You define the type of components in the declaration of the PLC data type.



You can use the PLC data type as a base data type for defining tags and as a template for creating global data blocks. If you later make changes to the PLC data type, the changes are automatically updated at all points of use.

You can also symbolically access individual elements of an array within a PLC data type.

You can find additional information on the new data types under "See also".

You can find an example for using PLC data types under: Using PLC data types (UDT) (Page 194)

### **Uniform instructions in all programming languages**

You are provided with a uniform set of instructions in all programming languages (LAD, FBD, STL, SCL, and GRAPH).

### **Slice access**

Slice access gives you the option of specifically addressing areas within declared tags. You can implement symbolic access to a single bit up to the level of the tag. The single bit is then addressed absolutely.

You can find additional information on slice access under "See also".

### **Indirect addressing**

Indirect addressing offers you the option of addressing operands whose address is not calculated until runtime. All programming languages provide general methods for indirect addressing, for example, via POINTER. In the SCL programming language, you can also use PEEK and POKE instructions.

You can find additional information on indirect addressing under "See also".

### **FAQs**

You can find additional information on the programming recommendations under FAQ ID: 67582299 (<http://support.automation.siemens.com/WW/llisapi.dll?aktprim=0&lang=en&referer=%2fWW%2f&func=cslib.csinfo&siteid=csius&Datakey=47071380&extranet=standard&groupid=4000002&viewreg=WW&nodeid0=29156492&objaction=csopen>)

## **4.2.2 Symbolic addressing**

### **Advantages of symbolic addressing**

The use of universally applied and meaningful symbols in the overall project makes the program code easier to read and understand.

This gives you the following advantages:

- You do not have to write detailed comments.
- Data access is faster.
- No errors occur when accessing data.
- You no longer have to work with absolute addresses.
- The assignment of the symbol to the memory address is monitored by STEP 7, which means all points of use are automatically updated when the name or the address of a tag changes.

### **Programming in STEP 7 V5.x**

STEP 7 V5.x already gave you the option to write a program that is easier to read by using descriptive names for operands and blocks. You did this by assigning the symbolic operands to memory addresses and blocks in the symbol table. In order for a change in the symbolism to also have an effect on the program code in the programming editor, you had to use the "Operand priority" property to specify whether the symbol or the absolute value had priority.

The use of symbolic addressing allowed you to create a program with greater clarity. However, in some cases, such as when programming with user-defined data types (UDT), this could impair performance.

You could increase the performance by ignoring the symbolism in the UDT and using absolute addressing. This made it necessary, however, to know the data storage. Changes to the UDT were not automatically updated. Using absolute addressing, you could also access parts of a tag and edit these. The only drawback of absolute addressing, however, was that after a certain level the program code was cluttered and you had to insert additional comments for better orientation.

### **Procedure in STEP 7 TIA Portal**

The S7-1500 CPU offers much higher performance than the S7-300/400 CPUs. To fully use this high performance, we recommend you enable optimized block access for all blocks and use symbolic addressing in the program code.

The programming editor helps you work with symbols through context-sensitive input help, for example, auto-complete. Using it, you can easily access existing tags or instructions during programming.

## Programming example

The following example shows you how to symbolically access individual elements:

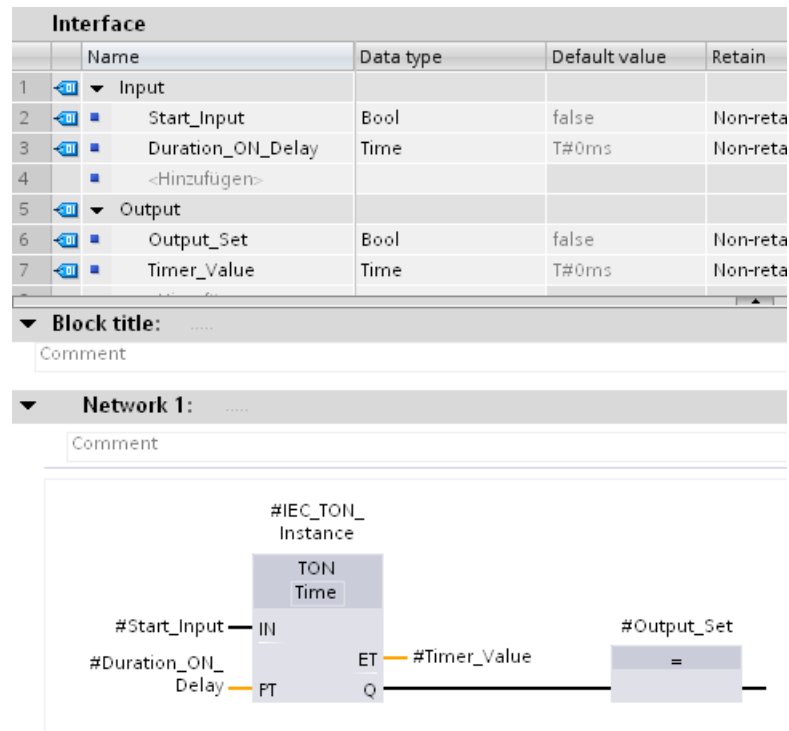

You can use the tag names that you have defined in the block interface directly at the parameters of the TON instruction without knowing the absolute address of the tag.

### 4.2.3 Using IEC timers and counters

#### Advantages of IEC timers and counters

The universal use of IEC timers and counters makes your program code more efficient.

This gives you the following advantages:

- The blocks can be called multiple times with newly generated instance data blocks.
- The IEC counters have a large counting range.
- Compared to S5 timers, IEC timers have better performance and greater time accuracy.

#### Programming in STEP 7 V5.x

The S5 timers and counters in STEP 7 V5.x were addressed absolutely via a number. Due to this dependency on numbers, program blocks were not reusable with S5 timers and counters.

The value range of a timer was limited to 9990 seconds and that of a counter limited to a maximum of 999.

### Procedure in STEP 7 TIA Portal

You declare IEC timers and counters in the program block where they are called or needed. The IEC timer is a structure of data type IEC\_TIMER, IEC\_LTIMER, or TON\_TIME and TON\_LTIME, for example, which you can also declare as a local tag in a block. The IEC counter is a structure of data type IEC\_SCOUNTER, IEC\_USCOUNTER, etc.

### Programming example in the TIA Portal

The following example shows you how to declare an IEC timer and IEC counter as a local tag:

Interface						
	Name	Data type	Default value	Retain	Visible in ...	Setpoint
1	▶ Input				<input type="checkbox"/>	<input type="checkbox"/>
2	▶ Output				<input type="checkbox"/>	<input type="checkbox"/>
3	▶ InOut				<input type="checkbox"/>	<input type="checkbox"/>
4	▼ Static				<input type="checkbox"/>	<input type="checkbox"/>
5	▶ SwitchDelay	TON_TIME		Non-ret...	<input checked="" type="checkbox"/>	<input type="checkbox"/>
6	▶ CountDB	CTU_INT		Non-retain	<input checked="" type="checkbox"/>	<input type="checkbox"/>

▶ Block title: .....

▼ Network 1: .....

Comment

The data of the TON IEC timer and the CTU IEC counter is stored as a local tag (multi-instance) in the block interface.

### 4.2.4 Flexibly using enable output ENO

#### Advantages

You can to detect runtime errors and avoid program termination using the EN/ENO mechanism for each instruction and block call. Overflow, for example, is reported via the ENO enable output for mathematical functions.

In STEP 7 TIA Portal, the ENO enable output is disabled by default in the programming languages LAD and FBD. If needed, you can activate the enable output and thereby deliberately target the instructions for which you want to have error evaluation.

This gives you the following advantages:

- The performance increases with ENO disabled.
- Runtime errors do not cause the CPU to go to STOP when ENO is enabled.

### Procedure in STEP 7 TIA Portal

Proceed as follows to activate the EN/ENO mechanism of an instruction:

1. In your program, right-click the instruction at which you want to activate the EN/ENO mechanism.
2. Select the "Generate ENO" command from the shortcut menu.  
The ENO value is generated for the instruction. Other instructions are inserted with the enable output.

The tables below list the instructions for which ENO enable output can be disabled:

<b>Basic instructions</b>	
Math functions	ADD, SUB, MUL, DIV, MOD, INC, DEC, ABS, NEG, SQR, SQRT, LN, EXP, SIN, COS, TAN, ASIN, ACOS, ATAN, FRAC, EXPT, MIN, MAX, LIMIT, CALCULATE
Move operations	MOVE, SWAP, MOVE_BLK, UMOVE_BLK, FILL_BLK, UFILL_BLK, MOVE_BLK_VARIANT
Conversion operations	CONVERT, ROUND, CEIL, TRUNC, FLOOR, NORM_X, SCALE_X
Word logic operations	AND, OR, XOR, INV, DECO, ENCO
Shift and rotate	SHR, SHL, ROR, ROL

<b>Extended instructions</b>	
String + Char	CONCAT, LEFT, RIGHT, MID, DELETE, INSERT, REPLACE, FIND, LEN, S_CONV
Date and time	T_CONV

You can find additional information on the EN/ENO mechanism in each programming language under "See also".

### Programming example

The following example shows you how to use instructions with the ENO enable output enabled and disabled:

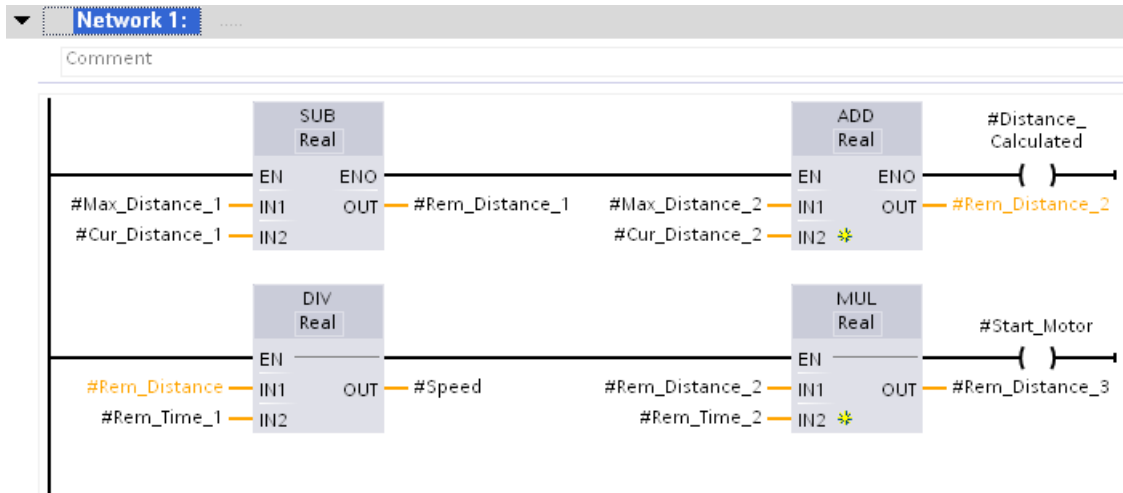

If you have activated the ENO enable output, for example with the SUB instruction, all subsequent instructions are also applied with an activated enable output. If an arithmetic error occurs during the execution of the SUB instruction, the ADD instruction is not executed.

The ENO enable output is disabled for the DIV instruction in the second branch. If a runtime error occurs during execution, the MUL instruction is executed anyway.

### 4.2.5 Using MOVE instructions in STL

#### Possible applications

You can now program with MOVE instructions in STL on an S7-1500 CPU.

This gives you the following advantages:

- The program structure is easier to create.
- The performance of the CPU increases.

#### Programming in STEP 7 V5.x

In STEP 7 V5.x, you used the "BLKMOV: Move block" and "UBLKMOV: Move block uninterruptible" system functions to implement the MOVE functionality.

## Procedure in STEP 7 TIA Portal

The following new MOVE instructions are available in STEP 7 TIA Portal:

- MOVE: Move value
- MOVE\_BLK: Move block
- MOVE\_BLK\_VARIANT: Move block
- UMOVE\_BLK: Move block uninterruptible

You can find additional information on the new MOVE instructions under "See also".

## Programming example

The following example shows you how the "MOVE\_BLK instruction works: Move block". An array block is copied into another array block:

Data_DB		
	Name	Data type
1	Static	
2	Array_1	Array [0..10] of Int
3	Array_1[0]	Int
4	Array_1[1]	Int
5	Array_1[2]	Int
6	Array_1[3]	Int
7	Array_1[4]	Int
8	Array_1[5]	Int
9	Array_1[6]	Int
10	Array_1[7]	Int
11	Array_1[8]	Int
12	Array_1[9]	Int
13	Array_1[10]	Int
14	Array_2	Array [0..10] of Int
15	Array_2[0]	Int
16	Array_2[1]	Int
17	Array_2[2]	Int
18	Array_2[3]	Int
19	Array_2[4]	Int
20	Array_2[5]	Int
21	Array_2[6]	Int
22	Array_2[7]	Int
23	Array_2[8]	Int
24	Array_2[9]	Int
25	Array_2[10]	Int

```

Network 1:
-----
Comment
-----
1  | CALL MOVE_BLK
2  |   Int  UInt
3  |   IN   := "Data_DB".Array_1[0]
4  |   COUNT := 10
5  |   OUT  := "Data_DB".Array_2[0]
6  |
7  |
    
```

Using the MOVE\_BLK instruction, ten elements from "Array\_1" of the "Data\_DB" data block are copied into "Array\_2" of the same data block.

### 4.2.6 Implementing array access with a variable index

#### Advantages of the variable index

For addressing the components of an array, you can specify tags of the integer data type as well as constants as the index. Integers with lengths up to 32 bits are allowed here. When tags are used, the index is calculated during runtime. You can, for example, use a different index for each cycle in program loops. You can also access an array within a PLC data type.

This gives you the following advantages:

- No need for addressing with address registers or a self-generated POINTER.
- More flexibility within your program.
- The variable index is available in all STEP 7 programming languages.
- It uses the existing names of data blocks and array tags. This improves readability of the program code.
- The start address of the array does not have to be known.
- The program code is easier to write.
- The compiler generates optimized program code.

#### Procedure in STEP 7 V5.x

In STEP 7 V5.x, you had to use an address register with the help of a self-configured POINTER for indexed addressing of array elements. The SCL programming language already supported indirect addressing with variable index.

#### Programming example in STEP 7 V5.x

The "Data\_classic" data block is required for the following STL example. To address an element of the "Quantities" array, the following commands must be used:

STL	Explanation
OPN "Data_classic"	// The "Data_classic" data block is called.



STL	Explanation
L #index	// The value of the local tag #index is loading in accumulator 1.
SLD 3	// Move bits 0 to 31 of accumulator 1 by 3 positions to the left. // Fill the now empty bit places with zeros.
LAR1	// Load address register 1 with contents of accumulator 1.
L DBW [AR1, P#10.0]	// Load the array element addressed with #index into accumulator 1. // P#10.0 = Start address of the array

You need to consider the following with this procedure, however:

- The array name is not used. This reduces the readability of the program code and makes it necessary to add a comment.
- The start address of the array (P#10.0) must be known to perform the addressing.
- The indexed addressing must involve the use of the address register.

### Programming example in STEP 7 TIA Portal

The following syntax is used for indirect indexing of the "Quantities" array that was declared in the "Data\_DB" data block:

"Data_DB".Quantities["i"]	// One-dimensional array
"Data_DB".Quantities["i"].a	// One-dimensional array of STRUCT
"Data_DB".Quantities["i","j"]	// Multi-dimensional array
"Data_DB".Quantities["i","j"].a	// Multi-dimensional array of STRUCT

Part	Description
Data_DB	Name of the data block in which the array is located
Quantities	Tag of the Array data type
i, j	PLC tags of the integer data type that are used as pointers
a	Additional partial tag of the structure

The following example shows indirect indexing of an array component in STL.

You need another program line for addressing an array element:

Addressing in STL	Explanation
L "Data_DB".Quantities[#index]	// The value of the array element #index is loaded directly from the data block into accumulator 1.

Note the following to get the best performance:

- Declare tags that are used as an array index as an integer of less than or equal to 32 bits.
- Store intermediate results and array indexes in the temporary local data area.

### 4.2.7 Using PLC data types (UDT)

#### Advantages of the PLC data types

PLC data types (UDT) are data structures that you define and that can be used multiple times within the program. The structure of a PLC data type is made up of several components, each of which can contain different data types. You define the type of components in the declaration of the PLC data type. By using PLC data types, you can optimally exploit the high performance of the S7-1500 CPU.

Many programs require contiguous data records that have to be processed by different locations in the program. They are optimized or replaced as the program runs. These are, for example:

- Data records for material tracking
- A parameter set for a motor setting
- Various recipes

This gives you the following advantages:

- PLC data type elements can also be addressed indirectly, which means the address is variable and is first calculated in runtime.
- Tags based on a PLC data type inherit all properties of the PLC data type.
- Modifying the PLC data type results in automatic adjustment of all tags derived from it.
- Using universal symbolism makes the program easier to read, because the names of the individual elements of a PLC data type are displayed in the program.
- Increased performance because optimized program code is generated.
- The PLC data type can be passed as a complete structure for a block call.
- Simplified calling interface due to fewer parameters that have to be supplied.

#### Procedure in STEP 7 V5.x

STEP 7 V5.x already gave you the option to create a data record as a structured tag using the STRUCT data type or a PLC data type (UDT). However, the performance was adversely affected by the use of symbolic addressing.

The declaration in the data blocks was mostly implemented as an anonymous structure. The blocks themselves were then programmed to pass the values of the structure as actual parameters and the calculated values were copied back into the structure. This enabled you to also pass the data block number and use absolute addressing in the block. The number of parameters that you had to supply was often very large. The actual data was stored in the data blocks and the calculated values were passed to other blocks. But no symbolism was available when passing the data block tags.

## Procedure in STEP 7 TIA Portal

If you work with PLC data types in your program, you can assign them to both a formal parameter and an actual parameter. This means you no longer have to declare each individual parameter. If a block has an input parameter that is based on a PLC data type, you must transfer a tag that has the same PLC data type as an actual parameter.

To use a PLC data type, follow these steps:

1. Declare the data records as PLC data type with a suitable name, for example, "Material tracking".
2. Use this data type to declare a data block or a DB tag.
3. Define the formal parameter as VAR\_IN\_OUT / VAR\_IN or VAR\_OUT tag in the block interface.
4. Assign the PLC data type to the formal parameter in the "Data type" column.

## Programming example in the TIA portal

The following example shows the call and the parameter assignment of a function block (FB) with two formal parameters. The data type of the DB tag (Array [1 .. 10] of BOOL) and the PLC data type (UDT) are identical to the data types of the FB parameters.

Data_block_1			
	Name	Data type	Start value
1	Static		
2	Arr_Var	Array [1..10] of Bool	
3	UserData_Var	"UserDataType"	
4	Var1	Bool	false
5	Var2	Bool	false
6	ByteVar1	Byte	16#0
7	WordVar1	Word	16#0
8	IntVar1	Int	0
9	RealVar1	Real	0.0

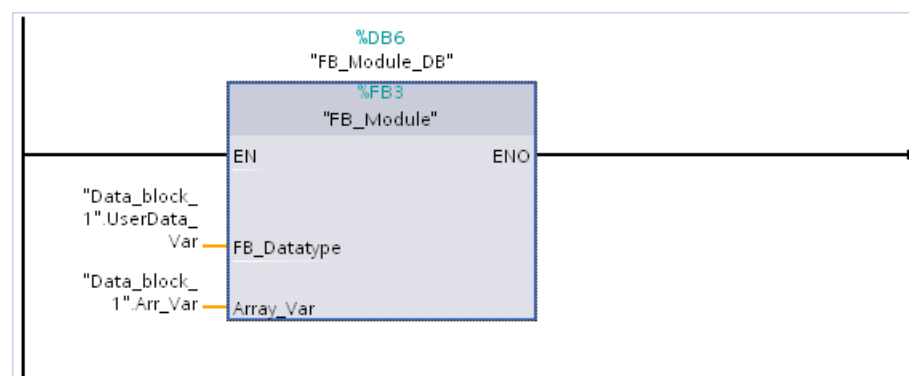

Declare the "UserDataType" PLC data type in the project tree in the "PLC data types" folder. Then use it as a data type for the "UserData\_Var" tag. You declare both tags "UserData\_Var" and "Arr\_Var" in the "Data\_block\_1" data block and use them to supply the parameters of the "FB\_Module" block.



## First steps

### 5.1 Getting Started Documentation

#### Getting started with the TIA Portal

The Getting Started documentation is available to help you begin using the TIA portal.

The Getting Started documentation contains instructions which show you, step-by-step how to create a project in the TIA portal and give you the chance to get a quick overview of all the possibilities the TIA portal offers you.

#### Contents

The Getting Started documents describe the creation of a single, continuous project for STEP 7 and WinCC that is extended with each chapter. You start with simple basic functions, and use more complex ones as you continue with the creation of the project.

In addition to the step-by-step instructions, the Getting Started documents also give you background information that explains the functions used and illustrate how they relate to each other.

#### Target audience

The Getting Started documents are intended for beginners, but are also useful for users migrating from a previous version of SIMATIC STEP 7 and WinCC.

#### Download

The documentation is available, free of charge at the Service&Support (<https://support.automation.siemens.com>) portal in PDF form.

You can download the documents here:

- STEP 7 Basic and WinCC Basic (V10.5) (<http://support.automation.siemens.com/WWW/view/en/40263542/0/en>)
- STEP 7 Professional and WinCC Advanced (V11) (<http://support.automation.siemens.com/WWW/view/en/28919804/133300>)
- STEP 7 Professional and WinCC Advanced (V12) ([http://www.automation.siemens.com/salesmaterial-as/interactive-manuals/getting-started\\_simatic-s7-1500/\\_content/EN/content\\_en.html](http://www.automation.siemens.com/salesmaterial-as/interactive-manuals/getting-started_simatic-s7-1500/_content/EN/content_en.html))



## Introduction to the TIA Portal

### 6.1 User interface and operation

#### 6.1.1 Starting, setting and exiting the TIA Portal

##### 6.1.1.1 Starting and exiting the TIA Portal

#### Starting the TIA Portal

Follow the steps below to start the TIA Portal:

1. In Windows, select "Start > Programs > Siemens Automation > TIA Portal V12".  
The TIA Portal opens with the last settings used.

#### Exiting the TIA Portal

Follow the steps below to exit the TIA Portal:

1. In the "Project" menu, select the "Exit" command.  
If the project contains any changes that have not been saved, you will be asked if you wish to save them.
  - Select "Yes" to save the changes in the current project and close the TIA Portal.
  - Select "No" to close the TIA Portal without saving the most recent changes in the project.
  - Select "Cancel" to cancel the closing procedure. The TIA Portal will remain open if you select this option.

##### 6.1.1.2 Overview of the program settings

#### Overview

The following table shows the application settings that you can make:

Group	Setting	Description
General settings	User name	The user name of the user. The user name is stored in the project properties when a new project is created.
	User interface language	Language for the program interface

6.1 User interface and operation

Group	Setting	Description
	Mnemonic	Specifies the mnemonics for programming: "German" uses the German mnemonics, for example, "E1.0". "International" uses international mnemonics, for example, "I1.0". For information on the differences in the mnemonics of the individual commands, refer to the description of the relevant programming language.
	Show list of recently used projects	Number of entries in the list of recently used projects in the "Project" menu
	Load most recent project during startup	The last opened project is opened automatically after the TIA Portal starts.
	Displaying truncated text in full	Texts which are truncated due to their length are displayed in a tooltip.
	Show tooltips (context-sensitive help is available)	Tooltips are displayed and you get context-sensitive help. If this function is disabled, you can open the tooltip with <F1>.
	Open cascade automatically in tooltips	After a brief time, the tooltips automatically expand to display a cascade containing additional help. If this option is cleared, the tooltips must be manually expanded.
Reset to default	All application settings	All changes that you made in the TIA Portal after installation are reversed.
	Layout of the editors	Resets the complete layout of the application to the factory state.
	Show all message windows	All message windows whose appearance was manually suppressed are displayed again.
Start view	Most recent view	Starts the program in the last view that was used. This can be either the portal view or the project view.
	Portal view	The TIA Portal will always be started in the portal view, irrespective of the last view you worked in.
	Project view	The TIA Portal will always be started in the project view, irrespective of the last view you worked in.
View for objects in overview	Details	When several views are available, the detail view opens by default, for example, in the overview window.
	List	When several views are available, the list view opens by default, for example, in the overview window.
	Thumbnails	When several views are available, the symbol view opens by default, for example, in the overview window.
Storage settings	Recently used storage location	When a project is saved the first time, the most recently used file path is set by default.
	Default storage location	Enables the specification of file paths for: <ul style="list-style-type: none"> <li>• Projects</li> <li>• Libraries</li> </ul>
Data exchange	Storage location for data import	Imported files are searched for at this storage path by default.
	Storage location for data export	This is the default storage path for the data export.
	Storage location for support packages	When support packages are downloaded, they are stored in the specified storage path and can be installed from there.
	Storage location for log files	Log files are stored at the location specified here.



**See also**

- Starting and exiting the TIA Portal (Page 199)
- Resetting the user interface layout (Page 233)
- Changing the settings (Page 203)
- Configuring the display of tooltips and tooltip cascades (Page 253)

**6.1.1.3 Overview of the script and text editor settings**

**Overview**

The following table shows the available settings for script and text editors:

Group	Setting	Description
Font	Font type and size	Sets the font type and size for the text in text editors.
Font colors	Color settings	You can choose the colors for individual text elements from the respective drop-down lists in the text editors. Optional settings are available for the following text elements: <ul style="list-style-type: none"> <li>• Text</li> <li>• Keywords</li> <li>• Comments</li> <li>• Translatable comments</li> <li>• Instructions</li> <li>• Scripts</li> <li>• Standard functions</li> <li>• System functions</li> <li>• Constant strings</li> <li>• Constant tags</li> <li>• Tags</li> <li>• Object models</li> <li>• Formal parameters</li> </ul>
	Reset to default	Resets all font colors in editors to their factory settings.
Tabs	Tab width	Sets the width of tabs.
	Use tabs	Enables the use of tabs.
	Use spaces	Specifies use of space characters instead of tabs.
Indent	Indentation at start of paragraph	Specifies whether the start of a new paragraph is to be indented. The following selection options are available: <ul style="list-style-type: none"> <li>• None No indentation is used at the beginning of a paragraph in editors.</li> <li>• Block The first line of a paragraph in the editors is automatically indented.</li> <li>• Smart The program code is detected and the paragraphs are automatically indented to improve readability of the syntax.</li> </ul>

6.1 User interface and operation

Group	Setting	Description
View	Show line numbers	Displays the line numbers on the left side of the text.
	Show white spaces	Shows control characters within a text.
STL (statement list)	Font type and size	Sets the font type and size for STL program code.
SCL (Structured Control Language)	Font type and size	Sets the font type and size for SCL.
	Tab width	Sets the tab width in SCL programs.
	Indentation	Creates SCL programs automatically with syntactically correct indentation.
	Show line numbers	Shows the row numbers in SCL programs.

See also

Changing the settings (Page 203)

6.1.1.4 Overview of the print settings

Overview

The following table shows the available settings for printing:

Group	Setting	Description
General	Always print table data as pairs of values	Tables are printed as a list and not in tabular form. The corresponding values are listed for each column. Enable this option, for example, if you want to print a table that is too large for the print area.
	Always print data in tables	All parameters of technology objects are printed in tabular format.
	Print mask graphics if possible	If the utilized editor supports this function, the contents of the editor are printed not only as a table but rather as a complete graphic as it appears on the screen.
Hardware configuration	Active graphic view	The graphics of network and device view are included in the printout.
	Active table	A table associated with an editor is included when printing with the editor.
PLC Programming	Zoom factor	Specifies the size in which blocks are to be printed out.
	With interface	The interfaces of blocks are included in the printout.
	With comments	Comments on blocks are included in the printout.
	With line numbers	The line numbers of the program code are printed for text-based programming languages.
HMI screens	Show tab order	In the printout you can specify the order in which the runtime objects can be selected with the TAB key.

See also

Changing the settings (Page 203)

### 6.1.1.5 Changing the settings

#### Procedure

To change the settings, proceed as follows:

1. Select the "Settings" command in the "Options" menu.  
The "Settings" window is displayed in the work area.
2. Select the "General" group in the area navigation to change the settings described in the previous sections. Or click on one of the other entries in area navigation to make settings for your installed products.
3. Change the settings.

#### Result

The change will be adopted immediately, there is no need to save it explicitly.

#### See also

Overview of the program settings (Page 199)

Overview of the script and text editor settings (Page 201)

Overview of the print settings (Page 202)

## 6.1.2 Layout of the user interface

### 6.1.2.1 Views

#### Views

Three different views are available for your automation project:

- The portal view is a task-oriented view of the project tasks.
- The project view is a view of the components of the project, as well as the relevant work areas and editors.
- The library view (Page 207) shows the elements of the project library and the open global libraries.

You can change over between the two views using a link.

### 6.1.2.2 Portal view

#### Purpose of the portal view

The portal view provides you with a task-oriented view of the tools. Here, you can quickly decide what you want to do and call up the tool for the task in hand. If necessary, the view changes automatically to the project view (Page 205) for the selected task.

#### Layout of the portal view

The following figure shows an example of the components in the portal view:

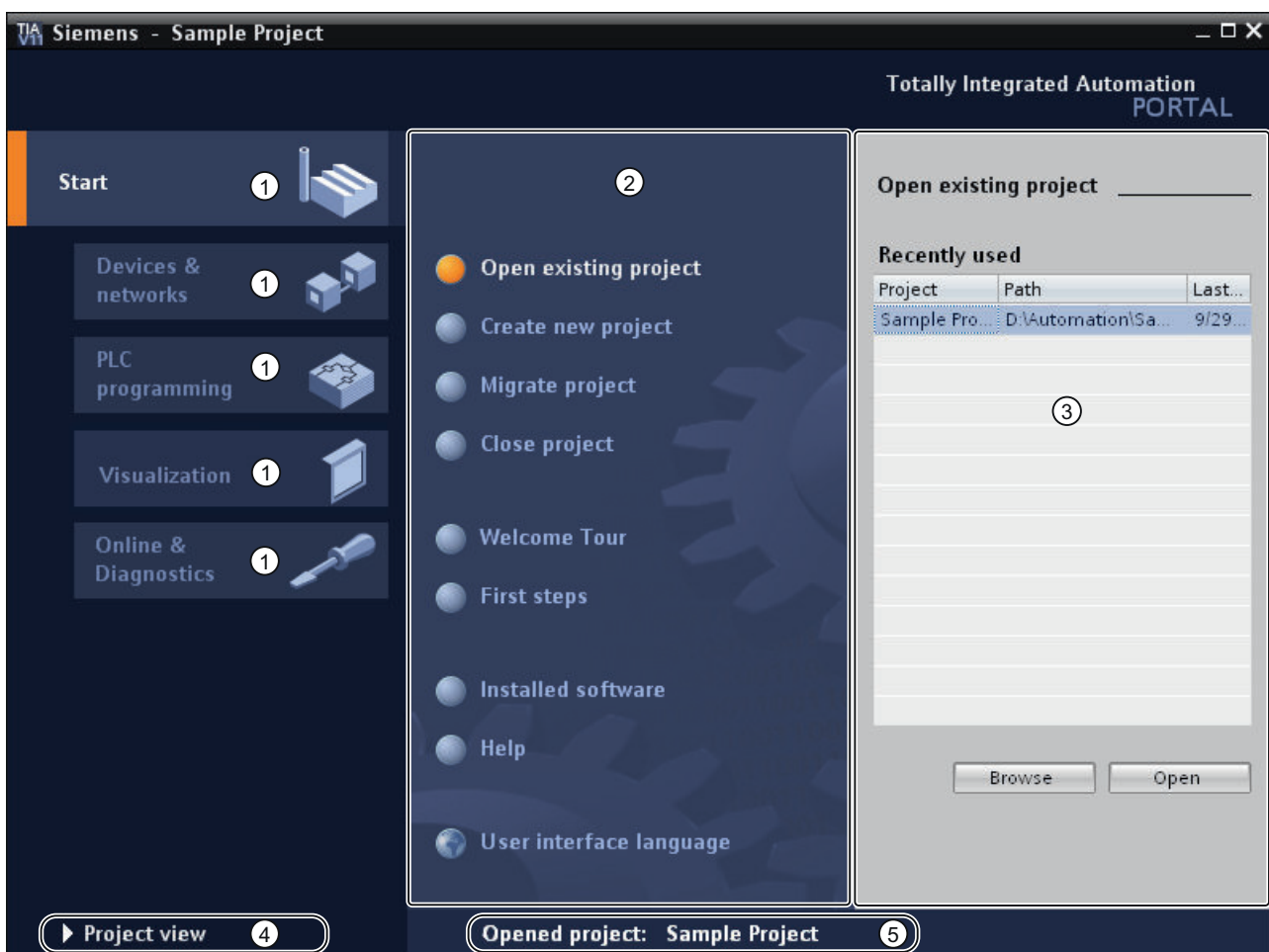

- ① Portals for different tasks
- ② Actions for the selected portal
- ③ Selection panel for the selected action
- ④ Change to the project view
- ⑤ Display of the project that is currently open

## **Portals**

The portals provide the basic functions for the individual task areas. The portals that are provided in the portal view depends on the products that have been installed.

### **Actions for the selected portal**

Here, you will find the actions available to you in the portal you have selected. You can call up the help function in every portal on a context-sensitive basis.

### **Selection panel for the selected action**

The selection panel is available in all portals. The content of the panel adapts to your current selection.

### **Change to the project view**

You can use the "Project view" link to change to the project view.

### **Display of the project that is currently open**

Here, you can obtain information about which project is currently open.

### **See also**

Project tree (Page 208)  
Basics of the work area (Page 211)  
Inspector window (Page 219)  
Basics on task cards (Page 221)  
Details view (Page 225)

## **6.1.2.3 Project view**

### **Purpose of the project view**

The project view is a structured view of all components of the project.

### Layout of the project view

The following figure shows an example of the components of the project view:

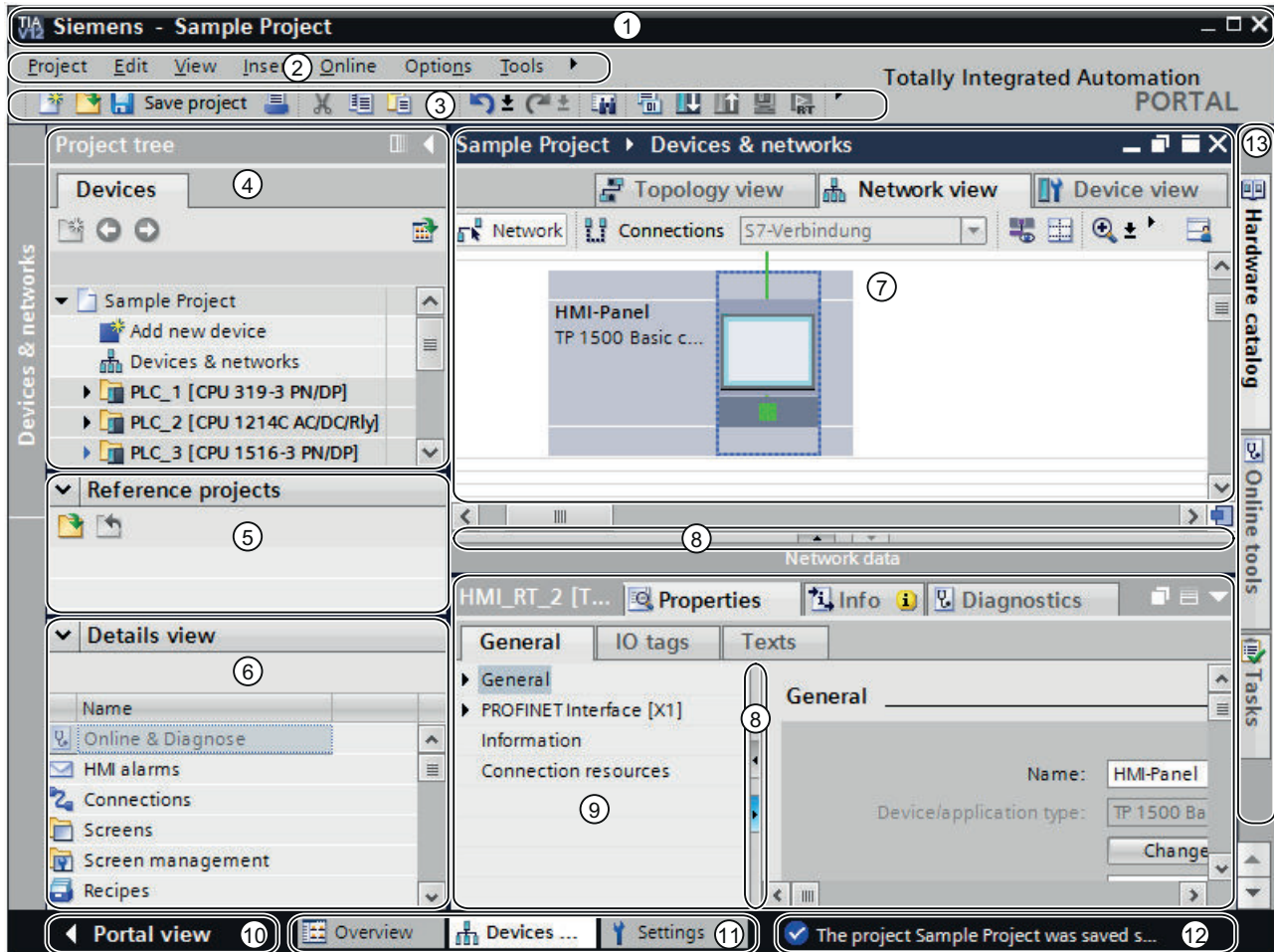

- ① Title bar
- ② Menu bar
- ③ Toolbar
- ④ Project tree (Page 208)
- ⑤ Reference projects (Page 223)
- ⑥ Details view (Page 225)
- ⑦ Work area (Page 221)
- ⑧ Dividers
- ⑨ Inspector window (Page 219)
- ⑩ Changing to the Portal view (Page 204)
- ⑪ Editor bar
- ⑫ Status bar with progress display
- ⑬ Task cards (Page 221)

### **Title bar**

The name of the project is displayed in the title bar.

### **Menu bar**

The menu bar contains all the commands that you require for your work.

### **Toolbar**

The toolbar provides you with buttons for commands you will use frequently. This gives you faster access to these commands.

### **Dividers**

Dividers separate individual components of the program interface. The arrows on the dividers allow you to display and hide the adjacent sections of the user interface.

### **Changing to the portal view**

You can use the "Portal view" link to change to the portal view.

### **Editor bar**

The Editor bar displays the open editors. If you have opened a lot of editors, they are shown grouped together. You can use the Editor bar to change quickly between the open elements.

### **Status bar with progress display**

In the status bar, you will find the progress display for processes that are currently running in the background. This also includes a progress bar that shows the progress graphically. Hover the mouse pointer over the progress bar to display a tooltip providing additional information on the active background process. You can cancel the background processes by clicking the button next to the progress bar.

If no background processes are currently running, the status bar displays the last generated alarm.

### **See also**

Basics of the work area (Page 211)

## **6.1.2.4 Library view**

### **Function of the library view**

The library view provides an overview of the elements in the project library and the open global libraries. You can switch to the library view using the "Libraries" task card.

See also: Overview of the library view (Page 343)

### **6.1.2.5 Project tree**

#### **Function of the project tree**

Using the project tree features gives you access to all components and project data. You can perform the following tasks in the project tree:

- Add new components
- Edit existing components
- Scan and modify the properties of existing components

You can select the objects of the project tree either with the mouse or via the keyboard by typing the first letter of the desired object. If more than one object begins with the same letter, the next lower object is selected. The project tree must be the focused user interface element in order for you to select an object with its initial letter.



## Layout of project tree

The following figure shows an example of the project tree components:

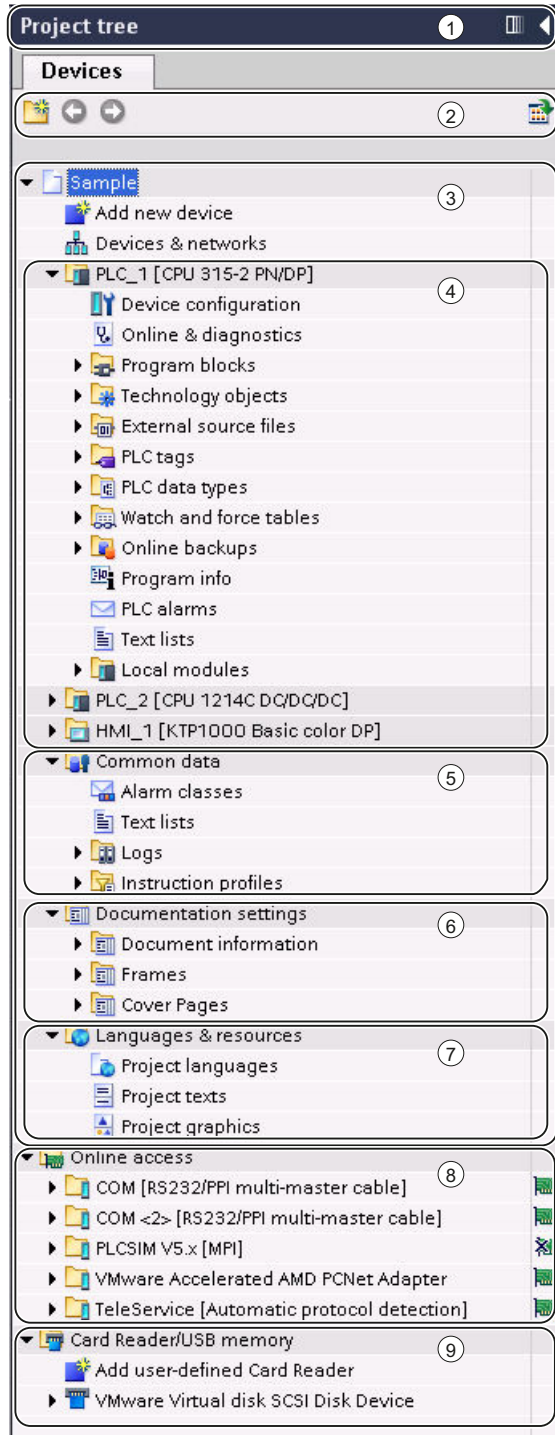

## 6.1 User interface and operation

- ① Title bar
- ② Toolbar
- ③ Project
- ④ Devices
- ⑤ Common data
- ⑥ Documentation settings
- ⑦ Languages & resources
- ⑧ Online access
- ⑨ Card Reader / USB memory

### Title bar

The title bar of the project tree has a button for automatically and manually collapsing the project tree. Once it is collapsed manually, the button is "Reduced" to the left-hand margin. It changes from an arrow pointing left to one that is pointing right, and can now be used to reopen the project tree. You can use the "Reduce automatically" button collapse to project tree automatically when you do not need it.

See also: Maximizing and minimizing the work area (Page 213)

### Toolbar

You can do the following tasks in the toolbar of the project tree:

- Create a new user folder; for example, in order to group blocks in the "Program blocks" folder.
- Navigate forward to the source of a link and back to the link itself.  
There are two buttons for links in the project tree. You can use these to navigate from the link to the source and back.
- Show an overview of the selected object in the work area.  
When the overview is displayed, the lower-level objects and actions of the elements in the project tree are hidden.

### Project

You will find all the objects and actions related to the project in the "Project" folder, e.g.:

- Devices
- Languages & resources
- Online access

### Device

There is a separate folder for each device in the project, which has an internal project name. Objects and actions belonging to the device are arranged inside this folder.

### **Common data**

This folder contains data that you can use across more than one device, such as common message classes, logs, scripts and text lists.

### **Documentation settings**

In this folder, you can specify the layout for project documentation to be printed at a later point.

### **Languages & resources**

You can determine the project languages and texts in this folder.

### **Online access**

This folder contains all the interfaces of the programming device / PC, even if they are not used for communication with a module.

### **Card Reader / USB memory**

This folder is used to manage all card readers and other USB storage media connected to the programming device / PC.

### **See also**

Portal view (Page 204)  
Project view (Page 205)  
Basics of the work area (Page 211)  
Inspector window (Page 219)  
Basics on task cards (Page 221)  
Details view (Page 225)

## **6.1.2.6 Work area**

### **Basics of the work area**

#### **Function of the work area**

The objects that you can open for editing purposes are displayed in the work area. These objects include, for example:

- Editors and views
- Tables

You can open several objects. However, normally it is only possible to see one of these at a time in the work area. All other objects are displayed as tabs in the Editor bar. If, you would

6.1 User interface and operation

like to view two objects at the same time when performing certain tasks, you can tile the work area either horizontally or vertically or undock elements of the work area. If no objects are open, the work area will be empty.

Layout of the work area

The following figure shows an example of a vertically split work area:

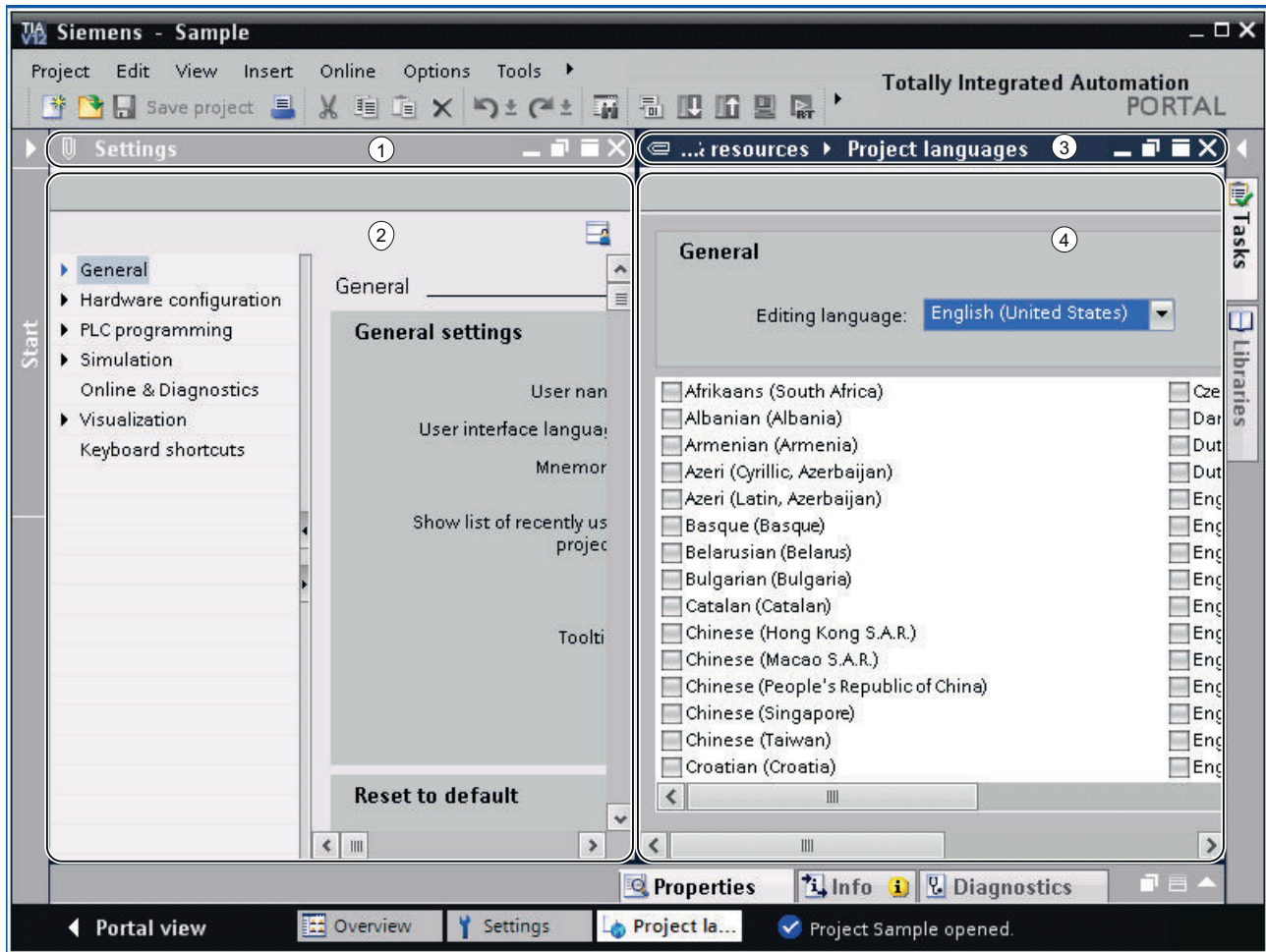

- ① Title bar of left-hand editor
- ② Work area of left-hand editor
- ③ Title bar of right-hand editor
- ④ Work area of right-hand editor

## See also

- Maximizing and minimizing the work area (Page 213)
- Splitting the work area (Page 215)
- Floating the work area elements (Page 215)
- Using grouped elements of the work area (Page 216)
- Minimizing and maximizing elements of the work area (Page 218)
- Switching between the elements in the work area (Page 218)
- Saving a layout of editors and tables (Page 232)
- Save user interface layout (Page 230)

## Maximizing and minimizing the work area

You have the option to adapt the work area to make it as large as possible. You can use the following function for this:

- Maximizing the work area  
You can close the task cards, project tree and inspector window with a single click. This increases the size of the work area. You can minimize the work area again at any time in order to return to the previous view.
- Collapsing task cards, project tree, and Inspector window automatically  
You can use the "Collapse automatically" option for the task cards, project tree, and Inspector window. This function causes these items to collapse automatically when you don't need them.

## Maximizing and minimizing the work area

To maximize the work area, follow these steps:

1. Open an element such as an editor or a table.  
The element appears in the work area.
2. Click the "Maximize" button in the title bar of the element.  
The task cards, project tree and inspector window collapse, and the work area is shown with its maximum dimensions.

To minimize the work area again, follow these steps:

## 6.1 User interface and operation

1. Click the "Embed" button in the title bar of the displayed element.  
This restores the view that existed before the work area was maximized. That is, if the task cards, project tree, or Inspector window were expanded before, they will be expanded again.

### Collapsing task cards, project tree, and Inspector window automatically

To collapse the task cards automatically, follow these steps:

1. Click "Collapse automatically" in the title bar of the task cards.  
The task cards collapse when you click anywhere outside the task cards.
2. To use the task cards, click the collapsed task cards.
3. The task cards expand and are available for use. The "Collapse automatically" option remains enabled.

To collapse the project tree automatically, follow these steps:

1. Click "Collapse automatically" in the title bar of the project tree.  
The project tree collapses when you click anywhere outside the project tree.
2. To use the project tree, click the collapsed project tree.  
The project tree expands and is available for use. The "Collapse automatically" option remains enabled.

To collapse the Inspector window automatically, follow these steps:

1. Click "Collapse automatically" in the title bar of the Inspector window.  
The Inspector window collapses when you click anywhere outside the Inspector window.
2. To use the Inspector window, click the collapsed Inspector window.  
The Inspector window expands and is available for use. The "Collapse automatically" option remains enabled.

To disable the automatic collapse option, follow these steps:

1. Click "Expand permanently" again in the relevant window.  
The "Collapse automatically" option is disabled, and the window remains expanded.

### See also

Basics of the work area (Page 211)

Splitting the work area (Page 215)

Floating the work area elements (Page 215)

Using grouped elements of the work area (Page 216)

Minimizing and maximizing elements of the work area (Page 218)

Switching between the elements in the work area (Page 218)

Saving a layout of editors and tables (Page 232)

## Splitting the work area

You can split the work area vertically or horizontally.

### Procedure

To split the work area vertically or horizontally, follow these steps:

1. In the "Window" menu, select the "Split editor space vertically" or "Split editor space horizontally" command.  
The element you have clicked and the next element in the Editor bar will be displayed either next to one another or one above the other.

---

#### Note

If no elements are open in the work area, the "Split editor space vertically" and "Split editor space horizontally" functions will not be available.

---

### See also

Basics of the work area (Page 211)  
Maximizing and minimizing the work area (Page 213)  
Floating the work area elements (Page 215)  
Using grouped elements of the work area (Page 216)  
Minimizing and maximizing elements of the work area (Page 218)  
Switching between the elements in the work area (Page 218)  
Saving a layout of editors and tables (Page 232)

## Floating the work area elements

You can float work area elements in their own separate window:

- Editors
- Tables
- Setting windows
- Task cards
- Inspector window

You can embed floating elements again in the work area at any time.

---

#### Note

##### Properties of elements in a floating window

The properties of elements that you have selected in a floating window are only displayed in the Inspector window if the Inspector window is floating as well.

---

### Floating the work area elements

To float work area elements, follow these steps:

1. Click the "Float" button in the title bar of the element.  
The element will be released from the work area and displayed in its own window. You can now place the window wherever you wish. If you have minimized the window, you can restore it via the editor bar.

### Embedding elements in the work area

To embed elements in the work area again, follow these steps:

1. Click the "Embed" button in the title bar of the element.  
The element will appear in the work area again.

### See also

Basics of the work area (Page 211)

Maximizing and minimizing the work area (Page 213)

Splitting the work area (Page 215)

Using grouped elements of the work area (Page 216)

Minimizing and maximizing elements of the work area (Page 218)

Switching between the elements in the work area (Page 218)

Saving a layout of editors and tables (Page 232)

### Using grouped elements of the work area

If you open more than five elements of the same type, e.g., editors or tables, they are grouped in the editor bar. You can use these groups as follows:

- Displaying individual elements of a group
- Displaying all elements of a group in separate windows
- Embedding all displayed elements of a group in the work area
- Minimizing all displayed elements
- Closing all elements of a group

### Displaying individual elements of a group

To display individual elements of a group, follow these steps:

1. In the editor bar, click the group containing the element you want to display.  
All list of all available elements of the group is displayed.
2. Click the element that you want to display.



### **Displaying all elements of a group in separate windows**

To display all elements of a group in separate windows, follow these steps:

1. In the editor bar, right-click the group whose elements you want to display.
2. Select "Restore group" in the shortcut menu.  
All elements of the group are displayed in separate, overlapping windows. Move the windows in order to see the individual element, or choose an element via the group in the editor bar.

### **Embedding all displayed elements of a group in the work area**

To embed all elements of a group displayed in separate windows in the work area again, follow these steps:

1. In the editor bar, right-click the group whose elements you want to embed.
2. Select "Embed group" in the shortcut menu.  
All elements of the group are embedded in the work area again.

### **Minimizing all displayed elements**

To minimize all elements of a group, follow these steps:

1. In the editor bar, right-click the group whose elements you want to minimize.
2. Select "Minimize group" in the shortcut menu.  
All elements of the group are minimized. However, the minimized elements remain open and can be quickly maximized again via the group in the editor bar.

### **Closing all elements of a group**

To close all elements of a group, follow these steps:

1. In the editor bar, right-click the group whose elements you want to close.
2. Select "Close group" in the shortcut menu.  
All elements of the group are closed. The group is removed.

### **See also**

- Basics of the work area (Page 211)
- Maximizing and minimizing the work area (Page 213)
- Splitting the work area (Page 215)
- Floating the work area elements (Page 215)
- Minimizing and maximizing elements of the work area (Page 218)
- Switching between the elements in the work area (Page 218)
- Saving a layout of editors and tables (Page 232)

### **Minimizing and maximizing elements of the work area**

You can minimize the elements that are open in the work area, such as editors or tables, as needed. However, an element remains open even if it has been minimized, and can quickly be maximized again using the editor bar.

#### **Minimizing elements in the work area**

To minimize elements in the work area, follow these steps:

1. Click the "Minimize" button in the title bar of the element.  
The element is minimized, but can still be accessed via the editor bar.

To minimize all elements at the same time, follow these steps:

1. In the "Window" menu, select the "Minimize all" command.

#### **Maximizing elements in the work area**

To maximize elements in the work area again, follow these steps:

1. Click the required element in the editor bar.  
The element is maximized and appears in the work area.

#### **See also**

Basics of the work area (Page 211)

Maximizing and minimizing the work area (Page 213)

Splitting the work area (Page 215)

Floating the work area elements (Page 215)

Using grouped elements of the work area (Page 216)

Switching between the elements in the work area (Page 218)

Saving a layout of editors and tables (Page 232)

#### **Switching between the elements in the work area**

You can switch between the elements in the work area at any time.

### Switching between the elements in the work area

To switch to the previous or next editor, follow these steps:

1. In the "Window" menu, select the "Next editor" or "Previous editor" command.  
The next or previous editor will be displayed.

### See also

- Basics of the work area (Page 211)
- Maximizing and minimizing the work area (Page 213)
- Splitting the work area (Page 215)
- Floating the work area elements (Page 215)
- Using grouped elements of the work area (Page 216)
- Minimizing and maximizing elements of the work area (Page 218)
- Saving a layout of editors and tables (Page 232)

## 6.1.2.7 Inspector window

### Function of the Inspector window

Additional information on an object selected or on actions executed are displayed in the inspector window.

### Layout of the Inspector window

The following figures show the components of the Inspector window:

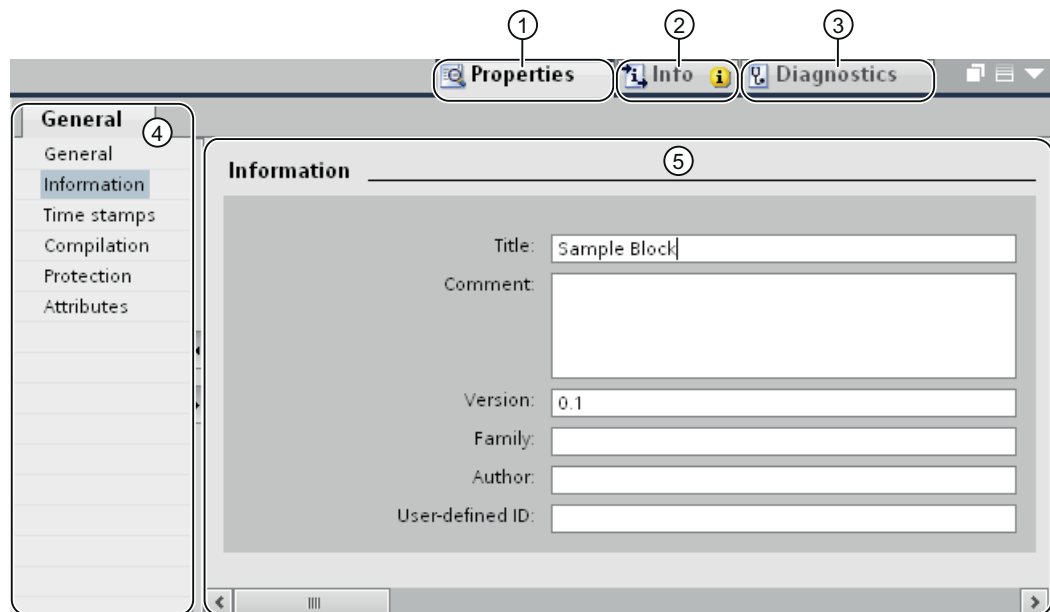

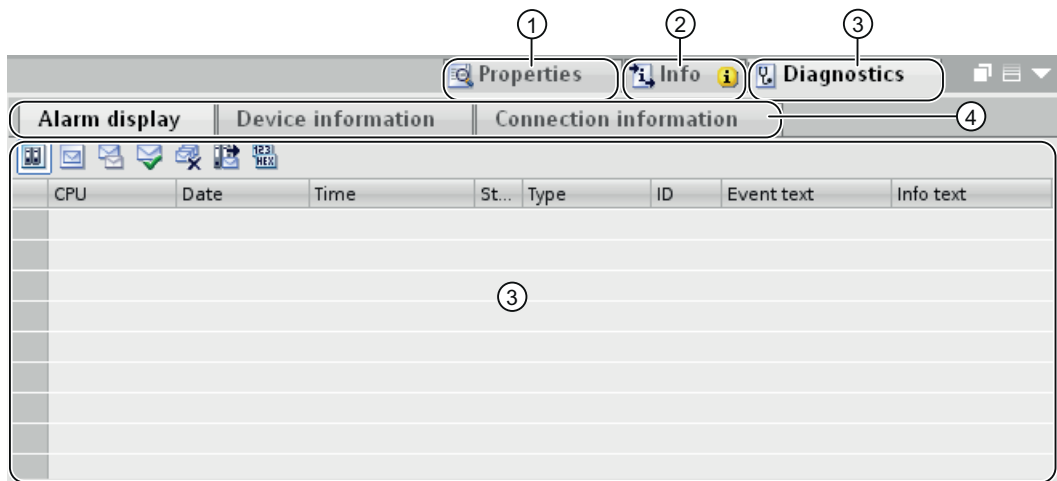

- ① "Properties" tab
- ② "Info" tab
- ③ "Diagnostics" tab
- ④ Navigation within the tabs:
  - Area navigation within the "Properties" tab
  - Lower-level tabs in the "Info" and "Diagnostics" tabs

### "Properties" tab

This tab displays the properties of the object selected. You can change editable properties here.

### "Info" tab

This tab displays additional information on the object selected, as well as alarms on the actions executed (such as compiling).

### "Diagnostics" tab

This tab provides information on system diagnostics events, configured alarm events, and connection diagnostics.

### Navigation within the tabs

You can use area navigation and the lower-level tabs to display the information you require within the tabs.

## **See also**

Project tree (Page 208)  
Basics of the work area (Page 211)  
Portal view (Page 204)  
Project view (Page 205)  
Basics on task cards (Page 221)  
Details view (Page 225)

### **6.1.2.8 Task cards**

#### **Basics on task cards**

#### **Function of task cards**

Depending on the edited or selected object, task cards that allow you perform additional actions are available. These actions include:

- Selecting objects from a library or from the hardware catalog
- Searching for and replacing objects in the project
- Dragging predefined objects to the work area

The task cards available can be found in a bar on the right-hand side of the screen. You can collapse and reopen them at any time. Which task cards are available depends on the products installed. More complex task cards are divided into panes that you can also collapse and reopen.

### Layout of task cards

The following figure shows an example of the bar with the task cards:

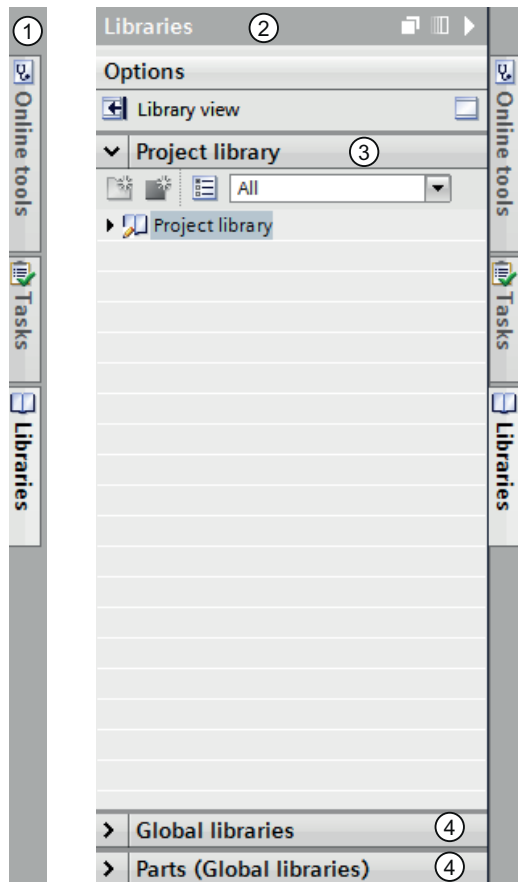

- ① Task cards closed
- ② Task card open
- ③ Opened palette of a task card
- ④ Closed palette of a task card

### See also

- Changing the pane mode (Page 223)
- Project tree (Page 208)
- Basics of the work area (Page 211)
- Inspector window (Page 219)
- Portal view (Page 204)
- Project view (Page 205)
- Details view (Page 225)

## Changing the pane mode

You can choose between two pane modes:

- **Single pane mode:**  
Only one pane is open at any given time. If you open another pane, the previously opened pane is closed automatically.
- **Multi-pane mode:**  
You can open several panes at the same time.

## Procedure

To change the pane mode, follow these steps:

1. Click the "Change pane mode" button above the panes inside a task card.

## See also

Basics on task cards (Page 221)

### 6.1.2.9 Reference projects

#### Function of reference projects

In the "Reference projects" palette, you can open other projects in addition to the current project. These reference projects are write-protected and cannot be edited. However, you can drag the objects of a reference project into your current project and further edit them there. You can also compare the objects of a reference project to the objects of your current project.

#### Layout of the "Reference projects" palette

The following figure shows the layout of the "Reference projects" palette:

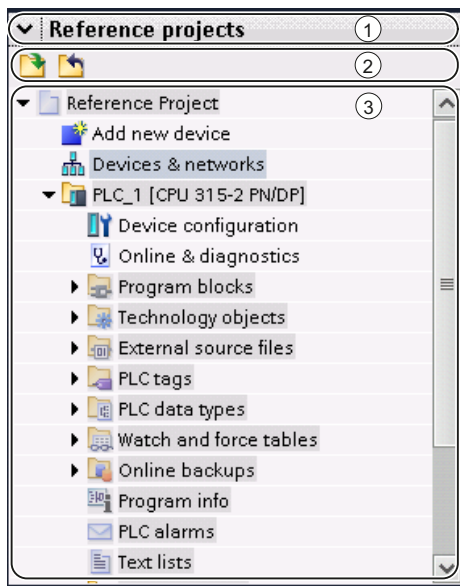

- ① Title bar
- ② Toolbar
- ③ Opened reference projects

### Title bar

The arrow for closing the palette is located in the title bar of the "Reference projects" palette. Once it is closed, the direction in which the arrow is pointing changes from downwards to right. It can now be used to reopen the palette.

### Toolbar

The toolbar contains buttons for opening and closing reference projects.

### Opened reference projects

Opened reference projects are displayed as read-only with their objects and their hierarchical structure.

### See also

Basics of reference projects (Page 277)

Opening and closing a reference project (Page 277)



### 6.1.2.10 Details view

#### Purpose of the details view

The detail view shows certain content of the selected object is in the overview window or in the project tree. This might include text lists or tags.

The content of folders is not shown, however. To display the content of folders, use the project tree or the Inspector window.

#### Layout of the details view

The following figure shows an example of the details view:

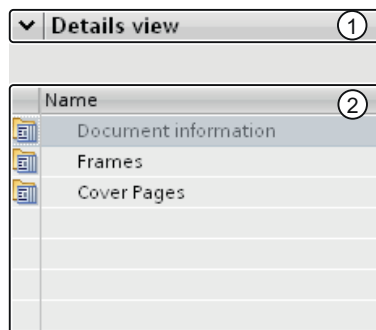

- ① Title bar
- ② Content of the selected object

#### Title bar

The arrow for closing the details view is located in the title bar of the details view. After it has closed, the direction in which the arrow is pointing changes from left to right. It can now be used to reopen the details view.

#### Objects

The displayed content varies depending on the selected object. You can move the content of objects from the details view to the required location using drag-and-drop.

**See also**

- Project tree (Page 208)
- Basics of the work area (Page 211)
- Inspector window (Page 219)
- Basics on task cards (Page 221)
- Portal view (Page 204)
- Project view (Page 205)

**6.1.2.11 Overview window**

**Overview window**

**Functions of the Overview window**

The Overview window supplements the project tree. The Overview window shows the contents of the folder currently selected in the project tree.

In addition, you can perform the following actions in the Overview window:

- Open objects
- Display and edit the properties of objects in the Inspector window
- Rename objects
- Call object-specific actions from the shortcut menu
- Compare objects side by side
- Perform various object operations, such as inserting objects from the library via drag-and-drop and moving, copying, pasting, and deleting objects

## Layout of the Overview window

The following figure shows the components of the Overview window:

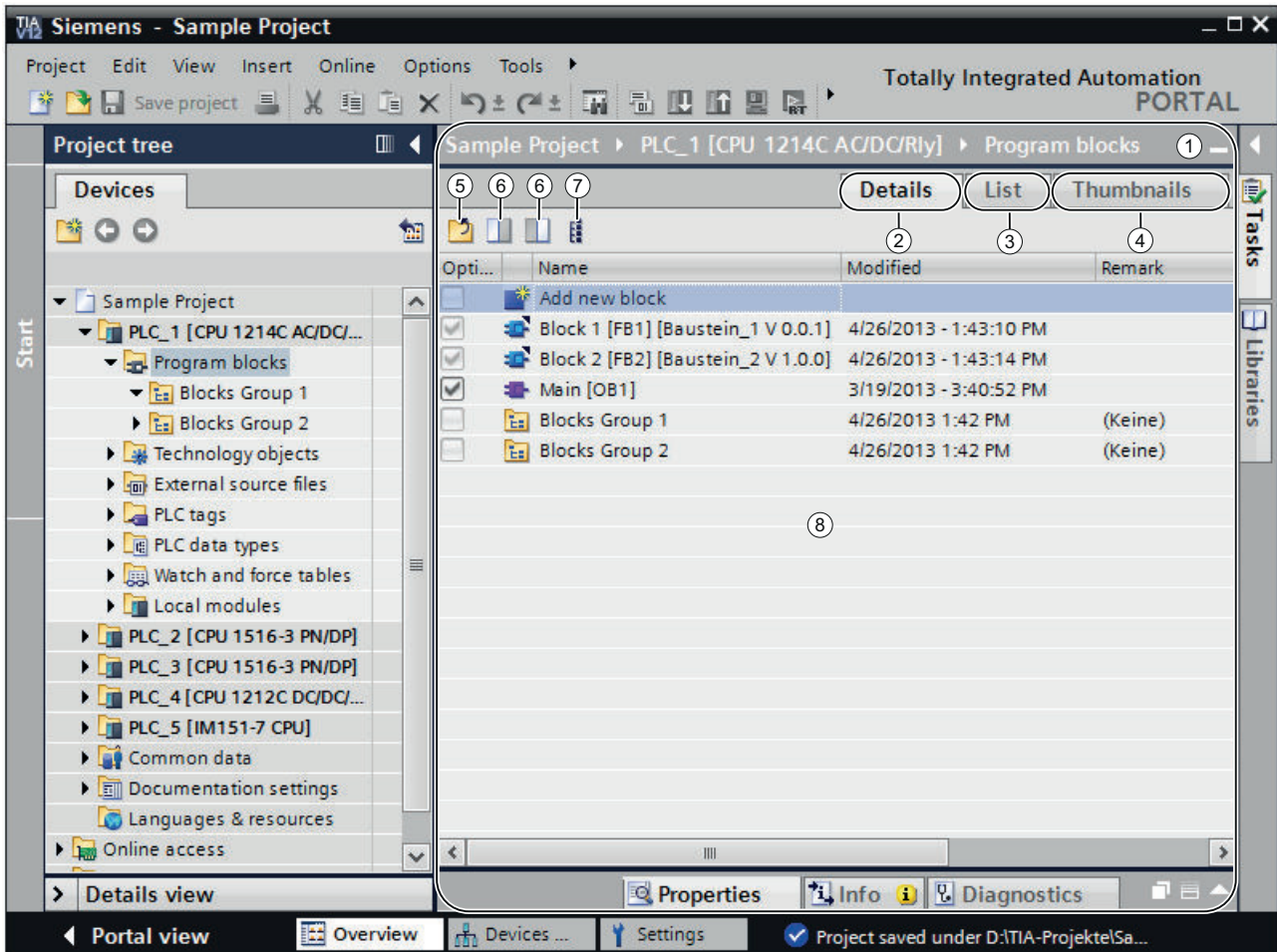

- ① Overview window
- ② Switch to the Details view
- ③ Switch to the List view
- ④ Switch to the Icon view
- ⑤ Move to higher level
- ⑥ Split the overview window in two. Either the right or left half of the overview window is synchronized. Clicking again cancels the split.
- ⑦ All blocks within the "Program blocks" folder are displayed even if these are located in lower-level groups. This option is only available in details view.
- ⑧ Contents of the object selected in the project tree.

### Display forms of the Overview window

The content of the Overview window can be displayed as follows:

- **Details view**  
The objects are displayed in a list with additional information, such as the date of the last change.
- **List view**  
The objects are displayed in a simple list.
- **Icon view**  
The objects are displayed as icons according to category.

### See also

Comparing objects in the overview window (Page 228)

Sorting the details view of the overview window (Page 229)

Overview of the library view (Page 343)

### Comparing objects in the overview window

You can display the contents of two folders or objects side by side in the Overview window. The Overview window is split in half and you can display different contents on the left and right sides.

In addition, you can use a drag-and-drop operation to move objects between the split windows. Thus, for example, you can move contents from one window to the other.

### Procedure

To split the Overview window in half or cancel the split, follow these steps:

1. In the toolbar, click on the "Synchronize left side" or "Synchronize right side" icon to split the overview window. Either the left or the right side of the overview window synchronized with the contents of the selected object in the project tree.
2. To cancel the split, click again on the previously selected icon.

### See also

Overview window (Page 226)

### **Sorting the details view of the overview window**

You have several options for adapting the display in the details view of the overview window:

- **Adding additional columns**  
Some columns are hidden by default to increase clarity. You can display hidden columns if needed. The columns available depend on the selected object.
- **Display of program blocks in flat hierarchy**  
Contents of the "Program blocks" folder can be displayed in a flat hierarchy. All blocks are displayed at once even if they are located in different groups.
- **Sorting the table columns**  
You can sort individual columns of the table in ascending or descending order.

### **Showing or hiding columns**

To show or hide additional table columns, follow these steps:

1. Right-click the title bar of the table.
2. Select the "Show/Hide" command in the shortcut menu, and select the columns you want to display.

### **Displaying program blocks in flat hierarchy**

To display the contents of the "Program blocks" folder in a flat hierarchy, follow these steps:

Select the "Program blocks" folder in the project tree.

Click the "Show subordinate elements" icon in the toolbar.

All blocks are displayed at once in the table even if they are located in lower-level groups.

### **Sorting a table in ascending or descending order**

To sort the table by a column in ascending or descending order, follow the steps below:

1. Click the table header of a column if you want to sort the column in ascending order.
2. Click again on the same column of the table header to sort the column in descending order.
3. Click a third time on the table header of the same column to cancel the sorting.

### **See also**

Overview window (Page 226)

### 6.1.2.12 User interface layout

#### Save user interface layout

##### Options for saving the user interface layout

When you make a change to the user interface, this is retained even after a restart of the TIA portal. A change to the user interface layout includes, for example, moving a window or adjusting the size of an editor.

In addition to the automatic saving of the user interface layout, you have the option of saving certain layouts:

- **Saving the window layout**  
You can save the layouts of the windows and editors of the TIA portal manually and restore these at a later time. It is possible to call five window layouts using a key combination. Use this function, for example, if you are work with a notebook which you connect to an external monitor when necessary. You can create a window layout for mobile use on the notebook display and another layout for when you work at the office with an external monitor.
- **Save the layout within editors**  
With some editors, you can adjust the display. You can, for example, adjust the width of tables or show or hide individual table columns.

#### See also

Save window layout (Page 230)

Load window layout (Page 231)

Managing window layouts (Page 232)

Saving a layout of editors and tables (Page 232)

Resetting the user interface layout (Page 233)

Basics of the work area (Page 211)

#### Save window layout

You can save the current window layout in order to call it again in the same form at a later time.

#### Procedure

To save a window layout, follow these steps:

1. Arrange all windows in the way in which you want to save them.
2. In the "Window" menu, select the "Save window layout as" command.  
The "Save window layout" dialog box appears.
3. Enter a name for the window layout in the "Name" field.

4. Enter a description of the window layout in the "Description" field in order to be able to identify the window layout more easily later.
5. Click "Save".

## Result

The new window layout is saved in the last position after the existing saved window layouts. The first five window layouts can be called using a key combination.

## See also

Save user interface layout (Page 230)

## Load window layout

If you have already saved a window layout, you can load this, allowing you to quickly adjust your work environment to the respective conditions. You can load the first five window layouts using quick access via the "Window" menu or via a key combination.

If you load a window layout and then make changes to the arrangement of the window, you can restore the originally saved window layout.

## Using quick access to load window layouts 1 to 5

To load one of the first five saved window layouts, follow these steps:

1. In the "Window" menu, select a window layout or select the key combination <Alt+Shift+[1 ... 5]>.

## Loading additional window layouts

To load a window layout that is not among the first five window layouts, follow these steps:

1. In the "Window" menu, select the "Additional window layouts" command.  
The "Manage window layouts" dialog box appears.
2. Select the desired window layout.
3. Click "OK".

## Restore window layout

To go back to a saved window layout, follow these steps:

1. In the "Window" menu, select the "Restore window layout" command or select the key combination <Alt+Shift+0>.

## See also

Save user interface layout (Page 230)

## Managing window layouts

You can carry out the following actions with existing window layouts:

- Changing the order of window layouts  
The order of the window layouts is important, as the first five window layouts can be called directly via the "Window" menu and via a key combination.
- Select a window layout  
If a window layout is not one of the first five window layouts, you can call it using the "Manage window layouts" dialog box.
- Deleting window layouts

## Procedure

To manage the existing window layouts, follow these steps:

1. In the "Window" menu, select the "Manage window layouts" command.  
The "Manage window layouts" dialog box appears.
2. Select the window layout which you want to modify.
3. Click the "Up" or "Down" symbol to move the window layout up or down.
4. Click the "Delete" symbol to delete the selected window layout.
5. Click "OK".  
The selected window layout is activated.

## See also

Save user interface layout (Page 230)

## Saving a layout of editors and tables

You have the option of adapting editors and tables to meet your requirements. For example, you can hide columns in tables that you don't need. You can then save your customized view.

## Procedure

To save the layout of editors and tables in the work area, follow these steps:

1. Adapt the editor or table according to your requirements.
2. Click the "Remember Layout" button in the editor or table.

## Result

The layout is saved. When you reopen the editor or table, this layout will be used.



## **See also**

Basics of the work area (Page 211)  
Maximizing and minimizing the work area (Page 213)  
Splitting the work area (Page 215)  
Floating the work area elements (Page 215)  
Using grouped elements of the work area (Page 216)  
Minimizing and maximizing elements of the work area (Page 218)  
Switching between the elements in the work area (Page 218)  
Save user interface layout (Page 230)

## **Resetting the user interface layout**

Every change you make to the layout of the user interface is saved. The changes are thus available even after a restart of the TIA Portal. For example, if you change the height and width of a text editor or the division of a table, your changes are retained so that you don't have to re-customize elements every time.

In some cases, however, it may be helpful to restore the original layout settings; for example, if another user prefers a different arrangement of the user interface.

## **Procedure**

To reset the user interface settings to the default, follow these steps:

1. Select the "Settings" command in the "Options" menu.  
The "Settings" window is displayed in the work area.
2. Select the "General" group in the area navigation.
3. Click the "Reset to default" button under "Reset to default > Editor layout".

## **Result**

The default settings for the user interface are restored.

## **See also**

Overview of the program settings (Page 199)  
Save user interface layout (Page 230)

### 6.1.3 Keyboard operation in the TIA Portal

#### 6.1.3.1 Operating the TIA Portal with the keyboard

You can navigate through the TIA Portal using the keyboard, for example if you do not have a mouse available at the given moment. Many functions are also accessible via keyboard shortcuts. You can find an overview of all keyboard shortcuts in the settings for the TIA Portal.

In the following sections, you will learn how to navigate in the TIA Portal using the keyboard, edit objects and customize the TIA Portal to your needs.

#### See also

Displaying an overview of all keyboard shortcuts (Page 234)

#### 6.1.3.2 Displaying an overview of all keyboard shortcuts

You can display an overview of all keyboard shortcuts.

#### Procedure

To display an overview of all available keyboard shortcuts, follow these steps:

1. Select the "Settings" command in the "Options" menu.  
The settings of the TIA Portal are displayed.
2. Open the "Keyboard shortcuts" entry in the area navigation.  
You can see an overview of all keyboard shortcuts, which are valid for the currently installed products.

#### 6.1.3.3 Basic functions of the TIA Portal

Below, you will learn how you can use the basic functions of the TIA Portal using only your keyboard.

#### Operating basic functions of the TIA Portal with a keyboard

The following table shows how you can access basic functions of the TIA Portal with keyboard shortcuts:

Function	Keyboard shortcuts	Menu command
Switch between the project view and the portal view	<Alt+F7>	
Open the Help system If you need help on the TIA Portal, press <F1>.	<F1>	Help > Show help
Cancel the current action	<Esc>	
Find	<Ctrl+F>	
Replace an object	<Ctrl+H>	

Function	Keyboard shortcuts	Menu command
Find next If you have started a search, you can jump to the next hit with <F3>	<F3>	
Print object	<Ctrl+P>	Project > Print

## Operating menus

The following table shows how you can navigate through menus using the keyboard:

Function	Keyboard shortcuts
Start keyboard operation in the menu You can access the menu using the <Alt> key and then continue to navigate with the arrow keys to scroll through the menu. Confirm your selection of the menu command with <Return>.	<Alt>
Go directly to a specific menu You can go directly to an individual menu command by holding down the <Alt> key. There is an underlined letter for each menu command. Press the <Alt> key along with the underlined letter.	<Alt+underlined letter in respective menu>
Open shortcut menu of an object With the shortcut menu key (on Microsoft Windows compatible keyboards), you can open the shortcut menu of the selected object. Alternatively, you can use <Shift+F10> if you are not using a Microsoft Windows compatible keyboard. You can use the arrow keys to scroll through the shortcut menu and select a menu command with <Return>.	<Shortcut menu key> Alternative: <Shift+F10>

## Operating expandable elements

The following table shows how you can operate expandable elements using the keyboard:

Function	Keyboard shortcuts
Expand a folder in a tree With <Arrow right>, for example, you expand a folder in the project tree.	<Arrow right>
Close a folder in a tree With <Arrow left>, for example, you collapse a folder in the project tree.	<Arrow left>
Open a drop-down list You can open drop-down lists with <F4> and then navigate with the arrow keys to scroll through the drop-down list. Finally, press the <Return> key to confirm your selection.	<F4>
Open autocompletion	<Ctrl+Space> <Ctrl+I>
Show object selection	<Ctrl+J>

### 6.1.3.4 Using project-related functions

#### Editing a project

Function	Keyboard shortcuts	Menu command
Open a project	<Ctrl+O>	Project > Open
Close a project	<Ctrl+W>	Project > Close
Save a project	<Ctrl+S>	Project > Save
Save a project under a different name	<Ctrl+Shift+S>	Project > Save as
Delete a project	<Ctrl+E>	Project > Delete project
Print project	<Ctrl+P>	Project > Print
Undo last action	<Ctrl+Z>	Edit > Undo
Redo last action	<Ctrl+Y>	Edit > Redo

#### Calling up the help function

Function	Keyboard shortcuts	Menu command
Calling up the help function	<F1> or <Shift+F1>	Help > Show help

### 6.1.3.5 Arranging windows

Below, you will learn how to open and close individual windows of the TIA Portal and save window layouts using the keyboard .

#### Opening and closing windows

The following table shows how you can open and close windows with keyboard shortcuts:

Function	Keyboard shortcuts	Menu command
Open/close project tree	<Ctrl+1>	View > Project tree
Opening/closing the detailed view	<Ctrl+4>	View > Details view
Opening/closing the overview	<Ctrl+2>	View > Overview
Opening/closing a task card	<Ctrl+3>	View > Task card
Open libraries	<Ctrl+Shift+L>	
Open hardware catalog If you are in the device or network view, the hardware catalog opens.	<Ctrl+Shift+C>	
Open/close inspector window	<Ctrl+5>	View > Inspector window
Open the "Properties" tab in the inspector window	<Ctrl+6>	
Open the "Info" tab in the Inspector window	<Ctrl+7>	
Open the "Diagnostics" tab in the Inspector window	<Ctrl+8>	
Display or hide reference projects	<Ctrl+9>	

Function	Keyboard shortcuts	Menu command
Display the on-screen keyboard You can display a keyboard on the screen, for example, to operate with a touch screen.	<Ctrl+Shift+K>	
Close all editors	<Ctrl+Shift+F4>	Window > Close all

### Using saved window layouts

You can save individual window arrangements and restore them at a later point in time. The following table shows how you to access saved window layouts with keyboard shortcuts:

Function	Keyboard shortcuts	Menu command
Restore active window layout If you use a saved window layout and have made changes to the program interface in the meantime, you can restore the original state of the active window layout with <Alt+Shift+0>.	<Shift+Alt+0>	Window > Restore window layout
Load window layout You can use <Alt+Shift+[number of the window layout]> to activate the first of the five saved window layouts.	<Shift+Alt+[Number of the window layout]>	Window > Window layout 1 to 5

#### 6.1.3.6 Navigating through the program interface

The TIA Portal is divided into several interface areas, for example, individual windows, toolbars and editors. If you want to work with the keyboard within an interface area, you first have to place the focus on it. Below, you will learn how to place the focus on individual interface areas using the keyboard. You will also learn how to move within an interface area in the TIA Portal using the keyboard.

#### Switching between interface areas and editors

The following table shows how to move between individual interface areas of the TIA Portal:

Function	Keyboard shortcuts
Move clockwise between the interface areas You can use the <F6> key to move clockwise between the various interface areas of the TIA Portal. The interface area currently in focus is highlighted with a blue title bar. If you are in the project tree, for example, and press the <F6> key, you jump to the currently open editor. If you press <F6> again, and the task cards are in focus. If you press <Shift+F6>, on the other hand, you move counterclockwise between the work areas.	<F6>
Move counter-clockwise between the interface areas With <Shift+F6> you move counter-clockwise between the interface areas of the TIA Portal.	<Shift+F6>
Go to the next open editor With <Ctrl+Alt+Arrow right> you move to the next open editor. You can see the open editors in the editor toolbar.	<Ctrl+Alt+Arrow right> Alternative: <Ctrl+F6>

6.1 User interface and operation

Function	Keyboard shortcuts
Go to the previously open editor With <Ctrl+Alt+Arrow left> you move to the most recently open editor.	<Ctrl+Alt+Arrow left> Alternative: <Ctrl+Shift+F6>
Go to the next higher section of the interface area With <Shift+Esc>, you move to the next higher section of the program interface. If, for example, you have selected a device in the project tree and you press <Shift+Esc>, the entire project navigation is put into focus.	<Shift+Esc> Alternative: <Alt+Arrow up>
Go to the next lower section of the interface area With <Return>, you place the focus on the next lower section of the program interface. For example, if you have just opened the properties of a device in the Inspector window in order to assign parameters to the device, press <Return> to go one level deeper in the program interface. You can then navigate to the desired parameter using the Tab key.	<Return> Alternative: <Alt+Arrow down>

Navigation within interface areas and editors

The following table shows how you can navigate within an interface area using the keyboard:

Function	Keyboard shortcuts
Jump to the next element within an interface area You can use the Tab key to jump from one element to the next within a work area. If, for example, you have opened the properties of a device and want to jump from one field to the next, press the Tab key. Any changes you have made to the current text box are applied in this case.	<Tab>
Jump to the previous element within an interface area With <Shift+Tab>, you can jump to the previous element in a work area, for example, a previous text box. Any changes you have made to the current text box are applied in this case.	<Shift+Tab>
Move to the next tab within an interface area If an interface area is divided into separate tabs, you can move between the tabs with the shortcut keys <Ctrl+Tab>. If, for example, you are in the "Properties" tab of the Inspector window and you want to jump to the "Info" tab, press the shortcut keys <Ctrl+Tab>.	<Ctrl+Tab>
Go to the previous tab With <Ctrl+Shift+Tab>, you move to the most recently open tab within an interface area.	<Ctrl+Shift+Tab>
Jumping to the toolbar of an editor You can use the <Alt+F10> key to jump to the toolbar of an editor. For example, if you have opened the print preview and want to switch to the next page of the printout in the toolbar, press <Alt+F10>. Then, use the arrow keys to navigate to the appropriate icon in the toolbar and confirm the selection with <Return>.	<Alt+F10>
Use arrows on the divider to display or hide user interface components The table in the work area can be minimized and maximized. First, navigate to the work area and use the Tab key to place the focus on one of the little arrows on the separator line above the table. The arrows have the focus as soon as they are highlighted in blue. Then, press the space bar to minimize or maximize the table.	<Space>

6.1.3.7 Customizing editors

Below, you will learn how to arrange editors using the keyboard. You will also learn how to select the display size and the area within a graphical editor.

## Arranging and customizing editors

The following table shows how to arrange open editors above and below each other or side-by-side, and how to close an open editor:

Function	Keyboard shortcuts	Menu command
Close active editor	<Ctrl+F4>	
Split editor space vertically If, for example, you have opened the overview window and the network view and want to display them side-by-side, press the <F12> key.	<F12>	Window > Split editor space vertically
Split editor space horizontally You can display two open editors in the work area above and below each other.	<Ctrl+F12>	Window > Split editor space horizontally
Remove window split If you have displayed two editors in the work area horizontally or vertically in split mode, you can remove the split with <Alt+Shift+F12>.	<Alt+Shift+F12>	Window > Unsplit editor space

## Customizing the display in an editor

The following table shows how you how to zoom in and out in graphical editors and how to move the area selection in an editor:

Function	Keyboard shortcuts
Zoom in step-by-step in an editor With <Ctrl> and the <Plus> key on the numeric keypad of the keyboard, you can zoom in on the display of the editor.	<Ctrl+Plus> Alternative: <Ctrl+mousewheel up>
Zoom out step-by-step in an editor Use the <Ctrl> and the <Minus> key on the numeric keypad of the keyboard to zoom out of the display of the editor.	<Ctrl+Minus> Alternative: <Ctrl+mousewheel down>
Set view in editor to 100% You can zoom in or out of the display in a graphical editor to set the current view to 100% by pressing <Ctrl+0>.	<Ctrl+0>
Moving the area selection of the editor If you hold down the spacebar, you can move the displayed section of an editor using the mouse.	<Space>

### 6.1.3.8 Editing objects

#### Selecting objects

The following table shows how to select individual objects, for example, devices in the project tree:

Function	Keyboard shortcuts	Menu command
Select an object located at the left, right, above or below	<Arrow keys>	
Jump to the first object within the current interface area The first object in the interface area currently in focus is selected. In the project tree, this would be the project node at the top, for example.	<Home>	
Jump to the last object within the current interface area The last object in the interface area currently in focus is selected, for example, the last item in the project tree.	<End>	
Select all objects in an area All objects in the work area currently in focus are selected.	<Ctrl+A>	Edit > Select all
Select multiple objects If you want to select several objects that are not located directly next to each other, you first have to move the focus (gray outline of an object) to the next desired object using <Ctrl+Arrow keys>. The current selection is maintained. Then, press the space bar to select the new focused object as well. Repeat this process until all desired objects are selected.	<Ctrl+Arrow keys> + <Space>	

#### Editing objects

The following table provides an overview of all the keyboard shortcuts required for editing objects:

Function	Keyboard shortcuts	Menu command
Insert new object A new object is inserted depending on your current context. If, for example, you are in the device view, the "Add Device" dialog opens for creating a new device.	<Ctrl+N>	
Open object	<Return>	
Rename an object	<F2>	Edit > Rename
Copy an object	<Ctrl+C> Alternative: <Ctrl+Ins>	Edit > Copy
Cut an object	<Ctrl+X> Alternative: <Shift+Del>	Edit > Cut
Paste an object	<Ctrl+V> Alternative: <Shift+Ins>	Edit > Paste
Delete an object	<Del>	Edit > Delete



Function	Keyboard shortcuts	Menu command
Compile an object	<Ctrl+B>	Edit > Compile
Open properties of an object Many objects in the TIA Portal have editable properties. Press the shortcut keys <Alt+Enter> to display the properties of an object.	<Alt+Return>	-

### 6.1.3.9 Text editing

Below, you will learn how to operate text editing functions using only the keyboard.

#### Editing text

The following table shows the basic editing functions for text:

Function	Keyboard shortcuts
Switch to insert or overwrite mode	<Insert>
Exit edit mode	<Esc>
Delete	<Del>
Delete characters	<Backspace>
Confirm entry in a text box and leave the text box	<Return>
Line break in a multiline text box In a multiline text box, hold down the <Shift> button to create a line break.	<Shift+Return>
Reset input in a text box If you are in an text box and press <Esc>, you exit the box and the changes are discarded.	<Esc>

#### Navigating within a text area

The following table shows how to navigate in a text area with the keyboard:

Function	Keyboard shortcuts
Jump to start of line	<Home>
Jump to end of line	<End>
Jump to start of text	<Ctrl+Home>
Jump to end of text	<Ctrl+End>
Jump to the previous page	<PgUp>
Jump to the next page	<PgDn>
Confirm entry in a text box and leave the text box	<Return>
Line break in a multiline text box	<Shift+Return>
Reset input in a text box If you are in an text box and press <Esc>, you exit the box and the changes are discarded.	<Esc>

### Selecting text

The following table shows how to select text with the keyboard:

Function	Keyboard shortcuts
Expand selection to the word at the left or right The text or current text selection is marked up to the end of word. If you are at the beginning or end of a word, the previous or next word is selected.	<Ctrl+Shift+Arrow left or Arrow right>
Expand selection to beginning of line	<Shift+Home>
Expand selection to end of line	<Shift+End>
Expand selection to beginning of text The text is selected up to the beginning or the end.	<Ctrl+Shift+Home>
Expand selection to end of text The text is selected up to the beginning or the end.	<Ctrl+Shift+End>

#### 6.1.3.10 Editing tables

Below, you will learn how to navigate with the keyboard in tables, edit individual fields, and select parts of tables.

#### General keyboard operation in tables

The following table shows how you can edit tables using only the keyboard:

Function	Keyboard shortcuts
Place a cell in edit mode	<F2> or <Return>
Confirm entry and exit edit mode	<Return>
Cancel editing and discard changes	<Esc>
Open drop-down list in a cell Open the drop-down list with <F4>. Use the arrow keys to select the desired entry and then confirm the selection with <Return>.	<F4>
Close drop-down list in a cell and discard changes	<Esc>

#### Navigate in tables

The following table shows how you can navigate within a table using the keyboard:

Function	Keyboard shortcuts
Go to the next cell	<Arrow keys>
Go to the next editable cell on the right	<Tab>
Go to the next editable cell on the left	<Shift+Tab>
Move a screen upwards	<PgUp>
Move a screen downwards	<PgDn>
Go to the first cell in the row	<Home>

Function	Keyboard shortcuts
Go to the last cell in the row	<End>
Go to the first cell in the table	<Ctrl+Home>
Go to the last cell in the table	<Ctrl+End>
Go to the top cell in the column	<Ctrl+Arrow up>
Go to the bottom cell in the column	<Ctrl+Arrow down>

### Selecting areas in tables

The following table shows how you can select areas within a table using the keyboard:

Function	Keyboard shortcuts
Select column	<Ctrl+Space>
Select line	<Shift+Space>
Select all cells	<Ctrl+A>
Expand selection by one cell	<Shift+arrow keys>
Extend selection up one page	<Shift+PgUp>
Extend selection down one page	<Shift+PgDn>
Expand selection up to the first row	<Ctrl+Shift+Arrow up>
Expand selection down to the last row	<Ctrl+Shift+Arrow down>
Expand selection to the first cell in the row	<Ctrl+Shift+Arrow left>
Expand selection to the last cell in the row	<Ctrl+Shift+Arrow right>

#### 6.1.3.11 Using online functions

### Controlling online functions with the keyboard

The following table provides an overview of the shortcut keys that you can use for the online functions of the TIA Portal:

Function	Keyboard shortcuts	Menu command
Establish an online connection	<Ctrl+K>	Online > Go online
Go offline	<Ctrl+M>	Online > Go offline
Download project data to the device	<Ctrl+L>	Online > Download to device
Show accessible devices This opens a dialog showing all devices that are connected to the PG/PC interface of the PG/PC.	<Ctrl+U>	Online > Show accessible devices
Start CPU The CPU is set to "RUN" mode. The CPU must be online for this.	<Ctrl+Shift+E>	Online > Start CPU

6.1 User interface and operation

Function	Keyboard shortcuts	Menu command
Stop CPU The CPU is set to "STOP" mode. The CPU must be online for this.	<Ctrl+Shift+Q>	Online > Stop CPU
Start simulation The hardware and software of the project can be tested in a simulated online environment, without the modules actually being online.	<Ctrl+Shift+X>	Online > Simulation > Start

6.1.3.12 Using the on-screen keyboard

Introduction

When working with the TIA portal, you also have the Microsoft on-screen keyboard available.

Displaying the on-screen keyboard

To display the on-screen keyboard, follow these steps:

1. In the "View" menu, select the "Screen keyboard" command.

Exiting the on-screen keyboard

To exit the on-screen keyboard, follow these steps:

1. In the "File" menu of the on-screen keyboard, select the "Exit" command.

6.1.4 Special features specific to the operating system

6.1.4.1 Influence of user rights

Restrictions when user rights are limited

The software provides several functions that require direct access to the hardware of the programming device / PC and therefore also to the installed operating system. To make full use of the range of functions, the software must cooperate closely with the operating system. To ensure problem-free interaction, you should therefore be logged on to the operating system with adequate user rights.

In particular, you may not be able to use functions requiring an online connection or those that change the settings of interface cards if you work with limited user rights.

## Recognizing restricted functions

You can recognize functions requiring special rights as follows:

-  shield icon is displayed beside the function.  
The function can be used but is regulated by the user account control.
- A box is grayed out and cannot be accessed.  
You require administrator privileges to access the box. In some operating system environments, you can obtain administrator privileges by entering an administrator password.

---

### Note

A box being grayed out does not necessarily mean a lack of rights. You should also check the additional information in the tooltip cascades to find out the conditions for editing the box.

---

## 6.1.4.2 Expanding user rights

### Counteracting restrictions due to user rights

Certain functions may not be available if you are not logged on to the operating system with adequate rights. You can counteract these restrictions in the following ways:

- Enabling of extended rights using Windows user account control
- Logging on to the operating system with administrator privileges
- Using temporary administrator rights

### Enabling extended rights using the Windows user account control

To be able to use a function indicated by the shield icon of the Windows user account control, follow these steps:

1. Click on the box or button with the shield icon.  
The security prompt of the Windows user account control opens.
2. Follow the instructions of the Windows user account control and, when prompted enter an administrator password, if possible.

The function can now be used once without restrictions.

### Logging on to the operating system with administrator privileges

To be able to use a function that is disabled due to lack of user rights, follow these steps:

1. Close the software.
2. Log off from the operating system.
3. Log on to the operating system with administrator privileges.
4. Restart the software.

### **Using temporary administrator rights**

To obtain administrator privileges temporarily, follow these steps:

1. Click the "Change settings" button. You will find this button in dialogs that allow the temporary assignment of administrator privileges.  
An operating system dialog box for entering an administrator password opens.
2. Enter an administrator password.

The settings can be temporarily changed. When you call the dialog again, the procedure must be repeated.

---

#### **Note**

This function is not supported by all operating systems. If no "Change settings" button is present or the button is grayed out, you will need to log on to the operating system with administrator privileges instead.

---

## 6.2 Help on the information system

### 6.2.1 General remarks on the information system

#### Quick answers to your questions

A comprehensive Help system is available for solving your tasks. It describes basic concepts, instructions and functions. While working with the program, you also receive the following support:

- Roll-out for correct inputs in dialog boxes
- Tooltips for information on elements of the user interface, for example text boxes, buttons and icons. Some of the tooltips are supplemented by cascades containing more precise information.
- Help on the current context, on menu commands for example when you click on the keys <F1> or <Shift+F1>.

The following figure shows an example of a cascading tooltip (top) and a roll-out (bottom):

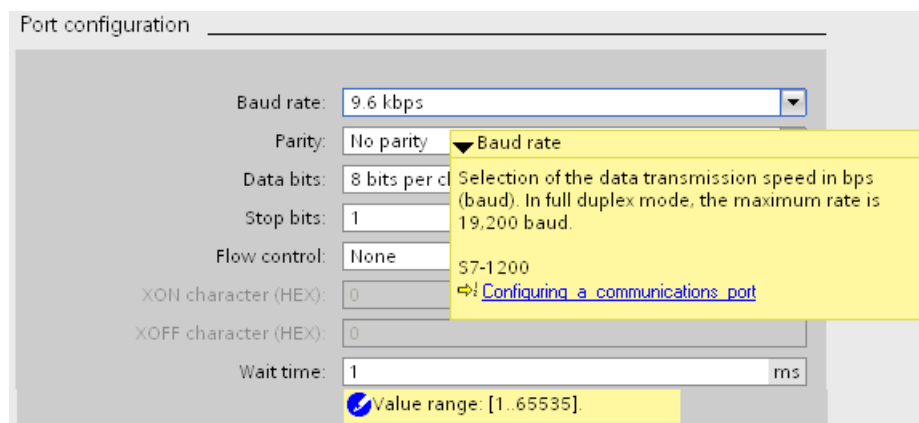

## Help





The Help system describes concepts, instructions and functions. It also contains reference information and examples. The help opens in a separate window.

A navigation pane appears on the left side of the help window. You can also hide the navigation pane to make room on the screen. The navigation pane provides you with the following functions:

- Table of contents
- Search in the index
- Full text search of the entire Help
- Favorites

### Identification of the topics in the Help according to the type of information

The help topics are identified by different symbols depending on the type of information they contain.

Symbol	Information type	Explanation
	Operating instructions	Describes the steps to follow in order to carry out a particular task.
	Example	Contains a concrete example to explain the task.
	Factual information	Contains background information that you need to know to carry out a task.
	Reference	Contains comprehensive reference information to refer back to.

### Identification of the topics in the Help according to the target system

Depending on the products that are installed, the help system may contain sections that apply only to specific devices. To be able to recognize such sections at a glance, you will find a note in brackets in the table of contents. The search results in the full text search and in the index are marked in the same way if they only apply to a specific device.

### Roll-out

Certain text boxes offer information that rolls out and helps you to enter valid parameters and values. The roll-out informs you about permissible value ranges and data types of the text boxes.

The following figure shows a roll-out (yellow) and a roll-out error message (red), which indicates an invalid value:

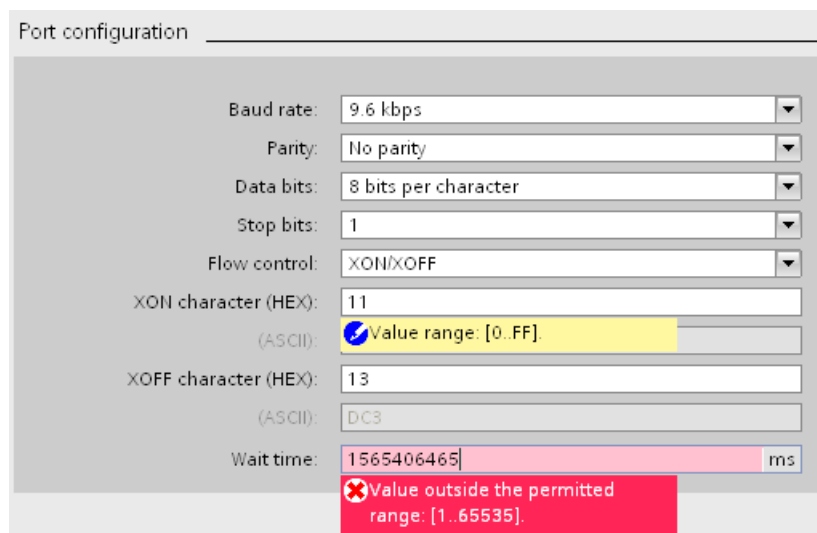

### Tooltip

Interface elements offer you a tooltip for easier identification.



Tooltips, which have an arrow icon on the left, contain additional information in tooltip cascades. If you position the mouse pointer briefly over the tooltip or click the arrow icon, this information is displayed. The automatic display of tooltip cascades can be disabled.

If additional information is contained in the Help system, a link appears to the corresponding Help topic in the cascade. If you click on the link, the corresponding topic opens in Help.

The following figure shows a tooltip with opened cascade:

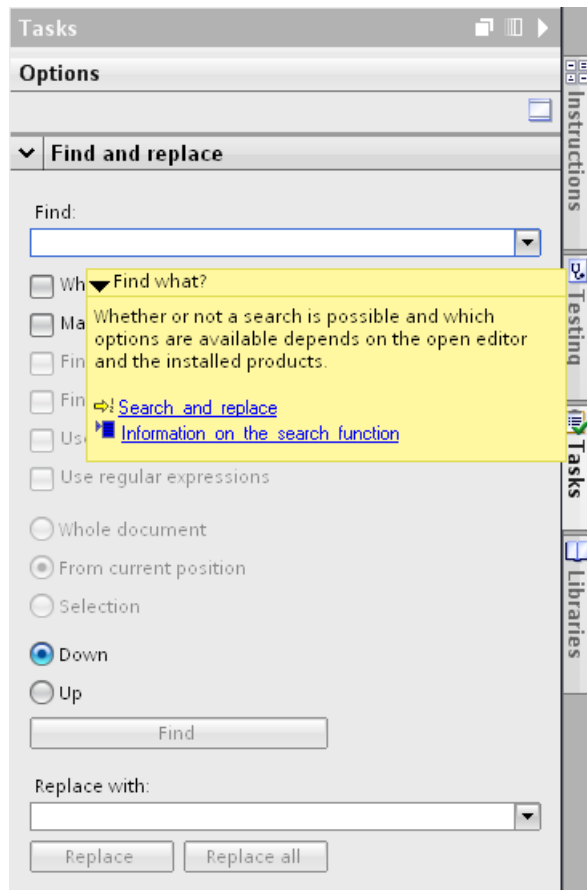

## See also

Configuring the display of tooltips and tooltip cascades (Page 253)

## 6.2.2 Opening the Help system

### Opening the Help system

You can open the Help system in the following ways:

1. In the "Help" menu, select the "Show help" command or press <F1> to display the corresponding help for the current context.

Or

1. Click on the link in a tooltip cascade to go directly to an additional point in the Help system.

## 6.2.3 Searching the Help system for keywords

### Searching for keywords in the help text

To search the help topics for predefined keywords, follow these steps:

1. Click the "Show/hide table of contents" button in the help toolbar to display the table of contents.  
The table of contents is displayed and the "Index", "Search" and "Favorites" tabs are visible.
2. Open the "Index" tab.
3. Enter the search term in the input box or select the search term from the list of key words.
4. Click "Display".

## 6.2.4 Full-text searches

### Full-text searches

To search the entire text for specific words, follow these steps:

1. Click the "Show/hide table of contents" button in the help toolbar to display the table of contents.  
The table of contents is displayed and the "Index", "Search" and "Favorites" tabs are visible.
2. Open the "Search" tab.
3. Type in your search term in the text box.
4. Refine your search if necessary using additional criteria:
  - Select "Search previous results" to start an additional search operation of your last search results only.
  - Select "Search for similar words" to find words that differ only slightly from your search term.
  - Select "Search titles only" to obtain only results that contain your search term in the title.  
The contents of the Help topics are ignored during the search.

5. Click on the arrow button to the right of the search field to use logic operations. The following logic operations are available:
  - Combine two or more search terms using the "AND" operator to find only Help topics that contain all the search terms in the text.
  - Combine two or more search terms using the "OR" operator to find only Help topics that contain one or more of the search terms in the text.
  - Combine two or more search terms using the "NEAR" operator to find only Help topics that contain terms in close proximity to each other (eight words).
  - Precede a word with the "NOT" operator to exclude Help topics from the search that contain this word.
6. Click on "List topics" to start the search.

The results are now listed with title, position and ranking. The "Position" column shows the section in which the Help topic found is located. Sorting according to ranking is based on the position of the Help topics found in the table of contents and based on the number of hits in the Help topics.

## 6.2.5 Using favorites

### Using favorites

You can save individual help topics as favorites. This saves you searching for the help topic a second time.

### Saving favorites:

To save a page as a favorite, follow these steps:

1. Open the help topic or the chapter you want to save as a favorite.
2. Click the "Show/hide table of contents" button in the help toolbar to display the table of contents.

The table of contents is displayed and the "Index", "Search" and "Favorites" tabs are visible.
3. Open the "Favorites" tab.
4. Click the "Add" button.

The help topic or chapter is saved as a favorite and is available the next time you open the help system.

### Calling up favorites:

To call up a page from the favorites, follow these steps:

1. Click the "Show/hide table of contents" button in the help toolbar to display the table of contents.

The table of contents is displayed and the "Index", "Search" and "Favorites" tabs are visible.
2. Open the "Favorites" tab.

3. Select the topic you want to open from the list.
4. Click the "Display" button.

### **Deleting favorites**

To delete an entry from the favorites, proceed as follows:

1. Click the "Show/hide table of contents" button in the help toolbar to display the table of contents.  
The table of contents is displayed and the "Index", "Search" and "Favorites" tabs are visible.
2. Open the "Favorites" tab.
3. Select the topic you want to remove from the list.
4. Click the "Remove" button.

## **6.2.6 Printing help topics**

### **Printing information**

You can either print all the contents of the Help system or individual topics only.

### **Procedure**

To select the topics you would like to print, follow these steps:

1. Click the "Display printing dialog" button.  
The table of contents opens in a separate window.
2. Select the check boxes for the folders and help topics to be printed in the "Print help topics" dialog.
3. Click the "Print" button to print the selected information.  
The "Print" dialog opens.
4. Select the printer on which you want print the help topics.
5. Click "Properties" if you want to make additional printer settings.
6. Confirm your entries with "OK".  
The help topics are printed out on the selected printer.

## 6.2.7 Configuring the display of tooltips and tooltip cascades

### Configuration options for tooltips and tooltip cascade

You can customize the display of tooltips and tooltip cascades to suit your needs. You can make the following settings:

- **Display or hide truncated text**  
Sometimes texts may be too long for a text field. The texts are then fully displayed in a tooltip when you hover your mouse over the text field. You can enable or disable this function.
- **Enable or disable tooltips**  
Tooltips provide more detailed information about an element of the user interface. You can also have tooltips displayed in a cascade. If you disable the tooltips, the cascade with context-sensitive help is also no longer displayed. However, you have the option of manually displaying the tooltip for the currently active interface element by pressing <F1>.
- **Enable or disable automatic opening of tooltip cascades**  
By keeping the mouse pointer over a tooltip for a brief time, any available cascades are displayed automatically. You can enable or disable the automatic display of cascades. When automatic display is disabled, you must open the cascade manually if necessary. To do this, click on the arrow icon in the tooltip.

### Procedure

To configure the display of tooltips and tooltip cascades, follow these steps:

1. Select the "Settings" command in the "Options" menu.
2. Select the "General" group in the area navigation.
3. Select or clear the individual check boxes in the "Tooltips" area to suit your needs. The "Open cascade automatically in tooltips" check box is only available if you have enabled the display of tooltips.

### See also

General remarks on the information system (Page 247)

## 6.2.8 Safety Guidelines

### Safety guidelines

This Help manual contains notices you have to observe in order to ensure your personal safety, as well as to prevent damage to property. The notices referring to your personal safety are highlighted in the manual by a safety alert symbol, notices referring only to property damage

have no safety alert symbol. These notices shown below are graded according to the degree of danger.

 <b>DANGER</b>
indicates that death or severe personal injury will result if proper precautions are not taken.

 <b>WARNING</b>
indicates that death or severe personal injury may result if proper precautions are not taken.

 <b>CAUTION</b>
with a safety alert symbol, indicates that minor personal injury can result if proper precautions are not taken.

<b>NOTICE</b>
without a safety alert symbol, indicates that property damage can result if proper precautions are not taken.

---

**Note**

indicates that an unintended result or situation can occur if the corresponding information is not taken into account.

---

If more than one degree of danger is present, the warning notice representing the highest degree of danger will be used. A notice warning of injury to persons with a safety alert symbol may also include a warning relating to property damage.

### Qualified Personnel

The device/system may only be set up and used in conjunction with this documentation. Commissioning and operation of a device/system may only be performed by qualified personnel. Within the context of the safety notes in this documentation qualified persons are defined as persons who are authorized to commission, ground and label devices, systems and circuits in accordance with established safety practices and standards.

### Prescribed Usage

Note the following:

 <b>WARNING</b>
This device may only be used for the applications described in the catalog or the technical description and only in connection with devices or components from other manufacturers which have been approved or recommended by Siemens. Correct, reliable operation of the product requires proper transport, storage, positioning and assembly as well as careful operation and maintenance.

## Trademarks

All names identified by ® are registered trademarks of the Siemens AG. The remaining trademarks in this publication may be trademarks whose use by third parties for their own purposes could violate the rights of the owner.

## Disclaimer of Liability

We have reviewed the contents of this publication to ensure consistency with the hardware and software described. Since variance cannot be precluded entirely, we cannot guarantee full consistency. However, the information in this publication is reviewed regularly and any necessary corrections are included in subsequent editions.

## 6.2.9 Assembling customized documentation

### Customized documentation

In the Service and Support section of the Siemens Website, you can assemble customized documentation that is tailored to your needs. All configurable manuals and operating instructions of the Service and Support section are available to you for this purpose. You can select the parts that are of interest to you and combine them into in a library to form personal documentation. You can organize the documentation using folders in the library. The folders will later become the individual chapters of your custom documentation.

You can open your personal library here (<https://www.automation.siemens.com/mdm/?guiLanguage=en>).

### Requirement

- The manuals or operating instructions used must be configurable. You can recognize configurable manuals by the suffix "configurable" in their name.
- In order to use all functions, you have to register in the Siemens Support Portal and log on.

### Documentation in different languages

You can change the language of the assembled documentation to German, French, Spanish, Italian and Chinese. This gives you the possibility, for example, to gather relevant information for a specific project and make it available to colleagues who speak other languages.

### Export function in the documentation

You can perform an export at any part of your library in various formats (PDF, XML, RTF).

### **Help on creating documentation**

You can find more help on creating and using custom documentation on the Service and Support Website ([https://www.automation.siemens.com/mdm\\_help/en/mdm\\_reference\\_manual\\_de-DE.htm](https://www.automation.siemens.com/mdm_help/en/mdm_reference_manual_de-DE.htm)).



# Editing projects

## 7.1 The basics of projects

### Introduction

Projects are used to organize the storage of data and programs resulting from the creation of an automation solution. The data that makes up a project includes the following:

- Configuration data on the hardware structure and parameter assignment data for modules
- Project engineering data for communication over networks
- Project engineering data for the devices
- Logs for important events in the life cycle of the project

### Project hierarchy

Data is stored in a project in the form of objects. Within the project, the objects are arranged in a tree structure (project hierarchy).

The project hierarchy is based on the devices and stations along with the configuration data and programs belonging to them.

Common data of the project and online access, for example, are also displayed in the project tree.

### See also

Creating a new project (Page 259)

Opening projects (Page 259)

Saving projects (Page 264)

Deleting projects (Page 265)

Using logs (Page 258)

## 7.2 Using logs

For some operations within the TIA Portal, logs are created automatically in the background. These logs document changes in the project. Logs are created automatically, for example, when you migrate projects and programs or when you update instances from the library.

Logs are displayed in the "Common data" folder in the project tree. They are stored together with the project in the project folder and can therefore be read independently of the programming device/PC used as soon as you have opened the project.

In addition to displaying them in the TIA Portal, logs can also be printed.

### Opening logs

To open a log, follow these steps:

1. Open the "Common data > Logs" folder in the project tree.
2. Double-click the desired log in the list.  
The contents of the log are displayed in the work area.

### Deleting logs

To delete a log, follow these steps:

1. Select the log in the project tree.
2. Press <Del>.  
The selected log is deleted from the project directory and removed from the project tree.

## 7.3 Creating and managing projects

### 7.3.1 Creating a new project

#### Procedure

To create a new project, follow these steps:

1. Select the "New" command in the "Project" menu.  
The "Create a new project" dialog opens.
2. Enter your project name and path or accept the proposed settings.
3. Click the "Create" button.

#### Result

The new project is created and displayed in the project tree.

#### See also

The basics of projects (Page 257)

Opening projects (Page 259)

Saving projects (Page 264)

Deleting projects (Page 265)

### 7.3.2 Opening projects

You can open all projects from the current and earlier versions in the TIA Portal.

Projects from TIA Portal V12 must first be upgraded to the current project format before they can be processed further in TIA Portal V12 SP1. You are prompted to upgrade the project when you open it. After upgrading the V12 project to the current product version, it can no longer be opened in TIA Portal V12. However, a copy of the original project is retained.

Projects from version V11.x can be opened as usual. However, the range of functions of the TIA Portal is limited to the functionality of TIA Portal V11.x in this case. You need to upgrade the project manually to continue working with the full range of functions from the current TIA Portal version.

## Procedure

To open an existing project, follow these steps:

1. Select the "Open" command in the "Project" menu.  
The "Open project" dialog opens and includes the list of most recently used projects.
2. Select a project from the list and click "Open".
3. If the project you require is not included in the list, click the "Browse" button. Navigate to the desired project folder and open the project file.  
Projects of the TIA Portal V12.x have the extension ".ap12". Older projects of the TIA Portal have the extension ".ap[version number]". For projects of the TIA Portal V11.x, for example, the extension is ".ap11".

## Result

The project opens in the project view.

## See also

Notes on compatibility (Page 260)

Upgrading projects (Page 262)

The basics of projects (Page 257)

Creating a new project (Page 259)

Saving projects (Page 264)

Deleting projects (Page 265)

### 7.3.3 Notes on compatibility

With the TIA Portal, you can open projects that were not created with the same version or that were created with another installation scope. In the following, you will learn what to consider in this case.

## Opening projects from older versions of the TIA Portal

You can open projects from previous versions of the TIA Portal. However, some peculiarities in projects from earlier versions of the TIA Portal must be taken into consideration:

- Projects from TIA Portal V10.0 and V10.5  
You can open projects from versions V10.0 or V10.5. These are converted into the current project format.
- Projects from TIA Portal V11.x  
Projects from version V11.x are opened and remain unchanged. The range of functions is limited to the capabilities of TIA Portal V11.x. Projects therefore remain backward compatible and can still be edited with the previous version of the TIA Portal. If you want to continue working on a project in TIA Portal V11 that you have saved once with the current version of the TIA Portal, the most recent version of TIA Portal V11 must be installed. This means all service packs and all other updates must be installed.  
When you open a project from version TIA Portal V11 or older in the current version of the TIA Portal, you can add components that were subsequently provided for this older version within the context of a Hardware Support Package (HSP) to the project. This project then remains compatible with this older version of the TIA Portal. All you have to do is install the Hardware Support Package in the older version to continue working with the project in it. If you want to use all the functions of the current version in a project from TIA Portal V11.x, you need to upgrade the project. The project is converted to the latest project format during the upgrade and the full range of functions of the current version become available.

## Opening projects from newer versions of TIA Portal

If you want to open a project from a newer version, this is possible if the following conditions are met:

- The project was created with a version of the TIA Portal that is newer than V12 SP1, for example, with a newer service pack.
- The project does not contain any data that is incompatible with the current installation.

## Compatibility of projects of the current TIA Portal version

Note that projects saved with TIA Portal V12 SP1 are not backward compatible due to the extended range of functions compared to the older versions. Projects saved with TIA Portal V12 SP1 can only be opened with TIA Portal V12 SP1 or later.

### Opening projects created with add-on products

If the project to be opened contains data that was created with optional software, but the corresponding software product is not installed, the following cases can occur:

- Software components are missing, but none of them are essential:  
A dialog appears listing the missing software components. After the project is opened, its properties are displayed. You now have the opportunity to install the missing products. All the devices contained in the project are available even if you do not install the missing products. However, you can only work with the devices that are supported by the currently installed software.  
If devices are not supported because software is missing, they are marked with the following symbol in the project tree:  

- At least one software package is required in order to open the project:  
A dialog appears listing the missing software components. The essential package(s) are marked. The project can only be opened if you install the missing components.

### See also

Opening projects (Page 259)

Upgrading projects (Page 262)

### 7.3.4 Upgrading projects

You can open and edit projects from TIA Portal version V11.x in the current version. The range of functions remains limited to the capabilities of version V11.x, however. This ensures backward compatibility of the project and allows the project continue to work with the previous version of the TIA Portal.

If you want to use the full range of functions from the current version of the TIA Portal, you need to upgrade the project.

Projects from TIA Portal V12 must always be upgraded before they can be further processed in TIA Portal V12 SP1. You are prompted accordingly when you open a V12 project.

If you want to continue using global libraries of TIA Portal V11.x, you have to upgrade these as well. This does not happen automatically when you upgrade the project.

### Procedure

To upgrade a project, follow these steps:

1. Open the project from an earlier version of the TIA Portal.
2. Select the "Upgrade" command in the "Project" menu.  
A security prompt appears.
3. Click "Yes" to confirm.

**Note****Upgrading know-how-protected blocks**

The block is only upgraded and downloaded after it has been opened once with the password. This means you should open know-how-protected blocks once after upgrading the project to also upgrade the blocks. If you have protected numerous know-how-protected blocks with the same password, you can select and open all of them at once.

---

**Result**

The original project is closed and will remain stored in its original state. A new version is created from the original project. The new version of the project opens.

**See also**

Notes on compatibility (Page 260)

Opening projects (Page 259)

Upgrading libraries from older versions (Page 350)

**7.3.5 Displaying properties of the project**

You can display the properties of a project. Properties include the following:

- **Metadata for the project**  
This includes the following information: creation time, author, file path, project size, copyright, project languages, etc. Many of the attributes can be changed.
- **Project history**  
The project history contains an overview with important events in the project life cycle. Here, for example, you can see the version of the TIA Portal used to create a project and whether it has been converted into another version in the meantime. If a project was created during a migration, for example, this is also indicated in the project history table with the date and time of the migration. If a log was created for an event, you can also call the log directly.
- **Support packages in the project**  
An overview of the add-on software needed to work with all devices in the project is displayed. In addition, installed GSD files are listed (device description files for other devices in the hardware catalog).
- **Software products in the project**  
You can display an overview of all installed software products needed for the project.

## Procedure

To display the project properties, follow these steps:

1. Select the open project in the project tree.
2. Select "Properties" in the shortcut menu of the project.  
The dialog with the properties of the project opens.
3. Select the project properties in the area navigation that you want to have displayed.

### 7.3.6 Saving projects

You can save the project at any time either under the same or a different name. You can even save a project when it still contains elements with errors.

#### Saving a project

To save a project, follow these steps:

1. Select the "Save" command in the "Project" menu.  
All changes to the project are saved under the current project name. If you are editing a project from an earlier version of the TIA Portal, the file extension of the project is also retained and you can continue to edit the project in the earlier version of the TIA Portal.

#### Project Save as

To save a project under another name, follow these steps:

1. Select the "Save as" command in the "Project" menu.  
The "Save current project as" dialog opens.
2. Select the project folder in the "Save in" box.
3. Enter the new project name in the "File name" box.
4. Confirm your entry with "Save".  
The project is saved under the new name and opened.

#### See also

The basics of projects (Page 257)

Creating a new project (Page 259)

Opening projects (Page 259)

Deleting projects (Page 265)

Upgrading projects (Page 262)

Notes on compatibility (Page 260)



### 7.3.7 Closing projects

#### Procedure

To close a project, follow these steps:

1. Select the "Close" command in the "Project" menu.  
If you have made changes to the project since the last time you saved it, a message is displayed.
2. Decide whether or not you want to save the changes.

### 7.3.8 Deleting projects

---

#### Note

When you delete a project, the entire project data is removed from the storage medium.

---

#### Requirement

The project you want to delete is not open.

#### Procedure

Follow the steps below to delete an existing project:

1. Select the "Delete project" command in the "Project" menu.  
The "Delete project" dialog opens and includes the list of most recently used projects.
2. Select a project from the list.  
If the project you require is not included in the list, click the "Browse" button. Navigate to the desired project folder, and open the project file.
3. Click the "Delete" button.
4. Click "Yes" to confirm. This starts the deletion of the project.

#### Result

The entire project folder is deleted from the file system.

#### See also

The basics of projects (Page 257)

Creating a new project (Page 259)

Opening projects (Page 259)

Saving projects (Page 264)

## 7.3.9 Working with multi-language projects

### 7.3.9.1 Project text basics

#### Texts in different languages in the project

When you enter texts while working on a project, you would normally do this in your own language. If you then pass on the project to someone else who does not know this language, this person will require a translation of the relevant texts to a language they know. This is why all texts can be translated. In this way, you can ensure that anyone who is subsequently confronted with the texts sees the texts in his/her language of choice.

#### Project language

Project languages are all languages in which a project will later be used. Based on the editing language, all the texts can be translated to the various project languages. You specify the languages that will be available in the project tree under "Languages & Resources > Project languages".

#### Editing language

Every project has an editing language. When you enter texts, these are always created in the editing language. You should therefore make sure that the editing language set is the language in which you enter the texts. This avoids problems if you translate the texts later.

The editing language does not depend on the language of the user interface. You could, for example, set English as the user interface language, but use Italian as the editing language. If you enter texts, these will be created in this case in the project language "Italian", although the user interface of the TIA Portal displays English.

You set the editing language in the project tree under "Languages & Resources > Project languages > Editing language".

#### Reference language

The reference language is used as a template for translation. The text is displayed in the reference language for each text box in the "Tasks > Languages and resources" task card. You therefore know which text that belongs in a text box, even when no text is entered in the currently selected editing language.

#### User texts and system texts

For clarification purposes, a distinction is made between user texts and system texts:

- User texts are texts that the user created.
- System texts are texts that are created automatically according to the configuration in the project.

You manage the project texts in the project tree under "Languages & Resources > Project texts".

## Examples of multilingual project texts

You can, for example, manage the following project texts in more than one language:

- Block titles and block comments
- Network titles and network comments
- Comments in tables
- Alarm texts
- Operator-relevant texts
- Text lists
- Labels of buttons
- Display names of recipes

## Translating texts

There are three ways of translating texts.

- Translate all texts used in the project in tabular form  
You can enter the translations for the individual project languages directly in the "Project texts" table. You will find this in the project tree under "Languages & Resources > Project texts".
- Specify text assigned to individual objects in the Inspector window  
In the Inspector window, you can translate the texts that are assigned to the currently selected objects. Columns are displayed in a table for all available project languages. You can enter the translations for each text there.
- Translating texts using reference texts  
You can change the editing language for shorter texts. All the text cells are filled again with the default values and can be filled in the current language. As orientation, you can display what you last entered in the box in the reference language. To do this, select the "Tasks" task card and open the "Languages & resources".
- Exporting texts and translating them externally  
With larger volumes of text, you can export the texts to an Office Open XML file and translate them with a normal table calculation program. You then import the translated texts again into the TIA Portal.

---

### Note

#### Using Asian project languages

East Asian project languages are only displayed correctly in Windows XP, if the option "Install files for East Asian languages" is selected on the Languages tab of Regional and Language Options in the Control Panel of Windows XP Professional.

---

## See also

Overview of the program settings (Page 199)

Changing the settings (Page 203)

Application examples for multilanguage projects (Page 273)

### 7.3.9.2 Select project languages

All the texts can be displayed within a project in the same language that you selected for your software user interface. This means that all project texts must exist in the corresponding language. You can select the available project languages yourself.

#### Requirement

- You are in the project view.
- A project is open.

#### Procedure

To select the project languages, follow these steps:

1. Click on the arrow symbol to the left of "Languages & Resources" in the project tree. The elements below this are displayed.
2. Double-click on "Project languages". In the work area, you will see a list of languages that you can select.
3. Select the required languages.

#### Result

All texts can be displayed in the activated languages if there is already a translation for these languages.

### 7.3.9.3 Setting the editing language

All the texts in the project are created in the editing language when they are entered. If you change the editing language, all future text input will be stored in the new editing language.

#### Requirement

- You are in the project view.
- A project is open.

## Procedure

To change the editing language, follow these steps:

1. Click on the arrow symbol to the left of "Languages & Resources" in the project tree. The lower-level elements are displayed.
2. Double-click on "Project languages". The possible settings for the project languages are displayed in the work area.
3. Select the editing language in "General > Editing language".

### 7.3.9.4 Translating all project texts in tabular form

You can display and edit all project text used in the currently open project in a list. User and system texts are separated into two different lists for clarity. Both lists contain a separate column for each project language in which you can enter the translations for text.

## Requirement

- You are in the project view.
- You have selected at least one further project language.

## Procedure

To translate text in the project-wide list, follow these steps:

1. Click on the arrow symbol to the left of "Languages & Resources" in the project tree. The elements below this are displayed.
2. Double-click "Project texts". A list with the user texts in the project is displayed in the work area.
3. Click on "System texts" if you want to edit the list of system texts rather than the user texts.
4. You can improve the clarity of the lists if you have a lot of texts.
  - To group identical texts and to translate them all at once, click the "Switch on/off grouping" button in the toolbar.
  - To hide texts that do not have a translation, click the "Filter for empty texts on/off" button in the toolbar.
  - To further limit the displayed project texts to certain devices, select the devices for which you want to display project texts in the drop-down list.
5. Enter the translation of the project texts in the relevant column.

### 7.3.9.5 Translating text associated with individual objects

If you want to edit the text of individual objects, it would be too difficult to locate the matching text in the table with all project texts. For this reason, there is a table in the Inspector window in which only the texts assigned to the currently selected objects are displayed. In the table, you can add missing translations for individual project languages or change existing texts.

## Requirement

Text must be entered in at least one project language for the texts to be translated.

## Procedure

To edit the text of the currently selected object, follow these steps:

1. Select the object whose text you want to edit.
2. Open the "Properties" tab in the Inspector window.
3. Open the lower-level "Texts" tab in the inspector window.  
A table with all the texts that belong to the selected objects is displayed. It contains one column for the currently selected editing language and the reference language, as well as additional columns for the other project languages.
4. Add or change the entries in the table for each project language.

## See also

Application examples for multilanguage projects (Page 273)

### 7.3.9.6 Translating texts using reference texts

#### Introduction

After changing the editing language, all texts are shown in input boxes in the new editing language. If there is not yet a translation available for the newly set language, the input boxes are empty or filled with default values.

If you enter text in an input box, this is saved in the current editing language. Following this, the texts exist in two project languages for this input field, in the previous editing language and in the current editing language. This makes it possible to create texts in several project languages.

You can display existing translations for an input box in other project languages. These serve as a comparison for text input in the current editing language and they are known as the reference language.

---

#### Note

The display of reference texts depends on the installed products and is not supported by every editor.

---

## Requirement

There is at least one translation into a different project language for an input field.

## Procedure

To display the translation of an input cell in a reference language, follow these steps:

1. In the "Tasks" task card, select the "Languages & Resources" pane.
2. Select a reference language from the "Reference language" drop-down list.

## Result

The reference language is preset. If you click in a text box, translations that already exist in other project languages are shown in the "Tasks > Languages & Resources" task card.

### 7.3.9.7 Exporting and importing project texts

You can export project texts for translation and then reimport them. The texts are exported to an Office Open XML file with the extension ".xlsx". This can be edited in Microsoft Excel or a number of other spreadsheet programs.

The following export options are available:

- Exporting individual project texts
- Exporting all user texts or system texts at once  
In this case, the export can be additionally limited by categories.

---

#### Note

##### Row limit in Microsoft Excel

Note that spreadsheet programs may be able to process only a certain number of rows. Microsoft Excel 2003 supports a maximum of 65536 rows, for example. Later versions of Microsoft Excel support significantly more rows.

---

### Exporting individual project texts

To export individual project texts, follow these steps:

1. Open the "Languages & Resources" folder in the project tree.  
The lower-level elements are displayed.
2. Double-click "Project texts".  
The project texts editor opens.
3. Choose the "User texts" or "System texts" tab in the editor, depending on which texts you want to export.
4. Select the project texts you want to export.
5. Click the "Export project texts" icon in the toolbar of the editor.  
The "Export" dialog box opens.
6. Choose the language you want to translate from in the "Source language" drop-down list.

7. Choose the language you want to translate to in the "Target language" drop-down list. The drop-down list contains the project languages you specified previously. If the required language is missing, you must first specify it in the project languages editor.
8. Specify a file path and a file name for the export file in the "Select file for export" input box.
9. Click "Export".

### **Exporting all system or user texts**

To export all project texts, follow these steps:

1. Select the "Export project texts" command in the "Tools" menu.  
The "Export" dialog box opens.
2. Choose the language you want to translate from in the "Source language" drop-down list.
3. Choose the language you want to translate to in the "Target language" drop-down list. The drop-down list contains the project languages you specified previously. If the required language is missing, you must first specify it in the project languages editor.
4. In "Select content", select the check box "User texts" to export user texts. To export system texts, select "System texts". To export both user texts and system texts, select both check boxes.
5. In "Select content", select the required text categories for the user texts or the system texts.
6. In the "Export file" input field, specify a file name for the export file.
7. In the "Path" input field, select a path in the data system to which the export file is to be saved.
8. Click "Export".

### **Importing project texts**

To import a file containing project texts, follow these steps:

1. Select the "Import project texts" command in the "Tools" menu.  
The "Import" dialog box opens.
2. Select the path and the file name of the import file from the "Select file for import" field.
3. Select the "Import base language" check box if you have made changes to the base language in the export file and you want to overwrite the entries in the project with the changes.
4. Click "Import".

### **See also**

Application examples for multilanguage projects (Page 273)



### 7.3.9.8 Application examples for multilanguage projects

#### Introduction

Let us assume you are working in a team with colleagues some of whom speak English, some French and some German. You have created a project with the TIA Portal and have already created a functioning configuration.

To allow your other colleagues to be able to keep track of the project, you would like all devices being used to have comments in English and German. First, you would like to enter the comments in German. Following this, to save time and costs, you want to have the texts translated into English in a spreadsheet program by an external translation office.

In addition to this, you also want a single comment for a particular device in French so that your French-speaking colleague can continue working on this device.

The section below describes an example of how you can achieve this with the tools of the TIA Portal.

#### Translating the project into English

To enter the comments in German and to have them translated into English later, follow these steps:

1. Set the editing language to "German" and fill all the comment boxes with the relevant texts in German.  
On the device selected from the French-speaking colleague, enter, for example "Unser neues Gerät" in German first.  
All the comments are now stored in German.
2. Export all user texts to an Office Open XML file with the extension ".xlsx".
3. Have the user texts contained in the file translated into English in a spreadsheet program such as Microsoft Excel.
4. Import the file into the TIA Portal after it has been translated.  
All texts are now available in German and English.

#### Translating a single comment field to French

To translate an individual comment field to French, follow these steps:

1. Open the comment box for the device on which the French-speaking colleague will be working.
2. Open the "Languages & Resources" pane in the "Tasks" task card.
3. Set "French" as the editing language in the "Languages & Resources" pane. As the reference language, set, for example, "English".  
Since no translation has yet been installed in French, the comment box is empty. In the "Languages & Resources" pane, the English translation "Our new device" is displayed as a reference.
4. Orientating yourself on the English reference text enter "Notre nouvel appareil" in the comment box.  
The comment for this device is now available in the languages German, English and French.

## See also

Project text basics (Page 266)

Exporting and importing project texts (Page 271)

Translating text associated with individual objects (Page 269)

## 7.3.10 Archiving and retrieving projects

### 7.3.10.1 Working with project archives

#### Archiving and transferring projects

If you work for a long time with a project, large files may result, especially with extensive hardware configurations. Therefore, you may want to reduce the size of the project, for example, when you archive it to an external hard drive, or when you send it via e-mail and require a smaller file size.

#### Options for reducing the size of the project

There are two ways to reduce the size of the project:

- **TIA Portal project archives**  
TIA Portal project archives are compressed files, each containing an entire project, including the entire folder structure of the project. Before the project directory is compressed into the archive file, all files are reduced to their essential components to further decrease the size of the project. Project archives are therefore well suited for sending via e-mail. Project archives of a project that was created with TIA Portal V11.x have the file extension ".zap11". Projects created with TIA Portal V12.x have the file extension ".zap12". To open a project archive, you need to retrieve the project. Here, the archive file is extracted into the original project directory structure with the included project files to a location you have selected.
- **Minimized TIA Portal project**  
You can skip additional compression in an archive file, and instead create a copy of the project directory. The included files are reduced to the essential elements of the project. This minimizes the required storage space. The full functionality of the project is maintained and you can open the project as usual.  
A minimized TIA Portal project is especially well suited for archiving, for example, on an external medium.

## See also

Retrieving projects (Page 276)

Archiving projects (Page 275)

### 7.3.10.2 Archiving projects

You can reduce the storage space required for the currently open project by compressing the project into a file, or by reducing the project files to their essential components. You can do both of these with the archiving function of the TIA Portal.

---

**Note**

The most recently saved state of the project is used for archiving. Therefore, save the project before using the archiving function. This will ensure that your most recent changes are included in the archived project.

---

**Procedure**

To archive a project, follow these steps:

1. Select the "Archive" command in the "Project" menu.  
The "Archive current project as..." dialog opens.
2. Select the directory where you want to save the archive file or the new project directory.
3. Select the file type from the "File type" drop-down list:
  - TIA Portal project archive, if you want to create a compressed file of the project.
  - Minimized TIA Portal project, if you only want to create a copy of the project directory with minimal storage space.
4. Enter a file name in the "File name" field if you are creating an archive file. If you are creating a minimized project directory instead, enter the name of the new project directory to be created in the "File name" box.
5. Click "Save".

**Result**

When you have created a project archive, a compressed file is generated with the extension ".zap11" (for projects created with version V11.x of the TIA Portal) or ".zap12" (for projects created with version V12.x of the TIA Portal). The file contains the complete project directory. The individual files of the project are also reduced to the essential components in order to save space.

If you have created a minimized TIA Portal project, only a copy of the original project directory is created at the desired location. The files contained within it are reduced to their essential components in order to save space.

**See also**

Working with project archives (Page 274)

Retrieving projects (Page 276)

### **7.3.10.3 Retrieving projects**

You can unpack projects that have been compressed with the archiving function of the TIA Portal. This restores the project directory structure including all project files.

#### **Requirement**

No project should be open.

#### **Procedure**

To unpack a project archive, follow these steps:

1. Select the "Restore from archive" command in the "Project" menu.  
The "Retrieve archived project" dialog opens.
2. Select the project archive.
3. Click "Open".
4. The "Find folder" dialog opens.
5. Select the target directory to which the archived project should be extracted.
6. Click "OK".

#### **Result**

The project is extracted to the selected directory and opened immediately.

#### **See also**

Working with project archives (Page 274)

## 7.4 Using reference projects

### 7.4.1 Basics of reference projects

#### Introduction

You can open other projects as a reference in addition to the current project. You can use these reference projects as follows:

- You can drag individual objects from a reference project into the current project and then edit them.
- You can open specific objects, for example, code blocks from a reference project as read-only. But this is not possible for all elements.
- You can use an offline/offline comparison to compare devices of the reference project to devices from the current project.

Note that reference projects are read-only. You cannot change the objects of a reference project.

#### See also

Comparing reference projects (Page 278)

Opening and closing a reference project (Page 277)

Reference projects (Page 223)

### 7.4.2 Opening and closing a reference project

#### Opening a reference project

To open a reference project, follow these steps:

1. In the "Reference projects" palette of the project tree, click on "Open reference project" in the toolbar.  
The "Open reference project" dialog box opens.
2. Navigate to the desired project folder, and open the project file. TIA Portal V12.x projects have the extension ".ap12". Older projects of the TIA Portal have the extension ".ap[version number]".
3. Click "Open".  
The selected project is opened as a read-only reference project.

### Closing a reference project

To close a reference project, follow these steps:

1. In the "Reference projects" palette of the project tree, select the reference project you want to close.
2. Click on "Close reference project" in the toolbar.  
The selected reference project is closed.

### See also

Basics of reference projects (Page 277)

Comparing reference projects (Page 278)

Reference projects (Page 223)

## 7.4.3 Comparing reference projects

### Introduction

You can compare devices from reference projects with devices from both the current project as well as from the same or another reference project or from a library.

---

#### Note

Please note the following:

- You cannot specify actions for the comparison objects, since the reference projects are write-protected.
  - You can perform a detailed comparison for the comparison objects, if the type of comparison object generally allows a detailed comparison.
  - When comparing reference projects, you can always switch between automatic and manual comparison.
- 

### Procedure

To compare the objects of a reference project to the device data of the current project, follow these steps:

1. In the project tree, select the device whose data you want to compare to the data of a reference project and which allows offline/offline comparison.
2. Select "Compare > Offline/Offline" from the shortcut menu.  
The compare editor opens with the selected device displayed in the left area.
3. Open the "Reference projects" palette in the project tree.

4. Select the device of a reference project that you want to compare to the device data from the current project.
5. Drag the device from the reference project into the right drop area of the compare editor. You can identify the status of the objects based on the symbols in the status and action area. When you select an object, the object's properties and the corresponding object of the associated device is clearly shown in the properties comparison. You can drag a library or other devices from a reference project from the current project into drop areas at any time and thus start a new comparison. It does not matter which device you drag into the drop area.

**See also**

Basics of reference projects (Page 277)

Reference projects (Page 223)

Opening and closing a reference project (Page 277)

Carrying out offline/offline comparisons (Page 287)

Using the comparison editor (Page 288)

## 7.5 Editing project data

### 7.5.1 Compiling and loading project data

#### 7.5.1.1 Compiling project data

#### General information on compiling project data

#### Compiling project data

During compilation, project data is converted so that it can be read by the device. Hardware configuration data and program data can be compiled separately or together. You can compile the project data for one or more target systems at the same time.

The following project data must be compiled prior to loading:

- Hardware project data, for example, configuration data of the devices or networks and connections
- Software project data, for example, program blocks or process screens

---

#### Note

While a device is being compiled, no additional compiling process can be started. Note in this regard that you can not only perform a compiling process manually, but you can also trigger it automatically for HMI devices.

---

#### Scope of the compilation

When you compile project data, you have the following options depending on the device involved:

- Hardware and software (only changes)
- Hardware (only changes)
- Software (only changes)
- Software (rebuild all blocks)
- Software (reset memory reserve)

#### See also

Compiling project data (Page 281)



## Compiling project data

The following section describes the general procedure for compiling project data in the project tree. You will find details of how certain objects are compiled and any special points to note in the online help of the product.

### Procedure

To compile project data, follow these steps:

1. In the project tree, select the devices whose project data you want to compile.
2. Select the option you require in "Compile" submenu of the shortcut menu.

---

**Note**

Note that the options available to you depend on the selected device.

---

The project data is compiled. You can check whether or not the compilation was successful in the Inspector window with "Info > Compile".

### See also

General information on compiling project data (Page 280)

## 7.5.1.2 Downloading project data

### General information on loading

#### Introduction

In order to set up your automation system, you must download the project data you generated offline to the connected devices. This project data is generated, for example when configuring hardware, networks, and connections or when programming the user program or when creating recipes. The first time you download, the entire project data is downloaded. During later loading operations, only changes are downloaded. You can download the project data to devices and memory cards.

---

**Note**

While a device is being compiled, no additional download process can be started. Note in this regard that you can not only perform a compiling process manually, but you can also trigger it automatically for HMI devices.

---

Depending on the object you want to download, you have the following options:

- **Hardware and software**  
Both hardware configuration as well as software are downloaded to the destination.
- **Hardware configuration**  
Only the hardware configuration is downloaded to the destination.
- **Software (only changes)**  
Only the objects that differ online and offline are downloaded to the destination.
- **Load PLC program to device and reset**  
All the blocks are loaded to the destination and all values are reset to their initial state. Be aware that this also applies to retentive values.

You can also upload project data already contained in a device back to your project. You have the following options:

- **Uploading a complete device**  
All relevant data of the device is uploaded to the project.
- **Uploading blocks and parameters**  
Only the blocks and parameters from the device are uploaded to the project.

In both cases all instances of library types are connected again with the corresponding version of the type in the project library during loading. If no suitable type is yet available for a loaded instance or the correct version of the type does not exist in the project library, the type or the version is added to the project library.

## See also

Downloading project data to a device (Page 282)

Downloading project data to a memory card (Page 283)

Uploading project data from a device (Page 284)

## Downloading project data to a device

The following section describes the general procedure for downloading project data to a device. You will find details of how certain objects are downloaded and any special points to note in the online help of the product.

## Requirement

- The project data is consistent.
- Each device to which you want to download is accessible via an online access.

## Procedure

To download the project data to the selected devices, follow these steps:

1. Select one or more devices systems in the project tree.
2. Right-click on a selected element.  
The shortcut menu opens.

3. Select the option you require in the shortcut menu of the "Download to device" submenu.

---

**Note**

Note that the options available to you depend on the selected device.

---

When necessary, the project data is compiled.

- If you had previously established an online connection, the "Load preview" dialog opens. This dialog displays messages and proposes actions necessary for downloading.
  - If you had not previously established an online connection, the "Extended download to device" dialog opens, and you must first select the interfaces via which you want to establish the online connection to the device.  
See also: Auto-Hotspot
4. Check the messages in the "Load preview" dialog, and select the actions in the "Action" column, if necessary.
- 

**Note**

Performing the proposed actions while the plant is in operation can cause serious bodily injury and property damage in the event of malfunctions or program errors.

Make sure that no dangerous situations can arise before you start the actions!

---

As soon as loading becomes possible, the "Load" button is enabled.

5. Click the "Load" button.  
The loading operation is performed. The "Load results" dialog then opens. In this dialog, you can check whether or not the loading operation was successful and take any further action that may be necessary.
6. Click the "Finish" button.

**Result**

The selected project data was downloaded to the devices.

**See also**

General information on loading (Page 281)

Downloading project data to a memory card (Page 283)

Uploading project data from a device (Page 284)

**Downloading project data to a memory card****Requirement**

The memory card is displayed.

See also: Accessing memory cards (Page 336)

## Procedure

To download project data to a memory card, follow these steps:

1. Use a drag-and-drop operation in the project tree to take the project data you want to download and move it to the memory card.  
The "Load preview" dialog opens. This dialog displays messages and proposes actions necessary for downloading.
2. Check the messages, and select the actions in the "Action" column, if necessary.  
As soon as loading becomes possible, the "Load" button is enabled.
3. Click the "Load" button.  
The loading operation is performed. The "Load results" dialog then opens. In this dialog, you can check whether or not the loading operation was successful and take any further action that may be necessary.
4. Click the "Finish" button.

## See also

General information on loading (Page 281)

Downloading project data to a device (Page 282)

Uploading project data from a device (Page 284)

## Uploading project data from a device

The following section describes the general procedure for uploading project data from a device. Which project data you can upload from a device depends on the products installed.

You have the following basic options for uploading project data from a device to your project:

- Uploading a device to a programming device or PC  
You can use this option to start with an empty project and upload existing project data directly from a device.
- Uploading from device  
Only certain project data are uploaded from the device to the project. You will find the project data that can be downloaded in the online help of the product.

In both cases all instances of library types are connected again with the corresponding version of the type in the project library during loading. If no suitable type is yet available for a loaded instance or the correct version of the type does not exist in the project library, the type or the version is added to the project library.

## Requirements

- A project is open.
- The hardware configuration and software to be downloaded have to be compatible with the TIA Portal. If the data on the device was created with a previous program version or with a different configuration software, please make sure they are compatible.

## Uploading a device to a programming device or PC

To upload the complete device to your project, follow these steps:

1. Select the project name in the project tree.  
The "Upload device to PG/PC" command in the "Online" menu is then enabled.
2. In the "Online" menu, select the "Upload device to PG/PC" command.  
The "Upload device to PG/PC" dialog opens.
3. Select the type of interface you want to use for the load operation in the "Type of the PG/PC interface" drop-down list.
4. Select the interface to be used from the "PG/PC interface" drop-down list.
5. Click the "Configure interface" button to the right of the "PG/PC interface" drop-down list to adapt the settings for the selected interface.  
See also: Auto-Hotspot
6. In the accessible devices table, select the device from which you want to upload project data.
7. Click on "Load".  
Depending on the selected device, a dialog appears in which you have to enter additional information, such as the position of the module rack.  
The project data of the device is uploaded to the project. You can edit it offline and then download it to the device again.

## Uploading from device

To upload only certain project data from a device to your project, follow these steps:

1. Establish an online connection to the device from which you want to download the project data.  
See also: Auto-Hotspot
2. Select an element in the project tree that allows uploading of project data.  
As a result, the "Upload from device" command in the "Online" menu becomes enabled.
3. Select the "Upload from device" command in the "Online" menu.  
The "Upload preview" dialog box opens.
4. Check the messages in the "Upload preview" dialog, and select the necessary actions in the "Action" column.  
As soon as uploading becomes possible, the "Upload from device" button is enabled.
5. Click the "Upload from device" button.  
The loading operation is performed.

## See also

General information on loading (Page 281)

Downloading project data to a device (Page 282)

Downloading project data to a memory card (Page 283)

## 7.5.2 Comparing project data

### 7.5.2.1 Basics of project data comparison

#### Function

You can compare project data of the same type in order to determine possible differences. In principle, the following comparison methods are available:

- **Online/offline comparison**  
With this type of comparison, the objects of a device are compared to the objects of a project. This is only possible when you establish an online connection to the device.
- **Offline/offline comparison**  
With this type of comparison you can compare objects from projects or libraries. You can decide whether the comparison should be performed automatically for all objects or whether you want to compare individual objects manually.
- **Detailed comparison**  
For some objects, for example, blocks, you can also perform a detailed comparison in addition to the online/offline and offline/offline comparison. This involves opening the blocks to be compared beside each other and highlighting the differences.

A simple online/offline comparison is performed as soon as you establish an online connection. During this process, comparable objects in the project tree are marked with icons that represent the result of the comparison.

The normal online/offline and offline/offline comparison is performed in the compare editor. You can also select actions for non-identical objects in the comparison editor.

---

#### Note

- Not all objects allow all types of comparison. Which comparison method you can use for which project data depends on the products installed.
  - Compile your user program before you start a comparison or detailed comparison. After each change of the program during a comparison, repeat this step before you update the result of the comparison. This ensures that the comparison shows the current status.
- 

#### See also

Carrying out an online/offline comparison (Page 287)

Carrying out offline/offline comparisons (Page 287)

Using the comparison editor (Page 288)

Running a detailed comparison (Page 294)

### 7.5.2.2 Carrying out an online/offline comparison

#### Requirement

The project tree is open.

#### Procedure

To perform an online/offline comparison, follow these steps:

1. Select a device in the project tree that allows online/offline comparison.
2. Select the "Compare > Offline/online" command in the shortcut menu.
3. If you have not already established an online connection to this device, the "Go online" dialog opens. In this case, set all the necessary parameters for the connection and click "Connect".  
The online connection is established and compare editor opens.

#### Result

All objects that exist online and offline are displayed. The symbols in the comparison editor and in the project tree show you the status of the objects. In the compare editor, you can now define certain actions for the objects, depending on their status.

#### See also

Basics of project data comparison (Page 286)

Carrying out offline/offline comparisons (Page 287)

Using the comparison editor (Page 288)

Running a detailed comparison (Page 294)

### 7.5.2.3 Carrying out offline/offline comparisons

With an offline/offline comparison, you can compare project data of two devices within one project or from different projects or from the library. You can decide whether the comparison should be performed automatically for all objects or whether you want to compare individual objects manually.

You can drag any other device to the drop area at any time to perform further comparisons.

#### Requirement

The project tree is open.

### Performing automatic offline/offline comparisons

To perform an automatic offline/offline comparison, follow these steps:

1. Select a device in the project tree that allows offline/offline comparison.
2. Select the "Compare > Offline/offline" command in the shortcut menu.  
The compare editor opens and the selected device is displayed in the left area.
3. Drag-and-drop an additional device to the drop area of the right pane. The device to be compared can originate from the same project, a reference project or the library.  
All existing objects of the selected devices are displayed depending on the settings of the compare editor. You can identify the status of the objects based on the symbols in the compare editor. You can define certain actions depending on the status of the objects.

### Performing manual offline/offline comparisons

To perform a manual offline/offline comparison, follow these steps:

1. Select a device in the project tree that allows offline/offline comparison.
2. Select the "Compare > Offline/offline" command in the shortcut menu.  
The compare editor opens and the selected device is displayed in the left area.
3. Drag-and-drop an additional device to the drop area of the right pane. The device to be compared can originate from the same project, a reference project or the library.
4. In the status and action area, click on the button for switching between automatic and manual comparison.
5. Select the objects that you want to compare.  
The properties comparison is displayed. You can identify the status of the objects based on the symbols. You can define certain actions depending on the status of the objects.

### See also

Basics of project data comparison (Page 286)

Carrying out an online/offline comparison (Page 287)

Using the comparison editor (Page 288)

Running a detailed comparison (Page 294)

#### 7.5.2.4 Using the comparison editor

### Overview of the comparison editor

#### Function

The comparison editor gives an overview of the results of online/offline and offline/offline comparisons in a table. You can also define which actions are to be carried out for non-identical objects compared.



## Components of the comparison editor

The following figure shows the components of the compare editor using a manual offline/offline comparison as an example:

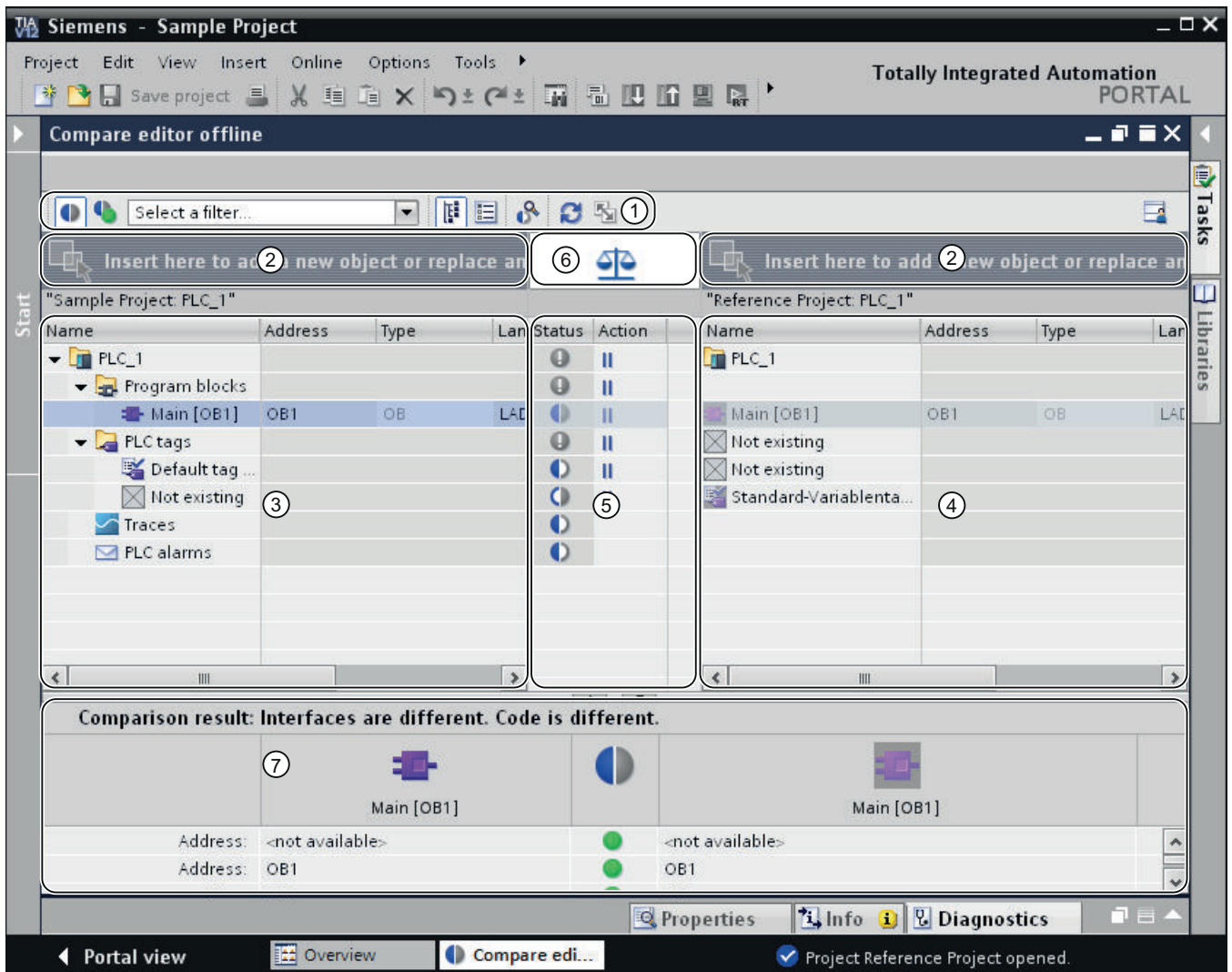

- ① Compare editor toolbar
- ② Drop areas (offline/offline comparison only)
- ③ Left comparison table
- ④ Right comparison table
- ⑤ Status and action area
- ⑥ Button to switch between automatic and manual comparison (offline/offline comparison only)
- ⑦ Properties comparison

### Compare editor toolbar

With the toolbar, you can access the following compare editor functions:

- Only show different objects  
You can hide identical objects to make the comparison easier to follow.
- Show identical and different objects  
You can display identical objects if you want to fully view the comparison.
- Scope of the comparison  
You can define which objects are to be compared.
- Start detailed comparison  
You can start a detailed comparison for objects to show the individual differences. This function is, however, not available for every object.
- Updating comparison results  
After you have modified objects, you can update the comparison results using this function.
- Synchronizing non-identical objects  
You can synchronize non-identical objects using specific actions.
- Changing the view  
You can choose between a hierarchical and a flat view. In the hierarchical view, the devices are shown in their structure; in the flat view, the objects of the devices are listed without structure.

### Drop areas

In the case of an offline/offline comparison, you can drag the devices you want to compare into the drop areas. The devices to be compared can originate from a project, from reference projects, from the project library or from global libraries. However, note that you can only drop complete libraries into the right drop area.

### Comparison tables

Comparison tables show the objects of the devices being compared to one another.

The following table shows the meaning of the columns of the comparison table:

Column	Description
Name	Name of the compare object
Comment	Comment on the compare object
Title	Title of the compare object
Address	Address of the compare object
Type	Type of compare object
Language	Programming language set for the compare object.
Time stamp interface	Time of the last modification to the block interface
Time stamp code	Time of the last modification to the source code
Author	Name of the author of the compare object
Version	Version of the compare object
Family	Name of the object family

Column	Description
Load memory	Memory usage of the load memory of the compare object
Work memory	Memory usage of the work memory of the compare object
Modified on	Time of last modification
Program signature	Program signature of the compare object (SIMATIC Safety)
Interface (checksum)	Checksum of the block interface of the compare object (SIMATIC Safety)

Not all columns are shown in the default setting. However, as in all table editors, you can show or hide the columns as required and sort according to individual columns.







## Status and action area

The status and action area offers the following options:





- With an offline/offline comparison, you can switch between automatic and manual comparison.
- You can view the results of automatic comparison. The results are displayed with symbols.
- You can define actions for non-identical objects.



## Status and action symbol

The following table shows the comparison results symbols for an online/offline comparison:





Symbol	Description
	Folder contains objects whose online and offline versions differ
	Comparison results are not known
	Online and offline versions of the object are identical
	Online and offline versions of the object are different
	Object only exists offline
	Object only exists online

The following table shows the comparison results symbols for an offline/offline comparison:

Symbol	Description
	Actual program
	Version compared
	Folder contains objects of which the versions compared differ
	Results of the offline/offline comparison are not known
	The versions of the object compared are identical

Symbol	Description
	The versions of the object compared differ
	Object only exists in the output program
	Object only exists in the version compared

The following table shows the symbols for possible actions:

Symbol	Description
	No action
	Overwrite the object of the compared version with the object from the output program
	Overwrite the object of the output program with the object from the compared version
	Different actions for the compare objects in the folder

### Properties comparison

The properties comparison compares the properties of the selectedcompare objects. The result is displayed with symbols. Only the properties comparison is made with a manual comparison so that the status and action area remains empty. With automatic comparison, you can perform the property comparison in addition to the comparison in the comparison tables.

### See also

- Basics of project data comparison (Page 286)
- Changing the view (Page 297)
- Carrying out an online/offline comparison (Page 287)
- Carrying out offline/offline comparisons (Page 287)
- Filtering the comparison editor view (Page 293)
- Updating the comparison results (Page 294)
- Synchronizing non-identical objects (Page 295)

## Filtering the comparison editor view

You can improve the clarity of the compare editor using the following filters:

- **Hiding identical comparison objects**  
You can hide comparison objects which have identical online/offline or offline/offline versions. Any such comparison objects you have hidden can also be shown again at any time.
- **Displayed objects**  
You can define the objects for which comparison results are to be shown.

## Requirement

The compare editor is open.

## Hiding identical comparison objects

To hide identical objects, follow these steps:

1. Click on the "Show only objects with differences" button in the toolbar.  
Only the elements that differ online and offline are displayed.

## Showing identical comparison objects

To show identical objects again, follow these steps:

1. Click on the "Show identical and different objects" button in the toolbar.  
All elements will be displayed.

## Selecting displayed objects

To select the objects for which comparison results should be displayed, follow these steps:

1. Click on the arrow button in the drop-down list in the toolbar.
2. Select the desired object.

## See also

[Changing the view \(Page 297\)](#)

[Carrying out an online/offline comparison \(Page 287\)](#)

[Carrying out offline/offline comparisons \(Page 287\)](#)

[Overview of the comparison editor \(Page 288\)](#)

[Updating the comparison results \(Page 294\)](#)

[Synchronizing non-identical objects \(Page 295\)](#)

## Running a detailed comparison

---

### Note

Not all objects allow a detailed comparison. The project data for which you can perform a detailed comparison depends on the products installed.

---

## Procedure

Proceed as follows to perform a detailed comparison:

1. First, perform an online/offline or an offline/offline comparison.  
The compare editor opens.

---

### Note

You can only perform a detailed comparison for objects that are listed in the left as well as the right comparison table.

---

2. In the compare editor, select the object for which you want to perform a detailed comparison.
3. Click the "Start detailed comparison" button in the toolbar.

## See also

Basics of project data comparison (Page 286)

Carrying out an online/offline comparison (Page 287)

Carrying out offline/offline comparisons (Page 287)

Changing the view (Page 297)

## Updating the comparison results

As soon as you change an object, the comparison results are no longer valid and must be updated.

---

### Note

For online/offline comparisons, you should note that changes in the device may result in the system automatically updating the comparison editor if objects in the comparison are affected by the change. This can have the following results:

- Some of the actions you have defined may become invalid, for example if the device no longer contains the object in question. Objects with such invalid actions will be highlighted so you can define new, valid actions.
  - The selection you made before the automatic update may also be cancelled.
- 

## Requirement

The comparison editor is open.

## Procedure

To update the comparison results, follow these steps:

1. Click the "Refresh view" button in the toolbar.  
The comparison results are updated.

---

### Note

Please note that the "Refresh view" button will not be available while the comparison editor is loading or synchronizing content.

---

## See also

Changing the view (Page 297)

Carrying out an online/offline comparison (Page 287)

Carrying out offline/offline comparisons (Page 287)

Overview of the comparison editor (Page 288)

Filtering the comparison editor view (Page 293)

Synchronizing non-identical objects (Page 295)

## Synchronizing non-identical objects

### Specifying actions

If you have performed a comparison, you can specify the actions to be performed for non-identical objects in the compare editor. You cannot select any actions for identical objects.

In the case of an online/offline comparison, only synchronization actions in one direction are permitted, in order to retain program consistency. Thus, for example, you can load multiple blocks to a device or from a device, but you cannot perform a combination of loading actions in one synchronization action. In this case, the first action you set in the compare editor determines the synchronization direction. For example, if you specify for a block that the offline block is to be loaded to the device, then the other objects can also only be loaded to the device via a synchronization action. To load objects from the device again, first select the "No action"

option. You can then specify the action settings again as required. Or, you can perform a new comparison.

---

**Note**

Please note the following CPU-specific aspects when defining actions:

- S7-300/400:
    - You can define actions for the "Program blocks" folder, for folders you have created yourself or for individual blocks.
    - Neither SCL nor GRAPH blocks can be loaded from the device to the offline project.
  - S7-1200/1500:
    - You can define actions for the "Program blocks" folder, for folders you have created yourself or for individual blocks. If you have performed an online/offline comparison and select download to the device as action, a consistent download is executed. If you upload the object from the device to the project, however, you can also upload individual blocks.
    - SCL blocks cannot be loaded from the device to the offline project.
- 

**Requirement**

The compare editor is open.

**Procedure**

To select an action for a non-identical object, follow these steps:

1. In the status and action area, double-click in the "Action" column on the cell of the object for which you want to define an action.  
The cell changes to a drop-down list.
2. Click on the drop-down list.
3. Select the action you want.  
The action set will be carried out for the object in question the next time synchronization is performed.  
If you have accidentally changed the action you had selected, you can undo the change before the next synchronization.
4. To restore the previous action selected, right-click on the object or folder.
5. Select the "Restore previous selection" command in the shortcut menu.

**See also**

Overview of the comparison editor (Page 288)

Filtering the comparison editor view (Page 293)

Updating the comparison results (Page 294)

Synchronizing objects (Page 297)



## **Synchronizing objects**

Synchronization executes the actions you have specified for non-identical objects. Note, however, that in the case of an online/offline comparison you can only perform actions in one direction in one synchronization action.

### **Requirement**

- The compare editor is open.
- The desired actions have been selected.

### **Procedure**

To synchronize objects, follow these steps:

1. Click the "Execute actions" button in the toolbar.

### **Result**

The actions you specified for the objects are performed.

### **See also**

Overview of the comparison editor (Page 288)

Filtering the comparison editor view (Page 293)

Updating the comparison results (Page 294)

Specifying actions (Page 295)

## **Changing the view**

You can choose between a hierarchical and a flat view. In the hierarchical view, the devices are shown in their structure; in the flat view, the objects of the devices are listed without structure.

### Setting the hierarchical view

To set the hierarchical view, follow these steps:

1. Click the "Display in hierarchical view" button in the toolbar of the comparison editor.

### Setting the flat view

To set the flat view, follow these steps:

1. Click the "Display in flat view" button in the toolbar of the comparison editor.

### See also

Basics of project data comparison (Page 286)

Overview of the comparison editor (Page 288)

Filtering the comparison editor view (Page 293)

Running a detailed comparison (Page 294)

Updating the comparison results (Page 294)

Synchronizing non-identical objects (Page 295)

## 7.5.3 Protecting project data

### 7.5.3.1 Protection concept for project data

#### Introduction

You can protect your project data from unauthorized access. These include, for example:

- Access protection for devices
- Copy and display protection of objects
- Restrictions for printouts of know-how-protected objects

For objects with know-how protection, this protection is also retained after the object is pasted into a library. Note that every protection mechanism is not available for all objects. How to protect specific objects is described in the online help of the product.

#### Revoking access rights for devices

If you want to execute a function that is password-protected by means of the device protection level, you are prompted to enter a password. When the password is entered correctly, you can execute the required function. You continue to have access rights on the device until you close the TIA Portal.

If you want to reactivate password protection while the TIA Portal is open, you can explicitly revoke the access rights for a device. As a result, certain functions for the protected device

cannot be executed until the correct password is entered again. You specify the functions for which a password must be entered when you assign the device protection level.

### See also

Printing project data (Page 317)

## 7.5.3.2 Revoking access rights for devices

### Requirement

- A protection level has been set for the device.
- A protected function for the device has been enabled by entering the password.

### Procedure

To revoke the access rights for the device, follow these steps:

1. Select the device for which you want to revoke access rights in the project tree.
2. Select the "Delete access rights" command in the "Online" menu.

### Result

The access rights are revoked, and starting from now the user will be prompted to enter the password again to execute a password-protected function on the device. The function can only be executed if the correct password is entered.

If the device has an online connection, it will be disconnected.

### See also

Protection concept for project data (Page 298)

## 7.5.4 Printing project contents

### 7.5.4.1 Printing project documentation

#### Documentation settings

#### Introduction

Once a project is created, the contents can be printed in an easy-to-read format. You may print the entire project or individual objects within the project. A well-structured printout is helpful

when editing the project or performing service work. The printout can also be used for your customer presentations or as full system documentation.

You can prepare the project in the form of standardized circuit manuals and print it in a uniform layout. You can limit the scope of the printout. You have the option to print to the entire project, individual objects along with their properties, or a compact overview of the project. In addition, you can print the contents of an open editor.

### **Improving the printout with frames and cover pages**

You can design the appearance of the printed pages according to your own requirements, for example, to add your own company logo or the corporate design of your company in the project documentation. You can create any number of design variants as frames and cover pages. The frames and cover pages are stored in the project tree under the item "Documentation settings" and are part of the project. You can insert placeholders for data from previously entered document information within the frames and cover pages. These will be filled automatically with the appropriate metadata during printing.

If you want to avoid designing your own template, there are ready-made frames and covers pages available. These include templates complying with the ISO standard for technical documentation.

### **Modular structure of a printout**

An printout generally consists of the following components:

- Cover page (only when printing from the project tree)
- Table of contents (only when printing from the project tree)
- Name and path of an object within the project tree
- Object data

Printout of the cover page or the table of contents can be deactivated in the "Print" dialog.

### **See also**

Creating frames (Page 306)

Creating a cover page (Page 306)

Editing cover pages and frames (Page 308)

Entering document information (Page 304)

Print function for module labels (Page 319)

## Printout of project contents

### Availability of print function

The following contents can be printed:

- An entire project in the project tree
- One or more project-related objects in the project tree
- Contents of an editor
- Tables
- Libraries
- Diagnostics view of the Inspector window

It is not possible to print in the following areas:

- Portal view
- Detailed view
- Overview window
- Compare editor
- All tabs of the Inspector window, except the diagnostics view
- All task cards, except the libraries
- Most of the dialogs
- Properties and devices of the programming device/PC not related to the project, for example online portals and connected card readers.

### Scope of printout

To be able to print, at least one printable element has to be selected.

If a selected object is printed, all subordinate objects are also printed. For example, if a device is selected in the project tree, all of its data is also printed. If you select the entire project in the project tree for printing, all project contents are printed with the exception of the graphical views. These have to be printed separately. Items in the project tree that are not part of the project cannot be printed. For example, this includes online portals and connected card readers and USB memory devices.

When table contents are printed, all lines in the table in which a cell is selected are printed. In order to print one or more table columns, the desired columns must be selected. If no individual cells or columns are selected, the entire table is printed.

### Limitations when printing

In general, it is possible to print all objects that can be visualized on the user interface. Conversely, this means that you cannot print objects that you do not have access to. If a printout fails, possible reasons may include the following:

- A valid license does not exist for displaying an object.
- There is no device description for an object.
- A software component needed to display an object is not installed.

### See also

Printing project data (Page 317)

### Changing the print settings

### Changing the print settings

You can specify general print settings that are retained even after the TIA Portal is closed and re-opened. Some settings are dependent on the products installed. The following settings are possible in every case:

### Always print table data as pairs of values

If this option is selected, tables are not printed in tabular format but rather as a pairs of key and value.

Example:

Object name	Property 1	Property 2
Object A	Value A1	Value A2
Object B	Value B1	Value B2

In this case, the printout has the following appearance:

#### Object A

Property 1: Value A1

Property 2: Value A2

#### Object B

Property 1: Value B1

Property 2: Value B2

## Printing mask editors

- Always print data in tables  
All parameters of technology objects are printed in tabular format.
- Print mask graphics if possible  
If the utilized editor supports this function, the contents of the editor are not printed as a table but rather as a complete graphic as it appears on the screen.

## Procedure

To change the print settings, follow these steps:

1. Select the "Settings" command in the "Options" menu.  
The "Settings" window is displayed in the work area.
2. Select the "General" group.
3. Select the desired default settings in the "Print settings" area.  
The changes are applied immediately and are retained for all projects, even after the TIA Portal is closed.

## See also

Overview of the print settings (Page 202)

## Specifying the print layout

### Specifying the print layout

If you do not want to rely on ready-made print templates, you can specify your own cover page or your own layout for the individual pages. Your designs are saved together with the respective project.

Your designs for the cover page and your templates for the page layout can be found in the project tree under the "Documentation information" group. You will also find metadata on the project there under the entry "Document information". For subsequent print operations, you can customize the appearance of the printout in the "Print" dialog using the saved cover pages and page layout templates and the available metadata.

### Designing the cover page

The cover page can be customized. You can insert a background graphic and provide placeholders for text on the page. The placeholders are automatically filled with data from a documentation information during printing.

Cover pages are located in the project tree under the "Documentation information > Cover pages" group.

## Designing the content page

The regular pages of a printout can contain the following elements:

- Frame with static content, such as a company logo
- Place holders for text, such as the name of the project, the page number, and the time the printout was started  
Several different values for the individual placeholders can be specified in the document information. Other values, such as the project name, are preassigned and are inserted automatically during printing.
- Footnote  
The footnote is always output below the content area.
- Content area  
You can specify an area where the printed content is to be embedded.

The design of the content pages is saved in Frames. The individual frames are located in the project tree under the "Documentation information > Frames" group.

## Entering document information

You can enter metadata in the document information for every project. In addition, a print frame and a cover page are specified in the document information. You can create different information, if required, to enable you to quickly switch between different document information containing different information, frames, cover pages, page sizes, and page orientations when printing. For example, this is useful if you want to generate printouts in different languages and different document information is provided for each language.

In the documentation editor, you can specify placeholders on the cover page or in the frame of the regular pages. These placeholders can be automatically replaced with metadata from the documentation information during printing.

The various document information are therefore part of the printing function and specify the print layout and print content.

## Procedure

To add metadata, follow these steps:

1. To create new document information, double-click "Add new document information" under "Documentation information > Document information" in the project tree.  
The new document information is created and opened immediately.
2. Enter a name for the set in the "Name" field.
3. Fill in the individual fields with the metadata for the project.



## Managing cover pages and frames

### Using cover pages and frames

#### Uses for cover pages

You can give your plant documentation printouts a professional appearance by adding a cover page. You can design your own cover page or use ready-made cover pages. Ready-made cover pages can be adapted and stored again as a template.

Cover pages can be saved in global libraries where they are available for use across projects.

Cover pages are designed for use as a right printed page only.

#### Uses of frames

You can embed the regular pages of your plant documentation inside a consistently uniform page frame. The frame can contain placeholders for project metadata, which is stored in the document information. It can also contain graphic elements that you design yourself.

You can create your own frames or rely on ready-made page frames. You can adapt a ready-made page frame and then store it again as a new frame.

Like cover pages, frames can be saved in global libraries where they are available for use across projects.

Frames are designed for use on right printed pages only.

## Cover pages and templates in the project tree

Cover pages and frames associated with the project are stored in the project tree under the entry "Documentation information". There are separate folders here for frames and cover pages.

The following actions are available in the project tree for cover pages and frames.

- Creating your own subfolders
- Copying and pasting
- Inserting cover pages and frames from the "Documentation templates" system library
- Copying cover pages and templates to a global library

## Cover pages and templates in libraries

The "Documentation templates" system library contains a few cover pages and templates that are available in every project. The cover pages and templates can be moved from there to the project tree using a drag-and-drop operation. You can then adapt the cover pages and templates in the project tree according to the requirements of your project.

Cover pages and templates can be moved from the project tree to a global library. Afterwards, these are available in every project.

## See also

- Library basics (Page 338)
- Overview of the "Libraries" task card (Page 339)
- Designing cover pages and frames (Page 308)
- Using ready-made frames and cover pages (Page 307)

## Creating frames

You can create any number of frames for each project. The frames are stored in the project tree below the "Documentation information > Frames" group. You can assign a frame to all document information. When you select document information for printing, its associated frame is used.

## Procedure

To create a new frame, follow these steps:

1. Double-click the entry "Add new frame" below the "Documentation information > Frames" group in the project tree.  
The "Creating frames" dialog opens.
2. Enter a name for the frame in the "Name" field.
3. Choose the paper size from the "Paper type" drop-down list.
4. Choose whether the page is to be created in portrait or landscape format in the "Orientation" drop-down list.

Click the "Add" button.

## Result

A new frame is created. The frame is then opened automatically in the documentation editor where it can be edited.

## See also

- Editing cover pages and frames (Page 308)
- Creating a cover page (Page 306)

## Creating a cover page

You can create any number of cover pages for the printout for each project. The cover pages are stored in the project tree below the the "Documentation information > Cover pages" group. You can assign a cover page to all document information. When you select specific document information for printing, its associated cover page is used.

## Procedure

To create a new cover page, follow these steps:

1. Double-click the entry "Add new cover page" below the "Documentation information > Cover pages" group in the project tree.  
The "Add new cover page" dialog box opens.
2. Enter a name for the cover page in the "Name" field.
3. Choose the paper size from the "Paper type" drop-down list.
4. Choose whether the page is to be created in portrait or landscape format in the "Orientation" drop-down list.

Click the "Add" button.

## Result

A new cover page is created. The cover page is then opened automatically in the documentation editor where it can be edited.

## See also

Editing cover pages and frames (Page 308)

Creating frames (Page 306)

## Using ready-made frames and cover pages

The TIA Portal comes with some ready-made frames and cover pages. These can change according to your wishes.

## Procedure

To create and edit the ready-made frames and cover pages, follow these steps:

1. Open the "Global libraries" pane in the "Libraries" task card.
2. In the "Templates" folder, open the "Cover Pages" or "Frames" folder.
3. Drag a cover page or a frame from one of the folders into the project tree and drop it into one of the following folders:
  - For frames: "Document information > Frames"
  - For cover pages: "Document information > Cover pages".

The ready-made frame or cover page can now be used in the project.

4. Double-click on the new entry in the project tree click to edit the frame or the cover page.

## See also

Using cover pages and frames (Page 305)

Editing cover pages and frames (Page 308)

## **Designing cover pages and frames**

### **Editing cover pages and frames**

The documentation editor is a graphical editor which allows you to design frames and cover pages for your plant documentation. You can place images or text elements on the frame and the cover pages in the document editor. The text elements are either static or they are automatically filled during printing with the data from the document information that you have selected in the print dialog.

### **Procedure**

To edit a cover page or a frame in the documentation editor, follow these steps:

1. In the project tree, double-click on the entry for an existing cover page or frame under the "Documentation information > Frames " or "Documentation information > Cover pages" group.  
The documentation editor opens.
2. Design the cover page or frame as desired.
3. Close the documentation editor.  
The changes to the cover page or frame are applied automatically.

### **See also**

Creating a cover page (Page 306)

Creating frames (Page 306)

General operation of the documentation editor (Page 309)

## General operation of the documentation editor

### Components of the documentation editor

The following figure provides an overview of the components of the documentation editor:

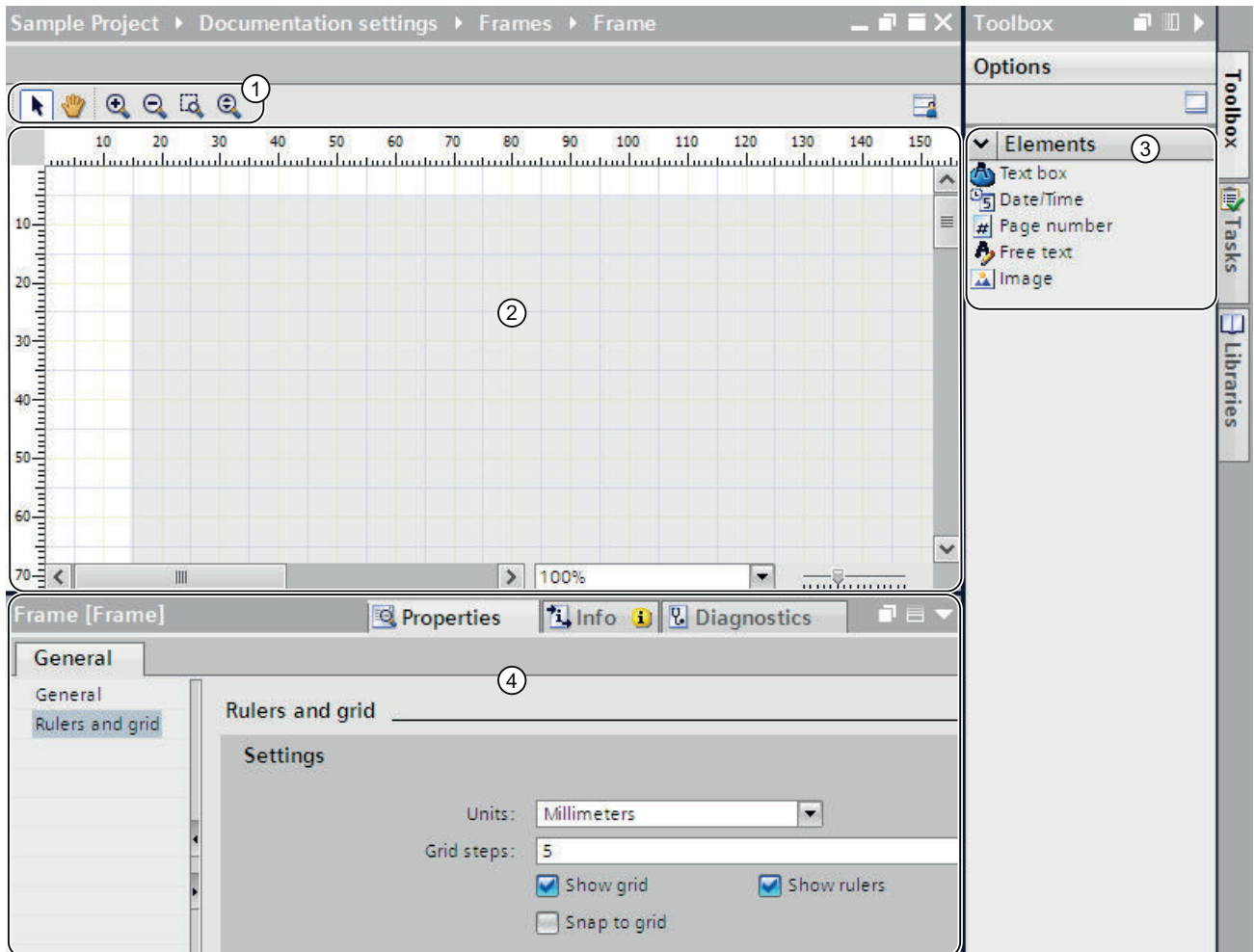

- ① **Toolbar**

The toolbar provides the following tools (from left to right):

  - Arrow tool  
Enables object selection.
  - Navigation tool  
Allows shifting of the partial page.
  - Zoom-in button  
Magnifies the page display incrementally.
  - Zoom-out button  
Reduces the page display incrementally.
  - Selecting a zoom factor  
Adapts the page size to the area selected with the lasso zoom tool.
  - Dynamic zoom  
Adapts the page width to the work area.
- ② **Work area**

You can design the cover page or frame in the work area.
- ③ **"Toolbox" task card**

The "Toolbox" task card contains various types of placeholders that you can use on the cover sheet or frame. The placeholders can be placed in the work place using a drag-and-drop operation.
- ④ **Properties in the Inspector window**

You can display and modify the properties of the currently selected object in the "Properties" tab of the Inspector window. For example, you can modify the properties of the page, format text, specify the position of objects on the page, etc.

## Operation in the documentation editor

The following basic functions are available in the documentation editor:

- **Drag-and-drop functionality**  
The documentation editor is a graphic editor, which means you can place objects anywhere with the mouse. An image of the page is displayed in the work area. This image corresponds to the ultimate print layout.  
If you want to select objects on the page in order to move them or modify their properties, the arrow tool must be activated in the toolbar.
- **Zoom function**  
You can use the zoom function to change the size of the page display. You have two options for changing the page size:
  - **Via the buttons in the toolbar**  
Select the "Zoom in" or "Zoom out" magnifying glass button in the toolbar of the documentation editor. Then click on the page in order to magnify (zoom in) or reduce (zoom out) the page incrementally.  
To zoom in on a particular area, select the "Select zoom factor" tool and use the mouse to drag an outline around the area you want to focus on.  
To continuously zoom in or zoom out of the work area, use the "Dynamic zoom" tool.  
To magnify the page display, click anywhere on the work area, and then hold down the mouse button while dragging the mouse toward the top of the page. To reduce the page display, drag the mouse toward the bottom of the page.
  - **Via the zoom bar**  
You can also use the zoom bar (located in the bottom right corner of the work area) to change the display size. Choose a percentage value from the drop-down list or enter a percentage value. Alternatively, you control the display size using the slider.
- **Navigation over the page**  
In addition to scrolling, you the option of changing the partial page with the navigation tool. To change the partial page with the navigation tool, select the Hand button in the toolbar. Then, click anywhere on the page and hold the mouse button down while moving the page to the desired position.

## Using and adapting the positioning aids

You have various aids at your disposal to help you position elements on the page:

- **Rulers**  
Rulers are affixed to the page margins in the work area.
- **Page grid**  
A grid is placed underneath the page in the work area.

You can display, hide or adapt the positioning aids in the Inspector window under "Properties > Rulers and grid". You can make the following settings:

- **Units:**  
Specify the unit of measurement for the grid and the rulers.
- **Grid steps:**  
Specify the width of the grid.
- **Show grid:**  
Specify whether the grid is to be displayed or hidden.

- Snap to grid:  
Specify whether objects are to be aligned automatically to the grid. If the option is selected, the grid lines function like a "magnet".
- Show rulers:  
Specify whether the rulers are to be displayed.

### See also

Editing cover pages and frames (Page 308)

Specifying the print area (Page 312)

Inserting placeholders for metadata (Page 312)

### Specifying the print area

An area within the frame is provided for the actual printed contents. The project data is then always inserted inside this defined and uniformly consistent area within the frame. You can adjust the size of the print area.

### Requirement

A frame is open in the documentation editor.

### Procedure

To define an area for the printed contents, follow these steps:

1. Click on the slightly darker area within the page display in the documentation editor to select the area for the print content.  
This opens the properties of the area to be printed in the Inspector window.
2. Enter the position of the print area on the X and Y axes in the Inspector window.
3. Specify the width and height of the print area in cm in the Inspector window.

Alternatively, you can change the width and position of the print area in the graphic display of the page. To do so, use the mouse to drag the margins of the print area until the desired size and position are achieved.

### See also

Creating frames (Page 306)

General operation of the documentation editor (Page 309)

### Inserting placeholders for metadata

You can provide placeholders on the cover page and in a frame. The placeholders are automatically filled with metadata from documentation information during printing, if they are placeholders for text. Alternatively, you can add non-modifiable data, such as free text or an image.



All elements are arranged in numbered Z-Orders. If objects overlap, you can determine in which sequence these are to be arranged.

## Types of placeholders

The following types of placeholders are available to you:

- **Text field**  
The text field stands as a placeholder for a text element from a document information. In the properties of the text field, you set which text from a document information should be automatically inserted during printing.
- **Field for date and time**  
A date and time is inserted instead of the placeholder when printing. This can be the date of creation or the point in time when the last change was made to the project. In the properties of the Inspector window, you specify which date or time is printed.
- **Page number**  
The correct page number is automatically applied when printing.
- **Free text**  
You can enter freely selectable text in the properties of the text field. The text is static and is not influenced by the document information selected at the time of printing.
- **Image**  
Select the image file in the properties of the placeholder in the Inspector window. Images in the formats BMP, JPEG, PNG, EMF or GIF are possible.

## Requirement

An cover page or frame is open in the documentation editor.

## Procedure

To insert placeholders for metadata on the cover sheet or in a frame, follow these steps:

1. Drag a field from the "Toolbox > Elements" task card to the work area of the documentation editor.  
The placeholder is inserted. The placeholder properties are shown in the Inspector window and can be edited there.
2. Select the metadata to be inserted during printing from the "Text" drop-down list in the Inspector window under "Properties > General > Text box". Alternatively, you have the option of entering free text or selecting an image depending on the type of placeholder.
3. In the Inspector window under "Properties > General > Position and size", specify the position of the placeholder on the X and Y axis and enter the width and height of the text box in cm. You specify the sequence of the objects in the "Z-Order" field, if these overlap. The smaller the value, the further down an object is located.
4. In the Inspector window, go to "Properties > View" and select the font formatting and the orientation of the text as well as the alignment of the text. You cannot make this setting for images.

## See also

General operation of the documentation editor (Page 309)

## Displaying print preview

## Creating a print preview

## Creating a print preview

You can create a preview of the printout. Document information can be chosen for this, in the same way as for the actual printout. In this way, you preview the selected frame and, if applicable, the cover sheet. The settings are retained for later printing.

## Procedure

To create a print preview and to set the scope of the later printout, follow these steps:

1. Select the "Print preview" command in the "Project" menu.  
The "Print preview" dialog opens.
2. Select the frame layout you want to use for the printout.
  - In the "Document information" drop-down list, select the documentation information you want to use later for the printout.
  - Select the "Print cover page" check box to print the cover page, which is specified in the selected document information.
  - Select the "Print table of contents" check box to add a table of contents to the printout.

The check boxes for printing the cover page and the table of contents can only be selected if you have started the printout in the project tree.
3. Under "Print objects/area", select what is to be printed. The selection is only possible if you have started the printout from an editor that supports this function.
  - Choose "All" to print out the entire content of the editor.
  - Choose "Selection" to print only the objects currently selected in the editor.

4. Select the print scope under "Properties".
    - Choose "All" to print all configuration data of the selected objects.
    - Choose "Visible" to print the information of an editor that is currently visible on the screen. This option can only be chosen if you have started the printout from an editor that supports this function.
    - Choose "Compact" to print out an abbreviated version of the project data.
  5. Click "Preview" to generate the preview.  
A print preview is created in the work area.
- 

**Note**

**Wait time for extensive documents**

It can take several minutes to generate the print preview in the case of very extensive projects. You can continue working normally in the meantime on systems with adequate resources. The progress of the print preview is shown in the status bar.

---

**See also**

Operation within the print preview (Page 316)

## Operation within the print preview

### Functions within the print preview

The print preview shows an exact image of the subsequent printout. You can use the buttons in the toolbar to modify the print preview display. The following functions are available (from left to right):

- Navigation mode  
Allows shifting of the partial page.  
To change the partial page with the navigation tool, select the arrow button in the toolbar. Then, click anywhere on the page and hold the mouse button down while moving the page to the desired position.
- Zoom function
  - "Zoom in" and "Zoom out"  
Magnifies or reduces the page display.  
To zoom in or zoom out the display incrementally, select the corresponding button. Then click on the page in order to magnify (zoom in) or reduce (zoom out) the page incrementally.  
To zoom in on a particular area, select the "Lasso zoom" button and use the mouse to drag an outline around the area you want to focus on.  
To select an area to focus on, select the button "Zoom in / zoom out with rectangle".  
With the mouse, drag a border around the area to focus on it.  
To zoom dynamically through the page, select the button "Zoom in / zoom out dynamically". With pressed mouse button, scroll down over the page to zoom in. Scroll up to zoom out.
  - Percentage value in the drop-down list  
Specifies the display size of the page in percent.  
Enter a percentage value or select a percentage value from the drop-down list.  
Alternatively, choose the "Fit to page" option from the drop-down list to adapt the page size to the work area. Or, choose "Fit to width" to adapt the page width to the work area.

- "Forward" and "Backward":  
Each change in the partial page, the page count, or the display size is saved in a history in the background. You can use the "Forward" or "Backward" button to return to the previous view or the next view.
- Page navigation
  - "First page"  
Jumps back to the first page.
  - "Previous page"  
Goes one page back.
  - "Page number" input field  
Shows the current page. To jump directly to a page, enter the page number of the page you want to view.
  - "Next page"  
Goes to the next page.
  - "Last page"  
Jumps to the last page.

## See also

Creating a print preview (Page 314)

## Printing project data

You have two options for printing out project data:

- Print immediately using default settings by means of the "Print" button in the toolbar. The button is only active if a printable object is selected.
- Printout with additional setting options with the "Project > Print" menu command. For example, you can choose a different printer or specific documentation information or you can specify whether a cover page and table of contents are to be printed. In addition, you can specify the print scope or display a print preview prior to printing.

## Requirement

- At least one printer is configured.
- The objects to be printed are not protected.  
The print scope for protected objects is limited. Disable the know-how protection to print the objects in full.

## Printing project data

To print out data from the current project or the entire project with additional setting options, follow these steps:

1. Select the entire project in the project tree in order to print out the entire project. To print only individual elements within a project, select them in the project tree.
2. Select the "Print" command in the "Project" menu.  
The "Print" dialog opens.
3. Select the printer in the "Name" box.
4. Click "Advanced" to modify the Windows printer settings.
5. Select the frame layout you want to use for the printout.
  - Select the documentation information in the "Document information" drop-down list. The frame stored in the document information is used for the printout. All placeholders within the chosen frame are filled with the metadata from the selected document information.
  - Select the "Print cover page" check box to print the cover page, which is stored in the selected document information.
  - Select the "Print table of contents" check box to add a table of contents to the printout.The check boxes for printing the cover page and the table of contents can only be selected if you have started the printout in the project tree.
6. Under "Print objects/area", select what is to be printed. The selection is only possible if you have started the printout from an editor that supports this function.
  - Choose "All" to print out the entire content of the editor.
  - Choose "Selection" to print only the objects currently selected in the editor.
7. Select the print scope under "Properties".
  - Choose "All" to print all configuration data of the selected objects.
  - Choose "Visible" to print the information of an editor that is currently visible on the screen. This option can only be chosen if you have started the printout from an editor.
  - Choose "Compact" to print out an abbreviated version of the project data.
8. Click "Preview" to generate a print preview in advance.  
A print preview is created in the work area.
9. Click "Print" to start the printout.

---

### Note

#### Scope of the "Print" dialog

The options available in the "Print" dialog vary depending on the elements to be printed.

---

## Result

The project data is prepared in the background for printing and then printed on the selected printer. The status bar shows the progress of the print operation. You can continue working normally while data is being prepared for printing.

The print results and any errors or warnings are listed in the Inspector window under "Info" at the conclusion of the print job.

## Canceling a print job

To cancel an active print job, follow these steps:

1. Click the red "X" in the status bar next to the progress display for the printout. The printout is cancelled promptly.

## See also

Protection concept for project data (Page 298)

Revoking access rights for devices (Page 299)

Printout of project contents (Page 301)

Designing cover pages and frames (Page 308)

### 7.5.4.2 Printing module labels

#### Print function for module labels

#### Printing of module labels for hardware modules

You can print labels for the modules in your project with the help of the TIA Portal. The labels are custom-fit to each module and can contain the following printed information:

- Symbolic name of the input or output
- Absolute address of the input or output
- Symbolic name and additionally the absolute address of the input or output. The order of the information can be specified.

The modules are displayed graphically in the device view. If you set the zoom level in the device view to at least 200%, the labels for the individual modules will be visible. The printout on the labels corresponds to the representation of the labeling in the device view.

The following figure shows an example of two modules in the device view on which the labeling of the inputs and outputs is visible:

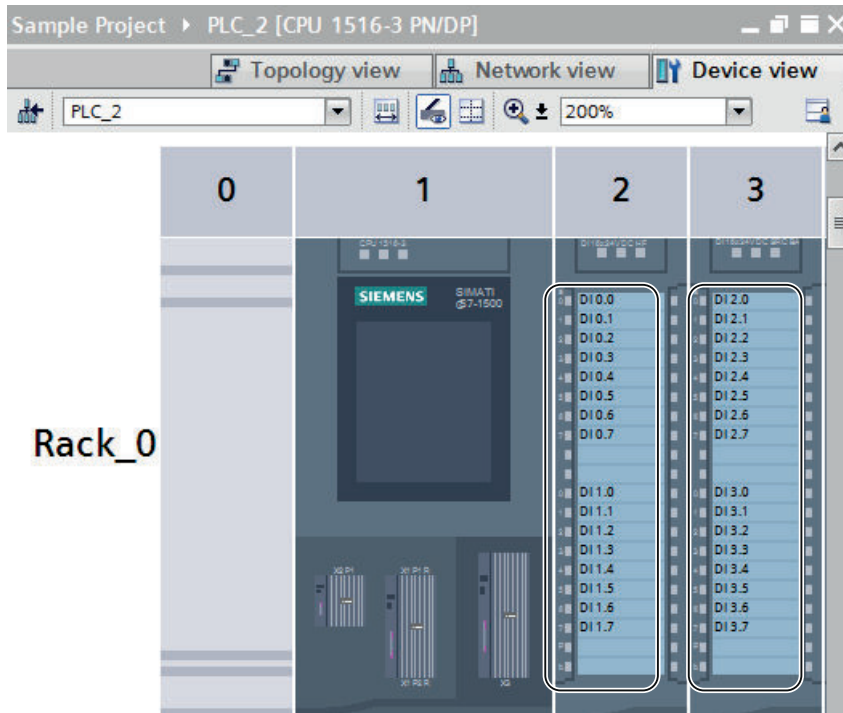

### Export and further editing as Microsoft Word file

Before you can print them, the labels are first exported as a Microsoft Word file (.docx). This file can be further edited with commonly available word processing programs such as Microsoft Word 2010. The individual labels are represented as a table in the .docx file. You can format the text or the backgrounds of the individual cells as desired.

The character spacing of the text within the table is adapted by default, so that texts are not truncated. If you want to prevent this from stretching or compressing the text too much, change the character spacing of the text in the table cell properties.

### Print media

You can print the labels either on ready-made print sheets or on standard DIN A4 paper. You can separate the individual labels from the ready-made print sheets and insert them in the designated labeling areas of your modules. If you print on standard paper, the individual labels must be cut out. Cut marks are automatically included on the printout and serve as aids.

Because the paper feeds of different printers differ slightly, the printout may be slightly offset on the paper. When the labels are printed on ready-made print sheets, printing that is accurate to the millimeter is important, because otherwise the text will not be custom-fit inside the stamped area. In addition, if the printing is imprecise, the labeling of an input or output may no longer be congruent with the channel status displays of the module. For this reason, you can enter an offset value for your printer in the TIA Portal to ensure precise printing. For information on how to determine the proper offset value for your printer, refer to Chapter "Determining the print area offset (Page 322)".



## See also

- Printing labels (Page 321)
- Determining the print area offset (Page 322)
- Documentation settings (Page 299)

## Printing labels

You can print labels for the modules in your project if provision has been made for attaching labels to the utilized modules. The labels are first exported to a Microsoft Word file (.docx). A separate .docx file is created for each module family (for example, for all selected S7-1500 modules). You can then modify the labels according to your wishes. The labels are always printed from the word processing program.

If no provision has been made for printing labels, the corresponding shortcut menu command is inactive. If you have selected multiple modules for printing of labels and at least one of the modules does not support this, a message is shown on the "Info > General" tab of the Inspector window. The message lists all unsupported modules, and the export of the print file is continued for the supported modules.

## Requirement

- The chosen modules must support the printing of labels.
- A word processing program that supports Microsoft Word .docx files must be installed, e.g., Microsoft Word 2010.
- You need the ready-made labels for your modules or commercially available DIN A4 paper.

## Procedure

To print labels for hardware modules, follow these steps:

1. In the project tree, select the modules for which you want to print labels.
  - You can select one or more stations in order to print out labels for all modules plugged into these stations.
  - Or, select the desired modules below the stations in the "Local modules" folder.
2. Right-click on one of the devices, and select the "Export labels" command from the shortcut menu.

The "Export labels" dialog box opens.
3. In the "Content of label" area, select which data are to be printed on the label.
  - Choose "Symbolic name" in order to print the symbolic name of the input or output (corresponds to the contents of the "Name" column in the IO tag table).
  - Choose "Absolute address" in order to print the absolute address of the input or output (corresponds to the contents of the "Address" column in the IO tag table).
  - Choose "Absolute and symbolic address" or "Symbolic and absolute address" in order to print both addresses. The print order corresponds to the indicated order.

4. Select which paper you plan to print on in the "Paper type" area.
  - Choose "Print on SIEMENS label sheet" if you want to print on a ready-made label sheet for your modules.
  - Choose "Print on standard paper" if you want to print on standard DIN A4 paper.
5. In the "Offset print area" area, select correction values for your printer, if required, for proper orientation of the print area. This is only necessary if you are printing on ready-made labels.
  - Enter a correction value, in millimeters, in the "Vertical offset" field. A negative value shifts the print area upward. A positive value shifts the print area downward.
  - Enter a correction value, in millimeters, in the "Horizontal offset" field. A negative value shifts the print area to the left. A positive value shifts the print area to the right.
6. In the "Path" field, select the path to which the exported .docx files should be stored.
7. Click the "Export" button to start the export to a .docx file.  
The .docx files are created.
8. Open the .docx files with a conventional word processing program, such as Microsoft Word 2010, and change the design of the labels if necessary.
9. Print out the labels from your word processing program. To do so, use the paper that you specified in the Export dialog box.
10. If you are using ready-made sheets, separate the labels at the stamped lines provided for that purpose. When standard DIN A4 paper is used, you must cut out the labels.

## See also

Determining the print area offset (Page 322)

## Determining the print area offset

If you are using a ready-made label sheet, the printing on it must be applied precisely so that the text is properly oriented on the prestamped labels and will have the proper fit relative to the channel status displays of the module. However, the paper feeds vary slightly from one printer to another. For this reason, you must enter a suitable correction value for your printer in the TIA Portal, if necessary. The print area is then shifted in the exported .docx file in such a way that the printing fits precisely on the ready-made label sheet.

The settings for shifting the print area are stored for the specific Windows user. If you log on to Windows using a different user name, you have to enter the correction values again.

The procedure for determining the correction value for your printer is described below.

## Requirement

- You require a ready-made label sheet.
- You must have access to the actual printer that you will use subsequently for the printout. The printer must be made ready for printing on standard DIN A4 paper.

## Procedure

To determine the correction value for your printer, follow these steps:

1. Print out a label sheet on standard DIN A4 paper, as described in Chapter "Printing labels (Page 321)".
2. Compare the printout on the DIN A4 paper with the ready-made label sheet.
3. If the print area is offset, you must use correction values.
  - Using a ruler, measure the horizontal offset relative to the ready-made label sheet. This will be entered later in the "Horizontal offset" field of the Export dialog box for the printing. If the print area is offset to the right, a negative correction value must be entered. If the print area is offset to the left, a positive correction value must be entered.
  - Using a ruler, measure the vertical offset relative to the ready-made label sheet. This will be entered later in the "Vertical offset" field of the Export dialog box for the printing. If the print area is offset downward, a negative correction value must be entered. If the print area is offset upward, a positive correction value must be entered.

## 7.6 Undoing and redoing actions

### 7.6.1 Basics of undoing and redoing actions

#### Function

You can undo performed actions at any time. For this purpose, every action you perform is saved in an action stack. When undoing actions, the stack is processed from top to bottom. In other words, if you undo an action that lies further down in the stack, all actions located above it in the stack will also be undone automatically.

You can redo previously undone actions until you execute a new action. Once you execute a new action, it is no longer possible to redo previously undone actions.

#### Particularities for undoing

There are a few actions that empty the action stack. You cannot undo these actions or the actions performed before these actions. The following actions empty the action stack:

- Saving
- Project management (creating a new project, opening project, closing a project, deleting a project)
- Compiling
- Restoring blocks
- Establishing an online connection
- Loading
- Writing to memory cards

#### Displaying the action stack

The "Undo" button in the toolbar is enabled as soon as you perform an action that can be undone. This button is split; you can use the arrow down portion to open a drop-down list containing all actions of the action stack that you can undo. If you had performed actions in an editor other than the currently displayed editor, the corresponding editor is also displayed as a subheading. This allows you to always identify the point at which the undo operation will be applied. The subheadings are removed from the list when the editor responsible can no longer undo actions.

Actions you have undone are entered in the action stack from where they can be redone. Here, you can redo actions you have undone. The display of actions you can redo it is analogous to the display of the actions that you can undo.

## Example of undoing actions

The figure below shows how actions performed in various editors and tables are undone:

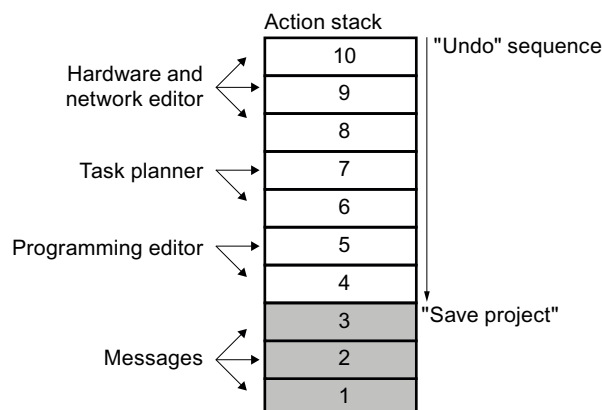

In this example, you cannot undo actions 1 to 3 because the project was saved. You can undo actions 4 to 10 in the order indicated by the direction of the arrow. In other words, you must undo action 10 first. Once you have undone action 8, you cannot then undo action 5. You must first undo actions 7 and 6. As the final step in the sequence, you can then undo action 4. You also have the option of undoing several actions in a single step by undoing an action located further down in the action stack. All actions located above it in the stack will be undone automatically.

The same principle also applies to redoing of actions.

## See also

Undoing an action (Page 325)

Redoing an action (Page 326)

## 7.6.2 Undoing an action

The following options are available for undoing actions:

- Undoing the last action only  
Only the last action performed is undone.
- Undoing as many actions as required  
Multiple actions in the action stack are undone in a single step.

### Undoing the last action only

To undo the last action performed, follow the steps below:

1. Click the "Undo" button in the toolbar.
  - If the action was not performed in the currently displayed editor, a confirmation prompt appears.
  - If the undo operation requires an editor containing a protected object to be opened, you must enter the password for the object.
2. Click "Yes" to confirm.
3. Enter the password, if necessary.  
The editor in which the action was performed is displayed and the action is undone.

### Undoing as many actions as required

To undo multiple actions in the action stack in a single step, follow these steps:

1. Click the Down arrow next to the "Undo" button in the toolbar.  
This opens a drop-down list containing all actions you can undo. Actions performed in other editors are identified by the editor name in the subheading.
2. Click the action you want to undo.  
The chosen action and all actions in the stack located above the chosen action are undone. If the undo operation requires an editor containing a protected object to be opened, you must enter the password for the object.
3. Enter the required passwords, if necessary.  
The editors in which the actions were performed are displayed and the actions are undone.

### See also

Basics of undoing and redoing actions (Page 324)

Redoing an action (Page 326)

### 7.6.3 Redoing an action

You have the option of redoing an action that has been undone, so that you can return to the status present before "Undo" was performed. However, this is only possible until you perform a new action. The following options are available for redoing actions:

- Redoing the last undone action only  
Only the last undone action is redone.
- Redoing as many undone actions as required  
Multiple undone actions in the action stack are redone in a single step.

### Redoing the last undone action only

To redo the last undone action, follow the steps below:

1. Click the "Redo" button in the toolbar.
  - If the action is not being redone in the currently displayed editor, a confirmation prompt appears.
  - If the redo operation requires an editor containing a protected object to be opened, you must enter the password for the object.
2. Click "Yes" to confirm.
3. Enter the password, if necessary.  
The editor in which the action was undone is displayed and the action is redone.

### Redoing as many undone actions as required

To redo multiple undone actions in the action stack in a single step, follow these steps:

1. Click the Down arrow next to the "Redo" button in the toolbar.  
This opens a drop-down list containing all actions you can redo. Actions performed in other editors are identified by the editor name in the subheading.
2. Click the action you want to redo.  
The chosen action and all actions in the stack located above the chosen action are redone. If the redo operation requires an editor containing a protected object to be opened, you must enter the password for the object.
3. Enter the required passwords, if necessary.  
The editors in which the actions were undone are displayed and the actions are redone.

### See also

Basics of undoing and redoing actions (Page 324)

Undoing an action (Page 325)

## **7.7 Finding and replacing in projects**

### **7.7.1 Information on the search function**

#### **Find and replace**

You can search for texts in the editors. The search function finds all texts containing the search key in the currently opened editor. The results are selected in sequence in the opened editor.

You also have the following options:

- Narrowing down the search with additional options
- Replacing found texts

The additional options and the type of texts for which you can search depend on the installed products and the currently open editor.

#### **See also**

Search and replace (Page 328)

### **7.7.2 Search and replace**

#### **Using Find**

The "Find and replace" function enables you to search for or replace texts in an editor.

#### **Additional options for searching**

You can narrow down your search by selecting one of the following additional options:

- **Whole words only**  
Only whole words are found. Words that contain the search key as part of the word are ignored.
- **Match case**  
Upper- and lowercase letters are taken into account in the search.
- **Find in substructures**  
The search also includes texts contained in another object.



- Find in hidden texts  
Texts that are assigned to another text but that are currently hidden are also included in the search.
- Use wildcards  
Enter an asterisk as the wildcard for any number of characters. Example: You want to search for all words starting with "Device". Type in "Device\*" in the search key box. Enter a question mark as the wildcard, however, if you only want to leave out a single character.
- Use regular expressions (for searching in scripts only)  
A regular expression is a character string used to describe sets of values and for filtering. This allows you to create complex search patterns.

The additional options available depend on the installed products and the editor opened.

## Start search

Follow these steps to start the "Find and replace" function:

1. Select the "Find and replace" command in the "Edit" menu or open the "Find and replace" pane in the "Tasks" task card.  
The "Find and replace" pane opens.
2. Enter a term in the "Find" drop-down list.  
As an alternative, you can select the most recent search key from the drop-down list.
3. Select the options desired for the search.
4. Using the option buttons, select the starting point for the search and the search direction.
  - Select "Whole document" if you want to search through the entire editor regardless of the current selection,
  - Select "From current position" if you want to start the search at the current selection.
  - Select "Selection" if you only want to search within the current selection.
  - Select "Down" to search through the editor from top to bottom or from left to right.
  - Select "Up" to search through the editor from bottom to top or from right to left.
5. Click "Find".  
The first hit is marked in the editor.
6. Click "Find" again to display the next hit.  
The next hit is marked in the editor. Repeat this process, as necessary, until you reach the last hit.

## Replacing the search key

You have the option of replacing hits individually or automatically replacing all the found texts, if the respective editor supports this function. Follow these steps to replace terms:

1. Enter a term in the "Find" drop-down list.  
As an alternative, you can select the most recent search key from the drop-down list.
2. Select the options desired for the search.

3. Click the "Find" button to start a search for the specified search key.  
The first hit is displayed in the editor.
4. In the "Replace" drop-down list, enter the text you wish to use to replace the search key.  
As an alternative, you can select the most recently text specified from the drop-down list.
5. Click the "Replace" button to replace the selected hit with the specified text.  
The found text is replaced and the next hit is marked in the editor.  
Repeat this process until you have replaced all the hits as wanted. To skip to the next hit without replacing the marked word, click the "Find" button instead of "Replace".
6. Click "Replace all" to automatically replace all hits at once.

**See also**

Information on the search function (Page 328)

## 7.8 Working with text lists

### 7.8.1 Text lists

#### Introduction

You can manage texts to be referenced in alarms centrally. All the texts are stored in text lists. Each text list has a unique name with which you can call up its content. A range of values is assigned to each text in a text list. If a value from a range of values occurs, the corresponding text is called up.

All the texts can be translated to all project languages. Here, you have two options available:

- You can enter the translation of the texts in a list. You will find the list in the project tree under "Languages & Resources > Project texts".
- You can export all texts to a file in Office Open XML format and enter the translation in a spreadsheet program. The translations can then be imported again.

The texts are translated into the other project languages within the framework of the project texts. In the text lists editor, you only have to manage the assignment of individual texts to a text list.

Each device in the project has its own text lists. For this reason, these lists are arranged under the devices in the project tree. In addition, there are text lists that apply to all devices. These can be found in the project tree under "Common data > Text lists".

#### User-defined and system-defined text lists

There are two types of text lists:

- **User-defined text lists**  
You can create user-defined text lists yourself and fill them with texts; in other words, you can specify value ranges and the corresponding texts yourself. With user-defined text lists, the name of the text list begins with "USER" as default. You can change this name to any suitable name.
- **System-defined text lists**  
System-defined text lists are created by the system. These always involve texts relating to devices. They are automatically created as soon as you insert a device in the project. With system alarms, the name of the text list begins with "SYSTEM". The name of the text list and the ranges of values it contains cannot be modified. You can only edit texts assigned to individual value ranges.

User-defined text lists	System-defined text lists
A user-defined text list can only be assigned to one device.	System-defined text lists can be assigned both to a device as well as to the entire project.
You can create new text lists and delete existing text lists.	You cannot create new text lists or delete text lists.

User-defined text lists	System-defined text lists
You can add and delete value ranges in the text lists.	You cannot add or delete value ranges in the text lists.
You can specify both the value ranges as well as the associated texts.	You can only edit the text associated with one value range.

### Device-specific and cross-device text lists

Device-specific text lists relate to only one device in the project and are therefore only valid for this device. For this reason, they are arranged under a device in the project tree. Device-specific text lists can be user-defined or created by the system.

If system-defined text lists are generally valid for several devices or not intended uniquely for one device, these are grouped together in the project tree under "Common data". These text lists are available for all devices. Cross-device text lists are always created by the system and are used solely for system diagnostics alarms. For this reason, you cannot store any user-defined text lists under "Common data".

### See also

Exporting and importing project texts (Page 271)

## 7.8.2 Creating user-defined text lists

### Creating text lists

You can create user-defined text lists for individual devices.

### Requirement

- You are in the project view.
- A project is open.
- The project includes at least one device.

### Procedure

To create user-defined text lists, follow these steps:

1. Click on the arrow to the left of a device in the project tree.  
The elements arranged below the device are displayed.
2. Double-click on "Text lists".  
All the text lists assigned to the device are displayed in the work area listed in a table.
3. Double-click on the first free row in the table.  
A new user-defined text list is created.
4. Enter a name for your new text list in the "Name" column.

5. From the drop-down list in the "Selection" column, select whether you want to specify the value ranges in decimal, binary or in bits. Depending on the device, there may be further options available at this point.
6. Enter a comment in the "Comment" column.  
A new user-defined text list has been created and you can now enter the value ranges and texts.

### 7.8.3 Editing user-defined text lists

#### Editing user-defined text lists

You can enter value ranges and the corresponding texts in user-defined text lists. User-defined text lists are always located below a device in the project tree.

#### Requirement

- You are in the project view.
- A project is open.
- The project includes a least one device.

#### Adding to user-defined text lists with value ranges and texts

To add to user-defined text lists with value ranges and texts, follow these steps:

1. Click on the arrow to the left of a device in the project tree.  
The elements arranged below are displayed.
2. Double-click on "Text lists".  
All the text lists assigned to the device are displayed in the work area listed in a table.
3. Select a text list in the table.  
The contents of the selected text list are displayed in the work area. There, you can enter a value range and assign texts to the individual value ranges.
4. Enter the value ranges you require in the "Range from" and "Range to" columns. The entry must be made in the numeric format selected for the text list.
5. Enter a text for each value range in the "Entry" column.

### 7.8.4 Editing system-defined text lists

#### Editing system-defined text lists

In system-defined text lists, you can only modify the individual texts assigned to a value range.

System-defined text lists are located in the project tree either below a device or under "Common data".

## **Requirement**

- You are in the project view.
- A project is open.
- The project includes a least one device.

## **Modifying texts in system-defined text lists**

To edit texts in system-defined text lists that are assigned to a value range, follow these steps:

1. Click on the arrow to the left of a device in the project tree or the "Common data" element. The elements arranged below are displayed.
2. Double-click on "Text lists".  
All the text lists assigned to the device or used in common are displayed in the work area listed in a table.
3. Select a text list in the table.  
The contents of the selected text list are displayed in the work area. Here, you can add to or edit the texts assigned to a value range.
4. Enter a text for each value range in the "Entry" column.

## 7.9 Using memory cards

### 7.9.1 Basics about memory cards

#### Introduction

Memory cards are plug-in cards that come in a variety of types and can be used for a variety of purposes. Depending on the device type or device family, memory cards can be used for purposes, such as:

- Load memory of a CPU
- Storage medium for projects, firmware backups, or any other files
- Storage medium for performing a firmware update
- Storage medium for the PROFINET device name

For information regarding the technical variants of the respective memory cards and general information on their handling, refer to the respective documentation for the device. For information on handling memory cards in the TIA Portal, refer to the online help under keyword "Memory Card".

NOTICE
Do not use memory cards for non-SIMATIC-related purposes, and do not use third-party devices or Windows tools to format them. This will irrevocably overwrite the internal structure of the memory card, rendering it unusable for SIMATIC devices!

#### See also

[Adding a user-defined card reader \(Page 335\)](#)

[Accessing memory cards \(Page 336\)](#)

[Displaying properties of memory cards \(Page 337\)](#)

### 7.9.2 Adding a user-defined card reader

#### Introduction

If your card reader is not detected automatically, you can add it manually.

#### Requirement

The project view is open.

## Procedure

To add a card reader, follow these steps:

1. Open the project tree.
2. Select the "Card Reader / USB memory > Add user-defined Card Reader" command in the "Project" menu.  
The "Add user-defined Card Reader" dialog opens.
3. In the drop-down list box, select the path for the card reader.
4. Confirm your entries with "OK".

## See also

Basics about memory cards (Page 335)

Accessing memory cards (Page 336)

Displaying properties of memory cards (Page 337)

## 7.9.3 Accessing memory cards

### Requirement

- A memory card is inserted in the card reader.
- The project view is open.

### Procedure

To access memory cards, follow these steps:

1. Open the project tree.
2. Select the "Card Reader / USB memory > Card Reader / Show USB memory" command in the "Project" menu.  
The "Card reader / USB memory" folder is displayed in the project tree.
3. Open the "Card Reader / USB memory" folder.  
You can now access the memory card.

---

#### Note

If data from a non-installed product is stored on the memory card, the folders that contain these data are shown in gray. You receive an error message when you attempt to access such a folder. Install the corresponding product if needed.

---



**See also**

Basics about memory cards (Page 335)

Adding a user-defined card reader (Page 335)

Displaying properties of memory cards (Page 337)

**7.9.4 Displaying properties of memory cards**

You can display the properties for the utilized memory cards. Note that different memory cards with different properties must be used, depending on the device.

**Requirement**

- A memory card is inserted in the card reader.
- The project view is open.

**Procedure**

To display the properties of a memory card, follow these steps:

1. Right-click on the memory card for which you want to display the properties.
2. Select the "Properties" command in the shortcut menu.  
The "Memory Card <name of the memory card>" dialog opens. The properties are displayed in this dialog.

**See also**

Basics about memory cards (Page 335)

Adding a user-defined card reader (Page 335)

Accessing memory cards (Page 336)

## 7.10 Using libraries

### 7.10.1 Library basics

#### Introduction

You can store objects you want to reuse in libraries. For each project there is a project library that is connected to the project. In addition to the project library, you can create any number of global libraries that can be used over several projects. Since the libraries are compatible with each other, library elements can be copied and moved from one library to another. Libraries are used, for example, to create templates for blocks that you first paste into the project library and then further develop there. Finally, you copy the blocks from the project library to a global library. You make the global libraries available to other employees working on your project. They use the blocks and further adapt them to their individual requirements, where necessary.

Both the project library and global libraries distinguish between two different types of objects:

- **Master copies**  
Almost every object can be saved as a master copy and pasted into the project again later. You can, for example, save entire devices with their contents or cover sheets for plant documentation as master copies.
- **Types**  
Elements that are required to run user programs, for example, blocks, PLC data types, user-defined data types or faceplates are suitable as types. Types can be versioned and therefore support professional further development. Projects using the types can be updated as soon as new versions of the types are available.

#### Project library

Each project has its own library, the project library. Here, you store the objects you want to use more than once in the project. This project library is always opened, saved, and closed together with the current project.

#### Global libraries

In addition to the project library, you create global libraries if you want to use these over several projects. Global libraries are independent of a specific project and can therefore be passed on to other users. Shared access to global libraries is also possible, for example on a network drive, if all users open the global library with write protection.

Siemens supplies global libraries for its own software products. These include off-the-peg functions and function blocks that you can use within your project. The supplied libraries cannot be changed.

Global libraries from TIA Portal V11.x can continued to be used. However, you have to upgrade them for use in the latest TIA Portal version.

## **Comparing library objects**

You can compare blocks and PLC data types with the objects of a device. This allows you to determine, for example, whether certain blocks or PLC data types have been used in a project and whether they have been modified.

## **See also**

Overview of the "Libraries" task card (Page 339)

Overview of the library view (Page 343)

Overview of the library management (Page 346)

Basics on master copies (Page 357)

Basics on types (Page 361)

## **7.10.2 Using the "Libraries" task card**

### **7.10.2.1 Overview of the "Libraries" task card**

#### **Function of the "Libraries" task card**

The "Libraries" task card enables you to work efficiently with the project library and the global libraries.

### Layout of the "Libraries" task card

The "Libraries" task card consists of the following components:

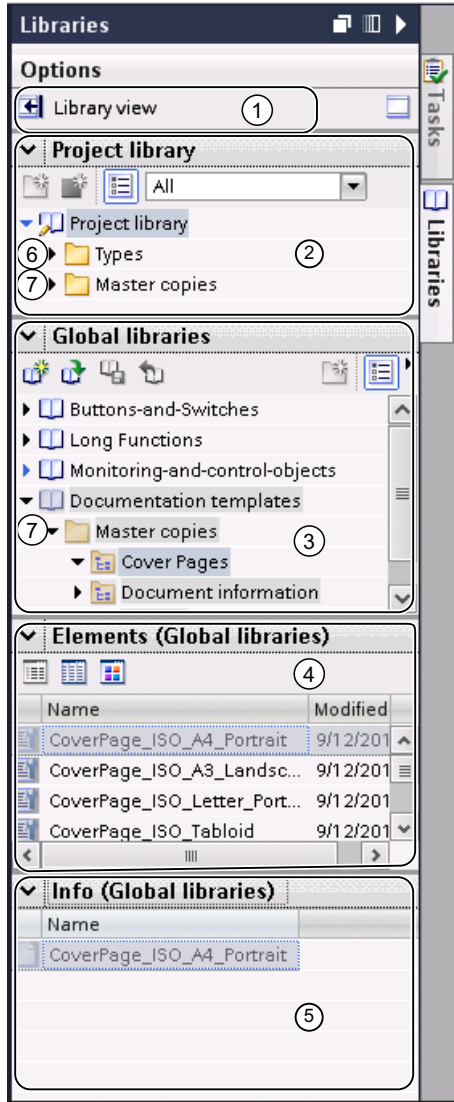

- ① "Library view" button
- ② "Project library" palette
- ③ "Global libraries" palette
- ④ "Elements" palette
- ⑤ "Info" palette
- ⑥ "Types" folder
- ⑦ "Master copies" folder

### **"Library view" button**

The "Library view" button is used to change to the library view. The "Libraries" task card and the project tree are closed by this action.

See also: Using the library view (Page 343)

### **"Project library" palette**

In the "Project library" palette, you can store the objects that you want to use more than once in the project.

### **"Global libraries" palette**

In the "Global libraries" palette, you can store objects you want to use over several projects.

The "Global libraries" palette also lists libraries that were shipped together with the products you purchased. These libraries provide you with ready-made functions and function blocks, for example. The supplied global libraries cannot be edited.

### **"Elements" palette**

In this palette, you can display the contents of folders in the library. The "Elements" palette is not displayed by default. If you want to display the "Elements" palette, you have to enable it first. Three view modes are available in the "Elements" palette:

- Details mode  
The properties of folders, master copies and types are shown in table form in details mode.
- List mode  
In list mode, the contents of folders are listed.
- Overview mode  
In overview mode, the contents of folders are displayed with large symbols.

See also: Using the element view (Page 342)

### **"Info" palette**

You can display the contents of the library elements in the "Info" palette. The individual versions of types and the last revision date of the version are also displayed.

### **"Types" folder**

In the "Types" directories, you can manage types and type versions of objects that you use as instances in the project.

See also: Using types (Page 361)

### **"Master copies" folder**

In the "Master copies" directories, you can manage master copies of objects that you can use as copies in the project.

See also: Using master copies (Page 357)

## See also

Library basics (Page 338)

Comparing library elements (Page 385)

### 7.10.2.2 Using the element view

#### Introduction

When you open the "Libraries" task card the first time, the "Project library" and "Global libraries" palettes are opened and the "Info" palette is closed. You can display the "Elements" palette if needed.

The elements view shows the elements of the selected library. Three view modes are available in the elements view:

- **Details**  
The properties of folders, master copies and types are shown in table form in details mode.
- **List**  
In list mode, the contents of folders are listed.
- **Overview**  
In overview mode, the contents of folders are displayed with large symbols.

The "Info" palette shows the contents of the selected library element. If you select a type in the elements view, for example, the type versions are displayed in the "Info" palette.

#### Requirement

The "Libraries" task card is displayed.

#### Procedure

To use the element view, follow these steps:

1. Click "Open or close the element view" in the "Project library" or "Global libraries" pane.
2. To change the view mode from the details view to the list mode or overview mode, click the corresponding icon on the toolbar.

## See also

Library basics (Page 338)

Overview of the "Libraries" task card (Page 339)

Using global libraries (Page 348)

Comparing library elements (Page 385)

### **7.10.3 Using the library view**

#### **7.10.3.1 Overview of the library view**

##### **Function of the library view**

The library view combines the functionality of the "Libraries" task card and the overview window. In the library view, the elements of a library are displayed in various views. In the details view, for example, you see additional properties of the individual elements. You can also edit and version the types in the library view.

### Layout of the library view

The following figure shows the components of the library view:

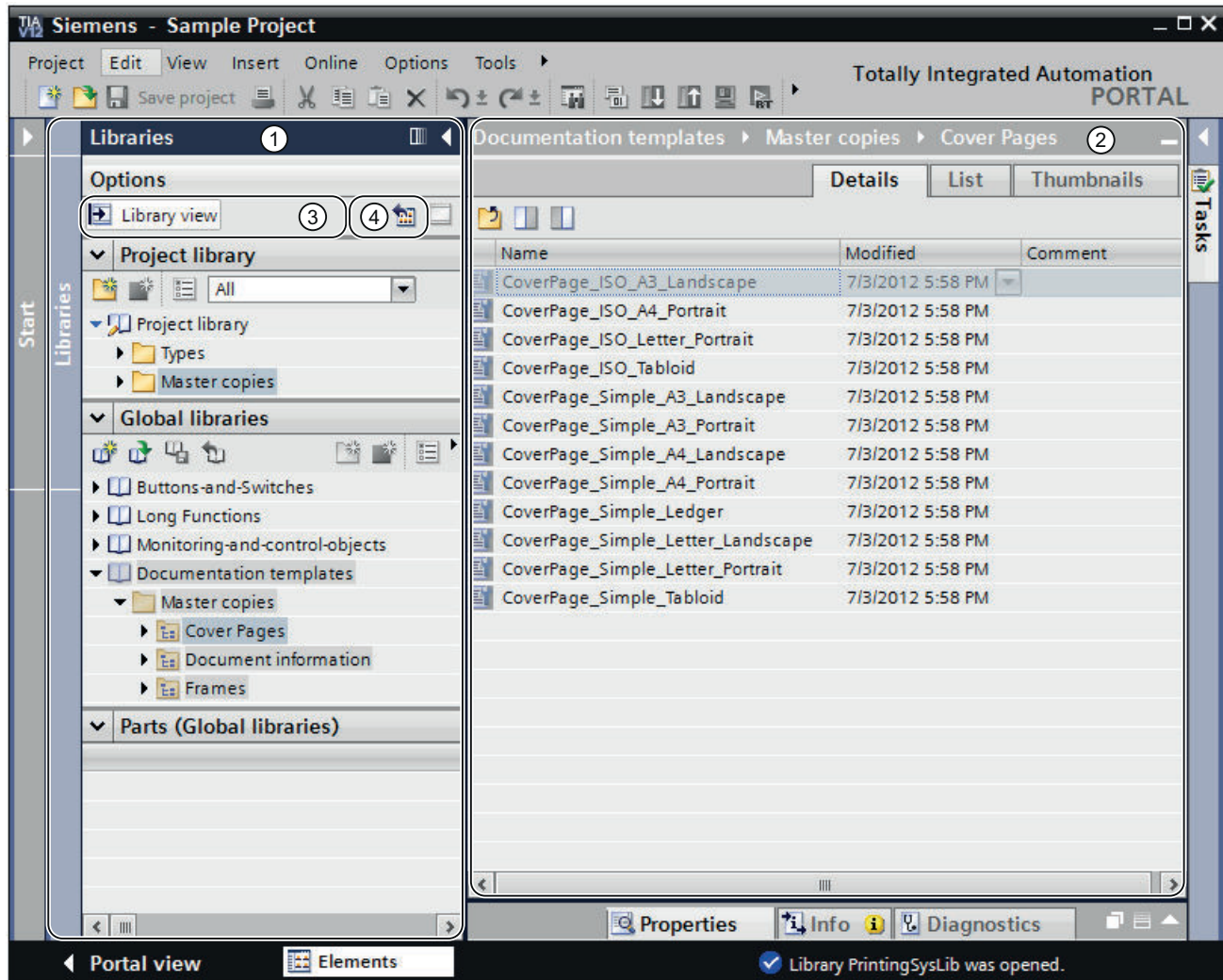

- ① Library tree
- ② Library overview
- ③ "Library view" button
- ④ "Open or close library overview" button

### Library tree

The library tree is similar to the "Libraries" task card, apart from a few minor differences. In contrast to the task card, there is no "Elements" palette, because the elements are displayed in the library overview. In addition, you can close the library view in the library tree, or open and close the library overview.

See also: "Libraries" task card (Page 339)



## Library overview

The library overview corresponds to the overview window and displays the elements of the currently selected object in the library tree. You can display the elements in three different views. In addition, you can perform the following actions in the library overview:

- Renaming elements
- Deleting elements
- Copying elements
- Moving elements
- Editing type instances
- Versioning types
- WinCC only: Editing faceplates and HMI user data types

See also: Overview window (Page 226)

## See also

Basics on master copies (Page 357)

Basics on types (Page 361)

Opening and closing the library view (Page 345)

Library basics (Page 338)

Comparing library elements (Page 385)

### 7.10.3.2 Opening and closing the library view

The library view is opened automatically in some cases, for example, when you edit the test instance of a type or when you edit faceplates and HMI user data types. You can also open the library view manually.

#### Opening the library view

To open the library view manually, follow these steps:

1. Open the "Libraries" task card.
2. Click the "Open library view" button in the "Libraries" task card.  
The library tree opens. The "Library" task card and the project tree are closed.
3. If the library overview is not displayed, click "Open/close library overview" button in the library tree.  
The library overview opens.

### **Exit library view**

To exit the library view, follow these steps:

1. Click the "Close library view" button in the library tree.  
The library tree closes. The "Libraries" task card and the project tree are opened.

### **See also**

Overview of the library view (Page 343)

Library basics (Page 338)

Using the "Libraries" task card (Page 339)

Using global libraries (Page 348)

Comparing library elements (Page 385)

## **7.10.4 Using library management**

### **7.10.4.1 Overview of the library management**

#### **Function of the library management**

Library management offers an overview of the dependencies of a type to other library elements. If a type is referenced in other types or master copies, the correlations are displayed in the library management. Types with dependencies to other library elements are subject to some functional restrictions. They can, for example, not be deleted as long as dependencies still exist. This prevents other library elements from becoming useless.

## Layout of the library management

The following figure shows the components of the library management:

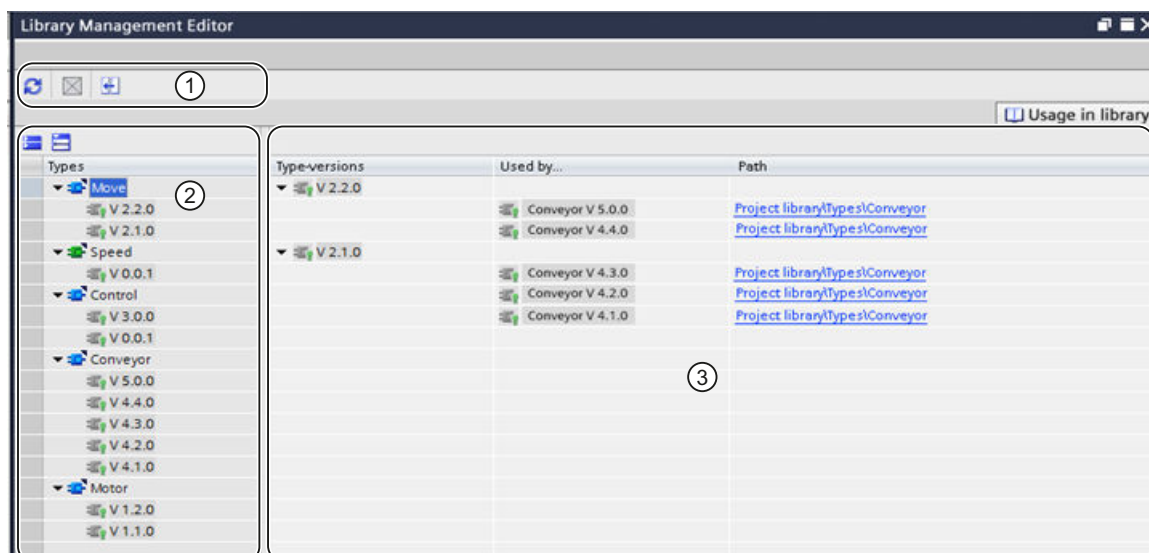

- ① Toolbar of the library management
- ② "Types" area
- ② "Type use" area

## Toolbar of the library management

You can perform the following tasks in the toolbar of the library management:

- Update view  
If the project has changed, you can update the view of the library management.
- Clean up library  
You can clean up the project library and global libraries. By cleaning up a library, you delete all types and type versions that are not linked to an instance in the project.
- Harmonize project  
By harmonizing a project, you adapt the names and the path structures of type uses in the project to the corresponding names and path structures of the types within a library.

## "Types" area

The "Types" area displays the contents of the folder that you have selected in the library view. You can open or close all types by using the buttons in the toolbar of the "Types" area.

## "Type use" area

The "Type use" area gives you an overview of the points of use of the selected type.

## See also

Opening library management (Page 348)

Basics on master copies (Page 357)

Basics on types (Page 361)

Library basics (Page 338)

## 7.10.4.2 Opening library management

### Procedure

To open the library management, follow these steps:

1. Open the library view.
2. Select a type or any folder that contains types.
3. Select the "Library management" command from the shortcut menu.

### Result

The library management opens and the types are displayed with their versions.

## See also

Overview of the library management (Page 346)

## 7.10.5 Using global libraries

### 7.10.5.1 Creating a global library

#### Requirement

The "Libraries" task card is displayed or the library view is open.

#### Procedure

To create a new global library, follow these steps:

1. Click the "Create new global library" icon in the toolbar of the "Global libraries" palette or select the command "Global libraries > Create new library" in the "Options" menu.  
The "Create new global library" dialog opens.
2. Specify the name and the storage location for the new global library.
3. Confirm your entries with "Create".

## Result

The new global library is generated and pasted into the "Global libraries" palette. A folder with the name of the global library is created in the file system at the storage location of the global library. This actual library file is given the file name extension ".al12".

## See also

Library basics (Page 338)

Opening a global library (Page 349)

Displaying properties of global libraries (Page 351)

Saving a global library (Page 352)

Closing a global library (Page 353)

Deleting a global library (Page 354)

### 7.10.5.2 Opening a global library

Global libraries can be further developed centrally and used over several projects. Several persons can open a global library simultaneously from a central storage location, provided all users open the global library in write-protected mode.

## Requirement

The "Libraries" task card is displayed or the library view is open.

## Procedure

To open a global library, follow these steps:

1. Click the "Open global library" icon in the toolbar of the "Global libraries" palette or select the command "Global libraries > Open library" in the "Options" menu.  
The "Open global library" dialog box is displayed.
2. Select the global library you want to open. You identify the library file by its file extension ".al12" or ".al11" (global libraries from TIA Portal V11.x).
3. Write protection is activated for the library. If you want to modify the global library, disable the "Open as read-only".
4. Click "Open".  
The selected global library is opened and pasted into the "Global libraries" palette.

---

### Note

#### Using global libraries from earlier versions of the TIA Portal

If you want to continue using global libraries from earlier versions of the TIA Portal, you first have to upgrade them to the latest TIA Portal version. You are prompted accordingly when you open the global library.

---

## See also

- Upgrading libraries from older versions (Page 350)
- Retrieving global libraries (Page 356)
- Library basics (Page 338)
- Creating a global library (Page 348)
- Displaying properties of global libraries (Page 351)
- Saving a global library (Page 352)
- Closing a global library (Page 353)
- Deleting a global library (Page 354)

### 7.10.5.3 Upgrading libraries from older versions

If you want to use a global library that was created with an earlier version of the TIA Portal, you first have to upgrade the library. This step ensures that all used elements are compatible with the latest version of the TIA Portal. The original library will remain unchanged and a copy is created that can be used for the latest version of the TIA Portal. You are prompted automatically to upgrade libraries from TIA Portal V12. Note that global libraries saved with the latest version of the TIA Portal are not backward compatible.

An exception are those projects you created with TIA Portal V11.x and that have not yet been updated to the latest version of the TIA Portal. You can continue using global libraries from TIA Portal V11.x without restrictions in such a project and save them in the format of the earlier version.

## Requirement

- You have loaded a global library that was created with TIA Portal V11.x.
- The library is not write-protected. The reasons for protecting a library can be, for example, a write-protected storage location or a simultaneous access to the library by another installation of the TIA Portal.

## Procedure

To upgrade global libraries for use in the current TIA Portal version, follow these steps:

1. Right-click on the global library you want to upgrade.
2. Select the "Upgrade library" command in the shortcut menu.  
The "Upgrade" dialog opens.
3. Confirm with "Yes".

## Result

The library is upgraded and saved as copy. The old library is closed and the new library is uploaded.

## See also

- Upgrading projects (Page 262)
- Opening a global library (Page 349)

### 7.10.5.4 Displaying properties of global libraries

Global libraries contain properties for describing the respective library in more detail. Properties include the following:

- General information about the library  
This includes the following information: creation time, author, file path, file size, copyright, etc. Many of the attributes can be changed.
- Library history  
The library history contains an overview of the migrations performed. Here you can also call the log file for the migrations. The library history also contains information on updates of the global library.
- Support packages in the library  
You can display an overview of the additional software needed to work with all devices in the project.
- Software products in the library  
You can display an overview of all installed software products needed for the project.

## Requirement

The "Libraries" task card is displayed or the library view is open.

## Procedure

To display the properties of a global library, follow these steps:

1. Right-click the global library whose properties you want to display.
2. Select the "Properties" command in the shortcut menu.  
A dialog containing the properties of the global libraries opens.
3. Select the properties in the area navigation that you want to have displayed.

## See also

- Opening a global library (Page 349)
- Library basics (Page 338)
- Creating a global library (Page 348)
- Saving a global library (Page 352)
- Closing a global library (Page 353)
- Deleting a global library (Page 354)

### 7.10.5.5 Displaying logs of global libraries

Logs listing all changes made to the global library are created when global libraries are updated. The logs are stored together with the global library and are always available once you have opened the global library.

#### Procedure

To open the logs of a global library, follow these steps:

1. Open the global library in the "Libraries" task card or in the library view.
2. Open "Common data > Logs" in the lower-level folder.
3. Double-click the required log.  
The log opens in the work area.

#### See also

Updating a library with the contents of another library (Page 381)

### 7.10.5.6 Saving a global library

After you have changed a global library, you need to save it. You can save a global library under another name using the "Save library as" command.

---

#### Note

##### **Backward compatibility to older versions of the TIA Portal**

Note that global libraries can no longer be opened in older versions of the TIA Portal once they have been saved in the newer version.

---

#### Requirement

The "Libraries" task card is displayed or the library view is open.

#### Saving changes

To save a global library, follow these steps:

1. Right-click on the global library you want to save.
2. Select the "Save library" command in the shortcut menu.

#### Saving a global library under another name

To save a global library under another name, follow these steps:

1. Right-click the global library that you want to save under a different name.
2. Select the "Save library as" command in the shortcut menu.  
The "Save global library as" dialog opens.



3. Select the storage location and enter the file name.
4. Confirm your entries with "Save".  
The library is saved in the specified location under the new name. The original library is retained.

**See also**

Working with archives of global libraries (Page 354)

Archiving global libraries (Page 355)

Library basics (Page 338)

Creating a global library (Page 348)

Opening a global library (Page 349)

Displaying properties of global libraries (Page 351)

Closing a global library (Page 353)

Deleting a global library (Page 354)

**7.10.5.7 Closing a global library**

Global libraries are independent of projects. This means that global libraries are not closed together with your project. You must therefore close global libraries explicitly.

**Requirement**

The "Libraries" task card is displayed or the library view is open.

**Procedure**

To close a global library, follow these steps:

1. Right-click on the global library you want to close.
2. Select the "Close library" command in the shortcut menu.  
If you have made changes to the global library, select whether or not you want to save the changes.  
The global library is closed.

**See also**

Creating a global library (Page 348)

Opening a global library (Page 349)

Displaying properties of global libraries (Page 351)

Saving a global library (Page 352)

Library basics (Page 338)

Deleting a global library (Page 354)

### **7.10.5.8 Deleting a global library**

If you no longer require a global library, you can delete it. Libraries supplied by Siemens cannot be deleted.

#### **Requirement**

The "Libraries" task card is displayed or the library view is open.

#### **Procedure**

To delete a global library, follow these steps:

1. Right-click the global library you want to delete.
2. Select the "Delete" command in the shortcut menu.
3. Click "Yes" to confirm.

#### **Result**

The global library is removed from the "Global libraries" palette. The entire library for the global library is deleted from the file system.

#### **See also**

Library basics (Page 338)

Creating a global library (Page 348)

Opening a global library (Page 349)

Displaying properties of global libraries (Page 351)

Saving a global library (Page 352)

Closing a global library (Page 353)

### **7.10.5.9 Archiving and disabling global libraries**

#### **Working with archives of global libraries**

If you want to back up global libraries on an external hard drive or send them via e-mail, for example, use the archiving function to reduce the storage space of the library.

## Options for reducing the size of the project

There are two ways to reduce the storage space of global libraries:

- **Compressed archives of global libraries**  
Archives of global libraries are compressed files, each containing an entire global library, including the entire folder structure of the library. Before the directory with the global library is compressed into the archive file, all files are reduced to their essential components to further decrease the storage space. Compressed archives of global libraries are therefore well suited for sending via e-mail.  
Compressed archives of global libraries have the file extension ".zal12".  
To open a compressed archive of a global library, you have to retrieve the archive. Here, the archive file is extracted to a location you have selected with the entire folder structure and all files.
- **Minimized global libraries**  
You can skip additional compression in an archive file, and instead create a copy of the global library directory. The included files can be reduced to the essential elements. This minimizes the required storage space. The full functionality of the global library is retained and the global library can be loaded as usual.  
Minimized global libraries are especially well suited for archiving, for example, on an external medium.

## See also

Archiving global libraries (Page 355)

Retrieving global libraries (Page 356)

## Archiving global libraries

You reduce the storage space of a global library by packing it into a compressed file. You can also reduce the storage space by saving the global library reduced to the essential elements. You can do both of these with the archiving function for global libraries.

## Requirement

The global library must be loaded.

## Procedure

To archive a global library, follow these steps:

1. Select the global library that you want to archive.
2. Right-click the global library and select the "Archive" command from the shortcut menu. The "Archive global library as..." dialog opens.
3. Select the directory where you want to save the archive file or the new directory of the global library.  
The directory may not be located in a project directory of a project or within the directory of a global directory.

4. Select the file type from the "File type" drop-down list:
  - Global libraries archive, if you want to create a compressed file of the project.
  - Minimized global library, if you only want to create a copy of the project directory with minimal storage space.
5. Enter a file name in the "File name" field if you are creating an archive file. If you are creating a minimized global library, enter the name of the new library directory to be created in the "File name" box.
6. Click "Save".

## Result

When you have created an archive of a global library, a compressed file with the extension ".zal12" is generated. The file includes the complete directory of the global library. The individual files of the global library are also reduced to the essential components in order to save space.

If you have minimized the global library, only a copy of the original directory of the global library is created at the required location. The files contained within it are reduced to their essential components in order to save space.

## See also

Working with archives of global libraries (Page 354)

Retrieving global libraries (Page 356)

## Retrieving global libraries

Before you can use an archived global library, you have to retrieve it. The global library is extracted and then opened in the TIA Portal.

## Procedure

To extract the archive of a global library, follow these steps:

1. Select the "Global libraries > Retrieve library" command in the "Options" menu. The "Retrieve archived global library" dialog opens.
2. Select the archive file.
3. Select the check box "Open read-only" if you want to load the global library write-protected.
4. Click "Open".
5. The "Find folder" dialog opens.
6. Select the target directory to which the archived global library should be extracted.
7. Click "OK".

## **Result**

The global library is extracted to the selected directory and opened immediately.

## **See also**

Working with archives of global libraries (Page 354)

Archiving global libraries (Page 355)

Opening a global library (Page 349)

## **7.10.6 Creating folders in a library**

The library elements are stored in the libraries according to their type in the "Types" and "Master copies" folders. Create additional folders below "Types" and "Master copies" to further organize master copies and types.

## **Requirements**

- The "Libraries" task card is displayed or the library view is open.
- If you want to create new folders within a global library, you have to open the global library with write permission.

## **Procedure**

To create a new folder, follow these steps:

1. Right-click any folder within the library.
2. Select "Add folder" from the shortcut menu.  
A new folder is created.
3. Enter a name for the new folder.

## **See also**

Working with types in the project library (Page 365)

Filtering master copies (Page 359)

## **7.10.7 Using master copies**

### **7.10.7.1 Basics on master copies**

Master copies are used to create standardized copies of frequently used elements. You can create as many elements as needed and insert them into the project based on a master copy. The elements inherit the properties of the master copy.

You store master copies either in the project library or in a global library. Master copies in the project library can only be used within the project. When you create the master copy in a global library, it can be used in different projects.

The following elements can be created as master copies in the library, for example:

- Devices with their device configuration
- Tag tables
- Instruction profiles
- Monitoring tables
- Elements from the documentation settings, for example, cover sheets and frames

In many cases, the objects you add as master copy contain additional elements. A CPU, for example, can contain blocks. If the included elements are uses of a type version, the used versions of the types are automatically created in the library. The elements contained therein are then used as an instance and linked to the type.

## See also

Adding master copies (Page 358)

Using master copies (Page 360)

Basics on types (Page 361)

Filtering master copies (Page 359)

### 7.10.7.2 Adding master copies

If you want to use objects multiple times, copy them as master copies in the project library or in a global library. You can choose from the following methods for creating master copies:

- You can select one or more elements and generate a master copy from it
- You can select multiple elements and generate a master copy from each element

## Requirement

- The "Libraries" task card is displayed.
- If you add a device as a master copy, this device meets the following requirements:
  - The device is compiled and consistent.
  - The device contains no test instance of a type.
- If you add the master copy to a global library, the global library is opened with write permission.

### **Creating a master copy from one or more elements**

To create a master copy for one or more elements, follow these steps:

1. Open the library in the "Libraries" task card.
2. Drag one or more elements and drop them into the "Master copies" folder or any subfolder of "Master copies".  
Alternative: Copy the elements to the clipboard and paste them at the required location. The element is pasted into the library as a single master copy.

### **Creating a master copy for each element among multiple elements**

To create a master copy for each element among multiple elements, follow these steps:

1. Open the library in the "Libraries" task card.
2. Copy to the clipboard the elements that you want to create as master copies.
3. Right-click on the "Master copies" folder or any of its subfolders in the library.
4. In the shortcut menu, select "Paste as separate master copies".  
The elements are pasted into the library as separate master copies. In each case, a separate type is created automatically for any objects contained.

### **See also**

- Basics on master copies (Page 357)
- Using master copies (Page 360)
- Library basics (Page 338)
- Adding types to the project library (Page 365)

#### **7.10.7.3 Filtering master copies**

To make it easier to keep track of a large number of master copies, you can filter the display according to the type of master copy.

### **Requirement**

The "Libraries" task card is displayed or the library view is open.

### **Procedure**

To filter the view, follow these steps:

1. Open the "Master copies" folder in the project library or a global library.
2. In the drop-down list of the toolbar, select the type of objects you want to display under "Master copies".

## Result

Only the selected type of master copies is displayed. You can set the filter to "All" to return to an unfiltered view.

## See also

Library basics (Page 338)  
Creating folders in a library (Page 357)  
Basics on master copies (Page 357)  
Using master copies (Page 360)  
Using the element view (Page 342)

### 7.10.7.4 Using master copies

Master copies are contained either in the project library or in a global library.

## Requirement

The "Libraries" task card is displayed.

## Procedure

To paste a master copy into the project, follow these steps:

1. Open the "Master copies" folder or any subfolder of "Master copies" in a library.
2. Drag-and-drop one or more master copies to the desired point of use.  
A copy of the master copy is inserted.

Or:

1. Open the element view.
2. Drag the master copy from the "Elements" palette and drop it at the location where you want to use it.  
A copy of the master copy is inserted.

## See also

Basics on master copies (Page 357)  
Adding master copies (Page 358)  
Filtering master copies (Page 359)  
Library basics (Page 338)  
Using the element view (Page 342)



## 7.10.8 Using types and their versions

### 7.10.8.1 Basics on types

#### Using types

Types are elements that are required for the execution of user programs. Types can be versioned and further developed from a central location.

The following elements can be stored as type in the project library or the global library:

- Functions (FCs)
- Function blocks (FBs)
- PLC data types
- User data types
- Faceplates
- Figures
- User-defined functions

Any number of instances can be derived from the versions of types in the project. The instances are then linked to the version of the type. If you are using types from a global library, the type is also created in the project library. If the type already exists in the project library, any missing type versions are added if necessary. The instance is then linked only to the respective type version in the project library.

Types and their instances are marked with a black triangle. The following figure shows an instance, marked with a black triangle, and an ordinary program block:



#### Basics on versioning types

Type versioning provides you with the means to develop types centrally and then roll out the most recent version to the individual projects as an update. In this way, error corrections and added functions can be easily integrated into existing projects. If you have created a new version of a global library, you can update existing projects in an automatic process. This minimizes errors and reduces the amount of maintenance work for large automation solutions that contain numerous individual projects.

Versioning allows you to trace the development process of individual types. Before you release a version, you can try it out in a test environment to determine whether changes made to a type integrate smoothly into an existing project. You only release a version for productive use after you have made sure that everything operates without errors. You can view the history of individual instances in the project at any time and determine the version from which the instance was derived.

The TIA Portal also checks automatically if there are associated objects with individual versions of a type. Associated objects can be, for example, PLC data types or other blocks referenced in a block. All associated objects are already taken into consideration during the creation of a type or during copying between libraries. Before being released, versions of types are checked for their consistency to ensure that no inconsistencies arise in the project.

## Versions of types

Versions are assigned to each type. The version number is displayed in both the "Libraries" task card as well as the library view next to the respective type. The version number is also displayed in the project tree next to instances of types. This allows you to see at all times which version of an instance is used in the project.

The version number consists of three digits. You can randomly assign the first two digits. The third digit is the build number. It is automatically incremented by one when you edit an instance related to the version. The build number is reset to zero when you release the version (first digit of the version number).

The versions of types can have three states:

- In progress (faceplates and HMI user data types)
- In testing (all sorts of types except faceplates and HMI user data types)
- Released

The following figure shows a type with two versions. One version is "in testing" and one version is released:

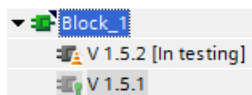

## See also

State of type versions (Page 362)

Basics on master copies (Page 357)

Adding types to the project library (Page 365)

Using types (Page 366)

### 7.10.8.2 State of type versions

The versions of types can be in three different states. The states can be determined from the instance or in the library.

#### "In progress" status

Only versions of faceplates and HMI user data types have the "in progress" state. If a version is in progress, "in progress" appears next to the version in the library.

When you create a new type or a new version of a released type, the type is assigned the status "in progress".

Types with the status "in progress" can be edited in the library view. A reference to an instance in the project does not have to exist. Upon release, the compatibility of the type is tested by a consistency check.

### "In testing" status

All types except for faceplates and HMI user data types can have the "in testing" status. If a version is in testing, "in testing" appears next to the instance and in the library. A version in the test state is linked to a test instance in the project. This allows you try out the effects of your changes in a test environment including all online functions before you release a type for use in actual operations.

### "Released" status

The "released" status is available for all types, regardless of the point of use. If a version has been released, the symbol of the version is marked with a seal in the library:

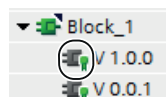

Released versions can be opened with write protection in their instance. If you want to edit a released version, you must first create a new "in progress" or "in testing" version.

### See also

Basics on types (Page 361)

Using types (Page 366)

Creating a test version of a type (Page 367)

Editing a test version of a type (Page 368)

Creating an editing version of a type (Page 369)

Performing a consistency check for a type version (Page 369)

Discarding a version of a type (Page 370)

Releasing a version of a type (Page 371)

Assigning a common version (Page 373)

Updating the project to the latest type versions (Page 374)

Remove the link between instance and type (Page 375)

#### 7.10.8.3 Displaying a released type version

If you display a released version but do not want to edit it, open the instance with write protection. All types except faceplates and HMI user data types can be opened directly at the instance. Faceplates and HMI user data types can only be opened in the "Libraries" task card or in the library view.

## Requirement

If it is not a faceplate or an HMI user data type, the released version has an instance in the project.

### Opening a type version at an instance

To open a released version of a type with write protection starting from an instance, follow these steps:

1. Select the released version at the instance in the project tree.
2. To do this, right-click the instance and select the "Open" command from the shortcut menu. The instance is opened with write protection.

### Opening a type version in the "Libraries" task card or library view

To open a released version of a type in the "Libraries" task card or in the library view, follow these steps:

1. Select the version.
2. To do this, right-click the version and select the "Open" command from the shortcut menu. If it is a faceplate or HMI user data type, it is opened directly in the library view. In this case, skip the remaining steps. If it is any other type, the "Open type" dialog opens.
3. Select the instance with the version that you want to display from the list of instances.
4. Click "OK" to confirm. The instance is opened with write protection.

#### 7.10.8.4 Displaying properties of a type or version

The following properties can be viewed and changed in the properties of a type or its versions, if needed:

- Name of the type
- Version number (only visible in the case of a version)
- Version number (only visible in the case of a version)
- Data and time of the last change to the version (only visible in the case of a version)
- Author that created the type or the version
- Comments on the type or the version of the type  
The comment can be changed.
- Original library (only visible in the case of a version)  
Displayed is the project and the library from which the current version of the type was generated. This information is important, for example, for finding the original of the type after it has been copied from another library.
- ID of the type or the version of the type  
This ID is used to uniquely identify the type or the version of the type, even if, for example, there are types or versions with an identical name within the project library or the global library. The ID cannot be changed and is assigned automatically.

## Procedure

To display the properties of a type or a version and to enter a comment, follow these steps:

1. Select a type or the version of a type in the "Libraries" task card or in the library view.
2. To do this, right-click on the type or one of its versions and select the "Properties" command from the shortcut menu.  
The "Properties" dialog box opens.
3. If needed, enter a comment on the type in the "Comment" field or edit an existing comment.

### 7.10.8.5 Working with types in the project library

#### Adding types to the project library

Types for reuse in the project can be created in the project library for various elements. You can create the following elements as types, for example:

- Program blocks
- Faceplates
- PLC data types
- HMI user data type

If you add an element as a type to the project library and this element has dependencies to other elements, the dependent elements are automatically created as a type as well.

After a type has been added to the project library, the type is linked to the added element from the project.

#### Requirement

- The "Libraries" task card is displayed.
- The elements that you want to add as type are compiled.
- The elements are consistent.

## Procedure

To add an existing element to the project library as a type, follow these steps:

1. Open the project library in the "Libraries" task card.
2. Drag-and-drop one or more elements into the "Types" folder or any subfolder of "Types".  
Alternative: Copy the elements in the project tree to the clipboard and add the elements in the desired project library folder.  
The "Generate type" dialog opens.

3. Enter the properties of the new type:
  - Enter a name for the new type in the "Name of the type" field.
  - Enter a version number for the new type in the "Version" field.
  - Enter the name of the editor who is responsible for the type in the "Author" field.
  - Enter a comment on the type in the "Comment" field.
4. Click "OK" to confirm.  
The new type is generated with a released version. The version is linked to the element that has been added.

### See also

Basics on types (Page 361)

Library basics (Page 338)

Adding master copies (Page 358)

### Using types

To use the version of a type, create an instance of the version at a suitable location in the project tree. You can also position faceplates and HMI user data types directly in the editor. The instance is then linked to the version of the respective type. If the type contains dependent elements such as a PLC data types referenced in a block, these are also created as instance at a suitable location. You can only assign a type in a specific version to a device once.

### Requirement

- The "Libraries" task card is displayed.
- The version is released.
- A device which supports the sort of desired type is available in the project
- The device is not assigned to any further instances of the same type.

### Procedure

To generate an instance from a version of a type, follow these steps:

1. In the project library, navigate to the version of the type that you want to use.
2. Drag the required version of the type from the project library and drop it at the location where you want to use it.  
Alternative: To automatically use the most recent version, drag the type from the project library and drop it at the location where you want to use it.

### Result

An instance is generated from the type and its dependent elements and pasted at the point of use. The instances are connected to the respective version of the type in the project library.

## See also

- Basics on types (Page 361)
- State of type versions (Page 362)
- Library basics (Page 338)
- Using master copies (Page 360)

## Creating a test version of a type

Before you release a type for productive use, you need to test the type within a project and on the automation system. The test is conducted in a specific test environment. This test environment can be a CPU, for example.

Create a version with "in testing" status for the test. The creation of a version "in testing" is suitable for all sorts of types except for faceplates and HMI user data types. On the other hand, versions "in progress" can be created from faceplates and HMI user data types.

There are two ways to create a test version of a type and define the test environment:

- In the "Libraries" task card or library view  
Generate the new version with "in testing" status in the "Libraries" task card or in the library view. You can generate the new version either directly from the type or from a specific version of the type.
- At an instance in the project tree  
You can also create the test version directly at the instance in the project tree. Since the instance is always used in a specific version in the project, a new version of the type is generated from the version used at the instance.

You can also create test versions from several types at the same time.

The following rules apply to a version "in testing":

- You can set only one version to "in testing" for each type at a given time.
- A version in testing may only be linked to a single instance in the project. Therefore, it is not possible to copy an instance to the clipboard, to duplicate it or to create an additional type from the instance as long as it has "in testing" status.

## Requirement

- There is at least one instance of the type within the project in a given version.
- If you want to create the new version from a particular version of the type, the instance must be used in this version in the project.

## Procedure

To generate a new test version of a type or the version of a type, follow these steps:

1. Select the type, a version of the type, or the instance.  
When you create the test version directly at the instance, you can select several elements or folders with multiple selection. You can skip steps 3 and 4 because the test environment is already defined by the selected instance.
2. Right-click the selected element and select the "Edit type" command from the shortcut menu.  
If you have started the editing in the "Libraries" task card or in the library view, the "Edit type" dialog opens. If you have started the editing at the instance in the project tree, the test instance is immediately opened for editing in the library view.
3. Select an instance of the type from the list in the project.  
If you have started editing at the type itself, the following applies:
  - The location at which the instance is used (for example, the CPU) is also used as test environment for the subsequent editing of the type.
  - Selecting the test instance also defines the version to be edited.The following applies to editing a specific version:  
If your starting point is a specific version, you can only select from the list instances that are used in the same version.
4. Click "OK" to confirm.

## Result

A new version of the type is created. The new version is "in testing" and is identified as such in the user interface.

## See also

Basics on types (Page 361)

State of type versions (Page 362)

Library basics (Page 338)

## Editing a test version of a type

When you edit a version "in testing", a new version is not created. You can start the editing of the test version at the instance in the project tree, in the "Libraries" task card" or in the library view.

---

### Note

#### Deleting and renaming interface parameters

You can add new parameters. However, if you rename or delete existing parameters, these parameters will not be supplied when the block is called.

---



## Procedure

To edit the test version of a type, follow these steps:

1. Right-click the test version or the instance.
2. Select the "Edit type" command from the shortcut menu.  
The test instance is opened in the library view and can be edited.

## See also

Basics on types (Page 361)

State of type versions (Page 362)

Library basics (Page 338)

Performing a consistency check for a type version (Page 369)

Discarding a version of a type (Page 370)

Releasing a version of a type (Page 371)

## Creating an editing version of a type

If you want to edit a type with faceplates or HMI user data types, create a new "in progress" version of the type. The new version is edited in the library view. To check the compatibility of the changes, a consistency check is automatically performed for the type prior to the release.

## Requirement

The project library is opened in the "Libraries" task card or in the library view.

## Procedure

To create a new version of a type in progress, follow these steps:

1. Right-click the type or the version of the type.
2. Select the "Edit type" command from the shortcut menu.  
A new "in progress" version is created and opened for editing in the library view.

## See also

Basics on types (Page 361)

State of type versions (Page 362)

Library basics (Page 338)

## Performing a consistency check for a type version

A type version can unintentionally obtain an inconsistent state during editing. To notice errors in the development process in good time, you can regularly perform a consistency check.

However, the consistency check always takes place automatically as soon as you release a version.

Details of how to start the consistency check manually for the version of a type are provided below.

### **Requirement**

- The project library is opened in the "Libraries" task card or in the library view.
- The version is "in progress" or "in testing".

### **Procedure**

To perform a consistency check for the version of a type, follow these steps:

1. Right-click on the version that you want to check for consistency.
2. Select the "Consistency check" command in the shortcut menu.  
The consistency check is carried out. You receive a message with the result of the consistency check.

### **See also**

Releasing a version of a type (Page 371)

Discarding a version of a type (Page 370)

Editing a test version of a type (Page 368)

Basics on types (Page 361)

State of type versions (Page 362)

Library basics (Page 338)

### **Discarding a version of a type**

Discard versions of a type "in testing" or "in progress" when you no longer need the version. All uses of the deleted version are reset to the last released status. You can also discard the versions for several types at the same time.

### **Requirement**

The version that you want to discard is in the state "in testing" or "in progress".

Your are in the library view of the "Libraries" task card is open.

### Discarding a version of a single type

To discard the version of a single type, follow these steps:

1. Right-click the version.
2. Select the "Discard changes and delete version" command from the shortcut menu.  
The version is deleted.

Alternative:

1. Click the "Discard version" button in the toolbar while a version is opened for editing.  
The version is deleted.

### Discarding versions of several types

To discard the version of several types, follow these steps:

1. Open the library view, library management or the "Libraries" task card.
2. Right-click any folder.
3. Select the "Discard changes and delete version" command from the shortcut menu.  
The versions are deleted.

### See also

Basics on types (Page 361)

State of type versions (Page 362)

Library basics (Page 338)

Performing a consistency check for a type version (Page 369)

### Releasing a version of a type

When you are finished editing the version of a type, release the version for productive use. Assign a version number for the release. You can also enable several type versions at once.

### Requirement

- The version that you want to release has "in testing" or "in progress" status.
- The version is consistent.  
A consistency check is performed as soon as you start the release. If errors that prevent a release occur during the consistency check, a message is displayed indicating how you can correct the errors.

### Releasing a version of a single type

To release a version of a type, follow these steps:

1. Right-click the version of the type.
2. Select the "Release version" command from the shortcut menu.  
The "Release version" dialog box opens.

3. If necessary, change the properties of the version:
  - Enter a name for the type in the "Name" field.
  - In the "Version" field, define a main and an intermediate version number for the version to be released.
  - In the "Author" field, enter the editor of the version to be released.
  - In the "Comment" field, enter a comment on the version to be released.
4. Select the options for the release:
  - Select the "Update all instances of the affected type" check box to update all instances of the type used in the project with the same original version to the most recent version. Instances within master copies are not changed.
  - Select the "Delete all unused versions of the affected type" to delete all versions of the same type from the library if these are not assigned any instance in the project and no other dependencies exist.
5. Click "OK" to confirm.

Alternative:

1. Click the "Release version" icon in the toolbar while a version is opened for editing.
2. Continue with steps 3 to 5 of the description above.

### Releasing versions of several types

To release versions for several types simultaneously, follow these steps:

1. Open the library view, library management or the "Libraries" task card.
2. Select any folder.
3. Select the "Release version" command from the shortcut menu.  
The "Release version" dialog box opens.
4. If necessary, change the properties of the version:
  - In the "Author" field, enter the editor of the version to be released.
  - In the "Comment" field, enter a comment on the version to be released.

You cannot change the "Number" and "Version" fields.

5. Select the options for the release:
  - Select the "Update all instances of the affected type" check box to update all instances of the type used in the project with the same original version to the most recent version. Instances within master copies are not changed.
  - Select the "Delete all unused versions of the affected type" to delete all versions of the same type from the library if these are not assigned any instance in the project and no other dependencies exist.
6. Click "OK" to confirm.

## Result

The properties are applied for the type itself, the version to be released, and for all future versions. Versions already released remain unaffected by the changes.

If needed, all instances with the same original version are updated to the most recent version and the unused versions of the type are deleted.

## See also

Basics on types (Page 361)

State of type versions (Page 362)

Library basics (Page 338)

Performing a consistency check for a type version (Page 369)

Assigning a common version (Page 373)

Adding types to a global library (Page 376)

Updating the project to the latest type versions (Page 374)

## Assigning a common version

When you are finished editing all types in the project library, create a new version of all types with a common version number.

## Requirement

- The project library is opened in the "Libraries" task card or in the library view.
- The project library may not contain a version of a type with "in testing" or "in progress" status.

## Procedure

To assign the same main version to all released types within the project library, follow these steps:

1. Right-click the project library.
2. Select the "Assign common version" command from the shortcut menu.  
The "Assign common version" dialog box opens.
3. If necessary, change the properties of the version:
  - In the "Version" field, determine the new version number. The version number must be higher than the highest version number of all types within the project library.
  - In the "Author" field, enter the person responsible for the version to be released.
  - In the "Comment" field, enter a comment on the version to be released.

4. Select the options for the release:
  - Select the "Update all instances" check box to update all instances in the project to the new version. Types used in master copies are not updated.
  - Select the "Delete all unused versions of the affected types" check box to delete all older versions of types from the library if these are not assigned to any instance in the project and if there are no dependencies to other types.
5. Click "OK" to confirm.

## Result

The project library is changed as follows:

- A new version of all types is created within the project library with the specified version number.
- The properties are applied to all types within the project library, the new version and for all future versions. Lower versions remain unaffected by the changes. If you make no changes to the properties, the properties of the last released version of each type are applied.
- If needed, all instances are updated to the most recent version and the unused versions of all types are deleted from the project library.

## See also

Basics on types (Page 361)

State of type versions (Page 362)

Library basics (Page 338)

Releasing a version of a type (Page 371)

Adding types to a global library (Page 376)

## Updating the project to the latest type versions

After you have updated several types in the project library, update all instances in the project to the most recent version of the types from the project library. If you do not want to apply the changes to the entire project, restrict the update to individual devices in the project.

Each of the following elements can be selected as source for the update:

- The entire project library
- Individual folders within the project library
- Individual types  
You can select multiple types.

## Requirement

You are in the "Libraries" task card or in the library view.

## Procedure

To update instances in a project with the contents from the project library, follow these steps:

1. Select the entire project library or individual elements from it.
2. Right-click the required elements and select the "Update > Project" command from the shortcut menu.  
The "Update project" dialog box opens.
3. Select either the entire project or individual devices for the update.
4. Select the options for the update process:
  - The "Update all instances of the affected types" check box is always selected during this process.
  - Select the "Delete all unused versions of affected types" check box to delete all older versions of the updated types from the project library.
5. Click "OK" to confirm.  
The update is performed.

## Result

The following changes were made to the project:

- All older versions were deleted from the project library as needed.
- All instances within the selected devices were updated to the most recent version of the linked types.
- You can find a log of the update process in the projection tree under "Common data".

## See also

Updating the project to the latest type versions (Page 378)

Using logs (Page 258)

Updating a library with the contents of another library (Page 381)

Basics on types (Page 361)

Library basics (Page 338)

State of type versions (Page 362)

## Remove the link between instance and type

Instances of types are always connected to the version of the corresponding types. They cannot be edited like an ordinary object. If you edit the instance, a new version of the type is created automatically in the library and the changes therefore affect the entire project.

If you remove the link between the instance and its type, you then edit the object like an ordinary object in the project tree.

---

**Note**

**Link to the type cannot be restored**

If you have removed the link between instance and type, this link cannot be re-established.

---

## Requirements

The instance may not be "in testing".

## Procedure

To remove the link between a type and the version of a type, follow these steps:

1. Select the instance in the project tree.
2. Right-click the instance and select the "Terminate connection to type" command from the shortcut menu.
3. The connection to the version of the corresponding type is removed.

## See also

Basics on types (Page 361)

Library basics (Page 338)

State of type versions (Page 362)

### 7.10.8.6 Working with types in global libraries

#### Adding types to a global library

Global libraries are used as a central resource when working on multiple projects. Among the types, only the types in the project library can be edited directly. Therefore, use the project library if you want to work on types. When you are finished editing a type in the project library, you can add the type to a global library. Adding a type from the project library corresponds to a usual copy process from the project library.

#### Requirement

- The "Libraries" task card is displayed or the library view is open.
- The global library to which you want to add a type is opened with write protection.



## Procedure

To add an existing element to a global library as a type, follow these steps:

1. Open the required folder in the global library in the "Libraries" task card or in the library view.
2. Drag a type from the project library to the "Types" folder or any subfolder of the global library. The new type is created.

Alternative:

1. Copy the required type from the project library to the clipboard.
2. In the "Global library" palette of the "Libraries" task card, open the global library to which you want to add a type.
3. Right-click the "Types" folder or any of its subfolders.
4. Select the "Paste" command in the shortcut menu. The new type is created.

## Result

The type is inserted in the global library. Dependent types, such as types of HMI user data types or tags, are also copied to the global library, provided they do not already exist there. This ensures that all necessary elements for generating an instance are present in the global library.

If the type that you want to add to the global library is already present there, the described process corresponds to an update of the global library. In this case, the most recent released versions of the types are added to the global library.

## See also

Basics on types (Page 361)

Releasing a version of a type (Page 371)

Assigning a common version (Page 373)

Updating the project to the latest type versions (Page 378)

Library basics (Page 338)

## Using types

To use the version of a type from the global library, create an instance of the version at a suitable location in the project tree. You can also position faceplates and HMI user data types directly in the editor.

In the project, instances of types from a global library are not linked to the type in the global library. Instead, a copy of the type and its dependent elements is generated in the project library when an instance is pasted into the project. Dependent elements, for example, can be PLC data types that are referenced in a block. In each case, the copy of the type and the dependent elements in the project library contain the version that you link to the instance. If the type or a dependent element already exists in the project library, only the missing version is added when necessary to the type in the project library.

The instance is linked to the type in the project library. You can only assign a type to a device once irrespective of the version.

## Requirement

- The "Libraries" task card is displayed.
- A device which supports the sort of desired type is available in the project.
- The device is not assigned to any further instances of the same type.

## Procedure

To generate and use an instance from a type, follow these steps:

1. In the global library, navigate to the version of the type that you want to use.
2. Drag the required version of the type and drop it at the location where you want to use it.  
Alternative: To automatically use the most recent version, drag the type to the location where you want to use it.

## Result

Missing elements are added to the project library. An instance is generated from the type and its dependent elements and pasted at the location where you want to use it. The instances are connected to the respective version of the type in the project library.

## See also

Basics on types (Page 361)

Updating the project to the latest type versions (Page 378)

Library basics (Page 338)

Using the element view (Page 342)

## Updating the project to the latest type versions

In large enterprises with numerous automation projects, the global libraries are frequently edited from a central location. The updated global libraries of the individual projects are made available after the completion of a new version. If you have received a more recent version of a global library, replace the outdated instances in your project with the most recent version. If you do not want to apply the changes to the entire project, restrict the update to individual devices in the project.

The project library is also updated with the new versions of the types in the global library during the updating of the project or individual devices.

The following elements can be selected as source for the updating:

- A global library
- Individual folders within a global library
- Individual types  
You can select multiple types.

## **Requirement**

- You are in the "Libraries" task card or in the library view.
- The updated global library is open.

## **Procedure**

To update instances in a project with the contents from a global library, follow these steps:

1. Select the updated global library or the individual elements from it.
2. Right-click the global library or the required elements and select the "Update > Project" command from the shortcut menu.  
The "Update project" dialog box opens.
3. Select either the entire project or individual devices for the update.
4. Select the options for the update process:
  - The "Update all instances of the affected types" check box is always selected during this process.
  - Select the "Delete all unused versions of affected types" check box to delete all older versions of the updated types from the project library.
5. Click "OK" to confirm.  
The update is performed.

## **Result**

The following changes were made to the project:

- The most recent version of the select types is present in the project library. All older versions were deleted if necessary.
- All instances within the selected devices were updated to the most recent version of the linked types.
- You can find a log of the update process in the projection tree under "Common data".

## See also

- Updating the project to the latest type versions (Page 374)
- Using logs (Page 258)
- Updating a library with the contents of another library (Page 381)
- Basics on types (Page 361)
- Library basics (Page 338)
- Adding types to a global library (Page 376)

### 7.10.9 Editing library elements

Types, master copies and folder can be cut, copied, pasted, moved, renamed or deleted in the usual way within the "Libraries" task card or the library view. Global libraries must be opened with write permission for each of the above-described processes.

#### Copying types

The following rules apply when you copy types to the clipboard:

- Types are always copied to the clipboard with all associated versions. However, only versions that have previously been released are copied.
- Types are always copied to the clipboard with all dependent elements.
- Master copies are always copied together with all types contained in them and all versions of the type.

#### Cutting elements

You can only paste previously cut library elements into the same library. In so doing, you can only paste master copies into the "Master copies" folder or any of its subfolders. Likewise, you can only paste types into the "Types" folder or any of its subfolders.

#### Pasting types

Pasting types in a different library corresponds to updating the target library.

The following rules apply when you have pasted a type into a different library:

- A type is always pasted with all its versions.
- If the type already exists in the target library, all versions that are more recent than the existing versions are added to the corresponding types in the target library.
- If there is already a version with released status in the target library, this version is not pasted again.
- If the same version exists with in testing or in progress status in the target library, it is replaced by the released version.
- If a type needs other types, these are also added at the respective location.

### Pasting master copies

When you paste master copies, all types and their versions contained in these copies are also pasted. If the corresponding type already exists in the library, only the missing versions are added. If a type does not yet exist, it is pasted with all its versions at the highest level in the library.

### Moving elements

When you move an element from one library to another, the element is copied and not moved. The same rules apply as described under "Pasting types" and "Pasting master copies".

### Deleting of types and type versions

Note the following when you delete types or type versions:

- A type or a type version can only be deleted if there are dependencies to other types.
- When you delete a type, all versions of the type are deleted.
- If you delete all versions of a type, the type is also deleted.
- If you delete a version that has instances in the project, the instances are also deleted from the project.

### Deleting instances

If you delete an instance that has dependencies to other instances, this instance is restored during the next compilation. The instance is then linked again to the original type version. This restores the consistency of the project.

### See also

Library basics (Page 338)

Remove the link between instance and type (Page 375)

Updating a library with the contents of another library (Page 381)

#### 7.10.10 Updating a library with the contents of another library

An existing library can be updated with the contents of another library. The following options are available for updating libraries:

- Updating a global library with types from another global library or from the project library
- Updating the project library with types from a global library

Each of the following elements can be selected as source for the update:

- An entire library
- Individual folders within a library
- Individual types  
You can select multiple types.

During the update, new versions are added to the types that already exist in the target library. Types that do not yet exist in the target library are copied together with all their versions to the target library.

## Requirement

If you want to update a global library, you have to open it with write permission.

## Procedure

To update a library with the contents of a different library, follow these steps:

1. Select a library or individual elements from a library as source for the update.
2. Right-click the source and select the "Update > Library" command from the shortcut menu. The "Update library" dialog box opens.
3. Select the type of library you want to update:
  - Select "Update the project library" to update the project library with types from a global library.
  - Select "Update a global library" if you want to update a global library.
4. Optional: In the drop-down list, select the global library that you want to update, if you want to update a global library.
5. Select the options for the update:
  - The "Update all instances of the affected types" option is always disabled during this process.
  - Select the "Delete all unused versions of the affected types" check box to delete all older versions of types from the project library if these are not assigned to any instance in the project and if there are no dependencies to other types. This option cannot be selected for the update of a global library, since types of a global library never have a point of use in the project.
6. Click "OK" to confirm.  
The update is performed.

## Result

The following changes were made to the target library:

- Types not yet available in the target library were copied together with all their versions. More recent versions were added to the types that already exist in the target library. If a more recent version of a type already existed in the target library, the latest version was nevertheless copied and automatically assigned a newer version number.
- If needed, all versions of types were deleted from the project library if these were not used in any instance in the project.
- A log listing all performed changes to the target library was created for the update process. If you have updated the project library, you can find the log in the project tree under "Common data > Logs". If you have updated a global library, you can find the log in the "Common data > Logs" folder in the level below the global library.

## See also

Using logs (Page 258)

Updating the project to the latest type versions (Page 374)

Updating the project to the latest type versions (Page 378)

Displaying logs of global libraries (Page 352)

Library basics (Page 338)

### 7.10.11 Harmonizing names and path structure

You can harmonize the project with a library. This helps you correct the following items:

- Names of interfaces:  
Instances can be created during the development phase of a library, the names of which are appended by "\_1", "\_2", etc. due to an automatic correction. This extension is used to prevent duplicate names in the project. During harmonization, the instances once again receive the names of their associated types.
- Path structure:  
The original path structure can be lost due to parallel development or copying of dependent instances. This affects the clarity of the project. During harmonization, the path structure within the project is adapted to the path structure of the library.

## Procedure

To harmonize the names and the path structure, follow these steps:

1. Open the library management.
2. Click "Harmonize project" in the toolbar.  
The "Harmonize project" dialog box opens.
3. Select the device with which you wish to harmonize the library.

4. Select the "Harmonize paths between project and library" check box if you want to restore the path structure.
5. Select the "Harmonize names between project and library" check box if you want to have the names corrected.
6. Confirm your entries with "OK".  
Depending on your settings, the names and the path structure in the project are harmonized with the library.

### See also

Library basics (Page 338)

Overview of the library view (Page 343)

Overview of the library management (Page 346)

### 7.10.12 Clean up library

You can clean up the project library or global libraries to remove types or versions when they are not connected to an instance in the project. This step provides more clarity within the libraries and decreases the size of the library.

#### Cleaning up the project library

To clean up the project library, follow these steps:

1. Open the library management.
2. Click on "Clean up library" in the toolbar.  
The "Clean up project library" dialog box opens.
3. Select if you only want to delete unused type versions or complete types from the library.
4. Confirm your entry with "OK".  
Depending on your selection, either unused type versions or types are removed from the project library.

#### Clean up global library

To clean up a global library, follow these steps:

1. Open the library management.
2. Click on "Clean up library" in the toolbar.  
The "Clean up global library" dialog box opens.
3. Click "Continue".  
Unused type versions are deleted. The latest version of a type is always retained.



## See also

Library basics (Page 338)

Overview of the library view (Page 343)

Overview of the library management (Page 346)

## 7.10.13 Comparing library elements

### Introduction

You can compare devices from libraries with devices from both the current project as well as from the same or another libraries or reference projects. Note, however, that reference projects are write-protected. You can also compare instances in a device with their type version in a library. Not all actions are available for the comparison with types. You cannot, for example, overwrite an instance of a newer version with an older type version from the library.

When comparing library elements, you can always switch between automatic and manual comparison.

### Procedure

To compare library elements with the device data of a project, follow these steps:

1. In the project tree, select the device whose data you want to compare to a library element and which allows offline/offline comparison.
2. Select the "Compare > Offline/offline" command in the shortcut menu.  
The compare editor opens and the selected device is displayed in the left area.
3. Open the "Libraries" task card.
4. Select the library element that you want to compare to the device data.
5. Drag the library element into the right drop area of the compare editor.  
You can identify the status of the objects based on the symbols in the status and action area. When you select an object, the object properties and the corresponding object of the assigned device are clearly shown in the property comparison.  
You can drag other devices into the drop areas from the current project, a library or from a reference point at any time to start a new comparison. It does not matter which device you drag into the drop area.

**See also**

- Using the comparison editor (Page 288)
- Carrying out offline/offline comparisons (Page 287)
- Using the library view (Page 343)
- Library basics (Page 338)
- Overview of the "Libraries" task card (Page 339)
- Overview of the library view (Page 343)
- Using the element view (Page 342)
- Using global libraries (Page 348)

## **7.11 Using cross-references**

### **7.11.1 Using cross-references**

#### **Introduction to cross-references**

The cross-reference list provides an overview of the use of objects within the project. You can see which objects are interdependent and where the individual objects are located. Cross-references are therefore part of the project documentation.

You can also jump directly to the point of use of an object.

Which objects you can display and localize in the cross-reference list depends on the installed products.

## 7.12 Simulating devices

### 7.12.1 Simulation of devices

#### Introduction

You can use the TIA Portal to run and test the hardware and software of the project in a simulated environment. The simulation is performed directly on the programming device or PC. No additional hardware is required.

The simulation software provides a graphical user interface for monitoring and changing the configuration. It differs according to the currently selected device.

#### Integration in the TIA Portal

The simulation software is fully integrated in the TIA Portal but is only supported by certain devices. Therefore, the button for calling the simulation software is only active if the selected device supports simulation.

The simulation software for some devices requires its own virtual interface to communicate with the simulated devices. The virtual interface can be found in the project tree under the "Online access" entry next to the physical interfaces of the programming device/PC.

Once you have opened the software, additional help on the simulation software is available via a separate link.

#### See also

Starting the simulation (Page 388)

### 7.12.2 Starting the simulation

Some devices can be simulated with additional software. You therefore do not have to have the actual devices to perform comprehensive testing of your project.

#### Procedure

To start the simulation software, follow these steps:

1. Select the device you want to simulate, for example, in the project tree.
2. Select the "Simulation > Start" command in the "Online" menu.  
This calls the simulation software.

#### See also

Simulation of devices (Page 388)

# Editing devices and networks

## 8.1 Configuring devices and networks

### 8.1.1 Hardware and network editor

#### 8.1.1.1 Overview of hardware and network editor

##### **Function of the hardware and network editor**

The hardware and network editor opens when you double-click on the "Devices and Networks" entry in the project tree. The hardware and network editor is the integrated development environment for configuring, networking and assigning parameters to devices and modules. It provides maximum support for the realization of the automation project.

##### **Structure of the hardware and network editor**

The hardware and network editor consists of the following components:

8.1 Configuring devices and networks

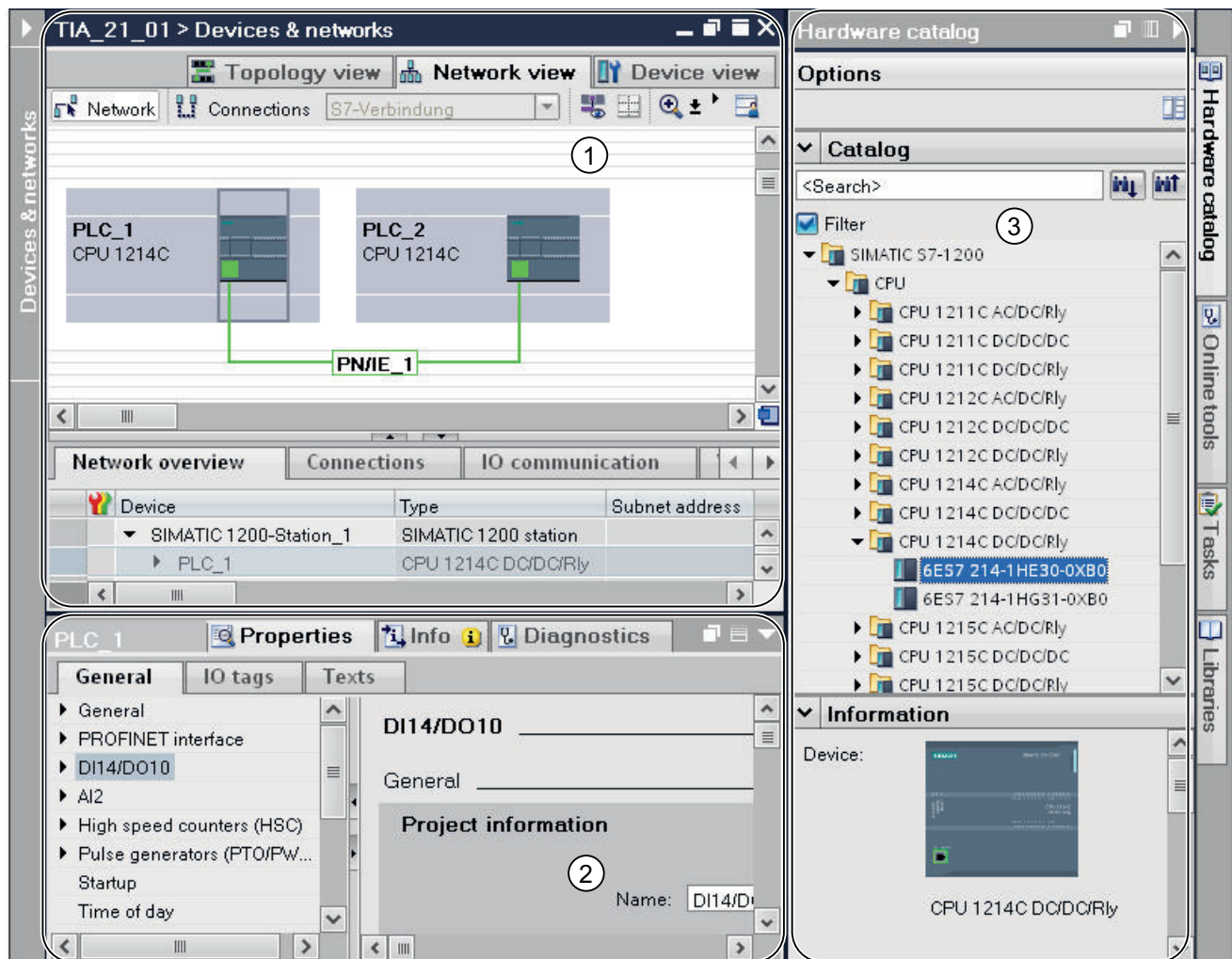

- ① Device view (Page 393), network view (Page 391), topology view (Page 396)
- ② Inspector window (Page 401)
- ③ Hardware catalog (Page 403)

The hardware and network editor provides you with three views of your project. You can switch between these three views at any time depending on whether you want to produce and edit individual devices and modules, entire networks and device configurations or the topological structure of your project.

The inspector window contains information on the object currently marked. Here you can change the settings for the object marked.

Drag the devices and modules you need for your automation system from the hardware catalog to the network, device or topology view.

### 8.1.1.2 Network view

#### Introduction

The network view is one of three working areas of the hardware and network editor. You undertake the following tasks here:

- Configuring and assign device parameters
- Networking devices with one another

#### Structure

The following diagram shows the components of the network view:

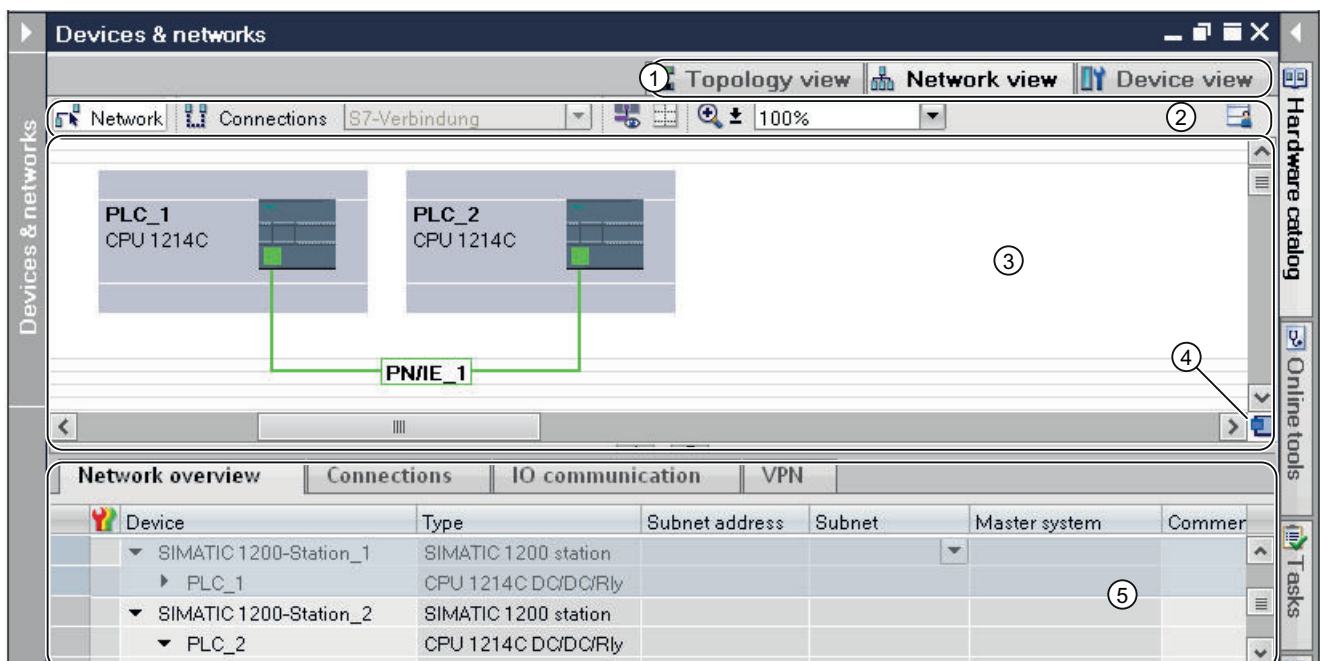







- ① Changeover switch: device view / network view / topology view
- ② Toolbar of network view
- ③ Graphic area of network view
- ④ Overview navigation
- ⑤ Table area of network view

You can use your mouse to change the spacing between the graphic and table areas of the network view. To do this, click on the upper edge of the table view and expand or contract this by moving the mouse with the mouse button held down. The Speedy Splitter (the two small arrow keys) allows you to use a single click to minimize the table view, maximize the table view or restore the last selected split.

## Toolbar

The toolbar provides the following functions:

Icon	Meaning
	Mode to network devices.
	Mode to create connections. You can use the adjacent drop-down list to set the connection type.
	Mode to create relations.
	Show interface addresses.
	Adjust the zoom setting. You can use the adjacent drop-down list to select or directly enter the zoom setting. You can also zoom in or zoom out the view in steps using the zoom symbol or draw a frame around an area to be zoomed in.
	Show page breaks Enables page break preview. Dotted lines are displayed at the positions where the pages break when printed.
	Remember layout Saves the current table view. The layout, width and visibility of columns in the table view is stored.

## Graphic area

The graphic area of the network view displays any network-related devices, networks, connections and relations. In this area, you add devices from the hardware catalog, connect them with each other via their interfaces and configure the communication settings.

## Overview navigation

Click in the overview navigation to obtain an overview of the created objects in the graphic area. By holding down the mouse button, you can quickly navigate to the desired objects and display them in the graphic area.

## Table area

The table area of the network view includes various tables for the devices, connections and communication settings present:

- Network overview
- Connections
- I/O communication

You can use the shortcut menu of the title bar of the table to adjust the tabular display.



## **See also**

Adding a device to the hardware configuration (Page 419)

Layout of the user interface (Page 203)

Displaying diagnostics status and comparison status using icons (Page 962)

Networking devices in the network view (Page 433)

Tabular network overview (Page 436)

### **8.1.1.3 Device view**

#### **Introduction**

The device view is one of three working areas of the hardware and network editor. You undertake the following tasks here:

- Configuring and assign device parameters
- Configuring and assign module parameters

Structure

The following diagram shows the components of the device view:

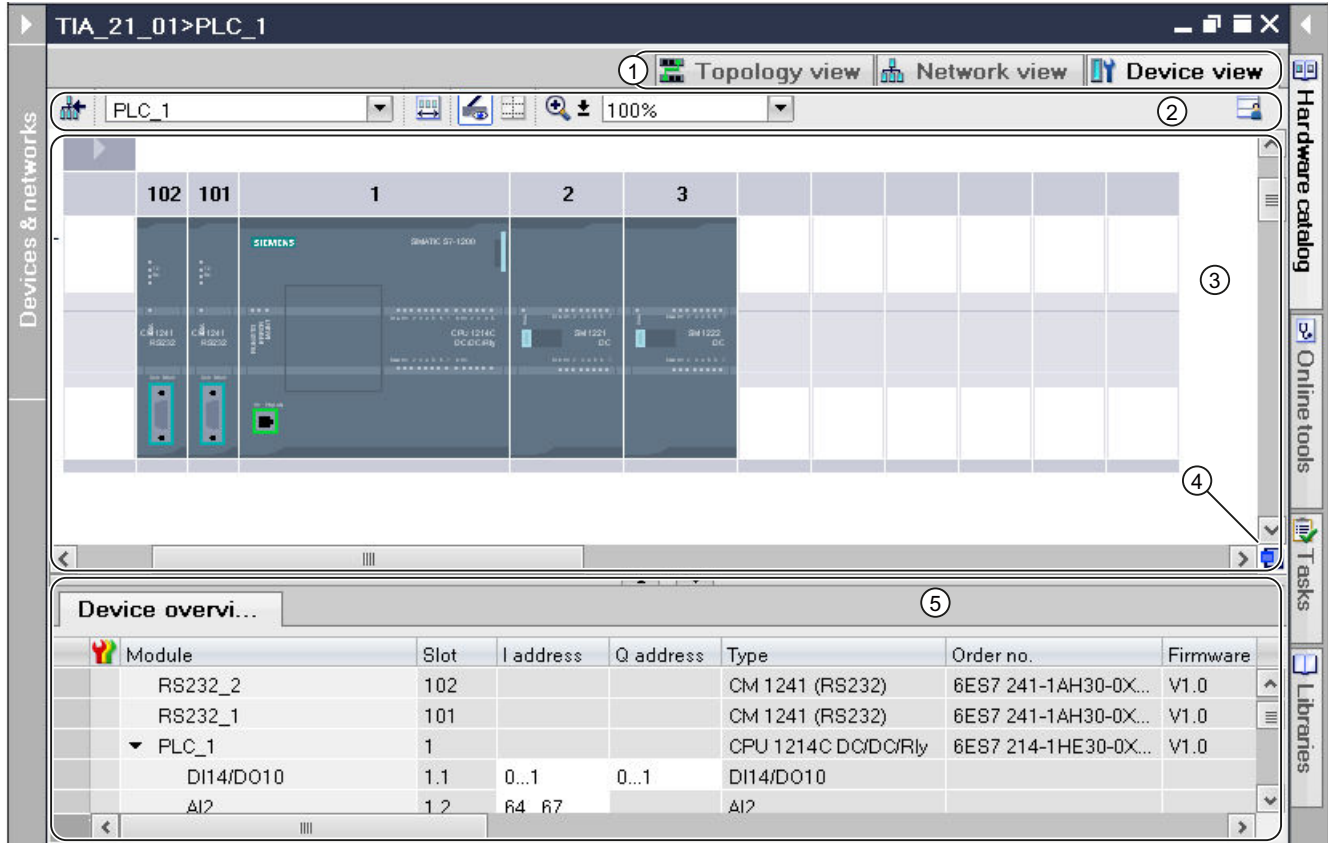







- ① Changeover switch: device view / network view / topology view
- ② Toolbar of device view
- ③ Graphic area of the device view
- ④ Overview navigation
- ⑤ Table area of device view

You can use your mouse to change the spacing between the graphic and table areas of the device view. To do this, click on the upper edge of the table view and expand or contract this by moving the mouse with the mouse button held down. The Speedy Splitter (the two small arrow keys) allows you to use a single click to minimize the table view, maximize the table view or restore the last selected split.

## Toolbar

The toolbar provides the following functions:

Icon	Meaning
	Switches to the network view. Note: The device view can switch between the existing devices using the drop-down list.
	Show the area of unplugged modules.
	Show module labels.
	Adjust the zoom setting. You can use the adjacent drop-down list to select or directly enter the zoom setting. You can use the Zoom icon to zoom in or out incrementally or to drag a frame around an area to be enlarged. With signal modules, you can recognize the address labels from a zoom level of 200% or higher.
	Show page breaks Enables page break preview. Dotted lines are displayed at the positions where the pages break when printed.
	Remember layout Saves the current table view. The layout, width and visibility of columns in the table view is stored.

## Graphic area

The graphic area of the device view displays hardware components and if necessary the associated modules that are assigned to each other via one or more racks. In the case of devices with racks, you have the option of installing additional hardware objects from the hardware catalog into the slots on the racks.

## Overview navigation

Click in the overview navigation to obtain an overview of the created objects in the graphic area. By holding down the mouse button, you can quickly navigate to the desired objects and display them in the graphic area.

## Table area

The table area of the device view gives you an overview of the modules used and the most important technical and organizational data.

You can use the shortcut menu of the title bar of the table to adjust the tabular display.

## **See also**

Working with racks (Page 413)

Network view (Page 391)

Area for unplugged modules (Page 416)

Inserting a module into a rack (Page 422)

Objects in the device view (Page 414)

Layout of the user interface (Page 203)

Displaying diagnostics status and comparison status using icons (Page 962)

### **8.1.1.4 Topology view**

#### **Introduction**

The topology view is one of three working areas of the hardware and network editor. You undertake the following tasks here:

- Displaying the Ethernet topology
- Configuring the Ethernet topology
- Identifying and minimizing differences between the desired and actual topology

## Structure

The following figure provides an overview of the topology view.

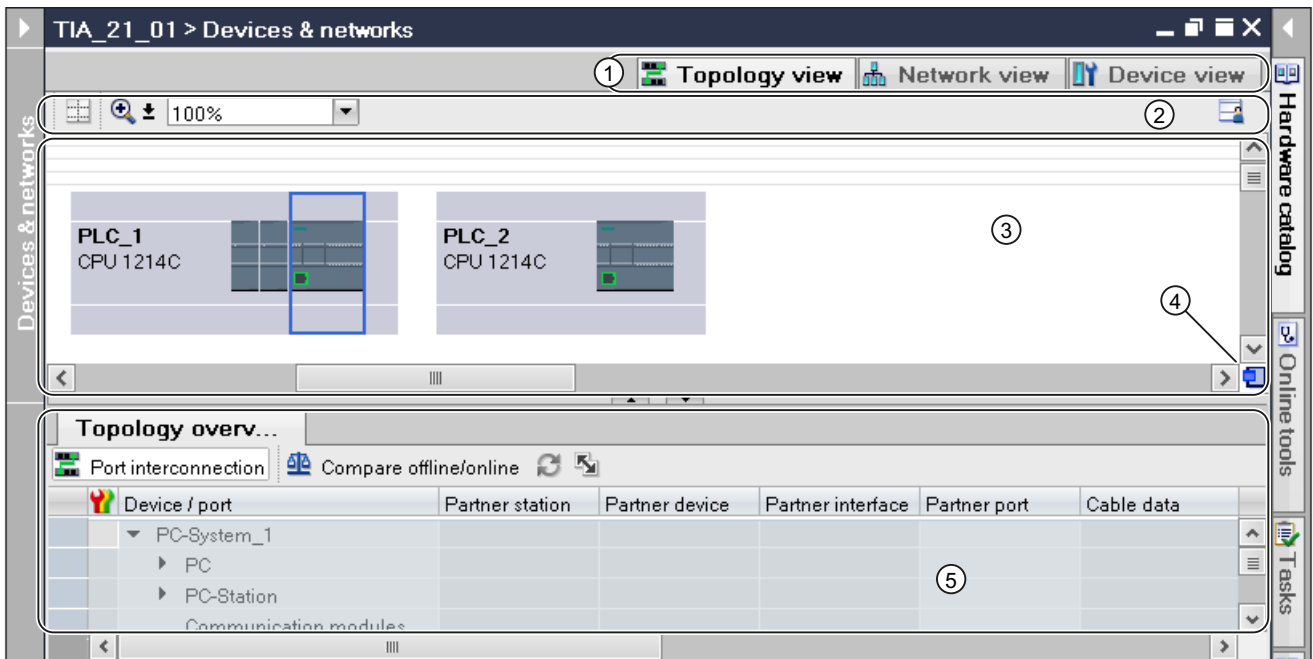



- ① Changeover switch: device view / network view / topology view
- ② Topology view toolbar
- ③ Graphic area of the topology view
- ④ Overview navigation
- ⑤ Table area of the topology view

You can use your mouse to change the spacing between the graphic and table areas of the topology view. To do this, click on the upper edge of the table view and expand or contract this by moving the mouse with the mouse button held down. The Speedy Splitter (the two small arrow keys) allows you to use a single click to minimize the table view, maximize the table view or restore the last selected split.

## Toolbar

The toolbar provides the following functions:

Icon	Meaning
	Adjusting the zoom setting. You can use the adjacent drop-down list to select or directly enter the zoom setting. You can also zoom in or zoom out the view in steps using the zoom symbol or draw a frame around an area to be zoomed in.
	Show page breaks Enables page break preview. Dotted lines are displayed at the positions where the pages break when printed.
	Remember layout Saves the current table view. The layout, width and visibility of columns in the table view is stored.

## Graphic area

The graphic area of the topology view displays Ethernet modules with their appropriate ports and port connections. Here you can add additional hardware objects with Ethernet interfaces. See: Adding a device to the hardware configuration (Page 419)

## Overview navigation

Click in the overview navigation to obtain an overview of the created objects in the graphic area. By holding down the mouse button, you can quickly navigate to the desired objects and display them in the graphic area.

## Table area

This displays the Ethernet or PROFINET modules with their appropriate ports and port connections in a table. This table corresponds to the network overview table in the network view.

You can use the shortcut menu of the title bar of the table to adjust the tabular display.

## See also

Layout of the user interface (Page 203)

Displaying diagnostics status and comparison status using icons (Page 962)

### 8.1.1.5 Printing hardware and network configurations

#### Printout of hardware and network configurations

You can print out the following elements of the hardware and network view as part of the project documentation:

- Graphic network view
- Network overview table
- Graphic device view
- The device overview table
- The parameters of the object currently selected in the editor

#### Printout of editor content

If you start a printout within an opened editor and no module is selected, the content of the editor is always printed. This includes a graphic representation of the editor as well as the table for the editor. You can adapt the scope of the printout. You can specify whether only the graphic view, the table or both together are to be printed. Read section "Changing the print options (Page 401)" for more on this.

If the graphic is larger than the page layout you have selected, the printout is continued on the next page. No content is lost this way. Alternatively, you can change the zoom level of the graphic representation to fit the printout on one page. The printout is always made in the currently selected zoom setting.

To check that all content fits on one page, you can either use the print preview or activate the page break preview. When page break preview is activated, dashed lines are displayed within the graphic editor at the location where the page break is later made.

#### Printing very large tables

If a table is larger than the print area and therefore cannot be fully printed, the content of the table is not printed as a table, but instead as pairs between value and key.

Example:

Object name	Property 1	Property 2
Object A	Value A1	Value A2
Object B	Value B1	Value B2

In this case, the printout has the following appearance:

##### **Object A**

Property 1: Value A1

Property 2: Value A2

##### **Object B**

Property 1: Value B1

Property 2: Value B2

You can also preset this as a template so that tables are always printed as pairs between the key and the value. Read section "Changing the print settings (Page 302)" for more on this.

## Printing module parameters

Parameters of selected modules are printed out along with the current value settings in text form. All parameters from corresponding modules are also printed. For example, if you have selected a CPU, the parameters of an inserted signal board, if present, are printed as well.

You can determine the scope of the module parameters to be printed. In the "Print" dialog, select whether all properties and parameters of a module are to be printed or whether to use the compact printout. If you select the compact form, only the entries in the "General" area of the module properties are printed. Comments on modules, as well as the author and module description, are excluded. In compact mode, the following module parameters are therefore printed, for example:

- Module specifications  
Name, module slot, short description, order number, firmware version
- Name of the PROFINET interface
- Subnet specifications  
Name of the subnet, ID of the S7 subnet

## See also

Changing the print options (Page 401)

Documentation settings (Page 299)

Creating a print preview (Page 314)

Printing project data (Page 317)

Activating the page break preview for printout (Page 400)

### 8.1.1.6 Activating the page break preview for printout

You can activate the page break preview for the printout in the graphic editor. If this option is activated, dashed lines are shown within the graphic editor at the locations where page breaks are later made during printout.

## Procedure

Proceed as follows to activate the page break preview:

1. Select the graphic area of the corresponding view.
2. Click on the "Show page break" symbol in the toolbar of the graphic editor.  
Dashed lines are displayed within the graphic editor at the location a page break is later made.



3. To modify the frame layout, select the "Print" command in the "Project" menu.
4. To disable page break preview, click again on the "Show page break" symbol in the toolbar of the graphic editor.

### **8.1.1.7 Changing the print options**

#### **Changing the scope of the printout**

When printing from an editor, you can specify whether both graphics and tables are to be printed or just one of the two. Both are printed by default.

#### **Procedure**

To change the scope of the printout, proceed as follows:

1. In the "Options" menu, select the "Settings" command.
2. In the area navigation, open the "Print settings" parameter group under "General".
3. Scroll to the "Hardware configuration" group.
4. Select or clear the "Active graphic view" check box, depending on whether you want to print the graphics of the network and device view as well.
5. Select or clear the "Active table" check box, depending on whether you want to print the table for the editor as well.

#### **See also**

Printing hardware and network configurations (Page 399)

### **8.1.1.8 Inspector window**

The properties and parameters shown for the object selected can be edited in the inspector window.

## Structure

The inspector window consists of the following components:

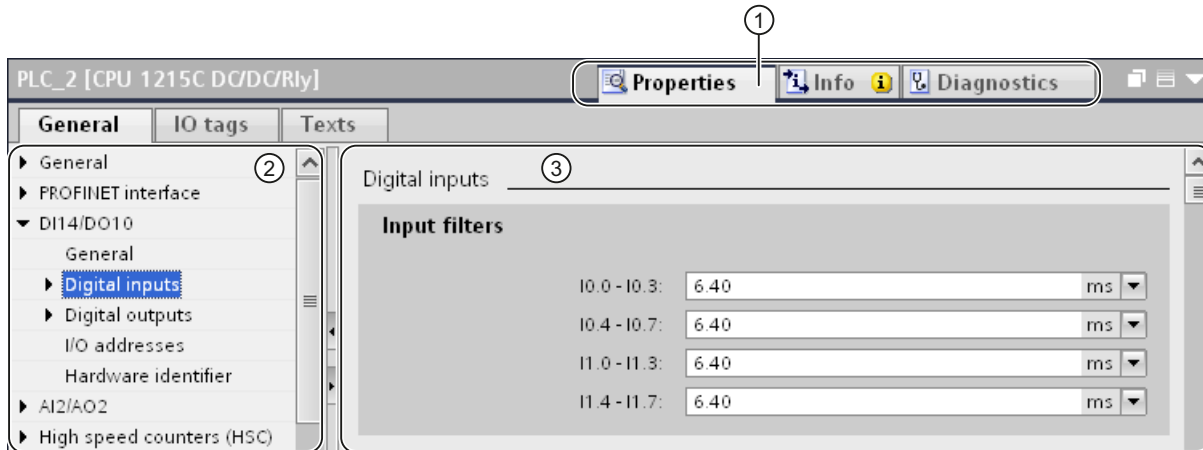

- ① Switch between various information and work areas
- ② Navigation between various pieces of information and parameters
- ③ Display showing the selected information and parameters

## Function

The information and parameters in the inspector window are split into different types of information:

- Properties
- Info
- Diagnostics

To display the corresponding information and parameters, click in the relevant area. The "Properties" area is the most important one for configuring an automation system. This area is displayed by default and contains various tabs:

- General
- IO tags
- Text

The left pane of the inspector window is used for area navigation. Information and parameters are arranged there in groups. If you click on the arrow symbol to the left of the group name, you can expand the group if sub-groups are available. If you select a group or sub-group, the corresponding information and parameters are displayed in the right pane of the inspector window and can be edited there too.

## See also

- Editing properties and parameters (Page 428)
- Overview of hardware and network editor (Page 389)
- Translating text associated with individual objects (Page 269)

### 8.1.1.9 Hardware catalog

The "Hardware catalog" task card gives you easy access to a wide range of hardware components.

#### Structure

The "Hardware catalog" task card consists of the following panes:

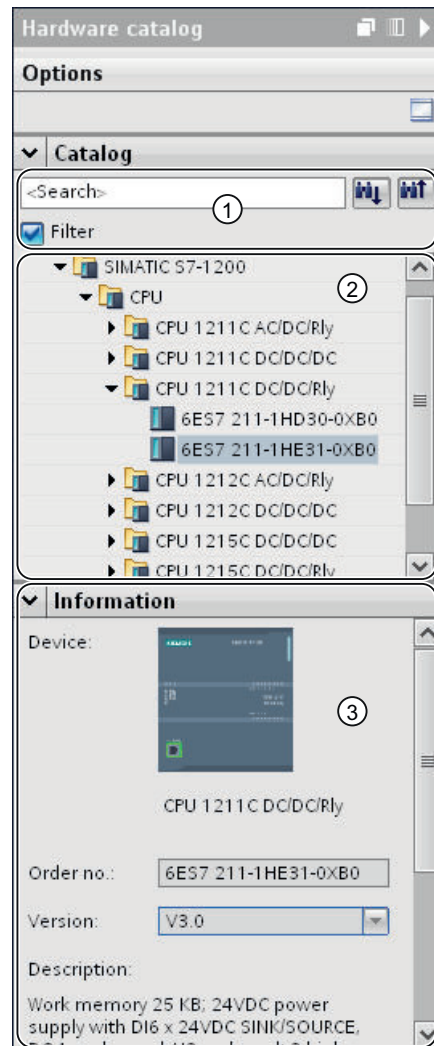

- ① "Catalog" pane, search and filter function
- ② "Catalog" pane, component selection
- ③ "Information" pane

#### Search and filter function

The search and filter functions of the "Catalog" pane make it easy to search for particular hardware components. You can limit the display of the hardware components to certain criteria

using the filter function. For example, you can limit the display to objects that you can also place within the current context or which contain certain functions.

Objects that can be used in the current context include, for example, interconnectable objects in the network view or only modules compatible with the device in the device view.

## **Component selection**

The component selection in the "Catalog" pane contains the installed hardware components in a tree structure. You can move the devices or modules you want from the catalog to the graphic work area of the device or network view.

Installed hardware components without a license are grayed out. You cannot use non-licensed hardware components.

Hardware components belonging to various components groups thematically are partially implemented as linked objects. When you click on such linked hardware components, a catalog tree opens in which you can find the appropriate hardware components.

## **Information**

The "Information" pane contains detailed information on the object selected from the catalog:

- Schematic representation
- Name
- Order number
- Version number
- Description

## **See also**

Browsing the hardware catalog (Page 411)

Overview of hardware and network editor (Page 389)

Information on hardware components (Page 404)

### **8.1.1.10 Information on hardware components**

In the hardware catalog, you can display information on selected hardware components in the "Information" pane. You can also display further information on the selected hardware components using the shortcut menu.

## Access to further information

If you select a hardware object in the hardware catalog and open the shortcut menu, you not only have the "Copy" function available but also three options for accessing information on Service & Support:

- Information regarding product support
- FAQs
- Manuals

The required information is displayed in the work area of the hardware and network editor.

---

### Note

You can only access Service & Support when you are connected to the Internet and the function is enabled. By default, the function is disabled. To enable the function, refer to the instructions in the section "Enabling product support (Page 405)".

---

## Information regarding product support

Here, you have access to general information on hardware and software components. The order number of the selected hardware object is entered automatically in the search mask. You can, however, also search for other hardware and software components.

## FAQs

Here, you have access to "Frequently Asked Questions" (FAQs). You can view various entries on hardware and software questions. Using a detailed search mask, you can filter the required topics.

## Manuals

Here, you have access to the manuals of the various hardware components. This is particularly useful if the configuration, addressing or parameter assignment you are planning requires more detailed knowledge of the hardware you are using.

## See also

Hardware catalog (Page 403)

Enabling product support (Page 405)

### 8.1.1.11 Enabling product support

#### Enabling Service & Support function

For each device in the hardware catalog, you have the option of displaying additional information that is stored in the Service & Support area of the Siemens website. By default, the function is disabled. Instructions for enabling the function are given below.

### Requirement

The software must have access to the Internet.

### Procedure

To enable the Service & Support function, proceed as follows:

1. In the "Options" menu, select the "Settings" command.
2. Open the "Hardware configuration" group in the area navigation.
3. Select the "Via Internet" check box.

### Result

You can now access product support, FAQs and manuals from the hardware catalog via the shortcut menu for the module.

### See also

Information on hardware components (Page 404)

#### 8.1.1.12 Keyboard operation: Navigation in the editor

You can use shortcut keys in the network and device view to navigate between the components of the hardware and network editor and its objects.

#### Navigating between elements and functions

Function	Shortcut keys
Switch to the next lower selection level You can for example, use <Return> to switch from a selected rack to the lower selection level of the devices and modules that are snapped onto it. If a device is selected, you can use <Return> to switch to the lower selection level of the interfaces that are displayed on the device.	<Return>
Switch to the next higher selection level You can use <Esc>, for example, to switch from a selected interface to the higher selection level of the devices and modules. If a device is selected, you can use <Esc> to switch to the higher selection level of the rack.	<Esc>
Navigation between objects in the current selection level You can use the arrow keys to switch between the objects within a current selection level. To change the selection level, use the <Return> or <Esc> keys.	<Up arrow> <Down arrow> <Right arrow> <Left arrow>
Switches to the device view	<Ctrl+Shift+D>
Switches to the network view	<Ctrl+Shift+N>
Switches to the topology view	<Ctrl+Shift+T>

Function	Shortcut keys
Switch between editor elements Use the <Tab> key to switch from one editor element to the next element. Use <Shift+Tab> to switch to the previous element. You can switch, for example, between the graphical view, Speedy Splitter, table view or underlying tabs.	<Tab> <Shift+Tab>
Switch between tabs Use the <Ctrl+Tab> keys to switch from one tab to the next tab on the right. Use <Ctrl+Shift+Tab> to switch to the next tab to the left. You can use these keys, for example, to switch between the device view, the network view and the topology view.	<Ctrl+Tab> <Ctrl+Shift+Tab>

## Opening elements and functions

Function	Shortcut keys
Opening the online and diagnostics view When a device is selected, <Ctrl+D> opens the online and diagnostics view for the selected device.	<Ctrl+D>
Opening the download to device dialog When a device is selected, <Ctrl+L> opens the advanced download dialog.	<Ctrl+L>
Add new device <Ctrl+N> opens the dialog for adding a new device.	<Ctrl+N>
Opens the "Hardware catalog" task card	<Ctrl+Shift+C>
Opens "Online Tools" task card	<Ctrl+Shift+O>

## See also

Keyboard operation in the TIA Portal (Page 234)

### 8.1.1.13 Keyboard operation: Editing objects

You can execute some of the functions of the network and device view directly with a combination of keyboard and mouse in the hardware and network editor. The keyboard operation in tables (Page 234) corresponds to standard characteristics. Here you find the keyboard operation for the graphic work area of the network and device view.

## General keyboard operation

Function	Shortcut keys
Zoom in on view in frame Drag a frame in the graphical view in order to correspondingly change the size of the view.	<Ctrl+Space> + pressed mouse button
Move view Move the mouse pointer in order to move the view.	<Space> + pressed mouse button
Cancel current operation	<Esc>

Function	Shortcut keys
Separate connection Use <Esc> or a double-click to exit connection mode when dragging a connection.	<Esc> or double-click
Zoom in graphic view The enlargement or reduction depends on the direction of rotation.	<Ctrl> + turn mouse wheel

### Selected objects

Function	Shortcut keys
Select object	Mouse click
Cut an object The selected object is copied to the clipboard and deleted from the graphical view.	<Ctrl+X>
Copy object The selected object is copied to the clipboard.	<Ctrl+C>
Paste object The object from the clipboard is inserted into the selection.	<Ctrl+V>
Delete selected object	<Del>
Select several objects 1 You can add several objects to the selected objects by clicking on them individually. Alternatively, you can use <Shift> + pressed mouse key to drag a frame around the objects that are to be selected.	<Shift> + click
Select several objects 2 You can add several objects to the selected objects by clicking on them individually. Alternatively, you can use <Shift> + pressed mouse key to drag a frame around the objects that are to be selected. When holding down the <Ctrl> key, you can use a mouse click to deselect selected objects.	<Ctrl> + click
Move selection When the mouse button is pressed, you can drag devices or modules to allowed slots on a rack.	Mouse button pressed
Copy selection Using <Ctrl> + pressed mouse button you can drag devices and modules to allowed slots on a rack. This copies the devices or modules.	<Ctrl> + pressed mouse button

## 8.1.2 Configuring devices

### 8.1.2.1 Basics

#### Introduction to configuring hardware

To set up an automation system, you will need to configure, assign parameters and interlink the individual hardware components. The work needed for this is undertaken in the device and network view.



## Configuring

"Configuring" is understood to mean arranging, setting and networking devices and modules within the device or network view. Racks are represented symbolically. Just like "real" racks, they allow you to plug in a defined number of modules.

An address is automatically assigned to each module. The addresses can be subsequently modified.

When the automation system is started, the CPU compares the setpoint configuration produced by the software with the system's actual configuration. Possible errors can be detected and reported straight away.

## Assigning parameters

"Assigning parameters" is understood to mean setting the properties of the components used. Hardware components and settings for the exchange of data are assigned:

- Properties of modules with selectable parameters
- Settings for data exchange between components

The parameters are loaded into the CPU and transferred to the corresponding modules when the CPU starts up. Modules can be replaced with ease since the parameters set are automatically loaded into the new module during startup.

## Adjusting the hardware to the project requirements

You need to configure hardware if you want to set up, expand or change an automation project. To do this, add hardware components to your structure, link these with existing components, and adapt the hardware properties to the tasks.

The properties of the automation systems and modules are preset such that in many cases they do not have to be parameterized again. Parameter assignment is however needed in the following cases:

- You want to change the default parameter settings of a module.
- You want to use special functions.
- You want to configure communication connections.

## See also

Changing properties of the modules (Page 854)

## Using existing configurations

### Open existing projects

When opening existing projects, an automatic check is made to determine if the appropriate software is installed for all modules used within the project. If you try to open a project with modules that are not supported by the current scope of the installation of the TIA portal, a message appears on opening the project informing you of the missing software components.

If the software components are not absolutely required to open the project, the project can still be opened.

### **Reaction to missing software components**

Projects that contain modules not supported by the current scope of the installation react as follows:

- Display the modules on the GUI
  - The non-supported modules are displayed in the project navigation with all of their nested objects. However, the modules themselves cannot be processed in editors or in inspector windows. When possible, a replacement module is used that best matches the original module. Replacement modules are indicated by an exclamation mark.
  - Display of properties in tables is limited. This applies in particular to the display of network parameters, such as the IP address.
- Functional limitations
  - Non-supported modules cannot be printed out or compiled.
  - An online connection cannot be established to the module. It is therefore also impossible to download.
  - To change the device type, the device must first be deleted and then re-inserted. The "Change device type" function is not supported.
  - Copying and inserting nested objects, such as modules, is possible although the device itself cannot be copied and inserted.
  - The network configuration cannot be changed with replacement modules within the network view.
  - Cross-references can be displayed. However, the cross-references only reflect the state last saved within the project because an online comparison to the original module cannot be made.

### **See also**

Opening projects (Page 259)

### **General slot rules**

#### **Introduction**

Specific slot rules apply to each automation system and module.

If you select a module from the hardware catalog in the device view, all possible slots for the module selected are marked in the rack. You can only drag modules to marked slots.

If you insert, move or swap a module, the slot rules are also applied.

## Consistency

Some slot rules depend on how the environment is configured. This means that you can sometimes plug modules into the rack although this would result in inconsistencies at the current time. If you change the configuration, for example by selecting different modules or module parameter settings, you can make the configuration consistent again.

In cases where inserting a module results in an inconsistency that can be corrected, this will be permitted. A consistency check is run when transferring the configuration. Inconsistencies are displayed as alarms in the inspector window under "Info". You can revise your configuration on the basis of the results of the consistency check and make it consistent again.

## Rules for arranging modules

As a rule of thumb, the following applies to modules in racks:

- You can only plug modules into a rack.
- You can only plug interface modules into a module.
- You can only use modules of the same product or system family in one rack.

There are also other special rules for some modules:

- Can only be inserted in certain slots
- Inertion depends on other modules, CPUs or settings
- Limitation of the number of times used in a rack

## Browsing the hardware catalog

### Introduction

Use the "Hardware catalog" task card to select the hardware components you want for a hardware configuration. Use the hardware catalog to select the interconnectable hardware components in the network and topology view and to select the modules you want in the device view.

### Context filter

You can use the "Filter" option of the hardware catalog to restrict the number of displayed hardware components and the number of hardware components that can be found by searching.

If you select the filter, only those components are displayed that can be selected currently in the hardware catalog. If the do not select the filter, the entire hardware catalog is displayed.



If you switch between the various views, the view of the filter objects is adapted to the current context.

### Search options

You can use the search function to search for specific entries in the hardware catalog. Note the following rules when entering search terms:

- No distinction is made between upper and lower case text.
- Dashes and blanks are ignored during the search.
- The search function considers parts of a search term.
- Several search terms must be separated by a space

You start the search from an object highlighted in the hardware catalog and either search upwards or downwards.

Symbol	Meaning
	Downwards search
	Upwards search

### Browsing the hardware catalog

If you want to browse the hardware catalog, proceed as follows:

1. Click in the entry field of the search function
2. Enter a search term. The search includes the following elements:
  - Name of device or module
  - Order number (MLFB)
  - Description in "Information" pane
3. Click on either the "Downwards search" or "Upwards search" buttons.

---

#### Note

To ensure the right search direction, note which point you have marked in the hardware catalog. To browse the entire catalog, click on the topmost object of the hardware catalog and start the search once you have entered the search term by clicking "Downwards search".

The first match with the search term found is displayed as the result. For more search results, again click on the "Downwards search" or "Upwards search" button.

Observe the context filter of the hardware catalog. If this is selected, the search in the hardware catalog is restricted to the displayed inserted hardware components.

---

### See also

Hardware catalog (Page 403)

Information on hardware components (Page 404)

## Working with racks

### Introduction

To assign modules to a device, you need a rack, for example a mounting rail. Secure the modules on the rack and connect these via the backplane bus with the CPU, a power supply or other modules.

### Creating a rack

If you insert a device in the network view, a station and a rack suitable for the device selected are created automatically. The rack and slots available are displayed in the device view. The number of slots available again depends on the type of device used.

### Rack structure

A rack always contains the device that has been inserted in the network view. The device is permanently assigned a slot which will depend on the type of device in question. There are additional slots on the right of the device and, if necessary, on left of the device; slot numbers are located above slots in which devices are plugged.

A corresponding short description is displayed above the plugged devices and modules. You show or hide this short description via the toolbar under "View" with the command "Display module titles" or the corresponding symbol in the toolbar of the device view (Page 393).

Symbol	Meaning
	Show module titles

When modules are selected in the hardware catalog, all the slots permitted for this module are marked. This allows you to see immediately the slot into which the selected module can be inserted.

In the following screenshot, a signal module has been selected in the hardware catalog for a partially filled S7-1200 rack:

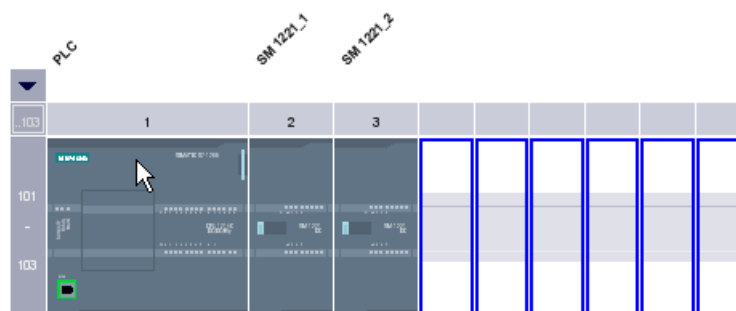

Since slots 101-103 are reserved for communications modules, only the other free slots are shown as available slots.

8.1 Configuring devices and networks

You can expand and collapse the front group of slots using an arrow symbol above the expandable slot. When the group of slots is collapsed, the first and last of the group's slot numbers are displayed.

The following figure shows the expanded slot group:

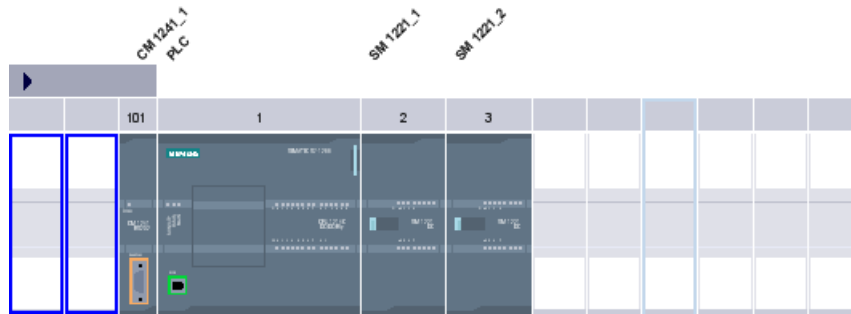

Groups of slots into which modules have already been plugged cannot be collapsed.

**Multiple selection of modules and slots**

There are various ways of selecting several modules or slots:

- By pressing <Shift> or <Ctrl>, you can select several modules or slots at the same time.
- Click outside the rack and then hold the mouse button and drag a frame to include the modules or slots you want to select.

**Objects in the device view**

A graphic display of the rack and the devices plugged into it is shown in the upper section of the device view.

You can see the device overview in the bottom part of the device view. The device overview is a table showing you the most important information about the modules inserted in the rack.

**Structure and content of device view**

The offline configuration of the devices in the rack are displayed in the graphic device view. This is a symbolic representation of the configuration on the real rack.

The rack configuration is displayed as a table in the device view. Each line in the table contains the information for assigning a slot.

The following screenshot shows the device view with the configuration of a SIMATIC S7-1200 CPU.

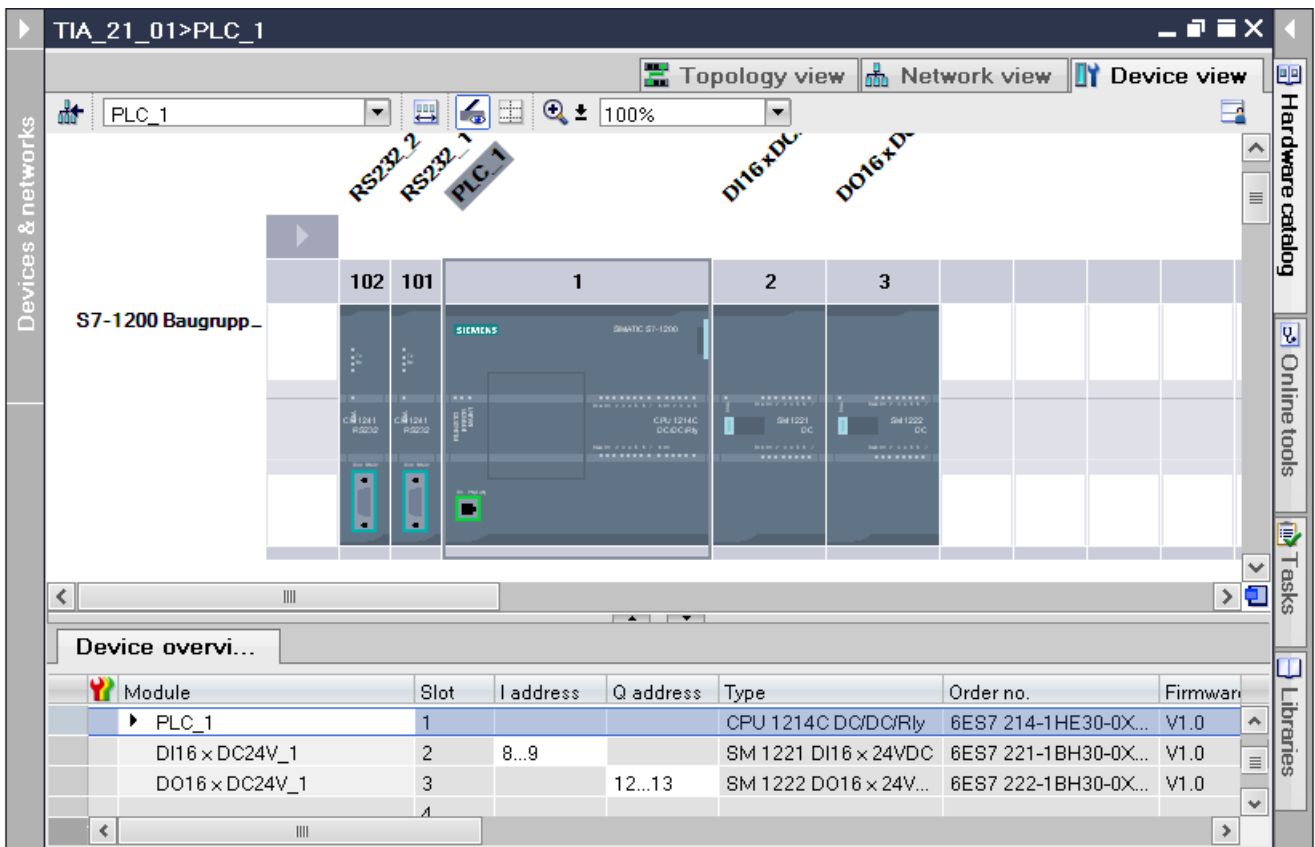

In the upper part, you can see the graphic view showing how the rack is occupied by various modules in slots 1 to 3 as well as 101. In the lower part you can see a tabular representation of the rack in the device overview.

Each line in the device overview represents one slot. The key information for each slot is displayed in the various columns:

Column	Meaning
Module	Name of module, can be edited in any way
Slot	Slot number
I address	Input address area, can be edited in any way
Q address	Output address area, can be edited in any way
Type	Catalog name of module
Order no.	Module order number
Firmware	Firmware version of module
Comments	Optional comments

**See also**

Device view (Page 393)

### Area for unplugged modules

In some cases, the modules for a hardware configuration are not assigned a slot for short periods. Such unplugged modules are moved to the area of unplugged modules, a special area in the device view.

### Adding modules to the storage area

The modules, which for example are to be assigned to a device using a copy action but for which the corresponding rack does not have a free compatible slot, are moved automatically into the area of unplugged modules.

Under the following conditions, modules are automatically added to the area of unplugged modules:

- In the network view, a module is moved to a device but the rack does not have a compatible free slot.
- In the device view, a module is moved from the rack, the hardware catalog or the project tree straight into the storage area.

CPs and FMs which occupy a network resource can be moved into the area for unplugged modules but will lose the network resources they have been assigned.

You can add modules to the area of unplugged modules by means of drag-and-drop, for example. To do this, the area must be opened.

### Using the area of unplugged modules

Use the corresponding button to open the area of unplugged modules.

You can find the area of unplugged modules in the device view.



You open the area of unplugged modules with the respective symbol in the toolbar of the device view (Page 393).

Symbol	Meaning
	Open area of unplugged modules

#### Note

To free up slots, move modules from your configuration into the storage area and plug the modules you want from the storage area into the freed up slots.

You can use this approach to temporarily move modules that have already been parameterized out of the configuration without deleting them.



## Treatment of modules in the storage area

The following rules apply to modules in the storage area:

- The modules appear in the project tree under the corresponding device in the "Local modules" folder.
- The modules retain all settings and parameters previously provided.
- The modules are not taken into account when downloading to a target system so a consistency check is not undertaken for modules in the area of unplugged modules.
- Using the context menu, the modules can be copied, pasted or deleted, for example.

### 8.1.2.2 Configuring individual devices

#### Selecting a CPU

##### Introduction

Select a CPU from the hardware catalog and place it, together with a rack, in the network view. On this device drag the desired modules from the hardware catalog; they are arranged automatically on the rack.

##### Selecting the components in the hardware catalog

Each hardware component is displayed as a folder in the hardware catalog. When you open this folder you will see the different versions of the selected hardware component with its respective order numbers.

There will be an example of how to set up a CPU with a rack in network view.

##### Requirement

- The hardware catalog is open.
- You must be in the network view.

##### Procedure

To select a CPU from the hardware catalog, proceed as follows:

1. In the hardware catalog navigate to the folder with the desired CPUs.
2. Open the folder with the desired CPU type; you will see all order numbers for the selected CPU type.

3. Click on a CPU order number to get information about the selected CPU under "Information" pane.

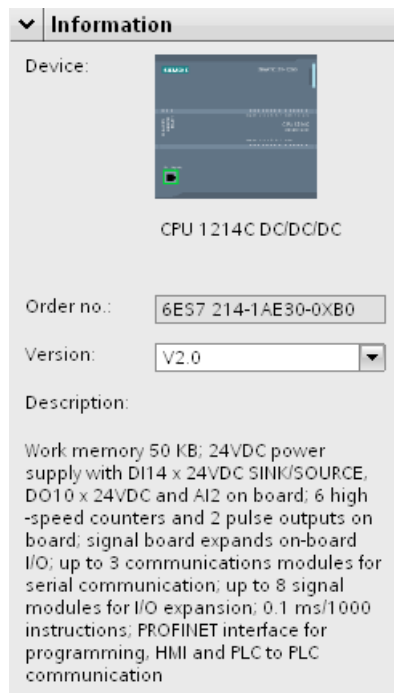

4. Set up the CPU and a rack. You have the following options:
  - Use drag-and-drop to drag the CPU from the hardware catalog into network view.
  - Use Copy & Paste to copy the CPU to the network view.
  - Double-click the CPU entry in the hardware catalog.

## See also

Browsing the hardware catalog (Page 411)

Adding a device to the hardware configuration (Page 419)

Inserting a module into a rack (Page 422)

Working with racks (Page 413)

Creating an unspecified CPU (Page 420)

Information on hardware components (Page 404)

## Adding a device to the hardware configuration

### Introduction

There are various ways of adding a connectable device from the hardware configuration in the network view and the topology view:

- Command "Add new device" in the project tree
- Double-click device in hardware catalog
- Drag-and-drop from the hardware catalog in network view or in topology view:
  - Text entry from the "Catalog" pane
  - Preview graphic from the "Information" pane
- "Add > Device" command from menu bar in network view or topology view
- Shortcut menu of a device in the hardware catalog for copying and pasting

A suitable rack is created along with the new device. The selected device is inserted at the first permitted slot of the rack.

Regardless of the method selected, the added device is visible in the project tree and the network view of the hardware and network editor.

### Adding device using the project tree

To use the project tree to add a device to the hardware configuration, proceed as follows:

1. Click on the command "Add new device" in the project tree.  
The "Add new device" dialog box opens.
2. Display the required device in the tree structure:
  - Go to required device in the tree structure.
  - Enter a device name in the entry field.
3. Select the required device from the tree.  
More information about the device presently selected is displayed on the right-side of the dialog box.
4. If necessary, set the firmware version using the drop-down list in the dialog box.
5. Select the "Open device view" check box if you want to change to the device view immediately after adding the device.  
There you can immediately continue with device configuration and equipping the rack.
6. Click on "OK" to add the device selected.  
The dialog box closes.

### Adding device from the hardware catalog

To add a device to the hardware configuration using the hardware catalog, proceed as follows:

1. Open the network view or the topology view.
2. Open the hardware catalog.

3. Go to the required device in the hardware catalog.
4. Click on the chosen device to select it.
5. If necessary, set the firmware version using the drop-down list in the hardware catalog.
6. Drag the device to the network view or the topology view.

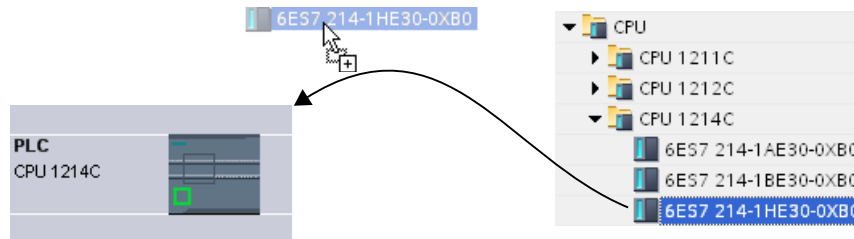

You have now placed the device in the network view or in the topology view. The displayed rectangle (in other words "Station") symbolizes the plugged device together with its rack and any lower-level modules. Double-click on the device or station to open the device view and view the new rack and inserted device. In the next steps, you can configure the device in the device view and equip the rack with modules.

## See also

- Network view (Page 391)
- Creating an unspecified CPU (Page 420)
- Information on hardware components (Page 404)
- Topology view (Page 396)

## Creating an unspecified CPU

### Introduction

If you have not yet selected a CPU but have already started programming or want to use an existing program, you have the option of using an unspecified CPU. You can also adjust some settings with unspecified CPUs. The setting options are restricted to parameters that all CPUs of the same CPU family have in common.

### Creating an unspecified CPU in the portal view

To create an unspecified CPU in the portal view, follow these steps:

1. Now, click one of the following options:
  - "Devices & networks > Add new device"
  - "PLC programming" > "Device" button
2. For a device family, select an unspecified CPU from the tree structure of the "Add new device" dialog.
3. Click on "Add".

An unspecified CPU is created and the device view for this CPU appears.

### Further options for creating unspecified CPUs

In the project view, you can create unspecified CPUs like specified CPUs:

- Using the "Add new device" button in the project tree
- In the "Hardware catalog" task card

You can also use these methods to create multiple unspecified CPUs.

### Specifying unspecified CPUs

You have two options for specifying unspecified CPUs:

- Use drag-and-drop to assign an existing CPU from the hardware catalog to an unspecified CPU by means of module replacement (Page 427).
- Select a selected, unspecified CPU and then the menu command "Online > Hardware detection" and assign a CPU identified online. For this purpose, you assign an IP address using the "Add address for PG/PC" button.

---

#### Note

If you want to go online after the hardware detection, you have to first download the detected configuration to your project; otherwise, an error may occur due to inconsistent configurations. After hardware detection, the order numbers of the CPU in the project and the actually existing CPU are identical, but their parameters are not. The parameters of the CPU in the project have the default values; the parameters of the actually existing CPU have the values set by you.

---

### See also

Selecting a CPU (Page 417)

Adding a device to the hardware configuration (Page 419)

## Inserting a module into a rack

### Introduction

Once you have added devices from the hardware catalog to your configuration in network view, you can add modules to the devices. There are various ways of adding a module to a rack in the device view:

- If there is an available valid slot, double-click a module in the hardware catalog.
- Use drag-and-drop to move the module from the hardware catalog to an available valid slot in the graphic or table area:
  - Text entry from the "Catalog" pane
  - Preview graphic from the "Information" pane
- Select "Copy" in the shortcut menu for a module in the hardware catalog and then select "Paste" in the shortcut menu on an available valid slot in the graphic or table area.

To access the device view from the network view, double-click a device or station in the network view or select the Device view tab. The device view contains an illustration of the device selected within a rack. The graphic illustration of the rack in the software corresponds to the real structure, i.e. you can see the same number of slots as exist in the real structure.

---

#### Note

You can also move a module to a rack in the network view. The filter function for the hardware catalog must be deactivated in this instance. The module is automatically plugged into a free and permitted slot. If there are no slots available, the module will be moved to the area of unplugged modules (Page 416).

---

## Equipping a rack

Arrange the modules on a rack according to the applicable slot rules.

After a module has been inserted in a rack with an already inserted CPU, the address areas are checked automatically so that addresses are not assigned twice. After it has been inserted, each module then has one valid address range. To do so, DP slaves and IO devices must be networked with a CPU via the corresponding DP master or IO system.

## Requirements

- You are in the device view.
- The hardware catalog is open.

## Adding module from the hardware catalog

How to insert a module from the hardware catalog into a rack is illustrated based on the example of a signal module. To do this, follow these steps:

1. Go to the required module board in the hardware catalog.

### Note

If you activate the filter function of the hardware catalog, only those modules which match the selected device type will be displayed.

2. Select the chosen module.
3. If necessary, set the firmware version using the drop-down list in the hardware catalog.
4. Drag the signal module to a free slot in the rack.

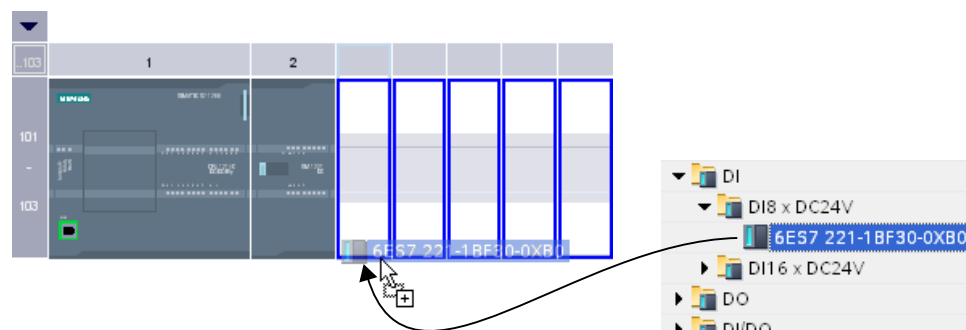

You have now inserted the digital signal module in a slot in the rack. Repeat these steps with the other modules.

The name of the module is displayed above the inserted modules. You can activate or deactivate module labeling in the menu bar with "View > Show module labels".

## Inserting module

You can also drag modules and drop them between modules that have already been inserted. To do this, drag a module above and between the two existing modules while holding down the mouse button.

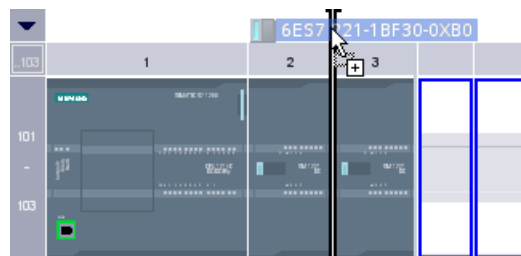

A mouse pointer appears. When you release the mouse button, all modules plugged to the right of the pointer are moved one slot to the right. Any redundant modules are moved to the area of unplugged modules. The new module is plugged at the point of the freed up slot.

## See also

- Device view (Page 393)
- Area for unplugged modules (Page 416)
- Information on hardware components (Page 404)
- General slot rules (Page 410)

## Deleting a hardware component

There are various ways of deleting hardware components. Deleted hardware components are removed from the system and assigned addresses made available again.

## Rules

- CPUs or modules from the rack and from the area of unplugged modules can be deleted.
- When a rack is deleted in the device view the plugged hardware components are moved to the area of unplugged modules.

## Procedure

Proceed as follows to delete a hardware component:

1. Select the hardware components you want to delete.
  - Network view: Select devices or network relevant hardware components in the graphic view or in the network view.
  - Device view: In the graphic view or device overview, select racks or modules in racks or in the area of unplugged components.
  - Topology view: Select devices or hardware components with Ethernet interfaces in the graphic view or in the topology view.
  - Project tree: Select devices or individual hardware components from the tree structure.
2. Select "Delete" from the shortcut menu or press <Del>.  
If the "Delete" menu item is unavailable, your selection contains at least one component that cannot be deleted.

The selected hardware components are deleted.

---

### Note

Deleting hardware components may result in inconsistencies in the project, for example infringement of slot rules. Inconsistencies are reported during the consistency check. Correct the inconsistencies by taking appropriate action, for example, make sure that slot rules are kept to.

---

## See also

- Keyboard operation: Editing objects (Page 407)



## Copying a hardware component

You can copy hardware components in the device or network view. Copied hardware components are stored on a clipboard and can be pasted at another point from this clipboard. Copied stations are pasted as new stations in the network view. Copied devices and modules can be pasted into existing racks in the network and device view.

## Rules

- Single objects as well as several objects can be copied at the same time.
- Modules inserted in the rack and in the area of unplugged modules can be copied.
- You can only copy devices and modules to free and valid slots in keeping with the slot rules.
- Racks with a CPU inserted cannot be copied individually, but only as complete units along with all inserted hardware components.

## Procedure

Proceed as follows to copy a hardware component:

1. Select the hardware components you want to copy.
  - Device view: Select the module in a rack or put it in the area of unplugged modules.
  - Network view: Select the station or the relevant hardware component from the network view.
  - Project tree: Select the station or module.
2. Select "Copy" from the shortcut menu or press <Ctrl+C>. If the "Copy" menu item is unavailable, your selection contains at least one component that cannot be copied.
3. Select the location at which the content of the clipboard is to be pasted.
  - Device view: Select a free slot in the rack or area of unplugged modules.
  - Network view: Select a station where you want to insert devices or modules or move the mouse pointer to a free location in the network view to paste a copied station or a hardware component relevant to the network view.
4. Select "Paste" from the shortcut menu or press <Ctrl+V>. If the "Paste" menu item is unavailable, the clipboard is empty or contains at least one component that cannot be pasted at this point.

The selected object is pasted at the chosen point.

## 8.1 Configuring devices and networks

Once you have selected a station where you want to insert a module in the network view, the module is inserted in the first free and valid slot. If no free, valid slots are available, the object is inserted in the area of unplugged modules.

---

### Note

You can also copy a module from one device to another:

To do so, copy a module in the hardware and network editor, select a different device in the network view or the drop down list of the device view and insert the module.

You can insert the copied object directly in a slot or place it in the area of unplugged modules in the device view. If you add the copied object in the network view of a device or a station, it will be inserted in the first available slot.

If there is no slot available for the object, it is automatically placed in the area of unplugged modules (Page 416).

---

### Note

You can use <Ctrl> and drag-and-drop to directly copy a selected hardware component.

---

## See also

Keyboard operation: Editing objects (Page 407)

## Moving a hardware component

You can move hardware components in the device or network view.

## Rules

- You can move devices and modules from the rack and the area for unplugged modules taking the slot rules into consideration.
- CPs can be moved in the network view. The CP is plugged in a free and valid slot in the target device. If there are no free slots available, the CP to be inserted is moved to the area for unplugged modules.
- In the network view, CPU and slave head modules can be moved between the devices; depending on CPU type also within the rack.

---

### Note

Moved CPs are disconnected from their network but keep their network parameters and address. If you reconnect the CP to the network and its address has been assigned, use a dialog to assign a new unique address to the CP.

---

## Procedure

Proceed as follows to move a hardware component:

1. Select the hardware component you want to move.
  - Device view: Select the module in a rack or put it in the area of unplugged modules.
  - Network view: Select the hardware component of relevance to the network view.
2. Select "Cut" from the shortcut menu or press <Ctrl+X>.  
If the "Cut" menu item is unavailable, your selection contains at least one component that cannot be cut.
3. Select the location to which the cut object is to be moved.
  - Device view: Select a free slot in the rack or area of unplugged modules.
  - Network view: Select a station where you want to insert devices or modules.
4. Select "Paste" from the shortcut menu or press <Ctrl+V>.  
If the "Paste" menu item is unavailable, the clipboard is empty or contains at least one component that cannot be pasted at this point.

The selected hardware component is moved to the target. If the hardware component being moved is a networked object, it is disconnected from the network.

---

### Note

You can use drag-and-drop to directly move a selected hardware component.

---

## See also

Keyboard operation: Editing objects (Page 407)

## Replacing a hardware component

You can replace hardware components with others. This, for example, allows you to replace unspecified CPUs (Page 420) with available CPUs from the hardware catalog.

## Rules

You can only replace hardware components if they support module replacement and if the two components are compatible.

## Procedure

To replace one module with another, proceed as follows:

1. Select the module you want to replace.
2. Open the shortcut menu:
  - If the "Replace device" entry is enabled, the module can be replaced.
  - If the "Replace device" entry is disabled, a module cannot be replaced.

### 8.1 Configuring devices and networks

3. Click on "Replace device" in the shortcut menu. ### The "Replace device" dialog box appears.
4. Under "New device" in the tree structure, select the module with which you want to replace your current module.
5. Click "OK".

The existing module is replaced by the new one.

As an alternative, you can take a module by dragging it from the hardware catalog to the module you are replacing. If the module can be replaced by the selected module, this is indicated by the mouse pointer symbol.

### Editing properties and parameters

Once you have inserted hardware components in your rack, you can edit their default properties, for example parameters or addresses in the network or device view.

### Requirement

You are in the device view.

---

#### Note

You can also edit properties and parameters in the network view. In the graphic network view, you have access to the network-related hardware components and the station. You can access modules and hardware components not displayed in the graphic network view using the table network view.

---

### Procedure

To change the properties and parameters of the hardware components, proceed as follows:

1. In the graphic view, select the CPU, module, rack or interface you want to edit.
2. Edit the settings for the selected object:
  - Use the table view to edit addresses and names, for example.
  - In the Inspector window additional setting possibilities are available in "Properties".

Note that modules can only be fully parameterized if they are assigned to a CPU. Therefore, PROFIBUS or PROFINET interfaces modules must first be networked with the CPU or a centrally inserted communication module so that they form a master system or IO system. Only then is it possible, for example, to edit the addresses of the distributed components that are inserted.

### Example of changing settings

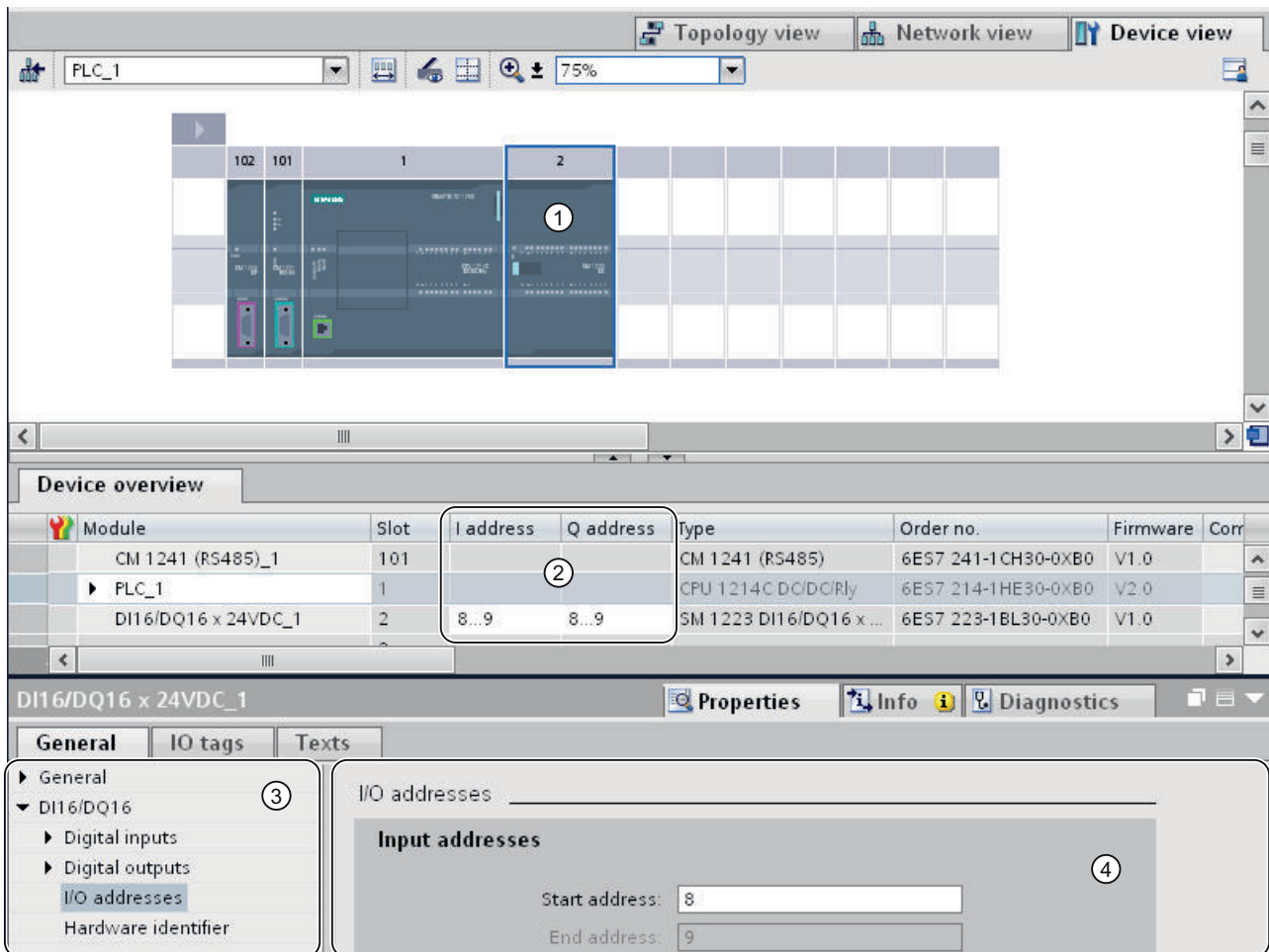

- ① Selection of a module
- ② Editing option for addresses in the device overview
- ③ Selection options in the inspector window
- ④ Editing option for addresses in the inspector window

### See also

Inspector window (Page 401)

## Input and output addresses in the address overview

### Introduction

The currently used input and output addresses can be displayed in the address overview in a table form. The address overview can be found in the inspector window under "Properties" of the CPU.

### Design of the address overview

With the different check boxes, you can set which objects should be displayed in the address overview:

- Inputs: Display of the input addresses
- Outputs: Display of the output addresses
- Address gaps: Display of open address spaces
- Slot: Display of the slot number

The following information is typically shown in the address overview:

Table header	Meaning
Type	Indicates whether the area is an input address area or an output address area.
Address from	Start address in the address range.
Address to	End address in the address range.
Module	Modules using the address area.
PIP	Number of the process image partition. Shows if the cyclical OB in the process image partition.
DP	Number of the master system. You can use the number to determine which slaves are assigned to a master. The value in brackets specifies the PROFIBUS address of the hardware component.
PN	Number of the IO system. The value in brackets stands for the device number of the hardware component.
Racks	Rack number on which the hardware component is inserted.
Slot	Slot number on the rack in which the hardware component is inserted.

### See also

Specifying input and output addresses (Page 638)

## Update module version

### Explanation of terms

The terms "Module version" and "Firmware version" are explained in more detail in the following section.

- **Module version:** The specific version of the configuration software from which the module description stems.  
Example: V11.0.0.0
- **Firmware version:** The version of the firmware of the offline configured module  
Example: V2.0

### Requirement

- You have created a device configuration.
- You have installed an update or an optional package at a later date. As a result of this installation, the module version of at least one module type was updated in the hardware catalog, whereby the new version is incompatible with the previous version.
- You have used such modules in your device configuration and want to use the modified or added properties.

### Procedure

Perform the following step for each affected module type.

1. Select the affected module in the device view.
2. In the inspector window, go to "Properties > General > Catalog Information". Click the "Update module version" button there.
3. In the query that then appears, specify whether you want to update the module version only for the selected module or for all modules of this type in the current project.

### Result

The selected modules are replaced by the same modules with updated module version in the the current project.

### In which cases is it unnecessary to update the module version?

An updating of the module version is not necessary in the following cases:

- You do not want to used the modified or added properties of the modules.
- You open an existing project with a version of the configuration software that is more recent than the version with which you created the project and the system automatically performs a project conversion, for example, from V11 to V12. In this case, all older module versions are automatically adapted.

### **8.1.3 Configure networks**

#### **8.1.3.1 Networking devices**

## **Communication and networks**

### **Communication between devices**

The basis of all types of communication is always a previously configured network. The network configuration provides the necessary requirements for communication:

- All the devices in a network are provided with a unique address
- Communication of the devices with consistent transmission properties

### **Network configuration**

The following steps are necessary when configuring networks:

- Connect devices to subnet
- Specify the properties/parameters for each subnet
- Specify the device properties for every networked module
- Download configuration data to the devices to supply interfaces with the settings resulting from the network configuration
- Document the network configuration

For Open User Communication, creating and configuring a subnet is supported by the assignment of connection parameters.

### **Relation between network configuration and project**

Within a project, subnets and their properties are managed. Properties result mainly from adjustable network parameters and the quantity and communication properties of the connected devices.

The devices to be networked must be in the same project.

### **Subnet name and subnet ID**

Within the project, subnets are clearly identified by a subnet name and ID. The subnet ID is saved in all components along with interconnectable interfaces. Components can then be clearly assigned to a subnet even after uploading into a project.



## Networking options

In the project, you can create and network devices with components capable of communication. The following basic options are available for networking the devices:

- You link the interfaces of the components capable of communication with one another. A new subnet is created suitable for the type of interface.
- You connect the interface of the devices capable of communication with a new or existing subnet.
- You create an Open User Communication connection. When you assign parameters to the connection for Open User Communication, a subnet is created automatically between the communication partners.
- You use the graphic connection configuration to configure connections; missing networks are hereby recognized and are created either automatically or via dialog.

Due to the different tasks of the devices or the span of the plant, you may need to use several subnets. These subnets are managed in a project.

## Networking devices in the network view

### Options

In the graphic network view, you have an overview of the subnets of the entire system in the project. You can use the tabular network overview for additional support.

Depending on the starting situation, there are various ways of undertaking configuration to network the interface for a component capable of communication. The procedures are described in the following section:

- Creating an individual subnet
- Creating several subnets at one time
- Connecting two target devices via a new subnet
- Connecting devices to existing subnet
- Selecting an existing subnet from a list
- Automatic networking during the configuration of the connection;  
See also: Auto-Hotspot

Possible starting situations are:

- A suitable subnet is not yet available.
- The subnet with which you want to connect the component already exists.

### Procedure - creating a single subnet

To create a subnet and to connect it to an interface, proceed as follows:

1. Select the interface of a CPU / a CP.
2. Select the "Create subnet" command in the shortcut menu of the interface.

The selected interface is connected to a new subnet. Consistent address parameters are set automatically for the interface.

The following schematic shows an interface with outgoing line connecting to a subnet:

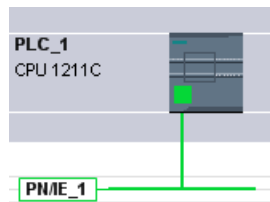

### Procedure - creating several subnets at one time

To create several subnets at one time, proceed as follows:

1. Select several interfaces by clicking on them while pressing the <Ctrl> button.
2. Select the "Create subnet" command in the shortcut menu of the interface.

Each selected interface is connected to a new subnet. Consistent address parameters are set automatically for the interface.

The following figure shows multiple subnets created by selecting multiple interfaces:

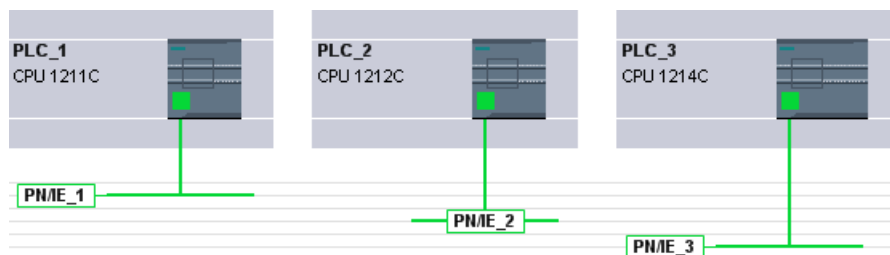

### Procedure – Connecting two target devices via a new subnet

To connect an interface with another device via a subnet that does not yet exist, proceed as follows:

1. Position the mouse pointer over the interface for a component capable of communication requiring networking.
2. Click with the left mouse button and hold the button down.
3. Move the mouse pointer.  
The pointer now uses the networking symbol to indicate "Networking" mode. At the same time, the mouse pointer shows the lock symbol that will only disappear when the pointer is on a valid target.

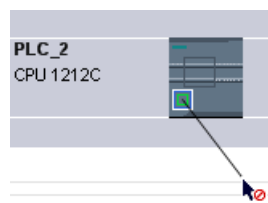

4. Now move the pointer onto the interface of the target device. You can either keep the mouse button pressed or release it.
5. Now release the left mouse button or press it again (depending on previous action).

A new subnet is created. The interfaces are now connected via the new subnet. Consistent address parameters are set automatically for the interface.

The following schematic shows two networked devices:

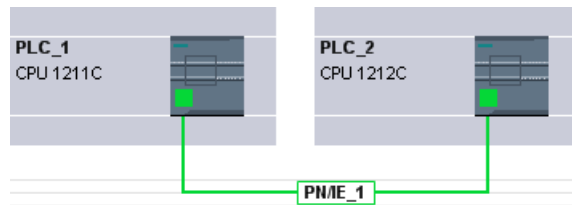

### Procedure - Connecting devices to existing subnet

To connect an interface to an existing subnet, proceed as follows:

1. Position the mouse pointer on the interface of a communications-compliant component you want to network or on the existing subnet.
2. Click with the left mouse button and hold the button down.
3. Move the mouse pointer.  
The pointer now uses the networking symbol to indicate "Networking" mode. At the same time, the mouse pointer shows the lock symbol that will only disappear once the pointer is moved to a valid target.
4. Now move the mouse pointer to the existing subnet or to the interface to be networked. You can either keep the mouse button pressed or release it.

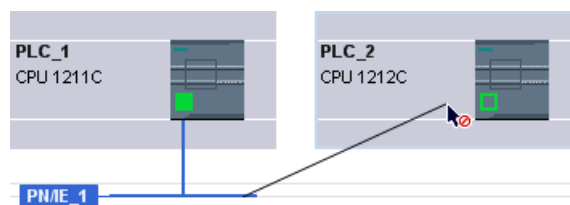

5. Now release the left mouse button or press it again (depending on previous action).

Result:

The interface and selected subnet are now connected. Consistent address parameters are set automatically for the interface.

### **Procedure - selecting an existing subnet from a list**

To link an interface with a subnet that has already been created, proceed as follows:

1. Select the interface of a CPU.
2. Select the "Assign to new subnet" command in the shortcut menu of the interface.  
A list box containing the available subnets appears.
3. Select a subnet from the list.

The interface and selected subnet are now connected. Consistent address parameters are set automatically for the interface.

### **Tabular network overview**

#### **Meaning**

The tabular network overview adds the following functions to the graphic network view:

- You obtain detailed information on the structure and parameter settings of the devices.
- Using the "Subnet" column, you can connect components capable of communication with created subnets.

#### **Basic functions for tables**

The network overview supports the following basic functions for editing a table:

- Displaying and hiding table columns  
Note: The columns of relevance to configuration cannot be hidden.
- Optimizing column width
- Sorting table
- Displaying the meaning of a column, a row or cell using tooltips.

### **Networking devices in the device view**

#### **Networking in the device view**

In the device view, you can check and set all the parameters of the components belonging to a device and the interfaces in detail. Here you can also assign the interfaces to the subnets created in the project.

#### **Requirements**

- The subnet with which you want to connect an interface has already been created.
- If the subnet has not yet been created, change to the network view and make the settings required for networking.

### **Procedure - connecting to an existing subnet**

To connect an interface to an existing subnet, proceed in the device view as follows:

1. Select the entire communications-compliant component or the interface to be networked. The properties of the selected interface or component are displayed in the Inspector window.
2. In the Inspector window, select the parameter group for the selected interface; for example, the "Ethernet addresses" parameter group for a PROFINET interface.
3. Select the subnet to be connected from the "Interface connected with" drop-down list.

The interface and selected subnet are now connected. Consistent address parameters are set automatically for the interface.

### **Procedure - creating a new subnet**

To create a subnet and to connect it to the interface, proceed as follows in the device view:

1. Select the entire communications-compliant component or the interface to be networked. The properties of the selected interface or component are displayed in the Inspector window.
2. In the Inspector window, select the parameter group for the selected interface; for example, the "Ethernet addresses" parameter group for a PROFINET interface.
3. In "Interface connected with", click the "Add new subnet" button.

The interface is connected to a new subnet of the appropriate subnet type. Consistent address parameters are set automatically for the interface.

## **Checking or changing network parameters and interface parameters**

### **Introduction**

Communication between networked devices requires the following parameters to be configured:

- **Network parameters**  
Network parameters identify the network within the system configuration, for example, using a name.
- **Interface parameters**  
Interface parameters define specific properties of a component capable of communication. Addresses and transmission characteristics are set automatically and are consistent with the network parameters.

---

#### **Note**

Network parameters and interface parameters are usually set during networking such that communication can take place for numerous applications without the parameters having to be changed.

---

### **Procedure - checking or changing network parameters**

Proceed as follows to check or change network parameters:

1. Enter the network view.
2. Select the subnet from the network view.  
You can see the network parameters in the "Properties" tab in the inspector window.
3. If necessary, check or modify the network parameters in the relevant group of parameters.

### **Procedure - checking or changing interface parameters**

You can check and modify interface parameters in the network and device view.

Proceed as follows to check or change interface parameters:

1. Enter the network view or device view.
2. Select the interface.  
You can see the interface parameters in the "Properties" tab in the inspector window.
3. If necessary, check or modify the interface parameters in the relevant group of parameters.

## **Changing networkings**

### **Introduction**

You can cancel an interface's network connection or assign it to another subnet of the same subnet type.

### **Consequences**

Depending on the version, a distinction should be made between:

- Canceling a network connection for an interface  
The configured parameters for the interface remain unchanged.
- Assigning a network connection to another subnet  
If the addresses in the assigned subnet are not unique, in other words, they already exist, they will be changed automatically to make them unique.

## Procedure - disconnecting from a network

Proceed as follows to cancel the network connection for an interface:

1. Select the networked interface.

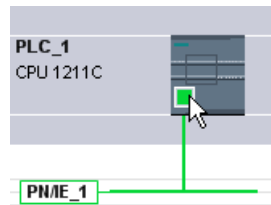

2. Select the "Disconnect from subnet" command in the shortcut menu of the interface.

The network connection is deleted, the interface addresses are, however, not changed.

Configured connections are retained; however these connections are marked red in the connection table because they are not networked. Specified connections remain specified.

## See also

Networking devices in the network view (Page 433)

## Copying, cutting or deleting subnets

### Introduction

You can copy subnets as individual objects or copy them along with networked devices or other networks.

For example, you can create complex configurations to be used more than once in different variants within the project with no additional effort.

### Effects on the copied subnet

Properties that have to be assigned explicitly within a project are re-assigned appropriately when the copied objects are copied.

For subnets, this means: The subnet ID and name are re-assigned to the copied subnet.

The configured properties are adopted in the copied subnet.

## Procedure - copying a subnet

Proceed as follows to copy one or more subnets:

1. Select one or more subnets.
2. In the shortcut menu, select the "Copy" command.
3. Select the "Paste" command in the shortcut menu.

The copied subnets are shown as "orphaned" subnets in the top part of the network view.

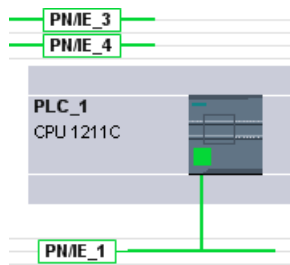

### Procedure - copying a subnet with connected devices

To copy one or more subnets with networked devices, proceed as follows:

1. Select one or more subnets with the connected devices, for example by drawing a lasso around them.
2. In the shortcut menu, select the "Copy" command.
3. Select the "Paste" command in the shortcut menu.

Complete copies of the subnets and connected devices are created.

Configured connections are adopted and remain within the copied devices. Connections to devices that have not been copied are interrupted and become unspecified.

### MPI network configuration

#### Allocating MPI addresses

Note the following for devices with an MPI interface: All devices of a subnet must have different device addresses.

CPUs with MPI address ship with the default MPI address 2. Since you can only use this address once in the MPI subnet, you will have to change the default address in all other CPUs.

The following applies to devices with the order no. 6ES7 3xx-xxxx-0AB0:

When planning the MPI addresses for several CPUs, you have to fill "MPI address gaps" for FMs and CPs with separate MPI addresses to prevent addresses being assigned twice.

Only when all the modules in a subnet have different addresses and your actual structure matches that of the network configuration produced, should you load the settings across the network.

#### Rules for assigning the MPI address

- Allocate the MPI addresses in ascending order.
- Reserve MPI address 0 for a programming device.
- You can link up to 126 (addressable) devices with one another in an MPI subnet; up to 8 devices at a transfer speed of 19.2 KB/s.
- All MPI addresses in an MPI subnet must be different.



You will find other rules relating to the structure of a network in the manuals for setting up automation systems.

## **PROFIBUS network configuration**

### **PROFIBUS addresses**

#### **Rules for the network configuration**

All the devices in a subnet must have a different PROFIBUS address.

Only when all the modules in a subnet have different addresses and your actual structure matches that of the network configuration produced, should you load the settings across the network.

You can connect devices to the PROFIBUS subnet that communicate via configured connections or that belong to a PROFIBUS DP master system.

You can find more information on configuring a DP master system in the following sections.

#### **Requirements**

The 121xC CPU is PROFIBUS compatible as of firmware version 2.0.

#### **Rules for assigning PROFIBUS addresses**

- Allocate the PROFIBUS addresses in ascending order.
- Reserve the PROFIBUS address "0" for a programming device.
- Allocate a unique PROFIBUS address between 0 and 126 for each device on the PROFIBUS network and/or for each DP master and each DP slave in the PROFIBUS network.
- There are modules with which the smallest address that can be set has to be greater than 1.
- All PROFIBUS addresses of a PROFIBUS subnet must be different.

You will find additional rules relating to the structure of a network in the manuals for setting up automation systems, for example SIMATIC S7-1200.

---

#### **Note**

##### **PROFIBUS address "0"**

Reserve PROFIBUS address "0" for a programming device that you will briefly connect up to the PROFIBUS network at a later date for servicing.

---

#### **See also**

What you need to know about PROFIBUS bus parameters (Page 442)

## What you need to know about PROFIBUS bus parameters

### Matching parameters to one another

The PROFIBUS subnet will only function without problem if the parameters for the bus profile are matched to one another. You should therefore only change the default values if you are familiar with how to configure the bus profile for PROFIBUS.

---

#### Note

It may be possible for the bus parameters to be adjusted depending on the bus profile. If the bus parameters cannot be adjusted, they are grayed out. The offline values of the bus parameters are always shown even if you are online and linked to the target system.

---

The parameters shown apply to the entire PROFIBUS subnet and are briefly explained below.

### Activating cyclic distribution of the bus parameters

If the "Enable cyclic distribution of the bus parameters" check box is selected under "Bus parameters" while PROFIBUS subnet is selected in the Inspector window, the bus parameters are transferred cyclically during operation by the modules that support this function. This allows a programming device, for example, to be easily connected to the PROFIBUS in runtime.

You should deactivate this function:

- For a heterogeneous PROFIBUS subnet (or more accurately: when external devices are connected whose protocol uses the DSAP 63 for Multicast)
- When in constant bus cycle time mode (minimize bus cycle)

### Bus parameters for the bus profile of PROFIBUS subnets

Bus parameter	Adjustable?	Limit values
Tslot_Init	Yes	Max. Tsdr + 15 <= Tslot_init <= 16.383 t_bit
Max. Tsdr	Yes	35 + 2*Tset + Tqui <= Max. Tsdr <= 1.023 t_bit
Min. Tsdr	Yes	11 t_bit <= Min. Tsdr <= MIN(255 t_bit, ... ... Max. Tsdr - 1, 34 + 2*Tset + Tqui)
Tset	Yes	1 t_bit <= Tset <= 494 t_bit
Tqui	Yes	0 t_bit <= Tqui <= MIN(31 t_bit, Min. Tsdr - 1)
GAP factor	Yes	1 <= GAP factor <= 100
Retry limit	Yes	1 <= Retry limit <= 15
Tslot	No	---
Tid2	No	Tid2 = Max. Tsdr
Trdy	No	Trdy = Min. Tsdr
Tid1	No	Tid1 = 35 + 2*Tset + Tqui
Ttr	Yes	256 t_bit <= Ttr <= 16.777.960 t_bit

Bus parameter	Adjustable?	Limit values
Ttr typical	No	This time is provided for information only and is not transferred to the nodes.
Response monitoring		10 ms ≤ response monitoring (watchdog) ≤ 650 s

If you want to create a customized bus profile, we recommend the following settings:

- Minimum target rotation time (Ttr) = 5000 x HSA (highest PROFIBUS address)
- Minimum response monitoring (watchdog) = 6250 x HSA

## Recalculating

You can use the "Recalculate" button to recalculate the parameters.

## See also

PROFIBUS addresses (Page 441)

Description of the bus parameters (Page 443)

## Description of the bus parameters

### Detailed description of PROFIBUS bus parameters

Bus parameter	Meaning
Tslot_Init	The wait-for-reception (slot time) defines the maximum time the sender will wait to receive a response from the addressed partner. If the influence of the line components on message frame run times is entered in the "Cable Configuration" parameter group, these components must also be taken into account. The component is added to the specified Tslot_Init and the total used as Tslot.
Max. TsdR	The maximum protocol processing time defines the latest time by which the responding node should have replied.
Min. TsdR	The minimum protocol processing time defines the earliest time by which the responding node may reply.
Tset	The trigger time is the time which may lapse between the reception of a data message frame and the response to it in the node.
Tqui	The modulator quiet time is the time which a sending node needs after the end of the message frame to switch from sending to receiving.
GAP factor	The GAP update factor defines the number of token rotations after which a newly added, active node can be added to the logical token ring.
Retry limit	This parameter defines the maximum number of attempts (message frame repeats) made to reach a node.
Tslot	The wait-for-reception time (slot time) defines the maximum time the sender will wait to receive a response from the addressed partner.  If the influence of the bus design components on message frame run times is entered in the "Cable Configuration" parameter group, these components must also be taken into account. The component is added to the specified Tslot_Init and the total used as Tslot.

Bus parameter	Meaning
Tid2	Idle time 2 defines the earliest time by which a sending node may send the next message frame after sending a message frame that has not been acknowledged.
Trdy	The ready time specifies the earliest time by which a sending node may receive a response message frame.
Tid1	Idle time 1 defines the earliest time by which a sending node may send the next message frame after receiving a response.
Ttr	The target rotation time is the maximum time made available for a token rotation. During this time, all active nodes (DP masters etc.) have the right to send (token) once. The difference between the target rotation time and the actual token holding time of a node determines how much time is left over for the other active nodes (programming device, other DP masters etc.) to send message frames.
Ttr typical	The typical data cycle time is the average response time on the bus if all configured slaves are exchanging data with the DP master. None of the slaves report diagnostics and there is no extra message frame traffic with programming devices or other active nodes etc. on the bus.
Response monitoring	The response monitoring time is only needed for PROFIBUS-DP bus systems. It defines the latest time by which a DP slave has to be addressed by its DP master with a new data message frame. If this does not happen, the DP slave assumes that the DP master has failed and resets its outputs to a secure mode.

**See also**

What you need to know about PROFIBUS bus parameters (Page 442)

**Bus profiles with PROFIBUS**

**Introduction**

Depending on the device types connected and protocols used on the PROFIBUS, different profiles are available. The profiles differ in terms of the setting options and calculation of bus parameters. The profiles are explained below.

**Devices with different profiles on the same PROFIBUS subnet**

The PROFIBUS subnet only functions without problem if the bus parameters of all devices have the same values. For example, if both DP and FMS services are being used on a subnet, the "slower" sets of bus parameters must always be set for all devices, i.e. even the "Universal (DP/FMS)" profile for DP devices.

**Profiles and transmission rates**

Profiles	Supported transmission speeds in Kbits/s
DP	9.6 19.2 45.45 93.75 187.5 500 1500 3000 6000 12000
Standard	9.6 19.2 45.45 93.75 187.5 500 1500 3000 6000 12000
Universal (DP-FMS)	9.6 19.2 93.75 187.5 500 1500
Customized	9.6 19.2 45.45 93.75 187.5 500 1500 3000 6000 12000

## Meaning of profiles

Profile	Meaning
DP	<p>Select the "DP" bus profile when the only devices connected to the PROFIBUS subnet are those which satisfy the requirements of standard EN 50170 Volume 2/3, Part 8-2 PROFIBUS. The bus parameter setting is optimized on these devices.</p> <p>This includes devices with DP master and DP slave interfaces of the SIMATIC S7 and distributed I/Os of other manufacturers.</p>
Standard	<p>Compared to the "DP" profile, the "Standard" profile also offers scope for devices of another project or devices which have not been configured here to be taken into account when calculating the bus parameters. The bus parameters are then calculated following a simple, non-optimized algorithm.</p>
Universal (DP/FMS)	<p>Select the "Universal (DP/FMS)" bus profile when individual devices on the PROFIBUS subnet use the PROFIBUS-FMS service.</p> <p>This includes the following devices for example:</p> <ul style="list-style-type: none"> <li>• CP 343-5 (SIMATIC S7)</li> <li>• PROFIBUS-FMS devices of other manufacturers</li> </ul> <p>As with the "Standard" profile, this profile allows you to take other devices into account when calculating the bus parameters.</p>
Customized	<p>The PROFIBUS subnet will only function without problem if the parameters for the bus profile are matched to one another. Select the "Customized" profile when none of the usual profiles "match" a PROFIBUS device and you need to adapt the bus parameters to your special structure. Information on this can be found in the documentation for the PROFIBUS device.</p> <p>You should only change the default values if you are familiar with how to configure the bus profile for PROFIBUS.</p> <p>Not all combinations that can be theoretically set can be used even with this bus profile. The PROFIBUS standard specifies several parameter limits that depend on other parameters. For example, a responder must not respond (Min Tsd) before the initiator can receive the message frame (Trdy). These standard specifications are also checked in the "Customized" profile.</p> <p>Tip: The bus parameters last valid on the PROFIBUS subnet are always automatically set as customized. For example, if the "DP" bus profile was valid for the subnet, then the bus parameters for "DP" are set in the "Customized" bus profile. The parameters can be modified on this basis.</p> <p>The monitoring times are not automatically recalculated so that you do not put at risk the consistency of set values, for example with configurations in other configuration tools without realizing that you have done so.</p> <p>You can also have the Ttr monitoring times and target rotation time calculated on the basis of parameters you have set: Click here on the "Recalculate" button.</p>

### Note

Both mono-master mode and multi-master mode are possible with all PROFIBUS profiles.

## What you need to know about PROFIBUS line configuration

### Cable configuration and bus parameters

Information regarding the cable configuration can be taken into consideration when calculating the bus parameters. For this purpose, you must select the "Consider cable configuration" check box in the properties for the PROFIBUS subnet.

The remaining information then depends on the type of cable used; the following settings are available:

- Copper cable
- Fiber-optic cable/optical ring

### PROFIBUS line configuration, optical ring

The calculation depends on the OLM types used. The selection is made by activating the check box (multiple activation is possible, at least one OLM type must be selected):

- OLM/P12
- OLM/G12
- OLM/G12-EEC
- OLM/G12-1300

The following bus parameter adjustments are made:

- Configuration of a node not present

---

#### Note

**The following restrictions apply to optical rings, even for passive nodes (DP slaves for example):**

A maximum of HSA-1 nodes may be connected to the PROFIBUS network. With an HSA of 126, addresses 126 and 125 must not be used. A maximum of 125 nodes are possible on the bus (No. 0 to 124).

If an HSA is less than or equal to 125, the addresses HSA and greater may not be used. The address HSA-1 may not be used.

---

- Increase the retry value to 3
- Setting of minimum slot time needed for ring mode

---

#### Note

Short slot time values are needed for OLM/P12, average ones for OLM/G12 and OLM/G12-EEC and long ones for OLM/G12-1300. This results in high performance for small network lengths and average to low performance for average to large network lengths.

---

## PROFIBUS communication load

### Communication load - allowing for additional network stations

The bus parameters depend on the volume of communication between the active network nodes. There are differences between cyclic communication (DP) and connection-based, acyclic communication (S7 communication, Send/Receive (FDL), FMS). Unlike DP, the volume and size of communication tasks (communication load) depends on the user program. For this reason, the communication load cannot always be calculated automatically.

To calculate the bus times you can define a network configuration in the "Additional network stations" parameter group that differs from the network configuration.

### Taking the profile into account

The network configuration can be defined for the "Standard", "Universal (DP/FMS)", and "User-defined" profiles. Parameters cannot be entered in the "Additional network stations" parameter group for the "DP" profile.

### Quantification of the communication load

The following settings are available in order to make allowance for the communication load.

- Information regarding the number of unconfigured network stations;
- Information on the communication load resulting from the user programs for FDL or S7 communication. Here you can selected from the following settings:
  - Low  
Typically used for DP, no great data communication apart from DP.
  - Medium  
Typically used for mixed operations featuring DP and other communication services (such as for S7 communication), when DP has strict time requirements and for average acyclic volumes of communication.
  - High  
For mixed operations featuring DP and other communication services (such as for S7 communication), when DP has loose time requirements and for high acyclic volumes of communication.

## Configuring Industrial Ethernet

### Rules for the network configuration

The Ethernet interfaces of the devices have a default IP address that you can change.

### IP address

The IP parameters are visible if the module capable of communication supports the TCP/IP protocol. This is usually the case for all Ethernet modules.

The IP address consists of 4 decimal figures in the range of 0 to 255. The decimal figures are separated from one another by a dot.

Example: 140.80.0.2

The IP address consists of:

- Address of the (sub) net
- Address of the node (generally also called host or network node)

### Subnet mask

The subnet mask splits these two addresses. It determines which part of the IP address addresses the network and which part of the IP address addresses the node.

The set bits of the subnet mask determine the network part of the IP address.

Example:

Subnet mask: 255.255.0.0 = 11111111.11111111.00000000.00000000

In the example given for the above IP address, the subnet mask shown here has the following meaning:

The first 2 bytes of the IP address identify the subnet - i.e. 140.80. The last two bytes address the node, thus 0.2.

It is generally true that:

- The network address results from AND linking the IP address and subnet mask.
- The device address results from AND NOT linking the IP address and subnet mask.

### Relation between IP address and default subnet mask

An agreement exists relating to the assignment of IP address ranges and so-called "Default subnet masks". The first decimal number (from the left) in the IP address determines the structure of the default subnet mask. It determines the number of "1" values (binary) as follows:

IP address (decimal)	IP address (binary)	Address class	Default subnet mask
0 to 126	0xxxxxxx.xxxxxxxx...	A	255.0.0.0
128 to 191	10xxxxxx.xxxxxxxx...	B	255.255.0.0
192 to 223	110xxxxx.xxxxxxxx...	C	255.255.255.0

#### Note

##### Range of values for the first decimal point

A value of between 224 and 255 is also possible for the first decimal number of the IP address (address class D etc). This is, however, not recommended because there is no address check for these values.



## Masking other subnets

You can use the subnet mask to add further structures and form "private" subnets for a subnet that is assigned one of the address classes A, B or C. This is done by setting other lower points of the subnet mask to "1". For each bit set to "1", the number of "private" networks doubles and the number of nodes they contain is halved. Externally, the network functions like an individual network as it did previously.

Example:

You have a subnet of address class B (for example IP address 129.80.xxx.xxx) and change the default subnet mask as follows:

Masks	Decimal	Binary
Default subnet mask	255.255.0.0	11111111.11111111.00000000.00000000
Subnet mask	255.255.128.0	11111111.11111111.10000000.00000000

Result:

All nodes with addresses between 129.80.001.xxx and 129.80.127.xxx are on one subnet, all nodes with addresses between 129.80.128.xxx and 129.80.255.xxx are on another subnet.

## Router

The task of the routers is to connect the subnets. If an IP datagram is to be sent to another network, it first has to be conveyed to a router. To make this possible, you have to enter the address of the router for each node in the subnet.

The IP address of a node in the subnet and the address of the router may only differ at the points at which there is a "0" in the subnet mask.

## Network configuration of AS interface

AS-Interface consists of an AS-i master and AS-i slaves connected to each other over an AS-i subnet.

## Rules for AS interface network configuration

All the nodes in an AS-i subnet must have a different AS-i node address.

You should only load the settings over the network when all the modules in a subnet have different addresses and when the actual structure matches that of the network configuration you have created.

One AS-i master and up to 31 AS-i slaves can be operated on one AS-i subnet.

For more information on configuring an AS-Interface with an AS-i master and AS-i slaves, refer to the section on AS-Interface and the documentation of the AS-i master modules.

### **8.1.3.2 Communication via connections**

#### **Working with connections**

#### **S7 connection**

#### **Introduction to configuring connections**

#### **Definition**

A connection defines a logical assignment of two communication partners in order to undertake communication services. A connection defines the following:

- Communication partner involved
- Type of connection (for example, S7 connection)
- Special properties (e.g., whether a connection is established permanently or whether it is established and terminated dynamically in the user program, and whether status messages are to be sent)
- Connection path

#### **What you need to know about connection configuration**

During connection configuration, a local connection name is assigned for an S7 connection as a unique local identification.

In the network view, a "Connections" tab is displayed in addition to the "Network overview" tab. This tab contains the connection table. A row in this connection table represents a configured connection from the viewpoint of the local communication partner with its properties, for example, between two S7-1200 CPUs.

#### **What you need to know about using connection resources**

#### **Introduction**

Each connection requires connection resources for the end point and/or transition point on the devices involved. The number of connection resources is device-specific.

If all the connection resources of a communication partner are assigned, no new connections can be established. This situation is apparent when a newly created connection in the connection table has a red background. The configuration is then inconsistent and cannot be compiled.

## **S7 connections**

In the case of S7 connections via the PN interface, one connection resource per S7 connection is assigned for the endpoint for the S7-1200 CPU. One connection resource is also required for the connection partner.

You can find an overview of available and assigned connection resources for selected S7-1200 CPU in the Inspector window at "Properties > Connection Resources"

### Views containing information about the configured connections

The views described below will provide you with comprehensive access to all the information and functions regarding configuring and checking communication connections.

- Connection display in the network view
- Connection table
- "Properties" tab for a connection in the inspector window

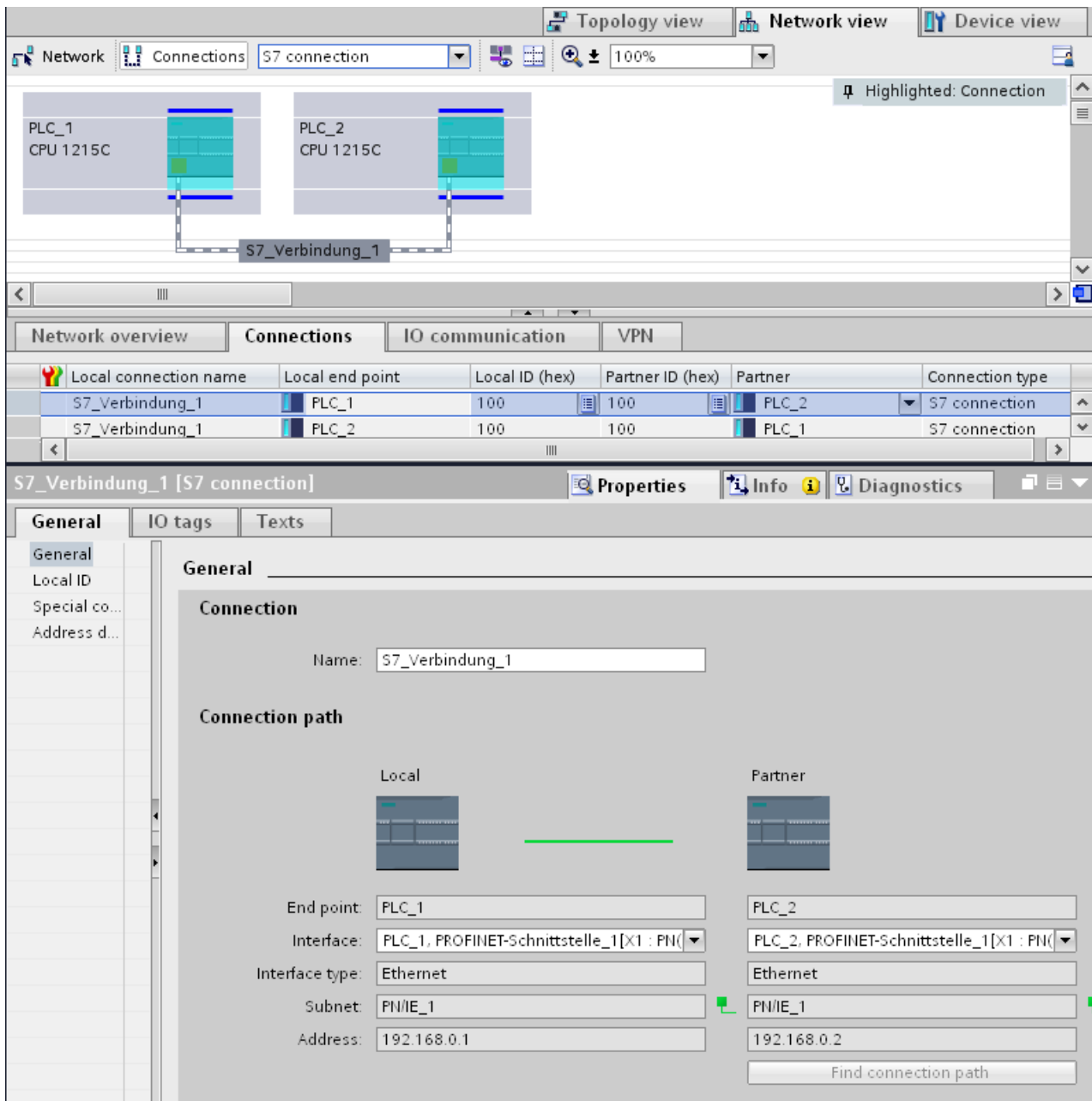

## Benefits

The information shown in these views are always up-to-date in terms of the current user actions. This means:

- The connection table displays all connections created.
- If you have selected a connection in the connection table:
  - When connection mode is enabled, the connection path is highlighted in the network view.
  - The "Properties" tab in the Inspector window displays the parameters of this connection.

## The connection table

The connection table offers the following functions:

- List of all connections in the project
- Selection of a connection and display of connections associated with it in the network view (when connection mode is enabled)
- Changing of connection partners
- Display showing status information

## "Properties" tab for a connection in the inspector window

The properties dialog has the following meaning:

- Display for connection parameters
- Display of connection path
- Subsequent specification of connections using the "Find connection path" button

## Creating a new connection

### Creating a connection - alternatives

You have the following options for creating a connection in the network view:

- Graphic connection configuration
- Interactive connection configuration

You'll find the individual steps for this in the following chapters.

## Requirement and result

In the network view, you have add devices between which the connections should be configured.

### Specifying a connection

If both partners for the connection type selected are networked on the same network, use the graphic or interactive selection of both communication partners to create a fully specified connection.

This connection is entered automatically in the connection table of the S7-1200 CPU. A local connection name is assigned for this connection.

The following schematic shows a configured connection with a networked device:

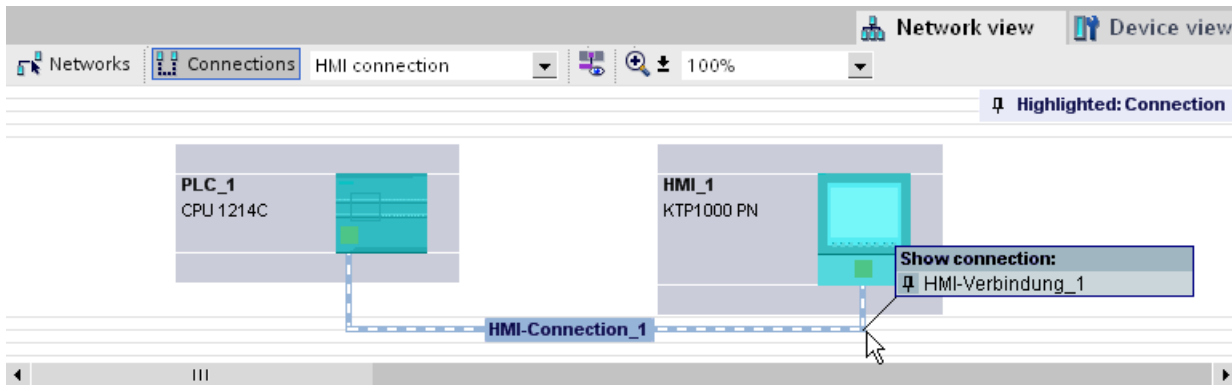

### Creating a new connection graphically

#### Graphically configuring connections

In the case of graphic connection configuration, the connection path is automatically specified provided interfaces and resources are available. Select the devices to be connected in the current configuration.

## Automatically determining connection path

To create a connection graphically, follow these steps:

1. Click the "Connections" button.



This step activates the connection mode: You can now select the connection type you want. You will see this from the following:  
The devices that can be used for the connection type selected in your project are color-highlighted in the network view.

2. Hold down the mouse button and drag the mouse pointer from the device from which the connection will originate to the device at which the connection ends.

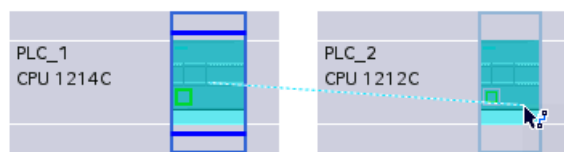

3. Release the mouse button over the destination device to create the connection between the two devices.

## Result

- A specified connection is created.
- The connection path is highlighted.
- The connection is entered in the connection table.

## Configuring a connection when there is no or no clear network assignment

Any networking not in place will if possible be created automatically when a connection is created. A query will be made upon completion of connection configuration if unique network assignment is not possible. You will be able to choose from the existing subnets.

Example below: A query is made upon creation of a connection between stations PLC\_1 and PLC\_2, which are not yet networked.

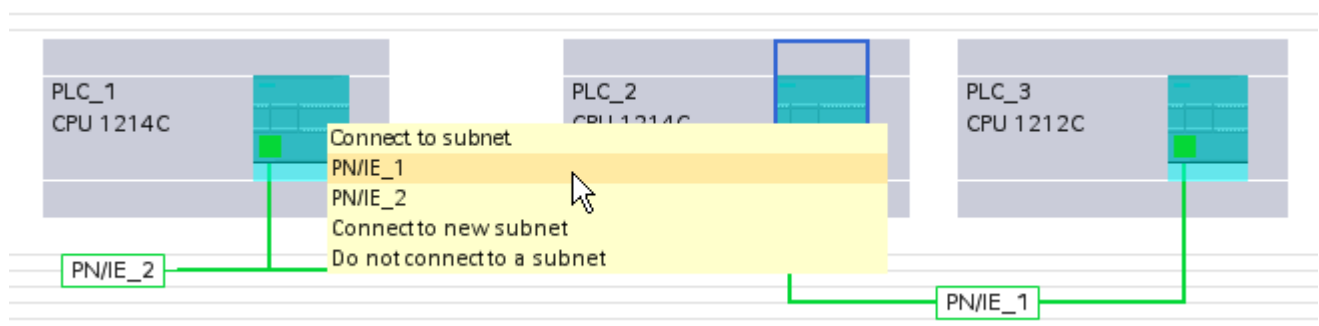

## Interactively creating a new connection

### Interactively configuring connections

Define the local device and its connection partners.

#### Procedure

Proceed as follows to interactively create a connection:

1. Select the "Add new connection" command in the shortcut menu of a connection partner for which you want to create a connection.  
The "Create new connection" dialog appears.
2. Select the partner endpoint.  
In the right pane of the dialog, a possible connection path fitting the selected endpoint is displayed, if available. Incomplete paths, for example, for a non-specified CPU, are marked by an exclamation mark on a red background.
3. To accept the configured connection and to configure additional connections to other endpoints, click "Add".  
To close the dialog, click "OK".

## Working in the network view

### Highlighting connection path and partner in the network view

To display the connection partners for all or certain connection types in the network view, proceed as follows:

1. Click the "Connections" button.



2. Select the S7-CPU for which you want to display the connection partners in the network view and then select the "Highlight connection partners" command in the shortcut menu.
3. Select "All connection partners" in the following menu.  
The local device and the CPUs of the target devices are selected. The local connection partner shows an arrow pointing right and the remote connection partners show an arrow pointing left.
4. To open a list with information on the target devices, click the arrow of the local device.  
This additional function is useful in complex network configurations in which some devices are not visible.

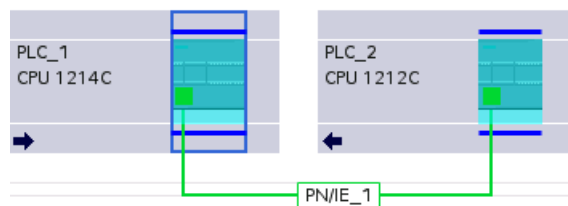



---

**Note**

You can display one of the connection partners which cannot be seen in the current display range of the network view. Click on the communication partner in the list that appears. Result: The display is moved such that the connection partner becomes visible.

---

## Working with the connection table

### Basic functions for tables

The connection table supports the following basic functions for editing a table:

- Changing column width
- Displaying the meaning of a column, a row or cell using tooltips.

### Changing column width

To adjust the width of a column to the content so that all texts in the lines are legible, follow these steps:

1. Position the cursor in the header of the connection table to the right of the column that you want to optimize until the cursor changes its shape to two parallel lines (as if you wanted to change the width of the column by dragging it with the cursor).
2. Double click on this point.

or

1. Open the shortcut menu on the header of the table.
2. Click on
  - "Optimize column width" or
  - "Optimize width of all columns".

For columns that are too narrow, the complete content of specific fields is shown when you pause with the cursor on the respective field.

### Show / hide columns

You can use the shortcut menu of the header of the connection table to control the display of the various table columns. The shortcut menu entry "Show/hide columns" provides you with an overview of the available columns. Use the check box to control whether columns are shown or hidden.

If you want to store the layout, width and visibility of the table columns, click on the "Remember layout" function in the top right-hand of the network view.

Symbol	Meaning
	Remember layout Saves the current table view. The layout, width and visibility of columns in the table view is stored.

### Using cursor keys to move within the connection table

You can use the UP and DOWN cursor keys to select a connection from the connection table; the selected connection is marked and is shown highlighted in the network view.

### Changing properties of connection

You can directly edit some of the parameters displayed in the connection table. The name of the connection can, for example, only be changed in the connection table.

### Changing connection partners

You can change the connection partner of a connection as follows:

1. Select the connection.
2. Select the new connection partner from the open drop-down list in the "Partner" column.

### Deleting connections

You can delete configured connections using the network view or the connection table.

In the network view you can delete one highlighted connection per action. In the connection table you can delete one or several connections per action.

### Procedure

To delete a connection, follow these steps:

1. Select the connection to be deleted:
  - In the network view: Select the connection to be deleted.
  - In the connection table: Select the rows of the connections to be deleted (multiple selection possible).
2. Open the shortcut menu with a right mouse click.
3. Select the "Delete" command.

### Result

The selected connection is removed completely.

## Copying connections

### Introduction

Connections are not copied singly but always in context along with the project or the device.

You can copy:

- Entire projects
- One or more devices within a project or from one project to another

### Copying a project

When you copy a project all configured connections will also be copied. No settings whatsoever are required for the copied connections because the connections remain consistent.

### Copying devices

If you copy devices for which connections have been configured, the connections are copied as well. To complete the connection path, you must still finalize the networking.

An S7-1200 CPU with a V.10 firmware is merely a server for connections and has no connection configuration itself. Consequently, no connections are copied along with it when an S7-1200 CPU with a V1.0 firmware is copied.

### Inconsistent connections - connections without assignment

With an inconsistent connection the structure of the connection data is destroyed or the connection is not functional in the project context.

Inconsistent connections cannot be compiled and loaded - operation is not possible with such a connection.

In the connection table inconsistent connections are marked in red.

### Possible causes for inconsistent connections

- Deletion or change of the hardware configuration.
- Missing interface network links in the project, which are necessary for a connection.
- Connection resources are exceeded
- Connections to an unspecified connection partner without partner address information.

Detailed information regarding the reasons for the inconsistency can be found in the "Compile" tab following compilation (Edit > Compile).

### Remedies

To assign a closed connection path to an existing open connection path, expand the device configuration in such a way that the interfaces required for the connection type are available

for both partners. At "Properties > General > Interface" in the Inspector window, you can use the "Find connection path" button to create a connection to an existing partner.

## **S7 connection - general settings**

### **General connection parameters**

General connection parameters are displayed in the "General" parameter group under the properties of the connection; these connection parameters identify the local connection end point.

Here, you can assign the connection path and specify all aspects of the connection partner.

### **Local ID**

The local ID of the module from which the connection is viewed is displayed here (local partner). You can change the local ID. You may need to do this if you have already programmed communication function blocks, and you want to use the local ID specified in those function blocks for the connection.

### **Special connection properties**

Display of connection properties (can be modified depending on the components used):

- One-way  
One-way means that the connection partner functions as a server on this connection and cannot send or receive actively.
- Active connection establishment  
In the case of one-way connection, for example with a S7-1200 CPU (firmware version V1.0), a connection partner can only be provided for the active connection establishment. In the case of a two-way connection you can set which connection partner will assume the active role.
- Sending operating mode messages  
Indicates whether or not the local partner sends operating mode messages to the connection partner.

### **Address details**

Displaying address details of the S7 connection. With an unspecified partner, the values for the rack and slot can be changed. All other values are obtained from the current configuration and cannot be changed.

## **S7 connection - address details**

### **Meaning**

The address details show the end points of the connection and can localize these via the specification of rack and slot.

When a connection is established, the connection-specific resources of a module are assigned specifically to this connection. This assignment requires that the connection resource can be addressed. The TSAP (Transport Service Access Point) is, as it were, the address of the resource that is formed with the help of the connection resource or, in the case of S7-1200 CPUs (firmware V2.0 or higher) with the SIMATIC-ACC (SIMATIC Application Controlled Communication).

### Configuration of TSAP for S7-1200

- For S7-1200 CPU (firmware V2.0 or higher):  
"SIMATIC-ACC"<nnn><mm>  
nnn = Local ID  
mm = any value
- For S7-1200 CPU (firmware V1.0):  
<xx>.<yz>  
xx = Number of the connection resource  
y = Rack number  
z = Slot number

### TSAP structure, dependent on partner

The configuration of the TSAP for S7-1200 CPUs is dependent on the respective firmware and on the remote connection partner. When a S7-1200 CPU is connected with a S7-300/400 CPU, a S7-1200 CPU also uses a TSAP configuration that includes the connection resource.

See the following examples for TSAPs of various connection configurations

- Connection between two S7-1200 CPUs (both with firmware V2.0):
  - S7-1200 CPU "A" with firmware V2.0 and local ID 100:  
TSAP: SIMATIC-ACC10001
  - S7-1200 CPU "B" with firmware V2.0 and local ID 5AE:  
TSAP: SIMATIC-ACC5AE01
- Connection between two S7-1200 CPUs (firmware V2.0 and V1.0):
  - S7-1200 CPU with firmware V2.0 and local ID 1FF:  
TSAP: SIMATIC-ACC1FF01
  - S7-1200 CPU with firmware V1.0 (rack 0, slot 1, connection resource 03):  
TSAP: 03.01
- Connection between S7-1200 CPUs (firmware V2.0) and S7-300/400 CPU:
  - S7-1200 CPU with firmware V2.0 (rack 0, slot 1, connection resource 12):  
TSAP: 12.01
  - S7-300/400 CPU (rack 0, slot 2, connection resource 11):  
TSAP: 11.02

## S7 connections via CM/CP

### Introduction

S7-1200 CPUs with a firmware version of V2.0 or higher support one-way and two-way S7 connections via CM/CP interfaces. This increases the number of Ethernet ports and networks that can be used for S7 connections. Even though the connection is then guided via the CM/CP, the associated S7-1200 CPU is an end point of the connection. The other end point can be any other device in the case of two-way connections. This other device must also support S7 connections.

### Data volumes and configuration limit

The number of communication connections which are supported by CM/CP can be found in the manual accompanying every CM/CP. The number of connections per device can be further increased by adding other CM/CPs.

If several CM/CPs are fitted in a device, an automatic switch is made to the next CM/CP when this limit is exceeded. Specifically assign the connections using the path selection as required.

---

#### Note

Data transfer > 240 byte transfer is supported by the current CPs.

CPs with an older product version support the transfer of data with a data length of up to 240 bytes.

For more information, refer to the details provided in the Ethernet CP equipment manual.

---

### Tasks of the Ethernet CM/CP in online mode

During data transfer via a connection, the Ethernet CM/CP takes on the following tasks:

- Receiving  
Receiving data from the Ethernet and forwarding to the user data area in the CPU
- Sending  
Transferring data from the user data area of the CPU and sending data via the Ethernet

The connection is established automatically as soon as the partner can be reached.

## HMI connection

### Introduction to configuring connections

#### Definition

A connection defines a logical assignment of two communication partners in order to undertake communication services. A connection defines the following:

- Communication partner involved
- Type of connection (e.g., HMI connection)
- Special properties (e.g., whether a connection is established permanently or whether it is established and terminated dynamically in the user program, and whether status messages are to be sent)
- Connection path

#### What you need to know about connection configuration

During connection configuration, a local connection name is assigned for an HMI connection as a unique local identification.

In the network view, a "Connections" tab is displayed in addition to the "Network overview" tab. This tab contains the connection table. A line in this connection table represents a configured connection, e.g., between an HMI device and PLC, along with its properties.

#### What you need to know about using connection resources

##### Introduction

Each connection requires connection resources for the end point and/or transition point on the devices involved. The number of connection resources is device-specific.

If all the connection resources of a communication partner are assigned, no new connections can be established. This situation is apparent when a newly created connection in the connection table has a red background. The configuration is then inconsistent and cannot be compiled.

##### HMI connections

For HMI connections via the **integrated** PN interface, one connection resource for the endpoint per HMI connection is occupied for the HMI device.

One connection resource is also required for the connection partner (PLC).

### Views containing information about the configured connections

The views described below will provide you with comprehensive access to all the information and functions regarding configuring and checking communication connections.

- Connection display in the network view
- Connection table
- "Properties" tab for a connection in the inspector window

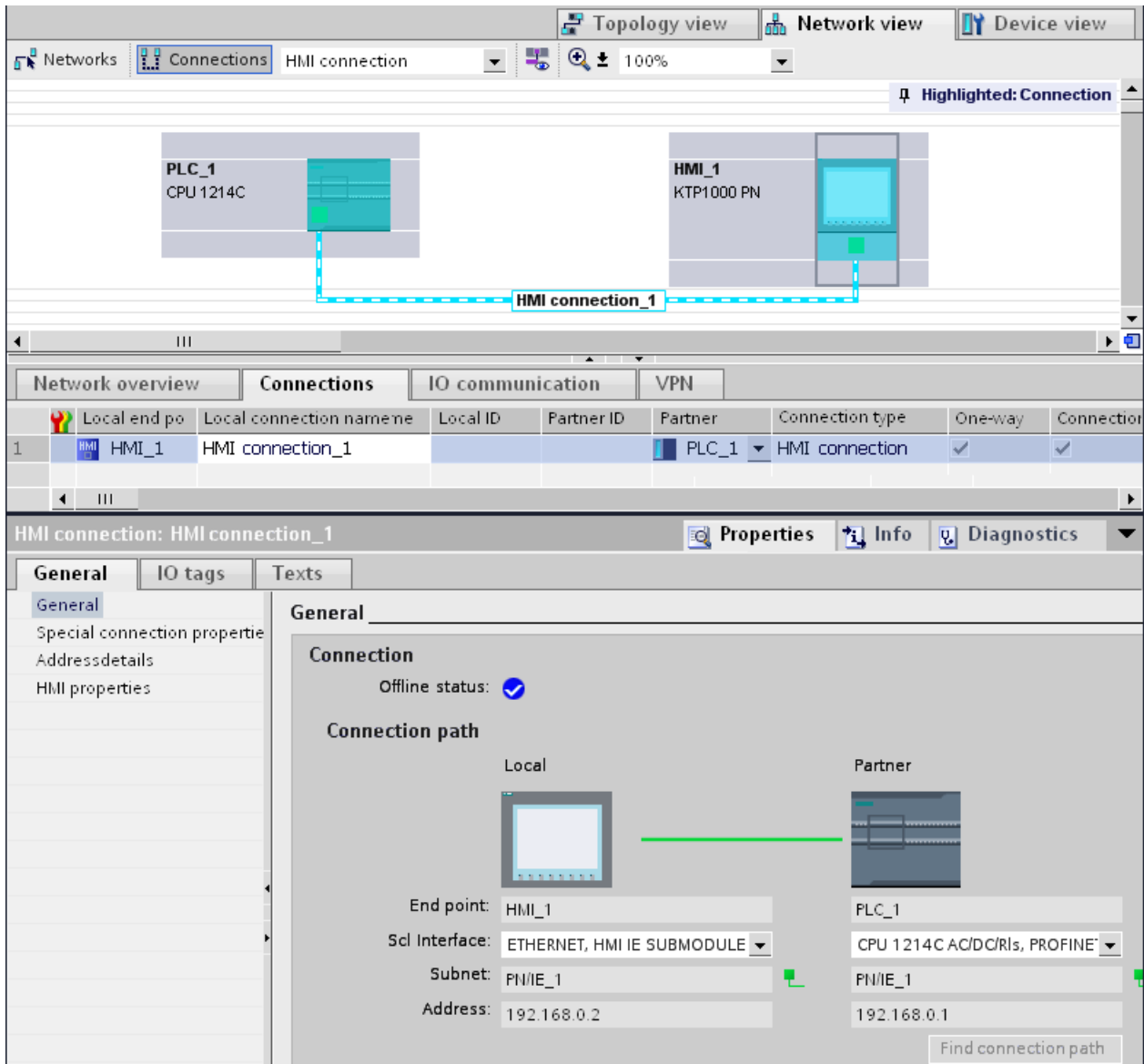



## Benefits

The information shown in these views are always up-to-date in terms of the current user actions. This means:

- The connection table displays all connections created.
- If you have selected a connection in the connection table:
  - You will graphically see the connection path in the network view.
  - The "Properties" tab in the Inspector window displays the parameters of this connection.

## The connection table

The connection table offers the following functions:

- List of all connections in the project
- Selection of a connection and display of connections associated with it in the network view
- Changing of connection partners
- Display showing status information

## "Properties" tab for a connection in the inspector window

The properties dialog has the following meaning:

- Display for connection parameters
- Display of connection path
- Subsequent specification of connections using the "Find connection path" button

## Creating a new connection

### Creating a connection - alternatives

You have the following options for creating a connection in the network view:

- Graphic connection configuration
- Interactive connection configuration

You'll find the individual steps for this in the following chapters.

## Requirement and result

You have created the devices with CPUs and HMI devices between which you want to configure connections in the network view.

### Specifying a connection

If both partners for the connection type selected are networked on the same network, use the graphic or interactive selection of both communication partners to create a fully specified connection.

This connection is entered automatically into the connection table of the HMI device. A local connection name is assigned for this connection.

The following schematic shows a configured connection with a networked device:

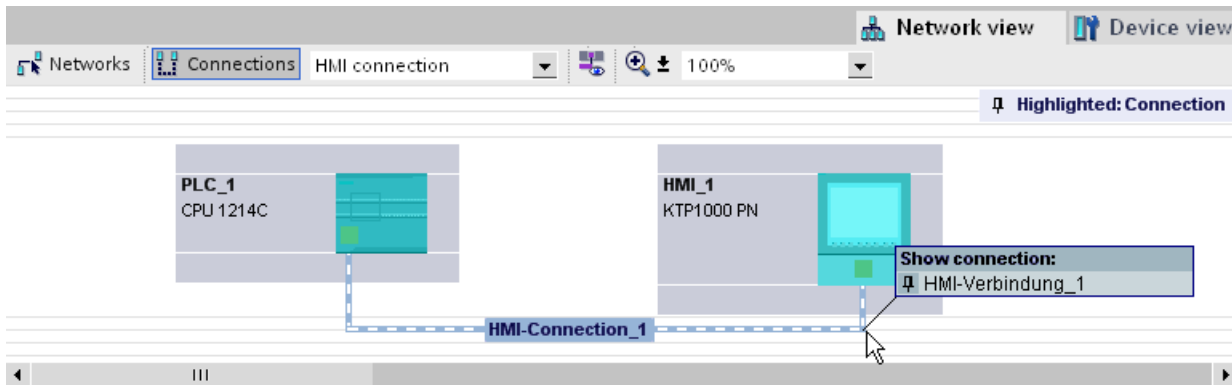

### Creating a new connection graphically

#### Graphically configuring connections

When using the graphic connection configuration, if necessary the system asks you to define the connection path. Select the devices to be connected in the current configuration.

## Automatically determining connection path

To create a connection graphically, follow these steps:

1. Click the "Connections" button.



The connection mode for the connection type you have selected is then activated.

You will see this from the following:

The devices that can be used for the connection type selected in your project are color-highlighted in the network view.

2. Hold down the mouse button and drag the mouse pointer from the device from which the connection will originate to the device at which the connection ends.

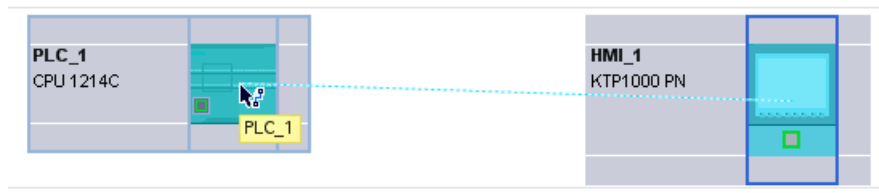

3. Release the mouse button over the destination device to create the connection between the two devices.

## Result

- A specified connection is created.
- The connection path is highlighted.
- The connection is entered in the connection table.

## Interactively creating a new connection

### Interactively configuring connections

Define the local device and its connection partners.

## Procedure

Proceed as follows to interactively create a connection:

1. Select the "Create new connection" command in the shortcut menu of a connection partner for which you want to create a connection.  
The "Create new connection" dialog is opened.
2. Select the partner endpoint.  
In the right pane of the dialog, a possible connection path fitting the selected endpoint is displayed, if available. Incomplete paths, for example, for a non-specified CPU, are marked by an exclamation mark on a red background.
3. To close the dialog, click "OK".  
To accept the configured connection and to configure additional connections to other endpoints, click "Apply".

## Working in the network view

### Highlighting connection path and partner in the network view

To display the connection partners for all or certain connection types in the network view, proceed as follows:

1. Click the "Connections" button.

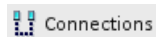

2. Select the "Highlight connection partners" command in the shortcut menu for the HMI device whose connection partners you want to display in the network view.
3. Select "All connection partners" in the following menu.  
The local device and the CPUs of the target devices are selected. The local connection partner shows an arrow pointing right and the remote connection partners show an arrow pointing left.
4. To open a list with information on the target devices, click the arrow of the local device.  
This additional function is useful in complex network configurations in which some devices are not visible.

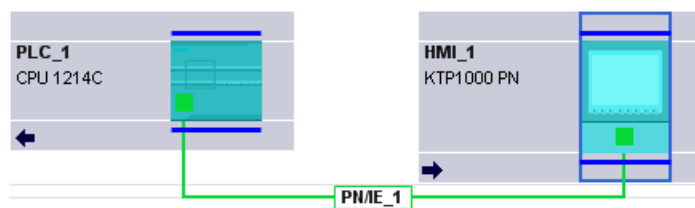

### Note

You can display one of the connection partners which cannot be seen in the current display range of the network view. Click on the communication partner in the list that appears. Result: The display is moved such that the connection partner becomes visible.

## See also

Creating a new connection graphically (Page 466)

## Working with the connection table

### Basic functions for tables

The connection table supports the following basic functions for editing a table:

- Changing column width
- Displaying the meaning of a column, a row or cell using tooltips.

### Changing column width

To adjust the width of a column to the content so that all texts in the lines are legible, follow these steps:

1. Position the cursor in the header of the connection table to the right of the column that you want to optimize until the cursor changes its shape to two parallel lines (as if you wanted to change the width of the column by dragging it with the cursor).

2. Double click on this point.

or

1. Open the shortcut menu on the header of the table.
2. Click on
  - "Optimize column width" or
  - "Optimize width of all columns".

For columns that are too narrow, the complete content of specific fields is shown when you pause with the cursor on the respective field.

### Show / hide columns

You can use the shortcut menu of the header of the connection table to control the display of the various table columns. The shortcut menu entry "Show/hide columns" provides you with an overview of the available columns. Use the check box to control whether columns are shown or hidden.

### Using cursor keys to move within the connection table

You can use the UP and DOWN cursor keys to select a connection from the connection table; the selected connection is marked and is shown highlighted in the network view.

### Changing properties of connection

You can directly edit the parameters displayed in the connection table in some cases. To change the name of a connection, you do not have to navigate to the Inspector window.

## **Changing connection partners**

You can change the connection partner of a connection as follows:

1. Select the connection.
2. Select the new connection partner from the open drop-down list in the "Partner" column.

## **Deleting connections**

You can delete configured connections using the network view or the connection table.

In the network view you can delete one highlighted connection per action. In the connection table you can delete one or several connections per action.

## **Procedure**

To delete a connection, follow these steps:

1. Select the connection to be deleted:
  - In the network view: Select the connection to be deleted.
  - In the connection table: Select the rows of the connections to be deleted (multiple selection possible).
2. Open the shortcut menu with a right mouse click.
3. Select the "Delete" command.

## **Result**

The selected connection is removed completely.

## **Copying connections**

### **Introduction**

Connections are not copied singly but always in context along with the project or the device.

You can copy:

- Entire projects
- One or more devices within a project or from one project to another

### **Copying a project**

When you copy a project all configured connections will also be copied. No settings whatsoever are required for the copied connections because the connections remain consistent.

## Copying devices

If you copy devices for which connections have been configured (HMI devices), the connections are copied as well. To complete the connection path, you must still finalize the networking.

An S7-1200 CPU with a V.10 firmware is only a server for connections and has no connection configuration itself. Consequently, no connections are copied along with it when an S7-1200 CPU with a V1.0 firmware is copied.

## Inconsistent connections - connections without assignment

With an inconsistent connection the structure of the connection data is destroyed or the connection is not functional in the project context.

Inconsistent connections cannot be compiled and loaded - operation is not possible with such a connection.

In the connection table inconsistent connections are marked in red.

## Possible causes for inconsistent connections

- Deletion or change of the hardware configuration.
- Missing interface network links in the project, which are necessary for a connection.
- Connection resources are exceeded
- Errors when backing up data due to insufficient memory
- Connections to an unspecified connection partner without partner address information.

Detailed information regarding the reasons for the inconsistency can be found in the "Compile" tab following compilation (Edit > Compile).

## Remedies

If the connection cannot be repaired by opening the connection properties, changing them or undoing them in the configuration, then it may be necessary to delete the connection and re-create it.

## HMI connection general settings

### General connection parameters

General connection parameters are displayed in the "General" parameter group under the properties of the connection; these connection parameters identify the local connection end point.

Here, you can also assign the connection path and specify all aspects of the connection partner.

## Special connection properties

Display of the connection properties (cannot be changed):

- Active connection establishment  
The connection establishment always starts from the HMI device. This option is selected by default if the address of the partner is specified.
- One-way  
One-way means that the connection partner functions as a server on this connection and cannot send or receive actively.
- Sending operating mode messages  
Not relevant for HMI devices.

## Address details

Displaying address details of the HMI connection. With an unspecified partner, the values for the rack and slot can be changed. All other values are obtained from the current configuration and cannot be changed.

## Miscellaneous

Display of the access points for the online connection between HMI device and connection partner.

## Using Open User Communication

### Basics of Open User Communication

#### Introduction

Open User Communication is the name given to a program-controlled communication process for communicating via the integrated PN/IE interface of the S7-1200/1500 and S7-300/400 CPUs. Different connection types are available for this communication process.

The main feature of Open User Communication is its high degree of flexibility in terms of the data structures transferred. This allows open data exchange with any communicating devices providing they support the connection types available here. Since this communication is controlled solely by instructions in the user program, event-driven connection establishment and termination is possible. Connections can also be modified by the user program during runtime.

For CPUs with an integrated PN/IE interface, the TCP, UDP, and ISO-on-TCP connection types are available for Open User Communication. The communication partners can be two SIMATIC PLCs or a SIMATIC PLC and a suitable third-party device.



## Instructions for Open User Communication

To create the connections, you have various instructions available after opening in the program editor in the "Instructions > Communication > Open User Communication" task card:

- Compact instructions for sending or receiving data via the integrated functions for establishing and terminating the connection (S7-1200/1500 only):
  - TSEND\_C (connection establishment/termination, sending)
  - TRCV\_C (connection establishment/termination, receiving)
- Individual instructions for sending and receiving data or for establishing or terminating connections:
  - TCON (connection establishment)
  - TDISCON (connection termination)
  - TSEND (TCP or ISO-on-TCP: Sending)
  - TRCV (TCP or ISO-on-TCP: Receiving)
  - TUSEND (UDP: Sending)
  - TURCV (UDP: Receiving)

## Connection establishment

For Open User Communication, instructions for establishing and terminating the connection must exist for both communication partners. One communication partner sends its data using TSEND, TUSEND or TSEND\_C while the other communication partner receives the data using TRCV, TURCV or TRCV\_C.

One of the communication partners starts the connection establishment as the active partner. The other communication partner reacts by starting its connection establishment as the passive partner. If both communication partners have initiated their connection establishment, the communication connection is fully established.

## Connection configuration

You can specify establishment of the connection via a connection description DB with the TCON\_Param, TCON\_IP\_v4, or TCON\_IP\_RFC structure by means of parameter assignment as follows:

- Manually create, assign parameters and write directly to the instruction.
- Supported by connection configuration.

Connection configuration supports the establishment of the connection and should, therefore, be given preference over the other methods.

You specify the following in the connection configuration:

- Connection partner
- Connection type
- Connection ID

## *8.1 Configuring devices and networks*

- Connection description DB
- Address details according to selected connection type

In addition, you specify here which communication partner activates the connection establishment and which partner establishes a connection passively in response to a request from its communication partner.

### **See also**

Principle of operation of connection-oriented protocols (Page 486)

### **Connection configuration**

#### **Overview of connection configuration**

#### **Introduction**

You can find the connection configuration in the inspector window of the program editor if you want to program Open User Communication with the communication instructions TSEND\_C, TRCV\_C or TCON.

Connection configuration supports the flexible functionality of communication programming: The parameters entered for the connection configuration are stored in an automatically generated global DB derived from the TCON\_Param, TCON\_IP\_v4 or TCON\_IP\_RFC structure. You can modify the connection parameters in this connection description DB.

## **Structure of the connection configuration**

The connection configuration is made up of the following components:

The screenshot displays the WinCC configuration environment. The top window shows a ladder logic network with a TCON block (labeled 1) connected to a network. The block's EN input is set to 'False', REQ to '1', ID to '%DB2', and CONNECT to '"PLC\_1\_Send\_DB"'. The ENO output is connected to the network. The network is labeled '%DB3 "TCON\_DB"'. The bottom window shows the 'Properties' dialog for the T\_CON [SFB102] block, with the 'Configuration' tab selected (labeled 2). The 'Connection parameter' section (labeled 3) shows the 'General' settings (labeled 4):

- Local End point: PLC\_1
- Partner End point: FLC\_2
- Interface: CPU 1215C DC/DC/Rly, PF
- Subnet: PN/IE\_1
- Address: 192.168.0.2 (Local) / 192.168.0.1 (Partner)
- Connection type: TCP
- Connection ID (dec): 1
- Connection data: PLC\_1\_Send\_DB (Local) / PLC\_2\_Receive\_DB (Partner)
- Establish active connection:  (Local) /  (Partner)

The 'Address details' section (labeled 5) shows:

- Local Port: (empty)
- Partner Port: 2000

- ① Communication instruction for TCON, TSEND\_C or TRCV\_C
- ② "Configuration" tab in the "Properties" tab
- ③ Area navigation of the "Configuration" tab
- ④ General properties of the connection parameters
- ⑤ Address details of the connection parameters (for selected connection DBs)

### **"Configuration" tab**

Enter the desired connection parameters in the "Configuration" tab. The area navigation of the "Configuration" tab includes the "Connection parameters" group. This group contains the connection configuration. Here, you can enter the parameters for the connections and the address details with system support. Here, you also connect the CONNECT (TCON, TSEND\_C, TRCV\_C) or ID (TCON, TSEND, TRCV, TUSEND, TURCV) block parameters of the selected communication instructions.

When all the required parameters are assigned, a check mark is set in front of the "Connection parameters" group in the area navigation.

---

#### **Note**

The connection parameter assignment does not check whether the connection IDs and port numbers (TCP, UDP) or TSAPs (ISO-on-TCP, ISO) are unique. When you configure Open User Communication, you should, therefore, make sure that the parameter settings are unique within a device.

---

### **See also**

Connection parameters with structure according to TCON\_Param (Page 488)

Connection parameters with structure according to TCON\_IP\_v4 (Page 491)

Connection parameters with structure according to TCON\_IP\_RFC (Page 492)

## Description of the connection parameters

### Overview

The following table shows the general connection parameters:

Parameter	Description
End point	<p>The names of the local end point and the partner end point are shown.</p> <p>The local end point is the CPU for which TCON, TSEND_C or TRCV_C is programmed. The local end point is, therefore, always known.</p> <p>The partner end point is selected from the drop-down list. The drop-down list shows all available possible connection partners including unspecified connection partners for devices whose data is unknown in the project.</p> <p>For S7-1500, broadcast can be selected as the partner end point (message to all subnet devices). For S7-1500 CPs/CMs, multicast can also be selected as the partner end point (message to a group within the subnet). The connection type is converted automatically to UDP in this case.</p> <p>As long as no connection partner is set, all other parameters in the mask are disabled.</p>
Interface	<p>The interface of the local end point is displayed. If multiple interfaces are available, e.g., by means of CPs or CMs, the interface can be selected from the drop-down list. To display or select the partner interface, a specified partner end point must first be selected.</p>
Subnet	<p>The subnet of the local end point is displayed, provided this exists. The partner subnet is displayed only after the partner end point has been selected.</p> <p>If at least one of the two connection partners is not connected with a subnet, the two connection partners are connected with each other.</p> <p>A connection between partners in different subnets is only possible with IP routing. The routing settings can be edited in the relevant interface properties.</p>
Address	<p>The IP address of the local end point is displayed. The IP address of the partner is displayed only after the partner end point has been selected.</p> <p>If you have selected an unspecified connection partner, the input box is empty and has a red background. In this case, you need to specify a valid IP address.</p> <p>Broadcast (S7-1500 only): If "Broadcast" is set as the partner end point, a non-editable IP address with host address 255 is entered automatically for the connection partner. The network allocation corresponds to that of the sender. Example: Local IP address 192.168.0.1, partner IP address 192.168.0.255.</p> <p>Multicast (S7-1500 CPs/CMs only): If "Multicast" is set as the partner end point, the editable IP address 224.0.1.0 is entered automatically for the connection partner.</p>
Connection type	<p>Select the connection type you want to use from the "Connection type" drop-down list:</p> <ul style="list-style-type: none"> <li>• TCP</li> <li>• ISO-on-TCP</li> <li>• UDP</li> </ul> <p>With the S7-1500, you can also select the ISO connection type at the configuration type of the configured connections for TSEND_C and TRCV_C.</p> <p>The connection types can only be used for partners that support the corresponding protocol.</p>

Parameter	Description
Connection type (for S7-1500 only)	<p>With the S7-1500, two different configuration types can be set for TSEND_C and TRCV_C:</p> <ul style="list-style-type: none"> <li>• Programmed connections use program blocks for the connection description.</li> <li>• Configured connections are created directly after the option selection, provided there is not already an appropriate connection. You can also use the configured connection to select the connection type ISO.</li> </ul> <p>The specified configuration method depends on the selected connection type. If both configuration methods are possible, the programmed connection is preset.</p> <p>The same configuration method must be set for both connection partners.</p>
Connection ID	<p>Enter the connection ID in the input box. You can change the connection ID in the input boxes or enter it directly in TCON.</p> <p>Ensure that the connection ID assigned is unique within the device.</p>
Connection data	<p>The names of the connection description DBs for the connection description structured according to TCON_Param, TCON_IP_v4 or TCON_IP_RFC are displayed in the drop-down lists.</p> <p>The drop-down list is still empty after selection of a connection partner. You can use the drop-down list to generate a new data block or to select an existing data block. This data block is filled automatically with the values from the connection configuration. The name of the selected data blocks is entered automatically in the CONNECT block parameter of the selected TSEND_C, TRCV_C or TCON instruction.</p> <p>From the drop-down list, you can also reference another valid data block. If a DB is referenced using the CONNECT input parameter of the TSEND_C, TRCV_C or TCON extended instruction and this does not correspond to the structure of a TCON_Param, TCON_IP_v4 or TCON_IP_RFC, the drop-down list is shown with no content on a red background.</p>
Connection name (for S7-1500 only)	<p>If the connection type of the configured connections is set for TSEND_C and TRCV_C for the S7-1500, the "Connection data" parameter is replaced with the "Connection name" parameter. The name of the configured connection serves here as the connection data.</p> <p>The drop-down list is still empty after selection of a connection partner. You can use the drop-down list to generate a new connection or to select an existing connection. If needed, a data block is created and automatically filled with the values from the connection configuration. The name of the data block is entered automatically in the CONNECT block parameter of the TSEND_C or TRCV_C instruction.</p> <p>You can also reference an existing connection from the drop-down list.</p>
Active connection establishment	<p>Use the "Active connection establishment" check box to specify the active partner of the Open User Communication (only with TCP and ISO-on-TCP).</p>
Port (only with TCP and UDP)	<p>Address component for a TCP or UDP connection. The default after creating a new TCP connection is 2000.</p> <p>You can change the port numbers.</p> <p>The port numbers must be unique on the device!</p>
TSAP (ISO-on-TCP only)	<p>Address component for an ISO-on-TCP connection. The default value after creating a new ISO-on-TCP connection is E0.01.49.53.4F.6F.6E.54.43.50.2D.31 (S7-1200/1500) or E0.02.49.53.4F.6F.6E.54.43.50.2D.31 (S7-300/400).</p> <p>You can enter the TSAP-ID with an extension or as an ASCII TSAP.</p> <p>The TSAPs must be unique on the device!</p>

---

**Note**

**UDP connection for the "Broadcast" setting (S7-300/400/1200)**

The parameters of the UDP connection for the "Broadcast" setting for the partner end point are stored in a connection description DB TCON\_IP\_v4 : With respect to UDP communication with TCON and TUSEND/TURCV , the TCON\_IP\_v4 is not filled with any partner parameters (value=0). However, the partner address and the partner port are necessary for sending the data and must be entered by the user in the TADDR\_Param . The TADDR\_Param for UDP communication is referenced by the TUSEND-/TURCV block parameter ADDR . The values for both parameters can be taken from the connection configuration.

The configuration must also be adapted for the other recipients of UDP communication. In order to receive broadcast frames, the partner port must be configured at the receiver end. For this purpose, the RemotePort parameter of the TADDR\_Param must be filled at the ADDR block.

---

**Note**

**Communication via TSEND\_C and TRCV\_C (S7-1500)**

When TSEND\_C and TRCV\_C are used, a separate TSEND\_C and TRCV\_C block pair with a configured connection is required for each communication. Multiple TSEND\_C and TRCV\_C block pairs cannot simultaneously use the same configured connection for communication.

Additional connections for a TSEND\_C or TRCV\_C instruction can be created in the inspector window for the connection parameters using the appropriate button next to the connection data.

The connections configured using TSEND\_C and TRCV\_C are displayed in a connection table in the inspector window under "Properties > Configuration > Overview of configured connections" when the TSEND\_C or TRCV\_C block is selected.

---

**See also**

Assignment of port numbers (Page 493)

TSAP structure (Page 496)

Examples of TSAP assignment (Page 498)

Ability to read back connection description parameters (Page 494)

Creating and assigning parameters to connections (Page 482)

Connection parameters with structure according to TCON\_Param (Page 488)

Connection parameters with structure according to TCON\_IP\_v4 (Page 491)

Connection parameters with structure according to TCON\_IP\_RFC (Page 492)



## Starting connection parameter assignment

The connection configuration for Open User Communication is enabled as soon as a TCON, TSEND\_C or TRCV\_C instruction for communication is selected in a program block.

### Requirement

- Your project must contain at least one S7-CPU.
- The program editor is open.
- A network is available.

### Procedure

To insert the extended instructions for Open User Communication, proceed as follows:

1. Open the task card, pane and folder "Instructions > Communication > Open User Communication".
2. Drag one of the following instructions to a network:
  - TSEND\_C
  - TRCV\_C
  - TCON

The "Call options" dialog opens.

3. Edit the properties of the instance DB in the "Call properties" dialog. You have the following options:
  - Change the default name.
  - Select the "Manual" check box to assign your own number.
  - You can also execute the DB as a multi-instance for function blocks.
4. Click "OK" to complete your entry.

### Result

A corresponding instance DB is created at a single instance for the inserted instruction TSEND\_C, TRCV\_C or TCON. In the case of a multi-instance, the instance DB of the function block is used.

With TSEND\_C, TRCV\_C or TCON selected, you will see the "Configuration" tab under "Properties" in the Inspector window. The "Connection parameters" group in area navigation contains the connection parameter assignment that you can now make.

### See also

Creating and assigning parameters to connections (Page 482)

## Creating and assigning parameters to connections

In the connection configuration for Open User Communication, you can create and configure connections of the TCP, UDP or ISO-on-TCP type.

### Requirement

A CPU exists with a TCON, TSEND\_C or TRCV\_C communication instruction.

### Procedure

To create a connection for Open User Communication, follow these steps:

1. Select a TCON, TSEND\_C or TRCV\_C block of Open User Communication in the program editor.
2. Open the "Properties > Configuration" tab in the inspector window.
3. Select the "Connection parameters" group. Until you select a connection partner, only the empty drop-down list for the partner end point is enabled. All other input options are disabled.

The connection parameters already known are displayed:

- Name of the local end point
- Interface of the local end point
- IP address of the local end point

4. In the drop-down list box of the partner end point, select a connection partner. You can select an unspecified device or a CPU in the project as the communication partner. Certain connection parameters are then entered automatically.

The following parameters are set:

- Name of the partner end point
- Interface of the partner end point
- IP address of the partner end point

If the connection partners are networked, the name of the subnet is displayed.

5. With the S7-1500, in the "Configuration type" drop-down list, you choose between using program blocks or configured connections.

6. Select an existing connection description DB in the "Connection data" drop-down list or for configured connections select an existing connection under "Connection name". You can also create a new connection description DB or a new configured connection. Later, you can still select other connection description DBs or configured connections or change the names of the connection description DBs in order to create new data blocks:
  - You can also see the selected data block at the interconnection of the CONNECT input parameter of the selected TCON, TSEND\_C or TRCV\_C instruction.
  - If you have already specified a connection description DB for the connection partner using the CONNECT parameter of the TCON, TSEND\_C or TRCV\_C instruction, you can either use this DB or create a new DB.
  - If you edit the name of the displayed data block in the drop-down list, a new data block with the changed name but with the same structure and content is generated and used for the connection.
  - Changed names of a data block must be unique in the context of the communication partner.
  - A connection description DB must have the structure TCON\_Param, TCON\_IP\_v4 or TCON\_IP\_RFC, depending on CPU type and connection.
  - A data block cannot be selected for an unspecified partner.

Additional values are determined and entered after the selection or creation of the connection description DB or configured connection.

The following is valid for specified connection partners:

- ISO-on-TCP connection type
- Connection ID with default of 1
- Active connection establishment by local partner
- TSAP ID
  - for S7-1200/1500: E0.01.49.53.4F.6F.6E.54.43.50.2D.31
  - for S7-300/400: E0.02.49.53.4F.6F.6E.54.43.50.2D.31

The following is valid for unspecified connection partners:

- TCP connection type
- Partner port 2000

The following applies for a configured connection with a specified connection partner:

- TCP connection type
- Connection ID with default of 257
- Active connection establishment by local partner
- Partner port 2000

The following applies for a configured connection with an unspecified connection partner:

- TCP connection type
- Local port 2000

7. Enter a connection ID as needed for the connection partner. No connection ID can be assigned to an unspecified partner.

---

**Note**

You must enter a unique value for the connection ID at a known connection partner. The uniqueness of the connection ID is not checked by the connection parameter settings and there is no default value entered for the connection ID when you create a new connection.

---

8. Select the desired connection type in the relevant drop-down list. Default values are set for the address details depending on the connection type. You can choose between the following:
  - TCP
  - ISO-on-TCP
  - UDP

For configured connections with S7-1500, ISO applies in addition.

9. You can edit the input boxes in the address details. Depending on the selected protocol, you can edit the ports (for TCP and UDP) or the TSAPs (for ISO-on-TCP and ISO).
10. Use the "Active connection establishment" check box to set the connection establishment characteristics for TCP, ISO and ISO-on-TCP. You can decide which communication partner establishes the connection actively.

Changed values are checked immediately for input errors by the connection configuration and entered in the data block for the connection description.

---

**Note**

Open User Communication between two communication partners can only work when the program section for the partner end point has been downloaded to the hardware. To achieve fully functional communication, make sure that you load not only the connection description of the local CPU on the device but also that of the partner CPU as well.

---

**See also**

Description of the connection parameters (Page 478)

Starting connection parameter assignment (Page 481)

TSAP structure (Page 496)

Assignment of port numbers (Page 493)

Connection parameters with structure according to TCON\_Param (Page 488)

Connection parameters with structure according to TCON\_IP\_v4 (Page 491)

Connection parameters with structure according to TCON\_IP\_RFC (Page 492)

## Deleting connections

### Introduction

The data of a created connection for Open User Communication is stored in a connection description DB. You can delete the connection by deleting the data block containing the connection description.

### Requirement

You have created an Open User Communication connection.

### Procedure

To delete a connection, follow these steps:

1. Select a communication partner for Open User Communication in the project tree.
2. Open the "Program blocks > System blocks > Program resources" folder below the selected communication partner.
3. Select the "Delete" command from the shortcut menu of the data block with the connection parameter assignment.

---

#### Note

If you are not certain which block to delete, open the extended instruction TCON, TSEND\_C or TRCV\_C. You will find the name of the data block as the CONNECT input parameter or in the connection parameter assignment as the "Connection data" parameter.

If you only delete the instance DBs of the extended instructions TCON, TSEND\_C or TRCV\_C, the assigned connections are not deleted as well.

---

#### Note

If the connection DB is still being used by other blocks of the extended instructions, then the corresponding calls, their instance DBs, and, if present, the combination blocks TSEND\_C and TRCV\_C must also be deleted from the block folder, provided they are not used elsewhere.

This action prevents the program from being inconsistent.

---

## Result

You have deleted the connection.

---

### Note

Insert an extended instruction TCON, TSEND\_C, or TRCV\_C again in order to reference an existing connection description with the TCON\_Param, TCON\_IP\_v4, or TCON\_IP\_RFC structure again via the "Connection data" parameter.

---

## How protocols work

### Principle of operation of connection-oriented protocols

#### Introduction

Connection-oriented protocols establish a logical connection to the communication partner before data transmission is started. After the data transmission is complete, they then terminate the connection, if necessary. Connection-oriented protocols are used especially when reliable data transmission is important. Several logical connections can exist over one physical line.

Open User Communication supports the following connection types:

- TCP
- ISO-on-TCP
- ISO (S7-1500 only)
- UDP

Both communication partners must support the same connection type for a connection. If a communication partner does not support a connection of the type ISO-on-TCP, for example, use the connection type TCP instead, if it is supported.

For communication partners that cannot be configured in the TIA Portal, such as third-party devices or PCs, enter "unspecified" for the partner end point during connection parameter assignment. The required connection type for unspecified devices is listed in the respective documentation.

---

### Note

#### Connections with ISO

For S7-1500 CPUs, configured connections of the type ISO can be created using the TSEND\_C and TRCV\_C instructions. For additional information on these connection types, refer to the general connection descriptions.

---

## Characteristics of TCP

TCP is a streaming protocol in which the length of the data stream is transmitted to the receiver so that it can receive the data stream as individual TCP segments. This means no information about the start and end of a message is transmitted during data transmission via a TCP connection. The receiver cannot determine by the received segments of the data stream where one message in the data stream ends and the next one begins. It is therefore recommended that the number bytes to be received (parameter LEN, instruction TRCV/TRCV\_C) be assigned the same value as the number of bytes to be sent (parameter LEN, instruction TSEND/TSEND\_C).

If the length of the sent data and the length of the expected data do not match, the following occurs:

- Length of data to be received (parameter LEN, instruction TRCV/TRCV\_C) greater than length of data to be sent (parameter LEN, instruction TSEND/TSEND\_C):  
TRCV/TRCV\_C copies the received data to the specified receive area (parameter DATA) only after the assigned length is reached. When the assigned length is reached, data of the subsequent job are already being received. As a result, the receive area contains data from two different send jobs. If you do not know the exact length of the first message, you are unable to recognize the end of the first message and the start of the second message.
- Length of data to be received (parameter LEN, instruction TRCV/TRCV\_C) less than length of data to be sent (parameter LEN, instruction TSEND/TSEND\_C):  
TRCV/TRCV\_C copies the number of bytes you specified in the LEN parameter to the receive data area (parameter DATA). Then, it sets the NDR status parameter to TRUE (job completed successfully) and assigns RCVD\_LEN (amount of data actually received) the value of LEN. With each subsequent call, you receive a further block of the sent data.

A receive area with fixed data length can be specified in the TRCV/TRCV\_C instructions with the protocol version of the Ad-hoc mode.

## Characteristics of ISO-on-TCP

ISO-on-TCP is a message-oriented protocol which detects the end of the message at the receiver end and indicates the data that belongs to the message to the user. This does not depend on the specified reception length of the message. This means that information regarding the length and the end of a message is included during data transmission via an ISO-on-TCP connection.

If the length of the sent data and the length of the expected data do not match, the following occurs:

- Length of data to be received (parameter LEN, instruction TRCV/TRCV\_C) greater than length of data to be sent (parameter LEN, instruction TSEND/TSEND\_C):  
TRCV/TRCV\_C copies all the sent data to the receive data area (parameter DATA). Then, it sets the NDR status parameter to TRUE (job completed successfully) and assigns RCVD\_LEN (amount of data actually received) the length of the data sent.
- Length of data to be received (parameter LEN, instruction TRCV/TRCV\_C) less than length of data to be sent (parameter LEN, instruction TSEND/TSEND\_C):  
TRCV/TRCV\_C does not copy any data to the receive data area (parameter DATA), but instead supplies the following error information: ERROR=1, STATUS=W#16#8088 (destination buffer too small).

### Characteristics of UDP

UDP is a message-oriented protocol which detects the end of the message at the receiver end and indicates the data that belongs to the message to the user. This does not depend on the specified reception length of the message. This means that information on the length and the end of a message is included during data transmission via a UDP connection.

If the length of the sent data and the length of the expected data do not match, the following occurs:

- Length of data to be received (parameter LEN, instruction TRCV/TRCV\_C) greater than length of data to be sent (parameter LEN, instruction TUSEND/TSEND\_C):  
TUSEND/TSEND\_C copies all the sent data to the receive data area (DATA parameter). Then, it sets the NDR status parameter to TRUE (job completed successfully) and assigns RCVD\_LEN (amount of data actually received) the length of the data sent.
- Length of data to be received (parameter LEN, instruction TRCV/TRCV\_C) less than length of data to be sent (parameter LEN, instruction TUSEND/TSEND\_C):  
TRCV/TRCV\_C copies as much data to the receive data area (parameter DATA) as the LEN parameter requests. No further error message is generated. In this case, the user has to call a T\_URCV again in order to receive the remaining bytes.

### See also

Basics of Open User Communication (Page 472)

### Connection parameters with structure according to TCON\_Param

#### Data block for connection description

A connection description DB with a structure according to TCON\_Param is used for some S7-1200 CPUs when it comes to the assignment of parameters for TCP, UDP and ISO-on-TCP communication connections. The fixed data structure of the TCON\_Param contains all the parameters that are needed to establish the connection. The connection description DB is automatically created for a new connection by the connection configuration for Open User Communication when the TSEND\_C, TRCV\_C or TCON instruction is used.

The CONNECT connection parameter of the instance DBs for TSEND\_C, TRCV\_C or TCON contains a reference to the data block used.

#### Structure of the connection description according to TCON\_Param

Byte	Parameter	Data type	Start value	Description
0 ... 1	block_length	UINT	64	Length: 64 bytes (fixed)
2 ... 3	id	CONN_OUC	1	Reference to this connection (value range: 1 to 4095). You must specify the value of this parameter for the TSEND_C, TRCV_C or TCON instruction under ID.



Byte	Parameter	Data type	Start value	Description
4	connection_type	USINT	17	Connection type: <ul style="list-style-type: none"> <li>• 17: TCP</li> <li>• 18: ISO-on-TCP</li> <li>• 19: UDP</li> </ul>
5	active_est	BOOL	TRUE	Identifier for the type of connection establishment: FALSE always applies to UDP, since data can be sent and received via local ID. The following is valid for TCP and ISO-on-TCP: <ul style="list-style-type: none"> <li>• FALSE: Passive connection establishment</li> <li>• TRUE: Active connection establishment</li> </ul>
6	local_device_id	USINT	1	ID for the local PN/IE interface.
7	local_tsap_id_len	USINT	0	Length of parameter local_tsap_id used, in bytes; possible values: <ul style="list-style-type: none"> <li>• 0 or 2, if connection type = 17 (TCP) Only the value 0 is permissible for the active side.</li> <li>• 2 to 16, if connection type = 18 (ISO-on-TCP)</li> <li>• 2, if connection type = 19 (UDP)</li> </ul>
8	rem_subnet_id_len	USINT	0	This parameter is not used.
9	rem_staddr_len	USINT	4	Length of address of partner end point, in bytes: <ul style="list-style-type: none"> <li>• 0: unspecified, in other words, parameter rem_staddr is irrelevant.</li> <li>• 4: valid IP address in the parameter rem_staddr (TCP and ISO-on-TCP only)</li> </ul>
10	rem_tsap_id_len	USINT	2	Length of parameter rem_tsap_id used, in bytes; possible values: <ul style="list-style-type: none"> <li>• 0 or 2, if connection type = 17 (TCP) Only the value 0 is permissible for the passive side.</li> <li>• 2 to 16, if connection type = 18 (ISO-on-TCP)</li> <li>• 0, if connection type = 19 (UDP)</li> </ul>
11	next_staddr_len	USINT	0	This parameter is not used.
12 ... 27	local_tsap_id	ARRAY [1..16] of BYTE	-	Local address component of connection: <ul style="list-style-type: none"> <li>• TCP and UDP: local port no. (possible values: 1...49151; recommended values: 2000...5000); local_tsap_id[1] = high byte of port no. in hexadecimal notation; local_tsap_id[2] = low byte of port no. in hexadecimal notation; local_tsap_id[3-16] = irrelevant</li> <li>• ISO-on-TCP: local TSAP-ID: local_tsap_id[1] = B#16#E0; local_tsap_id[2] = rack and slot of local end points (bits 0 to 4: Slot number, bits 5 to 7: rack number);  local_tsap_id[3-16] = TSAP extension, optional</li> </ul> <p>Note: Make sure that every value of local_tsap_id is unique within the CPU.</p>

8.1 Configuring devices and networks

Byte	Parameter	Data type	Start value	Description
28 ... 33	rem_subnet_id	ARRAY [1..6] of USINT	-	This parameter is not used.
34 ... 39	rem_staddr	ARRAY [1..6] of USINT	-	TCP and ISO-on-TCP only: IP address of the partner end point, for example, for 192.168.002.003: <ul style="list-style-type: none"> <li>rem_staddr[1] = 192</li> <li>rem_staddr[2] = 168</li> <li>rem_staddr[3] = 002</li> <li>rem_staddr[4] = 003</li> <li>rem_staddr[5-6]= irrelevant</li> </ul>
40 ... 55	rem_tsap_id	ARRAY [1..16] of BYTE	-	Partner address component of connection <ul style="list-style-type: none"> <li>TCP: partner port no. (possible values: 1...49151; recommended values: 2000...5000); rem_tsap_id[1] = high byte of port no. in hexadecimal notation; rem_tsap_id[2] = low byte of port no. in hexadecimal notation; rem_tsap_id[3-16] = irrelevant</li> <li>ISO-on-TCP: partner TSAP-ID: rem_tsap_id[1] = B#16#E0; rem_tsap_id[2] = rack and slot of partner end point (bits 0 to 4: Slot number, bits 5 to 7: rack number); rem_tsap_id[3-16] = TSAP extension, optional</li> <li>UDP: This parameter is not used.</li> </ul>
56 ... 61	next_staddr	ARRAY [1..6] of BYTE	-	This parameter is not used.
62 ... 63	spare	WORD	W#16#0000	Reserved.

**Note**

**TCON\_Param for S7-1500 CPU**

The connection description DB with the structure according to TCON\_Param is also supported by S7-1500 CPUs for migration reasons. However, we recommend that you use the new structures TCON\_IP\_v4 and TCON\_IP\_RFC.

**See also**

- Principle of operation of connection-oriented protocols (Page 486)
- Description of the connection parameters (Page 478)
- Ability to read back connection description parameters (Page 494)
- Overview of connection configuration (Page 474)
- TSAP structure (Page 496)
- Assignment of port numbers (Page 493)

**Connection parameters with structure according to TCON\_IP\_v4****Data block for connection description**

A connection description DB with a structure according to TCON\_IP\_v4 is used for CPUs of S7-1200 V4.0 and higher and S7-1500 to assign parameters for TCP and UDP communication connections. The fixed data structure of the TCON\_IP\_v4 contains all parameters that are required to establish the connection. The connection description DB is automatically created for a new connection by the connection configuration for Open User Communication when the TSEND\_C, TRCV\_C or TCON instruction is used.

The CONNECT connection parameter of the instance DBs for TSEND\_C, TRCV\_C or TCON contains a reference to the data block used.

**Structure of the connection description according to TCON\_IP\_v4**

Byte	Parameter	Data type	Start value	Description
0 ... 1	interface_id	HW_ANY	64	Hardware identifier of the local interface (value range: 0 to 65535).
2 ... 3	id	CONN_OUC	1	Reference to this connection (value range: 1 to 4095). You must specify the value of this parameter for the TSEND_C, TRCV_C or TCON instruction under ID.
4	connection_type	BYTE	11	Connection type: <ul style="list-style-type: none"> <li>• 11: TCP</li> <li>• 13: UDP</li> </ul>
5	active_established	BOOL	TRUE	Identifier for the type of connection establishment: <ul style="list-style-type: none"> <li>• FALSE: Passive connection establishment</li> <li>• TRUE: Active connection establishment</li> </ul>
6 ... 9	remote_address	ARRAY [1..4] of BYTE	-	IP address of the partner end point, for example, for 192.168.0.1: <ul style="list-style-type: none"> <li>• addr[1] = 192</li> <li>• addr[2] = 168</li> <li>• addr[3] = 0</li> <li>• addr[4] = 1</li> </ul>

Byte	Parameter	Data type	Start value	Description
10 ... 11	remote_port	UINT	2000	Port address of the remote connection partner (value range: 1 to 49151).
12 ... 13	local_port	UINT	2000	Port address of the local connection partner (value range: 1 to 49151).

**See also**

- Principle of operation of connection-oriented protocols (Page 486)
- Description of the connection parameters (Page 478)
- Ability to read back connection description parameters (Page 494)
- Overview of connection configuration (Page 474)
- Assignment of port numbers (Page 493)

**Connection parameters with structure according to TCON\_IP\_RFC**

**Data block for connection description**

A connection description DB with a structure according to TCON\_IP\_RFC is used for CPUs of S7-1200 V4.0 and higher and S7-1500 to assign parameters to ISO-on-TCP communication connections. The fixed data structure of the TCON\_IP\_RFC contains all parameters that are required to establish the connection. The connection description DB is automatically created for a new connection by the connection configuration for Open User Communication when the TSEND\_C, TRCV\_C or TCON instruction is used.

The CONNECT connection parameter of the instance DBs for TSEND\_C, TRCV\_C or TCON contains a reference to the data block used.

**Structure of the connection description according to TCON\_IP\_RFC**

Byte	Parameter	Data type	Start value	Description
0 ... 1	interface_id	HW_ANY	64	Hardware identifier of the local interface (value range: 0 to 65535).
2 ... 3	id	CONN_OUC	1	Reference to this connection (value range: 1 to 4095). You must specify the value of this parameter for the TSEND_C, TRCV_C or TCON instruction under ID.
4	connection_type	BYTE	12	Connection type: ISO-on-TCP
5	active_established	BOOL	TRUE	Identifier for the type of connection establishment: <ul style="list-style-type: none"> <li>• FALSE: Passive connection establishment</li> <li>• TRUE: Active connection establishment</li> </ul>

Byte	Parameter	Data type	Start value	Description
8 ... 11	remote_address	ARRAY [1..4] of BYTE	-	IP address of the partner end point, for example, for 192.168.0.1: <ul style="list-style-type: none"> <li>• addr[1] = 192</li> <li>• addr[2] = 168</li> <li>• addr[3] = 0</li> <li>• addr[4] = 1</li> </ul>
12 ... 45	remote_tselector	TSelector	-	TSelector of the remote connection partner: <ul style="list-style-type: none"> <li>• TSelLength = Value range 0 to 32 as UINT</li> <li>• TSel[1-32] = Value range each 0 to 255 in bytes</li> </ul>
46 ... 79	local_tselector	TSelector	-	TSelector of the local connection partner: <ul style="list-style-type: none"> <li>• TSelLength = Value range 0 to 32 as UINT</li> <li>• TSel[1-32] = Value range each 0 to 255 in bytes</li> </ul>

### See also

Principle of operation of connection-oriented protocols (Page 486)

Description of the connection parameters (Page 478)

Ability to read back connection description parameters (Page 494)

Overview of connection configuration (Page 474)

TSAP structure (Page 496)

### Assignment of port numbers

#### Introduction

When an Open User Communication is created, the value 2000 is automatically assigned as the port number.

Permissible values for port numbers are 1 to 49151. You can assign any port number within this range. However, because some ports may already be used depending on the system, port numbers within the range from 2000 to 5000 are recommended.

---

#### Note

Port numbers must be unique. The connection configuration or a corresponding block call is rejected with an error if the port numbers are assigned twice.

---

### Overview of port numbers

The following table summarizes the system reactions to various port numbers.

Port no.	Description	System reaction
2000 ... 5000	Recommended range	No warning, no error message on entry Port number is permitted and accepted
1 ... 1999, 5001 ... 49151	Can be used, but is outside the recommended range	Warning message on entry Port number is permitted and accepted
0, 20, 21, 25, 80, 102, 135, 161, 34962 ... 34964	Can be used conditionally*	
53, 80, 102, 135, 161, 162, 443, 520, 9001, 34962 ... 34964	Can be used conditionally**	

\* Ports defined for specific functions:  
0: ANY - Port number is automatically assigned by S7-1500 CPU as value (>49151)  
20: FTP data transmission  
21: FTP control  
25: TMAIL\_C (Simple Mail transfer protocol)  
80: Web server  
102: ISO-on-TCP (RFC1006)  
135: DCE Endpoint Mapper for PROFINET  
161: SNMP (Simple Network Management Protocol)  
34962 ... 34964: PROFINET

---

#### Note

The user usually specifies the value 0 for the local port on the active connection end point for UDP/TCP. In this case, the CPU operating system selects the next available port above 49151. The partner port usually has the default 0 with the passive connection end point. The corresponding parameter is disabled in the connection configuration.

---

\*\* These ports are disabled depending on the function scope of the CPU in use. The documentation of the respective CPUs provides the assignment of these ports.

### See also

- Description of the connection parameters (Page 478)
- Creating and assigning parameters to connections (Page 482)

### Ability to read back connection description parameters

#### Changing parameter values in the connection description

The connection description for exactly one connection of the Open User Communication is entered from the connection configuration in the connection description DB.

You can change the parameter values of the connection description DB outside of the connection configuration in the user program. Connection description DBs containing values

you changed subsequently can be read back from the connection configuration. Under "Properties > Configuration > Connection parameters", the inspector window displays only the connection parameters stored in the connection description DB.

---

**Note**

You can only change the values in the running user program if the instructions TCON, TSEND\_C or TRCV\_C are not being processed and the referenced connection is not established.

---

The connection configuration does not support nested entries of connection descriptions in DB types that can only be found via offset referencing (for example, Global-DB).

The structure of the connection description cannot be changed.

### Ability to read back individual connection parameters

For the "Address" parameter of the communication partner in a TCP or ISO-on-TCP connection, its IP address is displayed from the "rem\_staddr" parameter of the connection description.

The following values can also be reloaded from the connection description:

- Connection type
- Local connection ID
- Active/passive connection establishment (only with UDP)
- Local TSAP (ISO-on-TCP only)
- Partner TSAP (ISO-on-TCP only)
- Local port (only with TCP and UDP)
- Partner port (only with TCP)

The values of the connection ID parameters of the communication partner, the connection data, as well as the connection establishment, are not included in the connection description in the local connection description DB. Consequently, these parameters cannot be displayed when the connection configuration is reopened. The connection establishment of the partner results from the local connection establishment and is therefore also displayed.

A new communication partner can be selected at any time in the "Partners" drop-down list box.

When a CPU recognized in the project is selected as a specified communication partner, the entry options for the connection ID and the connection data are shown again.

### See also

Connection parameters with structure according to TCON\_Param (Page 488)

Description of the connection parameters (Page 478)

## TSAP structure

### Introduction

For an ISO-on-TCP connection, Transport Service Access Points (TSAPs) must be assigned for both communication partners. TSAP IDs are assigned automatically after an ISO-on-TCP connection is created. To ensure the uniqueness of TSAP IDs within a device, you can change the preassigned TSAPs in the connection parameter assignment.

### Structure of TSAPs

You must comply with certain rules when assigning TSAPs. A TSAP must contain a certain number of bytes, which are able to be displayed and entered as hexadecimal values (TSAP-ID) or as ASCII characters (ASCII-TSAP):

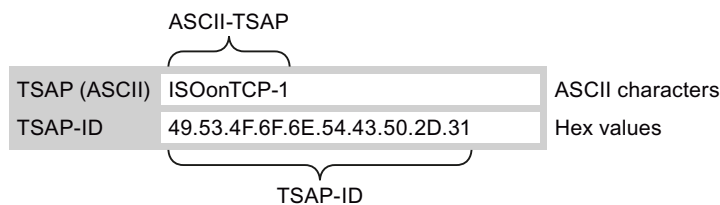

Entries or changes of the TSAP-ID or the ASCII-TSAP in the corresponding entry fields always take effect in the other display format as well.

If a TSAP contains no valid ASCII characters, the TSAP is displayed only as TSAP-ID and not as ASCII-TSAP. This is the case after a connection is created. The first two hex characters as TSAP-ID identify the communication type and the rack/slot. Because these characters are not valid ASCII characters for a CPU, the ASCII-TSAP is not displayed in this case.

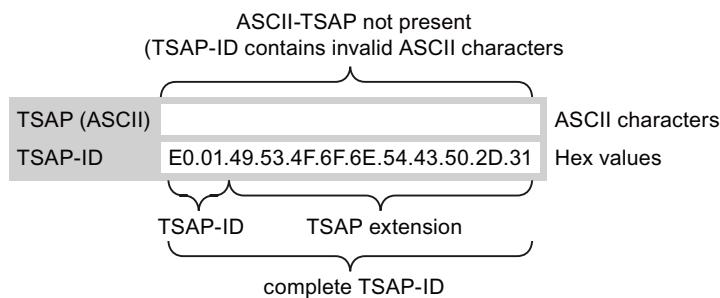

In addition to the rules for length and structure of TSAPs, you must also ensure the uniqueness of the TSAP-ID. The assigned TSAPs are not automatically unique.



### Length and content of TSAPs

A TSAP is structured as follows:

- TSAP-ID with TSAP extension  
 Length = 2 to 16 bytes  
 x\_tsap\_id[0] = 0xE0 (Open User Communication)  
 x\_tsap\_id[1] (bits 0 to 4) = slot number of CPU  
 x\_tsap\_id[1] (bits 5 to 7) = rack number of CPU  
 x\_tsap\_id[2...15] = any characters (TSAP extension, optional)  
 (x = loc (local) or x = rem (partner))
- TSAP-ID as ASCII-TSAP  
 Length = 3 to 16 bytes  
 x\_tsap\_id[0 to 2] = 3 ASCII characters (0x20 to 0x7E)  
 x\_tsap\_id[3...15] = any characters (optional)  
 (x = loc (local) or x = rem (partner))

The following table shows the schematic structure of a TSAP-ID:

TSAP-ID	tsap_id_len	tsap_id[0]	tsap_id[1]	tsap_id[2..15]	tsap_id[3..15]
...with extension	2...16 bytes	0xE0	0x01 or 0x02 or 0x00*	Extension (optional)	Extension (optional)
...as ASCII-TSAP	3...16 bytes	0x20...0x7E	0x20...0x7E	0x20...0x7	Any (optional)

\*An S7-1200/1500 CPU is normally inserted on rack 0 and slot 1, and an S7-300/400 CPU on rack 0 and slot 2. For this reason, hex value 01 or 02 is valid for the second position of the TSAP-ID with extension. If the connection partner is an unspecified CPU, for example, a third-party device, the hex value 00 is also permissible for the slot address.

#### Note

For unspecified communication partners, the local TSAP-ID and the partner TSAP-ID can have a length of 0 to 16 bytes, in which all hex values from 00 to FF are permitted.

### ASCII code table for entry of ASCII TSAPs

For entry of an ASCII-TSAP in the connection parameter assignment, only hexadecimal values from 20 to 7E are permitted:

Code	..0	..1	..2	..3	..4	..5	..6	..7	..8	..9	..A	..B	..C	..D	..E	..F
2..		!	"	#	\$	%	&	'	( )	*	+	,	-	.	/	
3..	0	1	2	3	4	5	6	7	8	9	:	;	<	=	>	?
4..	@	A	B	C	D	E	F	G	H	I	J	K	L	M	N	O
5..	P	Q	R	S	T	U	V	W	X	Y	Z	[ \ ]	^	_		
6..	`	a	b	c	d	e	f	g	h	i	j	k	l	m	n	o
7..	p	q	r	s	t	u	v	w	x	y	z	{   }	~			

**See also**

- Examples of TSAP assignment (Page 498)
- Description of the connection parameters (Page 478)
- Creating and assigning parameters to connections (Page 482)

**Examples of TSAP assignment**

The following examples show the processing of the TSAPs for CPUs of the S7-1200/1500 (CPU on slot 1) under various points of view:

- Example 1: Creating a new connection for PLC-PLC communication
- Example 2: Entry of a local ASCII-TSAP
- Example 3: Entry of a TSAP extension in the TSAP-ID
- Example 4: Incorrect editing of the TSAP-ID
- Example 5: Entry of an ASCII-TSAP via the "TSAP-ID" entry field

**Example 1: Creating a new connection for PLC-PLC communication**

Once you have created a new connection with two PLCs for the Open User Communication, the TSAP extension "ISOonTCP-1" is assigned automatically.

This TSAP extension produces the TSAP-ID E0.01.49.53.4F.6F.6E.54.43.50.2D.31, which is entered automatically in the connection description DB and in the entry fields of the local and the partner TSAP. The entry fields of the ASCII-TSAPs remain empty:

	Local TSAP	Partner TSAP
TSAP (ASCII)		
TSAP-ID	E0.01.49.53.4F.6F.6E.54.43.50.2D.31	E0.01.49.53.4F.6F.6E.54.43.50.2D.31

You can change the values in the entry fields of the TSAP-ID and the ASCII-TSAP at any time.

The entry field of the TSAP-ID shows the complete TSAP stored in the data block of the connection description. The TSAP-ID with TSAP extension, which is limited to 16 characters, is not displayed in the "TSAP (ASCII)" entry field because the character E0 does not represent a valid character for the ASCII-TSAP.

If the displayed TSAP-ID is a valid ASCII-TSAP, it is displayed in the "TSAP (ASCII)" entry field.

Changes in the entry fields for TSAP-ID and ASCII-TSAP affect the other field.

**Example 2: Entry of a local ASCII-TSAP**

If you have created a new connection and assigned an ASCII value for the local TSAP in the "TSAP (ASCII)" entry field, for example, "ISOonTCP-1", the resulting TSAP-ID is created automatically.

When you exit the "TSAP (ASCII)" entry field, the number of ASCII characters is checked automatically for compliance with the limit (3 to 16 characters) and the resulting TSAP-ID is entered into the corresponding entry field:

	Local TSAP	Partner TSAP
TSAP (ASCII)	ISOonTCP-1	
TSAP-ID	49.53.4F.6F.6E.54.43.50.2D.31	E0.01.49.53.4F.6F.6E.54.43.50.2D.31

### Example 3: Entry of a TSAP extension in the TSAP-ID

If, following creation of a connection and entry of an ASCII-TSAP (see examples 1 and 2) in the entry field of the local TSAP-ID, you add the prefix "E0.01" to the TSAP value, the ASCII-TSAP will no longer be displayed when the entry field is exited.

	Local TSAP	Partner TSAP
TSAP (ASCII)		
TSAP-ID	E0.01.49.53.4F.6F.6E.54.43.50.2D.31	E0.01.49.53.4F.6F.6E.54.43.50.2D.31

Once you have exited the entry field of the TSAP-ID, a check is performed automatically to determine whether the first character of the TSAP-ID is a valid ASCII character. Since the character "E0" now present in the TSAP-ID is not a valid character for the ASCII-TSAP, the "TSAP (ASCII)" entry field no longer displays an ASCII-TSAP.

If a valid ASCII character is used, the check for compliance with the length specification of 2 to 16 characters follows.

### Example 4: Incorrect editing of the TSAP-ID

If you remove the hex value "E0" from a TSAP-ID beginning with "E0.01", the TSAP-ID now begins with "01" and therefore no longer complies with the rules and is invalid:

	Local TSAP	Partner TSAP
TSAP (ASCII)		
TSAP-ID	01.49.53.4F.6F.6E.54.43.50.2D.31	E0.01.49.53.4F.6F.6E.54.43.50.2D.31

After the entry field is exited, a message is output because the TSAP-ID is neither a valid ASCII-TSAP (this would have to have a hex value in the range from 20 to 7E as the first value) or a valid TSAP-ID (this would have to have the identifier "E0" as the first value).

### Example 5: Entry of an ASCII-TSAP via the "TSAP-ID" entry field

If you remove the value "01" in addition to the value "E0" from the incorrect TSAP-ID in example 4, the TSAP-ID begins with the hex value 49. This value is within the permissible range for ASCII-TSAPs:

	Local TSAP	Partner TSAP
TSAP (ASCII)		
TSAP-ID	49.53.4F.6F.6E.54.43.50.2D.31	E0.01.49.53.4F.6F.6E.54.43.50.2D.31

When you exit the entry field, the TSAP-ID is recognized as a valid ASCII-TSAP and the resulting ASCII-TSAP "ISOonTCP-1" is written to the "TSAP (ASCII)" entry field.

## See also

TSAP structure (Page 496)

Description of the connection parameters (Page 478)

## Communication via PUT and GET instructions

### Basic information on communication via the PUT/GET instruction

#### Basic information on PUT/GET instructions

Use PUT and GET instructions to exchange data between two CPUs via an S7 connection.

The GET instruction is used to read data from a partner CPU. The PUT instruction is used to control the writing of tags by the communication partner via the user program. Apart from the PUT and GET instructions, no additional communication functions are provided for reading and writing tags.

To simplify the use of the two instructions, specify all required parameters for the connection and all block parameters in the Inspector window of the program editor.

#### Requirement

To be able to use the PUT and GET instructions, the following requirements must be satisfied:

- At least one S7-1200/1500 CPU or S7-300/400 CPU must be created in the project. Firmware 2.0 or higher must be installed on an S7-1200 CPU. If you have not yet created a second CPU in the project, you can initially establish the connection to an unspecified partner.
- An S7 connection must exist between the two CPUs. If you have not yet established a connection between two CPUs, a connection is automatically established during the configuration of the instructions.
- For both instructions, an instance data block is required in which all data used by the instruction is stored. The instance data block is created automatically as soon as you drag a PUT or GET instruction to a network in the program editor. For the correct execution of the program, it is essential that the instance data blocks are not changed; consequently, these data blocks are know-how protected. You only have read access to the instance data blocks.

## See also

Overview of connection configuration (Page 501)

Assigning parameters to start request (Page 506)

PUT: Set parameters for write and send area (Page 507)

GET: Set parameters for read and memory area (Page 508)

## **Connection configuration**

### **Overview of connection configuration**

#### **Introduction**

The connection parameters for the PUT and GET instructions are assigned in the inspector window of the program editor. All parameters are saved in the corresponding instance data block.

### Structure of the connection configuration

The connection configuration is made up of the following components:

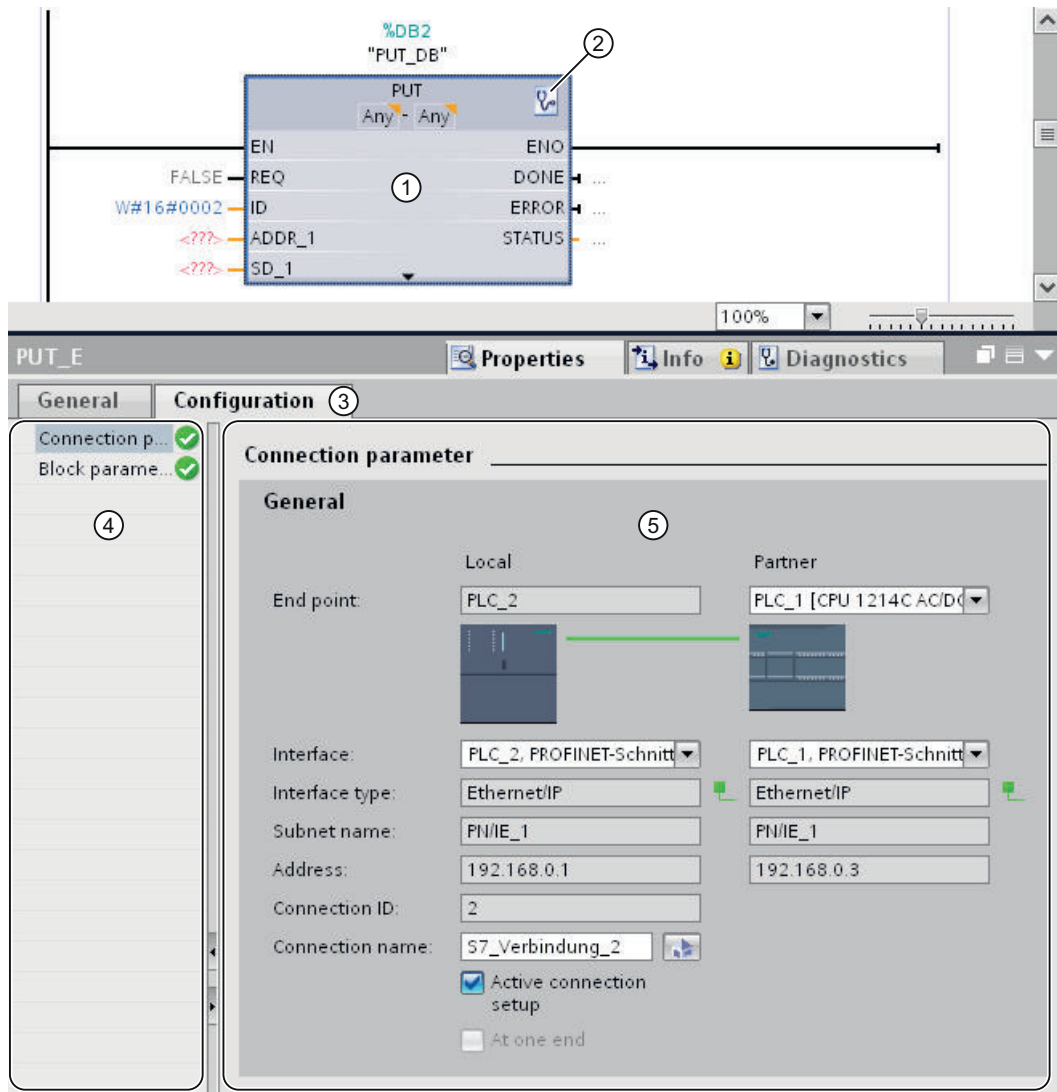

- ① Communication instruction for PUT or GET
- ② Call of online and diagnostic functions
- ③ "Configuration" tab in the "Properties" tab
- ④ Area navigation of the "Configuration" tab
- ⑤ General properties of the connection parameters

### Display of online and diagnostic functions

If you click the icon for starting the online and diagnostic functions, the associated CPU goes online automatically. The connection table in the network view is opened. In addition, the "Diagnostics" tab and the connection information are displayed in the inspector window.

## Entering the connection parameters

Enter the desired connection parameters in the "Configuration" tab. The area navigation of the "Configuration" tab includes the "Connection parameters" group. This group contains the connection configuration. Here, you can enter the parameters for the connections using system functions. When all the required parameters are assigned, a check mark is set behind the "Connection parameters" group in the area navigation.

## See also

Assigning parameters to start request (Page 506)

PUT: Set parameters for write and send area (Page 507)

GET: Set parameters for read and memory area (Page 508)

## Description of the connection parameters

### Overview

The following table shows the general connection parameters:

Parameter	Description
End point	<p>The names of the local end point and the partner end point are shown.</p> <ul style="list-style-type: none"> <li>• Local end point The local end point is the CPU in which the PUT or GET instruction is programmed.</li> <li>• Partner end point The partner end point is selected from the drop-down list. The drop-down list shows all available possible connection partners including unspecified connection partners for devices whose data is unknown in the project. As long as no connection partner is set, all other parameters in the mask are disabled.</li> </ul>
Interface	The interface of the partner CPU is displayed. The partner interface is not displayed until a specified partner CPU has been selected.
Interface type	The type of interface via which communication is handled is displayed.
Subnet name	<p>The subnet of the local end point is displayed, provided this exists. The partner subnet is displayed only after the partner end point has been selected.</p> <p>If at least one of the two connection partners is not connected with a subnet, the two connection partners are automatically connected with each other. The partner which is not connected to a network is hereby connected to the same subnet via which the other partner is already connected to a network.</p> <p>A connection of connection partners to different subnets is only possible with IP or S7 routing. The IP routing settings can be edited in the relevant interface properties.</p>
Address	<p>The IP address of the local end point is displayed. The IP address of the partner is displayed only after the partner end point has been selected.</p> <p>If you have selected an unspecified connection partner, the input box is empty and has a red background. In this case, you will need to specify a valid IP address for the connection partner.</p>
Connection ID	The currently set connection ID is displayed. You can change the connection ID in the connection table in the network view. You can also directly access the connection table while you are setting the connection parameters. To do this, click the "Create new connection" icon.

Parameter	Description
Connection name	The name of the connection which was automatically created when the PUT/GET instruction was inserted is displayed. You can change the name of the connection by entered a different name in the field. You can also create a new connection or edit existing connections by clicking the "Create new connection" icon.
Active connection establishment	Use the "Active connection establishment" option button to specify which partner starts the communication. When the connection is created, the local partner is initially specified by default for the establishment of the connection. If a device does not support active connection establishment, you have to activate active connection establishment on the other partner.
Configured at one end	If this check box is selected, the connection partner is the server for this connection. It cannot actively send or receive. This corresponds to the behavior of the PUT/GET instructions. In this case, other instructions are not possible. If the check box is not selected, other instructions can also be used for the communication.

### Starting connection parameter assignment

You can assign the connection parameters for PUT and GET in the inspector window as soon as you have inserted and selected a PUT or GET instruction in a program block.

### Procedure

To insert PUT/GET instructions, follow these steps:

1. Open the "Instructions" task card in the "Communication > S7 Communication" folder.
2. Drag a PUT or GET instruction to a network.  
The "Call options" dialog opens.
3. Optional: Edit the properties of the instance DB in the "Call properties" dialog. You have the following options:
  - Change the default name.
  - Select the "Manual" check box to assign your own number.
4. Click "OK".

### Result

A corresponding instance data block is created for the inserted PUT or GET instruction. For S7-300 CPUs, a function block is also created in the program resources.

When PUT or GET instruction is selected, you will see the "Configuration" tab under "Properties" in the inspector window. The "Connection parameters" group in area navigation contains the connection parameter assignment that you can now make.

### See also

Creating and assigning parameters to connections (Page 505)

Deleting connections (Page 506)



## Creating and assigning parameters to connections

You can create S7 connections and assign the parameters for these in the connection parameter assignment of the PUT/GET instructions. Changed values are checked immediately by the connection parameter assignment for input errors.

### Requirement

A CPU exists with a PUT or GET communication instruction.

### Procedure

To configure an S7 connection using PUT/GET instructions, follow these steps:

1. In the program editor, select the call of the PUT or GET instruction.
2. Open the "Properties > Configuration" tab in the inspector window.
3. Select the "Connection parameters" group. Until you select a connection partner, only the empty drop-down list for the partner end point is enabled. All other input options are disabled.  
The connection parameters already known are displayed:
  - Name of the local end point
  - Interface of the local end point
  - IP address of the local end point
4. In the drop-down list box of the partner end point, select a connection partner. You can select an unspecified device or a CPU in the project as the communications partner. The following parameters are automatically entered as soon as you have selected the connection partner:
  - Interface of the partner end point
  - Interface of the partner end point. If several interfaces are available, you can change the interface as required.
  - Interface type of the partner end point
  - Subnet name of both end points
  - IP address of the partner end point
  - Name of the connection which is used for the communication. If no connection exists yet, it is automatically established.
5. If required, change the connection name in the "Connection name" input box. If you want to create a new connection or edit an existing connection, click on the "Create new connection" icon.

---

#### Note

The PUT and GET instructions between two communication partners can only run if both the hardware configuration and the program part for the partner end point have been loaded into the hardware. To achieve fully functional communication, make sure that you load not only the connection description of the local CPU on the device but also that of the partner CPU as well.

---

## **Deleting connections**

A connection which was automatically created during the insertion of a PUT or GET instruction appears in the connection table of the network view like every standard connection. As a result, it can be deleted in the connection table.

## **Procedure**

To delete a connection, follow these steps:

1. Open the connection table in the network view.
2. In the connection table, select the connection that you want to delete.
3. To do this, right-click the connection and select the "Delete" command from the shortcut menu.

## **Result**

The connection is deleted. The PUT or GET instruction and the associated instance data blocks are retained and must be manually deleted if necessary.

To continue using the PUT or GET instruction, you must configure the connection again in the inspector window of the program editor, since all connection parameters were also deleted when the connection was deleted. In this case, specify a new communication partner and a suitable connection.

## **Block parameter assignment**

### **Assigning parameters to start request**

To start communication via the PUT or GET instruction, you have to specify an event which activates the instruction. This event is referred to as control parameter (REQ). The communication job is activated as soon as there is a positive edge at the control parameter REQ.

Please note that the control parameter REQ is assigned the default FALSE at first call.

## **Requirement**

- The program editor is open.
- You have already inserted a PUT or GET instruction.
- A connection has been established between two communication partners.

## **Procedure**

To define the REQ control parameter, follow these steps:

1. Select the PUT or GET instruction in the program editor.
2. Open the "Configuration" tab in the inspector window.

3. Select the "Block parameter assignment" entry in the area navigation.
4. In the "REQ" field, select a tag of the "BOOL" data type to initialize the execution of the instruction. Alternatively, you can also interconnect a previous instruction in the program editor.

## See also

PUT: Set parameters for write and send area (Page 507)

GET: Set parameters for read and memory area (Page 508)

## PUT: Set parameters for write and send area

For communication via the PUT instruction, you must specify the memory area of the partner CPU to which the data should be written. In addition, you must specify the memory area of the local CPU from which the data is to be read.

## Requirement

- The program editor is open.
- You have already inserted a PUT instruction.
- A connection has been established between two communication partners.

## Procedure

To specify the read and the memory area for the instruction, follow these steps:

1. Select the PUT instruction in the program editor.
2. Open the "Configuration" tab in the inspector window.
3. Select the "Block parameter assignment" entry in the area navigation.
4. In the "In/Outputs > Write area (ADDR\_1) > Start" field, select a "REMOTE" data type pointer to the area of the partner CPU which is to be written.  
Only absolute addressing is permitted.  
Example: P#DB10.DBX5.0 Byte 10
5. In the "Length" field, enter the length of the write area and select the data type of the memory area from the drop-down list.
6. In the "In/Outputs > Send area (SD\_1) > Start" field, select a pointer to the area in the local CPU which contains the data to be sent.
7. In the Length field, enter the length of the memory area to be read and select the data type from the drop-down list.  
Only the data types BOOL (for a bit array, "0" must be used as address and an integer multiple of byte must be used as length), BYTE, CHAR, WORD, INT, DWORD, DINT, REAL, COUNTER, TIMER are permitted.  
If the VARIANT pointer accesses a DB, the DB must always be specified (for example: P#DB10.DBX5.0 Byte 10).

## See also

GET: Set parameters for read and memory area (Page 508)

## GET: Set parameters for read and memory area

For communication via the GET instruction, you must specify the memory area of the local CPU to which the data should be written. In addition, you must specify the memory area of the partner CPU from which the data is to be read.

## Requirement

- The program editor is open.
- You have already inserted a GET instruction.
- A connection has been established between two communication partners.

## Procedure

To specify the read and the memory area for the instruction, follow these steps:

1. Select the GET instruction in the program editor.
2. Open the "Configuration" tab in the inspector window.
3. Select the "Block parameter assignment" entry in the area navigation.
4. In the "In/Outputs > Read area (ADDR\_1) > Start" field, select a "REMOTE" data type pointer to the area of the partner CPU which is to be read.  
Only absolute addressing is permitted.  
Example: P#DB10.DBX5.0 Byte 10
5. In the "Length" field, enter the length of the read area and select the data type of the memory area from the drop-down list.
6. In the "In/Outputs > Memory area (RD\_1) > Start" field, select a pointer to the area in the local CPU in which the read data is to be stored.
7. In the Length field, enter the length of the memory area and select the data type from the drop-down list.  
Only the data types BOOL (for a bit array, "0" must be used as address and an integer multiple of byte must be used as length), BYTE, CHAR, WORD, INT, DWORD, DINT, REAL, COUNTER, TIMER are permitted.

## See also

PUT: Set parameters for write and send area (Page 507)

### 8.1.3.3 Displaying and configuring topology

#### Overview of the topology view

#### Functions of the topology view

The topology view is one of three working areas of the hardware and network editor. You undertake the following tasks here:

- Displaying the Ethernet topology
  - Displaying all the PROFINET devices and passive Ethernet components of the project along with their ports
  - Displaying interconnections between the ports
  - Displaying corresponding logical networks
  - Display diagnostic information of all ports
- Configuring the Ethernet topology
  - Creating, modifying and deleting interconnections of the ports
  - Renaming stations, devices, interfaces or ports
  - Adding PROFINET devices and passive Ethernet components to the project from the hardware catalog
- Identifying and minimizing differences between the desired and actual topology
  - Running an offline/online comparison of Ethernet modules, ports and port interconnections
  - Adopting existing online topology information in the offline project

#### Differences between network view and topology view

- The network view shows all the logical subnets of the project. The topology view shows all Ethernet components of the project. These include passive components such as switches, media converters and cables.

---

**Note**

Stations with non-Ethernet components are also displayed if the station has a least one Ethernet component.

---

- The position of a device in the network view and its position in the topology view are not dependent on each other; in other words, the same device generally appears at different locations in the two views.
- If you open the hardware catalog in the topology view, you only see devices with an Ethernet interface.

### Structure of the topology view

The topology view (Page 396) essentially consists of a graphic area (called the graphic view below) and a table area (called the table view below).

### Which functions are there in the graphic view and which functions are there in the table view?

- Displaying the Ethernet topology

Function	Graphic view	Table view
Displaying all the PROFINET devices and passive Ethernet components of the project along with their ports	yes	yes
Display interconnections between the ports (including type of medium)	yes	yes
Displaying corresponding logical networks	no	yes
Displaying properties of the cables between the ports	no	yes
Display diagnostic information of all ports	yes	yes

- Configuring the Ethernet topology

Function	Graphic view	Table view
Creating, modifying and deleting interconnections of the ports	<ul style="list-style-type: none"> <li>• Create: yes</li> <li>• Modify: no</li> <li>• Delete: yes</li> </ul>	<ul style="list-style-type: none"> <li>• Create: yes</li> <li>• Modify: yes</li> <li>• Delete: yes</li> </ul>
Renaming stations, devices, interfaces or ports	no	yes
Adding PROFINET devices and passive Ethernet components to the project from the hardware catalog	yes	no

- Identifying and minimizing differences between the desired and actual topology

Function	Graphic view	Table view
Running an offline/online comparison of Ethernet modules, ports and port interconnections	no	yes
Adopting existing online topology information in the offline project	no	yes

### Starting the topology view

#### Requirement

The device or network view is open in the hardware and network editor.

#### Procedure

To start the topology view of your project, follow these steps:

1. Click on the "Topology view" tab.

Or:

1. Open the network view of the hardware editor.
2. Select a PROFINET device or a PROFINET module.
3. Select the "Go to topology view" command in the shortcut menu.

## **Result**

The graphic view of the topology view is started. If you opened the topology view using the shortcut menu, the selected component remains selected after the change of view.

## **Displaying topology**

### **Displaying the graphic view of the configured topology**

#### **What is shown?**

The graphic view of the configured topology shows the following:

- Configured PROFINET devices and passive Ethernet components along with their ports
- Configured stations with non-Ethernet components if there is at least one Ethernet component in the station
- Configured interconnections between the ports

#### **Type of display**

The way in which the graphic view of the topology view and the network view are displayed is very similar:

- Compared with the device view, components are shown in a simplified form.
- The interconnections between ports are shown as horizontal and vertical lines. These are dashed when an interconnection between a tool changer port and its possible partner ports is involved.

## Displaying the table view of the configured topology

### What is shown?

The table view of the configured topology shows exactly the same content as the graphic view except for the logical PROFINET subnets.

- All the configured PROFINET devices and passive Ethernet components along with their ports
- All the configured stations with non-Ethernet components if there is at least one Ethernet component in the station
- Configured interconnections between the ports  
For each port with the "Alternating partner port" property, there are as many completed rows as there are potential partner ports plus one empty row.

### Type of display

As the name implies, the table view of the topology view consists of a table, the topology overview table. It is structured like the network overview table. It consists of the following columns:

- Device / port  
This is the most important column of the table. The entries in this column have a hierarchical structure with the PROFINET ports being the last element in the hierarchy. You can expand and collapse the hierarchical entries. For a CPU, for example, an entry consists of the following elements:
  - Station name
  - Device name
  - Name of the PROFINET interface
  - Names of the ports

Note: All the other columns only have entries in the rows containing the port names.
- Type (as default, this column is not displayed)  
Shows what type of station, device or interface the table row relates to or whether it belongs to a port.
- Order no. (as default, this column is not displayed)  
Order no. of device
- Subnet (as default, this column is not displayed)  
Configured subnet to which the interface belongs
- Master / IO system (as default, this column is not displayed)  
Shows whether or not the interface belongs to a PROFIBUS DP master system or a PROFINET IO system.
- Device address (as default, this column is not displayed)  
Configured address of the interface in the subnet
- Partner station  
Name of the station that contains the partner port



- Partner device  
Name of the device that contains the partner port
- Partner interface  
Interface to which the partner port belongs
- Partner port
- Cable data  
Contains the cable length and the signal delay of the cable connecting the ports

### **Basic functions for tables**

The topology overview table supports the following basic functions for editing a table:

- Displaying and hiding table columns  
Note: The columns that define the configuration cannot be hidden.
- Optimizing column width
- Displaying the meaning of a column, a row or cell using tooltips.

### **Displaying the diagnostics status of ports and cables in the graphic view**

#### **Requirements**

The graphic view of the topology view is open.

#### **Procedure**

To determine the diagnostics status of the port, follow these steps:

1. Go online with the required component or components.

#### **Result**

The following icons are displayed:

- The corresponding diagnostics icon is displayed for each device.
- If there is an error in at least one lower-level component, the diagnostics icon "Error in lower-level component" is also displayed in the left-hand lower corner of the diagnostics icon.
- The corresponding diagnostics icon is displayed for each port.
- Every cable between two ports that are online has the color that matches its diagnostics status.

You will find the possible diagnostics icons for ports and the color coding of Ethernet cables in the description of hardware diagnostics. See: Displaying diagnostics status and comparison status using icons (Page 962)

## Showing the diagnostics status of hardware components in the table view

### Requirement

The table view of the topology view is open.

### Procedure

To obtain the diagnostics status of hardware components of the topology overview table, follow these steps:

1. Go online with the required components.

### Result

The following icons are displayed at the left-hand edge of the topology overview table in each row that belongs to the component involved:

- The diagnostics icon belonging to the hardware component is displayed.
- If the hardware component has lower-level components and if there is an error in at least one of the lower-level components, the diagnostics icon "Error in lower-level component" is also displayed in the left-hand lower corner of the diagnostics icon of the hardware component.

For the possible diagnostics icons for hardware components, refer to the description of hardware diagnostics. See: [Displaying diagnostics status and comparison status using icons](#) (Page 962)

---

#### Note

The display of the diagnostics status of hardware components in the topology overview table and the network overview table is identical.

---

## Running an offline/online comparison and displaying the results

### Requirement

The topology view is open. There may be an online connection to one or more devices, but this is not actually necessary.

## Procedure

To find the differences between the configured and the actual topology, follow these steps:

1. Click the "Offline/online comparison" button in the toolbar of the topology overview.

## Result

The "Partner station", "Partner interface" and "Cable data" columns in the topology overview table are removed.

Two additional groups of columns are added to the right-hand side of the table and these are initially empty:

- On the far right, columns for the topology to be identified online are added.
- Between the columns for the offline and the online topology, the "Status", "Action" and "Description" columns are added to show the result of the offline/online comparison.



---

### Note

As default, the "Description" column is not displayed.

---

The following buttons are enabled in the toolbar of the table:

Button	Name	Meaning
	Update	The detection of the existing online topology is started again.
	Synchronize	<ul style="list-style-type: none"> <li>• Adopting the port interconnections identified online in the project (Page 523)</li> <li>• Adopt the devices identified online in the project (Page 524)</li> </ul>

After the actual topology has been identified, the added columns are filled. These steps are described in more detail in the following section.

---

### Note

A difference between offline and online view is displayed for that port connected with the PG/PC which is only available online. This is because the PG/PC cannot be configured offline.

---

## Columns for the topology identified online

The following columns are displayed:





- "Device / port"
- "Type" (as default, this column is not displayed)
- "Order no." (as default, this column is not displayed)
- "IP address" (as default, this column is not displayed)
- "Partner device"

- "Partner port"
- "Cable data"



### Columns for the result of the offline/online comparison

The following columns are displayed:

- "Status"  
The result of the offline/online comparison is shown here in the form of diagnostics icons. The following icons are possible:

Diagnostics icon	Meaning
	Differing topology information in at least one lower-level component
	Identical topology information
	Topology information only available offline or device is disabled.
	Topology information only exists online
	Differing topology information
	If a device does not support topology functions, the "Status" column remains empty.

- "Action"  
The possible actions are shown here in the form of icons. The following icons are possible:

Icon	Meaning
	No action possible
	Adopt the interconnection found online

- "Description"  
This column describes the selected action in words.

### Configuring topology

### Interconnecting ports

### Overview

### Interconnecting ports in the topology view

In the topology view, you have the following options for interconnecting ports:

- in the graphic view (Page 517)
- in the graphic view of a tool changer (Page 519)

- in the table view (Page 518)
- in the table view of a tool changer (Page 520)
- by adopting port interconnections identified online (Page 523)

### What effects does the interconnection of ports have on the network view?

---

#### Note

In the properties of a subnet in the network view, you can specify that this subnet is used when a port interconnection is created between two devices that are not networked.

---

When you create an interconnection between two ports, the following effects are possible in the network view:

- If the corresponding interfaces are not networked: If you have specified a default subnet, this is used. Otherwise a new subnet is created to connect the two interfaces.
- If one (and only one) of the two interfaces involved is networked: The non-networked interface is connected to the same subnet as the already networked interface.
- In all other cases: The corresponding interfaces are not connected to a logical subnet.

#### See also

Interconnecting ports (Page 813)

### Interconnecting ports in the graphic view

#### Requirement

You are in the graphic view of the topology view.

#### Procedure – Creating a new interconnection between two ports

To interconnect a port of a device with a port of another device, follow these steps:

1. Place the mouse cursor on the port you want to interconnect.
2. Click with the left mouse button and hold it down.
3. Move the mouse pointer.  
The pointer now shows the networking symbol to indicate "Interconnect" mode. At the same time, the mouse pointer shows the lock symbol that will only disappear when the pointer is on a valid target.
4. Now drag the mouse cursor to the target port. You can do this while holding down or after releasing the mouse button.
5. Now release the left mouse button or press it again (depending on your previous action).

Result: A new port interconnection is created.

---

**Note**

**Creating a ring for S7-300, S7-400, and S7-1500 CPUs**

If you create a ring using port interconnections for S7-300, S7-400, or S7-1500 CPUs, an MRP domain is created automatically.

---

**Procedure – Changing an existing port interconnection without deleting it first**

To do this, follow these steps:

1. Place the mouse cursor on the port of an existing interconnection that is to receive a new partner port.
2. Drag the port to the new partner port.

Result: The existing port interconnection is deleted. The new port interconnection is created.

Alternative procedure:

1. Place the mouse cursor on a port without an interconnection that is to be connected with an already interconnected port.
2. Drag the port to the already interconnected port.

Result: The existing port interconnection is deleted. The new port interconnection is created.

**Procedure – Interconnecting two interconnected ports with each other without first deleting the two existing port interconnections**

To do this, follow these steps:

1. Place the mouse cursor on the interconnected port that is to receive a new partner port.
2. Drag the port to the new partner port that is also interconnected already.

Result: The two existing port interconnections are deleted. The new port interconnection is created.

**Interconnecting ports in the table view**

**Which actions are possible with port interconnections in the table view?**

The following actions are possible with port interconnections in the table view:

- Creating a new port interconnection
- Changing an existing port interconnection
- Deleting an existing port interconnection

## Requirement

The row with the port whose interconnection you want to create, modify or delete is visible in the topology overview.

## Procedure

To create the interconnection of a port for the first time, to modify it or delete it, follow these steps:

1. Move the mouse pointer to the "Partner port" column in the row of the source port.
2. Click the drop-down list there.
3. Select the required partner port (when creating or changing a port interconnection) or the "Not interconnected" entry (when deleting a port interconnection).

## Result

The required action is performed. The new partner port (after creating or modifying a port interconnection) or the "Select port" entry (after deleting a port interconnection) is displayed in the "Partner port" column.

## Interconnecting a port with more than one partner port in the graphic view

### Requirement

- You have configured a port of a PROFINET device with the "Alternative partners" property and have specified its possible partner ports.
- The graphic view of the topology view is open.

### Procedure

1. Interconnect this port (referred to hereafter as source port) with one of the partner ports you have specified (referred to hereafter as target port).
2. Interconnect the source port with an additional target port.  
You can do this in several ways:
  - Drag the mouse pointer from a partner port that is already interconnected to a target port.
  - Drag the mouse pointer from an interconnection that has already been created to a target port.
  - Drag the mouse pointer from a target port to a partner port that is already interconnected.
  - Drag the mouse pointer from a target port to an already created interconnection.
3. If necessary, repeat the step above one or more times.

## Result

An interconnection is created between the source port and the alternative partner ports. This is indicated by a dashed line.

## Interconnecting a port with more than one partner port in the table view

### Which actions are possible with port interconnections to several partner ports in the table view?

When working with a tool changer, the following actions can be performed with port interconnections to multiple partner ports in the table view:

- Creating a new port interconnection
- Changing an existing port interconnection
- Deleting an existing port interconnection

## Requirement

- You have configured a port of a PROFINET device with the "Alternative partners" property and have specified its possible partner ports.
- The row with the port whose interconnection you want to create, modify or delete is visible in the topology overview.

## Procedure

To create the interconnection of a port to one or more partner ports for the first time, to modify it, or to delete it, follow these steps:

1. Move the mouse pointer to the "Partner port" column in the row of the source port.
2. Click the drop-down list there.
3. Select the required partner port (when creating or changing a port interconnection) or the "Not interconnected" entry (when deleting a port interconnection).

## Result

The required action is performed:

- If you are creating an interconnection, a new row is inserted in the topology overview table. The new partner port is displayed there in the "Partner port" column.
- If you change an interconnection, the new partner port is displayed in the "Partner port" column.
- If you delete an interconnection, the row with the previous port interconnection is deleted.

---

### Note

With a tool changer, there are normally several rows for a port with port interconnections to more than one partner port. The last row is always an empty row. The first row can be edited, all other rows are read-only.

---



## Renaming stations, devices, interfaces or ports

### Rename a station, a device, an interface or a port

#### Requirement

The table view of the configured topology is open.

#### Procedure

To rename a station, a device, an interface or a port, proceed as follows:

1. Click twice in the relevant field of the topology overview table (the second click starts the editing mode).
2. Enter the new name and then press the ENTER key (this closes editing mode).

#### Result

The object is renamed.

## Offline/online comparison

### Automatic assignment of devices by offline/online comparison

#### Overview

During the offline/online comparison, the configured topology is compared with the actual existing topology. Devices identified online are automatically assigned to configured devices as far as this is possible.

### Start of availability detection

You start the availability detection the first time by clicking the "Compare offline/online" button in the toolbar of the topology overview.

You restart availability detection by clicking the "Update" button.

---

#### Note

The availability detection can take several seconds. During this time, no user input is possible.

---

### Automatic assignment

A device identified online is automatically assigned to a configured device if the following properties of the two devices match up:

- Device name
- Order number
- Number of ports

The following section describes the situations that can occur and what action you can take:



- Identical port interconnections  
This is the ideal situation. No action is necessary here.

"Action" column	Meaning
	No action

- There are interconnections for the identified and configured device, there are however differences.

The following actions are possible:



- If it is possible to adopt the online configuration

"Action" column	Meaning
	Adopt online interconnection (Page 523)
	No action

- If it is not possible to adopt the configuration

"Action" column	Meaning
	No action



- The interconnection only exists online.  
The following actions are possible:
  - If it is possible to adopt the online configuration

"Action" column	Meaning
	Adopt online interconnection (Page 523)
	No action

- If it is not possible to adopt the configuration

"Action" column	Meaning
	No action

- The interconnection only exists in the configuration.  
The following actions are possible:

"Action" column	Meaning
	Adopt the online interconnection (Page 523), in other words, the interconnection in the configuration will be deleted
	No action

### No automatic assignment

In the following situations, no automatic assignment is possible:

- No device can be identified online to match a configured device. In this case the corresponding columns in the "Online topology" area of the topology overview table are empty.  
In this case, you should add the already configured device to your system or delete the configured device from the configuration.
- A device identified online cannot be assigned to any configured device. In this case the corresponding columns in the "Offline topology" area of the topology overview table are empty.  
In this case, you can adopt the device identified online in the project (Page 524).

### Adopting the port interconnections identified online in the project

#### Requirement

You have run an offline/online comparison in the topology view. The result of this is that at least one device identified online was automatically assigned to a configured device, but that there are differences relating to the interconnection.

## **Procedure**

To adopt one more port interconnections identified online in the project manually, follow these steps:

1. Select the value "Adopt" in the "Action" column for a port of a configured device to which a device identified online was assigned.
2. Repeat the step if necessary for other ports of the same configured device.
3. Repeat the steps up to now if necessary for other configured devices to which devices identified online were assigned and for which there are differences relating to the interconnection.
4. Click the "Synchronize" button.

## **Result**

The port interconnections identified online and the cable information for the corresponding devices are adopted in the project. Successful adoption is indicated by the diagnostics icon "Identical topology information" for each port.

---

### **Note**

If other port interconnections are recognized for a device identified online and these differ from those that exist in the project, adopting these in the project means that the port interconnections that were previously in the project are replaced by those identified online. If no port interconnections are detected for a device identified online, adopting in the project means that all the port interconnections of this device are deleted in the project.

---

## **Adopt the devices identified online in the project**

### **Requirements**

You have run an offline/online comparison in the topology view. The result of this is that at least one device identified online could not be assigned to any configured device.

### **Procedure**

To adopt one more devices identified online in the project manually, follow these steps:

1. For a configured device without an online partner, move the mouse pointer to the "Device/port" column of the online topology.
2. Select the device you want to assign to the configured device from the drop-down list of this box.
3. Repeat the previous steps if necessary for other configured devices without an online partner.

## Result

The selected device that was identified online is moved up from the end of the table. Following this, it is in the row of the configured device to which you have just assigned it.

### 8.1.3.4 Industrial Ethernet Security

#### Configuring security

#### General

#### Supported devices

#### Supported devices

Security functions can be configured for the following products:

- SCALANCE S:
    - S602 V2/V3
    - S612 V2/V3
    - S613 V2
    - S623 V3

Note: SCALANCE S V3 devices can currently only be configured with those functions that are supported by SCALANCE S V2 devices. For the SCALANCE S623, the DMZ port is currently not configurable.
  - SOFTNET Security Client:
    - SOFTNET Security Client V4
  - S7-CPs: CP 343-1 GX31 Advanced, CP 443-1 GX30 Advanced, CP 1543-1
- Note: The S7 CPs, CP 343-1 GX31 Advanced and CP 443-1 GX30 are now grouped together under "CP x43-1 Advanced".
- PC CP: CP 1628
  - SCALANCE M: SCALANCE M875 and MD741-1

#### General terminology "security module"

In this section of the information system, the following products are grouped together under the term "security module": CP 343-1 GX31 Advanced, CP 443-1 GX30 Advanced, CP 1543-1, SCALANCE S602 / SCALANCE S612 / SCALANCE S613 / SCALANCE S623, CP 1628, SCALANCE M875/MD741-1.

## **Structure of this section of the help system**

Topics that are relevant to all security modules can be found in the "General" section. Information that is only relevant to certain module types can be found in the sections relating specifically to these modules.

## **Overview - Scope of performance and method of operation**

### **General use of the term "STEP 7"**

Configuration of security functions is supported as of STEP 7 V12. For this reason, in this section of the information system, the name "STEP 7" will be used for all versions of STEP 7 V12 or higher.

### **Scope of performance**

You can use the following security functions in STEP 7:

- Configuration of the security modules
- Creating configuration files for SOFTNET Security Client V4
- Creating the configuration data of the SCALANCE M875/MD741-1
- Diagnostics functions and status displays

### **Offline and online view**

The security functions are configured in two views:

- **Offline configuration view**  
In the offline configuration view, you create the configuration data for the security modules and the SOFTNET Security Client. Prior to downloading, there must already be a connection to the security module.
- **Online diagnostics view**  
The online diagnostics view is used for diagnostics of a security module and, among other things, allows you to run a firmware update.

### **How it works - security and consistency**

- **Access only for authorized users**  
The security functions of every project are protected from unauthorized access by assigning user names and passwords.
- **Consistent project data**  
Consistency checks are running even while you make the entries in the dialogs. In addition, cross-dialog, project-wide consistency checks are carried out. Only consistent project data can be downloaded to the security modules.
- **Protecting project data by encryption**  
The project and configuration data relevant to security are protected by encryption. Depending on the security module, data can be stored in the project and/or on the C-PLUG.

## User interface - layout and menu commands

### User interface for security functions in STEP 7

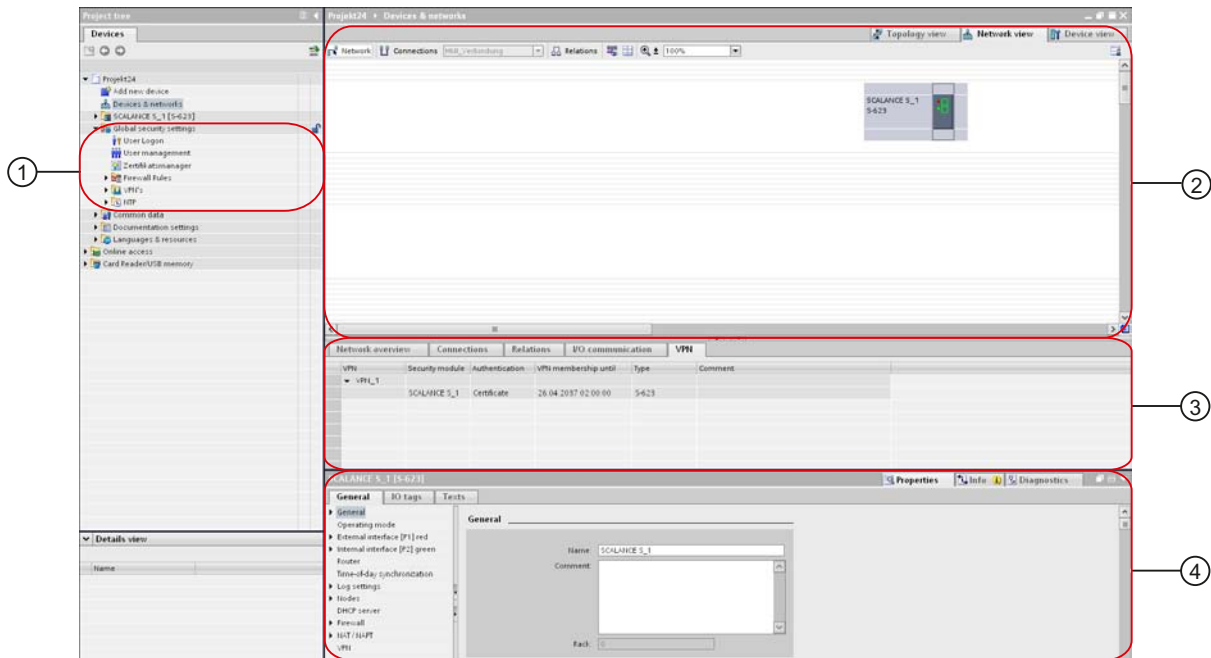

① Global security settings



The global security settings are located in the project navigation. These security settings can be configured independently of the module and subsequently assigned to individual security modules as required. If there are only CPs in the security configuration, the global security settings are shown only when the security functions have been enabled in the local security settings of a CP. The following main folders and entries are available in the global security settings:

- User login  
For the security configuration within a project, there is a separate user management. Log in to the security configuration as an existing user using the "User login" entry. You can create a new user in the user management when creating a security configuration.
- User administration  
In user administration, you can create users, define rights for roles and assign these roles to users.
- Certificate manager  
In the certificate manager, you see an overview of all the certificates used in the project. You can, for example, import new certificates as well as export, modify or replace existing certificates.
- Firewall  
In the "Firewall" entry, you can define global IP and MAC firewall rules and assign security modules. IP and MAC service definitions are used to define the IP and MAC firewall rules compactly and clearly.
- VPN groups  
All created VPN groups are contained in this folder. You can create new VPN groups here and assign security modules to these VPN groups.
- NTP  
Here, you can create NTP servers and assign them to one or more security modules. This ensures that time synchronization is performed through the assigned NTP server. Unsecured NTP servers can only be configured in the local security settings.

② Working area with security module

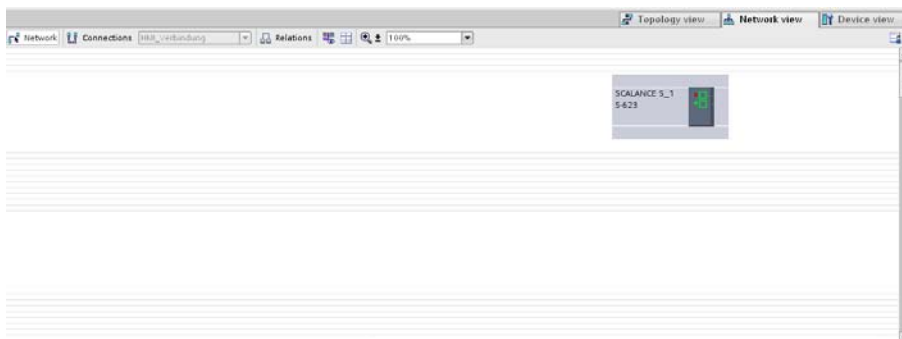

Detailed information about this object is shown in the "VPN" tab as well as in the inspector window under "Properties" > "General" when you select a security module in the working area.



③ VPN tab

VPN	Security module	Authentication	VPN membership until	Type	Comment
▼ VPN_1	SCALANCE S_1	Certificate	28.04.2037 02:00:00	S-623	

This tab displays information about all the VPN groups to which the security module that was selected in the working area belongs. Information about the respective participants of a VPN group can be displayed and hidden.

④ Local security settings

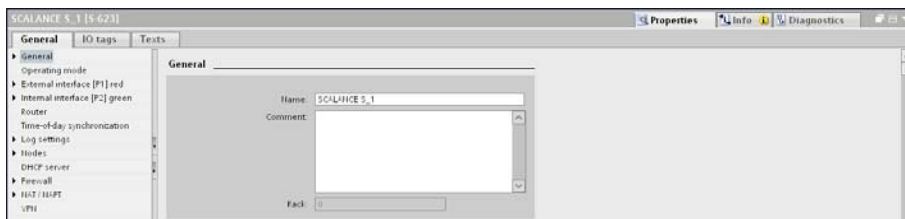

Local security settings are configured for a specific security module. After a security module has been selected in the working area, its local security settings are available in the inspector window under "Properties" > "General".

**Note for CPs:**

Before security settings can be configured for CPs, the local security settings must be enabled. To do this, log in to your security project and then in the Inspector window, select the "Activate security features" check box under "Properties" > "General" > "Security". The local security settings are then displayed below the "Security" entry. When the check box is selected, the following settings (assuming they were enabled) are migrated automatically to the local security settings.

CP x43-1 Advanced:

- SNMP
- FTP configuration
- Time-of-day synchronization
- Web server
- Entries of IP access lists

CP 1543-1:

- SNMP
- FTP configuration
- Time-of-day synchronization

CP 1628:

- SNMP
- Time-of-day synchronization

In addition, firewall rules that enable a connection to be established are created automatically for configured connections. For unspecified connections, you need to configure the firewall rules in advanced firewall mode manually. Log settings are available to record blocked packets.

## Running a consistency check

### Overview

The following consistency checks are available:

- Local consistency checks
- Project-wide consistency checks

In the individual dialog descriptions in this help system, the rules you need to take into account for your entries are listed under the keyword "Consistency check".

### Local consistency checks

A consistency check is local when it can be performed directly within a dialog. With the following actions, local consistency checks are made:

- After exiting a box
- After exiting a row in a table
- When you confirm a dialog with OK.

### Project-wide consistency checks

Project-wide consistency checks provide you with information indicating whether or not project data is correctly configured. With the following actions, there is a consistency check through the entire project:

- When compiling a configuration
- When downloading a configuration

---

#### Note

You can only download configured data when the entire project is consistent.

---

## Managing certificates

### Overview of certificates

#### How do you manage certificates?

In the certificate manager, you have an overview of all the certificates, for example, CA certificates used in the project with information about the applicant, issuer, validity, use and the existence of a private key.

The CA certificate is issued by a certificate authority from which the device certificates are derived. These include the SSL certificates required for authentication in secure

communication between a network node and a security module, as well as the VPN group certificates if the security module is a member of a VPN group. Certificate authorities can be:

- STEP 7 itself. If the "applicant" and "issuer" are the same, this is a self-signed certificate; in other words, issued by STEP 7.
- A higher ranking (commercial) certificate authority. These third-party certificates are external to the project and are imported and stored in the certificate store of STEP 7.

Certificates created by one of the two certificate authorities always have a private key so that the device certificates can be derived from them.

The following functions are also available in the certificate manager:

- Modification of existing certificates (for example, duration of validity).
- Import of new certificates and certificate authorities.
- Import of SSL certificates (S7 CPs only), e.g. for FTP communication.
- Export of the certificates and certificate authorities used in the project.
- Renewal of expired certificates and certificate authorities.
- Replacement of existing certificate authorities with others.
- Addition of trusted certificates and certificate authorities.
- Deleting manually imported certificates.

---

**Note****Downloading the configuration**

After replacing or renewing certificates, the configuration must be downloaded to the relevant security modules.

After replacing or renewing CA certificates, the configuration must be downloaded to all security modules.

---

---

**Note****Current date and current time of day on the security modules**

When using secure communication (for example, HTTPS, VPN...), make sure that the security modules involved have the current time of day and the current date. Otherwise the certificates used are not evaluated as valid and the secure communication does not work.

---

**How to access this function**

Double-click on the "Certificate manager" entry in the global security settings.

In the individual tabs, you have the following commands available in the shortcut menu:

Command	Meaning
Import / Export	Import / export of device certificates or CA certificates. The certificates are transferred to the security module. The following formats are permitted: *.cer (certificate only) *.crt (certificate only) *.pem (certificate only) *.p12 (certificate and corresponding private key)
Displays	Opens the certificate dialog of Windows where you see an overview of all certificate data.
Renew (only in the "CA" and "Device certificates" tabs)	Opens the "Create new certificate" dialog in which you can import a certificate or have a new certificate created by STEP 7 when necessary, for example with compromised certificates.
Replace (only in the "CA" tab)	Opens the "Change certificate authority (CA)" dialog in which you can replace an existing certificate authority with a new one.
Delete (only with manually imported certificates)	Deletes a certificate in the "Trusted certificates and root certification authorities" tab.

## Certificate authorities

### "CA" tab

The certificates displayed here are created by a certificate authority.

- CA certificates of a project: When you create a new project, a CA certificate is generated for the project. The SSL certificates for the individual security modules are derived from this certificate.
- CA group certificates: When you create a new VPN group, a CA certificate is generated for the group.

## Device certificates

### "Device certificates" tab

Display of the device-specific certificates generated by STEP 7 for a security module. These include:

- SSL certificates: An SSL certificate that is derived from a CA certificate of the project is generated for each security module that you create. SSL certificates are used for authentication in secure communication between PGs/PCs and security modules when downloading the configuration to a SCALANCE-S module, as well as for logging.
- Group certificates: A group certificate is also generated for each security module for each VPN group in which it is located.

## Trusted certificates and root certification authorities

### "Trusted root certification authorities" tab

Display of the third-party certificates imported into STEP 7. For example, server certificates can be imported from external FTPS servers or project certificates from other projects that were created with STEP 7.

With CPs, the imported third-party certificate is transferred to all the CPs managed in the project and these check the certificate. If you classify the certificate sent to the security modules as trusted, a connection can be established, for example, to an FTPS server. The imported certificate is not used at any other point in STEP 7.

For SCALANCE S modules, the certificate authorities that are necessary for verification of the security modules by means of external services such as DynDNS are displayed in this tab.

## Renewing certificates

### Meaning

In this dialog, you renew CA certificates and device certificates. If necessary, for example with compromised certificates, you can import a certificate or have a new certificate generated by STEP 7.

### How to access this function

1. Right-click on a list entry in the certificate manager.
2. Select the "Renew" entry in the shortcut menu.
3. Decide whether or not the new certificate will be self-signed or signed by a certificate authority.
4. If the certificate is to be signed by a certificate authority, select the certificate authority to be used with the "Select" button. Only certificate authorities stored in the certificate store of the current project can be selected.

- Depending on the certificate, enter the following values in the "Applicant" or "Alternative applicant name" input box:

Certificate to be renewed	Parameter	
	Applicant	Alternative applicant name
CA certificates of the project	Name of the CA certificate	-
CA group certificate	Name of the CA group certificate	-
SSL certificate for S7 CP	Name of the security module	Comma-separated IP addresses of the Gigabit and PROFINET interface
SSL certificate for PC CP	Name of the security module	IP address of the security module
SSL certificate for SCALANCE S, SCALANCE M, SOFTNET Security Client	Name of the security module	-
Group certificate of the security module	Name of the group certificate	Derived from the CA

- Select a period during which the certificate is valid. As default, the current time is entered in the "Valid from:" box and the value of the current certificate in the "Valid to" box.

## Replacing certificates

### Meaning

Open the "Change certification authority (CA)" to replace the existing CA certificate of the project or the CA group certificate with a new one.

### How to access this function

- Right-click a list entry in the "CA" tab.
- Select the "Replace" entry in the shortcut menu.
- The "Change certification authority (CA)" dialog opens.

All certificates listed in the "Certificates involved" table are derived once again. This means that the CA group certificate of an already configured VPN group can be replaced in the project by the CA group certificate of a different project. The group certificates for the VPN group members are therefore derived from the same CA group certificate in both projects.

After making changes in the certificate manager, download the configuration to all security modules affected.

### Which format can the certificate have?

Other certificates are derived from the imported certificate authority in STEP 7. For this reason, you can only select certificates with a private key.

- \*.p12

### Managing users and roles

#### Rules for user names, roles and passwords

#### Which rules apply to user names, role names and passwords?

When creating or modifying a user, a role or a password, remember the following rules:

Table 8-1 Rules for user management

Permitted characters	The following characters from the US-ASCII character set are permitted: 0123456789 A...Z a...z !#\$%&()*+,-./:;<=>?@ [ ]_{}~ ^`
Characters not allowed	" ' "
Length of the user name	1 ... 32 characters
Length of the password	8 ... 32 characters
Length of the role name	1 ... 32 characters
Maximum number of users per project	128
Maximum number of users on one security module	32 + 1 administrator when creating the project
Maximum number of roles per project	124 user-defined + 4 system-defined
Maximum number of roles on one security module	33 user-defined + 4 system-defined

#### Note

##### User names and passwords

As vital measure under the aspect of maximizing security, always make sure that user names and passwords have a minimum length of 8 characters and that these contain special characters, uppercase/lowercase letters, number, etc..

## Create users

### Meaning

The security functions configured in STEP 7 are protected from unauthorized access by a separate user management. Before you can access the global and local security settings of security modules, you need to log in in the security configuration as a user in the local security settings of a security module with the entry "Security properties".

### Creating the first user in the project

After creating the first security module in the project, you first need to create a user. To do this, in the local security settings of the created security module, click the "User login" button under the "Security properties" entry and enter the login data of the user you want to create. You will then be logged in as the created user and the user is assigned the system-defined "Administrator" role. This role includes all configuration and module rights.

### Creating users in the user management

When you are logged in as a user in the security configuration, you can create further users or delete users with the "User management" entry in the global security settings.

---

#### Note

##### Users with the "Administrator" role

There must always be at least one user with full configuration rights within a project. The administrator that is created automatically when you first enable the security functions in the project can only be deleted if at least one other user exists with the system-defined role "Administrator".

---

The following parameters are available in user management in the "User" tab:

Table 8-2 Information in the "User" tab

Parameter	Meaning
User name	Name of the user to be created. Click on the "Add new user" entry in the "User name" column to create a new user.
Password	Password with which a user authenticates him/herself when logging on.
Role	Selecting a system-defined or user-defined role.
Comment	Entry of optional comments.

## Creating roles

### Overview

You can assign a system-defined or a user-defined role to a user. Specify the module rights of a user-defined role for each security module.



## System-defined roles

The system-defined roles listed below are predefined. Certain rights are assigned to the roles that are the same on all modules and that the administrator can neither change nor delete.

- Administrator  
Default role when creating a security configuration.  
Unlimited access rights to all configuration data and all security modules.
- Standard  
Role with restricted access rights, see section  
Managing rights (Page 538)
- Diagnose  
Default role when creating new user.
  - Read access to configurations.
  - Read access to the security module in the "Online" mode for testing and diagnostics.
- Remote-Access  
Can be used as a template when creating user-defined roles.

You will find a detailed list of the configuration and module rights assigned to the system-defined roles "Administrator", "Standard" and "Diagnostics" in tables 1-3 to 1-7 of the section Managing rights (Page 538).

## User-defined role

In addition to the system-defined roles, you can create user-defined roles. For a user-defined role, select the configuration or module rights and specify the appropriate module rights for every security module used in the project. You manually assign the user-defined roles to the relevant user.

## How to access this function

1. Double-click on the "User management" entry in the global security settings.
2. Select the "Roles" tab in User management.

Table 8-3 Information in the "Roles" tab

Parameter	Meaning
Role	Freely selectable role name. Double-click on the "Add new role" entry to create a new user-defined role. You can then set the rights for the created role.
Description	Specifying the system-defined role With user-defined roles, the "User-defined role" character string is displayed.
Comment	Entry of additional, optional comments.

---

**Note**

**Deleting roles**

A user-defined role can only be deleted when it is no longer assigned to any user. If necessary, assign the user a different role.

System-defined roles cannot be deleted.

---

## Managing rights

### How to access this function

1. Double-click on the "User management" entry in the global security settings.
2. Select the "Roles" tab in User management.

### Creating and assigning a user-defined role

1. Double-click on the "Add new role" entry.
2. Enter a role name.
3. If necessary, select the system-defined role whose rights will be used as the template for the user-defined role from the drop-down list labeled "<Copy rights from>". User-defined roles cannot be selected from the drop-down list.  
Result: In the list of rights of the user roles, the rights are selected that are assigned to the selected system-defined role.
4. For each security module, enable or disable the rights to be assigned to the user-defined role.
5. Assign the role to a user in the "User" tab.

## Configuration rights

Configuration rights are not module dependent and control the rights for configuration in STEP 7.

Depending on the user type, the following configuration rights are available for selection:

Table 8-4 Configuration rights

Configuration right	Administrator	Standard	Diagnose
Diagnose security	x	x	x
Configure security	x	x	-
Managing users and roles	x	-	-

## Module rights

Module rights are configured per module. The "Service" column shows the service to which the particular right relates. With the "Copy rights" and "Paste rights" commands in the shortcut menu, you can transfer the rights from one module to another.

Depending on the user type, the following module rights are available for selection:

Table 8-5 Module rights CP x43-1 Advanced

Right within the service	Administrator	Standard	Diagnose	Service
Web: Format CP file system *	x	-	-	File system
FTP: Read files from the CP file system	x	x	x	
FTP: Write files to the CP file system	x	x	-	
FTP: Read files (DBs) from the S7 CPU **	x	x	x	PLC
FTP: Write files (DBs) to the S7 CPU ***	x	x	-	
Applet: Read tags using configured symbols *	x	x	-	
Applet: Write tags using configured symbols *				
Applet: Read tags using absolute addresses *	x	x	x	
Applet: Write tags using absolute addresses *	x	x	-	
Applet: Read status of the modules in the rack *	x	x	x	
Applet: Query order numbers of the modules in the rack *	x	x	x	
SNMP: Read MIB-II	x	x	x	SNMP
SNMP: Write MIB-II	x	x	-	
SNMP: Read automation MIB	x	x	x	
SNMP: Read LLDP-MIB	x	x	x	
SNMP: Read SNMPv2-MIB	x	x	x	
SNMP: Read MRP MIB	x	x	x	
SNMP: Write MRP MIB	x	x	-	
TIA Portal: Run diagnostics of the security module ****	x	x	x	Security
Web: Expand IP access control list *	x	-	-	Web
Web: Access Web diagnostics and CP file system	x	x	x	
Web: Send test e-mails *	x	x	x	
Web: Update firmware *	x	x	-	Maintenance
Web: Load diagnostics texts later *	x	x	-	

Table 8-6 Module rights CP 1628

Right within the service	Administrator	Standard	Diagnose	Service
SNMP: Read MIB-II	x	x	x	SNMP
SNMP: Write MIB-II	x	x	-	
SNMP: Read automation MIB	x	x	x	
SNMP: Read SNMPv2-MIB	x	x	x	
TIA Portal: Run diagnostics of the security module ****	x	x	x	Security

8.1 Configuring devices and networks

Table 8-7 Module rights SCALANCE S

Right within the service	Administrator	Standard	Diagnose	Service
Download the configuration files	x	x	-	Security
TIA Portal: Run diagnostics of the security module ****	x	x	x	

Table 8-8 Module rights CP 1543-1

Right within the service	Administrator	Standard	Diagnose	Service
FTP: Read files from the CP file system	x	x	x	File system
FTP: Write files to the CP file system	x	x	-	
TIA Portal: Run diagnostics of the security module ****	x	x	x	Security
SNMP: Read automation MIB	x	x	x	SNMP
SNMP: Read IPv6 MIB	x	x	x	
SNMP: Read LLDP-MIB	x	x	x	
SNMP: Read MIB-II	x	x	x	
SNMP: Write MIB-II	x	x	-	
SNMP: Read SNMPv2-MIB	x	x	x	
FTP: Read files (DBs) from the S7 CPU **	x	x	x	
FTP: Write files (DBs) to the S7 CPU ***	x	x	-	

- \* To be able to use the function, the module right "Web: Access Web diagnostics and CP file system" must be enabled as well.
- \*\* To be able to use the function, the module right "FTP: Read files from CP file system" must be enabled as well.
- \*\*\* To be able to use the function, the module right "FTP: Write files to CP file system" must be enabled as well.
- \*\*\*\* To use the function, the configuration right "Security diagnostics" must also be enabled.

**Setting module rights before and after creating the security modules**

Within a user-defined role, the module rights for each security module are defined separately. If a security module was created before this role was added and module rights within a role need to be set, STEP 7 presets the module rights for the security module according to the selected rights template. The preset module rights can then be adapted when adding the role. If a security module was created after adding a role, no rights are preset for this security module. In this case, you will need to edit an existing role and set all the module rights yourself for the security module.

You can also transfer existing module rights to another module by copying and, if necessary, adapting them there. To do this, select a module in the shortcut menu in the module rights and select the "Copy rights" or "Paste rights" menu command.

## Generating configuration data for SCALANCE M modules

### Context

You can generate the VPN information for the assignment of parameters to a SCALANCE M using STEP 7. For this to be possible, the module must be in at least one VPN group with a security module or a SOFTNET Security Client. With the generated files, you can then configure the SCALANCE M using the Web Based Management of the device.

### Generated files

The following file types are generated:

- Export file with the configuration data
  - File type: \*.txt file in ASCII format
  - Contains the exported configuration information for the SCALANCE M including information on the additionally generated certificates.
- Module certificate
  - File type of the private key: \*.p12 file
  - The file contains the module certificate and the key material.
  - Access is password protected.
- Group certificate
  - File type: \*.cer file

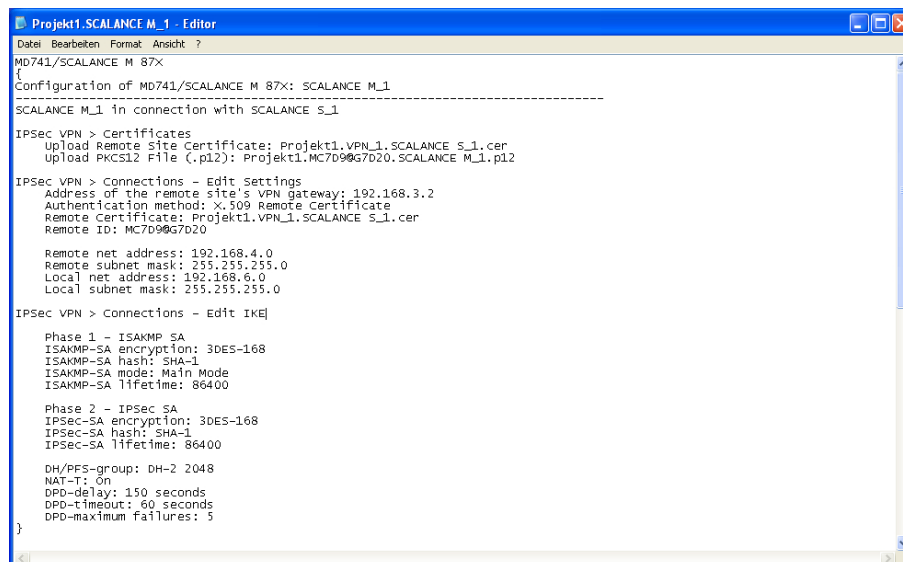

```
Projekt1_SCALANCE M_1 - Editor
Datei Bearbeiten Format Ansicht ?
MD741/SCALANCE M 87X
{
Configuration of MD741/SCALANCE M 87X: SCALANCE M_1
-----
SCALANCE M_1 in connection with SCALANCE_S_1
IPSec VPN > Certificates
  Upload Remote site Certificate: Projekt1.VPN_1.SCALANCE_S_1.cer
  Upload PKCS12 File (.p12): Projekt1.MC7D90G7D20.SCALANCE M_1.p12
IPSec VPN > Connections - Edit Settings
  Address of the remote site's VPN gateway: 192.168.3.2
  Authentication method: X.509 Remote Certificate
  Remote Certificate: Projekt1.VPN_1.SCALANCE_S_1.cer
  Remote ID: MC7D90G7D20
  Remote net address: 192.168.4.0
  Remote subnet mask: 255.255.255.0
  Local net address: 192.168.6.0
  Local subnet mask: 255.255.255.0
IPSec VPN > Connections - Edit IKE
  Phase 1 - ISAKMP SA
  ISAKMP-SA encryption: 3DES-168
  ISAKMP-SA hash: SHA-1
  ISAKMP-SA mode: Main Mode
  ISAKMP-SA lifetime: 86400
  Phase 2 - IPsec SA
  IPsec-SA encryption: 3DES-168
  IPsec-SA hash: SHA-1
  IPsec-SA lifetime: 86400
  DH/PFS-group: DH-2 2048
  NAT-T: On
  DPD-delay: 150 seconds
  DPD-timeout: 60 seconds
  DPD-maximum failures: 5
}
```

Figure 8-1 SCALANCE M configuration file

---

**Note**

**No transfer to the security module**

Configuration files are not transferred to the security module. An ASCII file is generated with which you can configure the SCALANCE M. To allow this, the SCALANCE M must be located in at least one VPN group with another security module.

---

**Follow the steps below**

1. Select the module of the type "SCALANCE M".
2. In the local security settings, select the entry "SCALANCE M configuration".
3. Select the "Generate SCALANCE M files" check box and select a storage location for the configuration files.
4. Compile the configuration of the SCALANCE M module.
5. In the dialog that follows, choose whether you want to create your own password for the created .p12 file.  
If you select "Cancel", the project name is assigned as the password, not the project password.

Result: The files (.txt file and certificates) are stored in the folder you specify.

**Configuring the mode and network parameters for SCALANCE S modules**

**Overview**

You will find information on configuration of the mode and network parameters of SCALANCE S modules in Auto-Hotspot of the section "SCALANCE S".

The configuration of the network parameters of CPs is described sections dealing with the CPs.

**Setting up a firewall**

**Overview of the firewall**

**Meaning**

The firewall functionality of the security modules is intended to protect networks and stations from third-party influence and interference. This means that only certain, previously specified communications relations are permitted. The firewall discards invalid frames without sending a response.

To filter the data traffic, IP addresses, IP subnets, port numbers or MAC addresses can be used. You can also set a bandwidth limitation.

The firewall functionality can be configured for the following protocol levels:

- IP firewall with stateful packet inspection (layer 3 and 4)
- Firewall also for Ethernet "non-IP" frames according to IEEE 802.3 (layer 2)

With security modules capable of VPN, the firewall can also be used for the encrypted data traffic (IPsec tunnel). With the SCALANCE S602 Security module, the firewall can only be used for unencrypted data traffic.

## Types of firewall rules

Firewall rules describe which packets in which direction are permitted or forbidden. A distinction is made between IP packet filter rules and MAC packet filter rules.

## Global and local firewall rules

- Global firewall rules can be assigned to several security modules at the same time. Global firewall rules are configured in the global security settings.
- Local firewall rules are configured in the local security settings of a security module.

## Service definitions

With the aid of service definitions, you can also define firewall rules clearly in a compact form. Service definitions are configured in the global security settings and can be used both in the global and in the local firewall rules.

## Automatically generated firewall rules for CP connections

For connections that were configured using CPs, STEP 7 automatically creates firewall rules that allow communication with the partner of the CP in the specified direction (CP active/passive). The connection establishment directions are taken into account. To display these firewall rules, if the advanced firewall mode is enabled, the "Update connection rules" button needs to be clicked. The firewall rules are then displayed in advanced firewall mode.

Which firewall rules are generated automatically is described in the following sections.

- For S7-300 CPs/S7-400 CPs/PC CPs: Connection-related automatic firewall rules (Page 621) in the section "Security for S7-300 / S7-400 / PC CPs".
- For S7-1500 CPs: Connection-related automatic firewall rules (Page 632) in the section "Security for S7-1500 CPs".

## Enabling the firewall

Firewall functionality for a specific security module is controlled in the local security settings using the "Enable firewall" check box. If the check box is enabled, the firewall can be configured and is effective following the download. For a security module that is a member of a VPN group, the "Enable firewall" check box is activated by default and cannot be deactivated. After switching to advanced firewall mode, it is not possible to switch back to standard mode. For more information about the standard and advanced firewall modes, refer to the section:

Overview of local firewall rules (Page 552).

## Global firewall rule sets

### Application

Global firewall rule sets are configured in the global security settings. A firewall rule set consists of one or more firewall rules and is assigned to the individual security modules.

In the global firewall rule sets, a distinction is made between the following:

- IP rule sets
- MAC rule sets

The following schematic illustrates the relationship between globally defined rule sets and locally used rule sets.

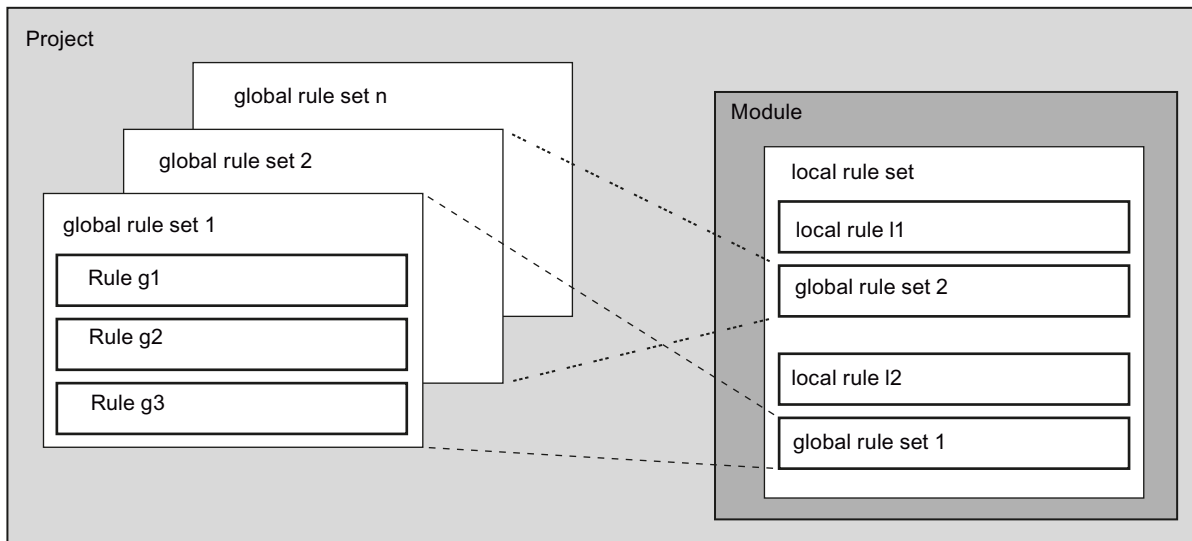

### Configuring

When configuring global firewall rules, you can make detailed firewall settings. You can allow individual services for a single node or all services for the node for access to the station or network.



## When are global IP and MAC firewall rules useful?

Global firewall rules are useful if you want to define identical filter criteria for communication with several security modules.

---

### Note

#### **Only assign rule sets that are supported by the security module**

A bad module assignment can lead to undesirable results. You should therefore always check the module-specific local firewall rules in the result. An incorrect assignment of firewall rule sets is not detected during the automatic consistency check. Only firewall rule sets that are actually supported by the security module are adopted correctly. A global firewall rule set containing a firewall rule with the direction "From: external" or "To: any" cannot be correctly assigned to a CP 1628.

---

## Global firewall rule sets - conventions

### Global firewall rule sets are used locally

The following conventions apply when creating a global set of firewall rules and when assigning it to a module:

- Configuration view  
Global firewall rule sets are configured in the global security settings.
- Priority  
As default, locally defined rules have a higher priority than the global IP and MAC firewall rule sets. Newly assigned global IP and MAC firewall rule sets are therefore initially entered at the bottom of the local rule list.  
The priority can be changed by changing the position in the rule list.
- Entering, changing or deleting rule sets  
Global firewall rule sets cannot be edited in the local rule list of the firewall rules in the module properties. They can only be displayed there and positioned according to the required priority.  
It is not possible to delete a single rule from an assigned rule set in the local security settings. Only the entire rule set can be removed from the local list of rules. The firewall rule sets in the global security settings remain unaffected.

## Creating global firewall rule sets

### How to access this function

1. In the global security settings, select the entry "Firewall" > "Global firewall rule sets" > "IP rule sets" or "MAC rule sets".  
Result: The previously created IP rule sets or MAC rule sets are displayed under the selected entry.
2. Double-click on the entry "Add new IP rule set" or "Add new MAC rule set".

3. Enter the following data:
  - Name: Project-wide, unique name of the rule set. The name appears in the local rule list of the security module after the rule set is assigned.
  - Description (optional): Enter a description of the global rule set.
4. Enter the firewall rules one by one in the list.  
Note the parameter description in the following sections:  
For IP rule sets: Defining IP packet filter rules (Page 553)  
For MAC rule sets: Defining MAC packet filter rules (Page 556)

## Result

You have created the global firewall rule set and can now assign this to the required security modules.

Note the descriptions in the following section:

Assigning global firewall rule sets (Page 546)

## Assigning global firewall rule sets

### Requirement

You have enabled the advanced firewall mode for the security modules you want to assign to a firewall rule set.

### Procedure

1. In the global security settings, select the entry "Firewall" > "Global firewall rule sets" > "Assign module to a firewall rule set".
2. From the "Rule set" drop-down list, select the rule set to which you want to assign the security module.  
In the right-hand table, you will see the security modules that you can assign to the selected firewall rule set. In the left-hand table, you will see the security modules already assigned to the selected firewall rule set.
3. In the "Available modules" area, select the security modules you want to assign to the selected rule set.
4. Click the  button to assign the selected modules to the selected rule set.

## Result

The global rule set is used by the assigned security modules as a local rule set and appears automatically at the end of the list of firewall rules in the local security settings.

## IP services

### Defining IP services

#### How to access this function

In the global security settings, select the entry "Firewall" > "Services" > "Define services for IP rules".

#### Procedure

Using the definition of IP services, you can define succinct and clear firewall rules for specific services. You select a name and assign the service parameters to it.

These services defined in this way can also be grouped together under a group name.

When you configure the packet filter rules, you then use this name.

### Parameters for IP services

You define the IP services using the following parameters:

Table 8-9 IP services: Parameter

Parameter	Meaning/comment	Available options / ranges of values
Name	Name for the service that is used as identification in the rule definition or in the group. The names of predefined services cannot be changed.	<ul style="list-style-type: none"> <li>• Name must start with a letter.</li> <li>• Name must not contain any special characters.</li> <li>• Name must not contain more than 20 characters.</li> <li>• Name must not be redundant.</li> </ul>
Protocol	Selection of the protocol type	<ul style="list-style-type: none"> <li>• TCP</li> <li>• UDP</li> <li>• All</li> </ul>
Source port	The filtering is based on the specified port number; this defines the service access at the frame sender.	Examples: *: Port is not checked 20 or 21: FTP service
Destination port	The filtering is based on the specified port number; this defines the service access at the frame recipient.	Examples: *: Port is not checked TCP 80: Web HTTP service TCP 102: S7 protocol

## Defining ICMP services

### How to access this function

1. In the global security settings, select the entry "Firewall" > "Services" > "Define services for IP rules".
2. Select the "ICMP" tab.

### Procedure

Using the definition of ICMP services, you can define succinct and clear firewall rules for specific services. You select a name and assign the service parameters to it.

These services defined in this way can be grouped together under a group name.

When you configure the packet filter rules, you then use this name.

### Parameters for ICMP services

Parameter	Meaning/comment	Available options / ranges of values
Name	User-definable name for the service that is used as identification in the rule definition or in the group. The names of predefined ICMPv6 services cannot be modified.	<ul style="list-style-type: none"> <li>• Name must start with a letter.</li> <li>• Name must not contain any special characters.</li> <li>• Name must not contain more than 20 characters.</li> <li>• Name must not occur more than once</li> </ul>
ICMPv6	If you enable this check box, the ICMP service is declared as an ICMPv6 service and you can select an ICMPv6-specific type and code for the service. An ICMPv6 service can only be used in the firewall rule of a security module that supports IPv6.	<ul style="list-style-type: none"> <li>• Enabled</li> <li>• Disabled (default)</li> </ul>
Type	Type of the ICMPv4 or ICMPv6 message.	If the "ICMPv6" check box is deselected, ICMPv4-specific types can be selected. If the check box is selected, ICMPv6-specific types can be selected.
Code	Code of the ICMP type.	Values depend on the selected type.

## Creating service groups

### How to access this function

1. In the global security settings, select the entry "Firewall" > "Services" > "Define services for IP rules".
2. Select the "Service groups" tab.

### Forming service groups

You can put several services together by creating service groups. This allows you set up more complex services that you can then use in the packet filter rules simply by selecting the name. IPv4 and IPv6 services can be collected in the same service group.

Create groups in the open "Service groups" tab. You can then assign services to a group in the "Group management" tab.

### Follow the steps below

1. First, create groups in this tab with names to suit your requirements and add a description if required.
2. Select the "Group management" tab. You can assign the previously specified IP services to the groups defined in this tab.

## Managing service groups

### How to access this function

1. In the global security settings, select the entry "Firewall" > "Services" > "Define services for IP rules".
2. Select the "Group management" tab.

### Forming service groups

You can put several services together by creating service groups. This allows you set up more complex services that you can then use in the packet filter rules simply by selecting the name. IPv4 and IPv6 services can be collected in the same service group.

Use the "Group management" tab to assign services to a selected group you created previously in the "Service groups" tab.

### Follow the steps below

1. Select a group created previously in the "Service groups" tab from the "Service groups" drop-down list in this tab.
2. Then assign the required services from the right-hand "Available services" list box to the group.

## MAC services

### Define MAC services

#### How to access this function

In the global security settings, select the entry "Firewall" > "Services" > "Define services for MAC rules".

#### Meaning

Using the definition of MAC services, you can define succinct and clear firewall rules for specific services. You select a name and assign the service parameters to it.

These services defined in this way can be grouped together under a group name.

When you configure the global or local packet filter rules, you use this name.

#### Parameters for MAC services

A MAC service definition is formed using protocol-specific MAC parameters:

Table 8-10 MAC services - parameters

Parameter	Meaning/comment	Available options / ranges of values
Name	User-definable name for the service that is used as identification in the rule definition or in the group.	<ul style="list-style-type: none"> <li>Name must start with a letter.</li> <li>Name must not contain any special characters.</li> <li>Name must not contain more than 20 characters.</li> <li>Name must not be redundant.</li> </ul>
Protocol	Name of the protocol type: <ul style="list-style-type: none"> <li>ISO ISO identifies frames with the following properties: Lengthfield &lt;= 05DC (hex), DSAP= userdefined SSAP= userdefined CTRL= userdefined</li> <li>SNAP SNAP identifies frames with the following properties: Lengthfield &lt;= 05DC (hex), DSAP=AA (hex), SSAP=AA (hex), CTRL=03 (hex), OUI=userdefined, OUI-Type=userdefined</li> <li>PROFINET IO</li> </ul>	<ul style="list-style-type: none"> <li>ISO</li> <li>SNAP</li> <li>PROFINET IO</li> <li>0x (code entry)</li> </ul>
DSAP	Destination Service Access Point: LLC recipient address	
SSAP	Source Service Access Point: LLC sender address	
CTRL	LLC control field	

Parameter	Meaning/comment	Available options / ranges of values
OUI	Organizationally Unique Identifier (the first 3 bytes of the MAC address = vendor ID)	
OUI type	Protocol type/identification	
*) The protocol entries 0800 (hex) and 0806 (hex) are not accepted since these values apply to IP or ARP frames.		

**Note****Processing for S7-CPs**

Only settings for ISO frames with DSAP=SSAP=FE (hex) are processed. Other frame types are not relevant for S7 CPs and are therefore discarded even before processing by the firewall.

**Special settings for SIMATIC NET services**

To filter special SIMATIC NET services, please use the following protocol settings:

- DCP (Primary Setup Tool):  
PROFINET
- SiClock :  
OUI= 08 00 06 (hex) , OUI-Type= 01 00 (hex)

**Creating service groups****How to access this function**

1. In the global security settings, select the entry "Firewall" > "Services" > "Define services for MAC rules".
2. Select the "Service groups" tab.

**Forming service groups**

You can put several services together by creating service groups. This allows you set up more complex services that you can then use in the packet filter rules simply by selecting the name.

Create groups in the open "Service groups" tab. You can then assign services to a group in the "Group management" tab.

**Follow the steps below**

1. First, create groups in this tab with names to suit your requirements and add a description if required.
2. Select the "Group management" tab. You can assign the previously specified MAC services to the groups defined in this tab.

## Managing service groups

### How to access this function

1. In the global security settings, select the entry "Firewall" > "Services" > "Define services for MAC rules".
2. Select the "Group management" tab.

### Forming service groups

You can put several services together by creating service groups. This allows you set up more complex services that you can then use in the packet filter rules simply by selecting the name.

Use the "Group management" tab to assign services to a selected group you created previously in the "Service groups" tab.

### Follow the steps below

1. Select a group created previously in the "Service groups" tab from the "Service groups" drop-down list in this tab.
2. Then assign the required services from the right-hand "Available services" list box to the group.

## Overview of local firewall rules

### Meaning

Local firewall rules are configured in the local security settings of a security module and apply only to this security module. After enabling the firewall functionality you can either use predefined firewall rules or define firewall rules in the advanced firewall mode.

### Using predefined firewall rules

Here, you use simple, predefined rules. You can only enable service-specific rules. The enabled services are allowed for all nodes in the specified direction. You can find detailed information on the definition of firewall rules in this dialog in the following module-specific sections:

- For SCALANCE S: Auto-Hotspot
- For S7-300 CPs/S7-400 CPs/PC CPs: Auto-Hotspot
- For S7-1500 CPs: Auto-Hotspot

### Defining firewall rules in advanced firewall mode

In advanced firewall mode, you can make detailed firewall settings. You can allow individual services for a single node or all services for the node for access to the station or network. You enable the advanced firewall mode using the "Activate firewall in advanced mode" check box.



In the local security settings, the firewall rules can then be configured in "Firewall" > "IP rules" or "MAC rules". The configuration options available here are described individually in the following section:

For IP packet filter rules: Defining IP packet filter rules (Page 553)

For MAC packet filter rules: Defining MAC packet filter rules (Page 556)

---

**Note**

**Deactivating the advanced firewall mode not possible**

Once you have activated the advanced firewall mode, you can no longer deactivate it.

---

**Quantity structure**

Number of firewall rules (advanced firewall mode)	
SCALANCE S	Maximum of 256
S7 CPs	Maximum of 256
CP 1628	Maximum of 256

**Defining IP packet filter rules**

**Meaning**

With IP packet filter rules, you filter according to IP frames, such as TCP, UDP and ICMP.

Within a packet filter rule, you can also fall back on the definitions of the IP services.

**Entering IP packet filter rules**

Enter the firewall rules one by one in the list. Note the following parameter description.

Table 8-11 IP rules: Parameter

Parameter	Meaning/comment	Available options / ranges of values
Action	Allow/disallow (enable/block)	<ul style="list-style-type: none"> <li>• Allow Allow frames according to definition.</li> <li>• Drop Block frames according to definition.</li> </ul> <p>For firewall rules generated automatically as result of configuring a connection and subsequently adapted manually:</p> <ul style="list-style-type: none"> <li>• Allow*</li> <li>• Drop*</li> </ul> <p>If you change automatically created connection rules, when the "*" option is selected they are not recreated and overwritten by STEP 7.</p>
From / To	Selection of the communications directions for which the rule will apply.	<p>Described in separate sections.</p> <ul style="list-style-type: none"> <li>• For SCALANCE S modules: IP packet filter directions SCALANCE S (Page 603)</li> <li>• For S7-300 CPs/S7-400 CPs/PC CPs: IP packet filter directions S7-300-/S7-400-/PC-CPs (Page 619)</li> <li>• For S7-1500 CPs: IP packet filter directions - CP 1543-1 (Page 631)</li> </ul>
IPv6 (for the CP 1543-1 only)	If this check box is selected, you can use a previously defined ICMPv6 service in the firewall rule. For the CP 1543-1 V1.1, after selecting the check box you can enter additional IPv6 addresses in the "Source IP address" and "Destination IP address" input boxes. For the CP 1543-1 V1.0, after enabling the check box you cannot enter any source IP address or any destination IP address for the firewall rule.	<p>The check box can only be selected and deselected if there are no entries in the "Source IP address" and "Destination IP address" input boxes.</p> <p>If IPv6 is disabled in the local settings of the CP 1543-1, you cannot select the "IPv6" check box in the local security settings of the CP and therefore cannot use ICMPv6 services or IPv6 addresses in firewall rules. Existing firewall rules that use IPv6 are shown grayed out if IPv6 is disabled.</p>
Source IP address	The firewall rule is applied to the frames whose sender has the IP address specified here. If you do not specify an IP address, the firewall rule applies to all nodes in the communications direction you selected in the "From" column.	You can find additional information about IP addresses in the IP addresses in IP packet filter rules (Page 557) section.
Destination IP address	The firewall rule is applied to the frames whose recipient has the IP address specified here. If you do not specify an IP address, the firewall rules applies to all nodes in the communications direction you selected in the "To" column.	

Parameter	Meaning/comment	Available options / ranges of values
Service	Name of the IP/ICMP service or service group used. Here, you select one of the services you defined in the "IP services" dialog: <ul style="list-style-type: none"> <li>• IP services</li> </ul> or <ul style="list-style-type: none"> <li>• ICMP services</li> </ul> Before you select an ICMPv6 service, you need to select the "IPv6" check box.	The drop-down list box displays the services and service groups configured in the global security settings and you can select them. No entry means: No service is checked, the rule applies to all services.
Bandwidth (Mbps)	Option for setting a bandwidth limitation Can only be entered if the "Allow" action is selected. A packet passes through the firewall if the allow rule matches and the permitted bandwidth for this rule has not yet been exceeded.	CP x43-1 and SCALANCE S < V3.0: 0.001 ... 100 Mbps CP 1628 and SCALANCE S ≥ V3.0: 0.001 ... 1000 Mbps For global and user-specific rules: 0.001 ... 100 Mbps
Logging	Enable and disable logging for this rule	<ul style="list-style-type: none"> <li>• Enabled</li> <li>• Disabled (default)</li> </ul>
No.	Automatically assigned number for the rule	
Comment	Space for your own explanation of the rule	If a comment is marked with "AUTO", it was created for an automatic connection rule. For rules you have created, entry of a comment is optional.

Table 8-12 Meaning of the entries in the shortcut menu

Entry in the shortcut menu	Meaning
Delete	This deletes the selected rule or the selected global rule set. Notes on removing a globally defined and locally assigned rule set: if you delete a rule set here, this only cancels the assignment to the security module.
Save as global rule set (only for local firewall rules)	Copies the selected firewall rule and inserts it as a global firewall rule set in the global security settings. The firewall configuration currently configured for the security module remains unaffected by this procedure.
Move up	Use this button to move the selected rule or selected global rule set up one position in the list. The rule / rule set you moved is therefore handled with higher priority.
Move down	Use this button to move the selected rule or selected global rule set down one position in the list. The rule / rule set you moved is therefore handled with lower priority.
Define service for IP rules	This opens the dialog in which you can manage the IP services and service groups.

## Defining MAC packet filter rules

### Meaning

With the MAC packet filter rules, you filter according to MAC frames.

Within a packet filter rule, you can also fall back on the definitions of the MAC services.

### Entering MAC packet filter rules

Enter the firewall rules one by one in the list. Note the following parameter description.

Table 8-13 MAC rules: Parameter

Parameter	Meaning/comment	Available options / ranges of values
Action	Allow/disallow (enable/block)	<ul style="list-style-type: none"> <li>Allow Allow frames according to definition.</li> <li>Drop Block frames according to definition.</li> </ul>
From / To	Selection of the communications directions for which the rule will apply.	Described in separate sections. <ul style="list-style-type: none"> <li>For SCALANCE S modules: MAC packet filter directions SCALANCE S (Page 604)</li> <li>For S7-300 CPs/S7-400 CPs/PC CPs: MAC packet filter directions S7-300-/S7-400-/PC-CPs (Page 620)</li> <li>For S7-1500 CPs: MAC packet filter directions CP 1543-1 (Page 631)</li> </ul>
Source MAC address	The firewall rule is applied to the frames whose sender has the MAC address specified here. If you do not specify a MAC address, the firewall rule applies to all nodes in the communications direction you selected in the "From" column.	MAC address in the correct format
Destination MAC address	The firewall rule is applied to the frames whose recipient has the MAC address specified here. If you do not specify a MAC address, the firewall rule applies to all nodes in the communications direction you selected in the "To" column.	
Service	Name of the MAC service or service group used	The drop-down list box displays the configured services and service groups you can select.  If nothing is selected, no service is checked and the rule applies to all services.
Bandwidth (Mbps)	Option for setting a bandwidth limitation. Can only be entered if the "Allow" action is selected.  A packet passes through the firewall if the allow rule matches and the permitted bandwidth for this rule has not yet been exceeded.	CP x43-1 and SCALANCE S < V3.0: 0.001 ... 100 Mbps CP 1628 and SCALANCE S ≥ V3.0: 0.001 ... 1000 Mbps For global and user-specific rules: 0.001 ... 100 Mbps

Parameter	Meaning/comment	Available options / ranges of values
Logging	Enable and disable logging for this rule.	<ul style="list-style-type: none"> <li>• Enabled</li> <li>• Disabled (default)</li> </ul>
No.	Automatically assigned number for the rule	
Comment	Space for your own explanation of the rule	If a comment is marked with "AUTO", it was created for an automatic connection rule. For rules you have created, entry of a comment is optional.

Table 8-14 Meaning of the menu commands

Button	Meaning
Delete	This deletes the selected rule or the selected global rule set. Notes on removing a globally defined and locally assigned rule set: if you delete a rule set here, this only cancels the assignment to the security module.
Save as global rule set (only for local firewall rules)	Copies the selected firewall rule and inserts it as a global firewall rule set in the global security settings. The firewall configuration currently configured for the security module remains unaffected by this procedure.
Move up	Use this button to move the selected rule or selected global rule set up one position in the list. The rule / rule set you moved is therefore handled with higher priority.
Move down	Use this button to move the selected rule or selected global rule set down one position in the list. The rule / rule set you moved is therefore handled with lower priority.
Define service for MAC rules	This opens the dialog in which you can manage the MAC services and service groups.

## IP addresses in IP packet filter rules

### Entering IP addresses in IP packet filter rules

In IP packet filter rules, you have the following options for entering IP addresses:

- Nothing specified  
The rule applies to all IP addresses.
- An IP address  
The rule applies specifically to the specified address.

8.1 Configuring devices and networks

- Address range  
 The rule applies to all the IP addresses covered by the address range.  
 An address range is defined by specifying the number of valid bit places in the IP address in the format: [IP address]/[number of bits to be included]
  - [IP address]/24 therefore means that only the most significant 24 bits of the IP address are included in the filter rule. These are the first three octets of the IP address.
  - [IP address ]/25 means that only the first three octets and the highest bit of the fourth octet of the IP address are included in the filter rule.
- Address area  
 For the source IP address, an address range can be entered in the following format: [Start IP address]-[End IP address]

**IPv4 addresses**

An IPv4 address consists of 4 decimal numbers in the range from 0 to 255 separated from each other by a dot.

Table 8-15 Examples of address ranges in IPv4 addresses

Source IP address or destination IP address	Address range		Number of addresses <sup>*)</sup>
	from	to	
192.168.0.0/16	192.168.0.0	192.168.255.255	65.536
192.168.10.0/24	192.168.10.0	192.168.10.255	256
192.168.10.0/25	192.168.10.0	192.168.10.127	128
192.168.10.0/26	192.168.10.0	192.168.10.63	64
192.168.10.0/27	192.168.10.0	192.168.10.31	32
192.168.10.0/28	192.168.10.0	192.168.10.15	16
192.168.10.0/29	192.168.10.0	192.168.10.7	8
192.168.10.0/30	192.168.10.0	192.168.10.3	4

<sup>\*)</sup> Note: Note that the network address and the broadcast address are not available as IP addresses of network nodes in an address range.

**IPv6 addresses**

IPv6 addresses consist of 8 fields each with four hexadecimal numbers (128 bits in total). The fields are separated by a colon. IPv6 addresses can only be entered in IP packet filter rules for the CP 1543-1 V1.1.

Example: fd00:ffff:ffff:ffff:ffff:ffff:2f33:8f21

Rules / simplifications:

- Leading zeros within a field can be omitted.  
Example: Instead of 2001:0db8:2426:08d3:1457:8a2e:0070:7344 it is also possible to use the notation 2001:db8:2426:8d3:1457:8a2e:70:7344.
- If one or more fields have the value 0 (or 0000), a shortened notation is possible.  
Example: Instead of 2001:0db8:0:0:0:0:1428:57ab it is also possible to use the notation 2001:db8::1428:57ab.  
To ensure uniqueness, this shortened form can only be used once within the entire address.
- Decimal notation with periods  
The last 2 fields or 4 bytes can be written in the normal decimal notation with periods.  
Example: The IPv6 address fd00::ffff.125.1.0.1 is equivalent to fd00::ffff:7d01:1.
- Address range notation in IP packet filter rules: In the same way as IPv4 addresses, IPv6 addresses can also be noted in the form of address ranges.  
Example: The entry "2001:0db8:85a3:08d3:1319:8a2e:0:0/96" covers all IPv6 addresses from 2001:0db8:85a3:08d3:1319:8a2e:0:0 to 2001:0db8:85a3:08d3:1319:8a2e:ffff:ffff.

## Carrying out module-specific log settings

### Log settings - overview

#### Log settings in the configuration

The log settings made here are loaded on the module with the configuration and take effect when the security module starts up.

You can restrict the configured packet filter log settings in the online functions if necessary. For example, you can use the online functions to specify that merely IP logging is displayed if you have configured IP and MAC logging.

#### Logging procedures and event classes

Here, you can specify which data should be logged. As a result, you enable logging as soon as you download the configuration to the security module.

During configuration, you also select one or both of the possible logging procedures:

- Local logging
- Network Syslog

In both logging procedures, the security module recognizes the three following types of events:

- Packet filter events
- Audit events
- System events

## Configuring local logging

### How to access this function

1. Select the module to be edited.
2. Select the "Log settings" > "Local log memory" entry in the local security settings.

## Configuring local logging

Table 8-16 Local logging - settings for log events

Log event	Meaning	Comments
Packet filter log (firewall)	The packet filter log records certain packets of the data traffic. Only those data packets for which a configured packet filter rule (firewall) applies or to which the basic protection reacts (corrupt or invalid packets) are logged. This is only possible when logging is enabled for the packet filter rule.	Packet filter log data is not retentive The data is stored in volatile memory on the security module and is therefore no longer available after the power supply has been turned off. For retentive storage, you can also save the log data displayed in the "Online & diagnostics" dialog in a file.
Audit log	The logging of audit events is always enabled. The logged information is always stored in the ring buffer. The audit log automatically records security-relevant events, for example user actions such as activating or deactivating packet logging or downloading configurations to the security module.	Audit log data is retentive The data is stored in a retentive memory of the security module and is therefore still available after turning off the power supply. <b>Note for CPs:</b> The audit log files are not retentive on CPs. You should therefore use a Syslog server to backup this data.
System log	The system log automatically logs successive system events, for example the start of a process or the failed login attempt of a user. Select the "Log settings" > "Configure system events" entry to configure the event filter and cable diagnostics functions.	System log data is not retentive The data is stored in volatile memory on the security module and is therefore no longer available after the power supply has been turned off. For retentive storage, you can also save the log data displayed in the "Online & diagnostics" dialog in a file.

Table 8-17 Local logging - storage of recorded data

Storage	Meaning
Ring buffer	At the end of the buffer, the recording continues at the start of the buffer and overwrites the oldest entries.
One-shot buffer	Recording stops when the buffer is full.



## Configuring system events

### How to access this function

1. Select the module to be edited.
2. Select the "Log settings" > "Configure system events" entry in the local security settings.

### Filtering of the system events

In this dialog, you set a filter level for the system events. As default, the following values are set:

- SCALANCE S: Level 3 (Error)
- CP: Level 3 (Error)

The priority of the selected filter level must be the same or lower than the severity set for the cable diagnostics; see the "Setting parameters for line diagnostics" table (not for CPs).

Recommendation: Select "Error" as the filter level or a higher value to exclude logging of general, uncritical events.

### Note for CP

For CPs, select only level 3 or level 6 since only events of these levels are generated for CPs.

- Level 0 to level 3 error messages are output if level 3 is selected.
- If you select level 6, the error messages of levels 0 to 6 are output.

### Properties of the system events - line diagnostics (not for CPs)

Line diagnostics generates a special system event. A system event is generated when a selectable percentage of bad frames is reached. This system event is assigned the severity and facility set in this dialog.

Table 8-18 Setting parameters for line diagnostics

Function / option / parameter	Meaning
Enable	Enabling and disabling logging
Limit	Selectable percentage of faulty frames representing the limit at which a system event is triggered.
Facility	Select a facility from the drop-down list that identifies the system event to be logged.
Severity	Using the severity, you weight the system events of line diagnostics relative to the severity of the other system events.

---

**Note**

**Severity of the system events of line diagnostics**

Make sure that you do not assign a lower severity to the system events of line diagnostics than for the filter. At a lower severity, these events will not pass through the filter and will not be logged.

---

## Configuring the network Syslog

### How to access this function

1. Select the module to be edited.
2. Select the "Log settings" > "Network Syslog" entry in the local security settings.

## Configuring the network Syslog

Table 8-19 Network Syslog - basic settings

Option / parameter	
Enable network Syslog	Enables and disables the transfer of logging events to the Syslog server.
Syslog server	Here, enter the IP address of the Syslog server. The Syslog server must be accessible from the security module at the specified IP address and, if applicable, using the router configuration under the "Routing" entry of the local security settings. If the Syslog server cannot be accessed no Syslog messages are sent. You can recognize this operating state on the basis of corresponding system alarms. To activate the sending of the Syslog information again, you may have to update the routing information and initiate a restart of the security module.
Module name	The security module uses the module name shown here as the host name for identification with the Syslog server. The module name cannot be changed at this point.

Table 8-20 Network Syslog - settings for log events

Log event	Configuring	Comments
Packet filter events (firewall)	The packet filter log records certain packets of the data traffic. Only those data packets for which a configured packet filter rule (firewall) applies or to which the basic protection reacts (corrupt or invalid packets) are logged. This is only possible if logging is activated for the packet filter rule.  Syslog alarms can be classified according to their origin and their severity level by setting Facility and Severity. This assignment is carried out with drop-down lists. The severity and facility that you set here is assigned to every event.	The value you select here depends on the evaluation in the Syslog server.  If you retain the "default" value setting, the security module specifies the combination of facility and severity with which the event is displayed.
Audit events	The audit log automatically records security-relevant events, for example user actions such as activating or deactivating packet logging or downloading configurations to the security module.  Assignment of the severity and facility is carried out with drop-down lists. The severity and facility that you set here is assigned to every event.	The value you select here for the severity and facility depends on the evaluation in the Syslog server.  If you retain the "default" value setting, the security module specifies the combination of facility and severity with which the event is displayed.
System events	The system log automatically logs successive system events, for example the start of a process or the failed login attempt of a user.	Select the "Log settings" > "Configure system events" entry in the local security settings to configure the event filter and cable diagnostics functions.

## Security module as router

### Overview of the routing settings

#### Meaning

If you operate the security module in routing mode, the networks connected to the internal and external ports are transformed into separate subnets.

You have the following additional options:

- Setting specific routes - can be set in the local security settings under "Routing" (SCALANCE S only), see Specifying routes (Page 604) in the section "SCALANCE S".
- Using a standard router - can be set in the local security settings with "External interface [P1] red" or Internal interface [P2] green" see subsection Configuring network parameters (Page 599) in the section "SCALANCE S".
- NAT/NAPT routing - can be set with "NAT / NAPT" (not for PC CPs and CP 1543-1) in the local security settings. To be able to use NAT/NAPT, the security module must be in routing mode.

### Enabling routing mode (required for SCALANCE S modules only)

If you have enabled routing mode, frames intended for an existing IP address in the subnet (internal or external) are forwarded. The firewall rules for the direction of transmission also apply.

For this mode, you configure an internal IP address and an internal subnet mask for addressing the router in the internal subnet in the local security settings. All network requests that do not belong to a subnet are forwarded by the security module to a different subnet.

Note: In contrast to the bridge mode of the security module, VLAN tags are lost in routing mode.

1. Select the "Routing mode" option under "Mode" in the local security settings.
2. In the local security settings, enter an internal IP address and an internal subnet mask for addressing the router on the internal subnet in the input boxes under "Internal interface [P2] green" > Ethernet addresses".

### Overview of NAT/NAPT

#### Module-specific function

This function is not available for PC CPs and S7-1500 CPs.

#### How to access this function

1. Select the module to be edited.
2. In the local security settings, select the entry "NAT / NAPT".
3. When required, enable address translation according to NAT(Network Address Translation) or NAPT (Network Address Port Translation).
4. Configure the address translation as shown in the following sections.

#### Address translation with NAT (Network Address Translation)

NAT is protocol for translating addresses between two address spaces. The main task is to translate private addresses into public addresses; in other words into IP addresses that are used and even routed in the Internet. As a result, the addresses of the internal network are not known to the outside in the external network. The internal nodes are only visible to the external network by means of external IP address that is specified in the address translation list (NAT table).

If the external IP address is not the address of the security module and if the internal IP address is unique, this is known as 1:1 NAT. With 1:1 NAT, the internal address is translated to this external address without port translation. Otherwise, n:1 NAT is being used.

### Address translation with NAPT (Network Address Port Translation)

The address translation with NAPT changes the target address and the target port to a communication relation.

Frames coming from the external network and intended for the external IP address of the security module are translated. If the destination port of the frame is identical to one of the values specified in the "External port" column, the security module forwards the request to the internal node with the IP address specified in the "Internal IP address" column. As the destination port, the port specified in the "Internal port" is used. For the reply, as the source IP address and source port, the security module sets the values entered in the "External IP address" input box and the "External port" column.

The difference to NAT is that with NAPT ports can also be translated. There is no 1:1 translation, but rather an n:1 translation of IP addresses. A public IP address is translated into a series of private IP addresses with port numbers added.

### Consistency check - these rules must be adhered to

When assigning addresses, remember the following rules to obtain consistent entries:

Check / rule	Check made	
	locally	project-wide
The configured network ID of the internal subnet must be different from the network ID of the external subnet.		x
The internal IP addresses must not be identical to the IP addresses of the module.		x
Use the part specified by the subnet mask for the IP addresses: <ul style="list-style-type: none"> <li>The external IP address must be in the same subnet range as the configured external IP address of the security module.</li> <li>The internal IP address must be in the same subnet range as the configured internal IP address of the security module.</li> </ul>		x
An IP address used in the NAT/NAPT address conversion list must not be a multicast or broadcast address.		x
The external ports assigned for the NAPT translation are in the range > 0 and ≤ 65535. The ports 123 (NTP), 443 (HTTPS), 514 (Syslog), 500+4500 (IPsec) and 161 (SNMP) are excluded.	x	
The external IP address of the security module may only be used for the "to external" direction in the NAT table.	x	
The internal IP address of the security module may only be used in the NAT table and not in the NAPT table.		x
Checking for duplicates in the NAT table An external IP address used in the direction "Dst-NAT (from external)" or "Src-NAT +Dst-NAT (external)" may only occur once in the NAT table.	x	

Check / rule	Check made	
	locally	project-wide
Checking for duplicates in the NAPT table <ul style="list-style-type: none"> <li>An external port number may only be entered once.</li> <li>The port numbers or port ranges of the external ports must not overlap.</li> </ul>	x	
Once the routing mode is activated, the address parameters for the internal interface (IP address/subnet) must be assigned to the security module.	x	
Internal NAPT ports can be in the range > 0 and ≤ 65535.	x	

**See also**

Overview of the routing settings (Page 563)

**NAT/NAPT routing**

**Enabling NAT**

The input boxes for NAT are enabled. NAT address conversions only take effect with the option described below and with entries in the address conversion list. In addition, you must configure the firewall accordingly.

The IP address translation can take place via the following interfaces:

- External: The address translation takes place on the external interface

The IP address translation can take place in both directions:

- Destination NAT (Dst-NAT): The IP address translation takes place from external to internal. Frames coming from the external subnet are checked for the specified external IP address and forwarded with the specified internal IP address into the internal network. Access from external to internal via the external address is possible.
- Source NAT (Src-NAT): The IP address translation takes place from internal to external. Frames coming from the internal subnet are checked for the specified internal IP address and forwarded to the external network with the specified external IP address. Access from internal to external is possible. In the external network, the external address is effective.
- Source and Destination NAT (Src-NAT + Dst-NAT): The IP address translation can take place from internal or external. Access from internal and external is possible. In the external network, the external address is effective.

**Possible entries for address translation on the external interface**

If the address translation is to take place on the external interface, you have the following options.

**Translation type "Dst-NAT (from external)"**

Box	Possible entries	Meaning
External IP address	<ul style="list-style-type: none"> <li>IP address in the external subnet</li> </ul> <p>With dynamic address assignment, this type of translation does not work.</p>	<p>Destination IP address in the external network via which an IP address in the internal subnet will be accessed.</p> <p>If the destination address in a frame matches the address entered, the address is replaced by the corresponding internal IP address.</p>
Internal IP address	<ul style="list-style-type: none"> <li>IP address in the internal subnet</li> </ul>	<p>The destination IP address is replaced by internal IP address. The address translation is from external to internal.</p>

**Translation type "Src-NAT (to external)"**

Box	Possible entries	Meaning
External IP address	<ul style="list-style-type: none"> <li>IP address in the external subnet</li> <li>IP address of the security module if the option "Allow all internal nodes access to the outside" is not selected.</li> </ul> <p>With dynamic address assignment, no entry is possible.</p>	<p>Entry of the IP address that will be used as the new source IP address.</p> <p>If you enter an address that is not the IP address of the security module, it is translated into an alias address. This means that the specified address is also registered as an address on the external interface. Verify that no IP address conflict exists with this address.</p>
Internal IP address	<ul style="list-style-type: none"> <li>IP address in the internal subnet</li> </ul>	<p>The source IP address of the specified internal node is replaced by the specified external address.</p> <p>The IP address translation is therefore from internal to external.</p>
	<ul style="list-style-type: none"> <li>Subnet or IP address range</li> </ul>	<p>The source IP addresses from the specified subnet or IP address range are replaced by the external IP address. The source port is replaced.</p> <p>The range is defined by the subnet address.</p>

The following function can also be enabled:

- Allow all internal nodes access to the outside

By selecting this option, the internal IP address is translated to the external module IP address for all frames sent from internal to external and an additional port number is assigned by the module. It is then no longer permitted to use the IP address of the external interface in the "External IP address" column.

This action is illustrated based on the additionally displayed NAT table that can be displayed in the local security settings using the "Allow all internal nodes access to the outside" entry. The "\*" symbol in the "internal IP address" column indicates that all frames transmitted in internal to external direction will be translated.

### Translation type "Src-NAT + Dst-NAT (external)"

Box	Possible entries	Meaning
External IP address	<ul style="list-style-type: none"> <li>IP address in the external subnet</li> </ul> <p>With dynamic address assignment, this type of translation does not work.</p>	<p>The address translation is from internal to external: See table "Src-NAT (to external)"</p> <p>The address translation is from external to internal: See table "Dst-NAT (from external)"</p>
Internal IP address	<ul style="list-style-type: none"> <li>IP address in the internal subnet</li> </ul>	

### Enabling NAPT

The input boxes for NAPT are enabled. NAPT translations only take effect with the option described below and with entries in the list. In addition, you must configure the firewall accordingly.

Box	Possible entries	Meaning
External port	<p>Port or port range</p> <p>Example of entering a port range: 2000:2005</p>	A node in the external network can send a frame to a node in the internal subnet by using this port number.
Internal IP address	IP address in the internal subnet	IP address of the addressed node in the internal subnet.
Internal port	Port	Port number of a node in the internal subnet.

### Configuring time-of-day synchronization

#### Overview of time-of-day synchronization

#### Meaning

The date and time are maintained on the security module to verify the validity (time) of a certificate and for time stamping log entries. For CPs, time-of-day synchronization is active as default.

The following alternatives can be configured:



- SIMATIC: If the security module receives MMS time-of-day messages, its local time is synchronized provided the NTP procedure was not configured (MMS = Manufacturing Message Specification).
- NTP: Automatic setting and cyclic synchronization of the time-of-day by means of Network Time Protocol server.

**Note**

Time-of-day synchronization relates solely to the security module and cannot be used to synchronize devices in the internal network of the security module. S7 CPs can forward the time of day to other modules of the station.

**Note**

**Configuring the firewall for communication with NTP servers**

If the NTP server cannot be reached by the security module, you will need to allow the frames from the NTP server explicitly in the firewall (UDP, port 123).

**Defining an NTP server**

**Creating NTP servers in the global security settings**

In the global security settings only secure NTP servers can be created and assigned CPs. Non-secure NTP servers for SCALANCE S modules and CPs therefore need to be created in the local security settings.

1. Double-click the "NTP" entry in the global security settings.
2. Double-click on the "Add new NTP server" entry.
3. Enter a name for the NTP server (secure).
4. Enter the IP address of the NTP server (secure).
5. Specify the encryption parameters for the NTP server (secure).

Property	Meaning
Key ID	Numeric value between 1 and 65534.
Authentication	Select the authentication algorithm.
Hex/ASCII	Select the format for the NTP key.
Key	Enter the NTP key with the following lengths: Hex: 22 ... 40 characters ASCII: 11 ... 20 characters

6. Assign a CP to the NTP server (secure) you have created, see section: Assigning the security module to an NTP server (secure) (Page 572).

**Creating NTP servers in the local security settings**

1. Select the module to be edited.
2. Select the "Time-of-day synchronization" entry in the local security settings.

8.1 Configuring devices and networks

3. Select the required synchronization mode.
4. If you have selected the "NTP" synchronization mode, enter a name and the IP address of the NTP server.
5. If you have selected the "NTP (secure)" synchronization mode, select an NTP server (secure) that you created in the global security settings in the "Name" column.

**Configuration limits for NTP servers**

The following rules apply when creating NTP servers:

- You can create 32 NTP servers throughout the project.
- You can assign a maximum of 4 NTP servers to one security module.

**Importing/exporting NTP servers (secure)**

Using the "Import" or "Export" commands in the shortcut menu, you can export the key list of the currently selected NTP server (secure) and import the file into an NTP server (secure) or vice versa.

**Configuring time-of-day synchronization for a security module**

**How to access this function**

1. Select the module to be edited.
2. Select the "Time-of-day synchronization" entry in the local security settings.
3. Select the "Activate time-of-day synchronization" check box.

**Alternatives for time-of-day synchronization**

The following alternatives can be configured:

Table 8-21 Time synchronization for CPs

Possible selection	Meaning / effect
SIMATIC	If the security module receives MMS time-of-day messages, its local time is synchronized provided the NTP procedure was not configured (MMS = Manufacturing Message Specification).
NTP	Automatic setting and periodic synchronization of the time using an NTP server.
NTP (secure)	Automatic setting and periodic synchronization of the time using an NTP server (secure).

Table 8-22 Time synchronization for SCALANCE S

Possible selection	Meaning / effect
SIMATIC	If the security module receives MMS time-of-day messages, its local time is synchronized provided the NTP procedure was not configured (MMS = Manufacturing Message Specification).
NTP	Automatic setting of the time using an NTP server.

### Selecting the mode of time-of-day synchronization

Follow these steps:

1. Select the synchronization mode.
2. The following configuration options are available to you depending on the selected mode:

- **SIMATIC:** For S7 CPs, select whether the S7 CP is to use or forward the time of day. The CP 1628 always forwards the time of day. For CPs you also the set direction for forwarding the time.

Available directions:

- Automatic (for S7 CPs only): The CP receives the time from the station or from the LAN and forwards it to the station or to the LAN. If multiple CPs are being operated in the station, this automatic setting can cause collisions. To avoid this, you can specifically define the forwarding direction.
- Form station (for S7 CPs only).
- From LAN.

If forwarding of the time of day is enabled, you can use the "Use corrected time" check box to specify whether or not a correction factor included in the time-of-day frame is used. For the CP 1628, this option is enabled as default and cannot be disabled.

- **NTP:**
  - Time zone: In NTP mode, generally UTC (Universal Time Coordinated) is transmitted. This corresponds to GMT (Greenwich Mean Time). The time offset from UTC can be set by configuring the local time zone.
  - Update interval in seconds: Defines the interval between the time queries in seconds.

---

**Note**

**Setting the update interval for CPs**

If the "Enable security functions" check box is enabled in the local security settings of a CP, the setting for the update interval is transferred from the CP's local settings into the CP's local security settings.

---

- Time-of-day synchronization on the full minute (only for S7-300 /S7 -400 / PC CPs): With this option, you can decide whether or not the time of day is forwarded to the communications bus on the full minute. This option is required for certain special applications.
- Accept time of non-synchronized NTP servers (only for CPs): Here you can specify whether the security module also accepts the time-of-day from non-synchronized NTP servers.
- Forward time of day to station (only for S7-300 /S7 -400 / PC CPs): Disable this option if the CPU requests the time separately from an NTP server. This prevents the time on the CPU obtained directly from the NTP server from being overwritten by the time detected in the CP. The accuracy may be reduced slightly due to forwarding via the CP.
- NTP server: Creating NTP servers in the local security settings is described in the section Defining an NTP server (Page 569).

## Assigning the security module to an NTP server (secure)

### Module-specific function

Assigning security modules to globally created NTP servers (secure) is possible only for CPs.

## Requirement

- You have defined an NTP server (secure) in the global security settings.
- "NTP (secure)" is selected as the time-of-day synchronization mode in the local security settings of the security module that you want to assign to an NTP server (secure).

## Procedure

1. Double-click the "NTP" entry in the global security settings.
2. Double-click the entry "Assign module to an NTP server".
3. From the "NTP Server" drop-down list, select the NTP server (secure) to which you want to assign a security module.
4. In the "Available modules" section, select the security module that you want to assign to the selected NTP server (secure).
5. Click the  button to assign the selected security module to the selected NTP server (secure).

## Result

You have assigned the security module to the NTP server (secure). The NTP server (secure) is displayed automatically in the local security settings in the list of NTP servers.

## Security module as DHCP server

### Module-specific function

The use of the security module as a DHCP server is only possible with SCALANCE S modules, see subsection:  
Auto-Hotspot in the section "SCALANCE S".

## Configuring SNMP

### Module-specific function

Configuration of SNMP is currently only available for CPs, see section below:

- For S7-300 CPs/S7-400 CPs/PC CPs: Auto-Hotspot
- For S7-1500 CPs: Auto-Hotspot

## Activate Web server on security module

### Module-specific function

This function is only available for CP x43-1 Advanced, see subsection: Activating the Web server on CP x43-1 Advanced (Page 625) in the section "Security for S7-300 / S7-400 / PC CPs".

## IPsec tunnel: Creating and assigning VPN groups

### How to create an IPsec tunnel with VPN groups

### Module-specific function

This function is not available for SCALANCE S602 and CP 1543-1 V1.0. CP 1543-1 supports this function only as of firmware V1.1.

### Requirement

---

#### Note

#### Current date and current time of day on the security modules

When using secure communication (for example, HTTPS, VPN...), make sure that the security modules involved have the current time of day and the current date. Otherwise the certificates used are not evaluated as valid and the secure communication does not work.

---

### How to access this function

1. Double-click on the entry "VPN groups" > "Add new VPN group" in the global security settings to create a VPN group.
2. Double-click on the entry "VPN groups" > "Assign module to a VPN group" in the global security settings and assign the security modules and SOFTNET security client modules to the VPN group between which VPN tunnels will be established. Here, note the rules for forming VPN groups. You will also find these rules in the section: Modes of VPN groups (Page 579).

## Display of the VPN groups with their properties

If you select a security module that is in one or more VPN group(s), the properties of the VPN group(s) of which the security module is a member are shown in the "Network data" area.

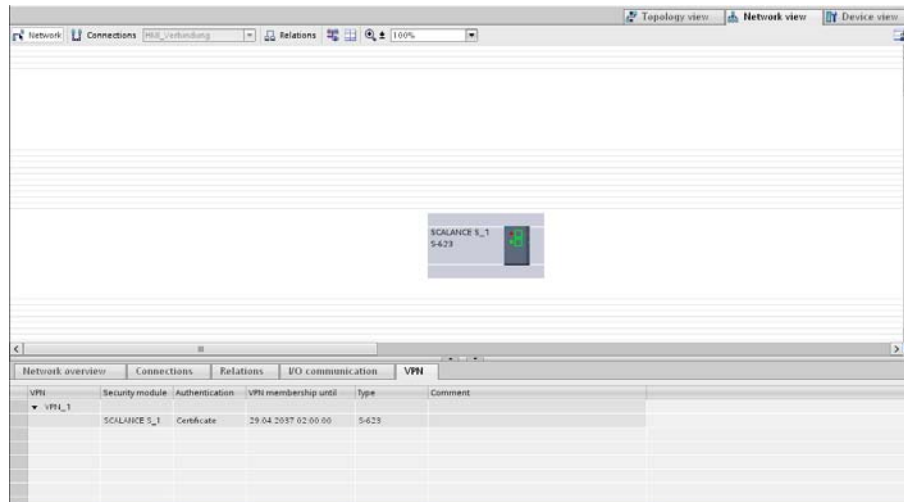

The following properties of the VPN groups are displayed in columns in the "VPN" tab of the "Network data" area:

Property/column	Meaning
VPN	Names of the VPN groups of which the selected security module is member
Security module	Names of the assigned security modules
Authentication	Type of authentication: Preshared key or certificate
Group membership until	Date and time up to which the VPN group certificate of the security module is valid
Type	Model numbers of the assigned security modules
Comment	Comment

## Setting the life of certificates

Open the dialog in which you can set the expiry date of the certificate as follows:

1. Select the VPN group you want to edit in the "VPN" tab.
2. In the "Properties" > "General" tab of the Inspector window, select the entry "Authentication".

### Note

#### Expiry of a certificate

Communication through the VPN tunnel continues after the certificate has expired until the tunnel is terminated or the SA lifetime expires. For more information on certificates, refer to section:  
Auto-Hotspot.

### Quantity structure

Number of IPSec tunnels	
SCALANCE S612 V2	Maximum of 64
SCALANCE S612 V3	Maximum of 128
SCALANCE S613	Maximum of 128
SCALANCE S623	Maximum of 128
CP x43-1 Advanced	Maximum of 32
CP 1628	Maximum of 64
CP 1543-1 V1.1	Maximum of 16

### Authentication methods

#### The following methods are available:

The authentication method is specified per VPN group and decides the type of authentication used.

The following key-based or certificate-based authentication methods are supported:

- **Preshared key**  
Authentication is achieved using a previously specified character string that is distributed to all modules in the group.  
Enter a preshared key in the "Key" field under "Authentication" > "General" in the VPN group properties dialog.
- **Certificate**  
Certificate-based authentication "Certificate" is the default setting. The procedure is as follows:
  - When a group is created, a CA certificate is generated as a root certificate.
  - Each security module that is a member of the VPN group also receives a group certificate signed with the key of the CA certificate.

All certificates are based on the ITU standard X.509v3 (ITU, International Telecommunications Union).

The certificates are generated by a certificate authority contained in STEP 7.

---

#### Note

##### Restriction in VLAN operation

No VLAN tagging is transmitted in IP frames via the VPN tunnel of the security module. The VLAN tags included in IP frames are lost when they pass through the security modules because IPsec is used to transfer the IP frames.

As default, no IP broadcast or IP multicast frames can be transferred with IPsec through a layer 3 VPN tunnel. Through a layer 2 VPN tunnel of the security module, IP broadcast or IP multicast frames are packaged just like MAC packets including the Ethernet header in UDP and transferred. With these packets, the VLAN tagging is therefore retained.

---



## Group properties for selected VPN group

### VPN group properties

#### Note

#### Knowledge of IPsec necessary

To be able to set these parameters, you require IPsec experience. If you do not make or modify any settings, the defaults apply.

The following settings can be configured in the properties of a VPN group:

- Authentication method (entry: "General")
- IKE settings (entry: "Advanced settings phase 1")
- IPsec settings (entry: "Advanced settings phase 2")

### How to access this function

1. In the "VPN" tab of the "Network data" area, select the VPN group you want to edit.
2. In the "Properties" > "General" tab of the Inspector window, select the entry "Authentication".
3. Select whether to use a preshared key or certificate for authentication. For more detailed information, refer to section: Authentication methods (Page 576).

### Parameters for advanced settings phase 1 - IKE settings

Phase 1: Key exchange (IKE = Internet Key Exchange):

Here, you set the parameters for the protocol of the IPsec key management. Key exchange is handled by means of the standardized IKEv1 method for which you can set the following protocol parameters:

Parameter	Description
IKE mode	Key exchange method: <ul style="list-style-type: none"> <li>• Main mode</li> <li>• Aggressive mode</li> </ul> The difference between the main and aggressive mode is the "identity protection" used in the main mode. The identity is transferred encrypted in main mode but not in aggressive mode.
DH group phase 1	Diffie-Hellman key agreement: <ul style="list-style-type: none"> <li>• Group 1</li> <li>• Group 2</li> <li>• Group 5</li> </ul> Diffie-Hellman groups (selectable cryptographic algorithms in the Oakley key exchange protocol).

Parameter	Description
SA lifetime type	Phase 1 Security Association (SA): <ul style="list-style-type: none"> <li>• Time: Time limit in minutes</li> </ul> The lifetime of the current key material is limited in time. When the time expires, the key material is renegotiated.
SA lifetime	Numeric value: Range of values for time: 1440 ... 2500000 minutes (default: 2500000)
Encryption phase 1	Encryption algorithm: <ul style="list-style-type: none"> <li>• DES*: Data Encryption Standard (56 bit key length, mode CBC)</li> <li>• 3DES-168: Triple DES (168-bit key length, mode CBC)</li> <li>• AES-128, 192, 256: Advanced Encryption Standard (128 bit, 192 bit or 256 bit key length, mode CBC)</li> </ul>
Authentication phase 1	Authentication algorithm: <ul style="list-style-type: none"> <li>• MD5: Message Digest Algorithm 5</li> <li>• SHA1: Secure Hash Algorithm 1</li> </ul>

\*DES is an insecure encryption algorithm. It should only be used for reasons of down compatibility. DES is not supported by the CP 1543-1 V1.1.

### Parameters for advanced settings phase 2 - IPsec settings

Phase 2: Data exchange (ESP = Encapsulating Security Payload)

Here, you set the parameters for the protocol of the IPsec data exchange. The data exchange is in "quick mode". The entire communication during this phase is encrypted using the standardized security protocol ESP for which you can set the following protocol parameters:

Parameter	Description
SA lifetime type	Phase 2 Security Association (SA): <ul style="list-style-type: none"> <li>• Time: Time limit in minutes. The lifetime of the current key material is limited in time. When the time expires, the key material is renegotiated.</li> <li>• Limit: Limitation of the data volume in MB</li> </ul>
SA lifetime	Numeric value: <ul style="list-style-type: none"> <li>• Range of values for time: 60 ... 16666666 minutes (default: 2880)</li> <li>• Range of values for limit: 2000 ... 500000 MB (default: 4000)</li> </ul>
Encryption phase 2	Encryption algorithm: <ul style="list-style-type: none"> <li>• DES*: Data Encryption Standard (56 bit key length, mode CBC)</li> <li>• 3DES-168: Triple DES (168-bit key length, mode CBC)</li> <li>• AES-128: Advanced Encryption Standard (128-bit key length, mode CBC)</li> </ul>
Authentication phase 2	Authentication algorithm: <ul style="list-style-type: none"> <li>• MD5: Message Digest Algorithm 5</li> <li>• SHA1: Secure Hash Algorithm 1</li> </ul>
Perfect Forward Secrecy	Select whether or not before each time an IPsec-SA is renegotiated, the key is negotiated again using the Diffie-Hellman method. Perfect Forward Secrecy safely prevents the new key from being derived from keys generated previously.

\*DES is an insecure encryption algorithm. It should only be used for reasons of down compatibility. DES is not supported by the CP 1543-1 V1.1.

## Modes of VPN groups

### VPN modes

Depending on the mode of the security modules that were added to a VPN group, different modes of VPN groups are distinguished. The mode of a VPN group provides information about the security modules and their modes that can be added to the VPN group.

### Rules for forming groups

Remember the following rules if you want to create VPN groups:

- For SCALANCE S612/S613/S623  
The first module assigned in a VPN group decides which other modules can be added to it.  
If the first SCALANCE S module added is in routing mode, you can only add other SCALANCE S modules that have routing mode enabled on them. If the first SCALANCE S module added is in bridge mode, you can only add other SCALANCE S modules in bridge mode. If you want to change the mode of a VPN group, you have to remove all the modules contained in the group and add them again. A CP can be added to a group with a SCALANCE S in bridge or routing mode.
- For CPs  
If a CP is inserted as the first module in a VPN group, the next security module to be inserted decides the VPN group mode. A CP can be assigned to several VPN groups at the same time and use different modes. The CP is then operated in mixed mode.
- It is not possible to add a SCALANCE M module to a VPN group that contains a module in bridge mode.

Refer to the following table to see which modules can be grouped together in a VPN group:

Table 8-23 Security modules and VPN modes

Module	Can be included in a VPN group in...	
	Bridge mode	Routing mode
SCALANCE S612/S613/S623 in bridge mode	x	-
SCALANCE S612/S613/S623 in routing mode	-	x
CP x43-1 Adv.	x	x
CP 1543-1 V1.1	x	x
CP 1628	x	x
SOFTNET Security Client V4.0	x	x
SCALANCE M875/MD741-1	-	x

### Including security module in configured VPN group

The configured VPN group properties are adopted for security modules added to in an existing VPN group.

### Procedure after including a security module in a configured VPN group

Depending on whether or not you have changed the VPN group properties since the last download, you must make a distinction between the following:

- **Case a:** If you have not changed the VPN group properties and the module to be added actively establishes the connection to the configured modules:
  1. Add the new security module to the VPN group.
  2. Download the configuration to the new module.
- **Case b:** If you have changed the VPN group properties or the module being added does not actively establish the connection to the already configured modules:
  1. Add the new security module to the VPN group.
  2. Download the configuration to all modules that belong to the VPN group.

In case a, it is not necessary to reconfigure and load the already commissioned security modules. Active communication is not influenced or interrupted.

### Settings for nodes with an unknown IP address

Nodes whose IP address is unknown at the time of configuration (unknown peers) can be inserted in an existing VPN group. Since the nodes are usually mobile and obtain their IP addresses dynamically (for example a SOFTNET security client or SCALANCE M), the VPN tunnel can only be established if you set the parameters for Phase 1 according to one of the following tables (1-23 to 1-27). If you use other settings, you cannot establish a VPN tunnel to the end device.

Table 8-24 Encryption parameter 1

Parameter	Setting
Authentication method	Certificate
DH group phase 1	Group 2
SA lifetime	1440 ... 2500000 minutes
Encryption phase 1	AES-256
Authentication phase 1	SHA-1

Table 8-25 Encryption parameter 2

Parameter	Setting
Authentication method	Certificate
DH group phase 1	Group 2
SA lifetime	1440 ... 2500000 minutes
Encryption phase 1	3DES-168
Authentication phase 1	SHA-1

Table 8-26 Encryption parameter 3

Parameter	Setting
Authentication method	Certificate
DH group phase 1	Group 2
SA lifetime	1440 ... 2500000 minutes
Encryption phase 1	DES
Authentication phase 1	MD5

Table 8-27 Encryption parameter 4

Parameter	Setting
Authentication method	Preshared key
DH group phase 1	Group 2
SA lifetime	1440 ... 2500000 minutes
Encryption phase 1	3DES-168
Authentication phase 1	SHA1

### Additional restrictions for the SOFTNET Security Client

For the SOFTNET security client, the following restrictions also apply:

Table 8-28 Encryption parameters for the SOFTNET Security Client

Parameter	Setting / special feature
Encryption phase 1	AES-256 possible only with Windows 7
SA lifetime phase 1	1440 to 2879 minutes
SA lifetime type	Must be selected identical for both phases
Encryption phase 2	No AES 128 possible
SA lifetime phase 2	1440 to 2879 minutes
Authentication phase 2	No MD5 possible

### Procedure after removing an active member from a VPN group

If you remove an active node from an existing VPN group, this can still establish a connection to the group members even if you have downloaded the project to all members of the VPN group again.

If you do not want the removed active node to be able to establish the connection any longer, renew the CA group certificate and download the project again to the members of the VPN group. The certificate can be renewed in the group properties of the VPN group or in the "CA" tab of Certificate Manager.

## Configuring internal network nodes

### Overview of configuring internal network nodes

#### Configuring internal network nodes

Each security module must know the network nodes in the entire internal network to be able to recognize the authenticity of a frame.

The security module must know both its own internal nodes as well as the internal nodes of the security modules in the same VPN group. This information is used on a security module to decide which data packet will be transferred in which tunnel.

SCALANCE S modules allow network nodes to be learned automatically or configured statically. The mode of the security module also decides the options available for learning internal network nodes.

#### SCALANCE S in bridge mode

In bridge mode, you can configure the internal IP/MAC nodes and the internal subnets or alternatively can allow automatic learning of internal nodes by the SCALANCE S.

#### SCALANCE S in routing mode

In routing mode there is no automatic learning mode available. Instead, enter entire subnets here that need to be released for tunnel communication.

#### CP x43-1 Advanced and CP 1628

- CP x43-1 Adv.  
Decide whether or not tunnel communication to the CP (Gbit interface) and/or to the internal subnet (PROFINET subnet) is permitted for VPN connection partners in routing mode (SCALANCE S / M).
- CP 1628  
Enter the NDIS nodes you want to be reachable through the tunnel of VPN connection partners in routing mode (SCALANCE S / M).

#### Automatic learning of internal network nodes

##### Module-specific function

SCALANCE S modules in bridge mode provide a learning mode with which the internal network nodes can be learned automatically during operation. For more detailed information, refer to subsection:

Using the learning mode to learn internal nodes (Page 608) in the section "SCALANCE S".

## **Configuring IP network nodes manually for SCALANCE S**

### **Module-specific function**

How to configure IP network nodes for SCALANCE S modules manually is explained in: Configuring IP network nodes manually (Page 610) in the section "SCALANCE S".

## **Configuring MAC network nodes manually for SCALANCE S**

### **Module-specific function**

How to configure MAC network nodes for SCALANCE S modules manually is explained in Configuring MAC network nodes manually (Page 610) in the section "SCALANCE S".

## **Configuring internal subnets for SCALANCE S manually**

### **Module-specific function**

How to configure the internal subnets for SCALANCE S modules is explained in Configuring internal subnets manually (Page 611) in the section "SCALANCE S".

## **Allow access to S7-300 / S7-400 CPs for VPN connection partners**

### **Module-specific function**

How to allow access to S7-300 / S7-400 CPs for VPN connection partners is explained in Allow access to S7-300 / S7-400 CPs for VPN connection partners (Page 626) in the section "Security for S7-300 /S7-400 /PC CPs".

## **Configuring NDIS nodes for PC CPs that can be reached through the tunnel**

### **Module-specific function**

How you configure NDIS nodes for PC CPs that can be reached through the tunnel is explained in Configuring NDIS nodes manually for PC CPs that can be reached through the tunnel (Page 626) in the section "Security for S7-300 / S7-400 / PC CPs".

## **Configuring module- and connection-specific VPN settings**

### **Requirement**

The module is a member of a VPN group.

### Module- and connection-specific settings

With module- and connection-specific settings, you can configure specific VPN settings. Module-specific settings are configured specifically for a security module while connection-specific settings are configured specifically for a security module in a certain VPN group.

You can configure the following **module-specific** properties in the local security settings with the "VPN" entry:

- Dead peer detection
- Permission to initiate connection establishment
- Public IP address for communication via Internet gateways

If you select a security module in the list of VPN groups in the "Network data" area, the following **connection-specific** VPN settings can be seen and can be configured:

- Permission to initiate connection establishment
- Partner modules to which tunnel connections exist
- Type of transferred packets
- Selection of the local interface of the selected security module that will serve as the tunnel endpoint
- Selection of the partner interface that will serve as the tunnel endpoint

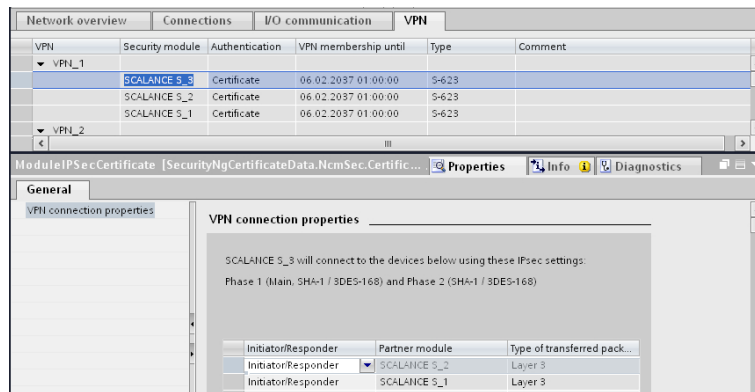

### Dead peer detection (DPD)

As default, DPD is enabled.

When DPD is enabled, the modules exchange additional messages at selectable intervals if no communication occurs at these points in time. This means that it is possible to recognize whether the IPsec connection is still valid or possibly needs to be re-established. If there is no longer a connection, the security associations (SA) of phase 2 are terminated prematurely. If DPD is disabled, the SA is ended only after the SA lifetime has expired. For information on setting the SA lifetime, see section Group properties for selected VPN group (Page 577).



## Permission to initiate connection establishment

You can restrict the permission for initiating the VPN connection establishment to certain modules in the VPN.

The decisive factor the setting of the parameter described is the assignment of the IP address for the gateway of the module you are configuring. If a static IP address is assigned, the module can be found by the partner. If the IP address is assigned dynamically and therefore changes constantly, the partner cannot establish a connection as things stand.

Mode	Meaning
Start connection to partner (initiator/responder) (default)	<p>If this option is selected, the module is "active", in other words, it attempts to establish a connection to the partner with a fixed IP address.</p> <p>This option is recommended when you obtain a dynamic IP address from the provider for the gateway of the security module you are configuring.</p> <p>The partner is addressed over its external module IP address or its configured WAP IP address.</p>
Wait for partner (responder)	<p>If this option is selected, the module is "passive", in other words, it waits for the partner to initiate the connection.</p> <p>This option is recommended when you have been assigned a static IP address by the provider for the gateway of the security module you are configuring. It means attempts to establish a connection can only be initiated by the partner. This partner can, for example, have a dynamic WAN IP address.</p>

### Note

Make sure that you do not set all the modules in a VPN group to "Wait for connection from remote VPN gateway" otherwise no connection is established.

## WAN IP address - IP addresses of the modules and gateways in a VPN over Internet

When operating a VPN with IPsec tunnel over the Internet, additional IP addresses are generally required for the Internet gateways such as DSL routers. The individual security or

SCALANCE M modules must know the external IP addresses of the partner modules in the VPN.

**Note**

To use a WAN as an external public network, enter the IP address that you received from the provider as the external IP address, through which the security module is then reachable in the WAN (Internet). To allow the security module to send packets via the WAN, you need to enter your DSL router as "Standard router".

If you use a DSL router as Internet gateway, the following ports (at least) must be opened on it:

- Port 500 (ISAKMP)
- Port 4500 (NAT-T)

To allow this, when you configure the module, you have the option of assigning an external IP address as a "WAN IP address". When you download the module configuration, the group members are then informed of the WAN IP addresses of the partner modules. If you do not enter a WAN IP address, the external IP address of the module is used. Whether the external IP address or the WAN IP address is used can be selected in module-specific VPN settings of the security module. In these settings, you can also specify the interface to be used for communication by the nodes of a VPN group and the security module that is authorized to set up connections.

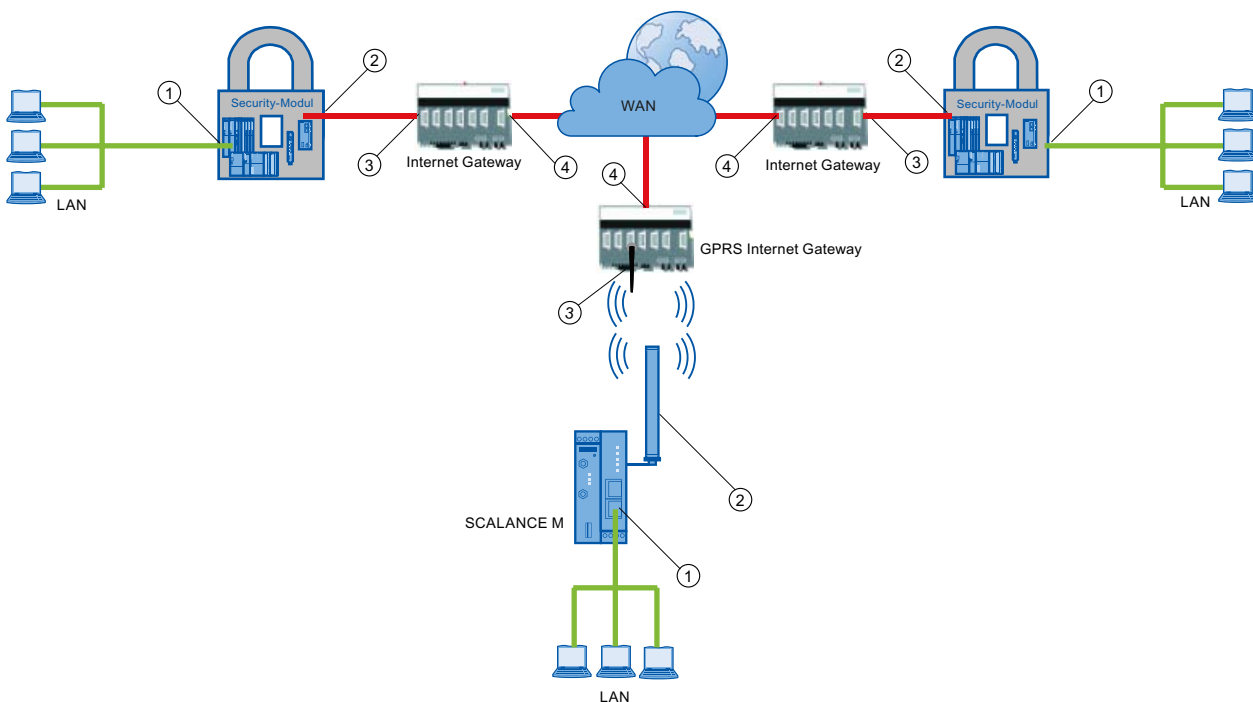

- ① Internal IP address - of a module
- ② External IP address - of a module
- ③ IP address of an Internet gateway (for example, GPRS gateway)
- ④ IP address (WAN IP address) of an Internet gateway (for example, DSL router)

## See also

How to create an IPsec tunnel with VPN groups (Page 574)

## Online functions - test / diagnostics and logging

### Overview of diagnostics and logging in

For test and monitoring purposes, the security module has diagnostic and logging functions.

- Diagnostic functions  
These include various system and status functions that you can use for an existing network connection to the security module.
- Logging functions  
This involves the logging of system and security events and data packets.

### Recording events with logging functions

You select the events to be logged in the log settings for the relevant security module.

You can configure the following variants for logging:

- Local logging  
In this variant, you log events in the local buffer of the security module. You can then access these logs, display them and archive them on the service station in the "Online & diagnostics" dialog. The evaluation of the buffer areas of the security module is only possible if there is a network connection to the selected security module.
- Network Syslog  
With Network Syslog, you use a Syslog server that exists in the network. This logs the events according to the configuration in the log settings for the relevant security module.

### Archiving log data and reading in from a file

You can save the logged events for archiving in a log file and open this later even without a network connection to the security module. For more detailed information, refer to section Auto-Hotspot.

## Overview of the functions in the online dialog

### Functions of the "Online & diagnostics" dialog

In STEP 7, the security module provides the following functions in the "Online & diagnostics" dialog:

Entry in the online dialog	Function
Status	Display of status information about the selected security module, such as the current IP addresses of the interfaces and the current time and date.
System log	Display of logged system events, starting and stopping logging (only if there is an online connection to SCALANCE S modules) and starting and stopping the reading out of log data from the local buffer of the security module.
Audit log	Display of logged security events, starting and stopping reading out of log data from the local buffer of the security module.
Packet filter log	Display of logged data packets, starting and stopping logging (only if there is an online connection to SCALANCE S modules) and starting and stopping the reading out of log data from the local buffer of the security module.
Communication status (not for SCALANCE S602 and CP 1543-1 V1.0)	Display of status information about VPN tunnel connections and members of VPN groups to which the selected security module belongs.
Internal nodes (not for SCALANCE S602 and PC CPs)	Display of the learned or configured internal network nodes of the security module.
Dynamically updated firewall rules (only for S7 CPs)	Display of the IP addresses that were released dynamically over HTTP or HTTPS, or loaded by a user.
Date and time (SCALANCE S only)	Date and time setting.

### Requirements for access

The following requirements must be met to use the online functions of a security module:

- There is a network connection to the selected module
- The project with which the module was configured is open
- a user with the required rights must be logged in in the project
- an online connection to the security module using HTTPS exists

### How to access this function

1. Right-click on the module to process.
2. Select the "Online & diagnostics" command from the shortcut menu.  
As soon as you select one of the entries for logging functions, you will see the current status of the logging function of the selected security module in the lower area:  
Memory settings: Circular buffer / linear memory  
The current logging status is derived from the loaded configuration or from the previous online diagnostics data.

### Online settings are not saved in the configuration

Settings that you make in online mode (for example settings for the logging memory) are not stored in the configuration on the security module. This is why the configuration settings are always applied at the restart of the module.

### Functions of the online diagnostics

#### Status information of the security module - "Status" entry

#### Meaning

Display of the status of the security module selected in the project.

Table 8-29 Online & diagnostics: - "Status" entry

System and status functions	Meaning
<b>Overview</b>	
Hardware type	The type of the security module.
External IP address	The external IP address of the security module. For CP 1628: The IP address of the Industrial Ethernet interface. For S7 CPs: The IP address of the Gbit interface.
Internal IP address	The internal IP address of the security module. For CP 1628: The IP address of the NDIS interface. If there is more than one NDIS address, only one is displayed. For S7 CPs: The IP address of the PROFINET interface.
Serial number	The serial number of the security module.
Order number	The MLFB identifier of the security module that is used when ordering.
Firmware version	The firmware version of the security module.
Operating mode	Setting in for interface routing
External MAC address	The external MAC address of the security module. For CP 1628: The MAC address of the Industrial Ethernet interface. For S7 CPs: The MAC address of the Gbit interface.
Internal MAC address	The internal MAC address of the security module. For CP 1628: The MAC address of the NDIS interface. For S7 CPs: The MAC address of the PROFINET interface.
Hardware release	The hardware product version of the security module.
C-PLUG	Shows whether or not a C-PLUG is inserted.

System and status functions	Meaning
<b>Local time</b>	
Current time	<p>Date and time that is displayed on the security module.</p> <p>Format for "German" user interface language: dd.mm.yyyy (date) hh:mm:ss (time)</p> <p>Format for "English" user interface language: mm/dd/yyyy (date) hh:mm:ss AM/PM (time)</p> <p>Format for "French" user interface language: dd/mm/yyyy (date) hh:mm:ss (time)</p> <p>Format for "Italian" user interface language: dd/mm/yyyy (date) hh:mm:ss (time)</p> <p>Format for "Spanish" user interface language: dd/mm/yyyy (date) hh:mm:ss (time)</p> <p><b>Note (not for CPs)</b></p> <p>You set the local time on the SCALANCE S module in "Functions" &gt; "Date and time".</p>
Operating time	<p>Time since the last restart of the security module.</p> <p>Format for "German" user interface language: dddd.hh:mm:ss</p> <p>Format for "English" user interface language: dddd.hh:mm:ss</p> <p>Format for "French" user interface language: dddd.hh:mm:ss</p> <p>Format for "Italian" user interface language: dddd.hh.mm.ss</p> <p>Format for "Spanish" user interface language: dddd.hh:mm:ss</p>
Time-of-day source	The source from which the date and time are obtained.
<b>Configuration</b>	
Created	<p>Date and time when the project was first created.</p> <p>Format for "German" user interface language: dddd.hh:mm:ss hh:mm:ss (time)</p> <p>Format for "English" user interface language: dddd.hh:mm:ss hh:mm:ss AM/PM (time)</p> <p>Format for "French" user interface language: dddd.hh:mm:ss hh:mm:ss (time)</p> <p>Format for "Italian" user interface language: dddd.hh.mm.ss hh.mm.ss (time)</p> <p>Format for "Spanish" user interface language: dddd.hh:mm:ss hh:mm:ss (time)</p>
Name	File name under which the project was last saved. The name is set by default by STEP 7 and is changed when you rename the project.
Author	Name of the user who created the project. Is adopted from the project properties.

System and status functions	Meaning
Loaded	Date and time when the project was last loaded on the security module. Format for "German" user interface language: dddd.hh:mm:ss hh:mm:ss (time) Format for "English" user interface language: dddd.hh:mm:ss hh:mm:ss AM/PM (time) Format for "French" user interface language: dddd.hh:mm:ss hh:mm:ss (time) Format for "Italian" user interface language: dddd.hh:mm:ss hh:mm:ss (time) Format for "Spanish" user interface language: dddd.hh:mm:ss hh:mm:ss (time)
Storage location	Location entered from the project properties. The location is transmitted along with the configuration download to the security module.
<b>File system (not for CPs)</b>	
RAM	Graphic and percentage display of how much RAM and flash is occupied in the file system.
Flash	

## VPN connections of the security module - "Communication status" entry

### Module-specific function

This function is not available for SCALANCE S 602 modules.

### Meaning

Display of the communication status of the following network components:

- Other security modules of the VPN group to which the selected security module belongs
- Internal network nodes of these security modules

Table 8-30 Online & diagnostics: "Communication Status" entry

System and status functions	Meaning
Known security devices or modules	<p>Display of the nodes with which the selected security module is in a VPN group. This also shows whether the tunnel status is active or passive. To obtain additional information on one of the nodes, select this in the list.</p> <p><b>Note:</b> Configured, inactive tunnels are indicated for CPs only.</p>
Endpoints	<p>Display of information on the internal network nodes of the security module that you selected in the "Known security devices or modules" table. For each internal network node, this shows whether it was learned or configured. It also shows the subnet in which the internal network node is located.</p> <p>With SCALANCE S modules, the subnet of network nodes is only displayed in bridge mode.</p>
Tunnel properties	<p>Display of properties of the VPN tunnel established to the security module that you selected in the "Known security devices or modules" table.</p>

**Found internal network nodes - "Internal nodes" entry**

**Module-specific function**

This function is not available for SCALANCE S602 modules and CP 1543-1.

**Meaning**

Display of all learned and configured network nodes. This also displays whether or not the learning mode of the security module is enabled.

**Updated firewall rules - "Dynamically updated firewall rules" entry**

**Module-specific function**

This function is only available for S7 CPs, see Updated firewall rules - "Dynamically updated firewall rules" entry (Page 626) in the section "Security for S7-300 / S7-400 / PC CPs".



## Setting the date and time - "Date and Time" entry

### Module-specific function

This function is available only for SCALANCE S modules, see section Setting the date and time - "Date and time" entry (Page 612).

### Logging functions

## Logging system events - "System log" entry

### Meaning

Display of logged system events and starting and stopping reading system events from the local memory of the security module.

The system log automatically logs successive system events, for example the start of a process. The logging can be scaled based on event classes.

System and status functions	Meaning
Start/stop logging (not for CPs)	Starts/stops recording of system events. The method and the event classes that are logged are configured in the local security settings.
Start/stop reading	Starts/stops reading of system events from the local memory of the security module. If you select the "Save log file" check box, the recorded log data is also saved as file. Select the storage location and enter a file name.  <b>Note</b> If you select the "Save log file" check box after starting reading, the data read out up to then can no longer be saved in a log file.
Clear display	Deletes the log data shown in the table.

For more information on opening saved system events in log files, refer to section Evaluating system events in offline mode - "System log" entry (offline view) (Page 595).

## Logging security events - "Audit log" entry

### Meaning

Display of logged security events and starting and stopping reading of security events from the local memory of the security module.

The audit log automatically logs successive security-relevant events. This includes, for example, user actions such as enabling and disabling packet logging.

System and status functions	Meaning
Start/stop reading	Starts/stops reading of security events from the local memory of the security module. If you select the "Save log file" check box, the recorded log data is also saved as file. Select the storage location and enter a file name.  <b>Note</b> If you select the "Save log file" check box after starting reading, the data read out up to then can no longer be saved in a log file.
Clear display	Deletes the log data shown in the table.

For more information on opening security events stored in log files, refer to section Evaluating security events in offline mode - "Audit log" entry (offline view) (Page 595).

### Logging data packets - "Packet filter log" entry

#### Meaning

Display of logged data packets and starting and stopping reading of packet filter events.

The packet filter log records certain packets of the data traffic. Data packets are only logged if they match a configured packet filter rule (firewall) or to which the basic protection reacts (corrupt or invalid packets). This is only possible when logging is enabled for the packet filter rule.

For information about activation of the logging, refer to section Auto-Hotspot.

As well as reading the log data from the buffer and transferring it to the display, it can also be saved in a file for archiving.

System and status functions	Meaning
Start/stop logging (not for CPs)	Starts/stops logging of data packets. The method with which the data is logged is configured in the local security settings.
Start/stop reading	Starts/stops reading out of logged data packets from the local memory of the security module. If you select the "Save log file" check box, the recorded log data is also saved as file. Select the storage location and enter a file name.  <b>Note</b> If you select the "Save log file" check box after starting reading, the data read out up to then can no longer be saved in a log file.

System and status functions	Meaning
Clear display	Deletes the log data shown in the table.
Log category	Select the data packets for which the logging will be displayed. The selection depends on the settings you configured offline in the local security settings. Only the data packets for which logging was enabled are logged. If you select a category for which logging was not enabled, no data will be logged for this category.

For information on opening the stored packet filter log data, refer to section Evaluating packet filter events in offline mode - "Packet filter log" entry (offline view) (Page 596).

## Evaluating log files in offline mode

### Evaluating system events in offline mode - "System log" entry (offline view)

#### How to access this function

1. Right-click on the module to process.
2. Select the "Online & diagnostics" command from the shortcut menu.
3. Select "Diagnostics" > "Log files (offline view)" > "System log".

#### Meaning

Opens logged system events that you saved as a file in the online view.

For more information, refer to chapter Logging system events - "System log" entry (Page 593).

### Evaluating security events in offline mode - "Audit log" entry (offline view)

#### How to access this function

1. Right-click on the module to process.
2. Select the "Online & diagnostics" command from the shortcut menu.
3. Select "Diagnostics" > "Log files (offline view)" > "Audit log".

#### Meaning

Opens logged security events that you saved as a file in the online view.

For more detailed information, refer to section Logging security events - "Audit log" entry (Page 593).

## Evaluating packet filter events in offline mode - "Packet filter log" entry (offline view)

### How to access this function

1. Right-click on the module to process.
2. Select the "Online & diagnostics" command from the shortcut menu.
3. Select "Diagnostics" > "Log files (offline view)" > "Packet filter log".

### Meaning

Opens logged data packets that you saved as a file in the online view.

For more detailed information, refer to section Logging data packets - "Packet filter log" entry (Page 594).

### Download functions

#### Special features when downloading security configurations

Security configurations can influence the reachability of the security module for the configuration PC. This, for example, is the case if there is a tunnel connection configured for one security module to another security module in a configuration and this configuration is downloaded from the configuration PC to the security module. After the download by the configuration PC, the security module can no longer be reached and the reachability test performed as default by STEP 7 following the download of the configuration fails. The error message output by STEP 7 relates solely to the reachability test; the actual download of the configuration is ensured if the project data is consistent and the IP address relationship between the security module and the configuration PC is correct.

Special features when downloading configurations and firmware to SCALANCE S modules are described in the following subsection of the section "SCALANCE S":  
Auto-Hotspot

## SOFTNET Security Client

### Using the SOFTNET Security Client

#### Area of application - access over VPN

With the SOFTNET Security Client (SSC) PC software, secure remote access is possible from PGs/PCs to automation systems protected by a security module via public networks. You require SOFTNET Security Client V4.0 HF1 for S7-300/S7-400 CPs and for the PC CP 1628. These CPs are not approved for operation with SOFTNET Security Client ≤ V4.0. The SOFTNET Security Client has not been released for the CP 1543-1.

With the SOFTNET Security Client, a PG/PC is configured automatically so that it can establish a secure IPsec tunnel communication in the VPN (Virtual Private Network) with one or more security modules.

This IPsec tunnel communication makes it possible for PG/PC applications such as NCM diagnostics to securely access devices or networks that are located in an internal network protected by SCALANCE S.

### How does the SOFTNET Security Client work?

The SOFTNET Security Client reads the configuration that was created by STEP 7 and determines from the file which certificates are to be imported.

The CA certificate and, when applicable, the private key are imported and stored on the local PG/PC.

Following this, security settings are made based on the data from the configuration so that applications can access IP addresses downstream from the security modules.

If the learning mode is enabled for the internal nodes or programmable controllers, a security policy is first set for secure access to security modules. Then, the SOFTNET Security Client addresses the security modules in order to obtain the IP addresses of the relevant internal nodes.

The SOFTNET Security Client enters these IP addresses in special filter lists belonging to this security policy. Applications can then communicate with the programmable controllers via VPN.

### Creating a configuration file in STEP 7

#### Configuring a SOFTNET Security Client module in the project

The SOFTNET security client is created as a module in the project. In contrast to the other security modules, you do not need to configure any further properties.

Assign the SSC module to the VPN group or groups at which an IPsec tunnel to the PG/PC is to be set up.

---

**Note**

Refer to the information on parameters in section  
Including security module in configured VPN group (Page 580).

---

---

**Note**

If you create several SOFTNET Security Clients within a group, no tunnels are set up between these clients but only from the relevant client to the security modules.

---

### Configuration files for the SOFTNET Security Client

The interface between STEP 7 as configuration tool and the SOFTNET Security Client is controlled by configuration files.

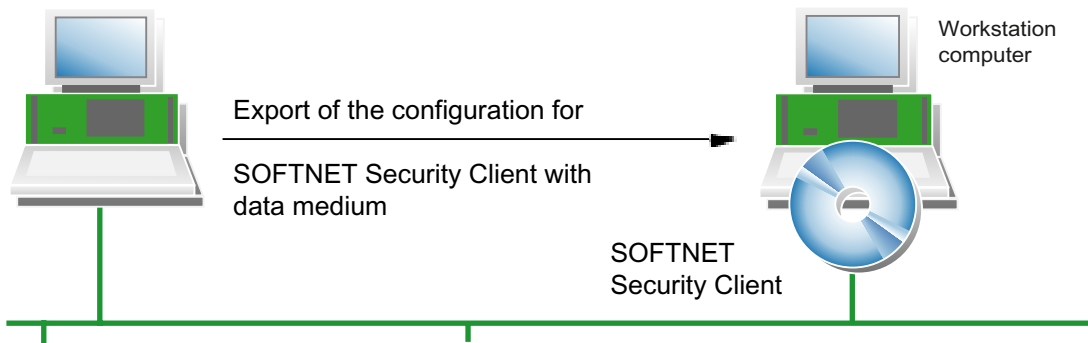

The configuration is stored in the following file types:

- \*.dat
- \*.p12
- \*.cer

### Procedure

To generate the configuration files, perform the following steps in STEP 7:

1. In the "Devices & networks" view, select the "Topology view" or the "Network view" tab.
2. Insert a PC system of the type "SOFTNET Security Client" in the selected tab from the hardware catalog.
3. Assign the SOFTNET Security Client to the VPN groups in which the PG/PC will communicate over IPsec tunnels.
4. Make sure that the "Generate SSC files" check box is selected under the "Configuration of the SOFTNET Security Client" entry in the local security settings of the SOFTNET Security Client.
5. Select the storage location for the configuration files.
6. Compile the configuration of the SOFTNET Security client to export the configuration file.
7. If you selected certificate as the authentication method, specify a password for the certificate of the VPN configuration. If you do not assign a password, the project name (not the project password) is used as the password.  
Result: Export of the configuration files is completed.
8. Adopt the files of the type \*.dat, \*.p12, \*.cer on the PG/PC on which you want to operate the SOFTNET Security Client.

## SCALANCE S

### Configuring the mode and network parameters for SCALANCE S modules

#### Setting the operating mode

#### How to access this function

1. Select the module to be edited.
2. In the local security settings, select the entry "Mode".

#### Operating mode - possible selections

You can change the operating mode in this dialog if the security module is not included in a VPN group. The selection is valid for port 1 and for port 2.

If the security module is in a VPN group, the mode cannot be changed.

Bridge mode	For operation in flat networks. External and internal port are in the same IP subnet. Only the external port can be configured.
Routing mode	The external and internal port are operated on different IP subnets. If you have activated the routing mode, you must configure an internal IP address and subnet mask for the port of the security module. <b>Note</b> If you have enabled the routing mode for the SCALANCE S module, no MAC firewall rules can be defined.

### Configuring network parameters

#### Meaning

Specify network parameters such as the IP address and subnet mask for the interface(s) of the security module.

### How to access this function

1. Select the module to be edited.
2. Select "External interface [P1] red" > "Ethernet addresses" in the local security settings.

---

**Note****Configuration of the internal interface in routing mode**

If you have selected the "Routing" mode for the security module, you must also configure an internal IP address and subnet mask for the internal interface of the security module. You can access this function in the local security settings under "Internal interface [P2] green" > Ethernet addresses".

---

3. Complete the settings specified in the following table.

Parameter	Meaning
IP address	IP address for the external interface. The IP address consists of four decimal numbers from 0 to 255, with each number being separated by a period, for example, 141.80.0.16.
Subnet mask	The subnet mask consists of four decimal numbers that are separated by period, for example, 255.255.0.0
Use router	Select this check box if you want to use a standard router and enter its IP address in the "Router address" input box.

### Port settings

#### Default "Autonegotiation" setting

The ports of the security modules are set to "Autonegotiation" by default. In "Autonegotiation" mode, the transmission speed and duplex mode are selected automatically. Moreover, the auto-crossing function is supported.

### Setting up a firewall

#### Local firewall rules for SCALANCE S modules

#### Configuring a firewall with predefined firewall rules

#### Configuring a firewall using predefined firewall rules

### How to access this function

1. Select the module to be edited.
2. Select the "Firewall" entry in the local security settings.



## Firewall enabled as default

The "Enable firewall" check box is enabled by default. The firewall is therefore activated automatically and all internal to external access and vice versa is inhibited. By clicking the relevant check box, enable the firewall rules for the specific direction.

### Note

#### Detailed firewall settings in advanced firewall mode

In advanced firewall mode, you can restrict firewall rules to individual nodes. To change to advanced firewall mode, select the "Enable firewall in advanced mode" check box. For more detailed information about the advanced firewall mode, refer to the section [Overview of local firewall rules \(Page 552\)](#)

## Firewall configuration with VPN

If the security module is in a VPN group, the "Tunnel communication only" check box is enabled as default. This means that only encrypted IPsec data transfer is permitted via the external interface.

If you deselect the check box, tunneled communication and also the types of communication selected in the other boxes are permitted.

Table 8-31 Available firewall rules and directions

Service	Internal to external	External to internal	Enabled ports	Meaning
Allow IP communication	x	x	-	IP communication for the selected communication directions is allowed.
Allow S7 protocol	x	x	TCP port 102	Communication of the nodes using the S7 protocol is allowed.
Allow FTP/FTPS (explicit mode)	x	x	TCP port 20 TCP port 21	For file management and file access between server and client.
Allow HTTP	x	x	TCP port 80	For communication with a Web server.
Allow HTTPS	x	x	TCP port 443	For secure communication with a Web server, for example, for Web diagnostics.
Allow DNS	x	x	TCP port 53 UDP port 53	Communication connection to a DNS server is allowed.
Allow SNMP	x	x	TCP port 161/162 UDP port 161/162	For monitoring nodes capable of SNMP.
Allow SMTP	x	x	TCP port 25	For sending e-mails via an SMTP server.
Allow NTP	x	x	UDP port 123	For synchronization of the time of day.
Allow DHCP	x	x	UDP port 67 UDP port 68	Communication connection with a DNS server is permitted.

Table 8-32 Logging

Option	Action when activated
Log tunneled packets	Only active if the security module is a member of a VPN group. All IP packets transferred via the tunnel are logged.
Log blocked incoming packets	All incoming IP packets that are discarded are logged.
Log blocked outgoing packets	All outgoing IP packets that are discarded are logged.

You can view the logged packets at the "Packet filter log" entry in the "Online & Diagnostics" dialog. For more detailed information, refer to the section Logging data packets - "Packet filter log" entry (Page 594).

### Configuring a firewall with predefined MAC rules

#### How to access this function

1. Select the module to be edited.
2. Select the "Firewall" entry in the local security settings.

#### Firewall enabled as default

The "Enable firewall" check box is enabled by default. The firewall is therefore activated automatically and all external to internal access and vice versa is inhibited. By clicking the relevant check box, enable the firewall rules for the specific direction.

---

#### Note

##### Detailed firewall settings in advanced firewall mode

In advanced firewall mode, you can restrict firewall rules to individual nodes. To change to advanced firewall mode, select the "Enable firewall in advanced mode" check box. For more detailed information about the advanced firewall mode, refer to the section Overview of local firewall rules (Page 552).

---

#### Firewall configuration with VPN

If the security module is in a VPN group, the "Tunnel communication only" check box is enabled as default. This means that only encrypted IPsec data transfer is permitted via the external interface.

If you deselect the check box, tunneled communication and also the types of communication selected in the other boxes are permitted.

**Available MAC rules and directions**

Service	Internal to external	External to internal	Meaning
Allow MAC communication	x	x	The MAC traffic from internal to external and vice versa is allowed.
Allow ISO protocol	x	x	The ISO traffic from internal to external and vice versa is allowed.
Allow SiClock	x	x	SiClock time frames from internal to external nodes and vice versa are permitted.
Allow DCP	x	x	Internal to external or external to internal DCP traffic for IP address assignment is permitted.

Table 8-33 Logging

Option	Action when activated
Log tunneled packets	Only active if the security module is a member of a VPN group. All MAC packets transferred via the tunnel are logged.
Log blocked incoming packets	All incoming MAC packets that are discarded are logged.
Log blocked outgoing packets	All outgoing MAC packets that are discarded are logged.

**IP packet filter directions SCALANCE S**

**Meaning**

Possible selections for the communication directions "From" and "To" in the IP rules of the advanced firewall mode.

**The following directions are available**

Available options / ranges of values		Security module			
From	To	S602 V2/V3	S612 V2/V3	S613 V2	S623 V3
Internal	External	x	x	x	x
	Tunnel	-	x	x	x
	Any	-	x	x	x
External	Internal	x	x	x	x
	Any	-	-	-	-
	Tunnel	-	-	-	-
Tunnel	Internal	-	x	x	x
	External	-	-	-	-
	Any	-	-	-	-
Any	Internal	-	x	x	x

Available options / ranges of values		Security module			
	External	-	-	-	-
	Tunnel	-	-	-	-

x = communication direction is configurable  
 - = communication direction is not configurable

### MAC packet filter directions SCALANCE S

#### Meaning

Possible selections for the communication directions "From" and "To" in the MAC rules of the advanced firewall mode.

The following directions are available

Available options / ranges of values		Security module			
From	To	S602 V2/V3	S612 V2/V3	S613 V2	S623 V3
Internal	External	x	x	x	x
	Tunnel	-	x	x	x
	Any	-	x	x	x
External	Internal	x	x	x	x
	Any	-	-	-	-
	Tunnel	-	-	-	-
Tunnel	Internal	-	x	x	x
	External	-	-	-	-
	Any	-	-	-	-
Any	Internal	-	x	x	x
	External	-	-	-	-
	Tunnel	-	-	-	-

x = communication direction is configurable  
 - = communication direction is not configurable

### Specifying routes

#### Meaning

Specify routes for addressing subnets that cannot be reached directly via the security module.

#### How to access this function

1. Select the module to be edited.
2. In the local security settings, select the "Routing" entry.

3. Double-click "Add new" in the table to add a route.
4. Enter the following values:

Parameter	Function	Example of a value
Network ID	Requests to nodes of the subnet with the network ID and the subnet mask specified here are forwarded to the subnet via the specified router IP address. Based on the network ID, the router recognizes whether a destination address is inside or outside the subnet. The specified network ID must not be located in the same subnet as the IP address of the security module.	192.168.11.0
Subnet mask	The subnet mask determines the network structure. Based on the network ID, the router recognizes whether a destination address is inside or outside the subnet.	255.255.255.0
Router IP address	IP address of the router that connects to the subnet. The specified router IP address must be in the same subnet as the IP address of the security module.	192.168.10.2

## Security module as DHCP server

### Overview DHCP server

#### Overview

You can operate the SCALANCE S module as DHCP server (DHCP = Dynamic Host Configuration Protocol) on the internal network. This allows IP addresses to be assigned automatically to the devices connected to the internal network.

The IP addresses are either distributed dynamically from an address range you have specified or you can select a specific IP address and assign it to a particular device.

#### Requirements

You configure the devices in the internal network so that they obtain the IP address from a DHCP server.

Depending on how the security module is configured, it informs the nodes in the subnet of the IP address of the standard router or you need to make the router IP address known to the nodes in the subnet.

## 8.1 Configuring devices and networks

- Router IP address will be transferred  
In the following situations, the DHCP protocol of the SCALANCE S module will inform the nodes of the router IP address:
  - The SCALANCE S module is configured for router mode.  
In this case, the SCALANCE S module sends its own IP address as the router IP address.
  - The SCALANCE S module is not configured for router mode. However, a standard router is specified in the configuration of the SCALANCE S module.  
In this case, the SCALANCE S module transmits the IP address of the standard router as the router IP address.
- Router IP address will not be transferred  
Enter the router IP address manually at the nodes in the following situations:
  - The SCALANCE S module is not configured for router mode and no standard router is specified in the configuration.

### See also

Configuring a DHCP server (Page 606)

## Configuring a DHCP server

### How to access this function

1. Select the module to be edited.
2. In the local security settings, select the entry "DHCP server".
3. Select the interface for which you want to make the DHCP settings.
4. Make the address assignment. You have the following configuration options:
  - Static address assignment  
Devices with a specific MAC address or client ID are assigned the specified IP addresses. You specify these addresses by entering the devices in the address list in the "Static address assignment" group box.
  - Dynamic address assignment  
Devices whose MAC address or whose client ID was not specified specifically, are assigned a random IP address from a specified address range. For this purpose, activate the "Dynamic IP address pool" check box. Set the address range in the "Dynamic IP address pool" input area.

**Note**

**Dynamic address assignment - reaction after interrupting the power supply**

Please note that dynamically assigned IP addresses are not saved if the power supply is interrupted. On return of the power, you must therefore make sure that the nodes request an IP address again.

You should therefore only use dynamic address assignment for the following nodes:

- Nodes that are used temporarily in the subnet (such as service devices).
- Nodes that have been assigned an IP address and send this as the "preferred address" the next time they request an address from the DHCP server (for example PC stations).

For permanent nodes you should preferably use static address assignment by specifying a client ID or the MAC address.

**Consistency check - these rules must be adhered to**

Remember the following rules when making the entries.

Check / rule	Check made <sup>1)</sup>	
	locally	Project-wide/ module-wide
The IP addresses assigned in the address list in the "Static address assignments" group box must not be in the range of the dynamic IP addresses.		x
IP addresses, MAC addresses and client IDs may only occur once in the "Static address assignment" table (related to the security module).		x
For the statically assigned IP addresses, you must specify either the MAC address or the client ID (computer name).	x	
The client ID is a string with a maximum of 63 characters. Only the following characters may be used: a-z, A-Z, 0-9 and - (dash). <b>Note</b> In SIMATIC S7, a client ID can be assigned to the devices on the Ethernet interface to allow them to obtain an IP address using DHCP. With PCs, the procedure depends on the operating system being used; it is advisable to use the MAC address here for the assignment.	x	
For the statically assigned IP addresses, you must specify the IP address.	x	
The following IP addresses must not be in the range of the free IP address range (dynamic IP addresses): <ul style="list-style-type: none"> <li>• All router IP addresses in the "Routing" entry</li> <li>• Syslog server</li> <li>• Standard router</li> <li>• Security module address(es)</li> </ul>		x

Check / rule	Check made <sup>1)</sup>	
	locally	Project-wide/ module-wide
DHCP is supported by the security module on the interface to the internal subnet. The following additional requirements for IP addresses in the range of the free IP address range (dynamic IP addresses) result from operational behavior of the security module: <ul style="list-style-type: none"> <li>• Bridge mode The free IP address range must be in the network defined by the security module.</li> <li>• Routing mode The free IP address range must be in the internal subnet defined by the security module.</li> </ul>		x
The free IP address range must be fully specified by entering the start address and the end address. This end address must be higher than the start address.	x	
The IP addresses you enter in the address list in the "Static address assignment" group box must be in the address range of the internal subnet of the security module.		x

**Legend:**

<sup>1)</sup> Note the explanations in the section  
Running a consistency check (Page 530).

**IPsec tunnel: Creating and assigning groups**

**Configuring internal network nodes**

**Using the learning mode to learn internal nodes**

**Finding nodes for tunnel communication automatically**

One great advantage when configuring and operating tunnel communication is that SCALANCE S modules in bridge mode can find the nodes on the internal interface automatically. New nodes are detected by the security module during operation. The detected nodes are signaled to the security modules belonging to the same group. This allows data exchange within the tunnels of a group in both directions at any time.



## Detectable nodes

The following nodes are detected:

- Network nodes with IP capability  
Network nodes with IP capability are found when they transmit an ICMP response to the ICMP subnet broadcast.  
IP nodes downstream from routers can be found if the routers pass on ICMP broadcasts.
- ISO network nodes  
You can also teach-in network nodes without IP capability that can be addressed by means of ISO protocols.  
This is only possible if they reply to XID or TEST packets. TEST and XID (Exchange Identification) are auxiliary protocols for exchanging information on layer 2. By sending these packets with a broadcast address, these network nodes can be located.
- PROFINET nodes  
Using DCP (Discovery and basic Configuration Protocol), it is possible to find PROFINET nodes.

Network nodes that do not meet these conditions must be configured manually.

Subnets located on the other side of internal routers also need to be configured manually.

## How to access the function

1. Select the module.
2. In the local security settings, select the entry "Node".

## Enabling/disabling the learning mode

The learning function is enabled in the configuration as default for every security module.

Learning can also be disabled completely for SCALANCE S. In this case, you will need to configure all internal network nodes participating in the tunnel communication manually.

## When is it useful to disable the automatic learning mode?

The default settings for the security module assume that internal networks are always secure; in other words, in a normal situation, no network node is connected to the internal network if it is not trustworthy.

Disabling the learning mode can be useful if the internal network is static; in other words, when the number of internal nodes and their addresses do not change.

If the learning mode is disabled, this reduces the load on the medium and the nodes in the internal network resulting from the learning packets. The performance of the security module is also slightly improved since it does not need to process the learning packets.

## **8.1 Configuring devices and networks**

Note: In the learning mode, all nodes in the internal network are detected. The information relating to VPN configuration limits relates only to nodes that communicate over VPN in the internal network.

---

### **Note**

If more than 128 internal nodes are being operated, the permitted configuration limits are exceeded and an illegal operating status results. Due to the dynamics in the network traffic, this causes internal nodes that have already been learned to be replaced by new previously unknown internal nodes.

---

### **See also**

Configuring internal subnets manually (Page 611)

### **Configuring IP network nodes manually**

#### **Meaning**

As an alternative to the learning mode that you enable using the "Enable learning of internal nodes" check box and that allows the security module to learn the internal network nodes dynamically, you can enter the network nodes to be learned manually in the "Internal IP nodes" entry and in doing so enable them for VPN tunnel communication. The MAC address of a network node can be specified as an option.

#### **Requirement**

- The security module is in bridge mode.
- The security module is a member of a VPN group.

#### **How to access this function**

1. Select the module to be edited.
2. In the local security settings, select the entry "Node" > "Internal IP nodes".

### **Configuring MAC network nodes manually**

#### **Meaning**

As an alternative to the learning mode that you enable using the "Enable learning of internal nodes" check box and that allows the security module to learn the internal network nodes dynamically, you can enter the network nodes to be learned manually in the "Internal MAC nodes" entry and in doing so enable them for VPN tunnel communication.

### Requirement

- The security module is in bridge mode.
- The security module is a member of a VPN group.

### How to access this function

1. Select the module to be edited.
2. In the local security settings, select the entry "Node" > "Internal MAC nodes".

### Configuring internal subnets manually

#### Requirement

- The security module is a member of a VPN group.

#### How to access this function

1. Select the module to be edited.
2. In the local security settings, select the entry "Node" > "Internal subnets".

#### Security module in bridge mode - "Internal subnets" entry

To be able to enable internal subnets for VPN tunnel communication manually, you need to enter the following address parameters:

Parameter	Function	Example of a value
Network ID	Network ID of the subnet to be enabled for VPN tunnel communication. Based on the network ID, the router recognizes whether a destination address is inside or outside the subnet. Must not be located in the same subnet as the IP address of the security module.	192.168.11.0
Subnet mask	The subnet mask determines the network structure. Based on the network ID, the router recognizes whether a destination address is inside or outside the subnet.	255.255.255.0
Router IP address	IP address of the router via which the subnet you are allowing is reached. Must be located in the same subnet as the IP address of the security module.	192.168.10.2

### Security module in routing mode - "Subnets reachable through tunnel" entry

In routing mode, entire subnets are always tunneled. To be able to enable internal subnets for VPN tunnel communication manually, you need to enter the following address parameters:

Parameter	Function	Example of a value
Network ID	Network ID of the subnet to be enabled for VPN tunnel communication. Based on the network ID, the router recognizes whether a destination address is inside or outside the subnet. Must not be located in the same subnet as the IP address of the security module.	192.168.11.0
Subnet mask	The subnet mask determines the network structure. Based on the network ID, the router recognizes whether a destination address is inside or outside the subnet.	255.255.255.0
Comment	Entry of additional, optional comments.	

### Online functions - testing / diagnostics and logging

#### Setting the date and time - "Date and time" entry

##### How to access this function

1. Select the security module whose time and date you want to check or set.
2. Select the "Online & diagnostics" command from the shortcut menu.
3. In online diagnostics, select the "Functions" > "Date and time" entry.

#### Setting the local time on the security module

In this area, you can read out and set the time and date of the security module. When you click the "Apply" button, the security module is assigned the time and date currently entered in the "Date" and "Time" input boxes.

#### Setting the local time on PC

This area shows the current time and current date of the PC on which STEP 7 is installed. If you click the "Adopt for module" button, the security module is assigned the current time and current date of the PC.

## Download functions

### Downloading a configuration

#### This needs to be taken into consideration before downloading a configuration

- IP address used for downloading configurations  
Configurations are always downloaded to the security module using the IP address configured in the local security settings for the internal or external port. This IP address must match that of the security module.
- Ports  
You can download the configuration data to the security module both via the external and the internal interface.  
Ideally, you should configure the modules of a VPN group via the common external network of these modules (device port 1). If the configuration computer is located on an internal network, you must enable the IP addresses of the other modules of the group explicitly in the firewall of this SCALANCE S module and first load this module.

---

**Note****Selecting a network adapter**

If you are using more than one network adapter in your PC/PG, first select the network adapter via which you can reach the SCALANCE S module in the "PG/PC Interface" drop-down list of the "Extended download to device" dialog.

---

- Operating mode  
Configurations can be downloaded while the SCALANCE S devices are operating. Restart the SCALANCE S module to activate your configuration changes.

---

**Note****Special characteristics**

- As long as a module has not yet set IP parameters (in other words, prior to the first configuration), there must be no router between the module and the configuration computer.
  - If you swap a PC from the internal to the external interface of the SCALANCE S, access from this PC to the SCALANCE S is blocked for approximately 20 minutes.
- 

## Transferring firmware

#### This needs to be taken into consideration before transferring new firmware

To transfer new firmware to a security module, the following conditions must be met:

- You have the rights required to transfer firmware; refer to section Auto-Hotspot.
- The security module is configured with an IP address.

### **The transfer is secure**

The firmware is transferred over a secure connection and can therefore also be transferred from the unprotected network.

The firmware itself is signed and encrypted. This ensures that only authentic firmware can be downloaded to the SCALANCE S module.

### **The transfer can take place during operation**

The firmware can be transferred while a SCALANCE S module is in operation. Newly downloaded firmware only becomes active after the SCALANCE S module has been restarted. If the transfer is disturbed and aborted, the module starts up again with the old firmware version.

## **Security for S7-300 /S7-400 / PC CPs**

### **Setting up a firewall**

#### **Local firewall rules for S7-300 /S7-400 / PC CPs**

#### **Overview S7-300 CPs / S7-400 CPs /PC CPs**

### **Enabling packet filter rules**

If you enable the security function for the CPs in the local security settings, initially all access to and via the CP is permitted. To enable individual packet filter rules, select the "Activate firewall" check box. Then enable the required services. Firewall rules created automatically due to a connection configuration have priority over rules set manually.

---

#### **Note**

##### **Detailed firewall settings in advanced firewall mode**

In advanced firewall mode, you can restrict firewall rules to individual nodes. To change to advanced firewall mode, select the "Activate firewall in advanced mode" check box.

---

### **Firewall configuration with VPN**

If the security module is added to a VPN group, the firewall is enabled by default. In addition, the "Tunnel communication only" check box is enabled. This means that only encrypted IPsec data transfer is permitted via the external interface. External data traffic is blocked.

If you deselect the check box, tunneled communication and also the types of communication selected in the other boxes are permitted.

## Updating connection rules

Changes to the connection configuration of CPs also change the connection-related firewall rules. To display the modified firewall rules, click the "Update connection rules" button. The modified firewall rules are then displayed in advanced firewall mode.

## Configuring a firewall with predefined firewall rules - CP x43-1 Advanced

## Configuring a firewall with predefined IP rules - CP x43-1 Advanced

### How to access this function

1. Select the module to be edited.
2. In the local security settings, select the entry "Firewall" > "Predefined IP rules".

Table 8-34 Available services and directions

Service	From station/ internal to external	External to internal	From external to station	Enabled ports	Meaning
Allow IP communication	x	x	x	All	IP traffic for the selected communication directions is allowed.
Allow S7 protocol	x	x	x	TCP port 102	Communication of the nodes using the S7 protocol is allowed.
Allow FTP/FTPS (explicit mode)	x	x	x	TCP port 20 TCP port 21	For file management and file access between server and client.
Allow HTTP	x	x	x	TCP port 80	For communication with a Web server.
Allow HTTPS	x	x	x	TCP port 443	For secure communication with a Web server, for example, for Web diagnostics.
Allow DNS	x	x	-	TCP port 53 UDP port 53	Communication connection to a DNS server is allowed.
Allow SNMP	x	x	x	TCP port 161/162 UDP port 161/162	For monitoring nodes capable of SNMP.
Allow SMTP	x	x	-	TCP port 25	For sending e-mails via an SMTP server.
Allow NTP	x	x	-	UDP port 123	For synchronization of the time of day.

Table 8-35 Logging

Option	Action when activated	Relevant firewall rule		
		Action	From	To
<b>IP log settings</b>				
Log tunneled packets	Only active if the security module is a member of a VPN group. All IP packets transferred via the tunnel are logged.	Allow	Station	Tunnel
		Allow	Tunnel	Station
Log blocked incoming packets	All incoming IP packets that are discarded are logged.	Drop	External	Station

**Note**

**Relationship between log settings in default mode and firewall rules**

Log settings that are made in "Predefined IP rules" and "Predefined MAC rules" have no effect on firewall rules that were automatically created as a result of configuring a connection. This means, for example, that tunneled frames belonging to a configured connection cannot be logged. In advanced firewall mode, logging can be extended to the automatically generated firewall rules of connections.

**Configuring a firewall with predefined MAC rules - CP x43-1 Advanced**

**How to access this function**

1. Select the module to be edited.
2. Select the entry "Firewall" > "Predefined MAC rules".

Table 8-36 Available services and directions

Service	From station to external	From external to station	Meaning
Allow MAC communication	x	x	The MAC traffic from station to external and vice versa is allowed.
Allow ISO protocol	x	x	The ISO traffic from station to external and vice versa is allowed.

Table 8-37 Logging

Option	Action when activated	Relevant firewall rule		
		Action	From	To
<b>MAC log settings</b>				
Log tunneled packets	Only active if the security module is a member of a VPN group. All MAC packets transferred via the tunnel are logged.	Allow	Station	Tunnel
		Allow	Tunnel	Station



Option	Action when activated	Relevant firewall rule		
MAC log settings		Action	From	To
Log blocked incoming packets	All incoming MAC packets that are discarded are logged.	Drop	External	Station
Log blocked outgoing packets	All outgoing MAC packets that are discarded are logged.	Drop	Station	External

**Note**

**Relationship between log settings in default mode and firewall rules**

Log settings that are made in "Predefined IP rules" and "Predefined MAC rules" have no effect on firewall rules that were automatically created as a result of configuring a connection. This means, for example, that tunneled frames belonging to a configured connection cannot be logged. In advanced firewall mode, logging can be extended to the automatically generated firewall rules of connections.

**Configuring a firewall with predefined firewall rules - CP 1628**

**Configuring a firewall with predefined IP rules - CP 1628**

**How to access this function**

1. Select the module to be edited.
2. Select the "Security" > "Firewall" > "Predefined IP rules" entry.

Table 8-38 Available services and directions

Service	From external to station	Enabled ports	Meaning
Allow IP communication	x	All	IP traffic from external to station is allowed.
Allow S7 protocol	x	TCP port 102	Communication of the nodes using the S7 protocol is allowed.
Allow FTP/FTPS (explicit mode)	x	TCP port 20 TCP port 21	For file management and file access between server and client.
Allow HTTP	x	TCP port 80	For communication with a Web server.
Allow HTTPS	x	TCP port 443	For secure communication with a Web server, for example, for Web diagnostics.
Allow DNS	x	TCP port 53 UDP port 53	Communication connection to a DNS server is allowed.

Service	From external to station	Enabled ports	Meaning
Allow SNMP	x	TCP port 161/162 UDP port 161/162	For monitoring nodes capable of SNMP.
Allow SMTP	x	TCP port 25	For sending e-mails via an SMTP server.
Allow NTP	x	UDP port 123	For synchronization of the time of day.

Table 8-39 Logging

Option	Action when activated	Relevant firewall rule		
		Action	From	To
<b>IP log settings</b>				
Log tunneled packets	Only active if the security module is a member of a VPN group. All IP packets transferred via the tunnel are logged.	Allow	Station	Tunnel
		Allow	Tunnel	Station
Log blocked incoming packets	All incoming IP packets that are discarded are logged.	Drop	External	Station

**Note**

**Relationship between log settings in default mode and firewall rules**

Log settings that are made in "Predefined IP rules" and "Predefined MAC rules" have no effect on firewall rules that were automatically created as a result of configuring a connection. This means, for example, that tunneled frames belonging to a configured connection cannot be logged. In advanced firewall mode, logging can be extended to the automatically generated firewall rules of connections.

**Configuring a firewall with predefined MAC rules - CP 1628**

**How to access this function**

1. Select the module to be edited.
2. Select the entry "Security" > "Firewall" > "MAC rules".

Table 8-40 Available services and directions

Service	From station to external	From external to station	Meaning
Allow MAC level communication	x	x	The MAC traffic from external to the station and vice versa is allowed.
Allow ISO communication	x	x	ISO traffic from external to the station and vice versa is allowed.
Allow SiClock	x	x	SiClock time-of-day frames from external to the station and vice versa are allowed.

Table 8-41 Logging

Option	Action when activated	Relevant firewall rule		
MAC log settings		Action	From	To
Log tunneled packets	Only active if the security module is a member of a VPN group. All MAC packets transferred via the tunnel are logged.	Allow	Station	Tunnel
		Allow	Tunnel	Station
Log blocked incoming packets	All incoming MAC packets that are discarded are logged.	Drop	External	Station
Log blocked outgoing packets	All outgoing MAC packets that are discarded are logged.	Drop	Station	External

**Note**

**Relationship between log settings in default mode and firewall rules**

Log settings that are made in "Predefined IP rules" and "Predefined MAC rules" have no effect on firewall rules that were automatically created as a result of configuring a connection. This means, for example, that tunneled frames belonging to a configured connection cannot be logged. In advanced firewall mode, logging can be extended to the automatically generated firewall rules of connections.

**IP packet filter directions S7-300-/S7-400-/PC-CPs**

**Meaning**

Possible selections for the communication directions "From" and "To" in the IP rules of the advanced firewall mode.

**The following directions are available**

Available options / ranges of values		Security module		Meaning
From	To	CP x43-1 Adv.	CP 1628	
Internal	Station	x	-	Access from the internal network to the station.
	Any	x	-	Access from internal to the external network, VPN tunnel partner and the station.
External	Station	x	x	Access from the external network to the station.
	Any	x	-	Access from external to the internal network and the station.
Station	Internal	x	-	Access from the station to the internal network.
	External	x	x	Access from the station to the external network.
	Tunnel	x	x	Access from the station to the VPN tunnel partner.
Tunnel	Station	x	x	Access via the VPN tunnel partner to the station.

8.1 Configuring devices and networks

Available options / ranges of values		Security module		Meaning
	Any	x	-	Access from VPN tunnel partners to the internal network and the station.
Any	External	x	-	Access from the internal network and the station to the external network.

MAC packet filter directions S7-300-/S7-400-/PC-CPs

Context

Possible selections for the communication directions "From" and "To" in the MAC rules of the advanced firewall mode.

The following directions are available

Available options / ranges of values		Security module		Meaning
From	To	CP x43-1 Adv.	CP 1628	
External	Station	x	x	Access from the external network to the station.
Station	External	x	x	Access from the station to the external network.
	Tunnel	x	x	Access from the station to the VPN tunnel partner.
Tunnel	Station	x	x	Access via the VPN tunnel partner to the station.

Configuring the access list

Module-specific function

This function is not available for the CP 1628.

## Meaning

You set access protection for certain IP addresses using the IP access lists. List entries that have already been created and the corresponding rights are displayed in the local settings of the CP in the entry "Firewall" > "IP rules" (advanced firewall mode).

---

### Note

#### Changed behavior after activation of security

- Once you have activated the security function for a CP, access protection will only apply to the external interface. You can apply access protection to the internal interface as well, by configuring suitable firewall rules in advanced firewall mode.
  - The CP also responds to ARP requests from IP addresses that have not been released (layer 2).
  - If the IP access list of a CP contains no entries and you activate security for the CP, the firewall will be activated and prevent access to the CP from external locations. Configure the corresponding firewall rules in advanced firewall mode so that the CP can be reached.
- 

## Effect of IP access list entries at activation of security

If security is enabled in the local settings of a CP, the corresponding rules are created in the advanced firewall mode. A firewall rule "Allow" > "External" > "Station" is created for an IP address you specified in the address list. The IP address from the IP access list is used accordingly as source IP address. IP addresses from a defined IP address range are also integrated into corresponding firewall rules.

## Requirements for editing

Before you can edit created firewall rules, the following condition must be met:

- for editing using STEP 7: "Configure security" configuration right
- for editing using a Web server: Module right "Web: Expand IP access control list"

The requirements for editing the IP access lists outside the local security settings are described in the sections on the specific CPs.

## Connection-related automatic firewall rules

### Meaning

For connections that were configured using CPs, STEP 7 automatically creates firewall rules that allow communication with the partner of the CP in the specified direction (CP active/passive). The connection establishment directions are taken into account. To display these

firewall rules, if the advanced firewall mode is enabled, the "Update connection rules" button needs to be clicked. The firewall rules are then displayed in advanced firewall mode.

**Note**

**Enabling UDP multicast and UDP broadcast connections manually**

No automatic firewall rules are created for UDP multicast and UDP broadcast connections. To enable the connections, add the relevant firewall rules manually in advanced firewall mode.

Depending on how the connection establishment is configured, the following level 3 firewall rules are created. If the security module is in a VPN group, the direction "External" changes to "Tunnel". This applies only to CPs that support VPN.

The IP address of the connection partner is entered in the "Source IP address" or "Destination IP address" column of these firewall rules.

CP->external	Action	From	To
active	Allow	Station	External
	Drop	External	Station
passive	Drop	Station	External
	Allow	External	Station
active and passive	Allow	External	Station
	Allow	Station	External

CP->internal	Action	From	To
active	Allow	Station	Internal
	Drop	Internal	Station
passive	Drop	Station	Internal
	Allow	Internal	Station
active and passive	Allow	Internal	Station
	Allow	Station	Internal

For level 2 connections, "Allow" rules are created for both directions. If the security module is in a VPN group, the direction "External" changes to "Tunnel". This applies only to CPs that support VPN.

The MAC address of the connection partner is entered in the "Source MAC address" or "Destination MAC address" column of these firewall rules.

CP->external	Action	From	To
active, passive, active and passive	Allow	Station	External
	Allow	External	Station

**Note****Changing the connection configuration**

Changes to the connection configuration of CPs also change the connection-related firewall rules. To display the modified firewall rules, click the "Update connection rules" button.

---

**Conventions for automatically created firewall rules**

- **Priority**  
The rules have highest priority and are therefore inserted at the top in the local rule list.
- **Deleting rules**  
The rules cannot be deleted. Logging can be enabled and services can be assigned. Moreover, you may insert a bandwidth and a comment.
- **Changing the action**  
If you set the action from "Allow" to "Drop" or vice versa, this is overwritten again during renewed system synchronization. Select "Allow\*" or "Drop\*" to retain your changes. In this case, only the IP address is synchronized and the action and direction remain as set. Settings for logging, service, bandwidth and comment are also retained after a renewed system synchronization even without changing the action to "Allow\*" or "Drop\*". If the configured connection is deleted, the corresponding rules are removed from the list.

**Security module in VPN group**

As default, the "Tunnel communication only" check box is enabled. If you deselect the check box, in addition to tunnel communication between tunnel partners, communication is also possible with network nodes to which there is no tunnel.

- Communication is untunneled if the partner address belongs to a station known in STEP 7 for which no VPN tunnel is configured.
- Communication is through the tunnel if the partner address is a VPN endpoint.
- If it is not clear whether connection should bypass or run through the VPN tunnel, the connection is assigned to the VPN tunnel and a message to this effect is displayed. The assignment can be adapted in advanced firewall mode, for example, by changing the "From" direction "Tunnel" to "External". To avoid this adaptation being overwritten by the next system synchronization, the "Allow\*" or "Drop\*" action must be selected.

---

**Note**

If you want to ensure that only communication through the tunnel is possible, you will need to create suitable firewall rules in advanced firewall mode, for example, for internal nodes or NDIS addresses.

To allow only tunneled communication for a CP, add a "Drop" > "Any" > "External" rule. For the CP 1628, add a "Drop" > "Station" > "External" rule. In addition to this, you need to remove existing firewall rules that allow untunneled communication.

---

## **Configuring SNMP**

### **Overview of SNMP**

#### **What is SNMP?**

The security module supports the transfer of management information using the Simple Network Management Protocol (SNMP). For this purpose, an SNMP agent that receives and responds to SNMP requests is installed on the security module. The information on the properties of SNMPcompliant devices is entered in MIB files (MIB = Management Information Base) for which the user must have the required rights.

In SNMPv1, the "community string" is also sent. The "community string" is like a password that is transmitted along with the SNMP request. If the community string is correct, the security module replies with the required information. If the string is incorrect, the security module discards the query and does not reply. The community string is transmitted via SNMPv1 without encryption.

SNMPv3 lets you transmit encrypted data.

### **Configuring SNMP - "SNMP" entry**

#### **How to access this function**

1. Select the module to be edited.
2. In the local security settings, select the entry "SNMP".
3. Activate the "Activate SNMP" check box.



4. Select one of the following SNMP protocol versions:

---

**Note**

**Encrypted data transmission with SNMPv3**

You should use SNMPv3 to transmit data in encrypted form in order to enhance security.

---

- SNMPv1  
The security module uses the following default values for the community strings to control the access rights in the SNMP agent:  
For read access: public  
For read and write access: private  
To enable write access using SNMP, select the "Allow write access" option.
  - SNMPv3  
Select either only an authentication algorithm or an authentication algorithm and an encryption algorithm.  
Authentication algorithm: none, MD5, SHA-1  
Encryption algorithm: none, AES-128, DES
- 

**Note**

**Preventing the use of DES**

DES is an insecure encryption algorithm. Therefore, it should only be used for reasons of down compatibility.

---

5. If SNMPv3 is to be used, assign a user a role with corresponding activated SNMP rights to enable access to the module via SNMP. An overview of SNMP rights is available in the section  
Managing rights (Page 538).

## Activating the Web server on CP x43-1 Advanced

### Module-specific function

This function is only available for CP x43-1.

### Meaning

After activating the Web server, you have access to the Web pages of the module. In the local security settings, you can restrict access to these Web pages using the HTTPS protocol. This access is controlled using the "Allow access only using HTTPS" check box. In addition, you must configure the firewall accordingly.

## **IPsec tunnel: Creating and assigning groups**

### **Configuring internal network nodes - "Nodes" entry**

#### **Allow access to S7-300 / S7-400 CPs for VPN connection partners**

##### **Possible selections**

Decide whether or not the VPN connection partner can have access to the CP and/or the internal subnet of the CP in routing mode (SCALANCE S / M).

##### **How to access this function**

1. Select the module to be edited.
2. In the local security settings, select the entry "Node".
3. Configure access for the VPN connection partner of the CP in routing mode (SCALANCE S / M):
  - Allow connection to the CP (Gbit interface)
  - Allow connection to the internal subnet (PROFINET subnet)

#### **Configuring NDIS nodes manually for PC CPs that can be reached through the tunnel**

##### **Configuring NDIS nodes that can be reached through the tunnel**

The internal nodes are learned and assigned to the routes dynamically. This concerns the NDIS IP addresses of the Windows PC.

##### **Follow the steps below**

1. Select the module to be edited.
2. In the local security settings, select the entry "Nodes" > "NDIS nodes reachable via tunnel".
3. Enter the NDIS IP addresses.

#### **Online functions - Debug / Diagnostics and Logging**

##### **Updated firewall rules - "Dynamically updated firewall rules" entry**

##### **Meaning**

Display of the IP addresses or IP address ranges that were enabled dynamically using HTTP or HTTPS, or loaded by a user. The rights assigned for accessing the S7 CP are displayed for

the enabled IP addresses. An update of the IP addresses in this tab can only be triggered by the following events:

- Extension/modification of the IP access control list
- Update of firewall rules
- Dynamic extensions transmitted to the CP at runtime, for example, PROFINET IO devices

Since only the dynamically updated firewall rules are displayed here, you also need to take into account the firewall rules that were configured offline and downloaded to the station for a full picture of the current firewall status of the module.

## Security for S7-1500 CPs

### Setting up a firewall

#### Local firewall rules for S7-1500 CPs

#### Overview of local firewall rules for S7-1500 CPs

#### Enabling packet filter rules

If you enable the security function for the CPs in the local security settings, initially all access to and via the CP is permitted. To enable individual packet filter rules, select the "Activate firewall" check box. Then enable the required services. Firewall rules created automatically due to a connection configuration have priority over rules set manually.

---

#### Note

##### Detailed firewall settings in advanced firewall mode

In advanced firewall mode, you can restrict firewall rules to individual nodes. To change to advanced firewall mode, select the "Activate firewall in advanced mode" check box.

---

#### Updating connection rules

Changes to the connection configuration of CPs also change the connection-related firewall rules. To display the modified firewall rules, click the "Update connection rules" button. The modified firewall rules are then displayed in advanced firewall mode.

**Configuring a firewall with predefined firewall rules - CP 1543-1**

**Configuring a firewall with predefined IP rules - CP 1543-1**

**How to access this function**

1. Select the module to be edited.
2. In the local security settings, select the entry "Firewall" > "Predefined IP rules".

Table 8-42 Available services and directions

Service	From external to station	Enabled ports	Meaning
Allow IP communication	x	All	IP traffic from external to station is allowed.
Allow S7 protocol	x	TCP port 102	Communication of the nodes using the S7 protocol is allowed.
Allow FTP/FTPS (explicit mode)	x	TCP port 20 TCP port 21	For file management and file access between server and client.
Allow HTTP	x	TCP port 80	For communication with a Web server.
Allow HTTPS	x	TCP port 443	For secure communication with a Web server, for example, for Web diagnostics.
Allow SNMP	x	TCP port 161/162 UDP port 161/162	For monitoring nodes capable of SNMP.
Allow security diagnostics	x	TCP port 8448	Allow/do not allow security diagnostics.

Table 8-43 Logging

Option	Action when activated	Relevant firewall rule		
		Action	From	To
<b>IP log settings</b>				
Log tunneled packets	Only active if the security module is a member of a VPN group. All IP packets transferred via the tunnel are logged.	Allow	Station	Tunnel
		Allow	Tunnel	Station
Log blocked incoming packets	All incoming IP packets that are discarded are logged.	Drop	External	Station

**Note**

**Relationship between log settings in default mode and firewall rules**

Log settings that are made in "Predefined IP rules" and "Predefined MAC rules" have no effect on firewall rules that were automatically created as a result of configuring a connection. This means, for example, that tunneled frames belonging to a configured connection cannot be logged. In advanced firewall mode, logging can be extended to the automatically generated firewall rules of connections.

## Configure firewall with pre-defined IPv6 rules - CP1543-1

### Meaning

With the predefined IPv6 rules, you have the option of configuring the firewall for services in which IPv6 is used. By enabling a predefined IPv6 rule in the local security settings of the CP 1543-1 V1.1, the system-defined ICMPv6 services that can be seen in the global security settings in the "ICMP" tab in "Firewall" > "Services" > "Define services for IP rules" are also enabled in the firewall. The firewall of the CP 1543-1 V1.0 allows ICMPv6 packets through even without enabling a predefined IPv6 rule.

### How to access this function

1. Select the module to be edited.
2. Select the "Firewall" > "Pre-defined IPv6 rules" item in the local security settings.

Table 8-44 Available services and directions

Service	From external to station	Enabled ports	Meaning
Allow IP traffic	x	All	IP traffic from external to station is allowed.
Allow S7 protocol	x	TCP port 102	Communication of the nodes using the S7 protocol is allowed.
Allow FTP/FTPS (explicit mode)	x	TCP port 20 TCP port 21	For file management and file access between server and client.
Allow HTTP	x	TCP port 80	For communication with a Web server.
Allow HTTPS	x	TCP port 443	For secure communication with a Web server, for example, for Web diagnostics.
Allow SNMP	x	TCP port 161/162 UDP port 161/162	For monitoring nodes capable of SNMP.
Allow security diagnostics	x	TCP port 8448	Allow/do not allow security diagnostics via IPv6.

Table 8-45 Logging

Option	Action when activated	Relevant firewall rule		
		Action	From	To
IP log settings				
Log tunneled packets	Only active if the security module is a member of a VPN group. All IP packets transferred via the tunnel are logged.	Allow	Station	Tunnel
		Allow	Tunnel	Station
Log blocked incoming packets	All incoming IP packets that are discarded are logged.	Drop	External	Station

**Note**

**Relationship between log settings in default mode and firewall rules**

Log settings made in "Predefined IPv6 rules" have no effect on firewall rules that were automatically generated as a result of configuring a connection. This means, for example, that tunneled frames belonging to a configured connection cannot be logged. In advanced firewall mode, logging can be extended to the automatically generated firewall rules of connections.

**Configuring a firewall with predefined MAC rules - CP 1543-1**

**How to access this function**

1. Select the module to be edited.
2. Select the entry "Firewall" > "Predefined MAC rules".

Table 8-46 Available services and directions

Service	From station to external	From external to station	Enabled ports	Meaning
Allow MAC communication	x	x	-	The MAC traffic from external to the station and vice versa is allowed.
Allow ISO protocol	x	x	-	ISO traffic from external to the station and vice versa is allowed.
Allow SiCLOCK	x	x	-	SiCLOCK traffic from external to the station and vice versa is allowed.

Table 8-47 Logging

Option	Action when activated	Relevant firewall rule		
		Action	From	To
MAC log settings				
Log blocked incoming packets	All incoming MAC packets that are discarded are logged.	Drop	External	Station
Log blocked outgoing packets	All outgoing MAC packets that are discarded are logged.	Drop	Station	External

**Note**

**Relationship between log settings in default mode and firewall rules**

Log settings that are made in "Predefined IP rules" and "Predefined MAC rules" have no effect on firewall rules that were automatically created as a result of configuring a connection. This means, for example, that tunneled frames belonging to a configured connection cannot be logged. In advanced firewall mode, logging can be extended to the automatically generated firewall rules of connections.

**IP packet filter directions - CP 1543-1**

**Meaning**

Possible selections for the communication directions "From" and "To" in the IP rules of the advanced firewall mode.

**The following directions are available**

Available options / ranges of values		Meaning
From	To	
External	Station	Access from the external network to the station.
Station	External	Access from the station to the external network.
	Tunnel	Access from the station to VPN tunnel partners.*
Tunnel	Station	Access by VPN tunnel partners to the station.*

\* Only for the CP 1543-1 V1.1.

**MAC packet filter directions CP 1543-1**

**Meaning**

Possible selections for the communication directions "From" and "To" in the MAC rules of the advanced firewall mode.

**The following directions are available**

Available options / ranges of values		Meaning
From	To	
External	Station	Access from the external network to the station.
Station	External	Access from the station to the external network.
	Tunnel	Access from the station to VPN tunnel partners.*
Tunnel	Station	Access by VPN tunnel partners to the station.*

\* Only for the CP 1543-1 V1.1.

### Connection-related automatic firewall rules

#### Meaning

For connections that were configured using CPs, STEP 7 automatically creates firewall rules that allow communication with the partner of the CP in the specified direction (CP active/passive). The connection establishment directions are taken into account. To display these firewall rules, if the advanced firewall mode is enabled, the "Update connection rules" button needs to be clicked. The firewall rules are then displayed in advanced firewall mode.

---

#### Note

##### Enabling UDP multicast and UDP broadcast connections manually

No automatic firewall rules are created for UDP multicast and UDP broadcast connections. To enable the connections, add the relevant firewall rules manually in advanced firewall mode.

---

Depending on how the connection establishment is configured, the following level 3 firewall rules are created. If the CP 1543-1 V1.1 is in a VPN group, the direction "External" changes to "Tunnel".

The IP address of the connection partner is entered in the "Source IP address" or "Destination IP address" column of these firewall rules.

CP->external	Action	From	To
active	Drop	External	Station
	Allow	Station	External
passive	Drop	Station	External
	Allow	External	Station
active and passive	Allow	External	Station
	Allow	Station	External

For level 2 connections, "Allow" rules are created for both directions. If the CP 1543-1 V1.1 is in a VPN group, the direction "External" changes to "Tunnel".

The MAC address of the connection partner is entered in the "Source MAC address" or "Destination MAC address" column of these firewall rules.

CP->external	Action	From	To
active, passive, active and passive	Allow	Station	External
	Allow	External	Station



---

**Note**

**Changing the connection configuration**

Changes to the connection configuration of CPs also change the connection-related firewall rules. To display the modified firewall rules, click the "Update connection rules" button.

---

**Conventions for automatically created firewall rules**

- **Priority**  
The rules have highest priority and are therefore inserted at the top in the local rule list.
- **Deleting rules**  
The rules cannot be deleted. Logging can be enabled and services can be assigned. Moreover, you may insert a bandwidth and a comment.
- **Changing the action**  
If you set the action from "Allow" to "Drop" or vice versa, this is overwritten again during renewed system synchronization. Select "Allow\*" or "Drop\*" to retain your changes. In this case, only the IP address is synchronized and the action and direction remain as set. Settings for logging, service, bandwidth and comment are also retained after a renewed system synchronization even without changing the action to "Allow\*" or "Drop\*". If the configured connection is deleted, the corresponding rules are removed from the list.

**Security module in VPN group**

As default, the "Tunnel communication only" check box is enabled. If you deselect the check box, in addition to tunnel communication between tunnel partners, communication is also possible with devices to which there is no tunnel.

- Communication is untunneled if the partner address belongs to a station known in STEP 7 for which no VPN tunnel is configured.
- Communication is through the tunnel if the partner address is a VPN endpoint.
- If it is not clear whether connection should bypass or run through the VPN tunnel, the connection is assigned to the VPN tunnel and a message to this effect is displayed. The assignment can be adapted in advanced firewall mode, for example, by changing the "From" direction "Tunnel" to "External". To avoid this adaptation being overwritten by the next system synchronization, the "Allow\*" or "Drop\*" action must be selected.

---

**Note**

If you want to ensure that only communication through the tunnel is possible, you will need to create suitable firewall rules in advanced firewall mode.

To allow only tunneled communication for a CP, add a "Drop" > "Any" > "External" rule. In addition to this, you need to remove existing firewall rules that allow untunneled communication.

---

## **Configuring SNMP**

### **Overview of SNMP**

#### **What is SNMP?**

The security module supports the transfer of management information using the Simple Network Management Protocol (SNMP). For this purpose, an SNMP agent that receives and responds to SNMP requests is installed on the security module. The information on the properties of SNMPcompliant devices is entered in MIB files (MIB = Management Information Base) for which the user must have the required rights.

In SNMPv1, the "community string" is also sent. The "community string" is like a password that is transmitted along with the SNMP request. If the community string is correct, the security module replies with the required information. If the string is incorrect, the security module discards the query and does not reply. The community string is transmitted via SNMPv1 without encryption.

SNMPv3 lets you transmit encrypted data.

### **Configuring SNMP - "SNMP" entry**

#### **How to access this function**

1. Select the module to be edited.
2. In the local security settings, select the entry "SNMP".
3. Activate the "Activate SNMP" check box.

4. Select one of the following SNMP protocol versions:

---

**Note**

**Encrypted data transmission with SNMPv3**

You should use SNMPv3 to transmit data in encrypted form in order to enhance security.

---

- SNMPv1  
The security module uses the following default values for the community strings to control the access rights in the SNMP agent:  
For read access: public  
For read and write access: private  
To enable write access using SNMP, select the "Allow write access" option.
  - SNMPv3  
Select either only an authentication algorithm or an authentication algorithm and an encryption algorithm.  
Authentication algorithm: none, MD5, SHA-1  
Encryption algorithm: none, AES-128, DES
- 

**Note**

**Preventing the use of DES**

DES is an insecure encryption algorithm. Therefore, it should only be used for reasons of down compatibility.

---

5. If SNMPv3 is to be used, assign a user a role with corresponding activated SNMP rights to enable access to the module via SNMP. An overview of SNMP rights is available in the section  
Managing rights (Page 538).

## 8.1.4 Creating configurations

### 8.1.4.1 Information about the web server

#### Introduction

The web server allows you to monitor the CPU via the Internet or the intranet of your company. This permits evaluation and diagnostics over long distances.

Alarms and status information are visualized on HTML pages.

#### Web browser

You need a web browser to access the HTML pages of the CPU.

The following web browsers, for example, are suitable for communication with the CPU:

## 8.1 Configuring devices and networks

- Internet Explorer (version 6.0 and higher)
- Mozilla Firefox (V1.5 and higher)
- Opera (version 9.0 and higher)

### Web access to the CPU via PG/PC

Proceed as follows to access the web server:

1. Connect the client (PG/PC) to the CPU via the PROFINET interface.
2. Open the web browser.  
Enter the IP address of the CPU in the "Address" field of the web browser in the format `http://ww.xx.yy.zz` (example: `http://192.168.3.141`).  
The start page of the CPU opens. From the start page, you can navigate to further information.

### Additional information

Additional information about the web server of the various CPU families is available under the key word "Web server" in the information system.

Information on creating your own web pages for access to the CPU is available under the keyword "User-defined web pages" in the information system.

## 8.1.4.2 Things you should know about PROFIBUS DP operating modes

### Introduction

DP master systems that consist of a DP master and DP slaves which are connected via a bus and communicate with one another via the PROFIBUS DP protocol are referred to as distributed I/O.

Below, we refer to communication-capable modules with DP interface that can take on the role of DP master or DP slave.

### "DP master" and "DP slave" option

Communication-capable modules, such as CPUs with DP interface and CPs or CMs with DP interface, have the area "Mode" in their module properties.

For S7-300 CPUs with integrated DP interface, for example, you can set the mode "DP master" and "DP slave". A CPU or a CP that is configured as DP slave is also referred to as intelligent DP slave (I-slave).

For S7-1500 CPUs with integrated DP interface, only the "DP master" mode is possible. To operate S7-1500 CPUs as I-slave, you have to insert the communication module CM 1542-5 and configure it as DP slave.

S7-1200 CPUs do not have integrated DP interfaces. To operate an S7-1200 as DP master or DP slave, you must insert a communication module CM 1243-5 (DP master only) or a communication module CM 1242-5 (DP slave only; I-slave).

## **Additional information**

Additional information on distributed I/O is available under the key word "Distributed I/O" and "I-slave" in the information system.

### **8.1.4.3 Configuring automation systems**

#### **Addressing modules**

#### **Addressing modules**

#### **Introduction**

In the device overview, you see the addresses or address ranges of the modules in the I address and Q address columns. There are other addresses as well, which are explained below.

#### **I/O address**

I/O addresses (input/output addresses) are required to read inputs and set outputs in the user program.

Input and output addresses are assigned automatically when modules are inserted in the rack. The address of the first channel is the start address of a module. The addresses of the other channels are derived from this start address. The address end is obtained from the module-specific address length.

#### **Device address (e.g., Ethernet address)**

Device addresses are addresses of programmable modules (Industrial Ethernet addresses). They are required to address the different stations of a subnet, for example, to download a user program to a CPU.

#### **Hardware identifier for identifying modules and submodules**

In addition to the I addresses and Q addresses, a hardware identifier (HW ID) is assigned automatically and is used to address and identify the module. Submodules (units of a module), such as an integrated counter, also receive such a hardware identifier.

The hardware identifier consists of an integer and is output by the system with diagnostics alarms to allow the faulty module or the faulty submodule to be localized.

In addition, the hardware identifier is used for a number of instructions to address the corresponding module.

The hardware identifier cannot be changed.

Example: Identifying high-speed counters of the S7-1200 CPU

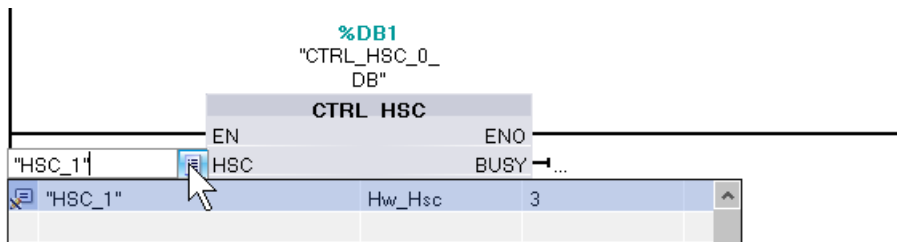

The hardware identifier is assigned automatically when components are inserted in the device or network view and in the PLC tags. A name is also assigned automatically for the hardware identifier. The system constants of the PLC tags cannot be changed either.

### See also

Specifying input and output addresses (Page 638)

Assigning addresses to a location in the program (Page 639)

Introduction to loading a configuration (Page 826)

### Specifying input and output addresses

Default input and output addresses are set automatically. You can, however, change the address assignment later.

All addresses of modules are located in the process image area. The process image is automatically updated cyclically.

### Requirement

You are in the device view.

### Procedure

To change the preset address range proceed as follows:

1. In the device view, click on the module for which you want to set the start address.
2. Go to "I/O addresses" in "Properties" in the inspector window.
3. Under "Start address" enter the required start address.
4. Press <Return> or click on any object to accept a modified value.

If you have entered an invalid address, a message indicating the next available address is displayed.

---

#### Note

You can also change the addresses directly in the device overview.

---

## **See also**

Editing properties and parameters (Page 428)

Input and output addresses in the address overview (Page 430)

## **Assigning addresses to a location in the program**

You can assign addresses of the I/O channels of modules directly to the points of use in the program or to a tag table.

## **Requirement**

- The device view of the hardware and network editor is open.
- The zoom level in the device view must be set to at least 200% to allow you to see the individual I/O channels.
- The instruction window of the programming editor or a tag table is open.

Procedure

To assign I/O channels of modules to the points of use in the program or to a tag table, follow these steps:

1. In the device view, navigate to the module with the desired I/O channel.
2. Click and hold down the mouse button to drag the desired I/O address to the corresponding point of use of the block or to the tag table.

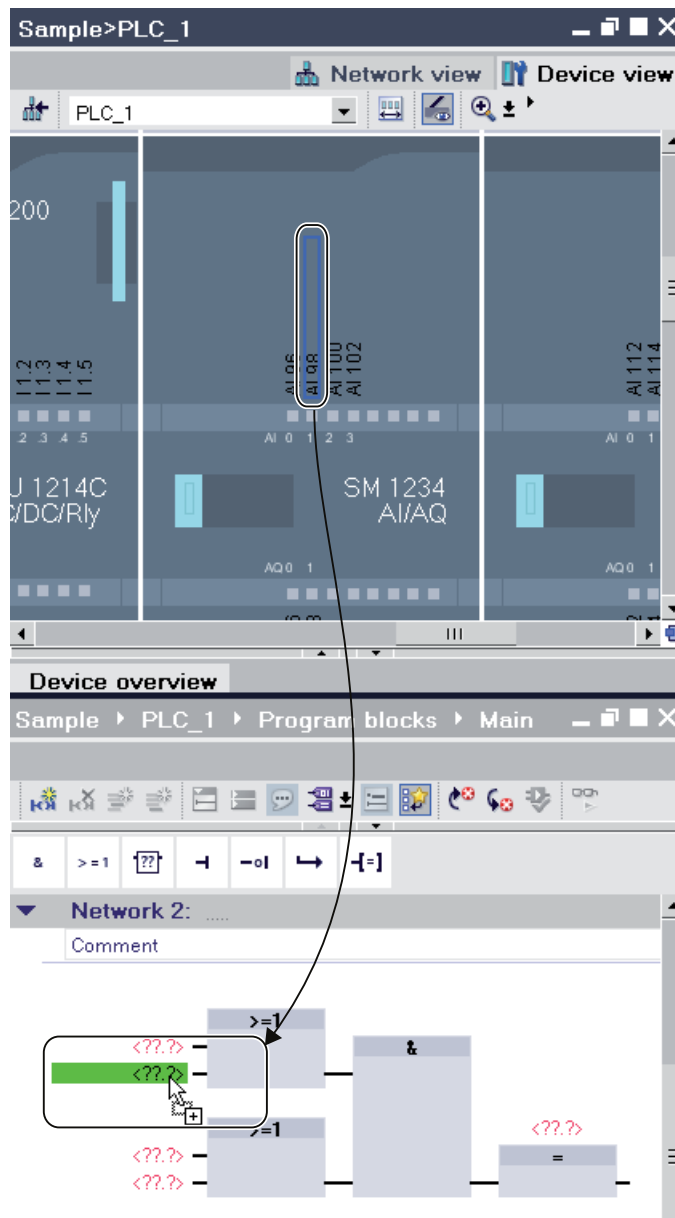



The address of the module is assigned to the point of use in the program or entered as a tag in the tag table.

---

**Note**

The tag for an input or output of a block can also be dragged to the input or output of a module in order to link the tag to the I/O channel of the module.

---

## Signal board

### Inserting a signal board in a CPU

#### Introduction

Signal boards allow you to increase the number of the S7-1200 CPU's own inputs and outputs. Just like all other hardware components, you will find signal boards in the hardware catalog. However, you do not insert signal boards in the rack like other modules but directly in a slot of the CPU itself.

Note the following points when using a signal board:

- Each CPU can have only one signal board inserted in it.
- A signal board can only be inserted when the slot in the CPU is free.

There are various ways of inserting a signal board in a CPU:

- Double click on a signal board in the hardware catalog when there is a free slot in the CPU
- Drag from the hardware catalog to a free slot in the CPU
- Shortcut menu of a signal board in the hardware catalog for copying and pasting

#### Requirement

- The hardware catalog is open.
- The S7-1200 CPU has a free slot for the signal board.

### Inserting a signal board in a CPU

To insert a signal board in a CPU, proceed as follows:

1. Go to the required signal board in the hardware catalog.
2. Select the signal board you want to use.
3. Drag the signal board to the free slot in the CPU.

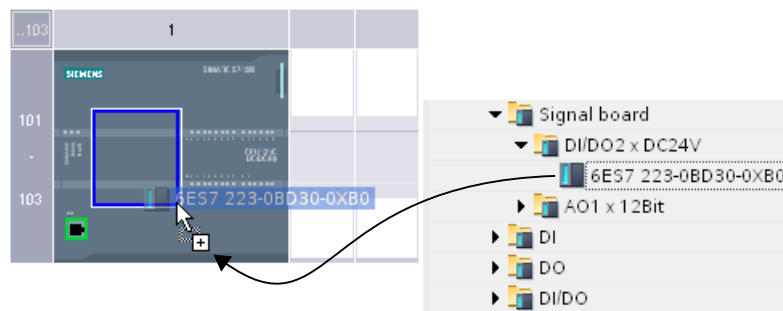

You have now inserted a signal board in the slot of the CPU.

If you are in the network view, you can also drag a signal board to a device. If the CPU has an empty slot for a signal board, the signal board is inserted automatically into this slot.

### Configurations for Web server

#### Information about the web server

##### Introduction

The web server allows you to monitor the CPU via the Internet or the intranet of your company. This permits evaluation and diagnostics over long distances.

Alarms and status information are visualized on HTML pages.

##### Web browser

You need a web browser to access the HTML pages of the CPU.

The following PC web browsers, for example, are suitable for communication with the CPU:

- Internet Explorer (Version 8.0, 9.0)
- Mozilla Firefox (Version 17.0.1 and higher)
- Google Chrome 23.0
- Apple Safari 5.1.7 (Windows)
- Apple Safari 6.0.2 (Mac)

The following Web browsers of mobile devices are also suitable:

- Internet Explorer 6.0 and lower, for HMI Panels
- Mobile Safari (iOS 5.0.1)

- Mobile Android Browser 2.3.4
- Mobile Google Chrome 23.0

### Reading information via the web server

The following information can be read from the CPU. The availability of the respective web pages depends on the CPU and its firmware version.

Page/information	Description
Intro	Entry page for the standard web pages
Start Page Start page with general CPU information	The start page provides an overview of general information on the CPU, the name of the CPU, the type of CPU and basic information on the current operating state.
Identification Identification information	Displays the static identification information such as serial number, order number and version numbers.
Diagnostic Buffer Diagnostic information	Displays the content of the diagnostics buffer with the most recent entries first.
Module Information Module information	Displays whether the centrally inserted components of a station are OK, whether there are maintenance requirements or components cannot be reached, for example.  As of firmware version 4 a firmware update is possible via this Web page.
Communication Communication	Displays the communication connections during open communication (OUC); displays resources and address parameters.
Variable Status Tags	Displays the status of operands of the user program to monitor and change the values.
Data Logs (File Browser as of firmware version 4)	Data logs in CSV format to transfer to the hard disk of the programming device. The data logs are created with data log instructions in the user program and filled with data.  As of firmware version 4 you have access to files of the internal load memory and of the external load memory (Memory Card), for example to the content of the directory "DataLogs" and "Recipes" via the Web page "File Browser".
User Pages User pages (if user-defined web pages have been configured and loaded)	The user web pages deliver a list of web pages with customer-specific web applications.

## Web access to the CPU via PG/PC

Proceed as follows to access the web server:

1. Connect the client (PG/PC) to the CPU via the PROFINET interface.
2. Open the web browser.  
Enter the IP address of the CPU in the "Address" field of the web browser in the format `http://ww.xx.yy.zz` (example: `http://192.168.3.141`).  
The start page of the CPU opens. From the start page, you can navigate to further information.

## Standard web pages

### Requirements for web access

The requirements for access to standard CPU web pages are explained in the following, as well as the effects of missing or existing configuration information.

### Requirement

The web server must be started.

The web server only starts when it has been activated in the properties of the CPU in the "Web server" section.

Note the following:

The web pages are normally transmitted via an non-secure connection and are not secured against hacker attacks. If you want to transfer the web pages in encrypted form to the browser, use the URL `https://`, followed by the IP address of the CPU.

## Logon

No logon is required to access the standard web pages read-only. A user must be logged on to execute certain actions like changing the operating mode of the CPU or for write access.

### For S7-1200 CPUs up to FW version V3:

You must be logged on as "admin" for the actions listed above. The logon input boxes are on the top left of each standard web page.



The image shows a small rectangular logon form with a light blue background. It contains two input fields: one labeled "Name" and one labeled "Password". Below these fields is a blue button with the text "Log in" in white.

If you log on as "admin", you must enter the user name and password there.

Name: admin.

Password: configured CPU password (for password-protected CPU).

### For S7-1200 CPUs as of FW version 4:

You can freely select the names of users and the passwords (CPU parameter "Web server", area "User management").

You assign rights to the users, for example the right to query diagnostics or to update the firmware.

### **JavaScript and cookies**

The standard web pages use JavaScript and cookies. You must enable both in your web browser.

If JavaScript is not enabled, the following limitations apply:

- Data from standard web pages is not automatically updated.
- You cannot log on as user.
- Fields cannot be sorted (module information)

If cookies are not enabled, you cannot log on.

### **See also**

Access for HTTPS (Page 646)

### **Settings for operation**

#### **Settings for operation**

To be able to use the web server of an S7-1200-CPU, you must select the CPU in the network view or the device view and make the following settings in the inspector window under "Properties > General > Web server":

- Enable the web server
- Restricting access to the CPU to HTTPS transmission protocol (encrypted transmission)  
Access via port 80 is then blocked. Communication is only possible via port 443.

- Enabling automatic update of web pages  
The update interval is set by default and cannot be changed. The CPU updates web pages with changing content (for example, status information or diagnostics information) at regular intervals.
- Creating and managing users  
Users are exclusively entitled to options that are assigned to the access rights. Depending on the CPU and firmware used, you can assign different user rights. Rights that your CPU does not support cannot be activated. A user called "Everybody" with minimal access rights, that you can, however, extend, is set by default in the user list. A user who uses the Web server without entering a password has "Everybody" user rights. You have the possibility of configuring further users with different access rights. These users have to log on with the configured user name and password.



**WARNING**

**Unauthorized access to the CPU by means of the Web server**

Unauthorized access to the CPU or the changing of PLC variables to invalid values can result in interruptions of the processes controlled by the CPU and cause death, serious bodily harm or material damage!

Since the activation of the Web server allows authorized persons for example to change operating modes, to write-access CPU data or to update the firmware, we recommend that the following security measures be taken:

- If possible limit access to the HTTPS protocol.
- Create users with secure passwords. An example of a secure password is one which is only used for a single application, is more than 8 characters long, and consists of lower- and upper-case letters as well as symbols and numbers (?!+%\$1234...). In addition, passwords based on common keyboard sequences or words from the dictionary should be avoided.  
Change the password at regular intervals.
- Do not extend the rights of the "Everybody" user.
- Check the PLC variables in the user program and limit the range of values to permissible ranges since users can set invalid values via the Web server.

## Access for HTTPS

### Access via HTTPS

HTTPS is used for encrypting and authentication of communication between the browser and web server.

To transfer data between the browser and the CPU using the HTTPS protocol, enter the URL as `https://ww.xx.yy.zz` in the address line of your browser, whereby `ww.xx.yy.zz` stands for the IP address of the CPU.

You require a valid, installed certificate for error-free HTTPS access to the CPU.

If no certificate is installed a warning is displayed with a recommendation not to use this page. To view the page you must explicitly "Add exception".

You can receive a valid certificate (Certification Authority) "SIMATIC CONTROLLER" as a download from the "Intro" web page under "Download certificate". The help function for your respective web browser provides information on how to install a certificate.

### Accessing data of the CPU memory

You can access data in the internal or external CPU load memory by means of a standard web page.

- Use the web page "Data logs" for S7-1200 CPUs up to and including FW version 3. From this web page, you transfer the data logs from the CPU to a drive on your PC.
- Use the web page "File Browser" for S7-1200 CPUs as of FW version 4. From this web page, you transfer data from the folders "Data logs" or "Recipes", for example, to a drive on your PC.

Depending on the file type and the access permissions you have configured for the web server user, you can download, delete, rename or upload the files. The actual directories can only be created, deleted or renamed.

### Example: Data logs

To open a data log, click on the link of the desired data log. You can then open the file (.csv), for example, in Microsoft Excel or in another program you choose or you can save the file.

Special note: Data logs are saved in U.S. American CSV format. You can only open the file directly using the U.S. version of Microsoft Excel. If you are using another national version of Microsoft Excel, you must import the file, selecting "comma" in the import assistant as the delimiter.

### Downloading a data log

To download a data log, click on the download icon of the desired data log. You can then open the file (.csv), for example, in Microsoft Excel or in another program you choose or you can save the file.

### Downloading and clearing or deleting a data log

For a CPU with FW version up to V3.0:

To download and delete the current entries of the data log, you must be logged on. To do this, click on the "Download and delete" icon of the required data log. You can then open the file (.csv), for example, in Microsoft Excel or in another program you choose or you can save the file.

For a CPU as of FW version V4.0:

To reset the data log, follow these steps:

1. Open the CSV file, for example with Excel.
2. Delete the rows between the headline and the row with the entry "//END", if this row exists.

3. Save the file to a drive on your PC.
4. On the web page "File Browser", delete the data log (which means the CSV file) and upload the prepared CSV file to the CPU with the "Upload file" button of the "File Browser" web page.

Additional information is available in the S7-1500 CPU system manual.

## **Create and download user-defined websites**

### **What you need to know about user-defined web pages**

#### **Concept**

The concept of user-defined web pages allows you to access freely-designed web pages of the CPU from a web browser. The web server of the CPU provides this function.

You are not dependent on special tools for the design and functionality of the user-defined web pages. You can adapt the pages in the layout with CSS, provide dynamic content with JavaScript or use any framework to produce web pages.

The totality of files processed by the web server is also referred to as the "web application".

#### **Web application and user program**

Using HTML code in user-defined web pages, you can also transmit data via a web browser to the user program of the CPU for further processing and can display data from the operand area of the CPU in the web browser.

You can use script instructions (such as Javascript) to optimize your web pages, for example to dynamically change contents or validate user entries.

To synchronize between the user program and the web server, but also to initialize, you must call the WWW (SFC 99) instruction in the user program.

- If no interaction is required between the web application and the user program, for example, if a web page only provides static information, only initialization in the user program is required.
- If a simple data exchange is necessary between PLC tags and tags in web applications, to display the contents of PLC tags or write a value in a PLC tag for example, the syntax for reading and writing tags has to be observed. In this case only an initialization is required in the user program, for example in the startup OB.
- If a further interaction is required between the web application and the user program, you must handle status and control information from the Web Control DB in addition to the synchronization between Web server and user program. This is the case, for example, when user entries are transmitted via the web browser to the web server for evaluation by the CPU. Unlike simple data exchange, the user program directly influences the time at which the requested web page is relayed back to the web browser. In this case, you must be acquainted with the concept of manual fragments and the structure of the Web Control DB.



## Initialization

User-defined web pages are "packaged" in data blocks for processing by the CPU. You must generate appropriate data blocks from the source data (HTML files, images, JavaScript files, etc.) during configuration to be able to download the web application into the CPU. The Web Control DB takes on a special role (default: DB 333). It contains status and control information as well as links to additional data blocks with coded web pages. Data blocks that contain coded web pages are termed "Fragment DBs".

When the data block is downloaded into the CPU, the CPU does not "know" that user-defined web pages are coded inside it. The "WWW" (SFC 99) instruction, for example, in the Startup OB informs the CPU which DB is the Web Control DB. The user-defined web pages can be accessed via a web browser after this initialization.

## Synchronization

If the user program is to exchange data with the user-defined web pages, the WWW (SFC 99) instruction must be used in the cyclic program section.

Examples of interaction between user program and web page:

- Check received data
- Compiling and returning data for web browser making request

In this case, the status information must be able to be evaluated and control information must be transmitted to the web server, for example, to release a requested web page.

## Procedural overview

### Basic information

This section provides a step-by-step explanation of the basic procedure used to create and download custom web pages and to use them in the operating phase.

The following graphic provides a simplified representation of the process used in creating and displaying custom web pages:

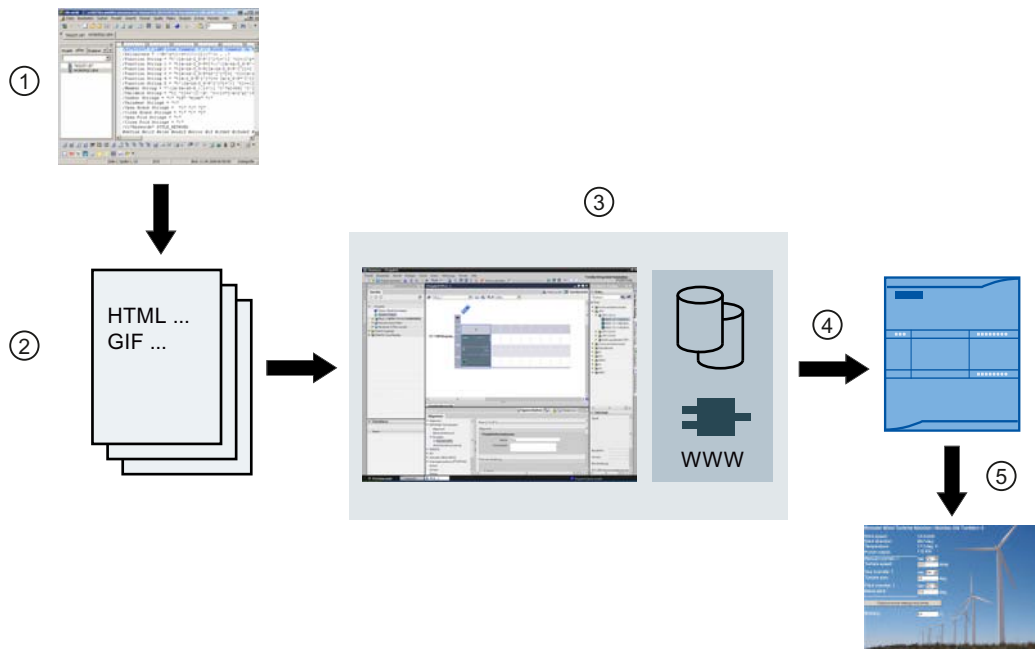

- ① Programming a web application (using suitable tools when required and AWP commands for dynamic pages when applicable).
- ② The web application is comprised of single source files, for example, \*.html, \*.gif, \*.js, etc.
- ③ Using STEP 7:
  - Generate the data blocks (Web Control DB and fragment DBs) from source files. The DBs contain meta information and the complete web application, including the images and the dynamic and static parts of the web application. The DBs are stored under "System blocks" in the project tree.
  - Call the "WWW" instruction in the user program. This instruction initializes the web server of the CPU for a web application.
  - If required, complete final programming for interaction between the web server and user program
- ④ Downloading the blocks to the CPU.
- ⑤ Call the web page in the browser. The web pages of the CPU are called by entering the IP address of the CPU.

### Additional information

You can find additional information and examples relating to the S7-1200 web server on the Internet (<http://support.automation.siemens.com/WW/view/en/36932465>).

### Creating web pages

Web design tools from various companies can be used to create user-defined web pages. As a rule, the web pages should be programmed and designed compliant to the conventions of the W3C (World Wide Web Consortium). No check is made for compliance to W3C criteria in the web server of the CPU.

## Rules

- The tool must be able to directly edit the HTML code so that the AWP command can be inserted into the HTML page.  
Only the AWP commands are parsed in the CPU and, for example, replaced by values from the user program/process image of the CPU.
- Files containing AWP commands must be coded in UTF-8. In the metadata of the HTML page, therefore, set the attribute charset to UTF-8 and save the file UTF-8 coded.
- Files containing AWP commands must not contain the following sequence: `]]`
- Files containing AWP commands must not contain the following sequence outside of the "Tag read ranges" (`:=<Tag name>:`): `:=`  
Tip: Replace the first character of a prohibited sequence with its character coding; for the colon, for example, `&#58;`.

A small example for a custom web page should make clear the basic design.

## Requirement

- The CPU must have a web server and the web server of the CPU must be activated.
- To be able to access PLC tags with write access as a user, you must be logged on as "admin".
- For the example below, PLC tags must be defined for those PLC tags that are to be shown on the web page. This is shown here for the first tab used, "Tank\_below\_max".

	Name	Data type	Address
1	 Tank_below_max	Bool	%I0.0

## Creating user-defined web pages

The following code for an example web page reads values from the process image and provides them in a table.

```
<!DOCTYPE HTML PUBLIC "-//W3C//DTD HTML 4.01//EN" "http://www.w3.org/TR/html4/strict.dtd">
<html>
  <head>
    <meta http-equiv="Content-Type" content="text/html; charset=utf-8">
    <title>Mix</title>
  </head>
  <body>
    <h1>Mix</h1>
    <h2> Actual State </h2>
    <table border="1">
      <tr>
        <th>Variable</th>
        <th>State</th>
      </tr>
      <tr>
        <td>Tank below max</td>
        <td>:="Tank_below_max":</td>
      </tr>
    </table>
  </body>
</html>
```

```
</tr>
<tr>
  <td>Tank above min</td>
  <td>:="Tank_above_min":</td>
</tr>
</table>
</body>
</html>
```

## AWP commands

The interface between a freely-programmable web application for a CPU that has a web server and the CPU data is declared by the AWP command (Automation Web Programming).

To develop web applications you are only subject to the restrictions of the web browser. In one of the programming languages of STEP 7, control with the user program which CPU data is displayed at what time in the web browser of the viewer. Use AWP commands, which you comment within the HTML files, to declare data to be used for intentional interaction between the web application and the user program.

AWP commands are inserted as HTML comments with a special syntax into HTML files; they declare the following features:

- Read PLC tags
- Write PLC tag
- Read special tags
- Write special tags
- Define enum types
- Assign tags to enum types
- Defining fragments
- Import fragments

## Syntax of AWP commands

An AWP command begins with "`<! --AWP_`" and ends with "`-->`". In JavaScript files, the commands should also be enclosed by JavaScript comments ("`/* . . . */`").

## Notation rules for PLC tag names within an AWP command

The AWP commands "AWP\_In\_Variable" and "AWP\_Out\_Variable" contain a name attribute and optionally a use attribute. A PLC tag name is assigned to these attributes, by means of which the PLC tags in the browser are written or read. The following rules apply to handling PLC tag names in HTML code:

- PLC tags must be enclosed in quotation marks ("`...` ").
- PLC tags used in AWP commands must also be enclosed by single quotation marks ("`'...` ") or with quotation marks masked by a backslash ("`\"... \`").

- If the PLC tag name contains the character \ (backslash), this character must be designated with the escape sequence \\ as standard character of the PLC tag name.
- If the PLC tag name in the AWP command is also enclosed by single quotation marks and the single quotation mark (') occurs within the name, it must also be designated as normal character by the escape sequence \'.
- If an absolute address (input, output, bit memory) is used in AWP command, it is enclosed by single quotation marks.

PLC tag	PLC tag in HTML code
"Velocity"	<!-- AWP_In_Variable Name="Velocity" -->
"Velocity\""	<!-- AWP_In_Variable Name="\Velocity\" -->
"abc\de"	<!-- AWP_In_Variable Name="abc\de" -->
"abc'de"	<!-- AWP_In_Variable Name="abc'de" -->
"abc'de"	<!-- AWP_In_Variable Name="abcde" Use="abc'de" -->
"DB name".tag	<!-- AWP_In_Variable Name="DB name".tag' -->
"DB name"."tag"	<!-- AWP_In_Variable Name="DB name"."tag" -->
-	<!-- AWP_Out_Variable Name='flag1' Use='M0.0' -->

## See also

Reading tags (Page 653)

Writing tags (Page 655)

Special tags (Page 656)

## Reading tags

User-defined web pages can read PLC tags.

The PLC tag must be specified by a PLC tag name.

These OUT variables (direction of output as viewed from the controller) are inserted at any location within the HTML text with the syntax described in the following.

## Syntax

```
:=<varname>:
```

These references are replaced when the web server is in operation by the current values of the PLC tag in each case.

<varname> can be a simple, global CPU tag but also a complete tag path to a structure element.

**Notation rules for PLC tag names**

- PLC tags in HTML code are enclosed by quotation marks ("), if they are defined in the tag table. In the case of data block tags, the name of the data block is enclosed by quotation marks. If special characters are used in the structure elements of the data block, for example the dot (.) or blank, this part must also be enclosed by quotation marks.
- Quotation marks are not used for absolute addresses of inputs, outputs or bit memories.

PLC tag	PLC tag in HTML code
"DB_name".var_name	:= "DB_name".var_name:
"DB_name".struct_name.var_name	:= "DB_name".struct_name.var_name:
"DB_name"."var.name"	:= "DB_name"."var.name":
"memory"	:= "memory":
-	:= I0.0:
	:= Q0.0:
	:= MW100:
	:= %MW100:
"My_Data_Block".flag1	<!-- AWP_Out_Variable Name='flag1' Use='My_Data_Block'.flag1' -->
	...
	:= flag1:

- If the PLC tag name contains the character : (colon) or \ (backslash), this character must be designated with the escape sequence \: or \\ as standard character of the PLC tag name.

PLC tag	PLC tag in HTML code
"abc:de"	:= "abc\:de":
"abc\de"	:= "abc\\de":

- Special characters "<, &, >"  
 Display problems can occur if these characters are contained in the tag name (for example, "a<b").  
 Avoid expressions such as := "a<b": in the HTML page.  
 To prevent display problems from occurring, use e.g. an AWP command with a use expression according to the pattern depicted below. The use attribute defines the PLC tag with the problematic character, the name attribute defines the name without problematic character, as it is used in the HTML page.

PLC tag	PLC tag in HTML code
"a<b"	<!--AWP_Out_Variable Name='simplename' Use='a<b"' -->
	...
	:= simplename:

**See also**

AWP commands (Page 652)

## Writing tags

Custom web pages can write data into the CPU.

This requires an AWP command that identifies the PLC tag to be written.

The PLC tag must also be specified by a PLC tag name.

The IN tags (direction of input as viewed from the controller) are placed on the browser page. This can be done, for example, in a form.

The tags are either set in the HTTP header (by cookie or POST method) or in the URL (GET method) by the browser and are then written by the web server into the respective PLC tag.

## Syntax

To allow the IN tags to be written to the CPU, the tags must first be defined by an explicit AWP instruction:

```
<!-- AWP_In_Variable Name='<PLC_Varname1>' Name='<PLC_Varname2>'
Name='<PLC_Varname3>' -->
```

Several tags can be defined in an instruction - such as that shown above.

The specific PLC tag name is hereby written in double quotation marks; for example  
<PLC\_Varname1> = "myVar".

In cases where the name of the tag that you use for the web application is not identical to the name of the PLC tag, the "Use" parameter can be used to assign to a PLC tag.

```
<!-- AWP_In_Variable Name='<Webapp_Varname>' Use='<PLC_Varname>'
```

## Example

The "AWP\_In\_Variable" AWP command is indispensable when handling forms.

```
<form method='post' action='/awp/appl/x.html'>
  <p>
    <input name='"var1"' type='text'>
    <input value='set' name='Button1' type='submit'>
  </p>
</form>
```

In the form defined above, the HTTP request method "post" is used to transfer the tag "var1" to the web server. The user places the "var1" tag in the form field. The tag 'Button1' has the value 'set', but is not required for the CPU. To allow the "var1" tag to be written to the CPU, the following instruction must be included in the same fragment:

```
<!-- AWP_In_Variable Name='"var1"' -->
```

Since PLC tags are enclosed in double quotation marks ("), the name in the AWP command must be enclosed in single quotation marks (') or in masked quotation marks (\"). To avoid the numerous escape sequences, we recommend the use of single quotation marks.

```
<!-- AWP_In_Variable Name=' "Info".par1' -->
<!-- AWP_In_Variable Name="\ "Info".par1\" " -->
```

### Conditions for write access during operation

The following requirements have to be met in order for a user to be able to write to PLC tags from a user-defined web page.

- The CPU is password protected.
- The user is logged in as "admin".

This rule applies to all writing access to web pages on a CPU.

### See also

Requirements for web access (Page 644)

AWP commands (Page 652)

### Special tags

Special tags are mainly HTTP tags set in the definition of the World Wide Web Consortium (W3C). Special tags are also used for cookies and server tags.

The AWP command to read and write special tags differ only in that they have additional parameters than the AWP command used to read and write normal tags.

### Reading a special tag

The Web server can read PLC tags and transfer these to special tags in the HTTP Response Header. You can, for example, read a URL for a diversion to another web page and transfer to the special tag HEADER:Location using the special tag HEADER:Location.

The following special tags can be read:

Name	Description
COOKIE_VALUE:name	Value of cookie with name: "name"
COOKIE_EXPIRES:name	Execution time of cookie with name: "name" in seconds (must be set beforehand).
HEADER:Status	HTTP status code (if no other value has been set, status code 302 is returned).
HEADER:Location	Path for forwarding to another page. Status code 302 must be set.
HEADER:Retry-After	Anticipated time in which the service is not available. Status code 503 must be set.
HEADER: ...	All other header tags can also be forwarded in this way.

Use the AWP command "AWP\_Out\_Variable" to specify which PLC tags are to be transferred in the HTTP header to the web browser.

Basic structure:

```
<!-- AWP_Out_Variable Name="<Typ>:<Name>" [Use="<Varname>"] -->
```



### Parameter description

- Name: Type and name of special tag
- Use (optional parameter): In cases where the name of the special tag is not identical to the name of the PLC tag, parameter "Use" can be used to assign to a PLC tag.

Example:

```
<!-- AWP_Out_Variable Name="COOKIE_VALUE:siemens" Use="'info'.language' -->
```

### Writing a special tag

In principle, all HTTP tags written in the HTTP header by the web browser can be evaluated by the user program of the CPU. Examples of tag types:

Name	Description
HEADER:Accept-Language	Accepted or preferred language
HEADER:Authorization	Proof of authorization for a requested resource
HEADER:Host	Host and port of the requested resource
HEADER:User-Agent	Information on the browser
HEADER: ...	All other header tags can also be forwarded in this way
SERVER:current_user_id	Indicates whether a user is logged on (current_user_id=0: no user logged on)
SERVER:current_user_name	User name of the user logged on
SERVER:GET	Request method is GET
SERVER:POST	Request method is POST
COOKIE_VALUE:name	Value of cookie with name: "name"

The AWP command "AWP\_In\_Variable" is used to define which special tags are to be evaluated in the user program of the CPU.

Basic structure:

```
<!-- AWP_In_Variable Name="<Typ>:<Name>" [Use="<Varname>"] -->
```

Parameter description:

Name: Type and name of special tag

Use (optional parameter): In cases where the name of the special tag is not identical to the name of the PLC tag, the parameter Use can be used to assign to a PLC tag.

## Examples:

```
<!-- AWP_In_Variable Name="COOKIE_VALUE:siemens" Use='"info".language' -->
```

The tag name in the HTTP header is replaced by the PLC tag name specified by Use . The cookie is written to the PLC tag "info".language .

```
<!-- AWP_In_Variable Name='COOKIE_VALUE:siemens' Use='"info".language' -->
```

The tag name in the HTTP header is replaced by the PLC tag name specified by Use. The cookie is written to the PLC tag "info".language .

```
<!-- AWP_In_Variable Name='"COOKIE_VALUE:siemens"' -->
```

The HTTP-header variable is written in the same-name PLC variable.

## See also

AWP commands (Page 652)

## Enumeration types

### Enumeration types (enums)

Numerical values from the PLC program can be converted into text and vice versa using enums. The numerical values can also be assigned for several languages.

### Creating enums

Enter an AWP command using the following syntax at the start of the HTML file:

```
<!-- AWP_Enum_Def Name="<Name of the enum type>"  
Values='0:"<Text_1>", 1:"<Text_2>", ... , x:"<Text_x>"' -->
```

For example, for German values to be saved as an HTML file in the "de" folder of the HTML directory:

```
<!-- AWP_Enum_Def Name="Enum1" Values='0:"an", 1:"aus", 2:"Störung"' -->
```

For example, for English values, to be saved as an HTML file in the "en" folder of the HTML directory:

```
<!-- AWP_Enum_Def Name="Enum1" Values='0:"on", 1:"off", 2:"error"' -->
```

## Assigning enums

Tags are assigned from the user program to the individual enum texts using a special AWP command:

```
<!-- AWP_Enum_Ref Name="<VarName>" Enum="<EnumTypeName>" -->
```

<VarName> is thereby the symbolic name from the user program and <EnumTypeName> is the previously set name of the enum type.

---

### Note

In each fragment in which enum texts are referenced by a PLC tag, this PLC tag must be assigned by the appropriate AWP command of the enum type name.

Ensure that no AWP command for importing fragments is positioned between an enum assignment and enum usage because this import can result in the enum assignment lying in a different fragment than the enum usage.

---

## Example

Enum type "state" is defined with values "0" and "1". "0" means "off", "1" means "on":

```
<!-- AWP_Enum_Def Name="state" Values='0:"off", 1:"on"' -->
```

The following code is contained in the HTML code of the web page to be output:

```
<!-- AWP_Enum_Ref Name="operating state" Enum="state" -->  
:=operating state:
```

Depending on the value of the "operating state" tag, the result displayed is no longer "0" or "1", but "off" or "on".

## Simplified use of enumeration types

At S7-1200 CPUs as of firmware version 4 it is possible to use enumerations directly in AWP commands to read and write PLC variables.

You create enums as described in the previous section, and you can then utilize the values with user program read and write commands.

### Creating enums

```
<!-- AWP_Enum_Def Name="<Name des Enum Typs>" Values='0:"<Text_1>",&br/>1:"<Text_2>",&br/>... , x:"<Text_x>"' -->
```

### Utilizing enums in the user program read and write commands

```
<!-- AWP_In_Variable Name='<Varname>' Enum="<EnumType>" -->  
<!-- AWP_Out_Variable Name='<Varname>' Enum="<EnumType>" -->
```

### Example of reading PLC tags

```
<!-- AWP_Enum_Def Name='AlarmEnum' Values='0:"No alarms", 1:"Tank is  
full", 2:"Tank is empty"' --><!-- AWP_Out_Variable Name=' "Alarm" '  
Enum="AlarmEnum" -->...<p>The current value of "Alarm"  
is := "Alarm":</p>
```

If the value of "Alarm" in the CPU is "2", the following text will be displayed on the HTML page:

'The current value of "Alarm" is Tank is empty' because the enum definition assigns the string "Tank is empty" to the numerical value 2.

### Example of writing PLC tags

```
<!-- AWP_Enum_Def Name='AlarmEnum' Values='0:"No alarms", 1:"Tank is  
full", 2:"Tank is empty"' --><!-- AWP_In_Variable Name=' "Alarm" '  
Enum='AlarmEnum' -->...  
<form method="POST">  
<p><input type="hidden" name=' "Alarm" ' value="Tank is full" /></p>  
<p><input type="submit" value='Set Tank is full' /></p>  
</form>
```

Because the enum definition assigns the string "Tank is full" to the numerical value "1", the value "1" is written to the PLC tag "Alarm".

## Definition of fragments

### Fragments

Fragments are "logical sections" of a web page to be processed by the CPU individually.

Fragments are usually complete pages but can also be individual elements such as files (for example, images) or complete documents.

## Defining fragments

```
<!-- AWP_Start_Fragment Name="<Name>" [Type="<Type>"] [ID="<Id>"]  
[Mode="<Mode>"]-->
```

The start of a fragment is specified by this command. A fragment runs to the start of the next fragment or to the end of the file.

- **<Name>** Indicates the name of the fragment.  
The name must start with a letter [a-zA-Z] or an underscore ( \_ ). Letters, underscores or numbers [0-9] can follow after this first character.
- **<Type>** Indicates the type of the fragment.
  - "manual" The user program is informed of the request for a fragment; the web page to be returned can be changed by the user program.
  - "automatic" The page is automatically processed (default).
- **<id>** A numeric ID can be stipulated for the fragment. If no ID is assigned, the fragment is automatically assigned an ID. For manual pages (<Type>=manual) , the fragment can be addressed in the user program of the CPU by this ID.

---

### Note

Keep the ID low because the highest ID influences the size of the Web Control DB.

---

- **<Mode>** Fragments support the visible and hidden modes.
  - "visible" The fragment is a part of the web page. This mode is preset and can also be omitted.
  - "hidden" The fragment is not part of the web page. However, the fragment will be saved in the Web DB and is available to the user program for inserting in a requested web page. You use an exchange of the fragment ID (Web-Control-DB.fragment\_index tag) to insert a "hidden" fragment in the requested web page.

The input document is completely divided into fragments by the "AWP\_Start\_Fragment" command. "AWP\_End\_Fragment" is therefore unnecessary.

Without a start fragment command, a file is mapped as a fragment; the fragment name is derived from the file name. If a file is divided into several fragments (by "AWP\_Start\_Fragment"), the file must begin with the "AWP\_Start\_Fragment" command.

## Importing fragments

You can declare a fragment in an HTML page and import this fragment into other web pages.

## Example

A company logo is to be displayed on all web pages of a web application.

There is only one instance of the HTML code for the fragment that displays the company logo. You can import the fragment as often and into as many HTML files as required.

## Syntax

```
<!-- AWP_Import_Fragment Name = "<name>"-->
```

- <name> is the name of the fragment to be imported.

## Example

HTML code within a web page that declares a fragment:

```
<!-- AWP_Start_Fragment Name = "My_Company_Logo"-->  
<p><img src = "compay_logo.jpg"></p>
```

## Example

HTML code within another web page that imports the declared fragment:

```
<!-- AWP_Import_Fragment Name = "My_Company_Logo"-->
```

## Creating and loading a data block

### Requirement

- All source files required for the web application (\*.html, \*.js, \*.png, ...) have been created.
- The source files are located in one folder, but only those source files that are required for the web application. No other files may be located in this folder.

---

### Note

#### Length of file names and tag names

If you have a comprehensive web application with many files and directories, the generation of the web data blocks may possibly fail. If this happens, the generation is aborted with the message "Text list overflow...". The cause is system-internal size limitations for management information saved in the web data block.

Remedy: Use short file names and short tag names.

---

## Procedure

To create data blocks from the source files for user-defined web pages in STEP 7, proceed as follows:

1. Select the CPU, for example, in the device configuration.
2. Select the properties for user-defined web pages in the inspector window under "Properties > General > Web server".
3. As "HTML source", select the folder that contains the source files for the web application.
4. Enter the HTML page to be opened on starting the web application as the start HTML page.
5. Enter a name for the application if required.
6. You can supplement a range of file name extensions as "Files with dynamic content" if necessary. Only enter those file name extensions that also contain AWP commands.
7. The number for the Web Control DB and for the fragment DB start number can be kept as long as they are not already being used by your user program.
8. Click on the "Generate" button to create DBs from the source files.  
The generated data blocks are saved in the project navigation in the "System block" folder (in the "Web server" subfolder).
9. In the CPU, select the network view to be loaded and then select the "Download to device" command in the "Online" menu to download the blocks. Compilation of the blocks is implicitly initiated before downloading.  
If errors are reported during this process, you must correct these errors before you can download the configuration.

## Structure of the PLC program

Your user program must call the "WWW" instruction to even allow the web application, for example, the user-defined web pages, to be available to the CPU on the standard web pages and to allow them to be called up there.

The Web Control DB you have created from the source files is the input parameter (CTRL\_DB) for the "WWW" instruction. The Web Control DB references the content of the user-defined web pages coded in the fragment DB and then receives status and control information.

## Calling the "WWW" instruction in the startup program

If you do not want the user program to influence requested web pages, it is sufficient to only call the "WWW" instruction once in a startup OB. This instruction initializes communication between the web server and the CPU.

## Calling the "WWW" instruction in the cyclic program

The "WWW" instruction can also be called in an OB processed in cycles (for example, OB 1). This has the advantage of being able to respond to web server requests from within the user program. Manual fragments must be used for this.

In this case, you must evaluate information from the Web Control DB in order to identify the requested web page or the requested fragment. On the other hand, you must set a bit in the

user program in order to explicitly release the web page to be returned by the web server after processing the web page request.

The structure of the Web Control DB is described in the following section.

### Web Control DB

The Web Control DB (DB 333 by default) is created by STEP 7 and contains information on the structure of user pages, the status of communication and any errors that occur.

Additional fragment DBs are also created as well as the Web Control DB. These fragment DBs (there may also only be one fragment DB) are referenced in the Web Control DB. The fragment DBs contain the web pages and media data coded in fragments, for example, images. The content of the fragment DB cannot be changed by the user program. It is created automatically and is only for data management.

The status and control tags of the Web Control DB are accessed via symbols.

The following lists the tags of the Web Control DB required for status evaluation and to control interaction.

The Web Control DB provides two types of information:

- Global status information: Not bound to a concrete web page request.
- Request status and control information: Information about queued requests.

### Global status information

"WEB-Control_DB".commandstate.init	Activates and initializes the web application.
"WEB-Control_DB".commandstate.deactivate	Deactivates the web application.
"WEB-Control_DB".commandstate.initializing	The web application is initialized (read Web Control DB, etc.).
"WEB-Control_DB".commandstate.error	Web application could not be initialized. The reason is coded in "WEB-Control_DB".commandstate.last_error .
"WEB-Control_DB".commandstate.deactivating	The web application is closed.
"WEB-Control_DB".commandstate.initialized	The web application has been initialized and is ready.
"WEB-Control_DB".commandstate.last_error	Refer to the next table for a value table of possible errors.

Last_error	Description
1	Fragment DB is inconsistent (does not match the Web Control DB).
2	A web application already exists with this name.
3	Memory problem initializing in the web server.
4	Inconsistent data in the Web Control DB.
5	A fragment DB is not available (not loaded).
6	No AWP ID for a fragment DB.



Last_error	Description
7	The enum fragment is not available (contains the texts and information on the enum types).
8	An action requested via the command flag in the Web Control DB is prohibited in the current state.
9	Web application is not initialized (if there is no reinitializing after disabling).
10	Web server is disabled.
...	Last_error is reset once the web application has been successfully initialized.

### Request status information

Request status information is bound to one of four possible requests,  $x = [1 \dots 4]$ .

"WEB-Control_DB".requesttab[x].idle	Nothing need be done.
"WEB-Control_DB".requesttab[x].waiting	The user program must react to a request from a manual fragment and explicitly initiate further processing in the web browser.
"WEB-Control_DB".requesttab[x].sending	The web server is occupied with processing the request/fragment.
"WEB-Control_DB".requesttab[x].aborting	The TCP connection is closed by the web server.

### Request control information

Request control information is bound to one of four possible requests,  $x = [1 \dots 4]$ .

"WEB-Control_DB".requesttab[x].continue	Releases the fragment being processed for transmission. Processing of the next fragment is initiated.
"WEB-Control_DB".requesttab[x].repeat	Releases the fragment being processed for transmission. The fragment is then processed again.
"WEB-Control_DB".requesttab[x].abort	Closes the TCP connection.
"WEB-Control_DB".requesttab[x].finish	Releases the fragment being processed for transmission. Stops further processing of requests (terminates the request).

### Example:

The tag for the DB is: "WEB-Control\_DB". Whether errors have occurred during initialization of the web application can be determined by requesting bit "WEB-Control\_DB".commandstate.error in the user program.

If an error has occurred you can analyze it using the "WEB-Control\_DB".commandstate.last\_error value.

### Interaction with the user program

Using manual fragments ensures that the user program reacts synchronously to the user program, thereby allowing the responding web page to be processed by the user program.

### Fragment type

To react to the received data in the user program the "manual" fragment type must be used for the fragment writing the data (for "manual pages"):

```
<!-- AWP_Start_Fragment Name="testfrag" ID="1" Type="manual" -->
```

The values are always transferred to the web server of the CPU for automatic and manual pages in the same way:

Example:

```
<form method="POST" action="">
<p>
<input type="submit" value="Set new value">
<input type="text" name="Velocity" size="20">
</p>
</form>
```

### User program for manual fragments

When using manual pages, the "WWW" instruction must be called in cycles in the user program of the CPU.

To react to values entered in the browser, the request - which is made by the manual page to the web server - must first be evaluated in the user program. To do this, the Web Control DB (for example, DB 333) must be examined in cycles for queued requests. The array that manages four requests is contained in the "requesttab" section of the Web Control DB. Each element of the array thereby contains information on the respective request within a structure.

A simple programming example shows how queued requests are checked based on the tags of the Web Control DB.

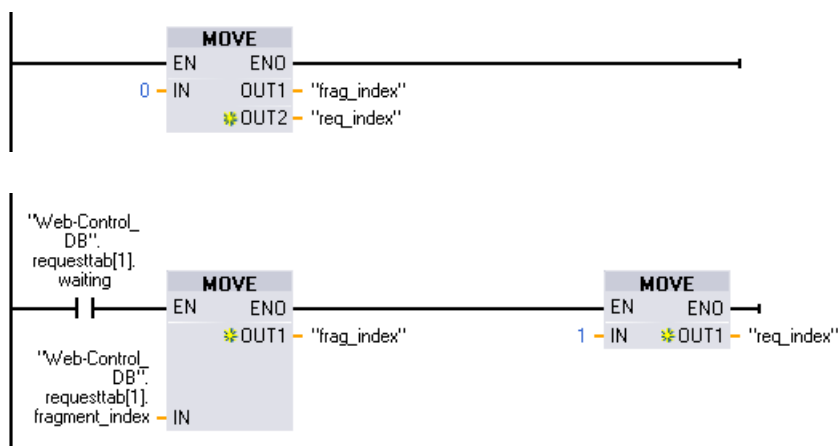

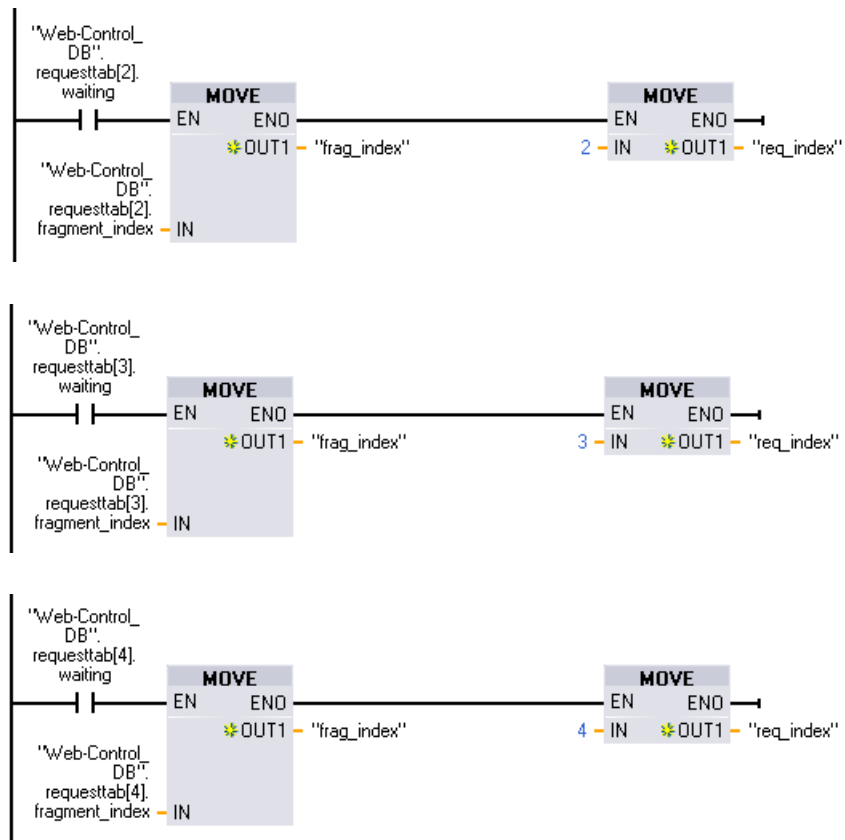

In cases where a request has been made, this program section writes the fragment ID in the #frag\_index tag and the request no. (value range 1-4) in the #req\_index tag.

Using the information from this, the information transferred in the request can now be processed separately for each fragment ID in the program (for example, plausibility check).

Once processing of the request has been completed by the program, the request must be answered and the appropriate entry is once more reset under "requesttab" of the Web Control DB (for example, DB 333).

A simple programming example for replying to requests:

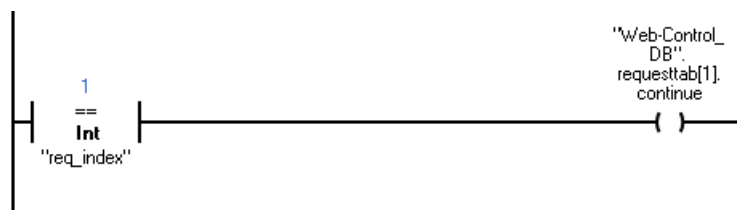

8.1 Configuring devices and networks

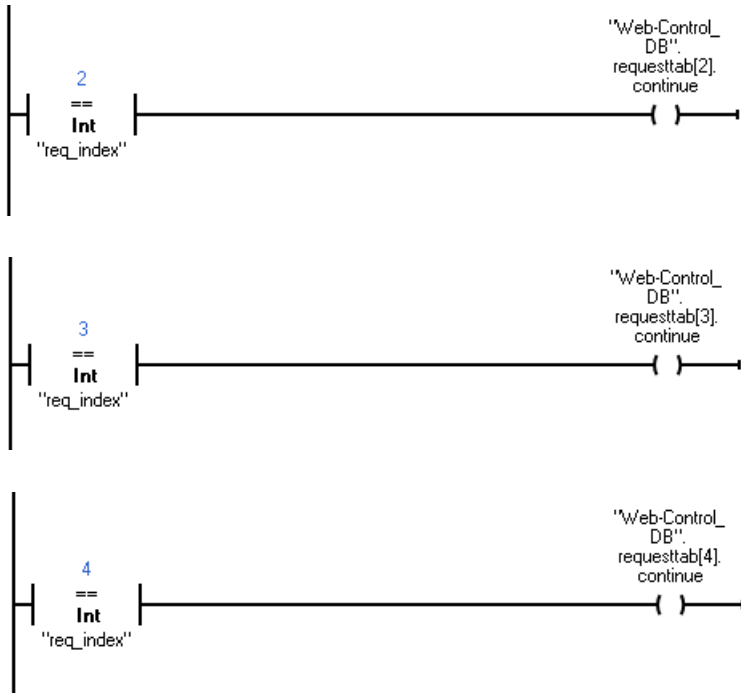

**Principle sequence of a browser request with interaction from the user program**

The following figure shows the simplified, principle sequence of the web browser request on the effects of Web Control DB content and the actions required from the user program until the processed web page is returned (response).

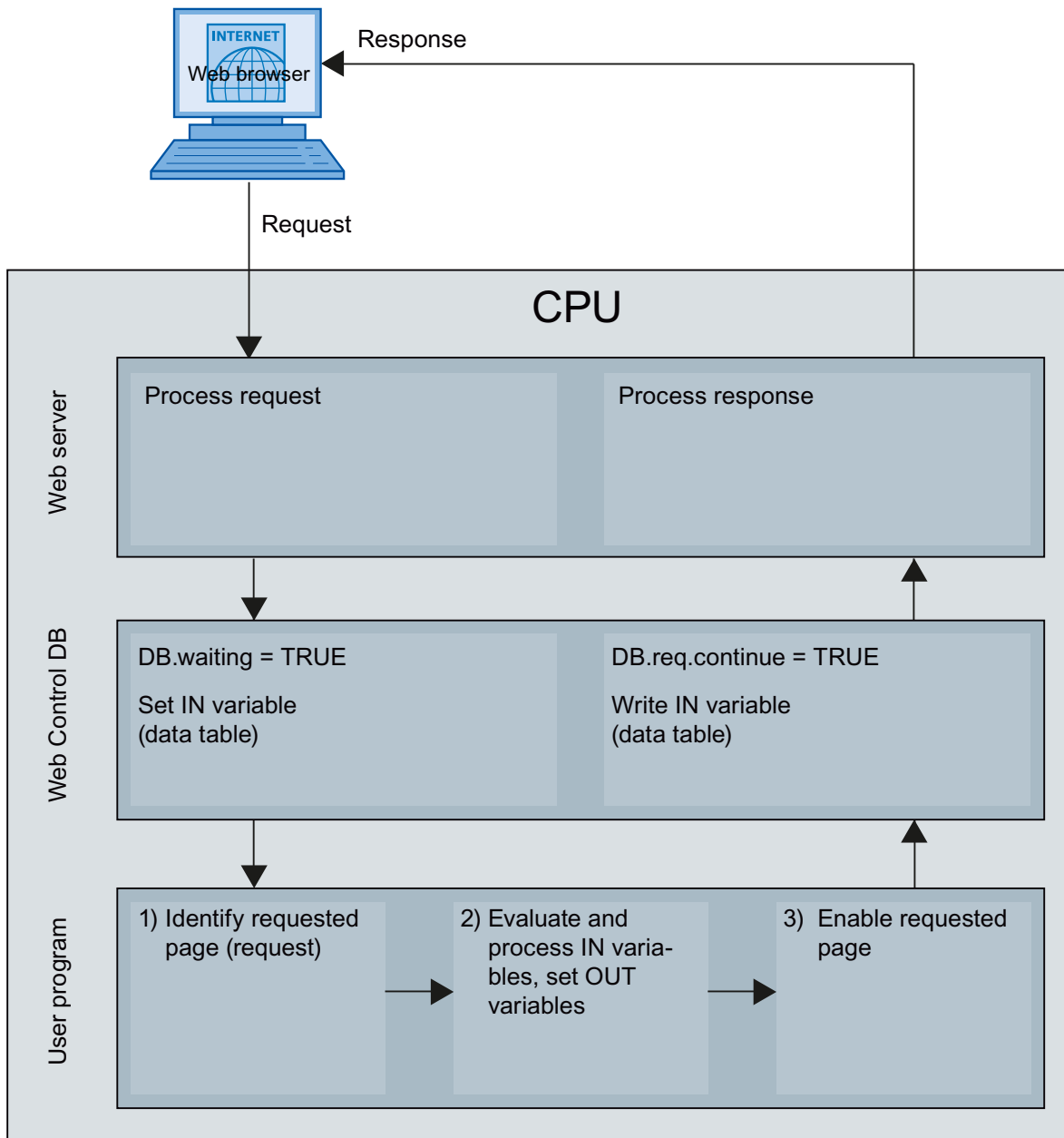

**Displaying custom web pages in the browser**

**Display web pages in browser**

Web pages are called from the standard web pages of the web browser.

In addition to the other links in the navigation bar, the standard web pages also have a link to "user pages".

Click on the "user pages" link to open the web browser you have configured as the default HTML page.

## Creating custom web pages in several languages

You can make each of your custom web pages available in various languages.

### Requirements

The language-dependent HTML; pages must be stored in a folder structure containing folders with the respective language abbreviations:



### Specified language abbreviations

Language abbreviations "de", "en", "fr", "es", "it" and "zh" are fixed. Additional language folders or other designated language folders are not supported.

Additional folders within the same folder hierarchy for other files can be created as required; for example, an "img" folder for images and a "script" folder for JavaScript files.

## Language switching for custom web pages

### Requirements

The HTML pages are contained in the predefined language folders, for example, HTML pages with German text are in the "de" folder, HTML pages with English text are in the "en" folder.

### Language switching concept

Language switching is based on a predefined cookie named "siemens\_automation\_language". If the cookie is set to value "de", at the next web page request or web page update, the web server switches to the web page from the "de" folder.

Similarly, the web server switches to the web page from the "en" folder when the cookie is set to "en".

## Example of language switching

The example is structured as follows:

- The language-dependent HTML files with the same name, for example, "langswitch.html" are located in both language folders "de" and "en". The text to be displayed within the two files are German or English, corresponding to the name of the folder.
- There is an additional "script" folder in the folder structure containing the JavaScript file "lang.js". Functions required for language switching are stored in this file .

## Structure of the "langswitch.html" file ("de" folder)

Meta data "content language", charset and path to JavaScript file are set in the file header.

```
<!DOCTYPE HTML PUBLIC "-//W3C//DTD HTML 4.01 Transitional//EN">
<html>
<head>
<meta http-equiv="Content-Language" content="de">
<meta http-equiv="Content-Type" content="text/html; charset=utf-8">
<title>Switch language to German page</title>
<script type="text/javascript" src="script/lang.js" ></script>
</head>
```

Language selection is implemented in the body of the file by the "select" HTML element. The select element initiates a list box and contains the "de" option, labeled as "German" and "en", labeled as "English"; "de" is the default.

The "DoLocalLanguageChange(this)" function is called using the "onchange" event handler. The "this" parameter transmits the select object with the selected option to this function. "onchange" calls the function each time the option is changed.

```
<!-- Language Selection -->
<table>
  <tr>
    <td align="right" valign="top" nowrap>
      <!-- change language immediately on change of the selection
-->
      <select name="Language"
onchange="DoLocalLanguageChange(this)" size="1">
        <option value="de" selected >Deutsch</option>
        <option value="en" >English</option>
      </select>
    </td>
  </tr>
</table>
<!-- Language Selection End-->
```

## Structure of the "langswitch.html" file ("en" folder)

The header of the HTML file with English text is structured similarly to the HTML file with German text.

```
<!DOCTYPE HTML PUBLIC "-//W3C//DTD HTML 4.01 Transitional//EN">
<html>
<head>
<meta http-equiv="Content-Language" content="en">
```

```
<meta http-equiv="Content-Type" content="text/html; charset=utf-8">
<title>Language switching english page</title>
<script type="text/javascript" src="script/lang.js" ></script>
```

Language selection is also implemented in the body of the file by the "select" HTML element. In contrast to the German HTML file, the English option is already selected as a default and the text or the labels are in English.

```
<!-- Language Selection -->
<table>
  <tr>
    <td align="right" valign="top" nowrap>
      <!-- change language immediately on change of the selection
-->
      <select name="Language"
onchange="DoLocalLanguageChange(this)" size="1">
        <option value="de" >German</option>
        <option value="en" selected >English</option>
      </select>
    </td>
  </tr>
</table>
<!-- Language Selection End-->
```

### Structure of "lang.js" file (in the "script" folder)

The " DoLocalLanguageChange" function is defined in the Java script file and calls the "SetLangCookie" function with the language selection value. SetLangCookie combines the cookie name and cookie value and then sets the cookie by means of the corresponding document.cookie property. The web page must then be reloaded (top.window.location.reload) to allow the web server to react to the setting of the cookie by displaying the required language.

```
function DoLocalLanguageChange(oSelect) {
  SetLangCookie(oSelect.value);
  top.window.location.reload();
}

function SetLangCookie(value) {
  var strval = "siemens_automation_language=";
  // this is the cookie by which the web server
  // detects the desired language
  // this name is required by the web server
  strval = strval + value;
  strval = strval + "; path=/ ;";
  // set path to the application, since otherwise
  // path would be set to the requesting page
  // would not get the cookie.
  // The path for user defined applications follows this
sample:
  // path=/awp/<application name>/<pagename>
  // example: path=/awp/myapp/myappstartpage.htm
  //(where myapp is the name of the web application
  // entered in the web server properties of the cpu)
```



```
/*
use expiration if this cookie should live longer
than the current browser session
var now      = new Date();
var endtime = new Date(now.getTime() + expiration);
strval = strval + "; expires=" + endtime.toGMTString()
+ ";";
*/
document.cookie = strval;
}
```

## Additional configurations

### Configuring additional functions

The S7-1200 automation system has numerous additional functions that are useful as integrated CPU functions or available via plug-in modules (for example, communication modules). You can find the description via the following links.

### See also

- Overview of point-to-point communication (Page 867)
- General information on high-speed counters (Page 863)
- Configuring PID\_Compact V1 (Page 5959)
- Configuring PID\_3Step V1 (Page 5991)
- Motion functionality of the CPU S7-1200 (Page 6008)

#### **8.1.4.4 S7-1200 CM/CP**

### **S7-1200 CM/CP**

### **Telecontrol S7-1200**

### **CP 1242-7**

### **CP 1242-7 configuration**

### **Modes of the GPRS-CP**

### **Modes of the CP**

The CP 1242-7 allows an S7-1200 to communicate as a GPRS station with a central station or other remote networks via the GSM network. For communication using GPRS, the CP is set to one of the following operating modes:

- **Telecontrol**  
This operating mode of the CP allows the GPRS station to exchange data with the following partners:
  - **Communication with the Telecontrol server**  
This CP mode allows the GPRS station to exchange data with a telecontrol server. The Telecontrol server is a PC connected to the Internet with the "TELECONTROL SERVER BASIC" application. It is generally located in the master station and serves to monitor and control the remote GPRS stations. Data can be exchanged with the OPC client of a central control system via the integrated OPC interface. The Telecontrol server PC is not configured in STEP 7. The "TELECONTROL SERVER BASIC" application has its own configuration user interface.
  - **Communication with another remote GPRS station**

The message frames are transmitted via the Telecontrol server.

- Communication with an engineering station (for TeleService)

Communication with the Telecontrol server is performed via the GSM network and the Internet.

This operating mode requires a SIM card with GPRS service enabled and a Telecontrol server that can be reached by the CP.

- GPRS direct

This operating mode of the CP is used for direct communication between remote stations via the GSM network. No Telecontrol server is required.

To allow network nodes in public wireless networks to be directly accessible, these need to be addressed using a fixed address. Here, SIM cards with a fixed IP address are used that allow the stations to address each other directly.

The possible communications services and security functions (for example VPN) depend on what is offered by the network provider.

Possible communications partners of the GPRS station with a CP 1242--7 in "GPRS direct" mode are:

- A subscriber that can be reached by the CP via an IP address (GPRS station with CP 1242-7)
- An engineering station (for TeleService)

## Establishing a connection using GPRS communication

### Connection modes

- "GPRS direct" mode

There are no different connection modes in the "GPRS direct" mode.

- "Telecontrol" mode

The CP can be configured for the following connection modes.

- "Permanent" connection mode

There is a permanent TCP connection to the telecontrol server. Following connection establishment, there is a permanent TCP connection to the telecontrol server even if data is not transferred permanently.

- "Temporary" connection mode

A connection is only established to the telecontrol server when required.

If a TCP connection is established, process data is sent as soon as the telecontrol instructions are called on the CPU.

A connection is always established by the CP. If a connection established by the CP is interrupted, the CP automatically attempts to re-establish the connection.

### Triggering connection establishment for permanent stations ("Telecontrol" mode)

In the "Telecontrol" mode, the permanent connection to the telecontrol server is established when the station starts up. If there is an interruption on the connection, the establishment of the connection can be triggered by a wake-up SMS (see below).

### Triggering connection establishment for temporary stations ("Telecontrol" mode)

With "temporary" stations, connection establishment can be triggered by the following events:

- Event on the local CPU that needs to be evaluated by the program.  
In terms of the program, two situations need to be distinguished:
  - Events that lead to a single connection establishment (for example alarms or commands from the operator).
  - Expiry of an interval that leads to cyclic connection establishment (for example once daily for data transmission)
- Request by a communications partner (OPC client or S7 station)  
The request from the communications partner leads to the connection being established.
- Request for TeleService by an engineering station  
The request switched by the telecontrol server or TeleService gateway does not need to be evaluated in the program.
- Wake-up SMS of the telecontrol server  
The wake-up SMS can be triggered spontaneously on the telecontrol server. It is also possible to configure cyclic sending on the telecontrol server.
- Telephone wake-up call  
The wake-up call can be sent from a telephone that has a phone number authorized in the STEP 7 project. The telephone must support the CLIP function (transfer of its own call number).  
The connection establishment with the (main) telecontrol server is triggered.
- Telephone wake-up SMS  
The wake-up SMS can be sent from a telephone that has a phone number authorized in the STEP 7 project. The telephone must support the CLIP function (transmission of its own number) and sending of SMS.  
The connection establishment with the telecontrol server specified in the SMS is triggered.

When a temporary station is woken up, all the data is transferred if this has changed since the last data transfer.

### Triggering connection establishment in "GPRS direct" mode

In "GPRS direct" mode, a connection establishment is triggered by the following events:

- Event on the local CPU that is evaluated by the program.
- Request by a communications partner (not an engineering station)  
The request in the frame received from the communications partner is evaluated in the program by calling the telecontrol instructions.
- Request for TeleService by an engineering station  
The request switched by the telecontrol server or TeleService gateway does not need to be evaluated in the program.

### **Right to wake-up by "authorized phone numbers"**

The CP only accepts an SMS if the sending communication partner is authorized based on its phone number. These numbers are in configured for the CP in STEP 7 in the "authorized phone numbers" list.

---

#### **Note**

##### **"Authorized phone numbers" in the STEP 7 project**

- A phone number entered here gives the sender who transfers this phone number the right to trigger connection establishment.
  - If an asterisk (\*) is entered in the list, the CP accepts SMS messages from all senders.
  - If the list is empty, the CP cannot be woken up for connection establishment.
-

## Wake-up SMS

Depending on the connection type and the triggering server or intermediary TeleService server, the following text must be transferred in the wake-up SMS:

- For telecontrol connections:
  - Text for the wake-up SMS message for establishing a connection to the telecontrol server:  
TELECONTROL
  - Text for the wake-up SMS message for establishing a connection to the main telecontrol server:  
TELECONTROL MAIN
  - Text for the wake-up SMS message for establishing a connection to the substitute telecontrol server:  
TELECONTROL BACKUP

The configuration of the telecontrol server for the GPRS CP is set in STEP 7 in "Telecontrol interface > Operating mode > main or substitute telecontrol server".

---

### Note

#### Wake-up with a mobile phone

- One of the texts listed above can be used in a wake-up SMS message.
  - With a wake-up call, the station always connects to the main telecontrol server.
- 

- For TeleService connections:
  - Text for the wake-up SMS message for establishing a connection to the first configured TeleService server:  
TELESERVICE  
or  
TELESERVICE 1
  - Text for the wake-up SMS message for establishing a connection to the second configured TeleService server:  
TELESERVICE 2

The configuration of the TeleService server for the GPRS CP is set in STEP 7 in "Telecontrol interface > TeleService authorization > 1st or 2nd TeleService server".

## Preferred GSM networks

### Selection of preferred GSM networks

The following options are provided to select the GSM networks that the CP 1242-7 should preferably dial up:

- **Automatic dialup**  
The CP dials with highest priority into the GSM network of the contracted network operator set on the SIM card. If a connection cannot be made within the contracted network, the CP dials up another GSM network with which the network operator has a roaming contract and whose access data is stored on the SIM card.
- **Contract network only**  
The CP only dials up the GSM network of the contracted network operations whose SIM card is plugged into the CP. No roaming.
- **Contracted network and alternative network**  
The CP dials up the contracted network with the highest priority. If dialup to the contracted network is unsuccessful, the CP dials up an alternative GSM network, in decreasing priority, as entered in the list of preferred network operators.  
The alternative networks are entered in the list as "Public Land Mobile Network" (PLMN). PLMN is a construct of Mobile Country Code (MCC) and Mobile Network Code (MNC).  
Example: 26276  
This is the PLMN for the test network of Siemens AG with MCC = 262 and MNC = 76.

### Time-of-day synchronization in NTP mode - parameter assignment

#### NTP mode (NTP: Network Time Protocol)

In NTP mode, the CP sends time-of-day queries at regular intervals to one or more NTP servers. From the responses of the servers, the CP selects the most accurate time of day.

The advantage of this mode is that it allows the time to be synchronized across subnets.

In NTP mode, it is generally UTC (Universal Time Coordinated) that is transferred. This corresponds to GMT (Greenwich Mean Time).

## CP 1242-7 TeleService

### TeleService via GPRS

#### Communication path for TeleService via GPRS

With TeleService for remote S7 stations with the CP 1242-7 via GPRS, the connection is always established via an intermediary between the engineering station and remote S7 station.

This intermediary can be either:

## *8.1 Configuring devices and networks*

- A telecontrol server (and possibly a substitute telecontrol server)  
The telecontrol server can be a separate PC or installed on the engineering station in the form of the "TELECONTROL SERVER BASIC" application.
- A TeleService server  
A TeleService server is used when no telecontrol server is available; in other words, when the CP operates in "GPRS direct" mode.

The telecontrol server or TeleService server can be connected to the engineering station via LAN or Internet and the TeleService function can be called from there.

### **Requirements for TeleService via GPRS**

- A telecontrol server or a TeleService server
- The STEP 7 project with the required data for GPRS communication

### **Note on project engineering**

The telecontrol server and TeleService server are not configured in STEP 7.

### **See also**

Establishing a connection using GPRS communication (Page 675)

Modes of the GPRS-CP (Page 674)

### **Establishing a TeleService connection via GPRS**

#### **Establishing a connection for TeleService via GPRS**

The request to establish a connection is triggered by the engineering station and transmitted by a wake-up SMS to the station. The CP 1242-7 in the S7-1200 station establishes a connection to the engineering station via the GSM network and the Internet.

#### **Starting the TeleService via GPRS**

Start the TeleService via GPRS as follows:

1. In the project on the authorized engineering station, select the remote S7 station with which you want to establish a TeleService connection via GPRS.
2. Alternatively, open the "Connect online" dialog box as follows:
  - "Connect online" button
  - "Connect online" shortcut menu (right mouse button)
  - "Online" > "Connect online" menu

The "Connect online" dialog box opens.

3. Choose interface type "TeleService GPRS" in the "Type of PG/PC interface" drop-down list.



4. In the "PG/PC interface" drop-down list, select the "GPRS TeleService board" option if it is not automatically displayed.
5. Click on the "Connect" icon next to the "PG/PC interface" drop-down list. The "Establish remote connection" dialog box opens.
6. Make the necessary settings in the "Establish remote connection" dialog. Details of this are contained in the tooltip cascade of STEP 7.

The following details are required to successfully establish a connection:

### **Details required to establish a connection with the GPRS station**

The following information is necessary in the "Establish remote connection" dialog:

- IP address or DNS name of the telecontrol server
- TCP port number of the telecontrol server or the DSL router via which the connection between the engineering station and the remote GPRS station is running.
- Server password of the ES to authenticate the engineering station at the telecontrol server  
Only required if a group-specific password has been configured in the "TELECONTROL SERVER BASIC" application.
- TeleService user name  
See CP configuration in STEP 7.
- TeleService password  
See CP configuration in STEP 7.
- Access ID of the CP  
Only required when there are several CP 1242-7s in the station. See CP configuration in STEP 7.

### **Status**

#### **Connection statuses of TeleService via GPRS**

The following connection statuses can be displayed in the "Establish remote connection" dialog box:

- Not connected  
There is no connection to the remote GPRS station. Connection establishment has not yet started.

If connection establishment was started by clicking the "Connect" button, the following statuses are displayed one after the other after the connection has been established:

- Connect to telecontrol server  
The engineering station connects to the telecontrol server.
- Wait for S7 station  
The wake-up SMS has been sent to the remote station. Wait for reply from station.

*8.1 Configuring devices and networks*

- Authentication at S7 station  
The S7 station has established an IP connection with the engineering station via GPRS and Internet and is checking the received logon and authentication data.
- Connected  
The station has successfully established the connection to the engineering station.

The following states may be displayed if the connection cannot be successfully established:

- Telecontrol server not accessible  
Possible causes:
  - The connection between the engineering station and the telecontrol server has been interrupted.
  - The telecontrol server is switched off.
- Wrong server password  
Cause: The wrong server password for logging on and authentication was entered at the telecontrol server.
- S7 station not responding  
Possible causes:
  - Faulty GSM communication between the telecontrol server and the station.
  - Faulty connection between the GSM network and the Internet.
  - Faulty Internet connection.
  - The telecontrol server could not send a wake-up SMS.
  - The CP has not received a wake-up SMS.
  - The sender of the SMS was not configured in the list of authorized wake-up call numbers.
- Wrong TeleService user name or TeleService password  
Possible causes:
  - An incorrect TeleService user name or incorrect TeleService password was entered in the authentication dialog for the CP 1242-7.
  - The TeleService user name or TeleService password was not configured in STEP 7.
- All TeleService access points are in use.
- The CP is not known to the telecontrol server.  
Cause: The CP originates from a STEP 7 project that does not match the project of the telecontrol server.
- No resources available for TeleService on the CP: Please contact the hotline.
- Protocol error  
Cause: Wrong frame or frame from wrong subscriber. Please contact the hotline.

## CP 1243-1

### CPU scan cycle

#### Structure of the CPU scan cycle

The cycle with which the CP scans the memory area of the CPU is made up of the following phases:

- **High-priority read jobs**  
For datapoints configured with the priority "high priority", the PLC tags are all read in every scan cycle.
- **Unsolicited write jobs**  
In every cycle, the values of a certain number of unsolicited write jobs are written to the CPU. The number of tags written per cycle is specified with the "Max. number of write jobs" parameter. The tags that exceed this value and can therefore not be written in one cycle are then written in the next or one of the following cycles.
- **PLC tags with change control**  
The values of PLC tags registered with the CPU for automatic change control are all read in every scan cycle.
- **Low-priority read jobs - proportion**  
For datapoints configured with the priority "low priority", a proportion of the values of their PLC tags is read in every scan cycle. The number of tags read per cycle is specified with the "Max. number of read jobs" parameter. The tags that exceed this value and can therefore not be read in one cycle are then read in the next or one of the following cycles.
- **System delay**  
This is the processing time of a scan cycle.

#### Duration of the CPU scan cycle

Since no fixed time can be configured for the cycle and since the individual phases cannot be assigned a fixed number of objects, the duration of the scan cycle is variable and can change dynamically.

A pause between cycles can also be configured to reserve adequate time for other processes that access the backplane bus of the station.

#### Datapoint types

During the configuration of the user data to be transferred by the CP 1243-1, each datapoint is assigned a protocol-specific datapoint type. The datapoint types supported by the CP along with the compatible S7 data types are listed below. They are grouped according to format and memory requirements.

**CP 1243-1 (DNP3): Datapoint types and object groups**

The DNP3 protocol specifies object groups that differ according to data type and send direction (**out**) or receive direction (**in**).

Table 8-48 Object groups and data types supported by the CP (DNP3)

Format (memory requirements)	Datapoint type (object group)	Direction: in / out	Compatible S7 data types
<ul style="list-style-type: none"> <li>• Bit</li> </ul>			<ul style="list-style-type: none"> <li>• BOOL</li> </ul>
	Binary Input (1)	in	
	Binary Input Event (2)	in	
	Binary Output (10)	out	
	Binary Output Event (11)	out	
	Binary Command (12)	out	
<ul style="list-style-type: none"> <li>• Byte</li> <li>• Integer (16 bits)</li> <li>• Integer (32 bits)</li> </ul>			<ul style="list-style-type: none"> <li>• BYTE, SINT, USINT</li> <li>• INT, UINT, WORD</li> <li>• DINT, UDINT, DWORD</li> </ul>
	Counter Static (20)	in	
	Frozen Counter (22)	in	
	Counter Static Event (21)	in	
	Frozen Counter Event (23)	in	
	Analog Input (30)	in	
	Analog Input Event (32)	in	
	Analog Output Status (40)	out	
	Analog Output (41)	out	
	Analog Output Event (42)	out	
	Octet String (110) *	in	
	Octet String Event (111) *	in	
	Octet String (110) *	out	
<ul style="list-style-type: none"> <li>• Floating-point number (32 bits)</li> <li>• Floating-point number (64 bits)</li> </ul>			<ul style="list-style-type: none"> <li>• REAL</li> <li>• LREAL</li> </ul>
	Analog Input (30)	in	
	Analog Input Event (32)	in	
	Analog Output Status (40)	out	
	Analog Output (41)	out	
	Analog Output Event (42)	out	
	Octet String (110) *	in	
	Octet String Event (111) *	in	
	Octet String (110) *	out	

\* Contiguous memory areas can be transferred up to size of 255 bytes via datapoint types of the object groups 110 (Octet String) and 111 (Octet String Event).

## Types of transmission and event classes

### Types of transmission for datapoint values

The values of datapoints can be assigned to various types of transmission. The value of a datapoint is sent either after being requested by the communications partner or unsolicited as an event. The following event classes are possible:

- **Transfer after call**  
The value of the datapoint is transferred only following a call by the communications partner.
- **Every value triggered**  
Each individual changed value in the image memory of the CP is transferred.
- **Event class ...**  
The value is transferred triggered as a class 1, 2 or 3 event.
- **Current value triggered**  
Only the value of a datapoint stored in the image memory of the CP at the time of the trigger that triggers the transfer is transferred.

### Analog value preprocessing

Some CPs have analog value preprocessing that, among other things, supports the functions described below.

### Smoothing factor

Analog values that fluctuate quickly can be evened out using the smoothing function.

The smoothing factors are calculated according to the following formula as with S7 analog input modules.

$$y_n = \frac{x_n + (k - 1)y_{n-1}}{k}$$

where

$y_n$  = smoothed value in the current cycle

$x_n$  = value acquired in the current cycle n

k = smoothing factor

The following values can be configured for the module as the smoothing factor.

- 1 = No smoothing
- 4 = Weak smoothing
- 32 = Medium smoothing
- 64 = Strong smoothing

### Fault suppression time

An analog value in the overflow range (32767 / 7FFF<sub>n</sub>) or underflow range (-32768 / 8000<sub>n</sub>) is not transferred for the duration of the fault suppression time. This also applies to live zero

inputs. The value in the overflow/underflow range is only sent after the fault suppression time has elapsed, if it is still pending.

If the value returns to the measuring range before the fault suppression time elapses, the current value is transferred immediately.

A typical use case for this parameter is the suppression of peak current values when starting up powerful motors that would otherwise be signaled to the control center as a disruption.

The suppression is adjusted to analog values that are acquired by the S7 analog input modules as raw values. These modules return the specified values for the overflow or underflow range for all input ranges (also for live zero inputs).

If the CPU makes preprocessed finished values available in the bit memory area or in a data block, fault suppression is only possible or useful if these values have the values listed above ( $32767 / 7FFF_h$ ) or ( $-32768 / 8000_h$ ) in the overflow or underflow range. If this is not the case, the parameter should not be enabled for preprocessed values.

## Mean value generation

With this parameter, acquired analog values are transferred as mean values.

The current values of an analog datapoint are acquired cyclically and totaled. The number of acquired values per time unit depends on the read cycle of the CPU and the CPU scan cycle of the CP. The mean value is calculated from the accumulated values as soon as the transfer is triggered by a time trigger. Following this, the accumulation starts again so that the next mean value can be calculated.

The mean value can also be calculated if the transmission of the analog value message is triggered by a request from the communications partner. The duration of the mean value calculation period is then the time from the last transmission (for example triggered by the trigger) to the time of the request. Once again, the accumulation restarts so that the next mean value can be calculated.

If the acquired analog value in the overflow range ( $32767 / 7FFF_h$ ) or underflow range ( $-32768 / 8000_h$ ), this value can either be taken into account immediately in the calculation of the mean value or it can be suppressed for a specific period for the calculation of the mean value. The required response can be decided with the Fault suppression time parameter:

- Fault suppression time = 0  
Acquisition of a value in the overflow or underflow range results in the mean calculation being stopped immediately. The value  $32767 / 7FFF_h$  or  $-32768 / 8000_h$  is saved as an invalid mean value for the current mean value calculation period and sent when the next analog value message is triggered. The calculation of a new mean value is then started. If the analog value remains in the overflow or underflow range, this new value is again saved immediately as an invalid mean value and sent when the next frame is triggered.
- Fault suppression time > 0  
If the acquired analog value is in the overflow or underflow range, the bad values are excluded from the calculation of the mean value for a maximum time as defined by the Fault suppression time. If this time is exceeded, the value  $32767 / 7FFF_h$  or  $-32768 / 8000_h$  is saved as an invalid mean value and sent when the next analog value frame is triggered. The procedure is identical in each new averaging period; in other words, bad values are again suppressed for the duration of the fault suppression time.

The duration of the fault suppression time also indirectly decides the proportion of invalid values per averaging period. If the mean value is formed, for example in a cycle of 15 minutes, and

the fault suppression time is set to 5 minutes, this means that the mean value is only transferred as invalid if more than 33% of the acquired analog values are in the overflow or underflow range in the current averaging period.

#### 8.1.4.5 IPv6 protocol

The Internet Protocol version 6 - called IPv6 below - extends the Internet Protocol version 4 (IPv4) that is used predominantly at the current time.

##### Address format IPv6: Notation

IPv6 addresses consist of 8 fields each with four-character hexadecimal numbers (128 bits in total). The fields are separated by a colon.

Example:

fd00:ffff:ffff:ffff:ffff:ffff:2f33:8f21

Rules / simplifications:

- Leading zeros within a field can be omitted.  
Example: fd01:0:ffff::2d12:7d23
- If one or more fields have the value 0, a shortened notation is possible.  
The address fd00:0:0:0:0:0:0:8f21 can also be shortened and written as follows:  
fd00::8f21  
To ensure uniqueness, this shortened form can only be used once within the entire address.
- Decimal notation with periods  
The last 2 fields or 4 bytes can be written in the normal decimal notation with periods.  
Example: The IPv6 address fd00::ffff.125.1.0.1 is equivalent to fd00::ffff:7d01:1

##### Entry and appearance

The entry of IPv6 addresses is possible in the notations described above. IPv6 addresses are always shown in the same notation in which they were entered.

#### 8.1.4.6 SCALANCE X, W and M

##### Legal notice

##### Qualified personnel

The product/system belonging to this documentation may only be handled by **qualified personnel** for the intended purpose taking into account the documentation relating to the intended purpose and, in particular, the safety and warning notices it contains. Due to training and experience, qualified personnel is capable of recognizing risks and avoiding possible dangers when handling these products/systems

## Editing properties and parameters

### Editing options

You have the following options for editing properties and parameters:

- **Hardware and network editor**  
Once you have inserted the network component, you can edit the properties and parameters, for example the device name. You will find more detailed information in "Hardware and network editor".
- **Web Based Management (WBM)**  
The parameters and properties are accessible using the supplied HTML pages (WBM pages). Each WBM page has its own help page that describes the properties and parameters. For further information, refer to the configuration manual "SCALANCE X500 Web Based Management". You will find the MIB at Siemens Industry Automation and Drives Service & Support on the Internet under the entry ID 67428305 (<http://support.automation.siemens.com/WW/view/en/67428305>).
- **Command Line Interface**  
All the configuration settings for the device can be made using the CLI. The CLI provides the same options as Web Based Management (WBM). For further information, refer to the configuration manual "SCALANCE X500 Command Line Interface". You will find the MIB at Siemens Industry Automation and Drives Service & Support on the Internet under the entry ID 67430663 (<http://support.automation.siemens.com/WW/view/en/67430663>).

### Requirement for WBM and CLI

- The device has an IP address
- There is a connection between the device and the client PC. With the ping command, you can check whether or not a connection exists.
- The integrated Web server is activated.
- Recommended Web browser:
  - Microsoft Internet Explorer version 9.0
  - Mozilla Firefox version ESR17
- JavaScript is activated in the Web browser.
- The Web browser must not be set so that it reloads the page from the server each time the page is accessed. The updating of the dynamic content of the page is ensured by other mechanisms.  
In the Internet Explorer, you can make the setting in the "Tools > Internet Options > General" menu in the section "Browsing history" with the "Settings" button. Under "Check for newer versions of stored pages:", select "Automatically".
- If a firewall is used, the relevant ports must be opened.
  - For access using HTTP: Port 80
  - For access using HTTPS: Port 443

#### Display of the WBM on mobile devices:

For mobile devices, the following minimum requirements must be met:



Resolution	Operating system	Web browser
960 x 640 pixels	Android as of version 4.2.1 iOS as of version 6.0.2	Chrome as of version 18 on Android Safari as of version 6 on iOS

Tested with the following Web browsers for mobile devices

- Safari as of V6 on iOS 6 (iPad Mini, iPod Touch 4. Generation)
- Chrome 25 on Android (Galaxy Nexus 4, Galaxy Nexus 7)

---

#### Note

##### Page display and working with the WBM on mobile devices

The display on the WBM pages and how you work with them on mobile devices may differ compared with the same pages on desktop devices. Some pages also have an optimized display for mobile devices.

---

## Availability

The availability of the properties and parameters depends on the port type. The following types are possible:

- Switch port
- Router port

## IP address assignment

### Configuration options

When shipped and after restoring to the factory settings, the device does not have an IP address.

The following options are available to assign an IP address to the device:

- DHCP (default setting)
- Primary Setup Tool  
For further information, refer to the configuration manual "Primary Setup Tool". You will find the MIB at Siemens Industry Automation and Drives Service & Support on the Internet under the entry ID 19440762 (<http://support.automation.siemens.com/WW/view/en/19440762>).
- STEP 7
- CLI via the serial interface  
For further information, refer to the configuration manual "SCALANCE X500 Command Line Interface". You will find the MIB at Siemens Industry Automation and Drives Service & Support on the Internet under the entry ID 67430663 (<http://support.automation.siemens.com/WW/view/en/67430663>).

## Requirement

- "Set IP address using a different method" is enabled in the properties of the device. You will find more detailed information in "Addressing PROFINET devices".

## System

## Configuration

On this page, you specify the services with which the device can be accessed. With some services, there are further configuration pages on which more detailed settings can be made.

## Settings

- **Telnet-server**  
Enable or disable the "Telnet Server" service for unencrypted access to the CLI.
- **SSH server**  
Enable or disable the "SSH Server" service for encrypted access to the CLI.
- **HTTPS server only**  
Enable or disable access using HTTP.
- **SMTP Client**  
Enable or disable the SMTP client. You can configure other settings in "System > SMTP Client".
- **Syslog Client**  
Enable or disable the system event client. You can configure other settings in "System > Syslog client".
- **DCP Server**  
Specify whether or not the device can be accessed with DCP (Discovery and Configuration Protocol):
  - "-" (disabled)  
DCP is disabled. Device parameters can neither be read nor modified.
  - Read/write  
With DCP, device parameters can be both read and modified.
  - Read only  
With DCP, device parameters can be read but cannot be modified.

- **Time setting**

Select the required setting. The following settings are possible:

  - Manual  
The system time is set manually.
  - SNTP Client  
The system time is set via an SNTP server. You can configure other settings in "System > System time > SNTP client".
  - NTP Client  
The system time is set via an NTP server. You can configure other settings in "System > System time > NTP client".
  - SIMATIC Time  
The system time is set using a SIMATIC time transmitter. You can configure other settings in "System > System Time > SIMATIC Time Client".
- **SNMP**

Select the required protocol. The following settings are possible:

  - "-" (SNMP disabled)  
Access to device parameters using SNMP is not possible.
  - SNMPv1/v2c/v3  
Access to device parameters is possible with SNMP versions 1, 2c or 3. You can configure other settings in "System > SNMP > General".
  - SNMPv3  
Access to device parameters is possible with SNMP version 3. You can configure other settings in "System > SNMP > General".
- **SNMPv1/v2c write protected**

Enable or disable write access to SNMP variables with SNMPv1/v2c.
- **SNMPv1 traps**

Enable or disable the sending of SNMP traps (alarm frames). You can configure other settings in "System > SNMP > Traps".
- **SINEMA configuration interface**

Enable or disable the SINEMA configuration interface.
- **Configuration mode**

Select the required mode. The following modes are possible:

  - Automatic save  
Automatic save mode. Approximately 1 minute after the last parameter change or when you restart the device, the configuration is automatically saved.
  - Test  
In Test mode, although changes are adopted, they are not saved in the configuration file (startup configuration).  
To save changes in the configuration file, use the "Write Startup Config" button. The button is displayed when you set test mode. The display area also shows the message "Trial mode active - Press "Write Startup Config" button to make your settings persistent" as soon as there are unsaved modifications. This message can be seen on every WBM page until the changes made have either been saved or the device has been restarted.

## General

### Device

This page contains the general device information.

### Settings

- **System Name**  
You can enter the name of the device. The entered name is displayed in the selection area. A maximum of 255 characters are possible. The system name is also displayed in the CLI input prompt. The number of characters in the CLI input prompt is limited. The system name is truncated after 16 characters.
- **System Contact**  
You can enter the name of a contact person responsible for managing the device.
- **Location**  
You can enter the location of the device. The entered installation location is displayed in the selection area.

---

#### Note

The ASCII code 0x20 to 0x7e is used in the input boxes.

At the start and end of the input boxes "System name", "System Contact" and "System Location", the characters "<", ">" and "space" are not permitted.

---

### Coordinates

On this page, you configure the geographic coordinates (latitude, longitude and the height above the ellipsoid according to WGS84). These boxes are purely for information with a maximum length of 32 characters.

#### Getting the coordinates

Use suitable maps for obtaining the geographic coordinates of the device.

The geographic coordinates can also be obtained using a GPS receiver. The geographic coordinates of these devices are normally displayed directly and only need to be entered in the input boxes of this page.

## Settings

- **Latitude**

Enter the north or south latitude for the location of the device.  
For example, +49° 1' 31.67" means that the device is located at 49 degrees, 1 arc minute and 31.67 arc seconds north latitude.  
A south latitude is shown by a preceding minus character.  
You can also append the letters N (north latitude) or S (south latitude) to the numeric information (49° 1' 31.67" N).
- **Longitude**

Enter the value of the eastern or western longitude of the location of the device.  
For example, +8° 20' 58.73" means that the device is located at 8 degrees, 20 minutes and 58.73 seconds east.  
A western longitude is indicated by a preceding minus sign.  
You can also add the letter E (eastern longitude) or W (western longitude) to the numeric information (8° 20' 58.73" E).
- **Height**

Enter the value of the height above sea level in meters.  
For example, 158 m means that the device is located at a height of 158 m above sea level.  
Heights below sea level (for example the Dead Sea) are indicated by a preceding minus sign.

## Load & save

### Uploading and saving using TFTP

### Loading and saving data via a TFTP server

On this page, you can configure the TFTP server and the file names. The WBM also allows you to store device data in an external file on your client PC or to load such data from an external file from the PC to the devices. This means, for example, that you can also load new firmware from a file located on your client PC.

---

#### Note

##### Incompatibility with predecessor versions

During the installation of a previous version, the configuration data can be lost. In this case, the device starts up with the factory settings after the firmware has been installed.

##### Incompatibility with predecessor versions with inserted PLUG

During the installation of a previous version, the configuration data can be lost. In this case, the device starts up with the factory settings after the firmware has been installed. In this situation, if a PLUG is inserted in the device, following the restart, this has the status "Not Accepted" since the PLUG still has the configuration data of the previous more up-to-date firmware. This allows you to return to the previous, more up-to-date firmware without any loss of configuration data. If the original configuration on the PLUG is no longer required, the PLUG can be deleted or rewritten manually using "System > PLUG".

---

**Note**

**Configuration files and trial mode/automatic save mode**

In "Automatic Save" configuration mode, the data is saved automatically before the configuration files (ConfigPack and Config) are transferred.

In Trial mode, although the changes are adopted, they are not saved in the configuration files (ConfigPack and Config). Use the "Write Startup Config" button on the "System > System Configuration" WBM page to save changes in the configuration files.

---

**Settings**

- **TFTP Server IP Address**  
Here, enter the IP address of the TFTP server with which you exchange data.
- **TFTP Server Port**  
Here, enter the port of the TFTP server via which data exchange will be handled. If necessary, you can change the default value 69 to your own requirements.

The table has the following columns:

- **File type**  
Shows the file type.
- **Description**  
Shows the short description of the file type.
- **File name**  
Enter a file name.

**Events**

**Configuration**

On this page, you specify how the device reacts to events.

## Settings

- **Signaling Contact Method**  
Select the behavior of the signaling contact. The following reactions are possible:
  - conventional  
Default setting for the signaling contact. An error/fault is displayed by the fault LED and the signaling contact is opened. When the error/fault state no longer exists, the fault LED goes off and the signaling contact is closed.
  - aligned  
The way the signaling contact works does not depend on the error/fault that has occurred. The signaling contact can be opened or closed as required by user actions.
- **Signaling Contact Status**  
Select the status of the signaling contact. The following statuses are possible:
  - close  
Signaling contact is closed.
  - open  
Signaling contact is opened.

Table 1 has the following columns:

- **1st column**  
Shows that the settings are valid for all ports of table 2.
- **E-mail/Trap/Log Table/Syslog/Error**  
Select the required setting. If "No Change" is selected, the entry in table 2 remains unchanged.
- **Copy to Table**  
If you click the button, the setting is adopted for all ports of table 2.

Table 2 has the following columns:

- **Event**  
The "Event" column contains the following values:
  - Cold/Warm Start  
The device was turned on or restarted by the user.
  - Link Change  
This event occurs only when the port status is monitored and has changed, see "System > Fault Monitoring > Link Change".
  - Authentication Failure  
This event occurs when attempting access with a bad password.
  - Power Change  
This event occurs only when power supply lines 1 and 2 are monitored. It indicates that there was a change to line 1 or line 2, see System > Fault monitoring > Power supply".
  - Spanning Tree Change  
The STP or RSTP or MSTP topology has changed.
  - Fault State Change  
The fault state has changed. The fault status can relate to the activated port monitoring, the response of the signaling contact or the power supply monitoring.
  - RMON Alarm  
An alarm or event has occurred relating to the remote monitoring of the system.
  - State Change VRRP (only with routing using VRRP)  
The status of the virtual router has changed
  - Loop Detection  
A loop was detected in the network segment.
  - OSPF State Change  
The status of OSPF has changed
- **E-mail**  
The device sends an e-mail. This is only possible if the SMTP server is set up and the "SMTP client" function is enabled.
- **Trap**  
The device sends an SNMP trap. This is only possible if "SNMPv1 traps" is enabled in "System > Configuration".
- **Log Table**  
The device writes an entry in the log table.
- **Syslog**  
The device writes an entry to the system log server. This is only possible if the system log server is set up and the "Syslog client" function is enabled.
- **Fault**  
The device triggers a fault. The error LED lights up

## Severity filter

On this page, set the threshold levels for sending system event notifications.



## Settings

The table has the following columns:

- **Client Type**  
Select the client type for which you want to make settings:
  - **E-mail**  
Sending system event messages by e-mail
  - **Log Table**  
Entering system events in the log table.
  - **Syslog**  
Entering system events in the Syslog file
- **Severity**  
Select the required level. The following settings are possible:
  - **Information**  
System events are processed as of the severity level "Information".
  - **Warning**  
System events are processed as of the severity level "Warning".
  - **Critical**  
System events are processed as of the severity level "Critical".

## SMTP client

The device provides the option of automatically sending an e-mail if an alarm event occurs (for example to the network administrator). The e-mail contains the identification of the sending device, a description of the cause of the alarm in plain language, and a time stamp. This allows centralized network monitoring to be set up for networks with few nodes based on an E-mail system. When an e-mail event message is received, the WBM can be started by the browser using the identification of the sender to read out further diagnostics information.

On this page, you can configure up to three SMTP servers and the corresponding e-mail addresses.

---

### Note

Depending on the properties and configuration of the SMTP server, it may be necessary to adapt the "From" input box for the e-mails. Check with the administrator of the SMTP server.

---

## Settings

- **SMTP Client**  
Enable or disable the SMTP client.
- **'From' Field**
  - Enter the name of the sender that will be included in the e-mail, for example the device name.

- **SMTP Port**  
Change the port if the SMTP server is not obtainable via port 25.
- **SMTP Server IP Address**  
Enter the IP address of the SMTP server.

This table contains the following columns:

- **SMTP Server IP Address**  
Shows the SMTP server IP address.
- **Receiver E-mail Address**  
Enter the e-mail address to which the device sends an e-mail if a fault occurs. The e-mail address can be the address of a single person or a distribution list.

## DHCP client

If the DHCP mode is activated, the DHCP client starts a DHCP request to a configured DHCP server and is assigned an IP address as the response. The server manages an address range from which it assigns IP addresses. It is also possible to configure the server so that the client always receives the same IP address in response to its request.

## Settings

- **DHCP Client**  
Enable or disable the DHCP client.
- **DHCP client configuration file request (opt. 66, 67)**  
Select this option if you want the DHCP client to use options 66 and 67 to download and then enable a configuration file.
- **DHCP Mode**  
Select the DHCP mode. The following modes are possible:
  - via MAC Address  
Identification is based on the MAC address.
  - via DHCP Client ID  
Identification is based on a freely defined DHCP client ID.
  - via System Name  
Identification is based on the device name. If the device name is 255 characters long, the last character is not used for identification.

## SNMP

### General

On this page, you make the basic settings for SNMP. Enable the functions you want to use.

## Description

The following settings are possible:

- **SNMP**  
Select the SNMP protocol. The following settings are possible:
  - "-" (disabled)  
SNMP is disabled.
  - SNMPv1/v2c/v3  
SNMPv1/v2c/v3 is supported.
  - SNMPv3  
Only SNMPv3 is supported.
- **SNMPv1/v2 Read-Only**  
If you enable this option, SNMPv1/v2c can only read the SNMP variables.

---

### Note

#### Community String

For security reasons, do not use the standard values "public" or "private". Change the community strings following the initial installation.

---

- **SNMPv1/v2c Read Community String**  
Enter the community string for read access of the SNMP protocol.
- **SNMPv1/v2c Read/Write Community String**  
Enter the community string for read and write access of the SNMP protocol.
- **SNMPv1 Traps**  
Enable or disable the sending of SNMP traps (alarm frames). On the "Trap" tab, specify the IP addresses of the devices to which SNMP traps will be sent.
- **SNMPv1/v2c Trap Community String**  
Enter the community string for sending SNMPv1/v2 messages.

## Traps

If an alarm event occurs, a device can send SNMP traps (alarm frames) to up to ten different management stations at the same time. Traps are only sent if events specified in "Events > Configuration" occur.

---

### Note

SNMP traps are sent only when the "SNMPv1 Traps" setting was selected in "SNMP > General".

---

## Introduction

The following setting is possible:

- **IP Address**  
Enter the IP address of the stations to which the device sends SNMP traps

The table has the following columns:

- **IP Address**  
Shows the IP addresses of the stations to which the device sends SNMP traps.
- **Trap**  
Enable or disable the sending of SNMP traps. Stations that are entered but not selected do not receive SNMP traps.

## v3 Groups

### Security settings and assigning permissions

SNMP version 3 allows permissions to be assigned, authentication, and encryption at protocol level. The security levels and read/write permissions are assigned according to groups. The settings automatically apply to every member of a group.

## Description

The following settings are possible:

- **Group Name**  
Enter the name of the group. This name must have at least two characters, the maximum length is 32 characters.
- **Security Level**  
Select the security level (authentication, encryption) valid for the selected group. In the security levels, the following options:
  - no Auth/no Priv  
No authentication enabled / no encryption enabled.
  - Auth/no Priv  
Authentication enabled / no encryption enabled.
  - Auth/Priv  
Authentication enabled / encryption enabled.

The table has the following columns:

- **Group Name**  
Shows the defined group names.

---

**Note**

Once a group name and the security level have been specified, they can no longer be modified after the group is created. If you want to change the group name or the security level, you will need to delete the group and recreate it and reconfigure it with the new name.

---

- **Security Level**  
Shows the configured security level.
- **Read**  
Enable or disable read access.
- **Write**  
Enable or disable write access.

## v3 users

### User-specific security settings

On the WBM page, you can create new SNMPv3 users and modify or delete existing users. The user-based security model works with the concept of the user name; in other words, a user ID is added to every frame. This user name and the applicable security settings are checked by both the sender and recipient.

### Description

The following settings are possible:

- **User name**  
Enter a freely selectable user name. After you have entered the data, you can no longer modify the name.

The table has the following columns:

- **User name**  
Shows the created users.
- **Group Name**  
Select the group to which the user will be assigned.
- **Authentication Protocol**  
Select the authentication protocol. Can only be enabled, if this group supports the function. The following settings are available:
  - None
  - MD5
  - SHA

- **Privacy Protocol**  
Specify whether or not the user uses the DES algorithm. Can only be enabled, if the group supports this function.
- **Authentication Password**  
Enter the authentication password in the first input box.
- **Authentication Password Confirmation**  
Confirm the password by repeating the entry.
- **Privacy Password**  
Enter your encryption password.
- **Privacy Password Confirmation**  
Confirm the encryption password by repeating the entry.

## System time

### SNTP client

SNTP (Simple **Network Time Protocol**) is used for synchronizing the time in the network. The appropriate frames are sent by an SNTP server in the network.

### Settings

- **SNTP Client**  
Enable or disable automatic time-of-day synchronization using SNTP.
- **Time Zone**  
Enter the time zone you are using in the format "+/- HH:MM". The time zone relates to UTC standard world time. Settings for daylight-saving and standard time are taken into account in this box by specifying the time offset.
- **SNTP Mode**  
Select the synchronization mode. The following types of synchronization are possible:
  - Poll  
If you select this protocol type, the input boxes "SNTP Server IP Address", "SNTP Server Port" and "Poll Interval" are displayed for further configuration. With this type of synchronization, the device is active and sends a time query to the SNTP server.
  - Listen  
With this type of synchronization, the device is passive and "listens" for SNTP frames that deliver the time of day.
- **SNTP Server IP Address**  
Enter the IP address of the SNTP server.
- **SNTP Server Port**  
Enter the port of the SNTP server.
- **Poll Interval [s]**  
Enter the interval in seconds between two time polls.

## NTP client

If you require time-of-day synchronization using NTP, you can make the relevant settings here.

### Settings

- **NTP Client**  
Enable or disable automatic time-of-day synchronization using NTP.
- **Time Zone**  
Enter the time zone you are using in the format "+/- HH:MM". The time zone relates to UTC standard world time. Settings for daylight-saving and standard time are taken into account in this box by specifying the time offset.
- **NTP Server IP Address**  
Enter the IP address of the NTP server.
- **NTP Server Port**  
Enter the port of the NTP server.
- **Poll Interval [s]**  
Enter the interval in seconds between two time polls.

## SIMATIC time client

On this page, you configure the time-of-day synchronization via the SIMATIC time client.

### Setting

- **SIMATIC Time Client**  
Enable or disable the SIMATIC Time Client.

## PTP Client

On this page, you configure time synchronization with PTP (Precision Time Protocol).

## Setting

- **PTP Client**  
Enable or disable time synchronization using PTP. You can configure other settings in "Layer 2 > PTP".

## Auto logout

On this page, set the times after which there is an automatic logout from WBM or the CLI following user in activity.

---

### Note

#### No automatic logout from the CLI

If the connection is not terminated after the set time, check the setting of the "keepalive" mechanism on the Telnet client.

If the interval is shorter than the configured time, the connection is kept alive although no user data is transferred. Example: you selected 300 seconds for the automatic logout and 120 seconds is set for the keepalive function. In this case, a packet is sent every 120 seconds that keeps the connection up.

- Disable the keepalive mechanism (interval time = 0)  
or
  - Set the interval high enough so that the underlying connection is terminated when there is inactivity.
- 

## Settings

- **Web Based Management [s]**  
Enter the time in seconds for the automatic logout from WBM. If you enter the value 0, the automatic logout is disabled.
- **CLI (TELNET, SSH, Serial) [s]**  
Enter the time in seconds for the automatic logout from the CLI. If you enter the value 0, the automatic logout is disabled.

## Button

The "Select/set" button is used for the following:

- Changing the display mode,
- Activating the redundancy manager
- Resetting to factory defaults,
- Defining the fault mask and the LED display,

You will find a detailed description of the individual functions available with the buttons in the operating instructions of the specific device.



## Settings

- **Restore Factory Defaults**  
Enables or disables the "Restore Factory Defaults" function for the Select/Set button.

 <b>CAUTION</b>
--

<b>Button function "Restore Factory Defaults" active during startup</b>
---

If you have disabled this function in your configuration, disabling is only valid during operation. When restarting, for example after power down, the function is active until the configuration is loaded so that the device can inadvertently be reset to the factory settings. This may cause unwanted disruption in network operation since the device needs to be reconfigured if this occurs. An inserted PLUG is also deleted and returned to the status as shipped
---

- **Redundancy Manager**  
Enables or disables the redundancy manager function for the Select/Set button.
- **Set Fault Mask**  
Enable or disable the function "Define fault mask via the LED display" with the Select/set button. This function only works in display mode D.

## Syslog client

Syslog according to RFC 3164 is used for transferring short, unencrypted text messages over UDP in the IP network. This requires a system log server.

### Requirements for sending log entries:

- The system log function is enabled on the device.
- The system log function is enabled for the relevant event.
- There is a system log server in your network that receives the log entries. Since this is a UDP connection, there is no acknowledgment to the sender.
- The IP address of the system log server is entered on the device.

## Settings

- **Syslog Client**  
Enable or disable the system log function.
- **Syslog Server IP Address**  
Enter the IP address of the system log server.

This table contains the following columns

- **Syslog Server IP Address**  
Shows the IP address of the system log server.
- **Server Port**  
Enter the port of the Syslog server being used.

## Ports

### Overview

The page shows the configuration for the data transfer for all ports of the device.

### Settings

- **Port**  
Shows the configurable ports. The port is made up of the port number and the slot number, for example port 0.1 is slot 0, port 1.
- **Port name**  
Shows the name of the port.
- **Negotiation**  
Shows whether the automatic configuration is enabled or disabled.
- **Flow Ctrl. Type**  
Shows whether flow control is enabled or disabled for the port.
- **Flow Ctrl.**  
Shows whether or not flow control is working on this port.
- **MTU**  
Shows the maximum packet size.
- **Port Type** (only with routing)  
Shows the type of the port. The following types are possible:
  - Switch port
  - Router port
- **Status**  
Shows whether the port is on or off. Data traffic is possible only over an enabled port.

### Configuration

On this page, you configure the ports of the device

## Settings

- **Port**  
Select the port to be configured. The port is made up of the port number and the slot number, for example port 0.1 is slot 0, port 1.
- **Status**  
Specify whether the port is enabled or disabled.
  - enabled  
The port is enabled. Data traffic is possible only over an enabled port.
  - disabled  
The port is disabled but the connection remains.
  - Link down  
The port is disabled and the connection to the partner device is terminated.
- **Port name**  
Enter a name for the port.
- **Mode Type**  
Shows the transmission speed and the transmission method of the port. You make the settings for "Autonegotiation" and "Transmission rate" in the port options.

---

**Note**

Before the port and partner port can communicate with each other, the settings must match at both ends.

---

- **Negotiation**  
Shows whether the automatic configuration of the connection to the partner port is enabled or disabled.
- **Flow Ctrl. Type**  
Shows whether or not flow control is working on this port.

---

**Note****Turning flow control on/off with autonegotiation**

Flow control can only be enabled or disabled if the "autonegotiation" function is turned off. The function cannot be enabled again afterwards.

---

- **Flow Ctrl.**  
Shows whether or not flow control is working on this port.
- **MTU**  
Enter the packet size.
- **Port Type** (only with routing)  
Select the type of the port.
  - Switch port
  - Router port

## Changing the port configuration

---

### Note

Optical ports only work with the full duplex mode and at maximum transmission rate. As a result, the following settings cannot be made for optical ports:

- Automatic configuration
  - Transmission speed
  - Transmission technique
- 

### Note

With various automatic functions, the device prevents or reduces the effect on other ports and priority classes (Class of Service) if a port is overloaded. This can mean that frames are discarded even when flow control is enabled.

Port overload occurs when the device receives more frames than it can send, for example as the result of different transmission speeds.

---

## Fault monitoring

### Power supply

Configure whether or not the power supply should be monitored by the messaging system. Depending on the hardware variant, there are one or two power connectors (Supply 1 / Supply 2). With a redundant power supply, configure the monitoring separately for each individual feed-in line.

If there is no power on one of the monitored lines (Supply 1 or Supply 2) or when the voltage is too low, a fault is signaled by the signaling system.

---

### Note

You will find the permitted operating voltage limits in the compact operating instructions of the device.

---

An error causes the fault LED to light up on the device. Depending on the configuration, the error may trigger a trap, an e-mail or an entry in the event log table.

## Settings

- **Line 1**  
Enable or disable the monitoring of power connector 1.
- **Line 2**  
Enable or disable the monitoring of power connector 2.

## Link Change

On this page, you configure whether or not an error message is triggered if there is a status change on a network connection.

If connection monitoring is enabled, an error is signaled

- when there should be a link on a port and this is missing.
- or when there should not be a link on a port and a link is detected.

An error causes the signaling contact to trigger and the fault LED to light up on the device. Depending on the configuration, the error may trigger a trap, an e-mail or an entry in the event log table.

## Settings

Table 1 has the following columns:

- **1st column**  
Shows that the settings are valid for all ports.
- **Setting**  
Select the setting from the drop-down list. You have the following options:
  - "-" (disabled)
  - Up
  - Down
  - No Change:  
The setting in table 2 remains unchanged.
- **Copy to Table**  
If you click the button, the setting is adopted for all ports of table 2.

Table 2 has the following columns

- **Port**  
Shows the available ports.
- **Setting**  
Select the setting. You have the following options:
  - Up  
Error handling is triggered when the port changes to the active status.  
(From "Link down" to "Link up")
  - Down  
Error handling is triggered when the port changes to the inactive status.  
(From "Link up" to "Link down")
  - "-" (disabled)  
The error handling is not triggered.

## Redundancy

On this page, you configure whether or not an error message is triggered if there is a status change on a network connection.

## Setting

- **Redundancy loss (HSR only)**  
Enable or disable connection monitoring. If the redundancy of the connection is lost, an error is signaled.

## PoE

### General

On this page, you specify the maximum power for the power sourcing equipment (PSE). If the power supply is redundant, the values of both power supplies are shown.

## Setting

- **PSE**  
Shows the number of the power supply.
- **Usage Threshold [%]**  
When the power being used by the end devices exceeds the percentage shown here, an event is triggered.

## Port

### Settings for the ports

For each individual PoE port, you can specify whether or not the power will be supplied via Ethernet. You can also set a priority for each connected powered device (PD). Devices for which a high priority was set, take preference over other devices for the power supply.

## Settings

The table has the following columns:

- **Port**  
Shows the configurable PoE ports.  
The port is made up of the port number and the slot number, for example port 0.1 is slot 0, port 1.
- **Setting**  
Enable the PoE power supply for this port or interrupt it.

- **Priority**  
Select which priority this port will have for the power supply.  
The following settings are possible, in ascending order of relevance:
  - Low  
low priority
  - High  
medium priority
  - Critical  
high priority

If the same priority is set for two ports, the port with the lower port number will be preferred when necessary.
- **Type**  
Here, you can enter a string to describe the connected device in greater detail.

## Layer 2

### Configuration

The functions of layer 2 are configured on this page. With some functions, there are further configuration pages on which more detailed settings can be made. You can also check the settings on the configuration pages.

### Settings

- **Protocol Based VLAN**  
Enable or disable protocol-based VLAN. You can configure other settings in "Layer 2 > VLAN".
- **Subnet Based VLAN**  
Enable or disable subnet-based VLAN. You can configure other settings in "Layer 2 > VLAN".
- **Dynamic MAC Aging**  
Enable or disable the "Aging" mechanism. You can configure other settings in "Layer 2 > Dynamic MAC Aging".
- **Redundancy Type**  
The following settings are available:
  - **"-" (disabled)**  
The redundancy function is disabled.
  - **Ring**  
Enables ring redundancy. You can configure other settings in "Layer 2 > Ring Redundancy".
  - **STP**  
If you select this option, you specify the required redundancy mode in "Redundancy Mode".

- **Redundancy Mode**

If you select "STP" for the "Redundancy Type", the following options are then available:

- **STP**  
Enables Spanning Tree Protocol (STP). Typical reconfiguration times with spanning tree are between 20 and 30 seconds. You can configure other settings in "Layer 2 > MSTP".
- **RSTP**  
Enables Rapid Spanning Tree Protocol (RSTP). If a spanning tree frame is detected at a port, this port reverts from RSTP to spanning tree. You can configure other settings in "Layer 2 > MSTP".

---

**Note**

When using RSTP (Rapid Spanning Tree Protocol), loops involving duplication of frames or frames being overtaken may occur briefly. If this is not acceptable in your particular application, use the slower standard spanning tree mechanism.

---

- **MSTP**  
Enables Multiple Spanning Tree Protocol (MSTP). You can configure other settings in "Layer 2 > MSTP".

If you select "Ring" for the "Redundancy Type", the following options are then available:

- **Automatic Redundancy Detection**  
Select this setting to create an automatic configuration of the ring redundancy mode. In this mode, the device automatically detects whether or not there is a device with the "HRP Manager" role in the ring. If this is the case, the device adopts the role of "HRP Client". If no HRP manager is found, all devices with the "Automatic Redundancy Detection" or "MRP Auto Manager" setting negotiate among themselves to establish which device adopts the role of "MRP manager". The device with the lowest MAC address will always become "MRP manager". The other devices automatically set themselves to the "MRP client" redundancy mode.
- **MRP Auto-Manager**  
Automatic media redundancy manager
- **MRP Client**  
Media redundancy client
- **HRP Client**  
High Speed Redundancy Protocol client
- **HRP manager**  
High Speed Redundancy Protocol manager
- **Standby**  
Enable or disable the "Standby redundancy" function. You can configure other settings in "Layer 2 > Ring Redundancy > Standby".
- **Passive Listening**  
Enable or disable the "passive listening" function.
- **RMON**  
If you select this check box, Remote Monitoring (RMON) allows diagnostics data to be collected on the device, prepared and read out using SNMP by a network management station that also supports RMON. This diagnostic data, for example port-related load trends, allow problems in the network to be detected early and eliminated.



- **Dynamic Multicast**  
The following settings are possible:
  - **"-" (disabled)**
  - **IGMP Snooping**  
Enables IGMP (Internet Group Management Protocol). You can configure other settings in "Layer 2 > Multicast > IGMP".
  - **GMRP**  
Enables GMRP (GARP Multicast Registration Protocol). You can configure other settings in "Layer 2 > Multicast > GMRP".

---

**Note**

GMRP and IGMP cannot operate at the same time.

---

- **GVRP**  
Enable or disable "GVRP" (GARP VLAN Registration Protocol). You can configure other settings in "Layer 2 > VLAN > GVRP".
- **Mirroring**  
Enable or disable port mirroring. You can configure other settings in "Layer 2 > Mirroring > Port".
- **Loop Detection**  
Enable or disable loop detection. You can configure other settings in "Layer 2 > Loop Detection".
- **PTP**  
Specify how the device will process PTP messages. You can configure other settings in "Layer 2 > PTP".
  - off  
The device does not process any PTP messages. PTP messages are, however, forwarded according to the rules of the switch.
  - transparent  
The device adopts the function of a transparent clock and forwards PTP messages to other nodes while at the same time making entries in the correction field of the PTP message.

## QoS

### CoS map

On this page, CoS priorities are assigned to certain queues (Traffic Queues).

## Settings

- **CoS**  
Shows the CoS priority of the incoming packets.
- **Queue**  
Select the forwarding queue (send priority) that is assigned the CoS priority.  
The higher the number of the queue, the higher the send priority.

## DSCP map

On this page, DSCP settings are assigned to various queues (Traffic Queues).

## Settings

- **DSCP**  
Shows the DSCP priority of the incoming packets.
- **Queue**  
Select the forwarding queue (send priority) that is assigned the DSCP value. The higher the queue number, the higher the send priority.

## Load limitation

### Limiting the transfer rate of incoming and outgoing data

On this page, you configure the load limitation (maximum number of data packets per second) for the individual ports. You can specify the category of frame for which these limit values will apply.

## Settings

Table 1 has the following columns:

- **1st column**  
Shows that the settings are valid for all ports.
- **Limit Ingress Unicast (DLF) / Limit Ingress Broadcast / Limit Ingress Multicast**  
Select the required setting.
  - Enabled: Enables the function.
  - Disabled: Disables the function
  - No Change: The setting in table 2 remains unchanged
- **Total Ingress Rate [pkts/s]**  
Specify the maximum number of incoming packets processed by the device. If "No Change" is entered, the entry in the table remains unchanged.

- **Egress Rate [Kb/s]**  
Specify the data rate for all outgoing frames. If "No Change" is entered, the entry in the table remains unchanged
- **Copy to Table**  
If you click the button, the settings are adopted for all ports of table 2.

Table 2 has the following columns:

- **Port**  
Shows the port to which the settings relate.
- **Limit Ingress Unicast (DLF)**  
Enable or disable the data rate for limiting incoming unicast frames with an unresolvable address (Destination Lookup Failure).
- **Limit Ingress Broadcast**  
Enable or disable the data rate for limiting incoming broadcast frames.
- **Limit Ingress Multicast**  
Enable or disable the data rate for limiting incoming multicast frames.
- **Total Ingress Rate [pkts/s]**  
Specify the maximum number of incoming packets processed by the device.
- **Egress Rate [Kb/s]**  
Specify the data rate for all outgoing frames.

---

**Note****Rounding of the values, deviation from desired value**

When you enter the values for transmission rates, note that the WBM rounds to correct values.

If values are configured for total ingress transmission rate and egress transmission rate, the actual values in operation can exceed or fall below the set values by 10%.

---

## VLAN

### General

On this page, you define the VLAN and specify the use of the ports.

---

**Note****Changing the Agent VLAN ID**

If the configuration PC is connected directly to the device via Ethernet and you change the agent VLAN ID, the device is no longer reachable via Ethernet following the change.

---

## Important rules for VLANs

Make sure you keep to the following rules when configuring and operating your VLANs:

- Frames with the VLAN ID "0" are handled as untagged frames but retain their priority value.
- As default, all ports on the device send frames without a VLAN tag to ensure that the end node can receive these frames.
- With SCALANCE X devices, the VLAN ID 1 is the default on all ports.
- If an end node is connected to a port, outgoing frames should be sent without a tag (static access port). If, however, there is a further switch at this port, the frame should have a tag added (trunk port).

## Settings

- **VLAN ID**  
Enter the VLAN ID.

The table has the following columns:

- **VLAN ID**  
Shows the VLAN ID. The VLAN ID is assigned once when you create a new data record and can then no longer be changed. To make a change, the entire data record must be deleted and created again.
- **Name**  
Enter a name for the VLAN. The name only provides information and has no effect on the configuration.

- **Status**  
Shows the status type of the entry in the port filter table. Here, static means that the address was entered as a static address by the user. The entry GVRP means that the configuration was registered by a GVRP frame. This is, however, only possible if GVRP was enabled for the device.
- **List of ports**  
Specify the use of the port. The following options are available:
  - "-"  
The port is not a member of the specified VLAN.  
With a new definition, all ports have the identifier "-".
  - M  
The port is a member of the VLAN. Frames sent in this VLAN are forwarded with the corresponding VLAN tag.
  - R  
The port is a member of the VLAN. A GVRP frame is used for the registration.
  - U (upper case)  
The port is an untagged member of the VLAN. Frames sent in this VLAN are forwarded without the VLAN tag. Frames without a VLAN tag are sent from this port.
  - u (lower case)  
The port is an untagged member of the VLAN, but the VLAN is not configured as a port VLAN. Frames sent in this VLAN are forwarded without the VLAN tag.
  - F  
The port is not a member of the specified VLAN and it is not possible for the VLAN to be registered dynamically at this port using GVRP. You can configure other settings in "Layer 2 > VLAN > Port-based VLAN".

## GVRP

### Configuration of GVRP functionality

Using GVRP frame, a different device can register at the port of the device for a specific VID. A different device, can, for example be an end device or a switch. The device can also send GVRP frames via this port.

### Settings

- **GVRP**  
Enable or disable the "GVRP" function.

Table 1 has the following columns:

- **1st column**  
Shows that the settings are valid for all ports of table 2.
  - **Setting**  
Select the setting. You have the following setting options:
    - Enabled  
Enables the sending of GVRP frames.
    - Disabled  
Disables the sending of GVRP frames.
    - No Change  
No change in table 2.
  - **Copy to Table**  
If you click the button, the setting is adopted for all ports of table 2.
- Table 2 has the following columns:
- **Port**  
Shows the available ports.
  - **Setting**  
Enable or disable the sending GVRP frames.

## Port-based VLAN

### Processing received frames

On this page, you specify the configuration of the port properties for receiving frames.

### Settings

Table 1 has the following columns:

- **Port**  
Shows that the settings are valid for all ports.
- **Priority / Port VID / Acceptable Frames / Ingress Filtering**
- Select the setting. If "No Change" is selected, the entry in table 2 remains unchanged.
- **Copy to Table**  
If you click the button, the setting is adopted for all ports of table 2.

Table 2 has the following columns:

- **Port**  
Shows the available ports and link aggregations. The port is made up of the port number and the slot number, for example port 0.1 is slot 0, port 1.
- **Priority**  
Select the priority assigned to untagged frames.  
The CoS priority (Class of Service) used in the VLAN tag. If a frame is received without a tag, it will be assigned this priority. This priority specifies how the frame is further processed compared with other frames.  
There are a total of eight priorities with values 0 to 7, where 7 represents the highest priority (IEEE 802.1p Port Priority).
- **Port VID**  
Select the VLAN ID. Only VLAN IDs defined on the "VLAN > General" page can be selected. If a received frame does not have a VLAN tag, it has a tag with the VLAN ID specified here added to it and is sent according to the rules at the port.
- **Acceptable Frames**  
Specify which types of frames will be accepted. The following alternatives are possible:
  - Only tagged frames  
The device discards all untagged frames. Otherwise, the forwarding rules apply according to the configuration.
  - All  
The device forwards all frames
- **Ingress Filtering**  
Specify whether the VID of received frames is evaluated.  
The following options are available:
  - Enabled  
The VLAN ID of received frames decides whether they are forwarded: To forward a VLAN tagged frame, the receiving port must be a member in the same VLAN. Frames from unknown VLANs are discarded at the receiving port.
  - Disabled  
All frames are forwarded.

### Protocol-based VLAN group

On this page, you specify groups to which a protocol will be assigned.

## Settings

- **Protocol Based VLAN**  
Enable or disable the protocol-based VLAN assignment.
- **Protocol Value**  
Enter the hexadecimal protocol value.  
A few examples are shown below:
  - PROFINET: 88:92
  - IP: 08:00
  - Novell: 81:37
  - netbios: f0:f0
  - appletalk: 80:9b
- **Group ID**  
Enter the ID of the group.

The table has the following columns:

- **Protocol Value**  
Shows the file value.
- **Group ID**  
Shows the group ID.

## Protocol-based VLAN port

On this page, you specify which protocol and which VLAN is assigned to the individual port.

## Settings

- **Port**  
Select the required port. All available ports and the link aggregations can be selected.
- **Group ID**  
Select the group ID from the drop-down list. Specify the ID in "Layer 2 > VLAN > Protocol Based VLAN Group".

The table has the following columns:

- **Port**  
All available ports and the link aggregations are shown.
- **Group ID**  
Shows the group ID assigned to the port.
- **VLAN ID**  
Select the required VLAN ID to be assigned to the port.

## IPv4 subnet-based VLAN

On this page, you specify which VLAN ID is assigned to the subnet.



## Settings

- **Subnet Based VLAN**  
Enable or disable the subnet-based VLAN assignment
- **Port**  
Select the port. All available ports and the link aggregations can be selected.
- **Subnet**  
Enter the network address.  
Example: 192.168.10.0 for the network 192.168.10.x with nodes 192.168.10.1 to 192.168.10.254.

The table has the following columns:

- **Port**  
All available ports and the link aggregations are shown.
- **Subnet**  
Shows the subnet assigned to the port.
- **VLAN ID**  
Select the VLAN ID you want to assign to the port or the subnet.

## Mirroring

### General

On this page, you make the basic settings for port mirroring.

### Settings

- **Mirroring**  
Enable or disable mirroring of the data traffic.
- **Monitor Barrier**  
Enable or disable the option to restrict communication via the monitor port.

---

**Note****Monitor Barrier**

If you enable the monitor barrier, the data traffic on the destination port is automatically blocked (broadcast, multicast, unicast, DCP forwarding, LLDP) so that only the mirrored traffic is present. To be able to allow other data traffic again, you need to configure this. The previous statuses of these options are not restored after stopping the monitor barrier and must be reconfigured.

---

- Enabled  
The monitor port is taken out of normal frame switching.
- Disabled  
Communication via the monitor port is unrestricted.

This table has the following columns:

- **Session ID**  
Enable or disable listening in on incoming packets at the required port.
- **Session Type**  
Specify which data traffic is mirrored. The following options are available:
  - ' '
  - None
  - Port based  
Port-based mirroring You can configure other settings in "Layer 2 > Mirroring > Port".
  - VLAN  
VLAN-based mirroring. You can configure other settings in "Layer 2 > Mirroring > VLAN".
  - MAC ACL  
Mirroring of the MAC Access Control List. You can configure other settings in "Layer 2 > Mirroring > MAC Flow".
  - IP ACL  
Mirroring of the IP Access Control List. You can configure other settings in "Layer 2 > Mirroring > IP Flow".
- **Status**  
Shows whether or not mirroring is active.
- **Dest. Port**  
Select the destination port to be mirrored to in this session.

## Port

### Mirroring ports

Mirroring a port means that the data traffic at a port (mirrored port) of the IE switch is copied to another port (monitor port). You can mirror one or more ports to a monitor port.

If a protocol analyzer is connected to the monitor port, the data traffic at the mirrored port can be recorded without interrupting the connection. This means that the data traffic can be investigated without being affected. This is possible only if a free port is available on the same device as the monitor port.

---

#### Note

If the maximum data rate of the mirrored port is higher than that of the monitor port, data may be lost and the monitor port then no longer reflects all the data traffic at the mirrored port. Several ports can be mirrored to one monitor port at the same time.

Mirroring a port does not work beyond switch core boundaries.

Disable port mirroring if you want to connect a normal end device to the monitor port.

---

## Settings

- **Session ID**  
Select the session ID. Only session IDs of the session type "Port-based" are available.
- **Port**  
Shows the port to be monitored.
- **Ingress Mirroring**  
Enable or disable mirroring of incoming packets at the required port.
- **Egress Mirroring**  
Enable or disable mirroring of outgoing packets at the required port.

## VLAN

### VLAN sources of the port mirroring function

On this page, you specify the VLAN whose incoming data traffic will be mirrored to the monitor port.

## Settings

- **Session ID**  
Select the session ID. Only session IDs of the session type "VLAN" are available.

The table has the following columns:

- **VLAN ID**  
Shows the VLAN ID. The VLAN ID can only be assigned once when you create a new data record and can then no longer be changed. To make a change, the entire data record must be deleted and created again.
- **Ingress Mirroring**  
Enable or disable mirroring of incoming frames.

## MAC Flow

The MAC ACL filter decides which data is available at the monitor port.

## Settings

- **Session ID**  
Select the session ID. Only session IDs of the session type "MAC ACL" are available.
- **ACL Filter Number**  
Shows the number of the ACL filter. You configure the MAC ACL filter in "Security > Port ACL MAC".

- **Ingress Mirroring**  
Shows whether incoming packets are mirrored.

---

**Note**

**Rules**

A rule selected for ingress mirroring only becomes active if it was configured as a port ingress rule on at least one port. You configure the port ingress rules in "Security > Port MAC IP > Port Ingress Rules".

---

- **Source MAC**  
Shows the MAC address of the sender.
- **Dest. MAC**  
Shows the MAC address of the recipient.
- **Egress Port**  
Shows a list of all egress ports to which this rule applies.
- **Ingress Port**  
Shows a list of all ingress ports to which this rule applies.

## IP Flow

The IP ACL filter decides which data is mirrored to the monitor port.

## Settings

- **Session ID**  
Select the session ID. Only session IDs of the session type "IP ACL" are available.
- **ACL Filter Number**  
Shows the number of the ACL filter. You configure the IP ACL filter in "Security > Port ACL IP".
- **Ingress Mirroring**  
Shows whether incoming packets are mirrored.

---

**Note**

**Rules**

A rule selected for ingress mirroring only becomes active if it was configured as a port ingress rule on at least one port. You configure the port ingress rules in "Security > Port ACL IP > Port Ingress Rules".

---

- **Source IP**  
Shows the IP address of the sender.
- **Source Subnet Mask**  
Shows the subnet mask of the sender.
- **Dest. IP**  
Shows the IP address of the recipient.

- **Dest. Subnet Mask**  
Shows the subnet mask of the recipient.
- **Egress Port**  
Shows a list of all egress ports to which this rule applies.
- **Ingress Port**  
Shows a list of all ingress ports to which this rule applies.

## Dynamic MAC aging

The device automatically learns the source addresses of the connected nodes.

This information is used to forward data frames to the nodes specifically involved. The network load for the other nodes is reduced.

If a device does not receive a frame whose source address matches a learnt address within a certain time, the learnt address is deleted. This mechanism is known as "Aging". Aging prevents frames being forwarded incorrectly, for example when an end device (for example a programming device) is connected to a different port. If the check box is not enabled, a device does not delete learned addresses automatically.

## Settings

- **Dynamic MAC Aging**  
Enable or disable the function for automatic aging of learned MAC addresses:
- **Aging Time [s]**  
Enter the time in seconds. After this time, a learned address is deleted if the device does not receive any further frames from this sender address.

## Ring redundancy

### Ring

On this page, you can select the required mode for fast ring redundancy. The "Automatic Redundancy Detection" ring redundancy mode is the default when the device ships.

---

#### Note

Ring redundancy cannot be enabled if a (M/R/S) Spanning Tree is enabled on the device.

---

## Settings

- **Ring redundancy**  
Enable or disable the ring redundancy function.
- **Ring Redundancy Mode**  
Specify the ring redundancy mode. The following options are available:
  - **"-" (disabled)**  
The redundancy function is disabled.
  - **Automatic Redundancy Detection**  
Select this setting to create an automatic configuration of the ring redundancy mode. In this mode, the device automatically detects whether or not there is a device with the "HRP Manager" role in the ring. If this is the case, the device adopts the role of "HRP Client". If no HRP manager is found, all devices with the "Automatic Redundancy Detection" or "MRP auto manager" setting negotiate among themselves to establish which device adopts the role of "MRP manager". The device with the lowest MAC address will always become "MRP manager". The other devices automatically set themselves to the "MRP client" redundancy mode.
  - **MRP Auto Manager**  
Automatic media redundancy manager
  - **MRP Client**  
Media redundancy client.
  - **HRP Client**  
High Speed Redundancy Protocol client
  - **HRP Manager**  
High Speed Redundancy Protocol manager

### Ring Ports

Specify the ports to be used as ring ports in media redundancy in ring topologies.

---

#### Note

If you restore the factory defaults, the default redundancy mode "Automatic Redundancy Detection" becomes active.

The ring port configuration is also reset to the factory default ports. If other ports were used previously as ring ports, with the appropriate attachment, a previously correctly configured device can cause circulating frames and therefore the failure of the data traffic.

---

## Standby

### Standby manager

The standby manager allows the redundant linking of two HRP rings. To do this, two neighboring devices within a ring must be configured as standby partners. Enable the standby manager for both standby partners and select the port via which the device is connected to the ring you want to link to. For the "Standby Connection Name", a name unique within the

---

ring must be assigned for both partners. This identifies the two modules as standby partners that belong together.

---

**Note**

To be able to use the function, HRP must be activated.

---

## Settings

- **Standby**  
Enable or disable the standby manager.

---

**Note**

If two devices are linked by the standby function, the "Standby" function must be enabled on both devices.

---

**Note**

The standby manager always requires an activated HRP client.

---

- **Standby Connection Name**  
Enter the name for the standby connection. This name defines the master/slave device pair. Both must be located in the same ring. This is achieved by entering the same name on two devices in the ring.

---

**Note**

Make sure that the standby name (for one pair of devices) is used only once in the network.

---

- **Force device to standby master**  
When selected, the device is configured as standby master regardless of its MAC address.
  - If the setting is enabled for neither of the two devices for which the standby function is enabled, then assuming that no error has occurred, the device with the higher MAC address adopts the role of standby master.
  - If the setting is enabled for both devices or if the setting is only supported by one device, the standby master is also selected based on the MAC address.

This type of assignment is important in particular when a device is replaced. Depending on the MAC addresses, the previous device with the slave function can take over the role of the standby master.

This table has the following columns:

- **Port**  
Shows the port to which the setting relates.
- **Setting**  
Here, you specify which ports are standby ports. The standby ports are involved in the redirection of data traffic.  
If there are no problems, only the standby ports of the master are enabled and handle to the data traffic into the connected HRP rings (buses). If the master or the Ethernet connection (link) of one of the standby ports of the master fails, all standby ports of the master will be disabled and the standby ports of the slave enabled. As a result, a functioning Ethernet connection to the connected network segments (HRP rings/linear buses) is restored.

## MSTP

### General

#### General settings of MSTP

On this page, you configure the settings for MSTP. As default, Rapid Spanning Tree is enabled that can be set to the MSTP, RSTP or STP compatible mode with a switch.

On the configuration pages of these functions, you can make detailed settings.

Depending on the compatibility mode, you can configure the corresponding function on the relevant configuration page.

### Settings

- **MSTP**  
Enable or disable MSTP.
- **Protocol Compatibility**  
Select the compatibility mode of MSTP, for example if you select RSTP, MSTP behaves like RSTP.  
The following settings are available:
  - STP
  - RSTP
  - MSTP

### CIST general

On this page, you configure CIST.



## Settings

- **Bridge Priority**  
Which device becomes the root bridge is decided based on the bridge priority. The bridge with the highest priority becomes the root bridge. The lower the value, the higher the priority. If several devices in a network have the same priority, the device whose MAC address has the lowest numeric value will become the root bridge. Both parameters, bridge priority and MAC address together form the bridge identifier. Since the root bridge manages all path changes, it should be located as centrally as possible due to the delay of the frames.
- **Bridge Hello Time [s]**  
Each bridge regularly sends configuration frames (BPDUs). The interval between two such frames is the Hello time. The default for this parameter is 2 seconds.
- **Bridge Forward Delay [s]**  
New configuration data is not used immediately by a bridge but only after the period specified in the parameter. This ensures that operation is only started with the new topology after all the bridges have the required information.
- **Bridge Max Age**  
Bridge Max Age defines the maximum "age" of a received BPDU for it to be accepted as valid by the switch.
- **Bridge Max Hop Count**  
This parameter specifies how many MSTP nodes a BPDU may pass through. If an MSTP BPDU is received and has a hop count that exceeds the value configured here, it is discarded.
- **Region Name**  
Enter the name of the MSTP region to which this device belongs. As default, the MAC address of the device is entered here. This value must be the same on all devices that belong to the same MSTP region.
- **Region Version**  
Enter the version number of the MSTP region in which the device is located. This value must be the same on all devices that belong to the same MSTP region.

## CIST port

### MSTP-CIST port configuration

When the page is called, the table displays the current status of the configuration of the port parameters.

To configure them, click the relevant cells in the port table.

## Settings

Table 1 has the following columns:

- **1st column**  
Shows that the settings are valid for all ports of table 2.
- **MSTP Status**  
Select the setting from the drop-down list. You have the following setting options:
  - Enabled  
Port is integrated in the spanning tree.
  - Disabled  
Port is not integrated in the spanning tree.
  - No change  
Table 2 remains unchanged.
- **Copy to Table**  
If you click the button, the setting is adopted for all ports of table 2.

Table 2 has the following columns:

- **Port**  
Shows the available ports.
- **MSTP Status**  
Specify whether or not the port is integrated in the spanning tree.

---

### Note

If you disable the "MSTP Status" option for a port, this may cause the formation of loops. The topology must be kept in mind.

---

- **Priority**  
Enter the priority of the port. The priority is only evaluated when the path costs are the same. The value must be divisible by 16. If the value that cannot be divided by 16, the value is automatically adapted.
- **Cost calc**  
Enter the path cost calculation. If you enter the value "0" here, the automatically calculated value is displayed in the "Path costs" box.

- **Edge type**

Specify the type of edge port. You have the following options:

- "\_"  
Edge port is disabled. The port is treated as a "no edge port".
- Admin  
Select this option when there is always an end device on this port. Otherwise a reconfiguration of the network will be triggered each time a connection is changed.
- Auto  
Select this option if you want a connected end device to be detected automatically at this port. When the connection is established the first time, the port is treated as a "no Edge Port".
- Admin/Auto  
Select these options if you operate a combination of both on this port. When the connection is established the first time, the port is treated as an Edge Port.

- **P.t.P. Type**

Select the required option. The selection depends on the port that is set.

- "\_"  
Point to point is calculated automatically. If the port is set to half duplex, a point-to-point link is not assumed.
- P.t.P.  
  
Even with half duplex, a point-to-point link is assumed.
- Shared Media  
Even with a full duplex connection, a point-to-point link is not assumed.

---

**Note**

Point-to-point connection means a direct connection between two devices. A shared media connection is, for example, a connection to a hub.

---

- **P.t.P. Type**  
Select the required option from the drop-down list. The selection depends on the port that is set.
  - "-"  
Point to point is calculated automatically. If the port is set to half duplex, a point-to-point link is not assumed.
  - P.t.P.  
  
Even with half duplex, a point-to-point link is assumed.
  - Shared Media  
Even with a full duplex connection, a point-to-point link is not assumed.

---

**Note**

Point-to-point connection means a direct connection between two devices. A shared media connection is, for example, a connection to a hub.

---

- **Hello Time**  
Enter the interval after which the bridge sends configuration BPDUs

---

**Note**

The port-specific setting of the Hello time is only possible in MSTP compatible mode.

---

## MST General

### Multiple Spanning Tree configuration

With MSTP, in addition to RSTP, several VLANs can be managed in a LAN with separate RSTP trees.

### Settings

- **MSTP Instance ID**  
Enter the number of the MSTP instance.  
  
The table has the following columns:
- **MSTP Instance ID**  
Shows the number of the MSTP instance.
- **Root Address**  
Shows the MAC address of the root bridge
- **Root Priority**  
Shows the priority of the root bridge.

- **Bridge Priority**  
Enter the bridge priority. The value for the bridge priority is a whole multiple of 4096.
- **VLAN ID**  
Enter the VLAN ID. Here, you can also specify ranges with Start ID, "-", End ID. Several ranges or IDs are separated by ",".

## MST port

### Configuration of the Multiple Spanning Tree port parameters

On this page, you set the parameters for the ports of the configured multiple spanning tree instances.

#### Settings

- **MSTP Instance ID**  
Select the ID of the MSTP instance.
- The table has the following columns:
- **Port**  
Shows all available ports and link aggregations.
  - **MSTP Instance ID**  
ID of the MSTP instance.
  - **MSTP Status**  
Enable or disable MSTP for this port.
  - **Priority**  
Enter the priority of the port. The priority is only evaluated when the path costs are the same. The value must be divisible by 16. If the value that cannot be divided by 16, the value is automatically adapted.
  - **Cost calc**  
Enter the path cost calculation in the input box. If you enter the value "0" here, the automatically calculated value is displayed in the next box "Path Cost".

### Expanded compatibility for passive listening

#### Enabling the function

On this page, you enable the expanded compatibility for passive listening.

#### Settings

- **Expanded compatibility for passive listening**  
Enable or disable this function for the entire device.

Table 1 has the following columns:

- **1st column**  
Shows that the settings are valid for all ports of table 2.
- **Setting**  
Select the setting. You have the following setting options:
  - Enabled  
Enables the function for all ports of the device.
  - Disabled  
Disables the function for all ports of the device.
  - No Change  
No change in table 2.
- **Copy to Table**  
If you click the button, the setting is adopted for all ports of table 2.

Table 2 has the following columns:

- **Port**  
Displays the port of the device.
- **Setting**  
Enable or disable the function for this port.

## Loop Detection

With the "Loop Detection" function, you specify the ports for which loop detection will be activated. The ports involved send special test frames - the loop detection frames. If these frames are sent back to the device, there is a Loop.

A Local Loop involving this device means that the frames are received again at a different port of the same device. If the sent frames are received again at the same port, there is a "Remote Loop" involving other network components.

---

### Note

A loop is an error in the network structure that needs to be eliminated. The loop detection can help to find the errors more quickly but does not eliminate them. The loop detection is not suitable for increasing network availability by deliberately including loops.

---

### Note

Note that loop detection is only possible at ports that were not configured as ring ports or standby ports.

---

## Settings

- **Loop Detection**  
Enable or disable loop detection.
- **VLAN Loop Detection**  
Enable or disable loop detection in a VLAN.

Table 1 has the following columns:

- **1st column**  
Shows that the settings are valid for all ports of table 2
- **Threshold / Remote Reaction / Local Reaction**  
Select the required settings.
- **Copy to Table**  
If you click the button, the setting is adopted for all ports of table 2.

Table 2 has the following columns:

- **Port**  
Shows the available ports.
- **Setting**  
Specify how the port handles loop detection frames.

---

**Note**

Test frames create additional network load. We recommend that you only configure individual switches, for example at branch points of the ring, as "sender" and the others as "forwarder".

---

- sender  
Loop detection frames are sent out and forwarded.
  - forwarder  
Loop detection frames from other devices are forwarded.
  - blocked  
The forwarding of loop detection frames is blocked.
- **Threshold**  
Specify the number of received loop detection frames as of which a loop is assumed.
  - **Remote Reaction**  
Specify how the port will react if a remote loop occurs. Select one of the two options from the drop-down list:
    - No action: A loop has no effect on the port.
    - Disable: The port is blocked.
  - **Local Reaction**  
Specify how the port will react if a local loop occurs. Select one of the two options from the drop-down list:
    - No action: A loop has no effect on the port.
    - Disable: The port is blocked

## Link aggregation

### Bundling network connections for redundancy and higher bandwidth

Link aggregations according to IEEE 802.3ad allow several connections between neighboring devices to be bundled to achieve higher bandwidths and protection against failure.

Ports on both partner devices are included in link aggregations and the devices are then connected via these ports. To assign ports (in other words links) correctly to a partner device, the Link Aggregation Control Protocol (LACP) from the IEEE 802.3ad standard is used.

Up to 8 link aggregations can be defined. A maximum of 8 ports can be assigned to each link aggregation.

## Settings

The table has the following columns:

- **Port**  
Shows the virtual port number of this link aggregation. This identifier is assigned internally by the firmware.
- **Link Aggregation Name**  
Enter the name for the link aggregation. This name can be specified by the user during configuration. The name is not absolutely necessary but can be useful to distinguish between the various link aggregations.
- **Status**  
Enable or disable link aggregation.
- **MTU**  
Specify the packet size.
- **LACP**
  - On  
Enables the sending of LACP frames.
  - Off  
Disables the sending of LACP frames.



- **Frame distribution**  
Set the type of distribution of packets on the individual links of an aggregation.
  - Destination&Source Mac  
The distribution is based on a combination of the destination and source MAC address.
  - Destination&Source IP  
The distribution is based on a combination of the destination and source IP address.
- **Port**  
Shows the ports that belong to this link aggregation. The following values can be selected from the drop-down list:
  - "-" (disabled)  
Link aggregation is disabled.
  - "a" (active)  
The port sends LACP frames and is only involved in the link aggregation when LACP frames are received.
  - "p" (passive)  
The port is only involved in the link aggregation when LACP frames are received.
  - "o" (on)  
The port is involved in the link aggregation and does not send any LACP frames.

---

**Note**

Within a "link aggregation", only ports with the following configuration are possible:

- all ports with "o"
  - all ports with "a" or "p"
- 

## DCP forwarding

### Applications

The DCP protocol is used by STEP 7 and the PST Tool for configuration and diagnostics. When shipped, DCP is enabled on all ports; in other words, DCP frames are forwarded at all ports. With this option, you can disable the sending of these frames for individual ports, for example to prevent individual parts of the network from being configured with the PST Tool or to divide the full network into smaller parts for configuration and diagnostics.

### Settings

Table 1 has the following columns:

- **1st column**  
Shows that the settings are valid for all ports of table 2.
- **Setting**  
Select the setting. If "No Change" is selected, the entry in table 2 remains unchanged.
- **Copy to table**  
If you click the button, the setting is adopted for all ports of table 2.

Table 2 has the following columns:

- **Port**  
Shows the available ports.
- **Setting**  
Specify whether the port should block or forward outgoing DCP frames. The following options are available:
  - **Forward**  
DCP frames are forwarded via this port.
  - **Block**  
No outgoing DCP frames are forwarded via this port. It is nevertheless still possible to receive via this port.

## LLDP

### Link Layer Discovery Protocol (LLDP)

PROFINET uses the LLDP protocol for topology diagnostics.

In the factory settings, LLDP is activated on the interface, in other words LLDP frames are sent and received. LLDP is supported only by the Ethernet interface and by the SFP interface P1.

On this WBM page, you activate or deactivate the sending or receiving of LLDP frames on the interface.

## Settings

Table 1 has the following columns:

- **1st column**  
Shows that the settings are valid for all ports of table 2.
- **Setting**  
Select the setting. If "No Change" is selected, the entry in table 2 remains unchanged.
- **Copy to table**  
If you click the button, the setting is adopted for all ports of table 2.

Table 2 has the following columns:

- **Port**  
Shows the port.
- **Setting**  
Specify the LLDP functionality. The following options are available:
  - Rx  
This port can only receive LLDP frames.
  - Tx  
This port can only send LLDP frames.
  - Rx & Tx  
This port can receive and send LLDP frames.
  - "-" (disabled)  
This port can neither receive nor send LLDP frames.

## Unicast

## Filter

### Address filtering

This page shows the current content of the unicast filter table. This table lists the source addresses of unicast address frames. Entries can be made either dynamically when a node sends a frame to a port or statically by the user setting parameters.

On this page, you also define the static unicast filters.

## Settings

- **VLAN ID**  
Select the VLAN ID in which you configure a new static MAC address. If nothing is set, "VLAN1" is set as the basic setting.
- **MAC Address**  
Enter the MAC address here.

This table contains the following columns:

- **1st column**  
Select the check box in the row to be deleted.
- **VLAN ID**  
Shows the VLAN-ID assigned to this MAC address.
- **MAC Address**  
Shows the MAC address of the node that the device has learned or the user has configured.

- **Status**  
Shows the status of each address entry:
  - **Learnt**  
The specified address was learned by receiving a frame from this node and will be deleted when the aging time expires if no further packets are received from this node.
  - **Static**  
Configured by the user. Static addresses are stored permanently; in other words, they are not deleted when the aging time expires or when the switch is restarted.
  - **Invalid**  
These values are not evaluated.
- **Port**  
Shows the port via which the node with the specified address can be reached. Frames received by the device whose destination address matches this address will be forwarded to this port.

---

**Note**

You can only specify **one** port for unicast addresses.

---

## Locked ports

### Activating the access control

On this page, you can block individual ports for unknown nodes.

If the Port Lock function is enabled, packets arriving at this port from unknown MAC addresses are discarded immediately. Packets from known nodes are accepted by the port. Since ports with the port lock function enabled cannot learn any MAC addresses, learned addresses on these ports are automatically deleted after the port lock function is enabled.

## Settings

Table 1 has the following columns:

- **1st column**  
Shows that the settings are valid for all ports of table 2.
- **Setting**  
Select the setting from the drop-down list. You have the following setting options:
  - **Enabled**  
Enables the port lock function.
  - **Disabled**  
Disables the port lock function.
  - **No change**  
Table 2 remains unchanged.
- **Copy to table**  
If you click the button, the setting is adopted for all ports of table 2.

Table 2 has the following columns:

- **Port**  
Shows the available ports.
- **Setting**  
Enable or disable access control for the port.

## Blocking

### Blocking the forwarding of unknown unicast frames

On this page, you can block the forwarding of unknown unicast frames for individual ports.

## Settings

Table 1 has the following columns:

- **1st column**  
Shows that the settings are valid for all ports of table 2.
- **Setting**  
Select the setting. You have the following setting options:
  - Enabled  
Blocking of unicast frames is enabled.
  - Disabled  
Blocking of unicast frames is disabled.
  - No change  
Table 2 remains unchanged.
- **Copy to table**  
If you click the button, the setting is adopted for all ports of table 2.

Table 2 has the following columns:

- **Port**  
Shows the available ports.
- **Setting**  
Enable or disable the blocking of unicast frames.

---

#### **Note**

#### **Ring redundancy / standby**

If ring redundancy or standby is enabled, the ports configured for this are not included in the blocking.

---

## Multicast

### Groups

### Multicast applications

In the majority of cases, a frame is sent with a unicast address to a particular recipient. If an application sends the same data to several recipients, the amount of data can be reduced by sending the data using one multicast address. For some applications, there are fixed multicast addresses (NTP, IETF1 Audio, IETF1 Video etc.).

### Reducing network load

In contrast to unicast frames, multicast frames represent a higher load for the device. Generally, multicast frames are sent to all ports. There are three ways of reducing the load caused by multicast frames:

- Static entry of the addresses in the multicast filter table.
- Dynamic entry of the addresses by listening in on IGMP parameter assignment frames (IGMP Configuration).
- Active dynamic assignment of addresses by GMRP frames.

The result of all these methods is that multicast frames are sent only to ports for which an appropriate address is entered.

"Multicast" shows the multicast frames currently entered in the filter table and their destination ports. The entries can be dynamic (the device has learned them) or static (the user has set them).

### Settings

- **VLAN ID**  
Select the VLAN ID to be assigned to the MAC multicast address.
- **MAC Address**  
Here you enter a new MAC multicast address you want to configure.

The table has the following columns:

- **VLAN ID**  
Shows VLAN ID of the VLAN to which the MAC multicast address is assigned.
- **MAC Address**  
Shows the MAC multicast address that the device has learned or the user has configured.
- **Status**  
Shows the status of each address entry. The following information is possible:
  - **Static**  
The address was entered statically by the user. Static addresses are stored permanently; in other words, they are not deleted when the aging time expires or when the device is restarted. These must be deleted by the user.
  - **IGMP**  
The destination port for this address was obtained by IGMP configuration.
  - **GMRP**  
The destination port for this address was registered by a received GMRP frame.

## IGMP

### Specifying the IGMP snooping aging time

On this page, you can configure the aging time for IGMP configuration. When the time elapses, entries created by IGMP are deleted from the address table if they are not updated by a new IGMP frame.

This applies to all ports; a port-specific configuration is not possible.

IE switches support not only "IGMP snooping" but also the IGMP querier function. If "IGMP snooping" is enabled, IGMP frames are evaluated and the multicast filter table is updated with this information. If IGMP Query is also enabled, IE switches also send IGMP queries that trigger responses from IGMP-compliant nodes.

## Settings

- **IGMP snooping**  
Enable or disable IGMP (Internet Group Management Protocol). The function allows the assignment of IP addresses to multicast groups. If the check box is selected, IGMP entries are included in the table and IGMP frames are forwarded.
- **IGMP Snooping Aging Time**  
Enter the value for the aging time in seconds in this box.
- **IGMP Querier**  
Enable or disable "IGMP Querier". The device sends IGMP queries.

## GMRP

### Activating GMRP

By selecting the check box, you specify whether or not GMRP is used for each individual port. If "GMRP" is disabled for a port, no registrations are made for it and it cannot send GMRP frames.

### Settings

- **GMRP**  
Enable or disable the GMRP function.

Table 1 has the following columns:

- **1st column**  
Shows that the settings are valid for all ports of table 2.
- **Setting**  
Select the setting. You have the following setting options:
  - Enabled  
Enables the sending of GRMP frames.
  - Disabled  
Disables the sending of GRMP frames.
  - No Change  
Table 2 remains unchanged.

- **Copy to Table**  
If you click the button, the settings are adopted for all ports of table 2.

Table 2 has the following columns:

- **Port**  
Shows the available ports and the link aggregations.
- **Setting**
- Enable or disable GMRP for the port or for the link aggregation.

### Blocking

On this page, you can block the forwarding of unknown multicast frames for individual ports.



## Settings

Table 1 has the following columns:

- **1st column**  
Shows that the settings are valid for all ports of table 2.
- **Setting**  
Select the setting. You have the following setting options:
  - Enabled  
Blocking of multicast frames is enabled.
  - Disabled  
Blocking of multicast frames is disabled.
  - No change  
Table 2 remains unchanged
- **Copy to table**  
If you click the button, the settings are adopted for all ports of table 2.

Table 2 has the following columns:

- **Port**  
Shows the available ports.
- **Setting**  
Enable or disable the blocking of multicast frames.

## Broadcast

### Blocking the forwarding of broadcast frames

On this page, you can block the forwarding of broadcast frames for individual ports.

---

#### Note

Some communication protocols work only with the support of broadcast. In these cases, blocking can lead to loss of data communication. Block broadcast only when you are sure that you do not need it.

---

## Settings

Table 1 has the following columns:

- **1st column**  
Shows that the settings are valid for all ports of table 2.
- **Setting**  
Select the setting. You have the following setting options:
  - Enabled  
The blocking of broadcast frames is enabled.
  - Disabled  
The blocking of broadcast frames is disabled.
  - No change  
Table 2 remains unchanged.
- **Copy to Table**  
If you click the button, the setting is adopted for all ports of table 2.

Table 2 has the following columns:

- **Port**  
All available ports and the link aggregations are shown.
- **Setting**  
Enable or disable the blocking of broadcast frames.

## PTP

### General

The Precision Time Protocol (PTP) complying with IEEE 1588v2 allows the time-of-day synchronization of devices connected to the ports of a device. These devices forward the synchronization frames through the network using the "Transparent Clock" (TC) mechanism. The connection mechanisms "end-to-end" and "peer-to-peer" are supported.

To use IEEE 1588v2, enable this function and configure every port that is on the synchronization path as well as ports that are blocked due to redundancy mechanisms. IEEE 1588v2 can also be used with redundancy mechanisms in the ring such as HRP, standby linking of rings, MRP and RSTP.

## Setting

- **1588 Mode**  
You can make the following settings:
  - **off**  
The device does not process any PTP messages. PTP messages are, however, forwarded according to the rules of the device.
  - **transparent**  
The device adopts the function of a Transparent Clock and forwards PTP messages to other nodes while at the same time making entries in the correction field of the PTP message.

## TC general

### 1588 Transparent Clock

On this page, you specify the general settings for PTP.

## Settings

- **Delay Mechanism**  
Specify the delay mechanism the device will work with:
  - End-to-end(delay request response mechanism will be used)
  - Peer-to-peer (peer delay mechanism will be used)
- **Domain Number**  
Enter the identification number for the time domain. Synchronization is only for the devices within the domain. The device ignores PTP messages with a different domain number. A SCALANCE device can only be assigned to one synchronization domain.

## TC port

On this page, you specify the ports that can process PTP messages.

## Settings

Table 1 has the following columns:

- **1st column**  
Shows that the settings are valid for all ports of table 2.
- **Setting / Transport Mechanism**  
Select the setting. If "No Change" is selected, the entry in table 2 remains unchanged.
- **Copy to Table**  
If you click the button, the settings are adopted for all ports of table 2.

Table 2 has the following columns:

## 8.1 Configuring devices and networks

- **Port**  
Shows the available ports.
- **Setting**  
Enable or disable PTP. When enabled, the port processes PTP messages.
- **Faulty Flag**  
Shows error status relating to PTP.
  - **true**  
An error occurred.
  - **false**  
No error has occurred on this port.
- **Transport Mechanism**  
Specifies the protocol for transferring the PTP messages. This protocol must also be supported by the communications partner of the port
  - Ethernet
  - UDP IPv4

### Layer 3

#### Configuration

The page contains the overview of the layer 3 functions of the device. To use the "Routing", "VRRP" and "OSPF" functions, the device requires a KEY-PLUG.

#### Settings

- **Routing** (only available on layer 3)  
Enable or disable the routing function.
- **DHCP Relay Agent**  
Enable or disable the DHCP relay agent. You can configure other settings in "Layer 3 > DHCP Relay Agent".
- **VRRP** (only available on layer 3)  
Enable or disable routing using VRRP. To use VRRP, first enable the "Routing" function. You can configure other settings in "Layer 3 > VRRP".
- **OSPF** (only available on layer 3)  
Enable or disable routing using OSPF. To use OSPF, first enable the "Routing" function. You can configure other settings in "Layer 3 > OSPF".

## Subnets

### Overview

### Subnet

The page shows the subnets for the selected interface. If more than one subnet is available on an interface, the first entry of this interface is of the address type "Primary". All other subnets have the address type "Secondary". All other subnets are created on this page and in "Layer 3 > Subnets > Configuration", you configure the settings.

### Settings

The following settings are possible for subnets of the "Secondary" address type:

- **Interface**  
Select the interface on which you want to configure another subnet.

The table has the following columns:

- **Interface**  
Shows the interface.
- **TIA Interface**  
Shows whether or not the entry is a TIA interface.
- **Interface Name**  
Shows the name of the interface.
- **IP Address**  
Shows the IP address of the subnet.
- **Subnet Mask**  
Shows the subnet mask.
- **Address Type**  
Shows the address type. The following values are possible:
  - Primary  
The first subnet of the interface.
  - Secondary  
All other subnets of the interface.

- **IP Assignment Method**  
Shows how the IP address is assigned.
  - Static  
The IP address is static. You enter the IP settings in "IP Address" and "Subnet Mask".
  - Dynamic (DHCP)  
The device obtains a dynamic IP address from a DHCP server.

## Configuration

On this page, you configure the subnet. You create the subnet in "Layer 3 > Subnets > Overview".

## Settings

- **Interface (Name)**  
Select the required interface.
- **Interface Name**  
Enter the name of the interface, e.g. eth0; P3.
- **DHCP**  
Enable or disable the DHCP client for this interface.
- **IP Address**  
Enter the IP address of the subnet. The IP address must not be used more than once.
- **Subnet Mask**  
Enter the subnet mask of the subnet you are creating. Subnets on different interfaces must not overlap.
- **Address Type**  
Shows the address type. The following values are possible:
  - Primary  
The first subnet of the interface.
  - Secondary  
All other subnets of the interface.
- **TIA Interface**  
Enable or disable the setting.

## Routes

### Static route

On this page, you create the static routes. During automatic adaptations, static routes are not taken into account and need to be adapted manually.

## Settings

- **Destination Network**  
Enter the network address of the destination.
- **Subnet Mask**  
Enter the corresponding subnet mask.
- **Gateway**  
Enter the IP address of the next gateway.

The table has the following columns:

- **Destination Network**  
Shows the network address of the destination.
- **Subnet mask**  
Shows the corresponding subnet mask.
- **Gateway**  
Shows the IP address of the next gateway.
- **Metric**  
Enter the metric for the route. When creating the route, "not used" is entered automatically. The metric corresponds to the quality of a connection, for example speed, costs. If there are several equal routes, the route with the lowest metric value is used.

## DHCP Relay Agent

### General

If the DHCP server is in a different network, the device cannot reach the DHCP server. The DHCP relay agent intercedes between a DHCP server and the device. The DHCP relay agent forwards the port number of the device with the DHCP query to the DHCP server. If a DHCP server is unreachable, the device can switch to a different DHCP server.

### Settings

- **DHCP Relay Agent (opt. 82)**  
Enable or disable the DHCP relay agent.
- **Server IP Address**  
Enter the IP address of the DHCP server.

The table has the following columns:

- **Server IP address**  
Shows the IP address of the DHCP server.

## Option

### Parameters of the DHCP relay agent

On this page, you can specify parameters for the DHCP server, for example the circuit ID. The circuit ID describes the origin of the DHCP query, for example which port received the DHCP query.

You specify the DHCP server on the "General" tab.

## Settings

- **Circuit ID router index**  
When enabled, the router index is added to the generated circuit ID.
- **Circuit ID recipient VLAN ID**  
When enabled, the VLAN ID is added to the generated circuit ID.
- **Circuit ID Receive Port**  
When enabled, the receiving port is added to the generated circuit ID.

---

### Note

You need to select a least one option.

---

- **Interface**  
Select the required interface.

The table has the following columns:

- **Interface**  
Shows the interface.
- **Remote ID type**  
Select the type of the device ID. You have the following options:
  - IP Address  
The IP address of the device is used as the device ID.
  - MAC Address  
The MAC address of the device is used as the device ID.
  - Free Text  
If you use "Free Text", you can enter the device name as the device identifier in "Remote ID".
- **Remote ID**  
Enter the device name. The box can only be edited if you select the entry "Free Text" for "Remote ID Type".



- **Circuit ID Type**  
Select the type of circuit ID from the drop-down list. You have the following options:
  - Default  
The circuit ID is created automatically based on the router index, VLAN ID or port.
  - Free Number  
If you use "Free Number", you can enter the ID for "Circuit ID".
- **Circuit ID**  
Enter the circuit ID. The box can only be edited if you select the "Free Number" entry for the "Circuit ID Type".

## VRRP

### Router

On this page, you create virtual routers. You can configure other parameters in "Layer 3 > VRRP > Configuration".

---

#### Note

- VRRP is available only on layer 3.
  - VRRP can only be used in conjunction with VLAN interfaces. Router ports are not supported.
  - Select "VRRP" to configure VRRP.
- 

## Settings

The following settings are available:

- **VRRP**  
Enable or disable routing using VRRP.
- **Reply to pings on virtual interfaces.**  
When enabled, the virtual IP addresses also reply to the ping.
- **Interface**  
Select the interface operating as virtual router.
- **VRID**  
Enter the ID of the virtual router in the input box. This ID defines the group of routers that form a virtual router (VR). In the group, this is the same. it can no longer be used for other groups.

The table has the following columns:

- **Interface**  
Shows the Interface that functions as the virtual router.
- **VRID**  
Shows the ID of the virtual router.

## 8.1 Configuring devices and networks

- **Primary IP Address**  
Shows the primary IP address in this VLAN. The entry 0.0.0.0 means that the "Primary" address on this VLAN is used. Otherwise all IP addresses configured in this VLAN in "Layer 3 > Subnets" are valid values.
- **Priority**  
Shows the priority of the virtual router.  
The current master router is automatically given 255. All other priorities can be distributed freely among the VRRP routers. The higher the priority, the earlier the VRRP router becomes "Master".
- **Backbone**  
Shows the interval at which the master router sends VRRP packets.
- **Preempt**  
Shows the precedence of a router when changing roles between backup and master.
  - yes  
This router has precedence when changing roles.
  - no  
This router does not have precedence when changing roles.

## Configuration

### Introduction

On this page, you configure the virtual router.

---

#### Note

VRRP is available only on layer 3.

---

### Description of the displayed values

The page contains the following boxes:

- **Interface / VRID**  
Select the ID of the virtual router to be configured.
- **Status**  
Enable or disable the "Status" function.

- **Primary IP Address**  
Select the primary IP address. If the router becomes master router, the router uses this IP address.

---

**Note**

If you only configure one subnet on this VLAN, no entry is necessary. The entry is 0.0.0.0. If you configure more than one subnet on the VLAN and you want a specific IP address to be used as the source address for VRRP packets, select the IP address from the drop-down list. Otherwise, the IP address with priority will be used.

---

- **Master**  
If this option is enabled, the primary IP address is entered for "Associated IP Address". This means that the highest priority IP address of the VRRP router is used as the virtual IP address of the virtual master router. The option must be disabled for the backup routers in this group and the IP address of the router in "Assigned IP address" must be used.
- **Priority**  
Enter the priority of this virtual router.  
The current master router is always given 255. All other priorities can be distributed freely among the redundant routers. The higher the priority, the earlier the router becomes "Master".
- **Advertisement Interval**  
Enter the interval in seconds after which a master router sends a VRRP packet again.
- **Preempt lower priority master**  
Allow the precedence when changing roles between backup and master based on the selection process.

## Address overview

### Overview

This page shows which IP addresses the virtual router monitors.

---

**Note**

VRRP is available only on layer 3.

---

### Settings

The table has the following columns:

- **Interface**  
Shows the Interface that functions as the virtual router.
- **VRID**  
Shows the ID of this virtual router.

- **Number of Addresses**  
Shows the number of IP addresses.
- **Associated IP Address (1) ... Associated IP Address (4)**  
Shows the router IP addresses monitored by this virtual router. If a router takes over the role of master, the routing function is taken over by this router for all these IP addresses.

## Address configuration

---

### Note

VRRP is available only on layer 3.

---

## Settings

The following settings are possible:

- **Interface / VRID**  
Select the required virtual router.
- **Associated IP Address**  
Enter the IP address that the virtual router will monitor.

The table has the following columns:

- **Associated IP Address**  
Shows the IP addresses that the virtual router monitors.

## OSPFv2

## Configuration

## Introduction

On this page, you configure routing with OSPF.

---

### Note

OSPF is available only on layer 3.

---

## Settings

- **OSPFv2**  
Enable or disable routing using OSPF.
- **Router ID**  
Enter the name of one of the OSPF interfaces. The name is entered in the IP address format and does not need to match the local IP address.

- **External LSA Maximum**  
To limit the number of entries of external LSAs in the database, enter the maximum number of external LSAs.
- **Exit Interval [s]**  
Enter the interval after which the OSPF router once again attempts to come out of the overflow status. A 0 means that the OSPF router attempts to exit the overflow status only following a restart.
- **Redistribute Routes**  
Specify which known routes are distributed using OSPF.  
The following types of route exist:
  - Default
  - Connected
  - Static

---

**Note**

The settings can only be enabled on an AS border router. Enabling "Default" and "Static", in particular, can cause problems if they are enabled at too many points in the network, for example, forwarding loops.

---

- **OSPFv2 RFC1583 Compatibility**  
Enable the option if you still have old OSPF routers in operation that are not compatible with RFC 2328.
- **AS Border Router**  
Specify whether the router is an AS border router. An AS border router intercedes between multiple autonomous systems, for example if you have an additional RIP network. An AS border router is also necessary to add and to distribute static routes.

## Areas

### Overview

An autonomous system can be divided into smaller areas.

On this page, you can view, create, modify or delete the areas of the router.

---

**Note**

OSPF is available only on layer 3.

---

## Settings

- **Area ID**  
Enter the ID of the area. The database is synchronized for all routers of an area.  
Input format: x.x.x.x  
x = 0 ... 255

This table contains the following columns:

- **Area ID**  
Shows the ID of the area.
- **Area Type**  
Select the area type from the drop-down list.
  - Standard
  - Stub
  - NSSA
  - Backbone
- **Summary**  
Specify whether summary LSAs are generated for this area.
  - Summary: Summary LSAs are sent to the area.
  - No summary: Summary LSAs are not sent to the area.
- **Metric**  
Displays the costs for the OSPF interface.

## Area range

### Creating a new OSPFv2 area range

On this page, networks can be grouped together under one area ID. The method is used only with area border routers. This means that an area border router only propagates one route for each address area to the outside.

---

#### Note

OSPF is available only on layer 3.

---

## Settings

- **Area ID**  
Select the area ID. You configure the ID in "Layer 3 > OSPF > Areas".
- **Subnet Address**  
Enter the address of the network that will be grouped.
- **Subnet Mask**  
Enter the subnet mask of the network that will be grouped.

This table contains the following columns:

- **Area ID**  
Shows the ID of the area.
- **Subnet Address**  
Shows the address of the network that will be grouped with other networks.
- **Subnet Mask**  
Shows the subnet mask of the network that will be grouped with other networks.
- **Advertise**  
Enable this option to advertise the grouped network.

## Interfaces

### Overview

On this page, you can configure OSPF interfaces.

---

**Note**

OSPF is available only on layer 3.

---

### Settings

- **IP Address**  
Select the IP address of the OSPF interface.
- This table contains the following columns:
- **IP Address**  
Displays the IP address of the OSPF interface.
  - **Area ID**  
Select the area ID with which the OSPF interface is connected.
  - **OSPF Status**  
Specify whether or not OSPF is active on the interface.
    - Enabled: OSPF is enabled on the interface.
    - Disabled: OSPF is disabled on the interface
  - **Metric**  
Enter the costs for the OSPF interface.
  - **Priority**  
Enter the router priority. The priority is only relevant for selecting the designated router. This parameter can be selected differently on routers within the same subnet.
  - **Trans. Delay**  
Enter the required delay when sending a connection update.
  - **Retrans. Delay**  
Enter the time after which an OSPF packet is transferred again if no confirmation was received.

- **Hello Interval**  
Enter the interval between two Hello packets.
- **Dead Interval**  
Enter the interval after which the neighbor router is marked as "failed" if no more Hello packets are received from it during this time.

## Interface authentication

### Configuring the interface login

On this page, you define the authentication of the interface.

---

#### Note

OSPF is available only on layer 3.

---

## Settings

- **OSPF Interface**  
Select the OSPF interface for which you want to configure authentication.
- **Authentication type**  
Select the authentication method of the OSPF interface. You have the following options:
  - None: No authentication
  - simple: Authentication using an unencrypted password
  - MD5: Authentication using MD5
- **Password**  
Enter the password for "simple authentication".
- **Confirmation**  
Confirm the entered password.
- **Authentication Key ID**  
Enter the ID for MD5 authentication with which the password will be used as a key. Since the key ID is transferred with the protocol, the same key must be stored under the same key ID on all neighboring routers.

The table has the following columns:

- **Authentication Key ID**  
Can only be edited if you set the MD5 authentication method. It is only possible to use several keys there.
- **MD5 Key**  
Enter the MD5 key.
- **MD5 Key Confirmation**  
Confirm the entered key.
- **Youngest Key ID**  
Shows whether or not the MD5 key is the latest key ID.



## Virtual links

### Overview

Due to the protocol, each area border router must have access to the backbone area. If a router is not connected directly to the backbone area, a virtual link to it is created.

---

**Note**

OSPF is available only on layer 3.

---

**Note**

Note that when creating a virtual link both the transit area and the backbone area must already be configured.

the virtual link must be configured identically at both ends.

---

### Settings

- **Neighbor Router ID**  
Enter the ID of the neighbor router at the other end of the virtual connection.
- **Transit Area ID**  
Select the ID of the area that connects the two routers.

This table contains the following columns:

- **Transit Area ID**  
Shows the ID via which the two routers are connected.
- **Neighbor Router ID**  
Shows the ID of the neighbor router at the other end of the virtual connection.
- **Virt. Link Status**  
Specify the status of the virtual link. The following statuses are possible:
  - down: The virtual link is inactive.
  - Point-to-point: The virtual link is active.
- **Trans. Delay**  
Enter the required delay when sending a link update packet.
- **Retrans. Delay**  
Enter the time after which a packet is transferred again if no confirmation was received.
- **Hello Interval**  
Enter the interval between two Hello packets.
- **Dead Interval**  
Enter the interval after which the neighbor router counts as "failed" if no more Hello packets are received from it during this time.

## Virtual Link Authentication

### Configuring the virtual link login

On this page, you define the authentication for the virtual link.

---

**Note**

OSPF is available only on layer 3.

---

### Settings

- **Virtual link (area/neighbor)**  
Select the virtual link for which you want to configure authentication.
- **Authentication type**  
Select the authentication method of the OSPF interface. You have the following options:
  - None: No authentication
  - simple: Authentication using an unencrypted password.
  - MD5: Authentication using MD5
- **Password**  
Enter the password for "simple authentication".
- **Confirmation**  
Confirm the entered password.
- **Authentication Key ID**  
Enter the ID for MD5 authentication with which the password will be used as a key. Since the key ID is transferred with the protocol, the same key must be stored under the same key ID on all neighboring routers.

The table has the following columns:

- **Authentication Key ID**  
Can only be edited if you set the MD5 authentication method. It is only possible to use several keys there.
- **MD5 Key**  
Enter the MD5 key.
- **MD5 Key Confirmation**  
Confirm the entered key.
- **Youngest Key ID**  
Shows whether or not the MD5 key is the latest key ID.

## Security

### AAA

#### General

On this page, you configure the login.

#### Settings

- **Login Authentication**  
Specify how the login is made:
  - Local  
Login with local user name and password.
  - Radius  
Login using a RADIUS server.
- **802.1x Reauthentication**  
If you select this check box, an authenticated 802.1X supplicant is forced to reauthenticate cyclically.

#### Radius client

##### Authentication over an external server

The concept of RADIUS is based on an external authentication server. An end device can only access the network after the device has verified the logon data of the device with the authentication server. Both the end device and the authentication server must support the EAP protocol (Extensive Authentication Protocol).

Each column of the table contains access data for one server. In the search order, the primary server is queried first. If the primary server cannot be reached, secondary servers are queried in the order in which they are entered.

If no server responds, there is no authentication. The client has no access to the network although a link is indicated at the port.

#### Settings

The table has the following columns:

- **Server IP Address**  
Enter the IP address of the RADIUS server.
- **Server Port**  
Here, enter the input port on the RADIUS server. As default, input port 1812 is set.
- **Shared Secret**
- Enter your access ID.

- **Shared Secret Conf.**  
Enter your access ID again as confirmation.
  - **Max. number of attempts**  
Enter the maximum number of query attempts before another configured RADIUS server is queried or the login counts as having failed. As default, 3 is set.
  - **Primary Server**  
Specify whether or not this server is the primary server. You can select one of the options "yes" or "no".
  - **Status**  
Enable or disable the RADIUS server.
- 

**Note**

You can configure a maximum of two servers on this page.

---

## 802.1x authentication

### Enabling authentication for individual ports

By selecting the check box, you specify whether or not network access protection according to IEEE 802.1x is enabled on this port.

### Settings

Table 1 has the following columns:

- **1st column**  
Shows that the settings are valid for all ports of table 2.
- **Setting**  
Select the setting. You have the following setting options:
  - Enabled  
Access protection is enabled.
  - Disabled  
Access protection is disabled.
  - No change  
Table 2 remains unchanged.
- **Copy to Table**  
If you click the button, the settings are adopted for all ports of table 2.

Table 2 has the following columns:

- **Port**  
Shows the port to which the setting relates.
- **Setting**  
Enable or disable the authentication for the required port. If this configuration is not possible for a port, it is displayed grayed out and you cannot modify the settings.

## Port ACL MAC

### Rule configuration

On this page, you specify the ACL rules for the MAC-based ACL.

### Settings

The table has the following columns:

- **Rule Number**  
Shows the number of the ACL rule. When you create a rule, a new row with a unique number is created.
- **Source MAC**  
Enter the unicast MAC address of the source.
- **Dest. MAC**  
Enter the unicast MAC address of the destination.
- **Action**  
Select the action. The following is possible:
  - Forward  
If the frame complies with the ACL rule, the frame is forwarded.
  - Discard  
If the frame complies with the ACL rule, the frame is not forwarded.
- **Egress Port**  
Shows a list of all egress ports to which this rule applies.
- **Ingress Port**  
Shows a list of all ingress ports to which this rule applies.

---

#### Note

If you enter the address "00:00:00:00:00:00" for the source and/or destination MAC address, the rule created in this way applies to all source or destination MAC addresses.

---

### Port ingress rules

On this page, you specify the ACL rule according to which incoming frames are handled by the port.

### Settings

- **Ports**  
Select the required port.
- **Add Rule**  
Select the ACL rule to be assigned to the port. You specify the ACL rule on the "Rules Configuration" page.

## 8.1 Configuring devices and networks

- **Add**  
To permanently assign the ACL rule to the port, click the "Add". The configuration is shown in the table.
- **Remove Rule**  
Select the ACL rule to be deleted.
- **Remove**  
To remove the ACL rule from the port, click the "Remove" button.

The table has the following columns:

- **Order**  
Shows the order of the ACL rules.
- **Rule Number**  
Shows the number of the ACL rule. When you create a rule, a new row with a unique number is created.
- **Source MAC**  
Shows the unicast MAC address of the source.
- **Dest. MAC**  
Shows the unicast MAC address of the destination.
- **Action**  
Select the action. The following is possible:
  - Forward  
If the frame complies with the ACL rule, the frame is forwarded.
  - Discard  
If the frame complies with the ACL rule, the frame is not forwarded.

### Port egress rules

On this page, you specify the ACL rule according to which outgoing frames are handled by the port.

### Description

- **Ports**  
Select the required port.
- **Add Rule**  
Select the ACL rule to be assigned to the port. You specify the ACL rule on the "Rules Configuration" page.
- **Add**  
To permanently assign the ACL rule to the port, click the "Add" button. The configuration is shown in the table.
- **Remove Rule**  
Select the ACL rule to be deleted.
- **Remove**  
To remove the ACL rule from the port, click the "Remove" button.

The table has the following columns:

- **Order**  
Shows the order of the ACL rules.
- **Rule Number**  
Shows the number of the ACL rule. When you create a rule, a new row with a unique number is created.
- **Source MAC**  
Shows the unicast MAC address of the source.
- **Dest. MAC**  
Shows the unicast MAC address of the destination.
- **Action**  
Select the action. The following is possible:
  - Forward  
If the frame complies with the ACL rule, the frame is forwarded.
  - Discard  
If the frame complies with the ACL rule, the frame is not forwarded.

## Port ACL IP

### Rule configuration

On this page, you specify the rules for the IP-based ACL.

### Settings

The table has the following columns:

- **Rule Number**  
Shows the number of the ACL rule. When you create a rule, a new row with a unique number is created.
- **Source IP**  
Enter the IP address of the source.
- **Source Subnet Mask**  
Enter the subnet mask in which the source is located.
- **Dest. IP**  
Enter the IP address of the destination.
- **Dest. Subnet Mask**  
Enter the subnet mask in which the destination is located.

## 8.1 Configuring devices and networks

- **Action**  
Select the action from the drop-down list. The following is possible:
  - Forward  
If the frame complies with the ACL rule, the frame is forwarded.
  - Discard  
If the frame complies with the ACL rule, the frame is not forwarded.
- **Egress Port**  
Shows a list of all egress ports to which this rule applies.
- **Ingress Port**  
Shows a list of all ingress ports to which this rule applies.

### Port ingress rules

On this page, you specify the ACL rule according to which incoming frames are handled by the port.

### Settings

- **Ports**  
Select the required port.
- **Add Rule**  
Select the ACL rule to be assigned to the port. You specify the ACL rule on the "Rules Configuration" page.
- **Add**  
To permanently assign the ACL rule to the port, click the "Add". The configuration is shown in the table.
- **Remove Rule**  
Select the ACL rule to be deleted.
- **Remove**  
To remove the ACL rule from the port, click the "Remove" button.

The table has the following columns:

- **Order**  
Shows the order of the ACL rules.
- **Rule Number**  
Shows the number of the ACL rule. When you create a rule, a new row with a unique number is created.
- **Source IP**  
Shows the IP address of the source.
- **Source Subnet Mask**  
Shows the subnet mask in which the source is located.
- **Dest. IP**  
Enter the IP address of the destination.



- **Dest. Subnet Mask**  
Enter the subnet mask in which the destination is located.
- **Action**  
Select the action. The following is possible:
  - Forward  
If the frame complies with the ACL rule, the frame is forwarded.
  - Discard  
If the frame complies with the ACL rule, the frame is not forwarded.

## Port egress rules

On this page, you specify the ACL rule according to which outgoing frames are handled by the port.

## Settings

- **Ports**  
Select the required port.
- **Add Rule**  
Select the ACL rule to be assigned to the port. You specify the ACL rule on the "Rules Configuration" page.
- **Add**  
To permanently assign the ACL rule to the port, click the "Add". The configuration is shown in the table.
- **Remove Rule**  
Select the ACL rule to be deleted.
- **Remove**  
To remove the ACL rule from the port, click the "Remove" button.

The table has the following columns:

- **Order**  
Shows the order of the ACL rules.
- **Rule Number**  
Shows the number of the ACL rule. When you create a rule, a new row with a unique number is created.
- **Source IP**  
Shows the IP address of the source.
- **Source Subnet Mask**  
Shows the subnet mask in which the source is located.
- **Dest. IP**  
Enter the IP address of the destination.

- **Dest. Subnet Mask**  
Enter the subnet mask in which the destination is located.
- **Action**  
Select the action from the drop-down list. The following is possible:
  - Forward  
If the frame complies with the ACL rule, the frame is forwarded.
  - Discard  
If the frame complies with the ACL rule, the frame is not forwarded.

## ACL management

On this page, you can increase the security of your device. To specify which station with which IP address is allowed to access your device, configure the IP address or an entire address range.

You can select the protocols and the ports of the station with which it is allowed to access the device. You define the VLAN in which the station may be located. This ensures that only certain stations within a VLAN have access to the device.

---

### Note

Note that a bad configuration may mean that you can no longer access the device.

---

## Settings

- **ACL management**  
Enable or disable the function.
- **IP Address**  
Enter the IP address or the network address to which the rule will apply. If you use the IP address 0.0.0.0, the settings apply to all IP addresses.
- **Subnet Mask**  
Enter the subnet mask. The subnet mask 255.255.255.255 is for a specific IP address. If you want to allow a subnet, for example a C subnet, enter 255.255.255.0. The subnet mask 0.0.0.0 applies to all subnets.

The table has the following columns:

- **Rule Number**  
Shows the number of the ACL rule. When you create a rule, a new row with a unique number is created.
- **IP Address**  
Shows the IP address.
- **Subnet Mask**  
Shows the subnet mask.
- **VLANs Allowed**  
Enter the number of the VLAN in which the device is located. The station can only access the device if it is located in this configured VLAN. If this input box remains empty, there is no restriction.

- **SNMP**  
Specify whether the station or the IP address can access the device using the SNMP protocol.
- **TELNET**  
Specify whether the station or the IP address can access the device using the TELNET protocol.
- **HTTP**  
Specify whether the station or the IP address can access the device using the HTTP protocol.
- **HTTPS**  
Specify whether the station or the IP address can access the device using the HTTPS protocol.
- **SSH**  
Specify whether the station or the IP address can access the device using the SSH protocol.
- **Px.y**  
Specify whether the station or the IP address can access this device via this port.

#### **8.1.4.7 Configuring PROFIBUS DP**

##### **The basics of configuring a DP master system**

##### **Distributed I/O**

DP master systems that consist of a DP master and DP slaves which are connected via a bus and communicate with one another via the PROFIBUS DP protocol are referred to as distributed I/O.

##### **Firmware version of the S7-1200 CPU**

Use of the PROFIBUS functions with the S7-1200, requires CPUs with firmware version 2.0 or higher.

##### **Configuring distributed I/O**

Since DP masters and DP slaves are different devices, these instructions only provide a basic configuration procedure. However, the process for configuring distributed I/O is practically identical to that of non-distributed configuration.

##### **Creating the DP master system in the network view**

After you have used dragged a DP master and a DP slave (for example, a CM 1243-5 and a CM 1243-5) from the hardware catalog to the network view, connect them both to a PROFIBUS subnet.

### **Additional information**

Observe additional information on the scope of functions in the manuals of the respective device.

### **DP slaves within the hardware catalog**

#### **DP slaves within the hardware catalog**

You will find the DP slaves in the "Distributed I/O" folder of the hardware catalog. Compact and modular DP slaves are located there:

- Compact DP slaves  
Modules with integrated digital/analog inputs and outputs, for example, ET 200L
- Modular DP slaves  
(Interface modules with S7 modules assigned, for example, ET 200M)

The available DP master and the desired functionality will determine which DP slaves can be used.

#### **I slaves within the hardware catalog**

The CM 1242-5 is, for example, an DP slave that can be configured as intelligent DP slave. You can find it in the hardware catalog at:

- CM 1242-5  
"PLC > SIMATIC S7 1200 > Communication module > PROFIBUS"

### **DP/DP coupler in the hardware catalog**

#### **Introduction**

A DP/DP coupler connects two PROFIBUS DP networks as a gateway so that the DP master from one network can transfer data to the DP master of the other network.

The maximum amount of data that can be transferred is 244 bytes input data and 244 bytes output data.

#### **DP/DP coupler in the hardware catalog**

Details of a DP/DP coupler as gateway between two DM master systems are contained in the hardware catalog in the folder "Other field devices > PROFIBUS-DP > Gateways".

#### **Configuring the DP/DP coupler**

DP/DP couplers are configured in both PROFIBUS networks, each in their own master systems.

The input and output areas of both networks must thereby be matched to one another. The output data from one end of the DP/DP coupler are accepted as input data at the other respective end and vice versa.

## Configurations involving PROFIBUS DP

### Configurations involving basic DP slaves

#### Communication between DP master and DP slave

In the case of a configuration involving simple DP slaves, data is exchanged between the DP master and simple DP slaves, i.e. with I/O modules via the DP master. The DP master sequentially polls each DP slave configured within the DP master system and contained in its polling list. In doing so, it transfers the output data to the slaves and receives their input data in return.

#### Mono-master system

The configuration with only one DP master is also described as mono-master system. A single DP master with its associated DP slaves is connected to a physical PROFIBUS DP subnet.

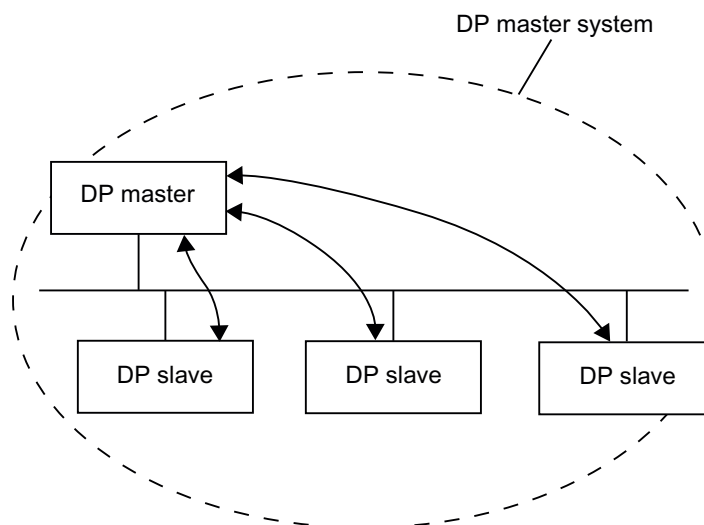

### Configurations involving intelligent DP slaves

#### Definition

DP slaves that feature their own preprocessing program are referred to as intelligent DP slaves (I-slaves).

CM 1242-5 is an intelligent DP slave.

### I-slave <> DP master data exchange

A higher-level automation system processes the automation task, which is broken down into sub-tasks. The sub-tasks are processed in the lower-level automation systems. The necessary control tasks are processed separately and efficiently in the CPUs as preprocessing programs.

In the case of configurations involving intelligent DP slaves, the DP master only accesses the operand area of the I-slave's CPU, and not the I/O modules of the intelligent DP slave. The operand area must not be assigned to any actual I/O modules in the I-slave. The assignment must be made during I-slave configuration.

The addresses of the data to be exchanged between the master and slave are configured in the transfer area of the I-slave.

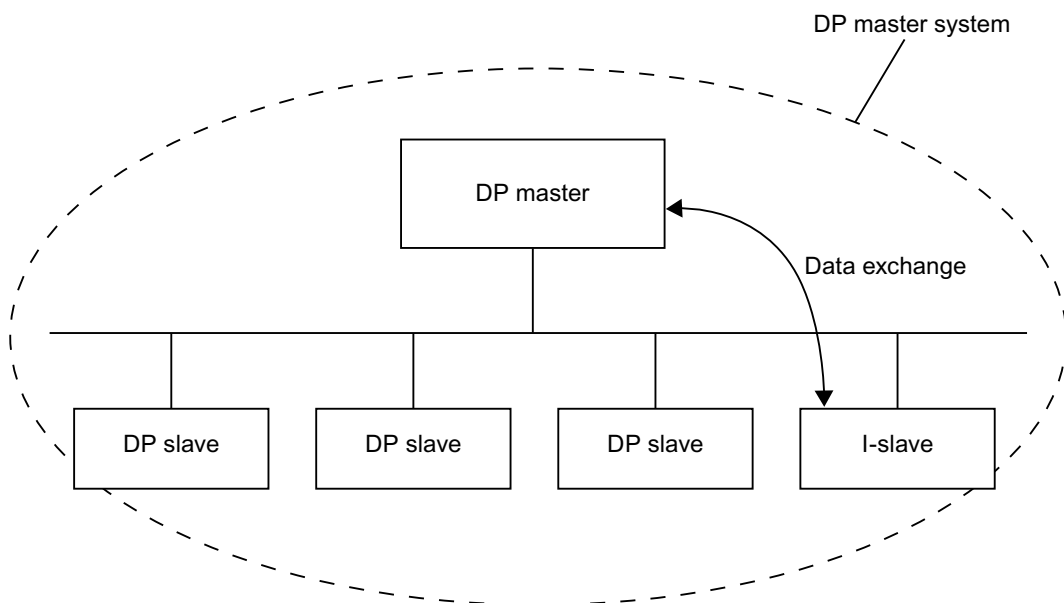

### Configuring distributed I/O systems

#### Hint: Quick configuration of master systems

If the DP master system has several DP slaves, use drag-and-drop operation to assign to the master in one step all DP slaves that were placed.

#### Requirements

DP master and DP slaves are placed in the network view.

## Assigning DP slaves to a DP master system

To do this, follow these steps:

1. Select an appropriate zoom factor so that you can see as many DP slaves as possible in the network view.
2. Arrange the DP slaves in a maximum of two rows.
3. Select all DP interfaces with the mouse cursor (not all devices!). This only works if you begin to drag the mouse cursor outside of the first DP slave and release the mouse button at the last DP slave (selection with the lasso).

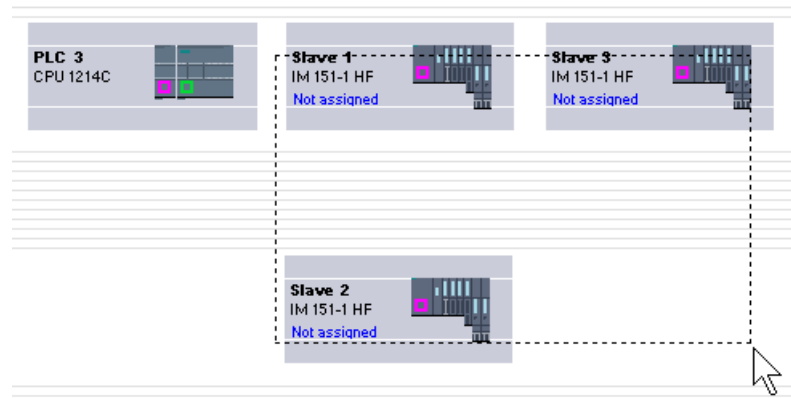

4. Select the shortcut menu "Assign to new master" and select the corresponding DP interface for the DP master in the subsequent dialog.

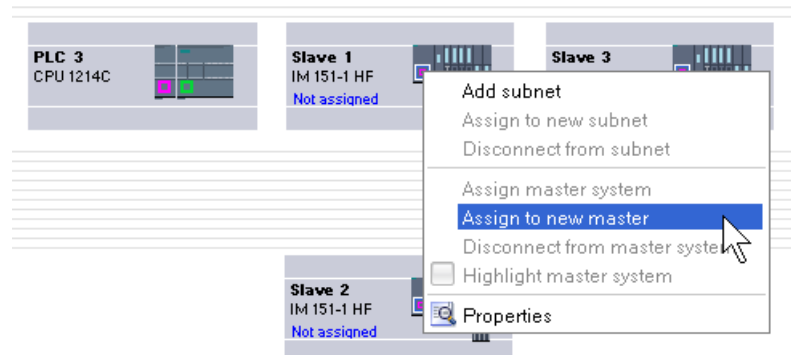

5. The DP slaves are automatically networked with the DP master and combine with it to form a DP master system.

### Note

When a DP master system is highlighted, you can double-click on a DP slave in the hardware catalog and thereby quickly add additional DP slaves. This will result in the DP slave being added to the highlighted DP master system automatically.

## **Creating a DP master system**

### **Introduction**

To create a DP master system, you need to have one DP master and at least one DP slave. As soon as you connect a DP master to a DP slave, a master-slave link is established.

### **DP master**

You can use any of the following devices as a DP master:

- CM 1243-5

### **Requirement**

- You must be in the network view.
- The hardware catalog is open.

### **Procedure**

To create a DP master system, follow these steps:

1. Select a DP master from the hardware catalog.
2. Pull the DP master onto the free area within the network view.
3. Right-click on the DP master's DP interface.
4. Select "Create master system" from the shortcut menu.  
A DP master system with one DP master will be created as a single node.

If you connect a DP slave's DP interface to that of the DP master, the DP slave will be added to the master system.



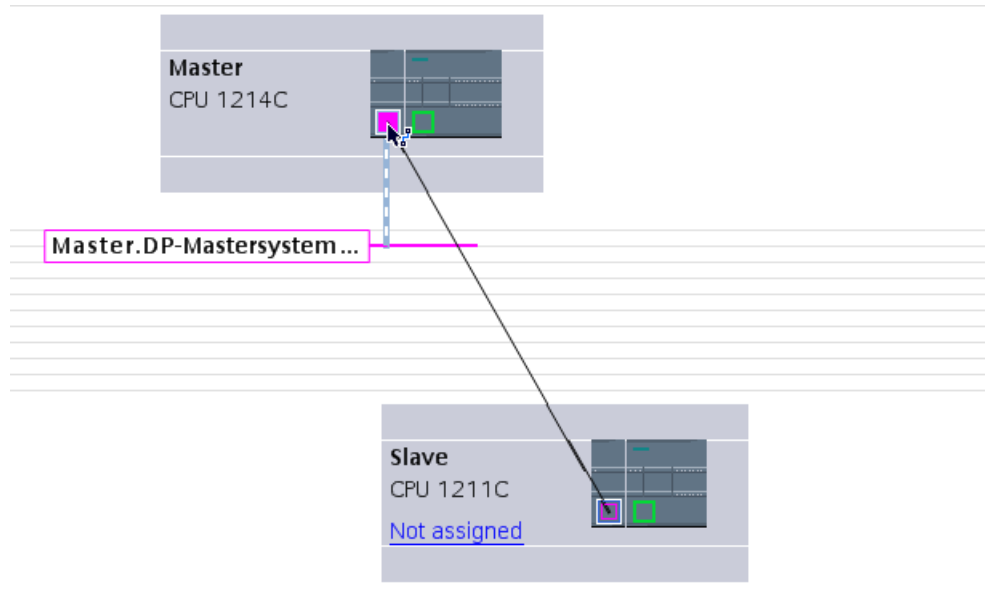

Assuming that you have already placed both a DP master and a DP slave within the network view, you can drag-and-drop to connect the two and thereby create a DP master system. To do so, follow these steps:

1. Click on the DP interface of either the DP master or DP slave.
2. Hold down the mouse button and draw a connecting line between this DP interface and that of the desired communication partner.

This will create a subnet with one DP master system between the DP master and DP slave.

### DP master display on the DP slave

When you connect a DP slave to a DP master, the name of the DP master is displayed on the DP slave as a hyperlink. Click the hyperlink to select the associated DP master.

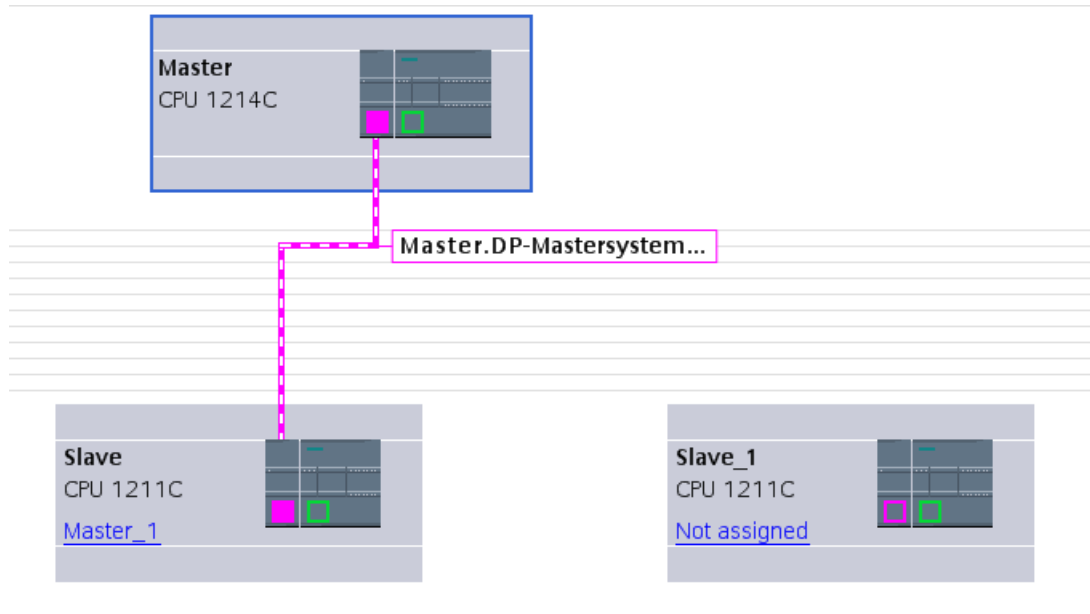

### Highlighting applied to the DP master system

When you create a new DP master system, highlighting will be applied to it. This enables you to identify quickly which devices belong to the DP master system. You can also highlight a DP master system yourself by moving the mouse pointer over a subnet. This will result in the names of the available DP master systems being displayed. Click the required DP master system to highlight it.

There are various ways of removing the highlighting from a DP master system:

- Highlight a different master system.
- Click on the drawing pin with the name of the master system in the top right-hand corner of the network view.

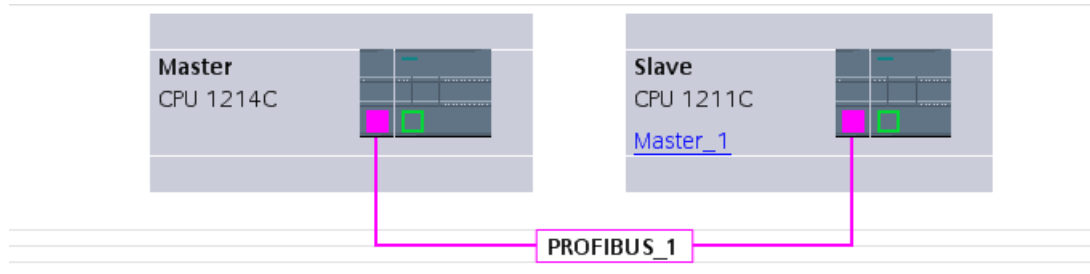

## Editing DP master systems and interfaces

### Introduction

Once you have created a DP master system, you also have the option of disconnecting the DP master system from its components. This can result in subnets with DP slaves but without DP master.

Generally, there is no need to edit the interfaces of a DP master.

You can change the name and number on the DP master system.

### Disconnection of master or slaves from the DP master system

If you have configured a PROFIBUS CP as a DP master with master system, you can then disconnect the DP master system from the DP master. After this, the device will no longer be connected to the DP master system.

Disconnecting the subnet from a DP master effectively eliminates the master system in the sense that it is no longer assigned to a DP master. However, the individual DP slaves are still interconnected via the subnet.

If you delete the DP slaves or disconnect them from the master system, the master system is then retained on the DP master.

### Requirement

- You must be in the network view.
- There has to be a DP master system with one DP master and at least one DP slave.

### Disconnecting the DP master from the DP master system

To disconnect the DP master system, proceed as follows:

1. Right-click on the DP master's DP interface.
2. Select "Disconnect from master system" from the shortcut menu.

The selected DP master will be disconnected from the DP master system. A subnet with the DP slaves will be retained.

### Adding a DP master to the DP master system

To reassign a DP master to a subnet, proceed as follows:

1. Right-click on the DP master's DP interface.
2. Select "Create master system" from the shortcut menu.
3. Draw connecting lines between the new DP master system and the DP interfaces of the DP slaves.

The DP master combines with the DP slaves to recreate a DP master system.

### Editing the properties of a DP master system

To edit the properties of a DP master system, proceed as follows:

1. Move the mouse pointer over a subnet with a DP master system.
2. A message will appear displaying the available DP master systems. Click the one you want to edit. The DP master system will now be color-highlighted.
3. Click on the highlighted DP master system.
4. In the inspector window, edit the DP master system attributes under "Properties > General".

---

#### Note

If you click a subnet when no DP master system is highlighted, you will be able to edit the properties of the entire subnet under "Properties" in the inspector window.

---

### Adding DP slaves to the master system and configuring them

In the network view, you can add various DP slaves from the hardware catalog directly by using the drag-and-drop function or by double-clicking.

### DP slaves

For configuration purposes, DP slaves are broken down into the following categories:

- Compact DP slaves  
(Modules with integrated digital/analog inputs and outputs, for example, ET 200L)
- Modular DP slaves  
(interface modules with S5 or S7 modules assigned, for example ET 200M)
- Intelligent DP slaves (I slaves)  
(CM 1242-5 or ET 200S with IM 151-7 CPU)

### Rules

- Your DP master system should only contain one DP master, but it may contain one or more DP slaves.
- You may only configure as many DP slaves in a DP master system as are permitted for the specific DP master.

---

#### Note

When configuring the DP master system, remember to observe the DP master technical data (max. number of nodes, max. number of slots, max. quantity of user data). User data restrictions may possibly prevent you from being able to use the maximum number of nodes that is theoretically possible.

---

## Requirements

- You must be in the network view.
- A DP master system must have been created.

## Adding a DP slave to the DP master system

To add a DP slave from the hardware catalog to the DP master system, follow these steps:

1. Select a DP slave from the hardware catalog.
2. Drag-and-drop the DP slave from the hardware catalog into the network view.
3. Draw a connecting line between the DP master's DP interface or a highlighted DP master system and the DP interface of the new DP slave.

A DP master system will be created and the DP slave will be connected to the DP master automatically.

---

### Note

When a DP master system is highlighted, you can double-click the required DP slave in the hardware catalog. This will result in the DP slave being added to the highlighted DP master system automatically.

---

## Disconnecting a DP slave from the DP master system

To disconnect a DP slave from the DP master system, follow these steps:

1. In the network view, right-click on the DP slave's DP interface.
2. From the shortcut menu, select the method for disconnecting from the DP master system:
  - "Disconnect from subnet": The PROFIBUS connection is broken and the device is no longer connected to the DP master system or a subnet.
  - "Disconnect from master system": The DP slave remains connected to the subnet, but is no longer assigned to the DP master system as a DP slave.

The selected DP slave will be disconnected from the DP master system.

## Assigning a DP slave to a new DP master system

To assign an existing DP slave to a new DP master system, follow these steps:

1. Right-click on the DP slave's DP interface.
2. From the shortcut menu, select "Assign to new master".  
It does not matter whether the DP slave concerned is already assigned to another DP master system.
3. From the selection list, select the DP master whose DP master system is to have the DP slave connected to it.  
The selected DP slave is now assigned to a new DP master system.

The "Assign to new subnet" function works in a similar way in that it allows you to connect a DP slave to a new subnet. However, in this case, the DP slave will not be connected to an existing DP master system.

### Configuring a DP slave

To configure a DP slave, follow these steps:

1. Switch to the DP slave's device view.
2. Select the module you want.
3. Configure the DP slave in the Inspector window.

### Configuring intelligent DP slaves

#### Adding an I-slave to a DP master system

##### Introduction

One of the characteristics of an intelligent DP slave (I-slave) is that the DP master is not provided with I/O data directly by a real I/O, but by a preprocessing CPU. Together with the CP, this preprocessing CPU forms the I-slave.

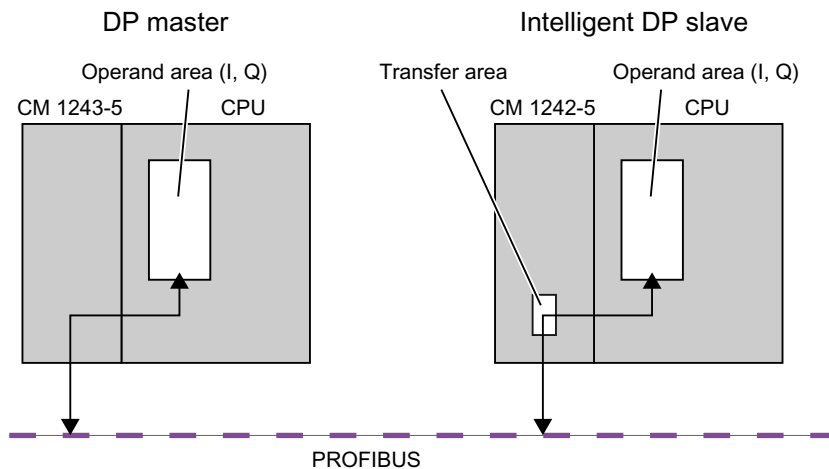

#### Difference: DP slave v. intelligent DP slave

In the case of a DP slave, the DP master accesses the distributed I/O directly.

In the case of an intelligent DP slave, the DP master actually accesses a transfer area in the I/O address space of the preprocessing CPU instead of accessing the connected I/O of the

intelligent DP slave. The user program running on the preprocessing CPU is responsible for ensuring data exchange between the address area and I/O.

#### Note

The I/O areas configured for data exchange between the DP master and DP slaves must not be used by I/O modules.

## Applications

Configurations involving intelligent DP slaves: I-slave <> DP master data exchange

## Procedure

To add an I-slave to a DP master system, follow these steps:

1. In the network view, drag from the hardware catalog to a station one CM 1242-5 as an I-slave and one CM 1243-5 as a DP master.
2. Draw a connecting line between the DP interfaces of both devices.  
This way you connect the I-slave with a DP master in a DP master system.  
Result: You have now set up a DP master system with one DP master and one I-slave.

## Configuring access to I slave data

## Data access

The following applies to the CP 1242-5 in its function as I-slave: The addresses for the data transfer area and the address for the I/O modules in the I-slave differ. This means that the start address occupied by an I/O module can no longer be used for the transfer memory. If the higher-level DP master is to access the data of an I/O module in the I-slave, you must configure this data exchange between the I/O module and transfer area in the I-slave user program.

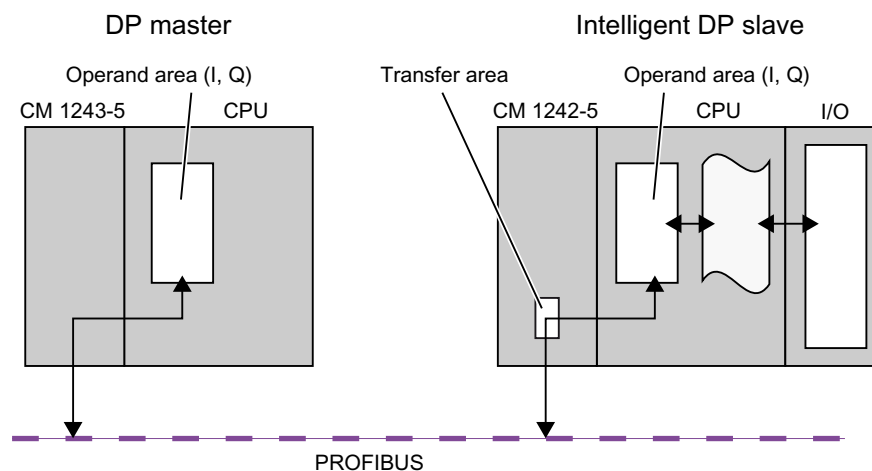

### **Configuration of the transfer area for the CM 1242-5 (transfer area)**

With CM 1242-5, the transfer area for the cyclic PROFIBUS data exchange is configured as transfer area in the parameter group "PROFIBUS interface > Mode > I Slave Communication".

### **Direct data access from CPU to CPU**

Direct data access from CPU to CPU via PROFIBUS is supported by the S7-1200 PROFIBUS CMs only via the PUT/GET services.

### **Configuring DP slaves as distributed I/O devices**

### **Configuring an ET 200S**

#### **Slot rules for configuring an ET 200S**

The following rules apply when configuring an ET 200S:

- Do not leave any gaps when inserting the ET 200S modules.
- Slot 1: only for PM-E or PM-D Power Modules.
- To the left of an Electronics Module (EM): an EM or a Power Module (PM-E or PM-D) only.
- To the left of Motor Starter (MS): an MS, a PM-D, PM-D Fx (1..x..4) Power Module or a PM-X Power Module only.
- To the left of a PM-X: a motor starter or a PM-D only
- Up to 63 modules and one IM Interface Module are permitted

---

#### **Note**

Remember to ensure that the correct PM-E and EM voltage ranges are assigned.

---

### **Configuring reference junctions**

A reference junction is the connection of a thermocouple to a supply line (generally in the terminal box). The voltage that occurs due to the effects of temperature falsifies the temperature value measured by the module.

On the ET 200S, one channel of the AI RTD module can be programmed as a reference junction. Other AI TC modules can correct their measured values using the temperature at the reference junction as measured by this module.



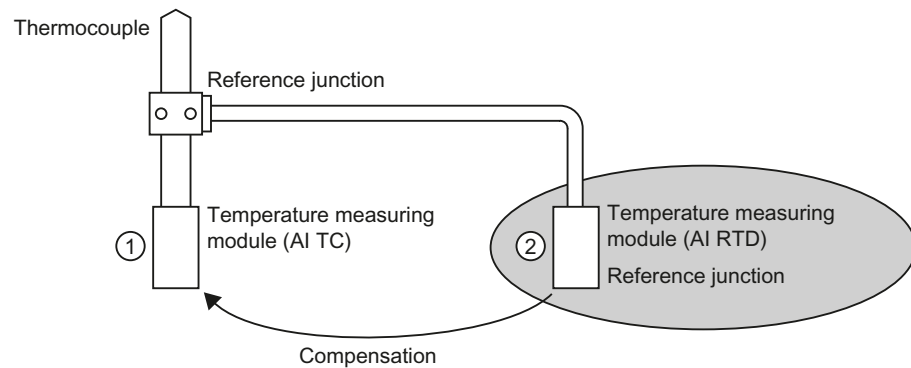

- ① Configuring the AI TC:
  - Selection of the reference junction used
- ② Configuring of the AI RTD:
  - Activation of the reference junction
  - Specifying the slot and channel of the AI RTD

### Special characteristics to be noted when assigning parameters for reference junctions

The process of assigning parameters for reference junctions will be explained based on the example of a resistance thermometer with a Pt 100 climatic range that is used for measuring the reference junction temperature.

To assign parameters for the reference junction, follow these steps:

1. In the ET 200S device view, insert an analog electronics module, for example a 2AI RTD HF.
2. Select the module on the rack.
3. Under "Properties > Inputs" in the inspector window, set a channel for the reference junctions function to the "RTD-4L Pt 100 climatic range" measuring range.
4. Select the ET 200S.
5. Under "Properties > Module parameters > Reference junctions" in the inspector window, select the "Reference junction" check box and specify the slot and channel number of the relevant RTD module.
6. Insert the analog electronics module for measuring the temperature using a thermocouple (TC module) and parameterize it with the reference junction number of the RTD module.

### Additional information

For additional information on the various types and uses of ET 200S modules, please refer to the operating instructions and the manual titled "ET 200S Distributed I/O System".

For additional information on analog value processing, please see the documentation for the ET 200S distributed I/O system.

## Packing addresses

### Introduction

DP slaves and I/O devices from the ET 200S family are configured in the same way as other modular DP slaves and I/O devices. As well as supporting all the standard modular DP slave and I/O device functions, the ET 200S also offers the "Pack addresses" function:

When digital electronics modules requiring an address space of 2 or 4 bits are inserted into the device view, they will initially be spread over a total area of 1 byte. However, the address area actually occupied can be compressed after configuration using the "Pack addresses" function.

	Initial state	After "Pack addresses"
Module	I address	I address
2DI (2-bit)	Byte 10	10.0...10.1
4DI (4-bit)	Byte 11	10.2...10.5

### Requirements

- You are in the device view.
- An ET 200S, for example an IM 151-1, must be present.
- A pair of digital electronics modules, for example 2DI AC120V ST, must be inserted into the slots.

### Packing addresses

To pack addressed, follow these steps:

1. Select the electronics modules whose addresses are to be packed. The following options are available for selecting multiple electronics modules:
  - Press and hold down <Shift> or <Ctrl> while clicking the relevant electronics modules.
  - Click off the rack and select the required electronics modules by drawing round them with the mouse.
2. Click "Pack addresses" in the shortcut menu for the selected electronics modules.

The address areas for inputs, outputs and motor starters are packed separately. The packed addresses will be displayed in the I address and Q address columns of the device overview.

## How packed addresses are generated and structured

If you make use of the "Pack addresses" function, the addresses of the selected electronics modules will be packed in accordance with the following rules:

- The start of the address area is determined by the lowest address of the selected electronics modules: X.0
- If the bit address is not "0", then the next (free) byte address as of which the selected area can be compacted will be selected automatically: (X+n).0
- If no coherent area exists, the addresses will be automatically packed into any available address gaps.

Electronics modules with packed addresses and the same byte address form a packing group.

## Unpacking addresses

To unpack addressed, follow these steps:

1. Select one or more electronics modules with packed addresses.
2. Click "Unpack addresses" in the shortcut menu for the selected electronics modules.

The packing groups of the selected electronics modules will be disbanded and the packed addresses for the relevant electronics modules unpacked.

The packing group will also be disbanded and the packed addresses unpacked in the following cases: if you delete electronics modules from a packing group, move electronics modules out of a packing group or insert electronics modules on a free slot within a packing group.

The start addresses of the unpacked electronics modules will be assigned to the next available byte addresses in each case.

## Special characteristics of electronics modules with packed addresses

The following special characteristics apply to electronics modules with packed addresses:

- As far as the CPU is concerned, there is no way of assigning a slot for the electronics module. Consequently, the instruction GADR\_LGC (SFC 5) outputs error information W#16#8099 "Slot not configured" for the actual slot of the electronic module.
- The instruction LGC\_GADR (SFC 49) and SZL-ID W#16#xy91 "module status information" cannot be evaluated for an electronics module.
- The electronics module receives an additional diagnostics address via the DPV1 function, because otherwise the packed addresses would prevent interrupts from being assigned as far as the CPU is concerned.
- The "Insert/remove interrupt" is not possible. This is because the "Pack addresses" and "Insert/remove interrupt" functions are mutually exclusive.

## Configuring option handling with standby modules

You can use the option handling function to prepare the ET 200S with PROFIBUS interface for future expansions (options). This section describes option handling with standby modules.

## 8.1 Configuring devices and networks

You do this by assembling, wiring, configuring, and programming the maximum configuration envisaged for the ET 200S and by using cost-effective standby modules (138-4AA00 or 138-4AA10) during assembly until it becomes time to replace them with the necessary electronics modules.

---

### Note

The ET 200S can be completely factory-wired with the master cabling, as no connection exists between a standby module and the terminals of the terminal module (and, in turn, to the process).

---

## Requirement

- ET 200S interface module
  - IM 151-1 STANDARD (6ES7 151-1AA03-0AB0 or higher)
  - IM 151-1 FO STANDARD (6ES7 151-1AB02-0AB0 or higher)
- Power module with option handling
  - PM-E DC24..48V
  - PM-E DC24..48V/AC24..230V

## Procedure

To activate option handling, follow these steps:

1. Select the IM 151-1 in the device view and enable it in "Option handling" check box under "Properties > General > Option handling" in the inspector window.
2. Select the numbered check boxes for the slots that are initially to accommodate the standby modules prior to the future electronics modules.
3. Select the power module in the device view and enable it in the "Option handling" check box under "Properties > Addresses" in the inspector window. Reserve the necessary address space for the control and check-back interface in the process image output (PIQ) and process image input (PII).

The assembled standby modules can be replaced with the configured modules at a later date without having to modify the configuration.

---

### Note

The addresses for these interfaces are reserved as soon as you activate option handling on the power module. The "Option handling" function must also be activated on the DP slave (IM 151-1 STANDARD Interface Module). If it is not activated, the addresses reserved for the control and check-back interface will be released again.

Note that activating and deactivating the option handling function repeatedly can change the address of the control and check-back interface.

Option handling may be activated for one PM-E DC24..48V or one PM-E DC24..48V/AC24..230V Power Module only.

---

## Additional information

For additional information on the assignment and significance of bytes within the process image, option handling with PROFIBUS and the use of standby modules, please refer to the documentation for the ET 200S distributed I/O system.

## How option handling works during startup

If "Startup when expected/actual config. differ" is not available, the ET 200S will still start up if a standby module is inserted instead of the configured electronics module and option handling has been activated for the slot concerned.

## How option handling works during operation

During operation, the option handling mode varies in accordance with the following:

- Option handling enabled for a slot:  
Either the standby module (option) or the configured electronics module can be plugged into this slot. If any other kind of module is present on this slot, diagnostics will be signaled (no module/incorrect module).
- Option handling disabled for a slot:  
Only the configured electronics module can be plugged into this slot. If any other kind of module is present, diagnostics will be signaled (no module/incorrect module).

## Standby module substitute values

- Substitute value for digital inputs: 0
- Substitute value for analog inputs: 0x7FFF

## Control and evaluation in the user program

The ET 200S is equipped with a control and feedback interface for the "Option handling" function.

The control interface is located in the process image output (PIQ). Each bit in this address area controls one of the slots from 2 to 63:

- Bit value = 0: Option handling parameterized. Standby modules are permitted.
- Bit value = 1: Option handling canceled. Standby modules are not permitted on this slot.

The check-back interface is located in the process image input (PII). Each bit in this address area provides information about the modules that are actually plugged into slots 1 to 63:

- Bit value = 0: This slot has the standby module, an incorrect module or no module plugged into it.
- Bit value = 1: The configured module is plugged into this slot.

## See also

Which modules support option handling? (<http://support.automation.siemens.com/WW/view/en/22564754>)

## **Configuring option handling without standby modules**

You can use the option handling function to prepare the ET 200S for future expansions (options) without installing standby modules. This section describes option handling without standby modules.

---

### **Note**

#### **ET 200S with PROFINET interface**

This description refers to the ET 200S with PROFIBUS interface. In principle, option handling for ET 200S with PROFINET interface functions as described here without standby modules. PN interface modules are to be used instead of the DP interface modules listed here. You can find additional information about option handling for ET 200S with PROFINET interface in the corresponding manuals.

---

## **Requirement**

- ET 200S interface module
  - IM 151-1 HIGH FEATURE (6ES7151-1BA02 or higher)
  - IM 151-1 STANDARD (6ES7 151-1AA05-0AB0 or higher)
- Power module with option handling
  - PM-E DC24..48V
  - PM-E DC24..48V/AC24..230V

## Procedure

To activate option handling, follow these steps:

1. Select the IM 151-1 in the device view and enable it in "Option handling" check box under "Properties > General > Option handling" in the inspector window.
2. Select the power module in the device view and enable it in the "Option handling" check box under "Properties > Addresses" in the inspector window. Reserve the necessary address space for the control and check-back interface in the process image output (PIQ) and process image input (PII).
3. Configure the slave's maximum configuration. The selection/clearing of options is controlled via the user program.

---

### Note

The addresses for these interfaces are reserved as soon as you activate option handling on the power module. The "Option handling" function must also be activated on the DP slave (IM 151-1 interface module). If it is not activated, the addresses reserved for the control and check-back interface will be released again.

Note that activating and deactivating the option handling function repeatedly can change the address of the control and check-back interface.

Option handling may be activated for one PM-E DC24..48V or one PM-E DC24..48V/AC24..230V Power Module only.

---

## Additional information

For additional information on the assignment and significance of bytes within the process image, option handling with PROFIBUS and the use of standby modules, please refer to the documentation for the ET 200S distributed I/O system.

## Control and evaluation in the user program

The ET 200S is equipped with a control and feedback interface for the "Option handling" function.

The control interface is located in the process image output (PIQ). Each bit in this address area controls one of the slots from 1 to 63:

- Bit value = 0: Slot is not available in the actual configuration.
- Bit value = 1: Slot is available in the actual configuration.

The check-back interface is located in the process image input (PII). Each bit in this address area provides information about the modules that are actually plugged into slots 1 to 63:

- Bit value = 0: Slot belongs to an option that is not available or module status is faulty.
- Bit value = 1: The configured module is plugged into this slot.

## See also

Sample applications for ET 200S, option handling without standby module (<http://support.automation.siemens.com/WW/view/en/29430270>)

### Configuring the ET 200S in DPV1 mode

PROFIBUS DPV1 enables you to access extended PROFIBUS functions.

#### Requirement

- You must be in network view.
- A DP master with DPV1 functionality must be available.
- A master-slave connection must be established with PROFIBUS.

#### Procedure

To switch the DP slave over to DPV1, follow these steps:

1. Select the DP slave.
2. Under "Properties > Module parameters" in the Inspector window, select "DPV1" mode from the "DP interrupt mode" drop-down list.

or

1. Select the DP master.
2. In the I/O communications table, select the row with the connection between the DP master and the desired DP slave.
3. Under "Properties > Module parameters" in the Inspector window, select "DPV1" mode from the "DP interrupt mode" drop-down list.

#### Special characteristics

The parameters are subject to interdependencies, which are outlined below:

Parameter	DPV0 mode	DPV1 mode
Operation when target configuration does not match actual configuration	Fully available	Fully available
Diagnostics interrupt (OB 82)	Not available, not set	Fully available
Hardware interrupt (OB 40 to 47)	Not available, not set	Fully available
Insert/remove interrupt (OB 83)	Not available, not set	Only available when addresses are not packed. "Startup when target configuration does not match actual configuration" is activated automatically along with an insert/remove interrupt.

#### Interrupts in the case of modules with packed addresses

If the module is capable of triggering interrupts and the bit address is not equal to 0 because of packed addresses, you will need to assign a diagnostics address in the ET 200S address dialog.



The diagnostics address is required for the purpose of assigning a DPV1 interrupt to the module as an interrupt trigger. The CPU will only be able to assign an interrupt correctly and store information on the interrupt in the interrupt OB start information/in the diagnostics buffer if the module concerned has this "unpacked" address. In this context, the CPU cannot make use of "packed" addresses.

From the point of view of interrupt processing (interrupt OB), this means the module will have the assigned diagnostics address, but from the point of view of processing the input and output data in the user program, the module will have the packed addresses.

---

**Note**

When the module addresses are packed, the insert/remove interrupt for the ET 200S is unavailable.

---

## Using GSD files

### GSD revisions

#### What you need to know about GSD revisions

The properties of DP slaves are made available to configuration tools by means of GSD files.

Functional enhancements in the area of the distributed I/O will have an effect on the GSD specification, for example, they will require the definition of new keywords.

This results in the versioning of the specification. In the case of GSD files, the version of the specification on which a GSD file is based is called a "GSD revision".

From GSD revision 1, the GSD revision must be included as a keyword "GSD\_revision" in GSD files. GSD files without this keyword will therefore be interpreted by configuration tools as GSD revision "0".

GSD files can be interpreted up to GSD revision 5. This means that DP slaves that support the following functions, for example, will be supported:

- Diagnostic alarms for interrupt blocks
- Isochronous mode and constant bus cycle time
- SYNC/FREEZE
- Clock synchronization for DP slaves

## Installing the GSD file

### Introduction

A GSD file (device data file) contains all the DP slave properties. If you want to configure a DP slave that does not appear in the hardware catalog, you must install the GSD file provided by the manufacturer. DP slaves installed via GSD files are displayed in the hardware catalog and can then be selected and configured.

## Requirement

- The hardware and network editor is closed.
- You have access to the required GSD files in a directory on the hard disk.

## Procedure

To install a GSD file, proceed as follows:

1. In the "Options" menu, select the "Install device master data files" command.
2. In the "Install device master data files" dialog box, choose the folder in which you want to save the GSD files.
3. Choose one or more files from the list of displayed GSD files.
4. Click on the "Install" button.
5. To create a log file for the installation, click on the "Save log file" button.  
Any problems during the installation can be tracked down using the log file.

You will find the new DP slave installed by means of the GSD file in a new folder in the hardware catalog.

---

### Note

Installation of GSD file cannot be undone.

---

## Configuring GSD-based DP slave

DP slaves that you have inserted through installation of a GSD file can be selected as usual via the hardware catalog and inserted in the network view. If you want to insert the modules of the GSD-based DP slaves, you must take into account some particular details.

## Requirements

- You have installed a DP slave using a GSD file.
- You have inserted the head module in the network view in the usual manner.
- The device overview opens in the device view.
- The hardware catalog is open.

## Procedure

To add the modules of a GSD-based DP slave, proceed as follows:

1. In the hardware catalog, navigate to the modules of the GSD-based DP slave.  
GSD-based DP slaves, also referred to as DP standard slaves, can be found in the "Other field devices" folder of the hardware catalog.
2. Select the desired module.

3. Use drag-and-drop to move the module to a free space in the device overview.
4. Select the module in the device overview to edit parameters.

You have now inserted the module in a free slot of the GSD-based DP slave and can edit its parameters.

---

**Note**

You can see only the GSD-based DP slave in the graphic area of the device view. The added modules of GSD-based DP slaves are only found in the device overview.

---

### Preset configuration

For modules with an adjustable preset configuration, you can change this configuration in the inspector window under "Properties > Preset configuration".

#### 8.1.4.8 Configurations for PROFINET IO

### What you need to know about PROFINET IO

#### What is PROFINET IO?

#### PROFINET IO

PROFINET is an Ethernet-based automation standard of PROFIBUS Nutzerorganisation e.V. (PNO) which defines a manufacturer-neutral communication, automation and engineering model.

#### Objective

The objective of PROFINET is:

- Integrated communication via field bus and Ethernet
- Open, distributed automation
- Use of open standards

#### Architecture

The PROFIBUS User Organisation e.V. (PNO) has designated the following aspects for PROFINET architecture:

- Communication between controllers as components within distributed systems.
- Communication between field devices, such as I/O devices and drives.

## Implementation by Siemens

The demand for "Communication between controllers as components within distributed systems" is implemented by "Component Based Automation" (CBA). Component Based Automation is used to create a distributed automation solution based on prefabricated components and partial solutions.

The demand for "Communication between field devices" is implemented by Siemens with "PROFINET IO". Just as with PROFIBUS DP, the complete configuration and programming of the components involved is possible using the Totally Integrated Automation Portal.

The following sections deal with the configuration of communication between field devices using PROFINET IO.

## Overview of RT classes

### RT classes in PROFINET IO

PROFINET IO is a scalable, real-time communication system based on Ethernet technology. The scalable approach is reflected in several real-time classes:

- **RT:** Transmission of data in prioritized, non-isochronous Ethernet frames. The required bandwidth is within the free bandwidth area for TCP/IP communication.
- **IRT:** Isochronous transmission of data with high stability for time-critical applications (for example, motion control). The required bandwidth is from the area of bandwidth reserved for cyclic data.

Depending on the device, not all real-time classes are supported.

## Connecting existing bus systems

### Connection of PROFINET and PROFIBUS

PROFINET IO and PROFIBUS DP can be connected with each other as follows:

- via Industrial Ethernet:  
To connect the two network types, Industrial Ethernet (control level) and PROFIBUS (cell level/field level), use e.g. the IE/PB link.
- via Industrial Wireless LAN:  
PROFIBUS devices, for example, can be connected to PROFINET IO via a wireless LAN/PB link. This allows existing PROFIBUS configurations to be integrated into PROFINET.

AS interface devices can be connected by an IE/AS-i link PN IO to the interface of a PROFINET device. This allows the existing AS-i network to be integrated into PROFINET.

The following figure shows the connection of a PROFIBUS subnet via PROFINET device with proxy functions.

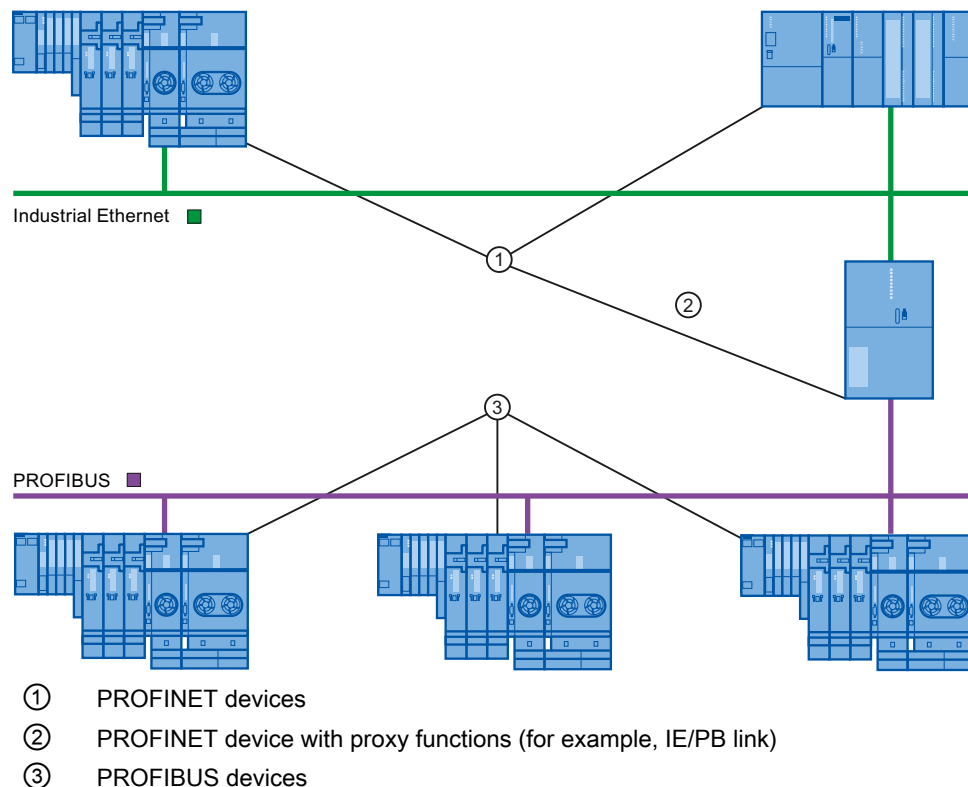

### PROFINET device with proxy functions used as proxy for a PROFIBUS device

The PROFINET device with proxy functions is the proxy for a PROFIBUS device on the Ethernet. Proxy functionality allows a PROFIBUS device that can communicate with all devices on the PROFINET and not just with its master.

Using PROFINET, existing PROFIBUS systems can easily be integrated into PROFINET communication using the proxy functions.

If, for instance, you connect a PROFIBUS device via an IE/PB link to PROFINET, the IE/PB link acts as a proxy for the PROFIBUS components to establish communication via PROFINET.

### Configuration using IE/PB link PN IO

### Configuration using IE/PB link PN IO

Use the IE/PB link IO to connect PROFIBUS DP configurations to PROFINET IO.

From the CPU perspective, the PROFIBUS DP slaves are connected to the same network as the IE/PB link PN IO. These slaves have the same device names and IP addresses as the IE/PB link PN IO, but different device numbers. Furthermore, each also has a specific PROFIBUS address.

In the properties of the IE/PB link, the PROFIBUS addresses of the connected DP slaves are displayed in addition to the PROFINET device numbers, as this device has two addressing schemes.

## Handling device numbers and PROFIBUS addresses on the master system

During placement, the same number is assigned for the PROFINET device number and the PROFIBUS address.

In the inspector window under "General Properties > PROFINET device number", you can find an overview of the device numbers used and the PROFIBUS addresses of an IE/PB link. The device number can also be changed here. You can also set that the device number and the PROFIBUS address should or should not always be identical. If the "PROFINET device number=PROFIBUS address" is activated, you do not have to track the device number when the PROFIBUS address changes.

The PROFIBUS addresses can be changed in the properties of the PROFIBUS device.

## Restrictions

The following restrictions apply to DP slaves configured as described above on the PROFIBUS subnet of an IE/PB link:

- No pluggable IE/PB link
- No pluggable DP/PA link
- No pluggable Y link
- Not CiR-compliant
- No pluggable redundant slaves
- No isochronous transmission / constant bus cycle time can be configured
- SYNC/FREEZE instructions ("DPSYC\_FR") of a CPU on the the Ethernet subnet for DP slaves behind the IE/PB-Link are not supported.

## Configuration using IWLAN/PN link

### Maximum number of devices in a IWLAN segment

If an Ethernet subnet is set up as wireless network (IWLAN = Industrial Wireless LAN), cyclic data exchange between IO controllers and IO devices is possible via a wireless route.

On one side of the wireless route there are fixed installed access points (for example, SCALANCE W 788) and on the other side mobile stations (with, for example IWLAN/PB links with PROFIBUS devices).

If the action radius of the mobile stations is large, it may be necessary to install several access points (SCALANCE W 788). Since each access point forms a segment with its wireless range, the IWLAN is made up of a series of segments.

The mobile devices "on the one side" of the wireless link with their IWLAN/PB links can move along the segments.

### Special feature

If several IWLAN/PB links are located within a segment, they have to share the bandwidth that is available for wireless transmission. This leads to a lengthening of the update time for these devices.

### Example

In the following example there are two IO devices (IWLAN/PB link) with a segment.

If no more than a maximum of two IWLAN/PB links are present in a IWLAN segment at the same time, enter a "2".

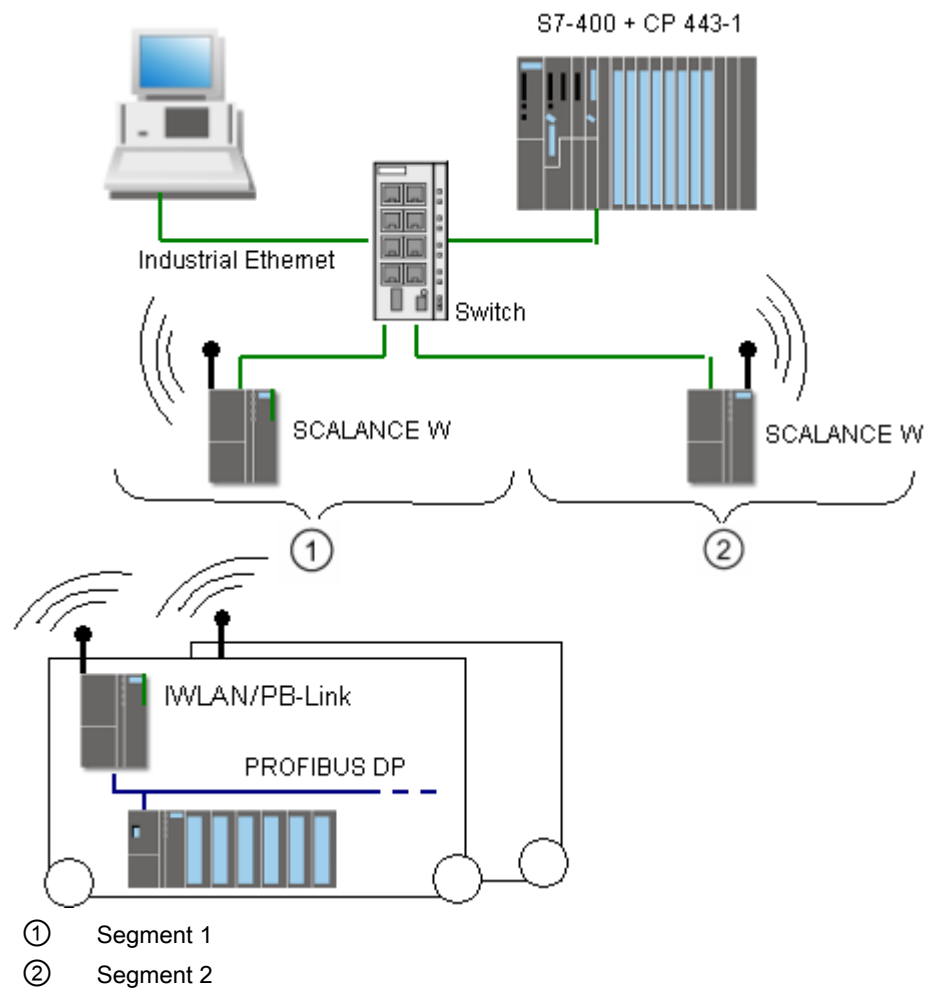

## Configure PROFINET IO

### Addressing PROFINET devices

#### Assigning addresses and names to PROFINET devices

In this chapter you will learn which address and naming conventions are valid for the PROFINET devices.

#### IP addresses

All PROFINET devices work with the TCP/IP protocol and therefore require an IP address for Ethernet operation.

You can set the IP addresses in the module properties. If the network is part of an existing company Ethernet network, ask your network administrator for this data.

The IP addresses of the IO devices are assigned automatically, usually at CPU startup. The IP addresses of the IO devices always have the same subnet mask as the IO controller and are assigned in ascending order, starting at the IP address of the IO controller.

#### Device names

Before an IO device can be addressed by an IO controller, it must have a device name. This procedure was chosen for PROFINET because names are easier to administer than complex IP addresses.

Both the IO controller as well as IO devices have a device name. When the "Generate PROFINET device name automatically" option is activated, the device name is automatically derived from the name configured for the device (CPU, CP or IM):

- The PROFINET device name is made up of the name of the device (for example, the CPU), the name of the interface (only with multiple PROFINET interfaces) and optionally the name of the IO system:  
<CPU name>.<Name of the interface>.<IO system name>  
You cannot change this name directly. You change the PROFINET device name indirectly, by changing the name of the affected CPU, CP or IM in the general properties of the module. This PROFINET device name is also displayed, for example, in the list of accessible devices. If you want to set the PROFINET device name independently of the module name, you have to deactivate the "Generate PROFINET device name automatically" option.
- A "converted name" is generated from the PROFINET device name. This is the device name that is actually loaded into the device.  
The PROFINET device name is only converted if it does not comply to the rules of IEC 61158-6-10. You cannot change this name directly either.



## Rules for the converted name

The rules for the converted name are listed in the following section. If the converted name is **not** different from the name of the module, the name of the module must comply with this rule.

- The name consists of one or more labels , which are separated by a dot [.]
- Restricted to a total of 240 characters (lower case letters, numbers, dash, or dot)
- A name component within the device name, which means a character string between two dots, must not exceed 63 characters.
- A name component consists of the characters [a-z, 0-9].
- The device name must not begin or end with the "-" character.
- The device name must not begin with a number.
- The device name form n.n.n.n (n = 0, ... 999) is not permitted.
- The device name must not begin with the string "port-xyz" or "port-xyz-abcde" (a, b, c, d, e, x, y, z = 0, ... 9).

## Example of device names

```
device-1.machine-1.plant-1.vendor
```

If you assign this name to a CPU, for example, STEP 7 will not convert it since it conforms to the rules described above.

## Device number

In addition to the device name, a device number is also automatically assigned when an IO device is plugged in. You can change this number.

## Devices in the PROFINET subnet

In a PROFINET subnet the maximum allowable number of devices is monitored during configuration.

## See also

Assigning the device name and IP address (Page 801)

Retentivity of IP address parameters and device names (Page 808)

## Assigning the device name and IP address

### Assigning an IP address and subnet mask for an IO controller the first time

There are various options for this: During the configuration of PROFINET interface, you have to set the following:

- IP address is set in the project.
- IP address is set using a different method.

Assign an IP address	Comments
Option: Set IP address in the project: Download with hardware configuration	When the hardware configuration is downloaded to the IO controller (e.g. CPU), the IP address and the device name are also downloaded.
Option: Set IP address in the project: Assign online via PROFINET interface	Connect your programming device/PC to the same network as the relevant PROFINET device. The interface of the PD/PC must be set to TCP/IP (Auto) mode. Have a list of accessible devices displayed. Select the target device via its MAC address and then assign its configured IP address before you download the hardware configuration including the configured IP address (IP address is then saved retentively).
Option: Set IP address in the project: Assign online via MPI/PROFIBUS interface	If your PROFINET device has an MPI or PROFIBUS DP interface, connect your programming device/PC directly to the PROFINET device via the MPI or PROFIBUS DP interface. The configured IP address is applied during download of hardware configuration.
Option "Use different method to obtain IP address" <ul style="list-style-type: none"> <li>• Assign online</li> <li>• Assign via user program</li> <li>• Higher-level IO controller (only with I devices)</li> </ul>	If you have selected this option in the properties of the PROFINET interface, the IP address can be assigned by the online and diagnostics editor, by the primary setup tool or by the user program ("IP_CONF" instruction)..  In case of an S7-1200-CPU, make sure that access to the CPU is not protected by a password. If the CPU is write-protected, no IP address and no device name can be assigned by any other method.

### Commissioning a PROFINET interface

Further details of how to commission a PROFINET interface can also be found in the operating instructions for the PROFINET devices from the SIMATIC family.

### Assigning device names for IO devices when the "Device replacement without removable media/PG" option is enabled

For IO devices where the "Device replacement without removable media/PG" option is activated, it is not necessary to assign the device name in the case of a device replacement.

## Assigning a device name and address for an IO device (exception in the case device exchange without media change/PG)

The following graphic illustrates the process for assigning the device name and address.

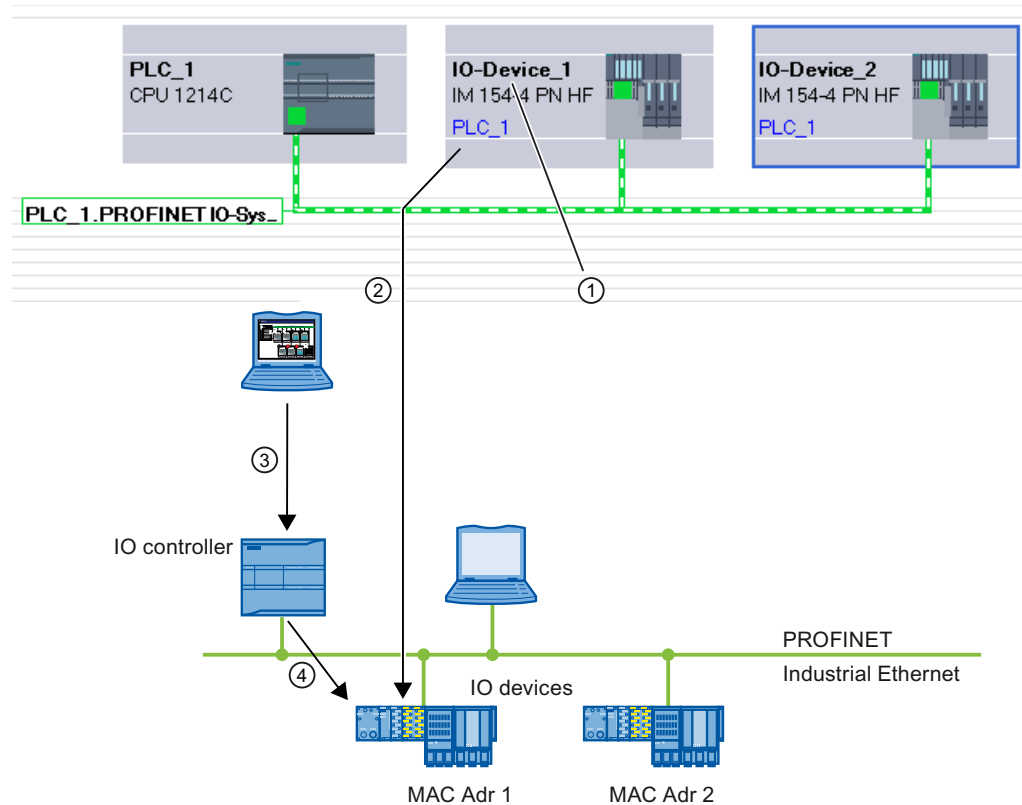

- ① Each device receives a name; STEP 7 automatically assigns an IP address.
- ② STEP 7 generates a PROFINET device name from the name. This is then assigned to an IP device online (MAC address) and is written into the device.
- ③ The configuration is downloaded to the IO controller.
- ④ The IO controller assigns the appropriate IP address to the IO device with the assigned PROFINET device name during startup.

A device name is assigned to each IO device. You can change the name and IP address manually.

You have two options for downloading configured data to the PROFINET IO device:

- **Offline with a Micro Memory Card:**  
Place the configured data (device name: for example, turbo-3) for the IO device in the MMC in the PG/PC. Use the command "SIMATIC Card Reader > Save Device Name to Memory Card" in the "Project" menu for this.  
Then insert the MMC into the IO device. The IO device automatically adopts the configured device name.
- **Online with programming device/PC:**  
Connect the programming device/PC directly to the Ethernet subnetwork via the PROFINET interface.  
Select the subnet in the network view and then select the "Assign device name" shortcut command.  
In the "Assign PROFINET device name" dialog box, select the suitable PG/PC interface to connect to the Ethernet subnet.  
All configured PROFINET device names are in the top drop-down list. Select a PROFINET device name from it and select the IO device to receive this device name from the table at the bottom. You can filter the display of devices in the table according to various criteria. You can easily identify the device using the "Flash LED" button.  
The IO controller recognizes the IO device by its device name and automatically assigns the configured IP address to it.

### IP address assignment for special IO devices

Special IO devices, for example, SCALANCE X, S7-300 CPs, support the option of assigning the IP addresses not from the IO controller during startup. In this case, the IP address is assigned in a different way. For additional information, refer to the manual of the respective PROFINET device of the SIMATIC device family.

### Requirement for additional procedures when assigning IP address and device name

If the IO device, as described above, should not obtain the IP address or device name from the IO controller, proceed as follows:

1. Select device or network view.
2. Open the properties for the respective PROFINET device.
3. Select the "Use different method to obtain IP address" option or "Different method for obtaining device name" option.

### Rules

If the "Different method for obtaining IP address / device name" option is used in a PROFINET device, note the following:

- The subnet part of the IP address of the IO device must match the subnet part of the IP address of the IO controller.
- The corresponding PROFINET device cannot be used as a router.

### See also

Starting the name assignment via "Accessible devices" (Page 998)

## Example of the assignment of the device name

In this example you assign device names to a PROFINET IO controller and a PROFINET IO device. To make assignment easier, the device names should also contain the names of the PROFINET IO system.

## Requirement

- You must be in the network view.
- A CPU 1214C (V2.0 or higher) must be available in the network view.
- An interface module IM 151-3PN exists.
- The PROFINET interfaces of both modules are networked.

## Procedure

To assign the names, follow these steps:

1. Select the CPU.  
Make sure that you have selected only the CPU and not the complete device!
2. Assign the name "myController" in the Inspector window, under "General".

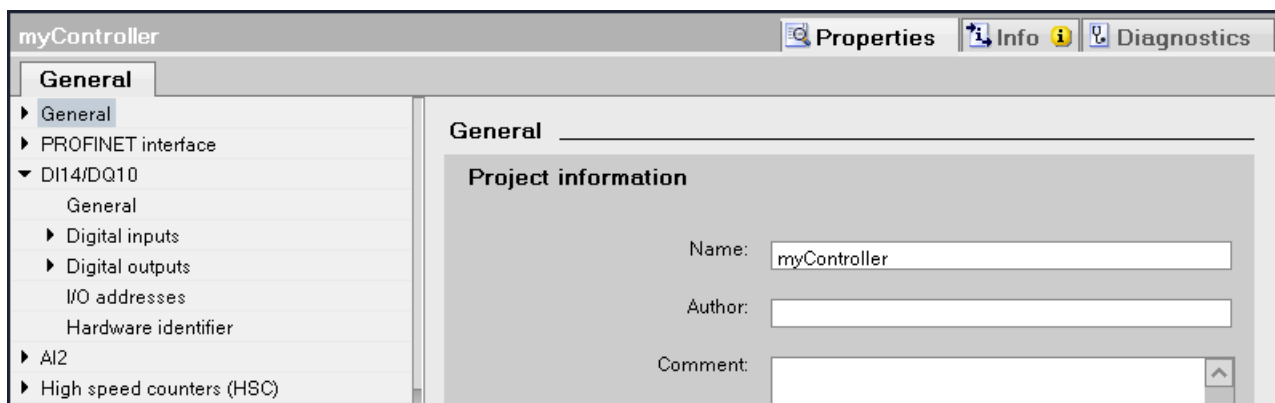

3. Select the interface module.  
Ensure that you have selected only the interface module and not the complete ET 200S device.
4. Assign the name "Device\_1" in the Inspector window, under "General".
5. Right-click on the PROFINET IO system and select the "Properties" command.

8.1 Configuring devices and networks

- 6. Assign the name "Plant\_section1" to the IO system and select the check box "Use name as extension for PROFINET device names".

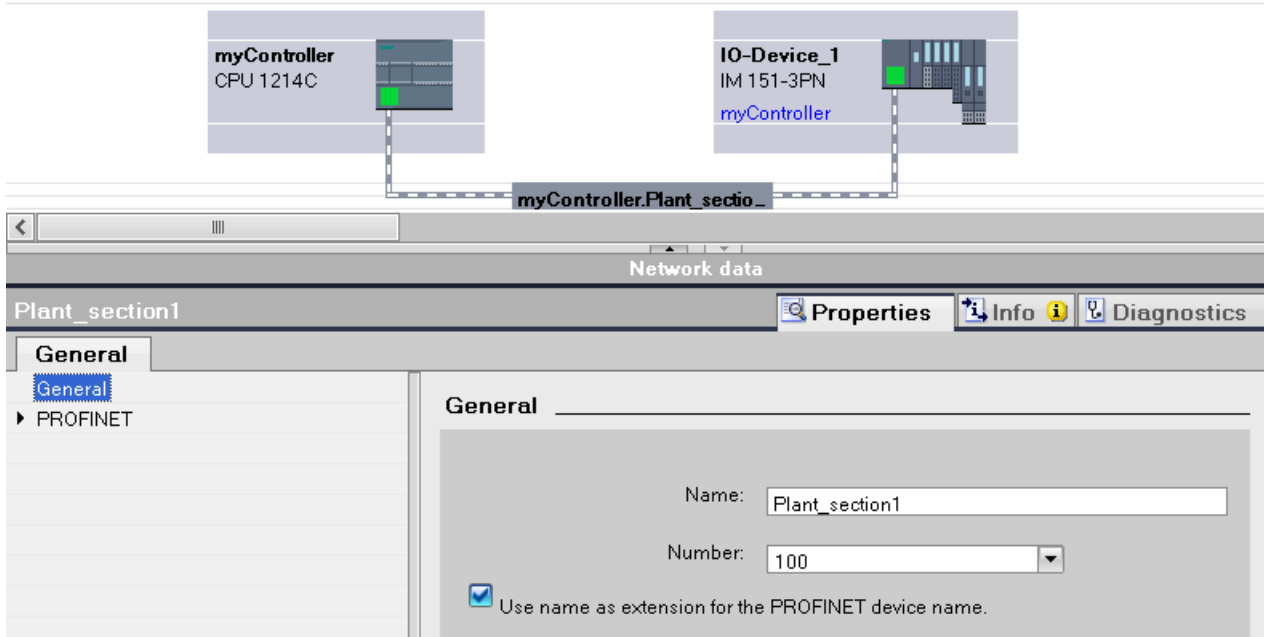

- 7. You can find the automatically generated PROFINET device names at the selected device in the Inspector window, at "PROFINET interface".

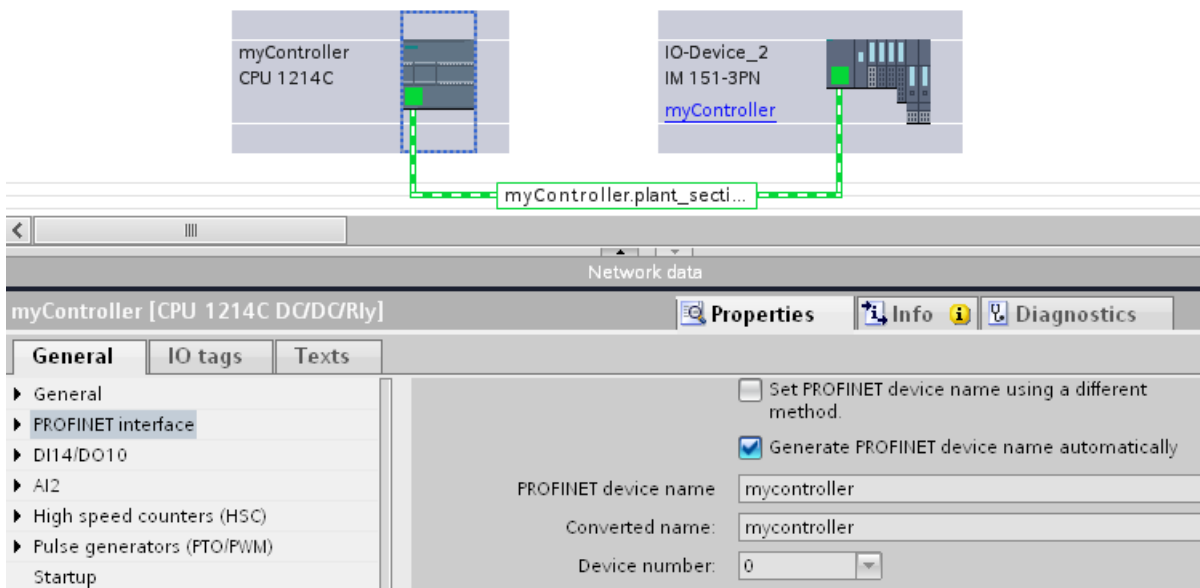

The PROFINET device name corresponds to the name of the module (with the name of the IO system as extension) with the difference that only lower case text is used. Background: No distinction is made between upper and lower case ("case insensitive") for the storing of the name.

If you want to specify the device name independently of the module name, you have to deactivate the "Generate PROFINET device name automatically" option. The PROFINET device name can be edited in this case.

The converted name is displayed below. This is the name that is automatically generated from the PROFINET device name and satisfies the DNS conventions. If you work with STEP 7, you do not require this name. This name is displayed here as a check and corresponds to the name that is stored in the device. If you work with other tools that are able to record the data exchange and read the actual device names, then you find the converted names.

## Other special features

For PROFINET devices with multiple PROFINET interfaces, the name of the interface is attached to the name of the module, separated by a dot.

Example:

- Name of the module: myController
- Name of the interface: Interface\_1
- PROFINET device name: mycontroller.interface\_1

## Assign device name via memory card

### Introduction

You can configure the device names of PROFINET IO devices offline. To do this, store a configured device name on a memory card and then insert the card into the appropriate IO device.

If an IO device has to be completely replaced due to a device defect, the IO controller automatically reconfigures the new device. Using the memory card, a device can be replaced without a programming device.

### Requirements

- The programming device has a card reader for memory cards.
- The IO device must support the assignment of the device name via memory card.
- The station and its PROFINET IO system is configured.

### Procedure

To store a device name on a memory card, follow these steps:

1. Insert the memory card into the card reader.
2. Select the IO device whose device name is to be assigned by the memory card.
3. Select the "Card reader > Save Device Name to Memory Card" command in the "Project" menu.

If the memory card is not empty, a message will be issued informing you of this and you will have the option to delete the card.

### Retentivity of IP address parameters and device names

The retentivity of IP address parameters (IP address, subnet mask, router setting) and device name depends on how the address is assigned.

The non-retentive, temporary assignment means:

- IP address parameters and device name remain valid for the following time period:
  - Until the next POWER OFF
  - Until the next bootstrap
  - Until termination of the online connection (for example, after downloading the program)  
After POWER OFF / POWER ON or a permanent deletion, the CPU can only be accessed via the MAC address.

If the IP address parameters are not retentive, communication can no longer take place after the above described events (for example, after POWER OFF/POWER ON) that are based on the IP protocol.

The assignment of a temporary IP address also deletes retentively saved IP address parameters.

### IP address parameters and device name not assign retentively

IP address parameters and device name are not retentive in the following cases:

- A temporary IP address that is not retentive is implicitly assigned with the "Accessible devices" function, if the device (e.g. CPU) does not yet have an IP address.
- The device is a "normal" IO controller (i.e., not an I-device), and it is specified in the user program ("IP\_Conf" instruction) that the IP address parameters/device name are not to be retentive.

### Assign IP address parameters and device name retentively

IP address parameters and device name are retentive in the following cases:

- In the properties of the PROFINET interface, it is specified that the IP address parameters are set in the project ("Set IP address in the project" option).
- The properties of the PROFINET interface have a setting specifying that the IP address is to be obtained by another method.
  - Once the configuration is downloaded, the IP address parameters and the device name are assigned via STEP 7 or a setup tool such as PST (STEP 7: online and diagnostic function "Assign IP address"). The assigned IP address parameters are retentive.
  - The device is a "normal" IO controller (i.e., not an I-device), and it is specified in the user program ("IP\_Conf" instruction) that the IP address parameters/device name are to be retentive.



## Special features of the I-device

It is specified in the properties of the PROFINET interface of the I-device that the IP address parameters are to be obtained by a different method. The IP address parameters for the I-device are assigned by the higher-level IO controller.

- If prioritized startup is set, the IP address parameters are retentive.
- If **no** prioritized startup is set, the IP address parameters are not retentive.

## Recommendation

If possible, use the "Set IP address in project" and specify an appropriate IP address. In this case, the IP address is assigned retentively.

## Resetting the IP address parameters and device names

Retentive IP address parameters and device names are reset via the online and diagnostic function "Reset to factory settings".

---

### Note

#### Consequences of repeated assignment of IP address parameters on top of existing IP parameters

- Through the temporary assignment of IP address parameters / device names, a reset of retentively saved IP address parameters/device names occurs.
- With a fixed assignment of IP address parameters/device names, previously retentively saved parameters are replaced with the newly assigned parameters.

---

### Note

#### Reuse of devices

Execute the "Reset to factory settings" before you install a device with retentive IP address parameters and device names in another subnet or system or before you place it in storage.

---

## Creating a PROFINET IO system

A PROFINET IO system is comprised of a PROFINET IO controller and its assigned PROFINET IO devices.

To create a PROFINET IO system you require an IO controller (for example, CPU 1214C) and one or more IO devices (for example, a head module from the distributed I/O family ET 200S).

As soon as you connect an IO controller to an IO device, a controller-device link is established.

## **Procedure**

To create a PROFINET IO system, proceed as follows:

1. Use drag-and-drop to pull an IO controller from the hardware catalog (for example, CPU 1214C) into the free area of the network view.  
The IO controller is created in the project.
2. Use drag-and-drop to move an IO device from the hardware catalog (for example, ET 200S) into the free area of the network view.
3. Click on the PROFINET interface of the IO controller or the IO device.
4. Hold down the mouse button and draw a connecting line between this selected interface and that of the partner device.  
A subnet with an IO system between the IO controller and the IO device is created.
5. If required, adapt the properties of the Ethernet subnet or the IO controller (for example, IP address) under "Properties" in the inspector window.

## **Handling PROFINET IO systems**

Using shortcut menu commands, you can delete PROFINET IO systems, create new ones or even connect the interface to another subnet from within the network view.

An existing PROFINET configuration can thereby be corrected in the network view.

## **Create new PROFINET IO system for IO controller**

To create a new PROFINET IO for an IO controller, proceed as follows:

1. Make sure that no IO system is already assigned to the IO controller. If an IO system is already assigned to the IO controller, the "Assign IO system" shortcut menu command is disabled.
2. Select the PROFINET interface and then select the "Assign IO system" shortcut menu command.

A new PROFINET IO system is created at the IO controller and you can assign IO devices to this IO system.

## Disconnecting PROFINET IO devices from PROFINET IO system

To disconnect an already networked PROFINET IO device from its PROFINET IO system, follow these steps:

1. Click on the PROFINET interface of an IO device.

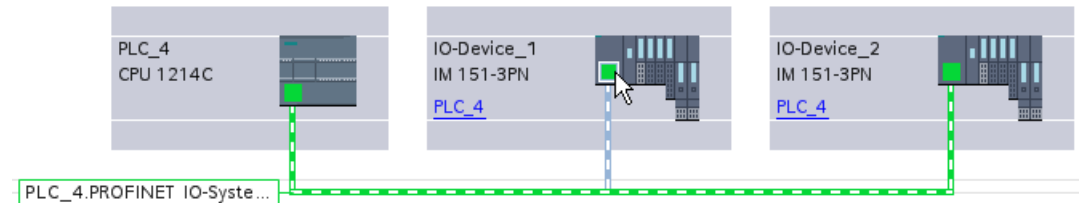

2. Select the "Disconnect from IO system" shortcut menu command.  
The IO device that was assigned to this IO system is then no longer assigned to it.

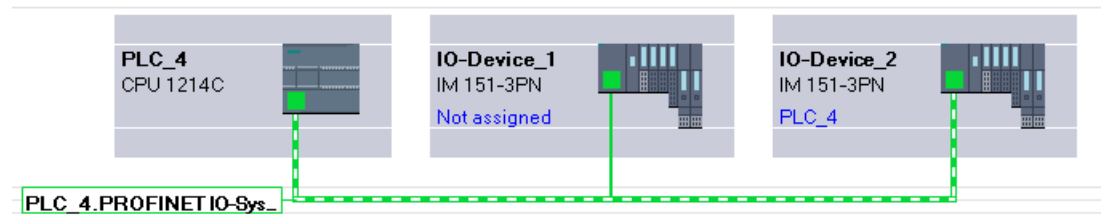

You can create a new IO systems and can assign each of the non-assigned IO devices to an IO controller.

## Assign PROFINET IO devices to other IO controllers

Existing PROFINET IO systems can be easily reconfigured in the network view:

1. Select the interface of an IO device and then select the shortcut menu. You have the following options here:
  - Assign a new subnet to the IO device or disconnect it from the existing subnet
  - Assign a new IO controller to the IO device
  - Assign a new IO system to the IO device or disconnect it from the existing subnet
2. To assign another IO controller to the IO device, select the "Assign to new IO controller" shortcut menu command.  
If there is no connection, a subnet is automatically created and the IO device is assigned to the IO system of the new IO controller.

### Tip: Quick configuration of IO systems

If the IO system has a lot of IO devices, assign all IO devices placed by drag-and-drop operation to an IO controller on one step.

## Requirements

IO controller and IO devices are placed in the network view.

### Assign IO devices to an IO system

To do this, follow these steps:

1. Select an appropriate zoom factor so that you can see as many IO devices as possible in the network view.
2. Arrange the IO devices in not more than of two rows.
3. Select all IO interfaces (not all devices) with the mouse cursor. This only works if you begin to drag the mouse cursor outside of the first IO device and release the mouse button at the last IO device (selection with the lasso).

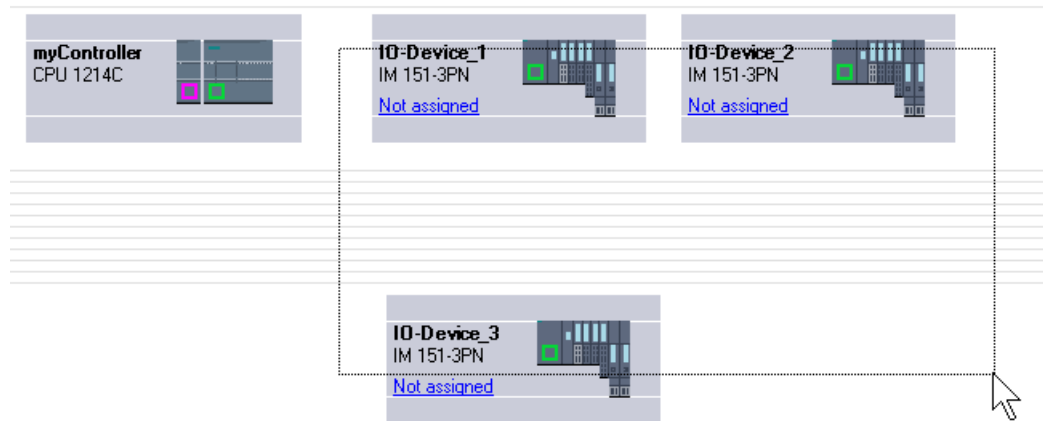

4. Select the shortcut menu "Assign new IO controller" and select the corresponding IO interface of the IO controller in the subsequent dialog.

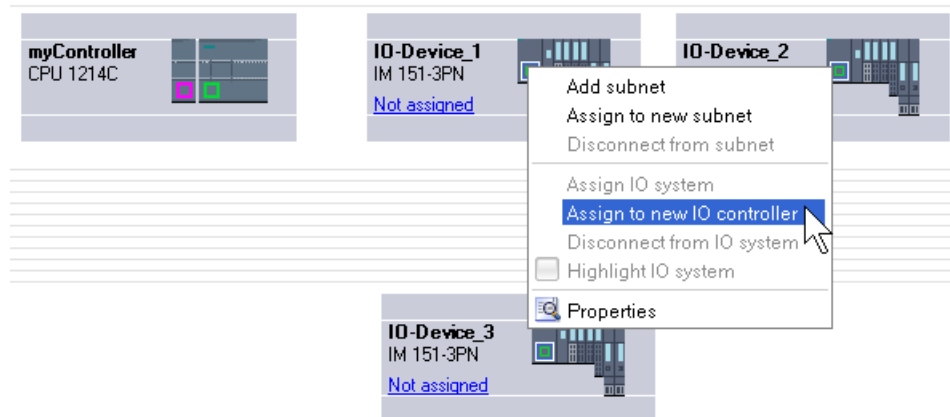

5. The IO devices are automatically networked with the IO controller and combine with it to form an IO system.

#### Note

When an IO system is highlighted, you can double-click on an IO device in the hardware catalog and thereby quickly add additional IO devices. Result: The IO device is automatically added to the highlighted IO system.

## Interconnecting ports

If an IO device is assigned to an IO controller, this does not yet specify that the ports are connected to each other.

Although a port interconnection is not required to use the PROFINET functions, it does offer the following advantages:

- A target topology is specified with the port interconnection. Based on an online-offline comparison, it is possible to conduct a target-actual comparison with all devices that support this function.
- Only with IRT communication: If a port interconnection is configured, STEP 7 can determine the required bandwidth more precisely. As a rule, this leads to a higher performance.

Make sure that no invalid ring structures occur through the interconnection of ports.

Port interconnection is only advisable for devices that support the topology configuration.

## Interconnecting ports in the Inspector window

To interconnect ports, follow these steps:

1. Select the PROFINET device or the PROFINET interface.
2. Navigate to the port property "Port interconnection".  
When the PROFINET interface is selected, you can find this setting in the Inspector window as follows: Properties > General > Advanced Options > Port [...] > Port Interconnection.
3. In the "Local port" section, you can find the settings at the local port. In the case of fiber-optic cable you can, for example, set the cable names here.  
In the "Partner port" section, click on the black triangle in the "Partner port" box to display and select the available partner ports.
4. If the port interconnection is a port interconnection with copper as medium and the devices support IRT communication, you can also set cable length and signal transit time.

If the PROFINET interface was not networked, it is automatically networked by this action. In the properties of the subnet you can set whether this subnet should or should not be used for the networking.

## See also

Overview (Page 516)

## Setting the send clock

### Requirements to change the send clock at the PROFINET device

No IRT (Isochronous Realtime) should be configured. In detail, this means:

- No device must be configured at the IO system as a sync slave or sync master.
- All devices at the IO system must be unsynchronized.

If IRT is configured (in other words, if the IO controller is configured as sync master), the send clock can only be configured in the sync domain.

## Procedure

To set the send clock on the PROFINET device, follow these steps:

1. Select the PROFINET IO controller in the device or network view.
2. Change the value for the shortest possible update interval in the properties of the PROFINET interface under "PROFINET Interface > Advanced options > Real-time settings > IO communication > Send clock".

The send clock is valid for all PROFINET devices at the IO system. If the synchronization role is set to a value other than "Unsynchronized", you can only set the send clock in the sync domain, in other words, centrally at the PROFINET IO system.

## Setting the update time

### Update time

An IO device / IO controller in the PROFINET IO system is supplied with new data from the IO controller / IO device within this time period. The update time can be separately configured for each IO device and determines the time interval in which data is transmitted from the IO controller to the IO device (outputs) as well as data from the IO device to the IO controller (inputs).

STEP 7 calculates the update time automatically in the default setting for each IO device of the PROFINET IO system, taking into account the volume of data to be exchanged as well as the set send clock.

## Setting the update time

If you do not want to have the update time calculated automatically, you can change the setting.

To change the update time, proceed as follows:

1. Select the PROFINET interface of the IO device in the network or device view.
2. Change the update time in the interface properties under "Advanced options > Realtime settings > IO cycle".
  - To have a suitable update time calculated automatically, select "Automatic".
  - To set the update yourself, select "Can be set" and enter the required update time in ms.
3. To ensure consistency between the send clock and the update time, activate the "Adapt update time when send clock changes" option.

This option ensures that the update time is not set to less than the send clock.

Non-automatic setting of the send clock may result in errors if the available bandwidth is insufficient or if other limits are exceeded (for example, too many devices are configured).

## Setting the watchdog time

### Watchdog time

You can configure the watchdog time for PROFINET IO devices.

If the IO device is not supplied with input or output data (IO data) by the IO controller within the watchdog time, it switches to the safe state.

Do not enter the watchdog time directly, but as "Accepted number of update cycles when IO data is missing". This makes setting easier because the update time can be shorter or longer, depending on the power of the IO device or the setting.

The resulting watchdog time is automatically calculated from the "Accepted number of update cycles when IO data is missing".

### Configuring the watchdog time

To specify the watchdog time, follow these steps:

1. Select the PROFINET interface of the IO device in the network or device view.
2. In the properties of the interface, navigate to "Advanced options > Realtime settings > IO cycle".
3. Select the required number of cycles from the drop-down list "Trigger watchdog after # cycles with missing IO data".

The watchdog time is subsequently calculated automatically based on the preset factor. It must not be more than 1.92 seconds.

---

#### Note

The default setting should only be changed in exceptional cases, for example, during the commissioning phase.

---

## Calculated bandwidth for cyclic IO data

### Calculated bandwidth for cyclic IO data

Adherence to the maximum available bandwidth for cyclic IO data is monitored by the system. The maximum bandwidth depends on the send clock cycle. If the send clock cycle is greater than or equal to 1 ms, the maximum bandwidth is 0.5 ms. If the send clock cycle is shorter, the maximum available bandwidth is also reduced.

The bandwidth actually required for cyclic IO data is determined by the system based on the number of configured IO devices and IO modules. Furthermore, the required bandwidth depends on the update time that is used.

In general, the calculated bandwidth increases in the following cases:

- There is a greater number of IO devices
- There is a greater number of IO modules
- The update times are shorter.

### Maximum bandwidth for cyclic IO data depending on the send clock

The following table shows how the maximum available bandwidth for cyclic IO data reacts based on the send clock:

Send clock cycle	Maximum bandwidth for cyclic IO data
250 $\mu$ s – 468.75 $\mu$ s	$\ll$ 125 $\mu$ s
500 $\mu$ s – 968.75 $\mu$ s	= send clock / 2
1 – 4 ms	= 500 $\mu$ s

### Setting port options

#### Setting the port options

#### Changing connection settings for the PROFINET IO port

You can change the network settings for the PROFINET IO port as required. By default, the settings are made automatically. In normal situations, this guarantees problem-free communication.

#### Possible settings for transmission medium/duplex

Depending on the selected device, you can make the following settings for "Transmission medium/duplex":

- Automatic setting  
Recommended default setting of the port. The transmission settings are automatically "negotiated" with the partner port. The "Enable autonegotiation" option is automatically selected by default.
- TP/ITP at x Mbps full duplex (half duplex)  
Setting of the transmission rate and the full duplex/half duplex mode. The effectiveness depends on the "Enable autonegotiation" setting:
  - Autonegotiation enabled  
You can use both cross cable and patch cable.
  - Autonegotiation disabled  
Make sure that you use the correct cable (patch cable or cross cable)! The port is also monitored with this setting.
- Deactivated  
Depending on the module type, the drop down list box can contain the "- Disabled -" option. This option, for example, allows you to prevent access to an unused port for security reasons. With this setting, diagnostic events are not generated.



### "Monitor" option

This option is used to activate or deactivate the port diagnostics. Examples of port diagnostics: The link status is monitored, in other words, the diagnostics are generated during link-down and the system reserve is monitored in the case of fiber optic ports.

### Option "Enable autonegotiation "

The autonegotiation setting can only be changed if a concrete medium (for example, TP 100 Mbps full duplex) is selected. Whether or not a concrete medium can be set depends on the properties of the module.

If autonegotiation is disabled, this causes the port to be permanently specified, as for example, is necessary for a prioritized startup of the IO device.

You must make sure the partner port has the same settings because, with this option, the operating parameters of the connected network are not detected and the data transmission rate and transmission mode can therefore not be optimally set.

---

#### Note

When a local port is interconnected, STEP 7 makes the setting for the partner port if the partner port supports the setting. If the partner port does not support the setting, an error message is generated.

---

### Wiring rules for disabled autonegotiation

#### Requirement

You have made the following settings for the port in question, for example, to accelerate the startup time of the IO device:

- Fixed transmission speed
- Autonegotiation incl. autocrossing disabled

This saves you the time required to negotiate the transmission rate during startup.

If you have disabled autonegotiation, you must observe the wiring rules.

### Wiring rules for disabled autonegotiation

PROFINET devices have the following two types of ports:

Type of port	PROFINET devices	Note
Switch port with crossed pin assignment	For IO devices: Port 2 For S7 CPUs with 2 ports: Ports 1 and 2	Crossed pin assignment means that the pin assignment for the ports for sending and receiving between the respective PROFINET devices is exchanged internally.
End device port with uncrossed pin assignment	For IO devices: Port 1 For S7 CPUs with one port: Port 1	-

### Validity of the wiring rules

The cabling rules described in the following paragraph apply exclusively for the situation in which you have specified a fixed port setting.

### Rules for cabling

You can connect several IO devices in a line using a patch cable (one-to-one wiring of both connectors). To do this, you connect port 2 (P2) of the IO device to port 1 (P1) of the next IO device. The following graphic gives an example with two IO devices.

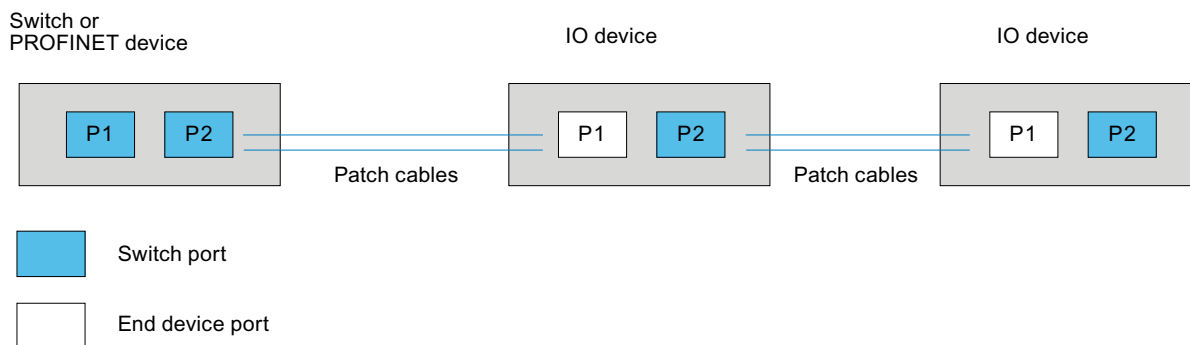

### Boundaries at the port

#### Requirement

To use boundaries, the respective device must have more than one port. If the PROFINET does not support boundary settings, they are not shown.

## Enable boundaries

"Boundaries" are limits for transmission of certain Ethernet frames. The following boundaries can be set at a port:

- "End of discovery of accessible devices"  
No forwarding of DCP frames to identify accessible devices. Devices downstream from this port cannot be reached by the project tree under "Accessible devices". Devices downstream from this port cannot be reached by the CPU.
- "End of topology discovery"  
LLDP frames (Link Layer Discovery Protocol) are not forwarded for topology detection.
- "End of sync domain"  
No forwarding of sync frames transmitted to synchronize nodes within a sync domain. If you operate, for example, a PROFINET device with more than two ports in a ring, you should prevent the sync frame from being fed into the ring by setting a sync boundary (at the ports not inside the ring).  
Additional example: If you want to use several sync domains, configure a sync domain boundary for the port connected to a PROFINET device from the other sync domain.

## Restrictions

The following restrictions must be observed:

- The individual check boxes can only be used if the port supports the function in question.
- If a partner port has been determined for the port, the following check boxes cannot be used:
  - "End of discovery of accessible devices"
  - "End of topology discovery"
- If autonegotiation is disabled, none of the check boxes can be used.

## Enabling device replacement without exchangeable medium

### Replacing an IO device without exchangeable medium

Replacement of IO devices is frequently required in automation systems. The IO devices are generally assigned a device name by either inserting an exchangeable medium or via the programming device. The CPU identifies the IO device by using these device names.

Replacing an IO device can be done without inserting an exchangeable medium (e.g. memory card) or without the programming device, under certain circumstances. For this purpose the Ethernet mechanism analyzes the relationship between the individual IO devices and the IO controller. From these relationships which are stored in the IO controller, the IO controller recognizes which IO device was replaced and assigns a device name to the new device.

## Requirements

- A port interconnection is already configured.
- The affected IO devices in the automation system must support device replacement without exchangeable medium.  
If the individual IO devices in the automation system do not support device replacement without exchangeable medium, a corresponding message is output for the IO device.

---

### Note

Use only new IO devices as replacements or restore configured IO devices to their delivery state.

---

## Procedure

In order to enable the replacement of an IO device without exchangeable medium, proceed as follows:

1. In the device, select the device or network view of the PROFINET interface in the corresponding IO controller.
2. In the interface properties under "Advanced settings > Interface options", select the "Allow device replacement without exchangeable medium"

## See also

Components with the the device replacement without exchangeable medium function (<http://support.automation.siemens.com/WWW/view/en/36752540>)

## Using GSD files

### GSD files for IO devices

#### Basic information on GSD files of IO devices

The properties of PROFINET IO devices are not stored in a keyword-based text file (as for PROFIBUS DP slaves), but in an XML file whose structure and rules are determined by a GSDML schema.

The language used to describe the GSD files is GSDML (Generic Station Description Markup Language). It is defined by the GSDML schema.

A GSDML schema contains validation rules that allow it, for example, to check the syntax of a GSD file. GSDML schemas (as schema files) are acquired by IO device manufacturers from PROFIBUS International.

Functional enhancements in the area of PROFINET IO will have an effect on the GSDML specification and the corresponding schema. A new version of the specification and of the schema is created by the functional enhancement.

## Names of GSD files for IO devices

One possible example of a GSD file name for IO devices is:

"GSDML-V1.0-Siemens-ET200S-20030616.xml"

Name component	Explanation
GSDML	String at the start of each GSD file for IO devices
V1.0	Version of the GSDML schema
Siemens	Manufacturer
ET200S	Name of the device
20030616	Version code (date)
.xml	File extension

## Versioning of GSD files for IO devices

The version information of GSD files is two-fold:

First, the version of the GSDML schema is indicated. This determines the language scope used by a GSD file.

This is followed by the version, listed as an issue date. The version number of GSD files is incremented, for example, after elimination of an error or introduction of a functional enhancement.

Functional enhancements may result in a new version of the GSDML schema. A new version of a GSDML schema might only be supported with restrictions.

## Installing the GSD file

### Introduction

A GSD file (generic station description file) contains all properties of an IO device. If you want to configure an IO device that is not available in the hardware catalog, you must install the GSD file provided by the manufacturer. IO devices installed via GSD files are displayed in the hardware catalog and can then be selected and configured.

### Requirement

- The hardware and network editor is closed.
- You have access to the required GSD files in a directory on the hard disk.

### Procedure

To install a GSD file, follow these steps:

1. In the "Options" menu, select the "Install generic station description files" command.
2. In the "Install generic station description files" dialog box, select the folder in which the GSD files are stored.

### *8.1 Configuring devices and networks*

3. Choose one or more files from the list of displayed GSD files.
4. Click on the "Install" button.
5. To create a log file for the installation, click on the "Save log file" button.  
Any problems during the installation can be tracked down using the log file.

You will find the new IO devices installed by means of GSD files in the hardware catalog under "Additional field devices > PROFINET".

---

**Note**

Installation of a GSD file cannot be undone.

---

### **Changing the revision of a GSD file**

#### **Changing the revision of a GSD file**

You can change the revision of a GSD file for an IO device:

- Only for the current IO device
- All suitable IO devices within the IO system
- All suitable IO devices within the complete project

First, all existing GSD files for the current IO device are shown. The only difference between the GSD files shown is their revision status. The currently used GSD file is highlighted.

#### **Requirement**

- The I/O data is the same for all IO devices whose revision is to be changed.
- The order number has not changed.
- The number of submodules is identical.
- The configuration data has not changed.
- There must be no module or submodule in a slot that is invalid after the new GSD file has been created.

#### **Procedure**

To change the revision of one or more IO devices, proceed as follows:

1. Select the IO device whose GSD file revision is to be changed.
2. Click on the "Change revision" button under "General> Catalog information" in the properties of the IO device.  
The "Change revision" dialog box opens.
3. Select the GSD revision you want to use in the "Available revisions" table.

4. Under "Use selected revision for", select the devices whose version are to be changed:
  - Only for the current IO device
  - For all suitable IO devices in the IO system
  - For all suitable IO devices in the project
5. Click the "Apply" button.

#### 8.1.4.9 Bus coupling with PN/PN coupler

##### Application and function

##### Application

The PN/PN coupler is used to link two Ethernet subnets with one another and to exchange data. That way use data about input or output address areas or datasets can be used. The maximum size of the transferable input and output data is 1024 bytes. The division into input and output data is preferable, so that e.g. 800 byte input data and 200 byte output data can be configured.

As a device, the PN/PN coupler has two PROFINET interfaces, each of which is linked to one subnet.

In the configuration, two IO Devices are produced from this one PN/PN coupler which means that there is one IO Device for each station with its own subnet. The other part of PN/PN coupler in each case is known as the bus node. Once configuring is complete, the two parts are joined.

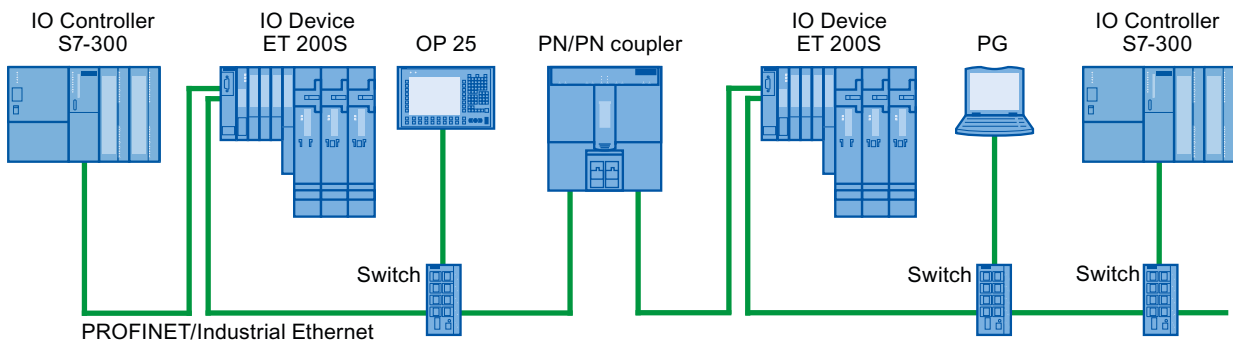

Figure 8-2 Coupling two PROFINET IO subnets with one PN/PN coupler

##### Additional information

For additional information on "PN/PN couplers", refer to Service & Support on the Internet (<http://support.automation.siemens.com/WW/view/en/44319532>).

## Linking Ethernet subnets

### Linking Ethernet subnets with a PN/PN coupler

You can link Ethernet subnets with the standard device PN/PN coupler.

To link Ethernet subnets, follow these steps:

1. Create your Ethernet subnets.
  2. Select the standard field devices in the hardware catalog. Find the PN/PN coupler as head module in the "PROFINET IO" folder.
  3. In the network view, drag the two components X1 and X2 to the required version of the PN/PN coupler per drag-and-drop operation. The components form a device, but are shown separately to make handling easier.
  4. Connect the Ethernet interface of the PN/PN coupler X1 to the first Ethernet subnet.
  5. Connect the Ethernet interface of the PN/PN coupler X2 to the second Ethernet subnet.
- The Ethernet subnets are now linked through the two components of the PN/PN coupler.

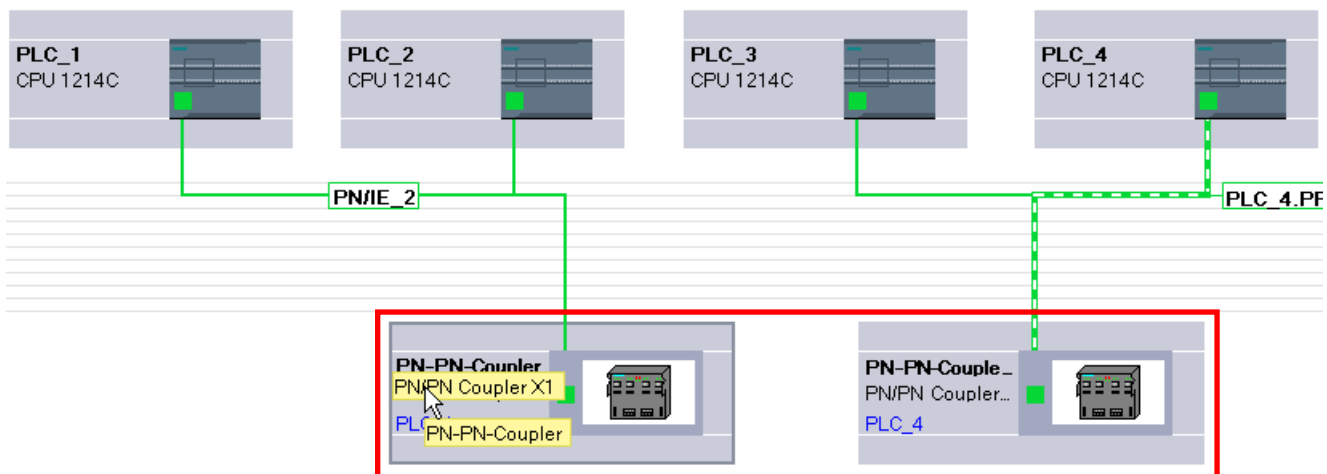

#### 8.1.4.10 Integrating external tools

### Integrating S7-external tools

#### Introduction

Tools external to STEP 7 ("Device Tools") with a special call interface (Tool Calling Interface) can be used to configure distributed devices. Such devices are also referred to as "TCI capable".

The performance range of these tools exceeds the possibilities provided within GSD configuration, for example, they can provide expanded graphical input options.

Distributed devices can be as follows:



- PROFIBUS DP slaves
- Modules within a DP slave
- PROFINET IO devices
- Modules within an IO device

---

**Note****Warranty and liability**

Siemens accepts no liability for third-party software (device tools) called with the TCI (Tool Calling Interface) or for proper interaction with the associated devices.

---

**Requirement**

The call interface of the tool complies with the TCI specification. Parameters and commands are forwarded to the distributed device via this call interface.

Such tools have to be installed using a setup provided by the manufacturer. The "S7-PCT" (Port Configuration Tool) device tool for IO-Link master modules and IO-Link devices is an exception; this is supplied with STEP 7. Special note: After the installation, the tool is not shown in the list of installed software or in the list of software products in the project.

The GSD file of the distributed device that is to be configured with the Device Tool must be installed.

**Starting the device tool**

The command for starting the device tool is available in the shortcut menu of the TCI-capable device in the shortcut menu of the graphical and tabular device view: "Start device tool".

**See also**

Starting the SIMATIC S7-PCT (Page 825)

**Starting the SIMATIC S7-PCT****Introduction**

The "S7-PCT" (Port Configuration Tool) device tool is installed with STEP 7.

The tool is used to assign parameters to the ports of IO-Link modules such as 4SI IO-Link (S7-1200, ET 200S) or 4IOL+8DI+4DO (ET 200eco PN).

**Requirement**

You have configured the corresponding CPU, the DP slave or the IO device with an IO-Link module.

## **Procedure**

To start via the graphical device view, follow these steps:

1. Select the IO-Link module in the device view.
2. Select "Start device tool" from the shortcut menu.

OR, to start with the tabular device view, follow these steps:

1. Select the IO-Link module in the device view.
2. Arrange the areas in the work area in such a way that the tabular device overview is visible (it is located between the device view and the inspector window).
3. Select the row with the IO-Link module in the device overview.
4. Select "Start device tool" from the shortcut menu.

## **Result**

The tool starts and you can configure the ports.

## **See also**

Integrating S7-external tools (Page 824)

### **8.1.4.11 Loading a configuration**

#### **Introduction to loading a configuration**

To start a device, identical configurations must be stored on the PG/PC as well as on the connected devices. Download a configuration to compare the PG/PC and the connected devices. Configuration data can generally be downloaded in two directions:

- Download configuration from PG/PC in a device
- Download configuration from a device to the PG/PC

## **See also**

Uploading project data from a device (Page 284)

General information on loading (Page 281)

Downloading a configuration to a device (Page 827)

Downloading project data to a device (Page 282)

Downloading a configuration to the PG/PC (Page 828)

Special features during startup (Page 839)

## Downloading a configuration to a device

### Downloading the hardware configuration

After you have inserted a new device in the project and configured it or if you have modified an existing hardware configuration, the next step is to load the current configuration on the device. This makes sure that the same configuration is set on the programming device/PC as well as on the physical module.

The first time you load, the entire hardware project data is loaded. When you load again later, only changes to the configuration are loaded.

You have the following options when loading the hardware configuration:

- Loading in the device or network view
- Loading in the project tree
- Loading on an accessible device



#### **WARNING**

##### **Load only in STOP mode**

After loading, you may experience unexpected behaviors on the machine or in the process if the parameter settings are incorrect. The CPU must be set to STOP mode for the download operation to rule out possible damage to equipment or personal injury.

### Special features for downloading of isochronous applications

Isochronous applications consist of a hardware configuration part and a software part.

Example: If you change the number of an IO system, the delay time, or the process image partition assignment of the isochronous I/O in the hardware configuration, this affects the parameters of the isochronous mode interrupt OB and thus also the software part.

For isochronous applications, we recommend performing a complete download (hardware and software). With partial downloading (downloading hardware and software separately at different times), inconsistencies can arise that, for example, can prevent CPU startup or isochronous operation of the application.

### See also

General information on loading (Page 281)

Downloading project data to a device (Page 282)

## Downloading a configuration to the PG/PC

### Introduction

If you have connected a new device to a PG/PC but have not yet inserted the device into the project, you can transfer the complete configuration from the newly connected device to the PG/PC. The device is thereby created in the project.

A device is always downloaded via the list of accessible devices in the project tree. You can download several devices into the project by selecting them accordingly. A configuration can be downloaded several times. A new device is created on each download, even if the device has already been downloaded.

### Requirements

- The original hardware configuration must be created in TIA Portal V12 or higher. A project with an older version than the current one may have to be upgraded (Page 262).
- The opened project is in offline mode.

### Scope of download

The following list presents an exact overview of the parts of the configuration that are transferred:

- Device parameters  
All set parameters of the module are transferred.
- PROFIBUS master systems and all PROFIBUS-relevant settings  
A DP master system and all connected slaves are inserted into the project. The respective settings remain unchanged. If a suitable PROFIBUS subnet has already been created, the downloaded modules are connected to the PROFIBUS interface at the existing subnet.
- PROFINET IO systems and all PROFINET-relevant settings  
The devices with IO controllers, all IO systems as well as all IO devices are transferred into the project. Settings and topologies are also transferred.  
If there already is a suitable Ethernet network in the project, the downloaded devices are integrated into the existing network.  
Relations between IO controllers and IO devices are only established within the project if both the IO controller as well as the I-device are downloaded to the PG. It is unimportant whether you download the IO controller or the I-devices first.
- I devices and I slaves  
Master-slave relations between the I slave and assigned DP master are only established in the project if both the master as well as the I slave are downloaded to the PG. It is unimportant whether you download the master system or the I-devices and I slaves first. As soon as both devices are downloaded, the connections are also established.
- Direct data exchange  
The configuration of a direct data exchange between two devices can also be downloaded into the project. You must download both partners one after the other to do this.

- **S7 connections**  
S7 connections are automatically accepted as configured at one end when downloading a device configuration, even if the S7 connection was configured at both ends in the original project. Once both connection partners are downloaded, the connection is once again linked together during the next compiling procedure.
- **Bus parameter**  
Downloaded bus parameters initially differ from the settings in the original project after downloading a single device. The bus parameters only match those of the original project after all devices involved are downloaded and there are no additional devices on the same bus.
- **An I/O module associated with the CPU**  
After downloading a CPU, all other modules within the address area of the CPU are also downloaded.

**See also**

Uploading project data from a device (Page 284)

General information on loading (Page 281)

**8.1.5 Displaying alarms**





**8.1.5.1 Overview of the alarm display**



The "Alarm display" function can be used to output asynchronous alarms of diagnostics events and user-defined diagnostics alarms as well a alarms from ALARM instructions.

From the alarm display, you can also start the alarm editor with the "Edit alarm" shortcut menu command and then create user diagnostic alarms.

**Icons**

The following table shows the icons and their functions:

Icon	Function
 Archive view	Shows the alarms located in the archive.
 Active alarms	Shows the currently active (pending) alarms. Alarms that must be acknowledged are shown in blue lettering.
 Ignore	Ignores the arrival of alarms, These alarms are neither shown in the window nor stored in the archive.
 Acknowledge	Confirms the selected alarm as read. Alarms requiring acknowledgment are shown in blue lettering.

Icon	Function
 Clear archive	Deletes all alarms in the archive.
 Export archive	Exports the current alarm archive to a file in xml format.

### 8.1.5.2 Archive view

In the archive view, alarms are displayed and archived according to the time they appear. You can set the size of the archive (between 200 and 3000 alarms) with the menu command "Options > Settings > Online & Diagnostics". If the selected archive size is exceeded, the oldest alarm it contains is deleted.

Alarms that must be acknowledged are displayed in blue lettering and can be acknowledged with the shortcut menu command "Acknowledge alarm(s)".

The archive is constantly updated and does not need to be saved explicitly.

### 8.1.5.3 Layout of the alarms in the archive view

In the archive view, all events occurring on the selected CPUs are logged. A new entry is created for each individual event and shown as a further row in the table.

#### Table structure

All attributes of the alarms can be shown as columns. You can show or hide individual columns as well as modify the width and order of the columns. These settings are saved when the project is closed.

The alarms can be displayed in one or more rows. In the single row display, only the first row of the multiple-row alarm data is displayed.

The alarms either require acknowledgment or do not require acknowledgment. The alarms requiring acknowledgment that have not yet been acknowledged are highlighted in blue lettering and can be acknowledged either with the button in the toolbar for the particular context or with the shortcut menu command "Acknowledge alarm(s)".

### 8.1.5.4 Receiving alarms

To allow alarms to be displayed, you must first set the receipt of alarms for each CPU.

## Procedure

To receive alarms, follow these steps:

1. Double-click on the "Online & Diagnostics" folder of the relevant CPU in project navigation.
2. Click the "Online access" group in the area navigation.
3. Select the option "Receive alarms".

---

### **Note**

**If you select this procedure, alarms are only received after you have re-established an online connection to the device.**

---

Or:

1. Select the relevant CPU in the device, network, or topology view.
2. Select the command "Receive alarms" in the "Online" menu or in the shortcut menu.

Or:

1. Select the CPU in project navigation.
2. Select the command "Receive alarms" in the "Online" menu or in the shortcut menu.

---

### **Note**

**If you select one of the two above-named procedures, you must have first established an online connection to the device.**

---

### **8.1.5.5 Export archive**

To archive alarms, you can export the archive. Follow these steps:

1. Go to the archive view.
2. Click the "Export archive" button.
3. In the dialog that opens, select the path to export the archive.

## Result

The archive is saved as an xml file at the location you selected.

### **8.1.5.6 Clear archive**

The archive is organized as a ring buffer, in other words, when it is full, the oldest alarms are deleted from the archive. With the "Clear archive" button, you can delete the entire archive.

## Procedure

To clear the archive, follow these steps:

1. Click the "Clear archive" button in the toolbar of the alarm display.

### 8.1.5.7 "Active alarms" view

The "Active alarms" view is an image of the alarm acknowledgement memory of the selected CPU(s).

### 8.1.5.8 Layout of the alarms in the "Active alarms" view

The "Active alarms" view represents an image of the alarm acknowledgment memory of the selected CPUs. One entry is shown in the table per active alarm. Events of an alarm ("incoming", "outgoing" and "acknowledged") are displayed in one row.

## Table structure

All attributes of the alarms can be shown as columns. You can show or hide individual columns as well as modify the width and order of the columns. These settings are saved when the project is closed.

The alarms can be displayed in one or more rows. In the single row display, only the first row of the multiple-row alarm data is displayed.

The alarms either require acknowledgment or do not require acknowledgment. The alarms requiring acknowledgment that have not yet been acknowledged are highlighted in bold print and can be acknowledged either with the button in the toolbar for the specific context or with the shortcut menu command "Acknowledge alarm(s)".

### 8.1.5.9 Status of the alarms

Depending on whether you are in the "Active alarms" view or the archive view, the displayed alarms may have a different status.

#### Status of the alarms in the "Active alarms" view

- I: Alarm came
- IA: Alarm came and was acknowledged
- IO: Alarm has gone

If more signal changes occur than can be sent (signal overflow), OV is displayed as the status and the status is shown in red.

#### Status of the alarms in the archive view

- No information: only with alarms generated by the PG/PC and displayed in the "Archive" tab, for example logon status, connection abort, mode changes
- I: Alarm came



- A: Alarm came and was acknowledged
- O Alarm has gone
- D: The alarm was deleted.

If more signal changes occur than can be sent (signal overflow), OV is displayed as the status and the status is shown in red.

#### 8.1.5.10 Acknowledging alarms

Alarms that must be acknowledged are shown in blue lettering.

##### Procedure

To acknowledge an alarm, follow these steps:

1. Select the required alarm or alarms from the table.
2. Click the "Acknowledge" button.

---

##### Note

You can select more than one alarm to acknowledge at the same time. To do this, hold down the <Ctrl> key and then select the alarms you want to acknowledge.

---

##### Result

The selected alarm was acknowledged and is then shown in normal characters.

---

##### Note

In the "Active alarms" view, acknowledged alarms that have already gone are no longer displayed.

---

#### 8.1.5.11 Ignoring alarms

##### Ignoring alarms

To ignore alarms, follow these steps:

1. Click the "Ignore" button.  
The icon is shown on a gray background.

##### Result

From this point onwards, all alarms will be ignored. A message is created in the archive view indicating that the display of alarms and events is disabled.

### Canceling the ignoring of alarms

To cancel the ignoring of alarms, follow these steps:

1. Click the "Ignore" button.  
The icon is shown on a white background.

### Result

All alarms, in other words, even the alarms currently pending on the CPU while the "Ignore alarms" function was active, are displayed again from this point onwards. A message is created in the archive view indicating that the display of alarms and events is enabled again.

#### 8.1.5.12 Keyboard commands in the alarm display

##### Alarm display

Function	Shortcut keys
Select all alarms	Ctrl+A
Acknowledge all selected alarms	Ctrl+Q

#### 8.1.6 Additional information on configurations

##### 8.1.6.1 Functional description of S7-1200 CPUs

##### Operating modes

##### Principles of the operating modes of S7-CPU

##### Introduction

Operating modes describe the behavior of the CPU. The following operating modes are possible:

- STARTUP
- RUN
- STOP

In these operating modes, the CPU can communicate via the PN/IE interface, for example.

## Other operating modes

If the CPU is not ready for operation, it is in one of following two operating modes:

- Deenergized, i.e. the supply voltage is switched off.
  - Defective, which means an internal error has occurred.  
If the "Defective" status is caused by a firmware error, this state is indicated by the status LEDs of the CPU (refer to the description of the CPU). To find out the cause, follow these steps:
    - Turn the power supply switch off and on again.
    - Read out the diagnostics buffer when the CPU starts up and send the data for analysis to Customer Support.
- If the CPU does not start up, replace it.

## See also

STOP mode (Page 840)

RUN mode (Page 840)

## Operating mode transitions

### Overview

The following figure shows the operating modes and the operating mode transitions of S7-1200 CPUs:

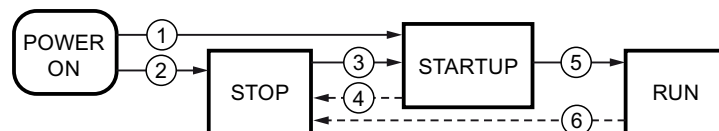

The following table shows the conditions under which the operating modes will change:

No.	Operating mode transition	Conditions
①	POWER ON → STARTUP	After switching on, the CPU goes to "STARTUP" mode if: <ul style="list-style-type: none"> <li>• "Warm restart" startup type is set, and</li> <li>• the hardware configuration and the program blocks are consistent.</li> </ul> Non-retentive memory is cleared and the contents of non-retentive DBs are reset to the initial values of the load memory. Retentive memory and retentive DB contents are retained.
②	POWER ON → STOP	When startup type "No startup" is set, the CPU goes to "STOP" mode after the supply voltage is switched on. Non-retentive memory is cleared and the contents of non-retentive DBs are reset to the initial values of the load memory. Retentive memory and retentive DB contents are retained.

No.	Operating mode transition	Conditions
③	STOP → STARTUP	The CPU switches to "STARTUP" mode if: <ul style="list-style-type: none"> <li>• CPU is set to "RUN" from the programming device, and</li> <li>• the hardware configuration and the program blocks are consistent.</li> </ul>
④	STARTUP → STOP	The CPU returns to the "STOP" mode in the following situations: <ul style="list-style-type: none"> <li>• Error detected during startup.</li> <li>• The CPU is set to "STOP" from the programming device.</li> <li>• A STOP command is processed in the STARTUP OB.</li> </ul>
⑤	STARTUP → RUN	If the STARTUP is successful, the CPU switches to "RUN".
⑥	RUN → STOP	The CPU returns to the "STOP" mode in the following situations: <ul style="list-style-type: none"> <li>• An error is detected that prevents continued processing.</li> <li>• The CPU is set to "STOP" from the programming device.</li> <li>• A STOP command is processed in the user program.</li> </ul>

## "STARTUP" operating mode

### Principles of the STARTUP mode

#### Function

After turning on the CPU, it executes a startup program before starting to execute the cyclic user program.

By suitably programming startup OBs, you can specify certain initialization variables for your cyclic program in the startup program. There is no rule in terms of the number of startup OBs. That is, you can set up one or several startup OBs in your program, or none at all.

### Parameter settings for startup characteristics

You can specify whether the CPU remains in STOP mode or whether a warm restart is run. Over and above this, you can set the response during startup (RUN or previous mode) in the "Startup" group of the CPU properties.

### Special characteristics

Note the following points regarding the "STARTUP" mode:

- The startup OBs are executed. All startup OBs you have programmed are executed, regardless of the selected startup mode.
- No time-based program execution can be performed.
- Interrupt controlled program execution limited to:
  - OB 82 (diagnostics interrupt)
- The outputs on the modules are disabled.
- The process image is not updated; direct I/O access to inputs is possible.

## See also

Editing properties and parameters (Page 428)  
Principles of the operating modes of S7-CPU's (Page 834)  
Organization blocks for startup (Page 883)  
Warm restart (Page 837)

## Warm restart

### Function

During a warm restart, all non-retentive bit memory is deleted and non-retentive DB contents are reset to the initial values from load memory. Retentive bit memory and retentive DB contents are retained.

Program execution begins at the call of the first startup OB.

### Triggering a warm restart

You can trigger a "Warm restart" using a corresponding menu command on your programming device in the following situations:

- The CPU must be in "STOP" mode.
- After a memory reset
- After downloading a consistent program and a consistent hardware configuration in the "STOP" mode of the CPU.

"POWER ON" triggers a "warm restart" if you have set the following parameters for the startup response:

- Startup type "warm restart - RUN" (regardless of the CPU operating mode prior to POWER OFF).
- "Warm restart - mode prior to POWER OFF" (depending on the CPU operating mode prior to POWER OFF. The CPU must have been in RUN mode prior to this.)

## See also

Retentive memory areas (Page 845)

## Startup activities

### Overview

The following table shows which activities the CPU performs at STARTUP:

Activities in execution sequence	At warm restart
Clear non-retentive bit memories	Yes
Clear all bit memories	No
Clear the process image output	Yes
Processing startup OBs	Yes
Update the process image input	Yes
Enable outputs after changing to "RUN" mode	Yes

### Sequence

The following figure shows the activities of the CPU in "STOP", "STARTUP", and "RUN" modes.

You can use the following measures to specify the state of the I/O outputs in the first cycle of the user program:

- Use assignable output modules to be able to output substitute values or to retain the last value.
- Set default values for outputs in startup OBs.

During the startup, all interrupt events are entered in a queue so that they can be processed later during RUN mode. In RUN mode, hardware interrupts can be processed at any time.

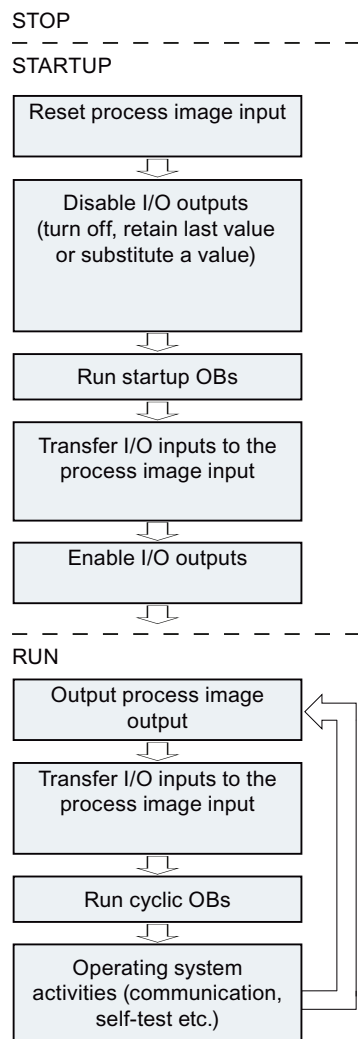

## Special features during startup

### Response when expected and actual configurations do not match

The expected configuration is represented by the engineering configuration loaded on the CPU. The actual configuration is the actual configuration of the automation system.

If the expected configuration and actual configuration differ, the CPU nevertheless initially changes to RUN.

### Canceling a STARTUP

If errors occur during startup, the startup is canceled and the CPU remains in "STOP" mode.

Under the following conditions, a startup will not be performed or will be canceled:

- If an invalid SD card is inserted.
- If no hardware configuration has been downloaded.

## See also

Overview of the CPU properties (Page 856)

## RUN mode

### Function

In "RUN" mode the cyclic, time-driven, and interrupt-driven program sections execute:

- The process image output is read out.
- The process image input table is read.
- The user program is executed.

Active data exchange between S7-1200 CPUs by means of Open User Communication is only possible in "RUN" mode.

### Running the user program

Once the CPU has read the inputs, the cyclic program runs from the first to the last instruction.

If you have configured a minimum cycle time, the CPU will not end the cycle until this minimum cycle time is up even if the user program is completed sooner.

A maximum cycle time is set which you can adjust according to your requirements. This ensures that the cyclic program is completed within a specified time. The system will respond with a time error if the cyclic program is not completed within this time.

Other events such as hardware and diagnostic interrupts can interrupt the cyclic program flow and prolong the cycle time.

## See also

Principles of the operating modes of S7-CPU's (Page 834)

Events and OBs (Page 848)

## STOP mode

### Function

In "STOP" mode, the user program is not executed. All outputs are disabled or react according to the parameter settings: They provide a substitute value as set in the parameters or retain the last value output and bring the controlled process to a safe status.

The CPU checks the following points:

- Hardware, for example whether all modules are available
- Whether the default settings for the CPU are applicable or parameter sets are present
- Whether the general conditions for the programmed startup behavior are correct



## See also

Principles of the operating modes of S7-CPU (Page 834)

## Basics of a memory reset

### Function

A memory reset on the CPU is possible only in STOP mode.

When memory is reset, the CPU is changed to an "initial status". This means:

- The content of the work memory and the retentive and non-retentive data are deleted.
- The load memory (code and data blocks) is then copied to work memory. As a result, the DBs no longer have current values but their initial values.
- An existing online connection between your programming device/PC and the CPU is terminated.
- The diagnostics buffer, the time, the IP address, the hardware configuration and active force jobs are retained.

## Memory areas

## Useful information on memory cards

### How the memory card functions

The SIMATIC Memory Card for a S7-1200 is an SD memory card preformatted by Siemens for the CPU user program.

You may only delete files and folders. If you format the memory card with Windows, for example with a commercially available card reader, you make the memory card unusable as a storage medium for an S7 CPU.



### Setting the card type

You can use the memory card as a transfer card, a program card or a firmware update card.

To set the card type, insert the memory card into the card reader of the programming device and select the "Card reader/USB memory" folder from the project navigation. In the properties of the selected memory card, designate the card type:

- Program  
If it is used as a program card, you can load the user program on the memory card. In this case, the internal load memory of the device is replaced by the memory card and the internal load memory is erased. The user program is then fully executable from the memory card. If the memory card with the user program is removed, there is no longer a program available.
- Transfer  
If it is used as a transfer card, you can transfer the user program from the memory card to the internal load memory of the CPU. You can then remove the memory card again.
- Firmware card  
Firmware for the S7-1200 modules can be stored on a memory card. Therefore it is possible to perform a firmware update with the help of a specifically prepared memory card. Likewise, a backup copy of firmware for a module can be stored on a memory card.

### Transferring objects from the project to a memory card

When the memory card is inserted in the programming device or in an external card reader, you can transfer the following objects from the project tree to the memory card:

- Individual blocks (multiple selection possible)  
In this case a consistent transfer is available, as the dependencies of the blocks to each other is taken into account with block selection.
- PLC  
In this case, all objects relevant to processing are transferred, such as blocks and the hardware configuration on the memory card, just as with downloading.

To perform the transfer, you can move the objects with drag-and-drop or use the command "Card reader/USB memory > Write to memory card" in the "Project" menu.

### Transferring objects from the memory card to the project

You can transfer Individual blocks (multiple selection is possible) by dragging them to the project. A hardware configuration cannot be transferred from the memory card to the project.

### Updating firmware with a memory card

You can get the latest firmware data on the Internet from the Service & Support pages:

<http://support.automation.siemens.com> (<http://support.automation.siemens.com/WW/view/en/34143537>)

Save the firmware files on the hard disk and plug the SIMATIC Memory Card into the card reader of your programming device.

To store the file on the memory card, select the memory card in the "Card Reader/USB memory" folder in the project navigation. Select the shortcut menu "Card Reader/USB memory > Create firmware update memory card".

Then follow the instructions in the Service & Support portal for performing a firmware update with your CPU.

Updating the firmware changes the CPU firmware status. If you have used the CPU in the project, you will have to update the CPU already configured to the CPU with the new firmware status by changing devices offline, and adapt and then load the program or configuration.

### **See also**

Replacing a hardware component (Page 427)

Useful information on CPU firmware versions and STEP 7 versions (Page 905)

### **Load memory**

#### **Function**

Each CPU has an internal load memory. The size of this internal load memory depends on the CPU used.

This internal load memory can be replaced by using external memory cards. If there is no memory card inserted, the CPU uses the internal load memory; if a memory card is inserted, the CPU uses the memory card as load memory.

The size of the usable external load memory cannot, however, be greater than the internal load memory even if the inserted SD card has more free space.

### **See also**

Using memory cards (Page 335)

### **Work memory**

#### **Function**

Work memory is a non-retentive memory area for storing elements of the user program that are relevant for program execution. The user program is executed exclusively in work memory and system memory.

### **System memory**

#### **System memory areas**

#### **Function**

System memory contains the memory elements that each CPU makes available to the user program, such as the process image and bit memory.

By using appropriate operations in your user program, you address the data directly in the relevant operand area.

The following table shows the operand areas of the system memory:

Operand area	Description	Access via units of the following size:	S7 notation
Process image output	The CPU writes the values from the process image output table to the output modules at the start of the cycle.	Output (bit)	Q
		Output byte	QB
		Output word	QW
		Output double word	QD
Process image input	The CPU reads the inputs from the input modules and saves the values to the process image input table at the start of the cycle.	Input (bit)	I
		Input byte	IB
		Input word	IW
		Input double word	ID
Bit memory	This area provides storage for intermediate results calculated in the program.	Bit memory (bit)	M
		Memory byte	MB
		Memory word	MW
		Memory double word	MD
Data block	Data blocks store information for the program. They can either be defined so that all code blocks can access them (global DBs) or assigned to a specific FB or SFB (instance DB). Requirement: The block attribute "Optimized block access" is not enabled.	Data bit	DBX
		Data byte	DBB
		Data word	DBW
		Data double word	DBD
Local data	This area contains the temporary data of a block while the block is being processed. Requirement: The block attribute "Optimized block access" is not enabled. Recommendation: Access local data (temp) symbolically.	Local data bit	L
		Local data byte	LB
		Local data word	LW
		Local data double word	LD
I/O input area	The I/O input and output areas permit direct access to central and distributed input and output modules.	I/O input bit	<tag>:P
I/O output area		I/O input byte	
		I/O input word	
		I/O input double word	
		I/O output bit	
		I/O output byte	
		I/O output word	
		I/O output double word	

**See also**

Diagnostics buffer (Page 847)

Basic principles of process images (Page 845)

Access to the I/O addresses (Page 848)

**Retentive memory areas****Retentive memory areas**

Data loss after power failure can be avoided by marking certain data as retentive. This data is stored in a retentive memory area. A retentive memory area is an area that retains its content following a warm restart, in other words, after cycling the power when the CPU changes from STOP to RUN.

The following data can be assigned retentivity:

- Bit memory: The precise width of the memory can be defined for bit memory in the PLC tag table or in the assignment list.
- Tags of a function block (FB): You can define individual tags as retentive in the interface of an FB if you have enabled optimized block access. Retentivity settings can be defined only in the assigned instance data block if optimized block access has not been activated for the FB.
- Tags of a global data block: You can define retentivity either for individual or for all tags of a global data block depending on the settings for access.
  - Block with optimized access: retentivity can be set for each individual tag.
  - Block with standard access: The retentivity setting applies to all tags of the DB; either all tags are retentive or no tag is retentive.

**See also**

Warm restart (Page 837)

**process image input/output****Basic principles of process images****Function**

When the user program addresses the input (I) and output (O) operand areas, it does not query or change the signal states on the digital signal modules. Instead, it accesses a memory area in the system memory of the CPU. This memory area is referred to as the process image.

### Advantages of the process image

Compared with direct access to input and output modules, the main advantage of accessing the process image is that the CPU has a consistent image of the process signals for the duration of one program cycle. If a signal state on an input module changes during program execution, the signal state in the process image is retained until the process image is updated again in the next cycle. The process of repeatedly scanning an input signal within a user program ensures that consistent input information is always available.

Access to the process image also requires far less time than direct access to the signal modules since the process image is located in the internal memory of the CPU.

### Updating the process images

#### Sequence

The operating system updates the process images at cyclic intervals unless defined otherwise in your configuration. The process image input/output is updated in the following order:

1. The internal tasks of the operating system are performed.
2. The process image output (PIQ) table is written to the outputs of the module.
3. The status of inputs is read to the process image input (PII) table.
4. The user program is executed with all the blocks that are called in it.

The operating system automatically controls the writing of the process image output to the outputs of the modules and the reading of the process image input.

#### Special characteristics

You have the option of accessing inputs or outputs directly using direct I/O access.

- If an instruction accesses an output directly and the output address is located in the process image output, the process image of the relevant output is updated.
- If an instruction accesses an output directly and the output address is **not** located in the process image output, the process image of the relevant output is **not** updated.

#### Example of normal I/O access by way of the process image

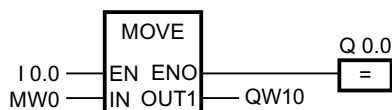

Update QW10 in the I/O output area with the value from MW0.

#### I/O access error during process image updating

If an error occurs while updating the process image (I/O access error), the CPU reacts with the default system reaction "STOP".

## See also

- Start address of a module (Page 847)
- Access to the I/O addresses (Page 848)
- Startup activities (Page 838)

## Diagnostics buffer

### Function

The diagnostics buffer is part of the system memory of the CPU. It contains the errors detected by the CPU or modules with diagnostics capability. It includes the following events:

- Every mode change of the CPU (for example, POWER UP, change to STOP mode, change to RUN mode)
- Every diagnostics interrupt

The diagnostics buffer of the S7-1200-CPU has a capacity of 50 entries of which the last (most recent) 10 entries are retained following power cycling.

Those entries can only be cleared by restoring the CPU to factory defaults.

You can read the content of the diagnostics buffer with the help of the Online and Diagnostics view.

## See also

- Basic information on the diagnostics buffer (Page 1003)

## I/O data area

## Start address of a module

### Definition

The start address is the lowest byte address of a module. It acts as the initial address of the module user data area.

## Configuring module start addresses

The addresses used in the user program and the module start addresses are coordinated when the modules are configured.

In the module properties ("I/O addresses" group), you can change the start addresses that were assigned automatically after the modules were inserted.

You can also make a setting that decides whether or not the addresses are located in the process image.

## Access to the I/O addresses

### I/O addresses

If you insert a module in the device view, its user data is located in the process image of the S7-1200 CPU (default). The CPU handles the data exchange between the module and the process image area automatically during the update of the process images.

Append the suffix ":P" to the I/O address if you want the program to access the module directly instead of using the process image.

`%I0.0:P`

`"TAG_1":P`

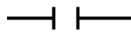

This could be necessary, for example, during execution of a time-sensitive program which also has to control the outputs within the same cycle.

## Basics of program execution

### Events and OBs

### Events and OBs

The operating system of S7-1200-CPU is based on events. There are two types of events:

- Events which can start an OB
- Events which cannot start an OB

An event which can start an OB triggers the following reaction:

- It calls the OB you possibly assigned to this event. The event is entered in a queue according to its priority if it is currently not possible to call this OB.
- The default system reaction is triggered if you did not assign an OB to this event.

An event which cannot start an OB triggers the default system reaction for the associated event class.

The user program cycle is therefore based on events, the assignment of OBs to those events, and on the code which is either contained in the OB, or called in the OB.

The following table provides an overview of the events which can start an OB, including the associated event classes and OBs. The table is sorted based on the default OB priority. Priority class 1 is the lowest.



Event class	OB no.	Number of OBs	Start event	OB priority (default)
Cyclic program	1, >= 123	>= 1	Starting or end of the last program cycle OB	1
Startup	100, >= 123	>=0	STOP to RUN transition	1
Time-of-day interrupt	>= 123	Max. 2	Start time has been reached	2
Time-delay interrupt	>= 123	Max. 4	Delay time expired	3
Cyclic interrupt	>= 123		Constant bus cycle time expired	8
Hardware interrupt	>= 123	Max. 50 (more can be used with DETACH and ATTACH)	<ul style="list-style-type: none"> <li>Positive edge (max. 16)</li> <li>Negative edge (max. 16)</li> </ul>	18
			<ul style="list-style-type: none"> <li>HSC: Count value = reference value (max. 6)</li> <li>HSC: Count direction changed (max. 6)</li> <li>HSC: External reset (max. 6)</li> </ul>	18
Status interrupt	55	0 or 1	CPU has received status interrupt	4
Update interrupt	56	0 or 1	CPU has received update interrupt	4
Manufacturer- or profile-specific interrupt	57	0 or 1	CPU has received manufacturer-specific or profile-specific interrupt	4
Diagnostic error interrupt	82	0 or 1	Module has detected an error	5
Pull/plug interrupt	83	0 or 1	Removal/insertion of modules of distributed I/O	6
Rack error	86	0 or 1	Error in the I/O system of the distributed I/O	6
Time error	80	0 or 1	<ul style="list-style-type: none"> <li>Maximum cycle time exceeded</li> <li>Called OB is still being executed</li> <li>Time-of-day interrupt missed</li> <li>Time-of-day interrupt missed during STOP</li> <li>Queue overflow</li> <li>Interrupt loss due to high interrupt load</li> </ul>	22

The following table describes events which do not trigger an OB start, including the corresponding reaction of the operating system. The table is sorted based on event priority.

Event class	Event	Event priority	System reaction
Insert/remove central modules	Insert/remove a module	21	STOP
I/O access error during process image update	I/O access error during process image update	22	Ignore
Programming error	Programming error in a block for which you use system reactions provided by the operating system (note: the error handling routine in the block program is executed if you activated local error handling).	23	RUN

Event class	Event	Event priority	System reaction
I/O access error	I/O access error in a block for which you use system reactions provided by the operating system (note: the error handling routine in the block program is executed if you activated local error handling).	24	RUN
Maximum cycle time exceeded twice	Maximum cycle time exceeded twice	27	STOP

### Assignment between OBs and events

With the exception of the cyclic program and startup program and event can only be assigned to one OB. However, in certain event classes such as hardware interrupts one and the same OB can be assigned to several events.

The assignment between OBs and events is defined in the hardware configuration. Defined assignments can be changed at runtime by means of ATTACH and DETACH instructions.

### OB priority and runtime characteristics

S7-1200 CPUs support the priority classes 1 (lowest) to 27 (highest). An OB is assigned the priority of its start event.

OBs are always executed on a priority basis: The OBs with the highest priority are executed first. Events of the same priority are processed in order of occurrence. This means:

- Any OB with priority  $\geq 2$  will interrupt cyclic program execution.
- An OB of priority 2 to 25 cannot be interrupted by any event of priority group 2 to 25. This rule also applies to events of a priority higher than that of the currently active OB. Such events are processed later.
- A time error (priority 26) will interrupt any other OB.

### OB start information

Certain OBs have start information, while others do not. This is explained in greater detail in the description of the relevant OB.

### See also

Event-based program execution (Page 850)

### Event-based program execution

### OB priority and runtime behavior

S7-1200-CPU support the priority classes 1 (lowest) to 27 (highest). An OB is assigned the priority of its start event.

Interrupt OBs can only be interrupted by time error interrupts. This rule also applies to events of a priority higher than that of the currently active OB. That is, only one interrupt OB can be active, with exception of the time error interrupt OB.

Any further event of generated while an interrupt OB is being executed is added to a queue in accordance with its priority. Start events within a queue are processed later based on the chronological order of their occurrence.

### Program execution on the CPU

Cyclic OBs are interrupted by interrupt OBs.

Interrupt OBs can only be interrupted by time error interrupt OBs.

The following figure shows the basic sequence:

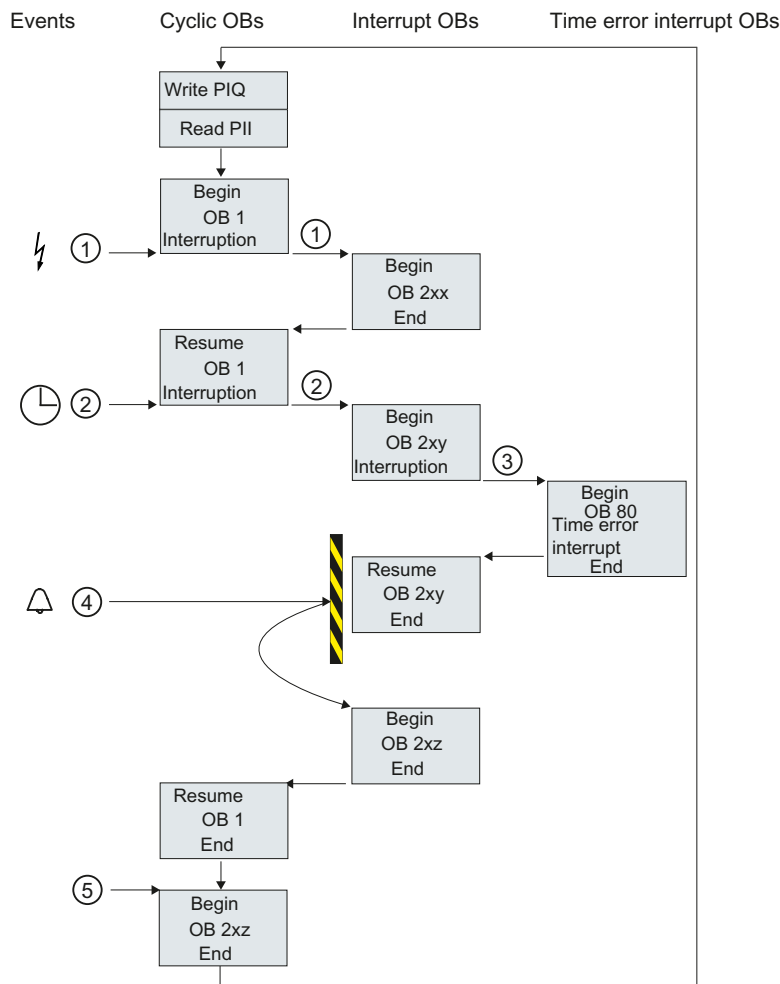

Figure 8-3 Program sequence

## Description of program execution

- ① and ② An event (e.g. a hardware interrupt) calls its associated OB.  
A called OB is executed without interruption, including all of its nested blocks. Execution of the cyclic OB is resumed on completion of interrupt processing, provided the queue does not contain any events which trigger an OB start.
- ③ An interrupt OB can only be interrupted by a time error interrupt OB (OB 80).
- ④ An new alarm-triggering event occurs during interrupt processing. This new event is added to a queue. The queued events successively call their corresponding OBs only after execution of the current interrupt OBs was completed and according to the following rules:
  - Events are processed in the order of their priority (starting at the highest priority)
  - Events of the same priority are processed in chronological order
- ⑤ The cyclic OBs are processed one after the other.

## Notes on queues

- Every priority class (OBs of the same priority to be called) is assigned a separate queue. The size of those queues is set by default.
- Any new event leading to the overflow of a queue is discarded and therefore lost. A "time error interrupt event" is generated simultaneously. Information identifying the OB that caused the error is included in the start information of the time error interrupt OB (OB 80). A corresponding reaction such as an alarm trigger can be programmed in the time error interrupt OB.

## Example of a hardware interrupt event

The function principle of event-oriented program execution in the S7-1200 CPU is described based on the example of a hardware interrupt-triggering module.

## Process events and their priority

Process events are triggered by the I/O (e.g. at a digital input) and initiate a call of the assigned OB in the S7-1200 CPU. OBs assigned to a process event are called hardware interrupt OBs.

Examples of process events and their priority:

- Process events "rising edge" or "falling edge" at an interrupt-triggering module: The hardware interrupt OB started by such an event is always assigned priority 5.
- Process events from a high-speed counter
  - Count value corresponds to the reference value
  - Change count direction
  - External reset of the high-speed counterThe hardware interrupt OB started by this event is always assigned priority 6.

The figure below shows the chronological sequence of hardware interrupt execution: In the case of two hardware interrupt events in immediate succession, the second hardware interrupt triggering event is held back in the queue until the first OBx has been processed. The next hardware interrupt triggering event can only start the associated OBx when the OBx has been processed. Additional hardware interrupt triggering events are lined up in the queue according to this principle.

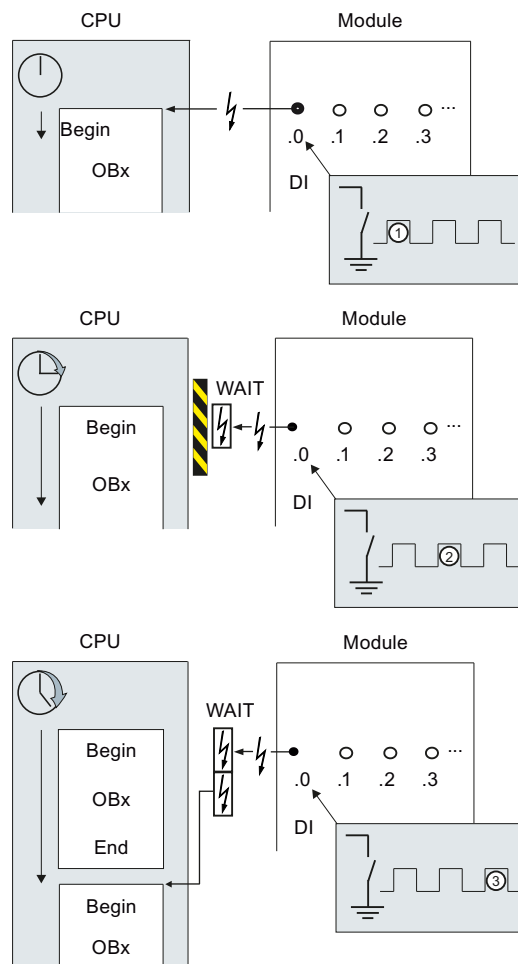

## Hardware interrupt execution

- ① A hardware interrupt-triggering event such as a rising edge at the input calls the OB to which it is assigned.
- ② If a new event occurs that triggers a hardware interrupt while the OB is executing, this event is entered in a queue.
- ③ The new event that triggers a hardware interrupt starts the hardware interrupt OB assigned to the event.

## **Assigning the interrupt-triggering event**

The interrupt-triggering event is assigned to an OB in the input properties of the device view.

- An interrupt-triggering event can only be assigned to a single OB.
- OBs, however, can be assigned to several interrupt-triggering events. This means, for example, that you can assign both the rising and the falling edge to the same interrupt OB in order to trigger the same reaction to any change of the input signal.
- The started OB can interrupt a cycle OB at every instruction. Consistent data access is secured up to dword size.
- You can parameterize module-specific interrupt-triggering events such as a rising and the falling edge at the input.
- Assign the interrupt-triggering event and the OB to be started in the configuration of the interrupt-triggering module. However, within the started hardware interrupt OB you can override this assignment using the DETACH instruction, or assign the same event to a different OB using the ATTACH instruction. This functionality allows a flexible reaction to external process signals.

## **Setting the operating behavior**

### **Changing properties of the modules**

#### **Default settings**

When they leave the factory, all hardware components with parameters have default settings suitable for standard applications. These default values allow the hardware components to be used immediately without making any additional settings.

You can, however, modify the behavior and the properties of the hardware components to suit the requirements and circumstances of your application. Hardware components with settable parameters include, for example, communications modules and several analog and digital modules.

#### **Setting and loading parameters**

When you have selected a hardware component in the device or network view, you can set the properties in the Inspector window. When you save a device configuration with its parameters, data is generated that needs to be loaded on the CPU. This data is transferred to the relevant modules during startup.

#### **Properties of the CPUs**

The properties of the CPUs have special significance for system behavior. For example for a CPU you can set:

- Interfaces
- Inputs and outputs
- High-speed counters

- Pulse generators
- Startup behavior
- Time-of-day
- Protection level
- Bit memory for system and clock
- Cycle time
- Communications load

The entry possibilities specify what is adjustable and in which value ranges. Fields that cannot be edited are disabled or are not shown in the properties window.

### **Requirement**

You have already arranged the hardware components for which you want to change properties on a rack.

### **Procedure**

To change the properties and parameters of the hardware components, follow these steps:

1. In the device or network view, select the hardware component or interface that you want to edit.
2. Edit the settings for the selected object:
  - For example in the device view you can edit addresses and names.
  - In the Inspector window additional setting possibilities are available.

You do not need to confirm your entries, the changed values will be applied immediately.

### **See also**

Editing properties and parameters (Page 428)

Introduction to loading a configuration (Page 826)

## CPU properties

### Overview of the CPU properties

#### Overview

The following table provides you with an overview of the CPU properties:

Group	Properties	Description
General	Project information	General information to describe the inserted CPU. Except for the slot number, you can change this information.
	Catalog information	Read-only information from the hardware catalog for this CPU.
PROFINET interface	General	Name and comment for this PROFINET interface. The name is limited to 110 characters.
	Ethernet addresses	Select whether the PROFINET interface is networked. If subnets have already been created in the project, they are available for selection in the drop-down list. If not, you can create a new subnet with the "Add new subnet" button.  Information on the IP address, subnet mask and IP router usage in the subnet is available in the IP protocol. If an IP router is used, the information about the IP address of the IP router is necessary.
	Advanced options	Name, comment and additional setting options of the Ethernet interface port.
	Time synchronization	Settings for time synchronization in the NTP time format.  The NTP (network time protocol) is a general mechanism for synchronizing system clocks in local and global area networks.  In NTP mode, the interface of the CPU sends time queries (in client mode) at regular intervals to NTP servers on the subnet (LAN) and the addresses must be set in the parameters here. Based on the replies from the server, the most reliable and most accurate time is calculated and synchronized. The advantage of this mode is that it allows the time to be synchronized across subnets. The accuracy depends on the quality of the NTP server being used.
DI#/DO#	General	Name of and comment on the integrated digital inputs of the CPU.
	Digital inputs	Input delays can be set for digital inputs. The input delays can be set in groups (in each case for 4 inputs).  The detection of a positive and a negative edge can be enabled for each digital input. A name and a hardware interrupt can be assigned to this event.  Depending on the CPU, pulse catches can be activated at various inputs. When the pulse catch is activated, even pulse edges that are shorter than the cycle time of the program are detected.
	Digital outputs	The reaction to a mode change from RUN to STOP can be set for all digital outputs:  The state can either be frozen (corresponds to retain last value) or you set a substitute value ("0" or "1")
	I/O addresses	The address space of the input and output addresses is specified as is the process image.



Group	Properties	Description
	Hardware identifier	The hardware identifier of the device is displayed.
AI#	General	Name of and comment on the integrated analog inputs of the CPU.
	Analog inputs	<p>During noise reduction, the specified integration time suppresses interference frequencies at the specified frequency (in Hz).</p> <p>The channel address, measurement type, voltage range, smoothing and overflow diagnostics must be specified in the "Channel #" group. The measurement type and voltage range are set permanently to voltage, 0 to 10 V.</p> <p>Smoothing analog values provides a stable analog signal for further processing. Smoothing analog values can be useful with slow measured value changes, for example, in temperature measurement. The measured values are smoothed with digital filtering. Smoothing is achieved by the module forming mean values from a specified number of converted (digitalized) analog values. The selected level (slight, medium, strong) decides the number of analog signals used to create the mean value.</p> <p>If overflow diagnostics is enabled, a diagnostics event is generated if an overflow occurs.</p>
	I/O addresses	The address space of the input addresses is specified as is the process image.
	Hardware identifier	The hardware identifier of the device is displayed.
High-speed counter (HSC)	High-speed counter (HSC)#	<p>High-speed counters are typically used to drive counting mechanisms.</p> <p>See: Configuring high-speed counters (Page 866)</p>
Pulse generators (PTO/PWM)	PTO#/PWM#	<p>A pulse generator is activated and can be initialized with project information.</p> <p>For the configuration of an activated pulse generator, specify the usage as PWM (Pulse Width Modulation) or as PTO (Pulse Train Output).</p> <p>Specify the output source, time base, pulse width format, cycle time and initial pulse width for PWM. A pulse output is specified as the hardware output. The PWM output is controlled by the CTRL_PWM instruction, see CTRL_PWM.</p> <p>Specify the output source for PTO. A pulse output and a direction output are specified as the hardware outputs. A PTO is operated together with a high-speed counter in the "axis of motion" count mode and controlled by the Motion Control technology object (see keyword "Motion Control S7-1200") .</p> <p>The hardware ID is displayed in the I/O-diagnostics addresses and, if the PWM function is selected, the address space of the output addresses and the process image can be selected.</p>
Startup	Startup after POWER ON	<p>Setting the startup characteristics after cycling power.</p> <p>See: Principles of the STARTUP mode (Page 836)</p>

8.1 Configuring devices and networks

Group	Properties	Description
	Comparison of preset configuration and actual configuration	Specifies whether modules (SM, SB, CM, CP or even the CPU) can be replaced: <ul style="list-style-type: none"> <li>• Startup of the CPU only if compatible</li> <li>• Startup of the CPU even if there are differences</li> </ul> Example: A signal module with 16 digital inputs and 16 digital outputs (DI16/DQ16) can be a compatible replacement for a signal module with 8 digital outputs (DQ8) or 4 digital inputs (DI4).
	Parameter assignment time for distributed I/O	Specifies a maximum period (standard: 60000 ms) in which the distributed I/O must start up. (The CMs and CPs are supplied with voltage and communication parameters during the CPU startup. This configuration time provides a time period during which I/O modules connected to the CM or CP must start up.) The CPU switches to RUN as soon as the distributed I/O has started and is ready for operation, regardless of the "Parameter assignment time for distributed I/O" parameter. If the distributed I/O has not started up during this period, the CPU switches to RUN without the distributed I/O.
Cycle	Maximum cycle time and minimum cycle time.	Specification of a maximum cycle time or a fixed minimum cycle time. If the cycle time exceeds the maximum cycle time, the CPU goes to STOP mode. See: Cycle time and maximum cycle time (Page 859)
Communication load	Maximum allocation of the cycle for communication (as a percentage)	Controls the duration of communication processes that always also extend the cycle time, within certain limits. Examples of communication processes include: Transferring data to another CPU or loading blocks (initiated via the PC). See: Cycle loading by communications (Page 860)
System and clock memory	System memory bits and clock memory bits	You use system memory bits for the following scans: <ul style="list-style-type: none"> <li>• Is the current cycle the first since cycling power?</li> <li>• Have there been any diagnostics state changes compared with the previous cycle?</li> <li>• Scan for "1" (high)</li> <li>• Scan for "0" (low)</li> </ul> Clock memory bits change their values at specified periodic intervals. See: Enabling system memory (Page 876) See: Using clock memory (Page 877)
Web server	Automatic update	Sends the requested web page with current CPU data periodically to the web browser. Enter the period duration under "Update interval". Automatic update can only be activated if the web server is enabled. See: Auto-Hotspot
	User-defined web pages	Allows access to freely-designed web pages of the CPU via a web browser. See: Auto-Hotspot
Time	Local time and daylight saving time	Setting of the time zone in which the CPU is operated and setting of the daylight-saving/standard time changeover.

Group	Properties	Description
Protection	Protection and password for read/write access	Setting the read/write protection and the password for access to the CPU. See: Setting options for the protection level (FW V1 to V3) (Page 878) See: Setting options for the protection (FW as of V4) (Page 879)
Connection resources	-	Display of available, reserved and previously configured connection resources of the CPU.
Address overview	-	Tabular representation of all addresses used by the CPU for integrated inputs/outputs as well as for the inserted modules. Addresses that are not used by any module are represented as gaps. The view can be filtered according to <ul style="list-style-type: none"> <li>• Input addresses</li> <li>• Output addresses</li> <li>• Address gaps</li> </ul>

### See also

- Specifying input and output addresses (Page 638)
- Assigning parameters to hardware interrupt OBs (Page 900)
- Access to the I/O addresses (Page 848)
- Addressing modules (Page 637)
- Special features during startup (Page 839)

### Cycle time and maximum cycle time

#### Function

The cycle time is the time that the operating system requires to execute the cyclic program and all the program sections that interrupt this cycle. The program execution can be interrupted by:

- Time errors and 2xMaxCycleTime errors
- System activities, e.g., process image updating

The cycle time (T<sub>cyc</sub>) is therefore not the same for every cycle.

The following schematic shows an example of different cycle times (TZ1 ≠ TZ2) for S7-1200 CPUs:

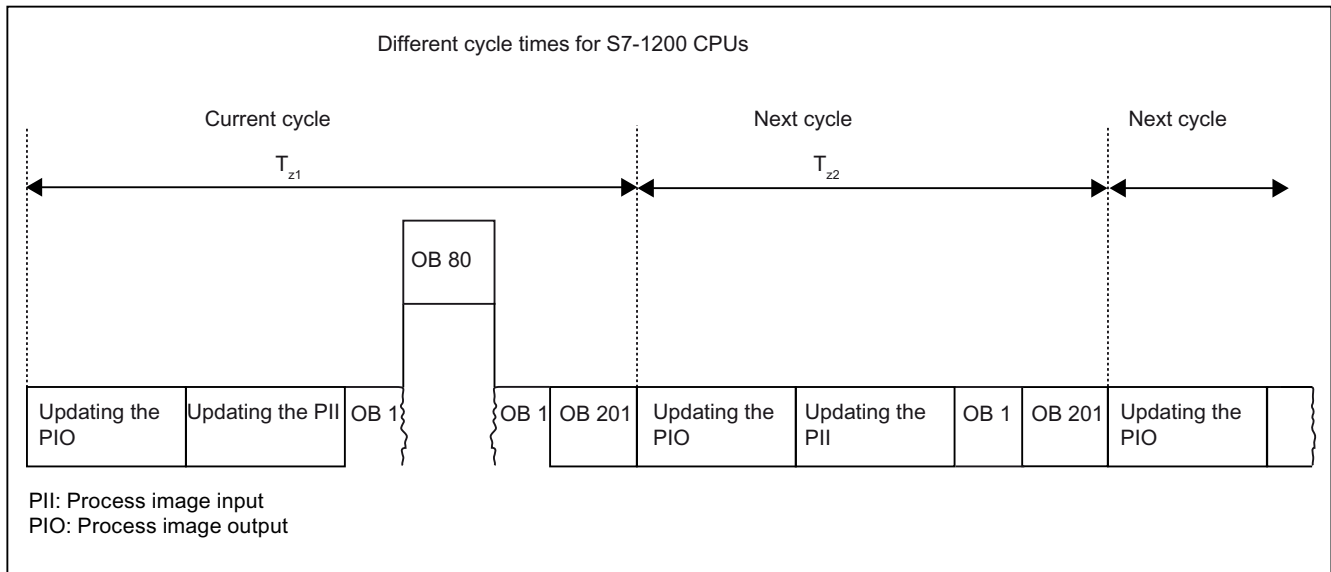

In the current cycle, the cyclic OB used here (e.g. OB 1) will be interrupted by a time error (e.g. OB 80). Following the cyclic OB, the next cycle OB 201 is processed.

### Maximum cycle time

The operating system monitors the execution time of the cyclic program for a configurable upper limit known as the maximum cycle time. You can restart this time monitoring at any point in your program by calling the RE\_TRIGR instruction.

If the cyclic program exceeds the maximum cycle time, the operating system will attempt to start the time error OB (OB 80). If the OB is not available, the CPU ignores the overshoot of the maximum cycle time.

In addition to monitoring the runtime for overshooting of the maximum cycle time, adherence to a minimum cycle time is guaranteed. To do this, the operating system delays the start of the new cycle until the minimum cycle time has been reached. During this waiting time, new events and operating system services are processed.

If the maximum cycle time is exceeded a second time, for example while the time error OB is being processed (2xMaxCycleTime error), the CPU changes to STOP mode.

### Cycle loading by communications

#### Function

The cycle time of the CPU can be extended due to communications processes. These communications processes include for example:

- Transferring data to another CPU
- Loading of blocks initiated by a programming device

You can control the duration of these communications processes to some extent using the CPU parameter "Cycle load due to communication".

In addition to communications processes, test functions also extend the cycle time. The "Cycle load due to communication" parameter can be used to influence the duration.

### How the parameter works

You use the "Cycle load due to communication" parameter to enter the percentage of the overall CPU processing capacity that can be available for communications processes. This CPU processing capacity is now available at all times for communication. This processing capacity can be used for program execution when not required for communication.

### Effect on the actual cycle time

The "Cycle load due to communication" parameter can be used to extend the cycle time of the cyclic organization block (e.g., OB 1) by a factor calculated according to the following formula:

$$\frac{100}{100 - \text{"Cycle load due to communication"}}$$

The formula does not take into account the effect of asynchronous events such as hardware interrupts or cyclic interrupts on the cycle time.

If the cycle time is extended due to communication processes, more asynchronous events may occur within the cycle time of the cyclic organization block. This extends the cycle still further. The extension depends on how many events occur and how long it takes to process them.

### Example 1 – no additional asynchronous events:

If the "Cycle load due to communication" parameter is set to 50%, this can cause the cycle time of the cyclic organization block to increase by up to a factor of 2.

### Example 2 – additional asynchronous events:

For a pure cycle time of 500 ms, a communication load of 50% can result in an actual cycle time of up to 1000 ms, provided that the CPU always has enough communications jobs to process. If, parallel to this, a cyclic interrupt with 20 ms processing time is executed every 100 ms, this cyclic interrupt would extend the cycle by a total of  $5 \times 20 \text{ ms} = 100 \text{ ms}$  without communication load. That is, the actual cycle time would be 600 ms. Because a cyclic interrupt also interrupts communications, it affects the cycle time by adding  $10 \times 20 \text{ ms}$  at 50 % communication load. That is, in this case, the actual cycle time amounts to 1200 ms instead of 1000 ms.

---

#### Note

Observe the following:

- Check the effects of changing the value of the "Cycle load due to communication" parameter while the system is running.
  - You must always consider the communication load when setting the minimum cycle time as time errors will otherwise occur.
-

## **Recommendations**

- Increase this value only if the CPU is used primarily for communication purposes and the user program is not time critical.
- In all other situations you should only reduce this value.

## **Time-of-day functions**

### **Basic principles of time of day functions**

All S7-1200 CPUs are equipped with an internal clock. The backup supports the display of the correct time for up to 10 hours if the power supply is interrupted.

### **Time-of-day format**

The clock always shows the time of day with a resolution of 1 millisecond and the date including the day of the week. The time adjustment for daylight-saving time is also taken into account.

### **Setting and reading the time of day**

#### **Setting and reading the time with instructions**

You can set, start and read the time-of-day and date on the CPU clock with the following instructions in the user program:

- Set the time-of-day: "WR\_SYS\_T"
- Read time of day "RD\_SYS\_T"
- Read local time "RD\_LOC\_T"
- Set time zone "SET\_TIMEZONE"

#### **Manual setting**

You can also read and set the time-of-day manually in the online and diagnostics view under "Functions > Set time-of-day".

## Assigning the clock parameters

### Clock parameters

The clock parameters allow you to make the following settings:

- Enable time synchronization via NTP server  
Select this check box if you want the internal clock to be synchronized using the NTP synchronization mode.
- Network time server  
The IP addresses of up to four NTP servers need to be configured.
- Update interval  
The update interval defines the interval between time queries.

### High-speed counters

#### General information on high-speed counters

##### Introduction

High-speed counters are typically used to drive counting mechanisms in which a shaft turning at a constant speed is equipped with an incremental step encoder. The incremental step encoder ensures a certain number of count values per rotation and a reset pulse once per rotation. The clock memory bit(s) and the reset pulse of the incremental step encoder supply the inputs for the high-speed counter.

The various S7-1200 CPUs have differing numbers of high-speed counters available:

S7-1200 CPU	Number of HSCs	HSC designation
CPU 1211C	3 (with digital signal board 4)*	HSC1...3 (and HSC5)*
CPU 1212C	4 (with digital signal board 5)*	HSC1...4 (and HSC5)*
CPU 1214C CPU 1215C CPU 1217C	6	HSC1...6

\* with DI2/DO2 signal board

##### How it works

The first of several default values is loaded on the high-speed counter. The required outputs are enabled for the time during which the current value of the counter is lower than the default value. The counter is set up so that an interrupt occurs if the current value of the counter is equal to the default value or when the counter is reset.

If the current value is equal to the default value and an interrupt event results, a new default value is loaded and the next signal state is set for the outputs. If an interrupt event occurs because the counter is reset, the first default value and the first signal states of the outputs are set and the cycle repeated.

Since the interrupts occur much less frequently than the high-speed counter counts, a precise control of the fast operations can be implemented with only a slight influence on the overall cycle of the automation system. Since you can assign specific interrupt programs to interrupts, each new default can be loaded in a separate interrupt program allowing simple control of the state.

---

**Note**

You can also process all interrupt events in a single interrupt program.

---

### Count algorithms of the various counters

All counters work in the same way, however some high-speed counters do not support all count algorithms. There are four basic count algorithms:

- Single-phase counter with internal direction control
- Single-phase counter with external direction control
- 2-phase counter with 2 clock inputs
- A/B counter

Each high-speed counter can be used with or without a reset input. If the reset input is activated, this resets the current value. The current value remains reset until the reset input is deactivated.

### See also

Configuring high-speed counters (Page 866)

Interdependency of the counter mode and counter inputs (Page 864)

### Interdependency of the counter mode and counter inputs

#### General information on counter mode and counter inputs

You can assign not only the counter modes and counter inputs to the high-speed counters but also functions such as clock pulse generator, direction control, and reset. The following rules apply:

- An input cannot be used for two different functions.
- If an input is not required by the current counter mode of the defined high-speed counter, it can be used other purposes.

If, for example, you set HSC1 to counter mode 1, in which inputs I0.0 and I0.3 are required, you can use I0.1 for edge interrupts or for HSC2.

If, for example, you set HSC1 and HSC5, inputs I0.0 (HSC1) and I1.0 (HSC5) are always used with the counting and frequency counter modes. As a result, these two inputs are not available for any other functions when counters are operated.

You have additional inputs available if you use a digital signal board.



**Overview of the interdependency of counter mode and counter inputs**

Counter mode	Description	Inputs		
	HSC1	I0.0 (CPU) I4.0 (signal board)	I0.1 (CPU) I4.1 (signal board)	I0.3 (CPU) I4.3 (signal board)
	HSC2	I0.2 (CPU) I4.2 (signal board)	I0.3 (CPU) I4.3 (signal board)	I0.1 (CPU) I4.1 (signal board)
	HSC3*	I0.4 (CPU)	I0.5 (CPU)	I0.7 (CPU)
	HSC4 (CPU 1212/14/15/17C only)	I0.6 (CPU)	I0.7 (CPU)	I0.5 (CPU)
	HSC5 (CPU 1214/15/17C only)**	I1.0 (CPU) I4.0 (signal board)	I1.1 (CPU) I4.1 (signal board)	I1.2 (CPU) I4.3 (signal board)
	HSC6 (CPU 1214/15/17C only)**	I1.3 (CPU)	I1.4 (CPU)	I1.5 (CPU)
Counting / frequency	Single-phase counter with internal direction control	Clock pulse generator	-	-
Counting				Resetting
Counting / frequency	Single-phase counter with external direction control	Clock pulse generator	Direction	-
Counting				Resetting
Counting / frequency	2-phase counter with 2 clock inputs	Clock pulse generator forwards	Clock pulse generator backwards	-
Counting				Resetting
Counting / frequency	A/B counter	Clock pulse generator A	Clock pulse generator B	-
Counting				Resetting
Motion axis	Pulse generators PWM/PTO	HSC1 and HSC2 support the motion axis count mode for the PTO1 and PTO2 pulse generators: <ul style="list-style-type: none"> <li>• For PTO1, HSC1 evaluates the Q0.0 outputs for the number of pulses.</li> <li>• For PTO2, HSC2 evaluates the Q0.2 outputs for the number of pulses.</li> </ul> Q0.1 is used as the output for the motion direction.		

\* HSC3 can only be used for CPU 1211 without a reset input

\*\* HSC5 can be also be used for CPU 1211/12 if a DI2/DO2 signal board is used

**See also**

General information on high-speed counters (Page 863)

Configuring high-speed counters (Page 866)

## Configuring high-speed counters

### Requirement

An S7-1200 CPU has been inserted in the hardware configuration.

### Procedure

To configure a high-speed counter, follow these steps:

1. Select an S7-1200 CPU in the device or network view.
2. Click on the required high-speed counter under "Properties > High-speed counter" in the inspector window:
  - CPU 1211C: HSC1 to HSC3 (also HSC5 with a DI2/DO2 signal board)
  - CPU 1212C: HSC1 to HSC4 (also HSC5 with a DI2/DO2 signal board)
  - CPU 1214C / 1215C / 1217C: HSC1 to HSC6
3. Enable the high-speed counter in the "General" parameter group using the relevant check box.

---

#### Note

If you use a CPU 1211C or CPU 1212C with a DI2/DO2 signal board, you can also enable the high-speed counter HSC5.

---

#### Note

If you activate the pulse generators and operate them as PTO1 or PTO2, they use the associated high-speed counter HSC1 or HSC2 with "Motion axis" counting mode to evaluate the hardware outputs. If you configure high-speed counter HSC1 or HSC2 for other counting tasks, these cannot be used by pulse generator PTO1 or PTO2, respectively.

---

If required, you can enter a name and a comment for the high-speed counter here.

4. Define the functionality of the high-speed counter in the "Function" parameter group:
  - Count mode: Select what you want to be counted from the drop-down list.
  - Operating phase: Select the count algorithm from the drop-down list.
  - Input source: Select the on-board CPU inputs or the inputs of an optional digital signal board as the input source for the count pulses from the drop-down list.
  - Count direction is specified by: If you have selected a single-phase operating phase, open the drop-down list and select whether the count direction is set internally by an SFB parameter of the user program or externally via a digital input.
  - Initial count direction: If the user program is set as the internal direction control for the count direction, you can select the count direction at the start of counting from the drop-down list.
  - Frequency meter period: If frequency is set as the count mode, you can select the duration of the frequency meter periods in the drop-down list.

5. Specify the initial values and reset condition of the high-speed counter in the "Reset to initial values" parameter group:

- Initial counter value: Enter a start value for the high-speed counter.
- Initial reference value: Enter a maximum value for the high-speed counter.

Here, you can also specify whether the high-speed counter will use a reset input and the set the corresponding signal level for the reset input from the drop-down list.

6. Configure the reaction of the high-speed counter to certain events in the "Event configuration" parameter group. The following events can trigger an interrupt:

- The counter value matches the reference value.
- An external reset event was generated.
- A change of direction was triggered.

Enable an interrupt reaction using the check box, enter a name and select a hardware interrupt for the interrupt from the drop-down list.

7. Assign the start address for the high-speed counter in the "I/O/Diagnostics addresses" parameter group.

---

**Note**

In the "Hardware inputs" parameter group, you can only see which hardware inputs and values are being used for the clock, direction determination, reset pulse, and maximum count speed.

---

## Result

You have now adapted the parameters of the high-speed counter to the requirements of your project.

## See also

General information on high-speed counters (Page 863)

Interdependency of the counter mode and counter inputs (Page 864)

## Point-to-point communication

### Overview of point-to-point communication

PtP communication is communication via a serial interface that uses standardized UART data transmission (Universal Asynchronous Receiver/Transmitter). The S7-1200 uses communications modules with an RS-232 or RS-485 interface to establish PtP communication.

## Functions of point-to-point communication

Point-to-point communication (PtP) allows numerous applications:

- Direct transmission of information to an external device, for example a printer or a barcode reader
- Reception of information from external devices such as barcode readers, RFID readers, cameras and third-party optical systems as well as many other devices.
- Exchange of information with third-party devices, for example GPS devices, radio modems and many others

## The Freeport protocol

The S7-1200 supports the Freeport protocol for character-based serial communication. Using Freeport communication, the data transmission protocol can be configured entirely by the user program.

Siemens provides libraries with Freeport communication functions that you can use in your user program:

- USS Drive protocol
- Modbus RTU Master protocol
- Modbus RTU Slave protocol

## See also

Configuring a communications port (Page 869)

## Using RS-232 and RS-485 communications modules

### Communications modules with RS-232 and RS-485 interfaces

In an S7-1200 CPU, you can use two different communications modules:

- RS-232 communications module
- RS-485 communications module

The communications modules can be connected to the S7-1200 CPU via the I/O channel on the left. You can plug in up to three different modules.

## Properties of the communications modules

The communications modules have the following features:

- Support of the Freeport protocol
- Configuration by the user program with the aid of expanded instructions and library functions

## Configuring a communications port

### Configuring a communications port

After you have inserted a communications module with an RS-232 or RS-485 interface, you then set the interface parameters. You set the parameters for the interface either in the properties of the interface or you control the interface parameters from the user program using the PORT\_CFG instruction. The following description relates to the graphic configuration.

---

#### Note

If you use the user program to change the port setting, the settings of the graphic configuration are overwritten.

You should also keep in mind that the settings made by the user program are not retained if there is a power down.

---

### Requirement

- A communications module is already plugged in.
- You are in the device view.

### Procedure

To configure the communications port, proceed as follows:

1. Select the interface in the graphic representation in the device view.  
The properties of the interface are displayed in the Inspector window.
2. Select the "Port configuration" group in the area navigation of the Inspector window.  
The settings of the port are displayed.
3. From the "Transmission speed" drop-down list, select the speed for the data transmission.  
With user-programmed communication, remember the influence of the transmission speed on the changeover time.
4. From the "Parity" drop-down list, select the type of detection of bad information words.
5. Using the "Data bits" drop-down list, decide whether a character consists of eight or seven bits.
6. From the "Stop bit" drop-down list, select how many bits will identify the end of a transmitted word.

## 8.1 Configuring devices and networks

7. From the "Flow control" drop-down list, select the method for ensuring a trouble-free data stream between sender and receiver. This parameter can only be set for the RS-232 interface.
  - Enter a HEX value in the "XON character" box that will cause the transmission of the message to be continued when it is detected. This parameter can only be set for software-controlled data flow control.
  - Enter a HEX value in the "XOFF character" box that will cause the transmission of the message to be suspended for the set wait time. This parameter can only be set for software-controlled data flow control.
8. In the "Wait time" box, enter a wait time in ms that must be kept to after the end of the message before the next transmission can start.

---

### Note

You can configure the interface in the network view as well. To do so, you must first select the communication module in the tabular network view and then select the interface in the Inspector window. Then you can continue as described above.

---

### See also

Setting data flow control (Page 870)

### Setting data flow control

#### Data flow control

Data flow control is a method that ensures a balanced send and receive behavior. In the ideal situation, the intelligent control does not allow data to be lost. It ensures that a device does not send more information than the receiving partner can process.

There are two methods of data flow control:

- Hardware-controlled data flow control
- Software-controlled data flow control

With both methods, the DSR signals of the communications partners must be active at the beginning of transmission. If the DSR signals are inactive, the transmission is not started.

The RS-232 communications module can handle both methods. The RS-485 communications module does not support data flow control.

#### Hardware-controlled data flow control

Hardware-controlled data flow control uses the request to send (RTS) and clear to send (CTS) signals. With the RS-232 communications module, the RTS signal is transmitted via the output by pin 7. The CTS signal is received via pin 8.

If hardware-controlled data flow control is enabled, the RTS signal is then always set to activated when data is sent. At the same time, the CTS signal is monitored to check whether

the receiving device can accept data. If the CTS signal is active, the module can transfer data until the CTS signal becomes inactive. If the CTS signal is inactive, the data transfer must be suspended for the set wait time. If the CTS signal is still inactive after the set wait time, the data transfer is aborted and an error is signaled back to the user program.

### **Data flow control using hardware handshaking**

If data flow control is controlled by hardware handshaking, the sending device sets the RTS signal to active as default. A device such as a modem can then transfer data at any time. It does not wait for the CTS signal of the receiver. The sending device itself monitors its own transmission by sending only a limited number of frames (characters), for example to prevent overflow of the receive buffer. If there is nevertheless an overflow, the transferring device must hold back the message and signal an error back to the user program.

### **Software-controlled data flow control**

Software-controlled data flow control uses certain characters within the messages and these control the transfer. These characters are ASCII characters selected for XON and XOFF.

XOFF indicates when a transmission must be suspended. XON indicates when a transmission can be continued.

If the sending device receives the XOFF character, it must suspend sending for the selected wait time. If the XON character is sent after the selected wait time, the transfer is continued. If no XON character is received after the wait time, an error is signaled back to the user program.

Software data flow control requires full duplex communication because the receiving partner needs to send the XON character during the ongoing transfer.

### **See also**

Configuring a communications port (Page 869)

### **Configuration of message transfer**

### **User-programmed communication**

You can control the data traffic between a communications module and a device connected externally via the serial interface using your own mechanisms. If you want to do this, you will need to define a communications protocol yourself. In freely programmable communication, ASCII and binary protocols are supported for message transfer.

Within the communications protocol, you will need to specify the criteria by which the start and end of a transferred message can be recognized in the data stream.

User-programmed communication can only be activated in RUN mode. If there is a change to STOP mode, the user-programmed communication is stopped.

## **Specifying the communications protocol**

You can specify the communications protocol as follows:

- With the user program
  - The behavior when sending data is controlled by the SEND\_CFG instruction.
  - The behavior when receiving data is controlled by the RCV\_CFG instruction.
- Using parameter settings set graphically in the Inspector window

---

### **Note**

If you change the communications protocol from the user program, the settings of the graphic configuration are overwritten.

You should keep in mind that the settings made by the user program are not retained if there is a power down.

---

## **See also**

User-programmed communication with RS-232 devices (Page 872)

Making the settings for sending (Page 874)

Specifying the start of the message (Page 874)

Specifying the end of the message (Page 875)

## **User-programmed communication with RS-232 devices**

### **RS-232/PIP multi-master cable and user-programmed communication with RS-232 devices**

Using the RS-232/PIP multi-master cable and user-programmed communication, you can connect a wide variety of RS-232-compliant devices to the communications modules of the S7-1200. The cable must, however, be set to the "PIP/user-programmed communication" mode.

## **Settings on the cable**

The switches on the cable must be set as follows:

- Switch 5 must be set to 0
- Switch 6 sets either the local mode (DCE) or the remote mode (DTE):
  - Switch set to 0 for the local mode
  - Switch set to 1 for the remote mode



## Changing over between send and receive mode

The RS-232/PIP multi-master cable is in send mode when data is sent from the RS-232 interface to the RS-485 interface. The cable is in receive mode when it is idle or when data is sent from the RS-485 interface to the RS-232 interface. The cable changes from receive to send mode immediately when it detects characters on the RS-232 send line.

## Supported transmission speeds

The RS-232/PIP multi-master cable supports transmission rates between 1200 baud and 115.2 kbaud. The RS-232/PIP multi-master cable can be set to the required transmission rate using the DIP switch on the PC/PIP cable.

The following table shows the switch settings for the various transmission speeds:

Transmission speed	Switchover time	Settings (1 = up)
115200 bps	0.15 ms	110
57600 bps	0.3 ms	111
38400 bps	0.5 ms	000
19200 bps	1.0 ms	001
9600 bps	2.0 ms	010
4800 bps	4.0 ms	011
2400 bps	7.0 ms	100
1200 bps	14.0 ms	101

The cable returns to receive mode when the RS-232 send line is idle for a certain time that is defined as the changeover time of the cable. The set transmission speed influences the changeover time as shown in the table.

## Influence of the changeover time

When working with an RS-232/PIP multi-master cable in a system in which user-programmed communication is used, the program must take into account the changeover time for the following reasons:

- The communications module reacts to messages sent by the RS-232 device. Once the communications module has received a request from the RS-232 device, it must delay the reaction message for a period that is equal to or longer than the changeover time of the cable.
- The RS-232 device reacts to messages sent by the communications module. Once the communications module has received a reaction message from the RS-232 device, it must delay the next request message for a period that is equal to or longer than the changeover time of the cable.

In both situations, the RS-232-PIP multi-master cable has enough time to change from send to receive mode so that the data can be sent from the RS-485 interface to the RS-232 interface.

**See also**

- Configuration of message transfer (Page 871)
- Making the settings for sending (Page 874)
- Specifying the start of the message (Page 874)
- Specifying the end of the message (Page 875)

**Making the settings for sending**

**Sending messages**

You can program pauses between individual messages.

The following table shows which pauses can be set:

Parameter	Definition
RTS ON delay	You can set the time that must elapse after the send request RTS (request to send) before the actual data transfer starts.
RTS OFF delay	You can set the time that must elapse after the complete transfer before RTS signal is deactivated.
Send pause at the start of the message	You can specify that a pause is sent at the start of every message transfer when the RTS ON delay has elapsed. The pause is specified in bit times.
Send Idle Line after a pause	You can make a setting so that following a selected pause at the start of the message, the "Idle Line" signal is output to signal that the line is not in use. To enable the parameter, "Send pause at message start" must be set. The duration of the "Idle Line" signal is specified in bit times.

**See also**

- Specifying the start of the message (Page 874)
- Specifying the end of the message (Page 875)
- User-programmed communication with RS-232 devices (Page 872)

**Specifying the start of the message**

**Recognizing the start of the message**

To signal to the receiver when the transfer of a message is completed and when the next message transfer starts, criteria must be specified in the transmission protocol to identify the end and start of a message.

If a criterion is met that indicates the start of a message, the receiver starts searching the data stream for criteria that mean the end of the message.

There are two different methods for identifying the start of a message:

- Starting with any character:  
Any character can defined the start of a message. This is the default method.
- Starting with a specific condition:  
The start of a message is identified based on selected conditions.

### Conditions for detecting the start of a message

The following table shows the various options for defining the start of a message:

Parameter	Definition
Recognize start of message by line break	The receiver recognizes a line break when the received data stream is interrupted for longer than one character. If this is the case, the start of the message is identified by the line break.
Recognize start of message by idle line	The start of a message is recognized when the send transmission line is in the idle state for a certain time (specified in bit times) followed by an event such as reception of a character.
Recognize start of message with individual characters	The start of a message is recognized when a certain character occurs. You can enter the character as a HEX value.
Recognize start of message by a character string	The start of a message is detected when one of the specified character sequences arrives in the data stream. You can specify up to four character sequences each with up to five characters.

The individual conditions can be logically linked in any way.

### See also

Making the settings for sending (Page 874)

User-programmed communication with RS-232 devices (Page 872)

### Specifying the end of the message

#### Recognizing the end of the message

To signal to the receiver when the transfer of a message is completed and when the next message transfer starts, criteria must be specified in the transmission protocol to identify the end and start of a message.

In total, there are six different methods of recognizing the end of a message and these can all be logically linked in any way. The following table shows the various possible setting options:

Parameter	Definition
Recognize end of message by message timeout	The end of a message is recognized automatically when a selected maximum duration for a message is exceeded. Values from 0 to 65535 ms can be set.
Recognize end of message by reply timeout	The end of a message is recognized when there is no reply within a set time after transferring data. Values from 0 to 65535 ms can be set.

Parameter	Definition
Recognize end of message by timeout between characters	The end of a message is detected when the time between two characters specified in bit times is exceeded. Values from 0 to 2500 bit times can be set. The S7-1200 CPU only accepts a maximum time of eight seconds even if the value that is set results in a duration of more than eight seconds.
Recognize end of message by maximum length	The end of a message is recognized when the maximum length of a message is exceeded. Values from 1 to 1023 characters can be set.
Read message length from message	The message itself contains information about the length of the message. The end of a message is reached when the value taken from the message is reached. Which characters are used for the evaluation of the message length is specified with the following parameters: <ul style="list-style-type: none"> <li>• Offset of the length field in the message The value decides the position of the character in the message that will be used to indicate the message length. Values from 1 to 1022 characters can be set.</li> <li>• Size of the length field This value specifies how many characters starting at the first evaluation position will be used to indicate the message length. Values of 0, 1, 2 and 4 characters can be set.</li> <li>• The data following the length field (does not belong to the message length) The value specifies the number of bytes after the length field that must be ignored in the evaluation of the message length. Values from 0 to 255 characters can be set.</li> </ul>
Recognize message end with a character sequence	The end of a message is detected when the specified character sequence arrives in the data stream. You can define up to five characters in the character string that are to be checked. If the specified characters appear at the correct location in the message, the message end is recognized. To recognize the message end when character 1 and character 3 have a certain value, for example, you have to activate the check box for character 1 and character 3 and enter a character value.

**See also**

Making the settings for sending (Page 874)

User-programmed communication with RS-232 devices (Page 872)

**Enabling system memory**

**System memory**

A system memory is a bit memory with defined values.

You decide which memory byte of the CPU will become the system memory byte when assigning the system memory parameters.

## Benefits

You can use system memory in the user program, for example to run program segments in only the first program cycle after start-up. Two system memory bits are constant 1 or constant 0.

## Bits of the system memory bytes

The following table shows the meaning of the system memory:

Bit of the system memory bytes	7	6	5	4	3	2	1	0
Meaning	Reserved (=0)	Reserved (=0)	Reserved (=0)	Reserved (=0)	=0	=1	=1 with change to the diagnosis status	=1 in first program cycle after startup, otherwise 0

---

### Note

The selected memory byte cannot be used for intermediate storage of data.

---

## Using clock memory

### Clock memory

A clock memory is a bit memory that changes its binary status periodically in the pulse-no-pulse ratio of 1:1.

You decide which memory byte of the CPU will become the clock memory byte when assigning the clock memory parameters.

## Benefits

You can use clock memory, for example, to activate flashing indicator lamps or to initiate periodically recurring operations such as recording of actual values.

## Available frequencies

Each bit of the clock bit memory byte is assigned a frequency. The following table shows the assignment:

Bit of the clock memory byte	7	6	5	4	3	2	1	0
Period (s)	2.0	1.6	1.0	0.8	0.5	0.4	0.2	0.1
Frequency (Hz)	0.5	0.625	1	1.25	2	2.5	5	10

---

**Note**

Clock memory runs asynchronously to the CPU cycle, i.e. the status of the clock memory can change several times during a long cycle.

The selected memory byte cannot be used for intermediate storage of data.

---

## Protection

### Setting options for the protection level (FW V1 to V3)

#### Protection level

The following section describes how to use the various protection levels of the S7-1200 CPUs V1 to V3.

#### Effects of the protection level setting

You can choose between the following protection levels:

- No protection: This corresponds to the default behavior. You cannot enter a password. Read and write access is always permitted.
- Write protection: Only read-only access is possible. You cannot change any data on the CPU and cannot load any blocks or a configuration. HMI access and communication between CPUs are excluded from the write protection. Assignment of a password is required to select this protection level.
- Write/read protection: No write or read access is possible in the "Accessible devices" area or in the project for devices that are switched online. Only the CPU type and the identification data can be displayed in the project tree under "Accessible devices". Display of online information or blocks under "Accessible devices", or in the project for devices interconnected online, is possible. HMI access and communication between CPUs are excluded from the write protection. Assignment of a password is required to select this protection level.

#### Behavior of a password-protected CPU during operation

The CPU protection takes effect after the settings are downloaded to the CPU.

Validity is checked before the online function is executed. If password protection is in place, you are prompted to enter a password.

Example: The module was assigned write protection and you want to execute the "Modify tags" function. This requires write access; therefore, the assigned password must be entered to execute the function.

The functions protected by a password can only be executed by one programming device/PC at any one time. Another programming device/PC cannot log on with a password.

Access authorization to the protected data is in effect for the duration of the online connection or until the access authorization is manually rescinded with "Online > Delete access rights". Access authorization will also expire when the project is closed.

---

**Note**

You can not restrict functions for process control, monitoring, and communications.

Some functions are still protected due to their use as online data. RUN/STOP in the "Online Tools" task card or "Set the time" in the diagnostics and online editor is therefore write-protected.

---

## Setting options for the protection (FW as of V4)

### Protection level

The following section describes how to use the various access levels of the S7-1200 CPUs as of V4.

S7-1200 CPUs provide various access levels to limit the access to specific functions.

The parameters for the access levels are assigned in a table. The green checkmarks in the columns to the right of the respective access level specify which operations are possible without knowing the password of this access level. If you want to use the functions of check boxes that are not selected, a password has to be entered.

<b>NOTICE</b>
<b>Configuring an access level does not replace know-how protection</b>
Configuring access levels prevents unauthorized changes to the CPU by restricting download privileges. However, blocks on the memory card are not write- or read-protected. Use know-how protection to protect the code of blocks on the memory card.

### Default characteristics

The default access level is "Full access (no protection)". Every user can read and change the hardware configuration and the blocks. A password is not set and is also not required for online access.

## The access levels in detail

With an S7-1200 CPU, you can configure the following access levels:

- Full access (no protection): The hardware configuration and the blocks can be read and changed by all users.
- Read access: With this access level, only read access to the hardware configuration and the blocks is possible without entering a password - meaning that you can load the hardware configuration and blocks into the programming device. In addition, HMI access and access to diagnostics data is possible.  
You cannot load blocks or a hardware configuration into the CPU without entering the password. Moreover, writing test functions and firmware updates are **not** possible without a password.
- HMI access: With this access level, only HMI access and access to diagnostics data is possible without entering the password.  
Without entering the password, you can neither load blocks and hardware configuration into the CPU, nor load blocks and hardware configuration from the CPU into the programming device. In addition, the following is **not** possible without a password: Writing test functions, changing the operating state (RUN/STOP) and firmware updates.
- No access (complete protection): When the CPU is completely protected, no read or write access to the hardware configuration and the blocks is possible. HMI access is also not possible. The server function for PUT/GET communication is disabled in this access level (cannot be changed).  
Authorization with the password again provides you full access to the CPU.

## Behavior of a password-protected module during operation

The CPU protection takes effect after the settings are downloaded to the CPU.

Validity is checked before the online function is executed. If password protection is in place, you are prompted to enter a password.

Example: The module was configured with read access and you want to execute the "Modify tags" function. This requires write access; therefore, the assigned password must be entered to execute the function.

The functions protected by a password can only be executed by one programming device/PC at any one time. Another programming device/PC cannot log on.

Access authorization to the protected data is in effect for the duration of the online connection or until the access authorization is manually rescinded with "Online > Delete access rights".

Each access level allows unrestricted access to certain functions without entering a password, for example, identification using the "Accessible devices" function.

## Configuring access levels

The following section describes how to configure an access level and enter passwords for an S7-1200 CPU as of V4.

For an S7-1200 CPU, you can enter multiple passwords and thereby set up different access rights for individual user groups.



The passwords are entered in a table in such a way that exactly one access level is assigned to each password.

The effect of the password is visualized in the "Access" column and explained in the text below the table.

### Example

You select the "No access (complete protection)" access level for a standard CPU (in other words, not an F-CPU) and enter a separate password for each of the access levels that lie above it in the table.

For users who do not know any of the passwords, the CPU is completely protected. Not even HMI access is possible.

For users who know one of the set passwords, the effect depends on the table row in which the password occurs:

- The password in row 1 (Full access (no protection)) allows access as if the CPU were completely unprotected. Users who know this password have unrestricted access to the CPU.
- The password in row 2 (read access) allows access as if the CPU were write-protected. Users who know this password have read-only access to the CPU.
- The password in row 3 (HMI access) allows access as if the CPU were write-protected and read-protected so that only HMI access is possible for users who know this password.

### Procedure

To configure the access levels of an S7-1200 CPU, follow these steps:

1. Open the properties of the module in the inspector window.
2. Open the "Protection" entry in the area navigation.

A table with the possible access levels appears in the inspector window.

Protection level	Access			Access permission	
	HMI	Read	Write	Password	Confirmation
<input checked="" type="radio"/> Full access (no protection)	✓	✓	✓		
<input type="radio"/> Read access	✓	✓			
<input type="radio"/> HMI access	✓				
<input type="radio"/> No access (complete protection)					

Figure 8-4 Access protection

3. Activate the required access level in the first column of the table. The green checkmarks in the columns to the right of the respective protection level show you which operations are still available without entering the password.

## **8.1 Configuring devices and networks**

4. In the "Password" column, specify a password for full access in the first row. In the "Confirmation" column, enter the selected password again to protect against incorrect entries.  
Ensure that the password is sufficiently secure, in other words, that it does not follow a machine-recognizable pattern!  
You must enter a password in the first row "Full access (no protection)". This enables unrestricted access to the CPU for those who know the password, regardless of the selected protection level.
5. Assign additional passwords as needed to other access levels if the selected protection level allows you to do so.
6. Download the hardware configuration so that the access level takes effect.

### **Result**

The hardware configuration and the blocks are protected against unauthorized access according to the set access level. If an operation cannot be executed without a password due to the set access level, a dialog for entering a password is displayed.

## **Restriction of communication services**

### **Introduction**

The CPU can be the server for a number of communication services. This means that other communication participants can access CPU data even if you have not configured and programmed connections for the CPU.

The local CPU as a server thus does not have the possibility to control communication to the clients.

The parameter "Connection mechanisms" in the "Protection" area of the CPU parameters is used to specify whether this type of communication is permitted or not for the local CPU during operation.

### **Permit access with PUT/GET communication from remote partners**

By default, the "Permit access with PUT/GET communication from remote partners (...)" option is disabled. In this case, read and write access to CPU data is only possible for communication connections that require configuration or programming both for the local CPU and for the communication partner. Access through BSEND/BRCV instructions is possible, for example.

Connections for which the local CPU is only a server (meaning that no configuration/programming of the communication with the communication partner exists at the local CPU), are therefore not possible during operation of the CPU, for example,

- For PUT/GET, FETCH/WRITE or FTP access via communication modules
- For PUT/GET access from other S7 CPUs
- For HMI access that is realized via PUT/GET communication

If you want to allow access to CPU data from the client side, meaning that you do not want to restrict the communication services of the CPU, activate the "Permit access with PUT/GET communication from remote partners" option.

## Organization blocks

### Organization blocks for startup

#### Description

You can determine the boundary conditions for the startup characteristics of your CPU, for example, the initialization values for "RUN". To do this, write a startup program. The startup program consists of one or more startup OBs (OB numbers 100 or  $\geq 123$ ).

The startup program is executed once during the transition from "STOP" mode to "RUN" mode. Current values from the process image of the inputs are not available for startup program, nor can these values be set.

After the complete execution of the startup OBs, the process image of the inputs is read in and the cyclic program is started.

There is no time limit for executing the startup routine. Therefore the scan cycle monitoring time is not active. Time-driven or interrupt-driven organization blocks cannot be used.

#### Start information

A startup OB has the following start information:

Tag	Data type	Description
LostRetentive	BOOL	= 1, if retentive data storage areas have been lost
LostRTC	BOOL	= 1, if realtime clock has been lost

#### See also

Events and OBs (Page 848)

### Organization blocks for cyclic program execution

#### Introduction

For the program execution to start, at least one program cycle OB must be present in the project. The operating system calls this program cycle OB once in each cycle and thereby starts the execution of the user program. You can use multiple OBs (OB numbers  $\geq 123$ ). When multiple program cycle OBs are used, these are called in one after the other in the order of their OB numbers. The program cycle OB with the lowest OB number is called first.

The program cycle OBs have the priority class 1. This corresponds to the lowest priority of all OBs. The cyclic program can be interrupted by events of any other event class.

### Programming cyclic program execution

You program cyclic program execution by writing your user program in the cycle OBs and the blocks that they call.

The first cyclic program execution begins as soon as the startup program has ended without errors. The cycle restarts after the end of each cyclic program execution.

### Sequence of cyclic program execution

One cycle of the program execution encompasses the following steps:

1. The operating system starts the maximum cycle time.
2. The operating system writes the values from the process image output to the output modules.
3. The operating system reads out the state of the inputs of the input modules and updates the process image input.
4. The operating system processes the user program and executes the operations contained in the program.
5. At the end of a cycle, the operating system executes any tasks that are pending, for example, loading and deleting blocks or calling other cycle OBs.
6. Finally, the CPU returns to the start of the cycle and restarts the scan cycle monitoring time.

See also: Auto-Hotspot

### Options for interrupting

Cyclic program execution can be interrupted by the following events:

- Interrupt
- A STOP command, triggered by
  - Operation of the programming device
  - "STP" instruction
- Supply voltage failure
- Occurrence of a device fault or program error

### Start information

- None
- Optimized start information:

Name	Data type	Meaning
first_scan	BOOL	= TRUE in the first call of this OB: <ul style="list-style-type: none"><li>• Transition from STOP or HOLD to RUN</li><li>• After reloading</li></ul>
retentivity	BOOL	= TRUE, if retentive data are available

## See also

Events and OBs (Page 848)

## Organization blocks for interrupt-driven program execution

## Organization blocks for time-of-day interrupt

### Function

Organization blocks for time-of-day interrupt (OB number  $\geq 123$ ) can be processed as follows:

- One time to a preset time (date with time of day)
- Periodically with preset start time and the following intervals:
  - Every minute
  - Hourly
  - Daily
  - Weekly
  - Monthly
  - Yearly
  - End of month

Time-of-day interrupt-OBs are therefore used to run parts of the user program on a time-controlled basis.

### Status for time-of-day interrupt

The following table contains the possible status of a time-of-day interrupt as well as its meaning.

Status	Meaning
Cancelled	The one-time processing has already taken place, or the start event of a not yet processed time-of-day interrupt has been deleted with the extended instruction CAN_TINT.
Set	You have scheduled the time or start time for processing.
Activated	You have scheduled whether processing takes place one time or periodically, and in the case of periodic processing, you have scheduled the interval.

### Rules for time-of-day interrupts

The following rules apply to the use of time-of-day interrupts:

- A time-of-day interrupt can only be processed if it is set and activated, and a corresponding organization block exists in the user program.
- The start times of periodic time-of-day interrupts must correspond to a real date. For example, it is not possible to repeat an organization block monthly which first occurs on January 31st. In this case, an OB will only be started in the months that have 31 days.

8.1 Configuring devices and networks

- A time-of-day interrupt activated during startup by extended instruction call ACT\_TINT will not be executed until the startup is complete.
- After each CPU startup, you must reactivate previously set time-of-day interrupts

**Setting and activating a time-of-day interrupt OB**

Before a time-of-day interrupt can be deleted and the corresponding time-of-day interrupt OB can be processed from the operating system, you must set and activate the interrupt. You have the following options:

Set time-of-day interrupt	Activate time-of-day interrupt
Means of configuring	Means of configuring
Means of configuring	By extended instruction call ACT_TINT
By extended instruction call SET_TINTL	By extended instruction call ACT_TINT

**Note**

If you configure a time-of-day interrupt in such a way that the corresponding OB is to be processed once, the start time must not be in the past (relative to the real-time clock of the CPU).

If you configure a time-of-day interrupt in such a way that the corresponding OB is to be processed periodically, but the start time is in the past, then the time-of-day interrupt will be processed the next time it is due.

**Time-of-day interrupt status query**

In order to query the status of the time-of-day interrupt, call the extended instruction QRY\_TINT.

**Cancelling a time-of-day interrupt**

You can cancel a time-of-day interrupt which has not yet been processed with the extended instruction CAN\_TINT.

You can reset cancelled time-of-day interrupts with the extended instruction SET\_TINTL and activate them with the extended instruction ACT\_TINT.

**Conditions that effect the time-of-day interrupt OBs**

Since a time-of-day interrupt occurs only at specific intervals, certain conditions can affect the function of the associated OBs during execution of your program. The following table shows

some of these conditions and describes how these affect the processing of a time-of-day interrupt OB.

Condition	Result
The extended instruction CAN_TINT is called in the user program.	The operating system deletes the start event (date and time) of the time-of-day interrupt. You must reset and reactivate the time-of-day interrupt if you are going to call the corresponding time-of-day interrupt OB again.
By synchronizing or correcting the CPU system clock, the time of day will be set ahead. With this, the start time for a time-of-day interrupt OB will be bypassed.	The operating system calls the time error interrupt OB (OB 80) and records the start event, the number, and the priority of the first bypassed time-of-day interrupt OB in its start information. After completion of the OB 80, the operating system processes the bypassed time-of-day interrupt OB only once.
By synchronizing or correcting the CPU system clock, the time of day will be set back. The corrected clock time is before the start time of an already processed time-of-day interrupt OB.	The time-of-day interrupt OB is repeated.
A time-of-day interrupt OB is still being processed when the start event for its next execution occurs.	The operating system then calls time error interrupt OB 80. The requested OB is processed only after the processing and further execution of the current time-of-day interrupt OB has completed.

### Start information

A time-of-day interrupt OB has the following start information:

Tag	Data type	Description
CaughtUp	BOOL	=1, if the OB call is executed because clock time is turned ahead.
SecondTime	BOOL	=1 if the OB is called a second time because clock time is turned back (more exactly, if the planned time of the current OB processing is earlier than or the same time as the planned time for the previous OB processing). Note: SecondTime is only set once.

### Organization block for status interrupts

#### Description

When it receives a status interrupt, the operating system of the S7-1200 CPU calls the status interrupt OB from a DP master or IO controller. This may be the case if a module of a slave changes its operating mode, for example, from "RUN" to "STOP". For more detailed information on events that trigger a status interrupt, refer to the documentation of the slave or device manufacturer.

### Structure of the start information

The status-interrupt OB has the following start information:

Name	Data type	Meaning
LADDR	HW_IO	Hardware address of the component triggering the interrupt
Slot	UINT	Slot number of the component triggering the interrupt
Specifier	WORD	Interrupt specifier from the interrupt frame

### See also

Events and OBs (Page 848)

### Organization block for update interrupts

#### Description

When it receives a status interrupt, the operating system of the S7-1200 CPU calls the update interrupt OB from a DP master or IO controller. This may be the case if you changed a parameter on a slot of a slave or device. For more detailed information on events that trigger an update interrupt, refer to the documentation of the slave or device manufacturer.

### Structure of the start information

The update interrupt OB has the following start information:

Name	Data type	Meaning
LADDR	HW_IO	Hardware address of the component triggering the interrupt
Slot	UINT	Slot number of the component triggering the interrupt
Specifier	WORD	Interrupt specifier from the interrupt frame

### See also

Events and OBs (Page 848)

### Organization block for manufacturer-specific or profile-specific interrupts

#### Description

When it receives a manufacturer-specific or profile-specific interrupt from a DP master or IO controller, the operating system of the S7-1200 CPU calls OB 57. For more detailed information on events that trigger this type of interrupt, refer to the documentation of the slave or device manufacturer.



## Structure of the start information

The OB for manufacturer-specific and profile-specific interrupts has the following start information:

Name	Data type	Meaning
LADDR	HW_IO	Hardware address of the component triggering the interrupt
Slot	UINT	Slot number of the component triggering the interrupt
Specifier	WORD	Interrupt specifier from the interrupt frame

## See also

Events and OBs (Page 848)

## Organization blocks for time-delay interrupts

### Description

A time-delay interrupt OB is started after a configurable time delay of the operating system. The delay time starts after the SRT\_DINT instruction is called.

You can use up to four time-delay interrupt OBs or cyclic OBs (OB numbers  $\geq 123$ ) in your program. If, for example, you are already using two cyclic interrupt OBs, you can insert a maximum of two further time-delay interrupt OBs in your program.

You can use the CAN\_DINT instruction to prevent the execution of a time-delay interrupt that has not yet started.

### Function of time-delay interrupt OBs

The operating system starts the corresponding OB after the delay time, which you have transferred with an OB number and an identifier to the SRT\_DINT instruction.

To use a time-delay interrupt OB, you must execute the following tasks:

- You must call the instruction SRT\_DINT.
- You must download the time-delay interrupt OB to the CPU as part of your program.

The delay time is measured with a precision of 1 ms. A delay time can immediately start again after it expires.

Time delay interrupt OBs are executed only when the CPU is in the "RUN" mode. A warm restart clears all start events of time-delay interrupt OBs.

The operating system calls the time-delay interrupt OB if one of the following events occurs:

- If the operating system attempts to start an OB that is not loaded and you specified its number when calling the SRT\_DINT instruction.
- If the next start event for a time-delay interrupt occurs before the time delay OB has completely executed.

You can disable and re-enable time-delay interrupts using the DIS\_AIRT and EN\_AIRT instructions.

---

**Note**

If you disable an interrupt with DIS\_AIRT after executing SRT\_DINT, this interrupt executes only after it has been enabled with EN\_AIRT. The delay time is extended accordingly.

---

**Start information**

- None
- Optimized start information:

Name	Data type	Meaning
sign	WORD	User ID: Input parameter SIGN from the call of the "SRT_DINT" instruction

**See also**

Events and OBs (Page 848)

**Organization blocks for cyclic interrupts**

**Description**

Cyclic interrupt OBs serve to start program in periodic time intervals independently of the cyclic program execution. The start times of a cyclic interrupt OB are specified using the time base and the phase offset.

The time base defines the intervals at which the cyclic interrupt OB is started and is an integer multiple of the basic clock cycle of 1 ms. The phase offset is the time by which the start time is offset compared with the basic clock cycle. If several cyclic interrupt OBs are being used, you can use this offset to prevent a simultaneous start time if the time bases of the cyclic interrupt OBs have common multiples.

You can specify a time period between 1 ms and 60000 ms as the time base.

You can use up to four cyclic interrupt OBs or time-delay OBs (OB numbers  $\geq 123$ ) in your program. If, for example, you are already using two time-delay interrupt OBs, you can insert a maximum of two further cyclic interrupt OBs in your program.

---

**Note**

The execution time of each cyclic interrupt OB must be noticeably smaller than its time base. If a cyclic interrupt OB has not been completely executed but execution is again pending because the cycle clock has expired, the time error OB is started. The cyclic interrupt that caused the error is executed later or discarded.

---

### Example of the use of phase offset

You have inserted two cyclic interrupt OBs in your program:

- Cyclic interrupt OB1
- Cyclic interrupt OB2

For cyclic interrupt OB1, you have set a time base of 20 ms and for cyclic interrupt OB2 a time base of 100 ms. After expiration of the time base of 100 ms, the cyclic interrupt OB1 reaches the start time for the fifth time, cyclic interrupt OB2 for the first time. To nevertheless execute the cyclic interrupt OBs offset, enter a phase offset for one of the two cyclic interrupt OBs.

### Start information

- None
- Optimized start information:

Name	Data type	Meaning
first_scan	BOOL	= TRUE in the first call of this OB <ul style="list-style-type: none"> <li>• At the transition from STOP or HOLD to RUN</li> <li>• After reloading</li> </ul>
event_count	INT	Number of lost start events since the last start of this OB

### See also

Assigning parameters to cyclic interrupt OBs (Page 899)

Events and OBs (Page 848)

### Organization blocks for hardware interrupts

#### Description

You can use hardware interrupt OBs to react to specific events. You can assign an event that triggers an alarm to precisely one hardware interrupt OB. A hardware interrupt OB in contrast can be assigned to several events.

Hardware interrupts can be triggered by high-speed counters and input channels. For each high-speed counter and input channel that should trigger a hardware interrupt, the following properties need to be configured:

- The process event that should trigger the hardware interrupt (for example, the change of a count direction of a high-speed counter)
- The number of the hardware interrupt OB which is assigned to this process event

You can use up to 50 hardware interrupt OBs (OB numbers  $\geq 123$ ) that are independent of each other in your program.

### Functionality of a hardware interrupt OB

After triggering a hardware interrupt, the operating system identifies the channel of the input or the high-speed counter and determines the assigned hardware interrupt OB.

If no other interrupt OB is active, the determined hardware interrupt OB is called. If a different interrupt OB is already being executed, the hardware interrupt is placed in the queue of its priority class. The hardware interrupt is acknowledged after the completion of the assigned hardware interrupt OB.

If another event that triggers a hardware interrupt occurs on the same module during the time between identification and acknowledgement of a hardware interrupt, the following applies:

- If the event occurs on the channel that previously triggered the hardware interrupt, then no additional hardware interrupt is triggered. Another hardware interrupt can only be triggered if the current hardware interrupt is acknowledged.
- If the event occurs on a different channel, a hardware interrupt is triggered.

Hardware interrupt OBs are called only in the CPU's "RUN" mode.

### Start information

- None
- Optimized start information:

Name	Data type	Meaning
Laddr	HW_IO	Hardware identifier of the module that triggers the hardware interrupt
USI	WORD	Identifier for future extensions (not user-relevant)
IChannel	USINT	Number of the channel that triggered the hardware interrupt
EventType	BYTE	Identifier for the event type associated with the event triggering the interrupt (e.g., positive edge) This identifier can be found in the description of the respective module.

### See also

Assigning parameters to hardware interrupt OBs (Page 900)

Events and OBs (Page 848)

### Organization block for time error

#### Description

The operating system calls the time error OB (OB 80) if one of the following events occurs:

- The cyclic program exceeds the maximum cycle time.
- The OB called is currently still being executed (possible for time-delay interrupt OBs and cyclic interrupt OBs).
- A time-of-day interrupt was missed because the clock time was set forward by more than 20 seconds.

- A time-of-day interrupt was missed during a STOP.
- An overflow has occurred in an interrupt OB queue.
- An interrupt was lost due to the excessive interrupt load.

If you have programmed no time error OB, the S7-1200 CPU reacts as follows:

- CPUs with firmware version V1.0: The CPU remains in RUN mode.
- CPUs with firmware version V2.0:
  - The CPUs goes to STOP mode when the maximum cycle time is exceeded.
  - With all other start events of the time error OB, the CPU remains in RUN mode.

With CPUs with firmware version V1.0, the two-time overshooting of the maximum cycle time does not lead to the calling of an OB, but to the STOP of the CPU. You can avoid the second violation by restarting the cycle monitoring of the CPU with the RE\_TRIGR instruction.

You can use only one time error OB in your program.

## Start information

The time error OB has the following start information:

Tag	Data type	Description
fault_id	BYTE	<ul style="list-style-type: none"> <li>• 0x01: Maximum cycle time exceeded</li> <li>• 0x02: Called OB is still being executed</li> <li>• 0x05: Expired time-of-day interrupt due to time jump</li> <li>• 0x06: Expired time-of-day interrupt on return to RUN mode</li> <li>• 0x07: Queue overflow</li> <li>• 0x09: Interrupt loss due to high interrupt load</li> </ul>
csg_OBnr	OB_ANY	Number of the OB being executed at the time of the error
csg_prio	UINT	Priority of the OB being executed at the time of the error

## See also

Events and OBs (Page 848)

## Organization block for diagnostic interrupts

### Description

You can enable the diagnostic error interrupt for diagnostics-capable modules so that the module detects changes in the I/O status. As a result, the module triggers a diagnostic error interrupt in the following cases:

- A fault is present (incoming event)
- A fault is no longer present (outgoing event)

8.1 Configuring devices and networks

If no other interrupt OB is active, then the diagnostic interrupt OB (OB 82) is called. If another interrupt OB is already being executed, the diagnostic error interrupt is placed in the queue of its priority group.

You can use only one diagnostic interrupt OB in your program.

**Start information**

The diagnostic interrupt OB has the following start information:

Tag	Data type	Description
IO_state	WORD	Contains the I/O status of the diagnostics-capable module.
laddr	HW_ANY	HW-ID
Channel	UINT	Channel number
multi_error	BOOL	= 1, if there is more than one error

**IO\_state tag**

The following table shows the possible I/O states that the IO\_state tag can contain:

IO_state	Description
Bit 0	Configuration correct: = 1, if the configuration is correct = 0, if the configuration is no longer correct
Bit 4	Error: = 1, if an error is present, e.g., a wire break = 0, if the error is no longer present
Bit 5	Configuration not correct: = 1, if the configuration is not correct = 0, if the configuration is correct again
Bit 6	I/O cannot be accessed: = 1, if an I/O access error has occurred In this case, laddr contains the hardware identifier of the I/O with the access error. = 0, if the I/O can be accessed again

**See also**

Events and OBs (Page 848)

## Organization block for pulling and plugging

### Description

The S7-1200 CPU operating system calls the pull/plug interrupt OB (OB 83) if a configured and non-disabled distributed I/O module or submodule (PROFIBUS, PROFINET, AS-i) is removed or inserted.

---

#### Note

The removal or insertion of a central module leads to the STOP of the CPU.

---

### Start information

The pull/plug interrupt OB has the following start information:

Name	Data type	Meaning
LADDR	HW_IO	Hardware identifier of the affected module or submodule
Event_Class	BYTE	<ul style="list-style-type: none"> <li>• B#16#38: (Sub)module plugged</li> <li>• B#16#39: (Sub)module pulled or not responding</li> </ul>
Fault_ID	BYTE	Error code (possible values: B#16#51, B#16#54, B#16#55, B#16#56, B#16#57, B#16#58)

The following table shows which event caused the start of the pull/plug interrupt OB.

ev_class (B#16# ...)	fault_id (B#16# ...)	Meaning
39	51	Module pulled
39	54	Submodule pulled
38	54	Submodule plugged, which conforms to the parameterized submodule
38	55	Submodule inserted, which does not conform to the submodule parameter assignment
38	56	Submodule inserted, but error in module parameter assignment
38	57	Submodule or module inserted, but with a fault or maintenance
38	58	Submodule access error remedied

### See also

Events and OBs (Page 848)

## Organization block for rack fault

### Description

The S7-1200 CPU operating system calls the OB 86 in the following cases:

- The failure of a DP master system or of a PROFINET IO system is detected (in the case of either an incoming or an outgoing event).
- The failure of a DP slave or of an IO device is detected (in the case of either an incoming or an outgoing event).
- Failure of some of the submodules of a PROFINET I-device is detected.

### Structure of the start information

The rack fault OB has the following start information:

Name	Data type	Meaning
LADDR	HW_IO	Hardware identifier of the defective hardware object
Event_Class	BYTE	<ul style="list-style-type: none"> <li>• B#16#32: Activation of a DP slaves or an IO device</li> <li>• B#16#33: Deactivation of a DP slaves or an IO device</li> <li>• B#16#38: outgoing event</li> <li>• B#16#39: incoming event</li> </ul>
Fault_ID	BYTE	Error code (possible values: B#16#C3, B#16#C4, B#16#C5, B#16#C6, B#16#C7, B#16#C8, B#16#C9, B#16#CA, B#16#CB, B#16#CC, B#16#CD, B#16#CE, B#16#CF, B#16#F8, B#16#F9)

The following table shows which event caused the start of OB 86.

Ev_class B#16# ...	Fault_id B#16# ...	Meaning
39	C3	Failure of a DP master system
39/38	C4	Failure/return of a DP slave
38	C5	Return of a DP slave; however, slave is faulty
38	C6	Expansion unit return, but error in module parameter assignment
38	C7	Return of a DP device, but there is error in module configuration
38	C8	Return of a DP device, but discrepancy between preset/actual configuration
32/33	C9	Activation/deactivation of a DP slave with the "D_ACT_DP" instruction
39	CA	Failure of a PROFINET IO system
39/38	CB	Failure/return of a PROFINET IO device
38	CC	Return of a PROFINET IO device with fault or maintenance
38	CD	Return of a PROFINET IO device, deviation between preset/actual configuration
38	CE	Return of a PROFINET IO device, error in module configuration
32/33	CF	Activation/deactivation of an IO device with the "D_ACT_DP" instruction



Ev_class B#16# ...	Fault_id B#16# ...	Meaning
39/38	F8	Failure/return of some of the submodules of a PROFINET I-device
38	F9	Return of some of the submodules of a PROFINET I-device with a device configuration difference

## See also

Events and OBs (Page 848)

## Block parameters of organization blocks

### Basics of block parameters

#### Introduction

Several organization blocks (OBs) have properties with which you can control their behavior or their assignment to specific events. You can influence these properties by assigning parameters.

#### Overview

You can assign parameters to the properties for the following organization blocks:

- Time-of-day interrupt OBs
- Cyclic interrupt OBs
- Hardware interrupt OBs

## See also

Assigning parameters to hardware interrupt OBs (Page 900)

Assigning parameters to cyclic interrupt OBs (Page 899)

## Parameter assignment for time-of-day interrupt OBs

### Procedure for setting the parameters

To set the parameters of a time-of-day interrupt OB, proceed as follows:

1. Open the "Properties" dialog belonging to the time-of-day interrupt OB in question.
2. Click the "Time-of-day interrupt" group in the area navigation.

## Overview of the parameters that can be set

You can set the following parameters:

- Execution
- Start date and time-of-day
- Option buttons "Local time" and "System time"

### "Execution" parameter

Use the drop-down list "Execution" to define the periods at which the time-of-day interrupt OB is to be executed. The time intervals relate to the settings for "Start date" and "Time-of-day".

The following values are possible for "Execution":

- Never
- Once
- Every minute
- Hourly
- Daily
- Weekly
- Monthly
- Yearly
- End of month

---

#### Note

With the value "End of month", the value specified under "Start date" is irrelevant.

---

### "Start date" and "Time-of-day" parameter

Here, you specify the time at which the time-of-day interrupt is to be executed for the first time.

Example: Start date = 07/05/2013, time =11:16

Depending on the value of the "Execution" parameter, the CPU generates additional time-of-day interrupts periodically. Depending on the setting, the start time relates either to the local time or to the coordinated universal timeUTC.

---

#### Note

If you set the "Execution" parameter to "Monthly", the start date cannot be set to the 29th, the 30th, or the 31st. If you want the time-of-day interrupt OB to start at the end of the month, you should set the parameter "Execution" to "End of month".

---

## "Local time" or "System time"

Here, you decide which time the start time of the time-of-day interrupt OB relates to:

- "Local time": The start time relates to the time zone set for the CPU.
- "System time": The start time relates to the coordinated universal time UTC (Universal Time Coordinated).

## Assigning parameters to cyclic interrupt OBs

### Introduction

You can use cyclic interrupt OBs to start programs at regular time intervals. To do so you must enter a scan time and a phase shift for each cyclic interrupt OB used.

You can use up to four cyclic interrupt OBs or time-delay OBs (OB numbers  $\geq 200$ ) in your program. If, for example, you are already using two time-delay interrupt OBs, you can insert a maximum of two further cyclic interrupt OBs in your program.

---

#### Note

If you assign multiple cyclic OBs, make sure that you assign a different cycle time or phase offset to each cyclic interrupt OB to avoid them executing at the same time or having to queue. When you create a cyclic interrupt OB, the cycle time 100 and the phase offset 0 are entered as start value.

---

### Procedure

To enter a scan time and a phase shift for a cyclic interrupt OB, proceed as follows:

1. Open the "Program blocks" folder in the project tree.
2. Right-click on an existing cyclic interrupt OB.
3. Select the "Properties" command in the shortcut menu.  
The "<Name of the cyclic interrupt OB>" dialog box opens.
4. Click the "Cyclic interrupt" group in the area navigation.  
The text boxes for the scan time and the phase shift are displayed.
5. Enter the scan time and the phase shift.
6. Confirm your entries with "OK".

### See also

Basics of block parameters (Page 897)

Organization blocks for cyclic interrupts (Page 890)

## Assigning parameters to hardware interrupt OBs

### Introduction

You must select the corresponding event and assign the following parameters for every input channel and high-speed counter that should trigger a hardware interrupt:

- Event name
- Number of the hardware interrupt OB that is assigned to this process event

The parameters of the hardware interrupt are assigned in the properties of the corresponding device. You can assign parameters for up to 50 hardware interrupt OBs.

You can create the hardware interrupt OB to be assigned parameters either before or during activation of an event.

### Procedure

To configure a hardware interrupt event, follow these steps:

1. Double-click the "Devices & Networks" command in the project tree. The hardware and network editor opens in the network view.
2. Change to the device view.
3. If the Inspector window closed in the device view, select the "Inspector window" check box in the "View" menu. The Inspector window opens.
4. Click the "Properties" tab.
5. In the device view, select the module for which you want to assign a hardware interrupt.
6. Select the corresponding event that will trigger a hardware interrupt, e.g., a positive edge.

The screenshot shows a configuration dialog box with a checked checkbox labeled "Enable rising edge detection:". Below it, there are two input fields: "Event name:" with the text "Rising edge0" and "Hardware interrupt:" with a dropdown menu showing "Hardware interrupt".

7. Enter an event name.
8. Select an existing hardware interrupt OB from the "Hardware interrupt" drop-down list or create a new hardware interrupt OB. If you have not previously created any hardware interrupt OBs, you can click the "Add new block" button in the drop-down list. The start information of the corresponding hardware interrupt OB, including all specifications for the interrupt-triggering event, is updated.

The screenshot shows a table titled "Triggers" with a header row and one data row. Above the table, a message states: "Configuration of events must be done in the properties of interrupt enabled modules".

Source Module	Triggers	Event	Tag	Priority
DI14/DO10_1	IO.0	Rising edge0		5

9. If you want to assign further hardware interrupts, repeat steps 5 to 8.

A system constant of data type Event\_HwInt is created automatically for the event identified by the explicit event name. The system constants are displayed in the standard tag table.

**See also**

- Basics of block parameters (Page 897)
- Organization blocks for hardware interrupts (Page 891)
- Events and OBs (Page 848)

**Symbolic and numerical names of instructions**

**Description**

The instructions from the task card are comprised of functions (FC), function blocks (FB), system functions (SFC) and system function blocks (SFB) that are identified internally by numbers.

The following tables show the assignment of numerical and symbolic names.

**Function blocks (FBs)**

Numerical name	Symbolic name
FB 105	TC_CONFIG
FB 110	Port_Config
FB 111	Send_Config
FB 112	Receive_Config
FB 113	Send_P2P
FB 114	Receive_P2P
FB 115	Receive_Reset
FB 116	Signal_Get
FB 117	Get_Features
FB 118	Set_Features
FB 163	TC_SEND
FB 164	TC_RECV
FB 165	TC_CON
FB 166	TC_DISCON
FB 804	SET_TIMEZONE
FB 1030	TSEND_C
FB 1031	TRCV_S
FB 1071	USS_DRIVE
FB 1080	MB_COMM_LOAD
FB 1081	MB_MASTER

8.1 Configuring devices and networks

Numerical name	Symbolic name
FB 1082	MB_SLAVE
FB 1084	MB_CLIENT
FB 1085	MB_SERVER
FB 1100	MB_Halt
FB 1101	MC_Home
FB 1102	MC_MoveAbsolute
FB 1103	MC_MoveJog
FB 1104	MC_MoveRelative
FB 1105	MC_MoveVelocity
FB 1107	MC_Power
FB 1108	MC_Reset
FB 1110	MC_MoveInterrupt
FB 1111	MC_ChangeDynamik
FB 1112	MC_CommandTable
FB 1113	MC_MoveLinearAbs_2D
FB 1114	MC_MoveLinearRel_2D
FB 1115	MC_MoveCircular_2D
FB 1130	PID_Compact
FB 1134	PID_3Step
FB 1140	HSC
FB 2040	RecipeCreate
FB 2041	RecipeOpen
FB 2042	RecipeRead
FB 2043	RecipeWrite
FB 2044	RecipeAppend
FB 2045	RecipeClose

Functions (FCs)

Numerical name	Symbolic name
FC 2 <sup>(1)</sup>	CONCAT
FC 4 <sup>(1)</sup>	DELETE
FC 11 <sup>(1)</sup>	FIND
FC 17 <sup>(1)</sup>	INSERT
FC 20 <sup>(1)</sup>	LEFT
FC 21 <sup>(1)</sup>	LEN
FC 22 <sup>(1)</sup>	LIMIT
FC 25 <sup>(1)</sup>	MAX
FC 26 <sup>(1)</sup>	MID
FC 27 <sup>(1)</sup>	MIN
FC 31 <sup>(1)</sup>	REPLACE
FC 32 <sup>(1)</sup>	RIGHT

Numerical name	Symbolic name
FC 36 <sup>(1)</sup>	ENCO
FC 36 <sup>(1)</sup>	SEL
FC 37	DECO
FC 800	LED
FC 801	IM_DATA
FC 802	DeviceStates
FC 803	ModuleStates
FC 1070	USS_PORT
FC 1072	USS_RPM
FC 1073	USS_WPM
<sup>(1)</sup> MC7+ instruction	

### System data types (SDTs)

Numerical name	Symbolic name
SDT 99	WWW_CDB
SDT 513	CONDITIONS
SDT 581	Send_Conditions
SDT 582	Receive_Conditions

### System function blocks (SFBs)

Numerical name	Symbolic name
SFB 0 <sup>(1)</sup>	CTU
SFB 1 <sup>(1)</sup>	CTD
SFB 2 <sup>(1)</sup>	CTUD
SFB 3 <sup>(1)</sup>	TP
SFB 4 <sup>(1)</sup>	TON
SFB 5 <sup>(1)</sup>	TOF
SFB 27	START_OB
SFB 52	RDREC
SFB 53	WRREC
SFB 54	RALRM
SFB 105	T_CONFIG
SFB 106	TDIAG
SFB 107	TRESET
SFB 110	PORT_CFG
SFB 111	SEND_CFG
SFB 112	RCV_CFG
SFB 113	SEND_PTP
SFB 114	RCV_PTP

8.1 Configuring devices and networks

Numerical name	Symbolic name
SFB 115	SGN_GET
SFB 116	SGN_SET
SFB 117	RCV_RST
SFB 120	CTRL_HSC
SFB 122	CTRL_PWM
SFB 140	DataLogCreate
SFB 141	DataLogOpen
SFB 142	DateLogWrite
SFB 143	DataLogClear
SFB 144	DataLogClose
SFB 145	DataLogDelete
SFB 146	DataLogNewFile

System functions (SFCs)

Numerical name	Symbolic name
SFC 7	DP_PRAL
SFC 11	DPSYC_FR
SFC 13	DPNRM_DG
SFC 14	DPRD_DAT
SFC 16	RD_OBINF
SFC 23	DEL_DB
SFC 28	SET_TINT
SFC 29	CAN_TINT
SFC 30	ACT_TINT
SFC 31	QRY_TINT
SFC 32	SRT_DINT
SFC 33	CAN_DINT
SFC 34	QRY_DINT
SFC 41	DIS_AIRT
SFC 42	EN_AIRT
SFC 43	RE_TRIGR
SFC 45	DE_ACT
SFC 46	STP
SFC 82	CREA_DBL
SFC 83	READ_DBL
SFC 84	WRIT_DBL
SFC 86	CREATE_DB
SFC 89	RST_EVOV
SFC 99	WWW
SFC 101	RTM
SFC 117	GET_DIAG



Numerical name	Symbolic name
SFC 124	ATTR_DB
SFC 140	IO2MOD
SFC 143	RD_ADDR
SFC 154	RD_LOC_T
SFC 154	DPWR_DAT
SFC 161	WR_LOC_T
SFC 180	ID2LOG
SFC 181	LOG2ID
SFC 182	ID2GEO
SFC 190	SET_CINT
SFC 191	QRY_CINT
SFC 192	ATTACH
SFC 193	DETACH
MC7+ Anweisung	GET_ERROR
MC7+ Anweisung	GET_ERR_ID

### Useful information on CPU firmware versions and STEP 7 versions

CPUs and engineering software for configuring the CPUs is constantly developed further to improve performance and security. New versions that have some special features with respect to the interaction of the components are created in this way. The sections below describe the special features of the S7-1200 CPUs with firmware version V4 as compared to firmware versions V1 to V3.

### Required engineering software

S7-1200 CPUs V4 can be configured with STEP 7 as of V12 Service Pack 1.

### Compatibility between memory card content and firmware version of the CPU

Memory cards with configuration and program for an S7-1200 CPU V1, V2 or V3 do not work with an S7-1200 CPU V4.

Memory cards with configuration and program for an S7-1200 CPU V4 do not work with an S7-1200 CPU V1, V2 or V3.

When you insert the memory card into a CPU with an incompatible firmware version, the CPU does not start up. When you insert a memory card for a CPU V1, V2 or V3 into an S7-1200 CPU V4, this CPU outputs a version error.

### Going online and loading

When you have configured an S7-1200 CPU with firmware version V1, V2 or V3 with STEP 7, the CPU to which you want to go online or which you want to download must have one of these firmware versions. You cannot go online to an S7-1200 CPU V4 with a configured S7-1200 CPU V1, V2 or V3.

On the other hand, you cannot go online to an S7-1200 CPU V1, V2 or V3 with a configured S7-1200 CPU V4 or download this CPU.

### **Replacing an existing CPU**

If you want to replace an existing S7-1200 CPU V1, V2 or V3 in your plant with a new CPU with a firmware version greater than or equal to 4, you have to configure and assign parameters for the hardware for this CPU in STEP 7. You transfer the blocks of the user program, the tags and the data types from the existing CPU or the existing project.

You cannot apply an existing configuration.

### **Communication with HMI devices**

When you connect an HMI device to an S7-1200 CPU V4, make sure that you use the appropriate Runtime software version of the HMI device.

You may have to transfer the latest HMI Runtime version by means of the WinCC engineering software.

### **See also**

Useful information on memory cards (Page 841)

### **8.1.6.2 Distributed I/O**

#### **Distributed I/O systems**

#### **SIMATIC ET 200 - The right solution for all applications**

SIMATIC ET 200 provides the most varied range of distributed I/O systems.

- Solutions for use in the control cabinet
- Solutions without control cabinet directly at the machine

Additionally, there are also components that can be used in explosive areas. SIMATIC ET 200 systems for construction without a control cabinet are contained in robust, glass-fibre reinforced plastic casing and are therefore shock-resistant, resistant to dirt and watertight.

Their modular design allows the ET 200 systems to be easily scaled and expanded in small steps. Fully-integrated auxiliary modules lower costs and also provide a wide range of possible applications. There are several combination possibilities available:

- Digital and analog I/OS
- Intelligent modules with CPU functions,
- Safety technology,
- Pneumatics,

- Frequency converters
- Various technology modules.

Communication via PROFIBUS and PROFINET, uniform engineering, clear diagnostic possibilities as well as optimal connection to SIMATIC controller and HMI devices vouch for the unique consistency provided by Totally Integrated Automation.

The following table provides an overview of I/O devices for use in the control cabinet:

I/O device	Properties
ET 200S	<ul style="list-style-type: none"> <li>• Highly modular design with multiple conductor connections</li> <li>• Multifunctional due to a wide range of modules</li> <li>• Use in explosive areas (Zone 2)</li> </ul>
ET 200S COMPACT	<ul style="list-style-type: none"> <li>• Highly modular design with multiple conductor connections</li> <li>• Multifunctional due to a wide range of modules</li> <li>• Use in explosive areas (Zone 2)</li> <li>• Integrated DE/DA</li> </ul>
ET 200L	<ul style="list-style-type: none"> <li>• Cost-effective digital block I/OS</li> <li>• Digital electronic blocks up to 32 channels</li> </ul>
ET 200M	<ul style="list-style-type: none"> <li>• Modular design with standard modules from SIMATIC-S7-300</li> <li>• Failsafe I/O modules</li> <li>• Use in explosive areas up to Zone 2, sensors and actuators up to Zone 1</li> <li>• High level of plant availability, for example by plugging and unplugging when in operation</li> </ul>
ET 200iSP	<ul style="list-style-type: none"> <li>• Modular design, also possible with redundancy</li> <li>• Robust and intrinsically safe design</li> <li>• Use in explosive areas up to Zone 1/21; sensors and actuators even up to Zone 0/20</li> <li>• High level of plant availability, for example by plugging and unplugging when in operation</li> </ul>

The following table provides an overview of I/O devices for use without a control cabinet:

I/O device	Properties
ET 200pro	<ul style="list-style-type: none"> <li>• Modular design with compact housing</li> <li>• Easy assembly</li> <li>• Multifunctional due to a wide range of modules</li> <li>• High level of availability due to plugging and unplugging in operation and permanent wiring</li> <li>• Comprehensive diagnostics</li> </ul>
ET 200eco PN	<ul style="list-style-type: none"> <li>• Cost-efficient, space-saving block I/OS</li> <li>• Digital modules up to 16 channels (also configurable)</li> <li>• Analog modules, IO-link master and load voltage distributor</li> <li>• PROFINET connection with 2-port switch in each module</li> <li>• Can be flexibly distributed via PROFINET in line or star shape directly within the plant</li> </ul>
ET 200eco	<ul style="list-style-type: none"> <li>• Cost-effective digital block I/OS</li> <li>• Flexible connection possibilities</li> <li>• Failsafe modules</li> <li>• High level of plant availability</li> </ul>
ET 200R	<ul style="list-style-type: none"> <li>• Specially for use on robots</li> <li>• Assembled directly on the chassis</li> <li>• Resistant to weld spatter due to robust metal housing</li> </ul>

**See also**

Documentation on ET 200L (<http://support.automation.siemens.com/WW/view/de/1142908/0/en>)

Documentation on ET 200S (<http://support.automation.siemens.com/WW/view/en/1144348>)

Documentation on ET 200M (<http://support.automation.siemens.com/WW/view/de/1142798/0/en>)

Documentation on ET 200pro (<http://support.automation.siemens.com/WW/view/de/21210852/0/en>)

Documentation on ET 200iSP (<http://support.automation.siemens.com/WW/view/de/28930789/0/en>)

Documentation on ET 200R (<http://support.automation.siemens.com/WW/view/de/11966255/0/en>)

Documentation on ET 200eco PN (<http://support.automation.siemens.com/WW/view/de/29999018/0/en>)

Documentation on ET 200eco (<http://support.automation.siemens.com/WW/view/de/12403834/0/en>)

## ET 200iSP

### ET 200iSP Distributed I/O Station

#### Definition

The ET 200iSP distributed I/O station is a highly modular and intrinsically safe DP slave with degree of protection IP 30.

#### Area of application

The ET 200iSP distributed I/O station can be operated in potentially explosive atmospheres characterized by gas and dust:

Approval	ET 200iSP Station*	Inputs and outputs
ATEX	Zone 1, Zone 21	up to Zone 0, Zone 20 **
IECEX	Zone 2, Zone 22	up to Zone 0, Zone 20 **
* In combination with an appropriate enclosure ** for electronic module 2 DO Relay UC60V/2A: up to Zone 1, Zone 21		

The ET 200iSP distributed I/O station can, of course, also be used in the safety area.

You can insert almost any combination of ET 200iSP I/O modules directly next to the interface module that transfers the data to the DP master. This means you can adapt the configuration to suit your on-site requirements.

Every ET 200iSP consists of a power supply module, an interface module and a maximum of 32 electronic modules (for example digital electronics modules). Remember not to exceed the maximum current consumption.

#### Terminal modules and electronic modules

In principle, the ET 200iSP distributed I/O station consists of various passive terminal modules onto which you plug the power supply and the electronic modules.

The ET 200iSP is connected to PROFIBUS RS 485-IS by means of a connector on terminal module TM-IM/EM. Every ET 200iSP is a DP slave on the PROFIBUS RS 485-IS.

#### DP master

All ET 200iSP modules support communication with DP masters that are compliant with *IEC 61784-1:2002 Ed1 CP 3/1* and operate with "DP" transmission protocol (DP stands for distributed peripherals or distributed I/O).

#### See also

Documentation on ET 200iSP (<http://support.automation.siemens.com/WW/view/de/28930789/0/en>)

## **Assigning the channel and IEEE tag**

### **Properties**

Analog electronic modules 4 AI | 2WIRE/HART, 4 AI | 4WIRE/ HART and 4 AO | HART support up to four IEEE tags.

The process input image (PII) provides up to 20 bytes per module for the IEEE tags. Thus, four blocks of 5 bytes each are available for the four IEEE tags within the PII.

### **Requirements**

The HART field device must support the assigned number of IEEE tags.

### Assigning IEEE tags

You assign the IEEE tags of the field devices to any one of the four blocks in the PII.

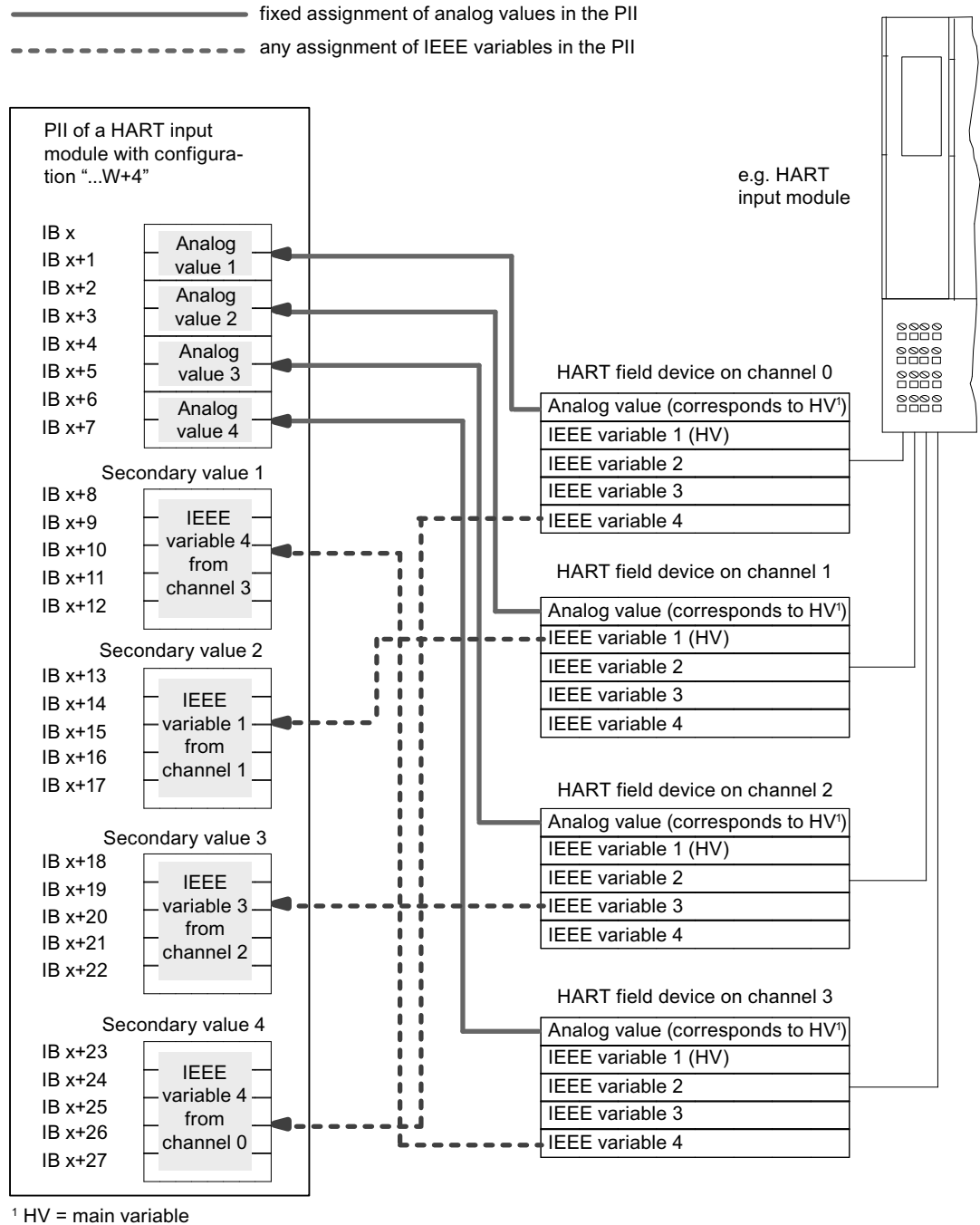

### See also

Documentation on ET 200iSP (<http://support.automation.siemens.com/WW/view/de/28930789/0/en>)

## Assigning parameters to reference junctions for thermocouples

### Compensation of the reference junction temperature

There are various ways of obtaining the reference junction temperature in order to get an absolute temperature value from the temperature difference between the reference junction and the measuring point.

Table 8-49 Compensation of the reference junction temperature

Option	Explanation	Reference junction parameters
No compensation	You record not only the temperature of the measurement point. The temperature of the reference junction (transition from Cu line to thermocouple line) also affects the thermo-electromotive force. The measured value then includes an error.	None
Use of a Pt100 Climatic Range resistance thermometer to record the reference junction temperature (best method)	You can record the reference junction temperature using a resistance thermometer (Pt100 Climatic Range). If parameterized accordingly, this temperature value is distributed to the 4 AI TC modules in the ET 200iSP where it is offset against the temperature value obtained at the measuring location. Number of reference junctions: 2	The parameter assignment of the IM 152 and the 4 AI TC must be coordinated: <ul style="list-style-type: none"> <li>• 4 AI RTD assigned parameters for Pt100 climatic range in correct slot;</li> <li>• 4 AI TC: Reference junction : "yes"; select reference junction number "1" or "2"</li> <li>• IM 152-1:Assignment of the reference junction to a slot with 4 AI RTD; channel selection;</li> </ul>
Internal compensation 4 AI TC	The TC sensor module (temperature sensor) is mounted onto the terminals of terminal module EM 4 AI TC. The temperature sensor reports the temperature of the terminals to the 4 AI TC. This value is then calculated together with the measured value from the channel of the electronic module.	<ul style="list-style-type: none"> <li>• 4 AI TC: Reference junction number "internal"</li> </ul>

### Compensation by means of a resistance thermometer at the 4 AI RTD

If thermocouples that are connected to the inputs of the 4 AI RTD have the same reference junction, compensate by means of a 4 AI RTD.

For both channels of the 4 AI TC module, you can select "1", "2" or "internal" as the reference junction number. If you select "1" or "2", the same reference junction (RTD channel) is always used for all four channels.



## Setting parameters for the reference junction

You set the reference junctions for the 4 AI TC electronic modules by means of the following parameters:

Table 8-50 Reference junction parameters

Parameter	Module	Range of values	Explanation
Slot reference junction 1 to slot 2	IM 152	none, 4 to 35	With this parameter, you can assign up to 2 slots (none, 4 to 35), on which the channels for reference temperature measurement (calculating the compensation value) are located.
Input reference junction 1 to 4 input reference junction	IM 152	RTD on channel 0 RTD on channel 1 RTD on channel 2 RTD on channel 3	This parameter allows you to set the channel (0/1/2/3) for measuring the reference temperature (calculation of the compensation value) for the assigned slot.
Reference junction E0 to reference junction E3	4 AI TC	None yes	This parameter allows you to enable the use of the reference junction.
Reference junction number	4 AI TC	1 2 Internal	This parameter allows you to assign the reference junction (1, 2) that contains the reference temperature (compensation value).

## See also

Documentation on ET 200iSP (<http://support.automation.siemens.com/WW/view/de/28930789/0/en>)

## Fundamentals of Time Stamping

### Properties

Time stamping is possible with the IM 152 in customer applications using FB 62 (FB TIMESTMP).

### Principle of operation

A modified input signal is assigned a time stamp and stored in a buffer (data record). If time stamped signals exist or a data record is full, a hardware interrupt is generated to the DP master. The buffer is evaluated with "Read data record". Special messages are generated for events that influence the time stamping (communication with the DP master interrupted, frame failure of time master, ...).

### Parameter Assignment

With the parameter assignment you define which IM 152 user data will be monitored. For the time stamping these are digital inputs that are monitoring for signal changes.

Parameter	Setting	Description
Time stamping	<ul style="list-style-type: none"><li>disabled</li><li>enabled</li></ul>	Activate the time stamping for the channels of the electronics module 8 DI NAMUR.
Edge evaluation incoming event	<ul style="list-style-type: none"><li>rising edge</li><li>falling edge</li></ul>	Determine the type of signal change that will be time-stamped.

### Counting

#### Count properties

#### Counting functions

The 8 DI NAMUR electronics module has configurable counting functions:

- 2 x 16-bit up counters (standard counting function) or
- 2 x 16-bit down counters (standard counting function) or
- 1 x 32-bit down counter (cascading counter function)
- Setting a setpoint with the PIQ
- GATE function
- You can configure the control signals of the counters:
  - Configuration channel 0..1: "Counter", channel 2..7: "DI": Two counters are configured. The control signals of the counters are stored in the PIQ (process image output).
  - Configuration channel 0..1: "Counter", channel 2..7: "Control": Two counters are configured. The control signals of the counters are stored in the PIQ (process image output). They are also controlled by the digital inputs of the 8 DI NAMUR.

#### See also

Principle of operation (Page 914)

Configuring counters (Page 917)

Assigning parameters to counters (Page 920)

### Principle of operation

#### 16-bit up counters (standard counting function)

The counting range is 0 to 65,535.

With each count pulse at the digital input, the count is incremented by 1. Once the count limit is reached, the counter is reset to 0 and it counts up again from this value.

If there is counter overflow, the corresponding output is set in the PII.

A positive edge of the *Reset output* control signal resets the output in the PII. This does not affect the current count value.

In 16-bit up counting operations, the system does not set any outputs in the PIQ. These are always reset.

The positive edge of the *Reset counter* control signal sets the counter to 0 and resets the set counter output.

The *GATE* control signal pauses the counting on a positive edge. Count pulses are processed at the digital input again, but only at the negative edge. The *Reset counter* control signal is also effective when *GATE* is active.

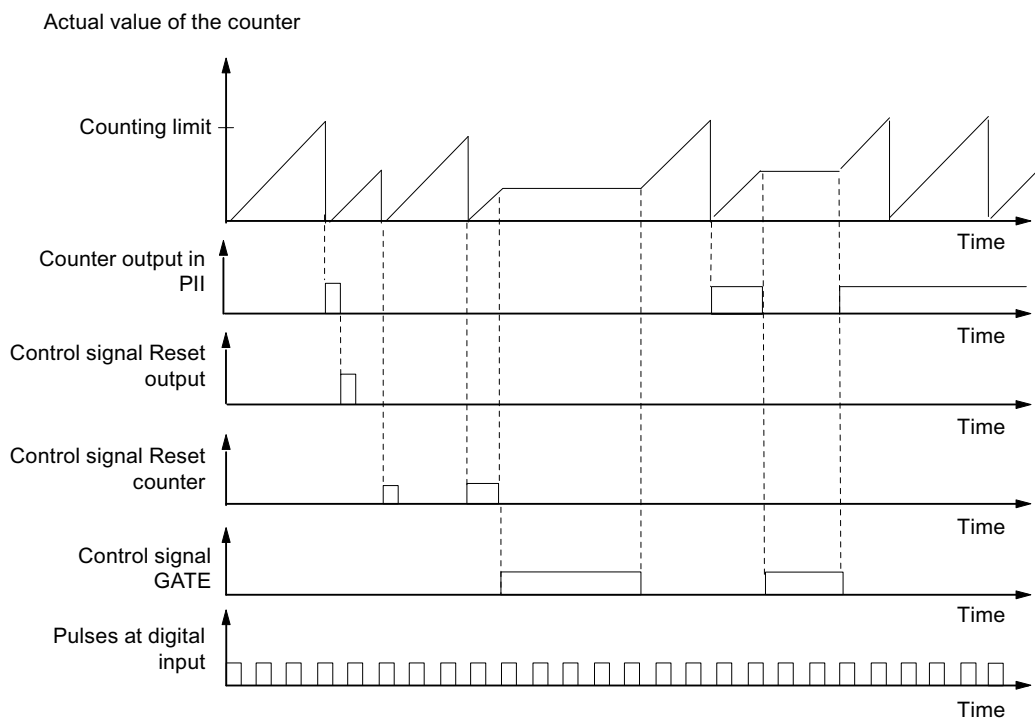

### 16-bit down counters (periodic counting function)

The maximum counting range is always 65,535 to 0.

When the counter is started, the actual value is set to the selected setpoint. Each counted pulse reduced the actual value by 1. Once the actual value reaches 0, the corresponding output in the PII is turned on and the actual value is set to the selected setpoint. The counter then counts down from this value.

The positive edge of the *Reset counter* control signal resets the selected setpoint and the corresponding output in the PII.

A positive edge of the *Reset output* control signal resets the output in the PII. This does not affect the current count value.

The *GATE* control signal pauses the counting on a positive edge. At the same time, the assigned output in the PII is reset. Count pulses are processed at the digital input again, but only at the negative edge. The *Reset output* and *Reset counter* control signals are also effective when *GATE* is active.

The setpoint of the counter is set and changed using the PIQ. The setpoint is adopted on a positive edge of the *Reset counter* control signal or when the counter has reached zero.

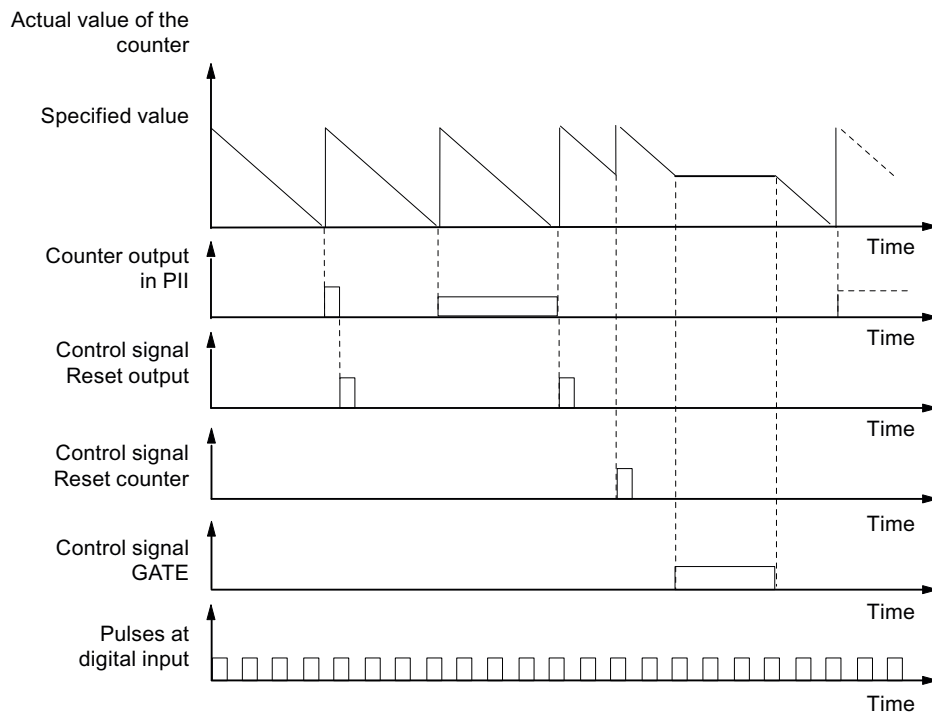

**32-bit down counter (cascading counter function)**

The maximum counting range is always 4294967295 to 0.

The principle of operation is identical to that of the 16-bit down counter. Channel 1 has no function.

**See also**

Count properties (Page 914)

## Configuring counters

### Procedure

1. Using the mouse, pull module 8 DI Namur from the hardware catalog into distributed I/O station ET 200iSP.
2. Select the required configuration (channel 0..1: "Counter", channel 2..7: "DI" or "Control"). In the module properties (inspector window), you can find this setting under "Parameters > Inputs > Configuration".

### Configuration channel 0..1: "Counter", channel 2..7: "DI"

- Assignment of the digital inputs on the electronic module 8 DI NAMUR

Table 8-51 Assignment of digital inputs for channel 0..1: "Counter", channel 2..7: "DI":

Digital input	Terminal	Assignment
Channel 0	1, 2	Counter 1
Channel 1	5, 6	Counter 2 (does not apply to 32-bit down counters)
Channel 2	9, 10	Digital input 2
Channel 3	13, 14	Digital input 3
Channel 4	3, 4	Digital input 4
Channel 5	7, 8	Digital input 5
Channel 6	11, 12	Digital input 6
Channel 7	15, 16	Digital input 7

8.1 Configuring devices and networks

• Assignment of the process image input (PII)

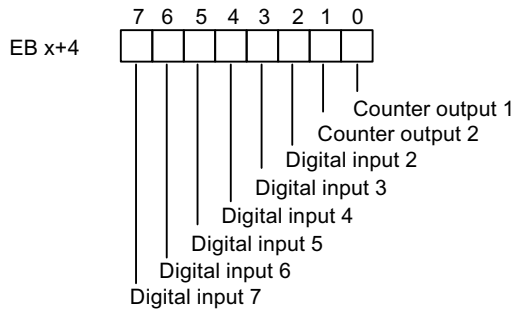
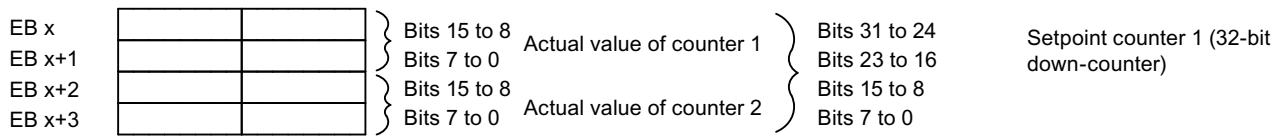

S7 format

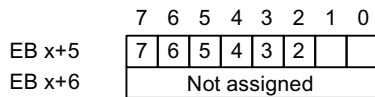

Value status for channels 2 to 7:  
 1<sub>B</sub>: Input signal is valid  
 0<sub>B</sub>: Input signal is invalid

• Assignment of the process image output (PIQ)

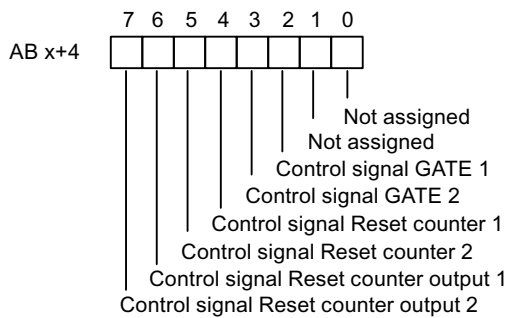
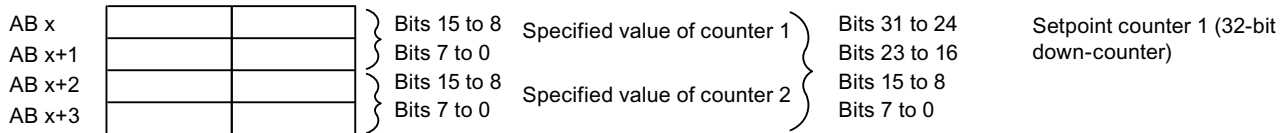

**Configuration channel 0..1: "Counter", channel 2..7: "CONTROL"**

With this configuration, you can also control the counters over the digital inputs.

- Assignment of the digital inputs on electronic module 8 DI NAMUR  
For further information on input assignments, refer to the technical data for electronic module 8 DI NAMUR.

Table 8-52 Assignment of the digital inputs for 2 Count/ 6 Control

Digital input	Terminal	Assignment
Channel 0	1, 2	Counter 1
Channel 1	5, 6	Counter 2 (does not apply to 32-bit down counters)
Channel 2	9, 10	control signal <i>GATE 1</i>
Channel 3	13, 14	control signal <i>GATE 2</i>
Channel 4	3, 4	control signal <i>Reset counter 1</i>
Channel 5	7, 8	control signal <i>Reset counter 2</i>
Channel 6	11, 12	control signal <i>Reset counter output 1</i>
Channel 7	15, 16	control signal <i>Reset counter output 2</i>

- Assignment of the process image input (PII)  
Assignment is identical to configuration 0..1: "Counter", channel 2..7: "DI".
- Assignment of the process image output (PIQ)  
Assignment is identical to configuration 0..1: "Counter", channel 2..7: "DI".

**See also**

Count properties (Page 914)

## Assigning parameters to counters

### Parameters for the counting function

Only those parameters that are relevant for the counters are explained below. These belong to the parameters of electronic module 8 DI NAMUR and depend on the selected configuration:

Table 8-53 Parameters for the counters

Parameter	Setting	Description
Sensor type counter inputs	<ul style="list-style-type: none"><li>Channel disabled</li><li>NAMUR sensor</li><li>Single contact, no load resistance</li></ul>	Select the sensor for the respective counter of channels 0 or 1.
Mode for counter 1	<ul style="list-style-type: none"><li>Standard counting function</li><li>Periodic counting function</li><li>Cascaded counting function</li></ul>	Select the mode for counter 1.
Mode for counter 2	<ul style="list-style-type: none"><li>Standard counting function</li><li>Periodic counting function</li><li>Cascaded counting function</li></ul>	Select the mode for counter 2. This parameter is not relevant if you have set the "Mode for counter 1" parameter to "Cascaded counter function".

### See also

Count properties (Page 914)

## Frequency measurement

### Frequency measurement properties

#### Properties

The electronic module 8 DI NAMUR allows the frequencies to be measured on channel 0 and 1:

- 2 frequency meters from 1 Hz to 5 kHz
- Configurable metering window (GATE)
- The signals of the frequency meter are read in by means of the digital inputs of the electronic module.

### See also

Principle of operation (Page 921)

Configuring frequency meters (Page 921)

Assigning parameters for the frequency meters (Page 923)



## Principle of operation

### Frequency measurement

The signal frequencies are identified from the input signals of channel 0 or 1 of the electronic module. To calculate the frequency the signals are measured within a configurable gate.

The frequency is displayed as 16-bit value in fixed-point format and transferred to the PII.

The frequency meter calculates the frequency according to the follow formula:

$$\text{Frequency [Hz]} = \frac{\text{Number of rising edges at digital input}}{\text{Measuring window [s]}}$$

### Exceeding the input frequency

If the input frequency exceeds 5kHz, 7FFF<sub>H</sub> is reported as actual value. If the input frequency is above approx. 8 kHz it is no longer possible to display correct actual values.

### See also

Frequency measurement properties (Page 920)

## Configuring frequency meters

### Procedure

1. Using the mouse, pull module 8 DI Namur from the hardware catalog into distributed I/O station ET 200iSP.
2. Select the required configuration (channel 0..1: "Trace", channel 2..7: "DI"). In the module properties (inspector window), you can find this setting under "Parameters > Inputs > Configuration".

### Configuration 0..1: "Trace", channel 2..7: "DI"

Assignment of the digital inputs on electronic module 8 DI NAMUR

Digital input	Terminal	Assignment
Channel 0	1, 2	Frequency counter 1
Channel 1	5, 6	Frequency counter 2
Channel 2	9, 10	Digital input 2
Channel 3	13, 14	Digital input 3
Channel 4	3, 4	Digital input 4
Channel 5	7, 8	Digital input 5
Channel 6	11, 12	Digital input 6
Channel 7	15, 16	Digital input 7

8.1 Configuring devices and networks

Assignment of process image input (PII) for configuration of channel 0..1: "Trace", channel 2..7: "DI"

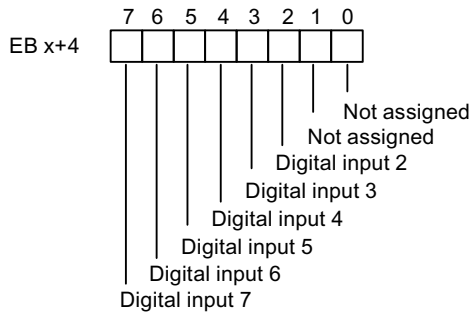
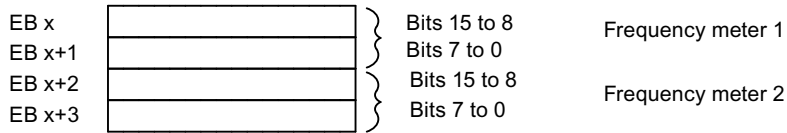

S7 format

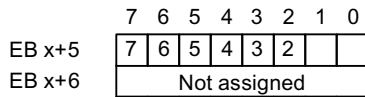

Value status for channels 2 to 7:

- 1<sub>b</sub>: Input signal is valid
- 0<sub>b</sub>: Input signal is invalid

Assignment of the process image output (PIQ): The PIQ is not assigned.

See also

Frequency measurement properties (Page 920)

## Assigning parameters for the frequency meters

### Parameters for frequency meter

Only those parameters that are relevant for the frequency meters are explained below. These are part of the parameters of electronic module 8 DI NAMUR.

Table 8-54 Parameters for the frequency meters

Parameter	Setting	Description
Sensor type frequency inputs	<ul style="list-style-type: none"> <li>• Channel disabled</li> <li>• NAMUR sensor</li> <li>• Single contact, no load resistance</li> </ul>	Select the sensor for the relevant frequency meter for channel 0 or 1.
Measuring window (GATE)	<ul style="list-style-type: none"> <li>• 50 ms</li> <li>• 200 ms</li> <li>• 1 s</li> </ul>	<p>Select the required measuring window for channel 0 or 1.</p> <p>To achieve the highest possible accuracy when metering frequencies, remember the following rules:</p> <ul style="list-style-type: none"> <li>• High frequencies (&gt; 4 kHz): Set a low measuring window (50 ms)</li> <li>• Variable/medium frequencies: set medium measuring window (200 ms)</li> <li>• Low frequencies (&lt; 1 kHz): Set a high measuring window (1 s)</li> </ul>

### See also

Frequency measurement properties (Page 920)

### ET 200eco PN

### ET 200eco PN Distributed I/O Device

### Definition

The ET 200eco PN distributed I/O device is a compact PROFINET IO device in degree of protection IP 65/66 or IP 67 and UL Enclosure Type 4x, Indoor use only.

## Field of application

The fields of application of the ET 200eco PN are derived from its special properties.

- A robust design and degree of protection IP 65/66 or IP 67 make the ET 200eco PN distributed I/O device suitable in particular for use in rugged industrial environments.
- The compact design of the ET 200eco PN is particularly favorable for applications in confined areas.
- The easy handling of ET 200eco PN facilitates efficient commissioning and maintenance.

## Properties

The ET 200eco PN has the following properties:

- Integrated switch with 2 ports
- Supported Ethernet services:
  - ping
  - arp
  - Network diagnostics (SNMP)
  - LLDP
- Interrupts
  - Diagnostics interrupts
  - Maintenance interrupts
- Port diagnostics
- Isochronous real-time communication
- Prioritized startup
- Device replacement without programming device
- Media redundancy
- Connection to intelligent sensors/actuators via IO link master interface module.

## IO Controller

The ET 200eco PN can communicate with all IO Controllers that conform to IEC 61158.

ET 200eco PN can be configured on a CPU with advanced diagnostics.

## See also

Documentation on ET 200eco PN (<http://support.automation.siemens.com/WW/view/en/29999018>)

## Parameter description analog input

### Group diagnostics

You can generally enable and disable the diagnostics function of the device with this parameter. The "Fault" and "Parameter assignment error" diagnostics functions are always independent of the group diagnostics.

### Diagnostics, missing 1L+

If you enable this parameter, the check for missing supply voltage is enabled.

### Diagnostics, sensor supply short circuit

If you enable this parameter, a diagnostics event is generated if a short-circuit of the sensor supply to ground is detected and the channel is enabled. The sensor supply is monitored for connectors X1, X3, X5 and X7. It is not possible to differentiate which connector has experienced the sensor short circuit.

### Interference frequency suppression

With this parameter, you set the integration time of the device, based on the selected interference frequency. Select the frequency of the supply voltage used. Interference frequency suppression **Off** means 500 Hz, which corresponds to an integration time of 2 ms for a measurement channel.

### Temperature unit

Specify the unit of the temperature measurement here.

### Measurement type (channel-wise)

With this parameter, you set the measurement type, for example, voltage. For any unused channels, you must select the **disabled** setting. For a disabled channel, the conversion time and integration time of the channel = 0 s and the cycle time is optimized.

### Measuring range

With this parameter, you set the measuring range of the selected measurement type.

### Temperature coefficient (for RTD, thermoresistor)

The correction factor for the temperature coefficients ( $\alpha$ -value) indicates by what extent the resistance of specific material changes relatively if the temperature increases by 1 °C.

The  $\alpha$ -values conform to EN 60751, GOST 6651, JIS C 1604 and ASTM E-1137.

The temperature coefficient depends on the chemical composition of the material.

### Smoothing

Smoothing of the analog values produces a stable analog signal for further processing. The smoothing of analog values is useful when handling wanted signals (measured values) with a slow rate of change, for example, temperature measurements.

The measured values are smoothed by digital filtering. To achieve smoothing, the device generates a mean value from a specified number of converted (digitized) analog values.

You assign a maximum of four levels for the smoothing (none, weak, medium, strong). The level determines the number of module cycles, from which the mean value is generated.

The stronger the smoothing, the more stable the smoothed analog value and the longer it takes until the smoothed analog value is applied following a signal change (see the example below).

The figure below shows the number of cycles a module requires to apply the smoothed analog value at almost 100% after a step response, based on the smoothing function settings. The figure applies to all signal changes at the analog input. The smoothing value defines the number of cycles a module requires to reach 63% of the end value of the changed signal.

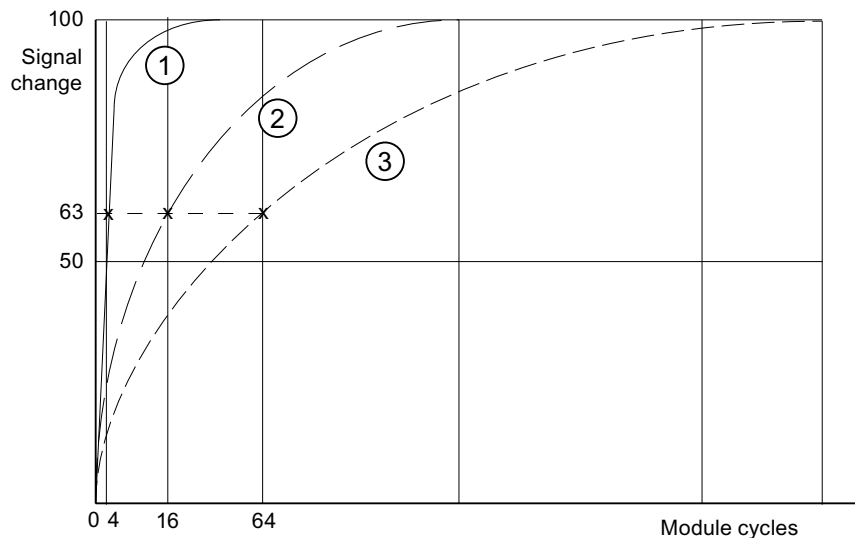

- ① Smoothing, weak
- ② Smoothing, medium
- ③ Smoothing, strong

### Diagnostics, wire break

When this parameter is enabled, the **Wire break** diagnostics event is generated when a wire break is detected.

Observe the rules outlined below to handle a wire break in the 1 to 5 V and 4 to 20 mA measuring ranges:

Parameter	Event	Measured value	Explanation
Enable wire break <sup>1</sup>	Wire break	7FFF <sub>H</sub>	Diagnostics, <b>wire break</b>
Wire break disabled <sup>1</sup>  Underflow enabled	Wire break	8000 <sub>H</sub>	Measured value after leaving the underrange  Diagnostic message <b>Lower limit value undershot</b>
Wire break disabled <sup>1</sup>  Underflow disabled	Wire break	8000 <sub>H</sub>	Measured value after leaving the underrange
<sup>1</sup> Measuring range limits for wire break detection and measuring range undershoot detection: <ul style="list-style-type: none"> <li>• 1 to 5 V: At 0.296 V</li> <li>• 4 to 20 mA: At 1.185 mA</li> </ul>			

### Diagnostics, underflow

If you enable this parameter, the **Underflow** diagnostics event is generated when the measured value reaches the underflow range.

### Diagnostics, overflow

If you enable this parameter, the **Overflow** diagnostics event is generated when the measured value reaches the overflow range.

### Reference junction for thermoresistor (TC)

A difference in temperature between the measuring point and the free ends of the thermocouple (terminal point) generates a voltage between the free ends, namely the thermoelectric voltage. The value of this thermoelectric voltage is determined by the temperature difference between the measuring point and the free ends and by the type of material combination of the thermocouple. Since a thermocouple always measures a temperature difference, the free ends at the reference junction must be maintained at a known temperature in order to determine the temperature of the measuring point.

If you specify **Internal compensation**, the temperature of the measuring point in the housing of the I/O device is measured. With the **External compensation** setting, you can connect a compensation box in series in order to increase the accuracy of the temperature measurement.

### Parameter description analog output

#### Group diagnostics

You can generally enable and disable the diagnostics function of the device with this parameter.

The "Fault" and "Parameter assignment error" diagnostics functions are always independent of the group diagnostics.

### Diagnostics, missing 1L+

If you enable this parameter, the check for missing supply voltage is enabled.

### Diagnostics, sensor supply short circuit

When this parameter is enabled, the system generates a diagnostics event if it detects a short-circuit of the sensor supply to ground. This diagnostics function is activated when the group diagnostics function is enabled.

### Response to CPU/Master STOP

Select how the module's outputs will respond to a CPU STOP:

- Shut down  
The I/O device goes to the safe state. The process image output is deleted (=0).
- Keep last value  
The I/O device retains the last value to be output before STOP.
- Substitute value  
The I/O device outputs the value for the channel set beforehand.

---

#### Note

Make sure that the plant is always in a safe state if "Keep last value" is selected.

---

### Type of output

With this parameter, you set the output type, for example, voltage. For any unused channels, select the **disabled** setting. For a disabled channel, the conversion time and integration time of the channel = 0 s, and the cycle time is optimized.

### Output range

With this parameter, you set the output range of the selected output type.

### Diagnostics, wire break (in current mode)

When this parameter is enabled, the **Wire break** diagnostics event is generated when a wire break is detected. This diagnostics event cannot be detected in the zero range.

### Diagnostics, short circuit (in voltage mode)

If you enable this parameter, a diagnostics event is generated in the event of a short circuit in the output line. This diagnostics event cannot be detected in the zero range.

### Diagnostics, overload

If you enable this parameter, the diagnostics event is generated in the event of an overload.



## Substitute values

With this parameter, you enter a substitute value that the module is to output in CPU-STOP mode. The substitute value must be in the nominal range, overrange, or underrange.

## ET 200SP

### ET 200SP distributed I/O system

#### Definition

The ET 200SP distributed I/O system is a scalable, highly flexible distributed I/O system for connection of process signals to a central controller via a field bus.

#### Application area

The ET 200SP is a multi-functional distributed I/O system for various fields of application. The scalable design allows you to configure the system exactly to the specific requirements on location.

The ET 200SP is approved for degree of protection IP 20 and for installation in a control cabinet.

#### Structure

The ET 200SP is mounted on a mounting rail and comprises:

- An interface module which can communicate with all IO controllers that conform to the PROFINET standard IEC 61158
- Up to 32 I/O modules which can be inserted on passive BaseUnits in any combination
- A server module that completes the design of the ET 200SP.

#### Interface module parameters

#### Status bytes

#### Status bytes

If you enable the "Status bytes" option, 4 bytes of input data are reserved for the status of the supply voltage of each I/O module.

	7	6	5	4	3	2	1	0	
Byte 0	8	7	6	5	4	3	2	1	I/O module slots
Byte 1	16	15	14	13	12	11	10	9	Bit = 0: Load voltage missing or I/O module not present
Byte 2	24	23	22	21	20	19	18	17	Bit = 1: Load voltage and I/O module present
Byte 3	32	31	30	29	28	27	26	25	

---

**Note**

An inserted or missing server module always reports for the slot bit = 0.

---

**Group diagnostics, missing supply voltage L+**

**Group diagnostics, missing supply voltage L+**

This diagnostics is a group diagnostics that covers the supply voltage status of all I/O modules of a potential group which are defined by BaseUnits with incoming power supply (light-colored BaseUnit BU...D).

The group diagnostics is formed from the states of the supply voltage of the inserted I/O modules within the potential group.

The group diagnostics does not depend on the "Missing supply voltage L+" parameter of the I/O modules being enabled.

The server module does not influence the missing supply voltage L+ group diagnostics.

**Requirements for the correct operation of the group diagnostics for missing supply voltage L+:**

- I/O modules or BU covers must be inserted on the light-colored and dark-colored BaseUnits. If no I/O module is inserted on a light-colored BaseUnit, the start of this potential group will not be detected by the interface module; the I/O modules of this potential group will thus belong to the previous potential group. A supply voltage L+ group error will then be assigned to the wrong potential group.  
When an I/O module is inserted on the light-colored BaseUnit, the interface module detects the new potential group, re-evaluates the status, and reports a new group diagnostics in the case of an error.
- The server module must be inserted.  
The server module itself does not influence the missing supply voltage L+ group diagnostics.

**Configuration control**

**Operating principle**

Configuration control allows you to operate various real configurations (options) with a single configuration of the distributed I/O device ET 200SP.

Configuration control provides you with the option of configuring the ET 200SP distributed I/O device with its maximum configuration and nevertheless operating with missing modules. If missing modules are retrofitted later, no new configuration is required and the hardware configuration does not have to be reloaded either.

Using control data records, which are transferred to the interface module in the user program, you define a current set configuration.

- The configured module is not present on a slot.
  - A base unit cover may be inserted on this slot instead of the configured I/O module. As there is no configured module on the slot, the term "Configuration control with empty slots" is also used.
  - The module that is configured to the right of the missing module can be inserted on this slot instead of the configured module. The missing module makes the actual configuration appear pushed together. As the configured module is missing but no gap arises in the configuration, this is also referred to as a "Configuration without empty slots".
- The configuration is extended by an already configured module.
  - In the case of configuration control with empty spaces, you extend the configuration by inserting the configured module on the corresponding empty slot.
  - In the case of configuration control without empty spaces, insert the configured module on the right-hand side next to the last module of the ET 200SP.

### More information and examples

For information on the rules for configuration control, the structure of the control data record, and the behavior during operation as well as examples of the structure of the control data record for various configurations, refer to the IM 155-6 PN interface module manual (<http://support.automation.siemens.com/WW/view/en/59768173>).

### Output module parameters

### Substitute value reaction

### Substitute value reaction

In the ET 200SP, the substitute value reaction is executed by the IO controller per slot.

The respective output reacts according to its set substitute value reaction:

- "Turn off"
- "Output substitute value"
- "Keep last value"

This substitute value reaction is triggered in the following cases:

- IO controller in STOP
- Controller failure (connection interruption)
- Firmware update
- Reset to factory settings
- More than one I/O module withdrawn simultaneously

- Disable the IO device
- Station stop
  - Missing server module
  - More than one I/O module withdrawn simultaneously
  - At least one I/O module is inserted on the wrong BaseUnit

---

**Note**

**Reducing a configuration**

If you reduce the configuration of the ET 200SP and download the configuration to the CPU, the modules which are no longer configured but still present retain their original substitute value reaction. This applies until the supply voltage on the BaseUnit BU...D or on the interface module is turned off.

---

## **Input module parameters**

### **Parameters of the digital input modules**

#### **Diagnostics missing supply voltage L+**

Enabling of the diagnostics for missing or insufficient supply voltage L+.

### Diagnostics short-circuit to ground

Enabling of the diagnostics if a short-circuit of the actuator supply to ground occurs.

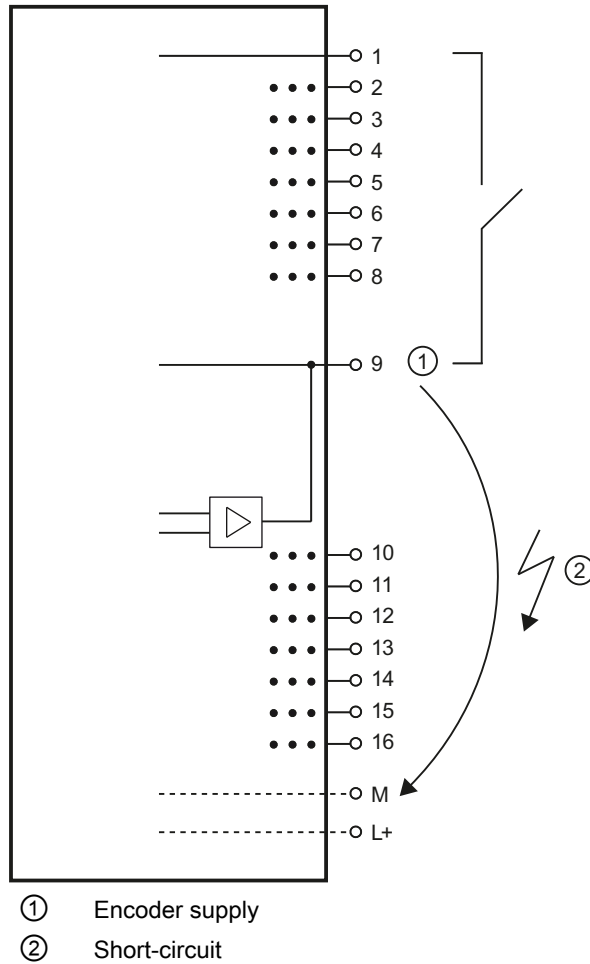

### Diagnostics short-circuit to L+

Enabling of the diagnostics if a short-circuit of the encoder supply to L+ occurs.

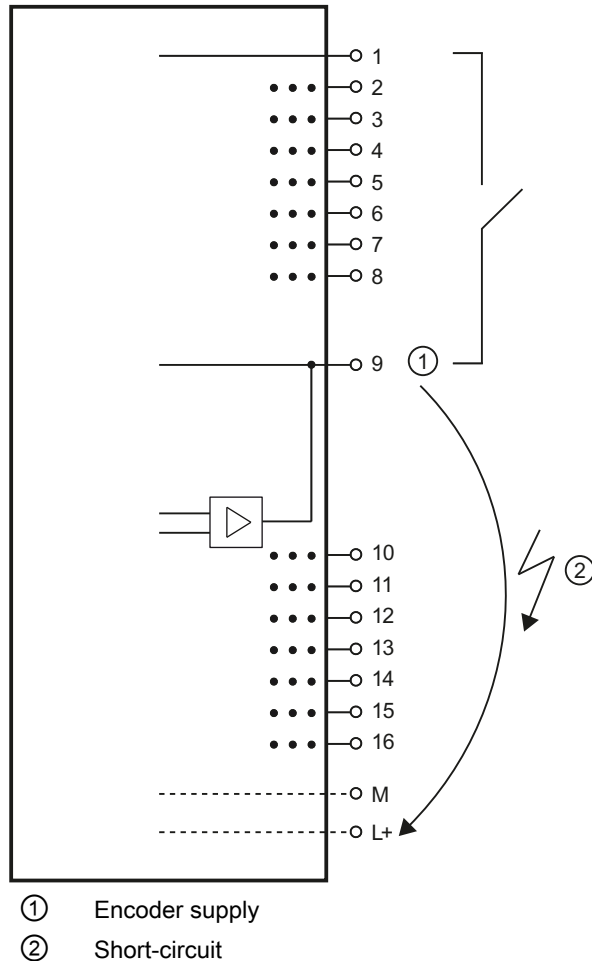

### Diagnostics wire break

Enabling diagnostics if the line to the encoder is interrupted.

### Operating mode

Determines whether a channel is enabled or disabled.

### Pulse extension (only High Feature modules)

Pulse extension is a function for changing a digital input signal. A pulse at a digital input is extended to at least the configured length. If the input pulse is already longer than the configured length, the pulse is not changed.

Pulse extension is started whenever the state of the input signal changes and no pulse extension is active for this channel.

**Potential group of the left module / new potential group**

Specifies whether the I/O module is located on a base unit with supply voltage feed (new potential group) or whether it is located on a base unit without supply voltage feed (in which case it belongs to the potential group of the left module).

**Parameters of the analog input modules****Missing supply voltage L+**

Enabling of the diagnostics, with missing or too little supply voltage L+.

**Reference junction (AI 4xRTD/TC 2-/3-/4-wire HF)**

A BaseUnit with internal temperature sensor (BU..T) or the channel 0 of the I/O module can be used as reference junction, provided this has been configured as "Thermal resistance Pt100 climatic range Celsius".

A possible configuration is shown below:

Table 8-55 RTD channel

Setting	Description
No reference channel operation	Temperature value at channel 0 can be used as module-wide reference value if the parameters of the other channels are assigned accordingly.
Reference channel of Group 0	The channel acts as sender for the reference junction temperature of Group 0. Distribution is performed via the interface module.

Table 8-56 TC channel

Setting	Description
Reference channel of the module	The corresponding TC channel uses the channel 0 of the same module as reference junction temperature. This must be set as "Thermal resistance Pt 100 climatic range Celsius" and "No reference channel operation"; otherwise, reference junction diagnostics is triggered.
Internal reference junction	The reference junction temperature is read by an internal temperature sensor on the BaseUnit. Reference junction diagnostics is triggered if there is a wrong BaseUnit type.
Reference channel of Group 0	With the setting "TC" (thermocouple...), the channel acts as receiver for the reference junction temperature of Group 0
Fixed reference temperature	No temperature compensation occurs. The linearization is executed with an assumed reference junction temperature of 0 °C.

**Overflow**

Enabling of the diagnostics if the measured value exceeds the overflow range.

### Underflow

Enabling of the diagnostics if the measured value falls below the underflow range.

### Wire break

Enabling of the diagnostics if the module has no current flow or too low a current flow for the measurement on the corresponding configured input.

### Smoothing

The individual measurements are smoothed using digital filtering. The smoothing can be set in 4 stages, whereby the smoothing factor  $k$  multiplied by the cycle time of the I/O module corresponds to the time constant of the smoothing filter. The larger the smoothing, the larger the time constant of the filter.

The following figure shows the step response for the various smoothing factors depending on the number of module cycles.

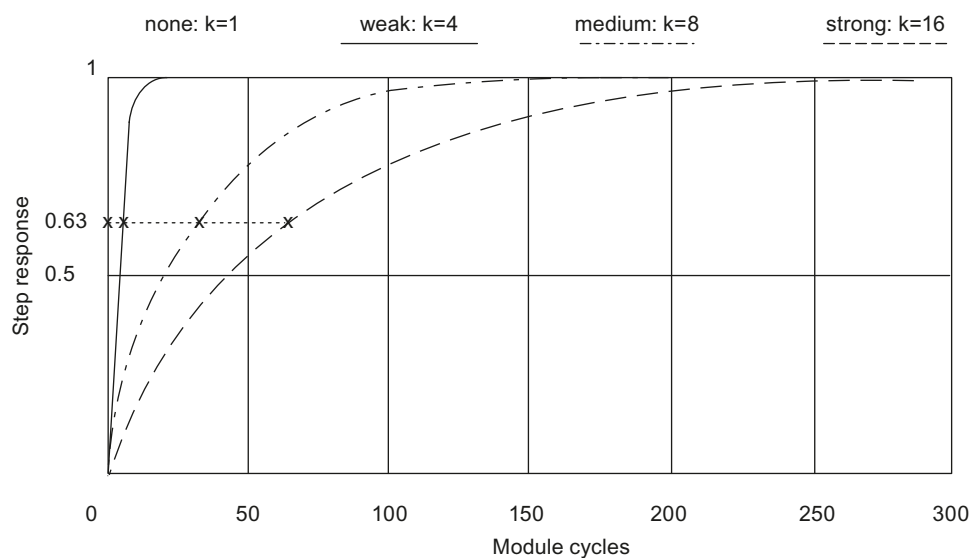

Figure 8-5 Smoothing with AI 4×RTD/TC 2-/3-/4-wire HF

### Interference frequency suppression

With analog input modules, suppresses the disturbance caused by the frequency of the AC network used.

The frequency of the AC network may interfere with measured values, particularly for measurements within low voltage ranges and when thermocouples are being used. This parameter is used to define the predominant power frequency of the system.

### Hardware interrupt limits

If the high limit 1/2 or the low limit 1/2 is violated, the module triggers a hardware interrupt.



Below are some examples for the selection of the limits 1 and 2.

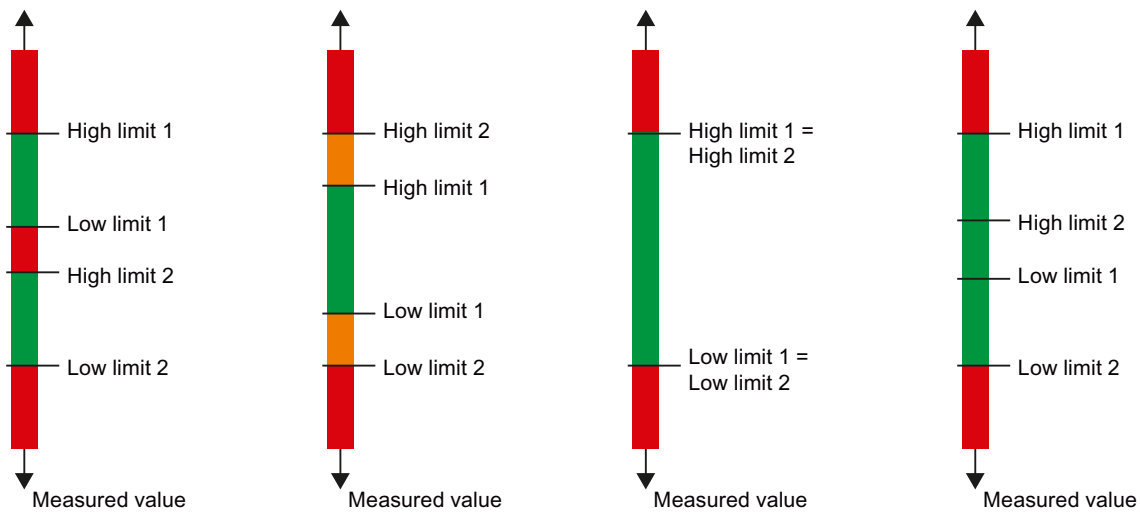

### Low limit 1/2

Specify a threshold whose undershoot triggers a hardware interrupt.

### High limit 1/2

Specify a threshold whose overrange triggers a hardware interrupt.

### Potential group of the left module / new potential group

Specifies whether the I/O module is located on a base unit with supply voltage feed (new potential group) or whether it is located on a base unit without supply voltage feed (in which case it belongs to the potential group of the left module).

### Temperature coefficient (measuring type thermoresistor)

The correction factor for the temperature coefficient ( $\alpha$  value) defines the relative rate of change of the resistance of a specific material at a temperature rise of 1 °C.

The temperature coefficient depends on the chemical composition of the material. In Europe, only one value is used per sensor type (default value).

The further values facilitate a sensor-specific setting of the temperature coefficient and enhance accuracy.

### See also

Special features of AI 4xRTD/TC 2-/3-/4-wire HF (Page 938)

## Special features of AI 4xRTD/TC 2-/3-/4-wire HF

### Use of Cu10 sensors

- Select "3-wire thermal resistor" and "Cu10" in the parameter assignment.
- Wire the Cu10 sensor using 3-wire connection technology.
- An automatic, internal compensation of the line resistance of the missing measuring line takes place during operation.

#### Note

To ensure optimum line compensation for Cu10, please note the following:

- The sum of cable resistance and measuring resistance must not exceed 31 Ω.
- Cable resistance should not exceed 8 Ω if you want to use the temperature range up to over 312 °C.  
Example: A 200 m long copper cable with 0.5 mm<sup>2</sup> core cross-section has approx. 7 Ω. A lower cross-section reduces the permissible cable length accordingly.

### Use of PTC resistors

PTCs are suitable for temperature monitoring of or as thermal protective equipment for complex drives or transformer windings.

- Select "2-wire resistor" and "PTC" in the parameter assignment.
- Connect the PTC using 2-wire technology.
- Use type A PTC resistors (PTC thermistors) in accordance with DIN/VDE 0660, Part 302.
- If the "Over-/underflow" diagnostics is enabled, a "low limit violation" diagnostics which shows a short circuit is generated for resistance values < 18 Ω.
- Sensor data on PTC resistance:

Table 8-57 Use of PTC resistors

Property	Technical specifications	Note
Switching points	<b>Reaction to rising temperature</b>	
	< 550 Ω	<b>Normal range:</b> • SIMATIC S7: bit 0 = "0", bit 2 = "0" (in the PII)
	550 Ω to 1650 Ω	<b>Prewarning range:</b> • SIMATIC S7: bit 0 = "0", bit 2 = "1" (in the PII)
	< 1650 Ω	<b>Response range:</b> • SIMATIC S7: bit 0 = "1", bit 2 = "0" (in the PII)
	<b>Reaction to falling temperature</b>	
	< 750 Ω	<b>Response range:</b> • SIMATIC S7: bit 0 = "1", bit 2 = "0" (in the PII)
	750 Ω to 540 Ω	<b>Prewarning range:</b> • SIMATIC S7: bit 0 = "0", bit 2 = "1" (in the PII)

Property	Technical specifications	Note
	< 540 Ω	<b>Normal range:</b> • SIMATIC S7: bit 0 = "0", bit 2 = "0" (in the PII)
(TNF-5) °C (TNF+5) °C (TNF+15) °C Measuring voltage Voltage on the PTC	max. 550 Ω min. 1330 Ω min. 4000 Ω max. 7.5 V	RRT= rated response temperature

- Assignment in the process image inputs (PII) with SIMATIC S7

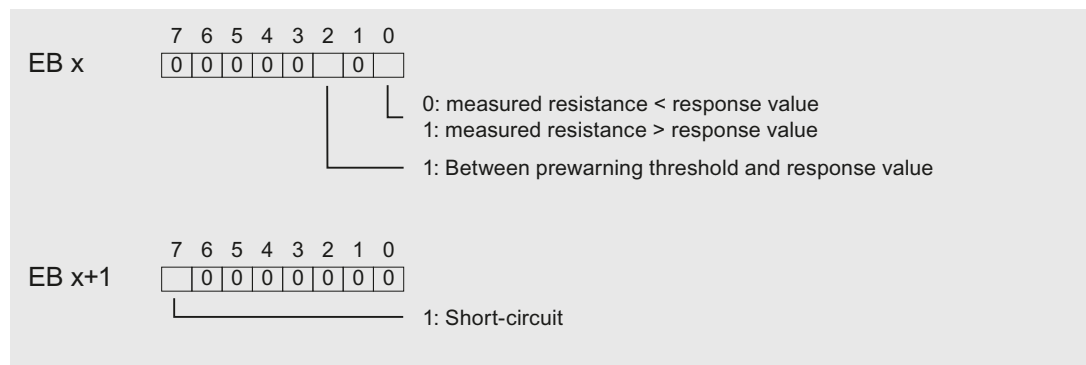

Figure 8-6 Assignment in the process image inputs (PII)

- Notes on programming

**Note**

Only the bits 0+2 are relevant for the evaluation in the process image inputs. You can use the bits 0+2 to monitor the temperature, for example, of a motor.

The bits 0+2 in the process image inputs have no latching function. When you are assigning parameters, take into consideration that a motor, for example, starts up in a controlled manner (via an acknowledgment).

Bits 0+2 can never be set simultaneously, but are instead set consecutively.

For safety reasons, always evaluate the diagnostic entries of the AI 4×RTD/TC 2-/3-/4-wire HF, as no measurement is possible if I/O modules are unplugged, if the supply voltage of the I/O module has failed, or if there is a wire break or short circuit of the measuring lines.

**Example**

The following diagram shows the temperature variation and the associated switching points.

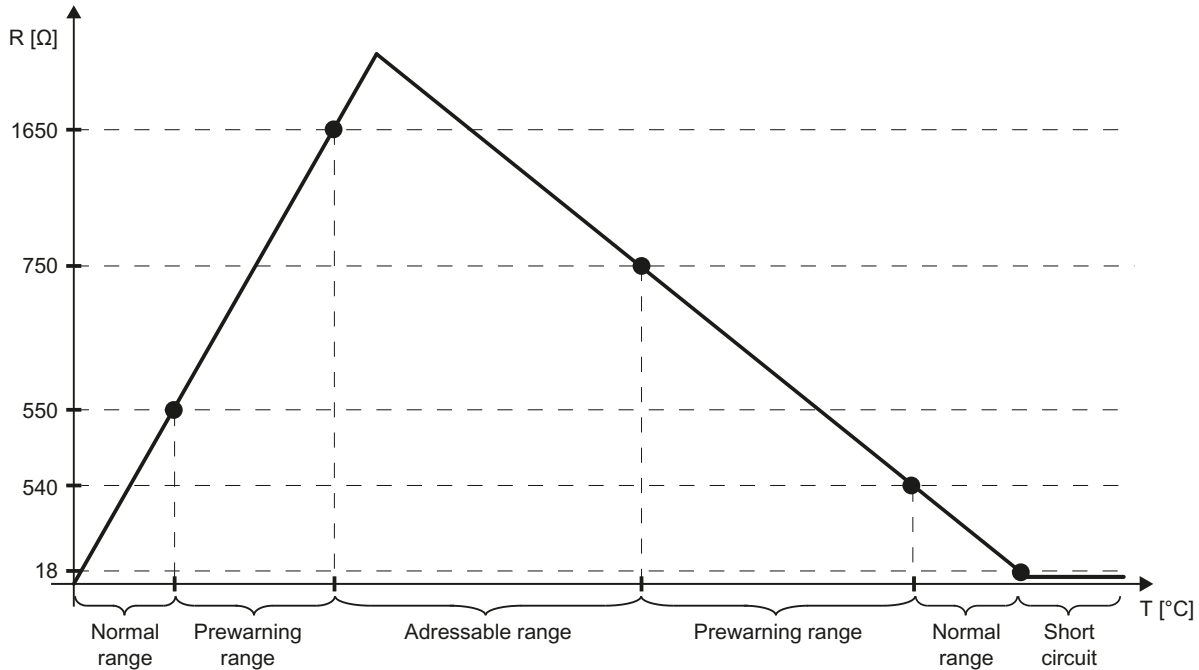

**See also**

Parameters of the analog input modules (Page 935)

**ET 200MP**

**ET 200MP distributed I/O system**

**Definition**

The ET 200MP distributed I/O system is a scalable and flexible distributed I/O system for connection of process signals to a central controller via a field bus.

**Application area**

The ET 200MP is a multi-functional distributed I/O system for various fields of application. The scalable design allows you to configure the system exactly to the specific requirements on location.

The ET 200MP complies with IP 20 degree of protection and is intended for installation in a control cabinet.

## Structure

The ET 200MP is installed on a mounting rail and comprises:

- An interface module that communicates with all IO controllers conforming to the PROFINET standard IEC 61158
- Up to 30 modules (power supply modules and I/O modules from the S7-1500 I/O range) can be inserted to the right of the interface module.
- If you insert a power supply module to the left of the interface module, this yields a possible maximum configuration of 32 modules in total.
- The number of insertable I/O modules is limited by their power requirements.

## Slot rules

- Slot 0: Power supply module (optional)
- Slot 1: Interface module
- Slot 2 to 31: I/O modules or power supply modules

## Interface module parameters

### Supply voltage L+ connected

#### Parameter "Supply voltage L+ connected"

This parameter influences the diagnostics and the checking of the power budget.

- Diagnostics of the ET 200MP:  
If the actual configuration does not conform to the setpoint configuration with regard to the supply voltage of the interface module, the interface module generates a diagnostic alarm.  
Example: You have deactivated the "Supply voltage L+ connected" option, but you have connected the supply voltage in the actual configuration.
- Power budget check during configuration:  
The power budget changes in accordance with the parameter setting: Either the interface module feeds power into the backplane bus or it draws power from the backplane bus.

The default ("Supply voltage L+ connected" option is **activated**) means that the front of the interface module is supplied with 24 V DC and the power is stored in the backplane bus.

If the "Supply voltage L+ connected" option is **deactivated**, the interface module may not be supplied with 24 V DC on the front.

In this case, insert a power supply unit (PS) on the left next to the interface module that supplies the interface module and the modules to the right of the interface module.

---

**Note**

We recommend that you always supply the interface module on the front side with 24 V DC. If a system power supply unit (PS) is inserted and connected additionally **before** or on the left next to the interface module, both the power from the system power supply unit (PS) as well as the power from the integrated power supply of the interface module are then available to the configuration.

In this case, you do not have to change the default setting of the parameter.

---

## **Input module parameters**

### **Parameters of the analog input modules**

#### **Missing supply voltage L+**

Enabling of the diagnostics for missing or insufficient supply voltage L+.

#### **Wire break**

Enabling of the diagnostics if the module has no current flow or the current is too weak for the measurement at the corresponding configured input or the applied voltage is too low.

#### **Current limit for wire break diagnostics**

Threshold at which a wire break is reported. The value can be set to 1.185 mA or 3.6 mA, depending on the sensor used.

#### **Overflow**

Enabling of the diagnostics if the measured value exceeds the overrange.

#### **Underflow**

Enabling of the diagnostics if the measured value undershoots the underrange.

#### **Common mode error**

Enable diagnostics if the valid common mode voltage is exceeded.

**Reference channel error (only for AI 8xU//RTD/TC ST)**

- Enable diagnostics on error at the temperature compensation channel, e.g. wire break.
- Dynamic reference temperature compensation type is configured and no reference temperature has been transferred to the module yet.

**Temperature coefficient**

The temperature coefficient depends on the chemical composition of the material. In Europe, only one value is used per sensor type (default value).

The correction factor for the temperature coefficient ( $\alpha$  value) specifies how much the resistance of a certain material changes when the temperature is raised by 1 °C.

The further values facilitate a sensor-specific setting of the temperature coefficient and enhance accuracy.

**Interference frequency suppression**

At analog input modules, this suppresses interference caused by the frequency of AC mains.

The frequency of the AC network may interfere with measured values, particularly for measurements within low voltage ranges and when thermocouples are being used. With this parameter, you define the mains frequency in your system.

**Smoothing**

The individual measured values are smoothed using filtering. Smoothing can be set in 4 stages for the analog input modules AI 8xU//RTD/TC ST and AI 8xU//HS.

Smoothing time = number of module cycles (k) x cycle time of the module.

The figure below shows the number of module cycles after which the smoothed analog value is almost 100%, depending on the set smoothing. Is valid for each signal change at the analog input.

8.1 Configuring devices and networks

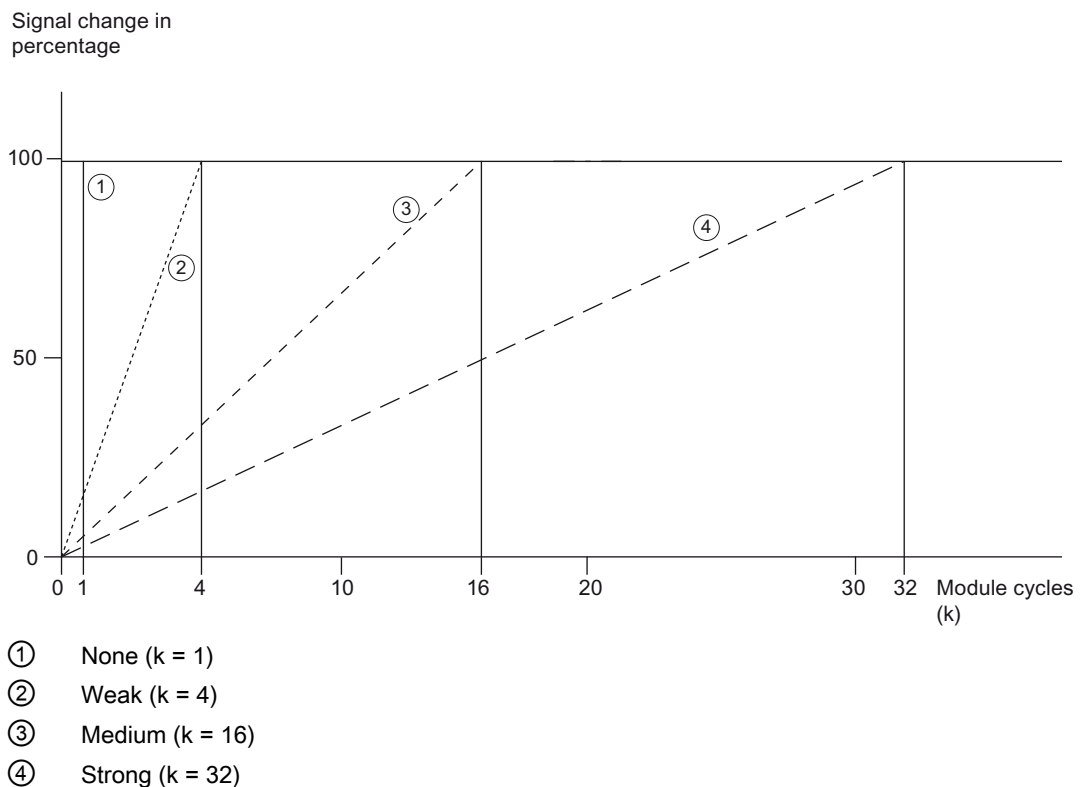

Reference junction (only for AI 8xU/I/RTD/TC ST)

The following settings can be configured for the reference junction parameter:

Table 8-58 Possible parameter assignments for the reference junction parameter

Setting	Description
Fixed reference temperature	The reference junction temperature is configured and stored in the module as a fixed value.
Dynamic reference temperature	The reference junction temperature is transferred in the user program from the CPU to the module by data records 192 to 199 using the WRREC (SFB 53) instruction.
Internal reference junction	The reference junction temperature is determined using an integrated sensor of the module.
Reference channel of the module	The reference junction temperature is determined using an external resistance thermometer (RTD) at the reference channel (COMP) of the module.

**Note**

**Fixed reference temperature**

During parameter assignment of a thermocouple Type B, only the setting "Fixed reference temperature" with a temperature of 0 °C is possible.



### **Enable hardware interrupt 1 or 2**

Enable a hardware interrupt if high limit 1 or 2 is exceeded, or low limit 1 or 2 is violated.

### **Low limit 1 or 2**

Specifies the low limit threshold that triggers hardware interrupt 1 or 2.

### **High limit 1 or 2**

Specifies the high limit threshold that triggers hardware interrupt 1 or 2.

## **Temperature compensation for thermocouples**

### **Introduction**

You have several options of measuring the reference junction temperature in order to obtain an absolute temperature value as a function of the temperature difference between the reference junction and the measuring point.

You can use various compensation options depending on the required location of the reference junction.

---

#### **Note**

During parameter assignment of a thermocouple Type B, only the setting "Fixed reference temperature" with a temperature of 0 °C is possible.

---

Options of compensating for the reference junction temperature

Compensation options	Explanation	Application case
Internal reference junction	<p>With this compensation, the reference junction temperature is determined using an integrated sensor of the module.</p> <p><b>Procedure</b> Connect the thermocouple to the I/O module directly or with compensating lines.</p>	<ul style="list-style-type: none"> <li>For the connection, you use compensating lines matching the thermocouple material.</li> <li>If the reference junction temperature and the module temperature are identical in your system, you may also use lines made from a different material.</li> </ul>
Reference channel of the module	<p>The reference junction temperature is determined using an external resistance thermometer (RTD).</p> <p><b>Procedure</b> Connect the thermocouple to the supply lines at the reference junction, either directly or with compensating lines. You connect the supply lines to the appropriate terminals of the module. Connect the resistance thermometer (RTD) to the reference channel of the module. The resistance thermometer (RTD) must be placed in the area of the reference junction.</p>	<ul style="list-style-type: none"> <li>You want to measure the temperature directly at the reference junction.</li> <li>The measured temperatures of all channels that you have configured for this compensation type is corrected automatically by the temperature value of the reference junction.</li> <li>You can use inexpensive lines, e.g., copper lines, from the reference junction to the module.</li> </ul>
Dynamic reference temperature	<p>The temperature of the reference junction is determined via a module. This temperature value is transferred to other modules via a data record in the user program.</p> <p><b>Procedure</b> Connect the resistance thermometer (RTD) for the reference junction to any channel. The reference junction temperature is communicated from the CPU to the module by data records 192 to 199 using the WRREC instruction.</p>	<ul style="list-style-type: none"> <li>You use multiple modules at the reference junction and can therefore compensate all channels using a common temperature value.</li> <li>You require only one resistance thermometer (RTD) to acquire the temperature value.</li> <li>You can use inexpensive lines, e.g., copper lines, from the reference junction to the module.</li> </ul>
Fixed reference temperature	<p>The reference junction temperature is stored in the module as a fixed value.</p> <p><b>Procedure</b> Connect the thermocouple to the supply lines at the reference junction, either directly or with compensating lines. You connect the supply lines to the appropriate terminals of the module. When configuring the module, specify a fixed temperature value for the reference junction (e.g. 20 °C).</p>	<ul style="list-style-type: none"> <li>You keep the reference junction temperature constant and know the temperature value.</li> <li>You can use inexpensive lines, e.g., copper lines, from the reference junction to the module.</li> </ul>

## **Output module parameters**

### **Parameters of the analog output modules**

#### **Missing supply voltage L+**

Enabling of the diagnostics, with missing or too little supply voltage L+.

#### **Short-circuit to ground**

Enabling of the diagnostics if a short-circuit of the actuator supply to ground occurs.

#### **Wire break**

Enabling diagnostics if the line to the encoder is interrupted.

#### **Overflow**

Enabling of the diagnostics if the measured value exceeds the overflow range.

#### **Underflow**

Enabling of the diagnostics if the measured value falls below the underflow range.

#### **Reaction to CPU STOP**

Determines the reaction of the output to the CPU going into STOP state.

#### **Substitute value**

The substitute values are values that the outputs (the output) issue in the event of a CPU STOP.

## **ET 200M**

### **Configuring an ET 200M**

#### **Introduction**

For the ET 200M series, you can find a wide range of modules in the hardware catalog under "Distributed I/O".

### Configuration and parameter assignment

Information on configuration and parameter assignment can be found in the following sections.

### ET 200M configuration

#### Definition

The distributed IO device, ET 200M, is a modular DP slave with an IP 20 degree of protection.

The ET 200M has the configuration technology of the S7-300 automation system and consists of an IM 153-x and I/O modules of the S7-300.

ET 200M supports communication with:

- all DP masters compliant with IEC 61784-1:2002 Ed1 CP 3/1
- all IO controllers compliant with IEC 61158

#### Configuration of the ET 200M (example)

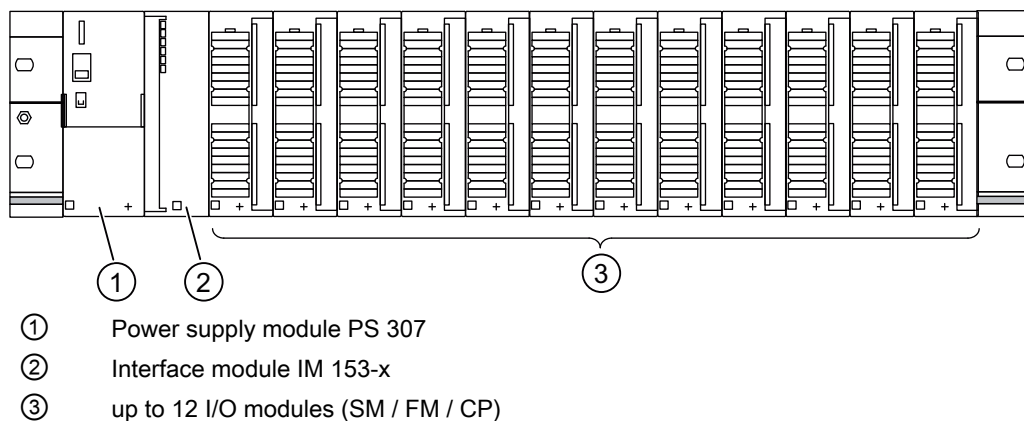

#### Configuration of the 'Module replacement during operation' function

##### Introduction

The ET 200M supports the "Replace modules during operation" function and the associated pull/plug interrupt.

The "Replace modules during operation" function makes it possible for you to pull modules from or plug modules into the ET 200M rack during operation.

##### Requirement

You have configured an interface module that supports replacing modules during operation. (as of IM 153-1, order no. 153-1AA02-0XB0).

In addition, the configured CPU must also support the function, e.g. for PROFIBUS an S7-400 with DP interface.

You must use the active backplane bus (bus rail with slots) for the hardware configuration. The conventional profile rail with bus connectors between the modules does not support this function.

## Configuring

If the configuration requirements have been met, the "Replace modules during operation" parameter is available for selection in the inspector window's "Module parameters" area. Below this parameter, a table for the configured modules is displayed, which shows the required active bus modules for the hardware configuration.

For a PROFIBUS configuration, the "Startup if preset configuration does not match actual configuration" option is displayed. This option is automatically enabled if "Replace modules during operation" is enabled.

## Configuring HART variables

### Introduction

Numerous HART field devices make available additional measured quantities (e.g. sensor temperature). These can be read if they are set accordingly in the field device configuration. Using the HART variables, it is possible to apply the set measured values directly from the field device into the I/O area of your automation system.

Regardless of the number of configured channels, a maximum of 8 HART variables can be assigned for HART modules and no more than 4 HART variables per channel. You assign the HART variables to a channel in the properties for the module ("HART variable settings" area).

### Requirement

The HART module is plugged into an ET 200 M (as of IM 153-2, 6ES7 153-2BA02-0AB0).

### Address assignment

The HART module occupies 16 input/output bytes. If you configure HART variables, the module occupies an additional 5 bytes for each HART variable.

If you use all 8 HART variables, the HART input module occupies a total of 56 input/output bytes (16 bytes + 8 x 5 bytes = 56 bytes).

The "None" configuration occupies no additional input bytes.

## Configuration of HART variables

You can configure up to 4 HART variables for a channel

- PV (Primary Variable)
- SV (Secondary Variable)

- TV (Tertiary Variable)
- QV (Quaternary)

CiR is a placeholder that reserves the address space for a HART variable. You must configure the HART variables you are not using with the "None" parameter.

### Configuration of HART variables

The HART variables are structured as follows:

4 bytes of HART data	1 byte QC
----------------------	-----------

### Structure of the "Quality-Code" byte

The Quality-Code (QC) can assume the following values:

Quality-Code (QC)	Meaning
0x4C or 0	Initialization: 0 value of IM and 4C of module
0x18	Communication cancelled / no communication
0x0C	Fault in HART device
0x47	HART device is busy
0x84	OK "Configuration changed"
0x80	OK

### See also

Documentation for HART analog modules (<http://support.automation.siemens.com/WW/view/en/22063748>)

## Signal modules for process automation

### Fundamentals

#### Introduction

Signal modules for the process automation are S7-300 models, such as SM 321; DI 16xNAMUR or SM 322; DO 16x24VDC/0.5A.

They are being operated in a DP slave (IM 153-2).

Unlike standard modules, they offer the following additional technical functions, such as pulse extension and chatter monitoring.

## See also

- Changeover contact (Page 951)
- Technological parameters (Page 951)

## Changeover contact

### "Changeover contact" sensor type

If the digital inputs of a channel group are configured as "changeover contacts", the module runs diagnostics for the changeover contact sensor type for this channel group.

## Changeover contact

A changeover contact is an auxiliary switch with only one moving switch element with one close setting each for closed and open switching device.

Remember the following rule:

- Always connect a normally open contact to the "even" channel
- Always connect a normally closed contact to the "odd" channel.

The tolerated switchover time between the two channels is fixed at 300 ms.

If the result of the check is negative, then

- the module identifies the value status of the normally open channel as "invalid"
- the module generates a diagnostic entry for the normally open channel
- triggers a diagnostic interrupt (if diagnostic interrupts have been enabled)

The digital input signal and the value status are updated only for the normally open channel. For the normally closed channel, the digital input signal is set permanently to "zero" and the value status to "invalid" since this channel is used only to check the sensor.

Diagnostics depends on the "Selection" parameter (of the sensor). You should also note the special features of diagnostics with the changeover contact sensor type in the "Signal Modules for Process Automation" manual.

## See also

Documentation on modules for process automation (<http://support.automation.siemens.com/WW/view/de/7215812/0/en>)

## Technological parameters

### Pulse extension and flutter monitoring

Pulse extension is a function for changing a digital input signal. A pulse at a digital input is extended to at least the length set in the parameters. If the input pulse is already longer than the specified length, it is not changed.

If you want the pulse to be extended, click in the box to select the time. If you do not want the pulses to be extended, select the "---" entry.

Flutter monitoring is a process control function for digital input signals. It detects and reports signal changes that are unexpected in process control, for example when an input signal fluctuates too often between "0" and "1".

Flutter monitoring is possible only when group diagnostics has also been enabled for this input.

### Monitoring window and number of signal changes

Flutter monitoring works with aid of the two parameters Monitoring window and Number of signal changes.

The first time the signal changes, the time set as the monitoring window is started. If the signal changes more often during this time than allowed by the number of signal changes parameter, this is signaled as a flutter error. If no flutter error is detected during the monitoring window time, the monitoring window can be restarted at the next signal change.

---

#### Note

If you set pulse extension for an input channel, this also affects the flutter monitoring enabled for this channel. The "extended pulse" signal is the input signal for the flutter monitoring. You should therefore make sure that the values set for pulse extension and flutter monitoring are compatible with each other.

---

### See also

Documentation on modules for process automation (<http://support.automation.siemens.com/WW/view/de/7215812/0/en>)

### IQ Sense module

#### Properties of 8 IQ-SENSE

#### Properties

The 8 IQ-SENSE module has the following properties:

- Connection of sensors with IQ-SENSE®, photoelectric proximity switches: for example, reflex sensors, diffuse sensors, and laser sensors.
- It can be used centrally in an S7-300 or distributed in an ET 200M.
- You can connect up to 8 sensors to every module. Each sensor requires a two-wire cable.
- Function reserve that can be assigned parameters.
- Time functions, switching hysteresis, synchronous mode that can be assigned parameters
- Sensitivity and distance values can be specified (*IntelliTeach* using the "IQ-SENSE Opto" FB)



- Teach-in
- Sensors can be removed and inserted during operation (automatic reassignment of parameters)

### Anti-interference group

Only for optical IQ Sense devices (IQ profile ID 1).

For IQ Sense devices with IQ profile ID 128 (ultrasound), see "Multiplex/synchronous mode" under the channel-specific parameters.

Prevention of interference (e.g., scattered light) by assigning an anti-interference group. This means:

- Anti-interference group: None (= default)  
Optical sensors on one or more modules can mutually influence each other when unfavorably arranged.
- Anti-interference group: 3 or 4  
Optical sensors on the same module with anti-interference group 3 or 4 cannot mutually influence each other. Similarly, optical sensors on different modules with anti-interference group 3 or 4 cannot mutually influence each other. You need not maintain minimum clearance between the IQ Sense devices and can, for example, align two retroreflective sensors on a single reflector.

### Operating principle

The diagram below explains the functioning of the anti-interference group parameter:

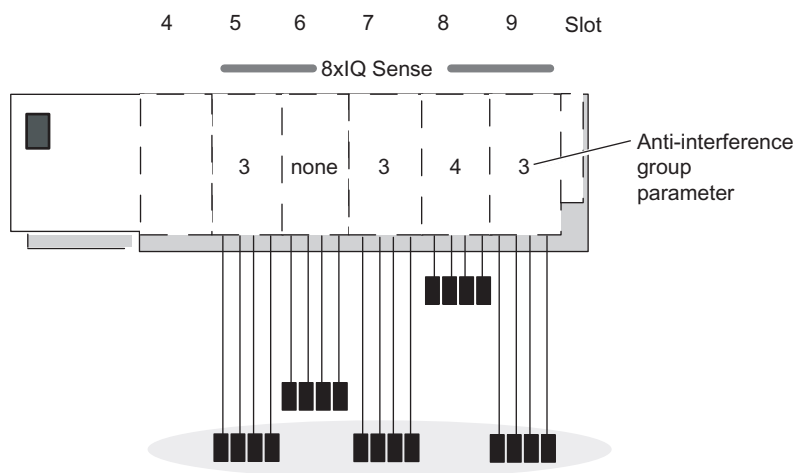

Mutual interference is only possible between the optical sensors of the modules in slot 5, 6, 7 and 9 because they are in the same anti-interference group 3 or "None" is set.

#### Note

Sensors in the same anti-interference group must be installed to maintain the minimum clearance (see sensor package insert) and to prevent mutual interference.

### Encoder type

This parameter is used to set the sensor type per channel:

- Reflex sensor or
- Diffuse sensor or
- Disabled

### Diffuse sensor

Table 8-59 Diffuse sensor

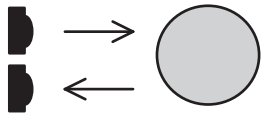
Diffuse sensor	Object	
Transmitter Receiver		Circuit state 0: No object detected, which means the object is not in the beam. The receiver does not see any light.
Transmitter Receiver		Circuit state 1: Object detected, which means the object is in the beam. The receiver does not see any light.

### Reflex sensor

Table 8-60 Reflex sensor

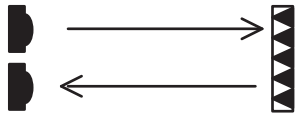
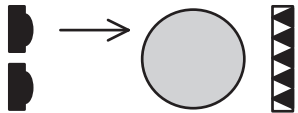
Reflex sensor	Object	
Transmitter Receiver		Circuit state 0: No object detected, which means the object is not in the beam. The receiver sees light.
Transmitter Receiver		Circuit state 1: Object detected, which means the object is in the beam. The receiver does not see any light.

### Switching hysteresis

Faults with the diffuse sensor or in the production process can result in signal wobbles. The measured value then changes the switching threshold by 100 % (object detected - object not detected). You can prevent this switching threshold wobble using the switching hysteresis parameter. This will ensure a stable output signal on the sensor.

You can assigned parameters to 5 %/10 %/20 %/50 % for switching hysteresis.

## Requirements

You can only set the switching hysteresis parameter for diffuse sensors with background fadeout.

## Operating principle

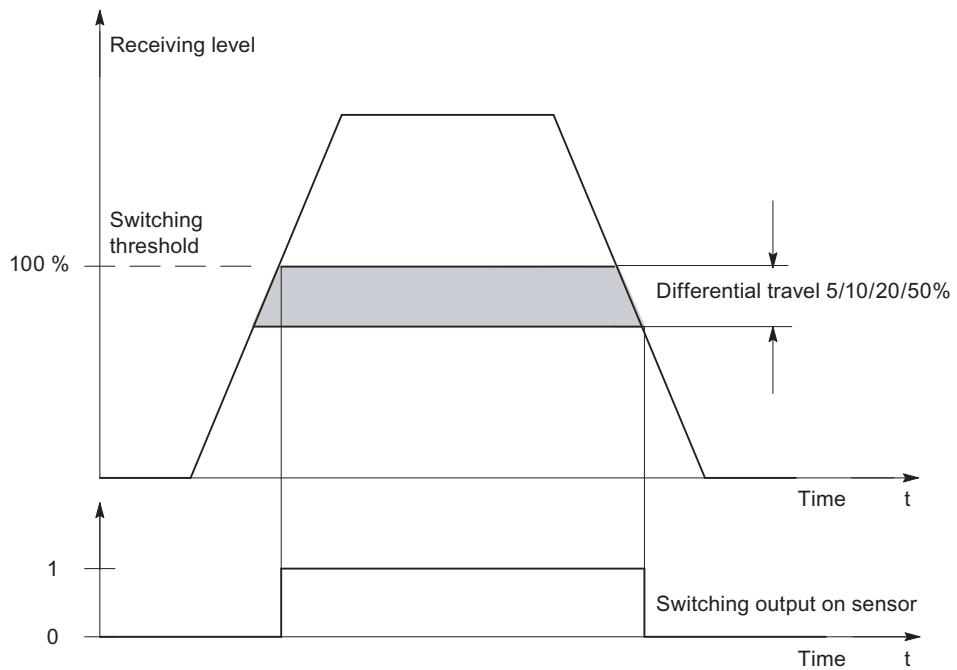

Figure 8-7 Switching hysteresis parameter

## Time function,time value

These parameters can be used to set the electronic module for its specific application.

**Operating principle**

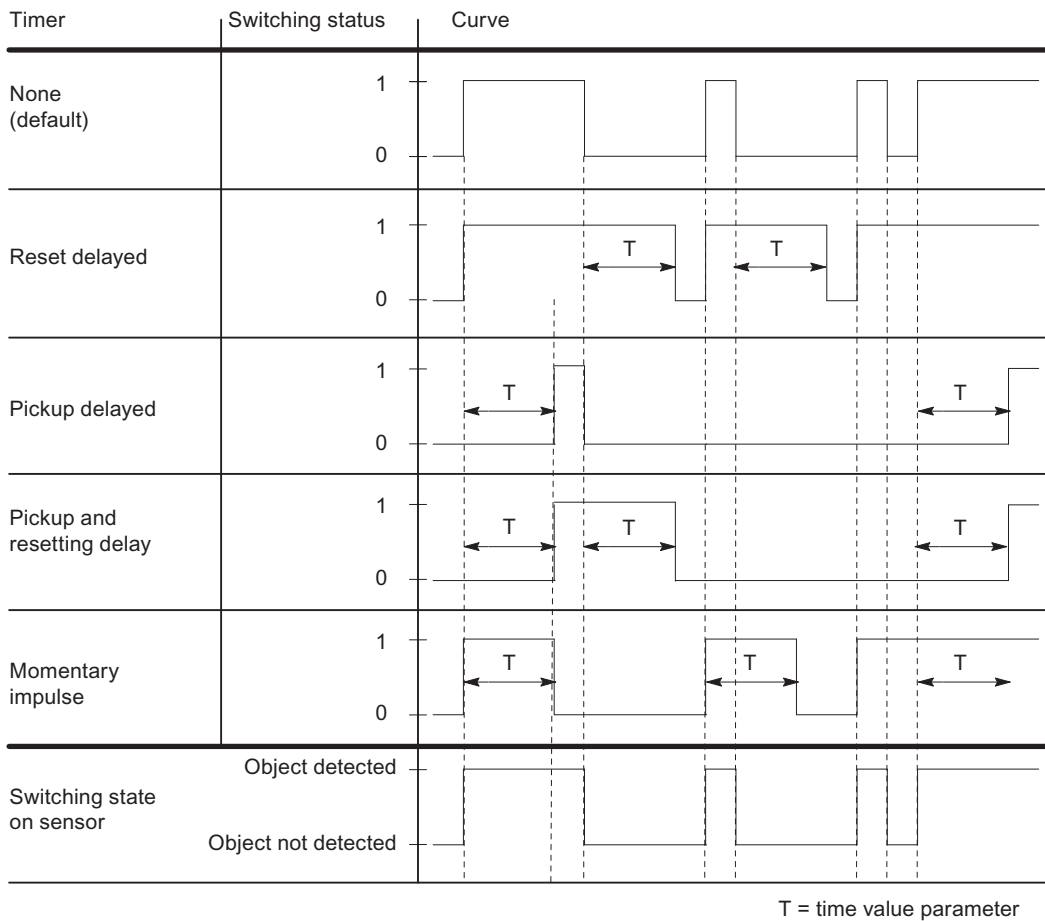

Figure 8-8 Time functions, time values parameters

**Multiplex/synchronous mode**

For the prevention of mutual influence between IQ Sense ultrasound devices in spatial proximity (devices with IQ profile ID 128), use the "Multiplex/synchronous operation" parameter.

**Settings for the multiplex/synchronous mode parameter**

Disabled: Mutual influence between IQ Sense ultrasound sensors in spatial proximity is possible (default). The cycle time is determined by the IQ Sense ultrasound sensor.

Multiplex: The IQ Sense ultrasound sensors determine the process value (distance) one after another, preventing them from affecting one another. The cycle time here is the sum of the configured synchronous cycle times of the IQ Sense ultrasound sensors that are to be multiplexed.

Synchronization: The IQ Sense ultrasound sensors determine the process value (distance) at exactly the same time, preventing them from affecting one another. The cycle time here

corresponds to the greatest configured synchronous cycle time from among the IQ Sense ultrasound sensors that are to be synchronized.

You can, for example, use synchronous operation for a curtain function in which several IQ Sense ultrasound sensors aligned in parallel share a single extended detection area. The sensors simultaneously emit an ultrasound impulse. When an object enters the detection area, the sensor nearest to the object receives the echo most quickly. The object can therefore not only be detected, it can be located as well.

### **AFI value**

Using the AFI value (application series identifier, as defined in the ISO 15693-3 international standard), transponders can be selected for different applications. Only transponders whose AFI value coincides with the value set on the sensor are processed. If a transponder has the AFI value "0", it can be identified and processed regardless of the AFI value of the sensor.

This parameter is only important if it is supported by the ident system, otherwise any value (normally "0") may be assigned.

### **Transponder type**

Depending on the type of the transponder, you must configure whether it is an ISO transponder or a vendor-specific type.

For transponders in accordance with international standard ISO 15693, the value "1" should be selected; for all other types "0" is set. Based on this setting, one of the two possible air interface drivers is selected in the sensor.

This parameter is only important if it is supported by the ID system, otherwise any value (normally "0") may be assigned.

## **ET 200S**

### **Configuring an ET 200S**

#### **Introduction**

For the ET 200S series, you can find a wide range of modules in the hardware catalog under "Distributed I/O".

#### **Assigning parameters**

For information on configuration and parameter assignment, refer to "See also".

## Frequency converters

### Use of the frequency converter

#### Frequency converters

The frequency converter ICU24 and ICU24F ( as fail-safe version) are modular design frequency converters that are completely embedded in the distributed I/O system ET 200S. For parameterization of both modules, please see the following.

#### Message frame

The message frame number and the operating mode of the module are only displayed and cannot be modified.

#### Application ID

You indicate the saved parameters in the frequency converter as a whole with the application ID. Enter an application ID from the value range 0 to 65535. During startup (or pull/plug), this ID is compared with the application ID stored on the converter.

Converters that work with identical applications are usually also identically parameterized and should be identified with the same application ID. Converters with the same application ID may be exchanged between each other. Copying of the complete parameterization of a converter to another converter, for example, via an MMC, is only accepted, if both have the same application ID.

Converters that work with different applications and are parameterized differently must be identified by different application IDs. This prevents a converter with unsuitable parameterization from starting on an incorrect slot, i.e. on the wrong application. This also prevents the parameterization that is saved in the converter from being accidentally overwritten with any parameterization that is stored on an MMC.

#### Enable diagnostic interrupt

You can enable the diagnostic interrupt for the frequency converter. If diagnostic interrupt is enabled, an OB 82 must be available in a CPU to process the diagnostic events.

#### See also

Documentation for the frequency converter (<http://support.automation.siemens.com/WW/view/en/26291825/0/en>)

## ET 200pro

### Use of the frequency converter

#### Frequency converters

The frequency converters ET 200pro FC and ET 200pro F-FC (as fail-safe version) are modularly design frequency converters that are completely embedded in the distributed I/O system ET 200pro. The following section describes how to configure the two modules.

#### Message frame

The message frame number and the operating mode of the module are only displayed and cannot be modified.

#### Application ID

You indicate the saved parameters in the frequency converter as a whole with the application ID. Enter an application ID from the value range 0 to 65535. During startup (or pull/plug), this ID is compared with the application ID stored on the converter.

Converters that work with identical applications are usually also identically configured and should be identified with the same application ID. Converters with the same application ID may be exchanged between each other. Copying of the complete configuration of a converter to another converter, for example, via an MMC, is only applied, if both have the same application ID.

Converters that work with different applications and are configured differently must be identified by different application IDs. This prevents a converter with unsuitable configuration from starting on an incorrect slot, in other words on the wrong application. This also prevents the configuration that is saved in the converter from being accidentally overwritten with any configuration that is stored on an MMC.

#### Enable diagnostic interrupt

You can enable the diagnostic interrupt for the frequency converter. If diagnostic interrupt is enabled, an OB 82 must be available in a CPU to process the diagnostic events.

## 8.2 Device and network diagnostics

### 8.2.1 Hardware diagnostics

#### 8.2.1.1 Overview of hardware diagnostics

##### Principal methods of hardware diagnostics

##### Principal methods of hardware diagnostics

Hardware diagnostics can be performed as follows:

- Using the Online and Diagnostics view
- Using the "Online Tools" task card
- Using the "Diagnostics > Device Info" area of the Inspector window
- Using diagnostics icons, for example, in the device view and the project tree

##### Structure of the Online and Diagnostics view

The Online and Diagnostics view consists of two windows alongside each other:

- The left window shows a tree structure with folders and - when you open the folder - groups.
- The right window contains detailed information on the selected folder or selected group.

The "Online access" group and the "Diagnostics" and "Functions" folders are located here:

- "Online access" group: Displays whether or not there is currently an online connection with the associated target. In addition, you can establish or disconnect the online connection.
- "Diagnostics": Contains several diagnostics groups for the selected module.
- "Functions": Contains several groups, in which you can make settings for the selected module or issue commands to the module.

##### Function and structure of the "Online Tools" task card

For modules with their own operating mode (such as CPUs), the "Online tools" task card allows you to read current diagnostics information and commands to the module.

If you selected a module without its own operating mode or if you selected several modules before activation of the "Online Tools" task card, the task card relates to the relevant CPU.

The "Online Tools" task card consists of the following panes:



- CPU control panel
- Cycle time
- Memory

---

**Note**

A pane is filled with content only if the module controls the associated functions and an online connection exists.

If there is no online connection to the respective module, the display "No online connection" appears in blue. If an existing online connection was disconnected, then "This target is not available" will be displayed.

---

### Structure or the "Diagnostics" tab of the Inspector window

The "Diagnostics" tab of the Inspector window itself consists of several tabs: Of these tabs, the following is relevant for the hardware diagnostics.

- Device information  
This tab relates to all CPUs of the project to which the online connection is established. Alarms are reported here if one or more CPUs are defective or are not in RUN mode.

### See also

Basics on task cards (Page 221)

Inspector window (Page 219)

### Determination of which of the devices that are connected online are defective

#### Overview of the defective devices

In the "Diagnostics > Device Info" area of the Inspector window you will obtain an overview of the defective devices that are or were connected online.

The "Diagnostics> Device Info" area of the Inspector window consists of the following elements:

- Header line with the number of defective devices
- Table with detailed information on each defective device

If you originate the establishment of an online connection to a device which is not reachable or reports one or more faults or is not in RUN mode, it will rank as defective.

#### Structure of the table with detailed information on the defective devices

The table consists of the following columns:

- Online status: Contains the online status as a diagnostic symbol and in words
- Operating mode: Contains the operating mode as a symbol and in words
- Device / module: Name of the affected device or the affected module

- **Message:** explains the entry of the previous column
- **Details:** The link opens the online and diagnostics view for the device, and places it in the foreground. If an online connection does not exist any longer, the link will open the connection establishment dialog.
- **Help:** The link supplies further information on the defect that has occurred.

### **See also**

Displaying diagnostics status and comparison status using icons (Page 962)

### **Displaying diagnostics status and comparison status using icons**

#### **Determining diagnostics status online and displaying using icons**

When the online connection to a device is established, the diagnostics status of the device and, if applicable, its lower-level components are determined. The operating mode of the device is also determined, where applicable.

The following is a description of the symbols that are displayed in a specific view.

- Device view
  - The associated diagnostics icon is displayed for every hardware component (except the signal board on the CPU).
  - For a hardware component with lower-level components, if there is a hardware error in at least one lower-level component, the diagnostics icon appears as follows: The hardware component's diagnostics icon has a pale appearance and the diagnostics icon "Hardware error in lower-level component" is also shown in the lower right corner.
  - For hardware components with their own operating mode, the operating mode icon is also displayed to the left of or above the diagnostics icon.
  - The following applies to modules or submodules of a Shared Device with an S7-1500 CPU: No diagnostics icons are displayed (due to the configuration as GSDML device).
- Device overview
  - The associated diagnostics icon is displayed for every hardware component.
  - For a hardware component with lower-level components, if there is a hardware error in at least one lower-level component, the diagnostics icon appears as follows: The hardware component's diagnostics icon has a pale appearance and the diagnostics icon "Hardware error in lower-level component" is also shown in the lower right corner.
  - The following applies to modules or submodules of a Shared Device with an S7-1500 CPU: For modules assigned to the CPU, the associated diagnostics icon is displayed (modules that are not assigned do not receive a diagnostics icon). The associated diagnostics icon is displayed for plug-in submodules of an assigned module (submodules that are not plug-in are not visible and therefore do not receive a diagnostics icon).
- Network view
  - The associated diagnostics icon is displayed for every device.
  - For a hardware component with lower-level components, if there is a hardware error in at least one lower-level component, the diagnostics icon appears as follows: The hardware component's diagnostics icon has a pale appearance and the diagnostics icon "Hardware error in lower-level component" is also shown in the lower right corner.
  - The following applies to modules or submodules of a Shared Device with an S7-1500 CPU: A diagnostics icon is displayed. It belongs to that part of the station that is assigned to the CPU.

8.2 Device and network diagnostics

- Network overview
  - The associated diagnostics icon is displayed for every hardware component.
  - For a hardware component with lower-level components, if there is a hardware error in at least one lower-level component, the diagnostics icon appears as follows: The hardware component's diagnostics icon has a pale appearance and the diagnostics icon "Hardware error in lower-level component" is also shown in the lower right corner.
  - The following applies to modules or submodules of a Shared Device with an S7-1500 CPU: A diagnostics icon is displayed. It belongs to that part of the station that is assigned to the CPU.
- Topology view
  - The associated diagnostics icon is displayed for every device.
  - For a hardware component with lower-level components, if there is a hardware error in at least one lower-level component, the diagnostics icon appears as follows: The hardware component's diagnostics icon has a pale appearance and the diagnostics icon "Hardware error in lower-level component" is also shown in the lower right corner.
  - The associated diagnostics icon is displayed for every port. The meaning of the individual colors is described further below.
  - Each cable between two online ports is assigned the color associated with its diagnostics status.  
The color of the cable between two ports depends on the status of the individual ports:

Color of the first port	Color of the second port	Color of the connecting cable
green	green	green
green	gray	gray
green	red	red
gray	red	red

- The following applies to modules or submodules of a Shared Device with an S7-1500 CPU: A diagnostics icon is displayed. It belongs to that part of the station that is assigned to the CPU.
- Topological overview
  - The associated diagnostics icon is displayed for every hardware component.
  - For a hardware component with lower-level components, if there is a hardware error in at least one lower-level component, the diagnostics icon appears as follows: The hardware component's diagnostics icon has a pale appearance and the diagnostics icon "Hardware error in lower-level component" is also shown in the lower right corner.
  - The following applies to modules or submodules of a Shared Device with an S7-1500 CPU: A diagnostics icon is displayed. It belongs to that part of the station that is assigned to the CPU.

- Project tree
  - The associated diagnostics icon is displayed behind every hardware component.
  - For a hardware component with lower-level components (e.g., distributed I/O, Slave\_1), if there is a hardware error in at least one lower-level component, the diagnostics icon appears as follows: The hardware component's diagnostics icon has a pale appearance and the diagnostics icon "Hardware error in lower-level component" is also shown in the lower right corner.
  - For hardware components with their own operating mode, the operating mode icon is also displayed in the top right corner of the diagnostics icon.
  - If forcing is active on a CPU, a red F is displayed at the left margin of the diagnostics icon.
  - The diagnostics icon "Hardware error in lower-level component" is displayed behind the "Local modules" folder when there is a hardware error in at least one of the associated modules.
  - The diagnostics icon "Hardware error in lower-level component" is displayed behind the "Distributed I/O" folder when there is a hardware error in at least one of the associated modules.
  - The diagnostics icon "Hardware error in lower-level component" is displayed behind the project folder when the "Hardware error on lower-level component" diagnostics icon is displayed behind at least one of the "Local modules" or "Distributed I/O" folders.
  - The following applies to modules or submodules of a Shared Device with an S7-1500 CPU: The associated diagnostics icon is displayed for modules assigned to the CPU (modules that are not assigned are grayed out and do not receive a diagnostics icon). The associated diagnostics icon is displayed for plug-in submodules of an assigned module (submodules that are not plug-in are not visible and therefore do not receive a diagnostics icon).

---





**Note**

If the diagnostic for a hardware component is "not reachable from the CPU", the diagnostics icon "Hardware error in lower-level component" is not additionally shown.













---

**Diagnostics icons for modules and devices**

The following table shows the available icons and their respective meaning.

Icon	Meaning
	The connection with a CPU is currently being established.
	The CPU is not reachable at the set address.
	The configured CPU and the CPU actually present are of incompatible types.
	On establishment of the online connection to a protected CPU, the password dialog was terminated without specification of the correct password.

8.2 Device and network diagnostics





Icon	Meaning
	No fault
	Maintenance required
	Maintenance demanded
	Error
	The module or device is deactivated.
	The module or the device cannot be reached from the CPU (valid for modules and devices below a CPU).
	Diagnostics data is not available because the current online configuration data differ from the offline configuration data.
	The configured module or device and the module or device actually present are incompatible (valid for modules or devices under a CPU).
	The configured module does not support display of the diagnostics status (valid for modules under a CPU).
	The connection is established, but the module status has not yet been determined or is unknown.
	The configured module does not support display of the diagnostics status.
	Hardware error in lower-level component: A hardware error is present in at least one lower-level hardware component. (occurs as a separate icon only in the project tree)



**Note**

Some modules, for example, the FM 450-1, are only indicated as having a problem in the case of an error if you have enabled the diagnostic interrupt when setting the module properties.

**Icons for the comparison status**

The diagnostics icons can be combined at the bottom right with additional smaller icons that indicate the result of the online/offline comparison. The following table shows the available comparison icons and their meaning.

Icon	Meaning
	Hardware error in lower-level component: The online and offline versions differ (only in the project tree) in at least one lower-level hardware component.
	Software error in lower-level component: The online and offline versions differ (only in the project tree) in at least one lower-level software component.
	Online and offline versions of the object are different
	Object only exists online

Icon	Meaning
	Object only exists offline
	Online and offline versions of the object are the same

**Note**



If both a comparison icon and the "Error in lower-level" diagnostics icon are to be displayed at the bottom right in the device view, the following rule applies: The diagnostics icon for the lower-level hardware component has a higher priority than the comparison icon. This means that a comparison icon is only displayed if the lower-level hardware components have no faults.

**Display of software errors in the project tree**

- The associated comparison icon is shown behind each block.
- Behind each folder, under which exclusively blocks are contained, the diagnostics icon "Software error in lower-level component" is displayed when there is a software error in at least one of the associated blocks.
- For a hardware component with lower-level software components, if there is no hardware error and there is an error in at least one lower-level software component, the diagnostics icon appears as follows: The hardware component's diagnostics icon has a pale appearance and the diagnostics icon "Software error in lower-level component" is also shown in the lower right corner.



**Combined diagnostics and comparison icons**





The following table shows examples of icons that are displayed in the diagnostics icon.

Icon	Meaning
	Folder contains objects whose online and offline versions differ (only in the project tree)
	Object only exists online

**Operating mode icons for CPUs and CPs**

The following table shows the available icons and their respective operating states.

Icon	Operating mode
	RUN
	STOP
	STARTUP





Icon	Operating mode
	HOLD
	DEFECTIVE
	Unknown operating mode
	The configured module does not support display of the operating mode.

**Note**

If forcing is active on a CPU, a red F is displayed on a pink background at the bottom right of the operating mode icon.

**Color marking of ports and Ethernet cables**

The following table shows the available colors and their respective meaning.

Color	Meaning
	No fault or maintenance required
	Maintenance demanded
	Communication error
	no diagnostic capability

**Start online and diagnostics view**

**Overview of possible ways of starting the Online and Diagnostics view**

You can start the Online and Diagnostics view of a module to be diagnosed at the following locations:

- Overview
- Project tree
- Device view
- Device overview
- Network view
- Network overview
- Topology view

In the following, examples are used to show how to proceed.



## Requirement

The project with the module to be diagnosed is open.

---

### Note

This requirement does not apply if you call the online and diagnostics view from the project tree after you have identified the accessible devices.

---

## Procedure

To start the online and diagnostics view of a module, follow these steps:

1. In the project tree, open the respective device folder.
2. Double click on "Online & Diagnostics".

Or:

1. In the project tree, select the respective device folder.
2. Select the "Online & Diagnostics" command in the shortcut menu or the "Online" main menu.

Or:

1. In the project tree, open the "Online access" folder.
2. Open the folder for the interface with which you want to establish the online connection.
3. Double click on "Show/Update accessible devices".
4. Select the module to be diagnosed.
5. Select the "Online & Diagnostics" command in the shortcut menu or the "Online" main menu.

Or:

1. In the project tree, open the "Local modules" folder.
2. Select the respective device or the module that is to be diagnosed.
3. Select the "Online & Diagnostics" command in the shortcut menu or the main menu.

Or:

1. Open the device view in the device configuration.
2. Select the module to be diagnosed.
3. Select the "Online & Diagnostics" command in the shortcut menu or the "Online" main menu.

Or:

1. Open the device view in the device configuration.
2. Establish an online connection to the module to be diagnosed.
3. Double-click on the diagnostics icon above the module.

Or:

## *8.2 Device and network diagnostics*

1. Open the network view in the device configuration.
2. Select the station with the module to be diagnosed.
3. Select the "Online & Diagnostics" command in the shortcut menu or the "Online" main menu.

Or:

### **Result**

The online and diagnostics view of the module to be diagnosed will be started. If an online connection to the associated CPU had previously been created, the header bar of the Online and Diagnostics view will now have an orange background.

---

#### **Note**

If no online connection exists when the online and diagnostics view is started, no online information is displayed and the display fields remain empty.

---

### **Activation of the "Online Tools" task card**

#### **Activation of the "Online Tools" task card**

You can activate this task card as follows:

1. Start the online and diagnostics view.
2. Click on the "Online Tools" task card.

Or:

1. Start the device view.
2. Click on the "Online Tools" task card.

Or:

1. Start the network view.
2. Click on the "Online Tools" task card.

### **8.2.1.2 Showing non-editable and current values of configurable module properties**

#### **Showing general properties and system-relevant information for a module**

##### **Where do I find the information I need?**

The general properties and system-relevant information for a module can be found in the "General" group in the "Diagnostics" folder in the online and diagnostics view of the module to be diagnosed.

## Structure of the "General" group

The "General" group consists of the following areas:

- Module
- Module information
- Vendor information

## "Module" area

This area shows the following data of the module:

- Short designation, for example, CPU 1214C DC/DC/DC
- Order no.
- Hardware
- Firmware
- Racks
- Slot

## "Module information" area

This area shows the following data of the module that you configured during hardware configuration:

- Module name
- Installation date (not displayed for all modules)
- Additional information (not displayed for all modules)

## "Manufacturer information" area

This area shows the following data of the module:

- Manufacturer
- Serial number
- Profile: Profile ID as hexadecimal number

---

### **Note**

You will find the corresponding profile name in the profile ID table for PROFIBUS International (see "[www.profibus.com](http://www.profibus.com)").

---

- Profile details: Profile-specific type as hexadecimal number

---

### **Note**

You will find the corresponding profile-specific type name in the profile-specific type table for PROFIBUS International (see "[www.profibus.com](http://www.profibus.com)").

---

## Display configured cycle times

### Where do I find the information I need?

The required information can be found in the following places:

- In the "Cycle time" group of the "Diagnostics" folder in the Online and Diagnostics view of the module to be diagnosed.
- In the "Cycle time" pane of the "Online Tools" task card

### Structure of the "Cycle time" group in the "Diagnostics" folder of the Online and Diagnostics view

The "Cycle time" group consists of the following areas:

- Cycle time diagram (graphical display of the assigned and measured cycle times)
- Cycle time configured (display of the assigned cycle times as absolute values)
- Cycle times measured (display of the measured cycle times as absolute values)

### Structure of the "Cycle time" pane of the "Online Tools" task card

The "Cycle time" pane displays the cycle time diagram and below it the measured cycle times as absolute values.

### Assigned cycle times

The following assigned cycle times are displayed in the cycle time diagram and in the "Cycle time configured" area.

- Minimum cycle time
- Maximum cycle time

In the cycle time diagram, the minimum cycle time and the maximum cycle time correspond to the two markings on the time axis.

In the "Cycle time configured" area, the assigned cycle times are displayed as absolute values.

## Show interfaces and interface properties of a module

### Where do I find the information I need?

The interfaces and interface properties of a module can be found in the "Diagnostics" folder in the Online and Diagnostics view of the module to be diagnosed in the following group:

- PROFINET interface

### "PROFINET interface" group

This group is divided into the following areas:

- "Ethernet address" with the "Network connection" and "IP Parameters" subareas
- "Ports"

### "Network connection" subarea of the "Ethernet address" area

This subarea shows the following data for the module:

- MAC Address:  
MAC address of the interface.  
The MAC address consists of two parts. The first part ("Basic MAC address") identifies the manufacturer (Siemens, 3COM, ...). The second part of the MAC address differentiates between the various Ethernet devices. Each Ethernet module is assigned a unique MAC address.

### "IP Parameters" subarea of the "Ethernet address" area

This subarea shows the following data for the module:

- IP address:  
Internet protocol address of the device on the bus (TCP/IP)
- Subnet mask:  
The subnet mask shows which part of the IP address determines the membership of a particular sub-network.
- Default router:  
If the subnet is connected via a router to other subnets, the IP address of the default router must be known. This is the only way a datagram can be forwarded with a non-matching subnet address.
- IP settings:  
Identifier for the path by which the device has obtained its IP settings (IP address, subnet mask, default router).

Identifier	Meaning
0	IP address is not initialized
1	By configuration (i.e., by the configuration loaded to the device from the device or network view)

Identifier	Meaning
2	Via the "Assign IP address" group of the Online and Diagnostics view
3	Via the DHCP server (i.e., the IP parameters are obtained by a special service from a DHCP server (Dynamic Host Configuration Protocol) and assigned for a limited time)

- IP setting time:  
Time stamp of the last change to the IP address directly through the Ethernet connection of the module

**"Ports" area**

This area shows the following data for the module:

- Ethernet ports  
Physical properties of the PROFINET interface

Properties of the PROFINET interface	Meaning
Port no.	Port number The short description of interface (X + interface no.) and port (P + port no.) is specified in parentheses. An "R" in the short description of a port means that it is a ring port.
Status	Displays the status of the port LINK LED. <ul style="list-style-type: none"><li>• Status "OK" means another device (such as a switch) is connected to the port and the physical connection is available.</li><li>• Status "disconnected" means no other device is connected to the port.</li><li>• Status "deactivated" means that access to the port is blocked.</li></ul>
Settings	Individual network settings of the device (automatic or manual)
Operating mode	Network settings for the speed and the transmission process

If you select a line in the port table, additional help information will be provided for the corresponding port.

## Displaying IO controllers that access modules of a Shared Device

### Where do I find the information I need?

The display of those IO controllers that access the modules of a Shared Device can be found in the Online and Diagnostics view of the interface module of the Shared Device in the "Diagnostics" folder in the following area of the "PROFINET interface" group:

- IO controller

## Displaying sync domain properties of a PROFINET device

### Where do I find the information I need?

The sync domain properties of a PROFINET device can be found in the following area of the "PROFINET interface" group in the "Diagnostics" folder of the Online and Diagnostics view of the device to be diagnosed:

- Domain

### "Domain" area

This area is divided into the following subareas:

- Sync domain
- MRP domain

### What is a sync domain?

A sync domain is a group of PROFINET devices that are synchronized to a common clock. Exactly one device has the role of the sync master (clock generator); all other devices assume the role of a sync slave. The sync master is usually an IO controller or a switch.

Non-synchronized PROFINET devices are not part of a sync domain.

### "Sync domain" subarea of the "Domain" area

This subarea shows the following properties of the sync domain:

- Name:  
Name of sync domain
- Role:  
Role of the PROFINET device in the sync domain. The following roles are possible:
  - Sync master
  - Sync slave
- Synchronization interval:  
Interval at which the synchronization is performed

- Send clock  
Smallest possible send interval for the data exchange
- Jitter accuracy of the send clock
- Reserved bandwidth for cyclic communication

## Displaying MRP domain properties of a PROFINET device

### Where do I find the information I need?

The MRP domain properties of a PROFINET device can be found in the following area of the "PROFINET interface" group in the "Diagnostics" folder of the Online and Diagnostics view of the device to be diagnosed:

- Domain

### "Domain" area

This area is divided into the following subareas:

- Sync domain
- MRP domain

### What is an MRP domain?

The Media Redundancy Protocol (MRP) enables redundant networks to be structured. Redundant transmission paths (ring topology) ensure that, if one transmission path fails, an alternative communication path is available. The PROFINET devices that are part of this redundant network form an MRP domain.

### "MRP domain" subarea of the "Domain" area

This subarea shows the following properties of the MRP domain:

- Name:  
Name of MRP domain
- Role:  
Role of the PROFINET device in the MRP domain. The following roles are possible:
  - Manager
  - Manager (Auto)
  - Client
  - Not a device of the ring
- Ring port 1:  
The port of the PROFINET device that has the "Ring port 1" property



- Ring port 2:  
The port of the PROFINET device that has the "Ring port 2" property
- Status of the MRP ring:  
Indicates whether the ring is interrupted ("open" status) or not ("closed" status).

## Displaying current firmware of a module

### Displaying firmware

You can display the currently installed firmware of a module.

### Requirements

- The module supports a firmware update.
- The module is connected online.

### Procedure

To display the current firmware, follow these steps:

1. Open the module in the Online and Diagnostics view.
2. Select the "Firmware update" group in the "Functions" folder.
3. You read off the current firmware in the "Online data" area under "Firmware".

## 8.2.1.3 Showing the current values of dynamic modules properties

### Display measured cycle times

#### Where do I find the information I need?

The measured cycle times can be found at each of the following places:

- In the "Cycle time" group of the "Diagnostics" folder in the Online and Diagnostics view of the module to be diagnosed.
- In the "Cycle time" pane of the "Online Tools" task card

#### Structure of the "Cycle time" group in the "Diagnostics" folder of the Online and Diagnostics view

The "Cycle time" group consists of the following areas:

- Cycle time diagram (graphical display of the assigned and measured cycle times)
- Cycle time configured (display of the assigned cycle times as absolute values)
- Cycle times measured (display of the measured cycle times as absolute values)

### Structure of the "Cycle time" pane of the "Online Tools" task card

The "Cycle time" pane displays the cycle time diagram and below it the measured cycle times as absolute values.

### Graphical display of the measured cycle times

The following measured cycle times are displayed in the cycle time diagram:

- Shortest cycle time: Duration of the shortest cycle since the last transition from STOP to RUN  
This corresponds to the dashed gray arrow on the left in the diagram.
- Current / last cycle time: Duration of the last cycle  
This corresponds to the green arrow in the diagram. If the current / last cycle time exceeds the maximum cycle time, the arrow will turn red.

---

#### Note

If the duration of the last cycle comes close to the maximum cycle time, it may be possible that it will be exceeded. Depending on the CPU type, parameter assignment and your user program, the CPU can switch to STOP mode. If for instance you are monitoring the tags in your program, this will increase the cycle time.

If the cycle lasts longer than double the maximum cycle time, and you do not restart the maximum cycle time in the user program (by calling the extended RE\_TRIGR) instruction, the CPU will switch to STOP mode.

---

- Longest cycle time: Duration of the longest cycle since the last transition from STOP to RUN.  
This corresponds to the dashed blue arrow on the right in the diagram.

A blue band extends between the two dashed lines; this band corresponds to the entire range of the measured cycle times. If a measured cycle time is greater than the maximum cycle time, the portion of the band that lies outside the assigned limits will be colored red.

### Display of the measured cycle times as absolute values

The following measured times are displayed in the "Cycle times measured" area and in the "Cycle time" pane.

- Shortest cycle time since the last transition from STOP to RUN.
- Current/last cycle time:
- Longest cycle time since the last transition from STOP to RUN.

### Showing the current status of the LEDs of a CPU

#### Where do I find the information I need?

The current status of the LEDs of a CPU can be found in the display area of the "CPU control panel" pane of the "Online tools" task card.

### Display area of the "CPU control panel" pane of the "Online Tools" task card

This area contains the following displays:

- Station name and CPU type (short designation)
- RUN / STOP (corresponds to the "RUN / STOP" LED of the CPU)
- ERROR (corresponds to the "ERROR" LED on the CPU)
- MAINT (corresponds to the "MAINT" LED on the CPU)

### Showing fill levels of all types of memory on a CPU

#### Where do I find the information I need?

The fill levels of all types of memory on a CPU can be found on the following two pages:

- In the display area of the "Memory" group in the "Diagnostics" folder in the online and diagnostics view of the module to be diagnosed
- In the display area of the "Memory" pane on the "Online Tools" task card

### Display area of the "Memory" group in the "Diagnostics" folder of the online and diagnostics view

This area contains the current memory utilization of the associated module and details of the individual memory areas.

The memory utilization is shown both as a bar diagram and as a numerical value (percentage).

The following memory utilizations are shown:

- Load memory  
If no memory card is inserted, the internal load memory is displayed.  
If a memory card is inserted, the operating system only uses the inserted load memory as the load memory. This is displayed here.
- Work memory
- Retentive memory

### Display area of the "Memory" pane of the "Online Tools" task card

This area contains the current memory utilization of the associated module. The available memory is shown both as a bar diagram and as a numerical value (percentage). The numerical value is rounded to an integer value.

---

#### **Note**

If less than 1% of a memory area is utilized, the available portion of this memory area is shown as "99%".

---

The following memory utilizations are shown:

- Load memory  
If no memory card is inserted, the internal load memory is displayed.  
If a memory card is inserted, the operating system only uses the inserted load memory as the load memory. This is displayed here.
- Work memory
- Retentive memory

**See also**

- Load memory (Page 843)
- Work memory (Page 843)
- Retentive memory areas (Page 845)

**Displaying fill level of all types of memory of an S7-1500 CPU**

**Where do I find the information I need?**

The fill levels of all types of memory of an S7-1500 CPU can be found at the following two places:

- In the display area of the "Memory" group in the "Diagnostics" folder in the online and diagnostics view of the module to be diagnosed
- In the display area of the "Memory" pane on the "Online Tools" task card

**Display area of the "Memory" group in the "Diagnostics" folder of the online and diagnostics view**

This area contains the current memory utilization of the associated module and details of the individual memory areas.

The memory utilization is shown both as a bar diagram and as a numerical value (percentage).

The following memory utilizations are shown:

- Load memory

---

**Note**

The load memory is located on the SIMATIC memory card.

---

- Code work memory: work memory for program code
- Data work memory: work memory for data blocks
- Retentive memory

### Display area of the "Memory" pane of the "Online Tools" task card

This area contains the current memory utilization of the associated module. The available memory is shown both as a bar diagram and as a numerical value (percentage). The numerical value is rounded to an integer value.

---

#### **Note**

If less than 1% of a memory area is utilized, the available portion of this memory area is shown as "99%".

---

The following memory utilizations are shown:

- Load memory

---

#### **Note**

The load memory is located on the SIMATIC memory card.

---

- Code work memory: work memory for program code
- Data work memory: work memory for data blocks
- Retentive memory

## 8.2.1.4 Checking a module for defects

### Determining the diagnostic status of a module

#### Where is the diagnostics status of a module displayed?

The diagnostic status of a module is displayed in the "Diagnostic status" group in the "Diagnostics" folder in the online and diagnostics view of the module to be diagnosed.

The "Diagnostics status" group consists of the following areas:

- Status
- Standard diagnostics (for S7-300 and S7-400 only for non-CPU modules)

### "Status" area

The following status information is displayed in this area:

- Status of the module as viewed by the CPU, for example:
  - Module available and OK.
  - Module defective.  
If the module experiences a fault and you have enabled the diagnostic error interrupt during configuration, the "Module defective" status is displayed.
  - Module configured, but not available.  
Example: Diagnostics data is not available because the current online configuration differs from the offline configuration.
- Detected differences between the configured and the inserted module. Provided it can be ascertained, the order number will be displayed for the set and actual type.

The scope of the displayed information depends on the selected module.

### "Standard diagnostics" area

The following diagnostics information for non-CPU modules is displayed in this area:

- Internal and external faults that relate to the overall module
- Associated diagnostics events

Examples of such diagnostics information are:

- Entire backup failed
- Module defective

---

#### **Note**

##### **Diagnostic interrupts**

A diagnostic interrupt can be reported to the CPU only if the module has diagnostic interrupt capability and the diagnostic interrupt has been enabled.

The display of the diagnostic interrupt is a snapshot. Sporadic module defects can be identified in the diagnostics buffer of the respective CPU.

---

## Reading out the diagnostics buffer of a CPU

### Where do you read out the diagnostics buffer of a CPU?

You read out the diagnostics buffer of a CPU in the "Diagnostics buffer" group in the "Diagnostics" folder in the Online and Diagnostics view.

## Structure of the "Diagnostics buffer" group

The "Diagnostics buffer" group consists of the following areas:

- "Events"
- "Settings"

## Diagnostics buffer

The diagnostics buffer is used as a log file for the diagnostics events that occurred on the CPU and the modules assigned to it. These are entered in the order of their occurrence, with the latest event shown at the top.

## "Events" area

The "Events" area consists of the following elements:

- Check box "CPU time stamp takes into account local PG/PC time"
- Event table
- "Freeze display" or "Cancel freeze" button
- Details of the event: Event no., event ID, description, time stamp, incoming/outgoing information
- "Help on event", "Open in editor", "Save as ..." buttons

## Check box "CPU time stamp takes into account local PG/PC time"

If you have not activated the check box, the diagnostics buffer entries are shown with the module time.

If you have activated the check box, the diagnostics buffer entries are shown with the time given by the following formula:

Displayed time = module time + time zone offset on your programming device / PC

This requires the module time to be identical to UTC.

You should use this setting if you wish to see the times of the diagnostics buffer entries for the module expressed in the local time of your programming device / PC.

Selecting or clearing the check box immediately changes the times displayed for the diagnostics buffer entries.

---

### Note

If you use the "WR\_SYS\_T" instruction in your program or if you set the real-time clock of the CPU using an HMI device instead of using UTC, we recommend that you clear the "CPU time stamp takes into account local PG/PC time" check box. In this case, the module time is the sole time of concern.

---

### Event table

The following information is displayed in the table for each diagnostics event:

- Sequential number of the entry  
The first entry contains the latest event.
- Date and time of the diagnostics event  
If no date and time are shown, the module has no integral clock.
- Short name of the event and, if applicable, the reaction of the CPU

---





**Note**

If an individual parameter of a text cannot be determined, the character string "###" is shown in its place.





If no display text is yet available for new modules or new events, the numbers of the events and the individual parameters are stated as hexadecimal values.

---

- Icon for information related to incoming/outgoing status  
The following table shows the available icons and their respective meaning.

Icon	Meaning
	Incoming event
	Outgoing event
	Incoming event to which there is no independent outgoing event
	User-defined diagnostics event

- Only for S7-1200 and S7-1500 CPUs: Icon for the severity of the event  
The following table shows the available icons and their respective meaning.

Icon	Meaning
	No maintenance and/or no fault
	Maintenance required
	Maintenance demanded
	Error

You can change the order of the columns, adjust the column widths and remove and add individual columns in the event table. In addition, you can sort as follows: by sequential number, by "Date and time" and by "Event".

### "Freeze display" or "Cancel freeze" button

The "Freeze display" or "Cancel freeze" button is only enabled when there is an online connection to the CPU.

The default setting is "Freeze display".

The following happens when you click the "Freeze display" button:



- The current display of the diagnostics buffer entries is frozen.
- The labeling of the button changes to "Cancel freeze".

If an error has occurred in your system, diagnostics events can occur very quickly in succession. This produces a high update rate on the display. Freezing the display allows you to calmly examine the situation in more detail.

If the display is frozen and you click the "Cancel freeze" button, the following happens:

- The display of the diagnostics buffer entries is updated again.
- The labeling of the button changes to "Freeze display".

---

**Note**

If you freeze the diagnostics buffer display, the CPU continues to enter events in the diagnostics buffer.

---

### Details of the event

If you select a line in the list of events, you obtain detailed information on the respective event:

- Sequential number of the event in the diagnostics buffer
- Event ID
- Description of the event with event-dependent additional information. Examples of this additional information:
  - Command that caused the event
  - Operating mode switch caused by the diagnostics event
- Time stamp
- Only for S7-1200 and S7-1500 CPUs: Associated I&M data (module, rack/slot, plant designation, location designation)
- Priority of the event
- Information on whether the event is an incoming or outgoing event

### "Help on event" button

If you click on this button, the selected event is explained in more detail and any remedies given.

---

**Note**

For a small number of events, the "Help on event" button is grayed out.

---

### "Open in editor" button

The following table shows if the "Open block" button is active and which function it conceals.

When is the "Open in editor" button enabled?	What happens when you click this button?
If the diagnostics event references the relative address of a block. This is the address of the command that caused the event.	The "Open in editor" function opens the referenced block in the offline view at the programming instruction that causes the error. This allows you to check and, if necessary, change the source code of the block at the specified place and then download it again to the CPU.
If the diagnostics event was triggered by a module.	The "Open in editor" function opens the Device view of the module involved.

### "Save as ..." button

If you click this button, the content of the diagnostics buffer is saved in a text file. "Diagnostics", depending on the language, with the extension ".txt" is suggested as the file name. You can however change this name.

### "Settings" area

The "Settings" area consists of the following elements:

- "Display events" list
- "Apply settings as default" button
- "Output event information in hexadecimal format" check box

### "Display events:" list

There is an check box in this list for every event class (default setting: all check boxes are selected). If you clear a check box, the events of that event class is no longer displayed in the "Events" area. Reselecting the check box displays the associated events once again.

### "Apply settings as default" button

If you click this button, the settings are also applied to future occasions when the "Events" tab is opened.

### "Output event information in hexadecimal format" check box

If you select the check box, the event IDs in the Events list of the "Events" area is displayed in hexadecimal format. If you clear the check box, the event information is given in text form.

### See also

Basic information on the diagnostics buffer (Page 1003)

## **Saving service data**

### **Purpose**

In the event of servicing it may be possible that the SIEMENS Customer Support requires very special information about the state of a module of your system for diagnostic purposes.

If such a case occurs in your system, you will be asked by Customer Support to save the service data of the module and send the resulting file to them.

### **Where do you carry out the saving of service data of a module?**

You carry out the saving of service data of a module in its online and diagnostics view at the following points: In the "Functions" folder in the "Save service data" group"

The "Save service data" group consists of the following areas:

- Online data
- Saving service data

### **"Online data" area**

This area shows the following data for the module:

- Order number
- Firmware version
- Module name (you configured this while configuring the hardware.)
- Rack
- Slot

### **"Save service data" area**

Proceed as follows to create and save a file with special service data:

1. Select the point in the file system at which you want to save the file:
  - You use the path preset in the "Path" field.
  - Click the three-dot (browse) button. In the dialog that opens specify the desired path and enter the file name.
2. Click the "Save data" button.

### 8.2.1.5 Changing the properties of a module or the programming device/PC

#### Changing the mode of a CPU

##### Requirement

There is an online connection to the CPU whose mode you want to change.

##### Procedure

To change the mode of the CPU, follow these steps:

1. Enable the "Online tools" task card of the CPU.
2. Click the "RUN" button in the "CPU control panel" pane if you want to change the CPU to RUN mode or the "STOP" button if you want to change the CPU to STOP mode.

---

**Note**

The only button active is the one that can be selected in the current operating mode of the CPU.

---

3. Acknowledge the confirmation prompt with "OK".

Or:

1. Open the "Online" menu.
2. Choose the "Start CPU" menu command if you want to set the CPU to RUN mode and "Stop CPU" if you want to set the CPU to STOP mode.

---

**Note**

The only button that is active is the one that can be chosen in the current operating mode of the CPU.

---

3. Acknowledge the confirmation prompt with "OK".

Or:

1. Click the "Start CPU" button in the toolbar if you want to set the CPU to RUN mode and the "Stop CPU" button if you want to set the CPU to STOP mode.

---

**Note**

The only button that is active is the one that can be chosen in the current operating mode of the CPU.

---

2. Acknowledge the confirmation prompt with "OK".

##### Result

The CPU will be switched to the required operating mode.

## Performing a memory reset

### Requirement

- There is an online connection to the CPU on which the memory reset is to be performed.
- The CPU is in STOP mode.

---

#### Note

If the CPU is still in RUN mode and you start the memory reset, you can place it in STOP mode after acknowledging a confirmation prompt.

---

### Procedure

To perform a memory reset on a CPU, follow these steps:

1. Enable the "Online Tools" task card of the CPU.
2. Click the "MRES" button in the "CPU control panel" pane.
3. Acknowledge the confirmation prompt with "OK".

### Result

The CPU is switched to STOP mode, if necessary, and the memory reset is performed on the CPU.

### See also

Basics of a memory reset (Page 841)

## Determining and setting the time of day on a CPU

### Where do I find the functions I need?

You determine and change the time of day on a CPU in the "Set time of day" group in the "Functions" folder of the Online and Diagnostics view. This requires an online connection.

### Structure of the "Set time of day" group

The "Set time of day" group consists of the following areas:

- Area for reading out and setting the time of day
- Time system (This area does not exist for S7-1200 and will not be examined here.)

### Structure of the area for reading out and setting the time of day

This area consists of the following parts:

- Programming device / PC time  
Here the time zone setting, the current date and the current time setting of your programming device / PC are displayed.
- Module time  
Here the date and time values currently read from the module (for example the CPU), are converted to local time and date and displayed.  
If the "Take from PG/PC" check box is selected, when you click the "Apply" button, the date and the PG/PC time converted to UTC are transferred to the module.  
If the "Take from PG/PC" check box is not selected, you can assign the date and time for the integrated clock of the module. After clicking the "Apply" button, the date and the time recalculated to UTC time are transferred to the module.

### Updating the firmware of a module

#### Performing a firmware update

Using firmware files, you can update the firmware of a module.

#### Requirements

- The module is connected online.
- The module supports a firmware update.
- For those modules that require a supply voltage to perform the firmware update correctly: The supply voltage of the module is secured. For details, see the documentation of the module.

#### Procedure

To perform a firmware update, follow these steps:

1. Open the module in the Online and Diagnostics view.
2. Select the "Firmware update" group in the "Functions" folder.

---

**Note**

For S7-1500-CPU's, this group is subdivided into "PLC" and "Display".

---

3. Click the "Browse" button in the "Firmware update" area in order to select the path to the firmware update files.
4. Select one of these files. The table then lists all modules for which an update is possible with the selected firmware file.

5. Optional: Select the "Run firmware after update" check box to reset the module after the load operation and to start the new firmware.
6. Click the "Start update" button. If the selected file can be interpreted by the module, it is downloaded to the module. If the mode of the CPU needs to be changed, you will be prompted to do this in dialogs.

**WARNING****Invalid plant states possible**

An S7-1500 CPU immediately goes to STOP mode when you start the firmware update, which can have an effect on the operation of an online process or a machine. Unexpected operation of a process or a machine can result in severe or fatal injuries and/or damage to property.

**Note**

After you have run a firmware update, you will need to replace the module involved with the same module with the current firmware version in the hardware configuration of your project. The engineering configuration then matches the actual physical configuration again.

**"Run firmware after update" check box**

If you have not selected the "Run firmware after update" check box, the previous firmware remains active until the module is reset (for example by cycling power). The new firmware only becomes active after the module has been reset.

If you have selected the check box, the module is automatically reset after the firmware has been downloaded and it then continues with the new firmware.

Activating the firmware following the update has the following consequences:

- A station executes a restart. This means that all modules in the station become unavailable.
- If the corresponding CPU is in RUN, activating the firmware can lead to access errors or other problems in the user program and might even mean that the CPU remains permanently in STOP.

**Note**

For some CPUs, the "Run firmware after update" check box is grayed out and deactivated. In this case, you must restart the CPU manually.

For S7-1500 CPUs, the "Run firmware after update" check box is grayed out and selected. In this case, the new firmware is activated immediately after the download operation.

**See also**

Replacing a hardware component (Page 427)

## Resetting an S7-1200 CPU to factory settings

### Requirement

- There is no memory card inserted in the CPU.
- There is an online connection to the CPU that you want to reset to the factory settings.
- The CPU is in STOP mode.

---

#### Note

If the CPU is still in RUN mode and you start the reset operation, you can place it in STOP mode by answering the security prompt with yes.

---

### Procedure

To reset an S7-1200 CPU to factory settings, follow these steps:

1. Open the Online and Diagnostics view of the CPU.
2. Select the "Reset to factory settings" group in the "Functions" folder.
3. Select the "Keep IP address" check box if you want to keep the IP address or the "Delete IP address" check box if you want to delete the IP address.

---

#### Note

The two check boxes mentioned are only available if the module to be reset is able to choose whether to retain or delete the IP address.

---

4. Click the "Reset" button.
5. Acknowledge the confirmation prompt with "OK".

### Result

The module is switched to STOP mode if necessary and the settings are then reset to factory settings. This means:

- The work memory and the internal load memory and all operand areas are cleared.
- All parameters are reset to their defaults.
- The diagnostic buffer is cleared.
- The time is reset.
- The IP address is kept or deleted depending on which setting you made.



## Resetting an S7-1500 CPU to factory settings

### Requirement

- If you start a reset to factory settings from the project context, an online connection to the relevant CPU must exist.
- The relevant CPU is in STOP mode.

---

#### Note

If the CPU is still in RUN mode and you start the reset operation, you can place it in STOP mode after acknowledging a confirmation prompt.

---

### Procedure

To reset an S7-1500 CPU to factory settings, follow these steps:

1. Open the Online and Diagnostics view of the CPU (either from the project context or via "Accessible devices").
2. Select the "Reset to factory settings" group in the "Functions" folder.
3. Select the "Keep IP address" check box if you want to keep the IP address or the "Delete IP address" check box if you want to delete the IP address.

---

#### Note

With "Delete IP address", all IP addresses are deleted. This applies regardless of how you created the online connection.

If a memory card is inserted, selecting the "Delete IP address" option causes the following: The IP addresses are deleted and the CPU is reset to factory settings. Then, the configuration (including IP addresses) that is stored on the memory card is transferred into the CPU (see below). If the memory card was formatted before resetting to factory settings or if it is empty, no IP address is transferred into the CPU.

---

4. Click the "Reset" button.
5. Acknowledge the confirmation prompt with "OK".

### Result

The module is switched to STOP mode if necessary and the settings are then reset to factory settings. This means:

- The work memory and the internal retentive system memory and all operand areas are cleared.
- All parameters are reset to their defaults.
- The diagnostic buffer is cleared.
- The time of day is reset.
- The I&M data are deleted except for I&M0 data.

- The runtime meters are reset.
- The IP address is kept or deleted depending on which setting you made.
- If a memory card was inserted prior to the reset to factory settings, the configuration contained on the memory card (hardware and software) is downloaded to the CPU.

## Formatting an S7-1500 memory card

### Requirement

- If you start the formatting of the memory card from the project context, an online connection to the relevant CPU must exist.
- The relevant CPU is in STOP mode.

---

#### Note

If the CPU is still in RUN mode and you start a formatting operation, you can place it in STOP mode after acknowledging a confirmation prompt.

---

### Procedure

To format an S7-1500 memory card, follow these steps:

1. Open the Online and Diagnostics view of the CPU (either from the project context or via "Accessible devices").
2. Select the "Format memory card" group in the "Functions" folder.
3. Click the "Format" button.
4. Answer the safety prompt with "Yes".

### Result

- The memory card is formatted.
- The CPU is temporarily unavailable.
- The project data on the CPU are deleted with the exception of the IP address.
- If you start the formatting of the memory card from the project context, the Online and Diagnostics view remains open. If formatting is started via "Accessible devices", the Online and Diagnostics view will close.

## Assigning an IP address to a PROFINET IO device

### Basic information on assigning an IP address to a PROFINET IO device

#### Overview

All PROFINET IO devices work with the TCP/IP protocol and therefore require an IP address for operation on Industrial Ethernet. Once an IP address has been assigned to an IO device, it can be accessed via this address. You can then download configuration data or perform diagnostics, for example.

#### Requirement

- The Ethernet LAN connection must already be established.
- The Ethernet interface of your programming device or PC must be accessible.
- The IO device that is to be assigned an IP address must be in the same IP band as the programming device or PC.

### Starting the address assignment via "Accessible devices"

#### Requirement

- You have opened the Online and Diagnostics view of the PROFINET IO device using "Update accessible devices" (in the project tree) or "Accessible devices..." ("Online" menu).

#### Procedure

1. Open the "Functions" folder and the "Assign IP address" group inside this folder. The "MAC address" field displays the MAC address of the PROFINET IO device. The "Accessible devices" button is grayed out.
2. Enter the desired IP address.
3. Enter the subnet mask.
4. If a router is to be used, select the "Use router" check box and enter its IP address.
5. Click the "Assign IP address" button.

## Result

The IP address is permanently assigned to the IO device or to the relevant PROFINET interface of the IO device. It is retained even through a startup or a power failure.

---

### Note

For an S7-1500 CPU, you can also use the above-described method to change the IP address of a PROFINET interface, if a project has already been downloaded to the CPU via this interface. This overwrites the IP address downloaded via the project.

---

## See also

Retentivity of IP address parameters and device names (Page 808)

## Starting the address assignment from the project context

### Requirement

- An online connection to the PROFINET IO device exists.
- You have opened the Online and Diagnostics view of the PROFINET IO device from the project context.
- The PROFINET IO device is not assigned to any IO controller.

### Procedure

1. Open the "Functions" folder and the "Assign IP address" group inside this folder.
2. Click the "Accessible devices" button in order to identify the devices that can be accessed.  
Note: For an S7-1500 CPU, there are two entries here because it has two PROFINET interfaces.
3. Select the IO device. The "IP address" field, "Subnet mask" field, "Use router" check box and "Router address" field are grayed out and contain the node properties you used to establish the current online access.
4. Click the "Assign IP address" button.

## Result

The IP address is permanently assigned to the IO device or to the relevant PROFINET interface of the IO device. It is retained even through a startup or a power failure.

## See also

Retentivity of IP address parameters and device names (Page 808)

## Assigning a PROFINET device name

### Basic information on assigning a name to a PROFINET IO device

#### Device name

Before an IO device can be addressed by an IO controller, it must have a device name. This procedure was chosen for PROFINET because names are easier to handle than complex IP addresses.

Assigning a device name to a PROFINET IO device is comparable to setting the PROFIBUS address for a DP slave.

An IO device has no device name in its delivery state. For an IO controller to address an IO device, it must first be assigned a device name using the programming device or PC. It is now ready to transfer the configuration information including the IP address during startup or exchange user data in cyclic operation.

#### Rules for the device name

The device name is subject to the following limitations:

- Restricted to a total of 240 characters (lower case letters, numbers, dash, or dot)
- A name component within the device name, which is a character string between two dots, must not exceed 63 characters.
- No special characters such as umlauts, brackets, underscore, slash, blank space, etc. The only special character permitted is the dash.
- The device name must not begin or end with the "-" character.
- The device name must not begin with a number.
- The device name form n.n.n.n (n = 0, ... 999) is not permitted.
- The device name must not begin with the string "port-xyz" or "port-xyz-abcde" (a, b, c, d, e, x, y, z = 0, ... 9).

#### Where do I find the function I am seeking?

To assign a name to a PROFINET IO device, go to the "Assign name" group in the "Functions" folder of the Online and Diagnostics view for the device. The user interface for this group differs depending on how you open the Online and Diagnostics view:

- Open via "Accessible devices"
- Open from the project context

#### See also

Starting the name assignment via "Accessible devices" (Page 998)

Calling the name assignment function from within the project context (Page 998)

## Starting the name assignment via "Accessible devices"

### Requirement

- You have opened the Online and Diagnostics view of the PROFINET IO device using "Update accessible devices" (in the project tree) or "Accessible devices..." ("Online" menu).

### Procedure

1. Open the "Functions" folder and the "Assign name" group inside this folder. The "Type" field displays the module type of the PROFINET IO device.
2. Enter the required device name in the "PROFINET device name" input box.
3. Optional: Select the "LED flashes" check box in order to run an LED flash test on the PROFINET IO device. In this way you verify that you are naming the desired IO device.

---

#### Note

The LED flash test is not supported by all PROFINET IO devices.

---

The LED flash test runs until you cancel it. This is done, for example, by clearing the "LED flashes" check box, by selecting another IO device in the table, or by closing the Online and Diagnostics view.

4. Click "Assign name".

### Result

The entered name is assigned to the PROFINET IO device.

## Calling the name assignment function from within the project context

### Requirement

- An online connection to the PROFINET IO device is not required.
- You have opened the Online and Diagnostics view of the PROFINET IO device from the project context.
- The PROFINET IO device can be accessed using at least one PG/PC.

## Procedure

1. Open the "Functions" folder and the "Assign name" group inside this folder. The "PROFINET device name" drop-down list displays the current name in the offline project, and the "Type" box shows the module type of the PROFINET IO device.

---

### Note

For S7-1500 CPUs, the names of the two PROFINET interfaces in the offline project are displayed.

---

2. Choose a different name from the drop-down list, if necessary.

---

### Note

In steps 3 to 5, you determine the IO devices that are present in the PROFINET subnet.

---

3. In the "PG/PC interface for assignment" drop-down list, select the PG/PC interface you want to use to establish the online connection.
4. Optional: Use the three check boxes to make a selection from all IO devices available online.
5. Click the icon for determining the IO devices present in the PROFINET subnet. The table is then updated.
6. Select the desired IO device in the table.
7. Optional: Select the "LED flashes" check box in order to run an LED flash test on the PROFINET IO device. In this way you verify that you are naming the desired IO device.

---

### Note

The LED flash test is not supported by all PROFINET IO devices.

---

The LED flash test runs until you cancel it. This is done, for example, by clearing the "LED flashes" check box, by selecting another IO device in the table, or by closing the Online and Diagnostics view.

8. Click "Assign name".

## Result

The selected name is assigned to the PROFINET IO device.

---

### Note

For S7-1500-CPU, the selected name is assigned to the PROFINET interface selected above.

---

## **Calibrating an S7-1500 analog module**

### **Calibrating an S7-1500 analog module - Overview**

#### **Where do you calibrate an S7-1500 analog module?**

You calibrate an S7-1500 analog module in its Online and Diagnostics view in the "Calibrate" group of the "Functions" folder.

#### **Overview of the function scope of the calibrating function**

You can perform the following functions for an S7-1500 analog module in the "Calibrate" group:

- Specifying the current calibration of all channels
- Calibrating a channel
- Canceling a running calibration
- Resetting the calibration of a channel to the factory settings

#### **Requirement for the calibrating function described below**

The following is required for the calibrating function described below:

- You have opened the Online and Diagnostics view from the project context (thus not from the project tree or via the "Online" menu).
- There is an online connection to the analog module that is to be calibrated.
- Offline and online configuration are identical.

## **Calibrating an S7-1500 analog module**

### **Overview of the calibration of a channel of an S7-1500 analog module**

The calibration of a channel of an S7-1500 analog module consists of the following steps:

1. Start calibration
2. Perform the second step up to the next to last step of the calibration
3. Complete calibration

These steps are described in more detail in the following section.



## Requirement

- You have opened the Online and Diagnostic view of the S7-1500 analog module from the project context and are in the "Calibrate" group of the "Functions" folder.
- The associated CPU is online.
- No calibration is currently running on the analog module (if you want to start the calibration) or the last step initiated has been performed successfully (if you want to resume or complete the calibration).

## Procedure for starting the calibration

To start the calibration, follow these steps:

1. In the overview table, select the line that belongs to the channel to be calibrated.
2. Click the "Start manual calibration" button.

The user interface then changes as follows:

- The overview table and the "Start manual calibration" button and "Set to factory settings" buttons become inactive.
- The step display is activated and displays the numbers of the current and last steps.
- The "Command" field becomes active and indicates what the user must do in the next calibration step.
- The "Status" field becomes active and shows the current status of the calibration, e.g., "Calibration successfully started".
- The "Measured value" field becomes active. For an input module a value is displayed here; you must enter a value here for an output module.
- The "Cancel" button becomes active.
- The "Next" button becomes active. This button can be used to advance to the next step of the calibration.

## Procedure for the second to the next to last step of the calibration

Follow these steps:

1. Click the "Next" button.

The fields of the user interface described above are then updated.

## Procedure for the last step of the calibration

Follow these steps:

1. Click the "Next" button.

The user interface then changes as follows:

- The overview table becomes active.
- The calibration display of the calibrated channel is updated.
- The "Start manual calibration" button and "Set to factory settings" buttons become active.

- The step display is deactivated and the numbers of the current step and last steps are empty.
- The "Command" field becomes inactive and is empty.
- The "Status" field becomes inactive and shows the last status of the calibration, e.g., "Calibration successfully finished".
- The "Measured value" field becomes inactive and is empty.
- The "Cancel" button becomes inactive.
- The "Next" button becomes inactive.

### Error occurrence

If an error occurs during the calibration, the module cancels the calibration. Afterwards, the channel that was to be calibrated has the same settings as before the start of the calibration.

Except for the "Status" field, the user interface appears the same after the occurrence of an error as before the calibration. The "Status" field displays the error that the module detected during the calibration.

### Canceling a running calibration of an S7-1500 analog module

#### Requirement

- You have opened the Online and Diagnostic view of the S7-1500 analog module from the project context and are in the "Calibrate" group of the "Functions" folder.
- The associated CPU is online.
- A calibration is currently running on the analog module.

#### Procedure

To cancel a running calibration, follow these steps:

1. Click the "Cancel" button.

#### Result

The running calibration is canceled, and afterwards the channel to be calibrated has the same settings as before the calibration.

All operator controls in the user interface are deactivated until the cancelation is complete. Except for the "Status" field, the user interface appears the same afterwards as before the calibration. The "Status" field displays the result of the cancelation.

## Resetting an S7-1500 analog module to factory settings

### Requirement

- You have opened the Online and Diagnostic view of the S7-1500 analog module from the project context and are in the "Calibrate" group of the "Functions" folder.
- The associated CPU is online.

### Procedure

To reset a channel of an S7-1500 analog module to factory settings, follow these steps:

1. Select the line associated with the channel to be reset in the overview table.
2. Click the "Set to factory settings" button.

### Result

All operator controls in the user interface are deactivated until the reset operation is complete. Except for the "Status" field, the user interface appears the same afterwards as before the reset operation. The "Status" field displays the result of the reset operation.

## 8.2.1.6 Diagnostics in STOP mode

### Basic information on the diagnostics buffer

#### Function

The operating system of the CPU enters the errors detected by the CPU and the diagnostics-capable modules into the diagnostics buffer in the order in which they occurred. This includes the following events:

- Every mode change of the CPU (POWER UP, change to STOP mode, change to RUN mode)
- Every hardware and diagnostic error interrupt

The top entry contains the most recent event. The entries in the diagnostics buffer are stored permanently. They are retained even if the power supply fails and can only be deleted by resetting the CPU to factory settings.

A diagnostics buffer entry contains the following elements:

- Time stamp
- Error ID
- Additional information specific to the error ID

### Advantages of the diagnostics buffer

The diagnostics buffer offers the following advantages:

- After the CPU has changed to STOP mode, you can evaluate the last events prior to the STOP so that you can locate and identify the cause of the STOP.
- You can detect and eliminate the causes of errors more quickly and thus increase the availability of the system.
- You can evaluate and optimize the dynamic system response.

### Organization of the diagnostics buffer

The diagnostics buffer is a ring buffer. The maximum number of entries for the S7-1200 CPUs is 50. When the diagnostics buffer is full and a further entry needs to be made, all existing entries are shifted by one position (which means that the oldest entry is deleted) and the new entry is made at the top position that is now free (FIFO principle: first in, first out).

### Evaluation of the diagnostics buffer

The contents of the diagnostics buffer can be accessed as follows:

- Using the Online and Diagnostics view

The evaluation of events occurring prior to the error event (e.g., transition to STOP mode) allows you to obtain a picture of the possible causes or to zero in more closely or specify in more detail the possible causes (depending on the error type).

Read the detailed information about the events carefully and use the "Help on event" button to obtain additional information and possible causes of individual entries.

---

#### Note

To make the best use of the time stamp information on the diagnostics buffer entries in time-critical systems, it is advisable to check and correct the date and time of day on the CPU occasionally.

Alternatively, it is possible to perform a time-of-day synchronization using an NTP time server.

---

### See also

Resetting an S7-1200 CPU to factory settings (Page 992)

Determining the cause of a STOP of a CPU (Page 1005)

Determining and setting the time of day on a CPU (Page 989)

Assigning the clock parameters (Page 863)

## Determining the cause of a STOP of a CPU

### Requirement

The CPU you want to analyze is in STOP mode.

### Procedure

To find out the reason why a CPU changed to STOP, follow these steps:

1. Open the online and diagnostics view of the CPU.
2. Select the "Diagnostics buffer" group from the "Diagnostics" folder.
3. Evaluate the events occurring prior to the transition to STOP mode. Use this to obtain a picture of the possible causes or to zero in on or specify in more detail the possible causes (depending on the error type).  
Read the detailed information about the events carefully and use the "Help on event" button to obtain additional information and possible causes of individual entries.

### Result

You were able to zero in on or determine in more detail the cause of the CPU STOP.

---

#### **Note**

If the analysis does not enable you to overcome the problem, contact Customer Support. In this case, use the "Save as" button to back up the content of the diagnostics data to a text file and submit it to Customer Support.

---

### See also

Reading out the diagnostics buffer of a CPU (Page 982)

### 8.2.1.7 Online accesses in the Online and Diagnostics view

#### Displaying status of the online connection

##### Requirement

- The associated device can be accessed using at least one PG/PC interface.

##### Procedure

1. Open the Online and Diagnostics view for the device whose online connection status you want to display.
2. Select the "Online access" group.

---

##### Note

The "Online access" group exists only for CPUs. However, if you have opened the Online and Diagnostics view using the "Show/update accessible devices" function, it will not be displayed.

---

##### Result

The status of the online connection is displayed in the "Status" area both graphically and in text form.

#### Specifying a PG/PC interface, going online

##### Requirement

- The associated device can be accessed using at least one PG/PC interface.
- There is currently no online connection to the relevant device.

##### Procedure

1. Open the Online and Diagnostics view of the device to which you want to establish an online connection.
2. Choose the "Online access" group and the "Online access" area within this group.

---

##### Note

The "Online access" group exists only for CPUs and some CPs. If you have opened the Online and Diagnostics view using the "Show/update accessible devices" function, it is not displayed.

---

3. If an online connection was established previously for the device, the associated data for this online connection is preset in the drop-down lists. In this case, you can immediately continue with the last step of this operation, provided you have not changed the IP address in the meantime using the Online and Diagnostics view.
4. Choose the interface type in the "Type of PG/PC interface" drop-down list. The "PG/PC interface for online access" drop-down list then shows only the interfaces of the programming device or PC that match the selected interface type.
5. In the "PG/PC interface for online access" drop-down list, select the programming device or PC interface via which you want to establish the online connection.
6. Optional: Click the "Properties" button to change the properties of the associated CP.
7. In the "Connection to subnet" drop-down list, select the subnet via which the device is connected to the PG/PC interface.

---

**Note**

The PG/PC interface is connected to an interface of a device.

If you only want to access this device, select the setting "Directly at slot <interface name>" in the drop-down list.

If you want to access another device by means of routing, however, create a subnet at this interface in the hardware configuration and then select this subnet in the drop-down list.

---

8. If the device is accessible via a gateway, select the gateway that connects the two subnets involved in the "1st gateway" drop-down list.
9. In the "Device address" entry field, enter the IP address of the device to which you want to establish an online connection, if necessary.

---

**Note**

For CPUs with multiple IP addresses, select the IP address of the PROFINET interface you want to use to establish an online connection from the "Device address" drop-down list.

---

10. Alternatively: Click the "Show accessible devices" button and choose the device from the list of accessible devices to which you want to establish an online connection.
11. Click the "Go online" button.

## Result

The online connection to the desired device is established.

## Going offline

### Requirement

- There is currently an online connection to the relevant device.

### Procedure

1. Open the Online and Diagnostics view of the device for which you want to disconnect the online connection.
2. Choose the "Online access" group and the "Online access" area within this group.

---

#### Note

The "Online access" group exists only for CPUs. However, if you have opened the Online and Diagnostics view using the "Show/update accessible devices" function, it will not be displayed.

---

3. Click the "Go offline" button.

### Result

The online connection to the desired device will be disconnected.

## Performing the flash test for a device with an online connection

### Requirement

- There is currently an online connection to the relevant device.
- The FORCE function is not active.

### Procedure

1. Open the Online and Diagnostics view of the device for which you want to perform a flash test.
2. Choose the "Online access" group and the "Status" area within this group.

---

#### Note

The "Online access" group exists only for CPUs. However, if you have opened the Online and Diagnostics view using the "Show/update accessible devices" function, it is not displayed.

---

3. Select the "LED flash test" check box.



## Result

- On an S7-1200 CPU, the RUN/STOP, ERROR and MAINT LEDs flash.
- On an S7-1500 CPU, the RUN/STOP, ERROR, and MAINT LEDs flash.
- On an S7-300 or S7-400 CPU, the FRCE LED flashes.

The LEDs flash until you cancel the flash test. This is done, for example, by clearing the "LED flash test" check box, by changing to another group of the Online and Diagnostics view, or by changing settings in the "Online accesses" area.

### 8.2.1.8 Checking PROFIBUS DP subnets for faults

#### Basic information on the diagnostic repeater

##### What is the diagnostic repeater?

The diagnostic repeater is a repeater that can monitor a segment of an RS 485 PROFIBUS subnet (copper cable) during operation and signal line errors to the DP master via a diagnostics message frame.

The diagnostic repeater detects, localizes and visualizes line errors during operation at an early stage. As a result, problems in the system are identified early and production downtimes will be minimized.

##### Function of the diagnostic repeater

The diagnostic repeater can perform line diagnostics on the DP2 and DP3 segments because it has a measuring circuit for these segments.

The line diagnostics run in two steps:

- Step 1: Topology determination  
You start the topology determination by calling the "DP\_TOPOL" instruction in your program. The diagnostic repeater then determines the PROFIBUS addresses and the distance of the devices and creates a topology table.
- Step 2: Error localization  
The diagnostic repeater checks the lines during operation. It determines the distance to the point of the error and the reason for the error; it then issues a diagnostics alarm with relative information on the error location.

##### Display of detailed information on the determined error location

You receive detailed information on the determined error location in the Online and Diagnostics view of the diagnostic repeater.

- By means of icons
- By means of a display with graphics and text

**See also**

Displaying the status of the segment diagnostics using icons (Page 1010)

Displaying the status of the segment diagnostics using graphics and text (Page 1010)

**Displaying the status of the segment diagnostics using icons**

**Where do I find the information I need?**



The icons for the status of the segment diagnostics are available:

- In the expanded "Segment diagnostics" folder in the navigation pane of the Online and Diagnostics view of the relevant diagnostic repeater.

The diagnostics icon associated with the segment will be displayed behind the segment designation. It must be noted here that line errors will be displayed for the DP2 and DP3 segments only. The DP1 and programming device segments do not display errors in the form of a diagnostics icon; rather, they signal only a few bus errors.

**Diagnostics icons**

The following table shows the available icons and their meaning.

Icon	Meaning
	Segment is error-free
	Segment contains errors
	Segment is deactivated

**Displaying the status of the segment diagnostics using graphics and text**

**Where is the status of the segment diagnostics displayed with graphics and text?**

The status of the segment diagnostics will be displayed using graphics and text in the "DP1", "DP2", "DP3", and "PG" groups of the "Segment diagnostics" folder in the Online and Diagnostics view of the relevant diagnostic repeater.

**Structure of the "DP1", "DP2" "DP3", and "PG" groups**

The "DP1", "DP2", "DP3", and "PG" groups consist of the following elements:

- "Error location" field
- "Error" field
- "Resolution" field

- "Help on event" button
- "Freeze display" or "Cancel freeze" button

### "Error location" field

This field displays the error location graphically, provided the diagnostic repeater can determine the location.

The following picture shows an example for a line error occurring in the DP2 segment.

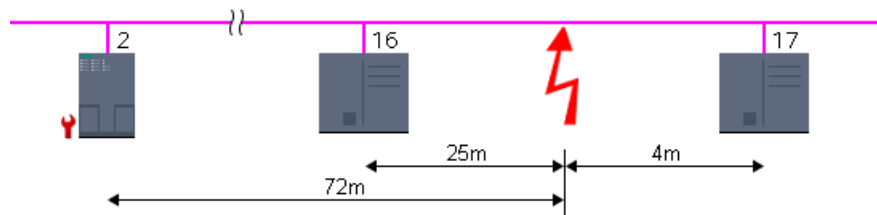

In this example, the diagnostic repeater has the PROFIBUS address 2, and a line error has occurred between the devices with PROFIBUS addresses 16 and 17. This line error is located 25 m from device 16, 4 m from device 17, and 72 m from the diagnostic repeater.

### "Error" field

The error is explained in plain text in this field.

### "Resolution" field

Here, you will find actions for resolving the error.

### "Help on event" button

Click this button to obtain a more detailed explanation of the error and additional details on resolving the error, if applicable.

### "Freeze display" or "Cancel freeze" button

The "Freeze display" or "Cancel freeze" button is only enabled when there is an online connection to the diagnostic repeater.

The default setting is "Freeze display".

The following happens when you click the "Freeze display" button:

- The current display of the segment diagnostics is frozen.
- The labeling of the button changes to "Cancel freeze".

If the display is frozen and you click the "Cancel freeze" button, the following happens:

- The display of the segment diagnostics is updated again.
- The labeling of the button changes to "Freeze display".

## 8.2.2 Connection diagnostics

### 8.2.2.1 Overview of connection diagnostics

#### Basics

Connection diagnostics, as described below, refers to the diagnostics of communication connections.

The connection diagnostics is started each time an online connection is established to a module (CPU or CP) that participates in one or more communication services. The connection status is updated automatically in the background.

In the case of one-way connections, an online connection must exist to the communication partner that has established the communication connection.

On connections configured at both ends, a distinction between the following two situations must be made:

- If there is an online connection to only one connection endpoint, only the part of the connection belonging to this connection endpoint can be diagnosed.
- If there is an online connection to both connection endpoints, both parts of the connection (and therefore the entire connection) can be diagnosed.

#### Basic connections diagnostics options

Connection diagnostics can be performed as follows:

- Using icons on the connection status display  
This display is generated in the connection table.
- Through detailed connection diagnostics  
This step is available in the "Diagnostics > Connection information" area of the Inspector window.

#### Requirement for the connection diagnostics described below

You can display the details of either all the communication connections created in the project (default) or selected communication connections in the connection table.

The connection diagnostics described in the following assume that you display the details of selected communication connections. To do this, clear the "Show all connections" option in the shortcut menu.

## 8.2.2.2 Displaying the connection status using icons

### Content of connection table without an online connection

- For a CPU or CP, the connection table lists the communication connections (including properties) configured offline, if an online connection is not established.

### Content of connection table with an online connection



After the online connection has been established, the properties of the communication connections listed offline will be expanded to include diagnostics icons for the connection status ("Online status" column).

In addition, entries for all communication connections that exist online only (e.g., connections for the instructions for Open User Communication, programming device and OP connections, connections for web server access) will now be added to the connection table.

For connections that exist online or offline only, the diagnostics icon at the bottom right is combined with a smaller additional comparison status icon.



### Diagnostics icons for communication connections

The following table shows the diagnostics icons for communication connections.

Icon	Meaning
	Connection setup
	Connection not setup / is being setup
	Connection not available

### Diagnostics icons for the comparison status

The diagnostic icons for communication connections can be combined at the bottom right with additional smaller icons that indicate the result of the online/offline comparison. The following table shows the available comparison icons and their meaning.

Icon	Meaning
	Connection exists online only
	Connection exists offline only

### 8.2.2.3 Detailed connection diagnostics

#### Detailed connection diagnostics - overview

##### Where do I perform detailed connection diagnostics?

To perform detailed connection diagnostics, go to the "Diagnostics > Connection" information of the Inspector window.

##### How do I open the "Diagnostics > Connection information" area of the Inspector window?

The following options are available for opening the "Connection information" tab of the Inspector window.

- Select the line of the relevant connection in the connection table. Click the "Diagnostics" and "Connection information" tabs one after the other in the Inspector window.
- Double-click the diagnostics icon of the relevant connection in the connection table.
- This step takes you to the programming editor for a S7 communication instruction or open user communication instruction. Double-click the diagnostic icon of the instruction (stethoscope).

##### Structure of the "Diagnostics > Connection information" area of the Inspector window

Requirements: the content of the "Connection information" tab has been filled, and an online connection to at least one end point of the relevant connection has been established.

If a module has been selected (network view), the tab will contain the following group:

- Connection resources (for S7-1200 and S7-1500)

If a connection has been selected (connection table), it will contain the following groups:

- Connection details
- Address details of the connection (for S7-1200 and S7-1500)

#### Determining online connection resources for S7-1200

##### Where do you determine the online connection resources?

The online connection resources are obtained in the "Connection resources" group. This group is located in the "Diagnostics > Connection information" area of the Inspector window. It is displayed only if you have selected a module in the network view to which an online connection exists.

### Number of connection resources

- **Maximum number:** Specifies the maximum number of available connection resources of the module.
- **Not assigned:** Indicates how many connection resources are not yet assigned. If connection resources are already reserved for certain types of communication, then the unreserved connection resources cannot always be used for the various connection types.

### Reserved and currently assigned connection resources

For the communication types indicated below, the connection resources that are reserved and currently assigned by the module will be displayed.

Communication type	Meaning
PG communication	Resources for connections between the module and programming devices (for example, for the establishment of a connection from the project tree, for online diagnostics, etc.)
HMI communication	Resources for connections between the module and HMI devices
Open User Communication	Resources for connection of open user communication instructions
S7 communication	Resources for configured S7 connections, through which data can be exchanged by calling instructions in the user program.
Other communication	Specifies other assigned connection resources for which connection resources are not reserved.

### Determining online connection resources for S7-1500

#### Where do you determine the online connection resources?

The online connection resources are obtained in the "Connection resources" group. This group is located in the "Diagnostics > Connection information" area of the Inspector window. It is displayed only if you have selected a module in the network view to which an online connection exists.

#### Description of the detailed display of the connection resources

The detailed display of the connection resources includes:

- Number of available connection resources
- Number of configured connection resources
- Number of connection resources still available

For a description of these, go to [here](#) .

## Determining connection details

### Where do I determine the connection details?

The connection details are obtained in the "Connection details" group. This group is located in the "Diagnostics > Connection information" area of the Inspector window.

### When is the "Connection details" group filled in?

The following requirements must be met to fill in the "Connection details" group on the "Connection information" tab:

- An online connection to the end point of the relevant connection must exist.
- You have selected a line in the connection table.

### Structure of the "Connection details" group

The "Connection details" group consists of the following elements:

- Local ID (hex)
- Connection type (for S7-1200 and S7-1500)
- Protocol
- Connection status: icon and description
- Details
- Last status change (for S7-300 and S7-400 only)

## Determining the address details of a connection

### Where do I determine the address details of a connection?

The address details of a connection are obtained in the "Connection address details" group. This group is located in the "Diagnostics > Connection information" area of the Inspector window.

### For which CPUs is the "Connection address details" group available?

The "Connection address details" group of the "Connection information" tab is available for S7-1200 and S7-1500 CPUs.

### When is the "Connection address details" group filled in?

The following requirements must be met to fill in the "Connection address details" group on the "Connection information" tab:

- An online connection to the end points of the relevant connection must exist.
- You have selected a line in the connection table.



### **Structure of the "Connection address details" group**

The address details relevant to the connection type are specified for the two communication partners.



# Programming the PLC

## 9.1 Creating a user program

### 9.1.1 Programming basics

#### 9.1.1.1 Operating system and user program

##### Operating system

###### Function

The operating system is contained in every CPU and organizes all CPU functions and sequences that are not associated with a specific control task.

The tasks of the operating system, for example, include the following:

- Processing a warm restart
- Updating the process image of the inputs and outputs
- Calling the user program
- Detecting interrupts and calling interrupt OBs
- Detecting and handling errors
- Managing memory areas

The operating system is a component of the CPU and is already installed there upon delivery.

###### See also

User program (Page 1019)

##### User program

###### Function

The user program contains all functions that are necessary for processing your specific automation task.

The tasks of the user program include:

9.1 Creating a user program

- Checking the requirements for a (warm) restart using startup OBs, for example, limit switch in correct position or safety relay active.
- Processing process data, e.g. linking binary signals, reading in and evaluating analog values, defining binary signals for output, and outputting analog values
- Reaction to interrupts, for example, diagnostic error interrupt if the limit value of an analog expansion module is overshoot.
- Error handling in normal program execution

You write the user program and load it into the CPU.

See also

Operating system (Page 1019)

9.1.1.2 Blocks in the user program

Linear and structured programming

Linear programming

Solutions for small automation tasks can be programmed linearly in a program cycle OB. This is only recommended for simple programs.

The following figure shows a linear program schematically: The "Main1" program cycle OB contains the complete user program.

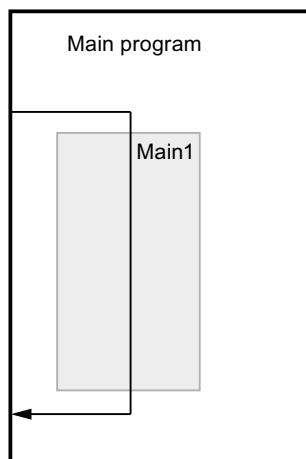

Structured programming

Complex automation tasks can be more easily handled and managed by dividing them into smaller sub-tasks that correspond to the technological functions of the process or that can be reused. These sub-tasks are represented in the user program by blocks. Each block is then an independent section of the user program.

Structuring the program offers the following advantages:

- Extensive programs are easier to program through the structure.
- Individual program sections can be standardized and used repeatedly with changing parameters.
- Program organization is simplified.
- Changes to the program can be made more easily.
- Debugging is simplified since separate sections can be tested.
- Commissioning is simplified.

The following figure shows a structured program schematically: The "Main1" program cycle OB calls subprograms one after the other that execute defined subtasks.

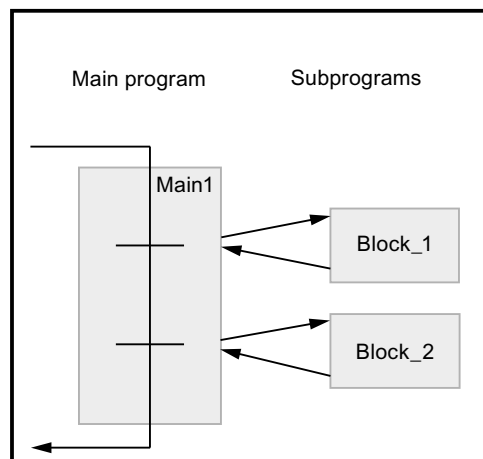

## Overview of the block types

### Block types

Different BLOCK types are available to perform tasks within an automation system. The following table shows the available block types:

Block type	Brief description
Organization blocks (Page 1022) (OB)	Organization blocks define the structure of the user program.
Functions (Page 1022) (FC)	Functions contain program routines for recurring tasks. They have no "memory".
Function blocks (Page 1023) (FB)	Function blocks are code blocks that store their values permanently in instance data blocks, so that they remain available even after the block has been executed.
Instance data blocks (Page 1025)	Instance data blocks are assigned to a function block when it is called for the purpose of storing program data.
Global data blocks (Page 1024)	Global data blocks are data areas for storing data that can be used by any blocks.

## Organization blocks (OB)

### Definition

Organization blocks (OBs) form the interface between the operating system and the user program. They are called by the operating system and control, for example, the following operations:

- Startup characteristics of the automation system
- Cyclic program processing
- Interrupt-driven program execution
- Error handling

You can program the organization blocks and at the same time determine the behavior of the CPU. Various organization blocks are available to you depending on the CPU used.

For more information on organization blocks, refer to the descriptions of the modes of operation of CPUs in the "Additional information on configurations" chapter in "Configuring Hardware and Networks".

### Start information of organization blocks

When certain organization blocks are started, the operating system provides information that can be evaluated in the user program. Refer to the descriptions of the organization blocks to find out which information is provided, if any.

### See also

Creating organization blocks (Page 1197)

## Functions (FCs)

### Definition

Functions (FCs) are code blocks without memory. You have no data memory in which values of block parameters can be stored. Therefore, when a function is called, all formal parameters must be assigned actual parameters.

Functions can use global data blocks to store data permanently.

### Application

A function contains a program that is executed when the function is called by another code block. Functions can be used, for example, for the following purposes:

- To return function values to the calling block, e.g. for mathematical functions
- To execute technological functions, e.g. individual controls using bit logic operations

A function can also be called several times at different points in a program. As a result, they simplify programming of frequently recurring functions.

---

**Note**

**Parameter transfer when calling functions**

To avoid errors when working with functions, observe the information in chapter "Auto-Hotspot".

---

**See also**

Creating functions and function blocks (Page 1198)

**Function blocks (FB)**

**Definition**

Function blocks are code blocks that store their input, output and in-out parameters permanently in instance data blocks, so that they remain available even after the block has been executed. Therefore they are also referred to as blocks "with memory".

Function blocks can also operate with temporary tags. Temporary tags are will not be stored in the instance DB, but are available for one cycle only.

**Application**

Function blocks contain subroutines that are always executed when a function block is called by another code block. A function block can also be called several times at different points in a program. As a result, they simplify programming of frequently recurring functions.

**Instances of function blocks**

A call of a function block is referred to as an instance. An instance data block is required for each instance of a function block; it contains instance-specific values for the formal parameters declared in the function block.

The function block can store its instance-specific data in its own instance data block or in the instance data block of the calling block.

## Access modes

S7-1200 and S7-1500 offer two different access options for the instance data blocks, which can be assigned to a function block when this is called:

- Data blocks with optimized access  
Data blocks with optimized access have no firmly defined memory structure. The data elements contain only a symbolic name in the declaration, no fixed address within the block.
- Data blocks with standard access (compatible with S7-300/400)  
Data blocks with standard access have a fixed memory structure. The declaration elements contain both a symbolic name in the declaration and a fixed address within the block.

---

### Note

To avoid errors when working with function blocks, refer to the section "Auto-Hotspot".

---

## See also

Creating functions and function blocks (Page 1198)

Multi-instances (Page 1035)

Instance data blocks (Page 1025)

Basics of block access (Page 1027)

## Global data blocks (DB)

### Definition

Data blocks are used to store program data. Data blocks thus contain variable data that is used by the user program. Global data blocks store data that can be used by all other blocks.

The maximum size of data blocks varies depending on the CPU. You can define the structure of global data blocks anyway you please.

You also have the option of using PLC data types (UDT) as a template for creating global data blocks.

### Global data blocks in the user program

Every function block, function, or organization block can read the data from a global data block or can itself write data to a global data block. This data remains in the data block even after the data block is exited. A global data block and an instance data block can be open at the same time.

The following figure shows the different accesses to data blocks:



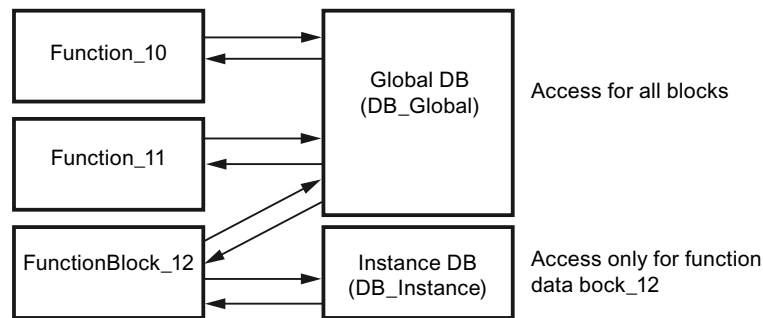

## Access modes

S7-1200 and S7-1500 offer two different access options for global data blocks:

- Data blocks with optimized access  
Data blocks with optimized access have no fixed defined structure. In the declaration, the data elements are assigned only a symbolic name and no fixed address within the block.
- Data blocks with standard access (compatible with S7-300/400)  
Data blocks with standard access have a fixed structure. In the declaration, the data elements are assigned both a symbolic name and a fixed address within the block.

## ARRAY data blocks (S7-1500)

ARRAY data blocks are a particular type of global data block. These consist of an ARRAY of any data type. For example, an ARRAY of a PLC data type (UDT) is possible. The DB contains no other elements besides the ARRAY. Because of their flat structure, ARRAY data blocks facilitate access to the ARRAY elements and their transfer to called blocks.

The "Optimized block access" attribute is always enabled for ARRAY data blocks. ARRAY data blocks with standard access are not possible.

The "Move operations" section of the "Instructions" task card offers options for addressing of ARRAY DBs.

## See also

Creating data blocks (Page 1199)

Basics of block access (Page 1027)

## Instance data blocks

### Definition

The call of a function block is referred to as an instance. The data with which the instance works is stored in an instance data block.

The maximum size of instance data blocks varies depending on the CPU. The tags declared in the function block determine the structure of the instance data block.

### Access modes

S7-1200 and S7-1500 offer two different access options for the instance data blocks, which can be assigned to a function block when this is called:

- Data blocks with optimized access  
Data blocks with optimized access have no firmly defined structure. The declaration elements contain only one symbolic name in the declaration, and no fixed address within the block.
- Data blocks with standard access (compatible with S7-300/400)  
Data blocks with standard access have a fixed structure. The declaration elements contain both a symbolic name in the declaration and a fixed address within the block.

See also: Auto-Hotspot

### See also

Creating data blocks (Page 1199)

Basics of block access (Page 1027)

### CPU data blocks

#### Definition

CPU data blocks are generated by the CPU at runtime. To this purpose, insert the "CREATE\_DB" instruction into your user program. You can use the data block that is generated at runtime to save your data.

CPU data blocks are indicated by means of a small CPU icon in the "Program blocks" folder of an available node. You can monitor the values of the variables of a CPU data block in online mode, similar to those of a different data block type.

You cannot create CPU data blocks in your offline project.

#### Loading CPU data blocks

The CPU data block that the user program has generated by means of the "CREATE\_DB" instruction is initially only available on the device in online mode. All CPU data blocks will be included with the other blocks the next time you perform a complete download from the device to the project. The CPU data blocks are marked with a small CPU icon in the process. However, you cannot upload these CPU data blocks to your device again.

## Restrictions on CPU data blocks in the project

Once the CPU data blocks have been loaded into your offline project, you can open and view their content. However, note that the CPU data blocks in the project are write-protected. The CPU data blocks in the project are therefore subject to the following restrictions:

- You cannot edit CPU data blocks, or convert these into a different data block type.
- CPU data blocks cannot be assigned a know-how protection.
- You cannot change the programming language of a CPU data block.
- CPU data blocks cannot be compiled or downloaded to a device.

## Comparing CPU data blocks

Once the CPU data blocks have been loaded into your offline project, you can run an online/offline comparison for the CPU DBs loaded. The comparison editor provides you with a corresponding overview of the differences. It is possible to synchronize the online and off-line version of CPU data blocks if differences are found, but not by downloading the offline version to the device.

## Deleting CPU data blocks

You can delete CPU data blocks both from the project and from the CPU.

## See also

Deleting CPU data blocks (Page 1218)

## Blocks with optimized access

### Basics of block access

#### Introduction

STEP 7 offers data blocks with different access options:

- Data blocks with optimized access (S7-1200/S7-1500)
- Data blocks with standard access (S7-300 / S7-400 / S7-1200 / S7-1500)

Within one program you can combine the two types of blocks.

#### Data blocks with optimized access

Data blocks with optimized access have no fixed defined structure. In the declaration, the data elements are assigned only a symbolic name and no fixed address within the block. The elements are saved automatically in the available memory area of the block so that there are no gaps in the memory. This makes for optimal use of the memory capacity.

### 9.1 Creating a user program

Tags are identified by their symbolic names in these data blocks. To address the tag, enter its symbolic name. For example, you access the "Fill Level" tag in the "Data" DB as follows:

```
"Data".Fill Level
```

Blocks with optimized access offers the following advantages:

- You can create data blocks with any structure without paying attention to the physical arrangement of the individual data elements.
- Quick access to the optimized data is always available because the data storage is optimized and managed by the system.
- Access errors, as with indirect addressing or from the HMI, for example, are not possible.
- You can define specific individual tags as retentive.
- Optimized blocks are equipped with a memory reserve by default which lets you expand the interfaces of function blocks or data blocks during operation. You can download the modified blocks without setting the CPU to STOP and without affecting the values of already loaded tags.

---

#### Note

The "Optimized block access" attribute is always enabled for the following blocks and cannot be deselected.

- GRAPH blocks
  - ARRAY data blocks
- 

### Data blocks with standard access

Data blocks with standard access have a fixed structure. In the declaration, the data elements are assigned both a symbolic name and a fixed address within the block. The address is shown in the "Offset" column.

Tags in these data blocks can be addressed in both symbolic and absolute form.

```
"Data".Fill Level
```

```
DB1.DBW2
```

### Setting Retentivity for Optimized Access or Standard Access

If you define data as retentive, its values are retained even after a power failure or a network off. A retentive tag is not initialized after the hot restart but retains the value it had prior to the power failure. If a DB tag is defined as retentive, it is stored in the retentive memory area of the data block.

The options for setting the retentivity depend on the access type of the block.

- In data blocks with standard access, you cannot set the retentive behavior of individual tags. The retentivity setting is valid for all tags of the data block.
- In data blocks with optimized access you can define the retentive behavior of individual tags.  
For structured data type tags, the retentivity setting always applies to the entire structure. You cannot make any individual retentivity setting for separate elements within the data type.

### Setting Addressing Options for Optimized Access or Standard Access

Blocks with optimized access permit only "type-safe" access. Type-safe access addresses tags by their symbolic name only. This means even changes to the block or the block interface will not result in inconsistencies in the program or access errors.

The following table shows the permitted addressing options for optimized data:

Addressing	Block with standard access	Block with optimized access
Symbolic addressing	x	x
Indexed addressing of ARRAYS		x
Slice access	x	x
Overlapping with AT	x	-
Absolute addressing	x	-
Indirect addressing via ANY	x	-
Indirect addressing via POINTER and VARIANT	x	with symbolic notation only

### See also

Setting up block access (Page 1029)

### Setting up block access

#### Introduction

Block access is set up automatically when you create a block:

- Blocks created on CPUs of the S7-1200/1500 product range provide optimized access by means of a default setting.
- New blocks created on CPUs of the S7-300/S7-400 product range provide standard access by means of a default setting.

Access to a block that you copy or migrate to a CPU of a different product range is not converted automatically. However, in certain situations it may be useful to change block access in manual mode, e.g., in order to utilize the full functional scope of the CPU.

In most cases, you will have to recompile and load the program after block access has been converted.

**NOTICE**

**Optimized block access for GRAPH blocks**

The "Optimized block access" attribute is always enabled for GRAPH blocks in S7-1500 and cannot be deselected.

**Procedure**

To set the block access, proceed as follows:

1. Open the "Program blocks" folder in the project tree.
2. Right-click on the block whose block access you want to change.
3. Select the "Properties" command in the shortcut menu.  
The properties dialog box of the block opens.
4. Click "Attributes" in the area navigation.
5. Enable or disable the "Optimized block access" option.
6. Confirm your entries with "OK".

**Restrictions and special features**

As a matter of principle, you can only convert block access on CPUs of the S7-1200/1500 product range, as only these support the "optimized" access mode.

The following restrictions or special features apply in this context:

- Instance data blocks  
The block access of instance data blocks is always determined by the assigned function block and cannot be changed in manual mode. If you change the access mode on a function block, you also need to update the assigned instance data blocks. This update procedure adapts the access mode of the instance data block.
- System blocks and know-how protected blocks  
You cannot manually edit the block access for system blocks and know-how protected blocks.
- Organization blocks  
The start information of an OB with standard access is always stored in the first 20 bytes of the "Temp" section in the block interface. By contrast, the start information of an OB with optimized access is always written to the "Input" section. For this reason, the block interface of OBs will also change whenever you convert block access. Additional information is provided in the following sections.

**Converting block access from "standard" to "optimized".**

A block copied from the CPU of the S7-300/400 product range to a CPU of the S7-1200/1500 product range will initially retain the "standard" access mode. However, you can significantly

increase the performance of program execution by using blocks with optimized access, which is why it may be useful to modify the access mode manually.

The blocks are adapted as follows in the course of conversion:

- **Function blocks**  
All interface parameters are assigned the "Non-retain" retentivity setting.
- **Global data blocks**  
The retentivity setting that was assigned centrally to the entire data block is transferred to the individual interface parameters. It is now possible to manipulate the retentivity setting of the various parameters.  
However, the following rule will still apply: For structured data type tags, the retentivity setting always applies to the entire structure. You cannot assign separate retentivity settings to the various elements within a structured data type. It therefore follows that you cannot assign individual retentivity settings to the tags of data blocks that are based on PLC data types.
- **Organization blocks**  
All interface parameters that are stored in the first 20 bytes of the "Temp" section will be deleted. New CPU-specific start information is entered in the "Input" section. Naming conflicts with user-defined interface parameters occurring in the process are resolved by renaming the user-defined interface parameters.

 **CAUTION**

**The conversion of the block access has the following consequences:**

- Absolute addressing of the interface parameters of the block is no longer possible after conversion of block access to the "optimized mode."  
Example: #L0.1 is no longer valid.
- Since conversion to the "optimized" block access mode of organization blocks also modifies the OB interface,

you may possibly have to adapt, recompile and load the program again due to these changes.

See also: Auto-Hotspot

### Converting block access from "optimized" to "standard".

If you want to copy or move a block from the CPU of the S7-300/400 product range to a CPU of the S7-1200/1500 product range, you first need to set the "standard" access mode.

The blocks are adapted as follows in the course of conversion:

- Function blocks and global data blocks.  
You can no longer set a retentivity in the function block. The corresponding setting is made in the instance data block.  
All interface parameters in the instance DB or global DB are assigned the same retentivity setting. The conversion is subject to the following rule:
  - If all interface parameters in the original block were retentive, the entire block will be retentive after conversion.
  - If all interface parameters in the original block were non-retentive, the entire block will be non-retentive after conversion.
  - If the interface parameters in the original block had different retentivity settings, the entire block will be non-retentive after conversion.
- Organization blocks  
All interface parameters stored in the "Input" section will be deleted. New CPU-specific start information is entered in the "Temp" section. This data is written to the first 20 bytes. Naming conflicts with user-defined interface parameters occurring in the process are resolved by renaming the user-defined interface parameters.

 <b>CAUTION</b>
<b>The conversion of the block access has the following consequences:</b> Since a conversion to "standard" block access mode might change the retentivity settings of the interface parameters, you may possibly have to adapt, recompile and load the program again due to these changes. See also: Auto-Hotspot

**See also**

Basics of block access (Page 1027)

**9.1.1.3 Block calls**

**Principles of block calls**

**Function of block calls**

For your blocks to be executed in the user program, they need to be called from another block. When one block calls another block, the instructions of the called block are executed. Only when execution of the called block has been completed does execution of the calling block resume. The execution is continued with the instruction that follows on the block call.

The following figure shows the sequence of a block call within a user program:



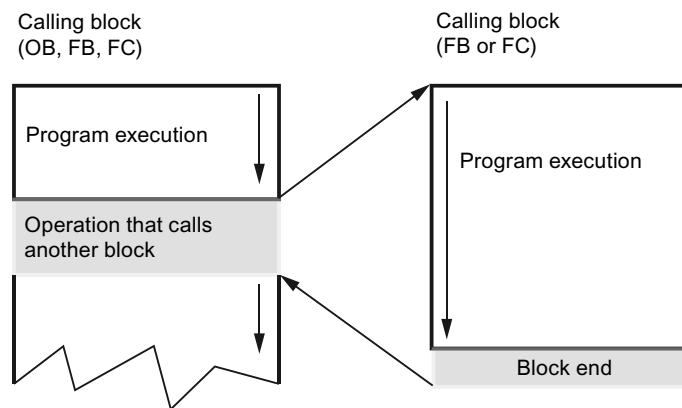

## Parameter transfer

When a block is called, you must assign values to the parameters in the block interface. By providing input parameters you specify the data with which the block is executed. By providing the output parameters you specify where the execution results are saved.

## See also

Call hierarchy (Page 1033)

Principles for single instances and multi-instances (Page 1034)

## Call hierarchy

## Definition

The order and nesting of block calls is referred to as the call hierarchy. The permissible nesting depth depends on the CPU.

The following figure shows an example of the order and nesting of block calls within an execution cycle:

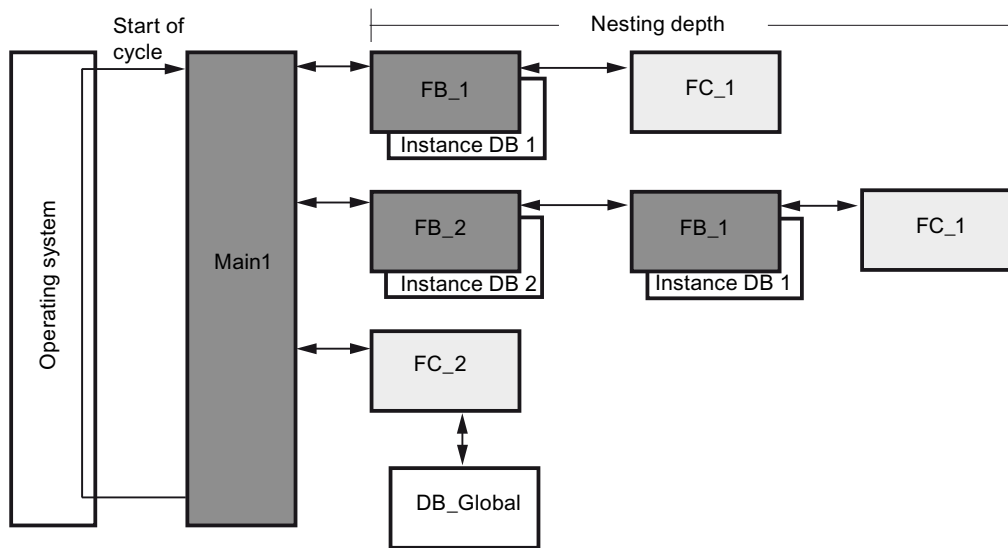

**See also**

Principles for single instances and multi-instances (Page 1034)

Principles of block calls (Page 1032)

**Call function blocks as single or multi-instances**

**Principles for single instances and multi-instances**

**Use of single instances and multiple instances**

Function blocks (FBs) store their data in instance data blocks. Instance data blocks store the values of the block parameters and the static local data of the function blocks.

You can assign instance data blocks as follows:

- Single instance:  
One instance data block for each instance of a function block
- Multiple instance:  
An instance data block for the instance of a function block and all instances of function blocks called in it.

**See also**

Principles of block calls (Page 1032)

Multi-instances (Page 1035)

Single instances (Page 1035)

Call hierarchy (Page 1033)

## Single instances

### Definition

The call of a function block, which is assigned its own instance data block, is called a single instance data block.

By assignment of the instance data block, you specify where the instance data of the FB is to be stored. By assigning a different instance data block to each call, you can use the same FBs several times with different instance data in each case.

### Example of a single instance

You can control several motors using one function block. For this purpose, you assign a different instance data block for each function block call for motor control.

The different data for the various motors, such as speed, ramp-up time, total operating time, are saved in the different instance data blocks. A different motor will be controlled, depending on the instance data block assigned.

The following figure shows the control of three motors using one function block and three different data blocks:

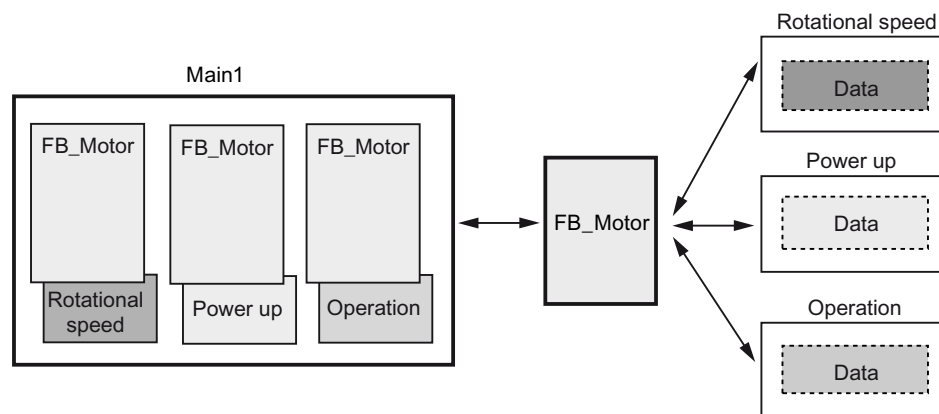

### See also

Principles for single instances and multi-instances (Page 1034)

Multi-instances (Page 1035)

## Multi-instances

### Definition

Multi-instances enable a called function block to store its data in the instance data block of the calling function block.

This allows you to concentrate the instance data in one instance data block and thus make better use of the number of instance data blocks available.

### One instance data block for the instances of different function blocks

The following figure shows how multiple different function blocks store their data in a calling block. The FB\_Workpiece calls the following one after the other: FB\_Grid, FB\_Punch and FB\_Conveyor. The called blocks store their data in the DB\_Workpiece, the instance data block of the calling block.

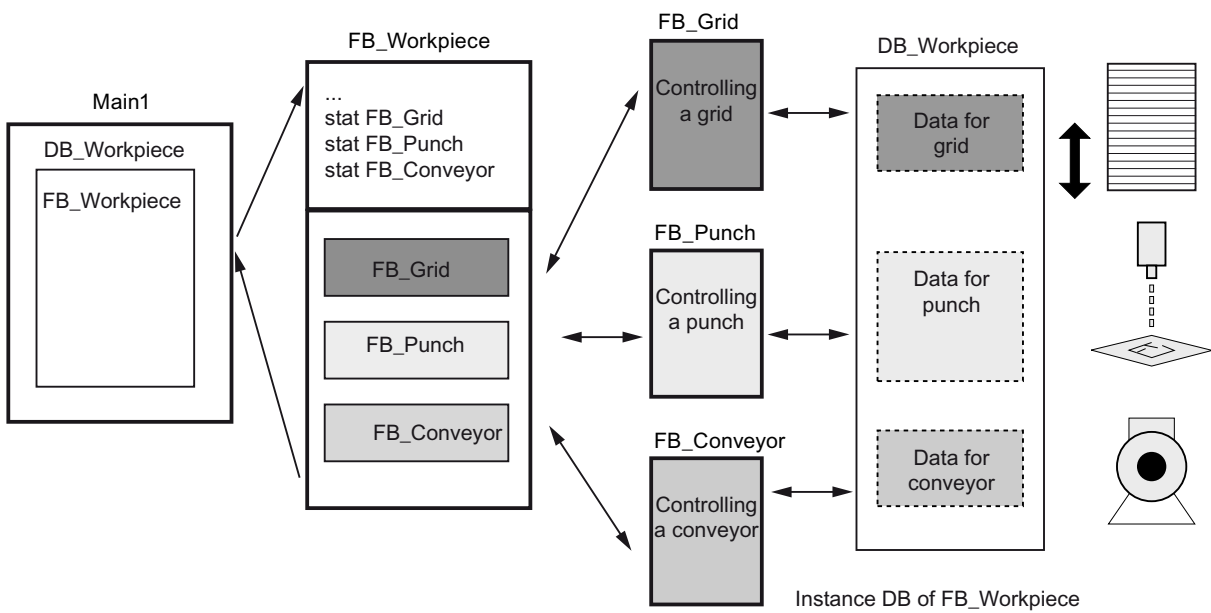

### One instance data block for multi-instances of a function block

The following figure shows how a function block that is called in multi-instances stores the data for all the instances in one instance data block.

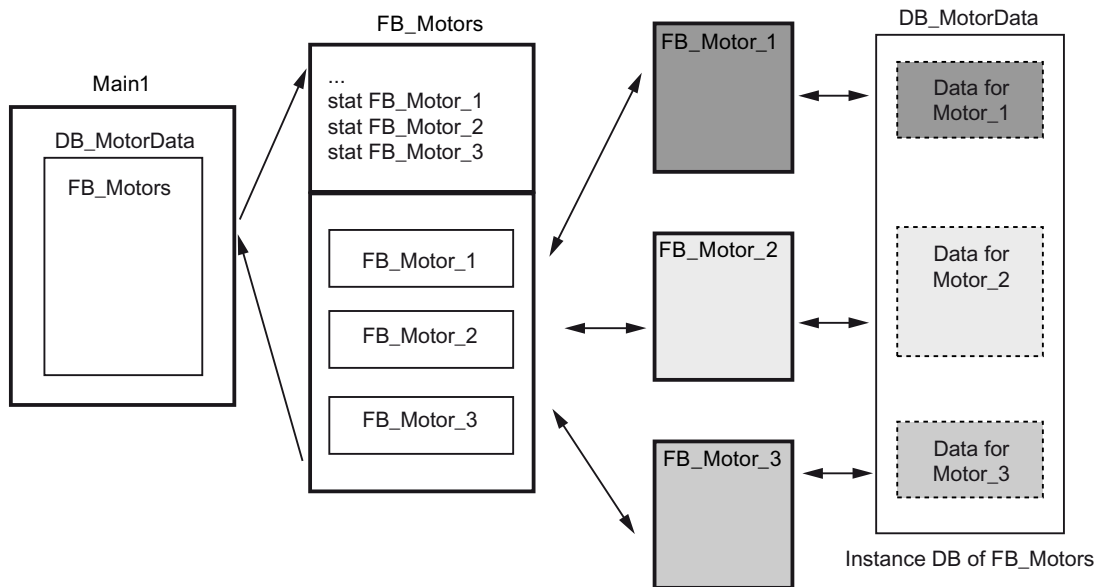

The function block `FB_Motors` calls three instances of the `FB_Motor`. The instances are "Motor\_1", "Motor\_2" and "Motor\_3". Each call uses different instance data. However, all instance data are located in a single instance data block, `DB_MotorData`.

### See also

- Principles for single instances and multi-instances (Page 1034)
- Single instances (Page 1035)

### Parameter transfer at block call

#### Basics of block parameters

#### Introduction

The calling block gives the called block the values with which it is to work. These values are referred to as block parameters. The input parameters provide the called block with the values that it has to process. The block returns the results via the output parameters.

Block parameters are therefore the interface between the calling and the call block.

You use input parameters when you want to only query or read values, and output parameters when you want to set or write these values. If block parameters are read and written you have to create these as in-out parameters.

## Formal and actual parameters

The block parameters are defined in the interface of the called block. These parameters are referred to as formal parameters. They are placeholders for the parameters that are transferred to the block when it is called. The parameters transferred to the block when it is called are referred to as actual parameters.

## Rules for using the block parameters

The following rules apply to the use of block parameters within the block:

- Input parameters may only be read.
- Output parameters may only be written.
- In/out parameters may be read and written.

## See also

Parameter assignment to function blocks (Page 1041)

Parameter assignment to functions (Page 1039)

General rules for assigning parameters (Page 1038)

Using tags within the program (Page 1049)

Keywords (Page 1051)

## Supplying block parameters during call

## General rules for assigning parameters

### Introduction

When you call a block with block parameters, assign actual parameters to its formal parameters. The rules described below apply here.

### Compatible data types

The data types of actual and formal parameters must be identical or convertible according to the rules of data type conversion.

### Transferring ARRAYS

You can transfer ARRAYS as parameters. If a block has an input parameter of ARRAY type, you must transfer as actual parameter an ARRAY with identical structure. You can also transfer individual elements of an ARRAY as actual parameter if the element corresponds to the data type of the formal parameter.

## Transferring PLC data types

You can also transfer tags that are declared as PLC data type as actual parameters. If the formal parameter is declared as PLC data type in the tag declaration, you must transfer a tag that has the same PLC data type as actual parameter.

An element of a tag declared by means of PLC data type can also be transferred as actual parameter at block call, provided that the data type of the element of the tag matches the data type of the formal parameter.

## Transferring structures (STRUCT)

You can transfer structures as parameters. If a block has an input parameter of the STRUCT type, you must transfer as actual parameter a STRUCT with identical structure. This means that the names and data types of all structure components have to be identical.

You can also transfer individual elements of an STRUCT as actual parameter if the element corresponds to the data type of the formal parameter.

---

### Note

We recommend programming structures as PLC data types. PLC data types make programming easier, since they can be used multiple times and modified centrally.

---

## See also

Parameter assignment to function blocks (Page 1041)

Parameter assignment to functions (Page 1039)

Basics of block parameters (Page 1037)

## Parameter assignment to functions

### Parameters of functions (FC)

Functions have no data memory in which values of block parameters can be stored. Therefore, when a function is called, all formal parameters must be assigned actual parameters.

### Input parameters (Input)

Input parameters are read only once per cycle, namely before the block call. Therefore, the rule is that writing an input parameter within the block does not affect the actual parameter. Only the formal parameter is written.

### Output parameters (Output)

Output parameters are read only once per cycle, namely after the block call. Therefore, the rule is that output parameters should not be read within the block. If you nevertheless read an

### 9.1 Creating a user program

output parameter, please note that only the value of the formal parameter is read. The value of the actual parameter cannot be read within the block.

If an output parameter of a function is not written in this function, the value that is predefined for the specified data type is used. For example, the value "false" is predefined for BOOL. However, structured output parameters are not pre-assigned with a value.

To prevent unintentional further processing of the predefined value or an undefined value, note the following when programming the block:

- Make sure that the output parameters are written with values for all possible program paths within the block. In doing so, note that jump commands may skip instruction sequences in which outputs are set, for example.
- Note that the set and reset commands are dependent on the result of the logic operation. If the value of an output parameter is determined with these commands and RLO = 0, a value will not be generated.
- If possible, assign a default value for the output parameters of functions.

#### In/out parameters (InOut)

In/out parameters are read before the block call and written after the block call. If you read or write the parameter within the block, you only access its formal parameter.

An exception is in/out parameters with a structured data type. Structured data types consist of several data elements, for example ARRAY or STRUCT. These are passed to the called block through a POINTER. You therefore always access the actual parameter when you read or write a structured in/out parameter within a block.

When an in/out parameter of a function is not written to this function, the old output value or the input value is used as a value. Nevertheless, you should observe the information provided above for output parameters so that old values are not inadvertently processed further.

#### Temporary local data (Temp)

Temporary local data is only available within a cycle. It is treated differently depending on the block type:

- Standard access  
The following rule applies to code blocks with standard access as well as to all tags with retentivity setting "Set in IDB":  
If you use temporary local data, you have to make sure that the values are written within the cycle in which you want to read them. Otherwise, the values will be random. Temporary data of the STRING data type is an exception: It is automatically pre-assigned the correct length information.
- Optimized access  
The following rule applies to code blocks with optimized access:  
If a temporary tag is not written within a function, the value that is predefined for the specified data type is used. For example, the value "false" is predefined for BOOL. Elements of the PLC data types are pre-assigned with the default value that is specified in the declaration of the PLC data type (UDT). ARRAY elements are pre-assigned with the value "0", even if they are used within a PLC data type. Strings are pre-assigned the correct length information.



## Function value (Return)

Functions normally calculate a function value. This function value can be returned to the calling block via the RET\_VAL output parameter. For this, the RET\_VAL output parameter must be declared in the interface of the function. RET\_VAL is always the first output parameter of a function. All data types are permitted for the RET\_VAL parameter except ARRAY and STRUCT, as well as parameter types TIMER and COUNTER.

In the SCL programming language functions can be call directly in an expression. The result of the expression is then formed with the calculated function value. Therefore, the data type ANY is not permitted in SCL for the function value.

## See also

- Parameter assignment to function blocks (Page 1041)
- Basics of block parameters (Page 1037)
- General rules for assigning parameters (Page 1038)
- Calling functions (Page 1365)
- Examples for calling functions in SCL (Page 1368)

## Parameter assignment to function blocks

### Supplying parameters of function blocks (FB)

In the case of function blocks the parameter values will be stored in the instance data.

If the input, output, or in-out parameters of a function block were not assigned with values, the stored values are used.

In some cases, it is mandatory to specify an actual parameter.

The following table shows which parameters of a function block must be assigned actual parameters:

Parameter	Elementary data type	Structured data type	Parameter type
Input (Input)	optional	optional	required
Output (Output)	optional	optional	required
In-out (InOut)	optional	required	Permitted with S7-1200 only, parameter assignment required
Temporary (Temp)	required S7-1500: Optional with optimized block access	required S7-1500: Optional with optimized block access	required

## See also

- Basics of block parameters (Page 1037)
- General rules for assigning parameters (Page 1038)
- Parameter assignment to functions (Page 1039)

## Access to block parameters during program execution

### Introduction

Block parameters of functions and function blocks are processed differently during program execution. The type of access varies depending on the CPU family, block type and data type of the block parameter.

We generally distinguish between the two following types of access:

- Parameters are transferred as parameter pointers  
A parameter pointer is transferred to the called block.  
This means that the called block can directly access the operand that is specified as actual parameter. Writing a parameter in the called block results in a change of the actual parameter in the calling block. Read access to a block parameter reads the actual parameter directly.
- Parameters are transferred as copy  
The value of the actual parameter is copied to the temporary data of the called blocks during a block call.  
This means that the called block always works with the value that the actual parameter had at the block call. It cannot directly access the operand that is specified as actual parameter. Writing a parameter in the called block does not result in a change of the actual parameter in the calling block. During read access, the formal parameter and not the actual parameter is accessed.  
The procedure for copying is as follows:
  - Input parameter:  
The value of the actual parameter is copied to the formal parameter of the called blocks during a block call.
  - Output parameter:  
The value of the formal parameter is copied to the actual parameter after leaving the block.
  - In/out parameter:  
The value of the actual parameter is copied to the formal parameter of the called block prior to the block call and copied back to the actual parameter after exiting the function.

### Parameter transfer for elementary data types

The following table shows how the different CPU families transfer block parameters with elementary data type. Elementary data types are, for example, Bool, Int, Byte.

Called block	Actual parameter in the area	S7-300/400	S7-1500
FC	I, Q, M, P, L	Pointer	Pointer
	Partially qualified DB address (e.g. DBW 2)	Pointer	Partially qualified DB addresses are not supported in S7-1500.
	Fully qualified DB address (e.g. "MyDB".value), forwarded parameters of the caller, static parameters of the caller	Copy	Copy
FB	All actual parameters	Copy	Copy

### Parameter transfer for structured data types

The following table shows how the different CPU families transfer block parameters with structured data type. Structured data types are data types that consist of several data elements, e.g. ARRAY or STRUCT.

Called block	Actual parameter in the area	S7-300/400	S7-1500
FC	IN, OUT, InOut	Pointer	Pointer
FB	IN, OUT	Copy	Copy
	InOut	Pointer	Pointer

### Forwarding of block parameters

#### Basic information on forwarding block parameters

##### Introduction

##### Definition

The "Forwarding" of block parameters is a special type of parameter use. In this case the block parameters of the calling block are forwarded to the parameters of the called block. The called block uses the values that are currently present at the block parameters of the calling block as the actual parameters.

The following figure shows how the parameters of the function FC\_10 are forwarded to the function FC\_12:

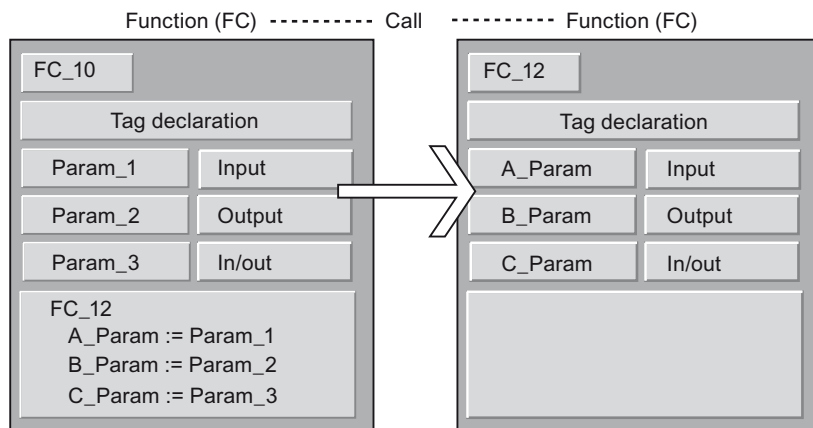

### Rules for LAD/FBD

The following general rules apply in LAD and FBD:

- Input parameters can only be forwarded to input parameters.
- Output parameters can only be forwarded to output parameters.
- In/out parameters can be forwarded to all parameter types.
- In S7-300/400, the two block parameters must have the same data type.
- In S7-1200/1500, the parameters can also be converted according to the rules of implicit conversion.

### Rules for STL

The following general rules apply in STL:

- Input parameters can only be forwarded to input parameters.
- Output parameters can only be forwarded to output parameters.
- In/out parameters can be forwarded to all parameter types.
- Both block parameters must have the same data type. In STL, this rule applies to all CPU families.

### Rules for SCL

The rules for SCL are less stringent. So that programs from previous SCL versions can be taken over more easily, additional parameter transfer options are permissible, but subject to warning. You can, for example, forward an in/out parameter to an input parameter, but a warning is output as the transferred in/out parameter cannot be written by the program.

Additional rules are described in detail in the following chapters.

**See also**

- Calling a function by another function (Page 1045)
- Call of a function by a function block (Page 1046)
- Call of a function block by a function (Page 1047)
- Call of a function block by another function block (Page 1048)

**Calling a function by another function**

**Permissible data types for the call of a function by another function**

Specific rules apply to the forwarding of formal parameters. The following table shows the rules according to which parameters can be forwarded in the various CPU families:

FC calls FC		Data types					
Actual parameter (calling block)	Formal parameters (called block)	Standard data types	ARRAY, STRUCT, STRING, DT	ANY, POINTER	VARIANT	Parameter types (TIMER, COUNTER, BLOCK_XX)	DB_Any
Input	Input	S7-300/400 S7-1200 S7-1500	S7-1200 S7-1500	S7-1500	S7-1200 S7-1500	S7-1500	S7-1200 as of V2 S7-1500
Output	Output	S7-300/400 S7-1200 S7-1500	S7-1200 S7-1500	-	S7-1200 S7-1500	-	-
InOut	Input	S7-300/400 S7-1200 S7-1500	S7-1200 S7-1500	S7-1500	S7-1200 S7-1500	-	-
InOut	Output	S7-300/400 S7-1200 S7-1500	S7-1200 S7-1500	-	S7-1200 S7-1500	-	-
InOut	InOut	S7-300/400 S7-1200 S7-1500	S7-1200 S7-1500	S7-1500	S7-1200 S7-1500	-	-

**See also**

- Basic information on forwarding block parameters (Page 1043)

**Call of a function by a function block**

**Permissible data types for the call of a function by a function block**

Specific rules apply to the forwarding of formal parameters. The following table shows the rules according to which parameters can be forwarded in the various CPU families:

FB calls FC		Data types					
Actual parameter (calling block)	Formal parameters (called block)	Standard data types	ARRAY, STRUCT, STRING, DT	ANY, POINTER	VARIANT	Parameter types (TIMER, COUNTER, BLOCK_XX)	DB_Any
Input	Input	S7-300/400 S7-1200 S7-1500	S7-300/400 S7-1200 S7-1500	S7-1500	S7-1200 S7-1500	S7-1500	S7-1200 as of V2 S7-1500
Output	Output	S7-300/400 S7-1200 S7-1500	S7-300/400 S7-1200 S7-1500	-	S7-1200 S7-1500	-	-
InOut	Input	S7-300/400 S7-1200 S7-1500	S7-1200 S7-1500	S7-1500	S7-1200 S7-1500	-	-
InOut	Output	S7-300/400 S7-1200 S7-1500	S7-1200 S7-1500	-	S7-1200 S7-1500	-	-
InOut	InOut	S7-300/400 S7-1200 S7-1500	S7-1200 S7-1500	S7-1500	S7-1200 S7-1500	-	-

**See also**

Basic information on forwarding block parameters (Page 1043)

## Call of a function block by a function

### Permissible data types for the call of a function block by a function

Specific rules apply to the forwarding of formal parameters. The following table shows the rules according to which parameters can be forwarded in the various CPU families:

FC calls FB		Data types					
Actual parameter (calling block)	Formal parameters (called block)	Standard data types	ARRAY, STRUCT, STRING, DT	ANY, POINTER	VARIANT	Parameter types (TIMER, COUNTER, BLOCK_XX)	DB_Any
Input	Input	S7-300/400 S7-1200 S7-1500	S7-1200 S7-1500	S7-1500	S7-1200 S7-1500	S7-300/400 S7-1500	S7-1200 as of V2 S7-1500
Output	Output	S7-300/400 S7-1200 S7-1500	S7-1200 S7-1500	-	S7-1200 S7-1500	-	-
InOut	Input	S7-300/400 S7-1200 S7-1500	S7-1200 S7-1500	S7-1500	S7-1200 S7-1500	-	-
InOut	Output	S7-300/400 S7-1200 S7-1500	S7-1200 S7-1500	-	S7-1200 S7-1500	-	-
InOut	InOut	S7-300/400 S7-1200 S7-1500	S7-1200 S7-1500	S7-1500	S7-1200 S7-1500	-	-

### See also

Basic information on forwarding block parameters (Page 1043)

**Call of a function block by another function block**

**Permissible data types for the call of a function block by another function block**

Specific rules apply to the forwarding of formal parameters. The following table shows the rules according to which parameters can be forwarded in the various CPU families:

FB calls FB		Data types					
Actual parameter (calling block)	Formal parameters (called block)	Standard data types	ARRAY, STRUCT, STRING, DT	ANY, POINTER	VARIANT	Parameter types (TIMER, COUNTER, BLOCK_XX)	DB_Any
Input	Input	S7-300/400 S7-1200 S7-1500	S7-300/400 S7-1200 S7-1500	S7-1500	S7-1200 S7-1500	S7-300/400 S7-1500	S7-1200 as of V2 S7-1500
Output	Output	S7-300/400 S7-1200 S7-1500	S7-300/400 S7-1200 S7-1500	-	S7-1200 S7-1500	-	-
InOut	Input	S7-300/400 S7-1200 S7-1500	S7-1200 S7-1500	S7-1500	S7-1200 S7-1500	-	-
InOut	Output	S7-300/400 S7-1200 S7-1500	S7-1200 S7-1500	-	S7-1200 S7-1500	-	-
InOut	InOut	S7-300/400 S7-1200 S7-1500	S7-1200 S7-1500	S7-1500	S7-1200 S7-1500	-	-

**See also**

Basic information on forwarding block parameters (Page 1043)



#### 9.1.1.4 Using and addressing operands

### Basic information about operands

#### Introduction

When you program instructions you must specify which data values the instruction should process. These values are referred to as operands. You can, for example, use the following elements as operands:

- PLC tags
- Constants
- Tags in instance data blocks
- Tags in global data blocks

#### Absolute address and symbolic name

Operands are identified by means of an absolute address and a symbolic name. You define the names and addresses in the PLC tag table or in the tag declaration of the blocks.

#### Data blocks with optimized access (S7-1200, S7-1500)

Data elements in data blocks with optimized access only receive a symbolic name and no absolute address in the declaration. For more information on this, refer to "See also".

#### See also

Displaying symbolic and absolute addresses (Page 1229)

Basics of block access (Page 1027)

### Using tags within the program

#### Definition

A variable is a placeholder for a data value that can be changed in the program. The format of the data value is defined. The use of variables makes your program more flexible. For example, you can assign different values to variables that you have declared in the block interface for each block call. As a result, you can reuse a block you have already programmed for various purposes.

A variable consists of the following elements:

- Name
- Data type

- Absolute address
  - PLC tags and DB tags in blocks with standard access have an absolute address.
  - DB variables in blocks with optimized access have no absolute address.
- Value (optional)

### Declaring Variables

You can define variables with different scopes for your program:

- PLC tags that apply in all areas of the CPU
- DB variables in global data block that can be used by all blocks throughout the CPU.
- DB tags in instance data blocks that are predominantly used within the block in which they are declared.

The following table shows the difference between the variable types:

	PLC tags	Variables in instance DBs	Variables in global DBs
Range of application	<ul style="list-style-type: none"> <li>• Are valid throughout the entire CPU.</li> <li>• Can be used by all blocks on the CPU.</li> <li>• The name is unique within the CPU.</li> </ul>	<ul style="list-style-type: none"> <li>• Are predominantly used in the block in which they are defined.</li> <li>• The name is unique within the instance DB.</li> </ul>	<ul style="list-style-type: none"> <li>• Can be used by all blocks on the CPU.</li> <li>• The name is unique within the global DB.</li> </ul>
Permissible characters	<ul style="list-style-type: none"> <li>• Letters, numbers, special characters</li> <li>• Quotation marks are not permitted.</li> <li>• Reserved keywords are not permitted.</li> </ul>	<ul style="list-style-type: none"> <li>• Letters, numbers, special characters</li> <li>• Reserved keywords are not permitted.</li> </ul>	<ul style="list-style-type: none"> <li>• Letters, numbers, special characters</li> <li>• Reserved keywords are not permitted.</li> </ul>
Use	<ul style="list-style-type: none"> <li>• I/O signals (I, IB, IW, ID, Q, QB, QW, QD)</li> <li>• Bit memory (M, MB, MW, MD)</li> </ul>	<ul style="list-style-type: none"> <li>• Block parameters (input, output and in-out parameters),</li> <li>• Static data of a block</li> </ul>	<ul style="list-style-type: none"> <li>• Static data</li> </ul>
Location of definition	PLC tag table	Block interface	Declaration table of the global DB

### See also

- Keywords (Page 1051)
- Basic information about operands (Page 1049)
- Displaying symbolic and absolute addresses (Page 1229)
- Valid names of PLC tags (Page 1175)
- Permissible addresses and data types of PLC tags (Page 1176)

## Constants

### Definition

A constant defines an unchangeable data value. Constants can be read by various program elements during the execution of the program but cannot be overwritten. A change of the constant value during the program's execution can lead to syntax or runtime errors.

### Symbolic constants (S7-1200, S7-1500)

In S7-1200 and S7-1500, you have the option of declaring symbolic names for constants and thus making static values available under a name in the program. The symbolic constants are valid throughout the CPU. Constants are declared in the "Constants" tab of the PLC tag table.

### Elements of Constants

A constant consists of the following elements:

- Name (in the case of symbolic constants)  
Valid characters in the constant name are letters, number and special characters; invalid characters are quotation marks and reserved keywords.
- Data type
- Constant value  
The input format and the value range of the constant depend on the data type of the constant.

---

#### Note

##### Constants of the BOOL type

Constants of the BOOL type may not be used as inputs in LAD or FBD in S7-300/400.

---

### Additional information

For more information on data types of constants and their input formats and value ranges, refer to the "Data types" section under "See also".

### See also

Rules for symbolic constants (Page 1187)

Enter constants (Page 1076)

Declaring constants (Page 1188)

### Keywords

SIMATIC recognizes a range of key words whose definitions are fixed and which have a certain meaning in the program. You should not use these keywords as names for tags or constants.

**Table of keywords**

The following table shows all keywords.

Keywords German mnemonics	Keywords English mnemonics	Description
&	&	And logical operation of logical expressions
A	Q	Output, bit
A1	CC1	Condition code bit
A0	CC0	Condition code bit
AB	QB	Output, byte
AD	QD	Output, double word
AND	AND	And logical operation of logical expressions
ANY	ANY	Data type, pointer
AR1	AR1	Address Register 1
AR2	AR2	Address Register 2
ARRAY	ARRAY	Introduces the specification of an array and is followed by the index list between "[" and "]"
AT	AT	Overlaying tag declaration
AUTHOR	AUTHOR	Name of the author, company name, department name, or other name (max. 8 characters, no spaces)
AW	QW	Output, word
B	B	Byte
BEGIN	BEGIN	Introduces the instruction part for code blocks or initialization part for a data block
BIE	BR	Binary result
BLOCK_FB	BLOCK_FB	Parameter type for specification of an FB
BLOCK_FC	BLOCK_FC	Parameter type for specification of an FC
BLOCK_SDB	BLOCK_SDB	Parameter type for specification of an SDB
BOOL	BOOL	Data type
BY	BY	Increment of the FOR loop
BYTE	BYTE	Data type
CALL	CALL	Call
CASE	CASE	Introduction to the CASE statement
CHAR	CHAR	Elementary data type

Keywords German mnemonics	Keywords English mnemonics	Description
CODE_VERSION1	CODE_VERSION1	Label, whether an FB is multiple instance capable or not. If you want to declare multiple instances, the FB must not have this characteristic.
CONST	CONST	Start of the constant declaration
CONTINUE	CONTINUE	Instruction to exit a loop in SCL
COUNTER	COUNTER	Parameter type for specification of a counter
DATA_BLOCK	DATA_BLOCK	Introduces the data block
DATE	DATE	Data type
DATE_AND_TIME	DATE_AND_TIME	Data type
DB	DB	Data block
DB_ANY	DB_ANY	Data type
DBB	DBB	Data block, data byte
DBD	DBD	Data block, data double word
DBLG	DBLG	Data block length
DBNO	DBNO	Data block number
DBW	DBW	Data block, data word
DBX	DBX	Data block, data bit
DI	DI	Instance data block
DIB	DIB	Instance data block, data byte
DID	DID	Instance data block, data double word
DILG	DILG	Instance data block length
DINO	DINO	Instance data block number
DINT	DINT	Data type
DIW	DIW	Instance data block, data word
DIX	DIX	Instance data block, data bit
DO	DO	Introduction of the instruction part in FOR and WHILE instruction
DT	DT	Data type
DTL	DTL	Data type
DWORD	DWORD	Data type
E	I	Input (via process image), bit
EB	IB	Input (via process image), byte
ED	ID	Input (via process image), double word
ELSE	ELSE	Alternative branch in IF and CASE statement
ELSIF	ELSIF	Alternative condition of the IF instruction
EN	EN	System operand of the EN/ENO mechanism

Keywords German mnemonics	Keywords English mnemonics	Description
ENO	ENO	System operand of the EN/ENO mechanism
END_CASE	END_CASE	End of the CASE statement
END_DATA_BLOCK	END_DATA_BLOCK	Ends the data block
END_FOR	END_FOR	End of the FOR statement
END_FUNCTION	END_FUNCTION	Ends the function
END_FUNCTION_BLOCK	END_FUNCTION_BLOCK	Ends the function block
END_IF	END_IF	End of the IF instruction
END_ORGANIZATION_BLOCK	END_ORGANIZATION_BLOCK	Ends the organization block
END_REPEAT	END_REPEAT	End of the REPEAT statement
END_STRUCT	END_STRUCT	Ends the specification of a structure
END_SYSTEM_FUNCTION	END_SYSTEM_FUNCTION	Ends the system function
END_SYSTEM_FUNCTION_BLOCK	END_SYSTEM_FUNCTION_BLOCK	Ends the system function block
END_TYPE	END_TYPE	Ends the PLC data type
END_VAR	END_VAR	Ends a declaration block
END_WHILE	END_WHILE	End of the WHILE instruction
EW	IW	Input (via process image), word
EXIT	EXIT	Instruction to exit a loop in SCL
FALSE	FALSE	Predefined Boolean constant: Logical condition false, value equal to 0
FAMILY	FAMILY	Block family name: e.g. controller
FB	FB	Function block
FC	FC	Function
FOR	FOR	Introduction of the FOR statement
FUNCTION	FUNCTION	Introduces the function
FUNCTION_BLOCK	FUNCTION_BLOCK	Introduces the function block
GOTO	GOTO	Introduction of the GOTO statement
IF	IF	Introduction of the IF instruction
INSTANCE	INSTANCE	Data type
INT	INT	Data type
KNOW_HOW_PROTECT	KNOW_HOW_PROTECT	Block protection
L	L	Local data bit
LB	LB	Local data byte
LD	LD	Local data double word
LDT	LDT	Data type
LINT	LINT	Data type
LTIME	LTIME	Data type
LTOD	LTOD	Data type

Keywords German mnemonics	Keywords English mnemonics	Description
LW	LW	Local data word
LWORD	LWORD	Data type
M	M	Memory bit
MB	MB	Memory byte
MD	MD	Memory double word
MOD	MOD	Modulo operator
MW	MW	Memory word
NAME	NAME	Block name
NETWORK	NETWORK	Network
NOT	NOT	Logic inversion
NULL	NULL	Zero pointer
OB	OB	Organization block
OF	OF	Introduction of the data type specification / Introduction of the instruction part of the CASE statement
OR	OR	Or logical operation of logical expressions
ORGANIZATION_BLOCK	ORGANIZATION_BLOCK	Introduces the organization block
OS	OS	Save overflow
OV	OV	Overflow
PA	PQ	Output (direct peripherals), bit
PAB	PQB	Output (direct peripherals), byte
PAD	PQD	Output (direct peripherals), double word
PAW	PQW	Output (direct peripherals), word
PE	PI	Input (direct peripherals), bit
PEB	PIB	Input (direct peripherals), byte
PED	PID	Input (direct peripherals), double word
PEW	PIW	Input (direct peripherals), word
POINTER	POINTER	Data type
READ_ONLY	READ_ONLY	Write protection for data blocks
REAL	REAL	Data type
REPEAT	REPEAT	Introduction of the REPEAT statement
RET_VAL	RET_VAL	Return value
RETURN	RETURN	RETURN statement in SCL
S5T	S5T	Syntax for data type S5TIME
S5TIME	S5TIME	Data type
S7_	S7_	Keywords for system attributes
SDB	SDB	System data block
SFB	SFB	System function block

Keywords German mnemonics	Keywords English mnemonics	Description
SFC	SFC	System function
SINT	SINT	Data type
STRING	STRING	Data type
STRUCT	STRUCT	Introduces the specification of a structure and is followed by a list of components
STW	STW	Status word
SYSTEM_FUNCTION	SYSTEM_FUNCTION	System function
SYSTEM_FUNCTION_BLOCK	SYSTEM_FUNCTION_BLOCK	System function block
T	T	Time element (timer)
THEN	THEN	Introduction of the instruction part of an IF instruction
THIS	THIS	Syntax for access to an ARRAY data block
TIME	TIME	Elementary data type for time information
TIME_OF_DAY	TIME_OF_DAY	Data type
TIMER	TIMER	Parameter type for specification of a timer
TITLE	TITLE	Optional block title or network title
TO	TO	Definition of the full-scale value of a FOR statement
TOD	TOD	Data type
TRUE	TRUE	Predefined Boolean constant: Logical condition true, value not equal to 0
TYPE	TYPE	Introduction of the PLC data type
UDT	UDT	Global or PLC data type
UDINT	UDINT	Data type
UINT	UINT	Data type
ULINT	ULINT	Data type
UNLINKED	UNLINKED	Marking 'non runtime-related'
UNTIL	UNTIL	End of the instruction part of a REPEAT statement
USINT	USINT	Data type
UO	UO	Query after (Q1=1) AND (Q0=1)
VAR	VAR	Introduces a declaration block
VAR_IN_OUT	VAR_IN_OUT	Introduces a declaration block
VAR_INPUT	VAR_INPUT	Introduces a declaration block
VAR_OUTPUT	VAR_OUTPUT	Introduces a declaration block
VAR_TEMP	VAR_TEMP	Introduces a declaration block
VARIANT	VARIANT	Data type
VERSION	VERSION	Version number of the block



Keywords German mnemonics	Keywords English mnemonics	Description
VOID	VOID	Function has no return value
WCHAR	WCHAR	Data type
WSTRING	WSTRING	Data type
WHILE	WHILE	Introduction of a WHILE instruction
WORD	WORD	Data type
XOR	XOR	Logic operation
Z	C	Counter

## Addressing operands

### Addressing global variables

### Addressing global variables

To address a global PLC variable, you can use the absolute address or the symbolic name.

---

#### Note

The LWORD, LINT, ULINT, LREAL, LTIME, LTOD and LDT data types can only be addressed by means of their symbolic name.

---

### Addressing global variables in symbolic form

When you use addressing in symbolic form, you enter the variable name from the PLC tag table. The symbolic name of global variables are automatically enclosed in quotation marks.

You address structured tags that are based on a PLC data type with the symbolic name of the PLC tag. You can also indicate the names of the individual components separated by a dot.

### Addressing global variables in absolute form

When you use addressing in absolute form, you enter the address of the variables from the PLC tag table. The absolute address uses numerical addresses starting with zero for each operand range. The address identifier % is set automatically as prefix for the absolute address of global tags.

## Examples

The following examples show applications of symbolic and absolute addressing:

Addressing	Description
%Q1.0	Absolute address: Output 1.0

Addressing	Description
%I16.4	Absolute address: Input 16.4
%IW4	Absolute address: Input word 4
"Motor"	Symbolic address "Motor"
"Value"	Symbolic address "Value"
"Structured_Tag"	Symbolic address of a tag that is based on a PLC data type
"Structured_Tag".Component	Symbolic address of the component of a structured tag.

See also: Permissible addresses and data types of PLC tags (Page 1176)

**See also**

Displaying symbolic and absolute addresses (Page 1229)

Accessing I/O devices (Page 1058)

**Accessing I/O devices**

**Description**

The process image of the CPU is updated once in a cycle. In time-critical applications, however, it can be that the current state of a digital input or output has to be read or transferred more often than once per cycle. For this purpose you can use a suffix for I/O access identifiers on the operand to directly access the I/O.

If you want to read the input directly from the peripherals, use the peripheral inputs memory area (PI) instead of the process input image (I). The peripherals memory area can be read as a bit, byte, word, or double word.

If you want to write directly to the output, use the peripheral output (PQ) memory area instead of the process output image (Q). The peripheral output memory area can be written as a bit, byte, word, or double word.

To read or write a signal directly from a peripheral input, you can add the suffix for I/O access ":P", to the operand.

Components of structured PLC tags can also be addressed with ":P". However, access to the higher-level tag with ":P" is not possible.

 <b>WARNING</b>
<b>Direct writing of the I/O</b>
Immediate writing to the I/O can lead to hazardous states, for example when writing multiple times to an output in one program cycle.

**Syntax**

<Operand>:P

## Example

The following example shows applications of I/O access identifiers:

Addressing	Description
"Motor"	Addresses the "Motor" tag in the process image.
"Motor":P	Addresses the "Motor" tag in the I/O memory area (PI or PQ).
"Structured_Tag".Component	Addresses the component of a structured PLC tag in the process image.
"Structured_Tag".Component:P	Addresses the component of a structured PLC tag in the I/O memory area (PI or PQ).

## See also

Addressing global variables (Page 1057)

## Addressing variables in data blocks

## Addressing variables in global data blocks

## Description

Tags in global data blocks can be addressed in symbolic or absolute form. For symbolic addressing, you use the name of the data block and the name of the tag, separated by a dot. The name of the data block is enclosed in quotation marks.

For absolute addressing, you use the number of the data block and the absolute address of the tags in the data block, separated by a dot. The address identifier % is set automatically as prefix for the absolute address.

The S7-1200/1500 provides you with an option of accessing a data block that is not yet known during programming. For this purpose, create a block parameter of data type DB\_Any in the block interface of the accessing block. The data block name or data block number is transferred to this parameter during runtime. In order to access the internal tags of the data block, use the name of the block parameter of data type DB\_Any and the absolute address of the tag, separated by a dot.

---

### Note

Absolute addressing is not possible for the following tags:

- Tags in blocks with optimized access.
- Tags of data type LWORD, LINT, ULINT, LREAL, LTIME, LTOD and LDT.

Best practice is to use the more convenient symbolic addressing for these tags.

---

**ARRAY data blocks**

ARRAY data blocks are a particular type of global data block. These consist of an ARRAY of any data type. For example, an ARRAY of a PLC data type (UDT) is possible.

You address elements in ARRAY data blocks with the help of the keyword "THIS". The index is then specified in square brackets. The index can be a constant as well as a tag. Integers with a width of up to 32 bits are permitted as tags for the index.

Extended options for addressing ARRAY DBs are available in the "Move" section of the "Instructions" task card. These instructions give you the option, for example, to also address the DB name indirectly.

**Syntax**

```
"<DBname>".TagName
%<DBnumber>.absoluteAddress
#<DBAny_name>.%absoluteAddress
"<ArrayDBname".THIS[#i].<Component>.<ComponentElement>
```

**SCL:**

```
"<ArrayDBname"."THIS"[#i].<Component>.<ComponentElement>
```

The following table show the possible absolute addresses of tags in data blocks:

Data type	Absolute address	Example	Description
BOOL	%DBn.DBXx.y	%DB1.DBX1.0	Data bit 1.0 in DB1
BYTE, CHAR, SINT, USINT	%DBn.DBBy	%DB1.DBB1	Data bit 1 in DB1
WORD, INT, UINT	%DBn.DBWy	%DB1.DBW1	Data word 1 in DB1
DWORD, DINT, UDINT, REAL, TIME	%DBn.DBDy	%DB1.DBD1	Data double word 1 in DB1

**Example**

The following examples show the addressing of tags in global data blocks:

Addressing	Description
"Motor".Value	Symbolic addressing of the "Value" tag in the "Motor" global data block.
%DB1.DBX1.0	Absolute addressing of the "DBX1.0" tags in the "DB1" global data block.
#MyDBAny.%DBX30.0	Absolute addressing of the "DBX30.0" tag in the global DB that is transferred at runtime at the "MyDBAny" parameter.
"MyARRAY_DB".THIS[#MyIndex].MyComponent.MyComponentElement	Addressing an ARRAY data block. The ARRAY index is specified with the "MyIndex" tag. The ARRAY element has two additional substructures: "MyComponent" and "MyComponentElement".

## See also

Addressing structured variables (Page 1062)  
Addressing areas of a tag with slice access (Page 1064)  
Basics of indirect addressing (Page 1068)  
Addressing instance data (Page 1061)

## Addressing instance data

### Description

You can address data elements from the interface of the current block. These tags are stored in the instance data block.

---

#### Note

Tags in blocks with optimized access can only be addressed in symbolic form.

---

To address a tag from the interface of the current block, enter the character # followed by the symbolic tag name.

You can also access the tags of a multiple instance block. Within the multiple instance block, also use the character # followed by the tag name to address the data. You access the data of the multiple instance block from the calling block using #<Multiple instanceName.TagName>.

### Syntax

Use the following syntax for addressing tags in instance data blocks:

```
#<TagName>  
#<Multiple instanceName.TagName>
```

### Examples

The following examples show the addressing of tags in instance data blocks:

Addressing	Description
#Value	Addressing the "Value" tag in the instance data block.
#On	Addressing the "On" tag within the multiple instance block
#Multi.On	Addressing the "On" tag of the multiple instance block from the calling block

## See also

- Addressing variables in global data blocks (Page 1059)
- Addressing structured variables (Page 1062)
- Addressing areas of a tag with slice access (Page 1064)
- Basics of indirect addressing (Page 1068)

## Addressing structured variables

### Addressing data elements of an ARRAY

You access an element in an ARRAY using the syntax `ArrayName[i,j,k...]`.

The index of the element is specified in square brackets. The index includes an integer value (-2147483648 ... 2147483647) for each ARRAY dimension.

Access errors result when you access an element during runtime which is located outside the declared ARRAY limits. The various CPU families react differently to violations of the ARRAY limits:

- S7-300/400
  - The CPU changes to "STOP" mode.
  - You can program the program execution error OB (OB 85) to prevent this.
  - In SCL, you also have the option of enabling the attribute "Check ARRAY limits" in the block properties. This causes the enable output ENO to be set to FALSE in the case of ARRAY access errors.
- S7-1200
  - The CPU generates a diagnostic buffer entry and remains in "RUN" mode.
- S7-1500
  - The CPU changes to "STOP" mode.
  - You can program the programming error OB (OB 121) to prevent this.
  - You also have the option of programming the local error handling with the instructions "GET\_ERROR: Get error locally" or "GET\_ERROR\_ID: Get error ID locally".

---

#### Note

##### Monitoring ARRAY access errors with ENO

The enable output ENO is not set to the signal state FALSE if the ARRAY limits are violated during execution of an instruction. The only exception is SCL blocks on CPUs of the S7-300/400 series for which the block property "Check ARRAY limits" is set.

---

See also:

Auto-Hotspot

Indirect indexing of ARRAY components (Page 1070)

### Addressing ARRAY data blocks

ARRAY data blocks are a particular form of the ARRAY. ARRAY data blocks are global data blocks that consist of exactly one ARRAY. You address elements in ARRAY data blocks using the following syntax:

```
"<GlobArrayDBname">.THIS[#i].<componentname>."<elementname>"
```

SCL:

```
"<GlobArrayDBname">."<THIS">[#i].<componentname>."<elementname>".
```

The "Move" section of the "Instructions" task card offers extended options for addressing ARRAY DBs. These instructions give you the option, for example, to also address the DB name indirectly.

### Addressing data elements in structures

You access individual elements in a structure using `StructureName.ElementName`.

See also:

Auto-Hotspot

### Addressing data elements of an PLC data type

The syntax `PLCDataTypeName.ElementName` is used to access elements of a PLC data type.

See also:

Auto-Hotspot

### Addressing individual characters of a STRING

Use the syntax `StringName[i]` to access an individual character of a STRING.

Access errors result when you access a character during runtime which is located outside the declared STRING length. The various CPU families react differently to violations of the STRING length:

- S7-300/400
  - If the instruction has the enable output ENO, ENO is set to the signal state FALSE.
  - In all other cases, exceeding the STRING length is not monitored. If access takes place outside the STRING, the wrong memory area is accessed. If the access takes place outside the data block, the CPU goes to STOP.
  - You can program the program execution error OB (OB 85) to prevent this.
- S7-1200/1500
  - If the instruction has the enable output ENO, ENO is set to the signal state FALSE.
  - In all other cases, there is no error response. You receive the character '\$00' with read access; write access is not executed.

**Examples:**

The following examples show the addressing of structured data type tags:

Addressing	Description
Motor.Value_1x3[2]	Addressing of a one-dimensional array
Motor.Value_2x4[2,4]	Addressing of a two-dimensional array
Motor.Value_4x7[2,4,1,3]	Addressing of a four-dimensional array
Batch_1.Temperature	Addressing of the element "Temperature" in the structure "Batch_1"
Values.Temperature	Addressing of the "Temperature" element in the "Values" tag, which is based on a PLC data type.
STRING[3]	Addresses the third character of the string.

**See also**

Basics of indirect addressing (Page 1068)

STRING (Page 1103)

**Addressing areas of a tag with slice access**

**Description**

You have the option to specifically address areas within declared tags. You can access areas of the 1-bit, 8-bit, 16-bit, or 32-bit width. The type of access is referred to as "slice access".

**Syntax**

The following syntax is used for addressing:

- <Tag>.X<Bit number>
- <Tag>.B<BYTE number>
- <Tag>.W<WORD number>
- <Tag>.D<DWORD number>

The syntax has the following components:

Part	Description
<Tag>	Tag that you access. The tag must be of the "Bit string" data type. In the case of activated IEC check, the access to tags of the "Integer" data type is also possible.
X	ID for the access width "Bit (1Bit)"
B	ID for the access width "Byte (8 Bit)"
W	ID for the access width "Word (16 Bit)"
D	ID for access width "DWord (32-bit)"
<BIT number>	Bit number within <tag> that is accessed. Number 0 accesses the least significant BIT.



Part	Description
<BYTE number>	Byte number within <tag> that is accessed. The number 0 accesses the least significant BYTE.
<WORD number>	Word number within <tag> that is accessed. The number 0 accesses the least significant WORD.
<DWORD number>	DWord number within <tag> that is accessed. The number 0 accesses the least significant DWORD.

## Examples

The following examples show the addressing of individual bits:

Addressing	Explanation
"Engine".Motor.X0 "Engine".Motor.X7	"Motor" is a tag of the BYTE, WORD, DWORD or LWORD data type in the global data block "Engine". X0 addresses the bit address 0, X7 the bit address 7 within "Motor".
"Engine".Speed.B0 "Engine".Speed.B1	"Speed" is a tag of the WORD, DWORD or LWORD data type in the global data block "Engine". B0 addresses the byte address 0, B1 the byte address 1 within "Speed".
"Engine".Fuel.W0 "Engine".Fuel.W1	"FUEL" is a tag of the DWORD or LWORD data type in the global data block "Engine". W0 addresses the word address 0, W1 the word address 1 within "Fuel".
"Engine".Data.D0 "Engine".Data.D1	"Data" is a tag of the LWORD data type in the global data block "Engine". D0 addresses the double word address 0, D1 the double word address 1 within "Data".

## Overlaying tags with AT

### Description

To access data areas within a declared tag, you can overlay the declared tags with an additional declaration. This provides you with the option of addressing an already declared tag with a different data type. You can, for example, address the individual bits of a tag of WORD data type with an ARRAY of BOOL.

### Rules

The following general rules are valid for tag overlaying:

- Overlaying is possible in S7-1200 and S7-1500 in STL, LAD, FBD and GRAPH.
- SCL supports overlaying in all CPU families.

- Overlaying of tags is possible in the following blocks:
  - In code blocks with standard access
  - In code blocks with optimized access for tags with the retain setting "Set in IDB"
- The data width of the overlaying tag must be equal to or less than that of the overlaid tag.
- It is not possible to overlay tags of the VARIANT and INSTANCE data types.
- Blocks from libraries which are declared as parameters in the interface cannot be overlaid.
- Structured PLC tags that are declared as parameters in the interface cannot be overlaid.

**Note**

**S7-1200/1500: Using AT in FCs**

The data widths of the overlaying tag and the overlaid tag must be identical for FCs in S7-1200/1500. If this is not possible in your program, you can also address areas within existing tags with the .X, .B, .W or .D syntax.

See also: Addressing individual areas of a tag (Page 1064)

The following combination rules are also valid:

		Overlaying tag	Overlaid tag			
Elementary	Structured *	Any/Pointer	DB_ANY			
FB	Input	Elementary	x	x		x
		Structured *	x	x	x	x
		Any/Pointer		x		
	Temp	Elementary	x	x		
		Structured	x	x	x	
		Any/Pointer		x		
	Static, Output	Elementary	x	x		x
		Structured	x	x		x
		Any/Pointer				
InOut	Elementary	x			x	
	Structured		x			
	Any/Pointer					
FC	Temp	Elementary	x	x		
		Structured	x	x	x	
		Any/Pointer		x		
	Input, Output, InOut	Elementary (both tags must have the same bit width)	x			x
		Structured		x	x	
		Any/Pointer				
OB	Temp	Elementary	x	x		

		Overlying tag	Overlaid tag		
		Structured	x	x	x
		Any/Pointer		x	

\* Structured data types consist of several data elements, e.g. ARRAY or STRUCT.

## Declaration

To overlay a tag, declare an additional tag directly after the tag that is to be overlaid and identify it with the keyword "AT".

## Example

The following figure shows the declaration of an overlaid tag in the interface of a FB:

▼ Input		
■ MyByte		Byte
▼ AT	AT "MyByte"	Array [0..7] of Bool
■ AT[0]		Bool
■ AT[1]		Bool
■ AT[2]		Bool
■ AT[3]		Bool
■ AT[4]		Bool
■ AT[5]		Bool
■ AT[6]		Bool
■ AT[7]		Bool

When a block is called with the shown tag declaration, the "MyByte" tag is assigned. Within the block there are now two options for interpreting the data:

- as a byte
- As one-dimensional ARRAY of BOOL

## Addressing operands indirectly

### Basics of indirect addressing

#### Introduction

Indirect addressing offers the option of addressing operands whose address is not calculated until during runtime. With indirect addressing, program sections can be executed several times and a different operand can be used during each run.

 <b>WARNING</b>
<b>Risk of access errors</b>
Since operands are only calculated during runtime with indirect addressing, there is a risk that access errors may occur and that the program will operate with incorrect values. In addition, memory areas may inadvertently be overwritten with incorrect values. The automation system can then react in unexpected manner.
Therefore, use indirect addressing only with caution.

## Indirect addressing

### Basics of indirect addressing

#### General indirect addressing options in S7-1200 and S7-1500

The following indirect addressing options are available in all programming languages:

- Indirect addressing via pointer
- Indirect indexing of ARRAY components
- Indirect addressing of a data block via DB\_ANY data type.

#### Language-specific options of indirect addressing

The following specific addressing options are also available in the various programming languages:

- In STL, you can address operands indirectly via the address register.
- In SCL, you can read or write a variable memory area with the following instructions:
  - POKE - Write memory address
  - POKE\_BOOL - Write memory bit
  - PEEK - Read memory address
  - PEEK\_BOOL - Read memory bit
  - POKE\_BLK - Write memory area

For a detailed description of these addressing options, refer to "See also".

## See also

Addressing variables in global data blocks (Page 1059)  
POKE: Write memory address (Page 2181)  
POKE\_BOOL: Write memory bit (Page 2183)  
PEEK: Read memory address (Page 2177)  
PEEK\_BOOL: Read memory bit (Page 2179)  
POKE\_BLK: Write memory area (Page 2184)  
Indirect addressing via pointer (Page 1069)  
Indirect indexing of ARRAY components (Page 1070)  
Indirect addressing in STL (Page 1074)

## Indirect addressing via pointer

### Description

For indirect addressing, a special data format is required that contains the address and possibly also the range and the data type of an operand. This data format is referred to as pointer. The following types of pointers are available to you:

- POINTER (S7-1500)
- ANY (S7-1500, only for blocks with standard access)
- VARIANT (S7-1200/1500)

For more information on the pointer data types, refer to "See also".

---

### Note

In SCL the use of the POINTER is restricted. The only option available is to forward it to the called block.

---

## Example

The following example shows an indirect addressing with an area-internal pointer:

Addressing in STL	Explanation
L P#10.0	// Load pointer (P#10.0) in accumulator 1
T MD20	// Transfer pointer to the operand MD20
L MW [MD20]	// Load MW10 in accumulator 1
....	// Any program
L MD [MD20]	// Load MD10 in accumulator 1
....	// Any program
= M [MD20]	// If RLO=1, set the memory bit M10.0

The pointer P#10.0 is transferred to the operand MD20. If the operand MD20 in square brackets is programmed, this will be replaced in runtime by the address that is contained in the pointer.

**See also**

Basics of indirect addressing (Page 1068)

**Indirect indexing of ARRAY components**

**Description**

For addressing the components of an ARRAY, you can specify tags of the integer data type as well as constants as the index. Integers with a length of up to 32 bits are allowed here. When tags are used, the index is calculated during runtime. You can, for example, use a different index for each cycle in program loops.

**Note**

When you call a block and transfer an indirectly indexed ARRAY component ("`<Data block>.<ARRAY>[\"i\"]`") to it as in/out parameter (InOut), you cannot change the value of the index tag [i] while the block is being executed. The value is therefore always written back to the same ARRAY component from which it was read.

**Syntax**

The following syntax is used for the indirect indexing of a ARRAY:

```
"<Data block>".<ARRAY>["i"] // one-dimensional ARRAY
"<Data block>".<ARRAY>["i"] // one-dimensional ARRAY of STRUCT
"<Data block>".<ARRAY>["i"] // multidimensional ARRAY
"<Data block>".<ARRAY>["i"] // multidimensional ARRAY of STRUCT
```

The syntax has the following components:

Part	Description
Data block	Name of the data block in which the ARRAY is located
ARRAY	Tag of the ARRAY data type
i, j	PLC tags of the integer data type that are used as pointers
a	Additional partial tag of the structure

**Examples**

The following example shows indirect array indexing of an ARRAY component in STL:

Several axes traverse at different angles. The values for axis number and angle are stored in the two-dimensional ARRAY "control\_axis".

You can use the "SEL" instruction to select the components of the "control\_axis" ARRAY to be written at the "#out" output parameter.

The axis number is defined by the constants "Constant\_Axis\_NoX" and "Constant\_Axis\_NoY"; the angle is defined by the "#Angle" tag.

#### Addressing in STL

```
CALL SEL
  value_type:=Int
  G := "Select"
  IN0 := #control_axis["Constant_Axis_NoX", #Angle]
  IN1 := #control_axis["Constant_Axis_NoY", #Angle]
  OUT := #out
```

The following examples are based on SCL and demonstrate indirect indexing of an ARRAY component. "MOTOR" is a one-dimensional ARRAY\_of\_INT with three rows. "VALUES" is a PLC tag of data type "Integer".

Addressing in SCL	Explanation
MOTOR[2] := VALUES;	(*Direct addressing: Assignment of VALUES to the second row of the ARRAY MOTOR*)
MOTOR["Tag_1"] := VALUES;	(*Indirect addressing: Assignment of VALUES to the rows of ARRAY MOTOR*) specified by "Tag_1"
#MOTOR["Tag_2"+"Tag_3"] := #VALUES;	(*Indirect addressing: Assignment of VALUES to the row of the MOTOR*) ARRAY specified by the expression "Tag_2"+"Tag_3"

The following example shows the indirect indexing of an ARRAY component as an example of LAD. "ARRAY" is a three-dimensional ARRAY. "Tag\_1", "Tag\_2" and "Tag\_3" are PLC tags of the "Integer" data type. Depending on their values, one of the "ARRAY" components will be copied to the "MyTarget" tag.

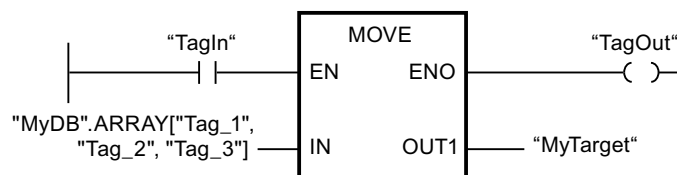

## Indexing ARRAY components using the "FieldRead" and "FieldWrite" instructions

You may also use the following instructions for indirect indexing of ARRAY components in LAD and FBD:

- FieldWrite - Write field
- FieldRead - Read field

For more information on these instructions, refer to the "References" chapter.

### Additional information

For more information on the ARRAY data type, refer to "See also".

### See also

Basics of indirect addressing (Page 1068)

Addressing structured variables (Page 1062)

## Indirect addressing of individual characters of a STRING

### Description

For addressing the individual characters of an STRING, you can specify both constants and tags of the integer data type as the index. When tags are used, the index is calculated during runtime. You can, for example, use a different index for each cycle in program loops.

The index tag [i] is read once at the start of the block call and cannot be changed by the called block while it is being executed.

---

#### Note

##### Monitoring STRING access in runtime

When a STRING that exceeds the defined length of the STRING tags is written in runtime, unwanted reactions may occur in the program. Violation of the STRING length is monitored in S7-1200/1500. You can choose whether you want to respond to violations with the global error handling of the CPU or with separate local error handling.

---

### Syntax

The following syntax is used for the indirect indexing of a STRING:

```
"<Data block>".<STRING>["i"]
```



## Example

The indirect indexing of a STRING is illustrated below based on the example of SCL. "STRING" is a tag of the STRING data type. "Tag\_1" is a PLC tag of the "Integer" data type.

Addressing in SCL	Explanation
<pre>STRING["Tag_1"] := CHARACTER;</pre>	(*Indirect addressing: Assignment of "CHARACTER" to the characters of the *) STRING specified by "Tag_1"

## Additional information

For additional information on the STRING data type, refer to "See also".

## See also

STRING (Page 1103)

## Indirect addressing in STL

## Basic information about address registers

### Introduction

Two address registers are available for the indirect addressing of operands: address register 1 (AR1), and address register 2 (AR2). The address registers are equal and are 32 bits in length. You can store area-internal and cross-area pointers in the address registers. To define the address of an operand, you can call the stored data in the program.

Data is exchanged between the registers and the other available memory areas with the assistance of load and transfer instructions.

---

#### Note

In S7-1500, special rules apply to data exchange via address register and data block register:

- The values in the registers do not remain in existence beyond the block limits.
  - The registers are reset when the language is changed within a block.
  - You can only reference data in blocks with optimized access if these have the retain setting "Set in IDB".
  - It is not possible to reference local data in blocks with optimized access with the help of the address registers (across areas).
- 

## Additional information

For more information on the statements that address registers use and on indirect addressing, refer to "See also".

**See also**

- Indirect addressing in STL (Page 1074)
- Addressing areas of a tag with slice access (Page 1064)

**Indirect addressing in STL**

In STL, the following options are available for indirect addressing:

- Memory-indirect addressing
- Register-indirect area-internal addressing
- Register-indirect cross-area addressing

**Memory-indirect addressing**

In the case of memory-indirect addressing, you store the address in a tag. The tag can be of WORD or DWORD data type. The tag can be located in the memory areas "Data" (DB or DI), "Bit memory" (M) or "Temporary local data" (L). In S7-1500, FB parameters can also be used to store the address. If the tag is located in a data block, it must be a data block with standard access.

The following example shows applications of memory-indirect addressing:

Addressing in STL	Explanation
U E [MD 2]	// Execute an AND logic operation with a variable input bit. The address of the input bit is located in the memory double word MD2.
= DIX [DBD 2]	// Assign the RLO to a variable data bit. The address of the data bit is located in the data double word DBD2.
L EB [DID 4]	// Load a variable input byte to ACCU 1. The address of the input byte is located in the instance double word DID4.
AUF DB [LW 2]	// Open a variable data block. The number of the data block is located in the local data word LW2.

**Register-indirect area-internal addressing**

Register-indirect addressing uses one of the address registers (AR1 or AR2) to pick up the address of the operand.

In the case of register-indirect, area-internal addressing, you index only the bit address and the byte address via the address register (e.g. P#10.0). You do not enter the memory area for which the address in the address register is to apply until during programming of the instruction. The address in the address register then moves to the memory area specified in the instruction.

Possible memory areas are "Inputs" (I), "Outputs" (Q), "I/O" (PI or PQ), "Bit memory" (M), "Temporary local data" (L) and "Data" (DB or DI). If the operand is located in a data block, it must be a data block with standard access.

When you enter register-indirect, area-internal addressing, specify an offset after the specification of the address register. This offset is added to the contents of the address register without changing the address register. This offset also has the format of a pointer. The specification of a pointer is mandatory and must be entered as constant (e.g. P#0.0 or P#2.0).

The following example shows an application of register-indirect area-internal addressing:

STL	Explanation
LAR1 P#10.0	// Load pointer (P#10.0) to address register 1
L IW [AR1, P#2.0]	// Increase contents of address register 1 (P#10.0) by offset P#2.0.
	// Load contents of input word IW12 into accumulator 1
L IW [AR1, P#0.0]	// Increase contents of address register 1 (P#10.0) by offset P#0.0.
	// Load contents of input word IW10 into accumulator 1

### Register-indirect cross-area addressing

In the case of register-indirect, cross-area addressing, use the address register to index the entire address of the operand, in other words, the bit address and byte address, as well as the memory area. Possible memory areas are "Inputs" (I), "Outputs" (Q), "I/O" (P), "Bit memory" (M), "Temporary local data" (L) and "Data" (DB or DI). If the operand is located in a data block, it must be a data block with standard access or the operand must have the retain setting "Set in IDB".

In the instruction, program only the operand width. Possible operand widths are bit, byte, word, and double word.

The following example shows an application of register-indirect cross-area addressing:

LAR1 P#M10.0	// Load cross-area pointer (P#M10.0) to address register 1
L W [AR1, P#2.0]	// Increase contents of address register 1 (P#M10.0) by offset P#2.0.
	// Load contents of memory word "MW12" into accumulator 1
LAR1 P#A10.0	// Load cross-area pointer (P#A10.0) to address register 1
L W [AR1, P#2.0]	// Add contents of address register 1 (P#A10.0) by offset P#2.0
	// Load contents of output word QW12.0 into accumulator 1

---

**Note**

**Special features in S7-1500**

In S7-1500, special rules apply to data exchange via address register and data block register:

- The values in the registers do not remain in existence beyond the block limits. The registers are also reset when the language is changed within a block.
- If you access an operand of the BYTE, WORD or DWORD type using register-indirect addressing, the address must begin at a byte limit.

Examples:

LAR1 P#0.0

L MW [AR1, P#0.0] // P#0.0 + P#0.0 = P#0.0 - The addressing is allowed, because P#0.0 points to a byte limit.

L MW [AR1, P#2.1] // P#0.0 + P#2.1 = P#2.1 - The addressing is not allowed, because P#2.1 does not point to a byte limit.

---

**See also**

Basics of indirect addressing (Page 1068)

Addressing structured variables (Page 1062)

Basic information about address registers (Page 1073)

**Enter constants**

**Description**

You have the following options for using constants in the program:

- Entering the value. You can enter just a value or, optionally, a value preceded by information on the data type. If you only enter a value, the program interprets the constant automatically in a suitable data type. If you provide information on the data type, the constant is always interpreted in the specified data type.
- Input of a symbolic name defined in the PLC tag table (with S7-1200/S7-1500). The symbolic name of a constant will be automatically included in quotation marks.

Both types of constant are displayed in blue in the program.

**Syntax**

- Enter a value:  
<Value>  
<DataType>#<Value>
- Input of a symbolic constant name from the PLC tag table:  
"<Name>"

## Example

The following examples show the use of constants:

Addressing	Explanation
4	Value input for a constant without information on data type. The program interprets the value independently in a data type that suits the current context.
INT#4	Value entry for a constant of Integer type with specification of data type.
FALSE	Value entry for a constant of Bool type
"Name"	Symbolic constants from the PLC tag table
"Offset"	Symbolic constants from the PLC tag table

---

### Note

#### Constants of the BOOL type

Constants of the BOOL type may not be used as inputs in LAD or FBD in S7-300/400.

---

## Additional information

For more information on data types of constants and their input formats and value ranges, refer to the "Data types" section under "See also".

## See also

Constants (Page 1051)

Declaring constants (Page 1188)

### 9.1.1.5 Data types

#### Overview of the valid data types

#### Validity of data type groups

The data type groups define the properties of the data, for example, the representation of the contents and the valid memory areas. In the user program, you can use predefined data type or also data types that you have defined.

The following tables show the availability of predefined data types in the various S7-CPU:

Table 9-1 Binary numbers

Binary numbers	S7-300/400	S7-1200	S7-1500
BOOL (Page 1081)	X	X	X
<b>Bit strings</b>			
BYTE (Page 1082)	X	X	X
WORD (Page 1083)	X	X	X
DWORD (Page 1083)	X	X	X
LWORD (Page 1084)	-	-	X

Table 9-2 Integers

Integers	S7-300/400	S7-1200	S7-1500
SINT (Page 1085)	-	X	X
INT (Page 1087)	X	X	X
DINT (Page 1089)	X	X	X
USINT (Page 1086)	-	X	X
UINT (Page 1088)	-	X	X
UDINT (Page 1089)	-	X	X
LINT (Page 1090)	-	-	X
ULINT (Page 1092)	-	-	X

Table 9-3 Floating-point numbers

Floating-point numbers	S7-300/400	S7-1200	S7-1500
REAL (Page 1093)	X	X	X
LREAL (Page 1094)	-	X	X

Table 9-4 Timers

Timers	S7-300/400	S7-1200	S7-1500
S5TIME (Page 1096)	X	-	X
TIME (Page 1098)	X	X	X
LTIME (Page 1098)	-	-	X

Table 9-5 Date and time

Date and time	S7-300/400	S7-1200	S7-1500
DATE (Page 1099)	X	X	X
TIME_OF_DAY (TOD) (Page 1099)	X	X	X
LTOD (LTIME_OF_DAY) (Page 1100)	-	-	X
DT (DATE_AND_TIME) (Page 1100)	X	-	X
LDT (Page 1101)	-	-	X
DTL (Page 1102)	-	X	X

Table 9-6 Character

Character	S7-300/400	S7-1200	S7-1500
CHAR (Page 1103)	X	X	X
STRING (Page 1103)	X	X	X

Table 9-7 Array

Array	S7-300/400	S7-1200	S7-1500
ARRAY [...] OF <type> (Page 1105)	X	X	X

Table 9-8 Structures

Structures	S7-300/400	S7-1200	S7-1500
STRUCT (Page 1110)	X	X	X

Table 9-9 Pointer

Pointer	S7-300/400	S7-1200	S7-1500
POINTER (Page 1111)	X	-	X
ANY (Page 1113)	X	-	X
VARIANT (Page 1115)	-	X	X

Table 9-10 Parameter types

Parameter types	S7-300/400	S7-1200	S7-1500
TIMER (Page 1117)	X	-	X
COUNTER (Page 1117)	X	-	X
BLOCK_FC (Page 1117)	X	-	X
BLOCK_FB (Page 1117)	X	-	X
BLOCK_DB (Page 1117)	X	-	-
BLOCK_SDB (Page 1117)	X	-	-
BLOCK_SFB (Page 1117)	X	-	-
BLOCK_SFC (Page 1117)	X	-	-
VOID (Page 1117)	X	X	X

Table 9-11 PLC data types

PLC data types	S7-300/400	S7-1200	S7-1500
PLC data type (Page 1118)	X	X	X

Table 9-12 System data types

System data types	S7-300/400	S7-1200	S7-1500
IEC_TIMER (Page 1119)	X <sup>1)</sup>	X	X
IEC_LTIMER (Page 1119)	-	-	X
IEC_SCOUNTER (Page 1119)	-	X	X

9.1 Creating a user program

System data types	S7-300/400	S7-1200	S7-1500
IEC_USCOUNTER (Page 1119)	-	X	X
IEC_COUNTER (Page 1119)	X <sup>2)</sup>	X	X
IEC_UCOUNTER (Page 1119)	-	X	X
IEC_DCOUNTER (Page 1119)	-	X	X
IEC_UDCOUNTER (Page 1119)	-	X	X
IEC_LCOUNTER (Page 1119)	-	-	X
IEC_ULCOUNTER (Page 1119)	-	-	X
ERROR_STRUCT (Page 1119)	-	X	X
NREF (Page 1119)	-	X	X
CREF (Page 1119)	-	X	X
FBTREF (Page 1119)	-	-	-
VREF (Page 1119)	-	-	-
STARTINFO (Page 1119)	X	-	X
SSL_HEADER (Page 1119)	X	-	X
CONDITIONS (Page 1119)	-	X	X
TADDR_Param (Page 1119)	-	X	X
TCON_Param (Page 1119)	-	X	X
<sup>1)</sup> For S7-300/400 CPUs, the data type is represented by TP, TON and TOF. <sup>2)</sup> For S7-300/400 CPUs, the data type is represented by CTU, CTD and CTUD.			

Table 9-13 Hardware data types

Hardware data types	S7-300/400	S7-1200	S7-1500
REMOTE (Page 1121)	-	X	X
GEOADDR (Page 1121)	-	-	X
HW_ANY (Page 1121)	-	X	X
HW_DEVICE (Page 1121)	-	X	X
HW_DPMASTER (Page 1121)	-	-	X
HW_DPSLAVE (Page 1121)	-	X	X
HW_IO (Page 1121)	-	X	X
HW_IOSYSTEM (Page 1121)	-	X	X
HW_SUBMODULE (Page 1121)	-	X	X
HW_MODULE (Page 1121)	-	-	X
HW_INTERFACE (Page 1121)	-	X	X
HW_IEPORT (Page 1121)	-	X	X
HW_HSC (Page 1121)	-	X	X
HW_PWM (Page 1121)	-	X	X
HW_PTO (Page 1121)	-	X	X
AOM_AID (Page 1121)	-	X	X
AOM_IDENT (Page 1121)	-	X	X
EVENT_ANY (Page 1121)	-	X	X
EVENT_ATT (Page 1121)	-	X	X
EVENT_HWINT (Page 1121)	-	X	X



Hardware data types	S7-300/400	S7-1200	S7-1500
OB_ANY (Page 1121)	-	X	X
OB_DELAY (Page 1121)	-	X	X
OB_TOD (Page 1121)	-	X	X
OB_CYCLIC (Page 1121)	-	X	X
OB_ATT (Page 1121)	-	X	X
OB_PCYCLE (Page 1121)	-	X	X
OB_HWINT (Page 1121)	-	X	X
OB_DIAG (Page 1121)	-	X	X
OB_TIMEERROR (Page 1121)	-	X	X
OB_STARTUP (Page 1121)	-	X	X
PORT (Page 1121)	-	X	X
RTM (Page 1121)	-	X	X
PIP (Page 1121)	-	-	X
CONN_ANY (Page 1121)	-	X	X
CONN_PRG (Page 1121)	-	X	X
CONN_OUC (Page 1121)	-	X	X
CONN_R_ID (Page 1121)	-	-	X
DB_ANY (Page 1121)	-	X	X
DB_WWW (Page 1121)	-	X	X

**Note**

Depending on the CPU version, the actually valid data types can deviate slightly from the table.

**Binary numbers**

**BOOL (bit)**

**Description**

An operand of data type BOOL represents a bit value and contains one of the following values:

- TRUE
- FALSE

The following table shows the properties of data type BOOL:

Length (bits)	Format	Range of values	Examples of value input
1	Boolean	FALSE or TRUE BOOL#0 or BOOL#1 BOOL#FALSE or BOOL#TRUE	TRUE BOOL#1 BOOL#TRUE
	Unsigned integers	0 or 1	1
	Binary numbers	2#0 or 2#1	2#0
	Octal numbers	8#0 or 8#1	8#1
	Hexadecimal numbers	16#0 or 16#1	16#1

**Note**

**Applies to CPUs of the S7-1500 series**

For a block with the block property "Optimized block access", the bit has a length of 1 byte.

**See also**

Overview of the valid data types (Page 1077)

Constants (Page 1051)

**Bit strings**

**BYTE (byte)**

**Description**

An operand of data type BYTE is a bit string of 8 bits.

The following table shows the properties of data type BYTE:

Length (bits)	Format	Range of values	Examples of value input
8	Unsigned integers	-128 to 255	15, BYTE#15, B#15
	Binary numbers	2#0 to 2#11111111	2#00001111, BYTE#2#00001111, B#2#00001111
	Octal numbers	8#0 to 8#377	8#17, BYTE#8#17, B#8#17,
	Hexadecimal numbers	B#16#0 to B#16#FF, 16#0 to 16#FF	16#0F, BYTE#16#0F, B#16#0F

**Note**

The BYTE data type cannot be compared for more than or less than. It can only be supplied with the same decimal data that can be processed by the SINT and USINT data types.

**See also**

Overview of the valid data types (Page 1077)  
 Constants (Page 1051)

**WORD**

**Description**

An operand of data type WORD is a bit string of 16 bits.  
 The following table shows the properties of data type WORD:

Length (bits)	Format	Range of values	Examples of value input
16	Unsigned integers	-32768 to 65535	61680, WORD#61680, W#61680
	Binary numbers	2#0 to 2#1111111111111111	2#1111000011110000, WORD#2#1111000011110000, W#2#1111000011110000
	Octal numbers	8#0 to 8#177777	8#170360, WORD#8#170360, W#8#170360
	Hexadecimal numbers	W#16#0 to W#16#FFFF, 16#0 to 16#FFFF	16#F0F0, WORD#16#F0F0, W#16#F0F0
	BCD	C#0 to C#999	C#55
	Decimal sequence	B#(0,0) to B#(255,255)	B#(127,200)

**Note**

The WORD data type cannot be compared for more than or less than. It can only be supplied with the same decimal data that can be processed by the INT and UINT data types.

**See also**

Overview of the valid data types (Page 1077)  
 Constants (Page 1051)

**DWORD**

**Description**

An operand of data type DWORD is a bit string of 32 bits.  
 The following table shows the properties of data type DWORD:

Length (bits)	Format	Range of values	Examples of value input
32	Unsigned integers	-2147483648 to 4294967295	15793935, DWORD#15793935, DW#15793935
	Binary numbers	2#0 to 2#11111111111111111111111111111111	2#00000000111100001111111110001111, DWORD#2#0000000011110000111111100001111, DW#2#000000001111000011111100001111
	Octal numbers	8#0 to 8#3777777777	8#74177417, DWORD#8#74177417, DW#8#74177417
	Hexadecimal numbers	DW#16#00000000 to DW#16#FFFFFF, 16#00000000 to 16#FFFFFF	16#00F0FF0F, DWORD#16#00F0FF0F, DW#16#00F0FF0F
	Decimal sequence	B#(0,0,0,0) to B#(255,255,255,255)	B#(127,200,127,200)

**Note**

The DWORD data type cannot be compared for more than or less than. It can only be supplied with the same decimal data that can be processed by the DINT and UDINT data types.

**See also**

Overview of the valid data types (Page 1077)

Constants (Page 1051)

**LWORD**

**Description**

An operand of data type LWORD is a bit string of 64 bits.

The following table shows the properties of data type LWORD:

Length (bits)	Format	Range of values	Examples of value input
64	Unsigned integers	-9223372036854775808 to 18446744073709551615	26123590360715, LWORD#26123590360715, LW#26123590360715
	Binary numbers	2#0 to 2#11111111111111111111 11111111111111111111 11111111111111111111	2#000000000000000000101111 100001001011110101001011011 11010001011, LWORD#2#0000000000000000 00101111000010010111101010 0101101111010001011, LW#2#00000000000000000010 111110000100101111010100101 101111010001011
	Octal numbers	8#0 to 8#177777777777777777 77	8#13724557213, LWORD#8#13724557213, LW#8#13724557213
	Hexadecimal numbers	LW#16#00000000 to LW#16#FFFFFFFFFFFFFF FF, 16#00000000 to 16#FFFFFFFFFFFFFF	16#000000005F52DE8B, LWORD#16#000000005F52DE8 B, LW#16#000000005F52DE8B
	Decimal sequence	B#(0,0,0,0,0,0,0,0) to B#(255,255,255,255,255,25 5,255,255)	B#(127,200,127,200,127,200,127 ,200)

**Note**

The LWORD data type cannot be compared for more than or less than. It can only be supplied with the same decimal data that can be processed by the LINT and ULINT data types.

**See also**

- Overview of the valid data types (Page 1077)
- Constants (Page 1051)

**Integers**

**SINT (8-bit integers)**

**Description**

An operand of data type SINT (Short INT) has a length of 8 bits and consists of two components: a sign and a numerical value in the two's complement. The signal states of bits 0 to 6 represent the number value. The signal state of bit 7 represents the sign. The sign may assume "0" for the positive, or "1" for the negative signal state.

An operand of data type SINT occupies one BYTE in the memory.

The following table shows the properties of data type SINT:

Length (bits)	Format	Range of values	Examples of value input
8	Signed integers	-128 to 127	+44, SINT#+44
	Binary numbers	2#0 to 2#01111111	2#00101100, SINT#2#00101100
	Octal numbers (only positive)	8#0 to 8#177	8#54, SINT#8#54
	Hexadecimal numbers (only positive)	16#0 to 16#7F	16#2C, SINT#16#2C

**Example**

The following figure shows the integer +44 as a binary number:

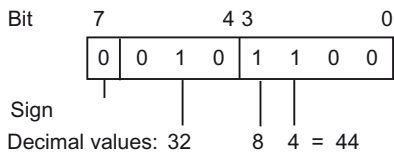

**See also**

Overview of the valid data types (Page 1077)

Constants (Page 1051)

**USINT (8-bit integers)**

**Description**

An operand of data type USINT (Unsigned Short INT) has a length of 8 bits and contains unsigned numerical values:

An operand of data type USINT occupies one BYTE in the memory.

The following table shows the properties of data type USINT:

Length (bits)	Format	Range of values	Examples of value input
8	Unsigned integers	0 to 255	78, USINT#78
	Binary numbers	2#0 to 2#11111111	2#01001110, USINT#2#01001110
	Octal numbers	8#0 to 8#377	8#116, USINT#8#116
	Hexadecimal numbers	16#0 to 16#FF	16#4E, USINT#16#4E

### Example

The following figure shows the integer 78 as a binary number:

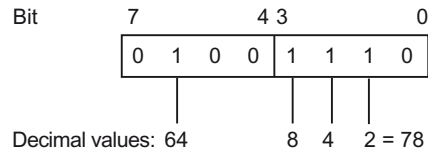

### See also

- Overview of the valid data types (Page 1077)
- Constants (Page 1051)

### INT (16-bit integers)

#### Description

An operand of data type INT has a length of 16 bits and consists of two components: a sign and a numerical value in the two's complement. The signal states of bits 0 to 14 represent the number value. The signal state of bit 15 represents the sign. The sign may assume "0" for the positive, or "1" for the negative signal state.

An operand of data type INT occupies two BYTE in the memory.

The following table shows the properties of data type INT:

Length (bits)	Format	Range of values	Examples of value input
16	Signed integers	-32768 to 32767	+3785, INT#+3785
	Binary numbers (only positive)	2#0 to 2#0111111111111111	2#0000111011001001, INT#2#0000111011001001
	Octal numbers	8#0 to 8#77777	8#7311, INT#8#7311
	Hexadecimal numbers (only positive)	16#0 to 16#7FFF	16#0EC9, INT#16#0EC9

### Example

The following figure shows the integer +3785 as a binary number:

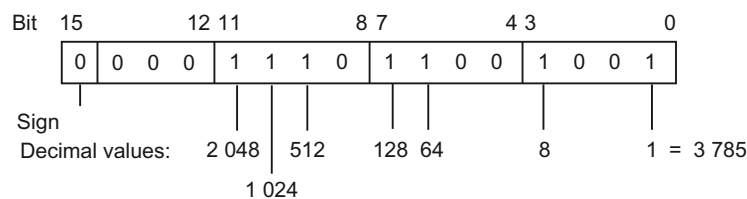

**See also**

Overview of the valid data types (Page 1077)

Constants (Page 1051)

**UINT (16-bit integers)**

**Description**

An operand of data type UINT (Unsigned INT) has a length of 16 bits and contains unsigned numerical values.

An operand of data type UINT occupies two BYTE in the memory.

The following table shows the properties of data type UINT:

Length (bits)	Format	Range of values	Examples of value input
16	Unsigned integers	0 to 65535	65295, UINT#65295
	Binary numbers	2#0 to 2#1111111111111111	2#1111111100001111, UINT#2#1111111100001111
	Octal numbers	8#0 to 8#177777	8#177417, UINT#8#177417
	Hexadecimal numbers	16#0 to 16#FFFF	16#FF0F, UINT#16#FF0F

**Example**

The following figure shows the integer 65295 as a binary number:

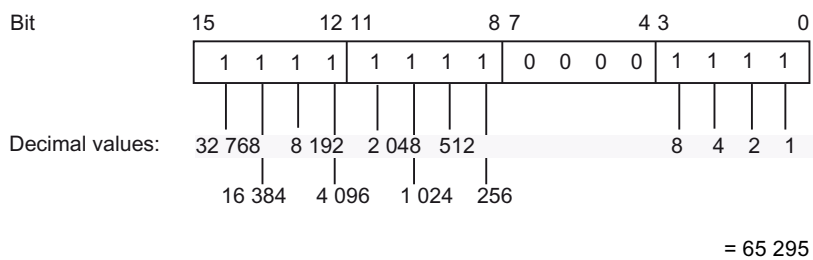

**See also**

Overview of the valid data types (Page 1077)

Constants (Page 1051)



## DINT (32-bit integers)

### Description

An operand of data type DINT (Double INT) has a length of 32 bits and consists of two components: a sign and a numerical value in the two's complement. The signal states of bits 0 to 30 represent the number value. The signal state of bit 31 represents the sign. The sign may assume "0" for the positive, or "1" for the negative signal state.

An operand of data type DINT occupies four BYTE in the memory.

The following table shows the properties of data type DINT:

Length (bits)	Format	Range of values	Examples of value input
32	Signed integers	-2147483648 to +2147483647	125790, DINT#125790, L#275
	Binary numbers (only positive)	2#0 to 2#01111111111111111111111111111111	2#0000000000000000000000000000000011110101101011110, DINT#2#0000000000000000000000001110101101011110
	Octal numbers (only positive)	8#0 to 8#17777777777	8#365536, DINT#8#365536
	Hexadecimal numbers	16#00000000 to 16#7FFFFFFF	16#0001EB5E, DINT#16#0001EB5E

### Example

The following figure shows the integer +125790 as a binary number:

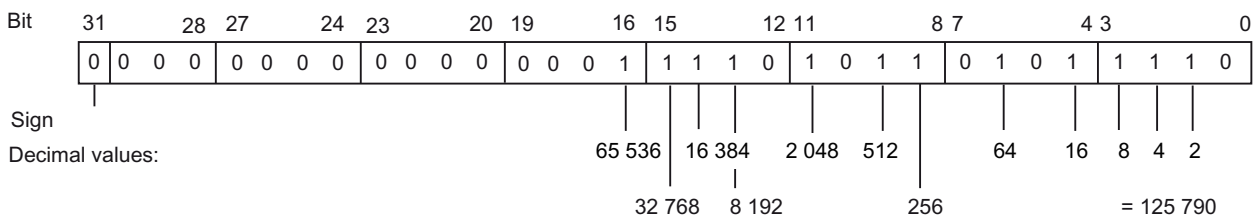

### See also

Overview of the valid data types (Page 1077)

Constants (Page 1051)

## UDINT (32-bit integers)

### Description

An operand of data type UDINT (Unsigned Double INT) has a length of 32 bits and contains unsigned numerical values.

9.1 Creating a user program

An operand of data type UDINT occupies four BYTE in the memory.

The following table shows the properties of data type UDINT:

Length (bits)	Format	Range of values	Examples of value input
32	Unsigned integers	0 to 4294967295	4042322160, UDINT#4042322160
	Binary numbers	2#0 to 2#11111111111111111111111111111111	2#1111000011110000111100001111000011110000, UDINT#2#11110000111100001111000011110000
	Octal numbers	8#0 to 8#377777777777	8#36074170360, UDINT#8#36074170360
	Hexadecimal numbers	16#00000000 to 16#FFFFFFFF	16#F0F0F0F0, UDINT#16#F0F0F0F0

**Example**

The following figure shows the integer 4042322160 as a binary number:

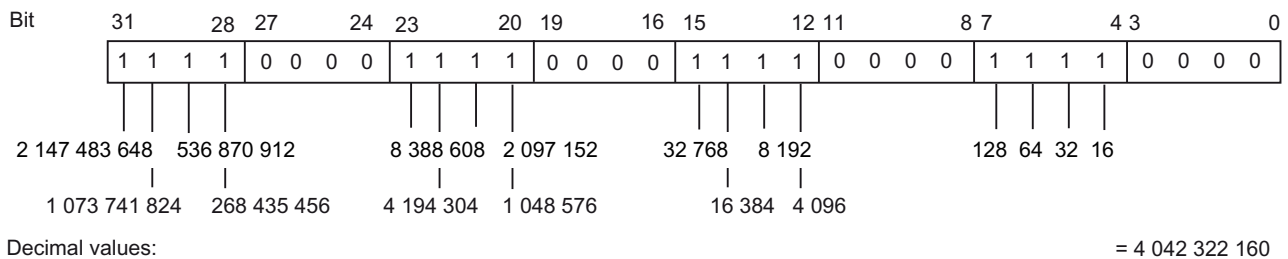

**See also**

- Overview of the valid data types (Page 1077)
- Constants (Page 1051)

**LINT (64-bit integers)**

**Description**

An operand of data type LINT (Long INT) has a length of 64 bits and consists of two components: a sign and a numerical value in the two's complement. The signal states of bits 0 to 62 represent the number value. The signal state of bit 63 represents the sign. The sign may assume "0" for the positive, or "1" for the negative signal state.

An operand of data type LINT occupies eight BYTE in the memory.

The following table shows the properties of data type LINT:

Length (bits)	Format	Range of values	Examples of value input
64	Signed integers	-9223372036854775808 to +9223372036854775807	+154325790816159, LINT# +154325790816159
	Binary numbers (only positive)	2#0 to 2#01111111111111111111111111111111 11111111111111111111111111111111 111111	2#0000000000000000100011000101 101111000101111100001111011110 011111, LINT#2#00000000000000001000110 001011011110001011111000011110 11110011111
	Octal numbers	8#0 to 8#77777777777777777777	8#4305570574173637, LINT#8#4305570574173637
	Hexadecimal numbers (only positive)	16#0 to 16#FFFFFFFFFFFFFF	16#00008C5BC5F0F79F, LINT#16#00008C5BC5F0F79F

**Example**

The following figure shows the integer +154325790816159 as a binary number:

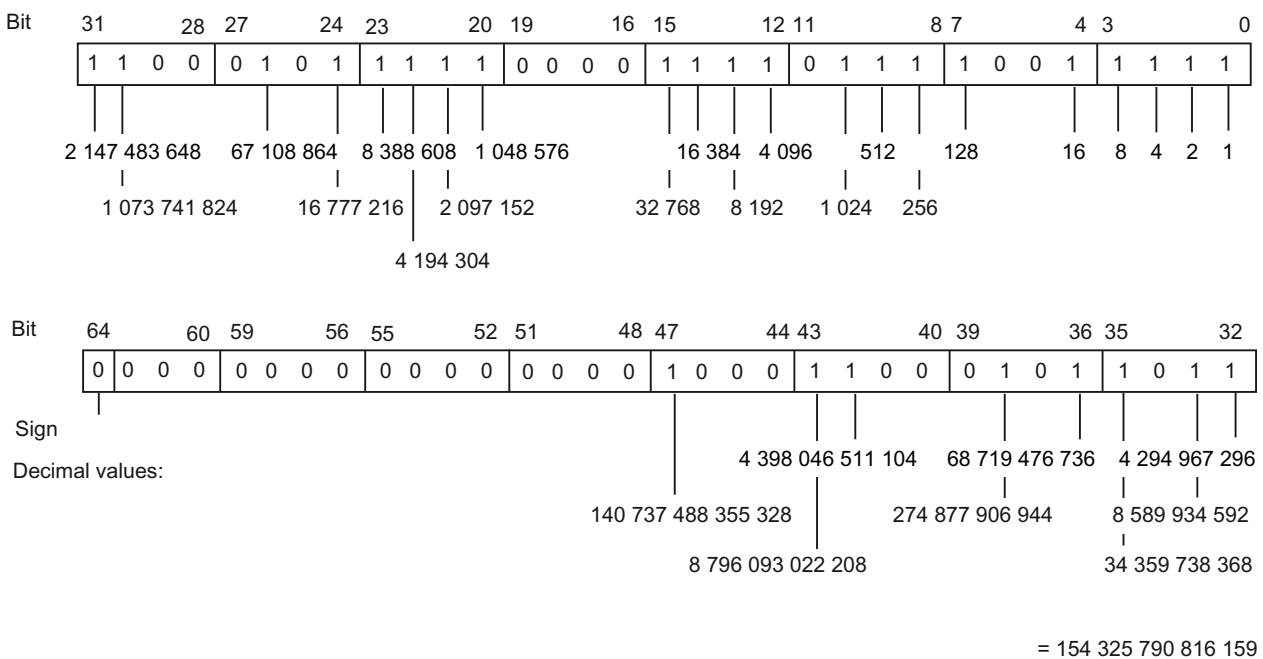

**See also**

- Overview of the valid data types (Page 1077)
- Constants (Page 1051)

### ULINT (64-bit integers)

#### Description

An operand of data type ULINT (Unsigned Long INT) has a length of 64 bits and contains unsigned numerical values.

An operand of data type ULINT occupies eight BYTE in the memory.

The following table shows the properties of data type ULINT:

Length (bits)	Format	Range of values	Examples of value input
64	Unsigned integers	0 to 18446744073709551615	154325790816159, ULINT#154325790816159
	Binary numbers	2#0 to 2#011111111111111111111111111111111111 111111111111111111111111111111111111 111111	2#0000000000000000100011000101 101111000101111100001111011110 011111, ULINT#2#000000000000000010001 100010110111100010111110000111 10111100111111
	Octal numbers	8#0 to 8#17777777777777777777	8#4305570574173637, ULINT#8#4305570574173637
	Hexadecimal numbers	16#0 to 16#FFFFFFFFFFFFFFFF	16#00008C5BC5F0F79F, ULINT#16#00008C5BC5F0F79F

#### Example

The following figure shows the integer 154325790816159 as a binary number:

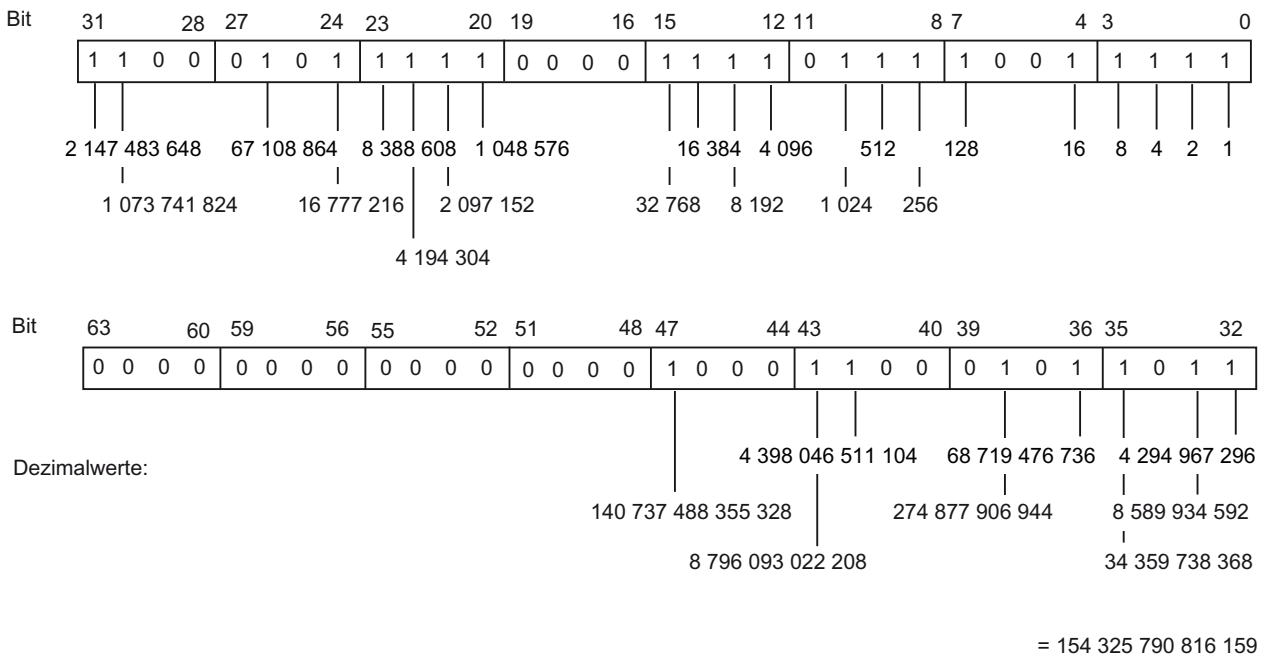

## See also

Overview of the valid data types (Page 1077)  
Constants (Page 1051)

## Floating-point numbers

## REAL

### Description

Operands of the data type REAL have a length of 32 bits and are used to display floating-point numbers. An operand of the REAL data type consists of the following three components:

- Sign: The sign is determined by the signal state of bit 31. The bit 31 assume the value "0" (positive) or "1" (negative).
- 8-bit exponents to basis 2: The exponent is increased by a constant (base, +127), so that it has a value range of 0 to 255.
- 23-bit mantissa: Only the fraction part of the mantissa is shown. The integer part of the mantissa is always 1 with normalized floating-point numbers and is not stored.

The REAL data type is processed with a precision of 7 digits after the decimal point.

The following figure shows the structure of the REAL data type:

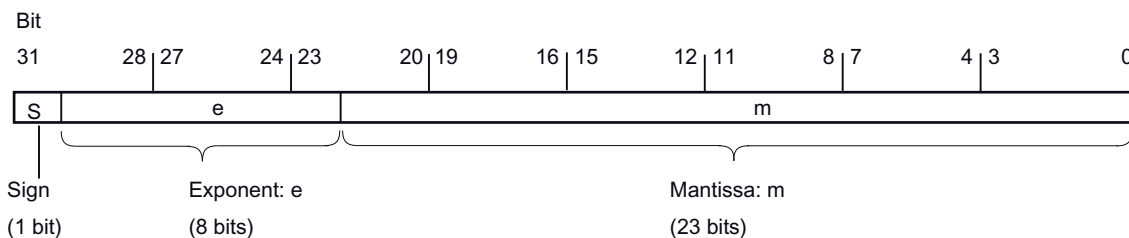

### Note

With floating-point numbers, only the precision defined by the IEEE754 standard is stored. Additionally specified decimals are rounded off according to IEEE754.

The number of decimal places may decrease for frequently nested arithmetic calculations.

If more decimal places are specified than can be stored by the data type, the number is rounded to the corresponding value of the precision allowed by this value range .

The following table shows the properties of data type REAL:

Length (bits)	Format	Range of values	Examples of value input
32	Floating-point numbers according to IEEE754	-3.402823e+38 to -1.175 495e-38 ±0 +1.175 495e-38 to +3.402823e+38	1.0e-5, REAL#1.0e-5
	Floating-point numbers		1.0, REAL#1.0

**See also**

Overview of the valid data types (Page 1077)

Constants (Page 1051)

**LREAL**

**Description**

Operands of the data type LREAL have a length of 64 bits and are used to represent floating-point numbers. An operand of the LREAL data type consists of the following three components:

- Sign: The sign is determined by the signal state of bit 63. The bit 63 assumes the value "0" (positive) or "1" (negative).
- 11-bit exponents to base 2: The exponent is increased by a constant (base, +1023), so that it has a value range of 0 to 2047.
- 52-bit mantissa: Only the fraction part of the mantissa is shown. The integer part of the mantissa is always 1 with normalized floating-point numbers and is not stored.

The LREAL data type is processed with a precision of 15 digits after the decimal point.

The following figure shows the structure of the LREAL data type:

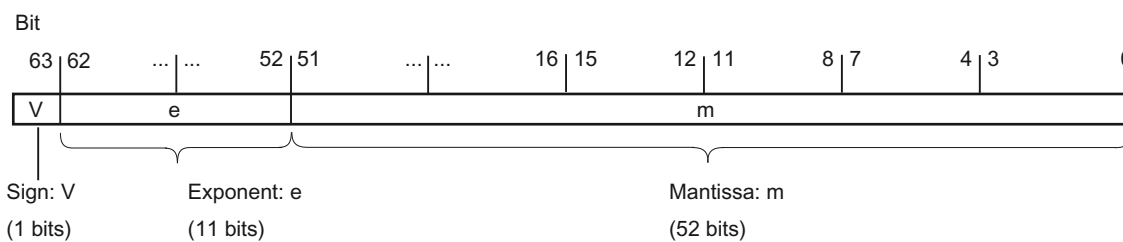

The following table shows the properties of data type LREAL:

Length (bits)	Format	Range of values	Examples of value input
64	Floating-point numbers according to IEEE754	-1.7976931348623158e+308 to -2.2250738585072014e-308 ±0 +2.2250738585072014e-308 to +1.7976931348623158e+308	1.0e-5, LREAL#1.0e-5
	Floating-point numbers		1.0, LREAL#1.0

---

**Note**

With floating-point numbers, only the precision defined by the IEEE754 standard is stored. Additionally specified decimals are rounded off according to IEEE754.

The number of decimal places may decrease for frequently nested arithmetic calculations.

If more decimal places are specified than can be stored by the data type, the number is rounded to the corresponding value of the precision allowed by this value range .

---

**See also**

Overview of the valid data types (Page 1077)

Constants (Page 1051)

**Invalid floating-point numbers****Description**

We distinguish between four number ranges for data types REAL and LREAL:

- normalized numbers stored with full accuracy
- denormalized numbers not stored with full accuracy
- Infinite numbers: +Inf/-Inf (infinity)
- Invalid numbers: NaN (Not a Number)

---

**Note**

Floating-point numbers are stored as specified by the IEEE754 standard. Results of conversion or arithmetic functions with a denormalized, infinite or NaN (Not a Number) floating point depend on the CPU.

---

If you are not working with normalized floating-point numbers in mathematical functions, the result will show significant differences depending on the series of the CPU which you are using.

A CPU cannot calculate with denormalized floating-point numbers, with the exception of older CPU versions of the S7-300 and S7-400 series. The bit pattern of a denormalized number is interpreted as a zero. If the result of calculation falls into this range, it is continued with zero; the status bits OV and OS are set (number range undershoot).

Even though the values of invalid floating-point numbers can only be displayed with limited accuracy for mathematical functions, numbers with an exponent of -39 (e.g., 2.4408e-039) can

be monitored in the TIA Portal and therefore do not necessarily represent a faulty result. This means that floating-point values may be located outside the range of valid numerical values.

---

**Note**

**The following applies to CPUs of the series S7-1200 V1, V2 and V3:**

The comparison operation "Equal" uses the bit pattern of the invalid floating-point number. If two "NaN numbers" with the same bit pattern are compared, the output of the "Equal" comparison operation returns the result TRUE.

---

**Note**

**The following applies to CPUs of the S7-1200 V4 and S7-1500 series:**

If two invalid numbers (NaN) are compared with each other, the result is always FALSE, regardless of the bit pattern of the invalid number or the relation (>, >, ...).

---

**Note**

**Comparison of denormalized floating-point numbers**

For the comparison operation "Equal" with two denormalized floating-point numbers, the output for CPUs of the S7-300/400 series is set to the signal state "0" and for CPUs of the S7-1200/1500 series to the signal state "1".

---

If the input variables of a mathematical function represent an invalid floating-point number, an invalid floating-point number will also be output as result.

You have the following options to evaluate possible errors caused by invalid floating-point numbers:

- In LAD/FBD and SCL, you can query the enable output ENO for FALSE
- In STL, you can evaluate the status bit OV

## See also

Overview of the valid data types (Page 1077)

Constants (Page 1051)

## Timers

### S5TIME (duration)

#### Format

Data type S5TIME stores the duration in BCD format. The duration is the product from a time in the range 0 to 999 and a time basis. The time basis indicates the interval at which a timer decrements the time value by one unit until it reaches "0". The resolution of the times can be controlled via the time basis.





**See also**

Overview of the valid data types (Page 1077)

Constants (Page 1051)

**TIME (IEC time)**

**Description**

The contents of an operand of the data type TIME is interpreted as milliseconds. The representation contains information for days (d), hours (h), minutes (m), seconds (s) and milliseconds (ms).

The following table shows the properties of data type TIME:

Length (bits)	Format	Range of values	Examples of value input
32	Signed duration	T#-24d20h31m23s648ms to T#+24d20h31m23s647ms	T#10d20h30m20s630ms, TIME#10d20h30m20s630ms

It is not necessary to specify all time units. T#5h10s is a valid entry, for example. If only one unit is specified, the absolute value of days, hours, and minutes must not exceed the high or low limits. When more than one time unit is specified, the value must not exceed 24 days, 23 hours, 59 minutes, 59 seconds or 999 milliseconds.

**See also**

Overview of the valid data types (Page 1077)

Constants (Page 1051)

**LTIME (IEC time)**

**Description**

The contents of an operand of data type LTIME is interpreted as nanoseconds. The representation contains information for days (d), hours (h), minutes (m), seconds (s) and milliseconds (ms), microseconds (us) and nanoseconds (ns).

The following table shows the properties of data type LTIME:

Length (bits)	Format	Range of values	Examples of value input
64	Signed duration	LT#-106751d23h47m16s854ms775us808ns to LT#+106751d23h47m16s854ms775us807ns	LT#11350d20h25m14s830ms652us315ns, LTIME#11350d20h25m14s830ms652us315ns

It is not necessary to specify all time units. LT#5h10s is therefore a valid entry, for example. If only one unit is specified, the absolute value of days, hours, and minutes must not exceed the

high or low limits. When more than one time unit is specified, the value must not exceed 106751 days, 23 hours, 59 minutes, 59 seconds, 999 milliseconds, 999 microseconds or 999 nanoseconds.

### See also

Overview of the valid data types (Page 1077)

Constants (Page 1051)

### Date and time

### DATE

#### Format

The DATE data type saves the date as an unsigned integer. The representation contains the year, the month, and the day.

The contents of an operand of DATE data type correspond in hexadecimal format to the number of days since 01-01-1990 (16#0000).

The following table shows the properties of data type DATE:

Length (bytes)	Format	Range of values	Examples of value input
2	IEC date (Year-Month-Day)	D#1990-01-01 to D#2168-12-31	D#2009-12-31, DATE#2009-12-31
	Hexadecimal numbers	16#0000 to 16#FF62	16#00F2

### See also

Overview of the valid data types (Page 1077)

Constants (Page 1051)

### TIME\_OF\_DAY (TOD)

#### Format

Data type TOD (TIME\_OF\_DAY) occupies a double word and stores the number of milliseconds since the beginning of the day (0:00 h) as unsigned integer.

The following table shows the properties of data type TOD:

Length (bytes)	Format	Range of values	Examples of value input
4	Time-of-day (hours:minutes:seconds)	TOD#00:00:00.000 to TOD#23:59:59.999	TOD#10:20:30.400, TIME_OF_DAY#10:20:30.400

You always need to specify the hours, minutes and seconds. The specification of milliseconds is optional.

**See also**

Overview of the valid data types (Page 1077)

Constants (Page 1051)

**LTOD (LTIME\_OF\_DAY)**

**Format**

Data type LTOD (LTIME\_OF\_DAY) occupies two double words and stores the number of nanoseconds since the beginning of the day (0:00 h) as unsigned integer.

The following table shows the properties of data type LTOD:

Length (bytes)	Format	Range of values	Examples of value input
8	Time-of-day (hours:minutes:seconds.millisecods.microseconds.nanoseconds)	LTOD#00:00:00.00000000 to LTOD#23:59:59.99999999	LTOD#10:20:30.400_365_215, LTIME_OF_DAY#10:20:30.400_365_215

You always need to specify the hours, minutes and seconds. The specification of milliseconds, microseconds and nanoseconds is optional.

**See also**

Overview of the valid data types (Page 1077)

Constants (Page 1051)

**DATE\_AND\_TIME (date and time of day)**

**Format**

The DT (DATE\_AND\_TIME) data type saves the information on date and time of day in BCD format.

The following table shows the properties of data type DT:

Length (bytes)	Format	Range of values	Example of value input
8	Date and time (year-month-day-hour:minute:second) <sup>3)</sup>	Min.: DT#1990-01-01-0:0:0 Max.: DT#2089-12-31-23:59:59.99	DT#2008-10-25-8:12:34.567, DATE_AND_TIME#2008-10-25-08:12:34.567

The following table shows the structure of the DT data type:

Byte	Contents	Range of values
0	Year	0 to 99 (Years 1990 to 2089) BCD#90 = 1990 ... BCD#0 = 2000 ... BCD#89 = 2089
1	Month	BCD#0 to BCD#12
2	Day	BCD#1 to BCD# 31
3	Hour	BCD#0 to BCD#23
4	Minute	BCD#0 to BCD#59
5	Second	BCD#0 to BCD#59
6	The two most significant digits of MSEC	BCD#0 to BCD#999
7 (4MSB) <sup>1)</sup>	The least significant digit of MSEC	BCD#0 to BCD#9
7 (4LSB) <sup>2)</sup>	Weekday	BCD#1 to BCD#7 BCD#1 = Sunday ... BCD#7 = Saturday
<sup>1)</sup> MSB: Most significant bit <sup>2)</sup> LSB: Least significant bit <sup>3)</sup> Fixed point number		

### See also

Overview of the valid data types (Page 1077)  
Constants (Page 1051)

### LDT (DATE\_AND\_LTIME)

#### Format

Data type LDT (DATE\_AND\_LTIME) stores the date and time-of-day information in nanoseconds since 01/01/1970 0:0.

The following table shows the properties of data type LDT:

Length (bytes)	Format	Range of values	Example of value input
8	Date and time (Year-Month-Day-Hour:Minute:Second)	Min.: LDT#1970-01-01-0:0:0.000 000000, 16#0  Max.: LDT#2262-04-11-23:47:16. 854775807, 16#7FFF_FFFF_FFFF_FFF F	LDT#2008-10-25-8:12:34.567

**See also**

Overview of the valid data types (Page 1077)

Constants (Page 1051)

**DTL**

**Description**

An operand of data type DTL has a length of 12 bytes and stores date and time information in a predefined structure.

The following table shows the properties of data type DTL:

Length (bytes)	Format	Range of values	Example of value input
12	Date and time (Year-Month-Day-Hour:Minute:Second.Nanos econds)	Min.: DTL#1970-01-01-00:00:00.0  Max.: DTL#2554-12-31-23:59:59.9 99999999	DTL#2008-12-16-20:30:20 .250

The structure of data type DTL consists of several components each of which can contain a different data type and range of values. The data type of a specified value must match the data type of the corresponding components.

The following table shows the structure components of data type DTL and their properties:

Byte	Component	Data type	Range of values
0	Year	UINT	1970 to 2554
1			
2	Month	USINT	1 to 12
3	Day	USINT	1 to 31
4	Weekday	USINT	1(Sunday) to 7(Saturday)  The weekday is not considered in the value entry.
5	Hour	USINT	0 to 23

Byte	Component	Data type	Range of values
6	Minute	USINT	0 to 59
7	Second	USINT	0 to 59
8	Nanosecond	UDINT	0 to 999999999
9			
10			
11			

### See also

Overview of the valid data types (Page 1077)  
Constants (Page 1051)

### Character strings

#### CHAR (character)

#### Description

An operand of data type CHAR has a length of 8 bits and occupies one BYTE in the memory. The CHAR data type stores a single character in ASCII format. You can find information on the coding of special characters under "See also".  
The following table shows the value range of the CHAR data type:

Length (bits)	Format	Range of values	Example of value inputs
8	ASCII characters	ASCII character set	'A', CHAR#'A'

### See also

Overview of the valid data types (Page 1077)  
Constants (Page 1051)

### STRING

#### Description

An operand of the STRING data type saves several characters in a character string that can consist of up to 254 characters. In a character string, all characters of the ASCII code are permitted. The characters are specified in single quotation marks.  
The following table shows the properties of a STRING tag:

Length (bytes)	Format	Range of values	Example of value input
n + 2 *	ASCII character string incl. special characters	0 to 254 characters	'Name', STRING#NAME'
* An operand of the STRING data type occupies two bytes more than the specified maximum length in the memory.			

A character string can also contain special characters. The alignment symbol \$ is used to identify control characters, dollar character and single quotation marks.

The following table shows examples for the notation of special characters:

Character	Hex	Meaning	Example
\$L or \$l	CCA	Line feed	'\$LText', '\$0AText'
\$N or \$n	0A and 0D	Line break The line break occupies 2 characters in the character string.	'\$NText', '\$0A\$0DText'
\$P or \$p	0C	Page feed	'\$PText', '\$0CText'
\$R or \$r	0D	Carriage return (CR)	'\$RText', '\$0DText'
\$T or \$t	09	Tabulator	'\$TText', '\$09Text'
\$\$	24	Dollar character	'100\$\$t', '100\$26'
\$'	27	Single quotation marks	'\$'Text\$', '\$27Text\$27'

The maximum length of the character string can be specified during the declaration of an operand using square brackets after the keyword STRING (for example, STRING[4]). If the information on maximum length is omitted, the standard length of 254 characters is set for the respective operand.

If the actual length of a specified character string is shorter than the declared maximum length, the characters are written to the character string right-justified and the remaining character spaces remain undefined. Only occupied character spaces are considered in the value processing.

**Note**

For S7-300/400 CPUs, please note: If a temporary tag of the STRING data type was defined, you must describe the BYTE "Max. length of string" with the defined length before you use the tags in the user program.



### Example

The example below shows the byte sequence if the STRING[4] data type is specified with output value 'AB':

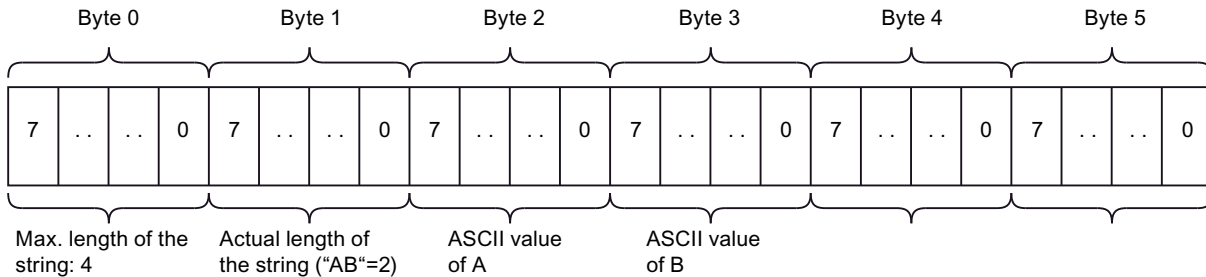

### See also

Overview of the valid data types (Page 1077)

Constants (Page 1051)

### Array

#### Format of array (16-bit limits)

#### Description

The Array data type represents a data structure that consists of a fixed number of components of the same data type. All data types except Array are permitted.

A tag with the Array data type always starts at a WORD limit.

The array components are addressed by means of an index. In the array declaration, the index limits are defined in square brackets after the keyword Array. The low limit must be smaller than or equal to the high limit. An array may contain up to six dimensions, the limits of which can be specified separated by a comma.

The following table shows the property of the Array data type:

Length	Format	Index limits	Data type
Number of components * length of the data type	Array [low limit...high limit] of <data type>	[-32768..32767] of <data type>	Bit strings, integers, floating-point numbers, timers, character strings, structures

**Example**

The following example shows how operands of data type Array can be declared:

Name	Declaration	Comment
Measured value	Array[1..20] of REAL	One-dimensional array with 20 components
Time-of-day	Array[-5..5] of INT	One-dimensional array with 11 components
Character	Array[1..2, 3..4] of CHAR	Two-dimensional array with 4 components

**Maximum array limits**

The maximum Array limits depend on the following factors:

- Data type of the Array elements
- Maximum storage capacity of the CPU (you can find more information in the relevant device manual)

**See also**

Overview of the valid data types (Page 1077)

Indirect indexing of ARRAY components (Page 1070)

**Format of array (32-bit limits)**

**Description**

The Array data type represents a data structure that consists of a fixed number of components of the same data type. All data types except Array are permitted.

The array components are addressed by means of an index. In the array declaration, the index limits are defined in square brackets after the keyword Array. The low limit must be smaller than or equal to the high limit. An array may contain up to six dimensions, the limits of which can be specified separated by a comma.

**Note**

Depending on the CPU, the storage capacity of a data block is limited and the number of components of the Array is therefore also limited. However, you may initialize the addressing of the array components at any position within index limits.

The following table shows the property of the Array data type:

Length	Format	Index limits	Data type
Number of components * length of the data type	Array [low limit...high limit] of <data type>	[-2147483648..2147483647] of <data type>	Bit strings, integers, floating-point numbers, timers, character strings, structures

**Note**

The length of the array depends on whether the block was created with the "Standard" or "with optimized access" block property.

**Note**

**Applies to CPUs of the S7-1500 series**

For a block with the block property "Optimized block access", a bit requires 1 byte of memory. This is also true when you use an array of <data type>. An array [0..1] of BOOL, for example, needs 8 bytes in an optimized block.

**Example**

The following example shows how operands of data type Array can be declared:

Name	Declaration	Comment
Measured value	Array[1..20] of REAL	One-dimensional array with 20 components
Time-of-day	Array[-5..5] of INT	One-dimensional array with 11 components
Character	Array[1..2, 3..4] of CHAR	Two-dimensional array with 4 components

**Maximum array limits**

The maximum array limits depend on the following factors:

- Data type of the array elements
- Memory reserve (only in blocks with optimized access)  
You can find additional information on this topic in the section "Loading block changes without reinitialization".
- Maximum size of a data block for a CPU (you can find more information in the respective device manual)
- The entire length of the array is available within a data block. Within a program block (OB, FB or FC), the possible length is reduced by the memory capacity required by the program code.

**Example based on a CPU of the S7-1200 series**

The following table shows the maximum number of elements within a block with the "with optimized access" block property:

Data type width (bits)	Maximum number of elements	Note
1	524272	= 65534*8
8	65534	Refer to the respective device manual of the CPU for the value.

Data type width (bits)	Maximum number of elements	Note
16	32767	= 65534/2 (integer division, remainder 0)
32	16383	= 65534/4 (integer division, remainder 2)
64	8191	= 65534/8 (integer division, remainder 6)

Due to various technical/internal constraints, the actual usable memory area may be approximately 70 - 100 bytes less. The memory area may be further restricted due to a default setting, for example, by the "Load without reinitialization" block property.

**See also**

Overview of the valid data types (Page 1077)

Indirect indexing of ARRAY components (Page 1070)

**Example of a one-dimensional array**

**Declaration**

The following table shows the declaration of a one-dimensional Array tag:

Name	Data type	Comment
Op_Temp	Array[1..3] of INT	One-dimensional array tag with 3 components.

The following figure shows the structure of the declared array tag:

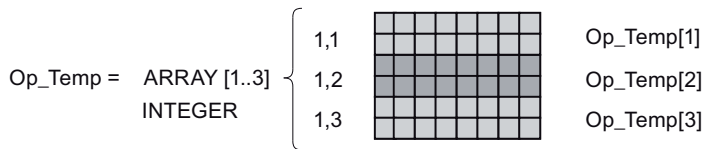

**Access to ARRAY components**

The individual array components are accessed via an index.. The index of the first ARRAY component is [1], of the second [2], and of the third [3]. To access the value of the second ARRAY component, you need to declare "Op\_Temp[2]" in the program.

## Example of a multi-dimensional array

### Declaration

The following table shows the declaration of a two-dimensional Array tag:

Name	Data type	Value	Comment
Betr_Temp	Array[1..2, 1..3] of INT	1,1,4(0)	Two-dimensional array tag with 6 components. The first two components are assigned the value "1". The remaining four components are assigned the value "0".

The following figure shows the structure of the declared array tag:

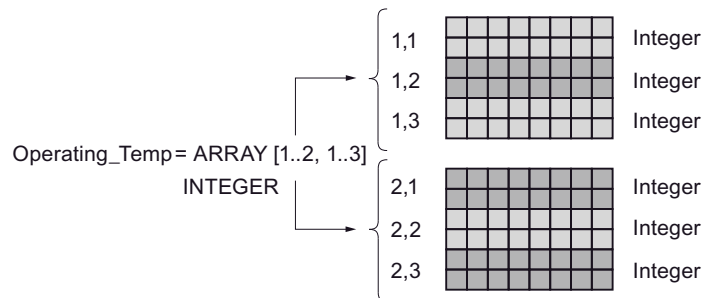

### Access to the array components

The values of the individual array components are accessed via an index. The index of the first array component is, for example, [1,1] and the index of the fourth array component is [2,1]. For example, you need to declare "Betr\_Temp[2,1]" in the program to enable access to the value of the fourth array component.

### Additional access option

You can also declare the "Betr\_Temp" TAG as a six-dimensional array. The following table shows an example of the declaration of a six-dimensional Array tag:

Name	Data type	Value	Comment
Betr_Temp	Array[1..3, 1..2, 1..3, 1..4, 1..3, 1..4] of INT	-	Six-dimensional array tag

The index of the first array component is in this case [1,1,1,1,1,1] and the index of the last component is [3,2,3,4,3,4]. Intermediate values are accessed by entering the corresponding value for each dimension.

**Structures**

**STRUCT**

**Description**

Data type STRUCT represents a data structure that consists of a fixed number of components of various data types. Components of STRUCT or ARRAY data type can also be nested in a structure. The nesting depth is hereby limited to eight levels. Structures can be used to group data according to the process control system and to transfer parameters as one data unit.

A component of the ARRAY data type always starts at a WORD limit.

The following table shows the properties of data type STRUCT:

Length	Format	Range of values	Example of value input
A STRUCT variable starts with one byte with even address and occupies the memory up to the next word limit.	STRUCT	The value ranges of the used data types apply.	The value input rules of the used data types apply.

**Example**

The following figure shows an example of the structure of a STRUCT variable:

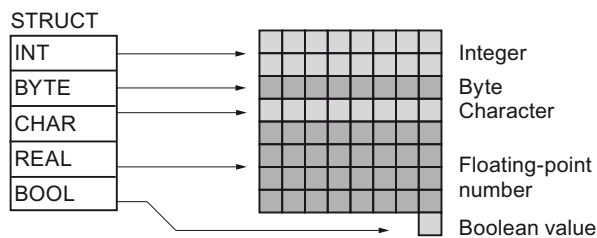

**See also**

Overview of the valid data types (Page 1077)

## Pointer

## POINTER

### Description

A parameter of the type POINTER is a pointer that can point to a specific tag. It occupies 6 bytes (48 bits) in memory and may contain the following tag information:

- DB number, or 0 if the data is not stored in a DB
- Memory area in the CPU
- Tag address

The following figure shows the structure of parameter type POINTER:

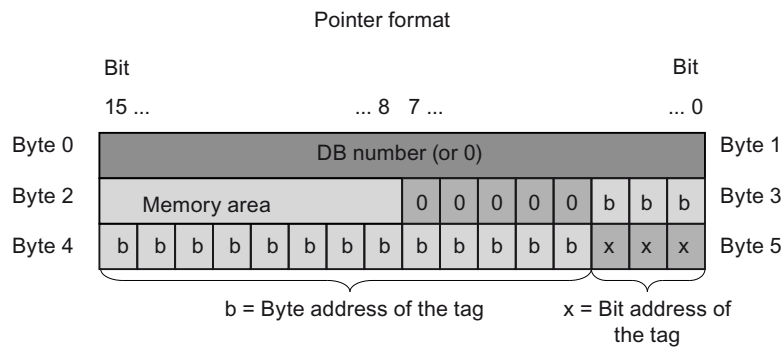

### Types of pointer

Depending on the information, you can use parameter type POINTER to declare the following four types of pointer:

- **Area-internal pointer:**  
An area-internal pointer contains information on the address of a tag.
- **Cross-area pointer:**  
A cross-area pointer contains information on the memory area and the address of a tag.
- **DB pointer:**  
You can use a DB pointer to point to a data block tag. A DB pointer also contains a data block number in addition to the memory area and the address of a tag.
- **Zero pointer:**  
Use the zero pointer to indicate a missing value. A missing value may indicate that no value exists, or that the value is not yet known. A zero value represents the absence of a value, but is also a value.

The following table shows the formats for the declaration of various pointer types:

P#ByteRepresentation	Format	Example of value input	Description
Symbolic	P#Byte.Bit	"MyTag"	Area-internal pointer
	P#OperandAreaByte.Bit	"MyTag"	Cross-area pointer
	P#Data_block.Data_oper and	"MyDB"."MyTag"	DB pointer
	P#Zero value	-	Zero pointer
Absolute	P#Byte.Bit	P#20.0	Area-internal pointer
	P#OperandAreaByte.Bit	P#M20.0	Cross-area pointer
	P#Data_block.Data_oper and	P#DB10.DBX20.0	DB pointer
	P#Zero value	P#0.0, ZERO	Zero pointer

You can enter a parameter of the type POINTER without prefix (P#). The entry is then automatically converted to the POINTER format.

**Note**

If you use the prefix P#, you can only point to memory areas with "standard" access mode.

**Memory areas**

The following table shows the hexadecimal codes of the memory areas for parameter type POINTER:

Hexadecimal code	Memory area	Description
B#16#80 <sup>1)</sup>	P	Peripherals on a CPU S7-300/400
16#1	P	Peripheral inputs on a CPU S7-1500
16#2	P	Peripheral outputs on a CPU S7-1500
B#16#81	I	Memory area of inputs
B#16#82	Q	Memory area of outputs
B#16#83	M	Memory area of bit memory
B#16#84	DBX	Data block
B#16#85	DIX	Instance data block
B#16#86	L	Local data
B#16#87	V	Previous local data
<sup>1)</sup> These data types can only be used for the POINTER pointer on a CPU S7-300/400.		



**See also**

- Basics of indirect addressing (Page 1068)
- Overview of the valid data types (Page 1077)
- Constants (Page 1051)

**ANY**

**Description**

An ANY type parameter points to the start of a data area and specifies its length. An ANY pointer occupies 10 bytes of memory and may contain the following information:

- Data type:  
Data type of the elements of the data area
- Repetition factor:  
Number of elements of the data area
- DB number:  
Data block that contains the declaration of data area elements.
- Memory area:  
Memory area of the CPU that stores the data area elements.
- Start address of the data in the format "byte.bit":  
Data area start identified by the ANY pointer.
- Zero pointer:  
Use the zero pointer to indicate a missing value. A missing value may indicate that no value exists, or that the value is not yet known. A zero value represents the absence of a value, but is also a value.

The following figure shows the structure of the ANY pointer:

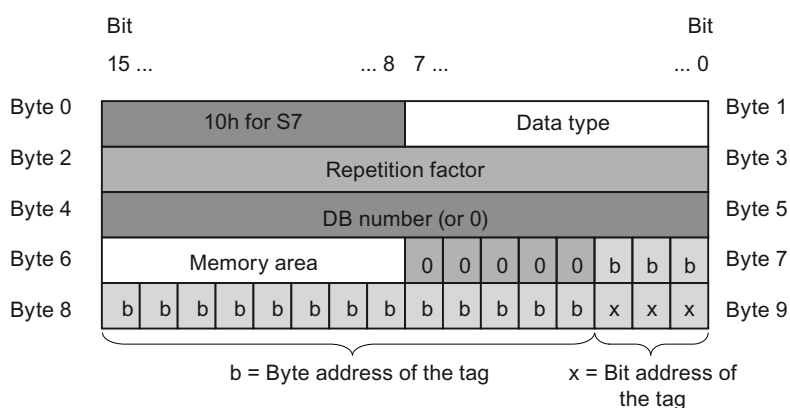

An ANY pointer cannot identify structures. It can only be assigned to local tags.

The following table shows the formats for the declaration of an ANY pointer:

Representation	Format	Example of value input	Description
Symbolic	P#DataBlock.MemoryArea DataAddress Type Number	"MyDB".StructTag.InitialComponents	Area with 10 words in global DB11 starting with DBB20.0
	P#MemoryArea DataAddress Type Number	"MyMarkerTag"	Area with 4 bytes starting with MB 20.0
		"MyTag"	Input I1.0
P#Zero value	-	Zero value	
Absolute	P#DataBlock.MemoryArea DataAddress Type Number	P#DB11.DBX20.0 INT 10	Area with 10 words in global DB11 starting with DBB20.0
	P#MemoryArea DataAddress Type Number	P#M20.0 BYTE 10	Area with 10 bytes starting with MB 20.0
		P#E1.0 BOOL 1	Input I1.0
P#Zero value	P#0.0 VOID 0, ZERO	Zero value	

**Note**

With the ANY pointer, you can only point to memory areas with "Standard" access mode.

**Coding of data types**

The following table lists the coding of data types for the ANY pointer:

Hexadecimal code	Data type	Description
B#16#00	NIL	Zero pointer
B#16#01 <sup>1)</sup>	BOOL	Bits
B#16#02	BYTE	bytes, 8 bits
B#16#03	CHAR	8-bit characters
B#16#04	WORD	16-bit words
B#16#05	INT	16-bit integers
B#16#06	DWORD	32-bit words
B#16#07	DINT	32-bit integers
B#16#08	REAL	32-bit floating-point numbers
B#16#0B	TIME	Duration
B#16#0C	S5TIME	Duration
B#16#09	DATE	Date
B#16#0A	TOD	Date and time
B#16#0E	DT	Date and time
B#16#13	STRING	Character string
B#16#17 <sup>1)</sup>	BLOCK_FB	Function block
B#16#18 <sup>1)</sup>	BLOCK_FC	Function
B#16#19 <sup>1)</sup>	BLOCK_DB	Data block
B#16#1A <sup>1)</sup>	BLOCK_SDB	System data block
B#16#1C <sup>1)</sup>	COUNTER	Counter

Hexadecimal code	Data type	Description
B#16#1D <sup>1)</sup>	TIMER	Time
<sup>1)</sup> These data types can only be used for the ANY pointer on a CPU S7-300/400.		

### Coding of the memory area

The following table lists the coding of the memory areas for the ANY pointer:

Hexadecimal code	Area	Description
B#16#80 <sup>1)</sup>	P	I/O
B#16#81	I	Memory area of inputs
B#16#82	Q	Memory area of outputs
B#16#83	M	Memory area of bit memory
B#16#84	DBX	Data block
B#16#85	DIX	Instance data block
B#16#86	L	Local data
B#16#87	V	Previous local data
<sup>1)</sup> These memory areas can only be used for the ANY pointer on an S7-300/400 CPU.		

### See also

Basics of indirect addressing (Page 1068)  
 Overview of the valid data types (Page 1077)  
 Constants (Page 1051)

## VARIANT

### Description

A parameter of the VARIANT type is a pointer that can point to tags of different data types other than an instance. The VARIANT pointer can be an object of an elementary data type, such as INT or REAL. It can also be a STRING, DTL, array of STRUCT, UDT, or array of UDT. The VARIANT pointer can recognize structures and point to individual structure components. An operand of data type VARIANT occupies no space in the instance DB or L stack. However, it will occupy memory space on the CPU.

But a tag of the VARIANT type is not an object but rather a reference to another object. Individual elements of the VARIANT type can only be declared within the block interface of a function. For this reason, it cannot be declared in a data block or in the static section of the

9.1 Creating a user program

block interface of a function block, for example, because its size is unknown. The size of the referenced objects can change.

**Note**

You can only point to a complete data block if it was originally derived from a user-defined data type (UDT).

The following table shows the properties of the VARIANT pointer:

Length (bytes)	Representation	Format	Example of value input
0	Symbolic	Operand	"TagResult"
		NameDataBlock.NameOperand.Component	"Data_TIA_Portal".StructVariable.FirstComponent
	Absolute	Operand	%MW10
		DataBlockNumber.Operand Type Length (valid only for blocks with standard access)	P#DB10.DBX10.0 INT 12
		P#Zero value	P#0.0 VOID 0, ZERO

**Note**

If you use the prefix P#, you can only point to memory areas with "standard" access mode.

**Example**

The following example shows how VARIANT works using the "MOVE: Move value" instruction of STL:

STL	Description
CALL MOVE	// The "Move value" instruction is called.
VARIANT	// Data type of the instruction
IN :=	// The contents of the "FirstComponent" operand
"Data_TIA_Portal".StructVariable.FirstComponent	are moved from the "Data_TIA_Portal" DB.
OUT := "MotorDB".StructResult.TagResult	// And transferred to the "TagResult" operand from the "MotorDB" DB.

**See also**

- Basics of indirect addressing (Page 1068)
- Overview of the valid data types (Page 1077)
- Constants (Page 1051)
- Basics of block access (Page 1027)

## Parameter types

## Parameter types

## Description

The parameter types are data types for formal parameters that are transferred to called blocks. A parameter type can also be a PLC data type.

The following table shows the available parameter data types and their purpose:

Parameter type	Length (bits)	Description
TIMER	16	Is used to specify a timer that is used in the called code block. If you supply a formal parameter of the TIMER parameter type, the associated actual parameter must be a timer. Example: T1
COUNTER	16	Is used to specify a counter that is used in the called code block. If you supply a formal parameter of the COUNTER parameter type, the associated actual parameter must be a counter. Example: C10
BLOCK_FC	16	Is used to specify a block that is used as input in the called code block.  The declaration of the parameter determines the block type (for example FB, FC, DB) that is to be used.  If you supply a formal parameter of the BLOCK parameter type, specify a block address as the actual parameter. Example: DB3
BLOCK_FB	16	
BLOCK_DB	16	
BLOCK_SDB	16	
BLOCK_SFB	16	
BLOCK_SFC	16	
BLOCK_OB	16	
BLOCK_SDT	-	
BLOCK_UDT	-	
VOID	-	The VOID parameter type does not save any values. This parameter type is used if the return values of an output are not required. The VOID parameter type can be specified at the STATUS output, for example, if no error information is required.

## See also

Overview of the valid data types (Page 1077)

Basics of PLC data types (Page 1409)

## PLC data types

## PLC data types

### Description

PLC data types are data structures that you define and that can be used multiple times within the program. The structure of a PLC is made up of several components, each of which can contain different data types. You define the type of components during the declaration of the PLC data type.

PLC data types can be used for the following applications:

- PLC data types can be used as data types for variables in the variable declaration of logic blocks or in data blocks.
- PLC data types can be used as templates for the creation of global data blocks with identical data structures.

### See also

Addressing structured variables (Page 1062)

### Example of a PLC data type

### Example

You can declare PLC data types as the type when creating data blocks. Based on this type you can create a number of data blocks, all of which have the same data structure. These data blocks can be adapted by entering different actual values for the corresponding task.

For instance, create a PLC data type for a recipe for blending paints. You can then assign this data type to several data blocks, each of which contains other quantity information.

The following figure shows this application:

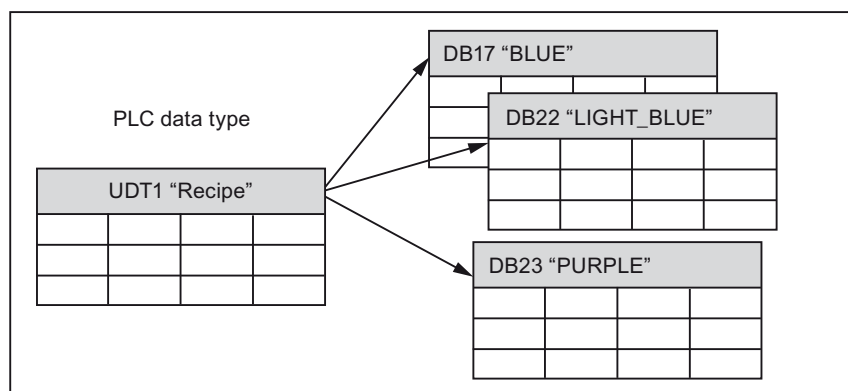

## System data types

## System data types

### Description

The system data types (SDT) are made available by the system and have a predefined structure. The structure of a system data type consists of a fixed number of components that can have various data types. It is not possible to change the structure of a system data type.

The system data types can only be used for specific instructions. The following table shows the available system data types and their purpose:

System data type	Length (bytes)	Description
IEC_TIMER	16	Structure of a timer whose timer values are of TIME data type. This data type is used for the "TP", "TOF", "TON", "TONR", "RT" and "PT" instructions, for example.
IEC_LTIMER	32	Structure of a timer whose timer values are of LTIME data type. This data type is used for the "TP", "TOF", "TON", "TONR", "RT" and "PT" instructions, for example.
IEC_SCOUNTER	3	Structure of a counter whose count values are of SINT data type. This data type is used for the "CTU", "CTD" and "CTUD" instructions, for example.
IEC_USCOUNTER	3	Structure of a counter whose count values are of USINT data type. This data type is used for the "CTU", "CTD" and "CTUD" instructions, for example.
IEC_COUNTER	6	Structure of a counter whose count values are of INT data type. This data type is used for the "CTU", "CTD" and "CTUD" instructions, for example.
IEC_UCOUNTER	6	Structure of a counter whose count values are of UINT data type. This data type is used for the "CTU", "CTD" and "CTUD" instructions, for example.
IEC_DCOUNTER	12	Structure of a counter whose count values are of DINT data type. This data type is used for the "CTU", "CTD" and "CTUD" instructions, for example.
IEC_UDCOUNTER	12	Structure of a counter whose count values are of UDINT data type. This data type is used for the "CTU", "CTD" and "CTUD" instructions, for example.
IEC_LCOUNTER	24	Structure of a counter with count values of data type UDINT. This data type is used for the "CTU", "CTD" and "CTUD" instructions, for example.

System data type	Length (bytes)	Description
IEC_ULCOUNTER	24	Structure of a counter with count values of data type UINT. This data type is used for the "CTU", "CTD" and "CTUD" instructions, for example.
ERROR_STRUCT	28	Structure of an error information to a programming or I/O access error. This data type is used, for example, for the "GET_ERROR" instruction.
CREF	8	Components of the ERROR_STRUCT data type, in which information about the address of a block is saved.
NREF	8	Components of the ERROR_STRUCT data type, in which information about the address of an operand is saved.
VREF	12	Is used for storage of a VARIANT pointer. This data type is, for example, used for instructions from S7-1200 Motion Control.
STARTINFO	12	Specifies the data structure in which the start information is saved. This data type is used, for example, for the "RD_SINFO" instruction.
SSL_HEADER	4	Specifies the data structure in which information about the data records are saved during the reading of the system status lists. This data type is used, for example, for the "RDSYSST" instruction.
CONDITIONS	52	User-defined data structure defining the conditions for start and end of a data reception. This data type is used, for example, for the "RCV_CFG" instruction.
TADDR_Param	8	Specifies the structure of a data block which stores descriptions of connections for Open User Communication via UDP. This data type is used for the "TUSEND" and "TURSV" instructions, for example.
TCON_Param	64	Specifies the structure of a data block which stores descriptions of connections for Open User Communication via Industrial Ethernet (PROFINET). This data type is used for the "TSEND" and "TRSV" instructions, for example.

**See also**

Overview of the valid data types (Page 1077)



## Hardware data types

## Hardware data types

### Description

The hardware data types are made available by the CPU. The number of available hardware data types depends on the CPU.

Constants of a specific hardware data type are stored based on the modules set in the hardware configuration. When an instruction for controlling or activating a configured module is inserted in the user program, the available constants can be used for the parameters.

The following table shows the available hardware data types and their purpose:

Data type	Basic data type	Description
REMOTE	ANY	Serves to specify the address of a remote CPU This data type is used, for example, for the "PUT" and "GET" instructions.
GEOADDR	HW_IOSYSTEM	Geographical address information
HW_ANY	WORD	Identification of any hardware component, e.g. a module
HW_DEVICE	HW_ANY	Identification of a DP slave/PROFINET IO device
HW_DPMMASTER	HW_INTERFACE	Identification of a DP master
HW_DPSLAVE	HW_DEVICE	Identification of a DP slave
HW_IO	HW_ANY	Identification number of the CPU or the interface The number is automatically allocated and is stored in the properties of the CPU or of the interface in the hardware configuration.
HW_IOSYSTEM	HW_ANY	Identification of a PN/IO system or DP master system
HW_SUBMODULE	HW_IO	Identification of a central hardware component
HW_MODULE	HW_IO	Identification of a module
HW_INTERFACE	HW_SUBMODULE	Identification of an interface component
HW_IEPORT	HW_SUBMODULE	Identification of a port (PN/IO)
HW_HSC	HW_SUBMODULE	Identification of a high-speed counter This data type is used, for example, for the "CTRL_HSC" instruction.
HW_PWM	HW_SUBMODULE	Identification of a pulse width modulation This data type is used, for example, for the "CTRL_PWM" instruction.
HW_PTO	HW_SUBMODULE	Identification of a pulse encoder This data type is used for Motion Control
AOM_AID	DWORD	Is used only in connection with a system function block.
AOM_IDENT	DWORD	Identification of an object in the runtime system of the AS
EVENT_ANY	AOM_IDENT	Used to identify any event

9.1 Creating a user program

Data type	Basic data type	Description
EVENT_ATT	EVENT_ANY	Is used to specify an event that can be assigned dynamically to an OB This data type is used, for example, for the "ATTACH" and "DETACH" instructions.
EVENT_HWINT	EVENT_ATT	Is used to specify a hardware interrupt event.
OB_ANY	INT	Serves to specify any organization block.
OB_DELAY	OB_ANY	Used to specify an organization block that is called when a time-delay interrupt occurs. This data type is used, for example, for the "SRT_DINT" and "CAN_DINT" instructions.
OB_TOD	OB_ANY	Specifies the number of a time-of-day interrupt OB. This data type is used, for example, for the "SET_TINT", "CAN_TINT", "ACT_TINT" and "QRY_TINT" instructions.
OB_CYCLIC	OB_ANY	Is used to specify an organization block that is called when a watchdog interrupt occurs.
OB_ATT	OB_ANY	Is used to specify an organization block that can be assigned dynamically to an event. This data type is used, for example, for the "ATTACH" and "DETACH" instructions.
OB_PCYCLE	OB_ANY	Is used to specify an organization block that can be assigned to an event of the "Cyclic program" event class.
OB_HWINT	OB_ATT	Is used to specify an organization block that is called when a hardware interrupt occurs.
OB_DIAG	OB_ANY	Is used to specify an organization block that is called when a diagnostic interrupt occurs.
OB_TIMEERROR	OB_ANY	Is used to specify an organization block that is called when a time error occurs.
OB_STARTUP	OB_ANY	Is used to specify an organization block that is called when a startup event occurs.
PORT	HW_SUBMODULE	Serves to specify a communication port. This data type is used for point-to-point communication.
RTM	UINT	Serves to specify the number of an operating hours counter. This data type is used, for example, for the "RTM" instruction.
PIP	UINT	Is used to create and connect a "Synchronous Cycle" OB. This data type is used for the SFCs 26, 27, 126 and 127.
CONN_ANY	WORD	Serves to specify any connection.
CONN_PRG	CONN_ANY	Serves to specify a connection for open communication over UDP.
CONN_OUC	CONN_ANY	Used to specify a connection for open communication over Industrial Ethernet (PROFINET).
CONN_R_ID	DWORD	Data type for the R_ID parameter on the S7 communication blocks.

Data type	Basic data type	Description
DB_ANY	UINT	Identification (number) of any DB The data type "DB_ANY" has the length 0 in the section "Temp".
DB_WWW	DB_ANY	Number of a DB generated via the Web application (for example, "WWW" instruction) The data type "DB_WWW" has the length 0 in the section "Temp".

## See also

Overview of the valid data types (Page 1077)

## Data type conversion

## Data type conversion

## Overview of data type conversion

## Introduction

If you link several operands in an instruction, you must make sure that the data types are compatible. This applies also for assignments or for supplying block parameters. If the operands are not the same data type, a conversion has to be carried out.

There are two options for the conversion:

- Implicit conversion  
The conversion take place automatically when the instruction is executed.
- Explicit conversion  
You use an explicit conversion instruction before the actual instruction is executed.

---

### Note

The data type conversion options described always refer to the latest version of the CPU (V. 4) Conversions marked as possible may not be available in CPU versions 1 - 3.

---

### Note

#### Converting bit strings in SCL

All bit strings (BYTE, WORD, DWORD and LWORD) are handled like the corresponding unsigned integers (USINT, UINT, UDINT and ULINT) in expressions. Therefore, implicit conversion from DWORD to REAL is carried out like a conversion from UDINT to REAL, for example.

---

## Implicit conversion

An implicit conversion is executed automatically if the data types of the operands are compatible. This compatibility test can be carried out according to criteria that are more or less strict:

- With IEC check (default)  
If IEC check is set, the following rules are applied:
  - Implicit conversion of BOOL to other data types is not possible.
  - Only the REAL, BYTE, WORD, DINT, INT, SINT, UDINT, UINT, USINT, TIME, DT, STRING and CHAR data types can be converted implicitly.
  - The bit length of the source data type must not exceed the bit length of the target data type. An operand of data type WORD, for example, cannot be declared at a parameter at which data type BYTE is expected.
- Without IEC check  
If IEC check is not set, the following rules are applied:
  - Implicit conversion of BOOL to other data types is not possible.
  - Only the REAL, LREAL, BYTE, WORD, DWORD, SINT, INT, DINT, USINT, UINT, UDINT, TIME, DTL, TOD, DATE, STRING and CHAR data types can be converted implicitly.
  - The bit length of the source data type must not exceed the bit length of the target data type. An operand of data type DWORD, for example, cannot be declared at a parameter at which data type WORD is expected.
  - The bit length of an operand entered in-out parameters InOut) must be the same as the programmed bit length for the parameter in question.

---

### Note

#### Implicit conversion without IEC check

The programming editor uses a gray rectangle to mark operands that are implicitly converted. The dark gray rectangle signals that an implicit conversion is possible without any accuracy loss, for example, if you convert the data type SINT to INT. A light gray rectangle signals that implicit conversion is possible, but errors could occur during runtime. If, for example, you are converting the data type DINT to INT and an overflow occurs, the enable output ENO is set to "0".

---

For more information about the setting of the IEC check and the implicit conversion, refer to "See also".

## Explicit conversion

If the operands are not compatible and an implicit conversion is therefore not possible, you can use an explicit conversion instruction. You can find the conversion instructions in the "Instructions" task card.

A possible overflow is displayed at the ENO enable output. An overflow is created, for example, if the value of the source data type is greater than the value of the target data type.

For more information about explicit conversion, refer to "See also".

The following figure shows an example in which an explicit data type conversion must be carried out:

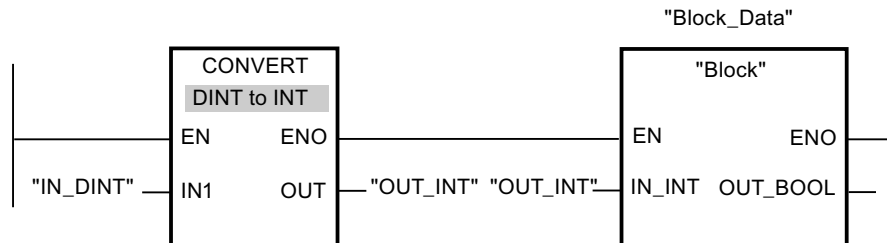

The "Block" function block expects a tag of the INT data type at the "IN\_INT" input parameter. Therefore, the value of the "IN\_DINT" tag must first be converted from DINT to INT. If the value of the "IN\_DINT" tag is within the permitted value range of the INT data type, the conversion takes place. Otherwise, an overflow is signaled. A conversion still takes place even in case of an overflow, but the values are cut off and the enable output ENO is set to "0".

## See also

Setting and canceling the IEC check (Page 1125)

## Implicit conversion

### Setting and canceling the IEC check

The data types of the operands used are checked for compatibility. This compatibility test can be carried out according to criteria that are more or less strict. If "IEC check" is activated, stricter criteria are applied.

You can set the IEC check centrally for all new blocks of the project or for individual blocks.

### Setting IEC check for new blocks

To set the IEC check for all new blocks in the project, proceed as follows:

1. Select the "Settings" command in the "Options" menu.  
The "Settings" window is displayed in the work area.
2. Select the "PLC programming > General" group in the area navigation.
3. Select or clear the "IEC check" check box in the "Default settings for new blocks" group.  
The IEC check is enabled or disabled for all new blocks in the program.

### Setting IEC check for a block

To set the IEC check for a block, proceed as follows:

1. Open the block.
2. Open the "Properties" tab in the Inspector window.

9.1 Creating a user program

3. Select the "Attributes" group in the area navigation.
4. Select or clear the "IEC check" check box.  
The IEC check is enabled or disabled for this block. The setting is stored together with the project.

**Binary numbers**

**Implicit conversion of BOOL**

**Options for implicit conversion**

The implicit conversion of the BOOL data type is not possible.

**See also**

BOOL (bit) (Page 1081)

**Bit strings**

**Implicit conversion of BYTE**

**Options for implicit conversion**

The following table shows the options for implicit conversion of the BYTE data type:

Source	Target	With IEC check	Without IEC check	Description
BYTE	BOOL	-	-	No implicit conversion
	WORD	x	x	The bit pattern of the source value is transferred unchanged right-justified to the target data type.
	DWORD	x	x	
	SINT	-	x	
	USINT	-	x	
	INT	-	x	
	UINT	-	x	
	DINT	-	x	
	UDINT	-	x	
	REAL	-	-	
LREAL	-	-		
TIME	-	-		
DTL	-	-		
TOD	-	-		
DATE	-	-		

Source	Target	With IEC check	Without IEC check	Description
	STRING	-	-	
	CHAR	-	x	The bit pattern of the source value is transferred unchanged to the target data type.
x: Conversion possible -: Conversion not possible				

### See also

- BYTE (byte) (Page 1082)
- Setting and canceling the IEC check (Page 1125)
- Overview of data type conversion (Page 1123)
- Explicit conversion of BYTE (Page 1143)

### Implicit conversion of WORD

#### Options for implicit conversion

The following table shows the options for implicit conversion of the WORD data type:

Source	Target	With IEC check	Without IEC check	Description
WORD	BOOL	-	-	No implicit conversion
	BYTE	-	X	The least significant byte is transferred to the target data type, while the most significant byte is ignored.
	DWORD	X	X	The bit pattern of the source value is transferred unchanged right-justified to the target data type.
	SINT	-	X	The least significant byte is transferred to the target data type, while the most significant byte is ignored.
	USINT	-	X	The bit pattern of the source value is transferred unchanged right-justified to the target data type.
	INT	-	X	
	UINT	-	X	
	DINT	-	X	
	UDINT	-	X	
	REAL	-	-	No implicit conversion
	LREAL	-	-	
	TIME	-	-	
	DTL	-	-	
	TOD	-	-	
	DATE	-	X	The bit pattern of the source value is transferred unchanged to the target data type.
	STRING	-	-	No implicit conversion

Source	Target	With IEC check	Without IEC check	Description
	CHAR	-	X	The bit pattern of the source value is transferred unchanged to the target data type.
x: Conversion possible -: Conversion not possible				

**See also**

- WORD (Page 1083)
- Setting and canceling the IEC check (Page 1125)
- Overview of data type conversion (Page 1123)
- Explicit conversion of WORD (Page 1144)

**Implicit conversion of DWORD**

**Options for implicit conversion**

The following table shows the options for implicit conversion of the DWORD data type:

Source	Target	With IEC check	Without IEC check	Description
DWORD	BOOL	-	-	No implicit conversion
	BYTE	-	X	The right bytes are transferred to the target data type; the left bytes are ignored.
	WORD	-	X	
	SINT	-	X	
	USINT	-	X	
	INT	-	X	
	UINT	-	X	
	DINT	-	X	The bit pattern of the source value is transferred unchanged right-justified to the target data type.
	UDINT	-	X	
	REAL	-	X	The value is converted to the format of the target data type. (The value "-1", for example, is converted to the value "-1.0".)
	LREAL	-	-	No implicit conversion
	TIME	-	X	The bit pattern of the source value is transferred unchanged right-justified to the target data type.
	DTL	-	-	No implicit conversion
	TOD	-	X	The bit pattern of the source value is transferred unchanged right-justified to the target data type.
	DATE	-	-	No implicit conversion
STRING	-	-		



Source	Target	With IEC check	Without IEC check	Description
	CHAR	-	X	The bit pattern of the source value is transferred unchanged right-justified to the target data type.
x: Conversion possible -: Conversion not possible				

### See also

- DWORD (Page 1083)
- Setting and canceling the IEC check (Page 1125)
- Overview of data type conversion (Page 1123)
- Explicit conversion of DWORD (Page 1146)

### Integers

#### Implicit conversion of SINT

#### Options for implicit conversion

The following table shows the options for implicit conversion of the SINT data type:

Source	Target	With IEC check	Without IEC check	Description
SINT	BOOL	-	-	No implicit conversion
	BYTE	-	X	The bit pattern of the source value is transferred unchanged right-justified to the target data type. The remaining bits are filled with "0".
	WORD	-	X	
	DWORD	-	X	
	USINT	-	X	The bit pattern of the source value is converted and transferred to the target data type. (for example, value transfer from SINT #-1 -> INT #-1, not filled with "0".)
	INT	X	X	
	UINT	-	X	
	DINT	X	X	
	UDINT	-	X	
	REAL	X	X	The value is converted to the format of the target data type. (The value "-1", for example, is converted to the value "-1.0".)
	LREAL	X	X	
	TIME	-	-	No implicit conversion
	DTL	-	-	
	TOD	-	-	
DATE	-	-		
STRING	-	-		

9.1 Creating a user program

Source	Target	With IEC check	Without IEC check	Description
	CHAR	-	X	The bit pattern of the source value is transferred unchanged right-justified to the target data type.
x: Conversion possible -: Conversion not possible				

See also

- SINT (8-bit integers) (Page 1085)
- Setting and canceling the IEC check (Page 1125)
- Overview of data type conversion (Page 1123)
- Explicit conversion of SINT (Page 1148)

Implicit conversion of USINT

Options for implicit conversion

The following table shows the options for implicit conversion of the USINT data type:

Source	Target	With IEC check	Without IEC check	Description
USINT	BOOL	-	-	No implicit conversion
	BYTE	-	X	The bit pattern of the source value is transferred unchanged right-justified to the target data type. The remaining bits are filled with "0".
	WORD	-	X	
	DWORD	-	X	
	SINT	-	X	The bit pattern of the source value is converted and transferred to the target data type. (for example, value conversion from USINT #10 -> DINT #10 or USINT #128 -> SINT #-128)
	INT	X	X	
	UINT	X	X	
	DINT	X	X	
	UDINT	X	X	
	REAL	X	X	The value is converted to the format of the target data type. (The value "1", for example, is converted to the value "1.0".)
	LREAL	X	X	
	TIME	-	-	No implicit conversion
	DTL	-	-	
	TOD	-	-	
	DATE	-	-	
	STRING	-	-	
CHAR	-	-	X	The bit pattern of the source value is transferred unchanged right-justified to the target data type.
x: Conversion possible -: Conversion not possible				

**See also**

- USINT (8-bit integers) (Page 1086)
- Setting and canceling the IEC check (Page 1125)
- Overview of data type conversion (Page 1123)
- Explicit conversion of USINT (Page 1150)

**Implicit conversion of INT**

**Options for implicit conversion**

The following table shows the options for implicit conversion of the INT data type:

Source	Target	With IEC check	Without IEC check	Description
INT	BOOL	-	-	No implicit conversion
	BYTE	-	X	The bit pattern of the source value is transferred unchanged right-justified to the target data type.
	WORD	-	X	
	DWORD	-	X	
	SINT	-	X	The bit pattern of the source value is converted and transferred to the target data type. (for example, value conversion from INT #-1 -> SINT #-1, or INT #-32 767 -> UINT #32 769)
	USINT	-	X	
	UINT	-	X	
	DINT	X	X	
	UDINT	-	X	
	REAL	X	X	The value is converted to the format of the target data type. (The value "-1", for example, is converted to the value "-1.0".)
	LREAL	X	X	
	TIME	-	-	No implicit conversion
	DTL	-	-	
	TOD	-	-	
	DATE	-	X	The bit pattern of the source value is transferred unchanged right-justified to the target data type.
	STRING	-	-	No implicit conversion
	CHAR	-	X	The bit pattern of the source value is transferred unchanged right-justified to the target data type.
x: Conversion possible -: Conversion not possible				

**See also**

- INT (16-bit integers) (Page 1087)
- Setting and canceling the IEC check (Page 1125)
- Overview of data type conversion (Page 1123)
- Explicit conversion of INT (Page 1151)

## Implicit conversion of UINT

### Options for implicit conversion

The following table shows the options for implicit conversion of the UINT data type:

Source	Target	With IEC check	Without IEC check	Description	
UINT	BOOL	-	-	No implicit conversion	
	BYTE	-	X	The bit pattern of the source value is transferred unchanged right-justified to the target data type.	
	WORD	-	X		
	DWORD	-	X		
	SINT	-	X	The bit pattern of the source value is converted and transferred to the target data type. (for example, value conversion from UINT #100 -> DINT #100 or UINT #60 000 -> INT #-5536)	
	USINT	-	X		
	INT	-	X		
	DINT	X	X		
	UDINT	X	X		
	REAL	X	X		The value is converted to the format of the target data type. (The value "1", for example, is converted to the value "1.0".)
	LREAL	X	X		
	TIME	-	-	No implicit conversion	
	DTL	-	-		
	TOD	-	-		
	DATE	-	X	The bit pattern of the source value is transferred unchanged right-justified to the target data type.	
	STRING	-	-	No implicit conversion	
	CHAR	-	X	The bit pattern of the source value is transferred unchanged right-justified to the target data type.	
x: Conversion possible -: Conversion not possible					

### See also

- UINT (16-bit integers) (Page 1088)
- Setting and canceling the IEC check (Page 1125)
- Overview of data type conversion (Page 1123)
- Explicit conversion of UINT (Page 1153)

## Implicit conversion of DINT

### Options for implicit conversion

The following table shows the options for implicit conversion of the DINT data type:

Source	Target	With IEC check	Without IEC check	Description
DINT	BOOL	-	-	No implicit conversion
	BYTE	-	X	The bit pattern of the source value is transferred unchanged right-justified to the target data type.
	WORD	-	X	
	DWORD	-	X	
	SINT	-	X	The bit pattern of the source value is converted and transferred to the target data type. (for example, value conversion from DINT #-1 -> SINT #-1 or DINT #-1 -> USINT #255)
	USINT	-	X	
	INT	-	X	
	UINT	-	X	
	UDINT	-	X	
	REAL	-	X	The bit pattern of the source value is converted and transferred to the target data type. (for example, value conversion from DINT #-1 -> REAL #-1.0, but there is a loss in accuracy for numbers with an absolute value greater than 8 388 608)
	LREAL	X	X	The value is converted to the format of the target data type. (The value "-1", for example, is converted to the value "-1.0".)
	TIME	-	X	The bit pattern of the source value is transferred unchanged right-justified to the target data type.
	DTL	-	-	No implicit conversion
	TOD	-	X	The bit pattern of the source value is transferred unchanged right-justified to the target data type.
	DATE	-	-	No implicit conversion
STRING	-	-		
CHAR	-	X	The bit pattern of the source value is transferred unchanged right-justified to the target data type.	
x: Conversion possible -: Conversion not possible				

### See also

- DINT (32-bit integers) (Page 1089)
- Setting and canceling the IEC check (Page 1125)
- Overview of data type conversion (Page 1123)
- Explicit conversion of DINT (Page 1155)

## Implicit conversion of UDINT

### Options for implicit conversion

The following table shows the options for implicit conversion of the UDINT data type:

Source	Target	With IEC check	Without IEC check	Description
UDINT	BOOL	-	-	No implicit conversion
	BYTE	-	X	The bit pattern of the source value is transferred unchanged right-justified to the target data type.
	WORD	-	X	
	DWORD	-	X	
	SINT	-	X	The bit pattern of the source value is converted and transferred to the target data type. (for example, value conversion from DINT #-1 -> SINT #-1 or DINT #-1 -> USINT #255)
	USINT	-	X	
	INT	-	X	
	UINT	-	X	
	DINT	-	X	
	REAL	-	X	The bit pattern of the source value is converted and transferred to the target data type. (for example, value conversion from DINT #-1 -> REAL #-1.0, but there is a loss in accuracy for numbers with an absolute value greater than 8 388 608)
	LREAL	X	X	The value is converted to the format of the target data type. (The value "1", for example, is converted to the value "1.0".)
	TIME	-	X	The bit pattern of the source value is transferred unchanged right-justified to the target data type.
	DTL	-	-	No implicit conversion
	TOD	-	X	The bit pattern of the source value is transferred unchanged right-justified to the target data type.
	DATE	-	-	No implicit conversion
	STRING	-	-	
CHAR	-	X	The bit pattern of the source value is transferred unchanged right-justified to the target data type.	
x: Conversion possible -: Conversion not possible				

### See also

- UDINT (32-bit integers) (Page 1089)
- Setting and canceling the IEC check (Page 1125)
- Overview of data type conversion (Page 1123)
- Explicit conversion of UDINT (Page 1157)

## Floating-point numbers

### Implicit conversion of REAL

#### Options for implicit conversion

The following table shows the options for implicit conversion of the REAL data type:

Source	Target	With IEC check	Without IEC check	Description
REAL	BOOL	-	-	No implicit conversion
	BYTE	-	-	
	WORD	-	-	
	DWORD	-	X	The bit pattern of the source value is transferred unchanged right-justified to the target data type.
	SINT	-	X	The bit pattern of the source value is rounded off and converted and transferred to the target data type. (for example, rounding off and value conversion of REAL #2.5 -> INT #2 or negative number REAL #-2.5 -> INT #-2 -> USINT #254. With an overflow, the remainder is determined REAL #305.5 -> INT #306 -> USINT #50)
	USINT	-	X	
	INT	-	X	
	UINT	-	X	
	DINT	-	X	
	UDINT	-	X	
	LREAL	X	X	
	TIME	-	-	No implicit conversion
	DTL	-	-	
	TOD	-	-	
	DATE	-	-	
	STRING	-	-	
	CHAR	-	-	
x: Conversion possible -: Conversion not possible				

#### See also

- REAL (Page 1093)
- Setting and canceling the IEC check (Page 1125)
- Overview of data type conversion (Page 1123)
- Explicit conversion of REAL (Page 1158)

### Implicit conversion of LREAL

#### Options for implicit conversion

The following table shows the options for implicit conversion of the LREAL data type:

Source	Target	With IEC check	Without IEC check	Explanation
LREAL	BOOL	-	-	No implicit conversion
	BYTE	-	-	
	WORD	-	-	
	DWORD	-	-	
	SINT	-	X	The bit pattern of the source value is rounded off and converted and transferred to the target data type. (for example, rounding off and value conversion of REAL #2.5 -> INT #2 or negative number REAL #-2.5 -> INT #-2 -> USINT #254. With an overflow, the remainder is determined REAL #305.5 -> INT #306 -> USINT #50)
	USINT	-	X	
	INT	-	X	
	UINT	-	X	
	DINT	-	X	
	UDINT	-	X	
	REAL	-	-	
	TIME	-	-	
	DTL	-	-	
	TOD	-	-	
	DATE	-	-	
	STRING	-	-	
	CHAR	-	-	
x: Conversion possible -: Conversion not possible				

#### See also

Explicit conversion of LREAL (Page 1160)



## Timers

### Implicit conversion of TIME

#### Options for implicit conversion

The following table shows the options for implicit conversion of the TIME data type:

Source	Target	With IEC check	Without IEC check	Description
TIME	BOOL	-	-	No implicit conversion
	BYTE	-	-	
	WORD	-	-	
	DWORD	-	X	The bit pattern of the source value is transferred unchanged to the target data type. The result of the conversion shows the duration in milliseconds.
	SINT	-	-	No implicit conversion
	USINT	-	-	
	INT	-	-	
	UINT	-	-	
	DINT	-	X	The bit pattern of the source value is transferred unchanged to the target data type. The result of the conversion shows the duration in milliseconds.
	UDINT	-	X	
	REAL	-	-	No implicit conversion
	LREAL	-	-	
	DTL	-	-	
	TOD	-	X	The bit pattern of a source value that is less than 24 h (86 400 00 ms) is transferred without changes to the target data type. No further changes are made to the target value. The result of the conversion shows the time that has passed since midnight.
	DATE	-	-	No implicit conversion
	STRING	-	-	
CHAR	-	-		

x: Conversion possible  
-: Conversion not possible

#### See also

- TIME (IEC time) (Page 1098)
- Setting and canceling the IEC check (Page 1125)
- Overview of data type conversion (Page 1123)
- Explicit conversion of TIME (Page 1161)

**Date and time**

**Implicit conversion of DTL**

**Options for implicit conversion**

The DTL data type cannot be implicitly converted.

**See also**

Explicit conversion of DTL (Page 1164)

**Implicit conversion of TOD**

**Options for implicit conversion**

The following table shows the options for implicit conversion of the TOD data type:

Source	Target	With IEC check	Without IEC check	Description
TOD	BOOL	-	-	No implicit conversion
	BYTE	-	-	
	WORD	-	-	
	DWORD	-	X	The bit pattern of the source value is transferred unchanged to the target data type. The result of the conversion corresponds to the number of milliseconds since the start of day (0:00 hrs).
	SINT	-	-	No implicit conversion
	USINT	-	-	
	INT	-	-	
	UINT	-	-	
	DINT	-	X	The bit pattern of the source value is transferred unchanged to the target data type. The result of the conversion corresponds to the number of milliseconds since the start of day (0:00 hrs).
	UDINT	-	X	
	REAL	-	-	No implicit conversion
	LREAL	-	-	
	TIME	-	X	The bit pattern of the source value is transferred unchanged to the target data type. The result of the conversion corresponds to the number of milliseconds since the start of day (0:00 hrs).
	DTL	-	-	No implicit conversion
	DATE	-	-	
STRING	-	-		
CHAR	-	-		
x: Conversion possible -: Conversion not possible				

**See also**

- TIME\_OF\_DAY (TOD) (Page 1099)
- Setting and canceling the IEC check (Page 1125)
- Overview of data type conversion (Page 1123)
- Explicit conversion of TOD (Page 1163)

**Implicit conversion of DATE**

**Options for implicit conversion**

The following table shows the options for implicit conversion of the DATE data type:

Source	Target	With IEC check	Without IEC check	Description
DATE	BOOL	-	-	No implicit conversion
	BYTE	-	-	
	WORD	-	X	The bit pattern of the source value is transferred unchanged to the target data type. The result of the conversion corresponds to the number of days since 01-01-1990.
	DWORD	-	-	No implicit conversion
	SINT	-	-	
	USINT	-	-	
	INT	-	X	The bit pattern of the source value is transferred unchanged to the target data type. The result of the conversion corresponds to the number of days since 01-01-1990.
	UINT	-	X	
	DINT	-	-	No implicit conversion
	UDINT	-	-	
	REAL	-	-	
	LREAL	-	-	
	TIME	-	-	
	DTL	-	X	The bit pattern of the source value is transferred unchanged to the target data type. The result of the conversion corresponds to the number of days since 01-01-1990.
	TOD	-	-	No implicit conversion
	STRING	-	-	
CHAR	-	-		
x: Conversion possible -: Conversion not possible				

**See also**

- DATE (Page 1099)
- Setting and canceling the IEC check (Page 1125)
- Overview of data type conversion (Page 1123)
- Explicit conversion of DATE (Page 1162)

**Character strings**

**Implicit conversion of CHAR**

**Options for implicit conversion**

The following table shows the options for implicit conversion of the CHAR data type:

Source	Target	With IEC check	Without IEC check	Description
CHAR	BOOL	-	-	No implicit conversion
	BYTE	-	X	The bit pattern of the source value is transferred unchanged right-justified to the target data type. The remaining bits are filled from the left with "0".
	WORD	-	X	
	DWORD	-	X	
	SINT	-	X	
	USINT	-	X	
	INT	-	X	
	UINT	-	X	
	DINT	-	X	
	UDINT	-	X	
	REAL	-	-	
	LREAL	-	-	
	TIME	-	-	
	DTL	-	-	
	TOD	-	-	
	DATE	-	-	
	STRING	X	X	The STRING is shortened to length 1 and includes the character.

x: Conversion possible  
 -: Conversion not possible

**See also**

- CHAR (character) (Page 1103)
- Setting and canceling the IEC check (Page 1125)
- Overview of data type conversion (Page 1123)
- Explicit conversion of CHAR (Page 1165)

**Implicit conversion of STRING**

**Options for implicit conversion**

The following table shows the options for implicit conversion of the STRING data type:

Source	Target	With IEC check	Without IEC check	Description
STRING	BOOL	-	-	No implicit conversion
	BYTE	-	-	
	WORD	-	-	
	DWORD	-	-	
	SINT	-	-	
	USINT	-	-	
	INT	-	-	
	UINT	-	-	
	DINT	-	-	
	UDINT	-	-	
	REAL	-	-	
	LREAL	-	-	
	TIME	-	-	
	DTL	-	-	
	DATE	-	-	
TOD	-	-		
	CHAR	-	X	The first character of the STRING is returned if the STRING includes one or more characters. Otherwise, the character is output with coding \$00.

x: Conversion possible  
-: Conversion not possible

**See also**

- Explicit conversion of STRING (Page 1166)

**Explicit conversion**

**Binary numbers**

**Explicit conversion of BOOL**

**Options for explicit conversion**

The following table shows the options and instructions for the explicit conversion of the BOOL data type:

Source	Target	Conversion	Description	Mnemonics of the instruction
BOOL	BYTE	X	Only the LSB (Least Significant Bit) is set in the target data type. The enable output ENO is always "1".	BOOL_TO_BYTE
	WORD	X		BOOL_TO_WORD
	DWORD	X		BOOL_TO_DWORD
	SINT	X		BOOL_TO_SINT
	USINT	X		BOOL_TO_USINT
	INT	X		BOOL_TO_INT
	UINT	X		BOOL_TO_UINT
	DINT	X		BOOL_TO_DINT
	UDINT	X		BOOL_TO_UDINT
	REAL	-	No explicit conversion	-
	LREAL	-		-
	TIME	-		-
	DTL	-		-
	TOD	-		-
	DATE	-		-
	STRING	-		-
	CHAR	-		-

x: Conversion possible  
 - : Conversion not possible

**See also**

- BOOL (bit) (Page 1081)
- Implicit conversion of BYTE (Page 1126)
- Overview of data type conversion (Page 1123)

## Bit strings

### Explicit conversion of BYTE

#### Options for explicit conversion

The following table shows the options and instructions for the explicit conversion of the BYTE data type:

Source	Target	Conversion	Description	Mnemonics of Instruction
BYTE <sup>1)</sup>	BOOL	X	The following scenarios are possible: <ul style="list-style-type: none"> <li>• If the source is "0", the target data type is also "0" and enable output ENO is "1".</li> <li>• If only the LSB (Least Significant Bit) "1" is set in the source value, the target data type is also "1" and enable output ENO is "1".</li> <li>• If bits are not equal to LSB in the source value, the target data type is set according to LSB and enable output ENO is "0".</li> </ul>	BYTE_TO_BOOL
	WORD <sup>1)</sup>	X	The bit pattern of the source value is transferred unchanged right-justified to the target data type.	BYTE_TO_WORD
	DWORD <sup>1)</sup>	X		BYTE_TO_DWORD
	SINT	X		BYTE_TO_SINT
	USINT	X		BYTE_TO_USINT
	INT	X		BYTE_TO_INT
	UINT	X		BYTE_TO_UINT
	DINT	X		BYTE_TO_DINT
	UDINT	X		BYTE_TO_UDINT
	REAL	X		BYTE_TO_REAL
	LREAL	X		BYTE_TO_LREAL
	TIME	X		BYTE_TO_TIME
	DTL	-	No explicit conversion	-
	TOD	X	The bit pattern of the source value is transferred unchanged right-justified to the target data type.	BYTE_TO_TOD
	DATE	X		BYTE_TO_DATE
	STRING	-	No explicit conversion	-
	CHAR	X	The bit pattern of the source value is transferred unchanged right-justified to the target data type.	BYTE_TO_CHAR

x: Conversion possible  
- : Conversion not possible

<sup>1)</sup> Bit strings (BYTE, WORD, DWORD) are interpreted as an unsigned integer with the same bit length.. Data type BYTE is interpreted as USINT, WORD as UINT and DWORD as UDINT.

**See also**

- BYTE (byte) (Page 1082)
- Implicit conversion of BYTE (Page 1126)
- Overview of data type conversion (Page 1123)

**Explicit conversion of WORD**

**Options for explicit conversion**

The following table shows the options and instructions for the explicit conversion of the WORD data type:

Source	Target	Conversion	Description	Mnemonics of the instruction
WORD <sup>1)</sup>	BOOL	X	The following scenarios are possible: <ul style="list-style-type: none"> <li>• If the source is "0", the target data type is also "0" and enable output ENO is "1".</li> <li>• If only the LSB (Least Significant Bit) "1" is set in the source value, the target data type is also "1" and enable output ENO is "1".</li> <li>• If bit is not equal to LSB in the source value, the target data type is set according to LSB and enable output ENO is "0".</li> </ul>	WORD_TO_BOOL
	BYTE <sup>1)</sup>	X	The bit pattern of the source value is transferred unchanged right-justified to the target data type.	WORD_TO_BYTE
	DWORD <sup>1)</sup>	X		WORD_TO_DWORD
	SINT	X	ENO = TRUE #sint1 := WORD_TO_SINT(16#FFFF); // -1 bis #sint1 := WORD_TO_SINT(16#FF80); // -128 #sint1 := WORD_TO_SINT(16#0); // 0 bis #sint1 := WORD_TO_SINT(16#007F); // 127  ENO = FALSE #sint1 := WORD_TO_SINT(16#FF7F); // -129 bis #sint1 := WORD_TO_SINT(16#8000); // -32768 #sint1 := WORD_TO_SINT(16#0080); // 128 bis #sint1 := WORD_TO_SINT(16#7FFF); // 32767	WORD_TO_SINT



Source	Target	Conversion	Description	Mnemonics of the instruction	
	USINT	X	The bit pattern of the source value is transferred unchanged right-justified to the target data type.	WORD_TO_USINT	
	INT	X		WORD_TO_INT	
	UINT	X		WORD_TO_UINT	
	DINT	X		WORD_TO_DINT	
	UDINT	X		WORD_TO_UDINT	
	REAL	X		WORD_TO_REAL	
	LREAL	X		WORD_TO_LREAL	
	TIME	X		WORD_TO_TIME	
	DTL	-	No explicit conversion	-	
	TOD	X	The bit pattern of the source value is transferred unchanged right-justified to the target data type.	WORD_TO_TOD	
	DATE	X		WORD_TO_DATE	
		STRING	-	No explicit conversion	-
		CHAR	X	The bit pattern of the source value is transferred unchanged right-justified to the target data type.	WORD_TO_CHAR
	WORD_BCD16	INT	X	The value to be converted has data type WORD and is accepted as a BCD-coded value between -999 and +999. The result is available after conversion as an integer (in binary notation) of the type INT. A real conversion takes place. If the bit pattern includes an invalid tetrad, a synchronous error is not triggered but only the status bit OV is set instead.	WORD_BCD16_TO_INT
BCD16	INT	X	BCD16_TO_INT		
<p>x: Conversion possible - : Conversion not possible 1) Bit strings (BYTE, WORD, DWORD) are interpreted as an unsigned integer with the same bit length.. Data type BYTE is interpreted as USINT, WORD as UINT and DWORD as UDINT.</p>					

**See also**

- WORD (Page 1083)
- Implicit conversion of WORD (Page 1127)
- Overview of data type conversion (Page 1123)

### Explicit conversion of DWORD

#### Options for explicit conversion

The following table shows the options and instructions for the explicit conversion of the DWORD data type:

Source	Target	Conversion	Description	Mnemonics of the instruction
DWORD <sup>1)</sup>	BOOL	X	The following scenarios are possible: <ul style="list-style-type: none"> <li>• If the source is "0", the target data type is also "0" and enable output ENO is "1".</li> <li>• If only the LSB (Least Significant Bit) "1" is set in the source value, the target data type is also "1" and enable output ENO is "1".</li> <li>• If bit is not equal to LSB in the source value, the target data type is set according to LSB and enable output ENO is "0".</li> </ul>	DWORD_TO_BOOL
	BYTE <sup>1)</sup>	X	The bit pattern of the source value is transferred unchanged right-justified to the target data type.	DWORD_TO_BYTE
	WORD <sup>1)</sup>	X		DWORD_TO_WORD
	SINT	X	ENO = TRUE #sint1 := DWORD_TO_SINT(16#FFFF_FFFF); // -1 bis #sint1 := DWORD_TO_SINT(16#FFFF_FF80); // -128 #sint1 := DWORD_TO_SINT(16#0); // 0 bis #sint1 := DWORD_TO_SINT(16#0000_007F); / / 127  ENO = FALSE #sint1 := DWORD_TO_SINT(16#FFFF_FF7F); // -129 #sint1 := DWORD_TO_SINT(16#8000_0000); / / -2147483648 #sint1 := DWORD_TO_SINT(16#0000_0080); / / 128 bis #sint1 := DWORD_TO_SINT(16#7FFF_FFFF); // 2147483647	DWORD_TO_SINT
	USINT	X	The bit pattern of the source value is transferred unchanged right-justified to the target data type.	DWORD_TO_USINT

Source	Target	Conversion	Description	Mnemonics of the instruction
	INT	X	ENO = TRUE #int1 := DWORD_TO_INT(16#FFFF_FFFF); // -1 bis #int1 := DWORD_TO_INT(16#FFFF_8000); // -32768 #int1 := DWORD_TO_INT(16#0); // 0 bis #int1 := DWORD_TO_INT(16#0000_7FFF); // 32767  ENO = FALSE #int1 := DWORD_TO_INT(16#FFFF_7FFF); // -32769 #int1 := DWORD_TO_INT(16#8000_0000); // -2147483648 #int1 := DWORD_TO_INT(16#8000); // 32768 bis #int1 := DWORD_TO_INT(16#7FFF_FFFF); // 2147483647	DWORD_TO_INT
	UINT	X	The bit pattern of the source value is transferred unchanged right-justified to the target data type.	DWORD_TO_UINT
	DINT	X		DWORD_TO_DINT
	UDINT	X		DWORD_TO_UDINT
	REAL	X	The data type DWORD is converted to REAL. If no errors occur during the conversion, the signal state of ENO = 1; if an error occurs during processing, the signal state of ENO = 0.	DWORD_TO_REAL
	LREAL	X	The data type DWORD is converted to LREAL. If no errors occur during the conversion, the signal state of ENO = 1; if an error occurs during processing, the signal state of ENO = 0.	DWORD_TO_LREAL
	TIME	X	The bit pattern of the source value is transferred unchanged right-justified to the target data type.	DWORD_TO_TIME
	DTL	-	No explicit conversion	-
	TOD	X	The bit pattern of the source value is transferred unchanged right-justified to the target data type.	DWORD_TO_TOD
	DATE	X		DWORD_TO_DATE
	STRING	-	No explicit conversion	-
	CHAR	X	The bit pattern of the source value is transferred unchanged right-justified to the target data type.	DWORD_TO_CHAR

9.1 Creating a user program

Source	Target	Conversion	Description	Mnemonics of the instruction
DWORD_BCD32	DINT	X	The value to be converted has data type DWORD and is accepted as a BCD-coded value between -9999999 and +9999999. The result is available after conversion as an integer (in binary notation) of the type DINT. A real conversion takes place. If the bit pattern includes an invalid tetrad, a synchronous error is not triggered but only the status bit OV is set instead.	DWORD_BCD32_TO_DINT
BCD32	DINT	X		BCD32_TO_DINT

x: Conversion possible  
 - : Conversion not possible  
 1) Bit strings (BYTE, WORD, DWORD) are interpreted as an unsigned integer with the same bit length.. Data type BYTE is interpreted as USINT, WORD as UINT and DWORD as UDINT.

See also

- DWORD (Page 1083)
- Implicit conversion of DWORD (Page 1128)
- Overview of data type conversion (Page 1123)

Integers

Explicit conversion of SINT

Options for explicit conversion

The following table shows the options and instructions for explicit conversion of the SINT data type:

Source	Target	Conversion	Description	Mnemonics of the instruction
SINT	BOOL	X	The following scenarios are possible: <ul style="list-style-type: none"> <li>• If the source is "0", the target data type is also "0" and enable output ENO is "1".</li> <li>• If only the LSB (Least Significant Bit) "1" is set in the source value, the target data type is also "1" and enable output ENO is "1".</li> <li>• If bit is not equal to LSB in the source value, the target data type is set according to LSB and enable output ENO is "0".</li> </ul>	SINT_TO_BOOL
	BYTE <sup>1)</sup>	X	The bit pattern of the source value is transferred unchanged right-justified to the target data type. If a negative value is converted to an unsigned target data type, the enable output ENO is set to "0".	SINT_TO_BYTE
	WORD <sup>1)</sup>	X		SINT_TO_WORD
	DWORD <sup>1)</sup>	X		SINT_TO_DWORD

Source	Target	Conversion	Description	Mnemonics of the instruction
	USINT	X	The bit pattern of the source value is converted and transferred to the target data type. (The value "-1" (16#FF) becomes the value "-1" (16#FFFFFFF)). Enable output ENO is set to "0" if a negative value is converted to an unsigned target data type.	SINT_TO_USINT
	INT	X		SINT_TO_INT
	UINT	X		SINT_TO_UINT
	DINT	X		SINT_TO_DINT
	UDINT	X		SINT_TO_UDINT
	REAL	X	The value is converted into the format of the target data type (the value "-1" will be converted into the value "-1.0" with the "Convert value" (CONVERT) instruction).	SINT_TO_REAL, NORM_X
	LREAL	X		SINT_TO_LREAL, NORM_X
	TIME	X	The value is transferred to the target data type and interpreted as milliseconds.	SINT_TO_TIME
	DTL	-	No explicit conversion	-
	TOD	X	The bit pattern of the source value is converted and transferred to the target data type. (The value "-1" (16#FF) becomes the value "-1" (16#FFFFFFF)). Enable output ENO is set to "0" if a negative value is converted to an unsigned target data type. (interpretation in milliseconds since 0:0)	SINT_TO_TOD
	DATE	X	The bit pattern of the source value is converted and transferred to the target data type. (The value "-1" (16#FF) becomes the value "-1" (16#FFFFFFF)). Enable output ENO is set to "0" if a negative value is converted to an unsigned target data type. (interpretation in days since 1990-1-1)	SINT_TO_DATE
	STRING	X	The value is converted to a character string. The character string is shown preceded by a sign. If the permitted length of the character string is violated, the enable output ENO is set to "0". The string has a minimum length of 4 characters.	SINT_TO_STRING, S_CONV, VAL_STRG
	CHAR <sup>1)</sup>	X	The bit pattern of the source value is transferred unchanged to the target data type. If negative values are converted, the enable output ENO is set to "0".	SINT_TO_CHAR

x: Conversion possible  
- : Conversion not possible

<sup>1)</sup> Bit strings (BYTE, WORD, DWORD) and data type CHAR are first extended to the necessary width including sign, and then the bits are copied. The source type determines the interpretation.

**See also**

SINT (8-bit integers) (Page 1085)

Implicit conversion of SINT (Page 1129)

Overview of data type conversion (Page 1123)

### Explicit conversion of USINT

#### Options for explicit conversion

The following table shows the options and instructions for explicit conversion of the USINT data type:

Source	Target	Conversion	Description	Mnemonics of the instruction
USINT	BOOL	X	The following scenarios are possible: <ul style="list-style-type: none"> <li>• If the source is "0", the target data type is also "0" and enable output ENO is "1".</li> <li>• If only the LSB (Least Significant Bit) "1" is set in the source value, the target data type is also "1" and enable output ENO is "1".</li> <li>• If bit is not equal to LSB in the source value, the target data type is set according to LSB and enable output ENO is "0".</li> </ul>	USINT_TO_BOOL
	BYTE <sup>1)</sup>	X	The bit pattern of the source value is transferred unchanged right-justified to the target data type.	USINT_TO_BYTE
	WORD <sup>1)</sup>	X		USINT_TO_WORD
	DWORD <sup>1)</sup>	X		USINT_TO_DWORD
	SINT	X	The bit pattern of the source value is transferred unchanged to the target data type. If the sign is changed during the conversion, the enable output ENO is set to "0".	USINT_TO_SINT
	INT	X	The bit pattern of the source value is transferred unchanged right-justified to the target data type.	USINT_TO_INT
	UINT	X		USINT_TO_UINT
	DINT	X		USINT_TO_DINT
	UDINT	X		USINT_TO_UDINT
	REAL	X	The value is converted into the format of the target data type (the value "1" will be converted into the value "1.0" with the "Convert value" (CONVERT) instruction).	USINT_TO_REAL, NORM_X
	LREAL	X		USINT_TO_LREAL, NORM_X
	TIME	X	The value is transferred to the target data type and interpreted as milliseconds.	USINT_TO_TIME
	DTL	-	No explicit conversion	-
	TOD	X	The bit pattern of the source value is transferred unchanged right-justified to the target data type.	USINT_TO_TOD
	DATE	X		USINT_TO_DATE
STRING	X	The value is converted to a character string. If the permitted length of the character string is violated, the enable output ENO is set to "0". The string has a minimum length of 4 characters.	USINT_TO_STRING, S_CONV, VAL_STRG	

Source	Target	Conversion	Description	Mnemonics of the instruction
	CHAR <sup>1)</sup>	X	The bit pattern of the source value is transferred unchanged to the target data type.	USINT_TO_CHAR
x: Conversion possible - : Conversion not possible <sup>1)</sup> Bit strings (BYTE, WORD, DWORD) and data type CHAR are first extended to the necessary width (the non-existing sign is replaced with zeros) and then the bits are copied. The source type determines the interpretation.				

### See also

- USINT (8-bit integers) (Page 1086)
- Implicit conversion of USINT (Page 1130)
- Overview of data type conversion (Page 1123)

### Explicit conversion of INT

#### Options for explicit conversion

The following table shows the options and instructions for explicit conversion of the INT data type:

Source	Target	Conversion	Description	Mnemonics of the instruction
INT	BOOL	X	The following scenarios are possible: <ul style="list-style-type: none"> <li>• If the source is "0", the target data type is also "0" and enable output ENO is "1".</li> <li>• If only the LSB (Least Significant Bit) "1" is set in the source value, the target data type is also "1" and enable output ENO is "1".</li> <li>• If bit is not equal to LSB in the source value, the target data type is set according to LSB and enable output ENO is "0".</li> </ul>	INT_TO_BOOL
	BYTE <sup>1)</sup>	X	The bit pattern of the source value is transferred unchanged right-justified to the target data type. If a negative value is converted to an unsigned target data type, the enable output ENO is set to "0".	INT_TO_BYTE
	WORD <sup>1)</sup>	X		INT_TO_WORD
	DWORD <sup>1)</sup>	X		INT_TO_DWORD
	SINT	X	The bit pattern of the source value is converted and transferred to the target data type. (The value "-1" (16#FF) becomes the value "-1" (16#FFFFFFFF). Enable output ENO is set to "0" if a negative value is converted to an unsigned target data type.	INT_TO_SINT
	USINT	X		INT_TO_USINT
	UINT	X		INT_TO_UINT
	DINT	X		INT_TO_DINT
	UDINT	X		INT_TO_UDINT
	REAL	X	The value is converted to the format of the target data type (the value "1", for example, is converted with the instruction "Convert value" (CONVERT) to the value "-1").	INT_TO_REAL, NORM_X
LREAL	X	INT_TO_LREAL, NORM_X		

Source	Target	Conversion	Description	Mnemonics of the instruction
	TIME	X	The value is transferred to the target data type and interpreted as milliseconds.	INT_TO_TIME
	DTL	-	No explicit conversion	-
	TOD	X	The bit pattern of the source value is converted and transferred to the target data type. (The value "-1" (16#FF) becomes the value "-1" (16#FFFFFFFF). Enable output ENO is set to "0" if a negative value is converted to an unsigned target data type. (interpretation in milliseconds since 0:0; check for 24h limit)	INT_TO_TOD
	DATE	X	The bit pattern of the source value is converted and transferred to the target data type. (The value "-1" (16#FF) becomes the value "-1" (16#FFFFFFFF). Enable output ENO is set to "0" if a negative value is converted to an unsigned target data type. (interpretation in days since 1990-1-1; check for negative value)	INT_TO_DATE
	STRING	X	The value is converted to a character string. The character string is shown preceded by a sign. If the permitted length of the character string is violated, the enable output ENO is set to "0". The string has a minimum length of 6 characters.	INT_TO_STRING, S_CONV, VAL_STRG <sup>1)</sup>
	CHAR <sup>1)</sup>	X	The bit pattern of the source value is converted and transferred to the target data type. (The value "-1" (16#FF) becomes the value "-1" (16#FFFFFFFF). Enable output ENO is set to "0" if a negative value is converted to an unsigned target data type.	INT_TO_CHAR
	BCD16	X	The value to be converted has type INT and is accepted as an integer with a value between -999 and +999. The result is available after conversion as a BCD-coded number of the type WORD. A real conversion takes place. If the value is outside the target area, a synchronous error is not triggered, but rather only the status bit OV is set.	INT_TO_BCD16
	BCD16_WORD	X		INT_TO_BCD16_WORD

x: Conversion possible

- : Conversion not possible

<sup>1)</sup> Bit strings (BYTE, WORD, DWORD) and data type CHAR are first extended to the necessary width including sign, and then the bits are copied. The source type determines the interpretation.

**See also**

INT (16-bit integers) (Page 1087)

Implicit conversion of INT (Page 1131)

Overview of data type conversion (Page 1123)



## Explicit conversion of UINT

### Options for explicit conversion

The following table shows the options and instructions for explicit conversion of the UINT data type:

Source	Target	Conversion	Description	Mnemonics of the instruction
UINT	BOOL	X	The following scenarios are possible: <ul style="list-style-type: none"> <li>If the source is "0", the target data type is also "0" and enable output ENO is "1".</li> <li>If only the LSB (Least Significant Bit) "1" is set in the source value, the target data type is also "1" and enable output ENO is "1".</li> <li>If bit is not equal to LSB in the source value, the target data type is set according to LSB and enable output ENO is "0".</li> </ul>	UINT_TO_BOOL
	BYTE <sup>1)</sup>	X	The bit pattern of the source value is transferred unchanged right-justified to the target data type. If bits are lost in the process, the enable output ENO is set to "0".	UINT_TO_BYTE
	WORD <sup>1)</sup>	X		UINT_TO_WORD
	DWORD <sup>1)</sup>	X		UINT_TO_DWORD
	SINT	X		UINT_TO_SINT
	USINT	X		UINT_TO_USINT
	INT	X	The bit pattern of the source value is transferred unchanged to the target data type. If the sign bit is changed during the conversion, the enable output ENO is set to "0".	UINT_TO_INT
	DINT	X	The bit pattern of the source value is transferred unchanged right-justified to the target data type.	UINT_TO_DINT
	UDINT	X		UINT_TO_UDINT
	REAL	X	The value is converted to the format of the target data type (the value "1", for example, is converted with the instruction "Convert value" (CONVERT) to the value "1.0").	UINT_TO_REAL, NORM_X
	LREAL	X		UINT_TO_LREAL, NORM_X
	TIME	X	The value is transferred to the target data type and interpreted as milliseconds.	UINT_TO_TIME
	DTL	-	No explicit conversion	-
	TOD	X	The bit pattern of the source value is converted and transferred to the target data type. (The value "-1" (16#FF) becomes the value "-1" (16#FFFFFFFF). Enable output ENO is set to "0" if a negative value is converted to an unsigned target data type. (interpretation in milliseconds since 0:0; check for 24h limit)	UINT_TO_TOD

Source	Target	Conversion	Description	Mnemonics of the instruction
	DATE	X	The bit pattern of the source value is converted and transferred to the target data type. (The value "-1" (16#FF) becomes the value "-1" (16#FFFFFFFF). Enable output ENO is set to "0" if a negative value is converted to an unsigned target data type. (interpretation in days since 1990-1-1; check for negative value)	UINT_TO_DATE, T_CONV
	STRING	X	The value is converted to a character string. If the permitted length of the character string is violated, the enable output ENO is set to "0". The string has a minimum length of 6 characters.	UINT_TO_STRING, S_CONV, VAL_STRG
	CHAR <sup>1)</sup>	X	The bit pattern of the source value is transferred unchanged to the target data type. The enable output ENO is set to "0" in the event of overflow.	UINT_TO_CHAR

x: Conversion possible

- : Conversion not possible

<sup>1)</sup> Bit strings (BYTE, WORD, DWORD, LWORD) and the data type CHAR are initially extended to the necessary width (the non-existing sign is replaced with zeros) and then the bits are copied. The source type determines the interpretation.

**See also**

UINT (16-bit integers) (Page 1088)

Implicit conversion of UINT (Page 1132)

Overview of data type conversion (Page 1123)

## Explicit conversion of DINT

### Options for explicit conversion

The following table shows the options and instructions for explicit conversion of the DINT data type:

Source	Target	Conversion	Description	Mnemonics of the instruction
DINT	BOOL	X	The following scenarios are possible: <ul style="list-style-type: none"> <li>If the source is "0", the target data type is also "0" and enable output ENO is "1".</li> <li>If only the LSB (Least Significant Bit) "1" is set in the source value, the target data type is also "1" and enable output ENO is "1".</li> <li>If bit is not equal to LSB in the source value, the target data type is set according to LSB and enable output ENO is "0".</li> </ul>	DINT_TO_BOOL
	BYTE <sup>1)</sup>	X	The bit pattern of the source value is transferred unchanged right-justified to the target data type. If a negative value is converted to an unsigned target data type, the enable output ENO is set to "0".	DINT_TO_BYTE
	WORD <sup>1)</sup>	X		DINT_TO_WORD
	DWORD <sup>1)</sup>	X		DINT_TO_DWORD
	SINT	X	The bit pattern of the source value is converted and transferred to the target data type. (The value "-1" (16#FF) becomes the value "-1" (16#FFFFFFFF). Enable output ENO is set to "0" if a negative value is converted to an unsigned target data type.	DINT_TO_SINT
	USINT	X		DINT_TO_USINT
	INT	X		DINT_TO_INT
	UINT	X		DINT_TO_UINT
	UDINT	X		DINT_TO_UDINT
	REAL	X		The value is converted to the format of the target data type (the value "1", for example, is converted with the instruction "Convert value" (CONVERT) to the value "-1").
	LREAL	X	DINT_TO_LREAL, NORM_X	
	TIME	X	The value is transferred to the target data type and interpreted as milliseconds.	DINT_TO_TIME, T_CONV
	DTL	-	No explicit conversion	-
	TOD	X	The bit pattern of the source value is converted and transferred to the target data type. (The value "-1" (16#FF) becomes the value "-1" (16#FFFFFFFF). Enable output ENO is set to "0" if a negative value is converted to an unsigned target data type. (interpretation in milliseconds since 0:0)	DINT_TO_TOD

Source	Target	Conversion	Description	Mnemonics of the instruction
	DATE	X	The bit pattern of the source value is converted and transferred to the target data type. (The value "-1" (16#FF) becomes the value "-1" (16#FFFFFFFF). Enable output ENO is set to "0" if a negative value is converted to an unsigned target data type. (interpretation in days since 1990-1-1)	DINT_TO_DATE
	STRING	X	The value is converted to a character string. The character string is shown preceded by a sign. If the permitted length of the character string is violated, the enable output ENO is set to "0". The string has a minimum length of 11 characters.	DINT_TO_STRING, S_CONV, VAL_STRG
	CHAR <sup>1)</sup>	X	The bit pattern of the source value is converted and transferred to the target data type. (The value "-1" (16#FF) becomes the value "-1" (16#FFFFFFFF). Enable output ENO is set to "0" if a negative value is converted to an unsigned target data type.	DINT_TO_CHAR
	BCD32	X	The value to be converted has type DINT and is accepted as an integer with a value between -999999 and +9999999. The result is available after conversion as a BCD-coded number of the type DWORD. The enable output is set to "0" in the event of overflow. A real conversion takes place. If the value is outside the target area, a synchronous error is not triggered, but rather only the status bit OV is set.	DINT_TO_BCD32
	BCD32_DWORD	X		DINT_TO_BCD32_DWORD
<p>x: Conversion possible                      -: Conversion not possible  <sup>1)</sup> Bit strings (BYTE, WORD, DWORD) and data type CHAR are first extended to the necessary width including sign, and then the bits are copied. The source type determines the interpretation.</p>				

**See also**

- DINT (32-bit integers) (Page 1089)
- Implicit conversion of DINT (Page 1133)
- Overview of data type conversion (Page 1123)

## Explicit conversion of UDINT

### Options for explicit conversion

The following table shows the options and instructions for explicit conversion of the UDINT data type:

Source	Target	Conversion	Description	Mnemonics of the instruction
UDINT	BOOL	X	The following scenarios are possible: <ul style="list-style-type: none"> <li>• If the source is "0", the target data type is also "0" and enable output ENO is "1".</li> <li>• If only the LSB (Least Significant Bit) "1" is set in the source value, the target data type is also "1" and enable output ENO is "1".</li> <li>• If bit is not equal to LSB in the source value, the target data type is set according to LSB and enable output ENO is "0".</li> </ul>	UDINT_TO_BOOL
	BYTE <sup>1)</sup>	X	The bit pattern of the source value is transferred unchanged to the target data type. Enable output ENO is set to "0" if bits are lost in the process.	UDINT_TO_BYTE
	WORD <sup>1)</sup>	X		UDINT_TO_WORD
	DWORD <sup>1)</sup>	X		UDINT_TO_DWORD
	SINT	X		UDINT_TO_SINT
	USINT	X		UDINT_TO_USINT
	INT	X		UDINT_TO_INT
	UINT	X		UDINT_TO_UINT
	DINT	X	The bit pattern of the source value is transferred unchanged to the target data type. If the sign bit is changed during the conversion, the enable output ENO is set to "0".	UDINT_TO_DINT
	REAL	X	The value is converted to the format of the target data type (the value "1", for example, is converted with the instruction "Convert value" (CONVERT) to the value "1.0").	UDINT_TO_REAL, NORM_X
	LREAL	X		UDINT_TO_LREAL, NORM_X
	TIME	X	The bit pattern of the source value is transferred unchanged right-justified and interpreted as milliseconds to the target data type.	UDINT_TO_TIME
	DTL	-	No explicit conversion	-
TOD	X	The bit pattern of the source value is converted and transferred to the target data type. (The value "-1" (16#FF) becomes the value "-1" (16#FFFFFFFF). Enable output ENO is set to "0" if a negative value is converted to an unsigned target data type. (interpretation in milliseconds since 0:0; check for 24h limit)	UDINT_TO_TOD, T_CONV	

9.1 Creating a user program

Source	Target	Conversion	Description	Mnemonics of the instruction
	DATE	X	The bit pattern of the source value is converted and transferred to the target data type. (The value "-1" (16#FF) becomes the value "-1" (16#FFFFFFFF)). Enable output ENO is set to "0" if a negative value is converted to an unsigned target data type. (interpretation in days since 1990-1-1; check for negative value)	UDINT_TO_DATE
	STRING	X	The value is converted to a character string. If the permitted length of the character string is violated, the enable output ENO is set to "0". The string has a minimum length of 11 characters.	UDINT_TO_STRING, S_CONV, VAL_STRG
	CHAR <sup>1)</sup>	X	The bit pattern of the source value is transferred unchanged to the target data type. The enable output is set to "0" in the event of overflow.	UDINT_TO_CHAR

x: Conversion possible

- : Conversion not possible

<sup>1)</sup> Bit strings (BYTE, WORD, DWORD, LWORD) and the data type CHAR are initially extended to the necessary width (the non-existing sign is replaced with zeros) and then the bits are copied. The source type determines the interpretation.

See also

UDINT (32-bit integers) (Page 1089)

Implicit conversion of UDINT (Page 1134)

Overview of data type conversion (Page 1123)

Floating-point numbers

Explicit conversion of REAL

Options for explicit conversion

The following table shows the options and instructions for explicit conversion of the REAL data type:

Source	Target	Conversion	Description	Mnemonics of the instruction
REAL	BOOL	-	No explicit conversion	-
	BYTE <sup>1)</sup>	X	The bit pattern of the source value is transferred unchanged to the target data type.	REAL_TO_BYTE
	WORD <sup>1)</sup>	X		REAL_TO_WORD
	DWORD <sup>1)</sup>	X		REAL_TO_DWORD
	SINT	X	The value is converted to the target data type. The result of the conversion depends on the instruction used. Enable output ENO is set to "0" if the valid range of values of the target	REAL_TO_SINT, ROUND, CEIL, FLOOR, TRUNC, NORM_X, SCALE_X

Source	Target	Conversion	Description	Mnemonics of the instruction
	USINT	X	data type is exceeded during conversion, or if the value to be converted is an invalid floating-point number.	REAL_TO_USINT, ROUND, CEIL, FLOOR, TRUNC, NORM_X, SCALE_X
	INT	X		REAL_TO_INT, ROUND, CEIL, FLOOR, TRUNC, NORM_X, SCALE_X
	UINT	X		REAL_TO_UINT, ROUND, CEIL, FLOOR, TRUNC, NORM_X, SCALE_X
	DINT	X		REAL_TO_DINT, ROUND, CEIL, FLOOR, TRUNC, NORM_X, SCALE_X
	UDINT	X		REAL_TO_UDINT, ROUND, CEIL, FLOOR, TRUNC, NORM_X, SCALE_X
	LREAL	X	The value is converted to the target data type. The result of the conversion depends on the instruction used, e.g. TRUNC(2.5) = 2.0; CEIL(2.5) = 3.0	REAL_TO_LREAL, ROUND, CEIL, FLOOR, TRUNC, NORM_X, SCALE_X
	TIME	-	No explicit conversion	-
	DTL	-		-
	TOD	-		-
	DATE	-		-
	STRING	X	The value is converted to a character string. Enable output ENO is set to "0" if the character string length is exceeded, or if the value to be converted is an invalid floating-point number. The string has a minimum length of 14 characters.	REAL_TO_STRING, S_CONV, VAL_STRG
	CHAR	-	No explicit conversion	-

x: Conversion possible

-: Conversion not possible

<sup>1)</sup> Bit strings (BYTE, WORD, DWORD) and data type CHAR are first extended to the necessary width and then the bits are copied. The source type determines the interpretation.

### See also

REAL (Page 1093)

Implicit conversion of REAL (Page 1135)

Overview of data type conversion (Page 1123)

Explicit conversion of LREAL

Options for explicit conversion

The following table shows the options and instructions for explicit conversion of the LREAL data type:

Source	Target	Conversion	Description	Mnemonics of the instruction	
LREAL	BOOL	-	No explicit conversion	-	
	BYTE	X	The bit pattern of the source value is transferred unchanged right-justified to the target data type.	LREAL_TO_BYTE	
	WORD	X		LREAL_TO_WORD	
	DWORD	X		LREAL_TO_DWORD	
	SINT	X	The value is converted to the target data type. The result of the conversion depends on the instruction used. Enable output ENO is set to "0" if the valid range of values of the target data type is exceeded during conversion, or if the value to be converted is an invalid floating-point number.	LREAL_TO_SINT, ROUND, CEIL, FLOOR, TRUNC, NORM_X, SCALE_X	
	USINT	X		LREAL_TO_USINT, ROUND, CEIL, FLOOR, TRUNC, NORM_X, SCALE_X	
	INT	X		LREAL_TO_INT, ROUND, CEIL, FLOOR, TRUNC, NORM_X, SCALE_X	
	UINT	X		LREAL_TO_UINT, ROUND, CEIL, FLOOR, TRUNC, NORM_X, SCALE_X	
	DINT	X		LREAL_TO_DINT, ROUND, CEIL, FLOOR, TRUNC, NORM_X, SCALE_X	
	UDINT	X		LREAL_TO_UDINT, ROUND, CEIL, FLOOR, TRUNC, NORM_X, SCALE_X	
	REAL	X		The value is converted to the target data type. Enable output ENO is set to "0" if the valid range of values of the target data type is exceeded during conversion, or if the value to be converted is an invalid floating-point number. A loss in accuracy is tolerated.	LREAL_TO_LREAL, ROUND, CEIL, FLOOR, TRUNC, NORM_X, SCALE_X
	TIME	-		No explicit conversion	-
	DTL	-	-		
	TOD	-	-		
	DATE	-	-		
STRING	X	The value is converted to a character string. Enable output ENO is set to "0" if the character string length is exceeded, or if the value to be converted is an invalid floating-point number. The string has a minimum length of 21 characters.	REAL_TO_STRING, S_CONV, VAL_STRG		



Source	Target	Conversion	Description	Mnemonics of the instruction
	CHAR	-	No explicit conversion	-
x: Conversion possible -: Conversion not possible				

### See also

LREAL (Page 1094)

Overview of data type conversion (Page 1123)

### Timers

#### Explicit conversion of TIME

#### Options for explicit conversion

The following table shows the options and instructions for explicit conversion of the TIME data type:

Source	Target	Conversion	Description	Mnemonics of the instruction
TIME	BOOL	-	No explicit conversion	-
	BYTE <sup>1)</sup>	X	The bit pattern of the source value is transferred unchanged to the target data type.	TIME_TO_BYTE
	WORD <sup>1)</sup>	X		TIME_TO_WORD
	DWORD <sup>1)</sup>	X		TIME_TO_DWORD
	SINT	X	The bit pattern of the source value is transferred unchanged right-justified and interpreted as milliseconds to the target data type.	TIME_TO_SINT
	USINT	X		TIME_TO_USINT
	INT	X		TIME_TO_INT
	UINT	X		TIME_TO_UINT
	DINT	X	The bit pattern of the source value is transferred unchanged to the target data type. The result of the conversion shows the duration in milliseconds.	TIME_TO_DINT, T_CONV
	UDINT	X	The bit pattern of the source value is transferred unchanged right-justified and interpreted as milliseconds to the target data type. Enable output ENO is set to "0" if the sign changes.	TIME_TO_UDINT
	REAL	-	No explicit conversion	-
	LREAL	-		-
	DTL	-		-

Source	Target	Conversion	Description	Mnemonics of the instruction
	TOD	X	The bit pattern of the source value is transferred unchanged right-justified to the target data type. If the source value exceeds the range of values of TOD, the target data type remains unchanged.	TIME_TO_TOD
	DATE	-	No explicit conversion	-
	STRING	-		-
	CHAR	-		-

x: Conversion possible  
 -: Conversion not possible  
 1) Bit strings (BYTE, WORD, DWORD) and data type CHAR are first extended to the necessary width and then the bits are copied. The source type determines the interpretation.

**See also**

- TIME (IEC time) (Page 1098)
- Implicit conversion of TIME (Page 1137)
- Overview of data type conversion (Page 1123)

**Clock and calendar**

**Explicit conversion of DATE**

**Options for explicit conversion**

The following table shows the options and instructions for explicit conversion of the DATE data type:

Source	Target	Conversion	Description	Mnemonics of the instruction
DATE	BOOL	-	No explicit conversion	-
	BYTE <sup>1)</sup>	X	The bit pattern of the source value is transferred unchanged right-justified to the target data type.	DATE_TO_BYTE
	WORD <sup>1)</sup>	X		DATE_TO_WORD
	DWORD <sup>1)</sup>	X		DATE_TO_DWORD
	SINT	X	The number of days since 1/1/1990 is returned as result.	DATE_TO_SINT
	USINT	X		DATE_TO_USINT
	INT	X		DATE_TO_INT
	UINT	X		DATE_TO_UINT
	DINT	X		DATE_TO_DINT
	UDINT	X		DATE_TO_UDINT
	REAL	-	No explicit conversion	-
	LREAL	-		-
	TIME	-		-

Source	Target	Conversion	Description	Mnemonics of the instruction
	DTL	X	The bit pattern of the source value is transferred unchanged right-justified to the target data type.	DATE_TO_DTL
	TOD	-	No explicit conversion	-
	STRING	-		-
	CHAR	-		-

x: Conversion possible  
- : Conversion not possible

<sup>1)</sup> Bit strings (BYTE, WORD, DWORD) and data type CHAR are first extended to the necessary width and then the bits are copied. The source type determines the interpretation.

### See also

- DATE (Page 1099)
- Implicit conversion of DATE (Page 1139)
- Overview of data type conversion (Page 1123)

### Explicit conversion of TOD

#### Options for explicit conversion

The following table shows the options and instructions for explicit conversion of the TOD data type:

Source	Target	Conversion	Description	Mnemonics of the instruction
TOD	BOOL	-	No explicit conversion	-
	BYTE <sup>1)</sup>	X	The bit pattern of the source value is transferred unchanged to the target data type.	TOD_TO_BYTE
	WORD <sup>1)</sup>	X		TOD_TO_WORD
	DWORD <sup>1)</sup>	X		TOD_TO_DWORD
	SINT	X	The number of milliseconds since midnight is returned as result.	TOD_TO_SINT
	USINT	X		TOD_TO_USINT
	INT	X		TOD_TO_INT
	UINT	X		TOD_TO_UINT
	DINT	X		TOD_TO_DINT
	UDINT	X		The result of the conversion corresponds to the number of milliseconds since the start of day (0:00 hrs).
	REAL	-	No explicit conversion	-
	LREAL	-		-
	TIME	X	The duration since midnight is returned as result.	TOD_TO_TIME
	DTL	X	The date is set to 1.1.1970 as a result.	TOD_TO_DTL

9.1 Creating a user program

Source	Target	Conversion	Description	Mnemonics of the instruction
	DATE	-	No explicit conversion	-
	STRING	-		-
	CHAR	-		-

x: Conversion possible  
 -: Conversion not possible  
 1) Bit strings (BYTE, WORD, DWORD) and data type CHAR are first extended to the necessary width including the sign and then the bits are copied. The source type determines the interpretation.

See also

- TIME\_OF\_DAY (TOD) (Page 1099)
- Implicit conversion of TOD (Page 1138)
- Overview of data type conversion (Page 1123)

Explicit conversion of DTL

Options for explicit conversion

The following table shows the options and instructions for explicit conversion of the DTL data type:

Source	Target	Conversion	Description	Mnemonics of the instruction
DTL	BYTE	-	No explicit conversion	-
	WORD	-		-
	DWORD	-		-
	SINT	-		-
	USINT	-		-
	INT	-		-
	UINT	-		-
	DINT	-		-
	UDINT	-		-
	REAL	-		-
	LREAL	-		-
	TIME	-		-
	TOD	X		
DATE	X		During the conversion, the date is extracted from the DTL format and written to the target data type. The enable output ENO is set to "0" in the event of overflow.	DTL_TO_DATE, T_CONV
STRING	-		No explicit conversion	-

Source	Target	Conversion	Description	Mnemonics of the instruction
	CHAR	-		-
x: Conversion possible -: Conversion not possible				

### See also

DTL (Page 1102)

Overview of data type conversion (Page 1123)

### Character strings

#### Explicit conversion of CHAR

#### Options for explicit conversion

The following table shows the options and instructions for explicit conversion of the CHAR data type:

Source	Target	Conversion	Description	Mnemonics of the instruction
CHAR	BOOL	-	No explicit conversion	-
	BYTE <sup>1)</sup>	X	The bit pattern of the source value is transferred unchanged right-justified to the target data type.	CHAR_TO_BYTE
	WORD <sup>1)</sup>	X		CHAR_TO_WORD
	DWORD <sup>1)</sup>	X		CHAR_TO_DWORD
	SINT	X		CHAR_TO_SINT
	USINT	X		CHAR_TO_USINT
	INT	X		CHAR_TO_INT
	UINT	X		CHAR_TO_UINT
	DINT	X		CHAR_TO_DINT
	UDINT	X		CHAR_TO_UDINT
	REAL	-		No explicit conversion
	LREAL	-	-	
	TIME	-	-	
	DTL	-	-	
TOD	-	-		
DATE	-	-		

Source	Target	Conversion	Description	Mnemonics of the instruction
	STRING	X	The value is converted to the first character in the character string (STRING). If the length of the character string is not defined, the length "1" is set after the conversion. If the length of the character string is defined, this remains unchanged after the conversion.	CHAR_TO_STRING
x: Conversion possible - : Conversion not possible 1) Bit strings (BYTE, WORD, DWORD) and data type CHAR are first extended to the necessary width and then the bits are copied. The source type determines the interpretation.				

**See also**

- CHAR (character) (Page 1103)
- Implicit conversion of CHAR (Page 1140)
- Overview of data type conversion (Page 1123)

**Explicit conversion of STRING**

**Options for explicit conversion**

The following table shows the options and instructions for explicit conversion of the STRING data type:

Source	Target	Conversion	Description	Mnemonics of the instruction
STRING	BOOL	-	No explicit conversion	-
	BYTE	-		-
	WORD	-		-
	DWORD	-		-
	SINT	X	Conversion begins with the first character in the character string (STRING) and stops at the end of the string or at the first inadmissible character. The following characters are permitted for conversion: <ul style="list-style-type: none"> <li>• Digit</li> <li>• Sign</li> <li>• Dot</li> </ul> The first character of the string may be a sign (+, -) or a number. Leading spaces will be ignored. The dot is used as separation for the conversion of floating-point numbers. The exponential notation "e" or "E" is not permitted. The comma as thousand separator is permitted to the left of the decimal point but will be ignored. If the layout of the character string is invalid for the	STRING_TO_SINT, S_CONV, STRG_VAL
	USINT	X		STRING_TO_USINT, S_CONV, STRG_VAL
	INT	X		STRING_TO_INT, S_CONV, STRG_VAL
	UINT	X		STRING_TO_UINT, S_CONV, STRG_VAL
	DINT	X		STRING_TO_DINT, S_CONV, STRG_VAL
	UDINT	X		STRING_TO_UDINT, S_CONV, STRG_VAL
REAL	X	STRING_TO_REAL, S_CONV, STRG_VAL		

Source	Target	Conversion	Description	Mnemonics of the instruction
	LREAL	X	conversion or an overflow occurs, then the enable output ENO will be set to "0".	STRING_TO_LREAL, S_CONV, STRG_VAL
	TIME	-	No explicit conversion	-
	DTL	-		-
	TOD	-		-
	DATE	-		-
	CHAR <sup>1)</sup>	X		The first character in the character string (STRING) is transferred to the destination data type. If the string is empty, then the value "0" will be written in the destination data type.
x: Conversion possible -: Conversion not possible				

### See also

STRING (Page 1103)  
 Overview of data type conversion (Page 1123)

### 9.1.1.6 Program flow control

#### EN/ENO mechanism

#### Basics of the EN/ENO mechanism

##### Introduction

Runtime errors that require a program abort can occur during the processing of instructions. You can use the EN/ENO mechanism to avoid such program aborts. This mechanism can be used at two levels:

- EN/ENO mechanism for individual instructions
- EN/ENO mechanism for block calls

#### EN/ENO mechanism for instructions in LAD/FBD

In LAD and FBD, certain instructions have an enable input EN and an enable output ENO.

You can use the enable input EN to make the execution of the instruction dependent on conditions. The instructions are only executed if the signal state is "1" at the enable input EN.

You can use the enable output ENO to query runtime errors in instructions and react to these.

The enable output ENO returns the signal state "1" if one of the following conditions applies:

- No error occurred during processing.

The enable output ENO returns signal state "0" if one of the following conditions applies:

- The EN input has signal state "0".
- An error occurred during processing.

The EN/ENO mechanism is used for the following basic instructions:

- Mathematical functions
- Move operations
- Conversion operations
- Word logic operations
- Shift + rotate

In LAD and FBD, you can switch the evaluation of the enable output ENO on and off by means of the shortcut menu specifically for certain instructions.

### EN/ENO mechanism for block calls in LAD/FBD

All blocks that you call in LAD or FBD are provided with an enable input EN and an enable output ENO when called. This applies to all called blocks, regardless of the programming language in which they were created.

You can use the enable input EN to call the block depending on conditions. The block is only executed if the signal state is "1" at the enable input EN.

You can query the error status of the block with the enable output ENO. It has signal "1" as soon as the execution of the block starts. If you do not explicitly set the output ENO to "0" in the program code, it retains signal "1".

However, you can explicitly set it to "0" to return an error statement to the called block. In LAD or FBD, the output ENO is set with the instruction "RET: Return".

See also:

Example of the use of the EN/ENO mechanism in LAD (Page 1169)

Example of the use of the EN/ENO mechanism in FBD (Page 1170)

### EN/ENO mechanism for STL

In STL, the EN/ENO mechanism is not required for individual instructions. This function is mapped by language-specific instruction sequences.

Blocks that you call from an STL block are not provided with the EN and ENO parameters. Regardless of the programming language in which they were created, you can transfer an error statement to the calling STL block using the BR bit of the status word.

In STL, you can evaluate the error status of the called block by linking the BR bit of the status word with the RLO. It has signal "1" as soon as the execution of the block starts. If you do not explicitly set it to "0" in the program code, it retains signal "1".

However, you can explicitly set it to "0" to return an error statement to the calling block. In STL, the error statement is set with the instructions "SAVE" or "JNB".

See also: Example of the simulation of the EN/ENO mechanism in STL (Page 1171)



## EN/ENO mechanism in SCL

With SCL, the use of the EN/ENO mechanism for instructions is optional. You can activate it with the block property "Set ENO automatically". If the property is active, all blocks implicitly receive an error handling.

You can implement a conditional block call with the enable input EN. Use the enable input EN in the parameter list as a normal input parameter. If EN has signal "1" or when EN is not used, the block is called. If EN has signal "0", the block is not called.

---

### Note

When you call functions in SCL, you cannot use the release mechanism via EN. Use an IF statement instead to call functions conditionally.

---

You can query the error status of the block with the enable output ENO. If the ENO has signal "1", the block was processed without errors. If the ENO has signal "0", an error occurred during processing. To query the state of the enable output, insert an additional output parameter with the name ENO in the parameter list during a block call.

See also: Example of the use of the EN/ENO mechanism in SCL (Page 1170)

## EN/ENO mechanism for memory and I/O access errors

You cannot evaluate memory and I/O access errors with the EN/ENO mechanism. You do this either with the global troubleshooting via OBs (S7-300/400 and S7-1200/1500) or local troubleshooting using the "GetError" instruction (S7-1200/1500 only). If a memory access error occurred for an instruction, you can evaluate the associated ENO.

### See also

Enabling and disabling the EN/ENO mechanism (Page 1290)

## Example of the use of the EN/ENO mechanism in LAD

### Description

The following figure shows an ADD instruction with EN and ENO protective circuit:

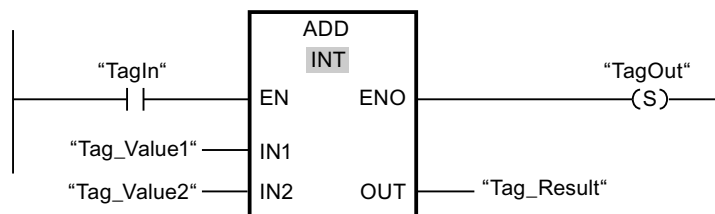

After the normally open contact, the RLO contains the previous result of logic operation:

- If "TagIn" signal is "0", the addition is not executed. EN and ENO both lead to the signal state "0".
- If "TagIn" signal is "1", EN is also "1" and the addition is executed. If no errors occur during the processing of the instruction, the output ENO also has the signal state "1" and the output ""TagOut"" is set.

**See also**

Basics of the EN/ENO mechanism (Page 1167)

ADD: Add (Page 1685)

**Example of the use of the EN/ENO mechanism in FBD**

**Description**

The following figure shows an ADD instruction with EN and ENO protective circuit:

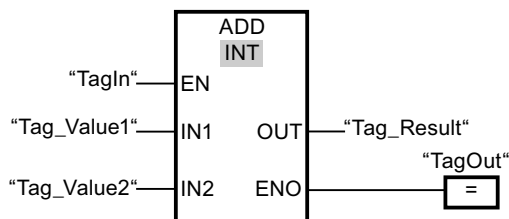

- If "TagIn" signal is "1", EN is also "1" and the addition is executed. If no errors occur during the processing of the instruction, the output ENO also has the signal state "1" and the output ""TagOut"" is set.
- If "TagIn" signal is "0", the addition is not executed. EN and ENO both lead to the signal state "0".

**See also**

Basics of the EN/ENO mechanism (Page 1167)

**Example of the use of the EN/ENO mechanism in SCL**

**Example of the EN/ENO mechanism for basic instructions**

To use the EN/ENO mechanism for instructions in SCL, you have to activate the block property "Set ENO automatically". The following example shows the use of the enable output ENO for the "a/b" instruction.

```
SCL
"MyoutputREAL" :=a/b;
```

```
SCL
IF ENO
    THEN "MyOutputBool":=1;
    ELSE "MyOutputBool":=0;
END_IF;
```

If the "a/b" instruction is executed error-free, MyOutputBool has signal "1".

### Example of the use of the EN/ENO mechanism in block calls

The following example shows the use of the enable output ENO for a block call.

```
SCL
"MyDB"."MyFB" (EN:="MyTag1">"MyTag2",
               in1:="MyInputBool1",
               in2:="MyInputBool1",
               ENO=>"MyOutputBool");
```

If MyTag1 is not greater than MyTag2 the block call is not processed. EN and ENO both lead to the signal state "0".

If MyTag1 is greater than MyTag2, EN has signal "1" and the block call is executed.

If all instructions within MyFB are executed error-free, MyOutputBool has signal "1".

### See also

Basics of the EN/ENO mechanism (Page 1167)

### Example of the simulation of the EN/ENO mechanism in STL

#### Description

The following example shows an program section for adding values with EN and ENO connected:

STL	Description
A"Tag_Input_1"	// Query whether the signal state of the operand is "1" and AND with current RLO
JNBMyLABEL	// Evaluation of the EN input // If RLO="0" jump to jump label "MyLABEL" and save the current RLO in the BR // Execute next instruction if RLO="1"
L"Tag_Input_2"	// Load first value of addition
L"Tag_Input_3"	// Load second value of addition
+I	// Add values
T "Tag_Result"	// Transfer sum to the operand "Tag_Result"
AN OV	// Query if errors occurred

STL	Description
SAVE	// Transfer signal state of the RLO to the BR bit
CLR	// Reset RLO to "0"
MyLABEL: U BR	// Jump label "MyLABEL"
	// Query BR and AND with RLO
= "Tag_Output"	// Assign signal state of the RLO to the operand "Tag_Output"

The query of the operand "U" Tag\_Input\_1" provides the result of the preceding logic operation (RLO). The instruction "Jump at RLO = 0 and save RLO (SPBNB)" saves the RLO to the BR. The instruction "Jump if RLO = 0 and save RLO" also evaluates the RLO and executes one of the following actions depending on the evaluation:

- If the RLO is "0", the processing of the program is continued at the jump label "MyLABEL" with the query of the BR. The addition is not executed. Assign the current RLO to the operand "Tag\_Output".
- If the RLO is "1", the addition is executed. A query of the overflow bit (OV) shows if an error occurred during the addition. The query result is saved in the BR. The operation "CLR" resets the RLO to "0". The BR is then queried for "1" and AND'd with the current RLO. The result is assigned to the operand "Tag\_Output". The signal state of the BR and of the operand "Tag\_Output" shows if the addition was carried out with any error

**See also**

Basics of the EN/ENO mechanism (Page 1167)

**9.1.2 Declaring PLC tags**

**9.1.2.1 Overview of PLC tag tables**

**Introduction**

PLC tag tables contain the definitions of the PLC tags and symbolic constants that are valid throughout the CPU. A PLC tag table is created automatically for each CPU used in the project. You can create additional tag tables and use these to sort and group tags and constants.

In the project tree there is a "PLC tags" folder for each CPU of the project. The following tables are included:

- "All tags" table
- Standard tag table
- Optional: Other user-defined tag tables

## All tags

The "All tags" table gives an overview of all PLC tags, user constants and system constants of the CPU. This table cannot be deleted or moved.

## Standard tag table

There is one standard tag table for each CPU of the project. It cannot be deleted, renamed or moved. The default tag table contains PLC tags, user constants and system constants. You can declare all PLC tags in the default tag table, or create additional user-defined tag tables as you want.

## User-defined tag tables

You can create multiple user-defined tag tables for each CPU to group tags according to your requirements. You can rename, gather into groups, or delete user-defined tag tables. User-defined tag tables can contain PLC tags and user constants.

## See also

Structure of the PLC tag tables (Page 1173)

Using tags within the program (Page 1049)

Constants (Page 1051)



### 9.1.2.2 Structure of the PLC tag tables

#### Introduction

Each PLC tag table contains a tab for tags and a tab for user constants. The default tag table and the "All tags" table also have a "System constants" tab.

#### Structure of the "PLC tags" tab

In the "Tags" tab you declare the global PLC tags that you require in the program. The following figure shows the tab structure. The number of columns shown may vary.





	Name	Data type	Address	Retain	Visible in HMI	Accessible from HMI	Comment
	Motor1	Bool	%Q3.1	<input type="checkbox"/>	<input checked="" type="checkbox"/>	<input checked="" type="checkbox"/>	
	Motor2	Bool	%Q3.2	<input type="checkbox"/>	<input checked="" type="checkbox"/>	<input checked="" type="checkbox"/>	
	Control	Bool	%I3.3	<input type="checkbox"/>	<input checked="" type="checkbox"/>	<input checked="" type="checkbox"/>	

The following table shows the meaning of the individual columns. The number of columns shown may vary. You can show or hide the columns as required.

Column	Explanation
	Symbol you can click on to drag-and-drop a tag to a program for use as an operand.
Name	Unique name for the constants throughout the CPU.
Data type	Data type of the tags.
Address	Tag address.
Retentivity	Marks the tag as retentive. The values of retentive tags are retained even after the power supply is switched off.
Accessible from HMI	Shows whether HMI can access this tag during runtime.
Visible in HMI	Shows whether the tag is visible by default in the operand selection of HMI.
Monitor value	Current data value in the CPU. This column only appears if an online connection is established and you select the "Monitor all" button.
Tag table	Shows which tag table includes the tag declaration. This column is only available in the "All tags" table.
Comment	Comment to document the tags.

**Structure of the "User constants" and "System constants" tabs**

In the "User constants" you define symbolic constants that are valid throughout the CPU. The constants required by the system are shown in the "Systems constants" tab. The following figure shows the structure of both tabs. The number of columns shown may vary.

	Name	Data type	Value	Comment
	Const_1	Bool	true	
	Const_2	Byte	12	
	Const_3	Bool	false	
	Const_4	Real	1.0	

The following table shows the meaning of the individual columns. You can show or hide the columns as required.

Column	Explanation
	Symbol you can click to move a tag into a network via a drag-and-drop operation for use as an operand.
Name	Unique name for the constants throughout the CPU.
Data type	Data type of the constants
Value	Value of the constants
Tag table	Shows which tag table includes the constant declaration. This column is only available in the "All tags" table.
Comment	Comments to document the tags.

## See also

Using tags within the program (Page 1049)  
Constants (Page 1051)  
Overview of PLC tag tables (Page 1172)  
Show and hide table columns (Page 1195)  
Editing tables (Page 242)

### 9.1.2.3 Rules for PLC tags

#### Valid names of PLC tags

##### Permissible characters

The following rules apply to the use of names for PLC tags:

- Letters, numbers, special characters are permitted.
- Quotation marks are not permitted.

##### Unique tag names

The names of the PLC tags must be unique throughout the CPU, even if the tags are located in different tag tables of a CPU. A name that is already used for a block, another PLC tag or a constant within the CPU, cannot be used for a new PLC tag. The uniqueness check does not differentiate between use of small and capital letters.

If you enter an already assigned name another time, a sequential number is automatically appended to the second name entered. For example, if you enter the name "Motor" a second time, the second entry is changed to "Motor(1)".

##### Unique table names

The names of the PLC tag tables must also be unique throughout the CPU. A unique name is automatically suggested when user-defined PLC tag tables are being created.

## See also

Using tags within the program (Page 1049)  
Permissible addresses and data types of PLC tags (Page 1176)  
Keywords (Page 1051)

### Permissible addresses and data types of PLC tags

The addresses of PLC tags are made up of the particulars of the operand area and the address within this area.

The addresses must be unique throughout the CPU. If you enter an address that is already assigned to another tag, the address will be highlighted at both places in yellow and an error message will be issued.

### Operand areas

The following table shows the possible operand areas. The available data types depend on the CPU you use:

Operand area		Description	Data type	Format	Address area:		
International mnemonics	German mnemonics				S7-1200	S7-300/400	S7-1500
I	E	Input bit	BOOL	I x.y E x.y	0.0..1023.7	0.0..65535.7	0.0..32766.7
I	E	Input (64-bit)	LWORD, LINT, ULINT, LTIME, LTOD, LDT, LREAL, PLC data type	I x.0 E x.0	-	-	0.0..32761.0
IB	EB	Input byte	BYTE, CHAR, SINT, USINT, PLC data type	IB x EB y	0..1023	0..65535	0..32767
IW	EW	Input word	WORD, INT, UINT, DATE, S5TIME, PLC data type	IW x EW y	0..1022	0..65534	0..32765
ID	ED	Input double word	DWORD, DINT, UDINT, REAL, TIME, TOD, PLC data type	ID x ED y	0..1020	0..65532	0..32763
Q	A	Output bit	BOOL	Q x.y A x.y	0.0..1023.7	0.0..65535.7	0.0..32766.7
Q	A	Output (64-bit)	LWORD, LINT, ULINT, LTIME, LTOD, LDT, LREAL, PLC data type	Q x.0 A x.0	-	-	0.0..32761.0



Operand area		Description	Data type	Format	Address area:		
International mnemonics	German mnemonics				S7-1200	S7-300/400	S7-1500
QB	AB	Output byte	BYTE, CHAR, SINT, USINT, PLC data type	QB x AB y	0..1023	0..65535	0..32767
QW	AW	Output word	WORD, INT, UINT, DATE, S5TIME, PLC data type	QW x AW y	0..1022	0..65534	0..32765
QD	AD	Output double word	DWORD, DINT, UDINT, REAL, TIME, TOD, PLC data type	QD x AD y	0..1020	0..65532	0..32763
M	M	Memory bit	BOOL	M x.y	0.0..8191.7	0.0..65535.7	0.0..16383.7
M	M	Bit memory (64-bit)	LREAL	M x.0	0.0..8190.0	-	0.0..16378.0
M	M	Bit memory (64-bit)	LWORD, LINT, ULINT, LTIME, LTOD, LDT	M x.0	-	-	0.0..16378.0
MB	MB	Memory byte	BYTE, CHAR, SINT, USINT	MB x	0..8191	0..65535	0..16383
MW	MW	Memory word	WORD, INT, UINT, DATE, S5TIME	MW x	0..8190	0..65534	0..16382
MD	MD	Memory double word	DWORD, DINT, UDINT, REAL, TIME, TOD	MD x	0..8188	0..65532	0..16380
T	T	Time function (for S7-300/400 only)	Timer	T n	-	0..65535	0..2047
C	Z	Counter function (for S7-300/400 only)	Counter	Z n C n	-	0..65535	0..2047

## Addresses

The following table shows the possible addresses of tags:

Data type	Address	Example
BOOL	Tags with BOOL data type are addressed with a byte number and a bit number. The numbering of the bytes begins for each operand area at 0. The numbering of the bits goes from 0 to 7.	A 1.0
BYTE, CHAR, SINT, USINT	Tags with BYTE, CHAR, SINT, and USINT data type are addressed with a byte number.	MB 1
WORD, INT, UINT, DATE, S5TIME	Tags with WORD, INT, UINT, DATE, S5TIME data type consist of two bytes. They are addressed with the number of the lowest byte.	IW 1
DWORD, DINT, UDINT, REAL, TIME, TOD	Tags with DWORD, DINT, UDINT, REAL, TIME, TOD data type consist of four bytes. They are addressed with the number of the lowest byte.	AD 1
LWORD, LINT, ULINT, LTIME, LTOD, LDT, LREAL	Tags of data type LWORD, LINT, ULINT, LTIME, LTOD, LDT, and LREAL consist of eight bytes. They are addressed with it number 0 and the number of the lower byte.	I 1.0

## Mnemonics used

The addresses that you enter in the PLC tag table are automatically adapted to the set mnemonics.

## See also

- Setting the mnemonics (Page 1229)
- Using tags within the program (Page 1049)
- Valid names of PLC tags (Page 1175)
- Overview of the valid data types (Page 1077)

### 9.1.2.4 Creating and managing PLC tag tables

#### Creating a PLC tag table

You can create multiple user-defined PLC tag tables in a CPU. Each tag table must have a unique name throughout the CPU.

## Requirement

The project view is open.

## Procedure

To create a new PLC tag table, follow these steps:

1. Open the "PLC tags" folder under the CPU in the project tree.
2. Double-click the "Add new tag table" entry.  
A new PLC tag table with the default name "TagTable\_x" is created.
3. Select the PLC tag table in the project tree.
4. Select the "Rename" command in the shortcut menu.
5. Type in a name that is unique throughout the CPU.

## Result

A new PLC tag table is created. You can now declare tag and constants in this table.

## See also

Overview of PLC tag tables (Page 1172)  
Structure of the PLC tag tables (Page 1173)  
Importing and exporting (Page 1549)

## Grouping PLC tag tables

You can gather the user-defined tag tables of the CPU into groups. You cannot, however, move the standard tag table and the "All tags" table into a group.

## Requirement

Multiple user-defined tag tables are contained in the "PLC tags" folder of the CPU.

## Procedure

To gather multiple PLC tag tables into a group, follow these steps:

1. Select the "PLC tags" folder under the CPU in the project tree.
2. Select the "Insert > Group" menu command.  
A new group with the standard name "Group\_x" is inserted.
3. Select the newly inserted group in the project tree.
4. Select the "Rename" command in the shortcut menu.
5. Assign the new group a unique name throughout the CPU.
6. Drag to the new group the tables you want to group together.

## **Result**

The tag tables are gathered in the new group.

## **See also**

Overview of PLC tag tables (Page 1172)

Structure of the PLC tag tables (Page 1173)

## **Opening the PLC tag table**

### **Procedure**

To open the PLC tag table in a CPU, proceed as follows:

1. Open the "PLC tags" folder under the CPU in the project tree.
2. Double-click the PLC tag table in the folder.
3. Select the desired tab in the upper corner.

## **Result**

The PLC tag table associated with the CPU opens. You can declare the required tags and constants.

## **See also**

Overview of PLC tag tables (Page 1172)

Structure of the PLC tag tables (Page 1173)

### **9.1.2.5 Declaring PLC tags**

#### **Entering a PLC tag declaration**

#### **Declaring tags in the PLC tag table**

### **Requirements**

The "Tags" tab of the PLC tag table is open.

## Procedure

To define PLC tags, follow these steps:

1. Enter a tag name in the "Name" column.
2. Enter the required data type in the "Data type" column. You will be supported by autocompletion during input.  
An address corresponding to the data type is automatically appended.
3. Optional: Click on the arrow key in the "Address" column and enter an operand identifier, an operand type, an address and a bit number in the dialog which then opens.
4. Optional: Enter a comment in the "Comments" column.
5. Repeat steps 1 to 4 for all the tags you require.

See also: Permissible addresses and data types of PLC tags (Page 1176)

## Syntax check

A syntax check is performed automatically after each entry, and any errors found are displayed in red. You do not have to correct these errors immediately - you can continue editing and make any corrections later. As long as the tag declaration contains syntax errors and the tag is used in the program, you will not be able to compile the program.

## See also

- Importing and exporting (Page 1549)
- Valid names of PLC tags (Page 1175)
- Declaring PLC tags in the program editor (Page 1181)
- Structure of the PLC tag tables (Page 1173)
- Editing tables (Page 242)

## Declaring PLC tags in the program editor

### Requirement

- The program editor is open.

### Procedure

To declare operands as global PLC tags, follow these steps:

1. Insert an instruction in your program.  
The "<???">", "<???.?>" or "..." strings represent operand placeholders.
2. Replace an operand placeholder with the name of the PLC tag to be created.
3. Select the tag name.  
If you want to declare multiple PLC tags, select the names of all the tags to be declared.

### 9.1 Creating a user program

4. Select the "Define tag" command in the shortcut menu.  
The "Define tag" dialog box opens. This dialog displays a declaration table in which the name of the tag is already entered.
5. Click the arrow key in the "Section" column and select one of the following entries:
  - Global Memory
  - Global Input
  - Global Output
6. In the other columns, enter the address, data type, and comments.  
See also: Permissible addresses and data types of PLC tags (Page 1176)
7. If the CPU contains multiple PLC tag tables, you can use an entry in the "PLC tag table" column to indicate in which table the tag is to be inserted. If you make no entry in the column, the new tag will be inserted in the default tag table.
8. Click the "Define" button to complete your entry.

#### Result

The tag declaration is written to the PLC tag table and is valid for all blocks in the CPU.

#### See also

- Valid names of PLC tags (Page 1175)
- Editing tables (Page 242)
- Declaring tags in the PLC tag table (Page 1180)

### Setting the retentivity of PLC tags

#### Retentive behavior of PLC tags

##### Retentive PLC tags

Each CPU has a memory area whose content remains available even after the supply voltage has been switched off. This area is referred to as retentive memory area.

To avoid data loss during power failure, you can save specific PLC tags to this memory area. You specify the retain setting of PLC tags in the PLC tag table.

Depending on the CPU family, the retentive memory area can accommodate various type of PLC tags. The following table provides an overview of the options of the various CPUs:

<b>CPU type</b>	<b>Retentive bit memories</b>	<b>Retentive SIMATIC timers</b>	<b>Retentive SIMATIC counters</b>
S7-300/400 series	✓	-	-
S7-1200 series	✓	-	-
S7-1500 series	✓	✓	✓

## See also

Setting the retentive behavior of PLC tags (Page 1183)

## Setting the retentive behavior of PLC tags

### Introduction

In the PLC tag table you can specify the width of the retentive memory area for PLC tags. All tags with addresses in this memory area are then designated as retentive. You can recognize the retentivity setting of a tag by the check mark set in the "Retain" column of the PLC tag table.

### Requirement

The "PLC tags" tab of the PLC tag table is open.

### Procedure

To define the width of the retentive memory area for PLC tags, follow these steps:

1. On the toolbar, click the "Retain" button.  
The "Retain memory" dialog will open.
2. Specify the width of the retentive memory area by entering the number of retentive bytes, timers or counters in the input field.
3. Click the "OK" button.

### Result

The width of the retentive memory area is defined. In the "Retain" column of the tag table a check mark is automatically set for all tags that are located within the retentive memory area.

## See also

Retentive behavior of PLC tags (Page 1182)

Editing tables (Page 242)

### 9.1.2.6 Grouping PLC tags for inputs and outputs in structures

#### Other useful information regarding structured PLC tags

##### Use of structured PLC tags (S7-1200 V4 and higher/S7-1500)

To make your program easier to view, you can group several input or output addresses in a higher-level PLC tag. The higher-level PLC tag represents a structure that contains several logically related inputs or outputs. When the block is called, you transfer the higher-level tag and thus need only an input or output parameter for all associated inputs or outputs.

#### Principle of operation

To create a structured PLC tag, you initially define a PLC data type (UDT). In it you declare the necessary data elements and specify their names and data types.

Then, you switch to the PLC tag table and specify the higher-level PLC tag there. As a data type for the tag, you select your PLC data types. The system now reserves a certain number of input or output addresses starting from the start address of the higher-level tag. The number of reserved addresses depends on the length of your PLC data type.

If you call a block that requires the reserved inputs or outputs for program execution, you transfer the higher-level tag as a block parameter.

You can address the individual PLC tags like structure elements in the program code.

A detailed description of the individual handling steps can be found in the following chapters.

#### Application example

You can use structured PLC tags in order to group the inputs or outputs of a function module. The following figure shows the schematic representation of a motor: A component was created in the "Datatype\_Motor" PLC data type for each of the three inputs.

The memory areas of the declared tags must not overlap. In the example, you see that the "Speed" component has the data type "Integer" and therefore must start at a word address. For this reason, the first input word has been filled with the "Dummy" fill tag. This means that "Speed" is located on the second input word.

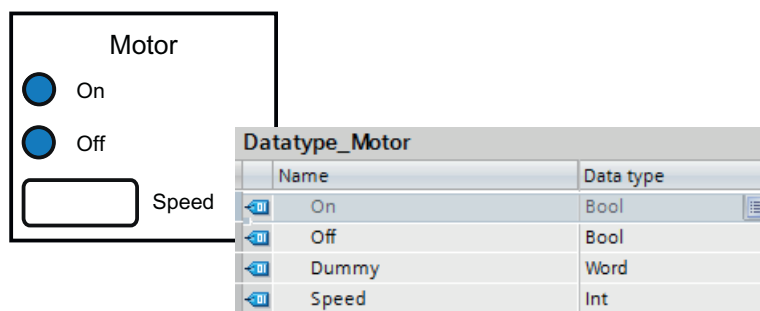



The following figure shows the higher-level "Motor" PLC tag that is based on the "Data type\_Motor" data type. With the declaration of "Motor", the addresses IW0 and IW1 are reserved on the input module.

MyTagTable			
	Name	Data type	Address
1	Motor	"Datatype_Motor"	%I0.0
2	<Add new>		

The following figure shows the transfer of the "Motor" PLC tag as an input parameter of the "Motor\_Control" block.

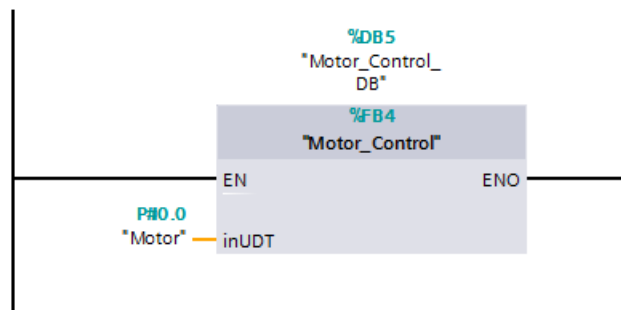

You can address the individual components of the tag in the "Motor\_Control" block.

Addressing	Description
"Motor"	Addressing the higher-level PLC tag.
"Motor".On	Addressing a component of a structured PLC tag.
"Motor".On:P	Addressing an I/O input or output (PI or PO).

### Rules for use of structured PLC tags

Note the following rules when creating and using structured PLC tags.

- Structured PLC tags can be used in the "Inputs" and "Outputs" operand areas.
- Structured tags are not permitted in the bit memory address area.
- Structured PLC tags cannot be addressed from HMI.

Observe the following rules when creating the PLC data type that is to serve as the basis for a PLC tag:

- The memory areas of the individual elements must not overlap.  
See also: Permissible addresses and data types of PLC tags (Page 1176)
- Do not group inputs and outputs in one PLC data type but create different PLC data types for inputs and outputs.

- Do not group inputs or outputs from different modules in a PLC data type because it is not guaranteed that the process images of the modules are updated synchronously.
- In the lower-level PLC data types, all data types are permitted except for the "STRING" data type.

### See also

Creating structured PLC tags (Page 1186)

## Creating structured PLC tags

### Rules

Note the following rules when creating structured PLC tags:

- Use separate PLC data types for the "Inputs" and "Outputs" operand areas.
- Structured tags are not permitted in the bit memory address area.
- Do not group inputs or outputs from different modules in a PLC data type because it is not guaranteed that the process images of the modules are updated synchronously.

### Procedure

To create a structured PLC tag, follow these steps:

1. Double-click the "Add new data type" command in the "PLC data types" folder in the project tree.  
A new declaration table for creating a PLC data type will be created and opened.
2. Declare all the necessary components in the PLC type. All data types except the "STRING" data type are permitted.
3. Select the PLC data type in the project tree and select the "Compile > Software (only changes)" command from the shortcut menu.  
The PLC data type is compiled and can then be used in the PLC tag table.  
Even when you make changes to existing PLC data types, you must recompile the program.  
This updates all locations of use of the PLC data type.
4. Open a PLC tag table within the same CPU.
5. Declare a new tag or select an existing tag.
6. In the "Data type" column, select the PLC data type and assign it to the PLC tag.  
The PLC tag receives the structure of the PLC data type. A suitable address is assigned automatically. Structured PLC tags always start at word addresses.  
The highest structure element is displayed without its subelements in the table.

---

**Note****Assignment rules and default values**

- For the declaration of the PLC data type, note that the memory areas of the individual tags must not overlap. For example, tags of data type "Integer" must start at a word limit. If necessary, insert "fill tags" to prevent overlaps.  
See also: Permissible addresses and data types of PLC tags (Page 1176)
  - It is not possible to assign default values for the individual components. Values that you enter in the "Default value" column are not evaluated. Tags of data types "DT" and "DTL" may therefore contain invalid values.
- 

**See also**

Other useful information regarding structured PLC tags (Page 1184)

**9.1.2.7 Declaring symbolic constants****Rules for symbolic constants****Permissible characters**

Names of symbol constants may consist of the following characters:

- Letters, numbers, special characters are permitted.
- Quotation marks are not permitted.

**Unique constant names**

The names of the symbolic constants must be unique throughout the CPU, even if the constants are located in different tag tables of a CPU. A name that is already used for a block, a PLC tag or another constant within the CPU, cannot be used for new constant. The uniqueness check does not differentiate between use of small and capital letters.

If you enter an already assigned name another time, a sequential number is automatically appended to the second name entered. For example, if you enter the name "Motor" a second time, the second entry is changed to "Motor(1)".

**Permissible data types**

For constants, all data types supported by the CPU are permitted, with the exception of structured data types.

**Permitted values**

You can select any value from the value range of the specified data type as constant value. For information on the value ranges, refer to the "Data types" chapter.

See also: Auto-Hotspot

## See also

Constants (Page 1051)

Declaring constants (Page 1188)

## Declaring constants

### Introduction

You declare constants in the "User constants" tab of a PLC tag table. During declaration you have to enter a symbolic name, a data type and a fixed value for each constant. The entry format and the value range of the constant value depend on the data type of the constant.

See also: Auto-Hotspot

### Procedure

To declare constants, follow these steps:

1. Open a PLC tag table.
2. Open the "User constants" tab.  
The constants table opens.
3. Enter a constant name in the "Name" column.
4. Enter the required data type in the "Data type" column. You will be supported by autocompletion during input.
5. Enter a constant value in the "Value" column; this constant value must be valid for the selected data type.
6. If you want, enter comments on the constants in the "Comments" column. The entry of a comment is optional.
7. If you want to declare additional constants, place the cursor in the next row and repeat steps 3 to 6.

### Syntax check

A syntax check is performed automatically after each entry, and any errors found are displayed in red. You do not have to correct these errors immediately - you can continue editing and make any corrections later. As long as the tag declaration contains syntax errors and the constant is used in the program, you will not be able to compile the program.

## See also

Opening the PLC tag table (Page 1180)  
Inserting a table row in the PLC tag table (Page 1192)  
Structure of the PLC tag tables (Page 1173)  
Rules for symbolic constants (Page 1187)  
Editing tables (Page 242)

### 9.1.2.8 Editing properties

#### Editing the properties of PLC tags

#### Properties of PLC tags

#### Overview

The following table provides an overview of the properties of PLC tags. The display of properties may vary depending on the CPU type.

Group	Property	Description
General	Name	A unique name within the CPU.
	Data type	Data type of the tags.
	Address	Tag address.
	Retain	Shows whether the tag is in the retentive memory area.
	Comment	Comment on the tag.
History	Date created	Time when the tag was created (cannot be changed).
	Last modified	Time when the tag was last changed (cannot be changed).
Usage	Visible in HMI	Shows whether the tag is visible by default in the HMI selection list.
	Accessible from HMI	Shows whether HMI can access this tag during runtime.

## See also

Editing the properties of PLC tags (Page 1190)

## Editing the properties of PLC tags

### Editing properties in a PLC tag table

To edit the properties of one or more tags, follow these steps:

1. In the project tree, double-click the PLC tag table that contains the tags.  
The PLC tag table opens.
2. Change the entries in the columns.

### Editing addresses in the program editor

To edit the address of a tag in the program editor, follow these steps:

1. Select the tag name.
2. Select the "Rewire tag" command in the shortcut menu.  
The "Rewire tag" dialog will open. The dialog shows a declaration table.
3. Enter the new address in the "Address" column.
4. Click the "Change" button to confirm the input.

### Editing names in the program editor

To edit the name of a tag in the program editor, follow these steps:

1. Select the tag name.
2. Select the "Rename tag" command in the shortcut menu.  
The "Rename tag" dialog opens. The dialog shows a declaration table.
3. Enter the new name in the "Name" column.
4. Click the "Change" button to confirm the input.

### Effect in the program

In the case of a change of the tag's name, data type or address, each location of use of the tag is automatically updated in the program.

### See also

Properties of PLC tags (Page 1189)

## Editing the properties of symbolic constants

### Properties of constants

#### Overview

The following table gives an overview of the properties of constants:

Group	Property	Description
General	Name	A unique name within the table
	Data type	Data type of the constants
	Value	Value that you defined for the constants. This value must be compatible with the declared data type. See also: Auto-Hotspot
	Comment	Comment on the constants
History	Date created	Time when the constant was created (cannot be changed)
	Last modified	Time when the constant was last changed (cannot be changed)

### Editing properties of constants

#### Editing properties in a PLC tag table

To edit the properties of one or more constants, follow these steps:

1. In the project tree, double-click the PLC tag table that contains the constants.  
The PLC tag table opens.
2. Open the "User constants" tab.
3. Change the entries in the "Name", "Data type", "Value", or "Comments" column.

#### Effect in the program

In the case of a change of a constant's name, data type or value, each location of use of the constant is automatically updated in the program.

#### See also

Editing tables (Page 242)

### 9.1.2.9 Monitoring of PLC tags

#### Monitoring of PLC tags

You can monitor the current data values of the tags on the CPU directly in the PLC tag table.

#### Requirements

An online connection to the CPU is available.

#### Procedure

To monitor the data values, proceed as follows:

1. Open a PLC tag table.
2. Start monitoring by clicking the "Monitor all" button.  
The additional "Monitor value" column is displayed in the table. This shows the current data values.
3. End the monitoring by clicking the "Monitor all" button again.

---

#### Note

You also have the option of copying PLC tags to a monitor or force table so that you can monitor, control or force them in the table.

---

#### See also

Structure of the PLC tag tables (Page 1173)

Introduction to testing with the watch table (Page 1499)

Introduction for testing with the force table (Page 1524)

Copying entries in the PLC tag table (Page 1193)

### 9.1.2.10 Editing PLC tag tables

#### Inserting a table row in the PLC tag table

#### Procedure

Proceed as follows to insert a row above the selected row:

1. Select the row in front of which you want to insert a new row.
2. Click the "Insert row" button on the toolbar of the table.



## Result

A new row is inserted above the selected row.

## See also

Editing tables (Page 242)

## Copying entries in the PLC tag table

You can copy PLC tags within a table or to other tables.

## Procedure

To copy a tag, follow these steps:

1. Select the tags you want to copy.  
You can also select several tags by clicking on them one after the other while holding down the <Ctrl> key or by pressing and holding down <Shift> and clicking on the first and last tag.
2. Select "Copy" in the shortcut menu.
3. Position the insertion pointer at the location where you want to insert the tags.
4. Select "Paste" in the shortcut menu.

Or

1. Select the tag.
2. Hold down the left mouse button.
3. At the same time, press <Ctrl>.
4. Drag the tag to the destination.

## Result

- The tag is copied to the destination.
- If there is a name conflict, a number is automatically appended to the tag name. For example, "Tag" becomes "Tag(1)".
- All other properties of the tag remain unchanged.

## See also

Editing tables (Page 242)

## Deleting entries in the PLC tag table

### Procedure

To delete a tag, follow these steps:

1. Select the row with the tag to be deleted. You can also select several rows by clicking on them one after the other while holding down the <Ctrl> key or by pressing and holding down <Shift> and clicking on the first and last row.
2. Select the "Delete" command in the shortcut menu.

### See also

Editing tables (Page 242)

## Sorting rows in the PLC tag tables

You can sort the rows in the tables alphanumerically by name, data type, or address.

### Procedure

To sort the table rows, follow these steps:

1. Select the column by which you want to sort.
2. Click the column header.  
The column will be sorted in order of increasing values.  
An up arrow shows the sort sequence.
3. In order to change the sort sequence, click the arrow.  
The column will be sorted in order of decreasing values. A down arrow shows the sort sequence.
4. To restore the original sequence, click a third time on the column header.

### See also

Editing tables (Page 242)

## Automatically filling in cells in the PLC tag table

You can load the contents of one or several table cells into the cells below, automatically filling in the successive cells.

If you automatically fill in cells in the "Name" column, a consecutive number will be appended to each name. For example, "Motor" will become "Motor\_1".

If you fill the cells in the column "Address" automatically, the addresses will be increased depending on the indicated data type.

## Procedure

To automatically fill in successive cells, follow these steps:

1. Select the cells to be loaded.
2. Click the "Fill" symbol in the bottom right corner of the cell.  
The mouse pointer is transformed into a crosshair.
3. Keep the mouse button pressed and drag the mouse pointer downwards over the cells that you want to fill in automatically.
4. Release the mouse button.  
The cells are filled in automatically. If entries are already present in the cells that are to be automatically updated, a dialog appears in which you can indicate whether you want to overwrite the existing entries or whether you want to insert new rows for the new tags.

## See also

Editing tables (Page 242)

## Show and hide table columns

You can show or hide the columns in a table as needed.

## Procedure

To show or hide table columns, follow these steps:

1. Click a column header.
2. Select the "Show/Hide" command in the shortcut menu.  
The selection of available columns is displayed.
3. To show a column, select the column's check box.
4. To hide a column, clear the column's check box.

## See also

Editing tables (Page 242)

## Editing PLC tags with external editors

To edit individual PLC tags in external editors outside the TIA portal, you can export or import these tags using copy and paste. However, you cannot copy structured tags to an editor.

## Requirement

A PLC tag table and an external editor are opened.

## Procedure

To export and import individual PLC tags, follow these steps:

1. Select one or more PLC tags.
2. Select "Copy" in the shortcut menu.
3. Switch to the external editor and paste the copied tags.
4. Edit the tags as required.
5. Copy the tags in the external editor.
6. Switch back to the PLC tag table.
7. Select "Paste" in the shortcut menu.

---

### Note

You also have the option of export or importing PLC tags as mass data.

See also: Importing and exporting (Page 1549)

---

## 9.1.3 Creating and managing blocks

### 9.1.3.1 Creating blocks

#### Block folder

#### Function

You can find a "Program blocks" folder in the project tree, in which you can create and manage the following blocks:

- Organization blocks (OB)
- Function blocks (FB)
- Functions (FCs)
- Data blocks (DB)

A "System blocks" subfolder containing another subfolder, "Program resources", is also created in the "Program blocks" folder the first time you drag an instruction to your program which is an internal system function block. The instance data block of the internal system function block is also pasted to the "Program resources" folder. You can move or copy such instance data blocks from the "Program resources" folder to any other folder and rename or delete them. You can also move your blocks into the "Program resources" folder. Blocks in the "Program resources" folder that are not required to run the user program are removed during the next compilation. If the "Program resources" folder contains no more blocks then it is also deleted with the "System blocks" folder.

A program cycle OB is automatically generated for each device and inserted in the "Program blocks" folder.

### See also

Creating functions and function blocks (Page 1198)

Creating data blocks (Page 1199)

Creating organization blocks (Page 1197)

Using blocks from libraries (Page 1200)

## Creating organization blocks

### Requirement

The "Program blocks" folder in the project tree is open.

### Procedure

To create an organization block, follow these steps:

1. Double-click the "Add new block" command.  
The "Add new block" dialog box opens.
2. Click the "Organization block (OB)" button.
3. Select the type of new organization block.
4. Enter a name for the new organization block.
5. Enter the properties of the new organization block.
6. To enter additional properties for the new organization block, click "Additional information".  
An area with further input fields is displayed.
7. Enter all the properties you require.
8. Activate the "Add new and open" check box if the organization block does not open as soon as it is created.
9. Confirm your entries with "OK".

### Result

The new organization block is created. You can find the organization block in the project tree in the "Program blocks" folder. You can assign additional parameters to some organization blocks in the inspector window or device view after they have been created. The organization block description will state whether the newly created organization block has additional parameters.

## See also

- Organization blocks (OB) (Page 1022)
- Block folder (Page 1196)
- Creating functions and function blocks (Page 1198)
- Creating data blocks (Page 1199)
- Using blocks from libraries (Page 1200)
- Entering a block title (Page 1206)
- Entering a block comment (Page 1207)

## Creating functions and function blocks

### Requirement

The "Program blocks" folder in the project tree is open.

### Procedure

To create a function (FC) or a function block (FB), follow these steps:

1. Double-click the "Add new block" command.  
The "Add new block" dialog box opens.
2. Click the "Function block (FB)" or "Function (FC)" button.
3. Enter a name for the new block.
4. Enter the properties of the new block.
5. To enter additional properties for the new block, click "Additional information".  
An area with further input fields is displayed.
6. Enter all the properties you require.
7. Activate the "Add new and open" check box if the block does not open as soon as it is created.
8. Confirm your entries with "OK".

### Result

The new block is created. You can find the block in the project tree in the "Program blocks" folder.

## See also

- Function blocks (FB) (Page 1023)
- Functions (FCs) (Page 1022)
- Basics of block access (Page 1027)
- Block folder (Page 1196)
- Creating organization blocks (Page 1197)
- Creating data blocks (Page 1199)
- Using blocks from libraries (Page 1200)
- Entering a block title (Page 1206)
- Entering a block comment (Page 1207)

## Creating data blocks

### Requirement

The "Program blocks" folder in the project tree is open.

### Procedure

To create a data block, follow these steps:

1. Double-click the "Add new block" command.  
The "Add new block" dialog box opens.
2. Click the "Data block (DB)" button.
3. Select the type of the data block. You have the following options available to you:
  - To create a global data block, select the list entry "Global DB".
  - To create an ARRAY data block, select the "ARRAY DB" entry in the list.
  - To create an instance data block, select the function block to which you want to assign the instance data block from the list. The list contains only the function blocks that were previously created for the CPU.
  - To create a data block based on a PLC data type, select the PLC data type from the list. The list contains only the PLC data types that were previously created for the CPU.
  - To create a data block based on a system data type, select the system data type from the list. The list contains only those system data types that have already been inserted to program blocks in the CPU.
4. Enter a name for the data block.
5. Enter the properties of the new data block.
6. If you have selected an ARRAY DB as the data block type, enter the ARRAY data type and the high limit for the ARRAY.  
You can change the high limit for the ARRAY at any time in the property window of the created block. The ARRAY data type cannot be changed subsequently.

### 9.1 Creating a user program

7. To enter additional properties of the new data block, click "Additional information". An area with further input fields is displayed.
8. Enter all the properties you require.
9. Activate the "Add new and open" check box if the block does not open as soon as it is created.
10. Confirm your entry with "OK".

#### Result

The new data block is created. You can find the data block in the project tree in the "Program blocks" folder.

#### See also

- Global data blocks (DB) (Page 1024)
- Instance data blocks (Page 1025)
- Block folder (Page 1196)
- Creating organization blocks (Page 1197)
- Creating functions and function blocks (Page 1198)
- Using blocks from libraries (Page 1200)
- Basics of block access (Page 1027)
- System data types (Page 1119)

#### Using blocks from libraries

You can save blocks in the project library or in a global library, so that you can use them more than once within a user program. You can insert the blocks as master copies or as types.

See also: Library basics (Page 338)

#### Requirement

- The "Libraries" task card is displayed.
- No write protection is set for global libraries.

#### Adding blocks as master copies to the project library or to a global library

To add new blocks as master copies to the project library or to a global library, follow these steps:

1. Maximize the project library or the global library.
2. Use drag-and-drop to move the block you wish to add to the library to the "Master copies" folder or any one of the "Master copies" subfolders in the project library or a global library. Do not release the left mouse button until a small plus sign appears underneath the mouse pointer.



Or:

1. Copy the element you want to add as master copy.
2. Maximize the project library or the global library.
3. Right-click the "Master copies" folder or any of its subfolders.
4. Select "Paste" in the shortcut menu.

### **Adding blocks as types to the project library or to a global library**

To add new blocks as types to the project library or to a global library, follow these steps:

1. Maximize the project library or the global library.
2. Drag-and-drop the element you want to add as a type into the "Types" folder or any of its subfolders in the project library or a global library. Do not release the left mouse button until a small plus sign appears underneath the mouse pointer.

Or:

1. Copy the element you want to add as a type.
2. Maximize the project library or the global library.
3. Right-click the "Types" folder or any of its subfolders.
4. Select "Paste" in the shortcut menu.

### **Using blocks of the project library or a global library**

To use a block from the project library or a global library in your project, follow these steps:

1. Maximize the project library or the global library so that you can see the block you wish to use.
2. Use a drag-and-drop operation to move the block to the CPU block folder. If the selected insertion points is not allowed, the mouse pointer will appear as a circle with a slash.

---

#### **Note**

If you derive an instance from a type in a global library, the type is also inserted into the project library. The instance is then only linked to the type in the project library.

---

### **See also**

Using libraries (Page 338)

## Copying and pasting blocks

### Basics of copying and pasting blocks

#### Function

You can also create new blocks by copying existing blocks and pasting the copy. Note the following principles when copying to CPUs of the same device family:

- You can copy organization blocks (OBs), functions (FCs), function blocks (FBs), and global data blocks (DBs) without restriction.
- You can copy instance data blocks only for the same function block, since the assignment to the function block cannot be changed afterwards. However, the assignment is canceled if you copy the instance data block to a different CPU. If a function block with the same name exists there, the instance data block will be assigned to this function block. If you copy the instance data block together with the function block into the other CPU, the instance data block is assigned to the copy of the function block.

The various device families sometimes support different blocks, especially in the case of organization blocks. However, function blocks and functions can also be programmed on the various devices with different access types. Therefore, not all blocks are supported on all devices. Note the following principles when copying to a different device family:

- Copying to an S7-1200 CPU:
  - Organization blocks with "Optimized" access type can be copied to an S7-1200. If the copied OB type is supported by the S7-1200 CPU, the copied OB retains the properties of its event. You must, however, compile it again.
  - Although organization blocks with the "Standard" access type can be copied to an S7-1200, they are not supported by the CPU.
  - Function blocks (FBs), functions (FCs) and global data blocks (DBs) with "Optimized" access type can be copied to an S7-1200. However, they must be recompiled after this.
  - Although function blocks (FBs), functions (FCs) and global data blocks (DBs) with "Standard" access type can be copied to an S7-1200, they are not supported by the CPU.
  - Instance data blocks: If there is a function block in the target CPU with the name that was assigned to the instance data block in the source CPU, the instance data block is assigned to the function block in the target CPU. If you copy the instance data block together with the function block to which it was assigned in the source CPU into the target CPU, the instance data block is assigned to the copy of the function block.
- Copying to an S7-1500 CPU:
  - Organization blocks with "Optimized" access type can be copied to an S7-1500. If the copied OB type is supported by the S7-1500 CPU, the copied OB retains the properties of its event. You must, however, compile it again. OB types that are not supported receive a no parking symbol.
  - Organization blocks with "Standard" access type can be copied to an S7-1500. If the OB derives from an S7-300/400 CPU, it receives the standard event of the corresponding OB type. If the OB derives from an S7-1200/1500 CPU, it receives the properties of its event. However, it must be compiled again.
  - Function blocks (FBs), functions (FCs) and global data blocks (DBs) with "Optimized" access type can be copied to an S7-1500. However, they must be recompiled after this.
  - Although function blocks (FBs), functions (FCs) and global data blocks (DBs) with "Standard" access type can be copied to an S7-1500, they are not supported by the CPU.
  - Instance data blocks: If there is a function block in the target CPU with the name that was assigned to the instance data block in the source CPU, the instance data block is assigned to the function block in the target CPU. If you copy the instance data block

together with the function block to which it was assigned in the source CPU into the target CPU, the instance data block is assigned to the copy of the function block.

- Copying to S7-300/400 CPUs:
  - Organization blocks can be copied as required between S7-300 and S7-400.
  - Although organization blocks from S7-1200/1500 CPUs can be copied to S7-300/400 CPUs, they are not supported by the target CPU.
  - Function blocks (FBs), functions (FCs) and global data blocks (DBs) can be copied as required between S7-300 and S7-400.
  - Although function blocks (FBs), functions (FCs) and global data blocks (DBs) can be copied from S7-1200/1500 CPUs to S7-300/400 CPUs, they are not supported by the target CPU.
  - Instance data blocks: If there is a function block in the target CPU with the name that was assigned to the instance data block in the source CPU, the instance data block is assigned to the function block in the target CPU. If you copy the instance data block together with the function block to which it was assigned in the source CPU into the target CPU, the instance data block is assigned to the copy of the function block.

In the project tree, blocks that are not supported are indicated by the no parking symbol. Blocks with a no parking symbol cannot be edited, but only used again as copy source.

## Copying data

With paste, all the block data is copied and forwarded to the copy. This data includes:

- Block interface tags
- All networks
- Comments in all existing compilations
- Messages defined in the block
- The entire program code of the copied block including the call instructions contained in the block.

However, called blocks and their associated instance data blocks are not copied.

## Avoiding name conflicts during pasting

When pasting copied blocks with identical names to already existing blocks, the following mechanisms are used to avoid name conflicts:

- Pasting the copied block into the same CPU:  
The copy of the block gets a name that is extended by a number. For example, if block "A" is copied, a possible name for the copy is "A\_1". Consecutive numbering is not used, but rather the smallest free number. The copy of block "A" can also get the name "A\_25", if no lower number is available.
- Pasting the copied block into another CPU:  
A dialog box opens in which you can select whether the block with the same name will be replaced or the copied block will be pasted with a duplicate designation (Name\_Number).

---

**Note****Number conflicts**

Number conflicts may occur, if the pasted block has the same block number as an existing block. The block number is not automatically changed during pasting. This double number may have an effect on block calls. When you copy blocks you should therefore check the block number carefully and correct duplicate block numbers manually or using the block properties. Duplicate block numbers lead to a compilation error.

---

**See also**

Copying blocks (Page 1205)

Pasting blocks (Page 1205)

**Copying blocks****Requirement**

The "Program blocks" folder is opened in the project tree.

**Procedure**

To copy a block, follow these steps:

1. Right-click the block that you want to copy.
2. Select "Copy" in the shortcut menu.

**Result**

A copy of the block is now on the clipboard and can be pasted either into the same CPU or into another one.

**See also**

Basics of copying and pasting blocks (Page 1202)

Pasting blocks (Page 1205)

**Pasting blocks****Requirement**

You have copied a block.

## Procedure

To paste a copied block and its data into a CPU, follow these steps:

1. In the project tree, open the folder structure for the CPU into which you want to paste the copied block.

---

### Note

Please note that you can only paste the copied block into a CPU which supports the block programming language and type.

---

2. Right-click on the "Program blocks" folder.
3. Select "Paste" in the shortcut menu.
  - If you are pasting the block into the same CPU as the original block, "\_<consecutive number>" will be appended to the name of the copy.
  - If you are pasting the block into a different CPU where a block of the same name already exists, the "Paste" dialog box opens. Select the required option and confirm with "OK".

## See also

Basics of copying and pasting blocks (Page 1202)

Copying blocks (Page 1205)

## Entering a block title

The block title is the title of the block. It is not the same thing as the block name, which was assigned when the block was created. The length of the block title is restricted to one row. You can enter the block title for open and closed blocks.

## Requirement

A code block is available.

## Enter block title for open block

To insert the block title in an open block, follow these steps:

1. Click on the title bar of the block in the program editor.
2. Enter the block title.

## Enter block title for closed blocks

To insert the block title in a closed block, follow these steps:

1. Right-click the block in the project tree.
2. Select the "Properties" command in the shortcut menu.  
The dialog with the properties of the block opens.

3. Select the entry "Information" in the area navigation.
4. Enter the block title in the "Title" input field.
5. Confirm your entry with "OK".

### See also

- Creating organization blocks (Page 1197)
- Creating functions and function blocks (Page 1198)
- Entering a block comment (Page 1207)

### Entering a block comment

You can use the block comment to document the entire code block. For example, you can indicate the purpose of the block or draw attention to special characteristics. You can enter the block comment for open and closed blocks.

### Requirement

A code block is available.

### Enter block comment for open blocks

To insert a block comment in an open block, proceed as follows:

1. Click the small arrow in front of the block title.  
The right arrow becomes a down arrow, and the comment area is displayed.
2. Click "Comment" in the comment area.  
The "Comment" text passage is selected.
3. Enter the block comment.

### Enter block comments for closed blocks

To insert the block comment in a closed block, follow these steps:

1. Right-click the block in the project tree.
2. Select the "Properties" command in the shortcut menu.  
The dialog with the properties of the block opens.
3. Select the entry "Information" in the area navigation.
4. Enter the block comment in the "Comment" input field.
5. Confirm your entry with "OK".

**See also**

- Creating organization blocks (Page 1197)
- Creating functions and function blocks (Page 1198)
- Entering a block title (Page 1206)

**9.1.3.2 Specifying block properties**

**Basics of block properties**

**Block properties**

Each block has certain properties, which you can display and edit. These properties are used amongst other things to:

- Identify the block
- Display the memory requirements and the compilation status of the block
- Display the time stamp
- Display the reference information
- Specify the access protection

**See also**

- Overview of block properties (Page 1208)
- Block time stamps (Page 1211)
- Displaying and editing block properties (Page 1213)
- Setting the mnemonics (Page 1229)

**Overview of block properties**

**Overview**

The properties of the blocks are block and CPU-specific. Not all properties are therefore available for all blocks or in all CPU families. The following table gives an overview of block properties:

Group	Property	Description
General	Name	Unique block name within the station
	Constant name	Name of the constant pasted for the OB in the PLC tag table
	Type	Block type (cannot be changed)
	Number	Block number
	Event class	Event class of an OB (cannot be changed)



Group	Property	Description
	Language	Programming language of the block
	Language in networks	Language used to program conditions in GRAPH blocks.
	Process image partition number	Display of the process image partitions that are assigned to the organization block (cannot be changed)
	ARRAY data type	Data type of an ARRAY data block (cannot be changed)
	ARRAY limit	High limit of an ARRAY data block The "Move operations" section of the "Instructions" task card offers options for addressing of ARRAY data blocks.
Information	Title	Block title
	Comment	Block comment
	Version	Version number of the block
	Family	Block family name
	Author	Name of the author, company name, department name, or other names
	User-defined ID	ID created by the user
Time stamps	Block	Times of creation and time of change of the block (cannot be changed)
	Interface	Time of creation of the block interface (cannot be changed)
	Code	Code modification time (non-editable)
	Data	Data modification time (non-editable)
Compilation	Status	Details of the last compilation run (cannot be changed)
	Lengths	Details of the block lengths (cannot be changed)
Protection	Protection	Setting up know-how protection and copy protection for the block See also: Protecting blocks
Attributes	Optimized block access	The tag declaration for blocks with optimized access contains only the symbolic names of the data elements. The system automatically optimizes and manages the addresses. The CPU performance increases and access errors, for example, from SIMATIC HMI, are prevented. See also: Auto-Hotspot
	IEC check	The compatibility of the operands in comparison operations and arithmetic operations are tested according to IEC 61131. You have to explicitly convert non-compatible operands. See also: Overview of data type conversion (Page 1123)
	Handle errors within block	Troubleshooting inside the block with the GET_ERROR or GET_ERR_ID instruction (cannot be changed). See also: Auto-Hotspot
	Create extended status information	Allows you to monitor all tags in an SCL block. This option does, however, increase the program memory space required and the execution times.
	Check ARRAY limits	Checks whether array indexes are within the range declared for an ARRAY during the runtime of an SCL block. The block enable output ENO is set to "0" if an array index is outside of the permitted range.
	Set ENO automatically	Checks whether errors occur in the processing of certain instructions during the runtime of an SCL block. The block enable output ENO is set to "0" if a runtime error occurs.

9.1 Creating a user program

Group	Property	Description
	Create minimized DB	Creates instance data blocks for GRAPH blocks of the S7-300 and S7-400 in minimized format. This option reduces the GRAPH FB memory space required, however you will only receive limited program status information.
	Skip steps	If the transitions before and after a step become valid simultaneously in a GRAPH block, the step will not be activated and will be skipped.
	Acknowledge supervision alarms	Any supervision error which occurs during the operation of a GRAPH block must be acknowledged before the program can continue.
	Permanent processing of all interlocks in manual mode	Permanently monitors all interlock conditions in a GRAPH block in manual mode.
	Lock operating mode selection	Prevents a GRAPH block operating mode being selected.
	Data block write-protected in the device	Indicates whether the data block is read-only in the target system, and cannot be overwritten while the program is running (for data blocks only)
	Only store in load memory	On activation the data block is stored only in the load memory, occupies no space in the work memory, and is not linked into the program. The "Move operations" section of the "Instructions" task card offers options for transferring data blocks to the work memory (for data blocks only).
	Start information	Here you specify the structure of the start information of the OB for S7-1500 CPUs: either like for S7-300 and S7-400 CPUs or optimized start information.
	Priority	Shows the priority set for organization blocks. The CPU family used and the type of the organization block determine whether you can change the priority.
	Parameter assignment by means of registers	Enables parameter input by means of registers in an STL block of S7-1500. This feature allows you to use the "Conditional call of blocks" (CC) and "Unconditional call of blocks" (UC) instructions in the block.
	Block can be used as know-how protected library item	Shows whether or not the block in the library can be used with know-how protection.
	Enable readback	Enables you to mark individual parameters of the block for readback. The "Tag readback" function is relevant if the block is used in a CFC chart.
	Block representation	Specifies how the block is represented in a CFC chart.
Time-of-day interrupt	Time-of-day interrupt	Parameters of the time-of-day interrupt OB: active (yes or no), execution, start date and time, local time or system time
Cyclic interrupt	Cyclic interrupt	Cycle time and phase shift of the cyclic interrupt OB
Triggers	Triggers	Display of start events of the hardware interrupt OB
Isochronous mode	Isochronous mode	Parameters of the isochronous mode interrupt OB: application cycles, automatic setting (yes or no), delay time. Also indicated is the PROFINET IO system or DP master system whose IO devices or DP slaves are assigned to the isochronous mode interrupt OB.
Download without re-initialization	Reserve in volatile memory	Defines the reserve in volatile memory that can be used for interface extensions. The number of currently available bytes is displayed in parentheses. This information is updated with each compilation.

Group	Property	Description
	Activate download without re-initialization for retentive tags	Enables definition of a reserve in retentive memory.
	Reserve in retentive memory	Defines the reserve in retentive memory that can be used for interface extensions. The number of currently available bytes is displayed in parentheses. This information is updated with each compilation.

## See also

- Basics of block properties (Page 1208)
- Block time stamps (Page 1211)
- Displaying and editing block properties (Page 1213)
- Basics of block access (Page 1027)

## Block time stamps

### Introduction

Blocks receive a number of different time stamps which show you when the block was created and when it was last changed. These time stamps are also used for automatic consistency checks before compilation.

### Code block time stamps

The following time stamps are generated for code blocks (OBs, FBs, FCs):

- Block: Created on, Modified on
- Interface: Modified on
- Code/data: Modified on

A time stamp conflict is displayed during compilation if the time stamp for the block calling is older than that of the interface for the block called.

Time stamps for code blocks are updated as follows:

- Block: The time stamp for the last block modification is always the same as the time stamp either of the interface or of the code depending on which area was modified last.
- Interface: The interface time stamp is updated each time the interface is modified. Even if you manually undo a change to the interface, for example change the name back, that is also a change which updates the time stamp. However, if you undo the change using the "Undo" function, the time stamp will be reset to the value it had before the undone change.
- Code/data: The code time stamp is updated each time the block code is changed. Even if you manually undo a change to the code, for example remove an instruction, that is also a change which will update the time stamp. However, if you undo the change using the "Undo" function, the time stamp will be reset to the value it had before the undone change.

### Global data block time stamps

The following time stamps are generated for global data blocks:

- Block: Created on, Modified on
- Interface: Modified on
- Data: Modified on

Time stamp conflict is reported during compilation of a global data block based on a PLC data type if the time stamp of the global data block is older than the time stamp of the PLC data type used.

The time stamps for global data blocks are updated as follows:

- Block: The time stamp for the last change to a global data block is always the same as the time stamp for the interface and the data.
- Interface and data: The interface time stamps and the data are updated each time the global data block is changed. Even if you manually undo a change, for example remove a tag, that is also a change which will update the time stamp. However, if you undo the change using the "Undo" function, the time stamps will be reset to the value they had before the undone change.

### Instance data block time stamps

The following time stamps are generated for instance data blocks:

- Block: Created on, Modified on
- Interface: Modified on
- Data: Modified on

A time stamp conflict will be reported during compilation of an instance data block if the interface time stamps of the instance data block are not identical to those of the function block.

The time stamps for instance data blocks are updated as follows:

- Block: The time stamp for the last change to an instance data block is always the same as the time stamp for the interface and the data.
- Interface and data: The interface time stamps and the data are updated each time the instance data block is changed. Even if you manually undo a change, for example cancel the tag retain setting, that is also a change which will update the time stamps. However, if you undo the change using the "Undo" function, the time stamps will be reset to the value they had before the undone change.

### PLC data type time stamps

The following time stamps are generated for PLC data types:

- Block: Created on, Modified on
- Interface: Modified on

The time stamps for PLC data types are updated as follows:

- **Block:** The time stamp for the last change to a PLC data type is always the same as the interface time stamp.
- **Interface:** The interface time stamp is updated each time the PLC data type is changed. Even if you manually undo a change, for example delete the content of a PLC data type, that is also a change which will update the time stamp. However, if you undo the change using the "Undo" function, the time stamp will be reset to the value it had before the undone change.

## See also

- Basics of block properties (Page 1208)
- Overview of block properties (Page 1208)
- Displaying and editing block properties (Page 1213)
- Basic information on compiling blocks (Page 1438)

## Displaying and editing block properties

The properties of the blocks are block and CPU-specific. Not all properties are therefore available for all blocks or in all CPU families. Properties that can only be displayed are write-protected.

### Displaying and editing properties of a closed block

To display and edit the properties of a closed block, follow these steps:

1. Open the "Program blocks" folder in the project tree.
2. Right-click the block whose properties you want to display or edit.
3. Select the "Properties" command in the shortcut menu.  
The properties dialog box of the block opens.
4. In the area navigation, click a group whose properties you want to display or edit.
5. Change the relevant property.
6. Confirm your entries with "OK".

### Displaying and editing properties of an open block

To display or edit the properties of an open block, follow these steps:

1. Select the "Inspector window" check box in the "View" menu.  
The Inspector window opens.
2. Click the "Properties" tab.  
The properties of the block are shown in the "Properties" tab of the Inspector window.
3. In the area navigation, click a group whose properties you want to display or edit.
4. Change the relevant property.

## Result

The properties of the block will be changed. The changes are not saved until the project is saved.

## See also

Basics of block properties (Page 1208)

Overview of block properties (Page 1208)

Block time stamps (Page 1211)

### 9.1.3.3 Managing blocks

#### Opening blocks

You can open a block in several different ways:

- **Open block directly**  
You can open a block directly if the corresponding block folder is open in the project tree or in the overview window.
- **Find and open block**  
You can look for blocks within a project, a device or the "Program blocks" folder and then open them.

#### Open block directly

To open a block directly, follow these steps:

1. Open the folder with the block you wish to open in the project tree or in the overview window.
2. Double-click on the block you wish to open.

#### Find and open block

To find and then open a block, follow these steps:

1. Right-click on the project, a device, the "Program blocks" folder or a lower-level folder of "Program blocks" in the project tree.
2. Select the "Search in PLC and open" command from the shortcut menu.  
The "Search in PLC and open" dialog box is displayed.
3. Enter the name, the address or the type of block you are looking for.  
The block list is filtered further with each letter entered. The block list is closed if there is no block that matches the input. You can show the complete block list at any time by clicking the button to the right of the text box. Keep in mind that there is no filtering in this case. If you want to filter for your inputs again, click the button once again.
4. In the block list, click the block you wish to open.

## Result

The block will open in the program editor.

## See also

Saving blocks (Page 1215)  
Closing blocks (Page 1215)  
Renaming blocks (Page 1216)  
Deleting blocks offline (Page 1217)  
Deleting blocks online (Page 1217)  
Opening know-how protected blocks (Page 1457)

## Saving blocks

Blocks are always saved together with the project. Faulty blocks can also be saved. This allows the error to be resolved at a convenient time.

## Procedure

To save a block, follow these steps:

1. Select the "Save" or "Save as" command in the "Project" menu.  
See also: Saving projects (Page 264)

## See also

Opening blocks (Page 1214)  
Closing blocks (Page 1215)  
Renaming blocks (Page 1216)  
Deleting blocks offline (Page 1217)  
Deleting blocks online (Page 1217)

## Closing blocks

## Procedure

To close a block, follow these steps:

1. Click the "Close" button in the title bar of the program editor.

---

### Note

Note that the block will not be saved on closing.

---

## See also

- Opening blocks (Page 1214)
- Saving blocks (Page 1215)
- Renaming blocks (Page 1216)
- Deleting blocks offline (Page 1217)
- Deleting blocks online (Page 1217)

## Renaming blocks

### Requirement

The "Program blocks" folder is opened in the project tree.

### Procedure

To change the name of a block, follow these steps:

1. Right-click the block that you want to rename.
2. Select the "Rename" command in the shortcut menu.  
The block name in the project tree changes to an input field.
3. Input the new name for the block.
4. Confirm your entry with the Enter key.

### Result

The name of the block is now changed at all points of use in the program.

## See also

- Opening blocks (Page 1214)
- Saving blocks (Page 1215)
- Closing blocks (Page 1215)
- Deleting blocks offline (Page 1217)
- Deleting blocks online (Page 1217)



## Deleting blocks offline

### Requirement

The "Program blocks" folder opens in the project tree.

### Procedure

To delete a block that exists offline, proceed as follows:

1. In the project tree in the "Program blocks" folder, right-click on the block that you want to delete.
2. Select the "Delete" command in the shortcut menu.
3. Confirm the safety prompt with "Yes".  
The block is deleted offline from the project.

---

### Note

If you are deleting organization blocks, note that events may be assigned to these blocks. If you delete such organization block the program cannot respond to parameterized events.

---

### See also

Opening blocks (Page 1214)

Saving blocks (Page 1215)

Closing blocks (Page 1215)

Renaming blocks (Page 1216)

Deleting blocks online (Page 1217)

## Deleting blocks online

### Requirement

The "Program blocks" folder in the project tree is open.

### Procedure

To delete a block that exists online, follow these steps:

1. In the "Program blocks" folder in the project tree, right-click on the block that you wish to delete from the device.
2. Select the "Delete" command from the shortcut menu.  
The "Delete" dialog opens.

## 9.1 Creating a user program

3. Select the "Delete from device" check box.
4. Click "Yes".  
The block will be deleted from the device online.

### See also

- Opening blocks (Page 1214)
- Saving blocks (Page 1215)
- Closing blocks (Page 1215)
- Renaming blocks (Page 1216)
- Deleting blocks offline (Page 1217)

### Deleting CPU data blocks

You may delete CPU data blocks both in offline and online mode.

#### Deleting CPU data blocks in offline mode

Proceed as follows to delete a CPU data block from the offline project:

1. Right-click the CPU data blocks that you want to delete in the project navigation, "Program blocks" folder.
2. Select the "Delete" command from the shortcut menu.
3. Confirm the safety prompt with "Yes".  
The CPU data block is deleted from the offline project.

#### Deleting CPU data blocks in online mode

Proceed as follows to delete a CPU data block from the online project:

1. Establish an online connection to the device containing the CPU data block that you want to delete.
2. Right-click the CPU data block that you want to delete from the device in the project navigation, "Program blocks" folder.
3. Select the "Delete" command from the shortcut menu.  
The "Delete" dialog opens.
4. Select the "Delete from device" check box.
5. Click "Yes".  
The CPU data block is deleted from the online device.

### See also

- CPU data blocks (Page 1026)

## **9.1.4 Programming blocks**

### **9.1.4.1 Program editor**

#### **Overview of the program editor**

#### **Function of the program editor**

The program editor is the integrated development environment for programming functions, function blocks, and organization blocks. It offers comprehensive support for programming and troubleshooting.

The appearance and functionality of the program editor can vary depending on the CPU, programming language and block type used.

### Structure of the program editor

Using LAD as an example, the following figure shows the components of the program editor:

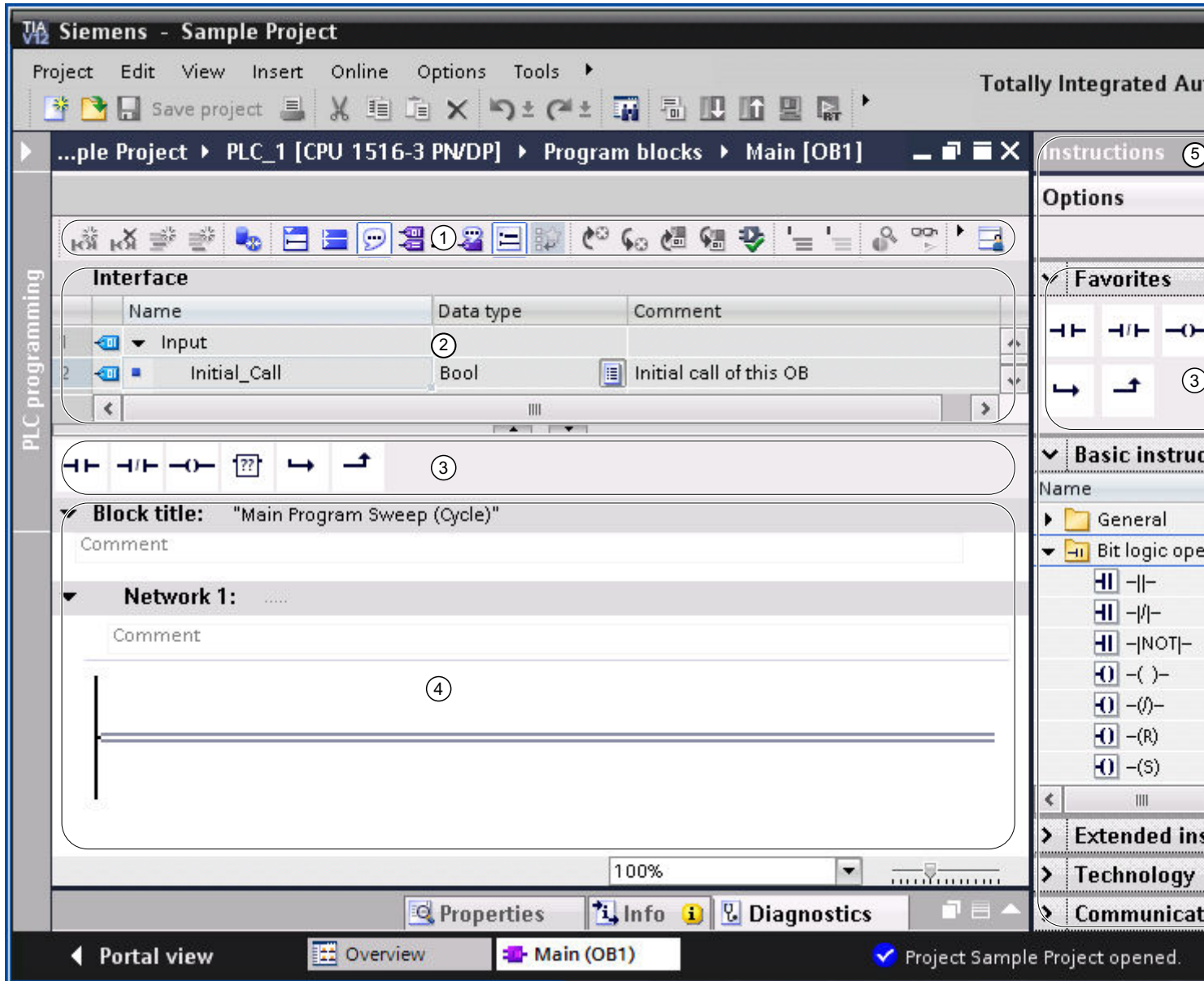

- ① Toolbar
- ② Block interface
- ③ "Favorites" pane in the "Instructions" task card and favorites in the program editor
- ④ Programming window
- ⑤ "Instructions" task card
- ⑥ "Testing" task card

## Toolbar

The toolbar allows you to access the principal functions of the program editor, such as:

- Show and hide absolute operands
- Showing and hiding favorites
- Skip to syntax errors
- Update block calls
- Show and hide program status

The functions available in the toolbar can vary depending on the programming language used.

## Block interface

The block interface contains the declarations for local tags used solely within the block. The sections available depend on the block type.

## Favorites

You can save frequently used instructions as favorites. These favorites are then displayed in the "Instructions" task card and the "Favorites" pane. You can also display favorites in the program editor using the program editor toolbar. This allows you to access your favorites even when the "Instructions" task card is not visible.

## Programming window

The programming window is the work area of the program editor. You can enter the program code in this window. The appearance and functionality of the program window can vary depending on the programming language used.

## "Instructions" task card

The "Instructions" task card offers you easy access to all instructions available for creating your program. The instructions are broken down by area into a number of different palettes. You can show additional information on the instructions via the "Show column headers and additional columns" button in the task card toolbar. You can modify the arrangement of columns by clicking a column header and moving the column to the new position by means of drag-and-drop.

If an instruction profile is active, the offered instructions may vary.  
See also: Using instruction profiles

## "Testing" task card

You can set settings in the "Testing" task card for troubleshooting using the program status. The functions of the "Testing" task card are only available in online mode. It contains the

following panes, which are displayed depending on the selected CPU and the configured programming language of the block:

- CPU operator panel  
The CPU operator panel allows you to switch the CPU operating mode.
- Breakpoints  
You can test blocks you created in the textual programming languages STL and SCL in single step mode. To do this, set breakpoints in the program code.  
In the "Breakpoints" pane, you can find all breakpoints that you have set and you can activate, delete, navigate to, or set the call environment for the individual breakpoints.
- PLC register  
This pane allows you to read off the values for the PLC registers and the accumulators.
- Sequence control  
In this pane you can set the operating mode for testing sequencers for GRAPH blocks.
- Test settings  
This pane allows you to specify the test settings for the GRAPH block.
- Call environment  
This pane allows you to specify the call environment for the block.
- Call hierarchy  
In this pane, you can trace the call hierarchy of the blocks. You only see the call hierarchy during block monitoring.

**See also**

- Layout of the block interface (Page 1239)
- Enlarging the programming window (Page 1227)

**Using the keyboard in the program editor**

**Navigating in the editor**

Function	Shortcut key
Open "Instructions" task card	<Ctrl+Shift+C>
Open "Testing" task card	<Ctrl+Shift+O>
Add new block	<Ctrl+N>
Expand all networks	<Alt+F11>
Collapse all networks	<Alt+F12>
Navigate to the next point of use of the selected block or operand	<Ctrl+Shift+F>
Navigate to the previous point of use of the selected block or operand	<Ctrl+Shift+G>
Navigate to the next read/write access	<Alt+F8>
Navigate to the previous read/write access	<Alt+F9>

### Navigating in the program code (LAD/FBD)

Function	Selected object	Shortcut key
Navigating between objects in the network	Object in the network	Arrow keys
Navigate to the first element of the network	Object in the network	<Home>
Navigate to the last element of the network	Object in the network	<End>
Navigate to the next element of the network	Object in the network	<Tab>
Navigate to the previous element of the network	Object in the network	<Shift+Tab>
Insert network	Any	<Ctrl+R>

### Navigating in the program code (STL/SCL)

Function	Position of the cursor	Shortcut key
Navigating in the program code	Line	Arrow keys
One word to the right/left	Line	<Ctrl+arrow keys>
Cursor to start of line	Line	<Home>
Cursor to end of line	Line	<End>
Cursor to start of code section	Line	<Ctrl+Home>
Cursor to end of code section	Line	<Ctrl+End>
To the next network (STL only)	Network title	<Down arrow>
To the next network (STL only)	Line	<Tab> Repeat the shortcut keys until the insertion point is in the next network.
To the previous network (STL only)	Network title	<Up arrow>
To the previous network (STL only)	Line	<Shift+Tab> Repeat the shortcut keys until the insertion point is in the previous network.
Insert network	Any	<Ctrl+R>

### Inserting instructions (LAD)

Function	Selected object	Shortcut key
Insert normally open contact	Rung	<Shift+F2>
Insert normally closed contact	Rung	<Shift+F3>
Insert empty box	Rung	<Shift+F5>
Insert assignment	Rung	<Shift+F7>
"Insert "Open branch"	Rung	<Shift+F8>
"Insert "Close branch"	Rung	<Shift+F9>

**Inserting instructions (FBD)**

Function	Selected object	Shortcut key
Insert assignment	Network, input or output	<Shift+F7>
Insert empty box	Network	<Shift+F5>
"Insert "Open branch"	Connection line between two boxes	<Shift+F8>
Invert RLO	Network, input or output	<Ctrl+Shift+4>
Insert input	Network, input or output	<Ctrl+Shift+3>

**Entering operands (LAD/FBD/GRAPH)**

Function	Selected object	Shortcut key
Activate the input field for the first operand of the instruction	Instruction	<Return> Or <Any letters/numbers> An empty input field opens on <Return>, any letters or numbers will be entered in the input field.
Activate input field for the operand	Operand	<F2>
Delete operand	Operand	<Del>
Define tag	Operand	<Ctrl+Shift+I>
Rewire tag	Operand	<Ctrl+Shift+P>
Rename tag	Operand	<Ctrl+Shift+T>
Entering operands	Input field for operands	<Any letters/numbers>
Confirm entry of the operand	Input field for operands	<Return>
Open autocompletion	Input field for operands	<Ctrl+I>
Discard current change	Input field for operands	<Esc> The input field is deactivated and the previous contents restored.



## Process instructions (STL/SCL)

Function	Selected object	Shortcut key
Indent line (SCL only)	Line	<Tab> or <Ctrl+R>
Outdent line (SCL only)	Line	<Shift+Tab> or <Ctrl+Shift+R>
Open "Call options" dialog	Cursor after block call	<Return>
Define tag	Operand	<Ctrl+Shift+I>
Rewire tag	Operand	<CtrlShift+P>
Rename tag	Operand	<Ctrl+Shift+T>
Expand/collapse parameter list (SCL only)	Operand	<Ctrl+Shift+Space>
Expand/collapse code section	Insertion mark within the code section	<Ctrl+Shift+Num+> <Ctrl+Shift+Num->
Expand/collapse all code sections	Any	<Ctrl+Shift+Num*> <Ctrl+Shift+Num/>
Open autocompletion	Any	<Ctrl+I> or <Ctrl+Spacebar>
Set/delete bookmarks		<Ctrl+Shift+M>
To the next bookmark		<Ctrl+Shift+6>
To the previous bookmark		<Ctrl+Shift+5>
Disable code	Line	<Ctrl+Shift+Y>
Enable code	Line	<Ctrl+Shift+U>

## Programming window of GRAPH

Function	Area	Shortcut key
Page Up/Down	Navigation view, single step view, sequence view, permanent instructions	<Page Up>/ <Page Down>
Navigate in the navigation view	Navigation view	<Up arrow> <Down arrow>
Expand/collapse object	Navigation view	<+> or <Right arrow> <-> or <Left arrow>
Switch between single step view and sequence view when a step or a transition is selected	Navigation view	<Return>
Switch between navigation view and work area	Navigation view, single step view, sequence view, permanent instructions	<ALT+F6>
Go to first element in a network	Single step view	<Home>

9.1 Creating a user program

Function	Area	Shortcut key
Go to last element in a network	Single step view	<End>
Switch to interlock	Single step view	<Ctrl+Home>
Switch to transition	Single step view	<Ctrl+End>
Navigate in the structure	Sequence view	Arrow keys
Go to first step	Sequence view	<Home> or <Ctrl+Home>
Go to last step	Sequence view	<End> or <Ctrl+End>
Open branch	Sequence view	<Shift+F8>
Close branch	Sequence view	<Shift+F9>
Insert sequence end	Sequence view	<Shift+F7>
Insert jump	Sequence view	<Shift+F12>
Insert step and transition	Sequence view	<Shift+F5>
Delete element	Sequence view	<Del>
Go to first editable element	Permanent instructions	<Home>
Go to next editable element	Permanent instructions	<Tab>
Go to last editable element	Permanent instructions	<End>
Go to previous editable element	Permanent instructions	<Shift+Tab>
Jump to the start of the "Action" cell	Actions	<Home>
Jump to the end of the "Action" cell	Actions	<End>
Insert new action	Actions	<Return>

Monitor program

Function	Shortcut key
Set/remove breakpoint (STL, SCL)	<Ctrl+Shift+F9>
Step over breakpoint (STL, SCL)	<Ctrl+Shift+F10>
Jump to lower-level block (STL, SCL)	<Ctrl+Shift+F11>
Return to calling block (STL, SCL)	<Ctrl+Shift+F12>
Run program up to marker (cursor position) (STL, SCL)	<Ctrl+F3>
Display program status (SCL, STL)	<Ctrl+T>
Enable all breakpoints (STL, SCL)	<Ctrl+Shift+F2>
Disable all breakpoints (STL, SCL)	<Ctrl+Shift+F3>
Modify to 0 (LAD, FBD)	<Ctrl+Shift+9>
Modify to 1 (LAD, FBD)	<Ctrl+Shift+1>
Modify operand (LAD, FBD)	<Ctrl+Shift+2>

## See also

- Keyboard operation in the TIA Portal (Page 234)
- Using project-related functions (Page 236)
- Arranging windows (Page 236)
- Editing tables (Page 242)
- Text editing (Page 241)

## Enlarging the programming window

### Introduction

The programming window is relatively small when all components of the application are shown. If the program code is large, you may find you have to rearrange the work area constantly. To avoid this problem, you can hide or minimize the display of the following components of the application and of the program editor:

- Project tree
- Task cards
- Block interface
- Favorites
- Comments
- Networks

---

#### Note

You can also use the "Reduce automatically" option for the task cards, project tree, and Inspector window. These windows will then be minimized automatically when you do not need them.

See also: Maximizing and minimizing the work area

---

## Hiding and showing the project tree

The project tree allows you to access all areas of the project. You can hide the project tree while you are creating a program so you have more space for the programming window.

To show and hide the project tree, follow these steps:

1. To hide the project tree, deselect the "Project tree" check box in the "View" menu, or click on "Collapse" on the project tree title bar.
2. To show the project tree, select the "Project tree" check box in the "View" menu or click on "Extend" on the project tree title bar.

### Opening and closing task cards

The task cards are located at the right-hand edge of the programming window.

To open or close the task cards, follow these steps:

1. To close the task cards, deselect the "Task card" check box in the "View" menu or click "Collapse" on the task cards title bar.
2. To open the task cards, select the "Task card" check box in the "View" menu or click "Expand" on the task cards title bar.

### Hiding and showing the block interface

The block interface is shown in the upper section of the program editor. During programming you can show and hide it as required.

To show and hide the block interface, follow these steps:

1. In the lower part of the interface within the window splitter, click on the Up arrow or Down arrow.

### Showing and hiding favorites

To hide or show the favorites in the program editor, follow these steps:

1. Click the "Display favorites in the editor" button in the program editor toolbar.

### Showing and hiding comments

Within a block you can enter a comment for the block or for each network. These two types of comments are shown and hidden differently.

To show or hide a block comment, follow these steps:

1. Click the the triangle at the start of the line with the block title.

To show or hide network comments, follow these steps:

1. Click "Network comments on/off" on the program editor toolbar.

---

#### Note

The comments available can vary depending on the programming language used.

---

### Opening and closing networks

Some programming languages use networks. You can open or close these networks as required.

To open or close networks, follow these steps:

1. If you want to open a network, click the right arrow in front of the network title. If you want to close a network, click the down arrow in front of the network title.

To open and close all networks, follow these steps:

1. Click "Open all networks" or "Close all networks" in the program editor toolbar.

---

**Note**

Networks are not used in every programming language.

---

**See also**

Overview of the program editor (Page 1219)

Maximizing and minimizing the work area (Page 213)

**Setting the mnemonics**

You can program blocks using German or international mnemonics. If you open the TIA portal for the first time the international mnemonics is set as default. You can change the mnemonics at any time.

**Procedure**

To set the mnemonics, follow these steps:

1. Select the "Settings" command in the "Options" menu.  
The "Settings" window is displayed in the work area.
2. Select the "General" group in the area navigation.
3. In the "General settings" group, select the mnemonics that you want to use.  
The mnemonics is changed in all blocks.

**Displaying symbolic and absolute addresses**

You have the following options for displaying operands in the program editor:

- Symbolic representation  
The symbolic operands are displayed in the program. The corresponding absolute addresses are shown in tooltips if you hold the mouse pointer over the operand.
- Absolute representation  
The absolute addresses are displayed in the program. The corresponding symbolic operands are displayed in tooltips.
- Symbolic and absolute representation  
Symbolic operands and absolute addresses are displayed in program.

**Requirement**

The program editor is open.

## Procedure

To change the representation of the operands, follow these steps:

1. Click the "Absolute/symbolic operands" button in the program editor toolbar.  
Each time you click the button, the representation and the symbol on the button change.

Or:

1. Click the small arrow next to the "Absolute/symbolic operands" button in the program editor toolbar.  
A drop-down list is displayed.
2. Select the required representation from the drop-down list.  
The symbol on the button changes.

## See also

Basic information about operands (Page 1049)

## Use instruction versions

### Basic information on instruction versions

The instructions available to you for programming the user program are managed in system libraries. If a new version of a system library is installed by an update, the newer versions of the instructions of this system library may also be installed.

If there are several versions for an instruction, these are listed in the "Instructions" task card after the respective instruction. If the instruction versions are not shown, you can show them via the "Show column headers and additional columns" button in the toolbar of the "Instructions" task card. You can then select the versions of the instructions to be used in the program from the dropdown-list box of the "Version" column. If you do not select any versions, the most recent versions are used.

---

#### Note

Please note the following:

- You can only ever use the same version of an instruction within a device.
  - If you change the version of an instruction that other instructions depend on, the versions of the dependent instructions are also changed.
  - If you select a version for an instruction that can not be run on the CPU used, the instruction is shaded out. This means that you cannot use this instruction in this version with your CPU.
  - When you change the version of an instruction, you must compile the block before the new version number is displayed in the properties of the instruction.
-

## Changes in the versions

New versions can be main versions or secondary versions. New versions, such as 2.0 or 3.0, have more substantial changes to them. New main versions may therefore result in changes to the block interface. New secondary versions, such as 1.3 or 1.4, contain lesser changes or remedies to errors.

## Using instruction versions

You can decide within a device which version of an instruction you want to use. If you select another version for an instruction, the new version is specified for all locations of use of this instruction within your program. These instructions are identified in the program by a red frame. You must then download your program to the device to use the new instruction version.

## Using instruction profiles

### Basics of instruction profiles

#### Introduction

The TIA Portal provides you with numerous instructions that you can use to program the user program. However, you may filter out specific instructions that you do not want to use. To this end you can create instruction profiles in which you can explicitly specify the instructions to be listed in the "Instructions" task card. However, although you may create several instruction profiles in a project, only one of these profiles may be active at any given time. You can exchange instruction profiles with other users by means of shared libraries.

---

#### Note

Please note the following:

- The use of instructions that are not allowed in the active profile in a block will trigger the output of a block compilation error. Such a situation may be triggered if you drag-and-drop a block from the library to your program.
  - Instructions of a profile that are not supported by the currently installed products are deleted from the profile the next time it is edited. If you transfer this profile to an engineering system in which these instructions are supported by the installed products, the instructions are again present in the profile but they are disabled. You can enable these instructions as required at any time.
  - If you want to make changes to the active profile, you must recompile the blocks in the project. This is also necessary when you disable or delete the active profile or when you enable a profile.
-

## See also

- Creating new instruction profiles (Page 1232)
- Opening and editing instruction profiles (Page 1233)
- Activating and deactivating instruction profiles (Page 1234)
- Deleting instruction profiles (Page 1235)

## Creating new instruction profiles

### Requirement

The "Common data > Instruction profiles" folder is open in the project navigation.

### Procedure

Proceed as follows to create a new instruction profile:

1. Double-click the "Add new profile" command.  
The Instruction Profile Editor opens and displays the new instruction profile. All instructions are activated for the new instruction profile.
2. Edit the new instruction profile to suit your requirements.

If necessary, you can rename the new instruction profile. To do this, follow these steps:

1. Right-click on the new instruction profile.
2. Select the "Rename" command in the shortcut menu.
3. Enter a name for the new instruction profile.

---

### Note

The first instruction profile that you create will be used as active profile. In this case, compile all blocks in the project. If other instruction profiles are already available you must explicitly activate the new one in order to use it as active profile. You can identify the active profile by its icon in the project navigation.

---

## See also

- Basics of instruction profiles (Page 1231)
- Opening and editing instruction profiles (Page 1233)
- Activating and deactivating instruction profiles (Page 1234)
- Deleting instruction profiles (Page 1235)



## Opening and editing instruction profiles

Once you have opened an instruction profile, you can edit it as follows:

- **Activating and deactivating instructions**  
You can explicitly specify the instructions to be allowed in the instruction profile.

---

### **Note**

Note that dependencies exist between some instructions. As a result, it is possible that several instructions may be activated or deactivated by an action. The check box icon indicates the folders in which instructions are deactivated.

---

- **Activating and deactivating instruction versions**  
Certain instructions are available with different versions. You can explicitly specify the instruction versions to be allowed in the instruction profile.
- **Renumbering blocks**  
An instruction representing an internal function block (FB) or function (FC) in the system is assigned a specific block number by the system. You can replace this block number with your own block number. Within a version, there are several implementations for certain instructions. The block numbers in such instructions can only be changed for the specific implementation.

---

### **Note**

If an instruction from the instruction profile is used in the program and the specified block number is already in use by a different block, the specified block number of the instruction will be replaced by a free block number.

---

## Requirement

The "Common data > Instruction profiles" folder is open in the project navigation.

## Opening instruction profiles

Proceed as follows to open an instruction profile:

1. Double-click the instruction profile that you want to edit.  
The instruction profile opens in the Instruction Profile Editor.

## Editing instruction profiles

Proceed as follows to edit an instruction profile in the Instruction Profile Editor:

1. Select the device that you want to edit from the "Device family" drop-down list box.
2. Select the programming language for which you want to edit the instruction profile from the "Language" drop-down list box.
3. Deactivate the instructions or instruction versions that you want to exclude from the instruction profile. You can deactivate a folder to deactivate all subordinate instructions.

4. Activate the instructions or instruction versions that you want to allow in the instruction profile.
5. You may assign your own block numbers.

---

**Note**

You can assign the number up to 65535 for CPUs of the S7-1200/1500 series. For CPUs of the S7300/400 series you find the restrictions of the number ranges in the respective CPU manual.

---

---

**Note**

A new compilation process is required for all blocks in the project when you change the active profile.

---

**See also**

- Basics of instruction profiles (Page 1231)
- Creating new instruction profiles (Page 1232)
- Activating and deactivating instruction profiles (Page 1234)
- Deleting instruction profiles (Page 1235)
- Use instruction versions (Page 1230)

**Activating and deactivating instruction profiles**

You first need to activate an instruction profile in order to include filtering of its instructions. You can always deactivate the instruction profile to reset the instructions task card to the default scope of instructions.

---

**Note**

A new compilation process is required for all blocks in the project.

---

**Requirement**

The "Common data > Instruction profiles" folder is open in the project navigation.

**Activating instruction profiles**

Proceed as follows to activate an instruction profile:

1. Right-click on the instruction profile that you want to activate.
2. Select the "Activate profile" command from the shortcut menu.  
The selected instruction profile is now active. Instructions can now only be used in accordance with the settings of this profile.

## Deactivating instruction profiles

Proceed as follows to deactivate the instruction profile:

1. Right-click on the instruction profile that you want to deactivate.
2. Select the "Deactivate profile" command from the shortcut menu.  
No instruction profile is active and the "Instructions" task card once again shows all instructions that are available for use.

## See also

Basics of instruction profiles (Page 1231)

Creating new instruction profiles (Page 1232)

Opening and editing instruction profiles (Page 1233)

Deleting instruction profiles (Page 1235)

## Deleting instruction profiles

### Requirement

The "Common data > Instruction profiles" folder is open in the project tree.

### Procedure

Proceed as follows to delete an instruction profile:

1. Right-click on the instruction profile that you want to delete.
2. Select the "Delete" command in the shortcut menu.

---

#### Note

A new compilation process is required for all blocks in the project when you delete the active profile.

---

### Result

The selected instruction profile is deleted. If you deleted the active instruction profile, no more active profiles are available and the "Instructions" task card once again shows all instructions that are available for use.

## See also

- Basics of instruction profiles (Page 1231)
- Creating new instruction profiles (Page 1232)
- Opening and editing instruction profiles (Page 1233)
- Activating and deactivating instruction profiles (Page 1234)

## Using autocompletion

### Basics of autocompletion

#### Function

You can use autocompletion in the program window of the program editor as an easy way to access available tags or instructions during programming. Autocompletion means a context-specific list appears in a dialog from which you can select the tags or instructions you need.

## See also

- Using autocompletion in graphic programming languages (Page 1236)
- Using autocompletion in textual programming languages (Page 1237)

## Using autocompletion in graphic programming languages

### Inserting tags using autocompletion

To insert tags in graphic programming languages using autocompletion, follow these steps:

1. Select an operand of the instruction to which you wish to assign a tag.  
The input field for the operand opens. The autocompletion button will appear beside the input field.
2. Either click the autocompletion button or use the shortcut <Ctrl+I>.  
Autocompletion opens. It contains only the local and global tags, data blocks and multiple instances which are admissible for the operand in the given context. You can exit autocompletion at any time by pressing <Esc>.

3. Select the required tag from the list. If necessary, you can also filter the list:
  - For example, enter the first few letters of the name of the tag or instruction you wish to insert. Autocompletion will be filtered further with each letter entered. If there is no tag or instruction starting with the letters entered, autocompletion will remain at the last match.
  - Enter # to access the local tags from the block interface.
  - Enter " to access the global tags.
  - Enter % to access absolute addresses.

If the tag is a structured tag, a data block or a multiple instance, then an arrow is displayed at the end of the row. Click on the arrow to display the lower-level elements. You can navigate to the very last level in this way. If a structure is allowed as a data type for the operand, you can choose "None" from the list. This assigns the entire structure to the operand as a tag. Use the <Backspace> key to return to the previous level.

4. Press the <Return> key to apply the tag.

## See also

Basics of autocompletion (Page 1236)

Using autocompletion in textual programming languages (Page 1237)

## Using autocompletion in textual programming languages

### Inserting tags and instructions using autocompletion

To insert tags and instructions in textual programming languages using autocompletion, follow these steps:

1. Enter the first few letters of the name of the tag or instruction you wish to insert. If necessary, you can directly filter the kind of tags:
  - Enter # to access the local tags from the block interface.
  - Enter " to access the global tags.
  - Enter % to access absolute addresses.

Autocompletion opens. It contains only the local and global tags, data blocks, multiple instances and instructions which are admissible at the current position. You can exit autocompletion at any time by pressing <Esc>.

2. Enter more letters of the name of the tag or instruction you wish to insert. You can use <Enter> or <Tab> to apply the tag or instruction and close autocompletion. Autocompletion will be filtered further with each letter entered. If there is no tag or instruction starting with the letters entered, autocompletion only contains the previous matches.

9.1 Creating a user program

3. Select the tag or instruction required from the list.  
 If a tag is a structured tag, a data block or a multiple instance, first select the tag, the data block or multiple instance from the autocompletion and apply the selection with <Enter>. To select the additional components of the structure, data block, or multiple instance, enter a period. Autocompletion then reopens and you can select the next component.
4. Press the <Return> key to apply the tag.

**See also**

Basics of autocompletion (Page 1236)

Using autocompletion in graphic programming languages (Page 1236)

**General settings for the PLC programming**

**Overview of the general settings**

**Overview**

The following table shows the general settings that you can make:

Group	Setting	Description
View	With comments	Network comments are shown.
	with tag information	Additional information for the tags used is displayed in the program editor. This setting only has an effect on blocks that were programmed with LAD, FBD, STL, or GRAPH.
Compilation	Delete actual parameters on interface update	Actual parameters are deleted if the associated formal parameters were deleted in the called block, and you run the "Update block call" function or compile the block.
Default settings for new blocks	IEC check	The compatibility of operands in comparison operations and arithmetic operations are tested according to IEC rules. You have to explicitly convert non-compatible operands.
Memory reserve for download without reinitialization	Memory reserve for new blocks	Defines the size of reserve in volatile memory that can be used for interface extensions.
Additional settings	Show autocompletion list	The autocomplete list is displayed.
	Mnemonics	German or international designation of operations and operands

## See also

- Changing the settings (Page 1239)
- Permissible addresses and data types of PLC tags (Page 1176)
- Overview of the print settings (Page 202)
- Basics of block access (Page 1027)
- Setting and canceling the IEC check (Page 1125)

## Changing the settings

### Procedure

To change the settings, follow these steps:

1. Select the "Settings" command in the "Options" menu.  
The "Settings" window is displayed in the work area.
2. In the area navigation, select the "PLC programming" group.
3. Change the settings.

### Result

The change will be loaded directly, there is no need to save it explicitly.

## See also

- Overview of the general settings (Page 1238)

## 9.1.4.2 Programming code blocks

### Declaring the block interface

### Layout of the block interface

#### Introduction

The interface contains the declarations of local tags that are used within the block. The tags are subdivided into two groups:

- Block parameters that form the block interface when it is called in the program.
- Local data that are used for storage of intermediate results.

You use tag declaration to define the call interface of a block in the program and the names and data types of tags that you want to use in the block.

The interface of function blocks also defines the structure of the instances that are assigned to the function block.

**Layout of the block interface**

The following figure shows the structure of the block interface. The number of columns and sections varies depending on the type of block.

Name	Data type	Default value	Retain	Visible in HMI	Comment
▼ Input					
■ MyInput1	Bool	false	Retain	<input checked="" type="checkbox"/>	
▼ Output					
■ MyOutput1	Byte	0	Non-Retain	<input checked="" type="checkbox"/>	
▼ InOut					
■ <add new>				<input type="checkbox"/>	
▼ Static					
■ <add new>				<input type="checkbox"/>	
▼ Temp					
■ MyTemp	Int			<input type="checkbox"/>	

**Block parameters**

The following table shows the types of block parameters:

Type	Section	Function	Available in
Input parameters	Input	Parameters whose values are read by the block.	Functions, function blocks and some types of organization blocks
Output parameters	Output	Parameters whose values are written by the block.	Functions and function blocks
In/out parameters	InOut	Parameters whose values are read by the block when it is called, and whose values are written again by the block after execution.	Functions and function blocks
Return value	Return	Function value that is returned to the calling block.	Functions

Depending on the type of block opened, additional sections may be displayed.



## Local data

The following table shows the types of local data:

Type	Section	Function	Available in
Temporary local data	Temp	Tags that are used to store temporary intermediate results. Temporary local data are retained for only one cycle. If you use temporary local data, you have to make sure that the values are written within the cycle in which you want to read them. Otherwise the values will be random.	Functions, function blocks and organization blocks
Static local data	Static	Tags that are used for storage of static intermediate results in the instance data block. Static data is retained until overwritten, which may be after several cycles. The names of the blocks, which are called in this code block as multiple instance, will also be stored in the static local data.	Function blocks

## Meaning of the columns

The following table shows the meaning of the individual columns. You can show or hide the columns as required. The number of columns displayed varies depending on the CPU series and the type of the open object.

Column	Explanation
	Symbol you can click on to drag-and-drop a tag to a program for use as an operand.
Name	Name of the tags.
Data type	Data type of the tags.
Offset	Relative address of the tags. The column is only visible in blocks with standard access.
Default value	Value with which you can pre-assign specific tags in the interface of the code block. Specification of the default value is optional. If you do not specify any value the predefined value for the indicated data type is used. For example, the value "false" is predefined for BOOL. The default value is assumed as the start value in the corresponding instance data block. You can replace these values with instance-specific start values in the instance data block. The column is only available in the interface of function blocks.
Retentivity	Marks the tag as retentive. The values of retentive tags are retained even after the power supply is switched off. This column is only visible in the interface of the function block with optimized access.
Visible in HMI	Shows whether the tag is visible by default in the HMI selection list.
Accessible from HMI	Shows whether HMI can access this tag during runtime.

Column	Explanation
Setting value	Marks the tag as setting value. Setting values are the values that will probably have to be fine tuned during commissioning. The column is only available in the interface of function blocks.
Comment	Comment to document the tags.

**See also**

Using tags within the program (Page 1049)

Keywords (Page 1051)

Valid data types in the block interface (Page 1243)

Setting the retentivity of local tags (Page 1254)

**Rules for declaring the block interface**

**General rules for declaring the block interface**

**Using POINTER**

The following rules apply to the use of block parameters within the block:

- Input parameters may only be read.
- Output parameters may only be written.
- In/out parameters may be read and written.

**Assigning default values to block parameters**

You can assign default values to specific parameters in the function block interface. The possibility of the assignment depends on the declaration subsection and data type of the parameter.

The following table shows which parameters can be assigned a default value:

Parameter type	Section	Assignment of a default value is possible		
		Elementary data types	Structured data types	Parameter types
Input parameters	Input	X	X	-
Output parameters	Output	X	X	-
In/out parameters	InOut	X	-	-
Static local data	Static	X	X	-
Temporary local data	Temp	-	-	-

**See also**

Using tags within the program (Page 1049)  
Keywords (Page 1051)

**Valid data types in the block interface**

**Valid data types in the block interface in S7-1200**

The following table shows which data types you can assign in the parameters in the individual sections of the interface.

Section	Standard Data types	ARRAY STRUCT STRING DT	VOID	VARIANT
<b>Organization block</b>				
Temp	X	X	-	X
<b>Function block</b>				
Input	X	X	-	X
Output	X	X	-	-
InOut	X	X <sup>(1)</sup>	-	X
Static	X	X	-	-
Temp	X	X	-	X
<b>Function</b>				
Input	X	X <sup>(1)</sup>	-	X
Output	X	X <sup>(1)</sup>	-	X
InOut	X	X <sup>(1)</sup>	-	X
Temp	X	X	-	X
Return	X	X	X	-

<sup>(1)</sup> STRING can only be defined in the standard length of 254 characters.

**Valid data types in the block interface in S7-1500**

The following table shows which data types you can assign in the parameters in the individual sections of the interface.

Section	Standard Data types	ARRAY STRUCT STRING DT	Parameter types	VOID	DB_ANY	POINTER	ANY	VARIANT
<b>Organization block</b>								
Temp	X	X	_(4)	-	X	-	X <sup>(3)</sup>	X
<b>Function block</b>								

9.1 Creating a user program

Section	Standard Data types	ARRAY STRUCT STRING DT	Parameter types	VOID	DB_ANY	POINTER	ANY	VARIANT
Input	X	X	X	-	X	X	X	X
Output	X	X	-	-	X	-	-	-
InOut	X	X <sup>(1)</sup>	_(4)	-	X	X	X	X
Static	X	X	-	-	X	-	-	-
Temp	X	X	_(4)	-	-	-	X <sup>(3)</sup>	X
<b>Function</b>								
Input	X	X <sup>(1)</sup>	X	-	X	X	X	X
Output	X	X <sup>(1)</sup>	-	-	X	X	X	X
InOut	X	X <sup>(1)</sup>	_(4)	-	X	X	X	X
Temp	X	X	_(4)	-	X	-	X <sup>(3)</sup>	X
Return	X	x	-	X	X	X	x <sup>(2)</sup>	-
<p><sup>(1)</sup> STRING can only be defined in the standard length of 254 characters.</p> <p><sup>(2)</sup> In SCL, ANY is not permissible as return value.</p> <p><sup>(3)</sup> ANY can only be used in blocks with standard access in the "Temp" section.</p> <p><sup>(4)</sup> The "INSTANCE" parameter type is the only exception permissible in the "TEMP" and "InOut" sections.</p>								

**Declaring local tags**

**Declaring local tags in the block interface**

**Requirement**

The block interface is open.

**Procedure**

To declare a tag of the elementary data type, follow these steps:

1. Select the appropriate declaration section in the interface:
2. Enter a tag name in the "Name" column.
3. Enter the required data type in the "Data type" column. You will be supported by autocompletion during input.
4. Optional: Change the properties of the tags that are displayed in the other columns of the block interface.

**Result**

The tag is created.

## Syntax check

A syntax check is performed after each entry, and any errors found are displayed in red. You do not have to correct these errors immediately - you can continue editing and make any corrections later. However, you will not be able to compile the program if the tag declaration contains syntax errors.

---

### Note

If you change the interface of a block, the calls of the block in the program will possibly become inconsistent. The call locations are automatically updated, if possible.

If an automatic updating is not possible, the inconsistent blocks have to be updated manually.

See also:

Updating block calls in LAD (Page 1279)

Updating block calls in FBD (Page 1320)

---

## See also

Editing tables (Page 242)

Basic information on start values (Page 1392)

Using tags within the program (Page 1049)

Keywords (Page 1051)

Properties of local tags (Page 1253)

Setting the retentivity of local tags (Page 1254)

## Declaring local tags in the program editor

### Requirement

The program editor is open.

### Procedure

To declare a local tag, follow these steps:

1. Insert an instruction in your program.  
The "<???">", "<???.?>" or "... " strings represent operand placeholders.
2. Replace an operand placeholder with the name of the tag to be created.
3. Select the tag name.  
If you want to declare multiple tags, select the names of all the tags to be declared.
4. Select the "Define tag" command in the shortcut menu.  
The "Define tag" dialog box opens. This dialog displays a declaration table in which the name of the tag is already entered.

5. To declare a local tag, select one of the following sections:
  - Local In
  - Local Out
  - Local InOut
  - Local Static
  - Local Temp
6. In the other columns, enter data type and comments.
7. Click the "Define" button to complete your entry.

## Result

The declaration is written directly into the block interface and is valid within the entire block.

---

### Note

If you change the interface of a block, the calls of the block in the program will possibly become inconsistent. The call locations are automatically updated, if possible.

If an automatic updating is not possible, the inconsistent blocks have to be updated manually.

See also:

Updating block calls in LAD (Page 1279)

Updating block calls in FBD (Page 1320)

---

## See also

Editing tables (Page 242)

Using tags within the program (Page 1049)

Keywords (Page 1051)

Basic information on start values (Page 1392)

Properties of local tags (Page 1253)

Setting the retentivity of local tags (Page 1254)

## Declaring tags of the ARRAY data type

### Requirement

The block interface is open.

## Procedure

To declare a tag of the ARRAY data type, follow these steps:

1. Select the appropriate declaration section in the interface.
2. Enter a tag name in the "Name" column.
3. In the "Data type" column, click the button for the data type selection.  
A list of the permissible data types is opened.
4. Select the "Array" data type.  
The "Array" dialog opens.
5. In the "Data type" text box, specify the data type of the array elements.
6. In the "ARRAY limits" text box, specify the high and low limit for each dimension.  
Example of a one-dimensional ARRAY:  
[0..3]  
Example of a three-dimensional ARRAY:  
[0..3, 0..15, 0..33]
7. Confirm your entry.
8. Optional: Change the properties of the tags that are displayed in the other columns of the block interface.

## Result

The tag of ARRAY data type is created.

---

### Note

You cannot define specific default values for ARRAY elements. However, you can assign them start values in the instance.

---

## See also

Using tags within the program (Page 1049)  
Keywords (Page 1051)  
Properties of local tags (Page 1253)  
Setting the retentivity of local tags (Page 1254)  
Editing tables (Page 242)

## Declaring tags of STRUCT data type

## Requirement

The block interface is open.

## Procedure

To declare a tag of the STRUCT data type, follow these steps:

1. Select the appropriate declaration section in the interface:
2. Enter a tag name in the "Name" column.
3. Enter "Struct" in the "Data type" column. You will be supported by autocompletion during input.  
An empty, indented row is inserted after the new tag.
4. Insert the first structural element in the first empty row.  
An additional empty row is inserted after the element.
5. Select a data type for the structure element.
6. Optional: Change the properties of the structural element that is displayed in the other columns of the block interface.
7. Repeat the step 4 to 7 for all additional structure elements.  
It is not necessary to end the structure explicitly. The structure ends with the last element that is entered.
8. To insert a new tag after the structure, leave a blank row after the end of the structure and then start the new tag in the second empty row.

## Result

The tag of STRUCT data type is created.

## See also

Using tags within the program (Page 1049)

Keywords (Page 1051)

Properties of local tags (Page 1253)

Setting the retentivity of local tags (Page 1254)

Editing tables (Page 242)

## Declaring tags based on a PLC data type

### Requirement

A PLC data type is declared in the current CPU.

### Procedure

To declare a tag based on a PLC data type, follow these steps:

1. Select the appropriate declaration section in the interface:
2. Enter the PLC data type in the "Data type" column. You will be supported by Autocomplete during input.



## Result

The tag is created.

---

### Note

You define the default values of tags within a PLC data type when the PLC data type is created. You cannot change these values at the point of use of the PLC data type.

If you change or delete PLC data types that are used in the block interface, the interface becomes inconsistent. To remedy this inconsistency, the interface has to be updated.

See also: Updating the block interface (Page 1250)

---

## See also

Editing tables (Page 242)

Basics of PLC data types (Page 1409)

## Declaring higher-level tags

### Introduction

To access data areas within a declared tag, you can overlay the declared tags with an additional declaration. This provides you with the option of addressing an already declared tag with a different data type. You can, for example, address the individual bits of a tag of WORD data type with an ARRAY of BOOL.

### Overlaying tags

To overlay a tag with a new data type, follow these steps:

1. Open the block interface.
2. In the interface, select the tag that you want to overlay with a new data type.
3. Click "Add row" in the toolbar.  
A row is inserted after the tag to be overlaid. The overlaying tag must be declared in the row directly after the tag that is to be overlaid.
4. Enter a tag name in the "Name" column.
5. Enter the "AT" entry in the "Data type" column. You will be supported by Autocomplete in this step.  
The following is added to the entry in the "Name" column.  
`"AT<Name of the higher-level tag>"`
6. Click the data type selection button again and select the data type for the new tag.  
The tag is created. It points to the same data as the higher-level tag, however interprets this data with the new data type.

## Removing overlay

To remove the overlay of a tag, follow these steps:

1. Select the overlaid tag that you want to remove.
2. Select the "Delete" command in the shortcut menu.
3. The overlay is removed.

## See also

Editing tables (Page 242)

Overlaying tags with AT (Page 1065)

## Declaring multi-instances

### Requirement

- The function block to be called exists in project tree and is multi-instance capable.
- The block interface of the calling function block is open.

### Procedure

To declare a function block to be called as a multi-instance, follow these steps:

1. In the "Name" column of the "Static" section, enter a designation for the block call.
2. In the "Data type" column, enter the symbolic name for the function block to be called.

---

### Note

The program editor will declare the multi-instance automatically if you program a block call in a network and then specify in the "Call options" dialog that you want to call the block as a multiple instance.

---

## See also

Updating the block interface (Page 1250)

## Updating the block interface

### Introduction

If you change or delete PLC data types or multiple instances that are used in the block interface, the interface will become inconsistent. To remedy this inconsistency, the interface has to be updated.

You have two options for updating the block interface:

- **Explicit updating of the block interface.**  
The used PLC data types and multiple instances will be updated. The instance data blocks that belong to the block are not implicitly updated during this process.
- **Implicit updating during compilation.**  
All used PLC data types and multiple instances as well as the related instance data blocks will be updated.

### **Explicit updating of the block interface**

To explicitly update the block interface, follow these steps:

1. Open the block interface.
2. Select the "Update" command in the shortcut menu.

### **Implicit Updating during Compilation**

Proceed as follows to implicitly update all uses of PLC data types and multiple instances as well as the instance data blocks during compilation:

1. Open the project tree.
2. Select the "Program blocks" folder.
3. Select the command "Compile > Software (rebuild all blocks)" in the shortcut menu.

### **See also**

Basics of PLC data types (Page 1409)  
Declaring tags based on a PLC data type (Page 1248)  
Editing tables (Page 242)  
Basic information on start values (Page 1392)  
Using tags within the program (Page 1049)  
Keywords (Page 1051)  
Properties of local tags (Page 1253)  
Setting the retentivity of local tags (Page 1254)  
Updating block calls in LAD (Page 1279)  
Declaring multi-instances (Page 1250)

### **Extending the block interface**

#### **Description**

In order to enable the editing of PLC programs that have already been commissioned and that are running without error on a system, CPUs of the S7-1500 series and most CPUs of the S7-1200 V4 series support the option of extending the interfaces of function blocks during runtime.

You can download the modified blocks without setting the CPU to STOP and without affecting the values of already loaded tags.

This is a simple means of implementing program changes. This load process (download without reinitialization) will not have a negative impact on the controlled process.

### Principle of operation

Each function block is always assigned a default memory reserve. The memory reserve is not used initially. Activate the memory reserve if you decide on loading interface changes after having compiled and downloaded the block. All tags that you subsequently declare will be saved to the memory reserve. The subsequent download does not influence any tags that are already loaded or have a negative impact on runtime.

If you decide to review your program at a later time while the plant is not in operation, you are also provided an option of reworking the memory layout of individual or several blocks in a single pass. With this action, you move all tags from the reserve area to the regular area. The memory reserve is now cleared and made available for further interface extensions.

### Requirements

This "Download without reinitialization" function is available if the following requirements are met:

- The project is available in "TIA Portal V12" format.
- You are working with a CPU that supports "Download without reinitialization".
- The blocks were created in LAD, FBD, STL, or SCL.
- The blocks were created by the user, i.e. they are not included with the blocks delivered in your package.
- These blocks are assigned the optimized access attribute.

### Basic steps

Perform the following steps if you want to extend the interface of a function block and then load the block without re-initialization.

1. All blocks have a default memory reserve of 100 bytes. You can adapt this memory reserve to suit your requirements.
2. Activate the memory reserve.
3. Extend the block interface.
4. Compile the block.
5. Download the block to the CPU as usual.

For more information on the various steps, refer to chapter "Loading blocks (S7-1200/1500)".

**Note**

The full scope of the "Download without reinitialization" function is only available on CPUs of the S7-1500 and S7-1200 V4 series.

However, all CPU families support the option of extending the interface of function blocks and downloading newly declared tags without repercussion:

- You may add new tags in the "Temp" section and download these without influencing the process.
- You may create new tags of a structured data type in the "InOut" section and download these without influencing the process.

## Editing the properties of local tags

### Properties of local tags

#### Properties

The following table gives an overview of the properties of local tags:

Group	Property	Description
General	Name	Name of the tags.
	Data type	Data type of the tags.
	Default value	Value with which you pre-assign the tag in the interface of the code block.  Specification of the default value is optional. If you do not specify any value the predefined value for the indicated data type is used. For example, the value "false" is predefined for BOOL.  The default value will be adopted as the start value in the corresponding instance. You can then replace these adopted values with instance-specific start values.  This property is only available in the interface of function blocks.
	Comment	Comment on the tag.
Attributes	Retain	Marks the tag as retentive.  The values of retentive tags are retained even after the power supply is switched off.  This attribute is only available in the interface of the function block with optimized access.
	Accessible from HMI	Shows whether HMI can access this tag during runtime.
	Visible in HMI	Shows whether the tag is visible by default in the HMI selection list.

Group	Property	Description
	Hidden parameter	Indicates whether the tag should be hidden for the block call. This is only possible if you have specified a valid predefined actual parameter beforehand.
	Predefined actual parameter	Defines a parameter that is to be used as actual parameter during the block call.
	Configurable	Indicates whether a parameter is configurable in CFC.
	For test	Indicates whether a parameter is registered for the CFC test mode.
	Visible	Indicates whether a parameter is visible in CFC.
	Interconnectable	Indicates whether a parameter is interconnectable in CFC.
	Enable tag readback	Indicates whether a parameter is relevant for the "Read back chart" function in CFC.
	Enumeration texts	Assigns a parameter to an enumeration in CFC.
	Engineering unit	Assigns a parameter to a unit in CFC.
	Low limit	Defines the low limit for the parameter in CFC:
	High limit	Defines the high limit for the parameter in CFC:

**See also**

Setting the retentivity of local tags (Page 1254)

Changing properties of local tags (Page 1255)

Keywords (Page 1051)

**Setting the retentivity of local tags**

**Introduction**

Function blocks store their data in an instance. To prevent data loss in the event of power failure, you can mark the data as retentive. This data is stored in a retentive memory area. The option of setting the retentivity depends on the set access type of the function block.

**Retentive behavior in blocks with standard access**

In blocks with standard access you cannot set the retentive behavior of individual tags. You can only define them as retentive in the assigned instance. All tags contained in the block are then considered as retentive.

**Retentivity for optimized block access**

In data blocks with optimized access you can define the retentive behavior of individual tags.

For structured data type tags, the retentivity setting always applies to the entire structure. You can make no individual retentivity setting for individual elements within the structure.

You cannot create retentive tags of the structured data type in the "InOut" section. In/out parameters with structured data type, for example ARRAY, STRUCT, or STRING, are always non-retentive.

The following settings are available:

- Retentive  
The values of the tags or the structure are available even after a power failure.
- Non-retentive  
The values of the tags or the structure are lost in the event of a power failure.
- Set in IDB  
The retentivity can be set in the instance data block. The setting that is made in the instance data block than applies, however, centrally to all tags that are selected with "Set in IDB".

### See also

Properties of local tags (Page 1253)

Basics of block access (Page 1027)

## Changing properties of local tags

### Editing properties in the block interface

To edit the properties of one or more tags, follow these steps:

1. Open the block interface.
2. Change the entries in the columns.

### Editing properties in the properties window

To edit the properties of an individual tag, follow these steps:

1. Select a tag in the table.  
The tag properties will be displayed in the Inspector window.
2. Change the entries in the inspector window.

### Renaming tags directly in the program editor

To rename one or more tags, follow these steps:

1. Select one or more tags in the program.
2. Select the "Rename tag" command in the shortcut menu.  
The "Rename tag" dialog opens. This dialog box displays a declaration table with the selected tags.
3. Change the entries in the "Name" column.
4. Confirm the input by clicking the "Change" button.

### Editing the data type or comment in the program editor

Proceed as follows to edit the data type or tag comment in the program editor:

1. Select the tag name.
2. Select the "Rewire tag" command in the shortcut menu.  
The "Rewire tag" dialog will open. The dialog shows a declaration table.
3. Change the entry in the "Data type" or "Comment" columns.
4. Click the "Change" button to confirm the input.

### Effect in the program

In the case of a change of the tag's name, data type or address, each location of use of the tag is automatically updated in the program.

---

#### Note

If you change the interface of a block, the program may become inconsistent. The inconsistencies are automatically updated, if possible.

If an automatic updating is not possible, the inconsistent calls are marked in red. You then have to manually update the inconsistencies.

See also:

Updating block calls in LAD (Page 1279)

Updating block calls in FBD (Page 1320)

---

### See also

Layout of the block interface (Page 1239)

Editing tables (Page 242)

Properties of local tags (Page 1253)

Setting the retentivity of local tags (Page 1254)

Basic information on start values (Page 1392)

Using tags within the program (Page 1049)

Keywords (Page 1051)

Updating the block interface (Page 1250)



## Editing the block interface

### Inserting table rows

#### Procedure

Proceed as follows to insert a row above the selected row:

1. Select the row in front of which you want to insert a new row.
2. Click the "Insert row" button on the toolbar of the table.

#### Result

A new row is inserted above the selected row.

#### See also

Editing tables (Page 242)

### Inserting table rows

#### Procedure

Proceed as follows to insert a row below the selected row:

1. Select the row below which you want to insert a new row.
2. Click the "Add row" button on the table toolbar.

#### Result

A new empty row will be inserted below the selected row.

#### See also

Editing tables (Page 242)

### Deleting tags

#### Procedure

To delete a tag, follow these steps:

1. Select the row with the tag to be deleted. You can also select several rows by clicking on them one after the other while holding down the <Ctrl> key or by pressing and holding down <Shift> and clicking on the first and last row.
2. Select the "Delete" command in the shortcut menu.

## See also

Editing tables (Page 242)

## Automatically filling in successive cells

You can load the contents of one or several table cells into the cells below, automatically filling in the successive cells.

If you automatically fill in cells in the "Name" column, a consecutive number will be appended to each name. For example, "Motor" will become "Motor\_1".

You can define individual or more cells as well as entire rows as source area.

If less rows exist in the open table than you want to fill, then you will first have to insert additional empty rows.

## Requirement

- The table is open.
- Sufficient declaration rows are available.

## Procedure

To automatically fill in successive cells, follow these steps:

1. Select the cells to be loaded.
2. Click the "Fill" symbol in the bottom right corner of the cell.  
The mouse pointer is transformed into a crosshair.
3. Keep the mouse button pressed and drag the mouse pointer downwards over the cells that you want to fill in automatically.
4. Release the mouse button.  
The cells are filled in automatically.
5. If entries are already present in the cells that are to be automatically filled in, a dialog appears. In this dialog you can indicate whether you want to overwrite the existing entries or insert new rows for the new tags.

## See also

Editing tables (Page 242)

## Show and hide table columns

You can show or hide the columns in a table as needed.

## Procedure

To show or hide table columns, follow these steps:

1. Click a column header.
2. Select the "Show/Hide" command in the shortcut menu.  
The selection of available columns is displayed.
3. To show a column, select the column's check box.
4. To hide a column, clear the column's check box.

## Editing tags with external editors

To edit individual tags in external table editors, such as Excel, you can export or import these tags using copy and paste. However, you cannot copy structured tags to an editor.

## Requirements

The block interface and an external editor are opened.

## Procedure

To export individual tags to an external editor and import them again, follow these steps:

1. Select one or more tags.
2. Select "Copy" in the shortcut menu.
3. Switch to the external editor and paste the copied tags.
4. Edit the tags as required.
5. Copy the tags in the external editor.
6. Select the tags in the external editor.
7. Switch back to the block interface.
8. Select "Paste" in the shortcut menu.

## Creating program code

## Creating LAD programs

## Basic information on LAD

## LAD programming language

## Overview of the Ladder Logic (LAD) programming language

LAD is a graphical programming language. The representation is based on circuit diagrams.

The program is mapped in one or more networks. A network contains a power rail on the left where the rungs originate. The binary signal scans are arranged in the form of contacts on the rungs. The serial arrangement of the elements on a rung creates a series connection; arrangement on simultaneous branches creates a parallel connection. Complex functions are represented by boxes.

### Example of networks in LAD

The following figure shows a LAD network with two normally open contacts, one normally closed contact and one coil:

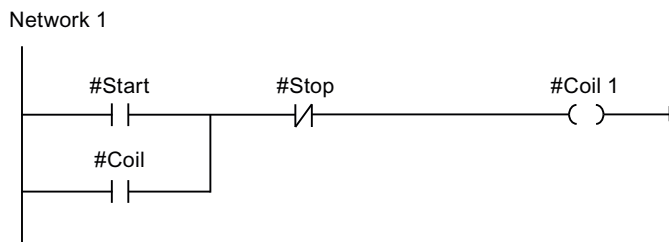

### Overview of the LAD elements

#### LAD elements

A LAD program consists of separate elements that you can arrange in series or parallel on the power rail of a network. Most program elements must be supplied with tags.

There is at least one rung from the power rail. Network programming starts at the left edge of the rung. You can expand the power rail by several rungs and branches.

For example, the following figure shows elements of a LAD network:

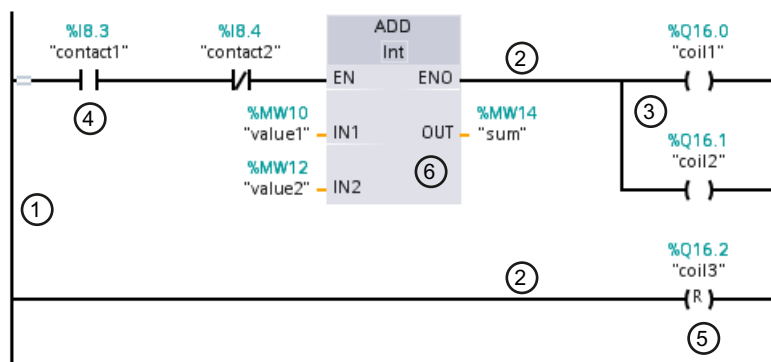

- 1) Power rail
- 2) Rung
- 3) Branch
- 4) Contact
- 5) Coil

## 6) Box

### Power rail

Each LAD network consists of a power rail that contains at least one rung. A network can be extended by adding additional rungs. You can use branches to program parallel connections in the specific rungs.

### Contacts

You can use contacts to create or interrupt a current-carrying connection between two elements. The current is relayed from left to right. You can use contacts to query the signal state or the value of an operand and control it depending on the result of the current flow.

The following types of contact are available to you in a LAD program:

- **Normally open contact:**  
Normally open contacts forward the current if the signal state of a specified binary operand is "1".
- **Normally closed contacts:**  
Normally closed contacts forward the current if the signal state of a specified binary operand is "0".
- **Contact with additional function:**  
Contacts with additional function forward the current if a specific condition is met. With these contacts you can also execute an additional function, such as an RLO edge detection and a comparison.

### Coils

You can use coils to control binary operands. Coils can set or reset a binary operand depending on the signal state of the result of logic operation.

The following types of coils are available to you in a LAD program:

- **Standard coils:**  
Standard coils set a binary operand if current flows in the coil. The "Assignment" instruction is an example of a standard coil.
- **Coils with additional function:**  
These coils have additional functions in addition to the evaluation of the logic operation result. Coils for RLO edge detection and program control are examples of coils with additional function.

### Boxes

Boxes are LAD elements with complex functions. The empty box is an exception. You can use the empty box as a placeholder in which you can select the required instruction.

The following types of boxes are available to you in a LAD program:

- Boxes without EN/ENO mechanism:  
A box is executed depending on the signal state at the box inputs. The error status of the processing cannot be queried.
- Boxes with EN/ENO mechanism:  
A box is only executed if the enable input "EN" carries the signal state "1". If the box is processed correctly, the "ENO" enable output has signal state "1". If an error occurs during the processing, the "ENO" enable output is reset.

Calls of code block are also shown in the network as boxes with EN/ENO mechanism.

**See also**

Rules for the use of LAD elements (Page 1270)

**Settings for LAD**

**Overview of the settings for LAD**

**Overview**

The following table shows the settings that you can make:

Group	Setting	Description
Font	Font size	Font size in program editor
View	Layout	Compact or wide Changes the vertical spacing between operands and other objects (such as operand and contact). The change becomes visible once the block is reopened.
	With absolute information	Additional display of the absolute addresses
Operand field	Maximum width	Maximum number of characters that can be entered horizontally in the operand field. This setting recalculates the layout of the networks.
	Maximum height	Maximum number of characters that can be entered vertically in the operand field. This setting recalculates the layout of the networks.

**See also**

Changing the settings (Page 1263)

## Changing the settings

### Procedure

To change the settings, follow these steps:

1. Select the "Settings" command in the "Options" menu.  
The "Settings" window is displayed in the work area.
2. In the area navigation, select the "PLC programming" group.
3. Change the settings.

### Result

The change will be loaded directly, there is no need to save it explicitly.

### See also

Overview of the settings for LAD (Page 1262)

## Working with networks

### Using networks

### Function

The user program is created in the block within networks. For a code block to be programmed, it must contain at least one network. To achieve a better overview of the user program, you can also subdivide your program into several networks.

### See also

Entering the network title (Page 1267)

Entering a network comment (Page 1268)

Navigating networks (Page 1269)

## Inserting networks

### Requirement

A block is open.

## Procedure

To insert a new network, follow these steps:

1. Select the network after which you want to insert a new network.
2. Select the "Insert network" command in the shortcut menu.

## Result

A new empty network is inserted into the block.

## See also

Selecting networks (Page 1264)

Copying and pasting networks (Page 1265)

Deleting networks (Page 1266)

Expanding and collapsing networks (Page 1266)

Entering the network title (Page 1267)

Entering a network comment (Page 1268)

Navigating networks (Page 1269)

## Selecting networks

### Requirements

A network is available.

### Selecting a network

To select a network, follow these steps:

1. Click the title bar of the network that you want to select.

### Selecting several networks

Proceed as follows to select several individual networks:

1. Press and hold down the <Ctrl> key.
2. Click all the networks that you want to select.

To select several successive networks, follow these steps:

1. Press and hold down the <Shift> key.
2. Click the first network that you want to select.
3. Click the last network that you want to select.  
The first and last networks and all those in between are selected.



## See also

Inserting networks (Page 1263)  
Copying and pasting networks (Page 1265)  
Deleting networks (Page 1266)  
Expanding and collapsing networks (Page 1266)  
Entering the network title (Page 1267)  
Entering a network comment (Page 1268)  
Navigating networks (Page 1269)

## Copying and pasting networks

Copied networks can be pasted within the block or in another block. Networks that were created in LAD or FBD can also be inserted in blocks of the respective other programming language.

## Requirement

A network is available.

## Procedure

To copy and paste a network, follow these steps:

1. Select the network or networks to be copied.
2. Select "Copy" in the shortcut menu.
3. Select the network after which you want to paste in the copied network.
4. Select "Paste" in the shortcut menu.

## See also

Inserting networks (Page 1263)  
Selecting networks (Page 1264)  
Deleting networks (Page 1266)  
Expanding and collapsing networks (Page 1266)  
Entering the network title (Page 1267)  
Entering a network comment (Page 1268)  
Navigating networks (Page 1269)

## **Deleting networks**

### **Requirement**

A network is available.

### **Procedure**

To delete a network, follow these steps:

1. Select the network that you want to delete.
2. Select the "Delete" command in the shortcut menu.

### **See also**

Inserting networks (Page 1263)

Selecting networks (Page 1264)

Copying and pasting networks (Page 1265)

Expanding and collapsing networks (Page 1266)

Entering the network title (Page 1267)

Entering a network comment (Page 1268)

Navigating networks (Page 1269)

## **Expanding and collapsing networks**

### **Requirements**

A network is available.

### **Opening and closing a network**

To open a network, follow these steps:

1. Click on the right arrow in the network title bar.

To close a network, follow these steps:

1. Click on the down arrow in the network title bar.

### **Opening and closing all networks**

To open and close all networks, follow these steps:

1. In the toolbar, click "Open all networks" or "Close all networks".

### **See also**

- Inserting networks (Page 1263)
- Selecting networks (Page 1264)
- Copying and pasting networks (Page 1265)
- Deleting networks (Page 1266)
- Entering the network title (Page 1267)
- Entering a network comment (Page 1268)
- Navigating networks (Page 1269)

### **Entering the network title**

The network title is the header of a network. The length of the network title is limited to one line.

### **Requirement**

A network is available.

### **Procedure**

To enter a network title, follow these steps:

1. Click on the title bar of the network.
2. Enter the network title.

## See also

- Using networks (Page 1263)
- Inserting networks (Page 1263)
- Selecting networks (Page 1264)
- Copying and pasting networks (Page 1265)
- Deleting networks (Page 1266)
- Expanding and collapsing networks (Page 1266)
- Entering a network comment (Page 1268)
- Navigating networks (Page 1269)

## Entering a network comment

You can use network comments to provide comments on the program contents of individual networks. For example, you can indicate the function of the network or draw attention to special characteristics.

## Requirement

A network is available.

## Procedure

To enter a network comment, follow these steps:

1. Click on the right arrow before the network title.
2. If the comment area is not visible, click "Network comments on/off" in the toolbar. The comment area is displayed.
3. Click "Comment" in the comment area. The "Comment" text passage is selected.
4. Enter the network comment.

## See also

Using networks (Page 1263)  
Inserting networks (Page 1263)  
Selecting networks (Page 1264)  
Copying and pasting networks (Page 1265)  
Deleting networks (Page 1266)  
Expanding and collapsing networks (Page 1266)  
Entering the network title (Page 1267)  
Navigating networks (Page 1269)

## Navigating networks

You can navigate straight to a specific position within a block.

## Procedure

To navigate to a specific position within a block, follow these steps:

1. Right-click in the code area of the programming window.
2. Select the "Go to > Network/line" command in the shortcut menu.  
The "Go to" dialog will open.
3. Enter the network to which you want to navigate.
4. Enter the line number of the network to which you want to navigate.
5. Confirm your entry with "OK".

## Result

The relevant line will be displayed if this is possible. If the network or line requested does not exist, the last existing network or the last existing line in the network requested will be displayed.

## See also

Using networks (Page 1263)  
Inserting networks (Page 1263)  
Selecting networks (Page 1264)  
Copying and pasting networks (Page 1265)  
Deleting networks (Page 1266)  
Expanding and collapsing networks (Page 1266)  
Entering the network title (Page 1267)  
Entering a network comment (Page 1268)

## Inserting LAD elements

### Rules for the use of LAD elements

#### Rules

Note the following rules when inserting LAD elements:

- Every LAD network must terminate with a coil or a box. However, the following LAD elements must not be used to terminate a network:
  - Comparator boxes
  - Instructions for positive and negative RLO edge detection
- The starting point of the branch for a box connection must always be the power rail. Logic operations or other boxes can be present in the branch before the box.
- Only contacts can be inserted into simultaneous branches with preceding logic operations. The contact for negating the result of logic operation (-|NOT|-) is an exception here. The contact for negating the result of logic operation, as well as coils and boxes, can be used in simultaneous branches if they originate directly from the power rail.
- Constants (e.g. TRUE or FALSE) cannot be assigned to normally closed or normally open contacts. Instead, use operands of the BOOL data type.
- Only one jump instruction can be inserted in each network.
- Only one jump label can be inserted in each network.
- Instructions with positive or negative edge detection may not be arranged directly at the left margin of the rung as they requires a prior logic operation.

#### Placement rules for S7-1200/1500 CPUs

The following table sets out the instructions that can only be positioned at the end of the network:

Instruction		Preceding logic operation required
Mnemonics	Name	
SET_BF	Set bit field	No
RESET_BF	Reset bit field	No
JMP	Jump if RLO = 1	No
JMPN	Jump if RLO = 0	Yes
JMP_LIST	Define jump list	No
SWITCH	Jump distributor	No
RET	Return	No

### Placement rules for S7-300/400 CPUs

The following table sets out the instructions that can only be positioned at the end of the network:

Instruction		Preceding logic operation required
Mnemonics	Name	
S	Set output	Yes
R	Reset output	Yes
SP	Start pulse timer	Yes
SE	Start extended pulse timer	Yes
SD	Start on-delay timer	Yes
SS	Start retentive on-delay timer	Yes
SF	Start off-delay timer	Yes
SC	Set counter value	Yes
CU	Count up	Yes
CD	Count down	Yes
JMP	Jump if RLO = 1	No
JMPN	Jump if RLO = 0	Yes
RET	Return	No
OPN	Open global data block	No
OPNI	Open instance data block	No
CALL	Call block	No
SAVE	Save RLO in BR bit	No
MCRA	Enable MCR range	No
MCRD	Disable MCR range	No
MCR<	Open MCR ranges	No
MCR>	Close MCR ranges	No

### See also

Prohibited interconnections in LAD (Page 1272)

Overview of the LAD elements (Page 1260)

### Prohibited interconnections in LAD

#### Power flow from right to left

No branches can be programmed that could result in a power flow in the reverse direction.

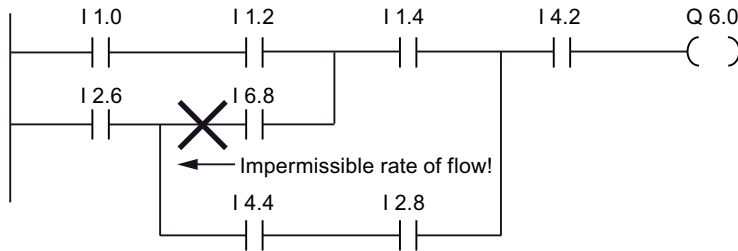

#### Short-circuit

No branches may be programmed that would cause a short-circuit.

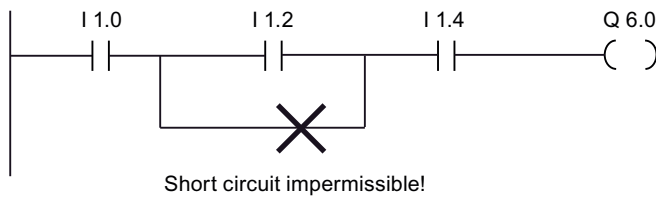

#### Logic operations

The following rules apply to logic operations:

- Only Boolean inputs can be combined with preceding logic operations.
- Only the first Boolean output can be combined with a further logic operation.
- Only one complete logical path can exist per network. Paths that are not connected can be linked.

#### See also

Rules for the use of LAD elements (Page 1270)

#### Inserting LAD elements using the "Instructions" task card

#### Requirement

A network is available.



## Procedure

To insert a LAD element into a network using the "Instructions" task card, follow these steps:

1. Open the "Instructions" task card.
2. Navigate to the LAD element that you want to insert.
3. Use drag-and-drop to move the element to the desired place in the network.  
If the element is an internal system function block (FB), the "Call options" dialog opens. In this dialog you can create an instance data block of the single-instance or multiple-instance type for the function block in which the data of the inserted element will be saved. You will find the new instance data block created in the project tree in the "Program resources" folder under "Program blocks > System blocks". If you have selected "multiple instance", these are located in the block interface in the "Static" section.

Or:

1. Select the point in the network at which you want to insert the element.
2. Open the "Instructions" task card.
3. Double-click on the element you want to insert.  
If the element is an internal system function block (FB), the "Call options" dialog opens. In this dialog you can create an instance data block of the single-instance or multiple-instance type for the function block in which the data of the inserted element will be saved. You will find the new instance data block created in the project tree in the "Program resources" folder under "Program blocks > System blocks". If you have selected "multiple instance", these are located in the block interface in the "Static" section.

## Result

The selected LAD element is inserted with placeholders for the parameters.

## Inserting LAD elements using an empty box

### Requirement

A network is available.

## Procedure

To insert an LAD element into a network using an empty box, follow these steps:

1. Open the "Instructions" task card.
2. Navigate to "General > Empty box" in the "Basic instructions" palette.
3. Use a drag-and-drop operation to move the "Empty box" element to the desired place in the network.

## 9.1 Creating a user program

4. Position the cursor over the triangle in the top right-hand corner of the empty box. A drop-down list is displayed.
5. Select the required LAD element from the drop-down list.  
If the element is an internal system function block (FB), the "Call option" dialog opens. In this dialog you can create an instance data block of the single-instance or multiple-instance type for the function block in which the data of the inserted element will be saved. You will find the new instance data block created in the project tree in the "Program resources" folder under "Program blocks > System blocks". If you have selected "multi-instance", these are located in the block interface in the "Static" section.

### Result

The empty box is changed to the respective LAD element. Placeholders are inserted for the parameters.

## Selecting the data type of a LAD element

### Selecting a data type

#### Introduction

Some instructions can be executed with several different data types. If you use one of these instructions in the program, you have to specify a valid data type for the instruction at the specific point in the program. For some instructions, you have to select the data types for the inputs and outputs separately.

---

#### Note

The valid data type (BOOL) for the tags on the enable input EN and the enable output ENO is predefined by the system and cannot be changed.

---

The valid data types for an instruction are listed in the instruction drop-down list. You specify the data type of the instruction by selecting an entry from the drop-down list. If the data type of an operand differs from the data type of the instruction and cannot be converted implicitly, the operand is displayed in red and a rollout with the corresponding error message appears.

## Data type selection of mathematical instructions

Some mathematical instructions provide you with the option of having the data type automatically set corresponding to the data types of the operand. In the drop-down list for data type selection, these instructions have the entry "Auto" in addition to the actual data types. If you select this entry and then allocate the first operand, the data type of the operand is selected as data type for the instruction. The entry in the drop-down list changes to "Auto (<Data type>)",

e.g. "Auto (Real)". If you allocate additional operands, the automatically set data type of the instruction is adjusted according to the following criteria:

- You supply all other operands with tags of the same data type:  
The data type of the instruction is not changed.
- You supply all other operands with tags whose data type is smaller than the data type of the instruction:  
The data type of the instruction is not changed. For the operand with the smaller data type, an implicit conversion is conducted if necessary.
- You supply an additional operand with a tag whose data type is greater than the data type of the instruction:  
The data type of the instruction is changed to the larger data type. An implicit conversion is performed, if necessary, for operands that deviate from the newly set data type of the instruction.

Each change in the data type of an operand can result in a change of the data type of the instruction. Other operands may possibly be implicitly converted as a result. Operands for which an implicit conversion is performed are marked with a gray square.

---

**Note**

Please also observe the information on data type conversion for your device and, in particular, the notes on the IEC check.

See also: Data type conversion

---

**See also**

Defining the data type of an instruction (Page 1275)

**Defining the data type of an instruction****Introduction**

Some instructions can be executed with several different data types. When you insert such instructions into your program, you must specify the data type for these instructions at the actual point in the program.

**Specifying the data type by means of the drop-down list**

To define the data type of an instruction using the drop-down list, follow these steps:

1. Insert the instruction at the required point in the program using drag-and-drop.  
The entry "???" (undefined) is displayed in the drop-down list of the inserted instruction.
2. Click the triangle in the upper corner of the drop-down list.  
The drop-down list will open to display the data types valid for the instruction.

3. Select a data type from the drop-down list.  
The selected data type is displayed.
4. If the instruction has two drop-down lists, select the data type for the instruction inputs in the left-hand drop-down list and the data type for the instruction outputs in the right-hand drop-down list.

### Specifying data type by assigning tags

To define the data type of an instruction by assigning tags, follow these steps:

1. Insert the instruction at the required point in the program using drag-and-drop.  
The entry "???" (undefined) is displayed in the drop-down list of the inserted instruction.
2. At an input or output, specify a valid tag, the data type of which is to be applied as the instruction data type.  
The data type of the tag is displayed in the drop-down list.
3. Enter a valid tag at an input and a valid tag at an output if data types need to be defined for both the inputs and outputs of the instruction. The tag specified at the input determines the data type of the inputs; the tag specified at the output determines the data type of the outputs of the instruction.

### Automatically specifying the data type of mathematical instructions

To automatically specify the data type for mathematical instructions, follow these steps:

1. Insert the mathematical instruction at the required point in the program using drag-and-drop.  
The entry "???" (undefined) is displayed in the drop-down list of the inserted instruction.
2. Select the "Auto" entry from the drop-down list.
3. Enter a valid tag at an input or output.  
The data type of the tag is applied as data type of the instruction. The entry in the drop-down list changes to "Auto (<Data type>".

See also: Selecting a data type (Page 1274)

### See also

Selecting a data type (Page 1274)

### Using favorites in LAD

### Adding LAD elements to Favorites

### Requirement

- A block is open.
- The multipane mode is set for the "Instructions" task card or the Favorites are also displayed in the editor.

## Procedure

To add SCL instructions to the Favorites, follow these steps:

1. Open the "Instructions" task card.
2. Maximize the "Basic instructions" pane.
3. Navigate in the "Basic instructions" pane to the instruction that you want to add to the Favorites.
4. Drag-and-drop the instruction into the "Favorites" pane or into the Favorites area in the program editor.

---

### Note

To additionally display the Favorites in the program editor, click the "Display favorites in the editor" button in the program editor toolbar.

---

## See also

- Removing LAD elements from Favorites (Page 1278)
- Overview of the program editor (Page 1219)

## Inserting LAD elements using favorites

### Requirement

- A block is open.
- Favorites are available.

## Procedure

To insert an instruction into a program using Favorites, follow these steps:

1. Drag-and-drop the desired instruction from Favorites to the desired position.

Or:

1. Select the position in the program where you want to insert the instruction.
2. In the Favorites, click on the instruction you want to insert.

---

### Note

To additionally display the Favorites in the program editor, click the "Display favorites in the editor" button in the program editor toolbar.

---

## See also

Removing LAD elements from Favorites (Page 1278)

Overview of the program editor (Page 1219)

## Removing LAD elements from Favorites

### Requirement

A code block is open.

### Procedure

To remove instructions from Favorites, follow these steps:

1. Right-click on the instruction you want to remove.
2. Select the "Remove instruction" command in the shortcut menu.

---

#### Note

To additionally display the Favorites in the program editor, click the "Display favorites in the editor" button in the program editor toolbar.

---

## See also

Adding LAD elements to Favorites (Page 1276)

Inserting LAD elements using favorites (Page 1277)

Overview of the program editor (Page 1219)

## Insert block calls in LAD

### Inserting block calls using a drag-and-drop operation

You can insert calls for existing functions (FC) and function blocks (FB) using a drag-and-drop operation from the project tree. If you call function blocks from other function blocks, you can either call them as single-instance or multi-instance blocks. If a function block is called as single instance, it will store its data in a data block of its own. If a function block is called as multi-instance, it will store its data in the instance data block of the calling function block.

### Requirement

- A network is available.
- The block that is to be called is available.

### Inserting a call of a function (FC)

To insert a call of a function (FC) into a network using a drag-and-drop operation, follow these steps:

1. Drag the function from the project tree to the required network.

### Inserting a call for a function block (FB)

To insert a call for a function block (FB), follow these steps:

1. Drag the function block from the project tree to the required network.  
The "Call options" dialog opens.
2. Enter in the dialog whether you wish to call the block as single or multi-instance.
  - If you click on the "Single instance" button, you will have to enter a name in the "Name" text box for the data block that you want to assign to the function block.
  - If you click on the "Multi-instance" button, you will have to enter the name of the tag in the "Name in the interface" text box; this is the name that you use to enter the called function block as a static tag in the interface of the calling block.
3. Confirm your entries with "OK".

### Result

The function or the function block is inserted with its parameters. You can then assign the parameters.

See also: Auto-Hotspot

---

#### Note

If when calling a function block you specify an instance data block that does not exist, it will be created. If you have called a function block as a multi-instance, this will be entered as a static tag in the interface.

---

### See also

Updating block calls in LAD (Page 1279)

Changing the instance type (Page 1280)

Single instances (Page 1035)

Multi-instances (Page 1035)

### Updating block calls in LAD

If interface parameters of a called block are changed, the block call can no longer be executed correctly. You can avoid such inconsistent block calls by updating the block calls.

You have two options to update the block calls:

## 9.1 Creating a user program

- Explicit updating in the program editor.  
The block calls in the open block will be updated.
- Implicit updating during compilation.  
All block calls in the program as well as the used PLC data types will be updated.

### Update blocks in the program editor

To update a block call within a block, follow these steps:

1. Open the block in the program editor.
2. Click "Update inconsistent block calls" in the toolbar.

Or:

1. Open the block in the program editor.
2. Right-click on the instruction with the block call.
3. Select the "Update" command in the shortcut menu.  
The "Interface update" dialog opens. This dialog shows the differences between the block interface in use and the changed interface of the called block.
4. If you want to update the block call, click "OK". To cancel the update, click "Cancel".

### Update block calls during compilation

Follow these steps to update all block calls and uses of PLC data types during compilation implicitly:

1. Open the project tree.
2. Select the "Program blocks" folder.
3. Select the command "Compile > Software (rebuild all blocks)" in the shortcut menu.

### See also

Inserting block calls using a drag-and-drop operation (Page 1278)

Changing the instance type (Page 1280)

### Changing the instance type

#### Instance type

There are two ways of calling function blocks:

- As a single instance
- As a multiple instance

See also: Auto-Hotspot

You can modify a defined instance type at any time.



## Requirement

The user program contains a block call.

## Procedure

To change the instance type of a function block, follow these steps:

1. Open the code block and select the block call.
2. Select the "Change instance" command in the shortcut menu.  
The "Call options" dialog opens.
3. Click the "Single instance" or "Multi instance" button.
  - If you select the "Single instance" instance type, enter a name for the data block that is to be assigned to the function block.
  - If you select "Multiple instance" as the instance type, enter in the "Name in the interface" text field the name of the tag with which the called function block is to be entered as a static tag in the interface of the calling block.
4. Confirm your entries with "OK".

---

### Note

The previous single and multiple instances will not be deleted automatically.

---

## See also

Inserting block calls using a drag-and-drop operation (Page 1278)

Updating block calls in LAD (Page 1279)

## Inserting complex LAD instructions

### Using the "Calculate" instruction

## Requirement

A network is available.

## Procedure

Proceed as follows to use the "Calculate" instruction:

1. Open the "Instructions" task card.
2. Navigate to "Math functions > CALCULATE" in the "Basic instructions" pane.

9.1 Creating a user program

3. Use drag-and-drop to move the element to the desired place in the network.  
The instruction "Calculate" will be inserted for the data type with a placeholder expression and question mark.
4. Enter the data type for the calculation.
5. Enter the operands for the calculation.

---

**Note**

The calculation is run with the inputs of the "Calculate" instruction. If you want to use constants you must also insert appropriate inputs for them.

---

6. Click on the "Edit 'Calculate' instruction" button to replace the placeholder expression with the correct expression.  
The "Edit 'Calculate' instruction" dialog will open.
7. Enter the required expression in the "OUT:= " text box.

---

**Note**

In the "Example" area you can find an example of a valid expression and possible instructions that you can use.

To determine a value with the help of Pythagoras' theorem, for example, enter "OUT := SQRT (SQR (IN1) + SQR (IN2))".

---

8. Confirm your entry with "OK".

**See also**

CALCULATE: Calculate (Page 1682)

**Using free-form comments**

**Basic information on using free-form comments in LAD**

**Introduction**

Free-form comments allow you to add comments to the source code for graphic programming languages similar to line comments for textual languages.

Free-form comments can be used for the following elements:

- Boxes
- Coils

## See also

- Inserting free-form comments (Page 1283)
- Editing free-form comments (Page 1283)
- Deleting free-form comments (Page 1285)

## Inserting free-form comments

### Requirement

A network with instructions is available.

### Procedure

To insert a free comment on an instruction, proceed as follows:

1. If necessary, activate the "Free-form comments on/off" button in the toolbar.
2. Right-click on the instruction for which you want to insert a free-form comment.
3. Select the "Insert comment" command in the shortcut menu.  
A comment box with a standard comment opens. The comment box is connected by an arrow to the corresponding instruction.
4. Enter the required comment in the comment box.

## See also

- Basic information on using free-form comments in LAD (Page 1282)
- Editing free-form comments (Page 1283)
- Deleting free-form comments (Page 1285)

## Editing free-form comments

### Introduction

Free-form comments can be edited as follows:

- Changing the comment text
- Changing the position and size of the comment box
- Attaching a comment to another element
- Showing and hiding free comments

### Changing the comment text

To change the text of free-form comments, follow these steps:

1. Click on the comment box.
2. Enter the desired text.

### Changing the position of the comment box

To change the positioning of the comment box, follow the steps below:

1. Left-click the comment box and keep the mouse button pressed.
2. Drag the comment box to the desired location.

### Changing the size of the comment box

To change the size of the comment box, follow the steps below:

1. Click on the comment box.
2. Drag the comment box on the move handle in the lower right corner to the desired size.

### Attaching a comment to another element

To attach a free-form comment to another element, follow these steps:

1. Left-click the point of the arrow that links the comment box with the instruction and keep the mouse button pressed.
2. Drag the arrow to the element to which you want to attach the comment. Possible insertion points are marked with a green square.
3. Release the mouse button.

### Showing and hiding free comments

To show or hide a free-form comments, follow these steps:

1. Click the "Free-form comment on/off" button in the toolbar.

### See also

Basic information on using free-form comments in LAD (Page 1282)

Inserting free-form comments (Page 1283)

Deleting free-form comments (Page 1285)

## Deleting free-form comments

### Procedure

To delete a free-form comment, proceed as follows:

1. Right-click on the free-form comment that you want to delete.
2. Select the "Delete" command in the shortcut menu.

### See also

Basic information on using free-form comments in LAD (Page 1282)

Inserting free-form comments (Page 1283)

Editing free-form comments (Page 1283)

## Editing LAD elements

### Selecting LAD elements

You can select several individual elements or all elements in a network.

### Requirement

LAD elements are available

### Selecting several individual LAD elements

To select several individual LAD elements, follow these steps:

1. Press and hold down the <Ctrl> key.
2. Click on all the LAD elements you wish to select.
3. Now release the <Ctrl> key.

### Selecting all LAD elements in a network

To select all LAD elements in a network, follow these steps:

1. Go to the network whose elements you wish to select.
2. Select the "Select all" command in the "Edit" menu or press <Ctrl A>.

## See also

- Copying LAD elements (Page 1286)
- Cutting LAD elements (Page 1287)
- Pasting an LAD element from the clipboard (Page 1287)
- Replacing LAD elements (Page 1288)
- Inserting additional inputs and outputs in LAD elements (Page 1289)
- Removing inputs and outputs (Page 1290)
- Enabling and disabling the EN/ENO mechanism (Page 1290)
- Deleting LAD elements (Page 1292)

## Copying LAD elements

### Requirement

An LAD element is available.

### Procedure

To copy a LAD element, follow these steps:

1. Right-click the LAD element that you want to copy.
2. Select "Copy" in the shortcut menu.

### Result

The LAD element will be copied and saved to the clipboard.

## See also

- Selecting LAD elements (Page 1285)
- Cutting LAD elements (Page 1287)
- Pasting an LAD element from the clipboard (Page 1287)
- Replacing LAD elements (Page 1288)
- Inserting additional inputs and outputs in LAD elements (Page 1289)
- Removing inputs and outputs (Page 1290)
- Enabling and disabling the EN/ENO mechanism (Page 1290)
- Deleting LAD elements (Page 1292)

## Cutting LAD elements

### Requirement

An LAD element is available.

### Cutting

To cut a LAD element, follow these steps:

1. Right-click the LAD element that you want to cut.
2. Select "Cut" in the shortcut menu.

### Result

The LAD element will be cut and saved to the clipboard.

### See also

Selecting LAD elements (Page 1285)

Copying LAD elements (Page 1286)

Pasting an LAD element from the clipboard (Page 1287)

Replacing LAD elements (Page 1288)

Inserting additional inputs and outputs in LAD elements (Page 1289)

Removing inputs and outputs (Page 1290)

Enabling and disabling the EN/ENO mechanism (Page 1290)

Deleting LAD elements (Page 1292)

## Pasting an LAD element from the clipboard

### Requirement

An LAD element is available.

### Procedure

To paste an LAD element from the clipboard, follow these steps:

1. Copy a LAD element or cut a LAD element.
2. Right-click the point in the network where you want to paste the element.
3. Select "Paste" in the shortcut menu.

## See also

- Selecting LAD elements (Page 1285)
- Copying LAD elements (Page 1286)
- Cutting LAD elements (Page 1287)
- Replacing LAD elements (Page 1288)
- Inserting additional inputs and outputs in LAD elements (Page 1289)
- Removing inputs and outputs (Page 1290)
- Enabling and disabling the EN/ENO mechanism (Page 1290)
- Deleting LAD elements (Page 1292)

## Replacing LAD elements

You can easily exchange LAD elements with other LAD elements of the same type. This has the advantage that the parameters are retained and need not be entered again. For example, you can exchange normally open contacts and normally closed contacts or RS FlipFlop and SR FlipFlop.

## Requirements

A network with at least one LAD element is present.

## Procedure

To replace an LAD element with another LAD element, follow these steps:

1. Select the LAD element that you want to replace.
2. Position the cursor over the triangle in the top right-hand corner of the LAD element.  
A drop-down list is displayed.
3. From the drop-down list, select the LAD element that you want to use to replace the existing LAD element.

## See also

- Selecting LAD elements (Page 1285)
- Copying LAD elements (Page 1286)
- Cutting LAD elements (Page 1287)
- Pasting an LAD element from the clipboard (Page 1287)
- Inserting additional inputs and outputs in LAD elements (Page 1289)
- Removing inputs and outputs (Page 1290)
- Enabling and disabling the EN/ENO mechanism (Page 1290)
- Deleting LAD elements (Page 1292)



## Inserting additional inputs and outputs in LAD elements

### Introduction

You can expand LAD elements which execute commutative arithmetic instructions by adding additional inputs. Such elements are, for example, the instructions "Add" (ADD) and "Multiply" (MUL). You can expand the MOVE and DEMUX instruction boxes by adding additional outputs.

### Requirement

An LAD element is available that permits the insertion of additional inputs and outputs.

### Inserting an additional input

To add an additional input to the box of a LAD element, follow these steps:

1. Right-click on an existing input of the LAD element.
2. Select "Insert input" in the shortcut menu.  
An additional input is added to the box of the LAD element.

Or:

1. Click on the yellow star symbol beside the last input in the instruction box.  
An additional input is added to the box of the LAD element.

### Inserting an additional output

To add an additional output to the box of a LAD element, follow these steps:

1. Right-click on an existing output of the LAD element.
2. Select "Insert output" from the shortcut menu.  
An additional output is added to the box of the LAD element.

Or:

1. Click on the yellow star symbol beside the last input in the instruction box.  
An additional output is added to the box of the LAD element.

### See also

- Selecting LAD elements (Page 1285)
- Copying LAD elements (Page 1286)
- Cutting LAD elements (Page 1287)
- Pasting an LAD element from the clipboard (Page 1287)
- Replacing LAD elements (Page 1288)
- Removing inputs and outputs (Page 1290)
- Enabling and disabling the EN/ENO mechanism (Page 1290)
- Deleting LAD elements (Page 1292)

## Removing inputs and outputs

### Introduction

Inputs and outputs which you have added to an instruction can be removed.

### Requirement

An LAD element is available to which you have added additional inputs and outputs.

### Remove input

To remove an input, follow these steps:

1. Select the input that you want to remove.
2. Select the "Delete" command in the shortcut menu.  
The input of the LAD element is removed.

### Remove output

To remove an output, follow these steps:

1. Select the output that you want to remove.
2. Select the "Delete" command in the shortcut menu.  
The output of the LAD element will be removed.

### See also

Selecting LAD elements (Page 1285)

Copying LAD elements (Page 1286)

Cutting LAD elements (Page 1287)

Pasting an LAD element from the clipboard (Page 1287)

Replacing LAD elements (Page 1288)

Inserting additional inputs and outputs in LAD elements (Page 1289)

Enabling and disabling the EN/ENO mechanism (Page 1290)

Deleting LAD elements (Page 1292)

## Enabling and disabling the EN/ENO mechanism

In LAD and FBD, certain instructions have an enable output ENO and thus use the EN/ENO mechanism. This allows you to query runtime errors in instructions and react to them. In order to increase the performance of the CPU, the EN/ENO mechanism is disabled in the default setting. This means that you are not initially able to react to runtime errors of the instruction

using the ENO value. However, you can enable the EN/ENO mechanism again at any time, if required.

You can enable the EN/ENO mechanism individually for each instruction in order to generate the ENO. If you enable the EN/ENO mechanism for an instruction, other instructions that you subsequently add to your program are also inserted with the EN/ENO mechanism enabled. You can disable the EN/ENO mechanism again at any time if you do not want to use the evaluation of ENO for an instruction. Further instructions that you subsequently add to your program will then be inserted without the EN/ENO mechanism.

See also: Basics of the EN/ENO mechanism (Page 1167)

### **Activating the EN/ENO mechanism**

Proceed as follows to activate the EN/ENO mechanism of an instruction:

1. In your program, right-click the instruction at which you want to activate the EN/ENO mechanism.
2. Select the "Generate ENO" command from the shortcut menu.  
The ENO value is again generated for the instruction. Other instructions are inserted with the enable output.

### **Deactivating the EN/ENO mechanism**

Proceed as follows to deactivate the EN/ENO mechanism of an instruction:

1. In your program, right-click the instruction at which you want to deactivate the EN/ENO mechanism.
2. Select the "Do not generate ENO" command from the shortcut menu.  
The ENO value is no longer generated for the instruction. Other instructions are inserted without enable output.

### **See also**

- Selecting LAD elements (Page 1285)
- Copying LAD elements (Page 1286)
- Cutting LAD elements (Page 1287)
- Pasting an LAD element from the clipboard (Page 1287)
- Replacing LAD elements (Page 1288)
- Inserting additional inputs and outputs in LAD elements (Page 1289)
- Removing inputs and outputs (Page 1290)
- Deleting LAD elements (Page 1292)

## Deleting LAD elements

### Requirement

An LAD element is available.

### Procedure

To delete a LAD element, follow these steps:

1. Right-click the LAD element that you want to delete.
2. Select the "Delete" command in the shortcut menu.

### See also

Selecting LAD elements (Page 1285)

Copying LAD elements (Page 1286)

Cutting LAD elements (Page 1287)

Pasting an LAD element from the clipboard (Page 1287)

Replacing LAD elements (Page 1288)

Inserting additional inputs and outputs in LAD elements (Page 1289)

Removing inputs and outputs (Page 1290)

Enabling and disabling the EN/ENO mechanism (Page 1290)

## Inserting operands into LAD instructions

### Inserting operands

The character strings "<???", "<??.>" and "..." are inserted as placeholders for the parameters when an LAD element is inserted. The "<???", "<??.>" strings displayed in red indicate parameters that need to be connected. The "..." string displayed in black indicates parameters that may be connected. "<??.>" stands for Boolean placeholders.

---

#### Note

If you position the cursor over the placeholder, the expected data type will be displayed.

---

### Requirement

An LAD element is available.

## Procedure

To connect the parameters of a LAD element, follow these steps:

1. Double-click the placeholder of the parameter.  
An entry field opens, and the placeholder is selected.
2. Enter the appropriate parameter.

---

### Note

If you enter the absolute address of a parameter that has already been defined, this absolute address will be changed to the symbolic name of the parameter as soon as the input is confirmed. If you have not yet defined the parameter, a new tag with this absolute address and the default name "Tag\_<n>" will be entered in the PLC tag table. When you confirm your input, the absolute address will be replaced with the symbolic name "Tag\_<n>".

---

3. Confirm the parameter with the Enter key.
4. If you have not yet defined the parameter, you can define it directly in the program editor using the shortcut menu.  
See also:  
Declaring PLC tags in the program editor (Page 1181)  
Declaring local tags in the program editor (Page 1245)

Or drag from it the PLC tag table:

1. In the project tree, select the "PLC tags" folder or open the PLC tag table.
2. If you have opened the PLC tag table, drag the symbol from the first column of the desired tag to the appropriate place in your program. If you have not opened the PLC tag table yet, open the detail view now. Drag the desired tag from the detail view to the appropriate place in your program.

Or drag from it the block interface:

1. Open the block interface.
2. Drag the required operand from the block interface to the instruction window.

## Result

- If the syntax is error-free, the displayed parameter is black. The editor then jumps to the next placeholder.
- If there is an error in the syntax, the cursor stays in the entry field and a corresponding error message is displayed in the status line. If you press the Enter key again, the entry field is closed and the faulty entry is displayed in red italics.

## Wiring hidden parameters

### Introduction

Depending on the CPU used, you can use complex instructions in your program that are dispatched with the TIA portal. These instructions can contain parameters that are declared as hidden.

If an instruction contains hidden parameters, the instruction box has a small arrow on the lower edge. You can recognize hidden parameters by their white font.

You can show and wire the hidden parameters at any time.

### Showing or hiding hidden parameters

To show or hide hidden parameters, follow these steps:

1. Click on the down arrow at the bottom edge of the instruction box to show hidden parameters.
2. Click on the up arrow at the bottom edge of the instruction box to hide hidden parameters.

## Wiring hidden parameters

To wire parameters, follow these steps:

1. Wire the hidden parameters like normally visible parameters.  
The hidden parameter is transformed into a visible parameter.

### See also

Using libraries (Page 338)

## Displaying or hiding variable information

### Introduction

You can display the following information about the tags to be used in the programming editor:

- Name of the tags
- Address of the tags
- Comments to document the tags

The information is taken from the block interface for local tags and DB tags and from the PLC tag table for tags that are valid CPU-wide.

You can display the tag information either for all the blocks or for individually opened blocks. If you display the tag information for all the blocks, the tag information for all the blocks currently opened and opened in future is shown.

You can hide the tag information at any time again. If you hidden the tag information for all the blocks, you display it again for individual ones that are opened.

## Displaying or hiding tag information for all the blocks

Proceed as follows to display or hide the tag information for all the blocks:

1. Select the "Settings" command in the "Options" menu.  
The "Settings" window is displayed in the work area.
2. In the area navigation, select the "PLC programming" group.
3. If you want to display the tag information activate the check box "With tag information" in the "View" section. If you want to hide the tag information, clear the "With tag information" check box.  
The tag information is displayed or hidden for all the blocks. When you open further blocks, the tag information is displayed or not displayed depending on the selected setting.

## Displaying or hiding tag information for an opened block

Proceed as follows to display or hide the tag information for an opened block:

1. Activate or deactivate the "Tag information" check box in the menu "View > Display with" or click the "Tag information on/off" button in the toolbar.  
The tag information is displayed or hidden.

## Branches in LAD

### Basic information on branches in LAD

#### Definition

You use branches to program parallel circuits with the Ladder Logic (LAD) programming language. Branches are inserted in the main rung. You can insert several contacts into the branch and thus achieve a parallel circuit of series connections. This allows you to program complex ladder logic.

The figure below shows an example of the use of branches:

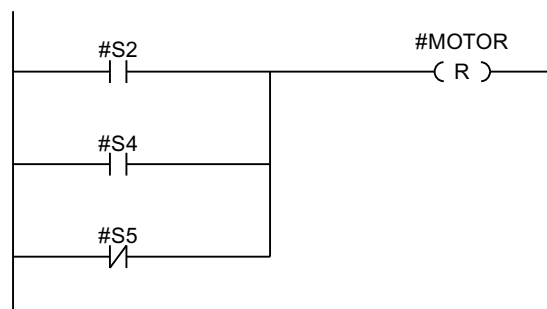

MOTOR carries signal 1, if one of the following conditions is fulfilled:

- Signal 1 is pending on S2 or S4
- Signal 0 is pending on S5.

## See also

- Rules for branches in LAD (Page 1296)
- Inserting branches into the LAD network (Page 1296)
- Closing branches in the LAD network (Page 1297)
- Deleting branches in LAD networks (Page 1297)

## Rules for branches in LAD

### Rules

The following rules apply to simultaneous branches:

- A simultaneous branch can only be inserted if the main branch already contains an LAD element.
- Simultaneous branches are opened downwards or are connected directly to the power rail. They are terminated upwards.
- Simultaneous branches are opened after the selected LAD element.
- Simultaneous branches are terminated after the selected LAD element.
- To delete a simultaneous branch, you must delete all LAD elements of this branch. When the last LAD element is removed from the branch, the rest of the branch is also removed.

## See also

- Basic information on branches in LAD (Page 1295)
- Inserting branches into the LAD network (Page 1296)
- Deleting branches in LAD networks (Page 1297)
- Closing branches in the LAD network (Page 1297)

## Inserting branches into the LAD network

You can create several branches in a network.

### Requirement

- A network is available.
- The network contains elements.



## Procedure

To insert a new branch in a network, follow these steps:

1. Open the "Instructions" task card.
2. Navigate to "General > Open branches" in the "Simple instructions" palette.
3. Use drag-and-drop to move the element to the desired place in the network.  
If you want to connect the new branch directly to the power rail, drag the element to the power rail.

## See also

Basic information on branches in LAD (Page 1295)

Rules for branches in LAD (Page 1296)

Deleting branches in LAD networks (Page 1297)

## Closing branches in the LAD network

Branches must be closed again at suitable places. If necessary, branches will be arranged so that they do not cross each other.

## Requirement

A branch is available.

## Procedure

To close an open branch, follow these steps:

1. Select the open branch.
2. Press and hold down the left mouse button.  
A dashed line will appear as soon as the cursor is moved.
3. Drag the dashed line to a suitable place on the network. Permissible connections are indicated by green lines.
4. Release the left mouse button.

## See also

Basic information on branches in LAD (Page 1295)

Rules for branches in LAD (Page 1296)

## Deleting branches in LAD networks

## Requirement

A branch is available.

### Procedure

To delete a branch, follow these steps:

1. Select the connection line that links the branch to the main branch.
2. Select the "Delete" command in the shortcut menu.

### See also

Basic information on branches in LAD (Page 1295)

Rules for branches in LAD (Page 1296)

Inserting branches into the LAD network (Page 1296)

### Crossings in LAD

#### Basic information on crossings in LAD

#### Definition

A crossing is a place in a LAD network where one branch is closed and at the same time another branch is opened.

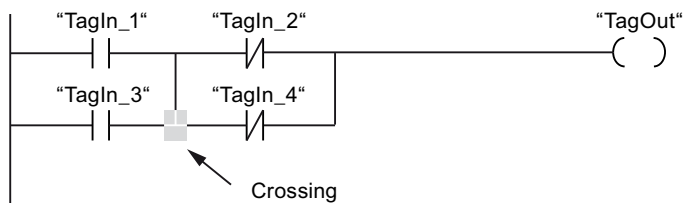

"TagOut" receives signal 1, if the following two conditions are met:

- "TagIn\_1" or "TagIn\_3" has signal 1
- "TagIn\_2" or "TagIn\_4" has signal 0

#### Inserting crossings

You can insert crossings in a LAD network by creating connections between the main branch and an additional branch or between different branches.

#### Requirements

A branch is available.

## Procedure

To insert a new crossing in an LAD network, follow these steps:

1. Open the "Instructions" task card.
2. Navigate to "General > Open branches" in the "Simple instructions" palette.
3. Drag the element behind the existing branch.
4. Insert any element into the open branch.
5. Click the arrow of the open branch after the inserted element.
6. Hold down the left mouse button and drag the dashed connecting line to the main branch.
7. Release the left mouse button.

## See also

Rearranging crossings (Page 1299)

Deleting crossings (Page 1300)

Inserting branches into the LAD network (Page 1296)

## Rearranging crossings

### Requirement

A crossing is available.

## Procedure

To rearrange a connection, follow these steps:

1. Select the connection line that defines the crossings in the respective branches.
2. Select the "Delete" command in the shortcut menu.
3. Open the "Instructions" task card.
4. Navigate to "General > Open branches" in the "Simple instructions" palette.
5. Use a drag-and-drop operation to move the element to the place in the network where you want to insert the new crossing.
6. Click on the arrow for the open branch.
7. Hold down the left mouse button and drag the dashed connecting line to the subsidiary branch in which you wish to insert the new crossing.
8. Release the left mouse button.

**See also**

Inserting crossings (Page 1298)

Deleting crossings (Page 1300)

**Deleting crossings**

**Requirement**

A crossing is available.

**Procedure**

To delete a crossing, follow these steps:

1. Select the connection line that defines the crossings in the respective branches.
2. Select the "Delete" command in the shortcut menu.

**See also**

Inserting crossings (Page 1298)

Rearranging crossings (Page 1299)

**Rungs in LAD**

**Basic information on rungs in LAD**

**Using rungs**

The program is mapped in one or more networks. A network contains a power rail on the left where one or more rungs originate. The binary signal scans are arranged in the form of contacts on the rungs. The serial arrangement of the elements on a rung creates a series connection; arrangement on simultaneous branches creates a parallel connection. A rung is closed by a coil or a box in which the result of logic operation will be written.

The figure below shows an example of the use of several rungs within a network:

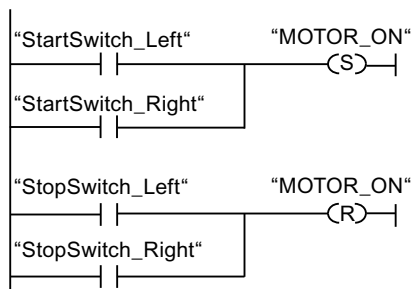

## Rules

Remember the following rules when using several rungs:

- Connections are not permitted between rungs.
- Only one jump instruction is permissible per network. The positioning rules for jump instructions remain valid.

## Running rungs

Rungs and networks are executed from top to bottom and from left to right. This means that the first instruction in the first rung of the first network is processed first. All instructions of this rung are then processed. After this come all other rungs of the first network. The next network is processed only after all rungs have first been run.

## Differences between branches and rungs

The difference between branches and rungs is that the rungs are independent branches that can also stand in a different network. Branches, on the other hand, permit the programming of a parallel connection.

## See also

Insert rung (Page 1301)

Deleting a rung (Page 1302)

## Insert rung

### Requirement

- A block is open.
- A network is available.

### Procedure

To insert a new rung in a network, proceed as follows:

1. Insert any coil on the power rail.  
A new rung will be inserted and the coil positioned at the end of the rung.
2. Insert additional instructions in the new rung.

## See also

Basic information on rungs in LAD (Page 1300)

Deleting a rung (Page 1302)

## Deleting a rung

### Requirement

A rung is available.

### Procedure

To delete a rung, proceed as follows:

1. Hold down the left mouse button and draw a frame around the rung. At the same time, make sure that you select all instructions. Alternatively, you can hold down the <Shift> key and select the first the last instruction of the rung.
2. Right-click on one of the instructions in the rung.
3. Select the "Delete" command in the shortcut menu.

### See also

Basic information on rungs in LAD (Page 1300)

Insert rung (Page 1301)

## Creating FBD programs

### Basic information on FBD

### FBD programming language

### Overview of the Function Block Diagram (FBD) programming language

FBD is a graphical programming language. The representation is based on electronic circuit systems.

The program is mapped in one or more networks. A network contains one or more logic operation paths. The binary signal scans are linked by boxes. The representation of the logic is based on the graphical logic symbols used in Boolean algebra.

### Example of networks in FBD

The following figure shows an FBD network with AND and OR boxes and an assignment:

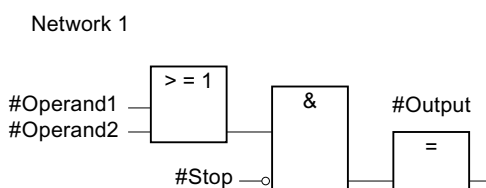

## Overview of the FBD elements

### FBD elements

An FBD program consists of separate elements that are linked by means of a binary signal flow. Most program elements must be supplied with tags.

A FBD network is programmed from left to right.

For example, the following figure shows elements of an FBD network:

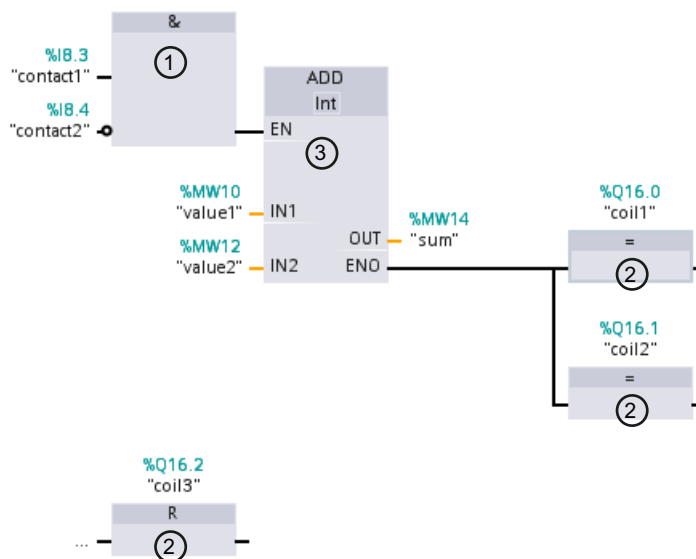

- 1) Binary function
- 2) Standard box
- 3) Complex box

### Binary functions

You can use binary functions to query binary operands and to combine their signal states. The following operations are examples of binary functions: "AND operation", "OR operation" and "EXCLUSIVE OR operation".

### Standard boxes:

You can use standard boxes to control binary operands, perform RLO edge detection or execute jump functions in the program. Standard boxes generally have only one single input.

### Complex boxes

Complex boxes represent program elements with complex functions. The empty box is an exception. You can use the empty box as a placeholder in which you can select the required instruction.

The following types of boxes are available to you in an FBD program:

- **Complex boxes without EN/ENO mechanism:**  
A box is executed independently of the signal state at the box inputs. The error status of the processing cannot be queried.
- **Complex boxes with EN/ENO mechanism:**  
A box is only executed if the enable input "EN" has the signal state "1". If the box is processed correctly, the "ENO" enable output has signal state "1". If an error occurs during processing, the "ENO" output is reset.  
If the EN enable input is not interconnected, the box is always executed.

Calls of code block are also shown in the network as complex boxes with EN/ENO mechanism.

### Settings for FBD

#### Overview of the settings for FBD

#### Overview

The following table shows the settings that you can make:

Group	Setting	Description
Font	Font size	Font size in program editor
View	Layout	Compact or wide Changes the vertical spacing between operands and other objects (such as operand and contact). The change becomes visible once the block is reopened.
	With absolute information	Additional display of the absolute addresses
Operand field	Maximum width	Maximum number of characters that can be entered horizontally in the operand field. This setting recalculates the layout of the networks.
	Maximum height	Maximum number of characters that can be entered vertically in the operand field. This setting recalculates the layout of the networks.



## See also

Changing the settings (Page 1305)

## Changing the settings

### Procedure

To change the settings, follow these steps:

1. Select the "Settings" command in the "Options" menu.  
The "Settings" window is displayed in the work area.
2. In the area navigation, select the "PLC programming" group.
3. Change the settings.

### Result

The change will be loaded directly, there is no need to save it explicitly.

## See also

Overview of the settings for FBD (Page 1304)

## Working with networks

### Using networks

### Function

The user program is created in the block within networks. For a code block to be programmed, it must contain at least one network. To achieve a better overview of the user program, you can also subdivide your program into several networks.

## See also

Entering the network title (Page 1309)

Entering a network comment (Page 1310)

Navigating networks (Page 1311)

## Inserting networks

### Requirement

A block is open.

## Procedure

To insert a new network, follow these steps:

1. Select the network after which you want to insert a new network.
2. Select the "Insert network" command in the shortcut menu.

## Result

A new empty network is inserted into the block.

## See also

Entering the network title (Page 1309)

Entering a network comment (Page 1310)

Navigating networks (Page 1311)

## Selecting networks

### Requirements

A network is available.

### Selecting a network

To select a network, follow these steps:

1. Click the title bar of the network that you want to select.

### Selecting several networks

Proceed as follows to select several individual networks:

1. Press and hold down the <Ctrl> key.
2. Click all the networks that you want to select.

To select several successive networks, follow these steps:

1. Press and hold down the <Shift> key.
2. Click the first network that you want to select.
3. Click the last network that you want to select.  
The first and last networks and all those in between are selected.

## See also

Inserting networks (Page 1305)  
Entering the network title (Page 1309)  
Entering a network comment (Page 1310)  
Navigating networks (Page 1311)

## Copying and pasting networks

Copied networks can be pasted within the block or in another block. Networks that were created in LAD or FBD can also be inserted in blocks of the respective other programming language.

## Requirement

A network is available.

## Procedure

To copy and paste a network, follow these steps:

1. Select the network or networks to be copied.
2. Select "Copy" in the shortcut menu.
3. Select the network after which you want to paste in the copied network.
4. Select "Paste" in the shortcut menu.

## See also

Inserting networks (Page 1305)  
Selecting networks (Page 1306)  
Entering the network title (Page 1309)  
Entering a network comment (Page 1310)  
Navigating networks (Page 1311)

## Deleting networks

## Requirement

A network is available.

## **Procedure**

To delete a network, follow these steps:

1. Select the network that you want to delete.
2. Select the "Delete" command in the shortcut menu.

## **See also**

Inserting networks (Page 1305)

Selecting networks (Page 1306)

Copying and pasting networks (Page 1307)

Entering the network title (Page 1309)

Entering a network comment (Page 1310)

Navigating networks (Page 1311)

## **Expanding and collapsing networks**

### **Requirements**

A network is available.

### **Opening and closing a network**

To open a network, follow these steps:

1. Click on the right arrow in the network title bar.

To close a network, follow these steps:

1. Click on the down arrow in the network title bar.

### **Opening and closing all networks**

To open and close all networks, follow these steps:

1. In the toolbar, click "Open all networks" or "Close all networks".

### **See also**

- Inserting networks (Page 1305)
- Selecting networks (Page 1306)
- Copying and pasting networks (Page 1307)
- Deleting networks (Page 1307)
- Entering the network title (Page 1309)
- Entering a network comment (Page 1310)
- Navigating networks (Page 1311)

### **Entering the network title**

The network title is the header of a network. The length of the network title is limited to one line.

### **Requirement**

A network is available.

### **Procedure**

To enter a network title, follow these steps:

1. Click on the title bar of the network.
2. Enter the network title.

## See also

- Using networks (Page 1305)
- Inserting networks (Page 1305)
- Selecting networks (Page 1306)
- Copying and pasting networks (Page 1307)
- Deleting networks (Page 1307)
- Expanding and collapsing networks (Page 1308)
- Entering a network comment (Page 1310)
- Navigating networks (Page 1311)

## Entering a network comment

You can use network comments to provide comments on the program contents of individual networks. For example, you can indicate the function of the network or draw attention to special characteristics.

## Requirement

A network is available.

## Procedure

To enter a network comment, follow these steps:

1. Click on the right arrow before the network title.
2. If the comment area is not visible, click "Network comments on/off" in the toolbar.  
The comment area is displayed.
3. Click "Comment" in the comment area.  
The "Comment" text passage is selected.
4. Enter the network comment.

## See also

Using networks (Page 1305)  
Inserting networks (Page 1305)  
Selecting networks (Page 1306)  
Copying and pasting networks (Page 1307)  
Deleting networks (Page 1307)  
Expanding and collapsing networks (Page 1308)  
Entering the network title (Page 1309)  
Navigating networks (Page 1311)

## Navigating networks

You can navigate straight to a specific position within a block.

## Procedure

To navigate to a specific position within a block, follow these steps:

1. Right-click in the code area of the programming window.
2. Select the "Go to > Network/line" command in the shortcut menu.  
The "Go to" dialog will open.
3. Enter the network to which you want to navigate.
4. Enter the line number of the network to which you want to navigate.
5. Confirm your entry with "OK".

## Result

The relevant line will be displayed if this is possible. If the network or line requested does not exist, the last existing network or the last existing line in the network requested will be displayed.

## See also

Using networks (Page 1305)  
Inserting networks (Page 1305)  
Selecting networks (Page 1306)  
Copying and pasting networks (Page 1307)  
Deleting networks (Page 1307)  
Expanding and collapsing networks (Page 1308)  
Entering the network title (Page 1309)  
Entering a network comment (Page 1310)

## Inserting FBD elements

### Rules for the use of FBD elements

#### Rules

Note the following rules when inserting FBD elements:

- An FBD network can consist of several elements. All elements of a logic path must be linked to each other according to IEC 61131-3.
- Standard boxes (flip flops, counters, timers, math operations, etc.) can be added as output to boxes with binary logic operations (for example, AND, OR). Comparison boxes are excluded from this rule.
- Only Boolean inputs in an instruction can be combined with preceding logic operations.
- Only the bottom Boolean output in an instruction can be combined with an additional logic operation.
- Enable input EN or enable output ENO can be connected to boxes, but this is not mandatory.
- Constants (for example, TRUE or FALSE) cannot be assigned to binary logic operations. Instead, use tags of the BOOL data type.
- Only one jump instruction can be inserted in each network.
- Only one jump label can be inserted in each network.
- Instructions for positive or negative RLO edge detection may not be arranged right at the left of the network as this requires a prior logic operation.

#### Placement rules for S7-1200/1500 CPUs

The following table sets out the instructions that can only be positioned at the end of the network:

Instruction		Preceding logic operation required
Mnemonics	Name	
SET_BF	Set bit field	No
RESET_BF	Reset bit field	No
JMP	Jump if RLO = 1	No
JMPN	Jump if RLO = 0	Yes
JMP_LIST	Define jump list	No
SWITCH	Jump distributor	No
RET	Return	No



### Placement rules for S7-300/400 CPUs

The following table sets out the instructions that can only be positioned at the end of the network:

Instruction		Preceding logic operation required
Mnemonics	Name	
S	Set output	Yes
R	Reset output	Yes
SP	Start pulse timer	Yes
SE	Start extended pulse timer	Yes
SD	Start on-delay timer	Yes
SS	Start retentive on-delay timer	Yes
SF	Start off-delay timer	Yes
SC	Set counter value	Yes
CU	Count up	Yes
CD	Count down	Yes
JMP	Jump if RLO = 1	No
JMPN	Jump if RLO = 0	Yes
RET	Return	No
OPN	Open global data block	No
OPNI	Open instance data block	No
CALL	Call block	No
SAVE	Save RLO in BR bit	No
MCRA	Enable MCR range	No
MCRD	Disable MCR range	No
MCR<	Open MCR ranges	No
MCR>	Close MCR ranges	No

### Inserting FBD elements using the "Instructions" task card

#### Requirement

A network is available.

## Procedure

To insert FBD elements into a network using the "Instructions" task card, follow these steps:

1. Open the "Instructions" task card.
2. Navigate to the FBD element that you want to insert.
3. Use drag-and-drop to move the element to the desired place in the network.  
If the element is an internal system function block (FB), the "Call options" dialog opens. In this dialog you can create an instance data block of the single-instance or multiple-instance type for the function block in which the data of the inserted element will be saved. You will find the new instance data block created in the project tree in the "Program resources" folder under "Program blocks > System blocks". If you have selected "multiple instance", these are located in the block interface in the "Static" section.

Or:

1. Select the point in the network at which you want to insert the element.
2. Open the "Instructions" task card.
3. Double-click on the element you want to insert.  
If the element is an internal system function block (FB), the "Call options" dialog opens. In this dialog you can create an instance data block of the single-instance or multiple-instance type for the function block in which the data of the inserted element will be saved. You will find the new instance data block created in the project tree in the "Program resources" folder under "Program blocks > System blocks". If you have selected "multiple instance", these are located in the block interface in the "Static" section.

## Result

The selected FBD element is inserted with dummy entries for the parameters.

## See also

Rules for the use of FBD elements (Page 1312)

## Inserting FBD elements using an empty box

### Requirement

A network is available.

### Procedure

To insert FBD elements into a network using an empty box, follow these steps:

1. Open the "Instructions" task card.
2. Navigate to "General > Empty box" in the "Basic instructions" palette.
3. Use a drag-and-drop operation to move the "Empty box" element to the desired place in the network.

4. Position the cursor over the triangle in the top right-hand corner of the empty box. A drop-down list is displayed.
5. Select the desired FBD element from the drop-down list.  
If the element is an internal system function block (FB), the "Call options" dialog opens. In this dialog you can create an instance data block of the single-instance or multiple-instance type for the function block in which the data of the inserted element will be saved. You will find the new instance data block created in the project tree in the "Program resources" folder under "Program blocks > System blocks". If you have selected "multi-instance", these are located in the block interface in the "Static" section.

## Result

The empty box is changed to the respective FBD element. Placeholders are inserted for the parameters.

## Selecting the data type of an FBD element

### Selecting a data type

#### Introduction

Some instructions can be executed with several different data types. If you use one of these instructions in the program, you have to specify a valid data type for the instruction at the specific point in the program. For some instructions, you have to select the data types for the inputs and outputs separately.

---

#### Note

The valid data type (BOOL) for the tags on the enable input EN and the enable output ENO is predefined by the system and cannot be changed.

---

The valid data types for an instruction are listed in the instruction drop-down list. You specify the data type of the instruction by selecting an entry from the drop-down list. If the data type of an operand differs from the data type of the instruction and cannot be converted implicitly, the operand is displayed in red and a rollout with the corresponding error message appears.

## Data type selection of mathematical instructions

Some mathematical instructions provide you with the option of having the data type automatically set corresponding to the data types of the operand. In the drop-down list for data type selection, these instructions have the entry "Auto" in addition to the actual data types. If you select this entry and then allocate the first operand, the data type of the operand is selected as data type for the instruction. The entry in the drop-down list changes to "Auto (<Data type>)",

## 9.1 Creating a user program

e.g. "Auto (Real)". If you allocate additional operands, the automatically set data type of the instruction is adjusted according to the following criteria:

- You supply all other operands with tags of the same data type:  
The data type of the instruction is not changed.
- You supply all other operands with tags whose data type is smaller than the data type of the instruction:  
The data type of the instruction is not changed. For the operand with the smaller data type, an implicit conversion is conducted if necessary.
- You supply an additional operand with a tag whose data type is greater than the data type of the instruction:  
The data type of the instruction is changed to the larger data type. An implicit conversion is performed, if necessary, for operands that deviate from the newly set data type of the instruction.

Each change in the data type of an operand can result in a change of the data type of the instruction. Other operands may possibly be implicitly converted as a result. Operands for which an implicit conversion is performed are marked with a gray square.

---

### Note

Please also observe the information on data type conversion for your device and, in particular, the notes on the IEC check.

See also: Data type conversion

---

### See also

Defining the data type of an instruction (Page 1316)

## Defining the data type of an instruction

### Introduction

Some instructions can be executed with several different data types. When you insert such instructions into your program, you must specify the data type for these instructions at the actual point in the program.

### Specifying the data type by means of the drop-down list

To define the data type of an instruction using the drop-down list, follow these steps:

1. Insert the instruction at the required point in the program using drag-and-drop.  
The entry "???" (undefined) is displayed in the drop-down list of the inserted instruction.
2. Click the triangle in the upper corner of the drop-down list.  
The drop-down list will open to display the data types valid for the instruction.

3. Select a data type from the drop-down list.  
The selected data type is displayed.
4. If the instruction has two drop-down lists, select the data type for the instruction inputs in the left-hand drop-down list and the data type for the instruction outputs in the right-hand drop-down list.

### **Specifying data type by assigning tags**

To define the data type of an instruction by assigning tags, follow these steps:

1. Insert the instruction at the required point in the program using drag-and-drop.  
The entry "???" (undefined) is displayed in the drop-down list of the inserted instruction.
2. At an input or output, specify a valid tag, the data type of which is to be applied as the instruction data type.  
The data type of the tag is displayed in the drop-down list.
3. Enter a valid tag at an input and a valid tag at an output if data types need to be defined for both the inputs and outputs of the instruction. The tag specified at the input determines the data type of the inputs; the tag specified at the output determines the data type of the outputs of the instruction.

### **Automatically specifying the data type of mathematical instructions**

To automatically specify the data type for mathematical instructions, follow these steps:

1. Insert the mathematical instruction at the required point in the program using drag-and-drop.  
The entry "???" (undefined) is displayed in the drop-down list of the inserted instruction.
2. Select the "Auto" entry from the drop-down list.
3. Enter a valid tag at an input or output.  
The data type of the tag is applied as data type of the instruction. The entry in the drop-down list changes to "Auto (<Data type>".

See also: [Selecting a data type \(Page 1315\)](#)

### **See also**

[Selecting a data type \(Page 1315\)](#)

### **Using favorites in FBD**

#### **Adding FBD elements to Favorites**

#### **Requirement**

- A block is open.
- The multipane mode is set for the "Instructions" task card or the Favorites are also displayed in the editor.

## Procedure

To add SCL instructions to the Favorites, follow these steps:

1. Open the "Instructions" task card.
2. Maximize the "Basic instructions" pane.
3. Navigate in the "Basic instructions" pane to the instruction that you want to add to the Favorites.
4. Drag-and-drop the instruction into the "Favorites" pane or into the Favorites area in the program editor.

---

### Note

To additionally display the Favorites in the program editor, click the "Display favorites in the editor" button in the program editor toolbar.

---

## See also

Removing FBD elements from Favorites (Page 1319)

Overview of the program editor (Page 1219)

## Inserting FBD elements using favorites

### Requirement

- A block is open.
- Favorites are available.

## Procedure

To insert an instruction into a program using Favorites, follow these steps:

1. Drag-and-drop the desired instruction from Favorites to the desired position.

Or:

1. Select the position in the program where you want to insert the instruction.
2. In the Favorites, click on the instruction you want to insert.

---

### Note

To additionally display the Favorites in the program editor, click the "Display favorites in the editor" button in the program editor toolbar.

---

## See also

Overview of the program editor (Page 1219)  
Removing FBD elements from Favorites (Page 1319)

## Removing FBD elements from Favorites

### Requirement

A code block is open.

### Procedure

To remove instructions from Favorites, follow these steps:

1. Right-click on the instruction you want to remove.
2. Select the "Remove instruction" command in the shortcut menu.

---

#### Note

To additionally display the Favorites in the program editor, click the "Display favorites in the editor" button in the program editor toolbar.

---

## See also

Adding FBD elements to Favorites (Page 1317)  
Inserting FBD elements using favorites (Page 1318)  
Overview of the program editor (Page 1219)

## Inserting block calls in FBD

### Inserting block calls using a drag-and-drop operation

You can insert calls for existing functions (FC) and function blocks (FB) using a drag-and-drop operation from the project tree. If you call function blocks from other function blocks, you can either call them as single-instance or multi-instance blocks. If a function block is called as single instance, it will store its data in a data block of its own. If a function block is called as multi-instance, it will store its data in the instance data block of the calling function block.

### Requirement

- A network is available.
- The block that is to be called is available.

### Inserting a call of a function (FC)

To insert a call of a function (FC) into a network using a drag-and-drop operation, follow these steps:

1. Drag the function from the project tree to the required network.

### Inserting a call for a function block (FB)

To insert a call for a function block (FB), follow these steps:

1. Drag the function block from the project tree to the required network.  
The "Call options" dialog opens.
2. Enter in the dialog whether you wish to call the block as single or multi-instance.
  - If you click on the "Single instance" button, you will have to enter a name in the "Name" text box for the data block that you want to assign to the function block.
  - If you click on the "Multi-instance" button, you will have to enter the name of the tag in the "Name in the interface" text box; this is the name that you use to enter the called function block as a static tag in the interface of the calling block.
3. Confirm your entries with "OK".

### Result

The function or the function block is inserted with its parameters. You can then assign the parameters.

See also: Auto-Hotspot

---

#### Note

If when calling a function block you specify an instance data block that does not exist, it will be created. If you have called a function block as a multi-instance, this will be entered as a static tag in the interface.

---

### See also

Updating block calls in FBD (Page 1320)

Changing the instance type (Page 1321)

Single instances (Page 1035)

Multi-instances (Page 1035)

### Updating block calls in FBD

If interface parameters of a called block are changed, the block call can no longer be executed correctly. You can avoid such inconsistent block calls by updating the block calls.

You have two options to update the block calls:



- Explicit updating in the program editor.  
The block calls in the open block will be updated.
- Implicit updating during compilation.  
All block calls in the program as well as the used PLC data types will be updated.

### **Update blocks in the program editor**

To update a block call within a block, follow these steps:

1. Open the block in the program editor.
2. Click "Update inconsistent block calls" in the toolbar.

Or:

1. Open the block in the program editor.
2. Right-click on the instruction with the block call.
3. Select the "Update" command in the shortcut menu.  
The "Interface update" dialog opens. This dialog shows the differences between the block interface in use and the changed interface of the called block.
4. If you want to update the block call, click "OK". To cancel the update, click "Cancel".

### **Update block calls during compilation**

Follow these steps to update all block calls and uses of PLC data types during compilation implicitly:

1. Open the project tree.
2. Select the "Program blocks" folder.
3. Select the command "Compile > Software (rebuild all blocks)" in the shortcut menu.

### **See also**

Inserting block calls using a drag-and-drop operation (Page 1319)

Changing the instance type (Page 1321)

### **Changing the instance type**

#### **Instance type**

There are two ways of calling function blocks:

- As a single instance
- As a multiple instance

See also: Auto-Hotspot

You can modify a defined instance type at any time.

## Requirement

The user program contains a block call.

## Procedure

To change the instance type of a function block, follow these steps:

1. Open the code block and select the block call.
2. Select the "Change instance" command in the shortcut menu.  
The "Call options" dialog opens.
3. Click the "Single instance" or "Multi instance" button.
  - If you select the "Single instance" instance type, enter a name for the data block that is to be assigned to the function block.
  - If you select "Multiple instance" as the instance type, enter in the "Name in the interface" text field the name of the tag with which the called function block is to be entered as a static tag in the interface of the calling block.
4. Confirm your entries with "OK".

---

### Note

The previous single and multiple instances will not be deleted automatically.

---

## See also

Inserting block calls using a drag-and-drop operation (Page 1319)

Updating block calls in FBD (Page 1320)

## Inserting complex FBD instructions

### Using the "Calculate" instruction

#### Requirement

A network is available.

#### Procedure

Proceed as follows to use the "Calculate" instruction:

1. Open the "Instructions" task card.
2. Navigate to "Math functions > CALCULATE" in the "Basic instructions" pane.

3. Use drag-and-drop to move the element to the desired place in the network.  
The instruction "Calculate" will be inserted for the data type with a placeholder expression and question mark.
4. Enter the data type for the calculation.
5. Enter the operands for the calculation.

---

**Note**

The calculation is run with the inputs of the "Calculate" instruction. If you want to use constants you must also insert appropriate inputs for them.

---

6. Click on the "Edit 'Calculate' instruction" button to replace the placeholder expression with the correct expression.  
The "Edit 'Calculate' instruction" dialog will open.
7. Enter the required expression in the "OUT:=" text box.

---

**Note**

In the "Example" area you can find an example of a valid expression and possible instructions that you can use.

To determine a value with the help of Pythagoras' theorem, for example, enter "OUT := SQRT (SQR (IN1) + SQR (IN2))".

---

8. Confirm your entry with "OK".

**See also**

CALCULATE: Calculate (Page 1935)

**Using free-form comments**

**Basic information on using free comments in FBD**

**Introduction**

Free-form comments allow you to add comments to the source code for graphic programming languages similar to line comments for textual languages.

Free-form comments can be used for all non-binary boxes.

**See also**

Inserting free-form comments (Page 1324)

Editing free-form comments (Page 1324)

Deleting free-form comments (Page 1325)

## Inserting free-form comments

### Requirement

A network with instructions is available.

### Procedure

To insert a free comment on an instruction, proceed as follows:

1. If necessary, activate the "Free-form comments on/off" button in the toolbar.
2. Right-click on the instruction for which you want to insert a free-form comment.
3. Select the "Insert comment" command in the shortcut menu.  
A comment box with a standard comment opens. The comment box is connected by an arrow to the corresponding instruction.
4. Enter the required comment in the comment box.

### See also

Basic information on using free comments in FBD (Page 1323)

Editing free-form comments (Page 1324)

Deleting free-form comments (Page 1325)

## Editing free-form comments

### Introduction

Free-form comments can be edited as follows:

- Changing the comment text
- Changing the position and size of the comment box
- Attaching a comment to another element
- Showing and hiding free comments

### Changing the comment text

To change the text of free-form comments, follow these steps:

1. Click on the comment box.
2. Enter the desired text.

### **Changing the position of the comment box**

To change the positioning of the comment box, follow the steps below:

1. Left-click the comment box and keep the mouse button pressed.
2. Drag the comment box to the desired location.

### **Changing the size of the comment box**

To change the size of the comment box, follow the steps below:

1. Click on the comment box.
2. Drag the comment box on the move handle in the lower right corner to the desired size.

### **Attaching a comment to another element**

To attach a free-form comment to another element, follow these steps:

1. Left-click the point of the arrow that links the comment box with the instruction and keep the mouse button pressed.
2. Drag the arrow to the element to which you want to attach the comment. Possible insertion points are marked with a green square.
3. Release the mouse button.

### **Showing and hiding free comments**

To show or hide a free-form comments, follow these steps:

1. Click the "Free-form comment on/off" button in the toolbar.

### **See also**

Basic information on using free comments in FBD (Page 1323)

Inserting free-form comments (Page 1324)

Deleting free-form comments (Page 1325)

### **Deleting free-form comments**

#### **Procedure**

To delete a free-form comment, proceed as follows:

1. Right-click on the free-form comment that you want to delete.
2. Select the "Delete" command in the shortcut menu.

## See also

Basic information on using free comments in FBD (Page 1323)

Inserting free-form comments (Page 1324)

Editing free-form comments (Page 1324)

## Editing FBD elements

### Selecting FBD elements

You can select several individual elements or all elements in a network.

### Requirement

FBD elements are available

### Selecting several individual FBD elements

To select several individual FBD elements, follow these steps:

1. Press and hold down the <Ctrl> key.
2. Click on all the FBD elements you wish to select.
3. Now release the <Ctrl> key.

### Selecting all FBD elements in a network

To select all FBD elements in a network, follow these steps:

1. Go to the network whose elements you wish to select.
2. Select the "Select all" command in the "Edit" menu or press <Ctrl+A>.

## See also

Copying FBD elements (Page 1327)

Cutting FBD elements (Page 1327)

Pasting an FBD element from the clipboard (Page 1328)

Replacing FBD elements (Page 1328)

Adding additional inputs and outputs to FBD elements (Page 1329)

Removing instruction inputs and outputs (Page 1330)

Enabling and disabling the EN/ENO mechanism (Page 1331)

Deleting FBD elements (Page 1332)

## Copying FBD elements

### Requirement

An FBD element is available.

### Procedure

To copy an FBD element, follow these steps:

1. Right-click the FBD element that you want to copy.
2. Select "Copy" in the shortcut menu.

### Result

The FBD element will be copied and saved to the clipboard.

### See also

Selecting FBD elements (Page 1326)

Cutting FBD elements (Page 1327)

Pasting an FBD element from the clipboard (Page 1328)

Replacing FBD elements (Page 1328)

Adding additional inputs and outputs to FBD elements (Page 1329)

Removing instruction inputs and outputs (Page 1330)

Enabling and disabling the EN/ENO mechanism (Page 1331)

Deleting FBD elements (Page 1332)

## Cutting FBD elements

### Requirement

An FBD element is available.

### Cutting

To cut an FBD element, follow these steps:

1. Right-click the FBD element that you want to cut.
2. Select "Cut" in the shortcut menu.

### Result

The FBD element will be cut and saved to the clipboard.

### See also

- Selecting FBD elements (Page 1326)
- Copying FBD elements (Page 1327)
- Pasting an FBD element from the clipboard (Page 1328)
- Replacing FBD elements (Page 1328)
- Adding additional inputs and outputs to FBD elements (Page 1329)
- Removing instruction inputs and outputs (Page 1330)
- Enabling and disabling the EN/ENO mechanism (Page 1331)
- Deleting FBD elements (Page 1332)

### Pasting an FBD element from the clipboard

#### Requirement

An FBD element is available.

#### Procedure

To paste an FBD element from the clipboard, follow these steps:

1. Copy an FBD element or cut an FBD element.
2. Right-click the point in the network where you want to paste the element.
3. Select "Paste" in the shortcut menu.

### See also

- Selecting FBD elements (Page 1326)
- Copying FBD elements (Page 1327)
- Cutting FBD elements (Page 1327)
- Replacing FBD elements (Page 1328)
- Adding additional inputs and outputs to FBD elements (Page 1329)
- Removing instruction inputs and outputs (Page 1330)
- Enabling and disabling the EN/ENO mechanism (Page 1331)
- Deleting FBD elements (Page 1332)

### Replacing FBD elements

You can easily exchange FBD elements with other FBD elements of the same type. This has the advantage that the parameters are retained and need not be entered again. For example, you can exchange OR and AND, RS-FlipFlop and SR-FlipFlop, comparison functions or jump instructions.



## Requirements

A network with at least one FBD element is present.

## Procedure

To replace an FBD element with another FBD element, follow these steps:

1. Select the FBD element that you want to replace.  
If elements compatible with the selected FBD element are available, a triangle will appear in the upper right-hand corner of the element.
2. Position the cursor above the triangle of the FBD element.  
A drop-down list is displayed.
3. From the drop-down list, select the FBD element that you want to use to replace the existing FBD element.

## See also

Selecting FBD elements (Page 1326)  
Copying FBD elements (Page 1327)  
Cutting FBD elements (Page 1327)  
Pasting an FBD element from the clipboard (Page 1328)  
Adding additional inputs and outputs to FBD elements (Page 1329)  
Removing instruction inputs and outputs (Page 1330)  
Enabling and disabling the EN/ENO mechanism (Page 1331)  
Deleting FBD elements (Page 1332)

## Adding additional inputs and outputs to FBD elements

### Introduction

You can expand several FBD elements with additional inputs that execute arithmetic or binary operations. Such elements are, for example, the instructions "Add" (ADD), "Multiply" (MUL), AND or OR. You can expand the "MOVE value" (MOVE) and "Demultiplex" (DEMUX) instruction boxes by adding additional outputs.

The name of the new inputs and outputs is comprised of the type of inserted element and a consecutive number. The name of a new input is may be "IN2"; the name of a new output may be "OUT2".

## Requirements

An FBD element is available that permits the insertion of additional inputs and outputs.

### Inserting an additional input

To add an additional input to the box of an FBD element, follow these steps:

1. Right-click on an existing input of the FBD element.
2. Select "Insert input" in the shortcut menu.  
An additional input is added to the box of the FBD element.

Or:

1. Click on the yellow star symbol beside the last input in the instruction box.  
An additional input is added to the box of the FBD element.

### Inserting an additional output

To add an additional output to the box of an FBD element, follow these steps:

1. Right-click on an existing output of the FBD element.
2. Select "Insert output" from the shortcut menu.  
An additional output is added to the box of the FBD element.

Or:

1. Click on the yellow star symbol beside the last output of the instruction box.  
An additional output is added to the box of the FBD element.

### See also

Selecting FBD elements (Page 1326)

Copying FBD elements (Page 1327)

Cutting FBD elements (Page 1327)

Pasting an FBD element from the clipboard (Page 1328)

Replacing FBD elements (Page 1328)

Removing instruction inputs and outputs (Page 1330)

Enabling and disabling the EN/ENO mechanism (Page 1331)

Deleting FBD elements (Page 1332)

### Removing instruction inputs and outputs

#### Introduction

Inputs and outputs which you have added to an instruction can be removed.

#### Requirement

An FBD element is available, which you have expanded with additional inputs or outputs.

## Remove input

To remove an input, follow these steps:

1. Select the input that you want to remove.
2. Select the "Delete" command in the shortcut menu.  
The input of the FBD element is removed.

## Remove output

To remove an output, follow these steps:

1. Select the output that you want to remove.
2. Select the "Delete" command in the shortcut menu.  
The output of the FBD element will be removed.

## See also

Selecting FBD elements (Page 1326)  
Copying FBD elements (Page 1327)  
Cutting FBD elements (Page 1327)  
Pasting an FBD element from the clipboard (Page 1328)  
Replacing FBD elements (Page 1328)  
Adding additional inputs and outputs to FBD elements (Page 1329)  
Enabling and disabling the EN/ENO mechanism (Page 1331)  
Deleting FBD elements (Page 1332)

## Enabling and disabling the EN/ENO mechanism

In LAD and FBD, certain instructions have an enable output ENO and thus use the EN/ENO mechanism. This allows you to query runtime errors in instructions and react to them. In order to increase the performance of the CPU, the EN/ENO mechanism is disabled in the default setting. This means that you are not initially able to react to runtime errors of the instruction using the ENO value. However, you can enable the EN/ENO mechanism again at any time, if required.

You can enable the EN/ENO mechanism individually for each instruction in order to generate the ENO. If you enable the EN/ENO mechanism for an instruction, other instructions that you subsequently add to your program are also inserted with the EN/ENO mechanism enabled. You can disable the EN/ENO mechanism again at any time if you do not want to use the evaluation of ENO for an instruction. Further instructions that you subsequently add to your program will then be inserted without the EN/ENO mechanism.

See also: Basics of the EN/ENO mechanism (Page 1167)

### Activating the EN/ENO mechanism

Proceed as follows to activate the EN/ENO mechanism of an instruction:

1. In your program, right-click the instruction at which you want to activate the EN/ENO mechanism.
2. Select the "Generate ENO" command from the shortcut menu.  
The ENO value is again generated for the instruction. Other instructions are inserted with the enable output.

### Deactivating the EN/ENO mechanism

Proceed as follows to deactivate the EN/ENO mechanism of an instruction:

1. In your program, right-click the instruction at which you want to deactivate the EN/ENO mechanism.
2. Select the "Do not generate ENO" command from the shortcut menu.  
The ENO value is no longer generated for the instruction. Other instructions are inserted without enable output.

### See also

Selecting FBD elements (Page 1326)

Copying FBD elements (Page 1327)

Cutting FBD elements (Page 1327)

Pasting an FBD element from the clipboard (Page 1328)

Replacing FBD elements (Page 1328)

Adding additional inputs and outputs to FBD elements (Page 1329)

Removing instruction inputs and outputs (Page 1330)

Deleting FBD elements (Page 1332)

### Deleting FBD elements

#### Requirement

An FBD element is available.

#### Procedure

To delete an FBD element, follow these steps:

1. Right-click the FBD element that you want to delete.
2. Select the "Delete" command in the shortcut menu.

## See also

Selecting FBD elements (Page 1326)  
Copying FBD elements (Page 1327)  
Cutting FBD elements (Page 1327)  
Pasting an FBD element from the clipboard (Page 1328)  
Replacing FBD elements (Page 1328)  
Adding additional inputs and outputs to FBD elements (Page 1329)  
Removing instruction inputs and outputs (Page 1330)  
Enabling and disabling the EN/ENO mechanism (Page 1331)

## Inserting operands in FBD instructions

### Inserting operands

The character strings "<???", "<??.>" and "..." are inserted as placeholders for the parameters when a FBD element is inserted. The "<???", "<??.>" strings displayed in red indicate parameters that need to be connected. The "..." string displayed in black indicates parameters that may be connected. "<??.>" stands for Boolean placeholders.

---

#### Note

To display the available data types in a tooltip, move the cursor over the placeholder.

---

### Requirement

An FBD element is available.

### Procedure

To connect the parameters of an FBD element, follow these steps:

1. Click the placeholder of the parameter.  
An input field is opened.
2. Enter the corresponding parameters, for example a PLC tag, a local tag or a constant.

---

#### Note

If you enter the absolute address of a parameter that has already been defined, this absolute address will be changed to the symbolic name of the parameter as soon as the input is confirmed. If you have not yet defined the parameter, a new tag with this absolute address and the default name "Tag\_1" will be entered in the PLC tag table. When you confirm your input, the absolute address will be replaced with the symbolic name "Tag\_1".

---

### 9.1 Creating a user program

3. Confirm the parameter with the Enter key.
4. If you have not yet defined the parameter, you can define it directly in the program editor using the shortcut menu.  
See also: "Declaring PLC tags in the program editor (Page 1181)".

Or drag from it the PLC tag table:

1. In the project tree, select the "PLC tags" folder and open the PLC tag table.
2. If you have opened the PLC tag table, drag the desired tag to the corresponding location in your program. If you have not opened the PLC tag table yet, open the detail view now. Drag the desired tag from the detail view to the appropriate place in your program.

Or drag from it the block interface:

1. Open the block interface.
2. Drag the desired operand from the block interface to the corresponding location in your program.

### Result

- If the syntax is error-free, the displayed parameter is black.
- If there is an error in the syntax, the cursor stays in the input field and a corresponding error message is displayed in the inspector window in the "Info > Syntax" register.

### Wiring hidden parameters

#### Introduction

Depending on the CPU used, you can use complex instructions in your program that are dispatched with the TIA portal. These instructions can contain parameters that are declared as hidden.

If an instruction contains hidden parameters, the instruction box has a small arrow on the lower edge. You can recognize hidden parameters by their white font.

You can show and wire the hidden parameters at any time.

#### Showing or hiding hidden parameters

To show or hide hidden parameters, follow these steps:

1. Click on the down arrow at the bottom edge of the instruction box to show hidden parameters.
2. Click on the up arrow at the bottom edge of the instruction box to hide hidden parameters.

## Wiring hidden parameters

To wire parameters, follow these steps:

1. Wire the hidden parameters like normally visible parameters.  
The hidden parameter is transformed into a visible parameter.

## See also

Using libraries (Page 338)

## Displaying or hiding variable information

### Introduction

You can display the following information about the tags to be used in the programming editor:

- Name of the tags
- Address of the tags
- Comments to document the tags

The information is taken from the block interface for local tags and DB tags and from the PLC tag table for tags that are valid CPU-wide.

You can display the tag information either for all the blocks or for individually opened blocks. If you display the tag information for all the blocks, the tag information for all the blocks currently opened and opened in future is shown.

You can hide the tag information at any time again. If you hidden the tag information for all the blocks, you display it again for individual ones that are opened.

### Displaying or hiding tag information for all the blocks

Proceed as follows to display or hide the tag information for all the blocks:

1. Select the "Settings" command in the "Options" menu.  
The "Settings" window is displayed in the work area.
2. In the area navigation, select the "PLC programming" group.
3. If you want to display the tag information activate the check box "With tag information" in the "View" section. If you want to hide the tag information, clear the "With tag information" check box.  
The tag information is displayed or hidden for all the blocks. When you open further blocks, the tag information is displayed or not displayed depending on the selected setting.

### Displaying or hiding tag information for an opened block

Proceed as follows to display or hide the tag information for an opened block:

1. Activate or deactivate the "Tag information" check box in the menu "View > Display with" or click the "Tag information on/off" button in the toolbar.  
The tag information is displayed or hidden.

### Branches in FBD

#### Basic information on branches in FBD

#### Definition

You can use the Function Block Diagram (FBD) programming language to program parallel branches. This is done using branches that are inserted between the boxes. You can insert additional boxes within the branch and in this way build up complex function block diagrams.

The figure below shows an example of the use of branches:

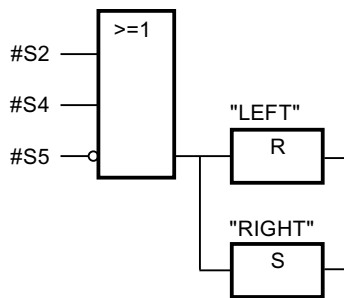

#### See also

- Rules for branches in FBD (Page 1336)
- Inserting branches in FBD networks (Page 1337)
- Deleting branches in FBD networks (Page 1337)

### Rules for branches in FBD

#### Rules

The following rules apply to the use of branches in FBD:

- Branches are opened downward.
- Branches can be inserted only between FBD elements.
- To delete a branch, you must delete all FBD elements, including the branch itself.
- If you delete the connection between two branches, the FBD elements of the interrupted branch will be positioned freely in the network.



## See also

- Basic information on branches in FBD (Page 1336)
- Inserting branches in FBD networks (Page 1337)
- Deleting branches in FBD networks (Page 1337)

## Inserting branches in FBD networks

### Requirement

A network is available.

### Procedure

To insert a new branch in a network, follow these steps:

1. Open the "Instructions" task card.
2. Navigate to "General > Branch" in the "Basic instructions" palette.
3. Drag the element from the "Elements" pane to the a required location on a connection line between two boxes.

## See also

- Rules for branches in FBD (Page 1336)
- Basic information on branches in FBD (Page 1336)
- Deleting branches in FBD networks (Page 1337)

## Deleting branches in FBD networks

### Requirement

A branch is available.

### Procedure

To delete a branch, follow these steps:

1. Select the connection line that links the branch to the main branch.
2. Select the "Delete" command in the shortcut menu.

### Result

The branch is now deleted. Boxes connected to the deleted branch are placed freely within the network.

**See also**

- Rules for branches in FBD (Page 1336)
- Basic information on branches in FBD (Page 1336)
- Inserting branches in FBD networks (Page 1337)

**Logic paths in FBD**

**Basic information on logic paths in FBD**

**Use of logic paths**

The user program will be mapped in one or more networks. The networks can contain one or more logic paths on which the binary signals are arranged in the form of boxes.

The following figure shows an example of the use of several logic paths within a network:

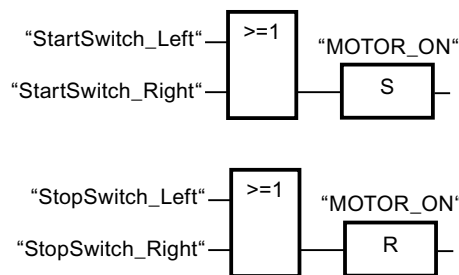

**Rules**

Remember the following rules when using logic paths:

- Connections are not permitted between logic paths.
- Only one jump instruction is permissible per network. The positioning rules for jump instructions remain valid.

**Executing logic paths**

Logic paths are executed from top to bottom and from left to right. This means that the first instruction in the first logic path of the first network is executed first. All instructions of this logic path are then executed. After this come all other logic paths of the first network. The next network is executed only after all logic paths have first been executed.

When jumps are used the regular execution of the logic paths is circumvented and the instruction is executed at the jump destination.

## Differences between branches and logic paths

The difference between branches and logic paths is that the logic paths are independent branches that can also stand in a different network. Branches, on the other hand, permit the programming of a parallel connection and have a common preceding logic operation.

## See also

Inserting a logic path (Page 1339)

Deleting a logic operation path (Page 1339)

## Inserting a logic path

### Requirement

- A block is open.
- A network is available.

### Procedure

To insert a new logic path in a network, follow these steps:

1. Insert any instruction in a network in such a way that it has no connection to existing instructions.  
A new logic path is inserted.
2. Insert an assignment at the end of the new logic path.
3. Insert additional instructions in the new logic path.

## See also

Basic information on logic paths in FBD (Page 1338)

Deleting a logic operation path (Page 1339)

## Deleting a logic operation path

### Requirement

A logic path is available.

## Procedure

To delete a logic path, proceed as follows:

1. Hold down the left mouse button and draw a frame around the logic path. At the same time, make sure that you select all instructions of the logic path. Alternatively, you can hold down the <Shift> key and select the first the last instruction of the logic path.
2. Right-click on one of the instructions in the logic path.
3. Select the "Delete" command in the shortcut menu.

## See also

Basic information on logic paths in FBD (Page 1338)

Inserting a logic path (Page 1339)

## Creating SCL programs

### Basics of SCL

### Programming language SCL

### Programming language SCL

SCL (Structured Control Language) is a high-level programming language based on PASCAL. The language is based on DIN EN 61131-3 (international IEC 1131-3).

The standard standardizes programming languages for programmable logic controllers. The SCL programming language fulfills the PLCopen Basis Level of ST language (Structured Text) defined in this standard.

### Language elements

SCL also contains higher programming languages in addition to the typical elements of the PLC, such as inputs, outputs, timers or memory bits.

- Expressions
- Value assignments
- Operators

### Program control

SCL provides convenient instructions for controlling the program allowing you, for example, to create program branches, loops or jumps.

## Application

SCL is therefore particularly suitable for the following areas of application:

- Data management
- Process optimization
- Recipe management
- Mathematical / statistical tasks

## Expressions

### Description

Expressions are calculated during the runtime of the program and return a value. An expression consists of operands (such as constants, tags or function calls) and optionally out of operators (such as \*, /, + or -). Expressions can be linked together or nested within each other by operators.

### Evaluation order

The evaluation of the expression occurs in a specific order that is defined by the following factors:

- Priority of the operators involved
- Left-to-right order
- Brackets

### Types of expressions

The following expression types are available depending on the operator:

- Arithmetic expressions  
Arithmetic expressions consist of either a numerical value or combine two values or expressions with arithmetic operators.
- Relational expressions  
Relational expressions compare the values of two operands and yield a Boolean value. The result is TRUE if the comparison is true, and FALSE if it is not met.
- Logical expressions  
Logical expressions combine two operands with logical operators (AND, OR, XOR) or negating operands (NOT).

## How expressions are used

You can use the result of an expression in different ways:

- As a value assignment for a tag
- As as a condition for a control instruction
- As a parameter for a calling a block or instruction

## See also

Operators and operator precedence (Page 1347)

Arithmetic expressions (Page 1342)

Relational expressions (Page 1344)

Logical expressions (Page 1346)

## Arithmetic expressions

### Description

Arithmetic expressions consist of either a numerical value or combine two values or expressions with arithmetic operators.

Arithmetic operators can process the data types that are allowed in the CPU in use. If two operands are involved in the operation, the data type of the result is determined based on the following criteria:

- If both operands are integers with sign and have different lengths, the result receives the data type of the longer integer (e. g. INT + DINT = DINT).
- If both operands are integers without sign and have different lengths, the result receives the data type of the longer integer (e. g. USINT + UDINT = UDINT).
- If one operand is an integer with sign and the other integer is an operand without sign, the result receives the next larger data type with sign that covers the integer without sign (e. g. SINT + USINT = INT).  
You can only execute an operation with such operands if the IEC check is not set.

- If one operand is an integer and the other operand is a floating-point number, the result receives the data type of the floating-point number (e. g. INT + REAL = REAL).
- If both operands are floating-point numbers and have different lengths, the result receives the data type of the longer floating-point number (e. g. REAL + LREAL = LREAL).
- The data type of the result of an operation that involves operands of the data type groups "Times" and "Date and time" can be found in the table in section "Data types of arithmetic expressions".  
You cannot use data types of the data type groups "Times" and "Date and time" when the IEC check is set.

## Data types of arithmetic expressions

The following table shows the data types you can use in arithmetic expressions:

Operation	Operator	1st Operand	2nd Operand	Result
Power	**	Integer/floating-point number	Integer/floating-point number	Integer/floating-point number
Unary plus	+	Integer/floating-point number TIME, LTIME	-	Integer/floating-point number TIME, LTIME
Unary minus	-	Integer/floating-point number TIME, LTIME	-	Integer/floating-point number TIME, LTIME
Multiplication	*	Integer/floating-point number	Integer/floating-point number	Integer/floating-point number
		TIME, LTIME	Integer	TIME, LTIME
Division	/	Integer/floating-point number	Integer/floating-point number (not equal 0)	Integer/floating-point number
		TIME, LTIME	Integer	TIME, LTIME
Modulo function	MOD	Integer	Integer	Integer
Addition	+	Integer/floating-point number	Integer/floating-point number	Integer/floating-point number
		TIME	TIME	TIME
		TIME	DINT	TIME
		LTIME	TIME, LTIME	LTIME
		LTIME	LINT	LTIME
		TOD	TIME	TOD
		TOD	DINT	TOD
		LTOD	TIME, LTIME	LTOD
		LTOD	LINT	LTOD
		DATE	LTOD	DTL
		DATE	TOD	<ul style="list-style-type: none"> <li>• S7-300/400: DT</li> <li>• S7-1200/1500: DTL</li> </ul>
		DT	TIME	DT
		LDT	TIME, LTIME	LDT
DTL	TIME, LTIME	DTL		
Subtraction	-	Integer/floating-point number	Integer/floating-point number	Integer/floating-point number
		TIME	TIME	TIME
		TIME	DINT	TIME
		LTIME <sup>1)</sup>	TIME, LTIME	LTIME
		LTIME	LINT	LTIME
		TOD	TIME	TOD
			DINT	TOD

Operation	Operator	1st Operand	2nd Operand	Result
		LTOD	TIME, LTIME	LTOD
		LTOD	LINT	LTOD
		DATE	DATE	<ul style="list-style-type: none"> <li>• S7-300/400: TIME</li> <li>• S7-1200/1500: LTIME</li> </ul>
		DT	TIME	DT
		LDT	TIME, LTIME	LDT
		DTL	TIME, LTIME	DTL
		DTL	DTL	LTIME
<sup>1)</sup> Combinations between nanoseconds and milliseconds are not possible within expressions.				

For additional information on valid data types, refer to "See also".

### Example

The following example shows an arithmetic expression:

```
SCL
" MyTag1" := " MyTag2" * " MyTag3";
```

### See also

Expressions (Page 1341)

Operators and operator precedence (Page 1347)

### Relational expressions

#### Description

Relational expressions compare the values of two operands and yield a Boolean value. The result is TRUE if the comparison is true, and FALSE if it is not met.

Relational operators can process the data types that are allowed in the CPU in use. The data type of the result always is BOOL.

Note the following rules when forming relational expressions:

- All tags are comparable within the following data type groups:
  - Integers/floating-point numbers
  - Binary numbers
  - String
- With the following data types/data groups, only tags of the same type can be compared:
  - TIME, LTIME
  - Date and time



- The comparison of strings is based on the ASCII character set. The length of the tags and the numerical value of each ASCII character are used for the comparison.
- S5TIME tags are not permitted as comparison operands. An explicit conversion from S5TIME to TIME or LTIME is necessary.

### Data types of relational expressions

The following table shows the data types/data type groups you can use in relational expressions:

Operation	Operator	1st Operand	2nd Operand	Result
Compare for equal, not equal	=, <>	Integer/floating-point number	Integer/floating-point number	BOOL
		Binary number	Binary number	BOOL
		String	String	BOOL
		TIME, LTIME	TIME, LTIME	BOOL
		Date and time	Date and time	BOOL
Compare for less than, less than-equal to, greater than, greater than or equal to	<, <=, >, >=	Integer/floating-point number	Integer/floating-point number	BOOL
		Bit strings (S7-1200/1500 only)	Bit strings (S7-1200/1500 only)	BOOL
		String	String	BOOL
		TIME, LTIME	TIME, LTIME	BOOL
		Date and time	Date and time	BOOL

For additional information on valid data types, refer to "See also".

### Example

The following example shows a relational expression:

```

SCL
IF a > b THEN c:= a;
IF A > 20 AND B < 20 THEN C:= TRUE;
IF A<>(B AND C) THEN C:= FALSE;

```

#### Note

The comparison for STRING and DT are executed internally in the S7-300/400 by extended instructions. The following operands are not permitted for these functions:

- Parameter of a FC
- In-out parameter of an FB of type STRUCT or ARRAY

**See also**

Expressions (Page 1341)

Operators and operator precedence (Page 1347)

**Logical expressions**

**Description**

Logical expressions combine two operands with logical operators AND OR XOR or negating operands NOT.

Logical operators can process the data types that are allowed in the CPU in use. The result of a logical expression is of BOOL data type, if both operands are of BOOL data type. If at least one of both operands is a bit string, then the result is also a bit string and is determined by the type of the highest operand. For example, when you link a BYTE type operand to a WORD type operand, the result is type WORD.

To link a BOOL type operand with a bit string, you must first explicitly convert it to a bit string.

**Data types of logical expressions**

The following table shows the data types you can use in logical expressions:

Operation	Operator	1st Operand	2nd Operand	Result
Negation	NOT	BOOL	-	BOOL
AND logic operation	AND or &	BOOL	BOOL	BOOL
		Bit string	Bit string	Bit string
OR logic operation	OR	BOOL	BOOL	BOOL
		Bit string	Bit string	Bit string
EXCLUSIVE OR logic operation	XOR	BOOL	BOOL	BOOL
		Bit string	Bit string	Bit string

**Example**

The following example shows a logical expression:

```
SCL
IF "MyTag1" AND NOT "MyTag2" THEN c:=a;
MyTag:=ALPHA OR BETA;
```

**See also**

Expressions (Page 1341)

Operators and operator precedence (Page 1347)

## Operators and operator precedence

### Operators and their order of evaluation

Expressions can be linked together or nested within each other by operators.

The order of evaluation for expressions depends on the precedence of operators and brackets. The following basic rules apply:

- Arithmetic operators are evaluated before relational operators and relational operators are evaluated before logical operators.
- Operators with no precedence are evaluated according to their occurrence from left to right.
- Operations in brackets are evaluated first.

The following table provides an overview of the operators and their precedence:

Operator	Operation	Precedence
<b>Arithmetic expressions</b>		
+	Unary plus	2
-	Unary minus	2
**	Power	3
*	Multiplication	4
/	Division	4
MOD	Modulo function	4
+	Addition	5
-	Subtraction	5
<b>Relational expressions</b>		
<	Less than	6
>	Greater than	6
<=	Less than or equal	6
>=	Greater than or equal	6
=	Equal	7
<>	Not equal	7
<b>Logical expressions</b>		
NOT	Negation	3
AND or &	Boolean AND	8
XOR	Exclusive OR	9
OR	Boolean OR	10
<b>Miscellaneous operations</b>		
()	Brackets	1
:=	Assignment	11

### See also

Expressions (Page 1341)

## Value assignments

### Definition

You can use a value assignment to assign the value of an expression to a tag. On the left side of the assignment is the tag that takes the value of the expression on the right.

The name of a function can also be specified as an expression. The function is called by the value assignment and sends its return value back to the tag on the left.

The data type of value assignment is defined by the data type of the tag on the left. The data type of the expression on the right must match this type.

For additional information on compatibility and conversion of data types, refer to "See also".

### Value assignments for STRUCT data type or PLC data types

An entire structure can be assigned to another if the structures are identically organized and the data types as well as the names of the structural components match.

You can assign a tag, an expression or another structural element to an individual structural element.

### Value assignments for the ARRAY data type

An entire ARRAY can be assigned to another ARRAY if both the data types of the ARRAY elements as well as the ARRAY limits match.

You can assign a tag, an expression or another ARRAY element to an individual ARRAY element.

### Value assignments for the STRING data type

An entire STRING can be assigned to another STRING. If the assigned character string is longer than the string on the left, a warning is generated during compiling.

You can assign another STRING element to an individual STRING element.

### Value assignments for the ANY data type

You can assign a tag with the ANY data type only to the following objects:

- Input parameters or temporary local data of FBs that also have the data type ANY.
- Temporary local data of FCs that also have the data type ANY.

Note that you can only point to memory areas with "standard" access mode with the ANY pointer.

### Value assignments for the POINTER data type

You cannot use POINTER in value assignments in SCL.

## Examples

The following table shows examples for value assignments:

SCL	
"MyTag1" := "MyTag2";	(* Assignment of a tag*)
"MyTag1" := "MyTag2" * "MyTag3";	(* Assignment of an expression*)
"MyTag" := "MyFC"();	(* Call a function, which assigns its return value to the "MyTag" tag*)
#MyStruct.MyStructElement := "MyTag";	(* Assignment of a tag to a structure element*)
#MyArray[2] := "MyTag";	(* Assignment of a tag to an ARRAY element*)
"MyTag" := #MyArray[1,4];	(* Assignment of an ARRAY element to a tag*)
#MyString[2] := #MyOtherString[5];	(* Assignment of a STRING element to another STRING element*)

## See also

Operators and operator precedence (Page 1347)

## Settings for SCL

### Overview of the settings for SCL

#### Overview

The following tables show the settings you can make for SCL:

#### Editor settings

Group	Setting	Description
View	Keyword highlighting	Notation used to represent the keywords of the programming language. You can choose between uppercase and lowercase letters or a notation corresponding to the conventions of the Pascal programming language.

### Default settings for new blocks

If you create new blocks, the following settings are set as default values. You can change these in the block properties at a later point in time.

Group	Setting	Description
Compile	Create extended status information	Allows all tags in a block to be monitored. The memory requirements of the program and execution times increase, however, with this option.
	Check ARRAY limits <sup>1)</sup>	Checks at runtime whether array indices are within the declared range for an ARRAY. If an array index exceeds the permissible range, the enable output ENO of the block is set to "0".
	Set ENO automatically	Checks at runtime whether errors occur in the processing of certain instructions. If a runtime error occurs, the enable output ENO of the block is set to "0".

<sup>1)</sup>For CPUs of the S7-300/400 series: When the ARRAY limits are violated, the enable output ENO is set to FALSE.  
For CPUs of the S7-1200/1500 series: When the ARRAY limits are violated, the enable output ENO is not set to FALSE.  
See "Auto-Hotspot" for error query options.

### See also

Changing the settings (Page 1350)

### Changing the settings

#### Procedure

To change the settings, follow these steps:

1. Select the "Settings" command in the "Options" menu.  
The "Settings" window is displayed in the work area.
2. In the area navigation, select the "PLC programming" group.
3. Change the settings.

#### Result

The change will be loaded directly, there is no need to save it explicitly.

### See also

Overview of the settings for SCL (Page 1349)

## The programming window of SCL

### Overview of the programming window

#### Function

The programming window is the work area, where you enter the SCL program.

The following figure shows the programming window of SCL:

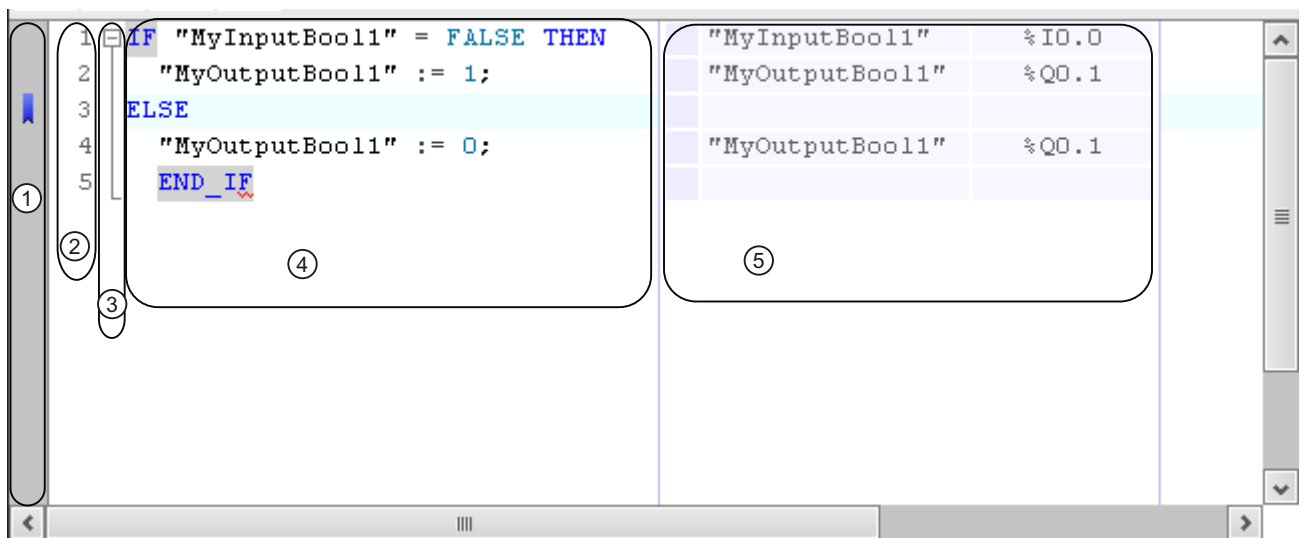

The programming window consists of the following sections:

Section	Meaning
① Sidebar	You can set bookmarks and breakpoints in the sidebar.
② Line numbers	The line numbers are displayed to the left of the program code.
③ Outline view	The outline view highlights related code sections.
④ Code area	You edit the SCL program in the code area.
⑤ Display of the absolute operands	This table shows the assignment of symbolic operands to absolute addresses.

#### See also

- Using bookmarks (Page 1354)
- Customizing the programming window (Page 1352)
- Indenting and outdenting lines (Page 1353)
- Expanding and collapsing sections of code (Page 1354)

## Customizing the programming window

### Introduction

You can customize the appearance of the programming window and the program code in the following way:

- By setting the font, size and color
- By setting the tab spacing
- By displaying the line numbers
- By showing or hiding the absolute operands

### Setting the font, size and color

To set the font, size and color, follow these steps:

1. Select the "Settings" command in the "Options" menu.  
The "Settings" window is displayed in the work area.
2. Select the "General > Script/text editors" group.
3. Select the desired font and font size or choose a font color for the individual language elements.

### Setting the tab spacing

To provide a better overview of the program, lines are indented according to syntax. Define the depth of indentation with the tab spacing.

To set the tab spacing, follow these steps:

1. Select the "Settings" command in the "Options" menu.  
The "Settings" window is displayed in the work area.
2. Select the "General > Script/text editors" group.
3. Set the tab spacing.

### Show line numbers

To display the line numbers, follow these steps:

1. Select the "Settings" command in the "Options" menu.  
The "Settings" window is displayed in the work area.
2. Select the "General > Script/text editors" group.
3. Select the "Show line numbers" option.

### Show or hide the absolute operands

You can show the assignment of symbolic and absolute operands in a table next to the program code, if required.



To hide or show the display of the absolute operands, follow these steps:

1. Click the "Absolute/symbolic operands" icon in the toolbar.  
The display of the absolute operands appears.
2. To move the display, click the table and drag it to the desired position while holding down the mouse button.
3. To change the width of the table, click on the right or left table border and drag it to the right or left while holding down the mouse button.

### **See also**

Using bookmarks (Page 1354)

Overview of the programming window (Page 1351)

Indenting and outdenting lines (Page 1353)

Expanding and collapsing sections of code (Page 1354)

## **Indenting and outdenting lines**

### **Introduction**

To provide a better overview of the program, lines are indented according to syntax. However, you can also manually indent individual lines.

### **Procedure**

To indent or outdent individual lines, follow these steps:

1. Press the "Indent text", "Outdent text" button into the toolbar of the programming editor.

---

#### **Note**

You can set the width of the indent in "Options > Settings".

---

### **See also**

Using bookmarks (Page 1354)

Overview of the programming window (Page 1351)

Customizing the programming window (Page 1352)

Expanding and collapsing sections of code (Page 1354)

## Expanding and collapsing sections of code

### Introduction

SCL instructions can span several lines. Examples for this are program control instructions or block calls.

These instructions are identified as follows:

- An outline view between the display line number and the program code marks the entire code section.
- When you select the opening keyword, the closing keyword is automatically highlighted.

### Procedure

To expand or collapse the code section, follow these steps:

1. Click the minus sign in the outline view.  
The code section closes.
2. Click the plus sign in the outline view.  
The code section opens.

### See also

Using bookmarks (Page 1354)

Overview of the programming window (Page 1351)

Customizing the programming window (Page 1352)

Indenting and outdenting lines (Page 1353)

## Using bookmarks

### Basics of bookmarks

### Function

You can use bookmarks to mark program locations in extensive programs so that you can find them quickly later if they need revising. Bookmarks are displayed in the sidebar of the programming window. You can navigate between multiple bookmarks within a block using menu commands.

Bookmarks are saved with the project and are therefore available for anyone who wants to edit the block. However, they are not loaded to a device.

Bookmarks are not evaluated when blocks are compared.

## See also

- Setting bookmarks (Page 1355)
- Navigating between bookmarks (Page 1355)
- Deleting bookmarks (Page 1356)

## Setting bookmarks

### Requirement

The SCL block is open.

### Procedure

To set a bookmark, follow these steps:

1. Right-click on the desired line in the sidebar.
2. Select the "Bookmarks > Set" command in the shortcut menu.

Or:

1. Click on the line in which you want to place the bookmark.
2. Click the "Set/delete bookmark" button in the toolbar.

Or:

1. Hold down the <Ctrl> key.
2. Click on the line in the sidebar in which you want to place the bookmark.

### Result

A bookmark is placed in the program code.

## See also

- Basics of bookmarks (Page 1354)
- Navigating between bookmarks (Page 1355)
- Deleting bookmarks (Page 1356)

## Navigating between bookmarks

### Requirement

Several bookmarks are set in a block.

## Procedure

To navigate between bookmarks, follow these steps:

1. Set the insertion cursor in the program code.
2. In the "Edit" menu, select the "Go to > Next bookmark" or "Go to > Previous bookmark" command.

Or:

1. Set the insertion cursor in the program code.
2. In the toolbar of the programming editor, click the "Go to next bookmark", "Go to previous bookmark" button.

Or:

1. Click in the sidebar.
2. Select the "Bookmarks > Next" or "Bookmarks > Previous" command in the shortcut menu.

## Result

The line with the bookmark is highlighted.

## See also

Basics of bookmarks (Page 1354)

Setting bookmarks (Page 1355)

Deleting bookmarks (Page 1356)

## Deleting bookmarks

You can delete individual bookmarks or all bookmarks from the block or the CPU.

### Deleting individual bookmarks

To delete an individual bookmark, follow these steps:

1. Right-click in the sidebar on the line in which you want to delete the bookmark.
2. Select the "Bookmarks > Remove" command in the shortcut menu.

Or:

1. Click on the line in which you want to delete the bookmark.
2. In the "Edit" menu, select the "Bookmarks > Remove" command.

Or:

1. Click on the line in which you want to delete the bookmark.
2. Click the "Set/delete bookmark" button in the toolbar.

## Deleting all bookmarks from the block

To delete all bookmarks from the block, follow these steps:

1. Right-click in the sidebar.
2. Select the "Bookmarks > Delete all from block" command in the shortcut menu.

Or:

1. In the "Edit" menu, select the "Bookmarks > Delete all from block" command.

## See also

Basics of bookmarks (Page 1354)

Setting bookmarks (Page 1355)

Navigating between bookmarks (Page 1355)

## Entering SCL instructions

## Rules for SCL instructions

## Instructions in SCL

SCL recognizes the following types of instructions:

- Value assignments  
Value assignments are used to assign a tag a constant value, the result of an expression or the value of another tag.
- Instructions for program control  
Instructions for program control are used to implement program branches, loops or jumps.
- Additional instructions from the "Instructions" task card  
The "Instructions" task card offers a wide selection of standard instructions that you can use in your SCL program.
- Block calls  
Block calls are used to call up subroutines that have been placed in other blocks and to further process their results.

## Rules

You need to observe the following rules when entering SCL instructions:

- Instructions can span several lines.
- Each instruction ends with a semicolon (;).

## 9.1 Creating a user program

- No distinction is made between upper and lower case.
- Comments serve only for documentation of the program. They do not affect the program execution.

### Examples

The following examples shows the various types of instructions:

```
SCL  
// Example of a value assignment  
"MyTag" := 0;  
// Example of a block call  
"MyDB"."MyFB" (ParamInput:= 10);  
// Example of a program control instruction  
WHILE "Counter" < 10 DO  
    "MyTAG" := "MyTag" + 2;  
END_WHILE;
```

### See also

Basics of SCL (Page 1340)

### Entering SCL instructions manually

#### Requirement

An SCL block is open.

#### Procedure

To enter SCL instructions, follow these steps:

1. Enter the syntax of the instruction using the keyboard.  
You are supported by the auto-complete function when performing this task. It offers all the instructions and operands that are allowed at the current location.
2. Select the required instruction or the desired operand from the auto-complete function.  
If you select an instruction that requires specification of operands, placeholders for the operands are inserted into the program. The placeholders for the operands are highlighted in yellow. The first placeholder is selected.
3. Replace this placeholder with an operand.
4. Use the <TAB> key to navigate to all other placeholders and replace them with operands.

---

#### Note

You can also drag-and-drop a defined operand from the PLC tag table or from the block interface into the program.

---

## Result

The instruction is inserted.

The programming editor performs a syntax check. Incorrect entries are displayed in red and italics. In addition, you also receive a detailed error message in the inspector window.

## See also

Expanding and reducing the parameter list (Page 1372)

## Inserting SCL instructions using the "Instructions" task card

The "Instructions" task card offers a wide selection of instructions that you can use in your SCL program. The SCL-specific instructions for program control are available in the "Instructions" task card.

## Requirement

An SCL block is open.

## Procedure

To insert SCL instructions into a program using the "Instructions" task card, follow these steps:

1. Open the "Instructions" task card.
  2. To insert the instruction, select one of the following steps:
    - Navigate to the SCL instruction you want to insert and drag-and-drop it to the required line in the program code. The insertion location is highlighted by a green rectangle.
    - Select the location in the program code where you want to insert the instruction and then double-click on the instruction you want to insert.
- The instruction is inserted in the program. The placeholders for the operands are highlighted in yellow. The first placeholder is selected.
3. Replace this placeholder with an operand. You can also drag a tag from the interface or the PLC tag table with drag-and-drop to the placeholder.
  4. Use the <TAB> key to navigate to all other placeholders and replace them with operands.

## Result

The instruction is inserted.

The programming editor performs a syntax check. Incorrect entries are displayed in red and italics. In addition, you also receive a detailed error message in the inspector window.

## See also

Expanding and reducing the parameter list (Page 1372)

## Defining the data type of an SCL instruction

### Basic information on the data types of SCL instructions

#### Introduction

The SCL instructions that you employ for block programming use specific data types to calculate function values. Certain SCL instructions only support the use of a specific data type. You cannot change the data type for these instructions. However, most of the SCL instructions support the use of different data types. We differentiate between the following two types of such instructions:

- Instructions for which the data type of the function value is determined by the data type of the input parameters. This is the case for most instructions.
- Instructions with default data type. The instructions listed in the following table are of this type.

You will have to change the default data type if this is incompatible with the data type of the input parameter used. You can always change the data type based on the following syntax:  
\_<data type>

#### SCL instructions with default data type

The following table lists the SCL instructions with default data types:

Instruction	Default data type
CEIL	DINT
DECO	DWORD
FLOOR	DINT
NORM_X	REAL
PEEK	BYTE
SCALE_X	INT
TRUNC	DINT
CONCAT	STRING

#### See also

[Changing the data type of an SCL instruction \(Page 1361\)](#)

[Example for changing the data type of an SCL instruction \(Page 1361\)](#)



## Changing the data type of an SCL instruction

### Procedure

Proceed as follows to insert an SCL instruction and change its data type:

1. Insert the instruction at the required point in the program using drag-and-drop.
2. Specify the operands for the instruction.  
The data type of the function value is specified based on the input parameters, or the default data type of the instruction is used.
3. Append the "\_<data type>" string to the instruction name.  
"<data type>" represents the data type you need for the instruction.

### See also

Basic information on the data types of SCL instructions (Page 1360)

Example for changing the data type of an SCL instruction (Page 1361)

## Modifying the data types of IEC timers and IEC counters

IEC timers and IEC counters are internal system function blocks and require an instance data block. You can create the instance data blocks either as single or multi-instance. The data type of the instance data block is determined according to the associated instruction. For CPUs of the S7-1200 and S7-1500 series, you can, however execute the instructions with different data types, depending on your requirements.

If the newly set data type of the instance data block does not match the data type of the input parameter, an implicit conversion takes place if possible. If the conversion is not possible, you will receive an error message.

### Procedure

To change the data type of an IEC timer or IEC-counter instance data block, proceed as follows:

1. Open the block in which you call the IEC timer or IEC counter.  
Depending on the instance type of the instance data block, there is a green-bordered box before (multi-instance) or after (single instance) the name of the instance data block.
2. Click the green-bordered box.  
A drop-down list box with the valid data types for the instance data block is opened.
3. Select the desired data type.

## Example for changing the data type of an SCL instruction

### Changing the default data type of instruction "Decode" (DECO)

Data type DINT is set as default if you insert the "Decode" instruction in the program.

### 9.1 Creating a user program

```
"Tag_Result" := DECO(IN := "Tag_Value");
```

Modify the program code as follows to convert the data type from DINT to BYTE:

```
"Tag_Result" := DECO_BYTE(IN := "Tag_Value");
```

#### See also

Basic information on the data types of SCL instructions (Page 1360)

Changing the data type of an SCL instruction (Page 1361)

### Using Favorites in SCL

#### Adding SCL instructions to the Favorites

##### Requirement

- A block is open.
- The multipane mode is set for the "Instructions" task card or the Favorites are also displayed in the editor.

##### Procedure

To add SCL instructions to the Favorites, follow these steps:

1. Open the "Instructions" task card.
2. Maximize the "Basic instructions" pane.
3. Navigate in the "Basic instructions" pane to the instruction that you want to add to the Favorites.
4. Drag-and-drop the instruction into the "Favorites" pane or into the Favorites area in the program editor.

---

##### Note

To additionally display the Favorites in the program editor, click the "Display favorites in the editor" button in the program editor toolbar.

---

#### See also

Inserting SCL instructions using Favorites (Page 1363)

Removing SCL instructions from the Favorites (Page 1363)

## Inserting SCL instructions using Favorites

### Requirement

- A block is open.
- Favorites are available.

### Procedure

To insert an instruction into a program using Favorites, follow these steps:

1. Drag-and-drop the desired instruction from Favorites to the desired position.

Or:

1. Select the position in the program where you want to insert the instruction.
2. In the Favorites, click on the instruction you want to insert.

---

#### Note

To additionally display the Favorites in the program editor, click the "Display favorites in the editor" button in the program editor toolbar.

---

### See also

Adding SCL instructions to the Favorites (Page 1362)

Removing SCL instructions from the Favorites (Page 1363)

## Removing SCL instructions from the Favorites

### Requirement

A code block is open.

### Procedure

To remove instructions from Favorites, follow these steps:

1. Right-click on the instruction you want to remove.
2. Select the "Remove instruction" command in the shortcut menu.

---

#### Note

To additionally display the Favorites in the program editor, click the "Display favorites in the editor" button in the program editor toolbar.

---

## See also

Adding SCL instructions to the Favorites (Page 1362)

Inserting SCL instructions using Favorites (Page 1363)

## Insert block calls in SCL

### Basic information on the block call in SCL

### Calling function blocks

#### Syntax of a call

The following syntax is used to call a function block as a single or multi-instance:

- Single instance:
  - If the function block originates from the project:  
    <DBName> (Parameter list)
  - If the function block originates from the "Instructions" task card:  
    <DB name>.<Instruction name> (Parameter list)
- Multi-instance  
    <#Instance name> (Parameter list)

#### Calling as single instance or multi-instance

Function blocks can be called either as a single instance or a multi-instance.

- Calling as a single instance  
    The called function block stores its data in a data block of its own.
- Calling as a multi-instance  
    The called function block stores its data in the instance data block of the calling function block.

For additional information on the types of calls, refer to "See also".

#### Parameter list

If you call another code block from a SCL block, you can supply the formal parameters of the called block with actual parameters.

The specification of the parameters has the form of a value assignment. This value assignment enables you to assign values (actual parameters) to the parameters you have defined in the called block.

The formal parameters of the called code block are listed in brackets directly after the call. Input and in-out parameters have the assignment identifier ":", output parameters have the assignment identifier "=". A placeholder placed after the parameter shows the required data type and the type of the parameter.

### Rules for supplying parameters

The following rules apply to supplying parameters:

- Constants, tags and expressions can be used as actual parameters.
- The assignment order is not of importance.
- The data types of formal and actual parameters must match.
- The individual assignments are separated by commas.
- If the called block has only one parameter, it is sufficient to specify the actual parameter in the brackets. The formal parameter need not be specified.

### See also

Manually inserting block calls (Page 1369)

Inserting block calls with drag-and-drop (Page 1370)

Examples for calling a function block in SCL (Page 1367)

### Calling functions

#### Syntax of a call

The following syntax is used to call a function:

```
<Function name> (Parameter list); //Standard call  
<Operand>:=<Function name> (Parameter list); // Call in an expression
```

#### Return value

The call options of functions depend on whether the function returns a return value to the calling block. The return value is defined at the RET\_VAL parameter. If the RET\_VAL parameter is of the VOID data type, then the function will not return a value to the calling block. If the RET\_VAL parameter has another data type, then the function returns a return value of this data type.

In SCL, all data types are permitted for the RET\_VAL parameter except ANY, ARRAY, STRUCT and VARIANT, as well as the parameter types TIMER and COUNTER.

## Call options

There are two possibilities for calling functions in SCL:

- Standard call for functions with and without a return value  
With a standard call, the results of the function is made available as an output and in-out parameter.
- Call in an expression for functions with a return value  
Functions that return a return value can be used in any expression in place of an operand, for example, in a value assignment.  
The function calculates the return value, which has the same name as the function and returns it to the calling block. There the value replaces the function call.  
After the call, the results of the function will be available as return value or as an output and in-out parameter.

## Parameter list

If you call another code block from a SCL block, you need to supply the formal parameters of the called block with actual parameters.

The specification of the parameters has the form of a value assignment. This value assignment enables you to assign values (actual parameters) to the parameters you have defined in the called block.

The formal parameters of the called code block are listed in brackets directly after the call. Input and in-out parameters have the assignment identifier ":", output parameters have the assignment identifier "=>". A gray placeholder placed after the parameter shows the required data type and the type of the parameter.

## Rules for supplying parameters

The following rules apply to supplying parameters to functions:

- All parameters of the function must be supplied.
- The assignment order is not of importance.
- Constants, tags and expressions can be used as actual parameters.
- The data types of formal and actual parameters must match.
- The individual assignments are separated by commas.
- If the called block has only one parameter, it is sufficient to specify the actual parameter in the brackets. The formal parameter need not be specified.
- When you call functions in SCL, you cannot use the release mechanism via EN. Use an IF statement instead to call functions conditionally.

## See also

Manually inserting block calls (Page 1369)  
Inserting block calls with drag-and-drop (Page 1370)  
Examples for calling functions in SCL (Page 1368)

## Examples for calling a function block in SCL

### Calling as a single instance

The following example shows the call of an FB as a single instance:

```
SCL  
// Call as a single instance  
"MyDB" (MyInput:=10, MyInout:= "Tag1");
```

### Result

After the call is executed, the value determined for the "MyInout" in/out parameter is available in "Tag1" in the "MyDB" data block.

### Calling as a multi-instance

The following example shows the call of an FB as a multi-instance:

```
SCL  
// Call as a multi-instance  
"MyFB" (MyInput:= 10, MyInout:= "Tag1");
```

### Result

After the "MyFB" block is executed, the value determined for the "MyInout" in-out parameter is made available in "Tag1" in the data block of the calling code block.

## See also

Calling function blocks (Page 1364)  
Manually inserting block calls (Page 1369)  
Inserting block calls with drag-and-drop (Page 1370)

## Examples for calling functions in SCL

### Standard call

The following example shows a standard function call:

```
SCL  
// Standard function call  
"MyFC" (MyInput := 10, MyInOut := "Tag1");
```

### Result

After the "MyFC" block is executed, the value determined for the "MyInOut" in/out parameter is available in "Tag1" in the calling block and has to be further processed there.

### Call in a value assignment

The following example shows a function call in a value assignment:

```
SCL  
(*Call in a value assignment, a return value was defined for "MyFC" *)  
#MyOperand := "MyFC" (MyInput1 := 3, MyInput2 := 2, MyInput3 := 8.9,  
MyInOut := "Tag1");
```

### Result

The return value of "MyFC" is transferred to "#MyOperand".

### Call in an arithmetic expression

The following example shows a function call in an arithmetic expression:

```
SCL  
(*Call in a mathematical expression, a return value was defined for "MyFC" *)  
#MyOperand := "Tag2" + "MyFC" (MyInput1 := 3, MyInput2 := 2, MyInput3 :=  
8.9);
```

### Result

The return value of "MyFC" will be added to "Tag2" and the result will be transferred to "MyOperand".



## See also

- Calling functions (Page 1365)
- Manually inserting block calls (Page 1369)
- Inserting block calls with drag-and-drop (Page 1370)

## Manually inserting block calls

You can insert calls for functions (FCs) and function blocks (FBs).

### Inserting a call for a function (FC)

Proceed as follows to insert a function call:

1. Enter the function name.
2. Confirm your entry with the Return key.  
The syntax for the function call including the parameter list is added to the SCL program. The placeholders for the actual parameters are highlighted in yellow. The first placeholder is selected.
3. Replace this placeholder with an actual parameter. You can also drag a tag from the interface or the PLC tag table with drag-and-drop to the placeholder.
4. Use the <TAB> key to navigate to all other placeholders and replace them with actual parameters.

### Inserting a call for a function block (FB)

To insert a call for a function block (FB), follow these steps:

1. Enter the name of the function block.
2. Confirm your entry with the Return key.  
The "Call options" dialog opens.
3. In the dialog, specify whether you want to call the block as a single or multi-instance.
  - If you click the "Single instance" button, in the "Name" field enter a name for the data block to be assigned to the call.
  - If you click the "Multi-instance" button, in the "Name in the interface" field enter a name of the tag with which the called function block is to be entered as a static tag in the interface of the calling block.
4. Confirm your entries with "OK".  
The syntax for the function block call including the parameter list is added to the SCL program. The placeholders for the actual parameters are highlighted in yellow. The first placeholder is selected.
5. Replace this placeholder with an actual parameter. You can also drag a tag from the interface or the PLC tag table with drag-and-drop to the placeholder.
6. Use the <TAB> key to navigate to all other placeholders and replace them with actual parameters.

## Result

The block call is inserted.

If you specify an instance data block that does not exist when calling a function block, it is created.

## See also

Updating block calls (Page 1371)

Expanding and reducing the parameter list (Page 1372)

Basic information on the block call in SCL (Page 1364)

## Inserting block calls with drag-and-drop

You can insert calls for existing functions (FC) and function blocks (FB) using a drag-and-drop operation from the project tree.

## Requirement

The function to be called (FC) or the function block (FB) to be called is present.

## Inserting a call for a function (FC)

To insert a function call using drag-and-drop, follow these steps:

1. Drag the function from the project tree into the program.  
The syntax for the function call including the parameter list is added to the SCL program. The placeholders for the actual parameters are highlighted in yellow. The first placeholder is selected.
2. Replace this placeholder with an actual parameter. You can also drag a tag from the interface or the PLC tag table with drag-and-drop to the placeholder.
3. Use the <TAB> key to navigate to all other placeholders and replace them with actual parameters.

## Inserting a call for a function block (FB)

To insert a call for a function block (FB) using drag-and-drop, follow these steps:

1. Drag the function block from the project tree and drop it into the program.  
The "Call options" dialog opens.
2. In the dialog, specify whether you want to call the block as a single or multi-instance.
  - If you click the "Single instance" button, in the "Name" field enter a name for the data block to be assigned to the call.
  - If you click the "Multi-instance" button, in the "Name in the interface" field enter a name of the tag with which the called function block is to be entered as a static tag in the interface of the calling block.

3. Confirm your entries with "OK".  
The syntax for the function block call including the parameter list is added to the SCL program. The placeholders for the actual parameters are highlighted in yellow. The first placeholder is selected.
4. Replace this placeholder with an actual parameter. You can also drag a tag from the interface or the PLC tag table with drag-and-drop to the placeholder.
5. Use the <TAB> key to navigate to all other placeholders and replace them with actual parameters.

## Result

The block call is inserted.

If you specify an instance data block that does not exist when calling a function block, it is created.

## See also

Updating block calls (Page 1371)

Expanding and reducing the parameter list (Page 1372)

Basic information on the block call in SCL (Page 1364)

## Updating block calls

If interface parameters of a called block are changed, the block call can no longer be executed correctly. You can avoid such inconsistent block calls by updating the block calls.

You have two options to update the block calls:

- Explicit updating in the program editor.  
The inconsistencies within the open block are displayed and can be updated.
- Implicit updating during compilation.  
All block calls in the program as well as the used PLC data types will be updated.

## Update blocks in the program editor

To update a block call within a block, follow these steps:

1. Open the block in the program editor.
2. Click "Update inconsistent block calls" in the toolbar.  
Inconsistent calls are displayed.
3. Correct the inconsistencies.

### Update block calls during compilation

Proceed as follows to update all block calls and uses of PLC data types during compilation implicitly:

1. Open the project tree.
2. Select the "Program blocks" folder.
3. Select the command "Compile > Software (rebuild all blocks)" in the shortcut menu.

### See also

Manually inserting block calls (Page 1369)

Inserting block calls with drag-and-drop (Page 1370)

### Expanding and reducing the parameter list

In SCL, if you call blocks or insert instructions that are system-internal function blocks, the syntax and the parameter list with the placeholders for the actual parameters are inserted in the SCL program. To make the program code easier to read, the unused optional parameters are removed from the parameter list when you edit other instructions. You can restore these at any time. You can also explicitly reduce the parameter list when you have finished assigning the parameters.

### Expanding the parameter list

To expand the parameter list, follow these steps:

1. Right-click in the block call or the instruction.
2. Select the "Expand parameter list" command from the shortcut menu or press the key combination <Ctrl+Shift+Space bar>. The parameter list is displayed in full again.

### Reducing the parameter list

To reduce the parameter list, follow these steps:

1. Right-click in the block call or the instruction.
2. Select the "Reduce parameter list" command from the shortcut menu or press the key combination <Ctrl+Shift+Space bar>. All unused optional parameters are hidden.

### See also

Entering SCL instructions manually (Page 1358)

Inserting SCL instructions using the "Instructions" task card (Page 1359)

Manually inserting block calls (Page 1369)

Inserting block calls with drag-and-drop (Page 1370)

## Inserting comments

### Commenting program code

You have various options for commenting SCL programs:

- Line comment  
A comment line starts with `"/"` and extends to the end of the line.
- Comment section  
A comment section is introduced with `"(*` and completed by `"*)"`. It can span several lines.

### Inserting line comments

To insert line comments, follow these steps:

1. Type `"/"` at the position where you want to place the comment. This does not have to be the beginning of the line.
2. Enter the comment.

### Inserting a comment section

To insert a comment section, follow these steps:

1. Type `"(*"` at the position where you want to place the comment. This does not have to be the beginning of the line.
2. Enter the comment.
3. Complete the comment with `"*)"`.

### Disabling one or more lines with comments

To disable program code with comments, follow these steps:

1. Select the code lines you want to disable.
2. Click the "Disable code" button in the editor.  
The line beginning `"/"` is inserted in the selected lines. The code that follows is interpreted as a comment. If lines already containing a line comment are disabled, `"/"` is inserted as well. If these lines are enabled again, the original comments are retained.

### Enabling comment lines

In order to once again enable lines that have been commented out in the code, follow these steps:

1. Select the code lines you want to enable.
2. Click the "Enable code" button in the editor.  
The `"/"` mark for line comments at the beginning of the line is removed.

### Example

The following code contains comment sections and line comments

```
(*****  
  A description of the instructions that follow can be placed here  
*****)  
IF "MyVal1" > 0 THEN //No division by 0  
  "MyReal" := "MyVal2" (* input value *) / "MyVal1" (* measured value *);  
END_IF;  
//Data type conversion  
"MyInt" := REAL_TO_INT("MyReal");
```

### Editing SCL instructions

#### Selecting instructions

You can select individual instructions or all instructions of a block.

#### Requirement

An SCL block is open.

#### Selecting individual instructions

To select individual instructions, follow these steps:

1. Set the insertion mark before the first character that you want to select.
2. Press and hold down the left mouse button.
3. Move the cursor to a position after the last character that you want to select.
4. Release the left mouse button.

#### Selecting all the instructions of a program

To select all instructions, follow these steps:

1. In the "Edit" menu, select the "Select All" command or use the keyboard shortcut <Ctrl+A>.

---

#### Note

When you select the opening keyword of an instructing, the closing keyword is automatically highlighted.

---

## **Copying, cutting and pasting instructions**

### **Copying an instruction**

To copy an instruction, follow these steps:

1. Select the instruction you want to copy.
2. Select "Copy" in the shortcut menu.

### **Cutting an instruction**

To cut an instruction, follow these steps:

1. Select the instruction you want to cut.
2. Select the "Cut" command in the shortcut menu.

### **Inserting an instruction from the clipboard**

To insert an instruction from the clipboard, follow these steps:

1. Copy or cut an instruction.
2. Click on the position at which you want to insert the instruction.
3. Select "Paste" in the shortcut menu.

## **Deleting instructions**

### **Requirement**

An SCL block is open.

### **Procedure**

To delete an instruction, follow these steps:

1. Select the instruction you want to delete.
2. Select the "Delete" command in the shortcut menu.

## Eliminating syntax errors in the program

### Basic information on syntax errors

#### Syntax errors

Below are some examples of syntax errors:

- Missing separators or the use of too many separators
- Incorrect keyword spelling
- Incorrect jump label spelling/notation
- Notation which does not match the set mnemonics (for example, "I2.3" instead of "E2.3")
- The use of key words as operands

#### Identification of syntax errors

Syntax errors are underlined in red or appear in red type.

This identification allows you to recognise incorrect inputs at a glance and jump from error to error to eliminate them. Syntax errors are also listed in the "Info" tab of the inspector window with an error message.

#### See also

Finding syntax errors in the program (Page 1376)

## Finding syntax errors in the program

### Procedure

To find syntax errors in the program, follow these steps:

1. Select the position in the program in which you wish to look for errors.
2. Click "Go to next error" in the toolbar.  
The first error after the position you have selected will be marked.

You can use "Go to next error" and "Go to previous error" in the toolbar to find and correct all errors in the block.

Or:



1. Open the error list in the inspector window with "Info > Syntax".  
All syntax errors are listed in the table with a short description of the error.
2. If there are any errors, click on the blue question mark next to the error text to obtain information on eliminating the problem.
3. Double-click the error you want to correct.  
The corresponding error is highlighted.

## See also

Basic information on syntax errors (Page 1376)

## Changing the programming language

### Rules for changing the programming language

#### Rules

Observe the following rules if you want to change the programming language for a block:

- All CPU series:
  - You can only change the programming language of entire blocks. The programming language cannot be changed for individual networks.
  - You cannot switch blocks programmed in the programming languages SCL or GRAPH. In GRAPH blocks, however, you can change between LAD and FBD as network languages.
- S7-300/400:
  - You can only change between the programming languages LAD, FBD and STL.
  - You can create networks within a block using another programming language and then copy them into the desired block.
  - If the language of individual networks of the block cannot be changed, these networks is displayed in their original language.
- S7-1200/1500:
  - You can change between the programming languages LAD and FBD.
- S7-1500:
  - You can create STL networks within the LAD and FBD blocks. However, you cannot copy between STL and LAD/FBD.

## Change the programming language

### Procedure

To change the programming language, follow these steps:

1. Right-click the block in the project tree.
2. Select the "Properties" command in the shortcut menu.  
The dialog with the properties of the block opens.
3. Select the "General" entry in the area navigation.
4. Select the new programming language in the "Language" drop-down list.
5. Confirm your selection with "OK".

### See also

Rules for changing the programming language (Page 1377)

## Handling program execution errors

### Basics of error handling

#### Introduction

Program execution errors are programming or I/O access errors. You have a number of different options for responding to program execution errors depending on the CPU used.

#### Handling program execution errors in S7-300/400

You can program the program execution error OB (OB 85) for S7-300/400 CPUs. If a program execution error occurs and you do not use the program execution error OB, the CPU will switch to "STOP" mode.

You will find additional information about the program execution error OB in the description of the mode of operation of S7-300/400 CPUs.

## Handling program execution errors in S7-1200/1500

You can select the type of error handling for CPUs of the S7-1200 and S7-1500 series. You have the following two options:

- Use the CPU's global troubleshooting:
  - S7-1200: The CPU generates a diagnostic buffer entry and remains in "RUN" mode.
  - S7-1500: You can program the programming error OB (OB 121) and the I/O access error OB (OB 122) for S7-1500 CPUs. If no programming error OB exists in the CPU, the CPU switches to "STOP" mode when a programming error occurs. In the event of an I/O access error, the CPU always remains in "RUN" mode, regardless of whether the I/O access error OB is present.

Please note, however, that an existing I/O access or programming error OB is not called synchronously to the error. Therefore, depending on the selected priority, the execution of I/O access or programming error OBs may be delayed instead of taking place immediately when the error occurs. If other errors occur before execution of the I/O access or programming error OB is complete, no further I/O access or programming error OB is called. If you want to prevent I/O access or programming error OBs from being discarded, set the priority correspondingly high.

You can use the enable output ENO to detect I/O access and programming errors for the instructions "Read field" (FieldRead), "Write field" (FieldWrite) , "Read memory address" (PEEK) and "Write memory address" (POKE).

You can find more information about these error OBs in the description of the mode of operation of S7-1500 CPUs.
- You use separate local error handling. Local error handling is error handling within a block. Local error handling has the following advantages:
  - The error information is stored in the system memory, which you can query and evaluate.
  - You can use the error information to program a response in the block to the error that has occurred.
  - Programmed error evaluation and error reactions do not interrupt the program cycle.
  - The system performance is not unnecessarily burdened by the local error handling. If no errors occur, programmed error analyses and reactions are not executed.

Local error handling applies only to blocks for which it has been set explicitly. If local error handling is set for a block, no global error handling is conducted for errors in this block.

---

### Note

Note the following information:

- All memory access errors and I/O access errors must be captured either by global or local error handling.
  - If the parameters of an instruction do not cause any memory access errors, you can query the associated ENO.
-

## See also

GET\_ERROR: Get error locally (Page 2040)

GET\_ERR\_ID: Get error ID locally (Page 2044)

GET\_ERROR: Get error locally (Page 1783)

GET\_ERR\_ID: Get error ID locally (Page 1787)

## Local error handling

### Principles of local error handling

#### Introduction

Local error handling makes it possible to query the occurrence of errors within a block and evaluate the associated error information. You can set local error handling for organization blocks (OBs), function blocks (FBs), and functions (FCs). If local error handling is enabled, the system reaction is ignored.

Local error handling applies only to blocks for which it has been set explicitly. The local error handling setting is not assumed by a calling block, nor is it transferred to called blocks. For higher-level blocks and lower-level blocks, the system settings still apply provided dedicated error handling has not been programmed for these blocks.

#### General procedure for local error handling

When errors occur while a block is being executed with local error handling, a predefined response is initiated based on the following error types:

- Write errors: These errors are ignored, and program execution simply continues.
- Read errors: Program execution continues with the substitute value "0".
- Execution errors: Execution of the instruction is aborted. Program execution resumes with the next instruction.

Information about the first error that occurs is stored in the system memory. This information can be queried and output with an instruction (GET\_ERROR or GET\_ERR\_ID). Error information is output in a format that can undergo additional processing. You can use additional instructions to analyze error information and program a reaction to the error based.

When information about the first error is queried, the error memory space in the system memory is enabled. Then, when additional errors occur, information about the next error is output.

#### Instructions for local error handling

You can use the following instructions for local error handling:

- GET\_ERROR: Get error locally
- GET\_ERR\_ID: Get error ID locally

The instructions differ in the amount of error information that is output with each one.

For additional information on the instructions, refer to "See also".

### See also

GET\_ERROR: Get error locally (Page 2040)

GET\_ERR\_ID: Get error ID locally (Page 1787)

GET\_ERR\_ID: Get error ID locally (Page 2044)

GET\_ERROR: Get error locally (Page 1783)

### Error output priorities

#### Overview of the priorities

In local error handling, information about the first error that occurred is displayed. If multiple errors occur at the same time while an instruction is being executed, these errors are displayed according to their priority. The following table shows the priority of different types of errors.

Priority	Error type
1	Error in the program code
2	Missing reference
3	Invalid range
4	DB does not exist
5	Operands are not compatible
6	Width of specified area is not sufficient
7	Timers or counters do not exist
8	No write access to a DB
9	I/O error
10	Instruction does not exist
11	Block does not exist
12	Invalid nesting depth

The highest priority is 1 and the lowest priority is 12.

### See also

GET\_ERROR: Get error locally (Page 2040)

GET\_ERR\_ID: Get error ID locally (Page 1787)

GET\_ERR\_ID: Get error ID locally (Page 2044)

GET\_ERROR: Get error locally (Page 1783)

## Enabling local error handling for a block

### Introduction

Local error handling is enabled for a block if you insert one of the following instructions in a network.

- GET\_ERROR: Get error locally
- GET\_ERR\_ID: Get error ID locally

For additional information on the instructions, refer to "See also".

If local error handling is enabled for a block, the system reactions for this block are ignored.

### Requirement

- The block is open.
- Die "Instructions" task card is open.

### Procedure

To enable local error handling for a block, proceed as follows:

1. Navigate to the "Basic instructions" pane of the "Instructions" task card.
2. Open the "Program Control" folder.
3. Drag the instruction "Get error locally" (GET\_ERROR) or "Get error ID locally" (GET\_ERR\_ID) to the required network.

### Result

Local error handling is enabled for the open block. The "Handle errors within block" check box is selected in the Inspector window under "Properties > Attributes". This setting cannot be edited in the Inspector window. Local error handling can be deactivated by deleting the inserted instructions on local error handling.

### See also

GET\_ERROR: Get error locally (Page 2040)

GET\_ERR\_ID: Get error ID locally (Page 1787)

GET\_ERR\_ID: Get error ID locally (Page 2044)

GET\_ERROR: Get error locally (Page 1783)

### 9.1.4.3 Programming data blocks

#### Basic principles for programming of data blocks

A data block (DB) is used to save the values that are written during execution of the program.

In contrast to the code block, the data block contains only tag declarations. It contains no networks or instructions. The tag declarations define the structure of the data block.

## Types of data blocks

There are two types of data blocks:

- **Global data blocks**  
The global data block is not assigned to a code block. You can access the values of a global data block from any code block. A global data block contains only static tags.  
The structure of the global data block can be freely defined. In the declaration table for data blocks, you declare the data elements that are to be contained in the global data block.
- **Instance data blocks**  
The instance data block is assigned directly to a function block (FB). The structure of an instance data block cannot be freely defined, but is instead determined by the interface declaration of the function block. The instance data block contains exactly those block parameters and tags that are declared there.  
However, you can define instance-specific values in the instance data block, for example, start values for the declared tags.

## ARRAY data blocks (S7-1500)

ARRAY data blocks are global data blocks that consist of an ARRAY. This ARRAY can be based on any data type. For example, an ARRAY of a PLC data type (UDT) is possible. The DB contains no other elements besides the ARRAY. Because of their flat structure, ARRAY data blocks facilitate access to the ARRAY elements and their transfer to called blocks.

The "Move operations" section of the "Instructions" task card offers options for addressing of ARRAY DBs.

## PLC data types as a template for global data blocks

PLC data types can be used as templates for the creation of global data blocks with identical data structures. You create the structure as PLC data type only once and then generate the required data blocks by assigning the PLC data type.

## System data types as a template for global data blocks

System data types can also be used as templates for creating global data blocks with identical data structure. System data types already have a pre-defined structure. You insert the system data type in the program only once and then generate additional data blocks with an identical structure by assigning the system data type.

**Access modes**

There are two different modes of accessing data values in data blocks:

- Data blocks with optimized access (only S7-1200)  
Data blocks with optimized access have no fixed defined structure. In the declaration, the data elements are assigned only a symbolic name and no fixed address within the block. You access the data values in these block via symbolic names. The "Optimized block access" attribute is always enabled for ARRAY data blocks.
- Data blocks with standard access (all CPU families)  
Data blocks with standard access have a fixed structure. In the declaration, the data elements are assigned both a symbolic name and a fixed address within the block. You can access the data values in these blocks via symbolic names or the address. ARRAY data blocks with standard access are not possible.

**Retentivity of data values**

To prevent data loss in the event of power failure, you can store the data values in a retentive memory area.

**See also**

Creating data blocks (Page 1199)

Global data blocks (DB) (Page 1024)

Instance data blocks (Page 1025)

**Structure of the declaration table for data blocks**

**Structure of the declaration table for data blocks**

The figure below shows the structure of the declaration table for data blocks. The display will vary depending on type of block and type of access.

	Name	Data type	Start value	Retain	Visible in HMI	Comment
	▼ Input					
	■ MyInput1	Bool	false	<input checked="" type="checkbox"/>	<input checked="" type="checkbox"/>	
	▼ Output					
	■ MyOutput1	Byte	0	<input type="checkbox"/>	<input checked="" type="checkbox"/>	
	▼ InOut					
	▼ Static					

**Display of instance-specific values**

In instance data blocks, you can apply the already defined values from the interface of the assigned function block or define instance-specific start values. Values that are applied from the function block cannot be edited. You can replace the grayed-out values with instance-specific values. Values that were already changed instance specific are not grayed out.



## Meaning of the columns

The following table shows the meaning of the individual columns. You can show or hide the columns as required. The number of columns displayed varies depending on the CPU series.

Column	Explanation
	Symbol you can click to move or copy the tag. You can, for example, drag-and-drop the tag into a program and use it there as operand.
Name	Name of the tags.
Data type	Data type of the tags.
Offset	Relative address of the tags. The column is only visible in data blocks with standard access.
Default value	Default value of the tag in the interface of a higher-level code block or in a PLC data type. The values contained in the "Default value" column can only be changed in the higher-level code block or PLC data type. The values are only displayed in the data block.
Start value	Value that the tag should assume at startup. The default values defined in a code block are used as start values during the creation of the data block. You can then replace these adopted values with instance-specific start values. Specification of an start value is optional. If you do not specify any value, the tag assumes the default value at startup. If a default is not defined either, the default value valid for the data type is used. For example, the value "FALSE" is specified as standard for BOOL.
Monitor value	Current data value in the CPU. This column only appears if an online connection is available and you click "Monitor".
Snapshot	Shows values that were loaded from the device.
Retentivity	Marks the tag as retentive. The values of retentive tags are retained even after the power supply is switched off.
Visible in HMI	Shows whether the tag is visible by default in the HMI selection list.
Accessible from HMI	Shows whether HMI can access this tag during runtime.
Setting value	Setting values are the values that will probably have to be fine tuned during commissioning. After commissioning, the values of these tags can be transferred to the offline program as start values and stored there.
Comment	Comment to document the tags.

## See also

Creating data blocks (Page 1199)

Basic information on start values (Page 1392)

## Creating data blocks

### Requirement

The "Program blocks" folder in the project tree is open.

### Procedure

To create a data block, follow these steps:

1. Double-click the "Add new block" command.  
The "Add new block" dialog box opens.
2. Click the "Data block (DB)" button.
3. Select the type of the data block. You have the following options available to you:
  - To create a global data block, select the list entry "Global DB".
  - To create an ARRAY data block, select the "ARRAY DB" entry in the list.
  - To create an instance data block, select the function block to which you want to assign the instance data block from the list. The list contains only the function blocks that were previously created for the CPU.
  - To create a data block based on a PLC data type, select the PLC data type from the list. The list contains only the PLC data types that were previously created for the CPU.
  - To create a data block based on a system data type, select the system data type from the list. The list contains only those system data types that have already been inserted to program blocks in the CPU.
4. Enter a name for the data block.
5. Enter the properties of the new data block.
6. If you have selected an ARRAY DB as the data block type, enter the ARRAY data type and the high limit for the ARRAY.  
You can change the high limit for the ARRAY at any time in the property window of the created block. The ARRAY data type cannot be changed subsequently.
7. To enter additional properties of the new data block, click "Additional information".  
An area with further input fields is displayed.
8. Enter all the properties you require.
9. Activate the "Add new and open" check box if the block does not open as soon as it is created.
10. Confirm your entry with "OK".

### Result

The new data block is created. You can find the data block in the project tree in the "Program blocks" folder.

## See also

- Instance data blocks (Page 1025)
- Global data blocks (DB) (Page 1024)
- Overview of block properties (Page 1208)

## Updating data blocks

### Introduction

Changes in the interface of a function block or a PLC data type can lead to the corresponding data blocks becoming inconsistent. These inconsistencies are marked in red in the declaration table and at the call point of the block. To remedy these inconsistencies, the data blocks must be updated.

You have three options to update block calls:

- Explicit updating in the declaration table for data blocks.  
The data block is updated. Changes from the interface of the assigned function block and changes to the used PLC data types are applied.
- Explicit updating in the program editor.  
The block calls in the open block will be updated. The associated instance data block is also adjusted in the process.
- Implicit updating during compilation.  
All block calls in the program as well as the used PLC data types and the corresponding instance data blocks are updated.

### Explicit Updating in the Declaration Table for Data Blocks

To explicitly update an individual data block, follow these steps:

1. Open the data block.
2. Select "Update interface" in the shortcut menu.

### Explicit Updating in the Program Editor

To update all block calls or a specific call within a block, follow these steps:

1. Open the block in the program editor.
2. Right-click on the instruction with the block call.
3. Select the "Update" command in the shortcut menu.
4. The "Interface update" dialog opens. This dialog shows the differences between the block interface in use and the changed interface of the called block.
5. If you want to update the block call, click "OK". To cancel the update, click "Cancel".

### Implicit Updating during Compilation

To implicitly update all block calls and uses of PLC data types as well as the instance data blocks during the compiling, follow these steps:

1. Open the project tree.
2. Select the "Program blocks" folder.
3. Select the command "Compile > Software (rebuild all blocks)" in the shortcut menu.

### See also

Changing the properties of tags in instance data blocks (Page 1399)

### Extending data blocks

#### Description

In order to enable the editing of PLC programs that have already been commissioned and that are running without error on a system, CPUs of the S7-1500 series and most CPUs of the S7-1200 V4 series support the option of extending global data blocks during runtime.

You can download the modified blocks without setting the CPU to STOP and without affecting the values of already loaded tags.

This is a simple means of implementing program changes. This load process (download without reinitialization) will not have a negative impact on the controlled process.

#### Principle of operation

Each data block is always assigned a default memory reserve. The memory reserve is not used initially. Activate the memory reserve if you decide on loading interface changes after having compiled and downloaded the block. All tags that you subsequently declare will be saved to the memory reserve. A subsequent download has no impact on the values of tags that have already been loaded.

If you decide to review your program at a later time while the plant is not in operation, you are also provided an option of reworking the memory layout of individual or several blocks in a single pass. With this action, you move all tags from the reserve area to the regular area. The memory reserve is now cleared and made available for further interface extensions.

#### Requirements

This "Download without reinitialization" function is available if the following requirements are met:

- The project is available in "TIA Portal V12" format.
- You are working with a CPU that supports "Download without reinitialization".
- The blocks were created in LAD, FBD, STL, or SCL.

- The blocks were created by the user, i.e. they are not included with the blocks delivered in your package.
- These blocks are assigned the optimized access attribute.

### **Basic steps**

Perform the following steps if you want to extend the data block and then load the block without re-initialization.

1. All blocks have a default memory reserve of 100 bytes. You can adapt this memory reserve to suit your requirements.
2. Activate the memory reserve.
3. Extend the block interface.
4. Compile the block.
5. Download the block to the CPU as usual.

### **Reference**

For more information on the various steps, refer to chapter "Loading blocks (S7-1200/1500)".

### **Creating a data structure for global data blocks**

#### **Declaring tags of elementary data type**

#### **Requirement**

A global data block is open.

---

#### **Note**

You cannot change the structure of instance data blocks and of data blocks based on a PLC data type directly, since the structures of these blocks are defined by the respective function block or the PLC data type.

The type of the data block is entered in the block properties.

---

#### **Procedure**

To declare a tag of the elementary data type, follow these steps:

1. Enter a tag name in the "Name" column.
2. In the "Data type" column, click the button for the data type selection.  
A list of the permissible data types is opened.
3. Select the desired data type.

4. Optional: Change the properties of the tags that are displayed in the other columns.
5. Repeat steps 1 to 4 for all tags that are to be declared.

### See also

Displaying and editing block properties (Page 1213)

Declaring tags of the ARRAY data type (Page 1390)

Declaring tags of STRUCT data type (Page 1391)

Editing tables (Page 242)

### Declaring tags of the ARRAY data type

#### Requirement

A global data block is open.

#### Procedure

To declare a tag of the ARRAY data type, follow these steps:

1. Enter a tag name in the "Name" column.
2. Enter the "Array" data type in the "Data type" column. You will be supported by autocompletion in this step.  
The "Array" dialog opens.
3. In the "Data type" text box, specify the data type of the array elements.
4. In the "ARRAY limits" text box, specify the high and low limit for each dimension.  
Example of a one-dimensional ARRAY:  
[0..3]  
Example of a three-dimensional ARRAY:  
[0..3, 0..15, 0..33]
5. Confirm your entry.
6. Optional: Change the properties of the tags that are displayed in the other columns.

### Entering start values of ARRAY elements

To set default start values for the individual elements of an ARRAY, follow these steps:

1. Click the triangle in front of the ARRAY data type tags.  
The ARRAY opens and the individual ARRAY elements are shown in separate rows.
2. Enter the required value in the "Start value" column.

## Declaring tags of STRUCT data type

### Requirement

A global data block is open.

### Procedure

To declare a tag of the STRUCT data type, follow these steps:

1. Enter a tag name in the "Name" column.
2. Enter "Struct" in the "Data type" column. You will be supported by autocompletion during input.  
An empty, indented row is inserted after the new tag.
3. Insert the first structural element in the first empty row.  
An additional empty row is inserted after the element.
4. Select a data type for the structure element.
5. Optional: Change the properties of the structural element that is displayed in the other columns of the block interface.
6. Repeat the step 4 to 7 for all additional structure elements.  
It is not necessary to end the structure explicitly. The structure ends with the last element that is entered.
7. To insert a new tag after the structure, leave a blank row after the end of the structure and then start the new tag in the second empty row.

### Result

The tag of STRUCT data type is created.

## Enter start values of structure elements

To set default start values for the individual elements of a structure, follow these steps:

1. Click the triangle in front of the STRUCT data type tags.  
The structure opens and the individual structure elements are shown in separate rows.
2. Enter the required value in the "Start value" column.

### See also

STRUCT (Page 1110)

## Declaring tags based on a PLC data type

### Requirements

- A global data block is open.
- A PLC data type is declared in the current CPU.

### Procedure

To declare a tag based on a PLC data type, follow these steps:

1. Enter a tag name in the "Name" column.
2. Enter the PLC data type in the "Data type" column. You will be supported by autocompletion during input.
3. Optional: Change the properties of the tags that are displayed in the other columns of the table.

### Result

The tag is created.

### See also

Layout of the block interface (Page 1239)

## Define start values

### Basic information on start values

#### Definition of "Start value"

The start value of a tag is a value defined by you which the tag assumes after a CPU startup.

The retentive tags have a special status. Their values take the defined start value only after a "cold restart". After a "warm restart", they retain their values and are not reset to the start value.

#### Definition of "Default value"

The structure of the data blocks can be derived from higher-level elements.

- An instance data block is based, for example, on the interface of a higher-level code block.
- A global data block can be based on a predefined PLC data type.

In this case you can define a default value for each tag in the higher-level element. These default values are used as start values during the creation of the data block. You can then replace these values with instance-specific start values in the data block.



Specification of an start value is optional. If you do not specify any value, the tag assumes the default value at startup. If a default is not defined either, the default value valid for the data type is used. For example, the value "FALSE" is specified as standard for BOOL.

## See also

Define start values (Page 1393)

Structure of the declaration table for data blocks (Page 1384)

Declaring local tags in the block interface (Page 1244)

Applying values from the online program as start values (Page 1407)

## Define start values

### Define start values

To define the start values for the tags of a data block, follow these steps:

1. Open the data block.  
The "Default value" column shows the default values that were defined for the tags in the interface of a higher-level code block or in a PLC data type.
2. Click the "Expanded mode" button to show all elements of structured data types.
3. Enter the desired start values in the "Start value" column. The value must match the data type of the tag and should not exceed the range of the data type.  
The start values are defined. The tag takes the defined value at startup, provided it was not declared as retentive.

### Resetting a tag to the default value

To reset a tag for which you have defined a start value to the default value, follow these steps:

1. Select a modified value in the table.
2. Delete the value.  
The default value is entered. The default value is displayed.

### Resetting all tags to the default value

To reset to the default value all tags for which you have defined an start value, follow these steps:

1. Select the "Reset start values" icon in the toolbar.  
The default values are transferred to the "Start value" column. Write-protected start values are not overwritten.

### See also

Basic information on start values (Page 1392)

Applying values from the online program as start values (Page 1407)

### Loading changed values

#### Introduction

To apply the changed start values from the offline program to the online program, you must load the changes. The following cases must be distinguished:

- Loading changed start values of non-retentive tags
- Loading changed start values of retentive tags
- Loading changed start values of setting values

#### Requirement

The start values in the offline program were changed.

#### Procedure

To load changed start values of non-retentive tags, follow these steps:

1. Select the blocks to be loaded in the project tree.
2. Select the "Download to device > Software (only changes)" command from the shortcut menu.  
The blocks are compiled and loaded.  
The start values of the newly defined tags are placed in the load memory of the CPU. The program runs with the new start values at the next transition from STOP to RUN.

To load changed start values of retentive tags, follow these steps:

1. Select the blocks to be loaded in the project tree.
2. Select the "Compile > Software (rebuild all blocks)" command in the shortcut menu.
3. In the "Online" menu, select the "Download and reset PLC program" command.  
The online blocks are deleted and replaced with the new blocks. This reinitializes all tags, including the retentive tags.

Information about loading changed setting values and general information about loading can be found under "See also".

### **See also**

Initializing setting values in the online program (Page 1406)

### **Setting retentivity**

#### **Retentivity of tags in data blocks**

#### **Retentive behavior**

To prevent data loss in the event of power failure, you can mark the data as retentive. This data is stored in a retentive memory area. The options for setting the retentivity depend on the type of data block and the type of block access that is set.

### **See also**

Setting retentivity in an instance data block (Page 1395)

Setting retentivity in a global data block (Page 1396)

### **Setting retentivity in an instance data block**

#### **Introduction**

In an instance data block, the editability of the retentive behavior depends on the type of access of the higher-level function block:

- **Function block with standard access**  
You can define the instance data both as retentive or non-retentive. Individual retentivity settings are not possible for individual tags.
- **Function block with optimized access**  
In the instance data block, you can define the retentivity settings of the tags that are selected in the block interface with "Set in IDB". With these tags also, you cannot individually set the retentive behavior for each tag. The retentivity setting has an impact on all tags that are selected in the block interface with "Set in IDB".

### Setting Retentivity for Standard Access

To centrally set the retentivity of all tags in the data block with standard access, follow these steps:

1. Open the instance data block.
2. Select the check box in the "Retain" column of a tag.  
All tags are defined as retentive.
3. To reset the retentivity setting for all tags, clear the check box in the "Retain" column of a tag.  
All tags will be defined as non-retentive.

### Setting Retentivity for Optimized Access

To set the retentive behavior of the tags that are selected with "Set in IDB" in data blocks with optimized access, follow these steps:

1. Open the instance data block.
2. Select the check box in the "Retain" column of a tag.  
All tags selected with "Set in IDB" in the data block interface are defined as retentive.
3. To reset the retentivity setting for the tags, clear the check box in the "Retain" column of a tag.  
All tags selected with "Set in IDB" in the data block interface will be defined as non-retentive.

### See also

Basics of block access (Page 1027)

Retentivity of tags in data blocks (Page 1395)

### Setting retentivity in a global data block

#### Introduction

In a global data block, the editability of the retentive behavior depends on the type of access:

- Global data block with standard access  
You can define the data both as retentive or non-retentive. Individual retentivity settings are not possible for individual tags.
- Global data block with optimized access  
You can individually define the retentivity settings of the tags. For tags with structured data types, retentivity settings are transferred for all tag elements.

### Setting Retentivity for Standard Access

To centrally set the retentivity of all tags in the data block with standard access, follow these steps:

1. Open the global data block.
2. Select the check box in the "Retain" column of a tag.  
All tags are defined as retentive.
3. To reset the retentivity setting for all tags, clear the check box in the "Retain" column of a tag.  
All tags are defined as non-retentive.

### Setting Retentivity for Optimized Access

To individually set the retentivity of all tags in data blocks with optimized access, follow these steps:

1. Open the global data block.
2. In the "Retain" column, select the check box for the tags for which you want to set a retentive behavior.  
The selected tag is defined as retentive.
3. To reset the retentivity setting for the tags, clear the check box in the "Retain" column of a tag.  
All selected tags are defined as non-retentive.

### See also

Basics of block access (Page 1027)

Retentivity of tags in data blocks (Page 1395)

### Editing the properties of tags in data blocks

#### Properties of the tags in data blocks

#### Properties

The following table provides an overview of the properties of tags in data blocks:

Group	Property	Description
General	Name	Name of the tags.
	Data type	Data type of the tags.

Group	Property	Description
	Default value	Default value of the tag in the interface of a higher-level code block or in a PLC data type. The values contained in the "Default value" column can only be changed in the higher-level code block or PLC data type. The values are only displayed in the data block.
	Start value	Value that the tag should assume at CPU startup. The default values defined in a code block are used as start values during the creation of the data block. You can then replace these adopted values with instance-specific start values. Specification of an start value is optional. If you do not specify any value, the tag assumes the default value at startup. If a default is not defined either, the default value valid for the data type is used. For example, the value "FALSE" is specified as standard for BOOL.
	Comment	Comment on the tag.
Attributes	Retain	Marks the tag as retentive. The values of retentive tags are retained even after the power supply is switched off. This attribute is only available in the interface of the function block with optimized access.
	Visible	Indicates whether a parameter is visible in CFC.
	Configurable	Indicates whether a parameter is configurable in CFC.
	For test	Indicates whether a parameter is registered for the CFC test mode.
	Interconnectable	Indicates whether a parameter is interconnectable in CFC.
	Enable tag readback	Indicates whether a parameter is relevant for the "Read back chart" function in CFC.
	Enumeration texts	Assigns a parameter to an enumeration in CFC.
	Engineering unit	Assigns a parameter to a unit in CFC.
	Low limit	Defines the low limit for the parameter in CFC.
	High limit	Defines the high limit for the parameter in CFC.

**See also**

Changing the properties of tags in instance data blocks (Page 1399)

Changing the properties of tags in global data blocks (Page 1400)

## Changing the properties of tags in instance data blocks

### Instance-specific tag properties

Two options are available for defining the tag properties:

- The tag properties are applied from the interface of the assigned function block. Properties that are applied from the function block are displayed grayed out in the columns of the declaration table. The "Name" and "Data type" properties are always applied.
- You define instance-specific properties. You can change some properties instance specific. Changeable values are, for example, "Comment" or "Visible in HMI". Properties that were changed instance specific are not grayed out in the columns of the declaration table. The instance-specific changes are retained, even if the interface of the higher-level function block is changed and the instance data blocks are subsequently updated.

### Editing properties in the declaration table

To edit the properties of one or more tags, follow these steps:

1. Open the instance data block.
2. Change the entries in the columns.

### Editing properties in the properties window

To edit the properties of an individual tag, follow these steps:

1. Select a tag in the table.
2. Select the "Properties" command in the shortcut menu. The properties window opens. It shows the properties of the tag in the "General" and "Attributes" areas.
3. Select the required area in the area navigation.
4. Change the entries in the text boxes.

### Reset individual properties to the default value.

To reset individual tag properties to the value that was defined as default in the function block, follow these steps:

1. Select an instance-specific, modified value in the table.
2. Delete the value. The instance-specific value will be deleted and the default value from the interface of the function block entered. The default value is displayed grayed out.

### See also

Updating data blocks (Page 1387)

Properties of the tags in data blocks (Page 1397)

## Changing the properties of tags in global data blocks

### Introduction

Two options are available for defining the tag properties:

- The tag properties are applied from the PLC data type.  
Properties that are applied from the PLC data type are shown grayed out in the columns of the declaration table. The "Name" and "Data type" properties are always applied.
- You define specific properties.  
You can change some properties in the global data block. Changeable values are, for example, "Comment" or "Visible in HMI". Properties that were changed are not grayed out in the columns of the declaration table. The changes are retained, even if the PLC data type changes and the global data block is subsequently updated.

### Editing properties in the declaration table

To edit the properties of one or more tags, follow these steps:

1. Open the global data block.
2. Change the entries in the columns.

### Editing properties in the properties window

To edit the properties of an individual tag, follow these steps:

1. Select a tag in the table.
2. Select the "Properties" command in the shortcut menu.  
The properties window opens. It shows the properties of the tag in the "General" and "Attributes" areas.
3. Select the required area in the area navigation.
4. Change the entries in the text boxes.

### Reset individual properties to the default value.

To reset individual tag properties to the value that was defined as default in the PLC data type, follow these steps:

1. Select a modified value in the table.
2. Delete the value.  
The default value from the PLC data type is entered. The default value is displayed grayed out.

### See also

Properties of the tags in data blocks (Page 1397)



## Editing the declaration table for data blocks

### Inserting table rows

#### Procedure

Proceed as follows to insert a row above the selected row:

1. Select the row in front of which you want to insert a new row.
2. Click the "Insert row" button on the toolbar of the table.

#### Result

A new row is inserted above the selected row.

#### See also

Editing tables (Page 242)

### Inserting table rows

#### Procedure

Proceed as follows to insert a row below the selected row:

1. Select the row below which you want to insert a new row.
2. Click the "Add row" button on the table toolbar.

#### Result

A new empty row will be inserted below the selected row.

#### See also

Editing tables (Page 242)

### Deleting tags

#### Requirements

A global data block is open.

## Procedure

To delete a tag, follow these steps:

1. Select the row with the tag to be deleted. You can also select several rows by clicking on them one after the other while holding down the <Ctrl> key or by pressing and holding down <Shift> and clicking on the first and last row.
2. Select the "Delete" command in the shortcut menu.

---

### Note

You cannot directly change the structure of instance data blocks and of global data blocks based on a PLC data type, since the structures of these blocks are defined in the higher-level object.

The type of the data block is entered in the block properties.

See also: Displaying and editing block properties (Page 1213)

---

## See also

Editing tables (Page 242)

## Automatically filling in successive cells

You can load the contents of one or several table cells into the cells below, automatically filling in the successive cells.

If you automatically fill in cells in the "Name" column, a consecutive number will be appended to each name. For example, "Motor" will become "Motor\_1".

You can define individual or more cells as well as entire rows as source area.

If less rows exist in the open table than you want to fill, then you will first have to insert additional empty rows.

## Requirement

- The table is open.
- Sufficient declaration rows are available.

## Procedure

To automatically fill in successive cells, follow these steps:

1. Select the cells to be loaded.
2. Click the "Fill" symbol in the bottom right corner of the cell.  
The mouse pointer is transformed into a crosshair.

3. Keep the mouse button pressed and drag the mouse pointer downwards over the cells that you want to fill in automatically.
4. Release the mouse button.  
The cells are filled in automatically.
5. If entries are already present in the cells that are to be automatically filled in, a dialog appears. In this dialog you can indicate whether you want to overwrite the existing entries or insert new rows for the new tags.

### **Show and hide table columns**

You can show or hide the columns in a table as needed.

#### **Procedure**

To show or hide table columns, follow these steps:

1. Click a column header.
2. Select the "Show/Hide" command in the shortcut menu.  
The selection of available columns is displayed.
3. To show a column, select the column's check box.
4. To hide a column, clear the column's check box.

### **Editing tags with external editors**

To edit individual tags in external editors outside the TIA portal, you can export or import these tags using copy & paste. However, you cannot copy structured tags to an editor.

#### **Requirement**

The data block and an external editor are opened.

#### **Procedure**

To export and re-import individual tags by drag-and-drop operation, follow these steps:

1. Select one or more tags.
2. Select "Copy" in the shortcut menu.
3. Switch to the external editor and paste the copied tags.
4. Edit the tags as required.
5. Copy the tags in the external editor.
6. Switch back to the declaration table.
7. Select "Paste" in the shortcut menu.

## Monitoring data values online

### Monitoring data values in data blocks online

You can monitor the current data values of the tags in the CPU directly in the declaration table.

#### Requirement

- An online connection is available.
- The data block has been loaded to the CPU.
- The program execution is active (CPU in "RUN").
- The data block is open.

#### Procedure

To monitor the data values, proceed as follows:

1. Start monitoring by clicking the "Monitor all" button.  
The additional "Monitor value" column is displayed in the table. This shows the current data values.  
See also: Structure of the declaration table for data blocks (Page 1384)
2. End the monitoring by clicking the "Monitor all" button again.

### Displaying data values loaded from the device

During the loading of a data block from a device, the current tag values are also loaded. You can display these values.

#### Requirement

A data block was loaded from the device.

#### Procedure

To display the current values, follow these steps:

1. Open the data block.
2. Click a column header.
3. In the shortcut menu, select the "Show/hide columns" command.  
The selection of available columns is displayed.
4. Select the check box in the "Snapshot" column.

## Result

The current values will be applied in the "Snapshot" column.

---

### Note

If you subsequently change the structure of the data block, the display of the current values gets lost. The "Snapshot" column will then be empty.

---

## Setting data values during commissioning

### Basic information on adjusting data values during commissioning

#### Introduction

During commissioning of a plant, data values have to be frequently adjusted in order to optimally adapt the program to the general operating conditions on site. The declaration table for data blocks offers the following functions for this purpose:

- Initialize data values in "RUN" mode  
This function enables you to change data values online in order to quickly determine the optimum tag values.
- Transfer tag values from the online program to the offline program as start values  
When you have determined the optimum tag values, you can apply these as start values in the offline program. This allows you to ensure that the program starts with the optimized values the next time it is loaded.

To use the function, first define specific tags as "Setting values" in the program. Setting values are the values that will probably have to be fine tuned during commissioning.

#### Marking data as values that can be set

You can mark specific tags in the program as "Setting values". Setting values are the values that will probably have to be fine tuned during commissioning.

#### Rules

You can mark tags as "Setting value" in the following block types:

- In function blocks (FB), but only in the "Static" section
- in global data blocks (DB)
- in PLC data types (UDT)  
In the case of PLC data types (UDT), however, the setting is only effective, if the UDT is used in the "Static" section of a function block or data block.

It is not possible to define setting values in the following block types:

### 9.1 Creating a user program

- In data blocks based on a PLC data type, and in instance data blocks. These inherit the setting from the higher-level FB or UDT.
- You cannot mark tags as a "Setting value" in ARRAY data blocks.
- You also cannot mark tags as a "Setting value" at the call point of a multi-instance. You have to make the setting in the interface of the function block that is called as multiple instance.
- You cannot change the "Setting value" marking in know-how-protected blocks. To do so, you must first remove the know-how protection.

#### Requirement

A function block, a global data block or a PLC data type (UDT) is open.

#### Procedure

To mark a tag as "Setting value", follow these steps:

1. Select a tag from the "Static" section.
2. Select the check box in the "Setting value" column.
  - You cannot define the higher-level element of a structure or a PLC data type as "Setting value". You have to make the setting for the lower-level elements individually.
  - In the case of ARRAYS, you can only mark the higher-level element as "Setting value". The lower-level elements inherit the setting.
  - For ARRAYS of STUCT, you can only mark the elements below the first structure as setting values. The elements of other structures inherit the setting.

#### Result

The tags are marked as setting values. During commissioning, these tags can be initialized in "RUN" mode. In addition, the current tag values can be transferred as start values to the offline program and saved there.

### Initializing setting values in the online program

#### Basics on initializing setting values

You can initialize all tags marked as a "Setting value" with new values in the online program. At the same time, the start values will be loaded from the offline program to the online program. The CPU remains in "RUN" mode. All tags that are marked as a setting value are initialized

once at the next cycle control point. This applies both to retentive and non-retentive tags. The program execution is then continued with the new tag values.

 **DANGER**

**Danger when changing tag values**

Changing the tag values while the plant is operating can cause serious damage to property or injury to persons if there are functional disturbances or program errors!

Make sure that no dangerous situations can arise before you re-initialize the setting values.

## Requirement

- An online connection to the CPU exists.
- The structure of the data block is identical offline and online.
- One or more tags are marked as a "Setting value".

## Procedure

To initialize all setting values of the data block, follow these steps:

1. Open a global data block or an instance data block.
2. Enter the desired values in the "Start value" column. The start values must correspond to the indicated data type.
3. Click the "Initialize setting values" button.

## Result

The setting values in the online program are initialized with the start values from the offline program at the next cycle control point.

The maximum number of tags that can be initialized is dependent on the CPU. If too many setting values are marked, an alarm informs you about this. In this case, you can insert the tags in a watch table and initialize them using the "Modify" function in the watch table. Alternatively, you can also load the entire data block. For more information on this, refer to "See also".

## See also

Loading changed values (Page 1394)

## Applying values from the online program as start values

In order to apply tag values from the online program to the offline program as start values, first create a snapshot of the tag values from the online program. You can then apply them to the offline program. Note that the values from the snapshot are always copied. There is no check to determine whether all values originate from the same cycle. Write-protected start values are not overwritten.

You have the following basic options for applying the values:

- Applying the values of an open data block  
You can apply all values or only the values of the tags marked as a "setting value" as start values in an open data block.
- Applying the values of multiple blocks in the project tree  
You can either apply all setting values or all retentive values as start values in the project tree.

### Requirement

- An online connection to the CPU is available.
- As least one data block has been loaded to the CPU.

### Procedure

In order to apply all values or only the values of the tags marked as a "setting value" in a data block, follow these steps:

1. Open the data block.
2. Start monitoring by clicking the "Monitor all" button.  
The "Monitor value" column is displayed in the table. This shows the current data values.
3. On the toolbar, click "Snapshot of monitored values".  
The latest monitored values will be applied in the "Snapshot" column.
4. Click one of the following buttons on the toolbar:
  - "Apply setting values from the snapshot as start values"
  - "Apply all values from the snapshot as start values"

The values from the "Snapshot" column are applied to the "Start value" column.

To apply the monitored values of multiple data blocks in the project tree, follow these steps:

1. Select the blocks in the project tree.
2. Select the "Snapshot of the monitored values" command in the shortcut menu.  
The current monitored values of all selected blocks will be applied in the "Snapshot" column.  
An alarm is shown in the Inspector window after the operation is complete.
3. Then select one of the following commands in the shortcut menu:
  - "Apply monitor values as start values > Only setpoints"
  - "Apply monitor values as start values > Only retain values"

The values from the "Snapshot" column are applied to the "Start value" column.



## Result

The new start values are stored in the offline program.

---

### Note

#### Applying values of individual tags

You can also transfer the values of individual tags that were not marked as a setting value beforehand from the "Snapshot" column to the "Start values" column. Use the "Copy" and "Paste" commands from the shortcut menu to copy the values and insert them in the "Start value" column.

---

## See also

Basic information on start values (Page 1392)

Define start values (Page 1393)

### 9.1.4.4 Programming PLC data types

#### Basics of PLC data types

#### Description

PLC data types are data structures that you define and that can be used multiple times within the program. The structure of a PLC is made up of several components, each of which can contain different data types. You define the type of components during the declaration of the PLC data type.

PLC data types can be used for the following applications:

- PLC data types can be used as data types for variables in the variable declaration of logic blocks or in data blocks.
- PLC data types can be used as templates for the creation of global data blocks with identical data structures.

## See also

Creating PLC data types (Page 1411)

### Structure of the declaration table for PLC data types

### Structure of the declaration table for PLC data types

The figure below shows the structure of the declaration table for PLC data types.

	Name	Data type	Default value	Visible in HMI	Comment
	Motor	Bool	false	<input checked="" type="checkbox"/>	
	MyTag1	Struct		<input checked="" type="checkbox"/>	
	Element1	Bool	false	<input checked="" type="checkbox"/>	
	Element2	Bool	false	<input checked="" type="checkbox"/>	
	MyTag2	Bool	false	<input checked="" type="checkbox"/>	<input type="text"/>

### Meaning of the columns

The following table shows the meaning of the individual columns. You can show or hide the columns as required. The number of columns displayed varies depending on the CPU series.

Column	Explanation
	Symbol you can click to move or copy the tag.
Name	Name of the tags.
Data type	Data type of the tags.
Default value	Value with which you predefine the tag in the declaration of the PLC data type. Specification of the default value is optional. If you do not specify any value the predefined value for the indicated data type is used. For example, the value "false" is predefined for BOOL.
Visible in HMI	Shows whether the tag is visible by default in the HMI selection list.
Accessible from HMI	Shows whether HMI can access this tag during runtime.
Setting value	Setting values are the values that will probably have to be fine tuned during commissioning. After commissioning, the values of these tags can be transferred to the offline program as start values and stored there.
Comment	Comment to document the tags.

### See also

Creating PLC data types (Page 1411)

Show and hide table columns (Page 1418)

## Creating PLC data types

### Requirement

The "PLC data types" folder opens in the project tree.

### Procedure

To create a PLC data type, proceed as follows:

1. In the "PLC data types" folder, click the "Add new data type" command.  
A new declaration table for creating a PLC data type will be created and opened.
2. Select the PLC data type and select the "Rename" command in the shortcut menu.
3. Enter the name of the PLC data type.

### Result

The new PLC data type is created. You can find the PLC data type in the project tree in the "PLC data types" folder.

### See also

Structure of the declaration table for PLC data types (Page 1410)  
Basics of PLC data types (Page 1409)

## Delete PLC data types

### Requirement

The PLC data type you want to delete is not open.

### Procedure

To delete a PLC data type, follow these steps:

1. In the project tree, open the "PLC data types" folder.
2. Select the PLC data type to be deleted. You can also select several PLC data types by clicking on them one after the other while holding down the <Ctrl> key or by pressing and holding down <Shift> and clicking on the first and last data type.
3. Select the "Delete" command in the shortcut menu.

---

**Note**

If you delete a PLC data type, the blocks that use the data type will become inconsistent. These inconsistencies are marked in red in the block used. To remedy these inconsistencies, the data blocks have to be updated.

See also:

Updating the block interface (Page 1250)

Updating data blocks (Page 1387)

---

## Programming the structure of PLC data types

### Declaring tags of elementary data type

#### Requirement

A PLC data type is open.

#### Procedure

To declare a tag, follow these steps:

1. Enter a tag name in the "Name" column.
2. Enter the required data type in the "Data type" column. You will be supported by autocompletion during input.
3. Optional: Change the properties of the tags that are displayed in the other columns.
4. Repeat steps 1 to 3 for all tags that are to be declared.

#### See also

Editing tables (Page 242)

### Declaring tags of the ARRAY data type

#### Requirement

A PLC data type is open.

## Procedure

To declare a tag of the ARRAY data type, follow these steps:

1. Enter a tag name in the "Name" column.
2. Enter the "Array" data type in the "Data type" column. You will be supported by autocompletion in this step.  
The "Array" dialog opens.
3. In the "Data type" text box, specify the data type of the array elements.
4. In the "ARRAY limits" text box, specify the high and low limit for each dimension.  
Example of a one-dimensional ARRAY:  
[0..3]  
Example of a three-dimensional ARRAY:  
[0..3, 0..15, 0..33]
5. Confirm your entry.
6. Optional: Change the properties of the tags that are displayed in the other columns.

---

### Note

You cannot define specific default values for ARRAY elements. You can, however, assign them start values at the usage point in the data block.

---

## See also

Structure of the declaration table for PLC data types (Page 1410)

## Declaring tags of STRUCT data type

### Requirements

A PLC data type is open.

## Procedure

To declare a tag of the STRUCT data type, follow these steps:

1. Enter a tag name in the "Name" column.
2. Enter "Struct" in the "Data type" column. You will be supported by autocompletion during input.  
An empty, indented row is inserted after the new tag.
3. Insert the first structural element in the first empty row.  
An additional empty row is inserted after the element.
4. Select a data type for the structure element.
5. Optional: Change the properties of the structural element that is displayed in the other columns.

### 9.1 Creating a user program

6. Repeat steps 3 to 5 for all additional structure elements.  
It is not necessary to end the structure explicitly. The structure ends with the last element that is entered.
7. To insert a new tag after the structure, leave a blank row after the end of the structure and then start the new tag in the second empty row.

#### Result

The tag of STRUCT data type is created.

#### See also

STRUCT (Page 1110)

Structure of the declaration table for PLC data types (Page 1410)

### Declaring tags based on a different PLC data type

#### Requirements

- A global data block is open.
- A PLC data type is declared in the current CPU.

#### Procedure

To declare a tag based on a different PLC data type, follow these steps:

1. Enter a tag name in the "Name" column.
2. Enter the PLC data type in the "Data type" column. You will be supported by autocompletion during input.

#### Result

The tag is created.

---

#### Note

You define the default values of tags within a PLC data type when the PLC data type is created. You cannot change these values at the point of use of the PLC data type.

---

#### See also

Basics of PLC data types (Page 1409)

Structure of the declaration table for PLC data types (Page 1410)

## Editing tag properties in PLC data types

### Properties of tags in PLC data types

#### Properties

The following table gives an overview of tag properties in PLC data types:

Group	Property	Description
General	Name	Name of the tags.
	Data type	Data type of the tags.
	Default value	Default value of the tag in the interface of a higher-level code block or in a PLC data type. The values contained in the "Default value" column can only be changed in the higher-level code block or PLC data type. The values are only displayed in the data block.
	Start value	Not relevant in PLC data types
	Comment	Comment on the tag.
Attributes	Retain	Not relevant in PLC data types
	Visible	Indicates whether a parameter is visible in CFC.
	Configurable	Indicates whether a parameter is configurable in CFC.
	For test	Indicates whether a parameter is registered for the CFC test mode.
	Interconnectable	Indicates whether a parameter is interconnectable in CFC.

#### See also

Changing the properties of tags in PLC data types (Page 1415)

Basics of PLC data types (Page 1409)

Structure of the declaration table for PLC data types (Page 1410)

## Changing the properties of tags in PLC data types

### Editing general properties in the declaration table

To edit the general properties of one or more tags, follow these steps:

1. Open the PLC data type.
2. Change the entries in the columns.

### Editing detailed properties in the properties window

To edit the detailed properties of an individual tag, follow these steps:

1. Select a tag in the table.
2. Select the "Properties" command in the shortcut menu.  
The inspector window shows the properties of the tag in the "General" and "Attributes" areas.
3. Select the required area in the area navigation.
4. Change the entries in the text boxes.

### See also

Updating the block interface (Page 1250)

Updating data blocks (Page 1387)

### Editing the declaration table for PLC data types

#### Inserting table rows

##### Procedure

Proceed as follows to insert a row above the selected row:

1. Select the row in front of which you want to insert a new row.
2. Click the "Insert row" button on the toolbar of the table.

##### Result

A new row is inserted above the selected row.

#### Inserting table rows

##### Procedure

Proceed as follows to insert a row below the selected row:

1. Select the row below which you want to insert a new row.
2. Click the "Add row" button on the table toolbar.

##### Result

A new empty row will be inserted below the selected row.



## Deleting tags

### Procedure

To delete a tag, follow these steps:

1. Select the row with the tag to be deleted. You can also select several rows by clicking on them one after the other while holding down the <Ctrl> key or by pressing and holding down <Shift> and clicking on the first and last row.
2. Select the "Delete" command in the shortcut menu.

### See also

Updating the block interface (Page 1250)

Updating data blocks (Page 1387)

## Automatically filling in successive cells

You can load the contents of one or several table cells into the cells below, automatically filling in the successive cells.

If you automatically fill in cells in the "Name" column, a consecutive number will be appended to each name. For example, "Motor" will become "Motor\_1".

You can define individual or more cells as well as entire rows as source area.

If less rows exist in the open table than you want to fill, then you will first have to insert additional empty rows.

### Requirement

- The table is open.
- Sufficient declaration rows are available.

### Procedure

To automatically fill in successive cells, follow these steps:

1. Select the cells to be loaded.
2. Click the "Fill" symbol in the bottom right corner of the cell.  
The mouse pointer is transformed into a crosshair.
3. Keep the mouse button pressed and drag the mouse pointer downwards over the cells that you want to fill in automatically.
4. Release the mouse button.  
The cells are filled in automatically.
5. If entries are already present in the cells that are to be automatically filled in, a dialog appears. In this dialog you can indicate whether you want to overwrite the existing entries or insert new rows for the new tags.

## Show and hide table columns

You can show or hide the columns in a table as needed.

### Procedure

To show or hide table columns, follow these steps:

1. Click a column header.
2. Select the "Show/Hide" command in the shortcut menu.  
The selection of available columns is displayed.
3. To show a column, select the column's check box.
4. To hide a column, clear the column's check box.

### 9.1.4.5 Using external source files

#### Basics of using external source files

#### Function

The textual programming languages STL and SCL allow you to enter the program code in any ASCII editor and save it as an external source file. This enables you to perform a range of tasks, for example:

- Declaring tags
- Specify block properties
- Programming blocks

You can import these source files to your project and use them to generate blocks. You can generate a number of different blocks from one source file. Observe the following special features when generating blocks from a source file:

- A block that exists under the same name in the project will be overwritten. However, the block type is retained for an organization block (OB).
- If a block was programmed with its absolute block number instead of a symbolic name in the source file and this number is already assigned by a block in the project, the new generated block is initially assigned the next free symbolic name.
- If you have not explicitly defined the access mode for a block in the external source file, the block access mode is set depending on the CPU series used:
  - Blocks generated for a CPU of the S7-1200/1500 series are assigned "optimized" access mode by default.
  - Blocks generated for a CPU of the S7-300/400 product range are assigned "standard" access mode by default.

Organization blocks are the exception in this case, as they are always assigned the "standard" access mode by default, regardless of the CPU series. You have the option of changing the block access mode manually.

- It is possible that not all comments from the source file will be applied in the block.
- If you use absolute addressing in the external source file, a symbolic tag is created for each absolute address during the generation of the block. The names of these tags are made up of "Tag\_" and a time stamp. This may result in relatively long tag names, which you can change manually if required.
- If you are using instructions in a different version in the external source file than in the target device, this may result in compilation errors. Correct the respective instructions in this case and start the compilation process once again. You can also select a different version for the target device.

You also have the option of saving existing blocks as external source files.

## See also

Rules for programming external source files (Page 1419)

Saving blocks as external source files (Page 1420)

Inserting external source files (Page 1421)

Opening and editing external source files (Page 1422)

Generating blocks from external source files (Page 1422)

## Rules for programming external source files

An external source file basically consists of continuous text. To compile the source into blocks, certain structures and syntax rules must however be adhered to.

## Syntax rules

The syntax of the instructions in external source files is very similar to that in the creation of user programs in the program editor with STL or SCL. Note, however, the following additional syntax rules:

- **Block call**  
When calling a block, transfer the parameters in the defined order in the ASCII editor. If you do not, the comment assignments for these lines may not match.  
Enter the parameters in brackets. The individual parameters are separated by a comma.
- **Upper or lower case**  
The program editor generally disregards upper or lower case. Jump labels are an exception to this. Character string entries are also case-sensitive ("STRING" data type). Keywords are displayed in upper case. For compilation purposes, however, case is disregarded; you can therefore specify keywords in upper or lower case or a mixture of the two.
- **Semicolon**  
Mark the end of every instruction and every tag declaration with a semicolon. You can enter several instructions per line.
- **Forward slashes**  
Begin every comment with two forward slashes (//) and end the comment with the <Enter> key.

## See also

- Basics of using external source files (Page 1418)
- Saving blocks as external source files (Page 1420)
- Inserting external source files (Page 1421)
- Opening and editing external source files (Page 1422)
- Generating blocks from external source files (Page 1422)

## Saving blocks as external source files

Depending on the programming language used for the block, you have the following options for storing blocks as external source files:

- STL and SCL: copy a block as text
- SCL: generate external source file from one or more blocks

## Copying a block as text

To copy a block as text and export it to an external source file, follow these steps:

1. In the project tree, right-click on the block you want to export to an external source file.
2. Select the "Copy as text" command in the shortcut menu.
3. Open an external text editor.
4. Paste the copied text from the clipboard.
5. Save the file with one of the following file name extensions:
  - ".scl" if you wish to generate a source file for SCL
  - ".stl" if you wish to generate a source file for STL

## Generating an external source file from SCL blocks

To generate an external source file from SCL blocks, follow these steps:

1. In the project tree or in the overview window, select the SCL blocks from which you want to generate an external source file.
2. Select the "Generate source from blocks" command from the shortcut menu. The "Generate source from blocks" dialog opens.
3. Specify a path and a name for the external source.
4. Click "OK".

You can also generate an external source file from an open SCL block. To do this, follow these steps:

1. Click on the "Generate source from block" button in the programming editor. The "Generate source from blocks" dialog opens.
2. Specify a path and a name for the external source.
3. Click "OK".

## Result

The block has been saved as an external source file. You can include this source file in a project in the TIA portal and use it to generate other blocks. However, please note that you can use STL source files only in S7-300/400/1500 CPUs.

## See also

Basics of using external source files (Page 1418)  
Rules for programming external source files (Page 1419)  
Inserting external source files (Page 1421)  
Opening and editing external source files (Page 1422)  
Generating blocks from external source files (Page 1422)

## Inserting external source files

### Requirement

- An external source file is available and complies with the syntax and structure rules.
- The "External source files" folder is open in the project tree.

### Procedure

Follow these steps to insert an external source file:

1. Double-click on the "Add new external file" command.  
The "Open" dialog box is opened.
2. Navigate to and select existing external source files.
3. Confirm your selection with "Open".

## Result

The new source file will be added to the "External source files" folder.

## See also

Basics of using external source files (Page 1418)  
Rules for programming external source files (Page 1419)  
Saving blocks as external source files (Page 1420)  
Opening and editing external source files (Page 1422)  
Generating blocks from external source files (Page 1422)

### Opening and editing external source files

By linking the files with the file name extensions ".stl" and ".scl" to an editor you will be able to open and edit external source files with these formats directly. Use Notepad as editor because other text editors may not let you open several sources at the same time.

This means you do not need to insert the external source files again after editing.

### Linking files with the file name extensions ".stl" and ".scl" file types to an editor

Proceed as follows to link files with the file name extensions ".stl" and ".scl" to an editor:

1. Open Windows Explorer.
2. Right-click on an STL file.
3. Select "Properties" in the shortcut menu.  
The "Properties" dialog box opens.
4. Click "Change" in the "File type" area on the "General" tab.  
The "Open with" dialog box opens.
5. Select the text editor you want to link to the ".stl" file type.
6. Confirm your selection with "OK".
7. Close the "Properties" dialog with "OK".
8. Repeat steps 2 to 7 with an SCL file.

### Opening and editing an external source file

To open an external source file, follow these steps:

1. Open the "External source files" folder in the project tree.
2. Double-click on the external source file you want to open.  
The external source file will open in the linked editor and can be edited.

### See also

Basics of using external source files (Page 1418)

Rules for programming external source files (Page 1419)

Saving blocks as external source files (Page 1420)

Inserting external source files (Page 1421)

Generating blocks from external source files (Page 1422)

### Generating blocks from external source files

#### Requirement

- The "External source files" folder is open in the project tree.
- An external source file is available.

## Procedure

To generate blocks from an external source file, follow these steps:

1. Open the external source file from which you wish to generate blocks.
2. Select the "Generate blocks from source" command in the "Edit" menu.
3. A prompt will appear telling you any existing blocks will be overwritten.
4. Confirm the safety prompt with "Yes".

## Result

The external source file blocks will be generated and inserted in the "Program blocks" folder in the project tree. In the event of errors, information about the errors which have occurred will be displayed in the inspector window. This information, however, relates to the external source file and not to the block generated.

## See also

Basics of using external source files (Page 1418)

Rules for programming external source files (Page 1419)

Saving blocks as external source files (Page 1420)

Inserting external source files (Page 1421)

Opening and editing external source files (Page 1422)

## 9.1.5 Comparing PLC programs

### 9.1.5.1 Basic information on comparing PLC programs

#### Introduction to comparing PLC programs

#### Function

You can compare the following objects of a PLC program in order to detect any differences:

- Code blocks with other code blocks
- Data blocks with other data blocks
- PLC tags of a PLC tag table with the PLC tags of another PLC tag table
- PLC data types with other PLC data types

### Types and levels of comparison

Two different basic types of comparison can be used:

- **Online/offline comparison:**  
The objects in the project are compared with the objects of the corresponding device. An online connection to the device is necessary for this comparison.
- **Offline/offline comparison:**  
The objects of two devices either within a project or from different projects or libraries are compared. No online connection is required for this comparison.

Please note that you cannot carry out an unlimited number of comparisons at the same time. The limit is one comparison for each comparison type (online/offline or offline/offline) and for each starting point (device or "Program blocks" folder).

You can choose between the following levels of comparison depending on how in-depth an object comparison you require:

- Compare editor
- Detailed comparison

When you start a comparison, you will first receive an overview in the compare editor. For some comparison objects, you can then start a detailed comparison in which the objects compared will be opened side-by-side, each in its own program editor instance. Any differences will be highlighted.

The table below gives an overview of the types and levels of comparison you can apply for each object:

Object	Online/offline		Offline/offline	
	Compare editor	Detailed comparison	Compare editor	Detailed comparison
LAD block	X	X	X	X
FBD block	X	X	X	X
STL block <sup>1</sup>	X	X	X	X
SCL block	X	X <sup>3</sup>	X	X
GRAPH block <sup>2</sup>	X	-	X	-
Global data block	X	X	X	X
Instance data block	X	X	X	X
PLC tags	-	-	X	X
PLC data type	X <sup>4</sup>	X <sup>4</sup>	X	X

Legend:  
X: available  
-: not available  
<sup>1</sup>: STL is not available for S7-1200  
<sup>2</sup>: GRAPH is not available for S7-1200/1500  
<sup>3</sup>: not for S7-1200 prior to version 2.0  
<sup>4</sup>: not for S7-300/400



---

**Note****Please note the following:**

- You cannot perform a detailed comparison for know-how protected blocks.
  - If the detail comparison detects differences only with respect to the data types of local tags, with offline being an interrupt data type (C\_ALARM C\_ALARM\_S C\_ALARM\_8 C\_ALARM\_8P C\_ALARM\_T C\_AR\_SEND C\_NOTIFY C\_NOTIFY\_8P) and online a DWORD, this difference is not marked as such.
  - You cannot run a detailed comparison for types and master copies from libraries.
- 

**See also**

Basics of project data comparison (Page 286)  
Comparison of code blocks (Page 1425)  
Comparison of data blocks (Page 1426)  
Comparing PLC tags and PLC data types (Page 1427)  
Carrying out an online/offline comparison (Page 287)  
Carrying out offline/offline comparisons (Page 287)  
Using the comparison editor (Page 288)

**Comparison of code blocks****Introduction**

The blocks to be compared in a code block comparison are assigned for comparison on the basis of the following criteria:

- Online/offline comparison: Addresses, e.g. FB100
- Offline/offline comparison: Symbolic names of the blocks

The comparison involves an evaluation of the block time stamps. The results are displayed as an overview in the comparison editor. You can then use actions to define what is to be done about the differences. You can also start detailed comparisons for the individual blocks. The versions of a block compared are opened beside each other and the differences are highlighted.

For the comparison of code blocks, both the block interfaces and the individual networks are compared. Any differing tag names are also determined. All comments and other block attributes are excluded from an online/offline comparison.

If the block interface changes, the time stamp of the code block interface will also change. This change means a change in the time stamp of the program code. The first step in comparing block interfaces is therefore a comparison of the program code time stamps. If these time stamps are the same, it is assumed that the interfaces are the same. If the time stamps of the interfaces differ, the next step is to compare the data types of the interfaces, section by section.

Multiple instances and PLC data types are included in the comparison. If the data types in the sections are the same, the start values of the tags are compared. All differences are displayed.

When networks are compared, first inserted or deleted networks are detected. Then the other networks are compared. Instructions are the same if the operator and operand are the same. The first difference in each instruction is displayed. However, several differences per network can be displayed.

### See also

Introduction to comparing PLC programs (Page 1423)

Comparison of data blocks (Page 1426)

Comparing PLC tags and PLC data types (Page 1427)

Carrying out an online/offline comparison (Page 287)

Carrying out offline/offline comparisons (Page 287)

Using the comparison editor (Page 288)

## Comparison of data blocks

### Introduction

The blocks to be compared in a data block comparison are assigned for comparison on the basis of the following criteria:

- Online/offline comparison: Addresses, e.g. DB100
- Offline/offline comparison: Symbolic names of the blocks

The first step in data block comparison is comparing the time stamps of the data block. If these time stamps are the same, it is assumed that the data structures are the same. If the time stamps differ, the structures are then compared until the first difference is found. If the data structures in the sections are the same, the initial and current values of the tags are then compared. All differences are displayed. Any differing tag names are also determined. Comments and PLC data type structures used in the data block are not included in the comparison.

### See also

Introduction to comparing PLC programs (Page 1423)

Comparison of code blocks (Page 1425)

Comparing PLC tags and PLC data types (Page 1427)

Carrying out an online/offline comparison (Page 287)

Carrying out offline/offline comparisons (Page 287)

Using the comparison editor (Page 288)

## Comparing PLC tags and PLC data types

### Introduction

The device PLC tag tables and the device PLC data types will also be shown in the comparison editor if you carry out an offline/offline comparison. The PLC tag tables and the PLC data types will be matched by name and you will receive the following information:

- Status: A symbol shows whether the PLC tags/PLC data types are identical or differ.
- Missing PLC tag tables / PLC data types: You can see at a glance whether the PLC tag tables / PLC data types are available in both devices.

You obtain the following information with an online/offline comparison of CPUs of the S7-1200/1500 series:

- PLC tags: A symbol shows whether the PLC tags are identical or differ. Because PLC tag tables are not downloaded to the device during loading, they cannot be displayed during an online/offline comparison.
- PLC data types: You receive the status symbol for each PLC data type. You can see at a glance whether the PLC data types are available in both devices.

### See also

Introduction to comparing PLC programs (Page 1423)

Comparison of code blocks (Page 1425)

Comparison of data blocks (Page 1426)

Carrying out an online/offline comparison (Page 287)

Carrying out offline/offline comparisons (Page 287)

Using the comparison editor (Page 288)

### 9.1.5.2 Comparing blocks

#### Comparing blocks in the compare editor

You have the following options for comparing blocks in the compare editor:

- Online/offline comparison  
The blocks in the project are compared with the blocks of the selected device.
- Automatic offline/offline comparison  
All blocks of the selected devices are compared offline.
- Manual offline/offline comparison  
The selected blocks of the devices are compared offline.

### Carrying out an online/offline comparison of blocks

To perform an online/offline comparison, follow these steps:

1. In the project tree, select a device that allows online/offline comparison.
2. Select the "Compare > Offline/online" command in the shortcut menu.
3. If you have not already established an online connection to this device, the "Go online" dialog opens. In this case, set all the necessary parameters for the connection and click "Connect".  
The online connection is established and the compare editor opens.
4. Open the "Program blocks" folder.  
You can identify the status based on the symbols in the status and action area. You can define certain actions depending on the status of the objects. Note, however, that you can only perform actions in one direction in a synchronization action.

### Carrying out an automatic offline/offline comparison of blocks

To perform an automatic offline/offline comparison of blocks, follow these steps:

1. Select a device in the project tree that allows offline/offline comparison.
2. Select the "Compare > Offline/offline" command in the shortcut menu.  
The compare editor opens and the selected device is displayed in the left area.
3. Drag-and-drop an additional device to the drop area of the right pane. The device to be compared can originate from the same project, a reference project or the library.
4. Open the "Program blocks" folder.  
You can identify the status of the objects based on the symbols in the status and action area. You can define certain actions depending on the status of the objects. When you select an object, the object's properties and the corresponding object of the assigned device are clearly shown in the properties comparison.

You can drag any other device to the drop area at any time to perform further comparisons.

### Carrying out a manual offline/offline comparison of blocks

To perform a manual offline/offline comparison of blocks, follow these steps:

1. Select a device in the project tree that allows offline/offline comparison.
2. Select the "Compare > Offline/offline" command in the shortcut menu.  
The compare editor opens and the selected device is displayed in the left area.
3. Drag-and-drop an additional device to the drop area of the right pane. The device to be compared can originate from the same project, a reference project or the library.
4. In the status and action area, click on the button for switching between automatic and manual comparison.
5. Select the objects that you want to compare.  
The properties comparison is displayed. You can identify the status of the objects based on the symbols. You can define certain actions depending on the status of the objects.

You can drag any other device to the drop area at any time to perform further comparisons.

## See also

- Introduction to comparing PLC programs (Page 1423)
- Using the comparison editor (Page 288)
- Comparing PLC tags (Page 1435)
- Comparing PLC data types (Page 1436)

## Performing detailed block comparisons

### Starting a detailed comparison

You can start a detailed comparison for blocks. The versions of a block compared are opened beside each other and the differences highlighted.

---

#### Note

Please note the following:

- You cannot carry out detailed comparisons of blocks created in the GRAPH programming language.
  - For blocks that are created in the programming language SCL, the detail comparison is not available for S7-1200 series CPUs with a version older than 2.0.
- 

### Starting detailed comparisons using the compare editor

To start a detailed comparison for a block using the compare editor, follow these steps:

1. First, perform an online/offline or an offline/offline comparison.  
The compare editor opens.
2. In the compare editor, select the block for which you want to perform a detailed comparison.
3. Click the "Start detailed comparison" button in the toolbar.

### Starting detailed comparisons in the program editor

For the comparison type online/offline, you can start the detailed comparison directly in the programming editor. To do this, follow these steps:

1. Open the block for which you wish to carry out a detailed comparison.
2. Establish an online connection.  
See also: [Go online](#) and [Go offline](#)

---

#### Note

Please note that the block must be available online in order for you to be able to start the detailed comparison for the block within the programming editor.

---

3. Click the "Detailed comparison" button in the toolbar.
4. Confirm the dialog for closing the block with "Yes".

## Result

One instance of the program editor will be opened for each version of the block compared and the two instances is displayed side by side. Any differences will be highlighted in color in each version.

## See also

- Carrying out offline/offline comparisons (Page 287)
- Carrying out an online/offline comparison (Page 287)
- Using the comparison editor (Page 288)
- Representation of the detailed comparison (Page 1430)
- Navigating in the detailed comparison (Page 1432)
- Changing blocks during detailed comparison (Page 1433)
- Updating comparison results (Page 1434)

## Representation of the detailed comparison

### Identification of the differences

The detailed comparison allows you to identify the exact places where versions of a block differ. The following color coding allows you to find these places as quickly as possible:

- The lines where there are differences are highlighted in gray.
- Differing operands and instructions are highlighted in green.
- If the number of networks differs, pseudo-networks are added to allow the display of identical networks to be synchronized. These pseudo-networks are highlighted in grey and contain the text "No corresponding network found" in the title bar of the network. Pseudo-networks cannot be edited.

### Example

The following figure shows an example of the detailed comparison for the LAD programming language:

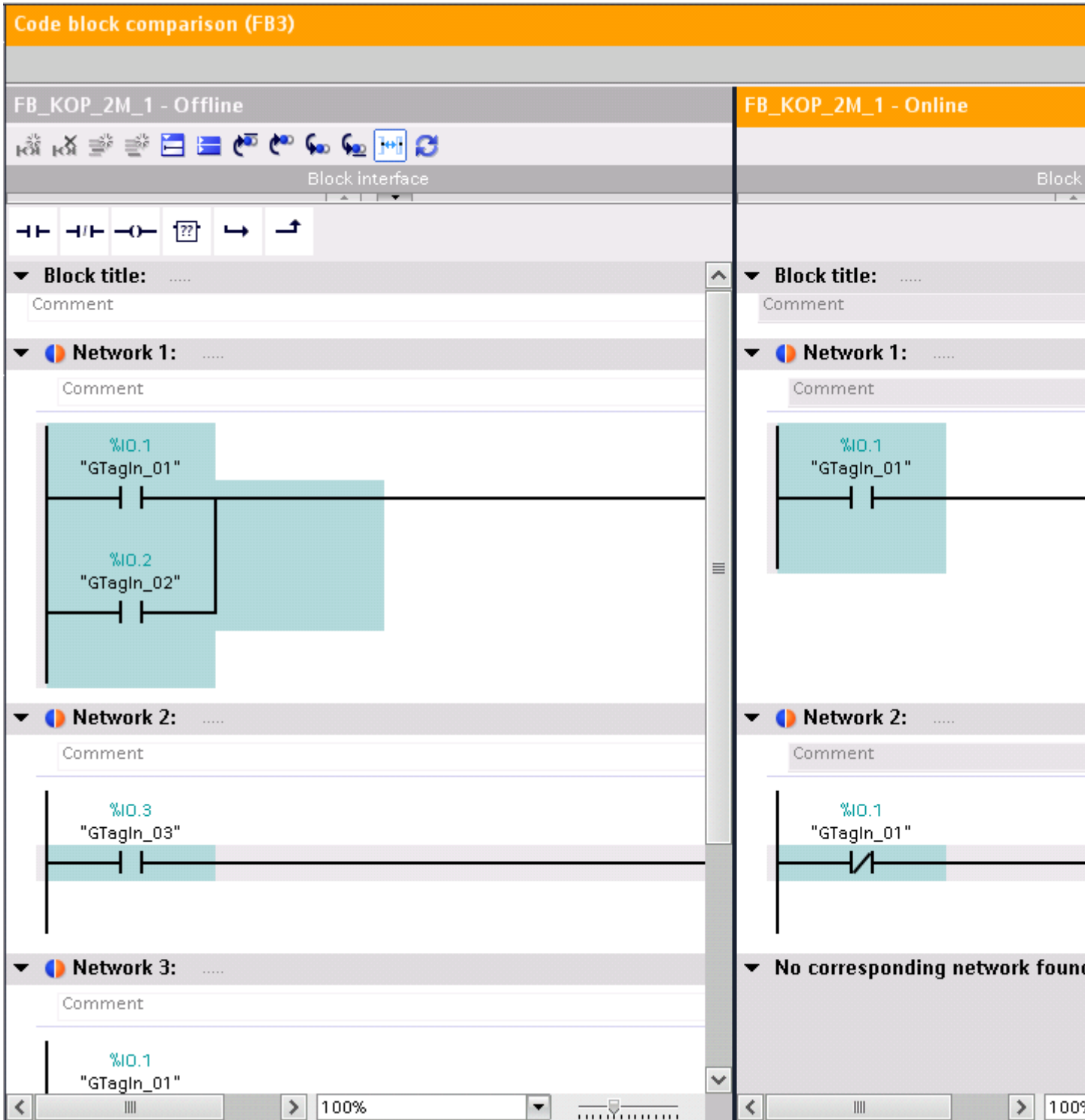

---

**Note**

The display of the symbolic name of the online version of the block is only possible for S7-1200 and S7-1500.

---

### Reducing the number of differences displayed

For the sake of clarity, not all the differences are highlighted but rather the first difference of an operation in each case. For example, if all the inputs in a box with multiple inputs are different in the offline and online versions of the block, only the first input is highlighted as a difference. You can resolve this difference and update the comparison list. The next input will then be highlighted as a difference.

The number of differences highlighted within a network therefore depends on the number of instructions.

### See also

Carrying out an online/offline comparison (Page 287)

Carrying out offline/offline comparisons (Page 287)

Using the comparison editor (Page 288)

Starting a detailed comparison (Page 1429)

Navigating in the detailed comparison (Page 1432)

Changing blocks during detailed comparison (Page 1433)

Updating comparison results (Page 1434)

### Navigating in the detailed comparison

#### Requirement

You have run a detailed comparison.

#### Navigate to the differences

To navigate to a difference between the two blocks, follow these steps:

1. Open the list of results for the detailed comparison under "Info > Comparison result" in the Inspector window.
2. Double-click a difference.  
The difference is selected in both editors.

Or:



1. Click one of the following navigation buttons on the toolbar:
  - Position on first difference  
Navigates to the first difference in the block, and displays the difference in both editors.
  - Position on previous difference  
Navigates to the previous difference starting from the current position, and displays the difference in both editors.
  - Position on next difference  
Navigates to the next difference starting from the current position, and displays the difference in both editors.
  - Position on last difference  
Navigates to the last difference in the block, and displays the difference in both editors.

### **Switching off/on the synchronization of the vertical scrolling between the editors**

The scrolling for both editors is synchronized to ensure that the corresponding networks are visible parallel to each other during vertical scrolling. You can switch this mode off and on. To do this, follow these steps:

1. To switch off synchronized scrolling, click the "Synchronize scrolling between editors" button in the toolbar.
2. To switch on synchronized scrolling again, click the "Synchronize scrolling between editors" button one more time in the toolbar.

### **See also**

- Carrying out an online/offline comparison (Page 287)
- Carrying out offline/offline comparisons (Page 287)
- Using the comparison editor (Page 288)
- Starting a detailed comparison (Page 1429)
- Representation of the detailed comparison (Page 1430)
- Changing blocks during detailed comparison (Page 1433)
- Updating comparison results (Page 1434)

### **Changing blocks during detailed comparison**

#### **Changing offline blocks**

You can change offline blocks at any time.

#### **Changing online blocks**

You cannot change online blocks.

**See also**

- Carrying out an online/offline comparison (Page 287)
- Carrying out offline/offline comparisons (Page 287)
- Using the comparison editor (Page 288)
- Starting a detailed comparison (Page 1429)
- Representation of the detailed comparison (Page 1430)
- Navigating in the detailed comparison (Page 1432)
- Updating comparison results (Page 1434)

**Updating comparison results**

As soon as you change an object, the comparison results are no longer valid and must be updated.

**Requirement**

You have run a detailed comparison.

**Procedure**

- To update the comparison results, follow these steps:
1. Click "Update the comparison result" in the toolbar.

**See also**

- Carrying out an online/offline comparison (Page 287)
- Carrying out offline/offline comparisons (Page 287)
- Using the comparison editor (Page 288)
- Starting a detailed comparison (Page 1429)
- Representation of the detailed comparison (Page 1430)
- Navigating in the detailed comparison (Page 1432)
- Changing blocks during detailed comparison (Page 1433)

### 9.1.5.3 Comparing PLC tags

You have the following options for comparing PLC tags:

- Automatic offline/offline comparison in the compare editor  
The PLC tag tables of the selected devices are compared offline.
- Manual offline/offline comparison in the compare editor  
The selected PLC tag tables of the devices are compared offline.
- Detailed comparison  
Use the detailed comparison to determine differences within the PLC tag tables.

#### **Performing automatic offline/offline comparison in the compare editor**

To perform an automatic offline/offline comparison of PLC tag tables, follow these steps:

1. Select a device in the project tree that allows offline/offline comparison.
2. Select the "Compare > Offline/offline" command in the shortcut menu.  
The compare editor opens and the selected device is displayed in the left area.
3. Drag-and-drop an additional device to the drop area of the right pane. The device to be compared can originate from the same project, a reference project or the library.
4. Open the "PLC tags" folder.  
You can identify the status of the PLC tag tables based on the symbols in the status and action area. You can define certain actions depending on the status.

You can drag any other device to the drop area at any time to perform further comparisons.

#### **Performing manual offline/offline comparison in the compare editor**

To perform a manual offline/offline comparison of PLC tag tables, follow these steps:

1. Select a device in the project tree that allows offline/offline comparison.
2. Select the "Compare > Offline/offline" command in the shortcut menu.  
The compare editor opens and the selected device is displayed in the left area.
3. Drag-and-drop an additional device to the drop area of the right pane. The device to be compared can originate from the same project, a reference project or the library.
4. In the status and action area, click on the button for switching between automatic and manual comparison.
5. Select the PLC tag tables that you want to compare.  
The properties comparison is displayed. You can identify the status based on the symbols.

You can drag any other device to the drop area at any time to perform further comparisons.

### Running a detailed comparison

To start a detailed comparison for a PLC tag table, follow these steps:

1. Perform an automatic or manual offline/offline comparison.
2. For an automatic offline/offline comparison in the compare editor, select the PLC tag table for which you want to run a detailed comparison. Note that two PLC tag tables must be selected for comparison for a manual offline/offline comparison.
3. Click the "Start detailed comparison" button in the toolbar.  
A separate compare editor opens. All existing PLC tags of the selected PLC tag tables are displayed depending on the settings of the compare editor. User and system constants are not shown, however. You can identify the status of the PLC tags based on the symbols. You can define certain actions depending on the status of the PLC tags.

### See also

Introduction to comparing PLC programs (Page 1423)

Using the comparison editor (Page 288)

Comparing PLC data types (Page 1436)

#### 9.1.5.4 Comparing PLC data types

You have the following options for comparing PLC data types:

- Online/offline comparison (S7-1200/1500 only)  
The PLC data types in the project are compared with the PLC data types of the selected device.
- Automatic offline/offline comparison in the compare editor  
The PLC data types of the selected devices are compared offline.
- Manual offline/offline comparison in the compare editor  
The selected PLC data types of the devices are compared offline.
- Detailed comparison  
Use the detailed comparison to determine differences between PLC data types.

### Performing online/offline comparison of PLC data types

To perform an online/offline comparison, follow these steps:

1. In the project tree, select a device that allows online/offline comparison.
2. Select the "Compare > Offline/online" command in the shortcut menu.  
If you have not already established an online connection to this device, the "Go online" dialog opens. In this case, set all the necessary parameters for the connection and click "Connect".  
The online connection is established and the compare editor opens.
3. Open the "PLC data types" folder.  
You can identify the status based on the symbols in the status and action area. When you select an object, the properties of the PLC data type and the corresponding PLC data type of the assigned device are displayed in the properties comparison.

### **Performing automatic offline/offline comparison in the compare editor**

To perform an automatic offline/offline comparison of PLC tag tables, follow these steps:

1. Select a device in the project tree that allows offline/offline comparison.
2. Select the "Compare > Offline/offline" command in the shortcut menu.  
The compare editor opens and the selected device is displayed in the left area.
3. Drag-and-drop an additional device to the drop area of the right pane. The device to be compared can originate from the same project, a reference project or the library.
4. Open the "PLC data types" folder.  
You can identify the status of the PLC tag tables based on the symbols in the status and action area. You can define certain actions depending on the status.

You can drag any other device to the drop area at any time to perform further comparisons.

### **Performing manual offline/offline comparison in the compare editor**

To perform a manual offline/offline comparison of PLC data types, follow these steps:

1. Select a device in the project tree that allows offline/offline comparison.
2. Select the "Compare > Offline/offline" command in the shortcut menu.  
The compare editor opens and the selected device is displayed in the left area.
3. Drag-and-drop an additional device to the drop area of the right pane. The device to be compared can originate from the same project, a reference project or the library.
4. In the status and action area, click on the button for switching between automatic and manual comparison.
5. Select the PLC data types that you want to compare.  
The properties comparison is displayed. You can identify the status based on the symbols.

You can drag any other device to the drop area at any time to perform further comparisons.

### **Running a detailed comparison**

To start a detailed comparison for a PLC data type, follow these steps:

1. Perform an offline/offline or an online/offline comparison (S7-1200/1500 only).
2. For an automatic offline/offline comparison in the compare editor, select the PLC data type for which you want to run a detailed comparison. Note that two PLC data types must be selected for comparison with a manual offline/offline comparison.
3. Click the "Start detailed comparison" button in the toolbar.  
The two PLC data types are opened next to each other so that you can easily identify the differences.

### **See also**

Introduction to comparing PLC programs (Page 1423)

Using the comparison editor (Page 288)

Comparing PLC tags (Page 1435)

## 9.1.6 Compiling and downloading blocks

### 9.1.6.1 Compiling blocks

#### Basic information on compiling blocks

##### Introduction

A user program must first be compiled before the CPU can execute it. You need to recompile your program each time you make a change.

The following procedures take place during compilation:

- The user program is checked for syntax errors.
- Unneeded instructions are removed from the user program.
- All the block calls within the compiled blocks are checked. In case of changes to the interface of called blocks, errors will be shown in the "Compilation" tab of the information window. You have to correct these errors first.
- Finally, the user program is compiled into a code that can be read by the CPU.

##### Compilation methods

You can start compilation in the following windows or editors:

- Compiling blocks in the project tree  
Serves to compile individual blocks or the simultaneous compilation of one or several blocks in the "Program blocks" folder.
- Compiling blocks in the program editor  
This is intended for compilation of a single open block.
- Compiling blocks in the call or dependency structure  
Used to compile individual blocks.  
See also: Call structure (Page 1470), Dependency structure (Page 1476)

## Compilation options

If you are compiling blocks in project tree, you have further options:

- **Software (changes only)**  
All program changes of the selected blocks are compiled. If you have selected a block folder, all program changes to the blocks contained in the folder are compiled.
- **Software (compile all blocks)**  
All blocks are compiled. This is recommended for the first compilation and after major revisions.
- **Software (reset memory reserve)**  
All tags declared in the reserve area of the interface of selected blocks are moved to the standard area of the interface. Memory reserve is now available for further interface extensions.

---

### **Note**

This option is only available for CPUs of the S7-1500 and S7-1200 V4 series.

---

## Consistency check

Changing the interfaces of blocks called or PLC data types used can result in inconsistencies between calling blocks and called blocks or between the PLC data types and the global data blocks which use these PLC data types.

To avoid such inconsistencies in the user program, the system performs an automatic consistency check before each compilation process. The time stamps are compared and compilation is then either carried out or cancelled depending on the results of the comparison.

- The calling block can only be compiled if the time stamps of the interfaces of the called blocks are older than those of the calling block.
- A global data block based on a PLC data type can only be compiled correctly if the time stamp of the global data block is newer than the time stamp of the PLC data type used.
- The instance data block can only be compiled correctly if the interface time stamps for the interface of the instance data block are identical to those of the assigned function block.

If the compilation process is cancelled, a message is displayed in the inspector window. Update the block calls in the relevant blocks and the PLC data types in the global data blocks and then restart compilation. The consistency check also finds know-how protected blocks which cannot be compiled. The corresponding messages will also be shown in the inspector window.

If you start loading immediately instead of first compiling, the blocks selected will be automatically compiled and the block call and global data blocks implicitly updated. Please note the following differences between the CPU families:

- S7-1200/1500: All blocks affected are loaded to ensure no inconsistencies can arise.
- S7-300/400: Only the block selected is loaded.

## See also

- Compiling blocks in the project tree (Page 1440)
- Compiling blocks in the program editor (Page 1441)
- Correcting compilation errors (Page 1442)
- Block time stamps (Page 1211)
- Updating block calls in LAD (Page 1279)
- Updating block calls in FBD (Page 1320)
- Compiling project data (Page 280)

## Compiling blocks in the project tree

You can compile one block, multiple blocks or all of the blocks in the project tree.

For CPUs of the S7-1500 and S7-1200 V4 series, you can also reset the memory layout of blocks with memory reserve by running a compilation. For more information on memory reserve, refer to chapter "Loading blocks (S7-1200/1500) > Loading block changes without reinitialization".

## Requirement

The project tree is open.

## Compiling one or more blocks in the project tree

To compile multiple blocks in the project tree, follow these steps:

1. Open the "Program blocks" folder in project tree.
2. Select the blocks you want to compile.
3. Select the "Compile > Software (only changes)" command from the shortcut menu.

## Compiling all blocks in the project tree

To compile all blocks in the "Program blocks" folder in project tree, follow these steps:

1. Select the "Program blocks" folder in the project tree.
2. You can select one of two different options for the compilation:
  - If you want to compile only the changes since the last compilation, select the "Compile > Software (only changes)" command in the shortcut menu.
  - If you want to compile all blocks completely, select the "Compile > Software (compile all blocks)" command in the shortcut menu.



## Resetting memory layout (S7-1500/S7-1200 V4)

Proceed as follows to reset the memory layout of blocks:

1. Select the "Program blocks" folder, or specific blocks in this folder.
2. Select the "Compile > Software (Reset memory reserve)" command from the shortcut menu.

## Result

The code for the blocks will be generated if the consistency check has been successful. Instance data blocks generated by the system which are no longer needed will be deleted.

The message under "Info > Compilation" in the inspector window reports whether the compilation was successful.

## See also

Basic information on compiling blocks (Page 1438)

Compiling blocks in the program editor (Page 1441)

Correcting compilation errors (Page 1442)

Finding syntax errors in the program (Page 1376)

## Compiling blocks in the program editor

---

### Note

Note that the block is recompiled even if you have not made any changes and the time stamp of the block is modified.

---

## Requirement

The block to be compiled is open.

## Procedure

To compile a block in the program editor, follow these steps:

1. Right-click in the instruction window of the programming editor.
2. Select the "Compile" command in the shortcut menu.

## Result

The code for the block is generated. Instance data blocks generated by the system which are no longer needed will be deleted.

The message under "Info > Compilation" in the inspector window reports whether the compilation was successful.

## See also

Basic information on compiling blocks (Page 1438)

Compiling blocks in the project tree (Page 1440)

Correcting compilation errors (Page 1442)

## Correcting compilation errors

In the Inspector window in "Info > Compile", you can see whether any compilation was successful or whether errors were detected in the program. If errors occur, you will need to correct them and then start the compilation again.

## Procedure

To correct errors following compilation, follow these steps:

1. Open the error list in the Inspector window with "Info > Compile".
2. If there is one, click on the blue question mark next to the error text for information on remedying errors.
3. Double-click the error you want to correct.  
The corresponding error is highlighted.
4. Correct the error.
5. Restart compilation.

## See also

Basic information on compiling blocks (Page 1438)

Compiling blocks in the program editor (Page 1441)

Compiling blocks in the project tree (Page 1440)

### 9.1.6.2 Downloading blocks

#### Introduction to downloading blocks

#### Downloading blocks to device

So that the CPU can execute the user program, the program must first be compiled and then downloaded to the device. The following options are available for downloading:

- Downloading blocks to the program editor  
You can load a single open block in the program editor.
- Downloading blocks to the project tree  
You can download several or all of the blocks in the block folder via the project tree.

During the loading operation, all information that is required for the reconstruction of the program, including symbolic information such as the names and comments for code and data

blocks, is also loaded in the current project language. If you change the project language, you must therefore re-load the program.

The symbolic information is not loaded to the work memory, but rather to the load memory.

After the data has been loaded from a device, the symbolic information is available again in your program, which increases the readability of your program code. Please note, however, that loading to and from a device is not a substitute for storing data in an offline project, as watch tables or projects' multi-language capability cannot be reproduced by loading to and from a device.

After loading from a device, you can only display all data from know-how-protected blocks by entering the correct password.

---

**Note**

To avoid inconsistencies between calling and called blocks, all blocks affected are compiled and loaded after each global change, such as a change in the block interface.

---

---

**Note****S7-1200 Version 1.0**

If you download an element of your project to the CPU, for example a program block, a data block or the hardware configuration, the CPU runs a cold restart the next time it changes to RUN mode. Apart from deleting the inputs, initializing the outputs and deleting the non-retentive memory, cold restart also deletes the retentive memory areas. All subsequent changes from STOP to RUN are warm restarts in which the retentive memory is not deleted.

---

---

**Note****S7-1500**

The load memory of S7-1500 series CPUs is on the SIMATIC memory card. Therefore, a SIMATIC memory card absolutely must be inserted in order to operate the CPU.

---

## Uploading blocks from device

You can load the blocks of a device to your project. This is necessary, for example, if you want to edit blocks that only exist in this device. You have the option of loading either all available blocks (organization blocks, function blocks, functions and data blocks) and global PLC tags or individual blocks to the project.

## Uploading blocks from or downloading blocks to a memory card

Memory cards are plug-in cards used with an S7-1200 series CPU, for example, to replace the load memory of a device. In the case of S7-1500 series CPUs, they contain the load memory. Only Siemens SD cards can be used for devices of the S7-1200 and S7-1500 product range.

### 9.1 Creating a user program

To use a memory card as load memory, you must download the user program or individual blocks to a memory card. You can just as well upload blocks from a memory card back into the project.

---

#### Note

##### S7-1200

Note the following when uploading to or downloading from a memory card:

- If the CPU contains no previous program and you insert an empty memory card in the CPU the program will be loaded from the PG/PC to the memory card and not to the CPU.
  - If you insert an empty memory card prior to the startup of the CPU, the program that is on the CPU will be transferred automatically to the memory card. The program on the CPU will then be deleted.
  - If you insert a memory card with a program in the CPU prior to the startup of the CPU and the CPU already contains a program, the program on the memory card will be executed and not the program on the CPU. The program on the CPU will be deleted.
- 

### Loading GRAPH function blocks

If you load a GRAPH function block together with its instance data block, the processing of the sequencer starts over at the initial step. As a result, problems may occur when synchronizing the sequencer with the process. You can avoid these problems by switching off the sequencer before loading.

### Loading block changes without reinitialization

It often proves necessary to edit or expand a PLC program that was already commissioned and that is running on the plant without error. Such operations should be performed without causing any major interruptions of current operations.

S7-1500 therefore offers the option of extending the interfaces of function or data blocks during runtime and loading the modified blocks without setting the CPU to STOP or affecting the value of tags that are already loaded. This is a simple means of implementing program changes. This load process (downloading without reinitialization) will not have a negative impact on the controlled process.

### Effects of a load operation on the tag values of a data blocks

When data blocks are downloaded to a device in STOP mode, the next transition of the device to RUN affects the current tag values as follows:

- Tags not marked as being retentive retain their defined start values.
- Retentive tags of the S7-1200 only retain their values if the following conditions are met:
  - You loaded the data block by means of "Download to device > Software (changes only)".
  - You made no changes to the DB structure.

Otherwise the retentive tags will also retain their defined start values.

- Retentive tags of the S7-1500 only retain their values if the following conditions are met:
  - You loaded the data block by means of "Download to device > Software (changes only)".
  - You made no changes to the structure of the data block or modified it within the memory reserve.

Otherwise the retentive tags will also retain their defined start values.

### Downloading blocks in the "RUN" operating mode to the device

#### Basics on downloading blocks in the "RUN" operating mode

When you download modified blocks to the device, it is not always necessary to switch the device to the "STOP" operating mode. Prior to a download operation, the Engineering System checks whether the device must be stopped before downloading. The result of this check is displayed in the "Load preview" dialog. If it is necessary to change to the "STOP" operating mode, you cannot continue the download process until you have set the appropriate option.

---

#### Note

Actual parameters are not overwritten by a download process in the "RUN" operating mode. Changes to the actual parameters will not become effective until the next time you change the operating mode from "STOP" to "RUN".

---

The following table shows the actions after which you can execute the download process in the "RUN" operating mode:

Action	Download in "RUN" operating mode possible	
	S7-1200	S7-1500
Downloading individual blocks	Yes	Yes
Downloading all blocks	No	No
Adding or deleting OBs	No	Yes
Adding or deleting DBs, FCs or FBs	Yes	Yes
Changing block interfaces for FBs	No	Only within the memory reserve
Changing block interfaces for FCs	Yes	Yes

Action	Download in "RUN" operating mode possible	
	S7-1200	S7-1500
Changing the structure of a DB or an instance DB	No	Only within the memory reserve
Changing the hardware configuration	No	No
Changing the retentivity settings of bit memories and DBs	No	No
Changing the program code of FC, FB or OB	Yes	Yes
Changing the attributes of OBs	Yes	Yes
Adding comments	Yes	Yes
Adding input, output or bit memory areas	Yes	Yes
Changing tag names	Yes	Yes
Maximum number of blocks that can be downloaded for the device used in "RUN" not exceeded	Yes	Yes

**See also**

- Downloading blocks from program editor to device (Page 1446)
- Downloading blocks from the project tree to the device (Page 1447)
- Downloading project data to a device (Page 282)

**Downloading blocks from program editor to device**

**Requirement**

The block to be downloaded is open.

**Procedure**

To download a block from the program editor to the device, follow these steps:

1. Right-click in the instruction window of the programming editor.
2. Select the "Download to device" command in the shortcut menu.
  - If you have not already established an online connection, the "Extended download to device" dialog opens. In this case, set all parameters required for the connection and click "Load". You can also open the "Extended download to device" dialog with the "Online" menu.  
See also: Go online and Go offline
  - If you have already specified an online connection, then the project data is compiled if necessary and the "Load preview" dialog opens. This dialog displays alarms and proposes actions necessary for loading.

3. Check the alarms and, where necessary, enable the actions in the "Action" column.

---

**Note**

**Actions**

Performing the proposed actions during ongoing plant operation can cause serious damage to property or injury to persons if there are functional faults or program errors.

Make sure that no dangerous situations can arise before you start the actions.

---

As soon as downloading becomes possible, the "Load" button is enabled.

4. Click "Load".  
The block is downloaded and the "Load results" dialog opens. This dialog shows you the status and the actions after downloading.
5. If you want to start the modules again directly after downloading, select the "Start all" check box.
6. To close the "Load results" dialog box, click "Finish".

## Result

The code for the block will be downloaded to the device. If the changes affect additional blocks, these will be compiled and also downloaded to the device. Blocks that only exist online in the device are deleted. Existing CPU data blocks are retained, however. Inconsistencies between the blocks in the user program are avoided by loading all blocks affected and deleting the unneeded blocks in the device.

The messages under "Info > General" in the Inspector window show whether the downloading process was successful.

## See also

Downloading blocks from the project tree to the device (Page 1447)

Downloading project data to a device (Page 282)

Downloading blocks in the "RUN" operating mode to the device (Page 1445)

## Downloading blocks from the project tree to the device

In the project tree you can download one block, multiple blocks or all blocks to a device.

## Loading one or more blocks from the project tree to the device

To download one block or multiple blocks to the device from the project tree, follow these steps:

1. Open the "Program blocks" folder in project tree.
2. Select the blocks you want to download.

3. Select the "Download to device > Software (only changes)" command from the shortcut menu.
    - If you have not already established an online connection, the "Extended download to device" dialog opens. In this case, set all parameters required for the connection and click "Load". You can also open the "Extended download to device" dialog with the "Online" menu.  
See also: Go online and Go offline
    - If you have already specified an online connection, then the project data is compiled if necessary and the "Load preview" dialog opens. This dialog displays alarms and proposes actions necessary for loading.
  4. Check the alarms and, where necessary, enable the actions in the "Action" column.
- 

**Note**

Performing the proposed actions during ongoing plant operation can cause serious damage to property or injury to persons if there are functional faults or program errors.

Make sure that no dangerous situations can arise before you start the actions.

---

As soon as downloading becomes possible, the "Load" button is enabled.

5. Click "Load".  
The block is loaded and the "Load results" dialog opens. This dialog shows you the status and the actions after downloading.
6. If you want to start the modules again directly after downloading, select the "Start all" check box.
7. To close the "Load results" dialog box, click "Finish".

### Loading blocks from the project tree to the device

To download all blocks in the "Program blocks" folder to the device from the project tree, follow these steps:

1. Select the "Program blocks" folder in the project tree.
2. Select the "Download to device" submenu in the shortcut menu.
3. If you only want to download the changes since the last download, select the "Software (only changes)" option. If all blocks are to be fully loaded and all values are to be reset to their start values, select "Download PLC program to the device and reset".
  - If you have not already established an online connection, the "Extended download to device" dialog opens. In this case, set all parameters required for the connection and click "Load". You can also open the "Extended download to device" dialog with the "Online" menu.  
See also: Go online and Go offline
  - If you have already specified an online connection, then the project data is compiled if necessary and the "Load preview" dialog opens. This dialog displays alarms and proposes actions necessary for loading.



4. Check the alarms and, where necessary, enable the actions in the "Action" column.

---

**Note**

Performing the proposed actions during ongoing plant operation can cause serious damage to property or injury to persons if there are functional faults or program errors.

Make sure that no dangerous situations can arise before you start the actions.

---

As soon as downloading becomes possible, the "Load" button is enabled.

5. Click "Load".  
The block is loaded and the "Load results" dialog opens. This dialog shows you the status and the actions after downloading.
6. If you want to start the modules again directly after downloading, select the "Start all" check box.
7. To close the "Load results" dialog box, click "Finish".

## Result

The code for the blocks is downloaded to the device. If the changes affect additional blocks, these will be compiled and also downloaded to the device. Blocks that only exist online in the device are deleted. Inconsistencies between the blocks in the user program are avoided by loading all blocks affected and deleting the unneeded blocks in the device.

The messages under "Info > General" in the Inspector window show whether the downloading process was successful.

## See also

Downloading blocks from program editor to device (Page 1446)

Downloading project data to a device (Page 282)

Downloading blocks in the "RUN" operating mode to the device (Page 1445)

## Uploading blocks from device

You can load either all blocks or individual blocks from a device into your project.

---

**Note**

Note the following information:

- Please note that when you load individual blocks, no tags or other required blocks to which you may refer are loaded together with the individual blocks. During the loading operation, reference to tags and blocks are reassigned where possible based on the names. After the loading operation, check whether these assignments are correct.
  - S7-1500: When GRAPH function blocks are loaded from a device to your project, the step-specific alarm texts for the interlock and supervision alarms are not loaded.
-

## Requirement

The online and offline versions of a block to be loaded are different or the blocks only exists online.

## Uploading all blocks from a device

To upload all blocks from a device, follow these steps:

1. Establish an online connection with the device from which you want to upload the blocks.  
See also: Establishing and terminating an online connection
2. In the project tree, select the device folder from which you want to upload blocks.
3. In the "Online" menu, select the "Upload from device" command.  
The "Upload preview" dialog box opens. This dialog displays alarms and proposes actions necessary for loading.
4. Check the alarms and, where necessary, enable the actions in the "Action" column.  
The "Upload from device" button will be enabled as soon as uploading becomes possible.
5. Click on the "Upload from device" button.  
The load is executed.

## Uploading individual blocks from a device

To upload individual blocks from a device, follow these steps:

1. Establish an online connection with the device from which you want to upload the blocks.  
See also: Establishing and terminating an online connection
2. In the project tree, select the blocks that you want to upload from the device.
3. In the "Online" menu, select the "Upload from device" command.  
The "Upload preview" dialog box opens. This dialog displays alarms and proposes actions necessary for loading.
4. Check the alarms and, where necessary, enable the actions in the "Action" column.  
The "Upload from device" button will be enabled as soon as uploading becomes possible.
5. Click on the "Upload from device" button.  
The load is executed.

## Result

The blocks will be uploaded from the device to the project. You can edit them as normal, recompile them and download them to the device again.

## Downloading blocks to a memory card

### Requirement

- The memory card is not marked as program card.
- The "Program blocks" folder of the memory card is open.

## Procedure

To download blocks to a memory card, follow these steps:

1. Open the device "Program blocks" folder in the project tree.
2. Select the blocks you want to download to the memory card.
3. Drag the blocks in project tree to the "Program blocks" folder of the memory card.  
The "Load preview" dialog opens. This dialog displays messages and proposes actions necessary for loading.
4. Check the messages and, where necessary, enable the actions in the "Action" column.
5. As soon as downloading becomes possible, the "Load" button is enabled.
6. Click the "Load" button.  
The load is executed. The "Load results" dialog will then open. In this dialog, you can check whether or not loading was successful and take any further action that may be necessary.
7. Click "Finish".

## Result

The block is downloaded to the memory card. If the changes affect additional blocks, these will also be downloaded to the memory card. Blocks that exist only on the memory card are deleted. Inconsistencies between the blocks in the user program are avoided by downloading all affected blocks and the deleting of the non-required blocks on the memory card.

The messages under "Info > General" in the Inspector window show whether the downloading process was successful.

## See also

Uploading blocks from a memory card (Page 1451)

Accessing memory cards (Page 336)

## Uploading blocks from a memory card

You can only upload all blocks from one memory card back into your project.

## Requirement

The memory card is displayed.

See also: Accessing memory cards (Page 336)

## Procedure

To upload blocks from a memory card to your project, follow these steps:

1. In the project tree, drag the folder of the memory card to the folder of the device in the project.  
The "Upload preview" dialog box opens. This dialog displays alarms and proposes actions necessary for loading.
2. Check the alarms and, where necessary, enable the actions in the "Action" column.  
The "Upload from device" button will be enabled as soon as uploading becomes possible.
3. Click on the "Upload from device" button.

## See also

Downloading blocks to a memory card (Page 1450)

## Switching off the sequencer prior to loading a GRAPH DB

You can specify the switching off of the sequencer prior to loading an instance data block either globally or during the load operation.

### Globally switching off the sequencer

To switch off the sequencer globally for each loading operation of an instance data block, follow these steps:

1. Select the "Settings" command in the "Options" menu.  
The "Settings" window is displayed in the work area.
2. Select the "PLC programming > GRAPH" group in the area navigation.
3. Select the "Turn off sequence before downloading DB" check box.  
For future loading operations, the sequencer is switched off prior to loading of the instance data block.

### Switching off the sequencer during the loading operation

To switch off the sequencer during the loading operation, follow these steps:

1. Load the GRAPH function block to the device.  
During the loading operation, the "Load preview" dialog opens. This dialog displays alarms and suggests the required actions for loading. If the instance data block must be loaded together with the GRAPH function block, the "Load preview" dialog suggests the action "Turn off sequence before downloading the DB".
2. Select the "Turn off sequence before downloading DB" check box.

## 9.1.7 Protecting blocks

### 9.1.7.1 Protecting blocks

#### Introduction

You can use a password to protect one or more blocks of the OB, FB, FC type and global data blocks from unauthorized access. Note the following particularities:

- You can not manually protect instance data blocks; they depend on the know-how protection of the assigned FB. This means that when you create an instance data block for a know-how protected FB, the instance data block also receives this know-how protection. This is independent of whether you explicitly create the instance data block or if it is created by a block call.
- You cannot provide global array data blocks with know-how protection.

If a block is know-how protected, only the following data is readable without the correct password:

- Interface parameters Input, Output, InOut, Return, Static
- Block title
- Block comment
- Block properties
- Global tags without information on the point of use

The following actions can be performed with a know-how protected block:

- Copying and deleting
- Calling in a program
- Online/offline comparison
- Load

The code of the block, on the other hand, is protected from unauthorized reading and modification. For S7-1200/1500 CPUs, you can also set up copy protection which binds execution of the block to the CPU, or to the SD card with the defined serial number.

---

**Note**

Note the following information:

- S7-1200 Version 1.0: If you download a know-how-protected block to a device, no restore information is loaded along with it. This means that you cannot open a know-how-protected block again even with the correct password if you upload it from the device.
  - Only the non-protected data is compared in offline-online comparison of know-how protected blocks.
  - You will no longer be able to access the block if you do not have the password.
  - If you add a know-how-protected block to a library, the master copy created will also be know-how protected.
  - For S7-1500, you can select the "Block can be used as know-how protected library item" check box in the block properties to obtain the information on whether or not the block can be used as protected library item. If the block can be used as know-how protected library item and you are using this block from the library, any number conflicts that may arise with other blocks already contained in the user program will be resolved.
  - Cross references to used tags, bit memories, inputs and outputs in know-how protected blocks are not displayed even after the correct password is entered..
  - If you change the name or number of a block, the loadable binary component of the device is out of date. This means that the block must be recompiled before loading it to a device. For know-how-protected blocks, this is only possible with the correct password. Keep this in mind particularly if you want to copy a know-how-protected block to another device in which there is already a block with the same name or number.
  - Always pass on a project that includes know-how-protected blocks as a project archive or library archive. In this way, you ensure that the know-how protection cannot be bypassed.
- 

**See also**

Setting up and removing block copy protection (Page 1455)

Setting up block know-how protection (Page 1456)

Opening know-how protected blocks (Page 1457)

Printing know-how protected blocks (Page 1457)

Removing block know-how protection (Page 1459)

Changing a password (Page 1459)

Archiving projects (Page 275)

Archiving global libraries (Page 355)

### 9.1.7.2 Setting up and removing block copy protection

For S7-1200 /1500 CPUs, you can set up copy protection which binds execution of the block to a specific CPU or SD card. The block can then only be executed if it is in the device with the set serial number.

It is important that you also know-how-protect any block for which you have set up copy protection. If you do not, anyone can reset the copy protection. You must, however, set up copy protection first as the copy protection settings are read-only if the block is already know-how-protected.

---

#### **Note**

S7-1500 and S7-1200 V2.2 and higher: If you download a copy protected block to a device that does not match the specified serial number, the entire download operation will be rejected. This means that blocks without copy protection, too, will not be downloaded.

---

#### **Requirement**

The block is not know-how protected.

#### **Setting up copy protection**

To set up copy protection for a block, follow these steps:

1. Open the block you wish to copy-protect.
2. Open the "Properties" tab in the inspector window.
3. Select "Protection" in the area navigation in the inspector window.
4. Select either "Bind to serial number of the CPU" or "Bind to serial number of the memory card" from the drop-down list in the "Copy protection" area.
5. Enter the serial number of the CPU or the memory card for a S7-1500 CPU. You can either enter the serial number directly for a S7-1200 CPU or enable the option "Serial number inserted when downloading to a device or memory card" if the serial number is to be inserted automatically during loading.
6. You can now set up the know-how protection for the block in the "Know-how protection" area.

#### **Removing copy protection**

To remove copy protection, follow these steps:

1. Remove the know-how protection for the block whose copy protection you wish to remove.
2. Open the block.
3. Open the "Properties" tab in the inspector window.
4. Select "Protection" in the area navigation in the inspector window.
5. Select "No binding" in the drop-down list in the "Copy protection" area.

## See also

- Protecting blocks (Page 1453)
- Setting up block know-how protection (Page 1456)
- Opening know-how protected blocks (Page 1457)
- Printing know-how protected blocks (Page 1457)
- Removing block know-how protection (Page 1459)
- Changing a password (Page 1459)

### 9.1.7.3 Setting up block know-how protection

You can set up know-how protection for blocks in the devices in your project.

## Procedure

To set up block know-how protection, follow these steps:

1. Select the blocks with no know-how protection which you want to protect.
2. Select the command "Know-how protection" in the "Edit" menu.  
The "Know-how protection" dialog will open.
3. Click "Define".  
The "Define password" dialog box opens.
4. Enter a password in the "New" field.
5. Enter the same password in the "Confirm" field.
6. Confirm your entries with "OK".
7. Close the "Know-how protection" dialog by clicking on "OK".

## Result

The blocks selected will be know-how-protected. Know-how protected blocks are marked with a lock in the project tree. The password entered is valid for all blocks selected.

## See also

- Protecting blocks (Page 1453)
- Setting up and removing block copy protection (Page 1455)
- Opening know-how protected blocks (Page 1457)
- Printing know-how protected blocks (Page 1457)
- Removing block know-how protection (Page 1459)
- Changing a password (Page 1459)



#### 9.1.7.4 Opening know-how protected blocks

You can only open multiple know-how protected blocks at once if they are protected with the same password.

#### Procedure

To open a know-how protected block, follow these steps:

1. Double-click on the block you wish to open.  
The "Access protection" dialog will open.
2. Enter the password for the know-how protected block.
3. Confirm your entry with "OK".

#### Result

The know-how protected block will open provided you have entered the correct password. However, the block will remain know-how protected. If you copy the block or add it to a library, for example, the copies will also be know-how protected.

Once you have opened the block, you can edit the program code and the block interface of the block for as long as the block or TIA portal is open. The password must be entered again the next time the block is opened. If you close the "Access protection" dialog with "Cancel", the block will open but the block code will not be displayed and you will not be able to edit the block.

#### See also

Protecting blocks (Page 1453)  
Setting up and removing block copy protection (Page 1455)  
Setting up block know-how protection (Page 1456)  
Printing know-how protected blocks (Page 1457)  
Removing block know-how protection (Page 1459)  
Changing a password (Page 1459)

#### 9.1.7.5 Printing know-how protected blocks

You can only print complete know-how protected blocks if they have been opened with the correct password. If you print a closed block or if the block was not opened with the correct password, only the non-protected block data will be printed.

## Procedure

To print a know-how protected block in full, follow these steps:

1. Open the know-how protected block you wish to print.  
See also: Opening know-how protected blocks (Page 1457)
2. Select the "Print" command in the "Project" menu.  
The "Print" dialog will open.
3. Select the printer in the "Name" field.
4. Click "Advanced" to modify the Windows printer settings.
5. Select the documentation information set in the "Document information" drop-down list that you want to use for the frame layout.
6. Under "Print objects/area" select whether you want to print all objects or the complete area, or only a selection.
7. Under "Properties" select the print scope.
  - Select "All" to print the complete block.
  - Choose "Visible" to print all the information within the block that is visible on the screen.
  - Select "Compact" to print a shortened form of the block.
8. Click "Preview" to generate a print preview in advance.  
A print preview is created in the work area.
9. Click "Print" to start the printout.

## See also

Printing project contents (Page 299)

Protecting blocks (Page 1453)

Setting up and removing block copy protection (Page 1455)

Setting up block know-how protection (Page 1456)

Removing block know-how protection (Page 1459)

Changing a password (Page 1459)

### 9.1.7.6 Changing a password

#### Procedure

To change the password, follow these steps:

1. Select the know-how protected blocks for which you want to change the password.

---

**Note**

You can only change the password for several blocks at once if all blocks selected have the same password.

---

2. Select the command "Know-how protection" in the "Edit" menu.  
The "Know-how protection" dialog will open.
3. Click the "Change" button.
4. Enter the old password in the "Old" field.
5. Enter the new password in the "New" field.
6. Enter the new password again in the "Confirm" field.
7. Confirm your entries with "OK".
8. Close the "Know-how protection" dialog by clicking on "OK".

#### See also

Protecting blocks (Page 1453)

Setting up and removing block copy protection (Page 1455)

Setting up block know-how protection (Page 1456)

Opening know-how protected blocks (Page 1457)

Printing know-how protected blocks (Page 1457)

Removing block know-how protection (Page 1459)

### 9.1.7.7 Removing block know-how protection

#### Procedure

To remove block know-how protection, follow these steps:

1. Select the blocks for which you want to remove know-how protection.

---

**Note**

You can only remove know-how protection for several blocks at once if all blocks selected have the same password.

---

2. Select the command "Know-how protection" in the "Edit" menu.  
The "Know-how protection" dialog will open.

*9.1 Creating a user program*

3. Deactivate the check box "Hide code (know-how protection)".
4. Enter the password.
5. Confirm your entries with "OK".

**Result**

Know-how protection will be disabled for the blocks selected.

**See also**

Protecting blocks (Page 1453)

Setting up and removing block copy protection (Page 1455)

Setting up block know-how protection (Page 1456)

Opening know-how protected blocks (Page 1457)

Printing know-how protected blocks (Page 1457)

Changing a password (Page 1459)

## 9.2 Displaying program information

### 9.2.1 Overview of available program information

#### Program information

The program information of a user program contains the view specified in the following table.

View	Application
Assignment list (Page 1462)	Provides an overview of the address bits for the I, Q, and M memory areas already allocated within the user program.  Also indicates if an address has been allocated by access from an S7 program or if the address has been assigned to a SIMATIC S7 module.
Call structure (Page 1470)	Shows the call structure of the blocks within the user program and provides an overview of the blocks used and their relationships.
Dependency structure (Page 1476)	Shows the list of blocks used in the user program. A block is shown at the first level and blocks that call or use this block are indented below it. In contrast to the call structure, instance blocks are listed separately.
Resources (Page 1481)	Shows the hardware resources of the CPU for objects (OB, FC, FB, DB, user-defined data types and PLC tags), for CPU memory areas and for the existing I/O modules.

#### Displaying several views simultaneously

You can generate and display several views for one or more user programs to facilitate testing and changing your user program.

Displaying multiple views, for example, enables you to:

- Display all program information for a user program next to one another
- Compare different user programs

## 9.2.2 Displaying an assignment list

### 9.2.2.1 Introduction to the assignment list

#### Program information in the assignment list

The assignment list shows if an address has been allocated by access from an S7 program or if the address has been assigned to a SIMATIC S7 module. It is therefore an important basis for locating errors or changes in the user program.

In the assignment list, you have a CPU-specific overview of which bit is used in which byte of the memory areas listed below:

- Input (I)
- Output (O)
- Bit memory (M)
- Timer (T)
- Counter (C)
- I/O (P)

#### Display of the assignment list

The assignment list of inputs, outputs, and bit memory is displayed in several separate work windows.

#### Filters

You can filter the display within the assignment list. You can use predefined filters or create your own.

#### Displaying cross-reference information

You have the option of displaying cross-reference information for selected addresses in the assignment list.

You can display the cross-references for a selected address in the Inspector window using the "Cross-reference information" shortcut menu command. The command "Tools > Cross-references" allows you to also open the cross-reference list for the selected object.

#### Displaying the PLC tag table

You can open the PLC tag table from the assignment list and edit the properties of the tags used.

To do this select an address of the assignment list and select the "Open editor" command in the shortcut menu.

### Enabling the display of retentivity

You can enable and disable the display of the retentive state of bit memory by selecting the "Hide/show retain area" toolbar button.

### See also

Symbols in the assignment list (Page 1464)

Layout of the assignment list (Page 1463)

## 9.2.2.2 Layout of the assignment list

### Layout of the assignment list

Depending on the CPU, the assignment list is displayed in several work windows with the following operands.

For S7-300/400 CPUs:

- Inputs
- Outputs
- Bit memory
- Timers
- Counters

For S7-1200 CPUs:

- Inputs
- Outputs
- Bit memory

### Displaying inputs, outputs, bit memory, timers and counters

It shows all operands used and their assignment in the S7 program.

For all displayed operands, each line in the assignment list is dedicated to a byte of the memory area, in which the corresponding eight bits from 7 to 0 are labeled according to their access. In conclusion, a "bar" indicates if access is made by a byte (B), word (W) or double word (D).

You can find an explanation of the symbols in the assignment list here. (Page 1464)















### See also

Introduction to the assignment list (Page 1462)

9.2.2.3 Symbols in the assignment list

Meaning of the symbols in the assignment list

The following table shows the meaning of the symbols in the assignment list:

Symbol	Meaning
	Indicates the address assignment in the selected state.
	Indicates the address assignment in the non-selected state.
	Indicates that a pointer start address and a tag address access the same address range and that they are selected.
	Indicates that a pointer start address and a tag address access the same address range and that they are not selected.
	Indicates the pointer assignment in the selected state.
	Indicates the pointer assignment in the non-selected state.
	Indicates that the byte is in use with byte access and the corresponding tag is selected. The shortcut menu allows you to display cross-reference information for the selected variables as well as the PLC tag table.
	Indicates that the byte is in use with byte access and the corresponding tag is not selected.
	Indicates that the byte is in use with word access and the corresponding tag is selected. The shortcut menu allows you to display cross-reference information for the selected variables as well as the PLC tag table.
	Indicates that the byte is in use with word access and the corresponding tag is not selected.
	Indicates that the byte is in use with double word access and the corresponding tag is selected. The shortcut menu allows you to display cross-reference information for the selected variables as well as the PLC tag table.
	Indicates that the byte is in use with double word access and the corresponding tag is not selected.
Background color: gray	Indicates that a byte is in use with byte, word or double word access and that the address is also in use by the hardware. The gray background color indicates overlapping memory access.
Background color: yellow	Indicates that the address is not in use by the hardware.
	Indicates that the memory area has been defined as system memory.
	Indicates that the memory area has been defined as clock memory.



## See also

Layout of the assignment list (Page 1463)

Introduction to the assignment list (Page 1462)

### 9.2.2.4 Displaying an assignment list

#### Requirement

A project has been created with programmed blocks.

#### Procedure

Proceed as follows to display the assignment list:

1. Select the "Program blocks" folder or one or more of the blocks it contains.
2. Select the "Assignment list" command in the "Tools" menu.

#### Result

The assignment list for the selected program is displayed.

#### View options in the assignment list

Refer to view respective view options that are set to display the desired information in the assignment list.

## See also

Setting the view options for the assignment list (Page 1465)

Layout of the assignment list (Page 1463)

### 9.2.2.5 Setting the view options for the assignment list

#### Introduction

The following view options are available for the assignment list:

- **Used addresses:**  
When this check box is activated, the addresses, I/Os and pointers used in the program are displayed.
- **Free hardware addresses:**  
When this check box is activated, only the free hardware addresses are displayed.

**Requirement**

- A project has been created with programmed blocks.
- The assignment list is open.

**Procedure**

Proceed as follows to set the view options for the assignment list:

1. Click on the arrow of the  symbol ("View options") in the task bar.  
The view options for the assignment list are opened. Check marks are set in front of the activated view options.
2. If you want to activate or deactivate a view option, click on the respective check box and set or remove the check mark.

**Result**

The view options are set and the desired information is displayed in the assignment list.

**9.2.2.6 Filter options in the assignment list**

**Filter settings**

You can define your own filter settings for the assignment list. The following options are available for defining filters:

- Display all addresses of the address areas specified.
- Display of single, defined addresses from the selected address area, for example, "0" and "200".
- Display of complete areas from the selected address area, for example, "0 - 256".

The following table provides an overview of all available options:

Selection in the	Selection	Symbol	Meaning
Address area	All CPU-dependent displayed addresses (I, O, M, T, C) can be activated as they are by default, or individual address areas can be activated.	Check box is activated	Only the activated address areas (I, O, M, T, C) are shown in the assignment list.
Filter area	Show assignment for all addresses	*	Displays the assignment of all addresses of the enabled address areas (I, Q, M).

Selection in the	Selection	Symbol	Meaning
	Show assignment for selected addresses, for example, for the inputs "IB 0" and "IB 256"	0;256 Separate individual addresses and areas by a semicolon.	Assignments of selected addresses for the activated address areas (I) are shown.
	Show assignment for selected areas, for example, for the inputs "IB 0 to IB 100" and "IB 200 to IB 256".	0-100;200-256 Contiguous areas should be connected by a hyphen.	Assignments of selected areas for the activated address areas (I) are shown.



### 9.2.2.7 Defining filters for assignment list

#### Requirement

- A project has been created with programmed blocks.
- The assignment list is open.



#### Defining filter

Proceed as follows to define a filter for the assignment list:

1. Click on the  symbol ("Filter") in the task bar.  
The "Assignment List Filter" dialog opens.
2. Click on the  symbol ("Create new filter") in the task bar.  
A new filter is created with the name "Filter\_1". The check boxes for all addresses (inputs, outputs, memory bits, timers and counters) are activated by default for the filter.
3. If you want to change the name of the filter, click on the drop-down list in the task bar and enter a new filter name.
4. Deactivate the check boxes of addresses that are not to be affected by the filter.
5. Enter one of the following options in the filter area of the activated address:
  - Show all addresses used = "\*"
  - Show single, defined addresses, for example, IB 0" and IB 25 = "0.25". Individual addresses and address areas are separated by commas or semicolons.
  - Show complete address areas, for example, IB 0 to IB 256 = "0-256". Complete address areas should be connected by a hyphen.
6. Confirm your entries with "OK".  
The newly defined filter is shown in the task bar of the assignment list under the specified name.

### Delete filter

Proceed as follows to delete a filter:

1. Click on the  symbol ("Filter") in the task bar.  
The filter dialog for the assignment list opens.
2. In the drop-down list of the task bar, select the filter you want to delete.
3. Click on the  symbol ("Delete selected filter") in the task bar.  
The selected filter is deleted.

### See also

Filter options in the assignment list (Page 1466)

Displaying an assignment list (Page 1465)

Introduction to the assignment list (Page 1462)

### 9.2.2.8 Filtering an assignment list

#### Requirement

- A project has been created with programmed blocks.
- The assignment list is open.

#### Procedure

1. Click on the arrow on the drop-down list.  
The available filter are displayed.
2. Select the desired filter.

#### Result

The assignment list is filtered according to the settings of the selected filter.

---

#### Note

The filter settings are saved when the project is closed.

---

### 9.2.2.9 Defining retentive memory areas for bit memories

#### Introduction

In the assignment list you can define the width of the retentive memory area for bit memories. The content of tags which are addressed in retentive memory is retained after power off and at the STOP to RUN transition after power on.

The display of retentive bit memories can be enabled and disabled in the assignment list. If their display is enabled, retentive bit memories are identified by an icon in the "Address" column.

#### Requirement

The assignment list is open.

#### Procedure

Proceed as follows to define the width of the retentive memory area for bit memories:

1. Click "Retain" in the toolbar.  
The "Retain memory" dialog will open.
2. Starting at the count of 0, define the width of the retentive memory area by entering the last byte of this area in the input field. Watch out for any addresses of tags already assigned to the retentive area.
3. Load the block to the target system. Select the "Program blocks" folder in the Project tree and select the "Download to device" submenu in the shortcut menu.

#### Result

The width of the retentive memory area is defined. If enabled in the assignment list, an icon will indicate the retentive state of all tags in the "Address" column.

### 9.2.2.10 Enabling the display of retentive bit memories

#### Introduction

In the assignment list you can enable and disable the display of retentive bit memories. The retentive bit memories are identified by means of an icon in the "Address" column if the display of retentivity is enabled.

#### Requirement

The assignment list is open.

## Procedure

Proceed as follows to enable and disable the display of retentive bit memories:

1. Click "Display/hide retentivity" in the toolbar.

## Result

The retentive tags are identified by means of an icon in the "Address" column of the bit memory area if the display of retentivity is enabled. The icons in the "Address" column are hidden if the display of retentivity is disabled.

## 9.2.3 Displaying the call structure

### 9.2.3.1 Introduction to the call structure

#### Call structure

The call structure describes the call hierarchy of the block within an S7 program.

It provides an overview of:

- The blocks used
- Jumps to the places of use of the blocks
- Relationships between blocks
- Local data requirements of the blocks
- Status of the blocks

#### Information in the call structure

Displaying the call structure provides you with a list of the blocks used in the user program. The first level of the call structure is highlighted in color and shows the blocks that are not called by any other block in the program. Organization blocks are always shown on the first level of the call structure. Functions, function blocks and data blocks are only shown on the first level if they are not called by an organization block. When a block calls other blocks or functions, they are listed indented under the calling block. Instructions and blocks are shown in the call structure only if they are called by a block.

## View options

The following view options are available for the call structure:

- **Show conflicts only:**  
When this check box is activated, only the conflicts within the call structure are displayed.
- **Group multiple calls together:**  
When this check box is activated, several block calls are grouped together. The number of block calls is displayed in the "Call frequency" column. The links to the various call locations are offered in a drop-down list in the "Details" column.

## Displaying the block calls

You can display the block calls in a block by clicking on the arrow in front of the block title. To display the call information of all blocks, click on the "Expand list" icon in the toolbar.

You can hide the total overview by clicking the "Collapse list" icon.

## Displaying cross-reference information

You can display the cross-reference information for a block in the Inspector window by right-clicking on the relevant block and selecting the "Cross-reference information" command from the shortcut menu.

To open the "Cross-references" view, click the "Cross-references" command in the shortcut menu.

## Displaying blocks in the program editor

You can open the program editor and edit blocks there from the call structure.

To do this select the required block in the call structure and select the "Open editor" command in the shortcut menu.

## Displaying deleted blocks

The rows belonging to deleted blocks are identified by an icon.

---

### Note

Please note that any existing local data can only be displayed or updated after compiling a block.

---















## See also

Symbols in the call structure (Page 1472)

9.2.3.2 Symbols in the call structure

Meaning of the symbols in the call structure

The following table shows the meaning of the symbols in the call structure:

Symbol	Meaning
	Indicates an organization block (OB).
	Indicates a function block (FB).
	Indicates a function (FC).
	Indicates a data block (DB).
	Indicates that the block is declared as a multiinstance.
	The object has an interface dependency to an object connected to the left.
	Indicates that the block needs to be compiled again.
	Indicates that the data block needs to be compiled again.
	Indicates that the object is not available.
	Indicates that the interface causes a time stamp conflict.
	Indicates that the variable causes a time stamp conflict.
	Indicates that the block is not called directly or indirectly from an OB.
	Indicates that an object has know-how protection.
	Indicates that the block is normally called recursively.
	Indicates that a tag declaration in the interface has a recursive dependency: <ul style="list-style-type: none"> <li>Scenario 1: FB1 calls FB2 and this then calls FB1. The instance data blocks of these FBs have a recursion in the interface.</li> <li>Scenario 2: A multiple instance FB uses the instance DB of its parent FB as a global DB.</li> </ul>



### 9.2.3.3 Layout of the call structure

#### Layout of the call structure

The view of the call structure consists of the following columns:

Column	Content/meaning
Call structure	Shows an overview of the blocks called If the viewing option "Group multiple calls together" is enabled, several block calls are grouped together and the "Number of calls" column is displayed.
Call type (!)	Shows the type of call, for example recursive block call.
Address	Shows the absolute address of the block. With a function block, the absolute address of the corresponding instance data block is also shown.
Call frequency	Indicates the number of multiple calls of blocks.
Details	Shows the network or interface of the calling block. All information are offered as a link in this column. With this link, you can jump to the location of the block call in the program editor. If the viewing option "Group multiple calls together" option is enabled, the calls are grouped together and are available as links in a drop-down list.
Local data (in path)	Indicates the local data requirement of the full path. Blocks with optimized access have higher local data requirements because the information for the symbolic addressing is stored with them. Please note that any existing local data can only be displayed or updated after compiling a block.
Local data (for blocks)	Show the local data requirements of the block. Blocks with optimized access have higher local data requirements because the information for the symbolic addressing is stored with them. Please note that any existing local data can only be displayed or updated after compiling a block.

#### See also

Symbols in the call structure (Page 1472)

Introducing the consistency check in the call structure (Page 1475)

### 9.2.3.4 Displaying the call structure

#### Requirement

A project has been created with blocks.

## Procedure

Proceed as follows to display the call structure:

1. Select the "Program blocks" folder or one or more of the blocks it contains.
2. Select the "Call structure" command in the "Tools" menu.

## Result

The call structure for the selected program is displayed.

---

### Note

Please note that any existing local data can only be displayed or updated after compiling a block.

---

## See also

Setting the view options for the call structure (Page 1474)

### 9.2.3.5 Setting the view options for the call structure

#### Introduction

The following view options are available for the call structure:

- Show conflicts only:  
Only the blocks causing conflicts within the call structure are displayed if this check box is activated.  
The following blocks cause conflicts:
  - Blocks executing any calls with older or newer code time stamps.
  - Blocks calling a block with modified interface.
  - Blocks using a tag with modified address and/or data type.
  - Block called neither directly, nor indirectly by an OB.
  - Blocks calling a block which no longer exists.
- Group multiple calls together:  
When this viewing option is enabled, several block calls and data block accesses are grouped together. The number of block calls is displayed in the "Call frequency" column. The links to the various call locations are offered in a drop-down list in the "Details" column.

#### Requirement

- A project has been created with programmed blocks.
- The call structure is open.

## Procedure

Proceed as follows to set the view options for the call structure:

1. Click on the arrow of the  symbol ("View options") in the task bar.  
The view options for the call structure opens. Check marks are set in front of the activated view options.
2. If you want to activate or deactivate a view option, click on the respective check box and set or remove the check mark.

## Result

The view options are set and the required information is displayed in the call structure.

### 9.2.3.6 Introducing the consistency check in the call structure

## Consistency check

Changing the time stamp of a block during or after the program is generated can lead to time stamp conflicts, which in turn cause inconsistencies among the blocks that are calling and being called.

## Using the consistency check

The "Consistency check" function is used to visualize inconsistencies when time stamp conflicts occur. When the consistency check is performed, the inconsistent blocks are shown in the call structure and marked with the corresponding symbols.

- Most time stamp and interface conflicts can be rectified by recompiling the blocks.
- If compilation fails to clear up inconsistencies you can use the link in the "Details" column to go to the source of the problem in the program editor and manually eliminate any inconsistencies.
- The blocks marked in red must be recompiled.

## See also

Symbols in the call structure (Page 1472)

### 9.2.3.7 Checking block consistency in the call structure

## Requirement

- A project has been created with programmed blocks.
- The call structure is open.

## Procedure

Proceed as follows to check the block consistency:

1. Click on the  symbol ("Consistency check") in the task bar.  
The block consistency is checked. Blocks found to be inconsistent are marked accordingly by a symbol.
2. If a block is inconsistent, click on the arrow in front of the block title in the call structure.  
The inconsistent blocks are displayed. The exact problem locations are listed as links in the "Details" column.
3. Click on the respective link in the "Details" column to jump to the location in the block requiring correction.
4. Check and correct the inconsistencies in the blocks.
5. Recompile the blocks by selecting the required blocks and clicking on the command "Compile" in the shortcut menu.
6. Download the corrected blocks to the target system by clicking the command "Download to device" in the shortcut menu.

## Result

The block consistency is checked. The inconsistencies in the blocks are corrected. The corrected blocks are loaded to the target system.

## See also

Symbols in the call structure (Page 1472)

## 9.2.4 Displaying the dependency structure

### 9.2.4.1 Introduction to the dependency structure

#### Introduction

The dependency structure shows the dependencies each block has to other blocks in the program.

#### Information in the dependency structure

Displaying the dependency structure provides you with a list of the blocks used in the user program. A block is shown at the far left and blocks that call or use this block are indented below it.

The dependency structure also shows the status of the individual blocks using symbols.

Objects causing a time stamp conflict and perhaps leading to an inconsistency in the program are marked with various symbols.

The dependency structure is an extension of the cross-reference list for objects.

## View options

The following view options are available for the dependency structure:

- **Show conflicts only:**  
When this check box is activated, only the conflicts within the dependency structure are displayed.
- **Group multiple calls together:**  
When this check box is activated, several block calls are grouped together. The number of block calls is shown numerically in the "Dependency structure" column. The links to the various call locations are offered in a drop-down list in the "Details" column.

## Displaying the dependency structure

Clicking on the arrow in front of the block title displays the blocks that call or use this block. To display the dependencies of all blocks,

click the "Expand list" icon in the toolbar.

You can hide the total overview by clicking the "Collapse list" icon.

## Displaying cross-reference information

You can display the cross-reference information for a block in the Inspector window by right-clicking on the respective block and selecting the "Display Usage" command from the shortcut menu.

## Displaying blocks in the program editor

You can open the program editor and edit blocks there from the dependency structure. To do this select the required block in the dependency structure and select the "Open editor" command in the shortcut menu.

### 9.2.4.2 Layout of the dependency structure

#### Layout of the dependency structure

The view of the dependency structure consists of the following columns:

Column	Content/meaning
Dependency	It indicates the dependencies between each block and the other blocks in the program.
Call type (!)	Shows the type of call, for example recursive block call.
Address	Shows the absolute address of the block.

Column	Content/meaning
Call frequency	Indicates the number of multiple calls of blocks.
Details	Shows the network or interface of the called block. All information are offered as a link in this column. With this link, you can jump to the location of the block call in the program editor. If the viewing option "Group multiple calls together" option is enabled, the calls are grouped together and are available as links in a drop-down list.











**See also**

Symbols in the dependency structure (Page 1478)

**9.2.4.3 Symbols in the dependency structure**

**Meaning of the symbols in the dependency structure**

The following table shows the meaning of the symbols in the dependency structure:

Symbol	Meaning
	Indicates an organization block (OB).
	Indicates a function block (FB).
	Indicates a function (FC).
	Indicates a data block (DB).
	The object has an interface dependency to an object connected to the left.
	Indicates that the block needs to be compiled again.
	Indicates that the data block needs to be compiled again.
	Indicates that there is an inconsistency with this object.
	Indicates that an object has know-how protection.
	Indicates that a tag declaration in the interface has a recursive dependency: <ul style="list-style-type: none"> <li>Scenario 1: FB1 calls FB2 and this then calls FB1. The instance data blocks of these FBs have a recursion in the interface.</li> <li>Scenario 2: A multiple instance FB uses the instance DB of its parent FB as a global DB.</li> </ul>

#### 9.2.4.4 Displaying the dependency structure

##### Requirement

A project has been created with programmed blocks.

##### Procedure

Proceed as follows to display the dependency structure:

1. Select the block folder or one or more of the blocks contained therein.
2. Select the "Dependency structure" command in the "Tools" menu.

##### Result

The dependency structure for the selected program is displayed.

##### See also

Setting the view options for the dependency structure (Page 1479)

#### 9.2.4.5 Setting the view options for the dependency structure

##### Introduction

The following view options are available for the dependency structure:

- Show conflicts only:  
When this check box is activated, only the conflicts within the dependency structure are displayed.  
The following blocks cause conflicts:
  - Blocks executing any calls with older or newer code time stamps.
  - Blocks called by a block with modified interface.
  - Blocks using a tag with modified address and/or data type.
  - Block called neither directly, nor indirectly by an OB.
- Group multiple calls together:  
When this check box is activated, several block calls are grouped together. The number of block calls is shown in the relevant column. The links to the various call locations are offered in a drop-down list in the "Details" column.

##### Requirement

- A project has been created with programmed blocks.
- The dependency structure is open.

## Procedure

Proceed as follows to set the view options for the dependency structure:

1. Click on the arrow of the  symbol ("View options") in the task bar.  
The view options for the dependency structure are opened. Check marks are set in front of the activated view options.
2. If you want to activate or deactivate a view option, click on the respective check box and set or remove the check mark.

## Result

The view options are set and the required information is displayed in the dependency structure.

### 9.2.4.6 Introducing the consistency check in the dependency structure

#### Consistency check

Changing the time stamp of a block during or after the program is generated can lead to time stamp conflicts, which in turn cause inconsistencies among the blocks that are calling and being called.

#### Using the consistency check

The "Consistency check" function is used to visualize inconsistencies. When the consistency check is performed, the inconsistent blocks are shown in the dependency structure and marked with the corresponding symbols.

- Most time stamp and interface conflicts can be rectified by recompiling the blocks.
- If compilation fails to clear up inconsistencies you can use the link in the "Details" column to go to the source of the problem in the program editor and manually eliminate any inconsistencies.
- The blocks marked in red must be recompiled.

#### See also

Layout of the dependency structure (Page 1477)

Symbols in the dependency structure (Page 1478)



### 9.2.4.7 Checking block consistency in the dependency structure

#### Requirement

- A project has been created with programmed blocks.
- The dependency structure is open.

#### Procedure

Proceed as follows to check the block consistency:

1. Click on the  symbol ("Consistency check") in the task bar.  
The block consistency is checked. Blocks found to be inconsistent are marked accordingly by a symbol.
2. If a block is inconsistent, click on the arrow in front of the block title in the dependency structure.  
The inconsistent blocks are displayed. The exact problem locations are listed as links in the "Details" column.
3. Check and correct the inconsistencies in the blocks.
4. Recompile the blocks by selecting the required blocks and clicking on the command "Compile" in the shortcut menu.
5. Download the corrected blocks to the target system by clicking the command "Download to device" in the shortcut menu.

#### Result

The block consistency is checked. The inconsistencies in the blocks are corrected. The corrected blocks are loaded to the target system.

#### See also

Symbols in the dependency structure (Page 1478)

## 9.2.5 Displaying CPU resources

### 9.2.5.1 Introducing resources

#### Introduction

The "Resources" tab indicates the hardware resources of the configured CPU for:

- the used programming objects,
- the assignment of the different memory areas within the CPU and
- the assigned inputs and outputs of the existing input and output modules.

### Information provided in the "Resources" tab

The resources tab provides an overview of the hardware resources. The display in this tab depends on the CPU which you are using. The following information is displayed:

- the programming objects used in the CPU (e.g. OB, FC, FB, DB, data types and PLC tags)
- the memory areas available on the CPU (load memory, work memory - divided into code work memory and data work memory depending on the CPU -, retentive memory), their maximum size and utilization by the programming objects stated above
- the I/O of modules which can be configured for the CPU (I/O modules, digital input modules, digital output modules, analog input modules, and analog output modules), including the I/O already in use.

### Display of the maximum available load memory

The maximum size of available load memory can be selected from a drop-down list box in the "Total" row of the "Load memory" column.

### Display of the maximum available work memory

The maximum size of available work memory is displayed in the "Work memory" column or in the "Code work memory" and "Data work memory" columns in the "Total" row.

### Display of the maximum available retentive memory

The maximum size of available retentive memory can be selected from a drop-down list box in the "Total" row of the "Retentive memory" column.

---

#### Note

#### Retentive memory data

All bit memories and data blocks specified as retentive will be integrated in the calculation of the retentive data.

---

### Updating the display in the "Resources" tab

Click the "Update view" toolbar button to update the display of objects.

### Benefits of the display in the "Resources" tab

The "Resources" tab of the program information dialog provides a detailed list of all objects and of the corresponding memory area used.

The tab also indicates shortage of resources and helps to avoid such states.

Blocks which are not compiled can be identified as their size is indicated by a question mark.

**See also**

Layout of the "Resources" tab (Page 1483)

Displaying resources (Page 1484)

Selecting the maximum load memory available (Page 1485)

**9.2.5.2 Layout of the "Resources" tab****Layout of the "Resources" tab in the program information**

The view of the "Resources" tab consists of the following columns:

Column	Content/meaning
Objects	The "Details" area provides an overview of the programming objects available in the CPU, including their memory assignments.
Load memory	Displays the maximum load memory resources of the CPU as a percentage and as absolute value. The values displayed under "Total" provide information on the maximum memory available in the load memory. The values displayed under "Used" provide information on the memory actually used in the load memory. If a value is displayed in red, the available memory capacity has been exceeded.
Work memory or code and data work memory	Displays the maximum work memory resources of the CPU as a percentage and as absolute value. The work memory depends on the CPU and is divided into "Code work memory" and "Data work memory" for a CPU from the S7-400 or S7-1500 series, for example. The values displayed under "Total" provide information on the maximum memory available in the work memory. The values displayed under "Used" provide information on the memory space actually used in the work memory. If a value is displayed in red, the available memory capacity has been exceeded.
Retentive memory	Displays the maximum resources for retentive memory in the CPU as a percentage and as absolute value. The values displayed under "Total" provide information on the maximum memory available in the retentive memory. The values displayed under "Used" provide information on the memory actually used in the retentive memory. If a value is displayed in red, the available memory capacity has been exceeded.

Column	Content/meaning
I/O	Displays the I/Os which are available on the CPU, including their module-specific availability in the next columns. The values displayed at "Configured" provide information about the maximum number of I/O available. The values displayed under "Used" provide information on the actually used inputs and outputs.
DI / DQ / AI / AQ	Displays the number of configured and used inputs/outputs: DI = Digital inputs DQ = Digital outputs AI = Analog inputs AQ = Analog outputs The values displayed at "Configured" provide information about the maximum number of I/O available. The values displayed under "Used" provide information on the actually used inputs and outputs.

**See also**

- Displaying resources (Page 1484)
- Selecting the maximum load memory available (Page 1485)
- Introducing resources (Page 1481)

**9.2.5.3 Displaying resources**

**Requirement**

A project with programmed blocks has been created.

**Procedure**

Proceed as follows to display the resources of the respective CPU memory areas:

1. Select the block folder below the relevant CPU, or one or several of the blocks contained therein.
2. Select the "Resources" command in the "Tools" menu.

**Result**

The memory resources of the assigned CPU are displayed.

#### 9.2.5.4 Selecting the maximum load memory available

##### Requirement

A project with programmed blocks has been created.

##### Procedure

Proceed as follows to display the available maximum of load memory resources:

1. Select the block folder below the relevant CPU, or one or several of the blocks contained therein.
2. Select the "Resources" command in the "Tools" menu.
3. In the dialog that is displayed, open the drop-down list in the "Total" field of the "Load memory" column by clicking the icon.
4. Select a corresponding value for the CPU used by clicking it in the drop-down list box.

##### Result

The "Total" field displays the selected maximum memory resources.

---

##### Note

##### Display of maximum memory resources

If a value is displayed in red for the maximum memory resources, the available memory capacity has been exceeded.

In this case, adapt the memory capacity as described above.

---

## 9.3 Displaying cross-references

### 9.3.1 General information about cross references

#### Introduction

The cross-reference list provides an overview of the use of operands and tags within the user program.

#### Uses of cross-references

The cross-reference list offers you the following advantages:

- When creating and changing a program, you retain an overview of the operands, tags and block calls you have used.
- From the cross-references, you can jump directly to the point of use of operands and tags.
- During a program test or when troubleshooting, you are informed of the following:
  - which operand is processed by which command in which block,
  - which tag is used in which picture,
  - which block is called by which other block.
- As part of the project documentation, the cross-references provide a comprehensive overview of all operands, memory areas, blocks, tags and pictures used.

#### See also

Structure of the cross-reference list (Page 1486)

Displaying the cross-reference list (Page 1488)

Displaying cross-references in the Inspector window (Page 1489)

### 9.3.2 Structure of the cross-reference list

#### Views of the cross-reference list

There are two views of the cross-reference list. The difference between the two views is in the objects displayed in the first column:

- Used by:  
Display of the referenced objects. Here, you can see where the object is used.
- Used:  
Display of the referencing objects. Here, you can see the users of the object.

The assigned tool tips provide additional information about each object.

## Structure of the cross-reference list

The cross-reference list has the following structure:

Column	Content/meaning
Object	Name of the object that uses the lower-level objects or that is being used by the lower-level objects.
Number	Number of uses
Point of use	Each point of use, for example, network
Property	Special properties of referenced objects, for example, the tag names in multi-instance declarations.
as	Shows additional information about the object, e.g., that an instance DB is used as template or as multiple instance.
Access	Type of access, whether access to the operand is read access (R) and/or write access (W).
Address	Address of the operand
Type	Information on the type and language used to create the object
Path	Path of object in project tree

Depending on the installed products, additional columns or different columns are displayed for the cross-references.

## Settings in the cross-reference list

You can make the following settings using the buttons in the toolbar of the cross-reference list:

- Update cross-reference list  
Updates the current cross-reference list.
- Making settings for the cross-reference list  
Here, you select check boxes to specify whether all used, all unused, all defined or all undefined objects will be displayed. If the "Undefined objects" option is enabled, references to previously deleted objects are also displayed.
- Collapse entries  
Reduces the entries in the current cross-reference list by closing the lower-level objects.
- Expand entries  
Expands the entries in the current cross-reference list by opening the low-level objects.

## Sorting in the cross-reference list

You can sort the entries in the "Object" column, including other product-specific columns, in ascending or descending order. To do this, click on the relevant column title.

## See also

General information about cross references (Page 1486)

Displaying the cross-reference list (Page 1488)

### 9.3.3 Displaying the cross-reference list

#### Prerequisites

You have created a project.

#### Introduction

There are several ways of displaying cross-references depending on whether you are in the Portal view or in the Project view and which object you have selected in the project tree.

In the Portal view, you can only display cross-references for the entire CPU; in the Project view, you can, for example, display cross-references for the following objects:

- "PLC tags" folder
- "PLC data types" folder
- "Program blocks" folder
- "Tags and connections" folder
- Individual tags
- Individual PLC data types
- Individual blocks
- Technological objects

#### Displaying cross-references

Proceed as follows to display cross-references:

1. Select the required action in the Portal view, for example "PLC programming" and the "Show cross-references" command or select one of the objects listed above in the Project view and select the "Cross-references" command in the "Tools" menu.
2. Click the "Used by" button to display where the objects shown in the cross-reference list are used.
3. Click the "Uses" button to view the users of the objects displayed in the cross-reference list.
4. You can perform the following actions using the buttons in the toolbar:
  - Update cross-reference list
  - Making settings for the cross-reference list
  - Collapse entries
  - Expand entries
5. You can sort the entries in the "Object" and "Address" columns in ascending or descending order by clicking on the relevant column title.
6. To go to the point of use of the object, click on the displayed link.



**See also**

General information about cross references (Page 1486)

Structure of the cross-reference list (Page 1486)

**9.3.4 Displaying cross-references in the Inspector window****Introduction**

The Inspector window displays cross-reference information about an object you have selected in the "Info > Cross-references" tab. This tab displays the instances where a selected object is being used and the other objects using it.

The Inspector window also includes blocks which are only available online in the cross-references.

You can use the "Show overlapping access..." shortcut menu command to also have overlapping access across block borders displayed for selected objects.

**Structure**

The Inspector window displays the cross-reference information in tabular format. Each column contains specific and detailed information on the selected object and its application. The table below shows the additional information listed in the "Info > Cross-reference" tab:

Column	Meaning
Object	Name of the object that uses the lower-level objects or that is being used by the lower-level objects.
Number	Number of uses
Point of use	Each location of use, for example, network
Property	Special properties of referenced objects, for example, the tag name in multi-instance declarations
as	Shows additional information about the object, e.g., that an instance DB is used as template or as multiple instance.
Access	Access mode Shows whether the operand is accessed by a read (R) and/or write (W) operation.
Address	Address of the operand
Monitor value	This column will only be displayed when the program editor is open.
Type	Information about the type and language used to create the object
Path	Path of object in project tree

*9.3 Displaying cross-references*

Depending on the installed products, additional columns or different columns are displayed for the cross-references.

## 9.4 Testing the user program

### 9.4.1 Basics of testing the user program

#### Functions

You have the option of testing the running of your user program on the device. You can then monitor signal states and values of tags and can assign values to tags to simulate certain situations in the running of the program.

#### Requirement

There must be an executable program loaded on the device.

#### Test options

The following test options are available:

- **Testing with program status**  
The program status allows you to monitor the running of the program. You can display the values of operands and the results of logic operations (RLO) allowing you to recognize and fix logical errors in your program.
- **Testing in single step mode (S7-300/400 only)**  
You can test blocks you created in STL or SCL in the single step mode. You do this by setting breakpoints in the program code at which program execution stops. You can then continue to run the program one step at a time. Within a CPU, you can test either with program status or in single step mode. You cannot, however, use both test options at the same time within a CPU.
- **Testing with the watch table**  
With the watch table, you can monitor and modify the current values of individual tags in the user program or on a CPU. You can assign values to individual tags for testing and run the program in a variety of different situations. You can also assign fixed values to the I/O outputs of a CPU in STOP mode, for example to check the wiring.
- **Testing with the force table**  
With the force table, you can monitor and force the current values of individual tags in the user program or on a CPU. When you force, you overwrite individual tags with specified values. This allows you to test your user program and run through various situations. When forcing, make sure that you keep to the necessary safety measures for forcing (Page 1540)!

#### See also

Introduction to testing with program status (Page 1492)

Introduction to testing with the watch table (Page 1499)

Introduction for testing with the force table (Page 1524)

## 9.4.2 Testing with program status

### 9.4.2.1 Introduction to testing with program status

#### Program Status function

If you display the program status, you can monitor the execution of the program. This provides you with an overview of the values of the individual operands and the results of the logic operations and you can check whether the components of the automation system are correctly controlled.

The display of the program execution in the program status can differ slightly, depending on the CPU family used.

#### Testing with program status for S7-300/400

During testing with program status, the CPU cycle time can become extended in test mode because the recording of all test data can deviate from the duration of the programmed instructions due to the CPU capacity and therefore not run in realtime.

During the execution of the following test functions an alarm indicating the danger of a time-out is displayed once for each online session.

- During testing with call conditions
- During testing with breakpoints

You can only perform these test functions after you have acknowledged the alarm.

---

#### Note

With older CPUs from the S7-300/400 CPU family, you will need to change the operating response using the hardware configuration and then download the hardware configuration to the device. You have the option to set the "Process operation" or "Test operation" operating response.

---

#### Restrictions with the "Program status" function

The monitoring of loops can increase the cycle time significantly, depending in each case on the number of tags to be monitored and on the actual number of loops processed.

To ensure that the cycle time is influenced as little as possible, the "Program status" function is restricted as follows:

- The status display of a programmed loop is stopped at the return point.

 <b>WARNING</b>
<b>Testing with program status</b>
A test with the "Program status" function can cause serious damage to property or injury to persons if there are functional disturbances or program errors.
Make sure that no dangerous situations can arise before you conduct a test with the "Program status" function.

### 9.4.2.2 Switching test with program status on/off

You can activate the program status for all programming languages. For the graphic programming languages LAD and FBD, you can also enable the program status at a specific position or for a specific selection.

#### Requirement

- The identical block exists in the device.
- The block is open.

#### Switching the program status on or off

To switch the program status for a block on or off, follow these steps:

1. Click the "Monitoring on/off" button in the toolbar.  
If you have not already established an online connection, the "Go online" dialog opens. In this dialog, you can establish an online connection.  
See also: Establishing and terminating an online connection

#### Enabling program status starting at a specific point in a network

To start the program status for LAD and FBD at a specific point, follow these steps:

1. Click the "Monitoring on/off" button in the toolbar.
2. Right-click on the tag you want program status to start from.
3. Select "Modify > "Monitor from here" in the shortcut menu.

#### Enabling program status for selected tags

To start the program status for LAD and FBD for selected tags, follow these steps:

1. Click the "Monitoring on/off" button in the toolbar.
2. Select the tags for which you want to start the program status.
3. Select "Modify > Monitor selection" in the shortcut menu.

---

**Note**

The resources for testing with program status are limited. If there are not enough resources for the current test, earlier tests will be terminated.

---

**Result**

If you enable the display of the program status, an online connection is established and the program status is displayed. When you turn off the display of the program status, you can terminate the online connection at the same time.

If the CPU is in "HOLD" or "STOP" mode, the call hierarchy of the block is displayed in the "Call hierarchy" pane on the "Testing" task card. With S7-1200 CPUs, the call hierarchy is also displayed during the test with program status. Using this call hierarchy, you can change to one of the calling blocks.

**9.4.2.3 Editing blocks during the program test**

If you edit blocks while the test with program status is still running, online monitoring will be interrupted and you will be able to edit the block offline. If the block is not available offline in the project, you will first have to load it from the device to the project. After editing the block, you will also have to compile and download it again.

**Procedure**

To edit blocks while the test with program status is still running, follow these steps:

1. Edit the block as necessary.  
The test with program status is interrupted and the block is switched offline assuming it exists offline.
2. If the block does not exist offline, load it to the project from the device.
3. Compile the block.  
See also: Auto-Hotspot
4. Download the block to the device.  
See also: Auto-Hotspot

**Result**

The block now contains your modifications both online and offline. The online connection is re-established and testing with program status continues.

#### 9.4.2.4 Modifying tags in the program status

While testing with the program status, you have the option of modifying tags to the following values once and immediately:

- **Modify to 1**  
Modifies tags of the "Bool" data type to the value "True".
- **Modify to 0**  
Modifies tags of the "Bool" data type to the value "False"
- **Modify operand**  
You can enter a modify value for tags that do not belong to the "Bool" data type.

Note that you cannot modify peripheral inputs, for example, via TagName:P.

#### Procedure

To modify tags during testing with the program status, proceed as follows:

1. Right-click on the tag you want to modify.
2. Select one of the following commands in the shortcut menu:
  - "Modify > Modify to 1"
  - "Modify > Modify to 0"
  - "Modify > Modify operand"
3. If you select "Modify operand", the "Modify operand" dialog opens. Enter the value you require in the "Modify value" box and confirm with "OK".

#### 9.4.2.5 Switching display formats in the program status

#### Introduction

The display formats for tags are generally displayed in "integer" form. In the program status, you have the option of switching the current display format by means of the shortcut menu. The possible display formats for a tag are offered in a list. This is useful, for example, when you need a hexadecimal display in order to search for a hexadecimal error code.

#### Procedure

To switch the display format, follow these steps:

1. Open the desired block in the programming editor.
2. Switch on the program status by clicking "Monitoring on/off" in the toolbar.  
If you have not already established an online connection, the "Go online" dialog opens. In this dialog, you can establish an online connection.
3. Select the tags for which you want to start the program status.

4. Select "Modify > Monitor selection" in the shortcut menu to start monitoring this tag.
5. Select the desired tag at the corresponding block output and then select the desired display format in the shortcut menu, for example, "Modify > Display format > Hexadecimal".

**Result**

The display format for the selected tag is shown in hexadecimal form.

**Note**

**Switching the display format in the program status**

Please note that it is not possible to switch the display format for unconnected outputs, as no monitoring value is output in this case.

**9.4.2.6 Examples of program status display**

**Program status display for LAD programs**

**Displays in program status**

The display of the program status is updated cyclically.

The following figure shows an example of the program status display for LAD:

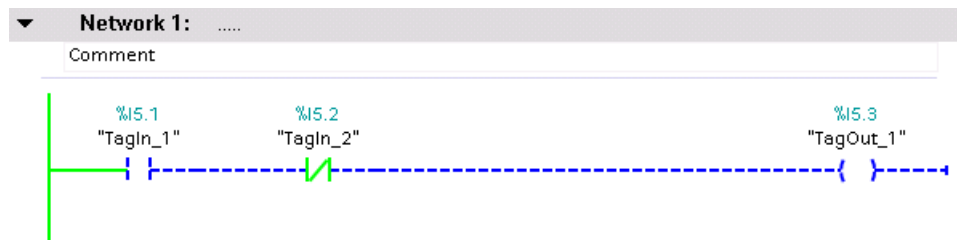

**Representation of the program status**

You can recognize the status of individual instructions and lines of a network quickly based on the color and type of lines and symbols. The following table shows the relationship between representation and status:

Representation	Status
Green solid	Satisfied
Blue dashed	Not satisfied
Gray solid	Unknown or not executed
Black	Not interconnected



Representation	Status
Parameter in a frame with a saturation of 100 %	Value is current
Parameter in a frame with a saturation of 50 %	Value originates from an earlier cycle. The point in the program was not executed in the current cycle.

## Program status display for FBD programs

### Displays in program status

The display of the program status is updated cyclically.

The following figure shows an example of the program status display for FBD:

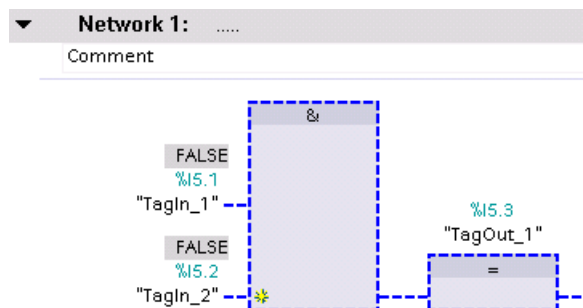

### Representation of the program status

You can recognize the status of individual instructions and lines of a network quickly based on the color and type of lines and symbols. The following table shows the relationship between representation and status:

Representation	Status
Green solid	Satisfied
Blue dashed	Not satisfied
Gray solid	Unknown or not executed
Black	Not interconnected
Parameter in a frame with a saturation of 100 %	Value is current
Parameter in a frame with a saturation of 50 %	Value originates from an earlier cycle. The point in the program was not executed in the current cycle.

The values of the operands are displayed above the relevant operand name in a gray box.

#### Note

#### Program status display for outputs which are not interconnected

Please note that a monitor value cannot be displayed for outputs which are not interconnected.

### Program status display for SCL programs

#### Displays in program status

The display of the program status is updated cyclically and shown in a table. The table is displayed immediately beside the SCL program and you can see the program status for each line of the program. The table contains the following information:

- Tag names
- Value

You can move the table to the left or right at any time.

The following figure shows an example of the program status display for SCL:

1	<input type="checkbox"/> IF "TagIn_1"	"TagIn_1"	FALSE
2	THEN "TagIn_2" :=1;	"TagIn_2"	TRUE
3	END_IF;		
4	<input type="checkbox"/> IF "TagIn_2" = false	"TagIn_2"	FALSE
5	THEN "TagIn_3" :=1;	"TagIn_3"	TRUE
6	END_IF;		
7			

In the first column, you can see the name of the tag for which the current value is being displayed. If the line includes the "IF", "WHILE" or "REPEAT" instruction, the result of the instruction is displayed in the line as "True" or "False". If the line contains more than one tag, the value of the first tag is displayed. In both cases, all tags of these lines are displayed with their values in a separate list as soon as you select a line. If you place the cursor in a tag in the program code, this is shown in bold face in the list. You can also display the other tags of a line explicitly by clicking the arrow right located in front of lines containing more than one tag.

If the code of the line is not executed, the tag name is displayed in the values table in gray text.

The current values of the tags are displayed in the last column. If no values can be displayed for a tag, the line has a yellow background and three question marks are shown. In this case, select the "Create extended status information" check box in the properties of the block and download the block to the device again. All values are then displayed.

## 9.4.3 Testing with the watch table

### 9.4.3.1 Introduction to testing with the watch table

#### Overview

The following functions are available in the watch table:

- **Monitoring tags**  
This displays the current values of the individual tags of a user program or a CPU on the programming device or PC.
- **Modifying tags**  
You can use this function to assign specific values to the individual tags of a user program or CPU. Modifying is also possible with Test with program status .
- **"Enable peripheral outputs" and "Modify now"**  
These two functions enable you to assign specific values to individual peripheral outputs of a CPU in STOP mode. You can also use them to check your wiring.

#### Monitoring and modifying tags

The following tags can be monitored and modified:

- Inputs, outputs, and bit memory
- Contents of data blocks
- I/O

#### Possible applications

The advantage of the watch table is that a variety of test environments can be stored. This enables you to reproduce tests during commissioning or for service and maintenance purposes.

#### See also

Creating and editing watch tables (Page 1503)

Layout of the watch table (Page 1500)

Basic mode and expanded mode in the watch table (Page 1501)

Icons in the watch table (Page 1502)

### 9.4.3.2 Layout of the watch table

#### Introduction

A watch table contains the tags you defined for the entire CPU. A "Watch and force tables" folder is automatically generated for each CPU created in the project. You create a new watch table in this folder by selecting the "Add new Watch table" command.

#### Layout of the watch table

The columns displayed in the watch table depend on the mode you are working in: basic mode or expanded mode.



The following additional columns are shown in expanded mode:

- Monitor with trigger
- Modify with trigger

The names of the columns can also be changed dynamically based on the action.

#### Meaning of the columns

The following table shows the meaning of the individual columns in basic mode and expanded mode:

Mode	Column	Meaning
Basic mode		Identifier column
	Name	Name of the inserted tag
	Address	Address of the inserted tag
	Display format	Selected display format
	Monitor value	Values of the tags, depending on the selected display format.
	Modify value	Value with which the tag is modified.
		Select the tag to be modified by clicking the corresponding check box.
The following additional columns are shown in expanded mode:	Monitor with trigger	Display of selected monitoring mode
	Modify with trigger	Display of selected modify mode

#### See also

Icons in the watch table (Page 1502)

### 9.4.3.3 Basic mode and expanded mode in the watch table

#### Difference between basic mode and expanded mode in the watch table

Depending on the mode specified, the watch table displays different columns and column headings that can be used to perform different actions.

You will find a detailed list of the columns in Layout of the watch table (Page 1500).

#### Switching between basic mode and expanded mode

You have the following options of toggling between the basic and expanded mode:

- Click the icon "Show/hide advanced setting columns". Click this icon again to return to the basic mode.  
Or:
- Activate the check box for the "Expanded Mode" command in the "Online" menu. Deactivate this check box to return to the basic mode.

#### Functionality in expanded mode

The following functionality is only possible in expanded mode:

- Monitor with trigger
- Modify with trigger
- Enable peripheral outputs
- Monitoring peripheral inputs
- Controlling peripheral outputs

<b>NOTICE</b>
<b>Danger of a time-out while monitoring peripheral inputs and controlling peripheral outputs</b>
Note that the monitoring of peripheral inputs and the controlling of peripheral outputs in the watch table can result in a time-out.
The CPU assumes the "STOP" mode.





















#### See also



Setting the monitoring and modify mode (Page 1513)

9.4.3.4 Icons in the watch table

Meaning of the icons

The following table shows the meaning of the icons in the watch table:

Icon	Meaning
	Identifies a table inside the project tree as a watch table.
	Shows information in the identifier column.
	Modifies the addresses of all selected tags immediately and once. This command is executed once and as quickly as possible without reference to a defined trigger point in the user program.
	Modifies the addresses of all selected tags with reference to a defined trigger point in the user program.
	Disables the command output disable of the peripheral outputs. You can then modify the peripheral outputs when the CPU is in STOP mode.
	Displays all columns of expanded mode. If you click this icon again, the columns of expanded mode will be hidden.
	Displays all modify columns. If you click this icon again, the modify columns will be hidden.
	Starts monitoring of the visible tags in the active watch table. The default setting for the monitoring mode in basic mode is "permanent". In expanded mode, you can set defined trigger points for the monitoring of tags.
	Starts monitoring of the visible tags in the active watch table. This command is executed immediately and the tags are monitored once.
	Displays the check box for the selection of tags to be modified.
	Indicates that the value of the selected tag has been modified to "1".
	Indicates that the value of the selected tag has been modified to "0".
	Indicates that the address is being used multiple times.
	Indicates that the substitute value is being used. Substitute values are values that are output to the process in case of signal output module faults or are used instead of a process value in the user program in case of signal input module faults. The substitute values can be assigned by the user (e.g., retain old value).
	Indicates that the address is blocked because it is already being modified.
	Indicates that the address cannot be modified.
	Indicates that the address cannot be monitored.
	Indicates that an address is being forced.
	Indicates that an address is being partly forced.
	Indicates that an associated I/O address is being fully or partly forced.

Icon	Meaning
	Indicates that an address cannot be fully forced. Example: It is indeed possible to force the address QW0:P, but it is not possible to force the address QD0:P since this address area is eventually not available on the CPU.
	Indicates that a syntax error occurred.
	Indicates that the address is selected but at the moment e.g. has not yet been modified.

### See also

Layout of the watch table (Page 1500)

### 9.4.3.5 Creating and editing watch tables

#### Creating a watch table

##### Introduction

The watch table allows you to monitor and modify tags in the user program. Once you have created a watch table, you can save it, duplicate it, and print it and use it again and again to monitor and modify tags.

##### Requirement

A project is open.

##### Procedure

To create a watch table, follow these steps:

1. Click "Project view" in the status bar.  
The project view is displayed.
2. In the project tree, double-click the CPU for which you want to create a watch table.
3. Double-click the "Watch and force tables" folder and then the "Add new watch table" command.  
A new watch table is added.
4. In the "Name" column or in the "Address" column, enter the name or the absolute address for the tags that you want to monitor or modify.
5. You can select a display format from the drop-down list in the "Display format" column if you want to change this default setting.
6. Now decide whether you want to monitor or modify the entered tags and, if applicable, enter the desired values for modifying.

## Opening a watch table

### Requirement

A watch table has been created.

### Procedure

To open a watch table, follow these steps:

1. Open the "Watch and force tables" folder below the desired CPU.
2. Double-click on the required watch table in the folder.

### Result

The selected watch table opens.

## Copying and pasting a watch table

### Requirement

A watch table has been created.

### Procedure

To copy a watch table, follow these steps:

1. Right-click the watch table that you want to copy.
2. In the context menu, select "Copy".
3. In the project tree, open the folder structure for the CPU in which you want to paste the copied watch table.
4. Right-click on the "Watch and force tables" folder.
5. In the context menu, select "Paste".
6. Alternatively, you can select the entire contents of the watch table and Drag & Drop it onto another watch table.

### Result

A copy of the selected watch table is placed in the "Watch and force tables" folder of the relevant CPU.



## **Saving a watch table**

### **Prerequisite**

A watch table has been created.

### **Procedure**

To save a watch table, follow these steps:

1. In the project tree select the watch table you want to save.
2. If you wish to change the preset name of the table, select the "Rename" command in the context menu and enter a new name for the table.
3. In the "Project" menu, select "Save". Note that this save operation will save the entire project.

### **Result**

The contents of the watch table and the project are saved.

---

#### **Note**

You can reuse saved watch tables to monitor and modify tags when retesting your program.

---

### **9.4.3.6 Entering tags in the watch table**

#### **Basic information on entering tags in the watch table**

##### **Recommended procedure**

- Select the tags whose values you want to monitor or modify, and enter them in the watch table.
- When entering tags into the watch table, please note that these tags must be previously defined in the PLC tag table.
- When entering tags, work from the outside to the inside. This means that you start by entering the tags for the inputs in the watch table. Then, you enter the tags that are affected by the inputs or that affect the outputs. Finally, you enter the tags for the outputs.

##### **Example of filling out a watch table**

- Enter the absolute address to be monitored or modified in the "Address" column.
- Enter the symbolic name for the tag in the "Name" column.

- Select the display format you require from the drop-down list in the "Display format" column, if you do not want to use the default setting.
- Now decide whether you want to monitor or modify the entered tags. Enter the desired values for modifying as well as a comment in the corresponding columns of the watch table.

### Syntax check

When you enter the tags in the watch table, the syntax of each cell is checked when you exit the cell. Incorrect entries are marked in red.

---

#### Note

When you place the mouse pointer in a cell marked in red, brief information is displayed with additional notes on the error.

---

### See also

Permitted operands for the watch table (Page 1506)

Permissible modify values for the watch table (Page 1507)

### Permitted operands for the watch table

### Permissible operands for the watch table

The following table shows the operands that are permitted for the watch table:

Permitted operand	Example of data type	Example (International mnemonics)
Input/output/bit memory	BOOL	I1.0, Q1.7, M10.1 I0.0:P; Q0.0:P
Input/output/bit memory	BYTE	IB1/QB10/MB100 IB1:P; QB1:P
Input/output/bit memory	WORD	IW1; QW10; MW100 IW2:P; QW3:P
Input/output/bit memory	DWORD	ID4; QD10; MD100 ID2:P; QD1:P
Timers	TIMER	T1
Counters	COUNTER	C1
Data block	BOOL	DB1.DBX1.0
Data block	BYTE	DB1.DBB1
Data block	WORD	DB1.DBW1
Data block	DWORD	DB1.DBD1

**Note**

Please observe the following notes to work with the watch table.

- You cannot enter "DB0..." because it is used by the system!
- Peripheral outputs can be modified but not monitored.
- Peripheral inputs can be monitored but not modified.

**NOTICE**

**Danger of a time-out while monitoring peripheral inputs and controlling peripheral outputs**

Note that the monitoring of peripheral inputs and the controlling of peripheral outputs in the watch table can result in a time-out.

The CPU assumes the "STOP" mode.

**See also**

Basic information on entering tags in the watch table (Page 1505)

**Permissible modify values for the watch table**

**Entry of modify values in the watch table**

The following table shows the operands that are permitted for the entry of modify values in the watch table:

Table 9-14 Bit operands

Possible bit operands	Example for permitted modify values
I1.0	True
M1.7	False
Q1.0	0
Q1.1:P	1
DB1.DBX1.1	2#0
M1.6	2#1

Table 9-15 Byte operands

Possible byte operands	Example for permitted modify values
IB1	2#00110011
MB12	B#16#1F
QB10	1F

9.4 Testing the user program

Possible byte operands	Example for permitted modify values
QB11:P	'a'
DB1.DBB1	10

Table 9-16 Word operands

Possible word operands	Example for permitted modify values
IW1	2#0011001100110011
MW12	W#16#ABCD
MW14	ABCD
QW10	B#(12, 34)
QW12:P	12345
DB1.DBW1	'ab'
MW16	S5T#9s_340ms
MW18	C#123
MW9	D#2006-12-31

Table 9-17 Double word operands

Possible double word operands	Example for permitted modify values
ID1	2#00110011001100110011001100110011
QD10	Dw#16#abcdef10
QD12:P	ABCDEF10
DB1.DBD2	b#(12,34,56,78)
MD8	L#-12
MD12	L#12
MD16	123456789
MD20	123456789
MD24	T#12s345ms
MD28	Tod#1:2:34.567
MD32	P#e0.0

Table 9-18 Timers

Possible operands of the "Timer" type	Permitted modify/force values	Explanation
T1	0 ms	Time value in milliseconds (ms)
T12	20 ms	Time value in milliseconds (ms)
T14	12345 ms	Time value in milliseconds (ms)
T16	S5t#12s340ms	Time value 12s 340 ms

Table 9-19 Counters

Possible operands of the "Counter" type	Permitted modify/force values
C1	0
C14	20
C16	C#123

### Notes on timers and counters

- Timers

---

#### Note

Modifying a timer influences only the value, not the status. Timer T1 can be modified to the value "0", but the result of logic operation for A T1 is not changed.

The time sequences "s5t" and "s5time" can be written in both lower-case and upper-case characters.

---

- Counter

---

#### Note

Modifying a counter influences only the value, not the status. Counter C1 can be changed to the value "0", but the result of the logic operation for A C1 is not changed.

---

### Overview of the display formats

#### Display formats in the watch table

The display format you select specifies the representation of a tag value.

When entering the address a display format is automatically preset. If you want to change this, you can select a display format from the drop-down list in the "Display formats" column. The drop-down list only offers the display formats which are valid for this data type. The display format that appears first in the list is the pre-selected format.

#### Example

The following table shows the 32-bit data types permitted for all CPU families in the watch table and their possible display formats:

Data type	Possible display formats
BOOL	Bool, Hex, BCD, Octal, Bin, Dec, Dec+/-
BYTE	Hex, BCD, Octal, Bin, Dec, Dec+/-, Character
WORD	Hex, BCD, Octal, Bin, Dec, Dec+/-, Dec_Sequence, Character, Unicode_Character, SIMATIC_Timer, Date, Counter
DWORD	Hex, BCD, Octal, Bin, Dec, Dec+/-, Dec_Sequence, Character, Unicode_Character, Floating-point number, Time of day, Timer, Pointer

Data type	Possible display formats
SINT	Dec, Dec+/-, Hex, BCD, Octal, Bin, Character
INT	Dec, Dec+/-, Hex, BCD, Octal, Bin, Character, Unicode_Character, Dec_Sequence, SIMATIC_Timer, Counter, Date
DINT	Dec, Dec+/-, Hex, BCD, Octal, Bin, Character, Unicode_Character, Dec_Sequence, Floating-point number, Time of day, Timer, Pointer
USINT	Dec, Dec+/-, Hex, BCD, Octal, Bin, Character
UINT	Dec, Dec+/-, Hex, BCD, Octal, Bin, Character, Unicode_Character, Dec_Sequence, SIMATIC_Timer, Counter, Date
UDINT	Dec, Dec+/-, Hex, BCD, Octal, Bin, Character, Unicode_Character, Dec_Sequence, Floating-point number, Time of day, Timer, Pointer
REAL	Floating-point number, Hex, BCD, Octal, Bin, Character, Unicode_Character, Dec, Dec+/-, Dec_Sequence, Time of day, Timer, Pointer
DATE	Date, Dec, Hex, BCD, Bin
TIME_OF_DAY	Time of day, Dec, Hex, BCD, Bin
TIME	Timer, Hex, BCD, Bin
DATE_AND_TIME	Date and time,
TIMER	SIMATIC_Timer, Hex, BCD, Bin
CHAR	Character, Hex, BCD, Octal, Bin, Dec, Dec+/-
STRING	Character string
POINTER	Pointer, Hex, BCD, Octal, Bin, Character, Unicode_Character, Dec, Dec+/-, Dec_Sequence, Floating-point number, Time of day, Timer, Number
COUNTER	Counter, Hex, BCD, Bin
S5TIME	SIMATIC_Timer, Hex, BCD, Bin

For the S7-1200 CPU family, all 32-bit data types are permitted (see table above), as well as the 64-bit data type LREAL with the following possible display formats:

Data type	Possible display formats
LREAL	In a project created with TIA Portal V12: Floating-point number Note: The display of LREAL is limited to 13 digits plus exponent.
LREAL	In a project created with TIA Portal V12: Floating-point number, Hex, BCD, Octal, Bin, Character, Unicode_Character, Dec, Dec+/-, Dec_Sequence, Time of day, Timer, Date and time Note: The display of LREAL is limited to 13 digits plus exponent.

For the S7-1500 CPU family, in addition to 32-bit data types, the 64-bit data types listed in the table are also permitted with the following possible display formats:

Data type	Possible display formats
LWORD	Hex, Octal, BCD, Bin, Character, Unicode_Character, Dec, Dec+/-, Dec_Sequence, Floating-point number, Time of day, Timer, Date and time
LINT	Dec+/-, Dec, Hex, BCD, Octal, Bin, Character, Unicode_Character, Dec_Sequence, Time of day, Timer, Date and time
ULINT	Dec, Dec+/-, Hex, BCD, Octal, Bin, Character, Unicode_Character, Dec_Sequence, Time of day, Timer, Date and time
LREAL	Floating-point number, Hex, BCD, Octal, Bin, Character, Unicode_Character, Dec, Dec+/-, Dec_Sequence, Time of day, Timer, Date and time
LTIME	Timer, Dec+/-, Dec, Hex
LTOD	Time of day, Dec, Hex, BCD, Bin
LDT	Date and time, Dec, Hex

For more information, refer to the description of the valid data types.

---

#### Note

##### Rounding of floating-point numbers

In the watch table, floating-point numbers are stored as binary numbers in IEEE format. Because not every floating point number (real, longreal) that can be displayed on the user interface can be mapped to the IEEE format, there is a possibility that floating-point numbers will be rounded. If a rounded floating-point number in the watch table is copied and, in turn, inserted in another input field, the rounding may cause a slight difference.

---



---

#### Note

##### Only symbolic addressing is possible

In the watch table, LongDataTypes such as LWORD or LREAL can only be addressed symbolically.

---

### Selecting the display format for tags

#### Procedure

To select the display format of the tags, follow these steps:

1. Enter the desired address in the watch table.
2. Click the desired cell in the "Display format" column, and open the drop-down list. The permissible display formats are shown in the drop-down list.
3. Select the desired display format from the drop-down list.

---

#### Note

If the selected display format cannot be applied, then the last selected display format will be displayed automatically.

---

#### 9.4.3.7 Monitoring tags in the watch table

#### Introduction to monitoring tags in the watch table

#### Introduction

The watch table allows you to monitor the tags of the configured input and output modules in the CPU, depending on the monitoring and modify mode (Page 1513) selected. To monitor tags, an online connection to the CPU must exist.

<b>NOTICE</b>
<b>Danger of a time-out while monitoring peripheral inputs</b>
Note that the monitoring of peripheral inputs can result in a time-out.
The CPU assumes the "STOP" mode.



## Options for monitoring tags

The following options are available for monitoring tags:

- Monitor now  
This command starts the monitoring of the visible tags in the active watch table immediately and once only.
- Monitor all  
This command starts the monitoring of all visible tags in the active watch table, depending on the selected watch mode:
  - In basic mode, the monitoring mode is set to "permanent" by default.
  - In expanded mode, you can specify defined trigger points for the monitoring of tags.

---

### Note

If the monitoring mode is changed while in expanded mode and then a switch is made to basic mode, the monitoring mode set before will also be applied in basic mode.

---

## CPU-specific limitations when monitoring tags

The following CPU-specific differences exist:

- CPU S7-300/400:  
CPUs from this family can only monitor the first 30 characters of a string.
- CPU S7-1200/1500:  
CPUs from this family can monitor a string up to the total size of 254 characters.

## Setting the monitoring and modify mode

### Introduction

By selecting the monitoring and modify mode, you specify the trigger point and the duration of the tag monitoring in the watch table and the force table.

### Possible monitoring and modify modes (duration of monitoring or modifying)

The following monitoring and modify modes are available:

- Permanent
  - In this mode, the inputs can be monitored at the start of the scan cycle and the outputs at the end.
- Once only, at start of scan cycle
- Once only, at end of scan cycle
- Permanently, at start of scan cycle
- Permanently, at end of scan cycle

- Once only, at transition to STOP
- Permanently, at transition to STOP

### Selecting the trigger point

The trigger points "Beginning of scan cycle", "End of scan cycle", and "Switch to stop" specify the time at which the tags are to be read from the CPU or updated in the CPU.

The following diagram shows the position of these trigger points:

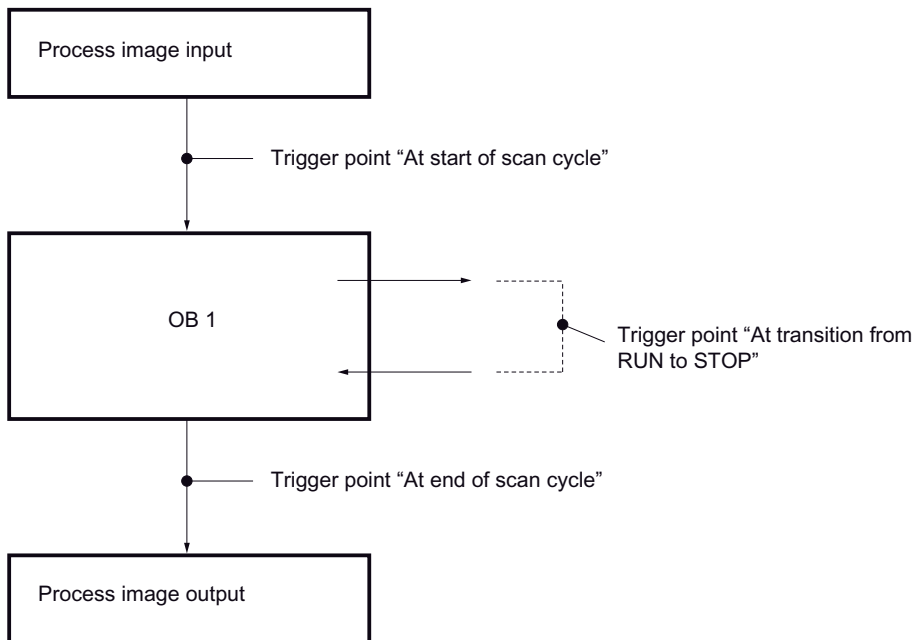

### Position of the trigger points

From the position of the trigger points, it follows that:

- Modifying of inputs is only appropriate at the beginning of the scan cycle (corresponding to the beginning of the user program OB 1), because otherwise the process image input is updated again after modifying and is thus overwritten.
- Modifying of outputs is only appropriate at the end of the scan cycle (corresponding to the end of the user program OB 1), because otherwise the process image output can be overwritten by the user program.
- The modified value is displayed in the "Monitor value" column, provided that monitoring is active and the modified value is not overwritten by the user program.

## Monitoring of tags

When tags are being modified, the following applies to the trigger points:

- If you have specified the modify mode as "once only", you will receive a message if the selected tags cannot be modified.
- In "permanent" modify mode, you do not receive a message.

## Note regarding the "Modify now" command

You can modify the values of selected tags immediately using the "Online > Modify >Modify now" command. This command is executed once only and as quickly as possible without reference to a defined position (trigger point) in the user program. This function is used mainly for modifying when the CPU is in STOP mode.

## "Monitor all" command for tags

### Introduction

The "Monitor all" command allows you to start monitoring the visible tags in the active watch table. The default setting for the monitoring mode in basic mode of the watch table is "permanent". In expanded mode, you can specify defined trigger points for the monitoring of tags. In this case, the tags are monitored with reference to the specified trigger points.

<b>NOTICE</b>
<b>Danger of a time-out while monitoring peripheral inputs</b>
Note that the monitoring of peripheral inputs can result in a time-out. The CPU assumes the "STOP" mode.

## Requirements

- A watch table has been created.
- An online connection to the CPU exists.

## Procedure

To execute the "Monitor all" command, follow these steps:

1. Enter the tags to be monitored and the corresponding addresses in the watch table.
2. Switch to expanded mode by clicking the icon "Show/hide advanced setting columns" in the toolbar.

3. If you want to change the default monitoring mode for a tag, click the appropriate cell in the "Monitor with trigger" column and select the desired monitoring mode from the drop-down list.
4. Click the "Monitor all" icon in the toolbar.

## Result

The tags of the active watch table are monitored using the monitoring mode selected.

## See also

Icons in the watch table (Page 1502)

Entering tags in the watch table (Page 1505)

Basic mode and expanded mode in the watch table (Page 1501)

## "Monitor now" command for tags

### Introduction

The "Monitor now" command starts the monitoring of tags immediately without reference to defined trigger points. The tag values are read out once only and displayed in the watch table.

<b>NOTICE</b>
<b>Danger of a time-out while monitoring peripheral inputs</b>
Note that the monitoring of peripheral inputs can result in a time-out.
The CPU assumes the "STOP" mode.

### Requirements

- A watch table has been created.
- An online connection to the CPU exists.

### Procedure

To execute the "Monitor now" command, follow these steps:

1. Enter the tags to be monitored and the corresponding addresses in the watch table.
2. Click the "Monitor now" icon in the toolbar.

## Result

The tags of the active watch table are monitored immediately and once only.

## See also

Icons in the watch table (Page 1502)

Entering tags in the watch table (Page 1505)

Basic mode and expanded mode in the watch table (Page 1501)

### 9.4.3.8 Modifying tags in the watch table

#### Introduction to modifying tags

#### Introduction

The watch table allows you to modify the tags of the configured input and output modules in the CPU, depending on the monitoring and modify mode (Page 1513) selected. To monitor the tags, an online connection to the CPU must exist.

#### DANGER

##### Danger when modifying:

Serious personal injury and material damage can result from changes in the tags or addresses during plant operation in the event of malfunctions or program errors!  
Make sure that dangerous conditions cannot occur before you execute the "Modify" function.

#### NOTICE

##### Danger of a time-out while controlling peripheral outputs

Note that the controlling of peripheral outputs in the watch table can result in a time-out.  
The CPU assumes the "STOP" mode.

#### Options for modifying tags

The following options are available for modifying tags:

- Modify to "0"  
This command modifies the selected address to the modify value "0".
- Modify to "1"  
This command modifies the selected address to the modify value "1".
- Modify once only and immediately  
This command modifies all selected addresses in the active watch table "once only and immediately".

- **Modify with trigger**  
This command modifies all selected addresses in the active watch table using the monitoring and modify mode (Page 1513) selected.  
The "Modify with trigger" function is only available in expanded mode. You will not receive a message indicating whether or not the selected addresses were actually modified with the specified value. You should use the "Modify once only and immediately" function if you require such a confirmation.
- **Enable peripheral outputs**  
This command disables the command output disable.  
This function can only be executed in expanded mode, when the CPU is in STOP and the option Force (Page 1539) of tags is not enabled. If desired, deactivate this function in the force table.

---

**Note**

**When modifying, note the following:**

Modifying can **not** be undone.

---

## Modify tags to "0"

### Introduction

You can assign one-time values to tags independent of the monitoring and modify mode and modify them. The modify command is executed as fast as possible, similar to a "Trigger now" command, without reference to a defined position in the user program.

 **DANGER**

**Danger when modifying:**

Serious personal injury and material damage can result from changes in the tags or addresses during plant operation in the event of malfunctions or program errors!  
Make sure that dangerous conditions cannot occur before you execute the "Modify" function.

**NOTICE**

**Danger of a time-out while controlling peripheral outputs**

Note that the controlling of peripheral outputs in the watch table can result in a time-out.  
The CPU assumes the "STOP" mode.

## Requirements

- A watch table has been created.
- An online connection to the CPU exists.

## Procedure

To modify tags to "0", follow these steps:

1. Enter the desired address in the watch table.
2. Select the "Online > Modify > Modify to 0" command in order to modify the selected address with the specified value.

## Result

The selected address is modified to "0".

---

### Note

**When modifying, note the following:**

Modifying can **not** be undone!

---

## Modify tags to "1"

### Introduction

You can assign one-time values to tags independent of the monitoring and modify mode and modify them. The modify command is executed as fast as possible, similar to a "Trigger now" command, without reference to a defined position in the user program.

### DANGER

#### Danger when modifying:

Serious personal injury and material damage can result from changes in the tags or addresses during plant operation in the event of malfunctions or program errors!  
Make sure that dangerous conditions cannot occur before you execute the "Modify" function.

### NOTICE

#### Danger of a time-out while controlling peripheral outputs

Note that the controlling of peripheral outputs in the watch table can result in a time-out.  
The CPU assumes the "STOP" mode.

### Requirements

- A watch table has been created.
- An online connection to the CPU exists.

### Procedure

To modify tags to "1", follow these steps:

1. Enter the desired address in the watch table.
2. Select the "Online > Modify > Modify to 1" command in order to modify the selected address with the specified value.

### Result

The selected address is modified to "1".

---

#### Note

**When modifying, note the following:**

Modifying can **not** be undone!

---

### "Modify now" command for tags

#### Introduction

You can assign one-time values to tags independent of the monitoring and modify mode and modify them immediately. The modify command is executed as fast as possible, similar to a "Trigger now" command, without reference to a defined position in the user program.

#### DANGER

##### Danger when modifying:

Serious personal injury and material damage can result from changes in the tags or addresses during plant operation in the event of malfunctions or program errors!  
Make sure that dangerous conditions cannot occur before you execute the "Modify" function.

#### NOTICE

##### Danger of a time-out while controlling peripheral outputs

Note that the controlling of peripheral outputs in the watch table can result in a time-out.  
The CPU assumes the "STOP" mode.



## Requirements

- A watch table has been created.
- An online connection to the CPU exists.

## Procedure

To modify tags immediately, follow these steps:

1. Enter the desired addresses and modify values in the watch table.
2. Select the addresses to be modified by selecting the check boxes for modifying in the column after the "Modify value".  
A yellow triangle appears behind the selected check box, indicating that the address is now selected for modifying but has not yet been modified.
3. Select the "Online > Modify > Modify once and now" command in order to immediately modify the selected address once only with the specified value.

## Result

The selected addresses are modified immediately and once only.

---

### Note

**When modifying, note the following:**

Modifying can **not** be undone!

---

## "Modify with trigger" command for tags

### Introduction

You can assign values to addresses dependent on the defined monitoring and modify mode and modify them. The modify command is executed as specified in the monitoring and modify mode, with reference to the defined trigger position in the user program.

### **DANGER**

#### **Danger when modifying:**

Serious personal injury and material damage can result from changes in the tags or addresses during plant operation in the event of malfunctions or program errors!  
Make sure that dangerous conditions cannot occur before you execute the "Modify" function.

**NOTICE**

**Danger of a time-out while controlling peripheral outputs**

Note that the controlling of peripheral outputs in the watch table can result in a time-out.  
The CPU assumes the "STOP" mode.

**Requirements**

- A watch table has been created.
- An online connection to the CPU exists.
- The watch table has to be in expanded mode.

**Procedure**

To modify tags "with trigger", follow these steps:

1. Enter the desired addresses and modify values in the watch table.
2. Select the addresses to be modified by selecting the check boxes for modifying in the column after the "Modify value".  
A yellow triangle appears behind the selected check box, indicating that the address is now selected for modifying but has not yet been modified.
3. Switch to expanded mode using the icon "Show/hide advanced settings columns" in the toolbar or the "Online > Expanded mode" command.  
The "Monitor with trigger" and "Modify with trigger" columns are displayed.
4. In the "Modify with trigger" column, select the desired modify mode from the drop-down list box. The following options are available:
  - Permanent
  - Permanently, at start of scan cycle
  - Once only, at start of scan cycle
  - Permanently, at end of scan cycle
  - Once only, at end of scan cycle
  - Permanently, at transition to STOP
  - Once only, at transition to STOP
5. Start modifying using the "Online > Modify > Modify with trigger" command.
6. Confirm the prompt with "Yes" if you want to start modifying with trigger.

## Result

The selected tags are modified using the selected monitoring and modify mode. The yellow triangle is no longer displayed.

---

### Note

**When modifying, note the following:**

Modifying can **not** be undone!

---

## Enable peripheral outputs

### Introduction

The "Enable peripheral outputs" function deactivates the command output disable of the peripheral outputs. You can then modify the peripheral outputs when the CPU is in STOP mode. This function is available in the watch table in "Expanded mode" only.

 <b>DANGER</b>
<b>Danger when enabling the peripheral outputs:</b> Attention, the enabling of the peripheral outputs can cause serious personal injury and material damage! Make certain that dangerous conditions cannot occur before you execute the "Enable peripheral outputs" function.

### Prerequisites

- A watch table has been created.
- An online connection to the CPU exists.
- The CPU is in STOP mode before you can enable the peripheral outputs.
- The watch table has to be in expanded mode.
- The option Force (Page 1539) of tags must not be enabled.

---

### Note

#### "Enable peripheral outputs" function

- This function is possible only in STOP mode. The function is exited by an operating state change of the CPU and by the termination of the online connection.
  - While the function is enabled, forcing is not possible.
-

## Procedure

To enable the peripheral outputs in STOP mode, follow these steps:

1. Enter the desired addresses and modify values in the watch table.
2. Select the addresses to be modified by selecting the check boxes for modifying in the column after the "Modify value".  
A yellow triangle appears behind the selected check box, indicating that the address is now selected for modifying but has not yet been modified.
3. Switch to expanded mode using the icon "Show/hide advanced settings columns" in the toolbar or the "Online > Expanded mode" command.  
The "Monitor with trigger" and "Modify with trigger" columns are displayed.
4. Change the relevant CPU to STOP using the operator panel.
5. Right-click to open the shortcut menu and select "Enable peripheral outputs".
6. Confirm the prompt with "Yes" if you want to unlock the command output disable for the peripheral outputs.
7. Modify the peripheral outputs using the "Online > Modify > Modify now" command.

## Result

The peripheral outputs are modified with the selected modify values. The yellow triangle is no longer displayed.

## Enabling the peripheral outputs

The "Enable peripheral outputs" function remains active until:

- The "Enable peripheral outputs" command is deactivated again via the shortcut menu or via the "Online > Modify > Enable peripheral outputs" command.
- The CPU is no longer in STOP mode.
- The online connection is terminated.

---

### Note

When modifying, note the following:

Modifying can **not** be undone!

---

## 9.4.4 Testing with the force table

### 9.4.4.1 Introduction for testing with the force table

#### Overview

You can use the force table to assign permanent values to individual tags

of the user program. This action is referred to as "forcing".

The following functions are available in the force table:

- **Monitoring tags**  
This displays the current values of the individual tags of a user program or a CPU on the programming device or PC. Tags can be monitored with or without a trigger condition.
- **Forcing tags**  
This function lets you assign a permanent value to individual peripheral tags of the user program.

### **Monitoring and forcing tags**

The monitoring and forcing of tags is always dependent on the operand scope of the CPU used.

The following tags can be monitored:

- Inputs, outputs, and bit memories
- Contents of data blocks
- Peripheral inputs

The following tags can be forced:

- Peripheral inputs
- Peripheral outputs

### **Example**

- Independent of the CPU used, only I/O can be forced, such as: "Tag\_1":P or "QW0:P" or "IW0:P". Note that "Tag\_1":P must not be the symbolic name of a bit memory.

### **Possible applications**

One advantage of the force table is that you can simulate different test environments and overwrite tags in the CPU with a permanent value. This enables you to intervene in the ongoing process for regulating purposes.

### **See also**

Layout of the force table (Page 1526)

Basic mode and expanded mode in the force table (Page 1527)

Icons in the force table (Page 1528)

Open and edit force table (Page 1529)

### 9.4.4.2 Safety precautions when forcing tags

#### Safety precautions when forcing tags

Because the forcing function allows you to intervene permanently in the process, observance of the following notices is essential:

 <b>DANGER</b>
<p><b>Prevent personal injury and material damage!</b></p> <p>Note that an incorrect action when executing the "Force" function can:</p> <ul style="list-style-type: none"><li>• Harm persons or pose a health hazard.</li><li>• Cause damage to machinery or the entire plant.</li></ul>

 <b>CAUTION</b>
<p><b>Prevent personal injury and material damage!</b></p> <ul style="list-style-type: none"><li>• Before you start the "Force" function, you should ensure that no one else is currently executing this function on the same CPU.</li><li>• Forcing can only be stopped by clicking the "Stop forcing" icon or using the "Online &gt; Force &gt; Stop forcing" command. Closing the active force table does <b>not</b> stop the forcing!</li><li>• Forcing can <b>not</b> be undone!</li><li>• Review the differences between "modifying tags" (Page 1517) and "forcing tags" (Page 1539).</li><li>• If a CPU does not support the "Force" function, the relevant icons cannot be selected.</li><li>• If the function "Enable peripheral outputs" is active on your CPU, then forcing is <b>not</b> possible on this CPU. If desired, deactivate this function in the watch table.</li></ul>

### 9.4.4.3 Layout of the force table

#### Introduction

In the force table, enter the CPU-wide tags that you have defined and selected and which are to be forced in the allocated CPU. Only peripheral inputs and peripheral outputs can be forced.

For each CPU created in the project, a force table will automatically be created in the "Watch and force tables" folder. Only one force table can be allocated to a CPU. This force table displays all the addresses forced in the allocated CPU.

### Layout of the force table

The columns displayed in the force table depend on the mode you are working in: basic mode or expanded mode.

In expanded mode the "Monitor with trigger" column is also displayed.

### Meaning of the columns

The following table shows the meaning of the individual columns in basic mode and expanded mode:

Mode	Column	Meaning
Basic mode	<b>i</b>	Identification column
	Name	Name of the inserted tag
	Address	Address of the inserted tag
	Display format	Selected display format
	Monitor value	Values of the tags, dependent on the selected display format.
	Force value	Value with which the tag is forced.
	<b>F</b> ("Force")	Select the tag to be forced by activating the corresponding check box.
Comment	Comment for documentation of the tags	
The following additional column is shown in expanded mode:	Monitor with trigger	Display of selected monitoring mode

### See also

Icons in the force table (Page 1528)

Basic mode and expanded mode in the force table (Page 1527)

#### 9.4.4.4 Basic mode and expanded mode in the force table

#### Difference between basic mode and expanded mode in the force table

In expanded mode the "Monitor with trigger" column is also displayed in the force table.

You will find a detailed list of the columns under Layout of the force table (Page 1526).

### Switching between basic mode and expanded mode

You have the following options of toggling between the basic and expanded mode:

- Click the icon "Show/hide advanced setting columns". Click this icon again to return to the basic mode.  
Or:
- Activate the check box for the "Expanded mode" command in the "Online" menu. Deactivate this check box to return to the basic mode.















### Functionality in expanded mode

The "Monitor with trigger" function can only be selected in expanded mode.



#### 9.4.4.5 Icons in the force table

### Meaning of the icons

The following table shows the meaning of the icons in the force table:

Icon	Meaning
	Identifies a table inside the project tree as a force table.
	Identification column
	Displays all columns of expanded mode. If you click this icon again, the columns of the expanded mode will be hidden.
	Starts forcing for all addresses of the selected tags. If forcing is already running, the previous action is replaced without interruption.
	Stops forcing of addresses in the force table.
	Starts monitoring of the visible tags in the force table. The default setting for monitoring in basic mode is "permanent". In expanded mode an additional column is shown and you can set certain trigger points for monitoring tags.
	Starts monitoring of the visible tags in the force table. This command is executed immediately and the tags are monitored once.
	Displays the check box for the selection of tags to be forced.
	Indicates that an address cannot be forced.
	Indicates that an address cannot be fully forced. Example: It is possible to force the address QW0:P, but it is not possible to force the address QD0:P because this address area is potentially not available on the CPU.
	Indicates that an address cannot be monitored.
	Indicates that an address is being forced.
	Indicates that an address is being partly forced.
	Indicates that the associated peripheral address is being forced.



Icon	Meaning
	Indicates that a syntax error occurred.
	Indicates that the address is selected but has not been forced yet.

### See also

Layout of the force table (Page 1526)

## 9.4.4.6 Open and edit force table

### Display force table

#### Introduction

You cannot create a new force table; one force table already exists for each CPU. It is permanently allocated to this CPU and cannot be copied or duplicated.

#### Requirements

A project with an allocated CPU has to be open.

#### Displaying a force table

The force table is always displayed below a CPU in the "Watch and force tables" folder.

### Open force table

#### Requirements

A project with an allocated CPU must be created.

#### Procedure

Proceed as follows to open a force table:

1. Open the "Watch and force tables" folder below the desired CPU.
2. Double-click the "Force table" in this folder.

#### Result

The selected force table opens.

## Save force table

### Requirements

A project with an allocated CPU has been created.

### Procedure

Proceed as follows to save a force table:

1. Enter the desired changes in the force table.
2. Select the "Save" command in the "Project" menu or click the "Save project" icon in the toolbar. Note that this save operation will save the entire project.

### Result

The contents of the force table and the associated project are saved.

---

#### Note

You cannot rename a force table.

---

## 9.4.4.7 Entering tags in the force table

### Basic principles for entering tags in the force table

#### Recommended procedure

Select the tags whose values you want to monitor or force, and enter them in the force table.

When entering tags in the force table, please note that these tags must be previously defined in the PLC tag table.

#### Example of filling out a force table

- You can enter the absolute address that is to be forced or monitored in the "Address" column or you can enter the symbolic name of the tag in the "Name" column.
- Select the display format you require from the drop-down list in the "Display format" column, if you do not want to use the default setting.
- Now you have to decide whether you want to monitor or force the entered tags. Enter the required force value and a comment in the appropriate columns of the force table.
- Note that only peripheral inputs and peripheral outputs can be forced and review the Safety precautions when forcing tags (Page 1540).

## Syntax check

When you enter tags in the force table, the syntax of each cell will be checked when you exit the cell. Incorrect entries are marked in red.

---

### Note

When you place the mouse pointer in a cell marked in red, brief information is displayed with additional notes on the error.

---

## Permitted operands for the force table

### Permitted operands for the force table

The following table shows the operands that are permitted for forcing in the force table:

Permitted operand	Example of data type	Example (International mnemonics)
Peripheral input/peripheral output	BOOL	I0.0:P; Q0.0:P
Peripheral input/peripheral output	BYTE	IB1:P; QB1:P
Peripheral input/peripheral output	WORD	IW2:P; QW3:P
Peripheral input/Peripheral output	DWORD	ID2:P; QD1:P

The following table shows the operands that are permitted for monitoring in the force table:

Permitted operand	Example of data type	Example (International mnemonics)
Input/output/bit memory	BOOL	I1.0, Q1.7, M10.1 I0.0:P
Input/output/bit memory	BYTE	IB1/QB10/MB100 IB1:P
Input/output/bit memory	WORD	IW1; QW10; MW100 IW2:P
Input/output/bit memory	DWORD	ID4; QD10; MD100 ID2:P
Data block	BOOL	DB1.DBX1.0
Data block	BYTE	DB1.DBB1
Data block	WORD	DB1.DBW1
Data block	DWORD	DB1.DBD1

**Note**

You cannot enter "DB0..." because it is used by the system!

**Permitted force values for the force table**

**Entering force values in the force table**

The following table shows the operands that are permitted for entering force values in the force table:

Table 9-20 Bit operands

Possible bit operands	Example for permitted force values
I1.0:P	True
I1.1:P	False
Q1.0P	0
Q1.1:P	1
I2.0:P	2#0
I2.1:P	2#1

Table 9-21 Byte operands

Possible byte operands	Example for permitted force values
IB1:P	2#00110011
IB2:P	B#16#1F
QB14:P	1F
QB10:P	'a'
IB3:P	10

Table 9-22 Word operands

Possible word operands	Example for permitted force values
IW0:P	2#0011001100110011
IW2:P	W#16#ABCD
QW10:P	ABCD
QW12:P	B#(12, 34)
IW4:P	'ab'
IW6:P	12345
IW8:P	S5T#9S_340ms
IW10:P	C#123
IW12:P	D#2006-12-31

Table 9-23 Double word operands

Possible double word operands	Example for permitted force values
ID0:P	2#00110011001100110011001100110011
ID4:P	1.2
QD10:P	1.234.e4
QD14:P	Dw#16#abcdef10
ID8:P	16#ABCDEF10
ID12:P	b#(12,34,56,78)
ID16:P	L#-12
ID20:P	L#12
ID24:P	123456789
ID28:P	123456789
ID32:P	T#12s345ms
ID36:P	Tod#14:20:40.645
ID40:P	P#e0.0

## Overview of the display formats

### Display formats in the force table

The display format you select specifies the representation of a tag value.

When entering the address a display format is automatically preset. If you want to change this, you can select a display format from the drop-down list in the "Display formats" column. The drop-down list only offers the display formats which are valid for this data type. The display format that appears first in the list is the pre-selected format.

### Example

The following table shows the 32-bit data types permitted for all CPU families in the force table and their possible display formats:

Data type	Possible display formats
BOOL	Bool, Hex, BCD, Octal, Bin, Dec, Dec+/-
BYTE	Hex, BCD, Octal, Bin, Dec, Dec+/-, Character
WORD	Hex, BCD, Octal, Bin, Dec, Dec+/-, Dec_Sequence, Character, SIMATIC_Timer, Date, Unicode_Character, Counter
DWORD	Hex, BCD, Octal, Bin, Dec, Dec+/-, Dec_Sequence, Character, Floating-point number, Time of day, Timer, Pointer, Unicode_Character
SINT	Dec, Dec+/-, Hex, BCD, Octal, Bin, Character
INT	Dec, Dec+/-, Hex, BCD, Octal, Bin, Character, Unicode_Character, Dec_Sequence, SIMATIC_Timer, Counter, Date
DINT	Dec, Dec+/-, Hex, BCD, Octal, Bin, Character, Unicode_Character, Dec_Sequence, Floating-point number, Time of day, Timer, Pointer

Data type	Possible display formats
USINT	Dec, Dec+/-, Hex, BCD, Octal, Bin, Character
UINT	Dec, Dec+/-, Hex, BCD, Octal, Bin, Character, Unicode_Character, Dec_Sequence, SIMATIC_Timer, Counter, Date
UDINT	Dec, Dec+/-, Hex, BCD, Octal, Bin, Character, Unicode_Character, Dec_Sequence, Floating-point number, Time of day, Timer, Pointer
REAL	Floating-point number, Hex, BCD, Octal, Bin, Character, Unicode_Character, Dec, Dec+/-, Dec_Sequence, Time of day, Timer, Pointer
DATE	Date, Dec, Hex, BCD, Bin
TIME_OF_DAY	Time of day, Dec, Hex, BCD, Bin
TIME	Timer, Hex, BCD, Bin
DATE_AND_TIME	Date and time,
TIMER	SIMATIC_Timer, Hex, BCD, Bin
CHAR	Character, Hex, BCD, Octal, Bin, Dec, Dec+/-
STRING	Character string
POINTER	Pointer, Hex, BCD, Octal, Bin, Character, Unicode_Character, Dec, Dec+/-, Dec_Sequence, Floating-point number, Time of day, Timer, Number
COUNTER	Counter, Hex, BCD, Bin
S5TIME	SIMATIC_Timer, Hex, BCD, Bin

For the S7-1200 CPU family, all 32-bit data types are permitted (see table above), as well as the 64-bit data type LREAL with the following possible display formats:

Data type	Possible display formats
LREAL	In a project created with TIA Portal V12: Floating-point number Note: The display of LREAL is limited to 13 digits plus exponent.
LREAL	In a project created with TIA Portal V12: Floating-point number, Hex, BCD, Octal, Bin, Character, Unicode_Character, Dec, Dec+/-, Dec_Sequence, Time of day, Timer, Date and time Note: The display of LREAL is limited to 13 digits plus exponent.

For the S7-1500 CPU family, in addition to 32-bit data types, the 64-bit data types listed in the table are also permitted with the following possible display formats:

Data type	Possible display formats
LWORD	Hex, Octal, BCD, Bin, Character, Unicode_Character, Dec, Dec+/-, Dec_Sequence, Floating-point number, Time of day, Timer, Date and time
LINT	Dec+/-, Dec, Hex, BCD, Octal, Bin, Character, Unicode_Character, Dec_Sequence, Time of day, Timer, Date and time
ULINT	Dec, Dec+/-, Hex, BCD, Octal, Bin, Character, Unicode_Character, Dec_Sequence, Time of day, Timer, Date and time
LREAL	Floating-point number, Hex, BCD, Octal, Bin, Character, Unicode_Character, Dec, Dec+/-, Dec_Sequence, Time of day, Timer, Date and time

Data type	Possible display formats
LTIME	Timer, Dec+/-, Dec, Hex
LTOD	Dec, Hex, BCD, Bin, Time of day
LDT	Dec, Hex, Date and time

For more information, refer to the description of the valid data types.

---

#### Note

##### Rounding of floating-point numbers

In the force table, floating-point numbers are stored as binary numbers in IEEE format. Because not every floating point number (real, longreal) that can be displayed on the user interface can be mapped to the IEEE format, there is a possibility that floating-point numbers will be rounded. If a rounded floating-point number in the force table is copied and, in turn, inserted in another input field, the rounding may cause a slight difference.

---

#### Note

##### Only symbolic addressing is possible

In the force table, LongDataTypes such as LWORD or LREAL can only be addressed symbolically.

## Selecting the display format for tags

### Procedure

To select the display format of the tags, follow these steps:

1. Enter the desired address in the force table.
2. Click the desired cell in the "Display format" column, and open the drop-down list. The permitted display formats are shown in the drop-down list.
3. Select the desired display format from the drop-down list.

---

#### Note

If the selected display format cannot be applied, then the last selected display format will be displayed automatically.

### 9.4.4.8 Monitoring tags in the force table

## Introduction to monitoring tags in the force table

### Introduction

Use the force table to monitor the tags of the configured input and output modules in the CPU, dependent on the monitoring mode (Page 1536) you have selected. An online connection to the CPU must exist to monitor tags.

### Options for monitoring tags

The following options are available for monitoring tags:

- **Monitor all**  
This command starts the monitoring of all visible tags in the active force table, dependent on the selected monitoring mode:
  - In basic mode, the monitoring mode is set to "permanent" by default.
  - In expanded mode, you can specify defined trigger points for the monitoring of tags.

---

#### Note

If the monitoring mode is changed while in expanded mode and then a switch is made to basic mode, the monitoring mode set before will also be applied in basic mode.

---

- **Monitor now**  
This command starts the monitoring of the visible tags in the active force table immediately and once only.

### CPU-specific limitations when monitoring tags

The following CPU-specific differences exist:

- **CPU S7-300/400:**  
CPUs from this family can only monitor the first 30 characters of a string.
- **CPU S7-1200:**  
CPUs from this family can monitor a string up to the total size of 254 characters.

## Setting the monitoring mode in the force table

### Introduction

By selecting the monitoring mode, you specify the trigger point and the duration of tag monitoring in the force table.



### Possible monitoring mode (duration of monitoring)

The following selection options are available:

- Permanent: In this mode, the inputs can be monitored at the start of the scan cycle and the outputs at the end.
- Once only, at start of scan cycle
- Once only, at end of scan cycle
- Permanently, at start of scan cycle
- Permanently, at end of scan cycle
- Once only, at transition to STOP
- Permanently, at transition to STOP

### Selecting the trigger point

The trigger points "Beginning of scan cycle", "End of scan cycle", and "Switch to stop" specify the time at which the tags are to be read from the CPU or updated in the CPU.

The following diagram shows the position of these trigger points:

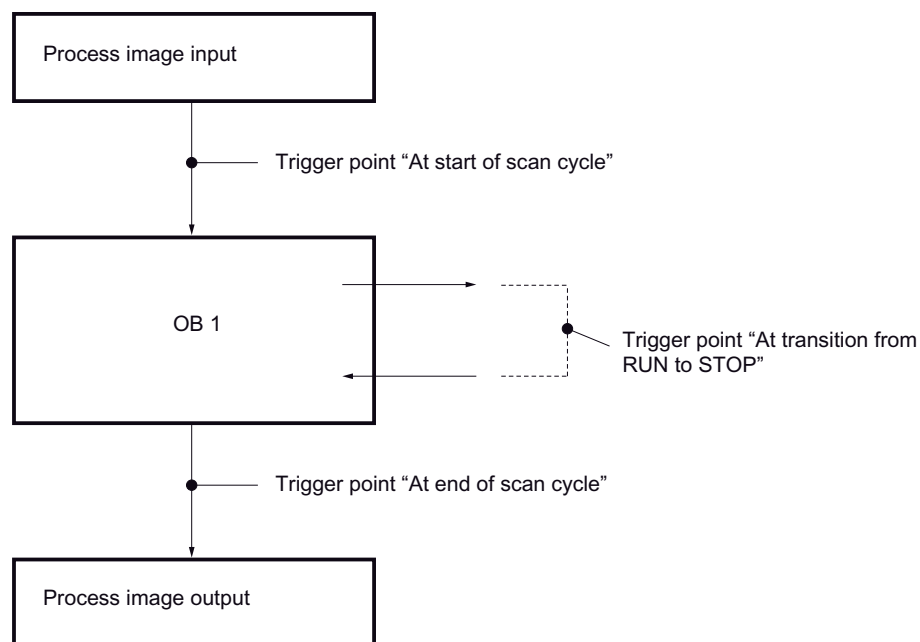

### "Monitor all" command for tags

#### Introduction

Use the "Monitor all" command to start monitoring the visible tags in the active force table. In basic mode of the force table, the default setting for the monitoring mode is "permanent". In

expanded mode, you can specify defined trigger points for the monitoring of tags. In this case, the tags are monitored with reference to the specified trigger points.

### Requirements

- A force table has been created.
- An online connection to the CPU exists.

### Procedure

To execute the "Monitor all" command, follow these steps:

1. Enter the tags to be monitored and the corresponding addresses in the force table.
2. Switch to expanded mode by clicking the icon "Show/hide advanced setting columns" in the toolbar.
3. If you want to change the default monitoring mode for a tag, click the appropriate cell in the "Monitor with trigger" column and select the desired monitoring mode from the drop-down list.
4. Click the "Monitor all" icon in the toolbar.

### Result

The tags of the active force table will be monitored using the set monitoring mode.

## "Monitor now" command for tags

### Introduction

The "Monitor now" command starts the monitoring of tags immediately without reference to defined trigger points. The tag values are read out only once and displayed in the force table.

### Requirements

- A force table has been created.
- An online connection to the CPU exists.

### Procedure

To execute the "Monitor now" command, follow these steps:

1. Enter the tags to be monitored and the corresponding addresses in the force table.
2. Click the "Monitor now" icon in the toolbar.

### Result

The tags of the active force table are monitored immediately and once only.

### 9.4.4.9 Forcing tags in the force table

#### Introduction to forcing tags

##### Introduction

You can use the force table to assign permanent values to individual tags of the user program. This action is referred to as forcing. Only peripheral inputs and peripheral outputs can be forced.

To use the forcing function, you must have an online connection to the CPU and the utilized CPU must support this functionality.

If you open a force table in the "Watch and force tables" folder below a CPU, all values forced in the allocated CPU will be displayed in this force table, provided that an online connection to the CPU exists.

##### Possible applications

By permanently assigning defined values to tags, you can specify defined default settings for your user program and, thus, test the programmed functions. Forcing is possible in basic mode and in expanded mode (Page 1527).

##### Caution when forcing tags

Before forcing, you must review the safety precautions (Page 1540) for this procedure.

 <b>DANGER</b>
<b>Prevent personal injury and material damage!</b>
Note that an incorrect action when executing the "Force" function can:
<ul style="list-style-type: none"><li>• Harm persons or pose a health hazard.</li><li>• Cause damage to machinery or the entire plant.</li></ul>

##### Options for forcing tags

The following options are available for forcing tags:

- Force to "0"  
This command forces the selected address in the CPU to the force value "0".
- Force to "1"  
This command forces the selected address in the CPU to the force value "1".

- **Force all**  
This command starts the forcing of enabled addresses in the active force table or replaces an existing force job without interruption.
- **Stop forcing**  
This command stops the forcing of all addresses in the active force table.

### Constraints when forcing tags

Note the following constraints when forcing:

- Forcing is always dependent on the operand scope of the CPU used.
- In principle, only peripheral inputs and peripheral outputs can be forced.
- If the function "Enable peripheral outputs" is active on your CPU, then forcing is not possible. If desired, deactivate this function in the watch table.

### Unique aspects when forcing tags

Note that forcing of tags will overwrite values in the CPU and will continue even after the online connection to the CPU is terminated.

- **Stop forcing**  
Terminating the online connection is not sufficient to stop the forcing operation! To stop forcing, you must select the "Online > Force > Stop forcing" command. Only then will the tags that are visible in the active force table no longer be forced.
- **Stop forcing of individual tags**  
The "Online > Force > Stop forcing" command always applies to all tags displayed in the force table. To stop forcing individual tags, you must clear the check mark for forcing of these tags in the force table and restart forcing using the "Online > Force > Force all" command.

### Safety precautions when forcing tags

### Safety precautions when forcing tags

Because the forcing function allows you to intervene permanently in the process, observance of the following notices is essential:

 <b>DANGER</b>
<b>Prevent personal injury and material damage!</b>
Note that an incorrect action when executing the "Force" function can:
<ul style="list-style-type: none"><li>• Harm persons or pose a health hazard.</li><li>• Cause damage to machinery or the entire plant.</li></ul>

 **CAUTION**

**Prevent personal injury and material damage!**

- Before you start the "Force" function, you should ensure that no one else is currently executing this function on the same CPU.
- Forcing can only be stopped by clicking the "Stop forcing" icon or using the "Online > Force > Stop forcing" command. Closing the active force table does **not** stop the forcing!
- Forcing can **not** be undone!
- Review the differences between "modifying tags" (Page 1517) and "forcing tags" (Page 1539).
- If a CPU does not support the "Force" function, the relevant icons cannot be selected.
- If the function "Enable peripheral outputs" is active on your CPU, then forcing is **not** possible on this CPU. If desired, deactivate this function in the watch table.

## Force tags to "0"

### Introduction

You can use the force function to assign permanent values to individual tags of a user program.

### Caution when forcing tags

Before forcing, you must review the safety precautions when forcing tags (Page 1540).

 **DANGER**

**Prevent personal injury and material damage!**

Note that an incorrect action when executing the "Force" function can:

- Harm persons or pose a health hazard.
- Cause damage to machinery or the entire plant.

### Requirements

- A force table has been created.
- An online connection to the CPU exists.
- The utilized CPU supports the force function.
- The "Enable peripheral outputs" function is **not** enabled on the CPU on which the tags are to be forced. If desired, deactivate this function in the watch table.

### Procedure

To force tags to "0", follow these steps:

1. Open the force table.
2. Enter the desired address in the force table.
3. Select the "Online > Force> Force to 0" command in order to force the selected address with the specified value.
4. Confirm the next dialog with "Yes".

### Result

The selected address is forced to "0". The yellow triangle is no longer displayed. A red "F" is displayed in the first column, for example, indicating that the tag is being forced.

### Stop forcing

To stop forcing, follow these steps:

1. Open the force table.
2. Select the "Online > Force > Stop forcing" command.
3. Confirm the next dialog with "Yes".

### Result

Forcing of the selected values is stopped. The red "F" in the first column is no longer displayed. The yellow triangle reappears behind the check box again to indicate that the address is selected for forcing but is not being forced at the moment.

---

#### Note

##### When forcing, note the following:

- Forcing can **not** be undone!
  - Terminating the online connection does **not** stop the forcing!
  - To stop forcing, the forced address must be visible in the active force table.
- 

### Force tags to "1"

#### Introduction

You can use the force function to assign permanent values to individual tags of a user program.

## Caution when forcing tags

Before forcing, you must review the safety precautions when forcing tags (Page 1540).

 <b>DANGER</b>
<b>Prevent personal injury and material damage!</b>
Note that an incorrect action when executing the "Force" function can:
<ul style="list-style-type: none"><li>• Endanger the life or health of personnel</li><li>• Cause damage to machinery or the entire plant.</li></ul>

## Requirements

- A force table has been created.
- An online connection to the CPU exists.
- The utilized CPU supports the force function.
- The "Enable peripheral outputs" function is **not** enabled on the CPU on which the tags are to be forced. If desired, deactivate this function in the watch table.

## Procedure

To force tags to "1", follow these steps:

1. Open the force table.
2. Enter the desired address in the force table.
3. Select the "Online > Force > Force to 1" command in order to force the selected address with the specified value.
4. Confirm the next dialog with "Yes".

## Result

The selected address is forced to "1". The yellow triangle is no longer displayed. A red "F" is displayed in the first column, for example, indicating that the tag is being forced.

## Stop forcing

To stop forcing, follow these steps:

1. Open the force table.
2. Select the "Online > Force > Stop forcing" command.
3. Confirm the next dialog with "Yes".

## Result

Forcing of the selected values is stopped. The red "F" in the first column is no longer displayed. The yellow triangle reappears behind the check box again to indicate that the address is selected for forcing but is not being forced at the moment.

---

### Note

#### When forcing, note the following:

- Forcing can **not** be undone!
  - Terminating the online connection does **not** stop the forcing!
  - To stop forcing, the forced address must be visible in the active force table.
- 

## "Force all" command for tags

### Introduction

You can use the force function to assign permanent values to individual tags of a user program. If forcing is already active, this forcing operation is replaced without interruption by the "Online > Force > Force all" command. Any forced addresses that are not selected will no longer be forced.

### Caution when forcing tags

Before forcing, you must review the safety precautions when forcing tags (Page 1540).

 <b>DANGER</b>
<b>Prevent personal injury and material damage!</b>
Note that an incorrect action when executing the "Force" function can:
<ul style="list-style-type: none"><li>• Harm persons or pose a health hazard.</li><li>• Cause damage to machinery or the entire plant.</li></ul>

### Requirements

- A force table has been created.
- An online connection to the CPU exists.
- The utilized CPU supports the force function.
- The "Enable peripheral outputs" function is **not** enabled on the CPU on which the tags are to be forced. If desired, deactivate this function in the watch table.



## Procedure

To force tags with the "Online > Force > Force all" command, follow these steps:

1. Open the force table.
2. Enter the desired addresses and force values in the force table.
3. Select the addresses to be forced by selecting the check boxes for forcing in the column after the "Force value".  
A yellow triangle appears behind the selected check box, indicating that the address is selected for forcing but is not being forced at the moment.
4. Select the "Online > Force > Force all" command in order to force the selected addresses with the specified values.
5. Confirm the next dialog with "Yes".

## Result

The selected addresses are forced to the specified values. The yellow triangle is no longer displayed. A red "F" is displayed in the first column, for example, indicating that the tag is being forced.

## Stop forcing

To stop forcing, follow these steps:

1. Open the force table.
2. Select the "Online > Force > Stop forcing" command.
3. Confirm the next dialog with "Yes".

## Result

Forcing of the selected addresses is stopped. The red "F" in the first column is no longer displayed. The yellow triangle reappears behind the check box again to indicate that the address is selected for forcing but is not being forced at the moment.

---

### Note

**When forcing, note the following:**

- Forcing can **not** be undone!
  - Terminating the online connection does **not** stop the forcing!
  - To stop forcing, the forced address must be visible in the active force table.
-

### 9.4.4.10 Stop forcing tags

#### Stop forcing all tags

##### Introduction

Note the following before you stop forcing tags:

- The stopping of forcing can **not** be undone!
- Terminating the online connection does **not** stop the forcing!
- To stop forcing, the forced address must be visible in the active force table.

##### Caution when forcing tags

Before forcing, you must review the safety precautions when forcing tags (Page 1540).

 <b>DANGER</b>
<p><b>Prevent personal injury and material damage!</b></p> <p>Note that an incorrect action when stopping the "Force" function can:</p> <ul style="list-style-type: none"><li>• Harm persons or pose a health hazard.</li><li>• Cause damage to machinery or the entire plant.</li></ul>

##### Requirements

- A force table has been created in which tags are being forced.
- An online connection to the CPU exists.
- The utilized CPU supports the force function.
- The "Enable peripheral outputs" function is not enabled on the CPU on which the tags are to be forced. If desired, deactivate this function in the watch table.

##### Procedure

Proceed as follows to stop **forcing all tags** :

1. Open the force table.
2. Select the "Online > Force > Stop forcing" command in order to stop forcing the displayed addresses.
3. Confirm the "Stop forcing" dialog with "Yes".

## Result

The forcing of all tags is stopped. The red "F" in the first column is no longer displayed. The yellow triangle reappears behind the check box again to indicate that the address is flagged for forcing but is not being forced at the moment.

## Stop forcing individual tags

### Introduction

Note the following before you stop forcing tags:

- The stopping of forcing can **not** be undone!
- Terminating the online connection does **not** stop the forcing!
- To stop forcing, the forced address must be visible in the active force table.

### Caution when forcing tags

Before forcing, you must review the safety precautions when forcing tags (Page 1526).

 <b>DANGER</b>
<b>Prevent personal injury and material damage!</b>
Note that an incorrect action when stopping the "Force" function can:
<ul style="list-style-type: none"><li>• Harm persons or pose a health hazard.</li><li>• Cause damage to machinery or the entire plant.</li></ul>

### Requirements

- A force table has been created in which tags are being forced.
- An online connection to the CPU exists.
- The utilized CPU supports the force function.
- The "Enable peripheral outputs" function is not enabled on the CPU on which the tags are to be forced. If desired, deactivate this function in the watch table.

### Procedure

Proceed as follows to stop **forcing individual tags** :

1. Open the force table.
2. Deactivate the check boxes for the addresses that are no longer to be forced.
3. Reselect the "Online > Force" command.

## **Result**

Forcing of the disabled addresses will be stopped. The red "F" in the first column is no longer displayed. The yellow triangle reappears behind the check box again to indicate that the address is flagged for forcing but is not being forced at the moment.

## **9.5 Using global project functions**

### **9.5.1 Importing and exporting**

#### **9.5.1.1 Basics for importing and exporting**

##### **Introduction**

You can export PLC tag tables to a standardized XLSX format for editing with external table editors. Similarly, you can import PLC tag tables created with external table editors to the TIA Portal.

##### **Overwriting existing PLC tags and constants during import**

Existing entries of the same name will be overwritten during import if they have the same name as the entries that will be imported.

##### **Link to existing objects**

References to PLC tags or constants that already exist in the project are updated automatically during import. The update is executed based on the name of the PLC tags and constants.

##### **See also**

Format of the export file (Page 1549)

Exporting PLC tags (Page 1550)

Importing PLC tags (Page 1551)

#### **9.5.1.2 Format of the export file**

##### **Introduction**

During the export of PLC tag tables, a standardized XSLX format will be generated that you can edit with external table editors.

This format is also expected during the import of tables.

##### **Format of the export file**

The sheet is always named "PLC Tags". This sheet can contain the displayed columns. The sorting order of columns can vary. The sheet does not necessarily have to include all columns. During import, the following values will be identified by a <no value> entry.

The names of the column headers are also clearly defined and are always expected in English.

The following table specifies the contents expected for the individual columns:

Element	Explanation
Name	Name of the tags
Path	Group and name of the PLC tag table
Data Type	The notation of the data type corresponds to the notation used in the PLC tag table.
Logical Address	The address can be specified with German or international mnemonics.
Comment	Free-form comments
Hmi Visible	The value TRUE or FALSE is expected.
Hmi Accessible	The value TRUE or FALSE is expected.

**See also**

Basics for importing and exporting (Page 1549)

Exporting PLC tags (Page 1550)

Importing PLC tags (Page 1551)

**9.5.1.3 Exporting PLC tags**

**Requirement**

A PLC tag table is open.

**Procedure**

To export PLC tags and constants, follow these steps:

1. In the PLC tag table, click the "Export" button.  
The "Export to Excel" dialog opens.
2. Select the path to which you want to save the export file.
3. Select whether to export tags and/or constants.
4. Click the "OK" button.

**Result**

The export file will be generated. Errors and warnings generated during export are indicated in the "Info" tab of the Inspector window.

## See also

Basics for importing and exporting (Page 1549)  
Format of the export file (Page 1549)  
Importing PLC tags (Page 1551)

### 9.5.1.4 Importing PLC tags

#### Requirement

A table exists and it conforms to format specifications.

#### Procedure

To import a PLC tag table, follow these steps:

1. Open the "All tags" table.
2. Click the "Import" button.  
The "Import from Excel" dialog opens.
3. Select whether to import PLC tags and/or constants.
4. Select the table you want to import.
5. Click the "OK" button.

#### Result

The PLC tag table will be imported.

Errors and warnings generated during export are indicated in the "Info" tab of the Inspector window.

## See also

Basics for importing and exporting (Page 1549)  
Format of the export file (Page 1549)  
Exporting PLC tags (Page 1550)

## 9.6 Programming examples

### 9.6.1 LAD programming examples

#### 9.6.1.1 Example of controlling a conveyor belt

##### Controlling a conveyor belt

The following figure shows a conveyor belt that can be activated electrically. There are two pushbutton switches at the beginning of the conveyor belt: S1 for START and S2 for STOP. There are also two pushbutton switches at the end of the conveyor belt: S3 for START and S4 for STOP. It is possible to start and stop the conveyor belt from either end.

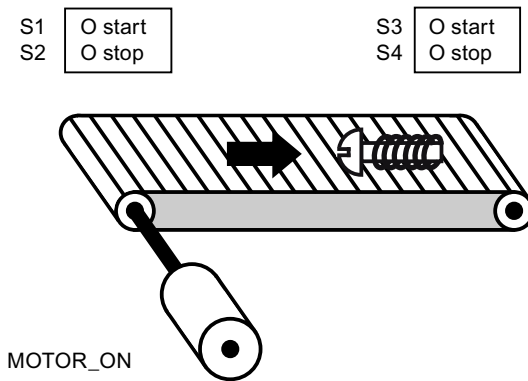

##### Implementation

The following table shows the definition of the tags used:

Name	Data type	Description
StartSwitch_Left (S1)	BOOL	Start switch on the left side of the conveyor belt
StopSwitch_Left (S2)	BOOL	Stop switch on the left side of the conveyor belt
StartSwitch_Right (S3)	BOOL	Start switch on the right side of the conveyor belt
StopSwitch_Right (S4)	BOOL	Stop switch on the right side of the conveyor belt
MOTOR_ON	BOOL	Turn on the conveyor belt motor

The following networks show the LAD programming for solving this task:

Network 1:

The conveyor belt motor is switched on when Start switch "S1" or "S3" is pressed.



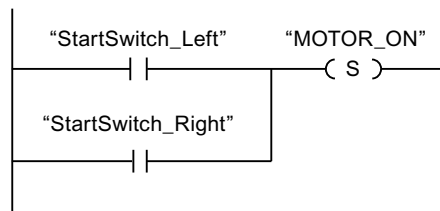

Network 2:

The conveyor belt motor is switched off when Stop switch "S2" or "S4" is pressed.

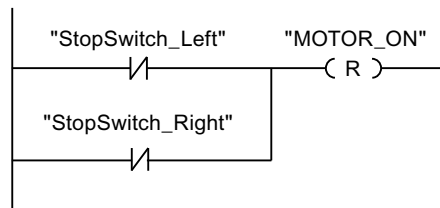

### 9.6.1.2 Example of detecting the direction of a conveyor belt

#### Detecting the direction of a conveyor belt

The following figure shows a conveyor belt that is equipped with two photoelectric barriers (PEB1 and PEB2). The photoelectric barriers are designed to detect the direction in which an object is moving on the conveyor belt.

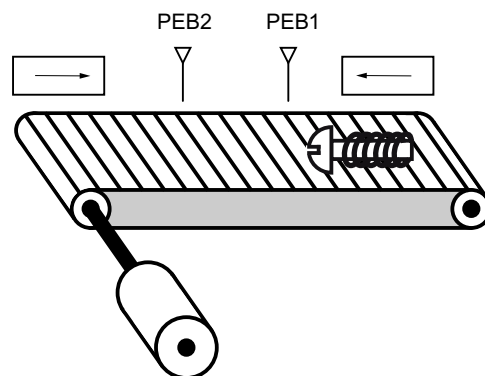

#### Implementation

The following table shows the definition of the tags used:

Name	Data type	Description
PEB1	BOOL	Photoelectric barrier 1
PEB2	BOOL	Photoelectric barrier 2
RIGHT	BOOL	Display during movement to right
LEFT	BOOL	Display during movement to left

Name	Data type	Description
CM1	BOOL	Edge bit memory 1
CM2	BOOL	Edge bit memory 2

The following networks show the LAD programming for solving this task:

Network 1:

If the signal state changes from "0" to "1" (positive edge) at photoelectric barrier "PEB1" and, at the same time, the signal state at "PEB2" is "0", the object on the belt is moving to the left.

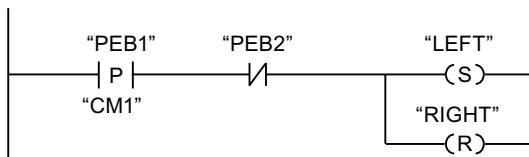

Network 2:

If the signal changes from "0" to "1" (positive edge) at photoelectric barrier "PEB2" and, at the same time, the signal state at "PEB1" is "0", the object on the belt is moving to the right.

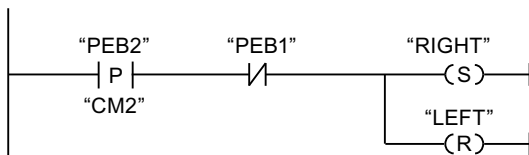

### 9.6.1.3 Example of detecting the fill level of a storage area

#### Detecting the fill level of a storage area

The following figure shows a system with two conveyor belts and a temporary storage area between them. Conveyor belt 1 delivers packages to the storage area. A photoelectric barrier at the end of conveyor belt 1 near the storage area detects how many packages are delivered to the storage area. Conveyor belt 2 transports packages from the temporary storage area to a loading dock onto which the packages are loaded for delivery to customers by truck. A photoelectric barrier at the storage area exit detects how many packages leave the storage area to be transported to the loading dock. Five display lamps indicate the capacity of the temporary storage area.

When a conveyor belt is restarted, the current count value is set to the number of packages available in the storage area.

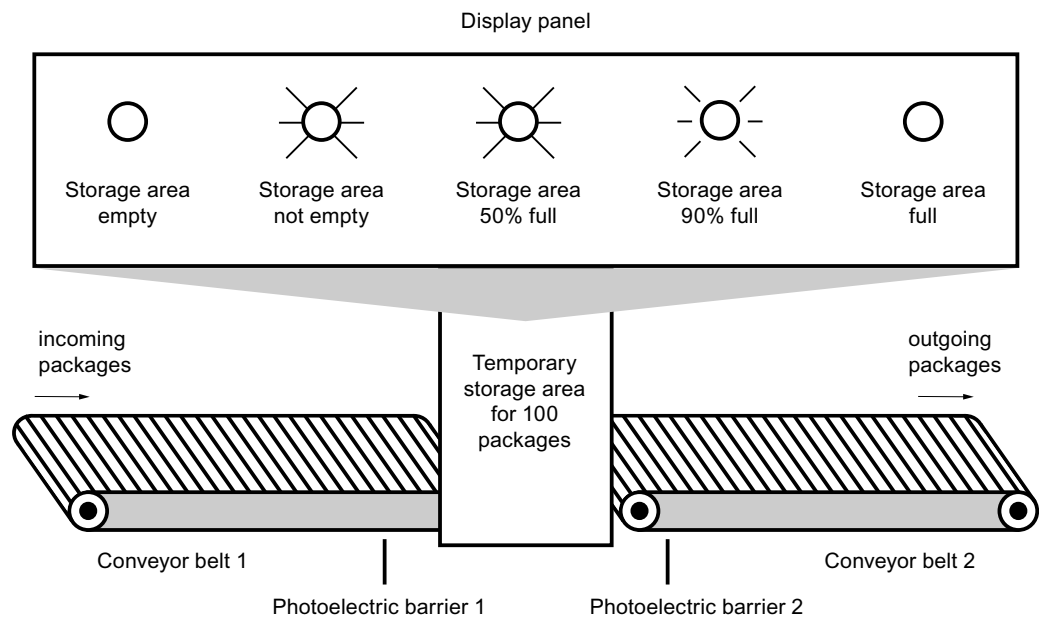

## Implementation

The following table shows the definition of the tags used:

Name	Data type	Description
PEB1	BOOL	Photoelectric barrier 1
PEB2	BOOL	Photoelectric barrier 2
RESET	BOOL	Reset counter
LOAD	BOOL	Set counter to value of "PV" parameter
STOCK	INT	Stock at restart
PACKAGECOUNT	INT	Number of packages in the storage area (current count value)
STOCK_PACKAGES	BOOL	Is set if the current count value is greater than or equal to the value of the tag "STOCK".
STOR_EMPTY	BOOL	Display lamp: Storage area empty
STOR_NOT_EMPTY	BOOL	Display lamp: Storage area not empty
STOR_50%_FULL	BOOL	Display lamp: Storage area 50% full
STOR_90%_FULL	BOOL	Display lamp: Storage area 90% full
STOR_FULL	BOOL	Display lamp: Storage area full
VOLUME_50	INT	Comparison value: 50 packages

Name	Data type	Description
VOLUME_90	INT	Comparison value: 90 packages
VOLUME_100	INT	Comparison value: 100 packages

The following networks show the LAD programming for activating the lamps:

Network 1:

When a package is delivered to the storage area, the signal state at "PEB1" switches from "0" to "1" (positive signal edge). On a positive signal edge at "PEB1", the "Up" counter is enabled, and the current count value of "PACKAGECOUNT" is increased by one.

When a package is delivered from the storage area to the loading dock, the signal state at "PEB2" switches from "0" to "1" (positive signal edge). On a positive signal edge at "PEB2", the "Down" counter is enabled, and the current count value of "PACKAGECOUNT" is decreased by one.

If there are no packages in the storage area ("PACKAGECOUNT" = "0"), the "STOR\_EMPTY" tag is set to signal state "1", and the "Storage area empty" lamp is switched on.

The current count value can be reset to "0" if the "RESET" tag is set to signal state "1".

If the "LOAD" tag is set to signal state "1", the current count value is set to the value of the "STOCK" tag. If the current count value is greater than or equal to the value of the "STOCK" tag, the "STOCK\_PACKAGES" tag supplies the signal state "1".

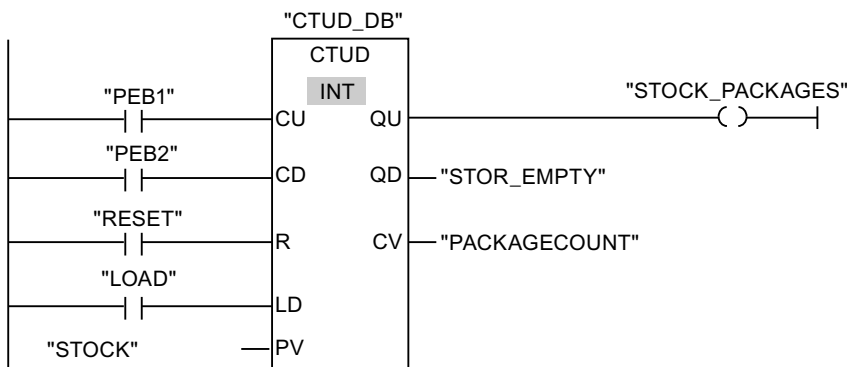

Network 2:

As long as there are packages in the storage area, the "STOR\_NOT\_EMPTY" tag is set to signal state "1", and the "Storage area not empty" lamp is switched on.

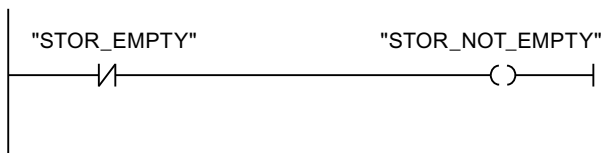

Network 3:

If the number of packages in the storage area is greater than or equal to 50, the lamp for the "Storage area 50% full" message switches on.

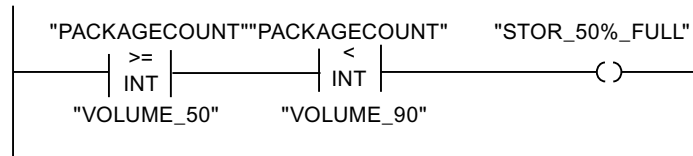

Network 4:

If the number of packages in the storage area is greater than or equal to 90, the "Storage area 90% full" lamp switches on.

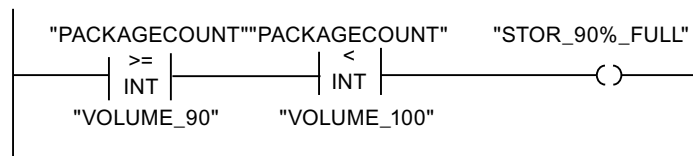

Network 5:

If the number of packages in the storage area reaches 100, the lamp for the "Storage area full" message switches on.

#### 9.6.1.4 Example of controlling room temperature

##### Controlling room temperature

In a cold room, the temperature must be maintained below zero degrees Celsius. Any temperature fluctuations are monitored by a sensor. If the temperature rises above zero degrees Celsius, the cooling system switches on for a preset time. The "Cooling system On" lamp is lit during this time.

The cooling system and the lamp are turned off if one of the following conditions is met:

- The sensor reports a temperature fall below zero degrees Celsius.
- The preset cooling time has elapsed.
- The pushbutton switch "STOP" has been pressed.

If the preset cooling time has expired and the temperature in the cold room is still too high, the cooling system can be restarted by means of the pushbutton switch "RESET".

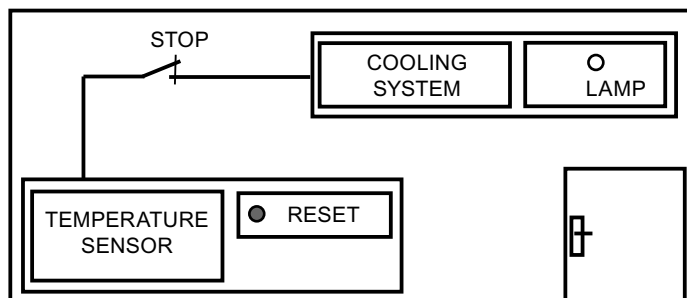

Implementation

The following table shows the definition of the tags used:

Name	Data type	Comment
Sensor	BOOL	Temperature sensor signal
RESET	BOOL	Restart
STOP	BOOL	The cooling system is switched off.
MaxCoolTime	TIME	Preset cooling time This tag is defined in the "DB_Cool" data block.
CurrCoolTime	TIME	Currently elapsed cooling time This tag is defined in the "DB_Cool" data block.
Cooling system	BOOL	The cooling system is switched on.
Lamp	BOOL	The lamp for the "Cooling system on" message is switched on.
TempVariable	BOOL	Temporary tag This tag stores the signal state of the IEC time TP.

The following network shows the LAD programming for controlling room temperature:

Network 1:

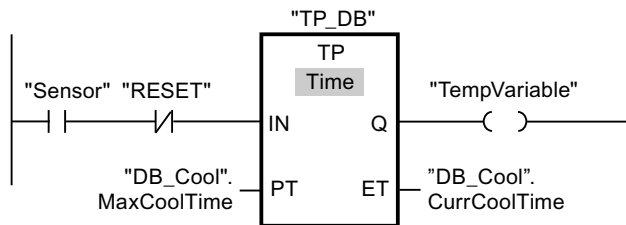

Network 2:

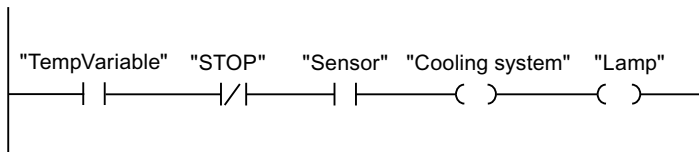

When the temperature in the cold room rises above zero degrees Celsius, the signal state at the "Sensor" operand switches from "0" to "1" (positive signal edge). In the case of a positive signal edge at the input IN of the time function, the preset cooling time is started and the "TempVariable" receives the signal state "1". The signal state "1" of the "TempVariable" has the result in network 2 that the cooling system as well as the display lamp are turned on. The outputs "Sensor", "Cooling system" and "Lamp" must be programmed in network 2, because you can program only one coil at output Q of the time function.

If the temperature in the cold room falls below zero degrees Celsius, the signal state of the sensor switches back to "0". This switches the cooling system and lamp off.

If the sensor does not signal a temperature drop, the cooling system and lamp are switched off after the preset cooling time has elapsed, at the latest. In this case, the cooling process can be restarted by pressing the "RESET" pushbutton switch. Pressing and releasing the pushbutton switch generates a new positive signal edge at input IN, which restarts the cooling system.

Using the pushbutton switch "STOP", the cooling system and the display lamp can be turned off at any time.

## 9.6.2 FBD programming examples

### 9.6.2.1 Example of controlling a conveyor belt

#### Controlling a conveyor belt

The following figure shows a conveyor belt that can be activated electrically. There are two pushbutton switches at the beginning of the conveyor belt: S1 for START and S2 for STOP. There are also two pushbutton switches at the end of the conveyor belt: S3 for START and S4 for STOP. It is possible to start and stop the conveyor belt from either end.

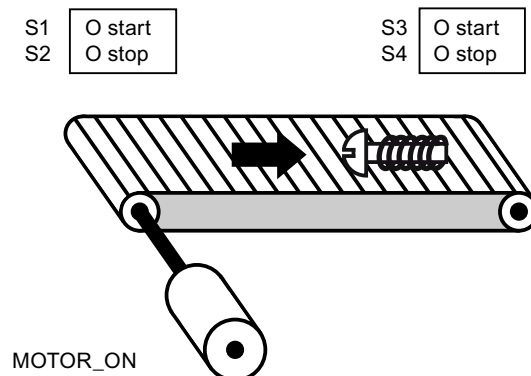

#### Implementation

The following table shows the definition of the tags used:

Name	Data type	Description
StartSwitch_Left (S1)	BOOL	Start switch on the left side of the conveyor belt
StopSwitch_Left (S2)	BOOL	Stop switch on the left side of the conveyor belt
StartSwitch_Right (S3)	BOOL	Start switch on the right side of the conveyor belt

Name	Data type	Description
StopSwitch_Right (S4)	BOOL	Stop switch on the right side of the conveyor belt
MOTOR_ON	BOOL	Turn on the conveyor belt motor

The following networks show the FBD programming for solving this task:

Network 1:

The conveyor belt motor is switched on when Start switch "S1" or "S3" is pressed.

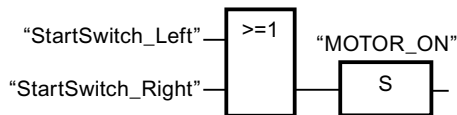

Network 2:

The conveyor belt motor is switched off when stop switch "S2" or "S4" is pressed.

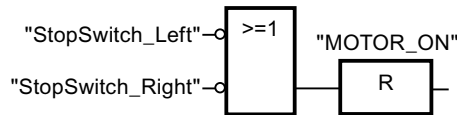

### 9.6.2.2 Example of detecting the direction of a conveyor belt

#### Detecting the direction of a conveyor belt

The following figure shows a conveyor belt that is equipped with two photoelectric barriers (PEB1 and PEB2). The photoelectric barriers are designed to detect the direction in which an object is moving on the conveyor belt.

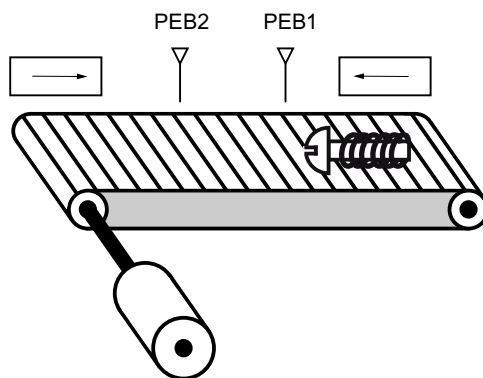



## Implementation

The following table shows the definition of the tags used:

Name	Data type	Description
PEB1	BOOL	Photoelectric barrier 1
PEB2	BOOL	Photoelectric barrier 2
RIGHT	BOOL	Display during movement to right
LEFT	BOOL	Display during movement to left
CM1	BOOL	Edge bit memory 1
CM2	BOOL	Edge bit memory 2

The following networks show the FBD programming for solving this task:

Network 1:

If the signal state changes from "0" to "1" (positive edge) at photoelectric barrier "PEB1" and, at the same time, the signal state at "PEB2" is "0", the object on the belt is moving to the left.

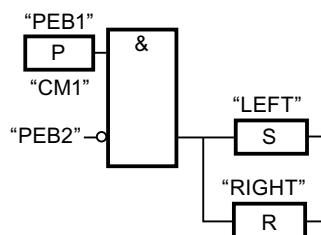

Network 2:

If the signal changes from "0" to "1" (positive edge) at photoelectric barrier "PEB2" and, at the same time, the signal state at "PEB1" is "0", the object on the belt is moving to the right.

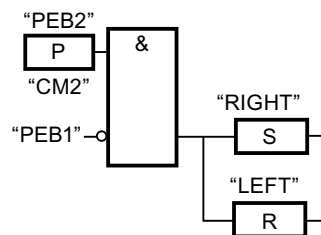

### 9.6.2.3 Example of detecting the fill level of a storage area

#### Detecting the fill level of a storage area

The following figure shows a system with two conveyor belts and a temporary storage area between them. Conveyor belt 1 delivers packages to the storage area. A photoelectric barrier at the end of conveyor belt 1 near the storage area detects how many packages are delivered to the storage area. Conveyor belt 2 transports packages from the temporary storage area to a loading dock onto which the packages are loaded for delivery to customers by truck. A photoelectric barrier at the storage area exit detects how many packages leave the storage

area to be transported to the loading dock. Five display lamps indicate the capacity of the temporary storage area.

When a conveyor belt is restarted, the current count value is set to the number of packages available in the storage area.

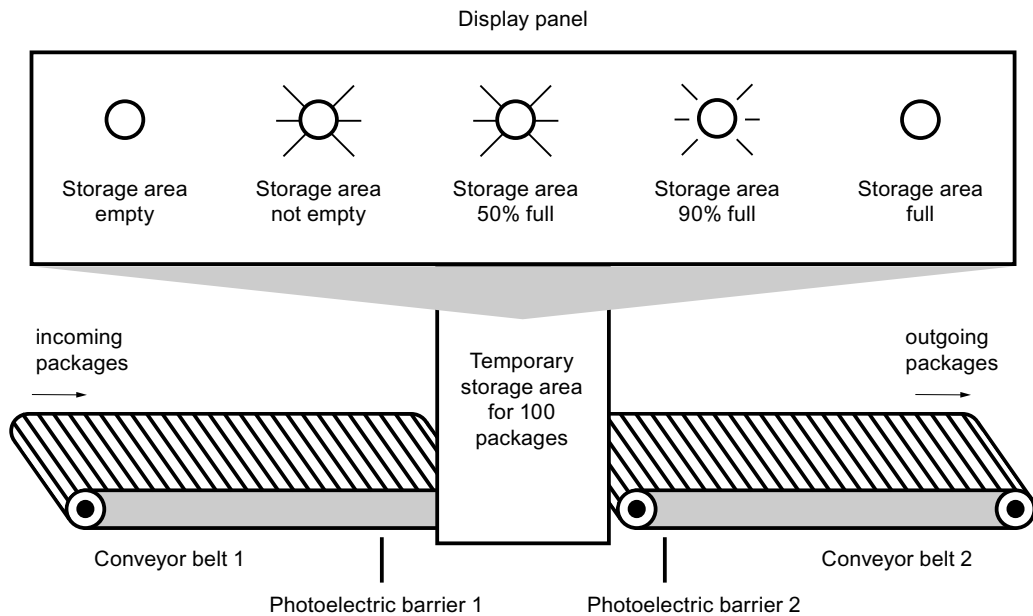

### Implementation

The following table shows the definition of the tags used:

Name	Data type	Description
PEB1	BOOL	Photoelectric barrier 1
PEB2	BOOL	Photoelectric barrier 2
RESET	BOOL	Reset counter
LOAD	BOOL	Set counter to value of "CV" parameter
STOCK	INT	Stock at restart
PACKAGECOUNT	INT	Number of packages in the storage area (current count value)
STOCK_PACKAGES	BOOL	Is set if the current count value is greater than or equal to the value of the tag "STOCK".
STOR_EMPTY	BOOL	Display lamp: Storage area empty
STOR_NOT_EMPTY	BOOL	Display lamp: Storage area not empty
STOR_50%_FULL	BOOL	Display lamp: Storage area 50% full

Name	Data type	Description
STOR_90%_FULL	BOOL	Display lamp: Storage area 90% full
STOR_FULL	BOOL	Display lamp: Storage area full
VOLUME_50	INT	Comparison value: 50 packages
VOLUME_90	INT	Comparison value: 90 packages
VOLUME_100	INT	Comparison value: 100 packages

The following networks show the FBD programming for activating the lamps:

Network 1:

When a package is delivered to the storage area, the signal state at "PEB1" switches from "0" to "1" (positive signal edge). On a positive signal edge at "PEB1", the "Up" counter is enabled, and the current count value of "PACKAGECOUNT" is increased by one.

When a package is delivered from the storage area to the loading dock, the signal state at "PEB2" switches from "0" to "1" (positive signal edge). On a positive signal edge at "PEB2", the "Down" counter is enabled, and the current count value of "PACKAGECOUNT" is decreased by one.

If there are no packages in the storage area ("PACKAGECOUNT" = "0"), the "STOR\_EMPTY" tag is set to signal state "1", and the "Storage area empty" lamp is switched on.

The current count value can be reset to "0" if the "RESET" tag is set to signal state "1".

If the "LOAD" tag is set to signal state "1", the current count value is set to the value of the "STOCK" tag. If the current count value is greater than or equal to the value of the "STOCK" tag, the "STOCK\_PACKAGES" tag supplies the signal state "1".

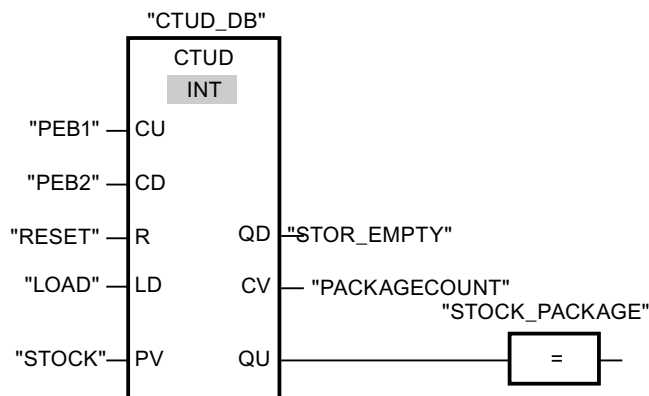

Network 2:

As long as there are packages in the storage area, the "STOR\_NOT\_EMPTY" tag is set to signal state "1", and the "Storage area not empty" lamp is switched on.

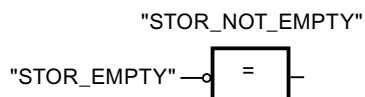

Network 3:

If the number of packages in the storage area is greater than or equal to 50, the lamp for the "Storage area 50% full" message switches on.

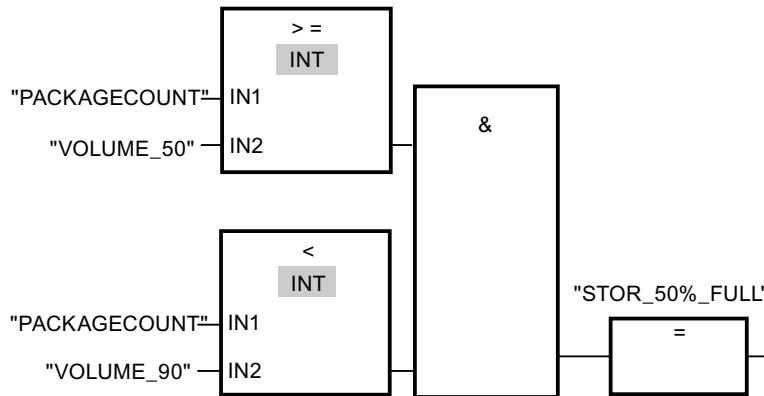

Network 4:

If the number of packages in the storage area is greater than or equal to 90, the "Storage area 90% full" lamp switches on.

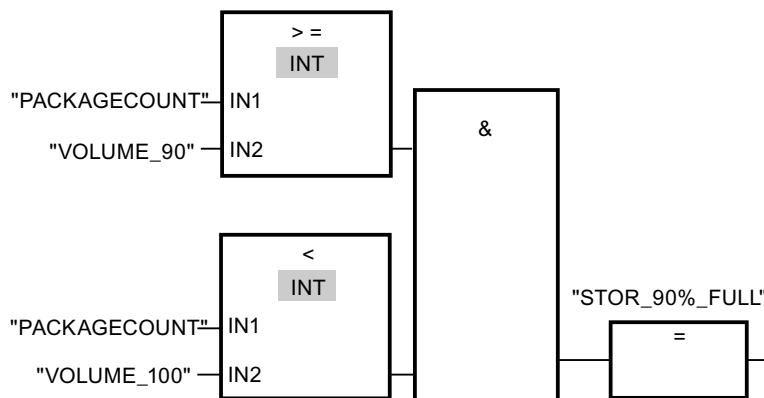

Network 5:

If the number of packages in the storage area reaches 100, the lamp for the "Storage area full" message switches on.

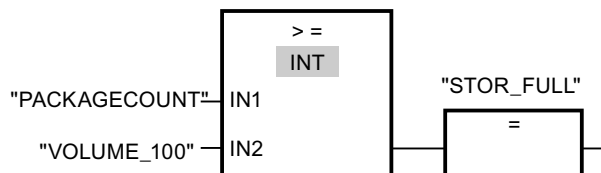

### 9.6.2.4 Example of controlling room temperature

#### Controlling room temperature

In a cold room, the temperature must be maintained below zero degrees Celsius. Any temperature fluctuations are monitored by a sensor. If the temperature rises above zero

degrees Celsius, the cooling system switches on for a preset time. The "Cooling system on" lamp is lit during this time.

The cooling system and the lamp are turned off if one of the following conditions is met:

- The sensor reports a temperature fall below zero degrees Celsius.
- The preset cooling time has elapsed.
- The pushbutton switch "Stop" has been pressed.

If the preset cooling time has expired and the temperature in the cold room is still too high, the cooling system can be restarted by means of the pushbutton switch "RESET".

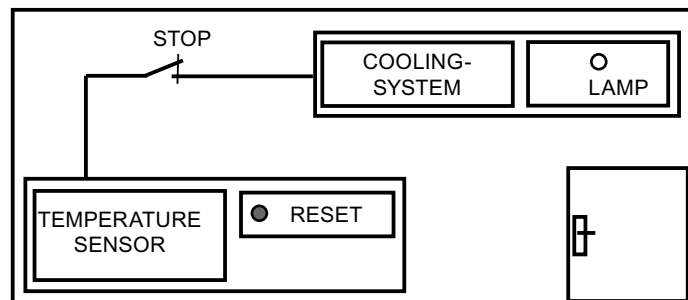

## Implementation

The following table shows the definition of the tags used:

Name	Data type	Comment
Sensor	BOOL	Temperature sensor signal
RESET	BOOL	Restart
STOP	BOOL	The cooling system is switched off.
MaxCoolTime	TIME	Preset cooling time This tag is defined in the "DB_Cool" data block.
CurrCoolTime	TIME	Currently elapsed cooling time This tag is defined in the "DB_Cool" data block.
Cooling system	BOOL	The cooling system is switched on.
Lamp	BOOL	The lamp for the "Cooling system on" message is switched on.
TempVariable	BOOL	Temporary tag This tag stores the signal state of the IEC time TP.

The following network shows the FBD programming for controlling room temperature:

Network 1:

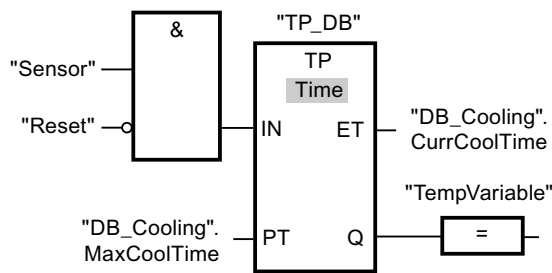

Network 2:

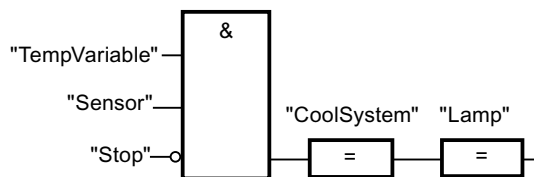

When the temperature in the cold room rises above zero degrees Celsius, the signal state at the "Sensor" operand switches from "0" to "1" (positive signal edge). In the case of a positive signal edge at the input IN of the time function, the preset cooling time is started and the "TempVariable" receives the signal state "1". The signal state "1" of the "TempVariable" has the result in network 2 that the cooling system as well as the display lamp are turned on. The outputs "Sensor", "Cooling system" and "Lamp" must be programmed in network 2, because you can program only one coil at output Q of the time function.

If the temperature in the cold room falls below zero degrees Celsius, the signal state of the sensor switches back to "0". This switches the cooling system and lamp off.

If the sensor does not signal a temperature drop, the cooling system and lamp are switched off after the preset cooling time has elapsed, at the latest. In this case, the cooling process can be restarted by pressing the pushbutton switch "RESET". Pressing and releasing the pushbutton switch generates a new positive signal edge at input IN, which restarts the cooling system.

Using the pushbutton switch "STOP", the cooling system and the display lamp can be turned off at any time.

### 9.6.3 STL programming examples

#### 9.6.3.1 Example: Bit logic instructions

##### Controlling a conveyor belt

The following figure shows a conveyor belt that can be activated electrically. There are two pushbutton switches at the beginning of the conveyor belt: S1 for START and S2 for STOP.

There are also two pushbutton switches at the end of the conveyor belt: S3 for START and S4 for STOP. It is possible to start and stop the conveyor belt from either end.

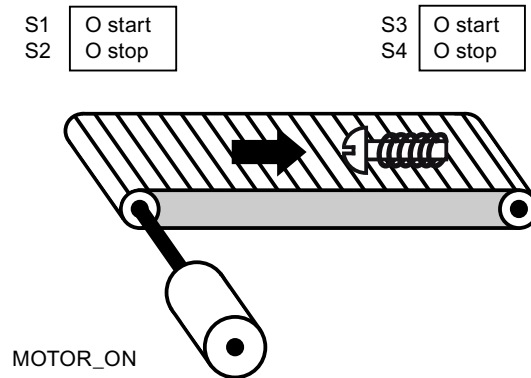

### Implementation

The following table shows the definition of the tags used:

Operand	Declaration	Data type	Description
StartSwitch_Left (S1)	Input	BOOL	Start switch on the left side of the conveyor belt
StopSwitch_Left (S2)	Input	BOOL	Stop switch on the left side of the conveyor belt
StartSwitch_Right (S3)	Input	BOOL	Start switch on the right side of the conveyor belt
StopSwitch_Right (S4)	Input	BOOL	Stop switch on the right side of the conveyor belt
MOTOR_ON/OFF	Output	BOOL	Switching the conveyor belt motor on/off

The following STL program shows how to implement this task:

STL	Explanation
O #S1	// Scan start switch S1 for "1".
O #S3	// Scan start switch S3 for "1".
S #"MOTOR_ON/OFF"	// If one of the start switches (S1 or S3) returns the signal state "1", the conveyor belt motor will be turned on.
O #S2	// Scan stop switch S2 for "1".
O #S4	// Scan stop switch S4 for "1".
R #"MOTOR_ON/OFF"	// If one of the stop switches (S2 or S4) returns the signal state "1", the conveyor belt motor will be turned off.

### 9.6.3.2 Example of detecting the direction of a conveyor belt

#### Detecting the direction of a conveyor belt

The following figure shows a conveyor belt that is equipped with two photoelectric barriers (PEB1 and PEB2). The photoelectric barriers are designed to detect the direction in which an object is moving on the conveyor belt.

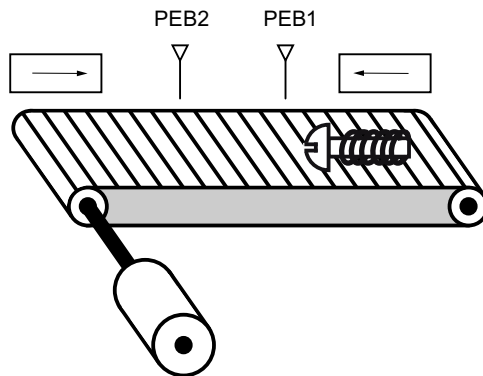

#### Implementation

The following table shows the definition of the tags used:

Name	Declaration	Data type	Description
S1	Input	BOOL	Photoelectric barrier 1
S2	Input	BOOL	Photoelectric barrier 2
TM1	Input	BOOL	Edge bit memory 1
TM2	Input	BOOL	Edge bit memory 2
RIGHT	Output	BOOL	Display for movement to the right
LEFT	Output	BOOL	Display for movement to the left

The following STL program shows how to implement this example:

STL	Explanation
A #S1	// Scan photoelectric barrier "S1" for "1"
FP #TM1	// Query positive edge
AN #S2	// Scan photoelectric barrier "S2" for "0"
S #LEFT	//If the signal state changes from "0" to "1" (positive edge) at the photoelectric barrier "S1" and, at the same time, the signal state at the photoelectric barrier "S2" is "0", the object on the belt is moving to the left.  // The display for movement to the left is activated.
A #S2	// Scan photoelectric barrier "S2" for "1"
FP #TM2	// Query positive edge



STL	Explanation
AN #S1	// Scan photoelectric barrier "S1" for "0"
S #RIGHT	//If the signal state changes from "0" to "1" (positive edge) at photoelectric barrier "S2" and, at the same time, the signal state at photoelectric barrier "S1" is "0", the object on the belt is moving to the right.  // The display for movement to the right is activated.
AN #S1	// Scan photoelectric barrier "S1" for "0"
AN #S2	// Scan photoelectric barrier "S2" for "0"
R #LEFT	// The display for movement to the left will be turned off when the signal state at both photoelectric barriers is "0".
R #RIGHT	// The display for movement to the right will be turned off when the signal state at both photoelectric barriers is "0".

### 9.6.3.3 Example of detecting the fill level of a storage area

#### Detecting the fill level of a storage area

The following figure shows a system with two conveyor belts and a temporary storage area between them. Conveyor belt 1 delivers packages to the storage area. A photoelectric barrier at the end of conveyor belt 1 near the storage area detects how many packages are delivered to the storage area. Conveyor belt 2 transports packages from the temporary storage area to a loading dock onto which the packages are loaded for delivery to customers by truck. A photoelectric barrier at the storage area exit detects how many packages leave the storage area to be transported to the loading dock. Five display lamps indicate the capacity of the temporary storage area.

When a conveyor belt is restarted, the current count value is set to the number of packages available in the storage area.

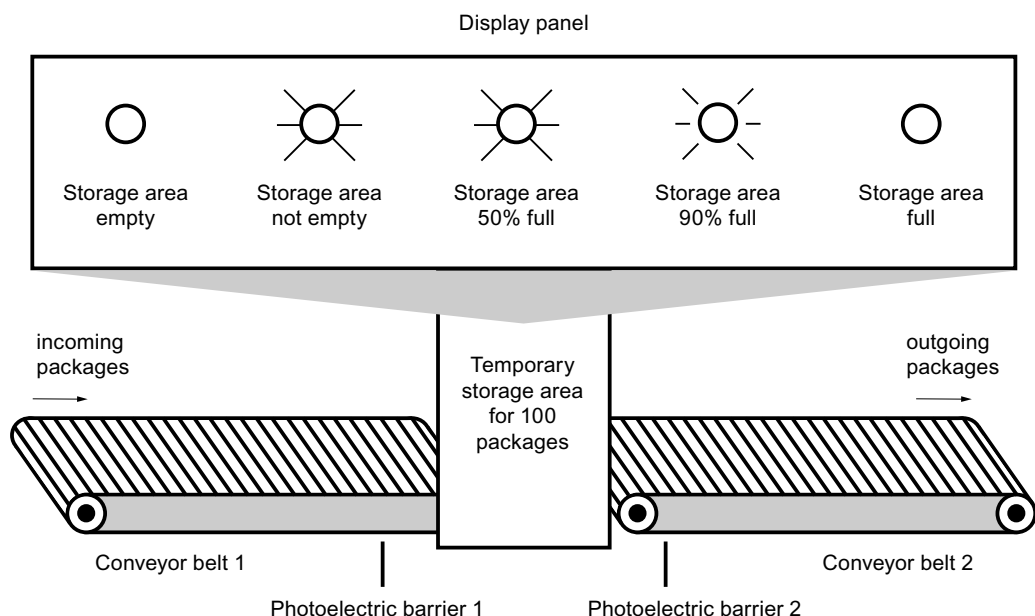

Implementation

The following table shows the definition of the tags used:

Name	Data type	Address	Description
PACKAGECOUNT	COUNTER	C1	Number of packages in the storage area (current count value)

Name	Section	Data type	Description
LS1	Input	BOOL	Photoelectric barrier 1
LS2	Input	BOOL	Photoelectric barrier 2
STOR_EMPTY	Output	BOOL	Display lamp: Storage area empty
STOR_NOT_EMPTY	Output	BOOL	Display lamp: Storage area not empty
STOR_50%_FULL	Output	BOOL	Display lamp: Storage area 50% full
STOR_90%_FULL	Output	BOOL	Display lamp: Storage area 90% full
STOR_FULL	Output	BOOL	Display lamp: Storage area full

The following STL program shows how to implement this example:

STL	Explanation
A #LS1	// Scan photoelectric barrier "LS1" for "1".
CU "PACKAGECOUNT"	// At a positive edge at photoelectric barrier "LS1", the count value of counter "PACKAGECOUNT" is increased by one.
A #LS2	// Scan photoelectric barrier "LS2" for "1".
CD "PACKAGECOUNT"	// At a positive edge at photoelectric barrier "LS2", the count value of counter "PACKAGECOUNT" is decreased by one.
AN "PACKAGECOUNT"	// Scan count value for "0".
= #STOR_EMPTY	// With a count value of "0" the display lamp "storage area empty" is switched on.
A "PACKAGECOUNT"	// Scan count value for "1".
= #STOR_NOT_EMPTY	// With a count value greater than "0" the display lamp "Storage area not empty" is switched on.
L 50	// Load the comparison value "50" to accumulator 1.
L "PACKAGECOUNT"	// Move the comparison value to accumulator 2.
	// Load the current count value to accumulator 1.
<=I	// Compare values
= #"STOR_50%_FULL"	// With a count value greater than or equal to "50" the display lamp "Storage area 50% full" is switched on.
L 90	// Move the counter value to accumulator 2.
	// Load the comparison value "90" to accumulator 1.
>=I	// Compare values

STL	Explanation
= #"STOR_90%_FULL"	// With a count value greater than or equal to "90" the display lamp "Storage area 90% full" is switched on.
L "PACKAGECOUNT"	// Load the current count value to accumulator 1.
L 100	// Move the counter value to accumulator 2.
	// Load the comparison value "100" to accumulator 1.
>=I	// Compare values
= #STOR_FULL	// At a count value greater than "100" the display lamp "Storage area full" is switched on.

### 9.6.3.4 Example of calculating an equation

#### Calculating an equation

The sample program shows you how to use three math instructions to calculate the following equation:

$$\text{RESULT} = ((A + B) \times C) / D$$

#### Implementation

The following table shows the declaration of the operands used in the PLC tag table:

Name	Data type	Comment
A	INT	First value for addition
B	INT	Second value for addition
C	INT	Multiplier
D	INT	Divisor
RESULT	INT	End result

The following STL program shows how to implement this example:

STL	Explanation
L "A"	// Load value of the operand "A" to accumulator 1
L "B"	// Load value of operand "A" to accumulator 2
	// Load value of the operand "B" to accumulator 1
+I	// Add the values of accumulator 1 and 2
	// Store sum in accumulator 1
L "C"	// Move the sum to accumulator 2
	// Load value of the operand "C" to accumulator 1
*I	// Multiply the values of accumulator 1 and 2
	// Store product in accumulator 1
L "D"	// Move the product to accumulator 2
	// Load value of the operand "D" to accumulator 1
/I	// Divide the value of accumulator 2 by the value of accumulator 1

STL	Explanation
	// Store result in accumulator 1
T "RESULT"	// Transfer the result to operand "RESULT"

9.6.3.5 Example: Word logic instructions

Heating an oven

The following illustration shows an oven that is turned on with a start switch. The heating process is started when the start switch is pressed. The heating period is set with digital thumbwheels. The heating period is set in seconds using the BCD format.

Digital thumbwheels for setting the heating period

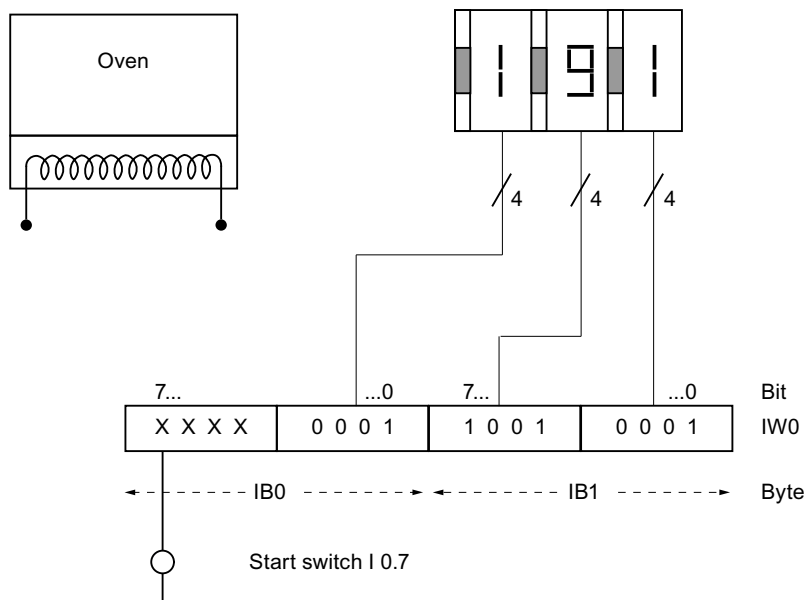

## Implementation

The following table shows the declaration of the operands used in the PLC tag table:

Name	Data type	Address	Comment
DURATION	WORD	EW0	Heating period in seconds <ul style="list-style-type: none"> <li>• I1.0 to I1.3: Thumbwheels for ones</li> <li>• I1.4 to I1.7: Thumbwheels for tens</li> <li>• I0.0 to I0.3: Thumbwheels for hundreds</li> </ul>
HEATING	TIMER	T1	Time that is started with the preset heating period.

The following table shows the declaration of the operands used in the block interface of the code block:

Name	Section	Data type	Comment
START	Input	BOOL	Start switch
START_HEATING	Output	BOOL	Start of the heating process

The following STL program shows how to implement this example:

STL	Explanation
A "HEATING"	// Scan to see if time has started
= #START_HEATING	// Start the heating process
BEC	// For RLO=1 End processing of block
	// This prevents the "HEATING" time from being restarted if the button is pressed
L "DURATION"	// Load the heating period in accumulator 1
AW W#16#0FFF	// Reset input bits I0.4 to I0.7 to "0"
OW W#16#4000	// Set seconds in bits I1.2 and I1.3 of accumulator 1
A #START	// Scan start switch for "1"
SE "HEATING"	// Start heating process as an extended pulse with a positive edge at the start switch

### 9.6.3.6 Example of a step sequence

#### Programming a step sequence

The following figure shows a station for removing glass containers from a pallet. The pallets are transported on a conveyor belt to the station. When a pallet with glass containers reaches the station, the conveyor belt will be stopped and a gripper moves from its basic position (P0) to the position above the pallet (P2). Once the gripper is above the pallet, the gripping clamps will open and the gripper lowered. Sensors detect the actual position of the gripper and the status of the gripping clamps. The sequence of the gripper movement in this example is implemented by a step sequence. You can program the additional steps required for removing the bottles and transporting them on an additional conveyor belt.

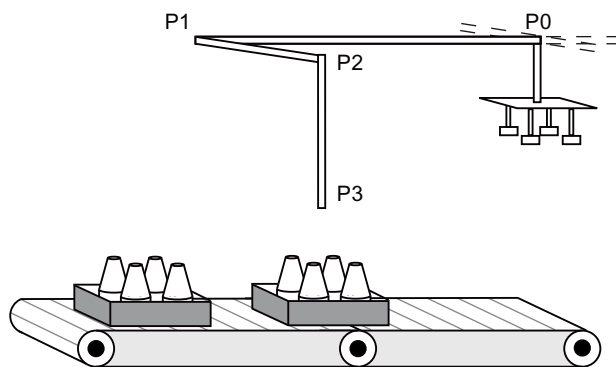

#### Implementation

The following table shows the declaration of the operands used in the PLC tag table:

Name	Data type	Comment
NUMBER	INT	Step number
Tag_Error	BOOL	Operand that is set when the step number is greater than 3 or if one of the steps was not executed.

The following table shows the declaration of the operands used in the block interface of the code block:

Name	Section	Data type	Comment
POS_0	Input	BOOL	Gripper in basic position (P0)
POS_1	Input	BOOL	Gripper in position 1 (P1)
POS_2	Input	BOOL	Gripper in position 2 (P2)
GRIPPER_OPEN	Input	BOOL	Gripping clamps open
OUT_POS_1	Output	BOOL	Move gripper to position 1

Name	Section	Data type	Comment
OUT_POS_2	Output	BOOL	Move gripper to position 2
OUT_GRIPPER	Output	BOOL	Open gripping clamps
OUT_POS_3	Output	BOOL	Move gripper to position 3

The following STL program shows how to implement this example:

STL	Explanation
L "NUMBER"	// Load the step number to accumulator 1.
JL END	// Start of the jump list
JU POSITION_0	// At a value of "0" in the accumulator 1 jump to jump label "POSITION_0".
JU POSITION_1	// At a value of "1" in the accumulator 1 jump to jump label "POSITION_1".
JU POSITION_2	// At a value of "2" in the accumulator 1 jump to jump label "POSITION_2".
JU POSITION_3	// At a value of "3" in the accumulator 1 jump to jump label "POSITION_3".
END: JU ERROR	// End of the jump list
	// At a step number greater than 3 jump to jump label "ERROR".
POSITION_0: A #POS_0	// Jump label "POSITION_0"
	// Scan to see if gripper is in basic position (P0).
= #OUT_POS_1	// If condition is met, set output "OUT_POS_1" and move gripper to position 1 (P1).
JCN ERROR	// With RLO "0" jump to jump label "ERROR".
JC NEXT	// With RLO "1" jump to jump label "NEXT".
POSITION_1: A #POS_1	// Jump label "POSITION_1"
	// Scan to see if gripper is in position 1 (P1).
= #OUT_POS_2	// If condition is met, set output "OUT_POS_2" and move gripper to position 2 (P2).
JCN ERROR	// With RLO "0" jump to jump label "ERROR".
JC NEXT	// With RLO "1" jump to jump label "NEXT".
POSITION_2: A #POS_2	// Jump label "POSITION_2"
	// Scan to see if gripper is in position 2 (P2).
= #OUT_GRIPPER	// If condition is met, set output "OUT_GRIPPER" and open gripping clamps.
JCN ERROR	// With RLO "0" jump to jump label "ERROR".
JC NEXT	// With RLO "1" jump to jump label "NEXT".
POSITION_3: A #POS_2	// Jump label "POSITION_3"
	// Scan to see if gripper is in position 2 (P2).
A #GRIPPER_OPEN	// Scan to see if the gripping clamps are open
= #OUT_POS_3	// If condition is met, set output "OUT_POS_3" and move gripper to position 3 (P3).
JCN ERROR	// With RLO "0" jump to jump label "ERROR".
JC NEXT	// With RLO "1" jump to jump label "NEXT".

STL	Explanation
NEXT: INC 1	// Jump label "NEXT" // Increase step number in accumulator 1 by one.
T "NUMBER"	// Transfer step number to operand "NUMBER".
L 3	// Move the current step number to accumulator 2. // Load value 3 to accumulator 1.
>I	// Scan to see if current step number is greater than 3.
JC RESET_NUMBER	// With a scan result "1" jump to jump label "RESET_NUMBER" and continue with program processing
BEU	// End block
RESET_NUMBER: L 0	// Jump label "RESET_NUMBER" // Load value "0" in accumulator 1.
T "NUMBER"	// Assign value "0" to operands "NUMBER" (step number).
BEU	// End block
ERROR: NOT	// Jump label "ERROR"
= "Tag_Error"	// Assign negated RLO to the operand "Tag_Error".
BEU	// End block

### 9.6.4 SCL programming examples

#### 9.6.4.1 Example: Bit logic instructions

##### Controlling a conveyor belt

The following figure shows a conveyor belt that can be activated electrically. There are two pushbutton switches at the beginning of the conveyor belt: S1 for START and S2 for STOP. There are also two pushbutton switches at the end of the conveyor belt: S3 for START and S4 for STOP. It is possible to start and stop the conveyor belt from either end.

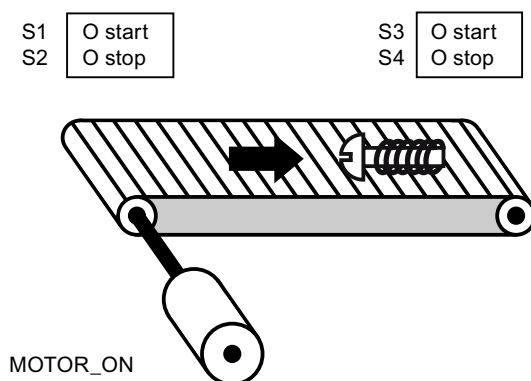



## Implementation

The following table shows the definition of the tags used:

Operand	Declaration	Data type	Description
StartSwitch_Left (S1)	Input	BOOL	Start switch on the left side of the conveyor belt
StopSwitch_Left (S2)	Input	BOOL	Stop switch on the left side of the conveyor belt
StartSwitch_Right (S3)	Input	BOOL	Start switch on the right side of the conveyor belt
StopSwitch_Right (S4)	Input	BOOL	Stop switch on the right side of the conveyor belt
MOTOR_ON	Output	BOOL	Turn on the conveyor belt motor
MOTOR_OFF	Output	BOOL	Turn off the conveyor belt motor

The following SCL program shows how to implement this task:

```
SCL
IF "StartSwitch_Left" OR "StartSwitch_Right" = 1 THEN 1 := "MOTOR_ON";
IF "StopSwitch_Left" OR "StopSwitch_Right" = 1 THEN 1 := "MOTOR_OFF";
```

The conveyor belt motor is switched on when start switch "StartSwitch\_Left" or "StartSwitch\_Right" is pressed. The conveyor belt motor is switched off when stop switch "StopSwitch\_Left" or "StopSwitch\_Right" is pressed.

## See also

Logical expressions (Page 1346)

### 9.6.4.2 Example of detecting the direction of a conveyor belt

#### Detecting the direction of a conveyor belt

The following figure shows a conveyor belt that is equipped with two photoelectric barriers (PEB1 and PEB2). The photoelectric barriers are designed to detect the direction in which an object is moving on the conveyor belt.

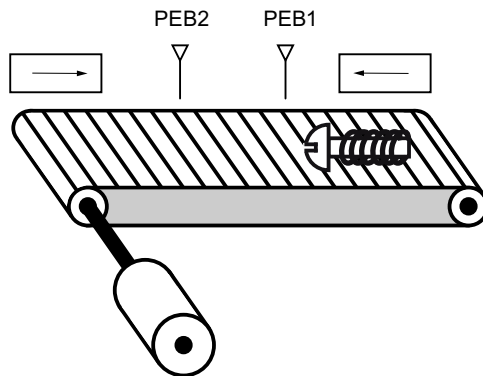

#### Implementation

The following table shows the definition of the tags used:

Name	Declaration	Data type	Description
LS1	Input	BOOL	Photoelectric barrier 1
LS2	Input	BOOL	Photoelectric barrier 2
RIGHT	Output	BOOL	Display for movement to the right
LEFT	Output	BOOL	Display for movement to the left

The following SCL program shows how to implement this example:

```

SCL
IF "LS1" = 1 AND NOT "LS2" = 0 THEN 1 := "LEFT";
IF "LS2" = 1 AND NOT "LS1" = 0 THEN 1 := "RIGHT";
IF "LS2" = 0 THEN 0 := "RIGHT";
IF "LS1" = 0 THEN 0 := "LEFT";
    
```

If the photoelectric barrier "PEB1" has signal state "1" and the photoelectric barrier "PEB2" has signal state "0" at the same time, the object on the belt is moving to the left. If the photoelectric barrier "PEB2" has signal state "1" and the photoelectric barrier "PEB1" has signal state "0" at the same time, the object on the belt is moving to the right. The displays for a movement to the left or right will be turned off when the signal state at both photoelectric barriers is "0".

**See also**

Logical expressions (Page 1346)

**9.6.4.3 Example of detecting the fill level of a storage area**

**Detecting the fill level of a storage area**

The following figure shows a system with two conveyor belts and a temporary storage area between them. Conveyor belt 1 delivers packages to the storage area. A photoelectric barrier at the end of conveyor belt 1 near the storage area detects how many packages are delivered to the storage area. Conveyor belt 2 transports packages from the temporary storage area to a loading dock onto which the packages are loaded for delivery to customers by truck. A photoelectric barrier at the storage area exit detects how many packages leave the storage area to be transported to the loading dock. Five display lamps indicate the capacity of the temporary storage area.

When a conveyor belt is restarted, the current count value is set to the number of packages available in the storage area.

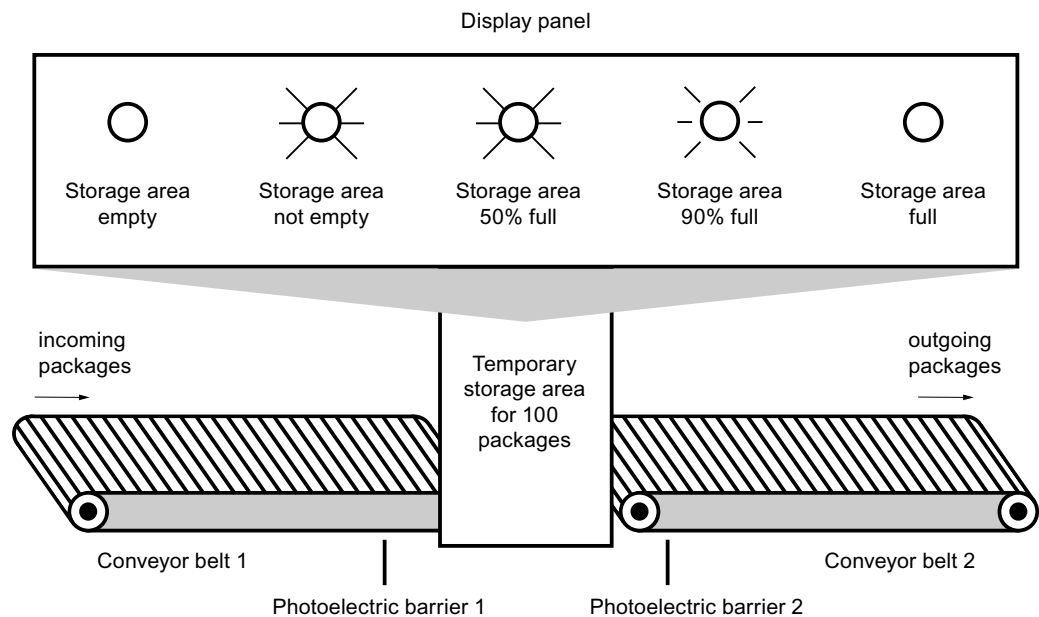

**Implementation**

The following table shows the definition of the tags used:

Name	Declaration	Data type	Description
PEB1	Input	BOOL	Photoelectric barrier 1
PEB2	Input	BOOL	Photoelectric barrier 2
RESET	Input	BOOL	Reset counter

Name	Declaration	Data type	Description
LOAD	Input	BOOL	Set counter to value of "CV" parameter
STOCK	Input	INT	Stock at restart
PACKAGECOUNT	Output	INT	Number of packages in the storage area (current count value)
STOCK_PACKAGES	Output	BOOL	Is set if the current count value is greater than or equal to the value of the tag "STOCK".
STOR_EMPTY	Output	BOOL	Display lamp: Storage area empty
STOR_NOT_EMPTY	Output	BOOL	Display lamp: Storage area not empty
STOR_50%_FULL	Output	BOOL	Display lamp: Storage area 50% full
STOR_90%_FULL	Output	BOOL	Display lamp: Storage area 90% full
STOR_FULL	Output	BOOL	Display lamp: Storage area full
VOLUME_50	Input	INT	Comparison value: 50 packages
VOLUME_90	Input	INT	Comparison value: 90 packages
VOLUME_100	Input	INT	Comparison value: 100 packages

The following SCL program shows how to implement this example:

When a package is delivered to the storage area, the signal state at "PEB1" switches from "0" to "1" (positive signal edge). On a positive signal edge at "PEB1", the "Up" counter is enabled, and the current count value of "PACKAGECOUNT" is increased by one.

When a package is delivered from the storage area to the loading dock, the signal state at "PEB2" switches from "0" to "1" (positive signal edge). On a positive signal edge at "PEB2", the "Down" counter is enabled, and the current count value of "PACKAGECOUNT" is decreased by one.

If there are no packages in the storage area ("PACKAGECOUNT" = "0"), the "STOR\_EMPTY" tag is set to signal state "1", and the "Storage area empty" lamp is switched on.

The current count value can be reset to "0" if the "RESET" tag is set to signal state "1".

If the "LOAD" tag is set to signal state "1", the current count value is set to the value of the "STOCK" tag. If the current count value is greater than or equal to the value of the "STOCK" tag, the "STOCK\_PACKAGES" tag supplies the signal state "1".

```

SCL
"CTUD_DB".CTUD(CU := "PEB1",
               CD := "PEB2",
               R  := "RESET",

```

SCL

```
LD := "LOAD",  
PV := "STOCK",  
QU := "STOCK_PACKAGES",  
QD := "STOR_EMPTY",  
CV := "PACKAGECOUNT");
```

As long as there are packages in the storage area, the "STOR\_NOT\_EMPTY" tag is set to signal state "1", and the "Storage area not empty" lamp is switched on.

SCL

```
"STOR_NOT_EMPTY" := NOT "STOR_EMPTY"
```

If the number of packages in the storage area is greater than or equal to 50, the lamp for the "Storage area 50% full" message switches on.

SCL

```
IF "PACKAGECOUNT" >= "VOLUME_50" THEN "STOR_50%_FULL" := 1;  
IF "PACKAGECOUNT" <= "VOLUME_90" THEN "STOR_50%_FULL" := 1;
```

If the number of packages in the storage area is greater than or equal to 90, the "Storage area 90% full" lamp switches on.

SCL

```
IF "PACKAGECOUNT" >= "VOLUME_90" THEN "STOR_90%_FULL" := 1;  
IF "PACKAGECOUNT" <= "VOLUME_100" THEN "STOR_90%_FULL" := 1;
```

If the number of packages in the storage area reaches 100, the lamp for the "Storage area full" message switches on.

SCL

```
IF "PACKAGECOUNT" >= "VOLUME_100" THEN "STOR_FULL" := 1;
```

## See also

Logical expressions (Page 1346)

## 9.7 References

### 9.7.1 General parameters of the instructions

#### 9.7.1.1 Meaning of the parameters REQ, RET\_VAL and BUSY with asynchronous instructions

##### Asynchronous instructions

For instructions that work asynchronously, the function is executed with several calls.

##### Identification of the job

If you use asynchronous instructions to trigger a process interrupt, output control commands to DP slaves, start a data transfer, or abort a non-configured connection with one of the SFCs listed above and then call the same SFC again before the current job is completed, then the reaction of the SFC will depend on whether the second call involves the same job.

##### Parameter REQ

The input parameter REQ (request) is used solely to start the job:

- If you call the instruction for a job that is not currently active, the job is started with REQ = 1 (case 1).
- If a particular job has been started and not yet completed and you call the instruction again to perform the same job (for example, in a cyclic interrupt OB), then REQ is not evaluated by the instruction (case 2).

##### Parameter RET\_VAL and BUSY

The output parameters RET\_VAL and BUSY indicate the status of the job.

Pay attention to the note in section: Evaluating errors with output parameter RET\_VAL (Page 1584)

- In case 1 (first call with REQ=1), the input parameter will be entered in RET\_VAL W#16#7001 if system resources are available and supply is correct. BUSY will be set.  
If the required system resources are currently being used or the input parameters have errors, the corresponding error code is entered in RET\_VAL and BUSY has the value 0.
- In case 2 (interim call) W#16#7002 will be entered in RET\_VAL (this corresponds to a warning: Job still being processed!), and BUSY will be set.
- The following applies to the last call for a job:
  - For instruction "DPNRM\_DG (Page 2378)", the number of data in bytes will be entered as integer in RET\_VAL in case there are no errors in data transmission. BUSY has the value "0" in this case.  
If there is an error, then the error information will be entered in RET\_VAL and you should not evaluate BUSY in this case.
  - For all other instructions, "0" will be entered in RET\_VAL if the job was executed without errors and BUSY has the value "0" in this case. If there is an error, the error code is entered in RET\_VAL and BUSY has the value "0" in this case.

---

**Note**

If the first and last call coincide, the reaction is the same for RET\_VAL and BUSY as described for the last call.

---

## Overview

The following table provides you with an overview of the relationships explained above. In particular, it shows the possible values of the output parameters if the execution of the job is not completed after an instruction call has been completed.

---

**Note**

Following every call, you must evaluate the relevant output parameters in your program.

---

Relationship between call, REQ, RET\_VAL and BUSY during execution of a "running" job.

Number of the call	Type of call	REQ	RET_VAL	BUSY
1	First call	1	W#16#7001	1
			Error code	0
2 to (n - 1)	Intermediate call	irrelevant	W#16#7002	1
n	Last call	irrelevant	W#16#0000, if no errors have occurred.	0
			Error code if errors occurred	0

### 9.7.1.2 Evaluating errors with output parameter RET\_VAL

#### Types of error information

An executed instruction indicates in the user program whether or not the CPU was able to execute the function of the instruction successfully.

You can obtain information about any errors that occurred in two ways:

- In the BR bit of the status word
- in the output parameter RET\_VAL (return value).

---

#### Note

Before evaluating the output parameters specific to an instruction, you should always follow the steps below:

- First, evaluate the BR bit of the status word.
- Then check the output parameter RET\_VAL.

If the BR bit indicates that an error has occurred or if RET\_VAL contains a general error code, you should not evaluate the instruction-specific output parameters.

---

#### Error information in the return value

An instruction indicates that an error occurred during its execution by entering the value "0" in the binary result bit (BR) of the status word. Some instructions provide an additional error code at an output parameter known as the return value (RET\_VAL). If a general error is entered in the output parameter RET\_VAL (see below for explanation), this is only indicated by the value "0" in the BR bit of the status word.

The return value is of the data type integer (INT). The relationship of the return value to the value "0" indicates whether or not an error occurred during execution of the function.

CPU execution of the instruction	BR	Return value	Sign of the integer
With error(s)	0	less than "0"	negative (sign bit is "1")
Without error	1	greater than or equal to "0"	positive (sign bit is "0")

#### Reacting to error information

There are two types of error codes in RET\_VAL:

- A general error code that all instructions can output and
- A specific error code that an instruction can output and which relates to its specific function.

You can write your program so that it reacts to the errors that occur during execution of an instruction. This way you prevent further errors occurring as a result of the first error.



## General and specific error information

The return value (RET\_VAL) of an instruction provides one of the two following types of error codes:

- A general error code that relates to errors that can occur in any instruction.
- A specific error code that relates only to the particular instruction.

Even though the data type of the output parameter RET\_VAL is an integer (INT), the error codes for the instruction are grouped according to hexadecimal values. If you want to examine a return value and compare the value with the error codes listed in this documentation, then display the error code in hexadecimal format.

The figure below shows the structure of a system function error code in hexadecimal format.

Error code, e.g. W#16#8081

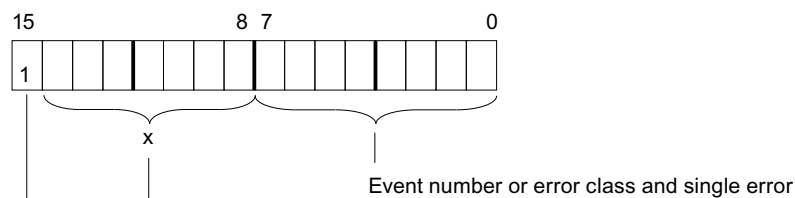

If  $x = '0'$ , then you are dealing with a specific error code of an instruction. The specific error code is included in the description of the individual instruction.

If  $x > '0'$ , then you are dealing with a general error code of an instruction. In this case  $x$  is the number of the instruction parameter that has caused the error. The possible general error codes are listed in the following table.

Sign bit = 1 indicates that an error has occurred.

## General error information

The general error code indicates errors that can occur in all instructions. A general error code consists of the following two numbers:

- A parameter number from 1 to 111, where 1 indicates the first parameter of the called instruction, 2 the second parameter, and so forth.
- An event number from 0 to 127. The event number indicates that a synchronous error occurred.

The following table lists the codes for general errors and an explanation of each error.

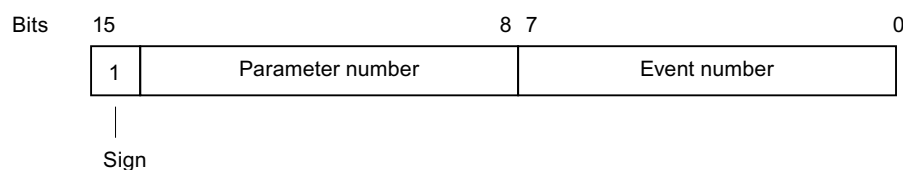

Sign

**Note**

If a general error code was entered in RET\_VAL, then the following situations are possible:

- The action associated with the instruction may have been started or already completed.
- A specific instruction error may have occurred when the action was performed. As a result of a general error that occurred later, the specific error could, however, no longer be indicated.

**Specific error information**

Some instructions have a return value that provides an error code specific for the instruction. A specific error code indicates errors that can occur only in specific instructions.

A specific error code consists of the following two numbers:

- An error class from 0 to 7.
- An error number from 0 to 15.

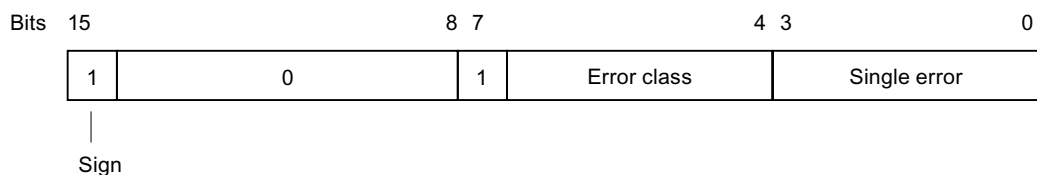
**General error codes**

The following table explains the general error codes of a return value. The error code is shown in hexadecimal format. The letter x in each code number is simply a place holder and represents the number of the system function parameter that caused the error.

General error codes

Error code (W#16#...)	Explanation
8x7F	Internal error This error code indicates an internal error at parameter x.
8x01	Illegal syntax ID at an VARIANT parameter
8x22	Range length error when reading a parameter.
8x23	Range length error when writing a parameter. This error code indicates that the parameter x is located either entirely or partly outside the range of an address, or that the length of a bit range is not a multiple of 8 with an VARIANT parameter.
8x24	Range error when reading a parameter.

Error code (W#16#...)	Explanation
8x25	Range error when writing a parameter. This error code indicates that the parameter x is located in a range that is illegal for the system function. Refer to the descriptions of the individual functions for information about the illegal ranges.
8x26	The parameter contains a timer cell number that is too high. This error code indicates that the timer cell specified in parameter x does not exist.
8x27	The parameter contains a counter cell number that is too high (counter number error). This error code indicates that the counter cell specified in parameter x does not exist.
8x28	Alignment error when reading a parameter.
8x29	Alignment error when writing a parameter. This error code indicates that the reference to parameter x is an operand with bit address that is not equal to 0.
8x30	The parameter is located in a read-only global DB.
8x31	The parameter is located in a read-only instance DB. This error code indicates that parameter x is located in a read-only data block. If the data block was opened by the system function itself, the system function always returns the value W#16#8x30.
8x32	The parameter contains a DB number that is too high (DB number error).
8x34	The parameter contains an FC number that is too high (FC number error).
8x35	The parameter contains an FB number that is too high (FB number error). This error code indicates that parameter x contains a block number higher than the highest permitted number.
8x3A	The parameter contains the number of a DB that is not loaded.
8x3C	The parameter contains the number of an FC that is not loaded.
8x3E	The parameter contains the number of an FB that is not loaded.
8x42	An access error occurred while the system was attempting to read a parameter from the peripheral input area.
8x43	An access error occurred while the system was attempting to write a parameter to the peripheral output area.
8x44	Error in the nth ( $n > 1$ ) read access after an error occurred.
8x45	Error in the nth ( $n > 1$ ) write access after an error occurred. This error code indicates that access to the required parameter is denied.

## 9.7.2 Basic instructions

### 9.7.2.1 LAD

#### Bit logic operations

--| |--: Normally open contact

#### Description

The activation of the normally open contact depends on the signal state of the associated operand. When the operand has signal state "1", the normally open contact closes and the signal state at the output is set to the signal state of the input.

When the operand has signal state "0", the normally open contact is not activated and the signal state at the output of the instruction is reset to "0".

Two or more normally open contacts are linked bit-by-bit by AND when connected in series. With a series connection, power flows when all contacts are closed.

The normally open contacts are linked by OR when connected in parallel. With a parallel connection, power flows when one of the contacts is closed.

#### Parameter

The following table shows the parameters of the instruction:

Parameter	Declaration	Data type	Memory area		Description
			S7-1200	S7-1500	
<Operand>	Input	BOOL	I, Q, M, D, L	I, Q, M, D, L, T, C	Operand whose signal state is queried.

#### Example

The following example shows how the instruction works:

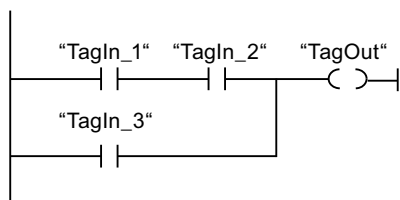

The "TagOut" operand is set when one of the following conditions is fulfilled:

- The operands "TagIn\_1" and "TagIn\_2" have signal state "1".
- The operand "TagIn\_3" has the signal state "1".

**See also**

Overview of the valid data types (Page 1077)

**---| / |---: Normally closed contact****Description**

The activation of the normally closed contact depends on the signal state of the associated operand. When the operand has signal state "1", the normally closed contact opens and the signal state at the output of the instruction is reset to "0".

When the operand has signal state "0", the normally closed contact is not enabled and the signal state of the input is transferred to the output.

Two or more normally closed contacts are linked bit-by-bit by AND when connected in series. With a series connection, power flows when all contacts are closed.

The normally closed contacts are linked by OR when connected in parallel. With a parallel connection, power flows when one of the contacts is closed.

**Parameter**

The following table shows the parameters of the instruction:

Parameter	Declaration	Data type	Memory area		Description
			S7-1200	S7-1500	
<Operand>	Input	BOOL	I, Q, M, D, L	I, Q, M, D, L, T, C	Operand whose signal state is queried.

**Example**

The following example shows how the instruction works:

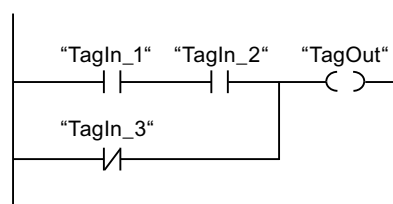

The "TagOut" operand is set when one of the following conditions is fulfilled:

- The operands "TagIn\_1" and "TagIn\_2" have signal state "1".
- The operand "TagIn\_3" has the signal state "0".

**See also**

Overview of the valid data types (Page 1077)

**--|NOT|--: Invert RLO**

**Description**

You use the "Invert RLO" instruction to invert the signal state of the result of logic operation (RLO). If the signal state is "1" at the input of the instruction, the output of the instruction has signal state "0". If the signal state is "0" at the input of the instruction, the output has the signal state "1".

**Example**

The following example shows how the instruction works:

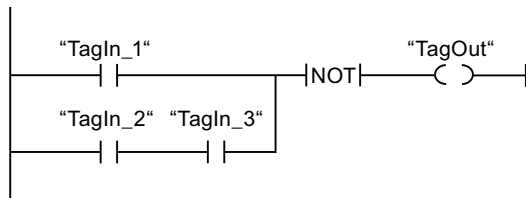

Operand "TagOut" is reset when one of the following conditions is fulfilled:

- The operand "TagIn\_1" has the signal state "1".
- The signal state of the operands "TagIn\_2" and "TagIn\_3" is "1".

**--( )--: Assignment**

**Description**

You can use the "Assignment" instruction to set the bit of a specified operand. If the result of logic operation (RLO) at the input of the coil has signal state "1", the specified operand is set to signal state "1". If the signal state is "0" at the input of the coil, the bit of the specified operand is reset to "0".

The instruction does not influence the RLO. The RLO at the input of the coil is sent directly to the output.

## Parameter

The following table shows the parameters of the "Assignment" instruction:

Parameter	Declaration	Data type	Memory area	Description
<Operand>	Output	BOOL	I, Q, M, D, L	Operand to which the RLO is assigned.

## Example

The following example shows how the instruction works:

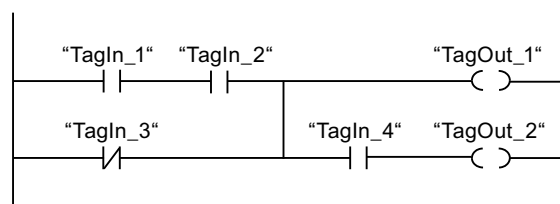

The "TagOut\_1" operand is set when one of the following conditions is fulfilled:

- The operands "TagIn\_1" and "TagIn\_2" have signal state "1".
- The signal state of the operand "TagIn\_3" is "0".

The "TagOut\_2" operand is set when one of the following conditions is fulfilled:

- Operands "TagIn\_1", "TagIn\_2", and "TagIn\_4" have signal state "1".
- The signal state of the "TagIn\_3" operand is "0" and the signal state of the "TagIn\_4" operand is "1".

## See also

Overview of the valid data types (Page 1077)

## --( / )--: Negate assignment

### Description

The "Negate assignment" instruction inverts the result of logic operation (RLO) and assigns it to the specified operand. When the RLO at the input of the coil is "1", the operand is reset. When the RLO at the input of the coil is "0", the operand is set to signal state "1".

**Parameter**

The following table shows the parameters of the "Negate assignment" instruction:

Parameter	Declaration	Data type	Memory area	Description
<Operand>	Output	BOOL	I, Q, M, D, L	Operand to which the RLO is assigned.

**Example**

The following example shows how the instruction works:

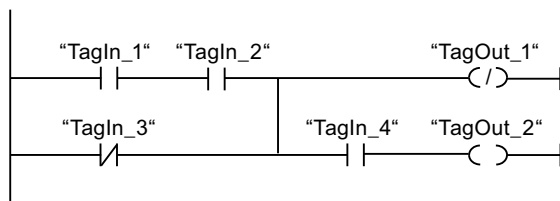

Operand "TagOut\_1" is reset when one of the following conditions is fulfilled:

- The operands "TagIn\_1" and "TagIn\_2" have signal state "1".
- The signal state of the operand "TagIn\_3" is "0".

**See also**

Overview of the valid data types (Page 1077)

**---( R )---: Reset output**

**Description**

You can use the "Reset output" instruction to reset the signal state of a specified operand to "0".

The instruction is only executed if the result of logic operation (RLO) at the input of the coil is "1". If power flows to the coil (RLO = "1"), the specified operand is reset to "0". If the RLO at the input of the coil is "0" (no signal flow to the coil), the signal state of the specified operand remains unchanged.



## Parameter

The following table shows the parameters of the "Reset output" instruction:

Parameter	Declaration	Data type	Memory area		Description
			S7-1200	S7-1500	
<Operand>	Output	BOOL	I, Q, M, D, L	I, Q, M, D, L, T, C	Operand that is reset when RLO = "1".

## Example

The following example shows how the instruction works:

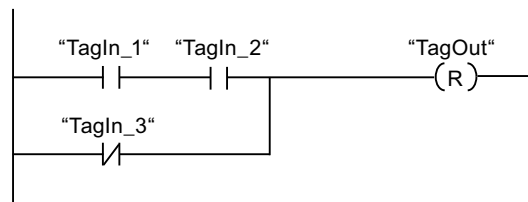

Operand "TagOut" is reset when one of the following conditions is fulfilled:

- The operands "TagIn\_1" and "TagIn\_2" have signal state "1".
- The signal state of the operand "TagIn\_3" is "0".

## See also

Overview of the valid data types (Page 1077)

## ---( S )---: Set output

### Description

You can use the "Set output" instruction to set the signal state of a specified operand to "1".

The instruction is only executed if the result of logic operation (RLO) at the input of the coil is "1". If power flows to the coil (RLO = "1"), the specified operand is set to "1". If the RLO at the input of the coil is "0" (no signal flow to the coil), the signal state of the specified operand remains unchanged.

## Parameter

The following table shows the parameters of the "Set output" instruction:

Parameter	Declaration	Data type	Memory area	Description
<Operand>	Output	BOOL	I, Q, M, D, L	Operand which is set with RLO = "1".

**Example**

The following example shows how the instruction works:

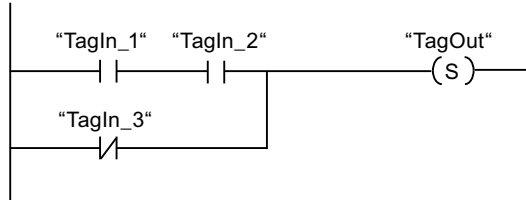

The "TagOut" operand is set when one of the following conditions is fulfilled:

- The operands "TagIn\_1" and "TagIn\_2" have signal state "1".
- The signal state of the operand "TagIn\_3" is "0".

**See also**

Overview of the valid data types (Page 1077)

**SET\_BF: Set bit field**

**Description**

You use the instruction "Set bit field" to set multiple bits starting from a certain address.

You determine the number of bits to be set using the value of <Operand1>. The address of the first bit to be set is defined by <Operand2>. If the value of <Operand1> is greater than the number of bits in a selected byte, then the bits of the next byte will be set. The bits remain set until they are explicitly reset, for example, by another instruction.

The instruction is only executed if the result of logic operation (RLO) at the input of the coil is "1". If the RLO at the input of the coil is "0", the instruction does not execute.

**Parameter**

The following table shows the parameters of the "Set bit field" instruction:

Parameter	Declaration	Data type	Memory area	Description
<Operand2>	Output	BOOL	I, Q, M In the case of a DB or an IDB, an element of an ARRAY[.] of BOOL	Pointer to the first bit to be set.
<Operand1>	Input	UINT	Constant	Number of bits to be set.

## Example

The following example shows how the instruction works:

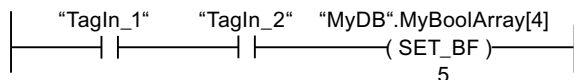

If the operands "TagIn\_1" and "TagIn\_2" have the signal state "1", 5 bits are set starting at the address of the operand "MyDB".MyBoolArray[4]

## See also

Overview of the valid data types (Page 1077)

## RESET\_BF: Reset bit field

### Description

You use the "Reset bit field" instruction to reset several bits starting from a certain address.

You specify the number of bits to be reset using the value of <Operand1>. The address of the first bit to be reset is specified by <Operand2>. If the value of <Operand1> is greater than the number of bits in a selected byte, the bits of the next byte will be reset. The bits remain reset until they are explicitly set, for example, by another instruction.

The instruction is only executed if the result of logic operation (RLO) at the input of the coil is "1". If the RLO at the input of the coil is "0", the instruction does not execute.

### Parameter

The following table shows the parameters of the "Reset bit field" instruction:

Parameter	Declaration	Data type	Memory area	Description
<Operand2>	Output	BOOL	I, Q, M In the case of a DB or an IDB, an element of an ARRAY[.] of BOOL	Pointer to the first bit to be reset.
<Operand1>	Input	UINT	Constant	Number of bits to be reset.

## Example

The following example shows how the instruction works:

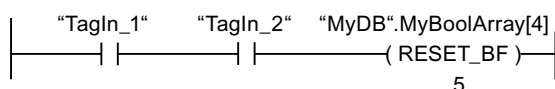

If the operands "TagIn\_1" and "TagIn\_2" have the signal state "1", 5 bits are reset starting at the address of the operand "MyDB".MyBoolArray[4]

**See also**

Overview of the valid data types (Page 1077)

**SR: Set/reset flip-flop**

**Description**

Use the instruction "Set/reset flip-flop" to set or reset the bit of the specified operand, depending on the signal state of the inputs S and R1. If the signal state is "1" at input S and "0" at input R1, the specified operand is set to "1". If the signal state is "0" at input S and "1" at input R1, the specified operand will be reset to "0".

Input R1 takes priority over input S. When the signal state is "1" on both inputs S and R1, the signal state of the specified operand is reset to "0".

The instruction is not executed if the signal state at the two inputs S and R1 is "0". The signal state of the operand then remains unchanged.

The current signal state of the operand is transferred to output Q and can be queried there.

**Parameter**

The following table shows the parameters of the "Set/reset flip-flop" instruction:

Parameter	Declaration	Data type	Memory area		Description
			S7-1200	S7-1500	
S	Input	BOOL	I, Q, M, D, L	I, Q, M, D, L	Enable setting
R1	Input	BOOL	I, Q, M, D, L	I, Q, M, D, L, T, C	Enable resetting
<Operand>	InOut	BOOL	I, Q, M, D, L	I, Q, M, D, L	Operand that is set or reset.
Q	Output	BOOL	I, Q, M, D, L	I, Q, M, D, L	Signal state of the operand

**Example**

The following example shows how the instruction works:

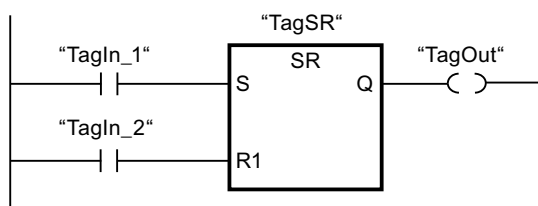

The operands "TagSR" and "TagOut" are set when the following conditions are fulfilled:

- The operand "TagIn\_1" has the signal state "1".
- The operand "TagIn\_2" has the signal state "0".

The operands "TagSR" and "TagOut" are reset when one of the following conditions is fulfilled:

- The operand "TagIn\_1" has signal state "0" and the operand "TagIn\_2" has signal state "1".
- The operands "TagIn\_1" and "TagIn\_2" have signal state "1".

## See also

Overview of the valid data types (Page 1077)

## RS: Reset/set flip-flop

### Description

You can use the "Reset/set flip-flop" instruction to reset or set the bit of a specified operand based on the signal state of the inputs R and S1. If the signal state is "1" at input R and "0" at input S1, the specified operand will be reset to "0". If the signal state is "0" at input R and "1" at input S1, the specified operand is set to "1".

Input S1 takes priority over input R. When the signal state is "1" at both inputs R and S1, the signal state of the specified operand is set to "1".

The instruction is not executed if the signal state at the two inputs R and S1 is "0". The signal state of the operand then remains unchanged.

The current signal state of the operand is transferred to output Q and can be queried there.

### Parameter

The following table shows the parameters of the "Reset/set flip-flop" instruction:

Parameter	Declaration	Data type	Memory area		Description
			S7-1200	S7-1500	
R	Input	BOOL	I, Q, M, D, L	I, Q, M, D, L	Enable resetting
S1	Input	BOOL	I, Q, M, D, L	I, Q, M, D, L, T, C	Enable setting
<Operand>	InOut	BOOL	I, Q, M, D, L	I, Q, M, D, L	Operand that is reset or set.
Q	Output	BOOL	I, Q, M, D, L	I, Q, M, D, L	Signal state of the operand

**Example**

The following example shows how the instruction works:

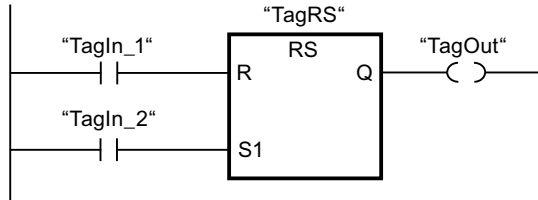

The operands "TagRS" and "TagOut" are reset when the following conditions are fulfilled:

- The operand "TagIn\_1" has the signal state "1".
- The operand "TagIn\_2" has the signal state "0".

The operands "TagRS" and "TagOut" are set when one of the following conditions is fulfilled:

- The operand "TagIn\_1" has signal state "0" and the operand "TagIn\_2" has signal state "1".
- The operands "TagIn\_1" and "TagIn\_2" have signal state "1".

**See also**

Overview of the valid data types (Page 1077)

**--|P|--: Scan operand for positive signal edge**

**Description**

You can use the "Scan operand for positive signal edge" instruction to determine if there is a "0" to "1" change in the signal state of a specified operand (<Operand1>). The instruction compares the current signal state of <Operand1> with the signal state of the previous scan that is saved in an edge memory bit (<Operand2>). If the instruction detects a change in the result of logic operation (RLO) from "0" to "1", there is a positive, rising edge.

If a positive edge is detected, the output of the instruction has the signal state "1". In all other cases, the signal state at the output of the instruction is "0".

Specify the operand to be queried (<Operand1>) in the operand placeholder above the instruction. Specify the edge memory bit (<Operand2>) in the operand placeholder below the instruction.

**Note**

The address of the edge memory bit must not be used more than once in the program, otherwise the bit memory is overwritten. This step influences the edge evaluation and the result is therefore no longer unique. The memory area of the edge memory bit must be located in a DB (static area for FB) or in the bit memory area.

## Parameter

The following table shows the parameters of the "Scan operand for positive signal edge" instruction:

Parameter	Declaration	Data type	Memory area		Description
			S7-1200	S7-1500	
<Operand1>	Input	BOOL	I, Q, M, D, L	I, Q, M, D, L, T, C	Signal to be scanned
<Operand2>	InOut	BOOL	I, Q, M, D, L	I, Q, M, D, L	Edge memory bit in which the signal state of the previous query is saved.

## Example

The following example shows how the instruction works:

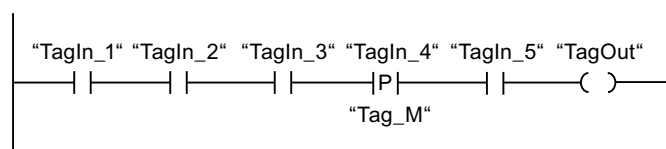

Operand "TagOut" is set when the following conditions are fulfilled:

- The operands "TagIn\_1", "TagIn\_2", and "TagIn\_3" have signal state "1".
- There is a rising edge at operand "TagIn\_4". The signal state of the previous scan is stored in the edge memory bit "Tag\_M".
- The signal state of the operand "TagIn\_5" is "1".

## See also

Overview of the valid data types (Page 1077)

## --|N|--: Scan operand for negative signal edge

### Description

You can use the "Scan operand for negative signal edge" instruction to determine if there is a "1" to "0" change in the signal state of a specified operand (<Operand1>). The instruction compares the current signal state of <Operand1> with the signal state of the previous scan that is saved in an edge memory bit <Operand2>. If the instruction detects a change in the result of logic operation (RLO) from "1" to "0", there is a negative, falling edge.

If a negative signal edge is detected, the output of the instruction has the signal state "1". In all other cases, the signal state at the output of the instruction is "0".

Specify the operand to be queried (<Operand1>) in the operand placeholder above the instruction. Specify the edge memory bit (<Operand2>) in the operand placeholder below the instruction.

**Note**

The address of the edge memory bit must not be used more than once in the program, otherwise the bit memory is overwritten. This step influences the edge evaluation and the result is therefore no longer unique. The memory area of the edge memory bit must be located in a DB (static area for FB) or in the bit memory area.

**Parameter**

The following table shows the parameters of the "Scan operand for negative signal edge" instruction:

Parameter	Declaration	Data type	Memory area		Description
			S7-1200	S7-1500	
<Operand1 >	Input	BOOL	I, Q, M, D, L	I, Q, M, D, L, T, C	Signal to be scanned
<Operand2 >	InOut	BOOL	I, Q, M, D, L	I, Q, M, D, L	Edge memory bit in which the signal state of the previous query is saved.

**Example**

The following example shows how the instruction works:

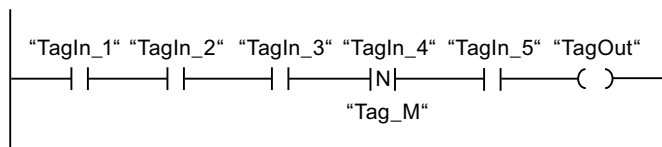

Operand "TagOut" is set when the following conditions are fulfilled:

- The operands "TagIn\_1", "TagIn\_2", and "TagIn\_3" have signal state "1".
- There is a negative signal edge at operand "TagIn\_4". The signal state of the previous scan is stored in the edge memory bit "Tag\_M".
- The signal state of the operand "TagIn\_5" is "1".

**See also**

Overview of the valid data types (Page 1077)



**--(P)--: Set operand on positive signal edge****Description**

You can use the "Set operand on positive signal edge" instruction to set a specified operand (<Operand1>) when there is a "0" to "1" change in the result of logic operation (RLO). The instruction compares the current RLO with the RLO from the previous query, which is saved in the edge memory bit (<Operand2>). If the instruction detects a change in the RLO from "0" to "1", there is a positive signal edge.

When a positive signal edge is detected, <Operand1> is set to signal state "1" for one program cycle. In all other cases, the operand has the signal state "0".

Specify the operand to be set (<Operand1>) in the operand placeholder above the instruction. Specify the edge memory bit (<Operand2>) in the operand placeholder below the instruction.

**Note**

The address of the edge memory bit must not be used more than once in the program, otherwise the bit memory is overwritten. This step influences the edge evaluation and the result is therefore no longer unique. The memory area of the edge memory bit must be located in a DB (static area for FB) or in the bit memory area.

**Parameter**

The following table shows the parameters of the "Set operand on positive signal edge" instruction:

Parameter	Declaration	Data type	Memory area	Description
<Operand1>	Output	BOOL	I, Q, M, D, L	Operand which is set by a positive edge.
<Operand2>	InOut	BOOL	I, Q, M, D, L	Edge memory bit

**Example**

The following example shows how the instruction works:

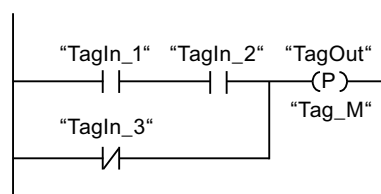

Operand "TagOut" is set for one program cycle, when the signal state at the input of the coil switches from "0" to "1" (positive signal edge). In all other cases, the operand "TagOut" has the signal state "0".

**See also**

Overview of the valid data types (Page 1077)

**--(N)--: Set operand on negative signal edge**

**Description**

You can use the "Set operand on negative signal edge" instruction to set a specified operand (<Operand1>) when there is a "1" to "0" change in the result of logic operation (RLO). The instruction compares the current RLO with the RLO from the previous query, which is saved in the edge memory bit (<Operand2>). If the instruction detects a change in the RLO from "1" to "0", there is a negative edge.

When a negative signal edge is detected, <Operand1> is set to signal state "1" for one program cycle. In all other cases, the operand has the signal state "0".

Specify the operand to be set (<Operand1>) in the operand placeholder above the instruction. Specify the edge memory bit (<Operand2>) in the operand placeholder below the instruction.

**Note**

The address of the edge memory bit must not be used more than once in the program, otherwise the bit memory is overwritten. This step influences the edge evaluation and the result is therefore no longer unique. The memory area of the edge memory bit must be located in a DB (static area for FB) or in the bit memory area.

**Parameter**

The following table shows the parameters of the "Set operand on negative signal edge" instruction:

Parameter	Declaration	Data type	Memory area	Description
<Operand1>	Output	BOOL	I, Q, M, D, L	Operand which is set by a negative edge.
<Operand2>	InOut	BOOL	I, Q, M, D, L	Edge memory bit

**Example**

The following example shows how the instruction works:

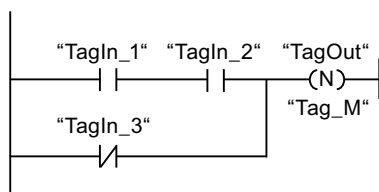

Operand "TagOut" is set for one program cycle, when the signal state at the input of the coil switches from "1" to "0" (negative signal edge). In all other cases, the operand "TagOut" has the signal state "0".

## See also

Overview of the valid data types (Page 1077)

## P\_TRIG: Scan RLO for positive signal edge

### Description

Use the "Scan RLO for positive signal edge" instruction to query a "0" to "1" change in the signal state of the result of logic operation (RLO). The instruction compares the current signal state of the RLO with the signal state of the previous query, which is saved in an edge memory bit (<operand>). If the instruction detects a change in the RLO from "0" to "1", there is a positive signal edge.

If a positive edge is detected, the output of the instruction has the signal state "1". In all other cases, the signal state at the output of the instruction is "0".

---

#### Note

The address of the edge memory bit must not be used more than once in the program, otherwise the bit memory is overwritten. This step influences the edge evaluation and the result is therefore no longer unique. The memory area of the edge memory bit must be located in a DB (static area for FB) or in the bit memory area.

---

### Parameter

The following table shows the parameters of the "Scan RLO for positive signal edge" instruction:

Parameter	Declaration	Data type	Memory area	Description
CLK	Input	BOOL	I, Q, M, D, L	Current RLO
<Operand>	InOut	BOOL	M, D	Edge memory bit in which the RLO of the previous query is saved.
Q	Output	BOOL	I, Q, M, D, L	Result of edge evaluation

**Example**

The following example shows how the instruction works:

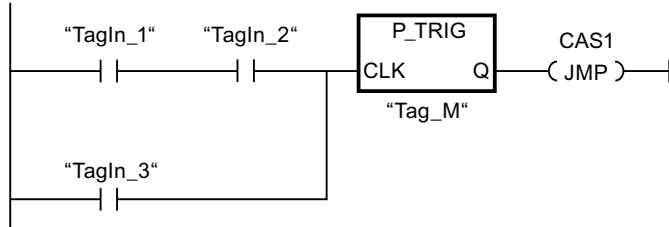

The RLO of the previous query is saved in the edge memory bit "Tag\_M". If a "0" to "1" change is detected in the signal state of the RLO, the program jumps to jump label CAS1.

**See also**

Overview of the valid data types (Page 1077)

**N\_TRIG: Scan RLO for negative signal edge**

**Description**

Use the "Scan RLO for negative signal edge" instruction to query a "1" to "0" change in the signal state of the result of logic operation (RLO). The instruction compares the current signal state of the RLO with the signal state of the previous query, which is saved in an edge memory bit (<operand>). If the instruction detects a change in the RLO from "1" to "0", there is a negative edge.

If a negative signal edge is detected, the output of the instruction has the signal state "1". In all other cases, the signal state at the output of the instruction is "0".

**Note**

The address of the edge memory bit must not be used more than once in the program, otherwise the bit memory is overwritten. This step influences the edge evaluation and the result is therefore no longer unique. The memory area of the edge memory bit must be located in a DB (static area for FB) or in the bit memory area.

## Parameter

The following table shows the parameters of the "Scan RLO for negative signal edge" instruction:

Parameters	Declaration	Data type	Memory area	Description
CLK	Input	BOOL	I, Q, M, D, L	Current RLO
<Operand>	InOut	BOOL	M, D	Edge memory bit in which the RLO of the previous query is saved.
Q	Output	BOOL	I, Q, M, D, L	Result of edge evaluation

## Example

The following example shows how the instruction works:

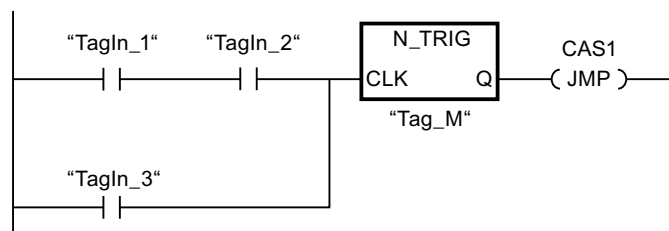

The RLO of the previous query is saved in the edge memory bit "Tag\_M". If a "1" to "0" change is detected in the signal state of the RLO, the program jumps to jump label CAS1.

## See also

Overview of the valid data types (Page 1077)

## R\_TRIG: Set tag on positive signal edge

### Description

You can use the "Set tag on positive signal edge" instruction to set a specified tag in the instance DB when there is a "0" to "1" change in the result of logic operation (RLO). The instruction compares the current RLO at the input CLK with the RLO from the previous query, which is saved in the specified instance DB. If the instruction detects a change in the RLO from "0" to "1", there is a positive signal edge.

If a positive edge is detected, the tag in the instance DB is set to signal state "1" and the output Q returns the signal state "1". In all other cases, the signal state at the output of the instruction is "0".

When you insert the instruction in the program, the "Call options" dialog opens automatically. In this dialog you can specify whether the edge memory bit is stored in its own data block (single instance) or as a local tag (multiple instance) in the block interface. If you create a

separate data block, you will find it in the project tree in the "Program resources" folder under "Program blocks > System blocks". For additional information on this topic, refer to "See also".

**Parameter**

The following table shows the parameters of the instruction "Set tag on positive signal edge":

Parameter	Declaration	Data type	Memory area	Description
EN	Input	BOOL	I, Q, M, D, L	Enable input
ENO	Output	BOOL	I, Q, M, D, L	Enable output
CLK	Input	BOOL	I, Q, M, D, L or constant	Incoming signal, the edge of which is to be queried.
Q	Output	BOOL	I, Q, M, D, L	Result of edge evaluation

**Example**

The following example shows how the instruction works:

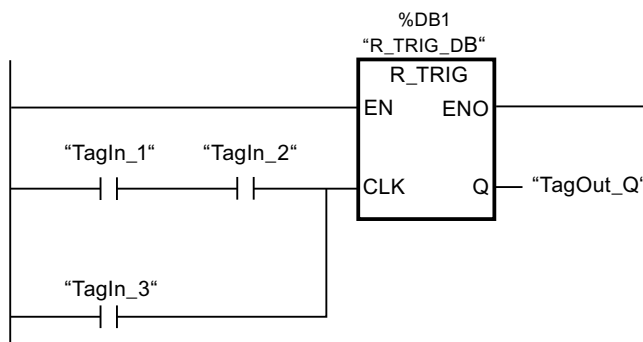

The RLO of the preceding query is saved in the instance DB "R\_TRIG\_DB". If a change in the signal state of the RLO from "0" to "1" is detected in the operands "TagIn\_1" and "TagIn\_2" or in the operand "TagIn\_3", the output "TagOut\_Q" has signal state "1".

**See also**

Overview of the valid data types (Page 1077)

**F\_TRIG: Set tag on negative signal edge**

**Description**

You can use the "Set tag on negative signal edge" instruction to set a specified tag in the instance DB when there is a "1" to "0" change in the result of logic operation (RLO). The instruction compares the current RLO at the input CLK with the RLO from the previous query, which is saved in the specified instance DB. If the instruction detects a change in the RLO from "1" to "0", there is a negative edge.

If a negative edge is detected, the tag in the instance DB is set to signal state "1" and the output Q returns the signal state "1" In all other cases, the signal state at the output of the instruction is "0".

When you insert the instruction in the program, the "Call options" dialog opens automatically. In this dialog you can specify whether the edge memory bit is stored in its own data block (single instance) or as a local tag (multiple instance) in the block interface. If you create a separate data block, you will find it in the project tree in the "Program resources" folder under "Program blocks > System blocks". For additional information on this topic, refer to "See also".

## Parameter

The following table shows the parameters of the instruction "Set tag on negative signal edge":

Parameter	Declaration	Data type	Memory area	Description
EN	Input	BOOL	I, Q, M, D, L	Enable input
ENO	Output	BOOL	I, Q, M, D, L	Enable output
CLK	Input	BOOL	I, Q, M, D, L or constant	Incoming signal, the edge of which is to be queried.
Q	Output	BOOL	I, Q, M, D, L	Result of edge evaluation

## Example

The following example shows how the instruction works:

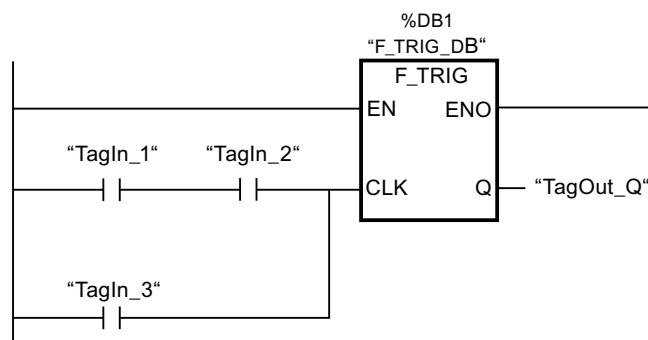

The RLO of the preceding query is saved in the instance DB "F\_TRIG\_DB". If a change in the signal state of the RLO from "1" to "0" is detected in the operands "TagIn\_1" and "TagIn\_2" or in the operand "TagIn\_3", the output "TagOut\_Q" has signal state "1".

## See also

Overview of the valid data types (Page 1077)

## Timer operations

### IEC Timers

#### TP: Generate pulse

##### Description

You can use the "Generate pulse" instruction to set the output Q for a programmed duration. The instruction is started when the result of logic operation (RLO) at input IN changes from "0" to "1" (positive signal edge). The programmed time PT begins when the instruction starts. Output Q is set for the duration PT, regardless of the subsequent course of the input signal. Even if a new positive signal edge is detected, the signal state at the output Q is not affected as long as the PT time duration is running.

You can scan the current time value at the ET output. The time value starts at T#0s and ends when the value of duration PT is reached. When the duration PT is reached and the signal state at input IN is "0", the ET output is reset.

Each call of the "Generate pulse" instruction must be assigned to an IEC timer in which the instruction data is stored.

---

##### Note

If the timer is not called in the program because it is skipped, for example, the ET output returns a constant value as soon as the timer has expired.

---

#### For S7-1200 CPU

An IEC timer is a structure of the data type IEC\_TIMER or TP\_TIME that you can declare as follows:

- Declaration of a data block of system data type IEC\_TIMER (for example, "MyIEC\_TIMER")
- Declaration as a local tag of the type TP\_TIME, TP\_LTIME or IEC\_TIMER in the "Static" section of a block (for example, #MyIEC\_TIMER)

#### For S7-1500 CPU

An IEC timer is a structure of the data type IEC\_TIMER, IEC\_LTIMER, TP\_TIME or TP\_LTIME that you can declare as follows:

- Declaration of a data block of system data type IEC\_TIMER or IEC\_LTIMER (for example, "MyIEC\_TIMER")
- Declaration as a local tag of the type TP\_TIME, TP\_LTIME, IEC\_TIMER or IEC\_LTIMER in the "Static" section of a block (for example, #MyIEC\_TIMER)

When you insert the instruction in the program, the "Call options" dialog opens in which you can specify whether the IEC timer is stored in its own data block (single instance) or as a local tag (multiple instance) in the block interface. If you create a separate data block, you will find



it in the project tree in the "Program resources" folder under "Program blocks > System blocks". For additional information on this topic, refer to "See also".

The instruction data is updated both when the instruction is called and also each time the outputs Q or ET are accessed.

The execution of the "Generate pulse" instruction requires a preceding logic operation. It can be placed within or at the end of the network.

## Parameter

The following table shows the parameters of the "Generate pulse" instruction:

Parameter	Declaration	Data type		Memory area		Description
		S7-1200	S7-1500	S7-1200	S7-1500	
IN	Input	BOOL	BOOL	I, Q, M, D, L	I, Q, M, D, L, P	Start input
PT	Input	TIME	TIME, LTIME	I, Q, M, D, L or constant	I, Q, M, D, L, P or constant	Duration of the pulse. The value of the PT parameter must be positive.
Q	Output	BOOL	BOOL	I, Q, M, D, L	I, Q, M, D, L, P	Pulse output
ET	Output	TIME	TIME, LTIME	I, Q, M, D, L	I, Q, M, D, L, P	Current time value

For additional information on valid data types, refer to "See also".

### Pulse timing diagram

The following figure shows the pulse timing diagram of the "Generate pulse" instruction:

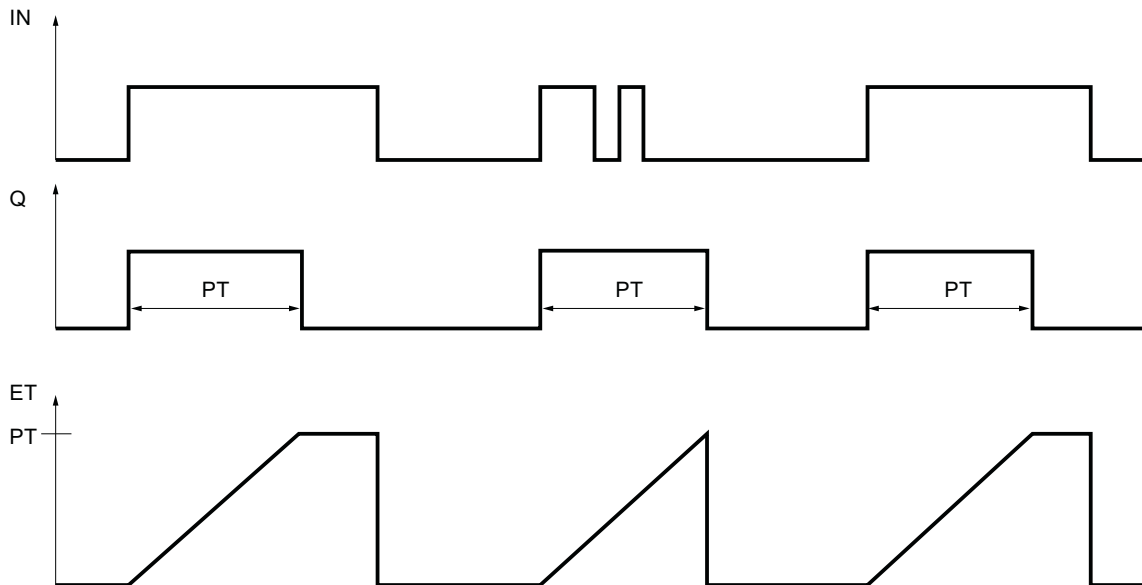

### See also

Overview of the valid data types (Page 1077)

### TON: Generate on-delay

#### Description

You can use the "Generate on-delay" instruction to delay setting of the Q output by the programmed duration PT. The instruction is started when the result of logic operation (RLO) at input IN changes from "0" to "1" (positive signal edge). The programmed time PT begins when the instruction starts. When the duration PT expires, the output Q has the signal state "1". Output Q remains set as long as the start input is still "1". When the signal state at the start input changes from "1" to "0", the Q output is reset. The timer function is started again when a new positive signal edge is detected at the start input.

The current time value can be queried at the ET output. The time value starts at T#0s and ends when the value of duration PT is reached. The ET output is reset as soon as the signal state at the IN input changes to "0".

Each call of the "Generate on-delay" instruction must be assigned to an IEC timer in which the instruction data is stored.

---

#### Note

If the timer is not called in the program because it is skipped, for example, the ET output returns a constant value as soon as the timer has expired.

---

**For S7-1200 CPU**

An IEC timer is a structure of the data type IEC\_TIMER or TON\_TIME that you can declare as follows:

- Declaration of a data block of system data type IEC\_TIMER (for example, "MyIEC\_TIMER")
- Declaration as a local tag of the type TON\_TIME or IEC\_TIMER in the "Static" section of a block (for example, #MyIEC\_TIMER)

**For S7-1500 CPU**

An IEC timer is a structure of the data type IEC\_TIMER, IEC\_LTIMER, TON\_TIME or TON\_LTIME that you can declare as follows:

- Declaration of a data block of system data type IEC\_TIMER or IEC\_LTIMER (for example, "MyIEC\_TIMER")
- Declaration as a local tag of the type TON\_TIME, TON\_LTIME, IEC\_TIMER or IEC\_LTIMER in the "Static" section of a block (for example, #MyIEC\_TIMER)

When you insert the instruction in the program, the "Call options" dialog opens in which you can specify whether the IEC timer is stored in its own data block (single instance) or as a local tag (multiple instance) in the block interface. If you create a separate data block, you will find it in the project tree in the "Program resources" folder under "Program blocks > System blocks". For additional information on this topic, refer to "See also".

The instruction data is updated both when the instruction is called and also each time the outputs Q or ET are accessed.

The execution of the "Generate on-delay" instruction requires a preceding logic operation. It can be placed within or at the end of the network.

**Parameter**

The following table shows the parameters of the "Generate on-delay" instruction:

Parameter	Declaration	Data type		Memory area		Description
		S7-1200	S7-1500	S7-1200	S7-1500	
IN	Input	BOOL	BOOL	I, Q, M, D, L	I, Q, M, D, L, P	Start input
PT	Input	TIME	TIME, LTIME	I, Q, M, D, L or constant	I, Q, M, D, L, P or constant	Duration of the on-delay The value of the PT parameter must be positive.
Q	Output	BOOL	BOOL	I, Q, M, D, L	I, Q, M, D, L, P	Output that is set when the time PT expires.
ET	Output	TIME	TIME, LTIME	I, Q, M, D, L	I, Q, M, D, L, P	Current time value

For additional information on valid data types, refer to "See also".

**Pulse timing diagram**

The following figure shows the pulse timing diagram of the "Generate on-delay" instruction:

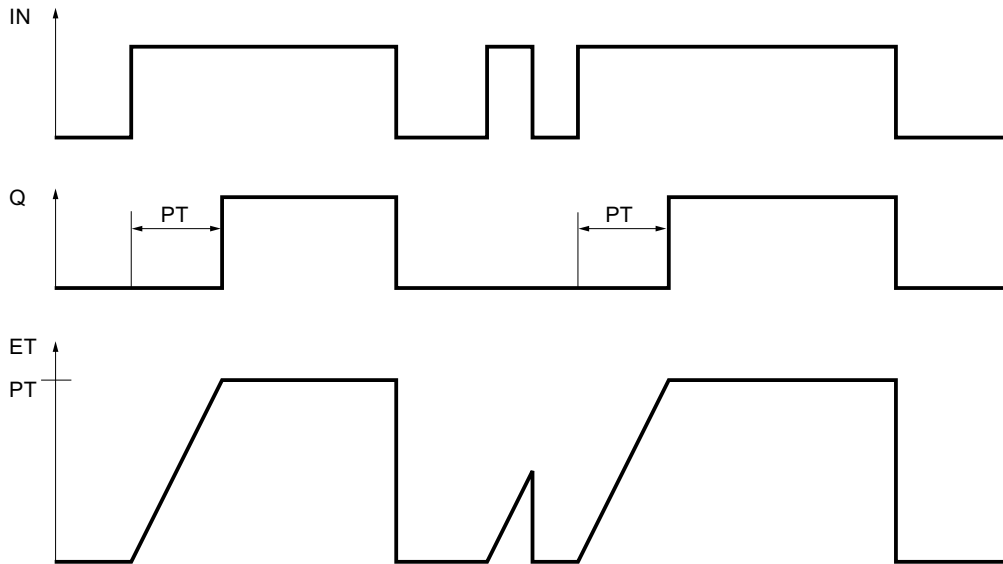

**See also**

Overview of the valid data types (Page 1077)

**TOF: Generate off-delay**

**Description**

You can use the "Generate off-delay" instruction to delay resetting of the Q output by the programmed duration PT. The Q output is set when the result of logic operation (RLO) at input IN changes from "0" to "1" (positive signal edge). When the signal state at input IN changes back to "0", the programmed time PT starts. Output Q remains set as long as the duration PT is running. When duration PT expires, the Q output is reset. If the signal state at input IN changes to "1" before the PT time duration expires, the timer is reset. The signal state at the output Q continues to be "1".

The current time value can be queried at the ET output. The time value starts at T#0s and ends when the value of duration PT is reached. When the time duration PT expires, the ET output remains set to the current value until the IN input changes back to "1". If input IN switches to "1" before the duration PT has expired, the ET output is reset to the value T#0s.

Each call of the "Generate off-delay" instruction must be assigned to an IEC timer in which the instruction data is stored.

---

**Note**

If the timer is not called in the program because it is skipped, for example, the ET output returns a constant value as soon as the timer has expired.

---

**For S7-1200 CPU**

An IEC timer is a structure of the data type IEC\_TIMER or TOF\_TIME that you can declare as follows:

- Declaration of a data block of system data type IEC\_TIMER (for example, "MyIEC\_TIMER")
- Declaration as a local tag of the type TOF\_TIME or IEC\_TIMER in the "Static" section of a block (for example, #MyIEC\_TIMER)

**For S7-1500 CPU**

An IEC timer is a structure of the data type IEC\_TIMER, IEC\_LTIMER, TOF\_TIME or TOF\_LTIME that you can declare as follows:

- Declaration of a data block of system data type IEC\_TIMER or IEC\_LTIMER (for example, "MyIEC\_TIMER")
- Declaration as a local tag of the type TOF\_TIME, TOF\_LTIME, IEC\_TIMER or IEC\_LTIMER in the "Static" section of a block (for example, #MyIEC\_TIMER)

When you insert the instruction in the program, the "Call options" dialog opens in which you can specify whether the IEC timer is stored in its own data block (single instance) or as a local tag (multiple instance) in the block interface. If you create a separate data block, you will find it in the project tree in the "Program resources" folder under "Program blocks > System blocks". For additional information on this topic, refer to "See also".

The instruction data is updated both when the instruction is called and also each time the outputs Q or ET are accessed.

The execution of the "Generate off-delay" instruction requires a preceding logic operation. It can be placed within or at the end of the network.

**Parameter**

The following table shows the parameters of the "Generate off-delay" instruction:

Parameter	Declaration	Data type		Memory area		Description
		S7-1200	S7-1500	S7-1200	S7-1500	
IN	Input	BOOL	BOOL	I, Q, M, D, L	I, Q, M, D, L, P	Start input
PT	Input	TIME	TIME, LTIME	I, Q, M, D, L or constant	I, Q, M, D, L, P or constant	Duration of the off delay The value of the PT parameter must be positive.
Q	Output	BOOL	BOOL	I, Q, M, D, L	I, Q, M, D, L, P	Output that is reset when the timer PT expires.
ET	Output	TIME	TIME, LTIME	I, Q, M, D, L	I, Q, M, D, L, P	Current time value

For additional information on valid data types, refer to "See also".

**Pulse timing diagram**

The following figure shows the pulse timing diagram of the "Generate off-delay" instruction:

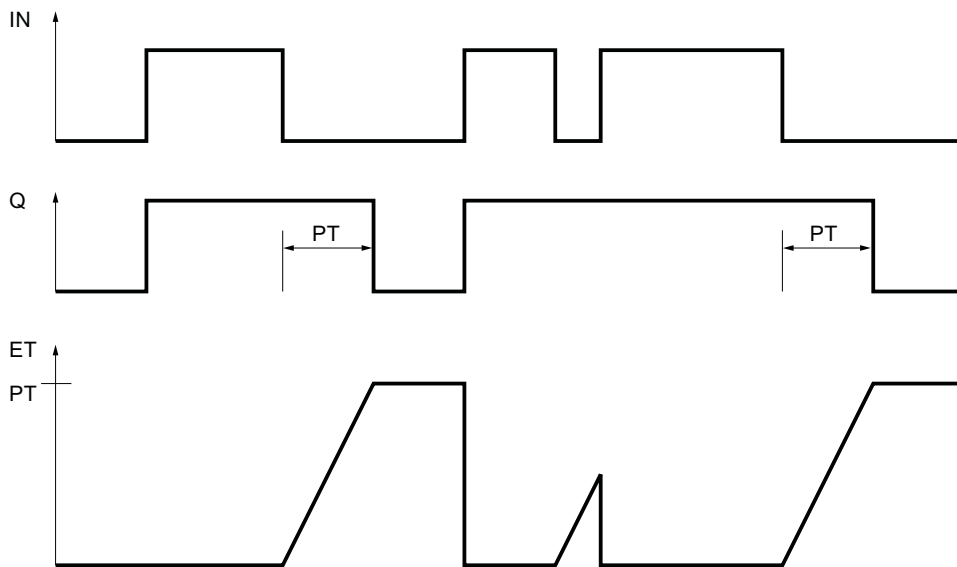

**See also**

Overview of the valid data types (Page 1077)

## TONR: Time accumulator

### Description

The "Time accumulator" instruction is used to accumulate time values within a period set by the PT parameter. When the signal state at input IN changes from "0" to "1" (positive signal edge), the instruction executes and the duration PT starts. While the duration PT is running, the time values are accumulated that are recorded when the IN input has signal state "1". The accumulated time is written to output ET and can be queried there. When the duration PT expires, the output Q has the signal state "1". The Q parameter remains set to "1", even when the signal state at the IN parameter changes from "1" to "0" (negative signal edge).

The R input resets the outputs ET and Q regardless of the signal state at the start input.

Each call of the "Time accumulator" instruction must be assigned to an IEC timer in which the instruction data is stored.

### For S7-1200 CPU

An IEC timer is a structure of the data type IEC\_TIMER or TONR\_TIME that you can declare as follows:

- Declaration of a data block of system data type IEC\_TIMER (for example, "MyIEC\_TIMER")
- Declaration as a local tag of the type TONR\_TIME or IEC\_TIMER in the "Static" section of a block (for example, #MyIEC\_TIMER)

### For S7-1500 CPU

An IEC timer is a structure of the data type IEC\_TIMER, IEC\_LTIMER, TONR\_TIME or TONR\_LTIME that you can declare as follows:

- Declaration of a data block of system data type IEC\_TIMER or IEC\_LTIMER (for example, "MyIEC\_TIMER")
- Declaration as a local tag of the type TONR\_TIME, TONR\_LTIME, IEC\_TIMER or IEC\_LTIMER in the "Static" section of a block (for example, #MyIEC\_TIMER)

When you insert the instruction in the program, the "Call options" dialog opens in which you can specify whether the IEC timer is stored in its own data block (single instance) or as a local tag (multiple instance) in the block interface. If you create a separate data block, you will find it in the project tree in the "Program resources" folder under "Program blocks > System blocks". For additional information on this topic, refer to "See also".

The instruction data is updated both when the instruction is called and also each time the outputs Q or ET are accessed.

The execution of the "Time accumulator" instruction requires a preceding logic operation. It can be placed within or at the end of the network.

**Parameter**

The following table shows the parameters of the "Time accumulator" instruction:

Parameter	Declaration	Data type		Memory area		Description
		S7-1200	S7-1500	S7-1200	S7-1500	
IN	Input	BOOL	BOOL	I, Q, M, D, L	I, Q, M, D, L, P	Start input
R	Input	BOOL	BOOL	I, Q, M, D, L or constant	I, Q, M, D, L, P or constant	Reset input
PT	Input	TIME	TIME, LTIME	I, Q, M, D, L or constant	I, Q, M, D, L, P or constant	Maximum duration of time recording The value of the PT parameter must be positive.
Q	Output	BOOL	BOOL	I, Q, M, D, L	I, Q, M, D, L, P	Output that is set when the time PT expires.
ET	Output	TIME	TIME, LTIME	I, Q, M, D, L	I, Q, M, D, L, P	Accumulated time

For additional information on valid data types, refer to "See also".



## Pulse timing diagram

The following figure shows the pulse timing diagram of the "Time accumulator" instruction:

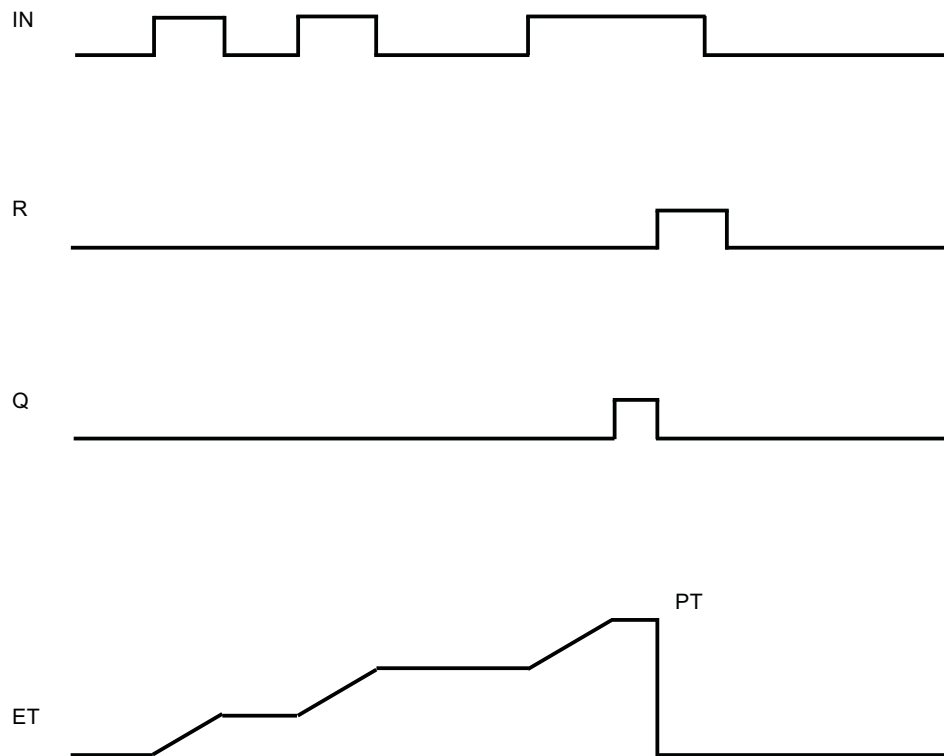

## See also

Overview of the valid data types (Page 1077)

## ---( TP )---: Start pulse timer

### Description

Use the "Start pulse timer" instruction to start an IEC timer with a specified duration as pulse. The IEC timer is started when the result of logic operation (RLO) changes from "0" to "1" (positive signal edge). The IEC timer runs for the specified duration regardless of any subsequent changes in the RLO. The run of the IEC timer is also not affected by the detection of a new positive signal edge. As long as the IEC timer is running, the querying of the timer status for "1" returns the signal state "1". When the IEC timer has expired, the timer status returns the signal state "0".

### Note

You can start and query the IEC timer at various execution levels, as each querying of the outputs Q or ET updates the IEC\_TIMER structure.

**For S7-1200 CPU**

The instruction "Start pulse timer" stores its data in a structure of the data type IEC\_TIMER or TP\_TIME. You can declare the structure as follows:

- Declaration of a data block of system data type IEC\_TIMER (for example, "MyIEC\_TIMER")
- Declaration as a local tag of the type TP\_LTIME or IEC\_TIMER in the "Static" section of a block (for example, #MyIEC\_TIMER)

**For S7-1500 CPU**

The instruction "Start pulse timer" stores its data in a structure of the data type IEC\_TIMER, IEC\_LTIMER, TP\_TIME or TP\_LTIME. You can declare the structure as follows:

- Declaration of a data block of system data type IEC\_TIMER or IEC\_LTIMER (for example, "MyIEC\_TIMER")
- Declaration as a local tag of the type TP\_TIME, TP\_LTIME, IEC\_TIMER or IEC\_LTIMER in the "Static" section of a block (for example, #MyIEC\_TIMER)

The instruction data is updated both when the instruction is called and also each time the assigned timer is accessed.

The current timer status is stored in the Q structure component of the IEC timer. You can use a normally open contact to query timer status for "1" or a normally closed contact for "0". The query on Q or ET (for example, "MyTimer".Q or "MyTimer".ET) updates the IEC\_TIMER structure.

The execution of the "Start pulse timer" instruction assumes a preceding logic operation. It can be placed only at the end of the network.

**Parameter**

The following table shows the parameters of the "Start pulse timer" instruction:

Parameter	Declaration	Data type		Memory area	Description
		S7-1200	S7-1500		
<Time duration>	Input	TIME	TIME, LTIME	I, Q, M, D, L or constant	Duration with which the IEC timer runs.
<IEC timer>	InOut	IEC_TIMER, TP_TIME	IEC_TIMER, IEC_LTIMER, TP_TIME, TP_LTIME	D, L	IEC timer that is started.

For additional information on valid data types, refer to "See also".

## Example

The following example shows how the instruction works:

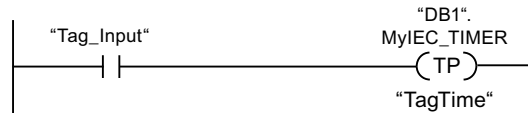

The "Start pulse timer" instruction is executed when the signal state of the operand "Tag\_Input" changes from "0" to "1". The timer "DB1".MyIEC\_TIMER is started for the time stored in the operand "TagTime".

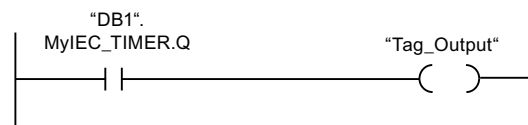

As long as the timer "DB1". MyIEC\_TIMER is running, the timer status ("DB1".MyIEC\_TIMER.Q) has signal state "1" and the operand "Tag\_Output" is set. When the IEC timer has expired, the signal state of the time status changes back to "0" and the "Tag\_Output" operand is reset.

## See also

Overview of the valid data types (Page 1077)

## ---( TON )---: Start on-delay timer

### Description

Use the "Start on-delay timer" instruction to start an IEC timer with a specified duration as on-delay. The IEC timer is started when the result of logic operation (RLO) changes from "0" to "1" (positive signal edge). The IEC timer runs for the specified time. The output returns the signal state "1" if the RLO at the input of the instruction has the signal state "1". If the RLO changes to "0" before the time expires, the IEC timer is reset. In this case, querying the timer status for "1" returns signal state "0". The IEC timer restarts when the next positive signal edge is detected at the input of the instruction.

#### Note

You can start and query the IEC timer at various execution levels, as each querying of the outputs Q or ET updates the IEC\_TIMER structure.

**For S7-1200 CPU**

The instruction "Start on-delay timer" stores its data in a structure of the data type IEC\_TIMER or TON\_TIME. You can declare the structure as follows:

- Declaration of a data block of system data type IEC\_TIMER (for example, "MyIEC\_TIMER")
- Declaration as a local tag of the type TON\_TIME or IEC\_TIMER in the "Static" section of a block (for example, #MyIEC\_TIMER)

**For S7-1500 CPU**

The "Start on-delay timer" instruction stores its data in a structure of the data type IEC\_TIMER, IEC\_LTIMER, TON\_TIME or TON\_LTIME. You can declare the structure as follows:

- Declaration of a data block of system data type IEC\_TIMER or IEC\_LTIMER (for example, "MyIEC\_TIMER")
- Declaration as a local tag of the type TON\_TIME, TON\_LTIME, IEC\_TIMER or IEC\_LTIMER in the "Static" section of a block (for example, #MyIEC\_TIMER)

The instruction data is updated both when the instruction is called and also each time the assigned timer is accessed.

The current timer status is stored in the ET structure component of the IEC timer. You can use a normally open contact to query timer status for "1" or a normally closed contact for "0". The query on Q or ET (for example, "MyTimer".Q or "MyTimer".ET) updates the IEC\_TIMER structure.

The execution of the "Start on-delay timer" instruction assumes a preceding logic operation. It can be placed only at the end of the network.

**Parameter**

The following table shows the parameters of the "Start on-delay timer" instruction:

Parameter	Declaration	Data type		Memory area	Description
		S7-1200	S7-1500		
<Time duration>	Input	TIME	TIME, LTIME	I, Q, M, D, L or constant	Duration with which the IEC timer runs.
<IEC timer>	InOut	IEC_TIMER, TON_TIME	IEC_TIMER, IEC_LTIMER, TON_TIME, TON_LTIME	D, L	IEC timer that is started.

For additional information on valid data types, refer to "See also".

## Example

The following example shows how the instruction works:

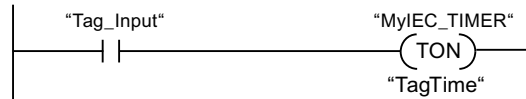

The "Start on-delay timer" instruction is executed when the signal state of the operand "Tag\_Input" changes from "0" to "1". The "MyIEC\_TIMER" timer is started for the time stored in the "TagTime" operand.

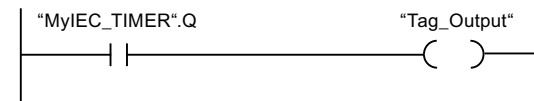

If the timer "MyIEC\_TIMER" has expired and the operand "Tag\_Input" has the signal state "1", querying the timer status ("MyIEC\_TIMER".Q) returns signal state "1" and the "Tag\_Output" operand is set. When the signal state of the operand "Tag\_Input" changes to "0", the querying of the timer status returns the signal state "0" and the operand "Tag\_Output" is reset.

## See also

Overview of the valid data types (Page 1077)

## ---( TOF )---: Start off-delay timer

### Description

Use the "Start off-delay timer" instruction to start an IEC timer with a specified duration as on-delay. The query of the timer status for "1" returns the signal state "0" if the result of logic operation (RLO) at the input of the instruction has the signal state "1". When the RLO changes from "1" to "0" (negative signal edge), the IEC timer starts with the specified time. The timer status remains at signal state "1" as long as the IEC timer is running. When the timer has run out and the RLO at the input of the instruction has the signal state "0", the timer status is set to the signal state "0". If the RLO changes to "1" before the time expires, the IEC timer is reset and the timer status remains at signal state "1".

### Note

You can start and query the IEC timer at various execution levels, as each querying of the outputs Q or ET updates the IEC\_TIMER structure.

**For S7-1200 CPU**

The instruction "Start off-delay timer" stores its data in a structure of the data type IEC\_TIMER or TOF\_TIME. You can declare the structure as follows:

- Declaration of a data block of system data type IEC\_TIMER (for example, "MyIEC\_TIMER")
- Declaration as a local tag of the type TOF\_TIME or IEC\_TIMER in the "Static" section of a block (for example, #MyIEC\_TIMER)

**For S7-1500 CPU**

The "Start off-delay timer" instruction stores its data in a structure of the data type IEC\_TIMER, IEC\_LTIMER, TOF\_TIME or TOF\_LTIME. You can declare the structure as follows:

- Declaration of a data block of system data type IEC\_TIMER or IEC\_LTIMER (for example, "MyIEC\_TIMER")
- Declaration as a local tag of the type TOF\_TIME, TOF\_LTIME, IEC\_TIMER or IEC\_LTIMER in the "Static" section of a block (for example, #MyIEC\_TIMER)

The instruction data is updated both when the instruction is called and also each time the assigned timer is accessed.

The current timer status is stored in the ET structure component of the IEC timer. You can use a normally open contact to query timer status for "1" or a normally closed contact for "0". The query on Q or ET (for example, "MyTimer".Q or "MyTimer".ET) updates the IEC\_TIMER structure.

The execution of the "Start off-delay timer" instruction assumes a preceding logic operation. It can be placed only at the end of the network.

**Parameters**

The following table shows the parameters of the "Start off-delay timer" instruction:

Parameter	Declaration	Data type		Memory area	Description
		S7-1200	S7-1500		
<Time duration>	Input	TIME	TIME, LTIME	I, Q, M, D, L or constant	Duration with which the IEC timer runs.
<IEC timer>	InOut	IEC_TIMER, TOF_TIME	IEC_TIMER, IEC_LTIMER, TOF_TIME, TOF_LTIME	D, L	IEC timer that is started.

For additional information on valid data types, refer to "See also".

## Example

The following example shows how the instruction works:

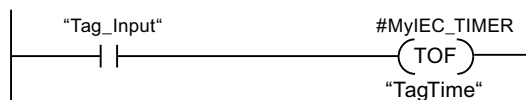

The "Start off-delay timer" instruction is executed when the signal state of the operand "Tag\_Input" changes from "1" to "0". The timer #MyIEC\_TIMER is started for the time stored in the operand "TagTime".



As long as timer #MyIEC\_TIMER is running, the query of the time status (#MyIEC\_TIMER.Q) returns the signal state "1" and operand "Tag\_Output" is set. If the timer has expired and the operand "Tag\_Input" has the signal state "0", the query of the timer status returns the signal state "0". If the signal state of the operand "Tag\_Input" changes to "1" before timer #MyIEC\_TIMER expires, the timer is reset. When the signal state of the operand "Tag\_Input" is "1", the query of the timer status returns the signal state "1".

## See also

Overview of the valid data types (Page 1077)

## ---( TONR )---: Time accumulator

### Description

You can use the "Time accumulator" instruction to record how long the signal is at the input of instruction "1". The instruction is started when the result of logic operation (RLO) changes from "0" to "1" (positive signal edge). The time is recorded as long as the RLO is "1". If the RLO changes to "0", the instruction is halted. If the RLO changes back to "1", the time recording is continued. The query of the timer status for "1" returns the signal state "1" if the recorded time exceeds the value of the specified duration and the RLO at the input of coil is "1".

The timer status and the currently expired timer can be reset to "0" using the "Reset timer" instruction.

---

### Note

You can start and query the IEC timer at various execution levels, as each querying of the outputs Q or ET updates the IEC\_TIMER structure.

---

**For S7-1200 CPU**

The "Time accumulator" instruction stores its data in a structure of the data type IEC\_TIMER or TONR\_TIME. You can declare the structure as follows:

- Declaration of a data block of system data type IEC\_TIMER (for example, "MyIEC\_TIMER")
- Declaration as a local tag of the type TONR\_TIME or IEC\_TIMER in the "Static" section of a block (for example, #MyIEC\_TIMER)

**For S7-1500 CPU**

The "Time accumulator" instruction stores its data in a structure of the data type IEC\_TIMER, IEC\_LTIMER, TONR\_TIME or TONR\_LTIME. You can declare the structure as follows:

- Declaration of a data block of system data type IEC\_TIMER or IEC\_LTIMER (for example, "MyIEC\_TIMER")
- Declaration as a local tag of the type TONR\_TIME, TONR\_LTIME, IEC\_TIMER or IEC\_LTIMER in the "Static" section of a block (for example, #MyIEC\_TIMER)

The instruction data is updated both when the instruction is called and also each time the assigned timer is accessed.

The current timer status is stored in the ET structure component of the IEC timer. You can use a normally open contact to query timer status for "1" or a normally closed contact for "0". The query on Q or ET (for example, "MyTimer".Q or "MyTimer".ET) updates the IEC\_TIMER structure.

The execution of the "Time accumulator" instruction requires a preceding logic operation. It can be placed only at the end of the network.

**Parameter**

The following table shows the parameters of the "Time accumulator" instruction:

Parameter	Declaration	Data type		Memory area	Description
		S7-1200	S7-1500		
<Time duration>	Input	TIME	TIME, LTIME	I, Q, M, D, L or constant	Duration with which the IEC timer runs.
<IEC timer>	InOut	IEC_TIMER, TONR_TIME	IEC_TIMER, IEC_LTIMER, TONR_TIME, TONR_LTIME	D, L	IEC timer that is started.

For additional information on valid data types, refer to "See also".



## Example

The following example shows how the instruction works:

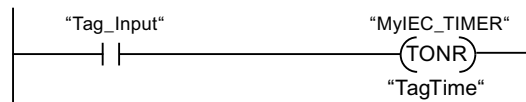

The "Time accumulator" instruction executes on a positive signal edge in the RLO. The time is recorded as long as the operand "Tag\_Input" has the signal state "1".

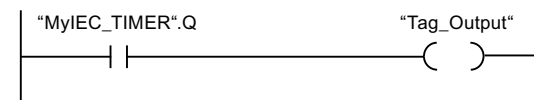

If the recorded time exceeds the value of the operand "TagTime", then the query of the timer status ("MyIEC\_TIMER".Q) will return the signal state "1" and the operand "Tag\_Output" will be set.

## See also

Overview of the valid data types (Page 1077)

## ---( RT )---: Reset timer

### Description

You can use the "Reset timer" instruction to reset an IEC timer to "0". The instruction is only executed if the result of logic operation (RLO) at the input of the coil is "1". If current is flowing to the coil (RLO is "1"), the structure components of the timer in the specified data block are reset to "0". If the RLO at the input of the instruction is "0", the timer remains unchanged.

The instruction does not influence the RLO. The RLO at the input of the coil is sent directly to the output of the coil.

You assign the "Reset timer" instruction an IEC timer that has been declared in the program.

The instruction data is updated only when the instruction is called and not each time the assigned IEC timer is accessed. Querying the data is only identical from the call of the instruction to the next call of the instruction.

**Parameters**

The following table shows the parameters of the "Reset timer" instruction:

Parameter	Declaration	Data type		Memory area	Description
		S7-1200	S7-1500		
<IEC timer>	Output	IEC_TIMER, TP_TIME, TON_TIME, TOF_TIME, TONR_TIME	IEC_TIMER, IEC_LTIMER, TP_TIME, TP_LTIME, TON_TIME, TON_LTIME, TOF_TIME, TOF_LTIME, TONR_TIME, TONR_LTIME	D, L	IEC timer that is reset.

For additional information on valid data types, refer to "See also".

**Example**

The following example shows how the instruction works:

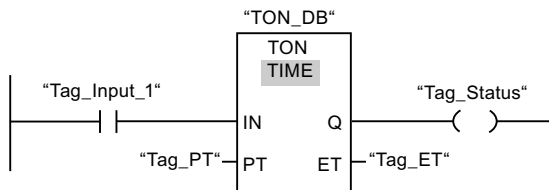

The "Generate on-delay" instruction executes when the signal state of the "Tag\_Input\_1" operand changes from "0" to "1". The timer stored in the "TON\_DB" instance data block starts running for the time duration specified by operand "Tag\_PT".

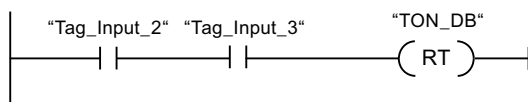

If operands "Tag\_Input\_2" and "Tag\_Input\_3" have the signal state "1", the "Reset timer" instruction is executed and the timer stored in the "TON\_DB" data block.

**See also**

Overview of the valid data types (Page 1077)

**---( PT )---**: Load time duration

**Description**

You can use the "Load time duration" instruction to set the time for an IEC timer. The instruction is executed in every cycle when the result of logic operation (RLO) at the input of the instruction

has the signal state "1". The instruction writes the specified time to the structure of the specified IEC timer.

### Note

If the specified IEC timer is running while the instruction executes, the instruction overwrites the current time of the specified IEC timer. This can change the timer status of the IEC timer.

You assign an IEC timer declared in the program to the "Load time duration" instruction.

The instruction data is updated only when the instruction is called and each time the assigned IEC timer is accessed. The query on Q or ET (for example, "MyTimer".Q or "MyTimer".ET) updates the IEC\_TIMER structure.

## Parameter

The following table shows the parameters of the "Load time duration" instruction:

Parameter	Declaration	Data type		Memory area	Description
		S7-1200	S7-1500		
<Time duration>	Input	TIME	TIME, LTIME	I, Q, M, D, L or constant	Duration with which the IEC timer runs.
<IEC timer>	Output	IEC_TIMER, TP_TIME, TON_TIME, TOF_TIME, TONR_TIME	IEC_TIMER, IEC_LTIMER, TP_TIME, TP_LTIME, TON_TIME, TON_LTIME, TOF_TIME, TOF_LTIME, TONR_TIME, TONR_LTIME	D, L	IEC timer, the duration of which is set.

For additional information on valid data types, refer to "See also".

## Example

The following example shows how the instruction works:

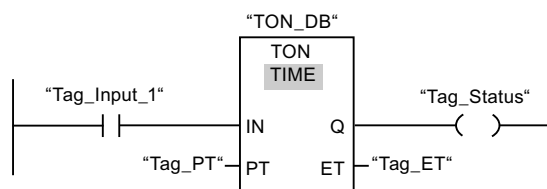

The "Generate on-delay" instruction executes when the signal state of the "Tag\_Input\_1" operand changes from "0" to "1". The IEC timer stored in the instance data block "TON\_DB" is started with the time duration that is specified by the operand "Tag\_PT".

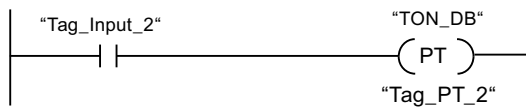

The "Load time duration" instruction is executed when the operand "Tag\_Input\_2" has the signal state "1". The instruction writes the time duration "Tag\_PT\_2" in the instance data block "TON\_DB" and at the same time overwrites the value of the operand "Tag\_PT" within the data block. The signal state of the timer status may therefore change at the next query or when "MyTimer".Q or "MyTimer".ET are accessed.

**See also**

Overview of the valid data types (Page 1077)

**SIMATIC Timers**

**S\_PULSE: Assign pulse timer parameters and start**

**Description**

The "Assign pulse timer parameters and start" instruction starts a programmed timer when a change from "0" to "1" (positive signal edge) is detected in the result of logic operation (RLO) at input S. The timer expires with the programmed duration (TV) as soon as the signal state at input S is "1". If the signal state at input S changes to "0" before the programmed duration expires, the timer is stopped. In this case, the signal state at output Q is "0".

The duration is made up internally of a time value and a time base and is programmed at parameter TV. When the instruction is started, the programmed time value is counted down towards zero. The time base indicates the time period with which the time value is changed. The current time value is output BI-coded at output BI and BCD-coded at output BCD.

If the timer is running and the signal state at input R changes to "1" then the current time value and the time base are also set to zero. If the timer is not running, the signal state "1" at the R input has no effect.

The "Assign pulse timer parameters and start" instruction requires a preceding logic operation for edge evaluation and can be placed within or at the end of the network.

The instruction data is updated at every access. It can therefore happen that the query of the data at the start of the cycle returns different values than at the end of the cycle.

---

**Note**

In the time cell, the operating system reduces the time value in an interval specified by the time base by one unit until the value equals "0". The decrementation is performed asynchronously to the user program. The resulting timer is therefore at maximum up to one time interval shorter than the desired time base.

---

You can find an example of how a time cell can be formed under: See also "L: Load timer value".

## Parameters

The following table shows the parameters of the instruction "Assign pulse timer parameters and start":

Parameter	Declaration	Data type	Memory area	Description
<Timer>	InOut/Input	TIMER	T	Time of the instruction The number of timers depends on the CPU.
S	Input	BOOL	I, Q, M, D, L	Start input
TV	Input	S5TIME, WORD	I, Q, M, D, L or constant	Preset time value
R	Input	BOOL	I, Q, M, T, C, D, L, P or constant	Reset input
BI	Output	WORD	I, Q, M, D, L, P	Current time value (BI-coded)
BCD	Output	WORD	I, Q, M, D, L, P	Current time value (BCD format)
Q	Output	BOOL	I, Q, M, D, L	Status of the timer

For additional information on valid data types, refer to "See also".

**Pulse timing diagram**

The following figure shows the pulse timing diagram of the instruction "Assign pulse timer parameters and start":

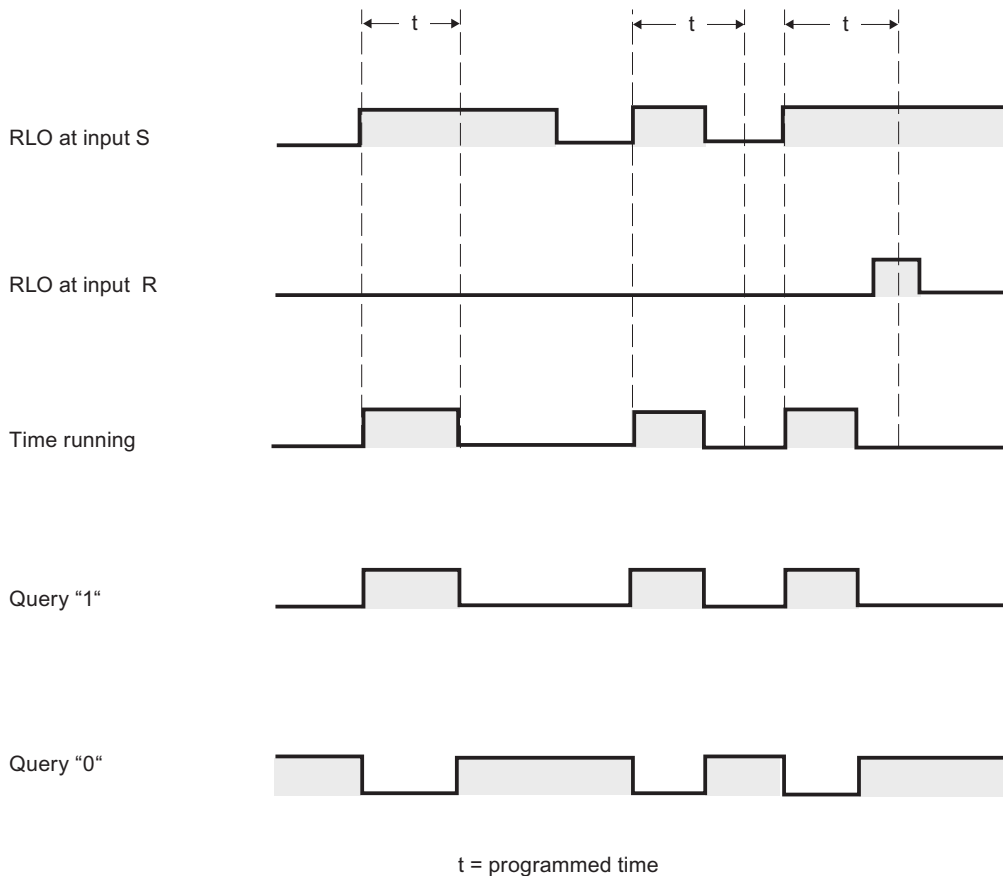

**Example**

The following example shows how the instruction works:

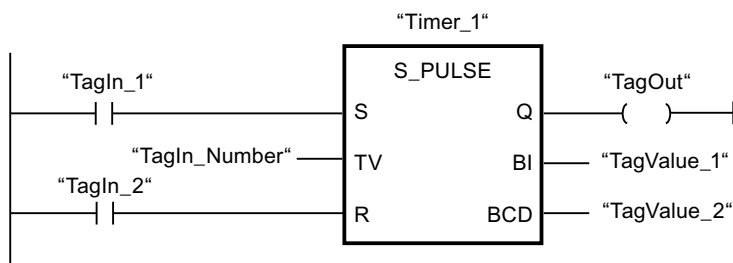

The timer "Timer\_1" is started when the signal state of the operand "TagIn\_1" changes from "0" to "1". The timer expires with the time value of the operand "TagIn\_Number" as long as the operand "TagIn\_1" has the signal state "1". If the signal state of the operand "TagIn\_1" changes from "1" to "0" before the timer expires, the timer "Timer\_1" is stopped. The operand "TagOut" is reset to "0" in this case.

The operand "TagOut" has the signal state "1" as long as the timer is running and the operand "TagIn\_1" has the signal state "1". When the timer expires or is reset, the operand "TagOut" is reset to "0".

### See also

Overview of the valid data types (Page 1077)

## S\_PEXT: Assign extended pulse timer parameters and start

### Description

The "Assign extended pulse timer parameters and start" instruction starts a programmed timer when a change from "0" to "1" (positive signal edge) is detected in the result of logic operation (RLO) at input S. The timer expires with the programmed duration (TV), even if the signal state at input S changes to "0". As long as the timer is running, the output Q has the signal state "1". When the timer expires, the output Q is reset to "0". If the signal state at input S changes from "0" to "1" while the timer is running, the timer is restarted with the duration programmed at input TV.

The duration is made up internally of a time value and a time base and is programmed at parameter TV. When the instruction is started, the programmed time value is counted down towards zero. The time base indicates the time period with which the time value is changed. The current time value is output BI-coded at output BI and BCD-coded at output BCD.

If the timer is running and the signal state at input R changes to "1" then the current time value and the time base are also set to zero. If the timer is not running, the signal state "1" at the R input has no effect.

The "Assign extended pulse timer parameters and start" instruction requires a preceding logic operation for edge evaluation and can be placed within or at the end of the network.

The instruction data is updated at every access. It can therefore happen that the query of the data at the start of the cycle returns different values than at the end of the cycle.

---

### Note

In the time cell, the operating system reduces the time value in an interval specified by the time base by one unit until the value equals "0". The decrementation is performed asynchronously to the user program. The resulting timer is therefore at maximum up to one time interval shorter than the desired time base.

---

You can find an example of how a time cell can be formed under: See also "L: Load timer value".

**Parameter**

The following table shows the parameters of the instruction "Assign extended pulse timer parameters and start":

Parameter	Declaration	Data type	Memory area	Description
<Timer>	InOut/Input	TIMER	T	Time of the instruction The number of timers depends on the CPU.
S	Input	BOOL	I, Q, M, D, L	Start input
TV	Input	S5TIME, WORD	I, Q, M, D, L or constant	Preset time value
R	Input	BOOL	I, Q, M, T, C, D, L, P or constant	Reset input
BI	Output	WORD	I, Q, M, D, L, P	Current time value (BI-coded)
BCD	Output	WORD	I, Q, M, D, L, P	Current time value (BCD format)
Q	Output	BOOL	I, Q, M, D, L	Status of the timer

For additional information on valid data types, refer to "See also".



### Pulse timing diagram

The following figure shows the pulse timing diagram of the "Assign extended pulse timer parameters and start" instruction:

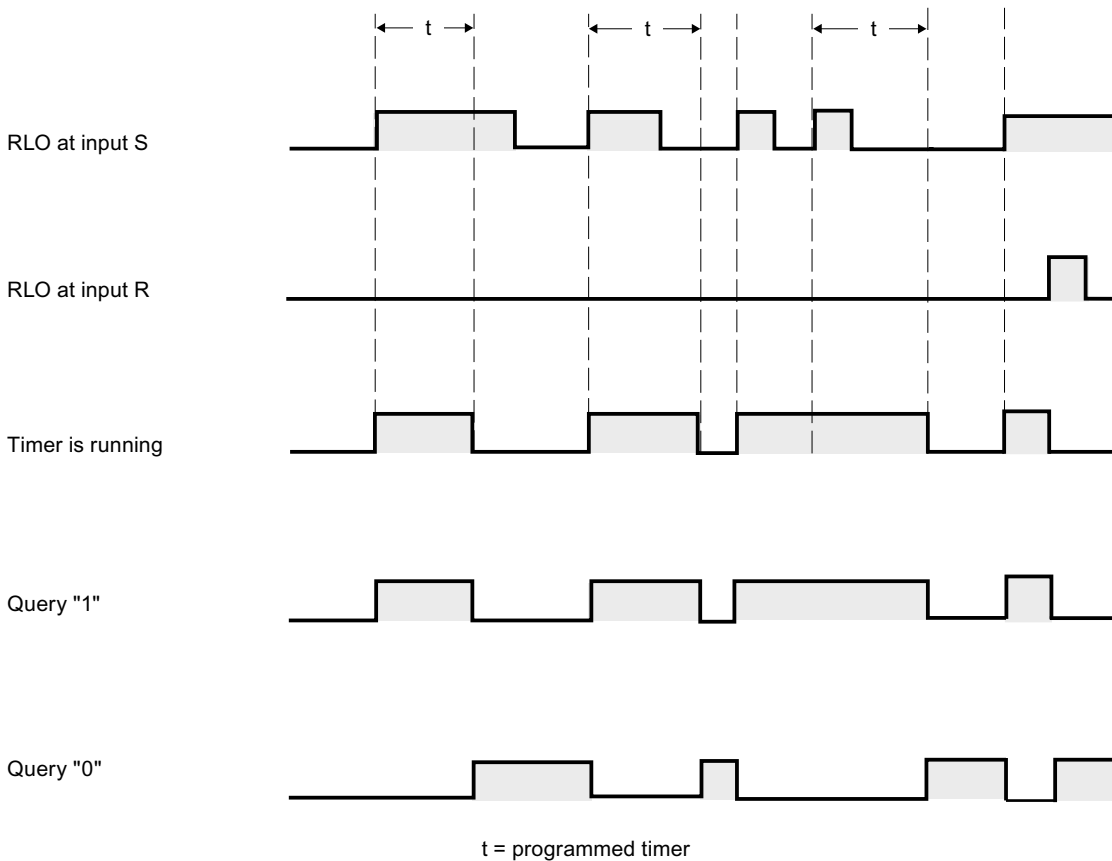

### Example

The following example shows how the instruction works:

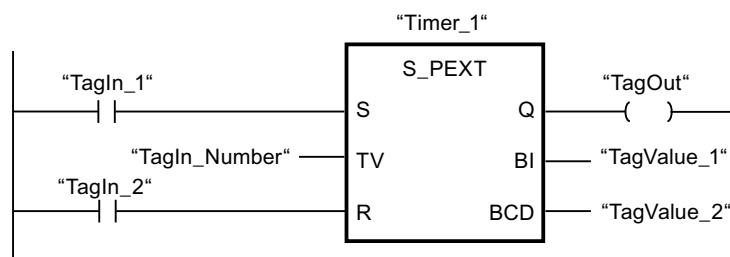

The timer "Timer\_1" is started when the signal state of the operand "TagIn\_1" changes from "0" to "1". The timer expires with the time value of the operand "TagIn\_Number" without being affected by a negative edge at input S. If the signal state of the operand "TagIn\_1" changes from "0" to "1" before the timer expires, the timer is restarted.

The operand "TagOut" has the signal state "1" as long as the timer is running. When the timer expires or is reset, the operand "TagOut" is reset to "0".

### See also

Overview of the valid data types (Page 1077)

## S\_ODT: Assign on-delay timer parameters and start

### Description

The "Assign on-delay timer parameters and start" instruction starts a programmed timer when a change from "0" to "1" (positive signal edge) is detected in the result of logic operation (RLO) at input S. The timer expires with the programmed duration (TV) as soon as the signal state at input S is "1". If the timer expires correctly and input S still has signal state "1" then output Q returns signal state "1". If the signal state at input S changes from "1" to "0" while the timer is running, the timer is stopped. In this case, output Q is reset to signal state "0".

The duration is made up internally of a time value and a time base and is programmed at parameter TV. When the instruction is started, the programmed time value is counted down towards zero. The time base indicates the time period with which the time value is changed. The current time value is output BI-coded at output BI and BCD-coded at output BCD.

If the time is running and the signal state at input R changes from "0" to "1" then the current time value and the time base are also set to zero. In this case, the signal state at output Q is "0". The timer is reset if the signal state is "1" at the R input even if the timer is not running and the RLO at input S is "1".

Specify the timer of the instruction in the placeholder above the box. The timer must be declared with the data type TIMER.

The "Assign on-delay timer parameters and start" instruction requires a preceding logic operation for edge evaluation and can be placed within or at the end of the network.

The instruction data is updated at every access. It can therefore happen that the query of the data at the start of the cycle returns different values than at the end of the cycle.

---

### Note

In the time cell, the operating system reduces the time value in an interval specified by the time base by one unit until the value equals "0". The decrementation is performed asynchronously to the user program. The resulting timer is therefore at maximum up to one time interval shorter than the desired time base.

---

You can find an example of how a time cell can be formed under: See also "L: Load timer value".

## Parameter

The following table shows the parameters of the "Assign on-delay timer parameters and start" instruction:

Parameter	Declaration	Data type	Memory area	Description
<Timer>	InOut/Input	TIMER	T	Time of the instruction The number of timers depends on the CPU.
S	Input	BOOL	I, Q, M, D, L	Start input
TV	Input	S5TIME, WORD	I, Q, M, D, L or constant	Preset time value
R	Input	BOOL	I, Q, M, T, C, D, L, P or constant	Reset input
BI	Output	WORD	I, Q, M, D, L, P	Current time value (BI-coded)
BCD	Output	WORD	I, Q, M, D, L, P	Current time value (BCD format)
Q	Output	BOOL	I, Q, M, D, L	Status of the timer

For additional information on valid data types, refer to "See also".

**Pulse timing diagram**

The following figure shows the pulse timing diagram of the "Assign on-delay timer parameters and start" instruction:

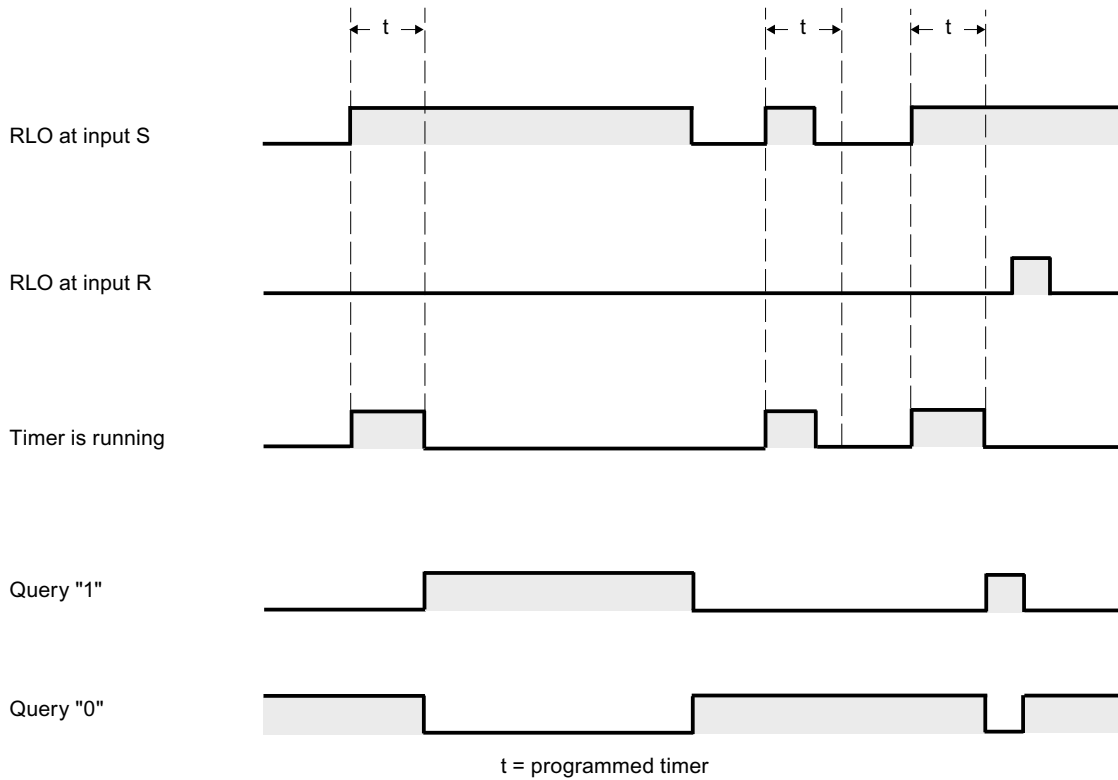

**Example**

The following example shows how the instruction works:

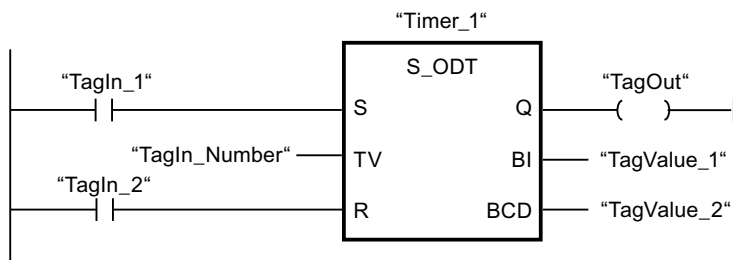

The timer "Timer\_1" is started when the signal state of the operand "TagIn\_1" changes from "0" to "1". The timer expires with the time value of the operand "TagIn\_Number". If the timer expires and the operand has the signal state "1", the operand "TagOut" is set to "1". If the signal state of the operand "TagIn\_1" changes from "1" to "0" before the timer expires, the timer is stopped. The operand "TagOut" has the signal state "0" in this case.

**See also**

Overview of the valid data types (Page 1077)

**S\_ODTS: Assign retentive on-delay timer parameters and start****Description**

The "Assign retentive on-delay timer parameters and start" instruction starts a programmed timer when a change from "0" to "1" (positive signal edge) is detected in the result of logic operation (RLO) at input S. The timer expires with the programmed duration (TV), even if the signal state at input S changes to "0". If the timer expires, the "Q" output returns signal state "1" regardless of the signal state at input "S". If the signal state at input S changes from "0" to "1" while the timer is running, the timer is restarted with the duration programmed at input (TV).

The duration is made up internally of a time value and a time base and is programmed at parameter TV. When the instruction is started, the programmed time value is counted down towards zero. The time base indicates the time period with which the time value is changed. The current time value is output BI-coded at output BI and BCD-coded at output BCD.

Signal state "1" at input R resets the current time value and time base to "0" regardless of the signal state at start input S. In this case, the signal state at output Q is "0".

The "Assign retentive on-delay timer parameters and start" instruction requires a preceding logic operation for edge evaluation and can be placed within or at the end of the network.

The instruction data is updated at every access. It can therefore happen that the query of the data at the start of the cycle returns different values than at the end of the cycle.

**Note**

In the time cell, the operating system reduces the time value in an interval specified by the time base by one unit until the value equals "0". The decrementation is performed asynchronously to the user program. The resulting timer is therefore at maximum up to one time interval shorter than the desired time base.

You can find an example of how a time cell can be formed under: See also "L: Load timer value".

**Parameter**

The following table shows the parameters of the "Assign retentive on-delay timer parameters and start" instruction:

Parameter	Declaration	Data type	Memory area	Description
<Timer>	InOut/Input	TIMER	T	Time of the instruction The number of timers depends on the CPU.
S	Input	BOOL	I, Q, M, D, L	Start input

Parameter	Declaration	Data type	Memory area	Description
TV	Input	S5TIME, WORD	I, Q, M, D, L or constant	Preset time value
R	Input	BOOL	I, Q, M, T, C, D, L, P or constant	Reset input
BI	Output	WORD	I, Q, M, D, L, P	Current time value (BI-coded)
BCD	Output	WORD	I, Q, M, D, L, P	Current time value (BCD format)
Q	Output	BOOL	I, Q, M, D, L	Status of the timer

For additional information on valid data types, refer to "See also".

### Pulse timing diagram

The following figure shows the pulse timing diagram of the "Assign retentive on-delay timer parameters and start" instruction:

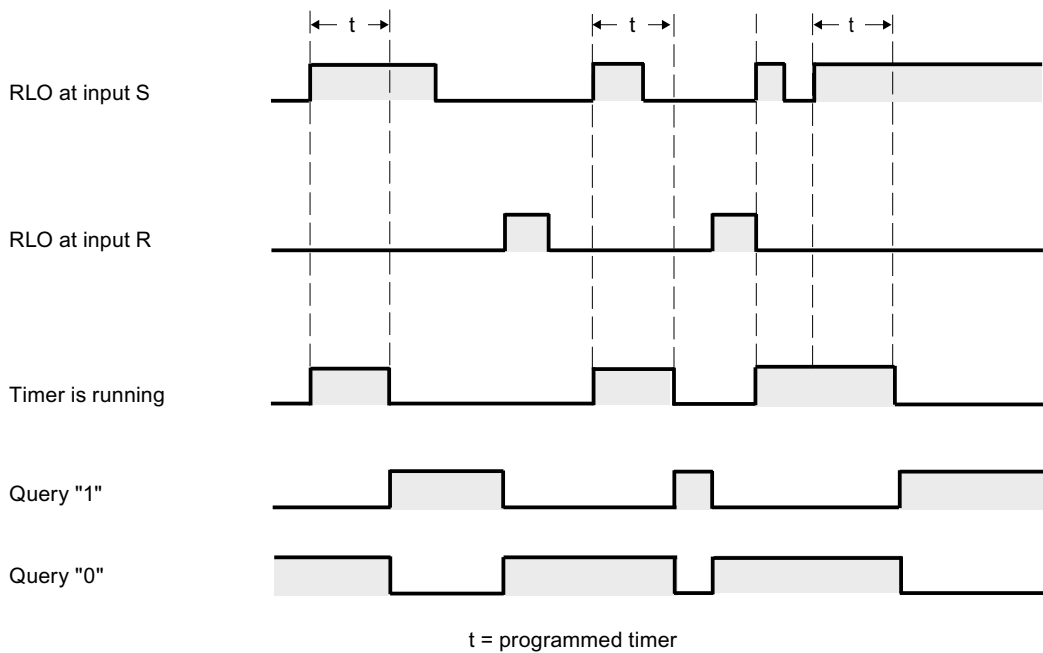

## Example

The following example shows how the instruction works:

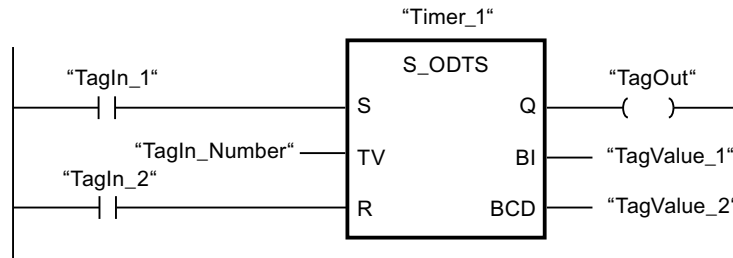

The timer "Timer\_1" is started when the signal state of the operand "TagIn\_1" changes from "0" to "1". The timer expires with the time value of the operand "TagIn\_Number", even if the signal state of the operand "TagIn\_1" changes to "0". When the timer expires, the operand "TagOut" is set to "1". If the signal state of the operand "TagIn\_1" changes from "0" to "1" while the timer is running, the timer is restarted.

## See also

Overview of the valid data types (Page 1077)

## S\_OFFDT: Assign off-delay timer parameters and start

### Description

The "Assign off-delay timer parameters and start" instruction starts a programmed timer when a change from "1" to "0" (negative signal edge) is detected in the result of logic operation (RLO) at input S. The timer expires with the programmed duration (TV). As long as the timer is running or input S returns signal state "1", then output Q has signal state "1". When the timer expires and the signal state at input S is "0", output Q is reset to the signal state "0". If the signal state at input S changes from "0" to "1" while the timer is running, the timer is stopped. The timer is only restarted after a falling signal edge is detected at input S.

The duration is made up internally of a time value and a time base and is programmed at parameter TV. When the instruction is started, the programmed time value is counted down towards zero. The time base indicates the time period with which the time value is changed. The current time value is output BI-coded at output BI and BCD-coded at output BCD.

Signal state "1" at input R resets the current time value and time base to "0". In this case, the signal state at output Q is "0".

The "Assign off-delay timer parameters and start" instruction requires a preceding logic operation for edge evaluation and can be placed within or at the end of the network.

The instruction data is updated at every access. It can therefore happen that the query of the data at the start of the cycle returns different values than at the end of the cycle.

**Note**

In the time cell, the operating system reduces the time value in an interval specified by the time base by one unit until the value equals "0". The decrementation is performed asynchronously to the user program. The resulting timer is therefore at maximum up to one time interval shorter than the desired time base.

You can find an example of how a time cell can be formed under: See also "L: Load timer value".

**Parameter**

The following table shows the parameters of the "Assign off-delay timer parameters and start" instruction:

Parameter	Declaration	Data type	Memory area	Description
<Timer>	InOut/Input	TIMER	T	Time of the instruction The number of timers depends on the CPU.
S	Input	BOOL	I, Q, M, D, L	Start input
TV	Input	S5TIME, WORD	I, Q, M, D, L or constant	Preset time value
R	Input	BOOL	I, Q, M, T, C, D, L, P or constant	Reset input
BI	Output	WORD	I, Q, M, D, L, P	Current time value (BI-coded)
BCD	Output	WORD	I, Q, M, D, L, P	Current time value (BCD format)
Q	Output	BOOL	I, Q, M, D, L	Status of the timer

For additional information on valid data types, refer to "See also".



### Pulse timing diagram

The following figure shows the pulse timing diagram of the "Assign off-delay timer parameters and start" instruction:

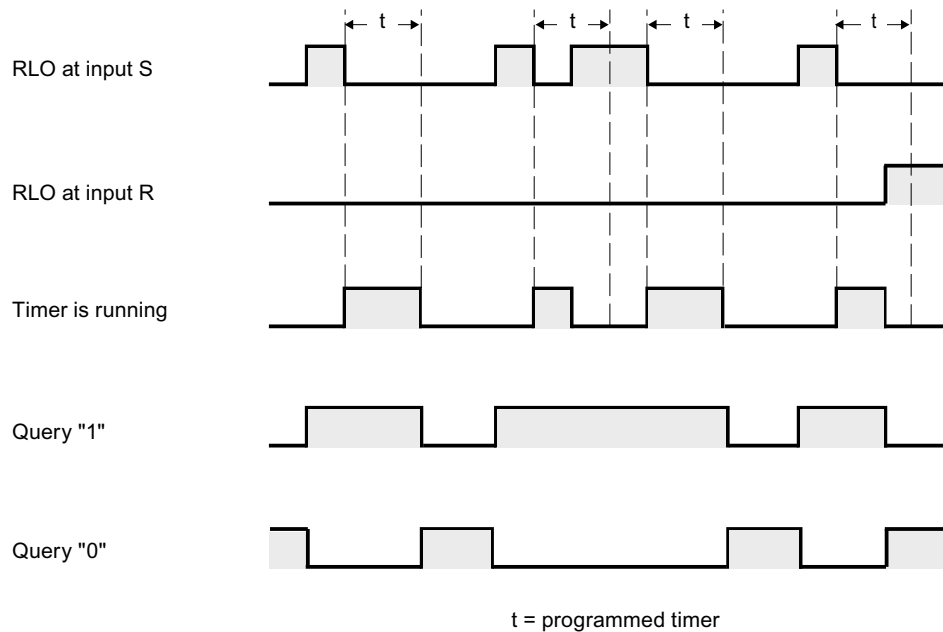

### Example

The following example shows how the instruction works:

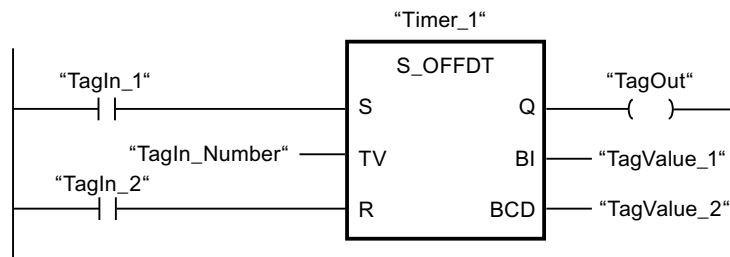

The timer "Timer\_1" is started when the signal state of the operand "TagIn\_1" changes from "1" to "0". The timer expires with the time value of the operand "TagIn\_Number". The operand "TagOut" is set to "1" when the timer is running and when the operand "TagIn\_1" has the signal state "0". If the signal state of the operand "TagIn\_1" changes from "0" to "1" while the timer is running, the timer is reset.

### See also

Overview of the valid data types (Page 1077)

---( SP ): Start pulse timer

**Description**

The "Start pulse timer" instruction starts a programmed timer when a change from "0" to "1" (positive signal edge) is detected in the result of logic operation (RLO). The time runs with the specified duration as long as the RLO has the signal state "1". As long as the timer is running, the querying of the timer status for "1" returns the signal state "1". If there is a change from "1" to "0" in the RLO before the time value has elapsed, the timer stops. In this case, the querying of the timer status for "1" returns the signal state "0".

The duration is made up internally of a time value and a time base. When the instruction is started, the programmed time value is counted down towards zero. The time base indicates the time period with which the time value is changed.

The "Start pulse timer" instruction requires a preceding logic operation for edge evaluation and can only be placed at the right side of the network.

**Note**

In the time cell, the operating system reduces the time value in an interval specified by the time base by one unit until the value equals "0". The decrementation is performed asynchronously to the user program. The resulting timer is therefore at maximum up to one time interval shorter than the desired time base.

You can find an example of how a time cell can be formed under: See also "L: Load timer value".

**Parameters**

The following table shows the parameters of the "Start pulse timer" instruction:

Parameter	Declaration	Data type	Memory area	Description
<Time duration>	Input	S5TIME, WORD	I, Q, M, D, L or constant	Duration with which the timer expires.
<Timer>	InOut/Input	TIMER	T	Timer which is started. The number of timers depends on the CPU.

For additional information on valid data types, refer to "See also".

## Example

The following example shows how the instruction works:

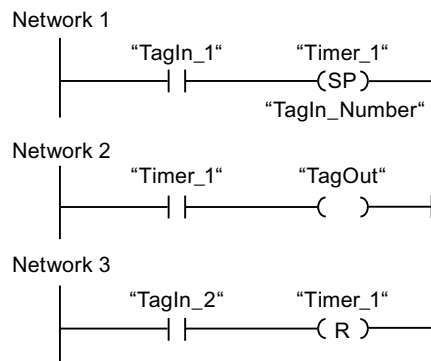

The timer "Timer\_1" is started when the signal state of the operand "TagIn\_1" changes from "0" to "1". The timer expires with the time value of the operand "TagIn\_Number" as long as the signal state of the operand "TagIn\_1" is "1". If the signal state of the operand "TagIn\_1" changes from "1" to "0" before the timer expires, the timer is stopped. As long as the timer is running, the operand "TagOut" has the signal state "1". A signal state change of the operand "TagIn\_1" from "0" to "1" resets the timer, which stops the timer and sets the current time value to "0".

## See also

Overview of the valid data types (Page 1077)

## ---( SE ): Start extended pulse timer

### Description

The "Start extended pulse timer" instruction starts a programmed timer when a change from "0" to "1" (positive signal edge) is detected in the result of logic operation (RLO). The timer expires with the specified duration, even if the RLO changes to the signal state "0". As long as the timer is running, the querying of the timer status for "1" returns the signal state "1". If the RLO changes from "0" to "1" while the timer is running, the timer is restarted with the programmed duration. The querying of the timer status for "1" returns the signal state "0" when the timer expires.

The duration is made up internally of a time value and a time base. When the instruction is started, the programmed time value is counted down towards zero. The time base indicates the time period with which the time value is changed.

The "Start extended pulse timer" instruction requires a preceding logic operation for edge evaluation and can only be placed at the right side of the network.

**Note**

In the time cell, the operating system reduces the time value in an interval specified by the time base by one unit until the value equals "0". The decrementation is performed asynchronously to the user program. The resulting timer is therefore at maximum up to one time interval shorter than the desired time base.

You can find an example of how a time cell can be formed under: See also "L: Load timer value".

**Parameter**

The following table shows the parameters of the "Start extended pulse timer" instruction:

Parameter	Declaration	Data type	Memory area	Description
<Time duration>	Input	S5TIME, WORD	I, Q, M, D, L or constant	Duration with which the timer expires.
<Timer>	InOut/Input	TIMER	T	Timer which is started. The number of timers depends on the CPU.

For additional information on valid data types, refer to "See also".

**Example**

The following example shows how the instruction works:

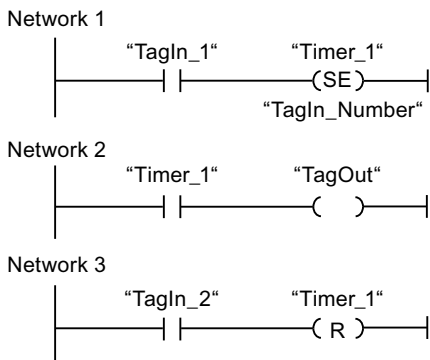

The timer "Timer\_1" is started when the signal state of the operand "TagIn\_1" changes from "0" to "1". The timer expires with the time value of the operand "TagIn\_Number" without being affected by a negative edge in the RLO. As long as the timer is running, the operand "TagOut" has the signal state "1". If the signal state of the operand "TagIn\_1" changes from "0" to "1" before the timer expires, the timer is restarted.

**See also**

Overview of the valid data types (Page 1077)

**---( SD ): Start on-delay timer****Description**

The "Start on-delay timer" instruction starts a programmed timer when a change from "0" to "1" (positive signal edge) is detected in the result of logic operation (RLO). The timer runs for the specified duration as long as the RLO is "1". If the timer expires and the RLO still has the signal state "1", the query of the timer status for "1" returns the signal state "1". If the RLO changes from "1" to "0" while the timer is running, the timer is stopped. In this case, the querying of the timer status for "1" returns the signal state "0".

The duration is made up internally of a time value and a time base. When the instruction is started, the programmed time value is counted down towards zero. The time base indicates the time period with which the time value is changed.

The "Start on-delay timer" instruction requires a preceding logic operation for edge evaluation and can only be placed at the right side of the network.

**Note**

In the time cell, the operating system reduces the time value in an interval specified by the time base by one unit until the value equals "0". The decrementation is performed asynchronously to the user program. The resulting timer is therefore at maximum up to one time interval shorter than the desired time base.

You can find an example of how a time cell can be formed under: See also "L: Load timer value".

**Parameter**

The following table shows the parameters of the "Start on-delay timer" instruction:

Parameter	Declaration	Data type	Memory area	Description
<Time duration>	Input	S5TIME, WORD	I, Q, M, D, L or constant	Duration with which the timer expires.
<Timer>	InOut/Input	TIMER	T	Timer which is started. The number of timers depends on the CPU.

For additional information on valid data types, refer to "See also".

**Example**

The following example shows how the instruction works:

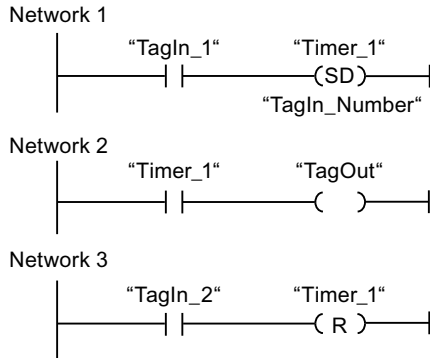

The timer "Timer\_1" is started when the signal state of the operand "TagIn\_1" changes from "0" to "1". The timer expires with the time value of the operand "TagIn\_Number". If the timer expires and the RLO has the signal state "1", the operand "TagOut" is set to "1". If the signal state of the operand "TagIn\_1" changes from "1" to "0" before the timer expires, the timer is stopped. If the signal state of the operand "TagIn\_2" is "1", the timer "Timer\_1" is reset, which stops the timer and sets the current time value to "0".

**See also**

Overview of the valid data types (Page 1077)

**---( SS ): Start retentive on-delay timer**

**Description**

The "Start retentive on-delay timer" instruction starts a programmed timer when a change from "0" to "1" (positive signal edge) is detected in the result of logic operation (RLO). The timer expires with the specified duration, even if the RLO changes to the signal state "0". When the timer expires, the querying of the timer status for "1" returns the signal state "1". After expiry of the timer, the timer can only be restarted if it is explicitly reset.

The duration is made up internally of a time value and a time base. When the instruction is started, the programmed time value is counted down towards zero. The time base indicates the time period with which the time value is changed.

The "Start retentive on-delay timer" instruction requires a preceding logic operation for edge evaluation and can only be placed at the right side of the network.

---

**Note**

In the time cell, the operating system reduces the time value in an interval specified by the time base by one unit until the value equals "0". The decrementation is performed asynchronously to the user program. The resulting timer is therefore at maximum up to one time interval shorter than the desired time base.

---

You can find an example of how a time cell can be formed under: See also "L: Load timer value".

## Parameters

The following table shows the parameters of the "Start retentive on-delay timer" instruction:

Parameter	Declaration	Data type	Memory area	Description
<Time duration>	Input	S5TIME, WORD	I, Q, M, D, L or constant	Duration with which the timer expires.
<Timer>	InOut/Input	TIMER	T	Timer which is started. The number of timers depends on the CPU.

For additional information on valid data types, refer to "See also".

## Example

The following example shows how the instruction works:

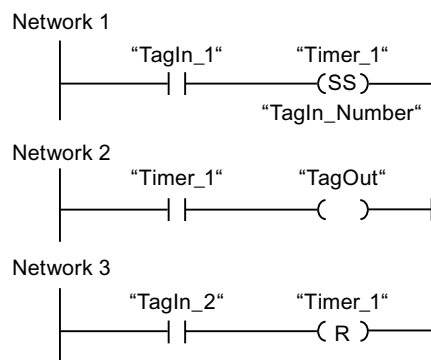

The timer "Timer\_1" is started when the signal state of the operand "TagIn\_1" changes from "0" to "1". The timer expires with the time value of the operand "TagIn\_Number". When the timer expires, the operand "TagOut" is set to "1". If the signal state of the operand "TagIn\_1" changes from "0" to "1" while the timer is running, the timer is restarted. If the signal state of the operand "TagIn\_2" is "1", the timer "Timer\_1" is reset, which stops the timer and sets the current time value to "0".

## See also

Overview of the valid data types (Page 1077)

---( SF ): Start off-delay timer

**Description**

The "Start off-delay timer" instruction starts a programmed timer when a change from "1" to "0" (negative signal edge) is detected in the result of logic operation (RLO). The timer expires with the specified duration. As long as the timer is running, the querying of the timer status for "1" returns the signal state "1". If the RLO changes from "0" to "1" while the timer is running, the timer is reset. The timer is always restarted when the RLO changes from "1" to "0".

The duration is made up internally of a time value and a time base. When the instruction is started, the programmed time value is counted down towards zero. The time base indicates the time period with which the time value is changed.

The "Start off-delay timer" instruction requires a preceding logic operation for edge evaluation and can only be placed at the right side of the network.

**Note**

In the time cell, the operating system reduces the time value in an interval specified by the time base by one unit until the value equals "0". The decrementation is performed asynchronously to the user program. The resulting timer is therefore at maximum up to one time interval shorter than the desired time base.

You can find an example of how a time cell can be formed under: See also "L: Load timer value".

**Parameter**

The following table shows the parameters of the "Start off-delay timer" instruction:

Parameter	Declaration	Data type	Memory area	Description
<Time duration>	Input	S5TIME, WORD	I, Q, M, D, L or constant	Duration with which the timer expires.
<Timer>	InOut/Input	TIMER	T	Timer which is started. The number of timers depends on the CPU.

For additional information on valid data types, refer to "See also".



## Example

The following example shows how the instruction works:

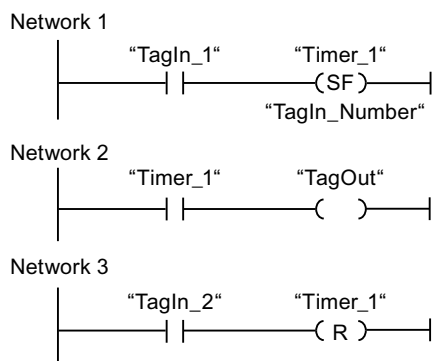

The timer "Timer\_1" is started when the signal state of the operand "TagIn\_1" changes from "1" to "0". The timer expires with the time value of the operand "TagIn\_Number". As long as the timer is running, the operand "TagOut" is set to "1". If the signal state of the operand "TagIn\_1" changes from "1" to "0" while the timer is running, the timer is restarted. If the signal state of the operand "TagIn\_2" is "1", the timer "Timer\_1" is reset, which stops the timer and sets the current time value to "0".

## See also

Overview of the valid data types (Page 1077)

## Counter operations

### IEC Counters

#### CTU: Count up

### Description

You can use the "Count up" instruction to increment the value at output CV. When the signal state at the CU input changes from "0" to "1" (positive signal edge), the instruction executes and the current counter value at the CV output is incremented by one. When the instruction executes for the first time, the current counter value at the CV output is set to zero. The counter value is incremented each time a positive signal edge is detected, until it reaches the high limit for the data type specified at the CV output. When the high limit is reached, the signal state at the CU input no longer has an effect on the instruction.

You can scan the counter status at the Q output. The signal state at the Q output is determined by the parameter PV. If the current counter value is greater than or equal to the value of the PV parameter, the Q output is set to signal state "1". In all other cases, the Q output has signal state "0".

The value at the CV output is reset to zero when the signal state at input R changes to "1". As long as the R input has signal state "1", the signal state at the CU input has no effect on the instruction.

**Note**

Only use a counter at a single location in the program to avoid risk of counting errors.

Each call of the "Count up" instruction must be assigned an IEC counter in which the instruction data is stored. An IEC counter is a structure with one of the following data types:

**For S7-1200 CPU**

Data block of system data type IEC_counter (global DB)	Local tag
<ul style="list-style-type: none"> <li>• IEC_SCOUNTER / IEC_USCOUNTER</li> <li>• IEC_COUNTER / IEC_UCOUNTER</li> <li>• IEC_DCOUNTER / IEC_UDCOUNTER</li> </ul>	<ul style="list-style-type: none"> <li>• CTU_SINT / CTU_USINT</li> <li>• CTU_INT / CTU_UINT</li> <li>• CTU_DINT / CTU_UDINT</li> <li>• IEC_SCOUNTER / IEC_USCOUNTER</li> <li>• IEC_COUNTER / IEC_UCOUNTER</li> <li>• IEC_DCOUNTER / IEC_UDCOUNTER</li> </ul>

**For S7-1500 CPU**

Data block of system data type IEC_counter (global DB)	Local tag
<ul style="list-style-type: none"> <li>• IEC_SCOUNTER / IEC_USCOUNTER</li> <li>• IEC_COUNTER / IEC_UCOUNTER</li> <li>• IEC_DCOUNTER / IEC_UDCOUNTER</li> <li>• IEC_LCOUNTER / IEC_ULCOUNTER</li> </ul>	<ul style="list-style-type: none"> <li>• CTU_SINT / CTU_USINT</li> <li>• CTU_INT / CTU_UINT</li> <li>• CTU_DINT / CTU_UDINT</li> <li>• CTU_LINT / CTU_ULINT</li> <li>• IEC_SCOUNTER / IEC_USCOUNTER</li> <li>• IEC_COUNTER / IEC_UCOUNTER</li> <li>• IEC_DCOUNTER / IEC_UDCOUNTER</li> <li>• IEC_LCOUNTER / IEC_ULCOUNTER</li> </ul>

You can declare an IEC counter as follows:

- Declaration of a data block of system data type IEC\_COUNTER (for example, "MyIEC\_COUNTER")
- Declaration as a local tag of the type CTU or IEC\_COUNTER in the "Static" section of a block (for example, #MyIEC\_COUNTER)

When you insert the instruction in the program, the "Call options" dialog opens in which you can specify whether the IEC counter is stored in its own data block (single instance) or as a local tag (multiple instance) in the block interface. If you create a separate data block, you will find it in the project tree in the "Program resources" folder under "Program blocks > System blocks". For additional information on this topic, refer to "See also".

The execution of the "Count up" instruction requires a preceding logic operation. It can be placed within or at the end of the network.

## Parameters

The following table shows the parameters of the "Count up" instruction:

Parameter	Declaration	Data type	Memory area	Description
CU	Input	BOOL	I, Q, M, D, L or constant	Count input
R	Input	BOOL	I, Q, M, T, C, D, L, P or constant	Reset input
PV	Input	Integers	I, Q, M, D, L, P or constant	Value at which the output Q is set.
Q	Output	BOOL	I, Q, M, D, L	Counter status
CV	Output	Integers, CHAR, DATE	I, Q, M, D, L, P	Current counter value

You can select the data type for the instruction from the "<???">" drop-down list of the instruction box.

For additional information on valid data types, refer to "See also".

## Example

The following example shows how the instruction works:

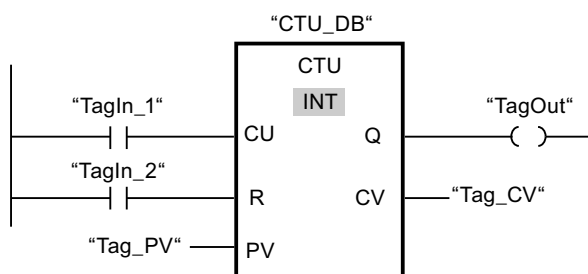

When the signal state of the "TagIn\_1" operand changes from "0" to "1", the "Count up" instruction executes and the current counter value of the operand "Tag\_CV" is incremented by one. With each additional positive signal edge, the counter value is incremented until the high limit value of the data type (INT = 32767) is reached.

The value of the PV parameter is adopted as the limit for determining the "TagOut" output. The "TagOut" output has signal state "1" as long as the current counter value is greater than or equal to the value of the "Tag\_PV" operand. In all other cases, the "TagOut" output has signal state "0".

## See also

Overview of the valid data types (Page 1077)

**CTD: Count down**

**Description**

You can use the "Count down" instruction to decrement the value at output CV. When the signal state at the CD input changes from "0" to "1" (positive signal edge), the instruction executes and the current counter value at the CV output is decremented by one. When the instruction executes the first time, the counter value of the CV parameter is set to the value of the PV parameter. Each time a positive signal edge is detected, the counter value is decremented until it reaches the low limit value of the specified data type. When the low limit is reached, the signal state at the CD input no longer has an effect on the instruction.

You can scan the counter status at the Q output. If the current counter value is less than or equal to zero, the Q output is set to signal state "1". In all other cases, the Q output has signal state "0".

The value at the CV output is set to the value of the PV parameter when the signal state at the LD input changes to "1". As long as the LD input has signal state "1", the signal state at the CD input has no effect on the instruction.

---

**Note**

Only use a counter at a single location in the program to avoid risk of counting errors.

---

Each call of the "Count down" instruction must be assigned an IEC counter in which the instruction data is stored. An IEC counter is a structure with one of the following data types:

**For S7-1200 CPU**

Data block of system data type IEC_counter (global DB)	Local tag
<ul style="list-style-type: none"> <li>• IEC_SCOUNTER / IEC_USCOUNTER</li> <li>• IEC_COUNTER / IEC_UCOUNTER</li> <li>• IEC_DCOUNTER / IEC_UDCOUNTER</li> </ul>	<ul style="list-style-type: none"> <li>• CTD_SINT / CTD_USINT</li> <li>• CTD_INT / CTD_UINT</li> <li>• CTD_DINT / CTD_UDINT</li> <li>• IEC_SCOUNTER / IEC_USCOUNTER</li> <li>• IEC_COUNTER / IEC_UCOUNTER</li> <li>• IEC_DCOUNTER / IEC_UDCOUNTER</li> </ul>

## For S7-1500 CPU

Data block of system data type IEC_counter (global DB)	Local tag
<ul style="list-style-type: none"> <li>• IEC_SCOUNTER / IEC_USCOUNTER</li> <li>• IEC_COUNTER / IEC_UCOUNTER</li> <li>• IEC_DCOUNTER / IEC_UDCOUNTER</li> <li>• IEC_LCOUNTER / IEC_ULCOUNTER</li> </ul>	<ul style="list-style-type: none"> <li>• CTD_SINT / CTD_USINT</li> <li>• CTD_INT / CTD_UINT</li> <li>• CTD_DINT / CTD_UDINT</li> <li>• CTD_LINT / CTD_ULINT</li> <li>• IEC_SCOUNTER / IEC_USCOUNTER</li> <li>• IEC_COUNTER / IEC_UCOUNTER</li> <li>• IEC_DCOUNTER / IEC_UDCOUNTER</li> <li>• IEC_LCOUNTER / IEC_ULCOUNTER</li> </ul>

You can declare an IEC counter as follows:

- Declaration of a data block of system data type IEC\_COUNTER (for example, "MyIEC\_COUNTER")
- Declaration as a local tag of the type CTD or IEC\_COUNTER in the "Static" section of a block (for example, #MyIEC\_COUNTER)

When you insert the instruction in the program, the "Call options" dialog opens in which you can specify whether the IEC counter is stored in its own data block (single instance) or as a local tag (multiple instance) in the block interface. If you create a separate data block, you will find it in the project tree in the "Program resources" folder under "Program blocks > System blocks". For additional information on this topic, refer to "See also".

The execution of the "Count down" instruction requires a preceding logic operation. It can be placed within or at the end of the network.

## Parameters

The following table shows the parameters of the "Count down" instruction:

Parameter	Declaration	Data type	Memory area	Description
CD	Input	BOOL	I, Q, M, D, L or constant	Count input
LD	Input	BOOL	I, Q, M, T, C, D, L, P or constant	Load input
PV	Input	Integers	I, Q, M, D, L, P or constant	Value at which the output Q is set.
Q	Output	BOOL	I, Q, M, D, L	Counter status
CV	Output	Integers, CHAR, DATE	I, Q, M, D, L, P	Current counter value

You can select the data type for the instruction from the "<???">" drop-down list of the instruction box.

For additional information on valid data types, refer to "See also".

**Example**

The following example shows how the instruction works:

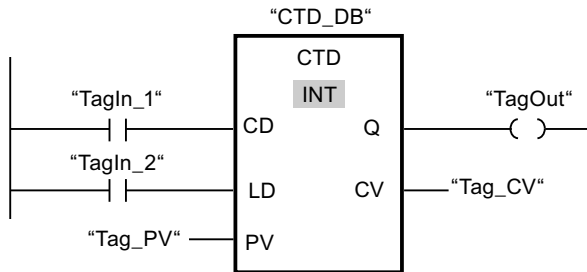

When the signal state of the "TagIn\_1" operand changes from "0" to "1", the "Count down" instruction is executed and the value at the "Tag\_CV" output is decremented by one. With each additional positive signal edge, the counter value is decremented until the low limit of the specified data type (INT = -32768) is reached.

The "TagOut" output has signal state "1" as long as the current counter value is less than or equal to zero. In all other cases, the "TagOut" output has signal state "0".

**See also**

Overview of the valid data types (Page 1077)

**CTUD: Count up and down**

**Description**

You can use the "Count up and down" instruction to increment and decrement the counter value at the CV output. If the signal state at the CU input changes from "0" to "1" (positive signal edge), the current counter value is incremented by one and stored at the CV output. If the signal state at the CD input changes from "0" to "1" (positive signal edge), the counter value at the CV output is decremented by one. If there is a positive signal edge at the CU and CD inputs in one program cycle, the current counter value at the CV output remains unchanged.

The counter value can be incremented until it reaches the high limit of the data type specified at the CV output. When the high limit value is reached, the counter value is no longer incremented on a positive signal edge. When the low limit of the specified data type is reached, the counter value is not decremented any further.

When the signal state at the LD input changes to "1", the counter value at the CV output is set to the value of the PV parameter. As long as the LD input has the signal state "1", the signal state at the CU and CD inputs has no effect on the instruction.

The counter value is set to zero when the signal state at the R input changes to "1". As long as the R input has signal state "1", a change in the the signal state of the CU, CD and LD inputs has no effect on the "Count up and down" instruction.

You can scan the current status of the up counter at the QU output. If the current counter value is greater than or equal to the value of the PV parameter, the QU output is set to signal state "1". In all other cases, the QU output has signal state "0".

You can scan the current status of the down counter at the QD output. If the current counter value is less than or equal to zero, the QD output is set to signal state "1". In all other cases, the QD output has signal state "0".

---

#### Note

Only use a counter at a single location in the program to avoid risk of counting errors.

---

Each call of the "Count up and down" instruction must be assigned an IEC counter in which the instruction data is stored. An IEC counter is a structure with one of the following data types:

#### For S7-1200 CPU

Data block of system data type IEC_counter (global DB)	Local tag
<ul style="list-style-type: none"> <li>• IEC_SCOUNTER / IEC_USCOUNTER</li> <li>• IEC_COUNTER / IEC_UCOUNTER</li> <li>• IEC_DCOUNTER / IEC_UDCOUNTER</li> </ul>	<ul style="list-style-type: none"> <li>• CTUD_SINT / CTUD_USINT</li> <li>• CTUD_INT / CTUD_UINT</li> <li>• CTUD_DINT / CTUD_UDINT</li> <li>• IEC_SCOUNTER / IEC_USCOUNTER</li> <li>• IEC_COUNTER / IEC_UCOUNTER</li> <li>• IEC_DCOUNTER / IEC_UDCOUNTER</li> </ul>

#### For S7-1500 CPU

Data block of system data type IEC_counter (global DB)	Local tag
<ul style="list-style-type: none"> <li>• IEC_SCOUNTER / IEC_USCOUNTER</li> <li>• IEC_COUNTER / IEC_UCOUNTER</li> <li>• IEC_DCOUNTER / IEC_UDCOUNTER</li> <li>• IEC_LCOUNTER / IEC_ULCOUNTER</li> </ul>	<ul style="list-style-type: none"> <li>• CTUD_SINT / CTUD_USINT</li> <li>• CTUD_INT / CTUD_UINT</li> <li>• CTUD_DINT / CTUD_UDINT</li> <li>• CTUD_LINT / CTUD_ULINT</li> <li>• IEC_SCOUNTER / IEC_USCOUNTER</li> <li>• IEC_COUNTER / IEC_UCOUNTER</li> <li>• IEC_DCOUNTER / IEC_UDCOUNTER</li> <li>• IEC_LCOUNTER / IEC_ULCOUNTER</li> </ul>

You can declare an IEC counter as follows:

- Declaration of a data block of system data type IEC\_COUNTER (for example, "MyIEC\_COUNTER")
- Declaration as a local tag of the type CTUD or IEC\_COUNTER in the "Static" section of a block (for example, #MyIEC\_COUNTER)

When you insert the instruction in the program, the "Call options" dialog opens in which you can specify whether the IEC counter is stored in its own data block (single instance) or as a local tag (multiple instance) in the block interface. If you create a separate data block, you will find it in the project tree in the "Program resources" folder under "Program blocks > System blocks". For additional information on this topic, refer to "See also".

The execution of the "Count up and down" instruction requires a preceding logic operation. It can be placed within or at the end of the network.

### Parameters

The following table shows the parameters of the "Count up and down" instruction:

Parameter	Declaration	Data type	Memory area	Description
CU	Input	BOOL	I, Q, M, D, L or constant	Count up input
CD	Input	BOOL	I, Q, M, D, L or constant	Count down input
R	Input	BOOL	I, Q, M, T, C, D, L, P or constant	Reset input
LD	Input	BOOL	I, Q, M, T, C, D, L, P or constant	Load input
PV	Input	Integers	I, Q, M, D, L, P or constant	Value at which the output QU is set.
QU	Output	BOOL	I, Q, M, D, L	Status of the counter up
QD	Output	BOOL	I, Q, M, D, L	Status of the down-counter
CV	Output	Integers, CHAR, DATE	I, Q, M, D, L, P	Current counter value

You can select the data type for the instruction from the "<???" drop-down list of the instruction box.

For additional information on valid data types, refer to "See also".

### Example

The following example shows how the instruction works:

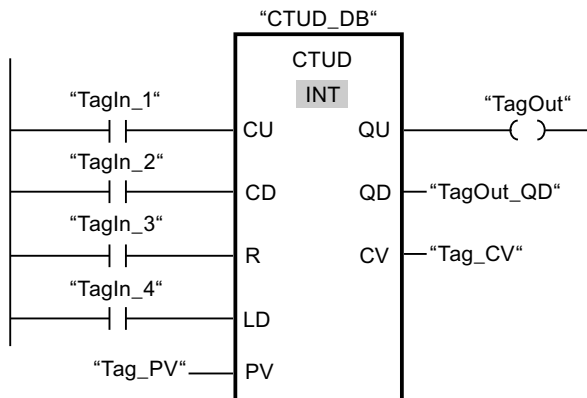

If the signal state at the "TagIn\_1" or "TagIn\_2" input changes from "0" to "1" (positive signal edge), the "Count up and down" instruction is executed. When there is a positive signal edge at the "TagIn\_1" input, the current counter value is incremented by one and stored at the



"Tag\_CV" output. When there is a positive signal edge at the "TagIn\_2" input, the counter value is decremented by one and stored at the "Tag\_CV" output. When there is a positive signal edge at the CU input, the counter value is incremented until it reaches the high limit of 32767. If input CD has a positive signal edge, the counter value is decremented until it reaches the low limit value of INT = -32768.

The "TagOut" output has signal state "1" as long as the current counter value is greater than or equal to the value at the "Tag\_PV" input. In all other cases, the "TagOut" output has signal state "0".

The "TagOut\_QD" output has signal state "1" as long as the current counter value is less than or equal to zero. In all other cases, the "TagOut\_QD" output has signal state "0".

### See also

Overview of the valid data types (Page 1077)

## SIMATIC Counters

### S\_CUD: Assign parameters and count up / down

#### Description

You can use the "Assign parameters and count up / down" instruction to increment or decrement the value of a counter. If the signal state at the CU input changes from "0" to "1" (positive signal edge), the current counter value is incremented by one. If the signal state at the CD input changes from "0" to "1" (positive signal edge), the counter value is decremented by one. The current counter value is output as a hexadecimal value at output CV and BCD-coded at output CV\_BCD. If there is a positive signal edge at the CU and CD inputs in one program cycle, the counter value remains unchanged.

The counter value can be incremented until the high limit of "999" is reached. When the high limit value is reached, the counter value is no longer incremented on a positive signal edge. When the low limit "0" is reached, the counter value is not decremented any further.

When the signal state at input S changes from "0" to "1", the counter value is set to the value of the PV parameter. If the counter is set and if RLO is "1" at the inputs CU and CD, the counter counts accordingly in the next scan cycle, even if no change in the signal edge was detected.

The counter value is set to zero when the signal state at the R input changes to "1". As long as the R input has the signal state "1", processing of the signal state of the CU, CD and S inputs has no effect on the counter value.

The signal state at output Q is "1" if the counter value is greater than zero. If the counter value is equal to zero, output Q has the signal state "0".

---

#### Note

Only use a counter at a single location in the program to avoid risk of counting errors.

---

The "Assign parameters and count up / down" instruction requires a preceding logic operation for edge evaluation and can be placed within or at the end of the network.

**Parameters**

The following table shows the parameters of the "Assign parameters and count up / down" instruction:

Parameter	Declaration	Data type	Memory area	Description
<Counter>	InOut/Input	COUNTER	C	Counter of the instruction The number of counters depends on the CPU.
CU	Input	BOOL	I, Q, M, D, L	Count up input
CD	Input	BOOL	I, Q, M, D, L, T, C or constant	Count down input
S	Input	BOOL	I, Q, M, D, L, T, C or constant	Input for presetting counter
PV	Input	WORD	I, Q, M, D, L, C or constant	Preset counter value (C#0 to C#999)
R	Input	BOOL	I, Q, M, D, L, T, C or constant	Reset input
BI	Output	WORD, S5TIME, DATE	I, Q, M, D, L	Current counter value (hexadecimal)
CV_BCD	Output	WORD, S5TIME, DATE	I, Q, M, D, L	Current counter value (BCD format)
Q	Output	BOOL	I, Q, M, D, L	Status of the counter

For additional information on valid data types, refer to "See also".

**Example**

The following example shows how the instruction works:

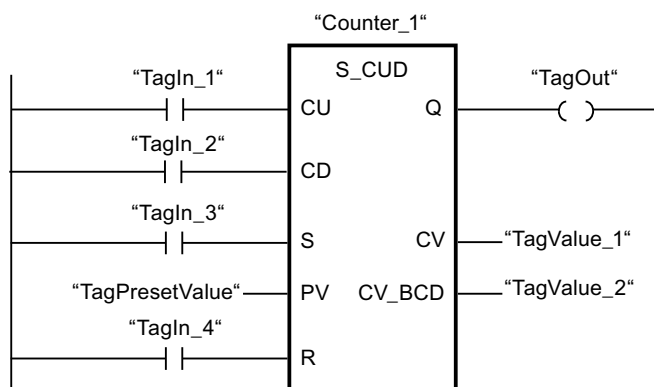

If the signal state at the "TagIn\_1" or "TagIn\_2" input changes from "0" to "1" (positive signal edge), the "Assign parameters and count up / down" instruction is executed. When there is a

positive signal edge at the "TagIn\_1" input and the current counter value is less than "999", the counter value is incremented by one. When there is a positive signal edge at the "TagIn\_2" input and the current counter value is greater than "0", the counter value is decremented by one.

When the signal state at input "TagIn\_3" changes from "0" to "1", the counter value is set to the value of the operand "TagPresetValue". The counter value is reset to "0" when the "TagIn\_4" operand has signal state "1".

The current counter value is saved as a hexadecimal value in the operand "TagValue\_1" and BCD-coded in the operand "TagValue\_2".

The "TagOut" output has the signal state "1" as long as the current counter value is not equal to "0".

### See also

Overview of the valid data types (Page 1077)

## S\_CU: Assign parameters and count up

### Description

You can use the "Assign parameters and count up" instruction to increment the value of a counter. If the signal state at the CU input changes from "0" to "1" (positive signal edge), the current counter value is incremented by one. The current counter value is output as a hexadecimal value at output CV and BCD-coded at output CV\_BCD. The counter value can be incremented until the limit of "999" is reached. When the limit is reached, the counter value is no longer incremented on a positive signal edge.

When the signal state at input S changes from "0" to "1", the counter value is set to the value of the PV parameter. If the counter is set and if RLO at input CU is "1", the counter will count accordingly in the next scan cycle, even when no change has been detected in the signal edge.

The counter value is set to zero when the signal state at the R input changes to "1". As long as the R input has the signal state "1", processing of the signal state of the CU and S inputs has no effect on the counter value.

The signal state at output Q is "1" if the counter value is greater than zero. If the counter value is equal to zero, output Q has the signal state "0".

---

### Note

Only use a counter at a single location in the program to avoid risk of counting errors.

---

The "Assign parameters and count up" instruction requires a preceding logic operation for edge evaluation and can be placed within or at the end of the network.

**Parameter**

The following table shows the parameters of the "Assign parameters and count up" instruction:

Parameter	Declaration	Data type	Memory area	Description
<Counter>	InOut/Input	COUNTER	C	Counter of the instruction The number of counters depends on the CPU.
CU	Input	BOOL	I, Q, M, D, L	Count up input
S	Input	BOOL	I, Q, M, D, L, T, C or constant	Input for presetting counter
PV	Input	WORD	I, Q, M, D, L, C or constant	Preset counter value (C#0 to C#999)
R	Input	BOOL	I, Q, M, D, L, T, C or constant	Reset input
BI	Output	WORD, S5TIME, DATE	I, Q, M, D, L	Current counter value (hexadecimal)
BCD	Output	WORD, S5TIME, DATE	I, Q, M, D, L	Current counter value (BCD format)
Q	Output	BOOL	I, Q, M, D, L	Status of the counter

For additional information on valid data types, refer to "See also".

**Example**

The following example shows how the instruction works:

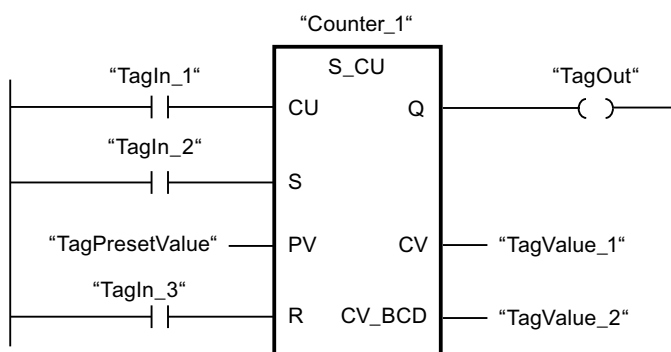

When the signal state at the "TagIn\_1" input changes from "0" to "1" (positive signal edge) and the current counter value is less than "999", the counter value is incremented by one. When the signal state at input "TagIn\_2" changes from "0" to "1", the counter value is set to the value of the operand "TagPresetValue". The counter value is reset to "0" when the "TagIn\_3" operand has signal state "1".

The current counter value is saved as a hexadecimal value in the operand "TagValue\_1" and BCD-coded in the operand "TagValue\_2".

The "TagOut" output has the signal state "1" as long as the current counter value is not equal to "0".

### See also

Overview of the valid data types (Page 1077)

## S\_CD: Assign parameters and count down

### Description

You can use the "Assign parameters and count down" instruction to decrement the value of a counter. If the signal state at the CD input changes from "0" to "1" (positive signal edge), the counter value is decremented by one. The current counter value is output as a hexadecimal value at output CV and BCD-coded at output CV\_BCD. The counter value can be decremented until the low limit of "0" is reached. When the low limit is reached, the counter value is no longer decremented on a positive signal edge.

When the signal state at input S changes from "0" to "1", the counter value is set to the value of the PV parameter. If the counter is set and if RLO at input CD is "1", the counter will count accordingly in the next scan cycle, even when no change has been detected in the signal edge.

The counter value is set to zero when the signal state at the R input changes to "1". As long as the R input has the signal state "1", processing of the signal state of the CD and S inputs has no effect on the counter value.

The signal state at output Q is "1" if the counter value is greater than zero. If the counter value is equal to zero, output Q has the signal state "0".

---

### Note

Only use a counter at a single location in the program to avoid risk of counting errors.

---

The "Assign parameters and count down" instruction requires a preceding logic operation for edge evaluation and can be placed within or at the end of the network.

**Parameter**

The following table shows the parameters of the "Assign parameters and count down" instruction:

Parameter	Declaration	Data type	Memory area	Description
<Counter>	InOut/Input	COUNTER	C	Counter of the instruction The number of counters depends on the CPU.
CD	Input	BOOL	I, Q, M, D, L or constant	Count down input
S	Input	BOOL	I, Q, M, D, L, T, C or constant	Input for presetting counter
PV	Input	WORD	I, Q, M, D, L, C or constant	Preset counter value (C#0 to C#999)
R	Input	BOOL	I, Q, M, D, L, T, C or constant	Reset input
CV	Output	WORD, S5TIME, DATE	I, Q, M, D, L	Current counter value (hexadecimal)
BCD	Output	WORD, S5TIME, DATE	I, Q, M, D, L	Current counter value (BCD format)
Q	Output	BOOL	I, Q, M, D, L	Status of the counter

For additional information on valid data types, refer to "See also".

**Example**

The following example shows how the instruction works:

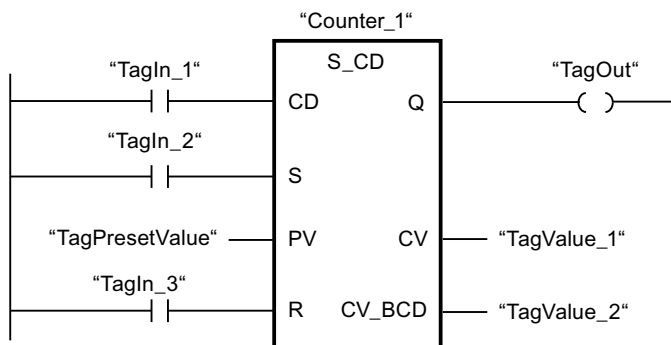

When the signal state at the "TagIn\_1" input changes from "0" to "1" (positive signal edge) and the current counter value is greater than "0", the counter value is decremented by one. When the signal state at input "TagIn\_2" changes from "0" to "1", the counter value is set to the value of the operand "TagPresetValue". The counter value is reset to "0" when the "TagIn\_3" operand has signal state "1".

The current counter value is saved as a hexadecimal value in the operand "TagValue\_1" and BCD-coded in the operand "TagValue\_2".

The "TagOut" output has the signal state "1" as long as the current counter value is not equal to "0".

## See also

Overview of the valid data types (Page 1077)

## ---( SC ): Set counter value

### Description

You can use the "Set counter value" instruction to set the value of a counter. The instruction is executed when the result of logic operation (RLO) at the input changes from "0" to "1". When the instruction is executed, the counter is set to the specified counter value.

The "Set counter value" instruction requires a preceding logic operation for edge evaluation and can only be placed at the right side of the network.

### Parameter

The following table shows the parameters of the "Set counter value" instruction:

Parameter	Declaration	Data type	Memory area	Description
<Count value>	Input	WORD	I, Q, M, D, L or constant	Value with which the counter is preset in the BCD format. (C#0 to C#999)
<Counter>	InOut/Input	COUNTER	C	Counter that is preset

For additional information on valid data types, refer to "See also".

### Example

The following example shows how the instruction works:

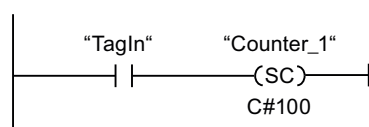

The counter "Counter\_1" is preset with the value "100" when the signal state of the operand "TagIn" changes from "0" to "1".

**See also**

Overview of the valid data types (Page 1077)

**---( CU ): Count up**

**Description**

With the "Count up" instruction you can increment the value of the specified counter by one if there is a positive signal edge in the result of logic operation (RLO). The counter value can be incremented until the limit of "999" is reached. When the limit is reached, the counter value is no longer incremented on a positive signal edge.

The "Count up" instruction requires a preceding logic operation for edge evaluation and can only be placed at the right side of the network.

**Parameter**

The following table shows the parameters of the "Count up" instruction:

Parameter	Declaration	Data type	Memory area	Description
<Counter>	InOut/Input	COUNTER	C	Counter whose value is incremented.

For additional information on valid data types, refer to "See also".

**Example**

The following example shows how the instruction works:

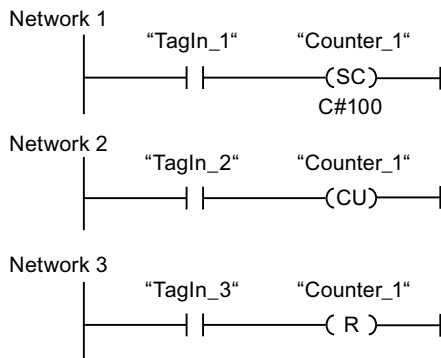

When the signal state of the "TagIn\_1" operand changes from "0" to "1" (positive signal edge), the counter "Counter\_1" is preset with the value "100".

The value of the counter "Counter\_1" is incremented by one when the signal state of the operand "TagIn\_2" changes from "0" to "1".

When the operand "TagIn\_3" has the signal state "1", the value of the counter "Counter\_1" is reset to "0".



**See also**

Overview of the valid data types (Page 1077)

**---( CD ): Count down****Description**

With the "Count down" instruction you can increment the value of the specified counter by one if there is a positive signal edge in the result of logic operation (RLO). The counter value can be decremented until the limit of "0" is reached. When the limit is reached, the counter value is no longer changed on a positive signal edge.

The "Count down" instruction requires a preceding logic operation for edge evaluation and can only be placed at the right side of the network.

**Parameter**

The following table shows the parameters of the "Count down" instruction:

Parameter	Declaration	Data type	Memory area	Description
<Counter>	InOut/Input	COUNTER	C	Counter whose value is decremented.

For additional information on valid data types, refer to "See also".

**Example**

The following example shows how the instruction works:

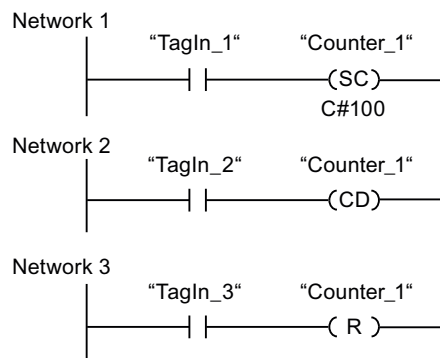

When the signal state of the "TagIn\_1" operand changes from "0" to "1" (positive signal edge), the counter "Counter\_1" is preset with the value "100".

The value of the counter "Counter\_1" is decremented by one when the signal state of the operand "TagIn\_2" changes from "0" to "1".

When the operand "TagIn\_3" has the signal state "1", the value of the counter "Counter\_1" is reset to "0".

**See also**

Overview of the valid data types (Page 1077)

**Comparator operations**

**CMP ==: Equal**

**Description**

You can use the "Equal" instruction to determine if a first comparison value (<Operand1>) is equal to a second comparison value (<Operand2>).

If the condition of the comparison is fulfilled, the instruction returns the result of logic operation (RLO) "1". If the comparison condition is not fulfilled, the instruction returns RLO "0". The RLO of the instruction is logically combined with the RLO of the entire rung as follows:

- By AND, when the comparison instruction is connected in series.
- By OR, when the comparison instruction is connected in parallel.

Specify the first comparison value (<Operand1>) at the operand placeholder above the instruction. Specify the second comparison value (<Operand2>) at the operand placeholder below the instruction.

The individual characters are compared by means of their ASCII code (for example, 'a' is greater than 'A') during the comparison of the strings. The comparison is performed from left to right. The first character that is different decides the result of the comparison.

The following table shows examples of string comparisons:

<Operand1>	<Operand2>	RLO of instruction
'AA'	'AA'	1
'Hello World'	'HelloWorld'	0
'AA'	'aa'	0

You can also use the "Equal" instruction to compare individual characters of a string (STRING). The number of the character to be compared is given in brackets next to the operand name. "MyString[2]", for example, compares the second character of the "MyString" string.

When IEC Check is selected, the operands to be compared must have the same data type. If IEC Check is not selected, the width (length) of the operands must be the same. When floating-point numbers are compared, the operands to be compared must have the same data type regardless of the setting for the IEC Check.

**Note**

**Comparison of floating-point numbers**

If you want to compare the data types REAL or LREAL, instead of the instruction "CMP ==: Equal", use the instruction "IN\_RANGE: Value within range".

## Parameters

The following table shows the parameters of the "Equal" instruction:

Parameter	Declaration	Data type		Memory area	Description
		S7-1200	S7-1500		
<Operand1>	Input	Bit strings, integers, floating-point numbers, strings, TIME, DATE, TOD, DTL	Bit strings, integers, floating-point numbers, character strings, TIME, LTIME, DATE, TOD, LTOD, DTL, DT, LDT	I, Q, M, D, L, P or constant	First comparison value
<Operand2>	Input	Bit strings, integers, floating-point numbers, strings, TIME, DATE, TOD, DTL	Bit strings, integers, floating-point numbers, character strings, TIME, LTIME, DATE, TOD, LTOD, DTL, DT, LDT	I, Q, M, D, L, P or constant	Second value to compare

You can select the data type for the instruction from the "<???">" drop-down list of the instruction box.

For additional information on valid data types, refer to "See also":

## Example

The following example shows how the instruction works:

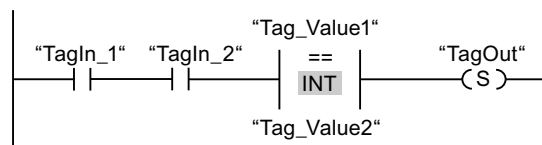

The "TagOut" output is set when the following conditions are fulfilled:

- The operands "TagIn\_1" and "TagIn\_2" have the signal state "1".
- The condition of the comparison instruction is fulfilled if ("Tag\_Value1" = "Tag\_Value2").

## See also

Overview of the valid data types (Page 1077)

## CMP <>: Not equal

### Description

You can use the "Not equal" instruction to determine if a first comparison value (<Operand1>) is not equal to a second comparison value (<Operand2>).

If the condition of the comparison is fulfilled, the instruction returns the result of logic operation (RLO) "1". If the comparison condition is not fulfilled, the instruction returns RLO "0". The RLO of the instruction is logically combined with the RLO of the entire rung as follows:

- By AND, when the comparison instruction is connected in series.
- By OR, when the comparison instruction is connected in parallel.

Specify the first comparison value (<Operand1>) at the operand placeholder above the instruction. Specify the second comparison value (<Operand2>) at the operand placeholder below the instruction.

The individual characters are compared by means of their ASCII code (for example, 'a' is greater than 'A') during the comparison of the strings. The comparison is performed from left to right. The first character that is different decides the result of the comparison.

The following table shows examples of string comparisons:

<Operand1>	<Operand2>	RLO of instruction
'AA'	'aa'	1
'Hello World'	'HelloWorld'	1
'AA'	'AA'	0

You can also use the "Not equal" instruction to compare individual characters of a string (STRING). The number of the character to be compared is given in brackets next to the operand name. "MyString[2]", for example, compares the second character of the "MyString" string.

When IEC Check is selected, the operands to be compared must have the same data type. If IEC Check is not selected, the width (length) of the operands must be the same. When floating-point numbers are compared, the operands to be compared must have the same data type regardless of the setting for the IEC Check.

## Parameters

The following table shows the parameters of the "Not equal" instruction:

Parameter	Declaration	Data type		Memory area	Description
		S7-1200	S7-1500		
<Operand1>	Input	Bit strings, integers, floating-point numbers, strings, TIME, DATE, TOD, DTL	Bit strings, integers, floating-point numbers, character strings, TIME, LTIME, DATE, TOD, LTOD, DTL, DT, LDT	I, Q, M, D, L, P or constant	First comparison value
<Operand2>	Input	Bit strings, integers, floating-point numbers, strings, TIME, DATE, TOD, DTL	Bit strings, integers, floating-point numbers, character strings, TIME, LTIME, DATE, TOD, LTOD, DTL, DT, LDT	I, Q, M, D, L, P or constant	Second value to compare

You can select the data type for the instruction from the "<???">" drop-down list of the instruction box.

For additional information on valid data types, refer to "See also".

## Example

The following example shows how the instruction works:

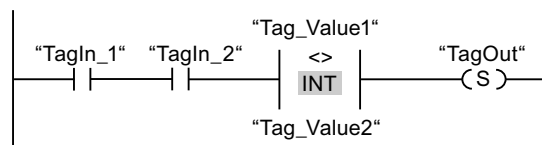

The "TagOut" output is set when the following conditions are fulfilled:

- The operands "TagIn\_1" and "TagIn\_2" have signal state "1".
- The condition of the comparison instruction is fulfilled if ("Tag\_Value1" <> "Tag\_Value2").

## See also

Overview of the valid data types (Page 1077)

## CMP >=: Greater or equal

### Description

You can use the "Greater or equal" instruction to determine if a first comparison value (<Operand1>) is greater than or equal to a second comparison value (<Operand2>). Both values to be compared must be of the same data type.

If the condition of the comparison is fulfilled, the instruction returns the result of logic operation (RLO) "1". If the comparison condition is not fulfilled, the instruction returns RLO "0". The RLO of the instruction is logically combined with the RLO of the entire rung as follows:

- By AND, when the comparison instruction is connected in series.
- By OR, when the comparison instruction is connected in parallel.

Specify the first comparison value (<Operand1>) at the operand placeholder above the instruction. Specify the second comparison value (<Operand2>) at the operand placeholder below the instruction.

The individual characters are compared by means of their ASCII code (for example, 'a' is greater than 'A') during the comparison of the strings. The comparison is performed from left to right. The first character that is different decides the result of the comparison. If the left part of the longer string is identical to the shorter string, the longer string is considered greater.

The following table shows examples of string comparisons:

<Operand1>	<Operand2>	RLO of instruction
'BB'	'AA'	1
'AAA'	'AA'	1
'Hello World'	'Hello World'	1
'Hello World'	'HelloWorld'	0
'AA'	'aa'	0
'AAA'	'a'	0

You can also use the "Greater or equal" instruction to compare individual characters of a string (STRING). The number of the character to be compared is given in brackets next to the operand name. "MyString[2]", for example, compares the second character of the "MyString" string.

When time values are compared, the RLO of the instruction is "1" if the point of time at <Operand1> is greater (more recent) than or equal to the point of time at <Operand2>.

## Parameters

The following table shows the parameters of the "Greater or equal" instruction:

Parameter	Declaration	Data type		Memory area	Description
		S7-1200	S7-1500		
<Operand1>	Input	Integers, floating-point numbers, strings, TIME, DATE, TOD, DTL	Integers, floating-point numbers, character strings, TIME, LTIME, DATE, TOD, LTOD, DTL, DT, LDT	I, Q, M, D, L, P or constant	First comparison value
<Operand2>	Input	Integers, floating-point numbers, strings, TIME, DATE, TOD, DTL	Integers, floating-point numbers, character strings, TIME, LTIME, DATE, TOD, LTOD, DTL, DT, LDT	I, Q, M, D, L, P or constant	Second value to compare

You can select the data type for the instruction from the "<???"> drop-down list of the instruction box.

For additional information on valid data types, refer to "See also".

## Example

The following example shows how the instruction works:

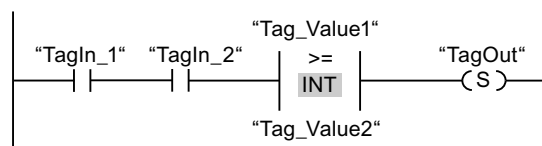

The "TagOut" output is set when the following conditions are fulfilled:

- The operands "TagIn\_1" and "TagIn\_2" have signal state "1".
- The condition of the comparison instruction is fulfilled if ("Tag\_Value1" >= "Tag\_Value2").

## See also

Overview of the valid data types (Page 1077)

Example of detecting the fill level of a storage area (Page 1554)

## CMP <=: Less or equal

### Description

You can use the "Less or equal" instruction to determine if a first comparison value (<Operand1>) is less than or equal to a second comparison value (<Operand2>). Both values to be compared must be of the same data type.

If the condition of the comparison is fulfilled, the instruction returns the result of logic operation (RLO) "1". If the comparison condition is not fulfilled, the instruction returns RLO "0". The RLO of the instruction is logically combined with the RLO of the entire rung as follows:

- By AND, when the comparison instruction is connected in series.
- By OR, when the comparison instruction is connected in parallel.

Specify the first comparison value (<Operand1>) at the operand placeholder above the instruction. Specify the second comparison value (<Operand2>) at the operand placeholder below the instruction.

The individual characters are compared by means of their ASCII code (for example, 'a' is greater than 'A') during the comparison of the strings. The comparison is performed from left to right. The first character that is different decides the result of the comparison. If the left part of the longer string is identical to the shorter string, the shorter string is considered smaller.

The following table shows examples of string comparisons:

<Operand1>	<Operand2>	RLO of instruction
'AA'	'aa'	1
'AAA'	'a'	1
'Hello World'	'Hello World'	1
'HelloWorld'	'Hello World'	0
'BB'	'AA'	0
'AAA'	'AA'	0

You can also use the "Less or equal" instruction to compare individual characters of a string (STRING). The number of the character to be compared is given in brackets next to the operand name. "MyString[2]", for example, compares the second character of the "MyString" string.

When time values are compared, the RLO of the instruction is "1" if the point of time at <Operand1> is less (less recent) than or equal to the point of time at <Operand2>.



## Parameters

The following table shows the parameters of the "Less or equal" instruction:

Parameter	Declaration	Data type		Memory area	Description
		S7-1200	S7-1500		
<Operand1>	Input	Integers, floating-point numbers, strings, TIME, DATE, TOD, DTL	Integers, floating-point numbers, character strings, TIME, LTIME, DATE, TOD, LTOD, DTL, DT, LDT	I, Q, M, D, L, P or constant	First comparison value
<Operand2>	Input	Integers, floating-point numbers, strings, TIME, DATE, TOD, DTL	Integers, floating-point numbers, character strings, TIME, LTIME, DATE, TOD, LTOD, DTL, DT, LDT	I, Q, M, D, L, P or constant	Second value to compare

You can select the data type for the instruction from the "<???"> drop-down list of the instruction box.

For additional information on valid data types, refer to "See also".

## Example

The following example shows how the instruction works:

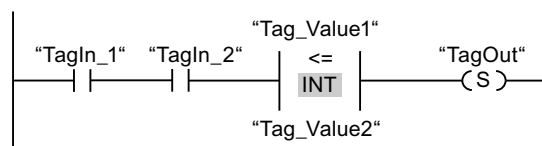

The "TagOut" output is set when the following conditions are fulfilled:

- The operands "TagIn\_1" and "TagIn\_2" have signal state "1".
- The condition of the comparison instruction is fulfilled if ("Tag\_Value1" <= "Tag\_Value2").

## See also

Overview of the valid data types (Page 1077)

**CMP >: Greater than**

**Description**

You can use the "Greater than" instruction to determine if a first comparison value (<Operand1>) is greater than a second comparison value (<Operand2>). Both values to be compared must be of the same data type.

If the condition of the comparison is fulfilled, the instruction returns the result of logic operation (RLO) "1". If the comparison condition is not fulfilled, the instruction returns RLO "0". The RLO of the instruction is logically combined with the RLO of the entire rung as follows:

- By AND, when the comparison instruction is connected in series.
- By OR, when the comparison instruction is connected in parallel.

Specify the first comparison value (<Operand1>) at the operand placeholder above the instruction. Specify the second comparison value (<Operand2>) at the operand placeholder below the instruction.

The individual characters are compared by means of their ASCII code (for example, 'a' is greater than 'A') during the comparison of the strings. The comparison is performed from left to right. The first character that is different decides the result of the comparison. If the left part of the longer string is identical to the shorter string, the longer string is considered greater.

The following table shows examples of string comparisons:

<Operand1>	<Operand2>	RLO of instruction
'BB'	'AA'	1
'AAA'	'AA'	1
'AA'	'aa'	0
'AAA'	'a'	0

You can also use the "Greater than" instruction to compare individual characters of a string (STRING). The number of the character to be compared is given in brackets next to the operand name. "MyString[2]", for example, compares the second character of the "MyString" string.

When time values are compared, the RLO of the instruction is "1" if the point of time at <Operand1> is greater (more recent) than the point of time at <Operand2>.

## Parameters

The following table shows the parameters of the "Greater than" instruction:

Parameter	Declaration	Data type		Memory area	Description
		S7-1200	S7-1500		
<Operand1>	Input	Integers, floating-point numbers, strings, TIME, DATE, TOD, DTL	Integers, floating-point numbers, character strings, TIME, LTIME, DATE, TOD, LTOD, DTL, DT, LDT	I, Q, M, D, L, P or constant	First comparison value
<Operand2>	Input	Integers, floating-point numbers, strings, TIME, DATE, TOD, DTL	Integers, floating-point numbers, character strings, TIME, LTIME, DATE, TOD, LTOD, DTL, DT, LDT	I, Q, M, D, L, P or constant	Second value to compare

You can select the data type for the instruction from the "<???"> drop-down list of the instruction box.

For additional information on valid data types, refer to "See also".

## Example

The following example shows how the instruction works:

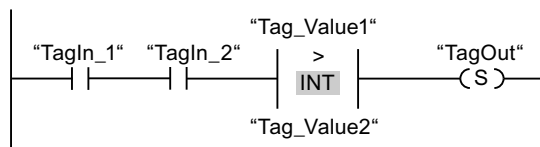

The "TagOut" output is set when the following conditions are fulfilled:

- The operands "TagIn\_1" and "TagIn\_2" have signal state "1".
- The condition of the comparison instruction is fulfilled if ("Tag\_Value1" > "Tag\_Value2").

## See also

Overview of the valid data types (Page 1077)

**CMP <: Less than**

**Description**

You can use the "Less than" instruction to determine if a first comparison value (<Operand1>) is less than a second comparison value (<Operand2>). Both values to be compared must be of the same data type.

If the condition of the comparison is fulfilled, the instruction returns the result of logic operation (RLO) "1". If the comparison condition is not fulfilled, the instruction returns RLO "0". The RLO of the instruction is logically combined with the RLO of the entire rung as follows:

- By AND, when the comparison instruction is connected in series.
- By OR, when the comparison instruction is connected in parallel.

Specify the first comparison value (<Operand1>) at the operand placeholder above the instruction. Specify the second comparison value (<Operand2>) at the operand placeholder below the instruction.

The individual characters are compared by means of their ASCII code (for example, 'a' is greater than 'A') during the comparison of the strings. The comparison is performed from left to right. The first character that is different decides the result of the comparison. If the left part of the longer string is identical to the shorter string, the shorter string is considered smaller.

The following table shows examples of string comparisons:

<Operand1>	<Operand2>	RLO of instruction
'AA'	'aa'	1
'AAA'	'a'	1
'BB'	'AA'	0
'AAA'	'AA'	0

You can also use the "Less than" instruction to compare individual characters of a string (STRING). The number of the character to be compared is given in brackets next to the operand name. "MyString[2]", for example, compares the second character of the "MyString" string.

When time values are compared, the RLO of the instruction is "1" if the point of time at <Operand1> is less (less recent) than the point of time at <Operand2>.

## Parameters

The following table shows the parameters of the "Less than" instruction:

Parameter	Declaration	Data type		Memory area	Description
		S7-1200	S7-1500		
<Operand1>	Input	Integers, floating-point numbers, strings, TIME, DATE, TOD, DTL	Integers, floating-point numbers, character strings, TIME, LTIME, DATE, TOD, LTOD, DTL, DT, LDT	I, Q, M, D, L, P or constant	First comparison value
<Operand2>	Input	Integers, floating-point numbers, strings, TIME, DATE, TOD, DTL	Integers, floating-point numbers, character strings, TIME, LTIME, DATE, TOD, LTOD, DTL, DT, LDT	I, Q, M, D, L, P or constant	Second value to compare

You can select the data type for the instruction from the "<???" drop-down list of the instruction box.

For additional information on valid data types, refer to "See also".

## Example

The following example shows how the instruction works:

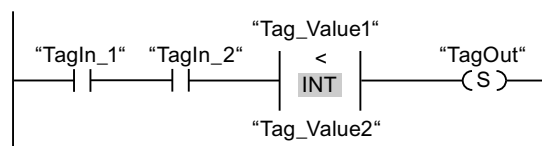

The "TagOut" output is set when the following conditions are fulfilled:

- The operands "TagIn\_1" and "TagIn\_2" have signal state "1".
- The condition of the comparison instruction is fulfilled if ("Tag\_Value1" < "Tag\_Value2").

## See also

Overview of the valid data types (Page 1077)

Example of detecting the fill level of a storage area (Page 1554)

## IN\_RANGE: Value within range

### Description

You can use the "Value within range" instruction to determine if the value at the VAL input is within a specific value range.

You specify the limits of the value range with the MIN and MAX inputs. The "Value within range" instruction compares the value at the VAL input with the values of the MIN and MAX inputs and sends the result to the box output. If the value at the VAL input fulfills the comparison  $MIN \leq VAL$  or  $VAL \leq MAX$ , the box output has the signal state "1". If the comparison is not fulfilled, the box output has the signal state "0".

If the box input has the signal state "0", the "Value within range" instruction is not executed.

The comparison function can only execute if the values to be compared are of the same data type and the box input is interconnected.

### Parameters

The following table shows the parameters of the "Value within range" instruction:

Parameter	Declaration	Data type	Memory area	Description
Box input	Input	BOOL	I, Q, M, D, L	Result of the previous logic operation
MIN	Input	Integers, floating-point numbers	I, Q, M, D, L or constant	Low limit of the value range
VAL	Input	Integers, floating-point numbers	I, Q, M, D, L or constant	Comparison value
MAX	Input	Integers, floating-point numbers	I, Q, M, D, L or constant	High limit of the value range
Box output	Output	BOOL	I, Q, M, D, L	Result of the comparison

You can select the data type for the instruction from the "<???">" drop-down list of the instruction box.

For additional information on valid data types, refer to "See also":

### Example

The following example shows how the instruction works:

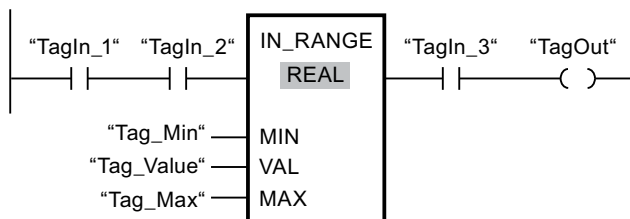

The "TagOut" output is set when the following conditions are fulfilled:

- The operands "TagIn\_1" and "TagIn\_2" have signal state "1".
- The value of the operand "Tag\_Value" is within the value range that is specified by the current values of the operands "Tag\_Min" and "Tag\_Max" ( $\text{MIN} \leq \text{VAL}$  or  $\text{VAL} \leq \text{MAX}$ ).
- The operand "TagIn\_3" has the signal state "1".

## See also

Overview of the valid data types (Page 1077)

## OUT\_RANGE: Value outside range

### Description

You can use the "Value outside range" instruction to determine if the value at the VAL input is outside a specific value range.

You specify the limits of the value range with the MIN and MAX inputs. The "Value outside range" instruction compares the value at the VAL input with the values of the MIN and MAX inputs and sends the result to the box output. If the value at the VAL input fulfills the comparison  $\text{MIN} > \text{VAL}$  or  $\text{VAL} > \text{MAX}$ , the box output has the signal state "1". The box output also has the signal state "1" if a specified operand with the REAL data type shows an invalid value.

The box output returns the signal state "0", if the value at input VAL does not satisfy the  $\text{MIN} > \text{VAL}$  or  $\text{VAL} > \text{MAX}$  condition.

If the box input has the signal state "0", the "Value outside range" instruction is not executed.

The comparison function can only execute if the values to be compared are of the same data type and the box input is interconnected.

### Parameters

The following table shows the parameters of the "Value outside range" instruction:

Parameter	Declaration	Data type	Memory area	Description
Box input	Input	BOOL	I, Q, M, D, L	Result of the previous logic operation
MIN	Input	Integers, floating-point numbers	I, Q, M, D, L or constant	Low limit of the value range
VAL	Input	Integers, floating-point numbers	I, Q, M, D, L or constant	Comparison value
MAX	Input	Integers, floating-point numbers	I, Q, M, D, L or constant	High limit of the value range
Box output	Output	BOOL	I, Q, M, D, L	Result of the comparison

You can select the data type for the instruction from the "<???" drop-down list of the instruction box.

For additional information on valid data types, refer to "See also".

**Example**

The following example shows how the instruction works:

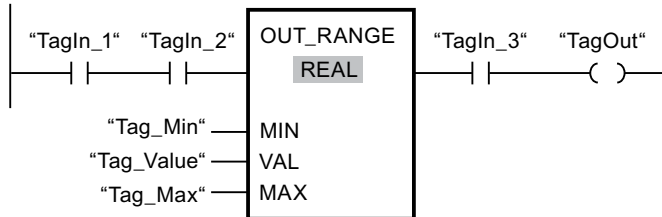

The "TagOut" output is set when the following conditions are fulfilled:

- The operands "Tag\_In\_1" and "Tag\_In\_2" have signal state "1".
- The value of the operand "Tag\_Value" is outside the value range that is specified by the values of the operands "Tag\_Min" and "Tag\_Max" (MIN > VAL or VAL > MAX).
- The operand "Tag\_In\_3" has the signal state "1".

**See also**

Overview of the valid data types (Page 1077)

**---| OK |---**: Check validity

**Description**

You can use the "Check validity" instruction to check if the value of an operand (<operand>) is a valid floating-point number. The query is started in each program cycle when the signal state at the input of the instruction is "1".

The output of the instruction has signal state "1" when the value of the operand is a valid floating-point number at the time of the query and the input of the instruction has signal state "1". In all other cases, the signal state at the output of the "Check validity" instruction is "0".

You can use the "Check validity" instruction together with the EN mechanism. If you connect the instruction box to an EN enable input, the enable input is set only when the result of the validity query of the value is positive. You can use this function to ensure that an instruction is enabled only when the value of the specified operand is a valid floating-point number.



## Parameters

The following table shows the parameters of the "Check validity" instruction:

Parameter	Declaration	Data type	Memory area	Description
<Operand>	Input	Floating-point numbers	I, Q, M, D, L	Value to be queried.

For additional information on valid data types, refer to "See also".

## Example

The following example shows how the instruction works:

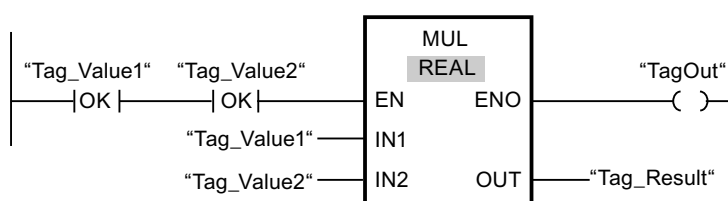

When the values of the operands "Tag\_Value1" and "Tag\_Value2" show valid floating-point numbers, the "Multiply" (MUL) instruction is activated and the ENO output is set. During the execution of the "Multiply" (MUL) instruction, the value of the operand "Tag\_Value1" is multiplied with the value of the operand "Tag\_Value2". The product of the multiplication is then stored in the operand "Tag\_Result". If the instruction is executed without errors, the ENO and "TagOut" outputs are set to signal state "1".

## See also

Overview of the valid data types (Page 1077)

## ----I NOT\_OK I----: Check invalidity

### Description

You can use the "Check invalidity" instruction to check if the value of an operand (<operand>) is an invalid floating-point number. The query is started in each program cycle when the signal state at the input of the instruction is "1".

The output of the instruction has signal state "1" when the value of the operand is an invalid floating-point number at the time of the query and the input of the instruction has signal state "1". In all other cases, the signal state at the output of the "Check invalidity" instruction is "0".

### Parameters

The following table shows the parameters of the "Check invalidity" instruction:

Parameter	Declaration	Data type	Memory area	Description
<Operand>	Input	Floating-point numbers	I, Q, M, D, L	Value to be queried.

For additional information on valid data types, refer to "See also".

### Example

The following example shows how the instruction works:

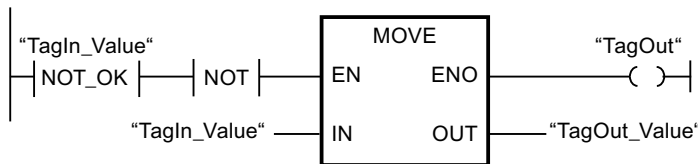

When the value of operand "TagIn\_Value" is an invalid floating-point number, the "Move value" (MOVE) instruction will not be executed. The "TagOut" output is reset to signal state "0".

### See also

Overview of the valid data types (Page 1077)

### Math functions

#### CALCULATE: Calculate

#### Description

The "Calculate" instruction is used to define and execute an expression for the calculation of mathematical operations or complex logic operations depending on the selected data type.

You can select the data type of the instruction from the "<???">" drop-down list of the instruction box. Depending on the data type selected, you can combine the functions of certain instructions to perform a complex calculation. The information for the expression to be calculated is entered in a dialog, which you can open with the icon at the upper right edge of the instruction box. The expression can contain names of input parameters and the syntax of the instructions. Operand names and operand addresses cannot be specified.

The following table shows the instructions that can be combined in the expression of the "Calculate" instruction, depending on the selected data type:

Data type	Instruction	Syntax	Example
Bit strings	AND: AND logic operation	AND	IN1 AND IN2 OR IN3
	OR: OR logic operation	OR	

Data type	Instruction	Syntax	Example
	XOR: EXCLUSIVE OR logic operation	XOR	
	INV: Create ones complement	NOT	
	SWAP: Swap <sup>1)</sup>	SWAP	
Integers	ADD: Add	+	(IN1 + IN2) * IN3; (ABS(IN2))*(ABS(IN1))
	SUB: Subtract	-	
	MUL: Multiply	*	
	DIV: Divide	/	
	MOD: Return remainder of division	MOD	
	INV: Create ones complement	NOT	
	NEG: Create twos complement	-(in1)	
	ABS: Form absolute value	ABS( )	
Floating-point numbers	ADD: Add	+	((SIN(IN2)*SIN(IN2)+ SIN(IN3)*SIN(IN3))/ IN3; (SQR(SIN(IN2))+ SQR(COS(IN3)))/IN2
	SUB: Subtract	-	
	MUL: Multiply	*	
	DIV: Divide	/	
	EXPT: Exponentiate	**	
	ABS: Form absolute value	ABS( )	
	SQR: Form square	SQR( )	
	SQRT: Form square root	SQRT( )	
	LN: Form natural logarithm	LN( )	
	EXP: Form exponential value	EXP( )	
	FRAC: Return fraction	FRAC( )	
	SIN: Form sine value	SIN( )	
	COS: Form cosine value	COS( )	
	TAN: Form tangent value	TAN( )	
	ASIN: Form arcsine value	ASIN( )	
	ACOS: Form arccosine value	ACOS( )	
	ATAN: Form arctangent value	ATAN( )	
	NEG: Create twos complement	-(in1)	
	TRUNC: Truncate numerical value	TRUNC( )	
	ROUND: Round numerical value	ROUND( )	
	CEIL: Generate next higher integer from floating-point number	CEIL( )	
	FLOOR: Generate next lower integer from floating-point number	FLOOR( )	
<sup>1)</sup> Not possible for data type BYTE.			

In its initial state, the instruction box contains at least 2 inputs (IN1 and IN2). The number of inputs can be extended. The inserted inputs are numbered in ascending order in the box.

The values of the inputs are used to execute the specified expression. Not all of the defined inputs have to be used in the expression. The result of the instruction is transferred to the output OUT.

If you use inputs in the expression that are not available in the box, they are inserted automatically. This requires that there are no gaps in the numbering of the inputs to be newly

defined in the expression. For example, you cannot use the IN4 input in the expression unless the IN3 input has been defined.

The ENO enable output has the signal state "0" if one of the following conditions is fulfilled:

- The EN enable input has the signal state "0".
- The result of the "Calculate" instruction is outside the range permitted for the data type specified at the OUT output.
- A floating-point number has an invalid value.
- An error occurred during execution of one of the instructions in the expression.

### Parameters

The following table shows the parameters of the "Calculate" instruction:

Parameters	Declaration	Data type	Memory area	Description
EN	Input	BOOL	I, Q, M, D, L	Enable input
ENO	Output	BOOL	I, Q, M, D, L	Enable output
IN1	Input	Bit strings, integers, floating-point numbers	I, Q, M, D, L, P or constant	First available input
IN2	Input	Bit strings, integers, floating-point numbers	I, Q, M, D, L, P or constant	Second available input
INn	Input	Bit strings, integers, floating-point numbers	I, Q, M, D, L, P or constant	Additionally inserted inputs
OUT	Output	Bit strings, integers, floating-point numbers	I, Q, M, D, L, P	Output to which the end result is to be transferred.

For additional information on valid data types, refer to "See also".

### Example

The following example shows how the instruction works:

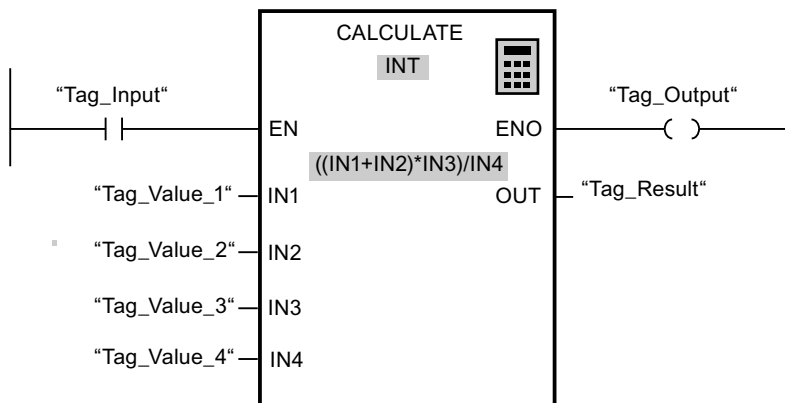

The following table shows how the instruction works using specific operand values:

Parameters	Operand	Value
IN1	Tag_Value_1	4
IN2	Tag_Value_2	4
IN3	Tag_Value_3	3
IN4	Tag_Value_4	2
OUT	Tag_Result	12

If the "Tag\_Input" input has the signal state "1", the "Calculate" instruction is executed. The value of operand "Tag\_Value\_1" is added to the value of operand "Tag\_Value\_2". The sum is multiplied with the value of operand "Tag\_Value\_3". The product is divided by the value of operand "Tag\_Value\_4". The quotient is transferred as end result to the operand "Tag\_Result" at the OUT output of the instruction. If the instruction is executed without errors, the enable output ENO and operand "Tag\_Output" are set to "1".

### See also

Using the "Calculate" instruction (Page 1281)

Overview of the valid data types (Page 1077)

Inserting additional inputs and outputs in LAD elements (Page 1289)

Removing inputs and outputs (Page 1290)

Basics of the EN/ENO mechanism (Page 1167)

### ADD: Add

#### Description

You can use the "Add" instruction to add the value at input IN1 and the value at input IN2 and query the sum at output OUT ( $OUT := IN1 + IN2$ ).

In its initial state, the instruction box contains at least 2 inputs (IN1 and IN2). The number of inputs can be extended. The inserted inputs are numbered in ascending order in the box. When the instruction is executed, the values of all available input parameters are added. The sum is stored at the OUT output.

The ENO enable output has the signal state "0" if one of the following conditions is fulfilled:

- The enable input EN has the signal state "0".
- The result of the instruction is outside the range permitted for the data type specified at the OUT output.
- A floating-point number has an invalid value.

### Parameters

The following table shows the parameters of the "Add" instruction:

Parameter	Declaration	Data type	Memory area	Description
EN	Input	BOOL	I, Q, M, D, L	Enable input
ENO	Output	BOOL	I, Q, M, D, L	Enable output
IN1	Input	Integers, floating-point numbers	I, Q, M, D, L, P or constant	First number to be added
IN2	Input	Integers, floating-point numbers	I, Q, M, D, L, P or constant	Second number to be added
INn	Input	Integers, floating-point numbers	I, Q, M, D, L, P or constant	Optional input values that are added.
OUT	Output	Integers, floating-point numbers	I, Q, M, D, L, P	Sum

You can select the data type for the instruction from the "<???" drop-down list of the instruction box.

For additional information on valid data types, refer to "See also":

### Example

The following example shows how the instruction works:

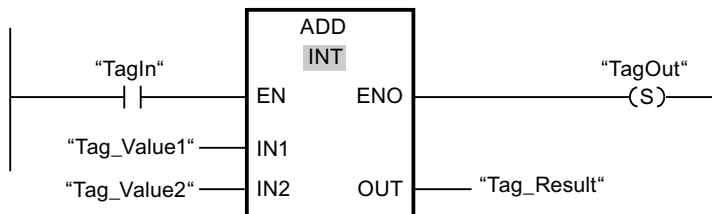

If operand "TagIn" has the signal state "1", the "Add" instruction is executed. The value of operand "Tag\_Value1" is added to the value of operand "Tag\_Value2". The result of the addition is stored in operand "Tag\_Result". If the instruction is executed without errors, the ENO enable output has the signal state "1" and the "TagOut" output is set.

### See also

- Overview of the valid data types (Page 1077)
- Removing inputs and outputs (Page 1290)
- Basics of the EN/ENO mechanism (Page 1167)
- Selecting a data type (Page 1274)
- Inserting additional inputs and outputs in LAD elements (Page 1289)

## SUB: Subtract

### Description

You can use the "Subtract" instruction to subtract the value at input IN2 from the value at input IN1 and query the difference at output OUT (OUT := IN1-IN2).

The ENO enable output has the signal state "0" if one of the following conditions is fulfilled:

- The EN enable input has the signal state "0".
- The result of the instruction is outside the range permitted for the data type specified at the OUT output.
- A floating-point number has an invalid value.

### Parameters

The following table shows the parameters of the "Subtract" instruction:

Parameter	Declaration	Data type	Memory area	Description
EN	Input	BOOL	I, Q, M, D, L	Enable input
ENO	Output	BOOL	I, Q, M, D, L	Enable output
IN1	Input	Integers, floating-point numbers	I, Q, M, D, L, P or constant	Minuend
IN2	Input	Integers, floating-point numbers	I, Q, M, D, L, P or constant	Subtracting
OUT	Output	Integers, floating-point numbers	I, Q, M, D, L, P	Difference

You can select the data type for the instruction from the "<???">" drop-down list of the instruction box.

For additional information on valid data types, refer to "See also".

### Example

The following example shows how the instruction works:

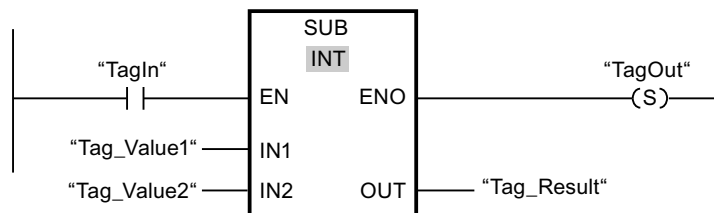

If operand "TagIn" has the signal state "1", the "Subtract" instruction is executed. The value of operand "Tag\_Value2" is subtracted from the value of operand "Tag\_Value1". The result of the subtraction is stored in operand "Tag\_Result". If the instruction is executed without errors, the ENO enable output has the signal state "1" and the "TagOut" output is set.

**See also**

- Overview of the valid data types (Page 1077)
- Basics of the EN/ENO mechanism (Page 1167)
- Selecting a data type (Page 1274)

**MUL: Multiply**

**Description**

You can use the "Multiply" instruction to multiply the value at input IN1 with the value at input IN2 and query the product at output OUT (OUT := IN1\*IN2).

The number of inputs can be expanded in the instruction box. The added inputs are numbered in ascending order in the box. When the instruction is executed, the values of all available input parameters are multiplied. The product is stored at the OUT output.

The ENO enable output has the signal state "0" if one of the following conditions is fulfilled:

- The EN input has the signal state "0".
- The result is outside the range permitted for the data type specified at output OUT.
- A floating-point number has an invalid value.

**Parameters**

The following table shows the parameters of the "Multiply" instruction:

Parameter	Declaration	Data type	Memory area	Description
EN	Input	BOOL	I, Q, M, D, L	Enable input
ENO	Output	BOOL	I, Q, M, D, L	Enable output
IN1	Input	Integers, floating-point numbers	I, Q, M, D, L, P or constant	Multiplier
IN2	Input	Integers, floating-point numbers	I, Q, M, D, L, P or constant	Number being multiplied
INn	Input	Integers, floating-point numbers	I, Q, M, D, L, P or constant	Optional input values that can be multiplied.
OUT	Output	Integers, floating-point numbers	I, Q, M, D, L, P	Product

You can select the data type for the instruction from the "<???" drop-down list of the instruction box.

For additional information on valid data types, refer to "See also".



## Example

The following example shows how the instruction works:

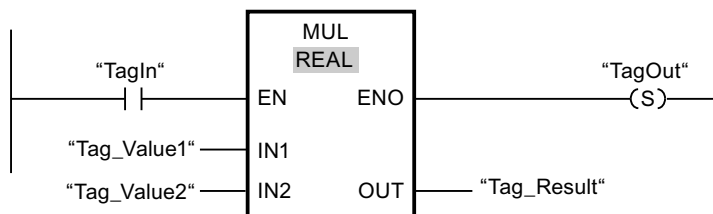

If operand "TagIn" has the signal state "1", the "Multiply" instruction is executed. The value of operand "Tag\_Value1" is multiplied by the value of operand "Tag\_Value2". The result of the multiplication is stored in operand "Tag\_Result". If the instruction is executed without errors, the ENO enable output has the signal state "1" and the "TagOut" output is set.

## See also

Overview of the valid data types (Page 1077)

Removing inputs and outputs (Page 1290)

Basics of the EN/ENO mechanism (Page 1167)

Selecting a data type (Page 1274)

Inserting additional inputs and outputs in LAD elements (Page 1289)

## DIV: Divide

### Description

You can use the "Divide" instruction to divide the value at input IN1 by the value at input IN2 and query the quotient at output OUT ( $OUT := IN1/IN2$ ).

The ENO enable output has the signal state "0" if one of the following conditions is fulfilled:

- The EN enable input has the signal state "0".
- The result of the instruction is outside the range permitted for the data type specified at the OUT output.
- A floating-point number has an invalid value.

### Parameters

The following table shows the parameters of the "Divide" instruction:

Parameter	Declaration	Data type	Memory area	Description
EN	Input	BOOL	I, Q, M, D, L	Enable input
ENO	Output	BOOL	I, Q, M, D, L	Enable output
IN1	Input	Integers, floating-point numbers	I, Q, M, D, L, P or constant	Dividend

Parameter	Declaration	Data type	Memory area	Description
IN2	Input	Integers, floating-point numbers	I, Q, M, D, L, P or constant	Divisor
OUT	Output	Integers, floating-point numbers	I, Q, M, D, L, P	Quotient value

You can select the data type for the instruction from the "<???" drop-down list of the instruction box.

For additional information on valid data types, refer to "See also".

**Example**

The following example shows how the instruction works:

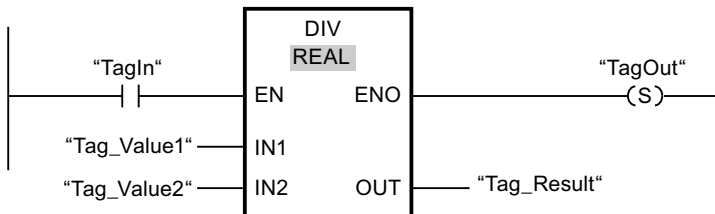

If operand "TagIn" has the signal state "1", the "Divide" instruction is executed. The value of operand "Tag\_Value1" is divided by the value of operand "Tag\_Value2". The division result is stored in operand "Tag\_Result". If the instruction is executed without errors, the ENO enable output has the signal state "1" and the "TagOut" output is set.

**See also**

- Overview of the valid data types (Page 1077)
- Basics of the EN/ENO mechanism (Page 1167)
- Selecting a data type (Page 1274)

**MOD: Return remainder of division**

**Description**

You can use the "Return remainder of division" instruction to divide the value at input IN1 by the value at input IN2 and query the remainder of division at output OUT.

**Parameters**

The following table shows the parameters of the "Return remainder of division" instruction:

Parameter	Declaration	Data type	Memory area	Description
EN	Input	BOOL	I, Q, M, D, L	Enable input
ENO	Output	BOOL	I, Q, M, D, L	Enable output

Parameter	Declaration	Data type	Memory area	Description
IN1	Input	Integers	I, Q, M, D, L, P or constant	Dividend
IN2	Input	Integers	I, Q, M, D, L, P or constant	Divisor
OUT	Output	Integers	I, Q, M, D, L, P	Remainder of division

You can select the data type for the instruction from the "<???"> drop-down list of the instruction box.

For additional information on valid data types, refer to "See also".

## Example

The following example shows how the instruction works:

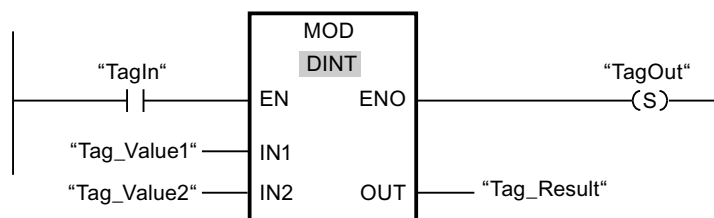

If operand "TagIn" has the signal state "1", the "Return remainder of division" instruction is executed. The value of operand "Tag\_Value1" is divided by the value of operand "Tag\_Value2". The remainder is stored in operand "Tag\_Result". If the instruction is executed without errors, the ENO enable output has the signal state "1" and the "TagOut" output is set.

## See also

Overview of the valid data types (Page 1077)

Basics of the EN/ENO mechanism (Page 1167)

Selecting a data type (Page 1274)

## NEG: Create twos complement

### Description

You can use the "Create twos complement" instruction to change the sign of the value at the IN input and query the result at the OUT output. If there is a positive value at input IN, for example, the negative equivalent of this value is sent to output OUT.

The ENO enable output has the signal state "0" if one of the following conditions is fulfilled:

- The EN enable input has the signal state "0".
- The result of the instruction is outside the range permitted for the data type specified at the OUT output.
- A floating-point number has an invalid value.

### Parameters

The following table shows the parameters of the "Create twos complement" instruction:

Parameter	Declaration	Data type		Memory area	Description
		S7-1200	S7-1500		
EN	Input	BOOL	BOOL	I, Q, M, D, L	Enable input
ENO	Output	BOOL	BOOL	I, Q, M, D, L	Enable output
IN	Input	SINT, INT, DINT, floating-point numbers	SINT, INT, DINT, LINT, floating-point numbers	I, Q, M, D, L, P or constant	Input value
OUT	Output	SINT, INT, DINT, floating-point numbers	SINT, INT, DINT, LINT, floating-point numbers	I, Q, M, D, L, P	Twos complement of the input value

You can select the data type for the instruction from the "<???" drop-down list of the instruction box.

For additional information on valid data types, refer to "See also".

### Example

The following example shows how the instruction works:

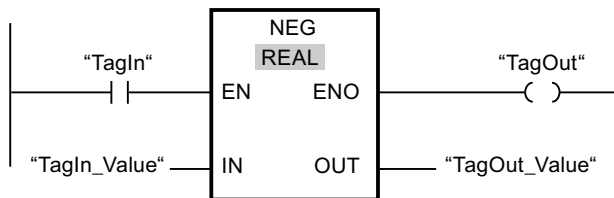

If operand "TagIn" has the signal state "1", the "Create twos complement" instruction is executed. The sign of the value at input "TagIn\_Value" is changed and the result is provided at "TagOut\_Value" output. If the instruction is executed without errors, the ENO enable output has the signal state "1" and the "TagOut" output is set.

### See also

- Overview of the valid data types (Page 1077)
- Basics of the EN/ENO mechanism (Page 1167)

### INC: Increment

#### Description

You can use the "Increment" instruction to change the value of the operand at the IN/OUT parameter to the next higher value and query the result. The "Increment" instruction is only

started when the signal state at the EN enable input is "1". If no overflow error occurs during the execution, the ENO enable output also has the signal state "1".

The ENO enable output has the signal state "0" if one of the following conditions is fulfilled:

- The EN enable input has the signal state "0".
- A floating-point number has an invalid value.

## Parameters

The following table shows the parameters of the "Increment" instruction:

Parameter	Declaration	Data type	Memory area	Description
EN	Input	BOOL	I, Q, M, D, L	Enable input
ENO	Output	BOOL	I, Q, M, D, L	Enable output
IN/OUT	InOut	Integers	I, Q, M, D, L	Value to be incremented.

You can select the data type for the instruction from the "<???"> drop-down list of the instruction box.

For additional information on valid data types, refer to "See also".

## Example

The following example shows how the instruction works:

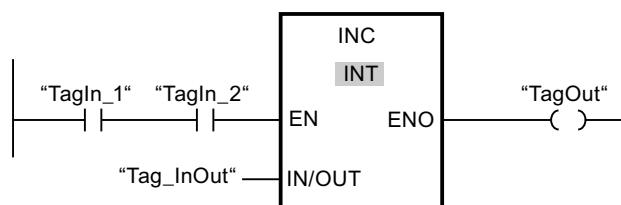

If operands "TagIn\_1" and "TagIn\_2" have the signal state "1", the value of operand "Tag\_InOut" is incremented by one and the "TagOut" output is set.

## See also

Overview of the valid data types (Page 1077)

Basics of the EN/ENO mechanism (Page 1167)

## DEC: Decrement

### Description

You can use the "Decrement" instruction to change the value of the operand at the IN/OUT parameter to the next lower value and query the result. The "Decrement" instruction is only

started when the signal state at the EN enable input is "1". If the range of values of the selected data type is not exceeded during processing, the ENO output also has the signal state "1".

The ENO enable output has the signal state "0" if one of the following conditions is fulfilled:

- The EN enable input has the signal state "0".
- A floating-point number has an invalid value.

### Parameter

The following table shows the parameters of the "Decrement" instruction:

Parameter	Declaration	Data type	Memory area	Description
EN	Input	BOOL	I, Q, M, D, L	Enable input
ENO	Output	BOOL	I, Q, M, D, L	Enable output
IN/OUT	InOut	Integers	I, Q, M, D, L	Value to be decremented.

You can select the data type for the instruction from the "<???" drop-down list of the instruction box.

For additional information on valid data types, refer to "See also".

### Example

The following example shows how the instruction works:

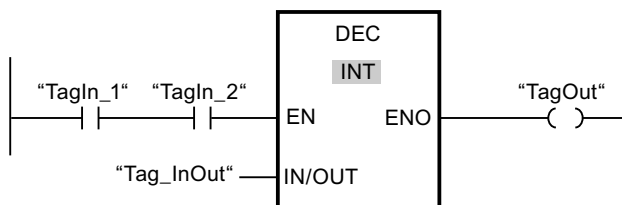

If operands "TagIn\_1" and "TagIn\_2" have the signal state "1", the value of operand "Tag\_InOut" is decremented by one and the "TagOut" output is set.

### See also

- Overview of the valid data types (Page 1077)
- Basics of the EN/ENO mechanism (Page 1167)

### ABS: Form absolute value

#### Description

You can use the "Form absolute value" instruction to calculate the absolute value of the value specified at input IN. The result of the instruction is sent to the OUT output and can be queried there.

The ENO enable output has the signal state "0" if one of the following conditions is fulfilled:

- The EN enable input has the signal state "0".
- A floating-point number has an invalid value.

## Parameters

The following table shows the parameters of the "Form absolute value" instruction:

Parameter	Declaration	Data type		Memory area	Description
		S7-1200	S7-1500		
EN	Input	BOOL	BOOL	I, Q, M, D, L	Enable input
ENO	Output	BOOL	BOOL	I, Q, M, D, L	Enable output
IN	Input	SINT, INT, DINT, floating-point numbers	SINT, INT, DINT, LINT, floating-point numbers	I, Q, M, D, L, P or constant	Input value
OUT	Output	SINT, INT, DINT, floating-point numbers	SINT, INT, DINT, LINT, floating-point numbers	I, Q, M, D, L, P	Absolute value of the input value

You can select the data type for the instruction from the "<???">" drop-down list of the instruction box.

For additional information on valid data types, refer to "See also".

## Example

The following example shows how the instruction works:

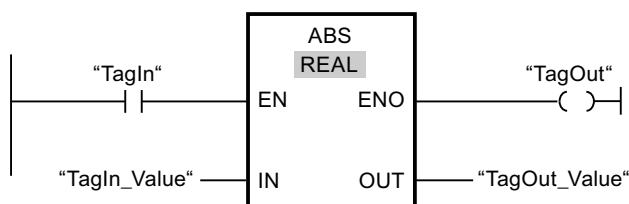

The following table shows how the instruction works using specific operand values:

Parameter	Operand	Value
IN	TagIn_Value	-6.234
OUT	TagOut_Value	6.234

If operand "TagIn" has the signal state "1", the "Form absolute value" instruction is executed. The instruction calculates the absolute value of the value at input "TagIn\_Value" and sends the result to output "TagOut\_Value". If the instruction is executed without errors, the "TagOut" output is set.

**See also**

- Overview of the valid data types (Page 1077)
- Basics of the EN/ENO mechanism (Page 1167)

**MIN: Get minimum**

**Description**

The "Get minimum" instruction compares the values at the available inputs and writes the lowest value to the OUT output. The number of inputs can be expanded at the instruction box by additional inputs. The inputs are numbered in ascending order in the box.

A minimum of two and a maximum of 100 inputs must be specified for the execution of the instruction.

The ENO enable output has the signal state "0" if one of the following conditions is fulfilled:

- Enable input EN has the signal state "0".
- The implicit conversion of the data types fails during execution of the instruction.
- A floating-point number has an invalid value.

**Parameters**

The following table shows the parameters of the "Get minimum" instruction:

Parameter	Declaration	Data type		Memory area	Description
		S7-1200	S7-1500		
EN	Input	BOOL	BOOL	I, Q, M, D, L	Enable input
ENO	Output	BOOL	BOOL	I, Q, M, D, L	Enable output
IN1	Input	Integers, floating-point numbers, TIME, TOD, DATE	Integers, floating-point numbers, TIME, LTIME, TOD, LTOD, DATE, LDT	I, Q, M, D, L, P or constant	First input value
IN2	Input	Integers, floating-point numbers, TIME, TOD, DATE	Integers, floating-point numbers, TIME, LTIME, TOD, LTOD, DATE, LDT	I, Q, M, D, L, P or constant	Second input value



Parameter	Declaration	Data type		Memory area	Description
		S7-1200	S7-1500		
INn	Input	Integers, floating-point numbers, TIME, TOD, DATE	Integers, floating-point numbers, TIME, LTIME, TOD, LTOD, DATE, LDT	I, Q, M, D, L, P or constant	Additionally inserted inputs whose values are to be compared
OUT	Output	Integers, floating-point numbers, TIME, TOD, DATE	Integers, floating-point numbers, TIME, LTIME, TOD, LTOD, DATE, LDT	I, Q, M, D, L, P	Result

You can select the data type for the instruction from the "<???">" drop-down list of the instruction box.

For additional information on valid data types, refer to "See also".

## Example

The following example shows how the instruction works:

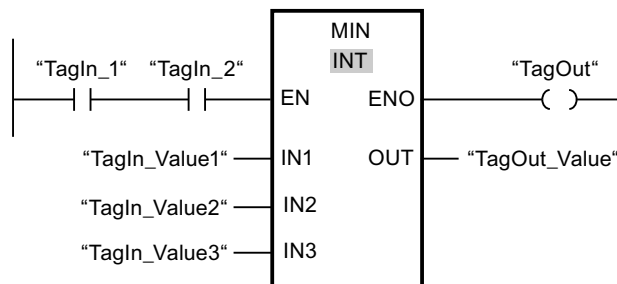

The following table shows how the instruction works using specific operand values:

Parameter	Operand	Value
IN1	TagIn_Value1	12222
IN2	TagIn_Value2	14444
IN3	TagIn_Value3	13333
OUT	TagOut_Value	12222

If the "TagIn\_1" and "TagIn\_2" operands have signal state "1", the "Get minimum" instruction is executed. The instruction compares the values of the specified operands and copies the lowest value ("TagIn\_Value1") to output "TagOut\_Value". If the instruction is executed without errors, the "TagOut" output is set.

**See also**

Overview of the valid data types (Page 1077)

Inserting additional inputs and outputs in LAD elements (Page 1289)

Basics of the EN/ENO mechanism (Page 1167)

**MAX: Get maximum**

**Description**

The "Get maximum" instruction compares the values at the available inputs and writes the highest value to the OUT output. The number of inputs can be expanded at the instruction box by additional inputs. The inputs are numbered in ascending order in the box.

A minimum of two and a maximum of 100 inputs must be specified for the execution of the instruction.

The ENO enable output has the signal state "0" if one of the following conditions is fulfilled:

- Enable input EN has the signal state "0".
- The implicit conversion of the data types fails during execution of the instruction.
- A floating-point number has an invalid value.

**Parameters**

The following table shows the parameters of the "Get maximum" instruction:

Parameter	Declaration	Data type		Memory area	Description
		S7-1200	S7-1500		
EN	Input	BOOL	BOOL	I, Q, M, D, L	Enable input
ENO	Output	BOOL	BOOL	I, Q, M, D, L	Enable output
IN1	Input	Integers, floating-point numbers, TIME, TOD, DATE	Integers, floating-point numbers, TIME, LTIME, TOD, LTOD, DATE, LDT	I, Q, M, D, L, P or constant	First input value
IN2	Input	Integers, floating-point numbers, TIME, TOD, DATE	Integers, floating-point numbers, TIME, LTIME, TOD, LTOD, DATE, LDT	I, Q, M, D, L, P or constant	Second input value

Parameter	Declaration	Data type		Memory area	Description
		S7-1200	S7-1500		
INn	Input	Integers, floating-point numbers, TIME, TOD, DATE	Integers, floating-point numbers, TIME, LTIME, TOD, LTOD, DATE, LDT	I, Q, M, D, L, P or constant	Additionally inserted inputs whose values are to be compared
OUT	Output	Integers, floating-point numbers, TIME, TOD, DATE	Integers, floating-point numbers, TIME, LTIME, TOD, LTOD, DATE, LDT	I, Q, M, D, L, P	Result

You can select the data type for the instruction from the "<???">" drop-down list of the instruction box.

For additional information on valid data types, refer to "See also".

### Example

The following example shows how the instruction works:

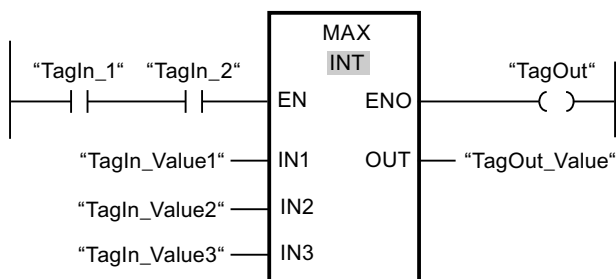

The following table shows how the instruction works using specific operand values:

Parameter	Operand	Value
IN1	TagIn_Value1	12222
IN2	TagIn_Value2	14444
IN3	TagIn_Value3	13333
OUT	TagOut_Value	14444

If the "TagIn\_1" and "TagIn\_2" operands have signal state "1", the "Get maximum" instruction is executed. The instruction compares the values of the specified operands and copies the highest value ("TagIn\_Value2") to output "TagOut\_Value". If the instruction is executed without errors, the "TagOut" output is set.

**See also**

- Overview of the valid data types (Page 1077)
- Inserting additional inputs and outputs in LAD elements (Page 1289)
- Removing inputs and outputs (Page 1290)
- Basics of the EN/ENO mechanism (Page 1167)

**LIMIT: Set limit value**

**Description**

You use the "Set limit value" instruction to limit the value at input IN to the values at the inputs MN and MX. If the value at the IN input meets the condition  $MN \leq IN \leq MX$ , it is copied to the OUT output. If the condition is not fulfilled and the input value IN is below the low limit MN, the output OUT is set to the value of the MN input. If the MX high limit is exceeded, the OUT output is set to the value of the MX input.

If the value at the MN input is greater than at the MX input, the result is undefined and the enable output ENO is "0".

The ENO enable output has the signal state "0" if one of the following conditions is fulfilled:

- Enable input EN has the signal state "0".
- The specified tags are not of the same data type.
- An operand has an invalid value.
- The value at the MN input is greater than the value at the MX input.

**Parameters**

The following table shows the parameters of the "Set limit value" instruction:

Parameter	Declaration	Data type		Memory area	Description
		S7-1200	S7-1500		
EN	Input	BOOL	BOOL	I, Q, M, D, L	Enable input
ENO	Output	BOOL	BOOL	I, Q, M, D, L	Enable output
MN	Input	Integers, floating-point numbers, TIME, TOD, DATE	Integers, floating-point numbers, TIME, LTIME, TOD, LTOD, DATE, LDT	I, Q, M, D, L, P or constant	Low limit
IN	Input	Integers, floating-point numbers, TIME, TOD, DATE	Integers, floating-point numbers, TIME, LTIME, TOD, LTOD, DATE, LDT	I, Q, M, D, L, P or constant	Input value

Parameter	Declaration	Data type		Memory area	Description
		S7-1200	S7-1500		
MX	Input	Integers, floating-point numbers, TIME, TOD, DATE	Integers, floating-point numbers, TIME, LTIME, TOD, LTOD, DATE, LDT	I, Q, M, D, L, P or constant	High limit
OUT	Output	Integers, floating-point numbers, TIME, TOD, DATE	Integers, floating-point numbers, TIME, LTIME, TOD, LTOD, DATE, LDT	I, Q, M, D, L, P	Result

You can select the data type for the instruction from the "<???"> drop-down list of the instruction box.

For additional information on valid data types, refer to "See also".

## Example

The following example shows how the instruction works:

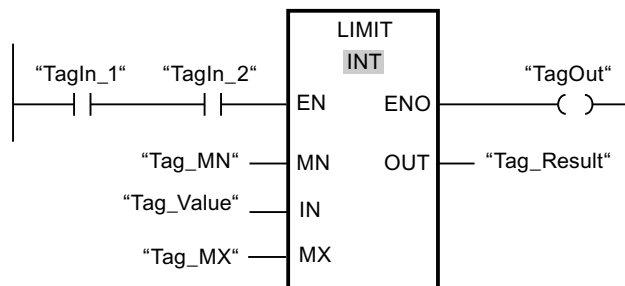

The following table shows how the instruction works using specific operand values:

Parameter	Operand	Value
MN	Tag_MN	12000
IN	Tag_Value	8000
MX	Tag_MX	16000
OUT	Tag_Result	12000

If operands "TagIn\_1" and "TagIn\_2" have the signal state "1", the "Set limit value" instruction is executed. The value of operand "Tag\_Value" is compared with the values of operands "Tag\_MN" and "Tag\_MX". Since the value of operand "Tag\_Value" is less than the low limit, the value of operand "Tag\_MN" is copied to the "Tag\_Result" output. If the instruction is executed without errors, the "TagOut" output is set.

**See also**

- Overview of the valid data types (Page 1077)
- Basics of the EN/ENO mechanism (Page 1167)

**SQR: Form square**

**Description**

You can use the "Form square" instruction to square the value at the IN input and query the result at the OUT output.

The ENO enable output has the signal state "0" if one of the following conditions is fulfilled:

- The EN enable input has the signal state "0".
- The value at the IN input is not a valid floating-point number.

**Parameters**

The following table shows the parameters of the "Form square" instruction:

Parameter	Declaration	Data type	Memory area	Description
EN	Input	BOOL	I, Q, M, D, L	Enable input
ENO	Output	BOOL	I, Q, M, D, L	Enable output
IN	Input	Floating-point numbers	I, Q, M, D, L, P or constant	Input value
OUT	Output	Floating-point numbers	I, Q, M, D, L, P	Square of the input value

You can select the data type for the instruction from the "<???" drop-down list of the instruction box.

For additional information on valid data types, refer to "See also".

**Example**

The following example shows how the instruction works:

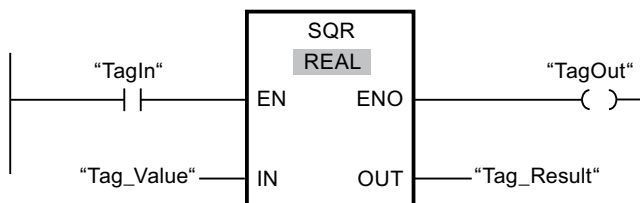

The following table shows how the instruction works using specific operand values:

Parameter	Operand	Value
IN	Tag_Value	5.0
OUT	Tag_Result	25.0

If operand "TagIn" has the signal state "1", the "Form square" instruction is executed. The instruction squares the value of operand "Tag\_Value" and sends the result to the "Tag\_Result" output. If the instruction is executed without errors, the "TagOut" output is set.

## See also

Overview of the valid data types (Page 1077)

Basics of the EN/ENO mechanism (Page 1167)

## SQRT: Form square root

### Description

You can use the "Form square root" instruction to find the square root of the value at the IN input and query the result at the OUT output. The instruction outputs a positive result if the input value is greater than zero. If input values are less than zero, the OUT output returns an invalid floating-point number. If the value at input IN is "0", then the result is also "0".

The ENO enable output has the signal state "0" if one of the following conditions is fulfilled:

- The EN enable input has the signal state "0".
- The value at the IN input is not a valid floating-point number.
- The value at the IN input is negative.

### Parameters

The following table shows the parameters of the "Form square root" instruction:

Parameter	Declaration	Data type	Memory area	Description
EN	Input	BOOL	I, Q, M, D, L	Enable input
ENO	Output	BOOL	I, Q, M, D, L	Enable output
IN	Input	Floating-point numbers	I, Q, M, D, L, P or constant	Input value
OUT	Output	Floating-point numbers	I, Q, M, D, L, P	Square root of the input value

You can select the data type for the instruction from the "<???">" drop-down list of the instruction box.

For additional information on valid data types, refer to "See also".

**Example**

The following example shows how the instruction works:

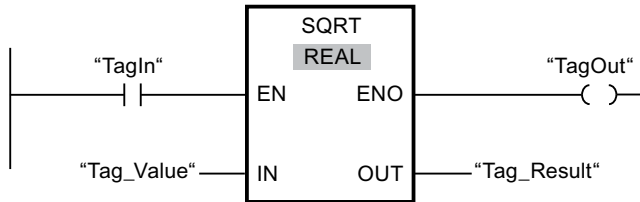

The following table shows how the instruction works using specific operand values:

Parameter	Operand	Value
IN	Tag_Value	25.0
OUT	Tag_Result	5.0

If operand "TagIn" has the signal state "1", the "Form square root" instruction is executed. The instruction finds the square root of the value of operand "Tag\_Value" and stores the result in the "Tag\_Result" output. If the instruction is executed without errors, the "TagOut" output is set.

**See also**

- Overview of the valid data types (Page 1077)
- Basics of the EN/ENO mechanism (Page 1167)

**LN: Form natural logarithm**

**Description**

You can use the "Form natural logarithm" instruction to calculate the natural logarithm to base e (e = 2.718282) of the value at input IN. The result is sent to the OUT output and can be queried there. The instruction outputs a positive result if the input value is greater than zero. If input values are less than zero, the OUT output returns an invalid floating-point number.

The ENO enable output has the signal state "0" if one of the following conditions is fulfilled:

- The enable input EN has the signal state "0".
- The value at the IN input is not a valid floating-point number.
- The value at the IN input is negative.



## Parameters

The following table shows the parameters of the "Form natural logarithm" instruction:

Parameters	Declaration	Data type	Memory area	Description
EN	Input	BOOL	I, Q, M, D, L	Enable input
ENO	Output	BOOL	I, Q, M, D, L	Enable output
IN	Input	Floating-point numbers	I, Q, M, D, L, P or constant	Input value
OUT	Output	Floating-point numbers	I, Q, M, D, L, P	Natural logarithm of the input value

You can select the data type for the instruction from the "<???" drop-down list of the instruction box.

For additional information on valid data types, refer to "See also".

## Example

The following example shows how the instruction works:

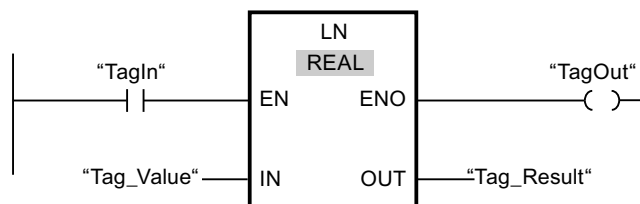

If operand "TagIn" has the signal state "1", the "Form natural logarithm" instruction is executed. The instruction forms the natural logarithm of the value at the "Tag\_Value" input and stores the result in the "Tag\_Result" output. If the instruction is executed without errors, the "TagOut" output is set.

## See also

Overview of the valid data types (Page 1077)

Basics of the EN/ENO mechanism (Page 1167)

## EXP: Form exponential value

### Description

You can use the "Form exponential value" instruction to calculate the exponent from the base  $e$  ( $e = 2.718282$ ) and the value specified at input IN. The result is provided at output OUT and can be queried there ( $OUT = e^{IN}$ ).

The ENO enable output has the signal state "0" if one of the following conditions is fulfilled:

- The enable input EN has the signal state "0".
- The value at the IN input is not a valid floating-point number.

### Parameters

The following table shows the parameters of the "Form exponential value" instruction:

Parameters	Declaration	Data type	Memory area	Description
EN	Input	BOOL	I, Q, M, D, L	Enable input
ENO	Output	BOOL	I, Q, M, D, L	Enable output
IN	Input	Floating-point numbers	I, Q, M, D, L, P or constant	Input value
OUT	Output	Floating-point numbers	I, Q, M, D, L, P	Exponential value of input value IN

You can select the data type for the instruction from the "<???" drop-down list of the instruction box.

For additional information on valid data types, refer to "See also".

### Example

The following example shows how the instruction works:

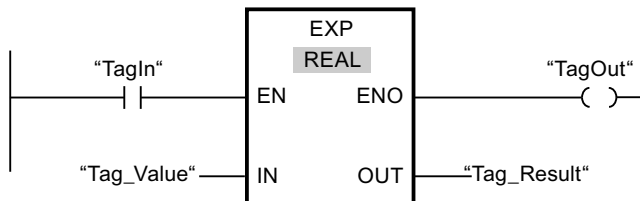

If operand "TagIn" has the signal state "1", the "Form exponential value" instruction is executed. The instruction calculates the exponent from base e and the value of operand "Tag\_Value" and sends the result to the "Tag\_Result" output. If the instruction is executed without errors, the "TagOut" output is set.

### See also

- Overview of the valid data types (Page 1077)
- Basics of the EN/ENO mechanism (Page 1167)

### SIN: Form sine value

#### Description

Use the "Form sine value" instruction to calculate the sine of the angle. The size of the angle is specified in radians at the IN input. The result of the instruction is sent to the OUT output and can be queried there.

The ENO enable output has the signal state "0" if one of the following conditions is fulfilled:

- The EN enable input has the signal state "0".
- The value at the IN input is not a valid floating-point number.

## Parameters

The following table shows the parameters of the "Form sine value" instruction:

Parameter	Declaration	Data type	Memory area	Description
EN	Input	BOOL	I, Q, M, D, L	Enable input
ENO	Output	BOOL	I, Q, M, D, L	Enable output
IN	Input	Floating-point numbers	I, Q, M, D, L, P or constant	Size of angle in radians
OUT	Output	Floating-point numbers	I, Q, M, D, L, P	Sine of the specified angle

You can select the data type for the instruction from the "<???"> drop-down list of the instruction box.

For additional information on valid data types, refer to "See also".

## Example

The following example shows how the instruction works:

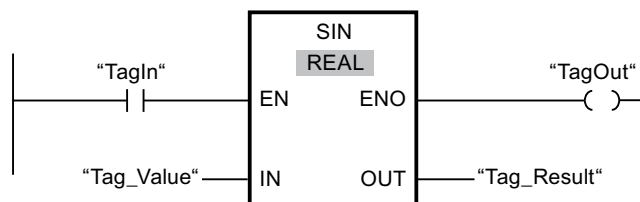

The following table shows how the instruction works using specific operand values:

Parameter	Operand	Value
IN	Tag_Value	+1.570796 ( $\pi/2$ )
OUT	Tag_Result	1.0

If operand "TagIn" has the signal state "1", the "Form sine value" instruction is executed. The instruction calculates the sine of the angle specified at the "Tag\_Value" input and stores the result in the "Tag\_Result" output. If the instruction is executed without errors, the "TagOut" output is set.

## See also

Overview of the valid data types (Page 1077)

Basics of the EN/ENO mechanism (Page 1167)

## COS: Form cosine value

### Description

Use the "Form cosine value" instruction to calculate the cosine of the angle. The size of the angle is specified in radians at the IN input. The result of the instruction is sent to the OUT output and can be queried there.

The ENO enable output has the signal state "0" if one of the following conditions is fulfilled:

- The EN enable input has the signal state "0".
- The value at the IN input is not a valid floating-point number.

### Parameters

The following table shows the parameters of the "Form cosine value" instruction:

Parameter	Declaration	Data type	Memory area	Description
EN	Input	BOOL	I, Q, M, D, L	Enable input
ENO	Output	BOOL	I, Q, M, D, L	Enable output
IN	Input	Floating-point numbers	I, Q, M, D, L, P or constant	Size of angle in radians
OUT	Output	Floating-point numbers	I, Q, M, D, L, P	Cosine of the specified angle

You can select the data type for the instruction from the "<???" drop-down list of the instruction box.

For additional information on valid data types, refer to "See also".

### Example

The following example shows how the instruction works:

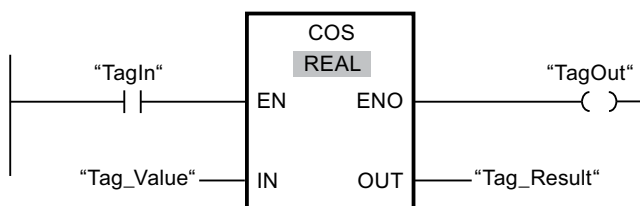

The following table shows how the instruction works using specific operand values:

Parameter	Operand	Value
IN	Tag_Value	+1.570796 ( $\pi/2$ )
OUT	Tag_Result	0

If operand "TagIn" has the signal state "1", the "Form cosine value" instruction is executed. The instruction calculates the cosine of the angle specified at the "Tag\_Value" input and stores

the result in the "Tag\_Result" output. If the instruction is executed without errors, the "TagOut" output is set.

## See also

Overview of the valid data types (Page 1077)

Basics of the EN/ENO mechanism (Page 1167)

## TAN: Form tangent value

### Description

Use the "Form tangent value" instruction to calculate the tangent of the angle. The size of the angle is specified in radians at the IN input. The result of the instruction is sent to the OUT output and can be queried there.

The ENO enable output has the signal state "0" if one of the following conditions is fulfilled:

- The EN enable input has the signal state "0".
- The value at the IN input is not a valid floating-point number.

### Parameters

The following table shows the parameters of the "Form tangent value" instruction:

Parameters	Declaration	Data type	Memory area	Description
EN	Input	BOOL	I, Q, M, D, L	Enable input
ENO	Output	BOOL	I, Q, M, D, L	Enable output
IN	Input	Floating-point numbers	I, Q, M, D, L, P or constant	Size of angle in radians
OUT	Output	Floating-point numbers	I, Q, M, D, L, P	Tangent of the specified angle

You can select the data type for the instruction from the "<???"> drop-down list of the instruction box.

For additional information on valid data types, refer to "See also".

### Example

The following example shows how the instruction works:

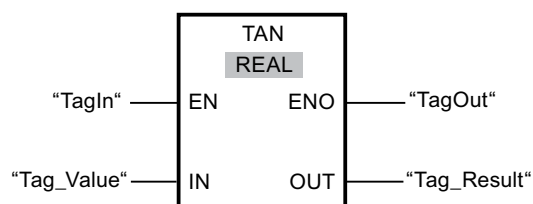

The following table shows how the instruction works using specific operand values:

Parameter	Operand	Value
IN	Tag_Value	+3.141593 ( $\pi$ )
OUT	Tag_Result	0

If operand "TagIn" has the signal state "1", the "Form tangent value" instruction is executed. The instruction calculates the tangent of the angle specified at the "Tag\_Value" input and stores the result in the "Tag\_Result" output. If the instruction is executed without errors, the "TagOut" output is set.

**See also**

- Overview of the valid data types (Page 1077)
- Basics of the EN/ENO mechanism (Page 1167)

**ASIN: Form arcsine value**

**Description**

You can use the "Form arcsine value" instruction to calculate the size of the angle from the arcsine value specified at input IN, which corresponds to this value. Only valid floating-point numbers within the range -1 to +1 can be specified at the IN input. The calculated angle size is output in radians at the OUT output and can range in value from  $-\pi/2$  to  $+\pi/2$ .

The ENO enable output has the signal state "0" if one of the following conditions is fulfilled:

- The EN enable input has the signal state "0".
- The value at the IN input is not a valid floating-point number.
- The value at the IN input is outside the permitted value range (-1 to +1).

**Parameters**

The following table shows the parameters of the "Form arcsine value" instruction:

Parameters	Declaration	Data type	Memory area	Description
EN	Input	BOOL	I, Q, M, D, L	Enable input
ENO	Output	BOOL	I, Q, M, D, L	Enable output
IN	Input	Floating-point numbers	I, Q, M, D, L, P or constant	Sine value
OUT	Output	Floating-point numbers	I, Q, M, D, L, P	Size of angle in radians

You can select the data type for the instruction from the "<???">" drop-down list of the instruction box.

For additional information on valid data types, refer to "See also".

## Example

The following example shows how the instruction works:

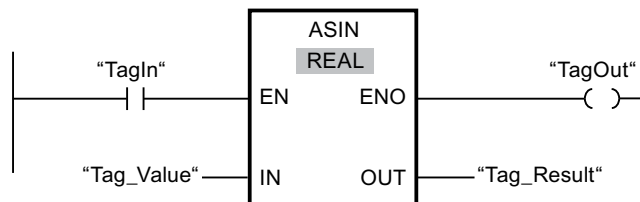

The following table shows how the instruction works using specific operand values:

Parameters	Operand	Value
IN	Tag_Value	1.0
OUT	Tag_Result	+1.570796 ( $\pi/2$ )

If operand "TagIn" has the signal state "1", the "Form arcsine value" instruction is executed. The instruction calculates the size of the angle corresponding to the sine value at the "Tag\_Value" input. The result of the instruction is stored in the "Tag\_Result" output. If the instruction is executed without errors, the "TagOut" output is set.

## See also

Overview of the valid data types (Page 1077)

Basics of the EN/ENO mechanism (Page 1167)

## ACOS: Form arccosine value

### Description

You can use the "Form arccosine value" instruction to calculate the size of the angle from the cosine value specified at input IN, which corresponds to this value. Only valid floating-point numbers within the range -1 to +1 can be specified at the IN input. The calculated angle size is output in radians at the OUT output and can range in value from 0 to  $+\pi$ .

The ENO enable output has the signal state "0" if one of the following conditions is fulfilled:

- The EN enable input has the signal state "0".
- The value at the IN input is not a valid floating-point number.
- The value at the IN input is outside the permitted value range (-1 to +1).

### Parameters

The following table shows the parameters of the "Form arccosine value" instruction:

Parameters	Declaration	Data type	Memory area	Description
EN	Input	BOOL	I, Q, M, D, L	Enable input
ENO	Output	BOOL	I, Q, M, D, L	Enable output
IN	Input	Floating-point numbers	I, Q, M, D, L, P or constant	Cosine value
OUT	Output	Floating-point numbers	I, Q, M, D, L, P	Size of angle in radians

You can select the data type for the instruction from the "<???" drop-down list of the instruction box.

For additional information on valid data types, refer to "See also".

### Example

The following example shows how the instruction works:

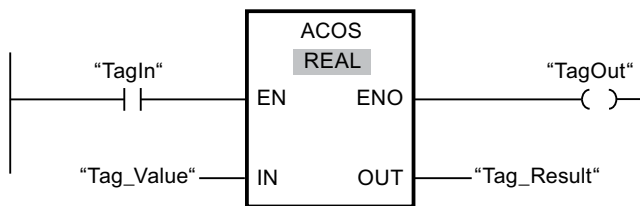

The following table shows how the instruction works using specific operand values:

Parameters	Operand	Value
IN	Tag_Value	0
OUT	Tag_Result	+1.570796 ( $\pi/2$ )

If operand "TagIn" has the signal state "1", the "Form arccosine value" instruction is executed. The instruction calculates the size of the angle corresponding to the cosine value at the "Tag\_Value" input. The result of the instruction is stored in the "Tag\_Result" output. If the instruction is executed without errors, the "TagOut" output is set.

### See also

Overview of the valid data types (Page 1077)

Basics of the EN/ENO mechanism (Page 1167)



## ATAN: Form arctangent value

### Description

You can use the "Form arctangent value" instruction to calculate the size of the angle from the tangent value specified at input IN, which corresponds to this value. Only valid floating-point numbers may be specified at the IN input. The calculated angle size is output in radians at the OUT output and can range in value from  $-\pi/2$  to  $+\pi/2$ .

The ENO enable output has the signal state "0" if one of the following conditions is fulfilled:

- The EN enable input has the signal state "0".
- The value at the IN input is not a valid floating-point number.

### Parameters

The following table shows the parameters of the "Form arctangent value" instruction:

Parameters	Declaration	Data type	Memory area	Description
EN	Input	BOOL	I, Q, M, D, L	Enable input
ENO	Output	BOOL	I, Q, M, D, L	Enable output
IN	Input	Floating-point numbers	I, Q, M, D, L, P or constant	Tangent value
OUT	Output	Floating-point numbers	I, Q, M, D, L, P	Size of angle in radians

You can select the data type for the instruction from the "<???"> drop-down list of the instruction box.

For additional information on valid data types, refer to "See also".

### Example

The following example shows how the instruction works:

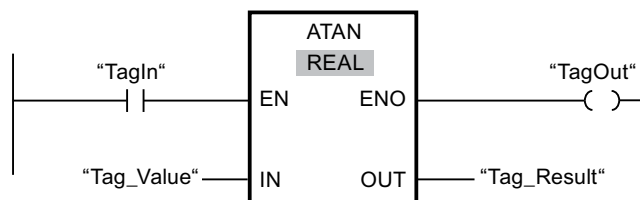

The following table shows how the instruction works using specific operand values:

Parameters	Operand	Value
IN	Tag_Value	1.0
OUT	Tag_Result	+0.785398 ( $\pi/4$ )

If operand "TagIn" has the signal state "1", the "Form arctangent value" instruction is executed. The instruction calculates the size of the angle corresponding to the tangent value at the "Tag\_Value" input. The result of the instruction is stored in the "Tag\_Result" output. If the instruction is executed without errors, the "TagOut" output is set.

**See also**

- Overview of the valid data types (Page 1077)
- Basics of the EN/ENO mechanism (Page 1167)

**FRAC: Return fraction**

**Description**

You can use the "Return fraction" instruction to determine the decimal places of the value at the IN input. The result of the query is stored at the OUT output and can be queried there. If, for example, the IN input has the value 123.4567, the OUT output returns the value 0.4567.

The ENO enable output has the signal state "0" if one of the following conditions is fulfilled:

- The EN enable input has the signal state "0".
- The value at input IN is not a valid floating-point number.

**Parameters**

The following table shows the parameters of the "Return fraction" instruction:

Parameter	Declaration	Data type	Memory area	Description
EN	Input	BOOL	I, Q, M, D, L	Enable input
ENO	Output	BOOL	I, Q, M, D, L	Enable output
IN	Input	Floating-point numbers	I, Q, M, D, L, P or constant	Value, whose decimal places are to be determined.
OUT	Output	Floating-point numbers	I, Q, M, D, L, P	Decimal places of the value at the IN input

You can select the data type for the instruction from the "<???">" drop-down list of the instruction box.

For additional information on valid data types, refer to "See also".

## Example

The following example shows how the instruction works:

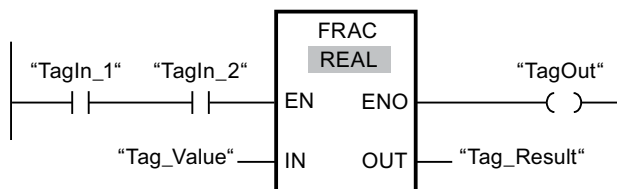

The following table shows how the instruction works using specific operand values:

Parameter	Operand	Value
IN	Tag_Value	2.555
OUT	Tag_Result	0.555

If operands "TagIn\_1" and "TagIn\_2" have the signal state "1", the "Return fraction" instruction is started. The decimal places from the value of operand "Tag\_Value" are copied to operand "Tag\_Result". If the instruction is executed without errors, the ENO output has the signal state "1" and the "TagOut" output is set.

## See also

Overview of the valid data types (Page 1077)

Basics of the EN/ENO mechanism (Page 1167)

## EXPT: Exponentiate

### Description

You can use the "Exponentiate" instruction to raise the value at the IN1 input to a power specified with the value at the IN2 input. The result of the instruction is provided at the OUT output and can be queried there ( $OUT = IN1^{IN2}$ ).

The IN1 input can only be assigned valid floating-point numbers. Integers can also be assigned to the IN2 input.

The ENO enable output has the signal state "0" if one of the following conditions is fulfilled:

- The EN enable input has the signal state "0".
- Errors occur during execution of the instruction, for example, an overflow occurs.

### Parameters

The following table shows the parameters of the "Exponentiate" instruction:

Parameter	Declaration	Data type	Memory area	Description
EN	Input	BOOL	I, Q, M, D, L	Enable input
ENO	Output	BOOL	I, Q, M, D, L	Enable output
IN1	Input	Floating-point numbers	I, Q, M, D, L, P or constant	Base value
IN2	Input	Integers, floating-point numbers	I, Q, M, D, L, P or constant	Value with which the base value is exponentiated
OUT	Output	Floating-point numbers	I, Q, M, D, L, P	Result

You can select the data type for the instruction from the "<???" drop-down list of the instruction box.

For additional information on valid data types, refer to "See also".

### Example

The following example shows how the instruction works:

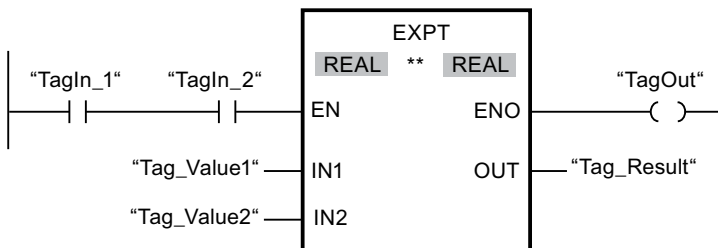

If operands "TagIn\_1" and "TagIn\_2" have the signal state "1", the "Exponentiate" instruction is started. The value of operand "Tag\_Value1" is raised to a power specified with the value of operand "Tag\_Value2". The result is stored in the "Tag\_Result" output. If the instruction is executed without errors, the ENO enable output has the signal state "1" and the "TagOut" output is set.

### See also

- Overview of the valid data types (Page 1077)
- Basics of the EN/ENO mechanism (Page 1167)

## Move operations

### MOVE: Move value

#### Description

You use the "Move value" instruction to transfer the contents of the operand at the IN input to the operand at the OUT1 output. The transfer is always made in the direction of the ascending address.

The following table shows the available transfers for the S7-1200 CPU family:

Source (IN)	Destination (OUT1)	
	With IEC check	Without IEC check
BYTE	BYTE, WORD, DWORD	BYTE, WORD, DWORD, SINT, USINT, INT, UINT, DINT, UDINT, TIME, DATE, TOD, CHAR
WORD	WORD, DWORD	BYTE, WORD, DWORD, SINT, USINT, INT, UINT, DINT, UDINT, TIME, DATE, TOD, CHAR
DWORD	DWORD	BYTE, WORD, DWORD, SINT, USINT, INT, UINT, DINT, UDINT, REAL, TIME, DATE, TOD, CHAR
SINT	SINT	BYTE, WORD, DWORD, SINT, USINT, INT, UINT, DINT, UDINT, TIME, DATE, TOD
USINT	USINT, UINT, UDINT	BYTE, WORD, DWORD, SINT, USINT, INT, UINT, DINT, UDINT, TIME, DATE, TOD
INT	INT	BYTE, WORD, DWORD, SINT, USINT, INT, UINT, DINT, UDINT, TIME, DATE, TOD
UINT	UINT, UDINT	BYTE, WORD, DWORD, SINT, USINT, INT, UINT, DINT, UDINT, TIME, DATE, TOD
DINT	DINT	BYTE, WORD, DWORD, SINT, USINT, INT, UINT, DINT, UDINT, TIME, DATE, TOD
UDINT	UDINT	BYTE, WORD, DWORD, SINT, USINT, INT, UINT, DINT, UDINT, TIME, DATE, TOD
REAL	REAL	DWORD, REAL
LREAL	LREAL	LREAL
TIME	TIME	BYTE, WORD, DWORD, SINT, USINT, INT, UINT, DINT, UDINT, TIME
DATE	DATE	BYTE, WORD, DWORD, SINT, USINT, INT, UINT, DINT, UDINT, DATE
TOD	TOD	BYTE, WORD, DWORD, SINT, USINT, INT, UINT, DINT, UDINT, TOD
DTL	DTL	DTL
CHAR	CHAR	BYTE, WORD, DWORD, CHAR, Character of a string <sup>1)</sup>
Character of a string <sup>1)</sup>	Character of a string	Character of a string CHAR
ARRAY <sup>2)</sup>	ARRAY	ARRAY
STRUCT	STRUCT	STRUCT

Source (IN)	Destination (OUT1)	
	With IEC check	Without IEC check
PLC data type (UDT)	PLC data type (UDT)	PLC data type (UDT)
IEC_TIMER	IEC_TIMER	IEC_TIMER
IEC_SCOUNTER	IEC_SCOUNTER	IEC_SCOUNTER
IEC_USCOUNTER	IEC_USCOUNTER	IEC_USCOUNTER
IEC_COUNTER	IEC_COUNTER	IEC_COUNTER
IEC_UCOUNTER	IEC_UCOUNTER	IEC_UCOUNTER
IEC_DCOUNTER	IEC_DCOUNTER	IEC_DCOUNTER
IEC_UDCOUNTER	IEC_UDCOUNTER	IEC_UDCOUNTER

The following table shows the available transfers for the S7-1500 CPU family:

Source (IN)	Destination (OUT1)	
	With IEC check	Without IEC check
BYTE	BYTE, WORD, DWORD, LWORD	BYTE, WORD, DWORD, LWORD, SINT, USINT, INT, UINT, DINT, UDINT, LINT, ULINT, TIME, LTIME, LDT, DATE, TOD, LTOD, CHAR
WORD	WORD, DWORD, LWORD	BYTE, WORD, DWORD, LWORD, SINT, USINT, INT, UINT, DINT, UDINT, LINT, ULINT, S5TIME, TIME, LTIME, LDT, DATE, TOD, LTOD, CHAR
DWORD	DWORD, LWORD	BYTE, WORD, DWORD, LWORD, SINT, USINT, INT, UINT, DINT, UDINT, LINT, ULINT, REAL, TIME, LTIME, LDT, DATE, TOD, LTOD, CHAR
LWORD	LWORD	BYTE, WORD, DWORD, LWORD, SINT, USINT, INT, UINT, DINT, UDINT, LINT, ULINT, LREAL, TIME, LTIME, LDT, DATE, TOD, LTOD, CHAR
SINT	SINT	BYTE, WORD, DWORD, LWORD, SINT, USINT, INT, UINT, DINT, UDINT, LINT, ULINT, TIME, LTIME, LDT, DATE, TOD, LTOD
USINT	USINT, UINT, UDINT, ULINT	BYTE, WORD, DWORD, LWORD, SINT, USINT, INT, UINT, DINT, UDINT, LINT, ULINT, TIME, LTIME, LDT, DATE, TOD, LTOD
INT	INT	BYTE, WORD, DWORD, LWORD, SINT, USINT, INT, UINT, DINT, UDINT, LINT, ULINT, TIME, LTIME, LDT, DATE, TOD, LTOD
UINT	UINT, UDINT, ULINT	BYTE, WORD, DWORD, LWORD, SINT, USINT, INT, UINT, DINT, UDINT, LINT, ULINT, TIME, LTIME, LDT, DATE, TOD, LTOD
DINT	DINT	BYTE, WORD, DWORD, LWORD, SINT, USINT, INT, UINT, DINT, UDINT, LINT, ULINT, TIME, LTIME, LDT, DATE, TOD, LTOD

Source (IN)	Destination (OUT1)	
	With IEC check	Without IEC check
UDINT	UDINT, ULINT	BYTE, WORD, DWORD, LWORD, SINT, USINT, INT, UINT, DINT, UDINT, LINT, ULINT, TIME, LTIME, LDT, DATE, TOD, LTOD
LINT	LINT	BYTE, WORD, DWORD, LWORD, SINT, USINT, INT, UINT, DINT, UDINT, LINT, ULINT, TIME, LTIME, LDT, DATE, TOD, LTOD
ULINT	ULINT	BYTE, WORD, DWORD, LWORD, SINT, USINT, INT, UINT, DINT, UDINT, LINT, ULINT, TIME, LTIME, LDT, DATE, TOD, LTOD
REAL	REAL	DWORD, REAL
LREAL	LREAL	LWORD, LREAL
S5TIME	S5TIME	WORD, S5TIME
TIME	TIME	BYTE, WORD, DWORD, LWORD, SINT, USINT, INT, UINT, DINT, UDINT, LINT, ULINT, TIME
LTIME	LTIME	BYTE, WORD, DWORD, LWORD, SINT, USINT, INT, UINT, DINT, UDINT, LINT, ULINT, LTIME
DATE	DATE	BYTE, WORD, DWORD, LWORD, SINT, USINT, INT, UINT, DINT, UDINT, LINT, ULINT, DATE
DT	DT	DT
LDT	LDT	BYTE, WORD, DWORD, LWORD, SINT, USINT, INT, UINT, DINT, UDINT, LINT, ULINT, LDT
TOD	TOD	BYTE, WORD, DWORD, LWORD, SINT, USINT, INT, UINT, DINT, UDINT, LINT, ULINT, TOD
LTOD	LTOD	BYTE, WORD, DWORD, LWORD, SINT, USINT, INT, UINT, DINT, UDINT, LINT, ULINT, LTOD
DTL	DTL	DTL
CHAR	CHAR	BYTE, WORD, DWORD, LWORD, CHAR, Character of a string <sup>1)</sup>
Character of a string <sup>1)</sup>	Character of a string	Character of a string CHAR
ARRAY <sup>2)</sup>	ARRAY	ARRAY
STRUCT	STRUCT	STRUCT
COUNTER	COUNTER, WORD, INT	WORD, DWORD, INT, UINT, DINT, UDINT
TIMER	TIMER, WORD, INT	WORD, DWORD, INT, UINT, DINT, UDINT
PLC data type (UDT)	PLC data type (UDT)	PLC data type (UDT)
IEC_TIMER	IEC_TIMER	IEC_TIMER
IEC_LTIMER	IEC_LTIMER	IEC_LTIMER
IEC_SCOUNTER	IEC_SCOUNTER	IEC_SCOUNTER
IEC_USCOUNTER	IEC_USCOUNTER	IEC_USCOUNTER
IEC_COUNTER	IEC_COUNTER	IEC_COUNTER
IEC_UCOUNTER	IEC_UCOUNTER	IEC_UCOUNTER

Source (IN)	Destination (OUT1)	
	With IEC check	Without IEC check
IEC_DCOUNTER	IEC_DCOUNTER	IEC_DCOUNTER
IEC_UDCOUNTER	IEC_UDCOUNTER	IEC_UDCOUNTER
IEC_LCOUNTER	IEC_LCOUNTER	IEC_LCOUNTER
IEC_ULCOUNTER	IEC_ULCOUNTER	IEC_ULCOUNTER

1) You can also use the "Move value" instruction to transfer individual characters of a string (STRING) to operands of CHAR data type. The number of the character to be transferred is given in brackets next to the operand name. "MyString[2]", for example, transfers the second character of the "MyString" string. It is also possible to transfer from operands of the data type CHAR to the individual characters of a string. You can also replace a specific character of a string with the character of another string.

2) Transferring entire arrays (ARRAY) is possible only when the array components of the operands at input IN and at output OUT1 are of the same data type.

If the bit length of the data type at IN input exceeds the bit length of the data type at OUT1 output, the higher order bits of the source value are lost. If the bit length of the data type at the IN input is less than the bit length of the data type at the OUT1 output, then the more significant bits of the destination value will be overwritten with zeros.

In its initial state, the instruction box contains 1 output (OUT1). The number of outputs can be extended. The added outputs are numbered in ascending order on the box. When the instruction is executed, the content of the operand at the IN input is sent to all available outputs. The instruction box cannot be extended if structured data types (DTL, STRUCT, ARRAY) or characters of a string (STRING) are transferred.

The "Move block" (MOVE\_BLK) and "Move block uninterruptible" (UMOVE\_BLK) instructions can also be used to copy operands of the ARRAY data type. You can move operands of the STRING data type with the instruction "Move character string" (S\_MOVE).

### Parameters

The following table shows the parameters of the "Move value" instruction:

Parameter	Declaration	Data type		Memory area	Description
		S7-1200	S7-1500		
EN	Input	BOOL	BOOL	I, Q, M, D, L	Enable input
ENO	Output	BOOL	BOOL	I, Q, M, D, L	Enable output



Parameter	Declaration	Data type		Memory area	Description
		S7-1200	S7-1500		
IN	Input	Bit strings, integers, floating-point numbers, DATE, TIME, TOD, DTL, CHAR, STRUCT, ARRAY, IEC data types, PLC data type (UDT)	Bit strings, integers, floating-point numbers, DATE, DT, LDT, S5TIME, TIME, LTIME, TOD, LTOD, DTL, CHAR, STRUCT, ARRAY, TIMER, COUNTER, IEC data types, PLC data type (UDT)	I, Q, M, D, L or constant	Source value
OUT1	Output	Bit strings, integers, floating-point numbers, DATE, TIME, TOD, DTL, CHAR, STRUCT, ARRAY, IEC data types, PLC data type (UDT)	Bit strings, integers, floating-point numbers, DATE, DT, LDT, S5TIME, TIME, LTIME, TOD, LTOD, DTL, CHAR, STRUCT, ARRAY, TIMER, COUNTER, IEC data types, PLC data type (UDT)	I, Q, M, D, L	Operands to which in the source value is transferred.

For additional information on valid data types, refer to "See also".

### Example

The following example shows how the instruction works:

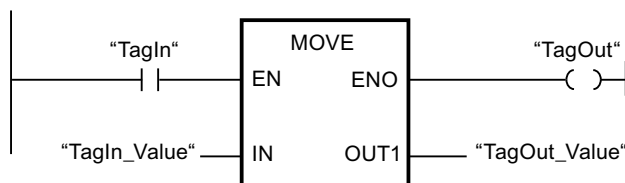

The following table shows how the instruction works using specific operand values:

Parameter	Operand	Value
IN	TagIn_Value	0011 1111 1010 1111
OUT1	TagOut_Value	0011 1111 1010 1111

If operand "TagIn" has the signal state "1", the "Move value" instruction is executed. The instruction copies the contents of operand "TagIn\_Value" to operand "TagOut\_Value" and sets output "TagOut" to signal state "1".

**See also**

- Overview of the valid data types (Page 1077)
- Removing inputs and outputs (Page 1290)
- Basics of the EN/ENO mechanism (Page 1167)
- MOVE\_BLK: Move block (Page 1726)
- UMOVE\_BLK: Move block uninterruptible (Page 1731)
- S\_MOVE: Move character string (Page 2294)
- Inserting additional inputs and outputs in LAD elements (Page 1289)

**FieldRead: Read field**

**Description**

You can use the "Read field" instruction to read out a specific component from the field specified at input MEMBER and transfer its content to the tag at output VALUE. You specify the index of the field component to be read at input INDEX. Specify the first component of the field from which reading is to occur at input MEMBER.

The data types of the field component at input MEMBER and the tags at output VALUE must correspond to the data type of the instruction "Read field".

The ENO enable output has the signal state "0" if one of the following conditions is fulfilled:

- The EN enable input has the signal state "0".
- The field component specified at input INDEX is not defined in the field specified at output MEMBER.
- Errors such as an overflow occur during execution.

**Parameters**

The following table shows the parameters of the "Read field" instruction:

Parameter	Declaration	Data type		Memory area	Description
		S7-1200	S7-1500		
EN	Input	BOOL	BOOL	I, Q, M, D, L	Enable input
ENO	Output	BOOL	BOOL	I, Q, M, D, L	Enable output

Parameter	Declaration	Data type		Memory area	Description
		S7-1200	S7-1500		
INDEX	Input	DINT	DINT	I, Q, M, D, L, P or constant	Index of field component whose content is read out
MEMBER	Input	Binary numbers, integers, floating-point numbers, TIME, DATE, TOD and CHAR as components of an ARRAY tag	Binary numbers, integers, floating-point numbers, timers, DATE, TOD, LTOD and CHAR as components of an ARRAY tag	D, L	First component of the field from which reading occurs.
VALUE	Output	Bit strings, integers, floating-point numbers, TIME, DATE, TOD and CHAR	Bit strings, integers, floating-point numbers, timers, DATE, TOD, LTOD and CHAR	I, Q, M, D, L, P	Operand to which the content of the field component is transferred

You can select the data type for the instruction from the "<???"> drop-down list of the instruction box.

For additional information on valid data types, refer to "See also".

### Example

The following example shows how the instruction works:

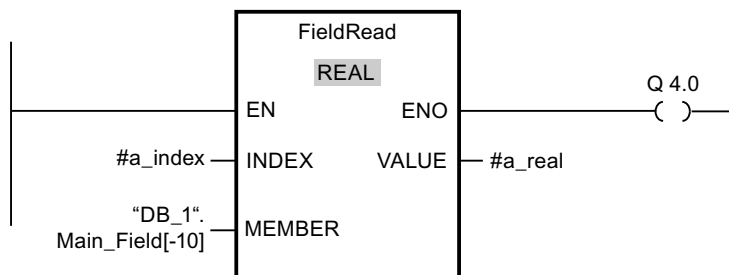

The following table shows how the instruction works using specific operand values:

Parameters	Tag	Value
INDEX	a_index	4
MEMBER	"DB_1".Main_Field[-10]	First component of the "Main_Field[-10..10] of REAL" field in the "DB_1" data block
VALUE	a_real	Component with index 4 of the "Main_Field[-10..10] of REAL" field

The field component with index 4 is read from the "Main\_Field[-10...10] of REAL" field and written to the "a\_real" tag. The field component to be read is specified by the value at input INDEX.

**See also**

- Overview of the valid data types (Page 1077)
- Basics of the EN/ENO mechanism (Page 1167)

**FieldWrite: Write field**

**Description**

The "Write field" instruction is used to transfer the content of the tag at the VALUE input to a specific component of the field at the MEMBER output. You use the value at the INDEX input to specify the index of the field component that is described. At the MEMBER output, enter the first component of the field which is to be written to.

The data types of the field component specified at the MEMBER output and the tags at the VALUE input have to match the data type of the "Write field" instruction.

The ENO enable output has the signal state "0" if one of the following conditions is fulfilled:

- The EN enable input has the signal state "0".
- The field component specified at the input INDEX is not defined in the field specified at the output MEMBER.
- Errors such as an overflow occur during execution.

**Parameters**

The following table shows the parameters of the "Write field" instruction:

Parameter	Declaration	Data type		Memory area	Description
		S7-1200	S7-1500		
EN	Input	BOOL	BOOL	I, Q, M, D, L	Enable input
ENO	Output	BOOL	BOOL	I, Q, M, D, L	Enable output
INDEX	Input	DINT	DINT	I, Q, M, D, L, P or constant	Index of the field component that is being written with the content of VALUE.

Parameter	Declaration	Data type		Memory area	Description
		S7-1200	S7-1500		
VALUE	Input	Bit strings, integers, floating-point numbers, TIME, DATE, TOD and CHAR	Bit strings, integers, floating-point numbers, timers, DATE, TOD, LTOD and CHAR	I, Q, M, D, L, P or constant	Operand whose content is copied.
MEMBER	Output	Binary numbers, integers, floating-point numbers, TIME, DATE, TOD and CHAR as components of an ARRAY tag	Binary numbers, integers, floating-point numbers, timers, DATE, TOD, LTOD and CHAR as components of an ARRAY tag	D, L	First component of the field to which the content of VALUE is written.

You can select the data type for the instruction from the "<???"> drop-down list of the instruction box.

For additional information on valid data types, refer to "See also".

### Example

The following example shows how the instruction works:

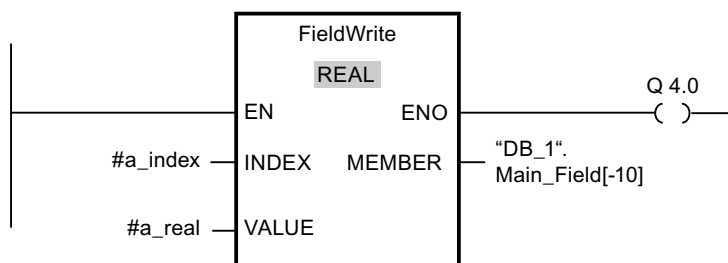

The following table shows how the instruction works using specific operand values:

Parameters	Operand	Value
INDEX	a_index	4
VALUE	a_real	10.54
MEMBER	"DB_1".Main_Field[-10]	First component of the "Main_Field[-10..10] of REAL" field in the "DB_1" data block

The value "10.54" of the "a\_real" tag is written to the field component with index 4 of the "Main\_Field[-10..10] of REAL" field. The index of the field component to which the content of the tag "a\_real" is transferred is specified by the value at the input INDEX.

**See also**

- Overview of the valid data types (Page 1077)
- Basics of the EN/ENO mechanism (Page 1167)

**MOVE\_BLK: Move block**

**Description**

You can use the "Move block" instruction to move the content of a memory area (source area) to another memory area (destination area). The number of elements to be moved to the destination area is specified at input COUNT. The width of the elements to be moved is defined by the width of the element at the IN input.

The instruction can only be executed if the source area and the destination area are of the same data type.

The ENO enable output has the signal state "0" if one of the following conditions is fulfilled:

- The EN enable input has the signal state "0".
- More data is copied than is made available at the IN input or OUT output.

When a Array of BOOL is copied, the enable output ENO for an overflow is set to "1" until the byte limit of the ARRAY structure is exceeded. If the byte limit of the ARRAY structure is exceeded by the value at the COUNT input, the ENO enable output is reset to "0".

**Parameters**

The following table lists the parameters of the "Move block" instruction:

Parameter	Declaration	Data type		Memory area	Description
		S7-1200	S7-1500		
EN	Input	BOOL	BOOL	I, Q, M, D, L	Enable input
ENO	Output	BOOL	BOOL	I, Q, M, D, L	Enable output
IN <sup>1)</sup>	Input	Binary numbers, integers, floating-point numbers, TIME, DATE, CHAR, TOD	Binary numbers, integers, floating-point numbers, timers, DATE, TOD, LTOD	D, L	The first element of the source area that is being copied
COUNT	Input	USINT, UINT, UDINT	USINT, UINT, UDINT, ULINT	I, Q, M, D, L, P or constant	Number of elements to be copied from the source area to the destination area.

Parameter	Declaration	Data type		Memory area	Description
		S7-1200	S7-1500		
OUT <sup>1)</sup>	Output	Binary numbers, integers, floating-point numbers, TIME, DATE, CHAR, TOD	Binary numbers, integers, floating-point numbers, timers, DATE, TOD, LTOD	D, L	The first element of the destination area to which the contents of the source area are being copied

<sup>1)</sup> The specified data types can only be used as elements of an ARRAY structure.

For additional information on valid data types, refer to "See also".

### Example

The following example shows how the instruction works:

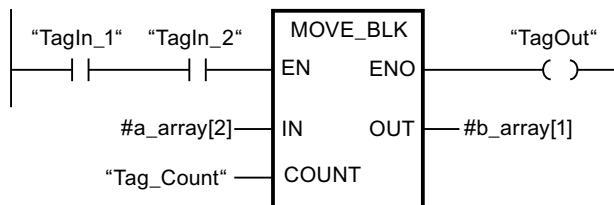

The following table shows how the instruction works using specific operand values:

Parameter	Operand	Value
IN	a_array[2]	The data type of the a_array operand is Array [0..5] of INT. It consists of six elements of data type INT.
COUNT	Tag_Count	3
OUT	b_array[1]	The data type of the b_array operand is Array [0..6] of INT. It consists of seven elements of data type INT.

If operands "TagIn\_1" and "TagIn\_2" have the signal state "1", the "Move block" instruction is executed. Starting from the third element, the instruction selects three INT elements from the #a\_array tag and copies their contents to the #b\_array output tag, beginning with the second element. If the instruction is executed without errors, the ENO enable output has the signal state "1" and the "TagOut" output is set.

### See also

Overview of the valid data types (Page 1077)

Basics of the EN/ENO mechanism (Page 1167)

Inserting additional inputs and outputs in LAD elements (Page 1289)

## MOVE\_BLK\_VARIANT: Move block

### Description

You can use the "Move block" instruction to move the content of a memory area (source area) to another memory area (destination area). You can copy elements of an array to another array of the same data type. The size (number of elements) of the source and destination array may be different. You can copy several elements within an array or individual elements.

If you are using the instruction, the array must not yet be known at the time the block is created, as the source and the destination are transferred using VARIANT.

The counting at the parameters SRC\_INDEX and DEST\_INDEX always starts with the low limit "0", regardless of the later declaration of the array.

Enable output ENO has the signal state "0" if one of the following conditions applies:

- The EN enable input has the signal state "0".
- More data is copied than is made available.

### Parameters

The following table lists the parameters of the "Move block" instruction:

Parameter	Declaration	Data type	Memory area	Description
EN	Input	BOOL	I, Q, M, D, L	Enable input
ENO	Output	BOOL	I, Q, M, D, L	Enable output
SRC	Input	VARIANT (array or single element)	I, Q, D, L)	The first element of the source area that is being copied
COUNT	Input	UDINT	I, Q, M, D, L or constant	Specifies the number of elements that will be copied.  Set the value at the parameter COUNT to "1", if no Array is specified at the parameter SRC or the parameter DEST.



Parameter	Declaration	Data type	Memory area	Description
SRC_INDEX	Input	UDINT	I, Q, M, D, L or constant	<ul style="list-style-type: none"> <li>• If an Array is specified at parameter SRC, the parameter SRC_INDEX specifies the first element at the parameter SRC, which is to be copied.</li> <li>• If no Array is specified at the parameter SRC, then enter the value "0" at the parameter SRC_INDEX.</li> </ul>
DEST_INDEX	Input	UDINT	I, Q, M, D, L or constant	<ul style="list-style-type: none"> <li>• If an Array is specified at parameter DEST, the parameter DEST_INDEX specifies the first element at the parameter DEST, which is to be copied.</li> <li>• If no Array is specified at the parameter DEST, then enter the value "0" at the parameter DEST_INDEX.</li> </ul>
DEST	InOut	VARIANT	I, Q, D, L)	The first element of the source area that is being copied
RET_VAL	Output	INT	I, Q, M, D, L	Error information: If an error occurs during execution of the instruction, an error code is output on the RET_VAL parameter.

For additional information on valid data types, refer to "See also".

**Parameter RET\_VAL**

The following table shows the meaning of the values of the RET\_VAL parameter:

Error code* (W#16#...)	Explanation
0000	No error
8082	Data types do not correspond
80B4	Data types do not correspond
8151	Code generation error at SRC parameter
8152	Code generation error at SRC parameter
8153	Code generation error at SRC parameter
8251	The COUNT parameter has an invalid value
8254	The COUNT parameter has an invalid value
8281	The COUNT parameter has an invalid value
8282	The COUNT parameter has an invalid value
8382	The value at the SRC_INDEX parameter is outside the limit of the VARIANT
8383	The value at the SRC_INDEX parameter is outside the high limit of the array.
8482	The value at the DEST_INDEX parameter is outside the limit of the VARIANT
8483	The value at the DEST_INDEX parameter is outside the high limit of the array.
8534	The DEST parameter is write protected.
8551	Code generation error at DEST parameter
8552	Code generation error at DEST parameter
8553	Code generation error at DEST parameter
85A2	The DEST parameter is write protected.

\*The error codes can be displayed as integer or hexadecimal value in the program editor. For additional information on toggling display formats, refer to "See also".

**Example**

The following example shows how the instruction works:

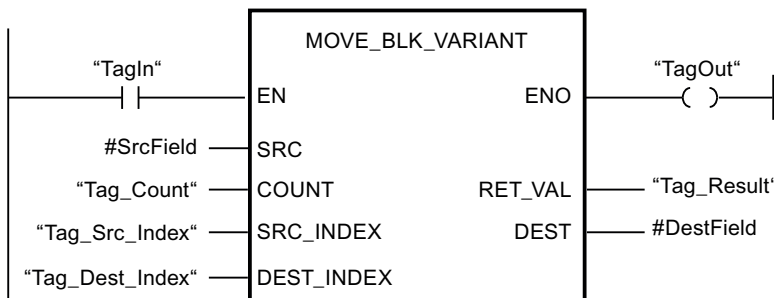

The following table shows how the instruction works using specific operand values:

Parameter	Operand	Value
SRC	#SrcField	The local operand #SrcField uses a UDT that was still unknown at the time when the block was programmed.
COUNT	Tag_Count	3
SRC_INDEX	Tag_Src_Index	4
DEST_INDEX	Tag_Dest_Index	2
DEST	#DestField	The local operand #DestField uses a UDT that was still unknown at the time when the block was programmed.

If the operand "TagIn" has the signal state "1", the "Move block" instruction is executed. If the instruction is executed without errors, the ENO enable output has the signal state "1" and the "TagOut" output is set.

### See also

Overview of the valid data types (Page 1077)

Basics of the EN/ENO mechanism (Page 1167)

Inserting additional inputs and outputs in LAD elements (Page 1289)

## UMOVE\_BLK: Move block uninterruptible

### Description

You can use the "Move block uninterruptible" instruction to move the content of a memory area (source area) to another memory area (destination area). The number of elements to be moved to the destination area is specified with the COUNT parameter. The width of the elements to be moved is defined by the width of the element at the IN input.

The instruction can only be executed if the source area and the destination area have the same data type.

---

#### Note

The copy operation cannot be interrupted by other operating system activities. This is why the interrupt reaction times of the CPU increase during the execution of the "Move block uninterruptible" instruction.

---

The ENO enable output has the signal state "0" if one of the following conditions is fulfilled:

- The EN enable input has the signal state "0".
- More data is copied than is made available at the IN input or OUT output.

When a Array of BOOL is copied, the enable output ENO for an overflow is set to "1" until the byte limit of the ARRAY structure is exceeded. If the byte limit of the ARRAY structure is exceeded by the value at the COUNT input, the ENO enable output is reset to "0".

You can use the "Move block uninterruptible" instruction to move a maximum of 16 KB. Note the CPU-specific restrictions for this.

### Parameters

The following table shows the parameters of the "Move block uninterruptible" instruction:

Parameter	Declaration	Data type		Memory area	Description
		S7-1200	S7-1500		
EN	Input	BOOL	BOOL	I, Q, M, D, L	Enable input
ENO	Output	BOOL	BOOL	I, Q, M, D, L	Enable output
IN <sup>1)</sup>	Input	Binary numbers, integers, floating-point numbers, TIME, DATE, CHAR, TOD	Binary numbers, integers, floating-point numbers, timers, DATE, TOD, LTOD	D, L	The first element of the source area that is being copied
COUNT	Input	USINT, UINT, UDINT	USINT, UINT, UDINT, ULINT	I, Q, M, D, L, P or constant	Number of elements to be moved from the source area to the destination area.
OUT <sup>1)</sup>	Output	Binary numbers, integers, floating-point numbers, TIME, DATE, CHAR, TOD	Binary numbers, integers, floating-point numbers, timers, DATE, TOD, LTOD	D, L	The first element of the destination area to which the contents of the source area are being copied

<sup>1)</sup> The specified data types can only be used as elements of an ARRAY structure.

For additional information on valid data types, refer to "See also".

### Example

The following example shows how the instruction works:

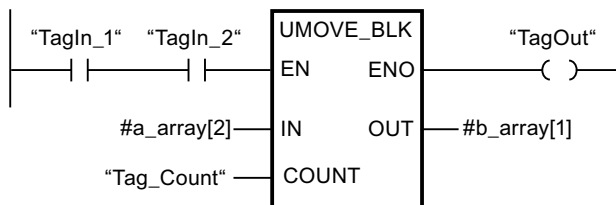

The following table shows how the instruction works using specific operand values:

Parameter	Operand	Value
IN	a_array[2]	The data type of the a_array operand is Array [0..5] of INT. It consists of six elements of data type INT.
COUNT	Tag_Count	3
OUT	b_array[1]	The data type of the b_array operand is Array [0..6] of INT. It consists of seven elements of data type INT.

If operands "TagIn\_1" and "TagIn\_2" have the signal state "1", the "Move block uninterruptible" instruction is executed. Starting from the third element, the instruction selects three INT elements from the #a\_array tag and copies their contents to the #b\_array output tag, beginning with the second element. The copy operation cannot be interrupted by other operating system activities. If the instruction is executed without errors, the ENO output has the signal state "1" and the "TagOut" output is set.

### See also

Overview of the valid data types (Page 1077)

Basics of the EN/ENO mechanism (Page 1167)

Inserting additional inputs and outputs in LAD elements (Page 1289)

### FILL\_BLK: Fill block

#### Description

You can use the "Fill block" instruction to fill a memory area (destination area) with the value of the IN input. The destination area is filled starting from the address specified at the OUT output. The number of repeated copy operations is specified with the COUNT parameter. When the instruction is executed, the value at the IN input is selected and copied to the destination area as often as specified by the value in the COUNT parameter.

The instruction can only be executed if the source area and the destination area are of the same data type.

The ENO enable output has the signal state "0" if one of the following conditions is fulfilled:

- The EN enable input has the signal state "0".
- More data is copied than is made available at the IN input or OUT output.

When a Array of BOOL is copied, the enable output ENO for an overflow is set to "1" until the byte limit of the ARRAY structure is exceeded. If the byte limit of the ARRAY structure is exceeded by the value at the COUNT input, the ENO enable output is reset to "0".

### Parameters

The following table shows the parameters of the "Fill block" instruction:

Parameter	Declaration	Data type		Memory area	Description
		S7-1200	S7-1500		
EN	Input	BOOL	BOOL	I, Q, M, D, L	Enable input
ENO	Output	BOOL	BOOL	I, Q, M, D, L	Enable output
IN <sup>1)</sup>	Input	Binary numbers, integers, floating-point numbers, TIME, DATE, TOD, CHAR	Binary numbers, integers, floating-point numbers, timers, DATE, CHAR, TOD, LTOD	I, Q, M, D, L, P or constant	Element used to fill the destination area
COUNT	Input	USINT, UINT, UDINT	USINT, UINT, UDINT, ULINT	I, Q, M, D, L, P or constant	Number of repeated move operations
OUT <sup>2)</sup>	Output	Binary numbers, integers, floating-point numbers, TIME, DATE, TOD, CHAR	Binary numbers, integers, floating-point numbers, timers, DATE, CHAR, TOD, LTOD	D, L	Address in destination area from which filling starts.

<sup>1)</sup> The specified data types can also be used as elements of an ARRAY structure.  
<sup>2)</sup> The specified data types can only be used as elements of an ARRAY structure.

For additional information on valid data types, refer to "See also".

### Example

The following example shows how the instruction works:

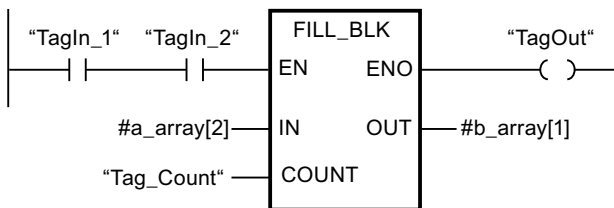

The following table shows how the instruction works using specific operand values:

Parameter	Operand	Value
IN	a_array[2]	The data type of the a_array operand is Array [0..5] of INT. It consists of six elements of data type INT.
COUNT	Tag_Count	3
OUT	b_array[1]	The data type of the b_array operand is Array [0..6] of INT. It consists of seven elements of data type INT.

If operands "TagIn\_1" and "TagIn\_2" have the signal state "1", the "Fill block" instruction is executed. The instruction copies the third element (#a\_array[2]) of the #a\_array tag three times to the #b\_array output tag. If the instruction is executed without errors, the ENO and "TagOut" enable outputs are set to signal state "1".

### See also

Overview of the valid data types (Page 1077)

Basics of the EN/ENO mechanism (Page 1167)

Inserting additional inputs and outputs in LAD elements (Page 1289)

### UFILL\_BLK: Fill block uninterruptible

#### Description

You can use the "Fill block uninterruptible" instruction to fill a memory area (destination area) with the value of the IN input without interruption. The destination area is filled starting from the address specified at the OUT output. The number of repeated copy operations is specified with the COUNT parameter. When the instruction is executed, the value at the IN input is selected and copied to the destination area as often as specified by the value in the COUNT parameter.

The instruction can only be executed if the source area and the destination area have the same data type.

#### Note

The copy operation cannot be interrupted by other operating system activities. This is why the alarm reaction times of the CPU increase during the execution of the "Fill block uninterruptible" instruction.

The ENO enable output has the signal state "0" if one of the following conditions is fulfilled:

- The EN enable input has the signal state "0".
- More data is copied than is made available at the IN input or OUT output.

When a Array of BOOL is copied, the enable output ENO for an overflow is set to "1" until the byte limit of the ARRAY structure is exceeded. If the byte limit of the ARRAY structure is exceeded by the value at the COUNT input, the ENO enable output is reset to "0".

You can use the "Fill block uninterruptible" instruction to move a maximum of 16 KB. Note the CPU-specific restrictions for this.

### Parameters

The following table shows the parameters of the "Fill block uninterruptible" instruction:

Parameter	Declaration	Data type		Memory area	Description
		S7-1200	S7-1500		
EN	Input	BOOL	BOOL	I, Q, M, D, L	Enable input
ENO	Output	BOOL	BOOL	I, Q, M, D, L	Enable output
IN <sup>1)</sup>	Input	Binary numbers, integers, floating-point numbers, TIME, DATE, CHAR, TOD	Binary numbers, integers, floating-point numbers, timers, DATE, CHAR, TOD, LTOD	I, Q, M, D, L, P or constant	Element used to fill the destination area.
COUNT	Input	USINT, UINT, UDINT	USINT, UINT, UDINT, ULINT	I, Q, M, D, L, P or constant	Number of repeated move operations
OUT <sup>2)</sup>	Output	Binary numbers, integers, floating-point numbers, TIME, DATE, CHAR, TOD	Binary numbers, integers, floating-point numbers, timers, DATE, CHAR, TOD, LTOD	D, L	Address in destination area from which filling begins.

<sup>1)</sup> The specified data types can also be used as elements of an ARRAY structure.  
<sup>2)</sup> The specified data types can only be used as elements of an ARRAY structure.

For additional information on valid data types, refer to "See also".

### Example

The following example shows how the instruction works:

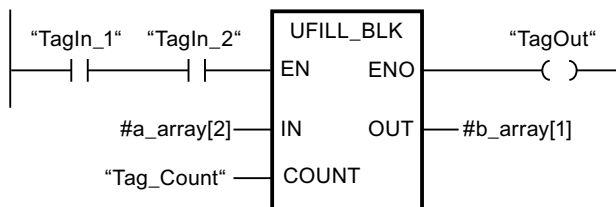

The following table shows how the instruction works using specific operand values:



Parameter	Operand	Value
IN	a_array[2]	The data type of the a_array operand is Array [0..5] of INT. It consists of six elements of data type INT.
COUNT	Tag_Count	3
OUT	b_array[1]	The data type of the b_array operand is Array [0..6] of INT. It consists of seven elements of data type INT.

If operands "TagIn\_1" and "TagIn\_2" have the signal state "1", the "Fill block uninterruptible" instruction is executed. The instruction copies the third element (#a\_array[2]) of the #a\_array tag three times to the #b\_array output tag. The copy operation cannot be interrupted by other operating system activities. If the instruction is executed without errors, the ENO and "TagOut" enable outputs are set to signal state "1".

### See also

Overview of the valid data types (Page 1077)

Basics of the EN/ENO mechanism (Page 1167)

Inserting additional inputs and outputs in LAD elements (Page 1289)

### SWAP: Swap

#### Description

You can use the "Swap" instruction to change the order of the bytes at input IN and query the result at output OUT.

The following figure shows how the bytes of an operand of the DWORD data type are swapped using the "Swap" instruction:

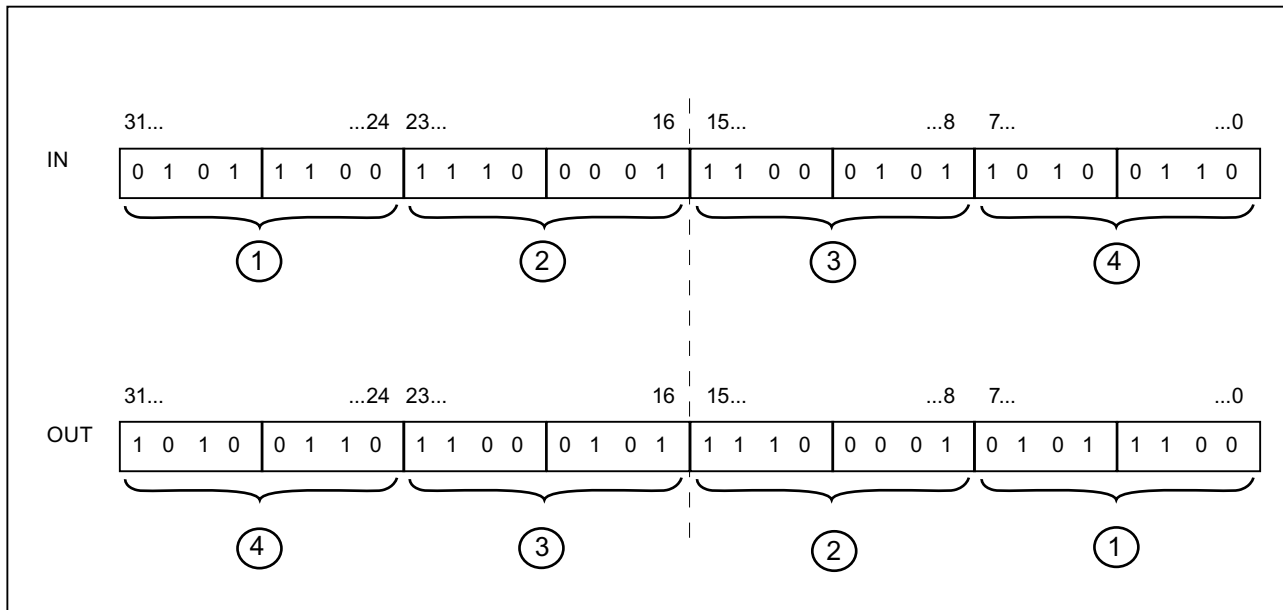

**Parameter**

The following table shows the parameters of the "Swap" instruction:

Parameter	Declaration	Data type		Memory area	Description
		S7-1200	S7-1500		
EN	Input	BOOL	BOOL	I, Q, M, D, L	Enable input
ENO	Output	BOOL	BOOL	I, Q, M, D, L	Enable output
IN	Input	WORD, DWORD	WORD, DWORD, LWORD	I, Q, M, D, L or, P constant	Operand whose bytes are swapped.
OUT	Output	WORD, DWORD	WORD, DWORD, LWORD	I, Q, M, D, L, P	Result

You can select the data type for the instruction from the "<???" drop-down list of the instruction box.

For additional information on valid data types, refer to "See also".

**Example**

The following example shows how the instruction works:

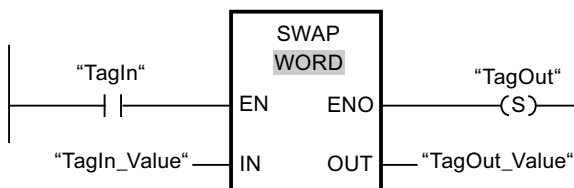

The following table shows how the instruction works using specific operand values:

Parameter	Operand	Value
IN	TagIn_Value	0000 1111 0101 0101
OUT	TagOut_Value	0101 0101 0000 1111

If operand "TagIn" has the signal state "1", the "Swap" instruction is executed. The order of the bytes is changed and stored in operand "TagOut\_Value".

## See also

Overview of the valid data types (Page 1077)

Basics of the EN/ENO mechanism (Page 1167)

Inserting additional inputs and outputs in LAD elements (Page 1289)

## Array data blocks

### ReadFromArrayDB: Read from array data block

#### Description

You can use the "Read from array data block" instruction to read data from an array DB.

An array DB is a data block which consists of exactly one array of [data type]. The elements of the array can be UDT data type or any other elementary data type. The counting of the array always starts with the low limit "0", regardless of the later declaration of the array.

The ENO enable output has the signal state "0" if one of the following conditions is fulfilled:

- The EN enable input has the signal state "0".
- If an error occurs during the execution of the instruction.

#### Parameters

The following table shows the parameters of the "Read from array data block" instruction:

Parameter	Declaration	Data type	Memory area	Description
EN	Input	BOOL	I, Q, M, D, L	Enable input
ENO	Output	BOOL	I, Q, M, D, L	Enable output
DB	Input	DB_ANY	I, Q, M, D, L	Data block that is read
INDEX	Input	DINT	I, Q, M, D, L	Element that is read

Parameter	Declaration	Data type	Memory area	Description
VALUE	InOut	VARIANT	I, Q, M, D, L	Value that is read
RET_VAL	Output	INT	I, Q, M, D, L	Error information: If an error occurs during execution of the instruction, an error code is output on the RET_VAL parameter.

For additional information on valid data types, refer to "See also".

### Parameter RET\_VAL

The following table shows the meaning of the values of the RET\_VAL parameter:

Error code* (W#16#...)	Explanation
0000	No error
80B4	Data types do not correspond
80B5	Copying process was interrupted
8131	The data block does not exist
8132	The data block is too short
8133	The data block is located in the load memory
8134	The data block is write protected
8135	The DB is not an array data block.
8282	The value at the INDEX parameter is outside the limit values of the array.
8350	The VARIANT data type contains no value
8352	Code generation error
8353	Code generation error

\*The error codes can be displayed as integer or hexadecimal value in the program editor. For additional information on toggling display formats, refer to "See also".

### See also

Overview of the valid data types (Page 1077)

Basics of the EN/ENO mechanism (Page 1167)

Inserting additional inputs and outputs in LAD elements (Page 1289)

### WriteToArrayDB: Write to array data block

#### Description

You can use the "Write to array data block" instruction to write data to an array DB.

An array DB is a data block which consists of exactly one array of [data type]. The elements of the array can be UDT data type or any other elementary data type. The counting of the array always starts with the low limit "0", regardless of the later declaration of the array.

The ENO enable output has the signal state "0" if one of the following conditions is fulfilled:

- The EN enable input has the signal state "0".
- If an error occurs during the execution of the instruction.

## Parameters

The following table shows the parameters of the "Write to array data block" instruction:

Parameter	Declaration	Data type	Memory area	Description
EN	Input	BOOL	I, Q, M, D, L	Enable input
ENO	Output	BOOL	I, Q, M, D, L	Enable output
DB	Input	DB_ANY	I, Q, M, D, L	Data block to which data is written
INDEX	Input	DINT	I, Q, M, D, L	Element in the DB to which data is written
VALUE	Input	VARIANT	I, Q, M, D, L	Value to be written
RET_VAL	Output	INT	I, Q, M, D, L	Error information: If an error occurs during execution of the instruction, an error code is output on the RET_VAL parameter.

For additional information on valid data types, refer to "See also".

## Parameter RET\_VAL

The following table shows the meaning of the values of the RET\_VAL parameter:

Error code* (W#16#...)	Explanation
0000	No error
80B4	Data types do not correspond
80B5	Copying process was interrupted
8131	The data block does not exist
8132	The data block is too short
8133	The data block is located in the load memory
8134	The data block is write protected
8135	The DB is not an array data block.

Error code* (W#16#...)	Explanation
8282	The value at the INDEX parameter is outside the limit values of the array.
8350	The VARIANT data type contains no value
8352	Code generation error
8353	Code generation error
*The error codes can be displayed as integer or hexadecimal value in the program editor. For additional information on toggling display formats, refer to "See also".	

**See also**

Overview of the valid data types (Page 1077)

Basics of the EN/ENO mechanism (Page 1167)

Inserting additional inputs and outputs in LAD elements (Page 1289)

**ReadFromArrayDBL: Read from array data block in load memory**

**Description**

You can use the "Read from array data block in load memory" instruction to read data from an array DB in load memory.

An array DB is a data block which consists of exactly one array of [data type]. The elements of the array can be UDT data type or any other elementary data type. The counting of the array always starts with the low limit "0", regardless of the later declaration of the array.

If the array DB is marked with the "Only store in load memory" block attribute, it is only stored in load memory.

The instruction is executed when a positive signal edge is detected at the REQ parameter. The BUSY parameter then has the signal state "1". The instruction is terminated if a negative signal edge is detected at the BUSY parameter. The DONE parameter has the signal state "1" for one program cycle and the read value is output at the VALUE parameter within this cycle. With all other program cycles, the value at the VALUE parameter is not changed.

When you insert the instruction in the program, the "Call options" dialog opens in which you can specify whether the block parameters will be stored in a separate data block (single instance) or as a local tag (multiple instance) in the block interface. If you create a separate data block, you will find it in the project tree in the "Program resources" folder under "Program blocks > System blocks". For additional information on this topic, refer to "See also".

The ENO enable output has the signal state "0" if one of the following conditions is fulfilled:

- The EN enable input has the signal state "0".
- If an error occurs during the execution of the instruction.

## Parameters

The following table shows the parameters of the "Read from array data block in load memory" instruction:

Parameter	Declaration	Data type	Memory area	Description
EN	Input	BOOL	I, Q, M, D, L	Enable input
ENO	Output	BOOL	I, Q, M, D, L	Enable output
REQ	Input	BOOL	I, Q, M, D, L	REQ = "1": Starting with the reading of the array DB
DB	Input	DB_ANY	I, Q, M, D, L	Data block that is read
INDEX	Input	DINT	I, Q, M, D, L	Element that is read
BUSY	Output	BOOL	I, Q, M, D, L	BUSY = "1": The array DB is still being read
DONE	Output	BOOL	I, Q, M, D, L	DONE = "1": The instruction was executed successfully
VALUE	InOut	VARIANT	I, Q, M, D, L	Value that is read
RET_VAL	Output	INT	I, Q, M, D, L	Error information: If an error occurs during execution of the instruction, an error code is output on the RET_VAL parameter.

For additional information on valid data types, refer to "See also".

## Parameter

The following table shows the meaning of the values of the RET\_VAL parameter:

Error code* (W#16#...)	Explanation
0000	No error
80B4	Data types do not correspond
80B5	Copying process was interrupted
8131	The data block does not exist
8132	The data block is too short
8133	The data block is not located in the load memory
8134	The data block is write protected
8135	The DB is not an array data block.

Error code* (W#16#...)	Explanation
8282	The value at the INDEX parameter is outside the limit values of the array.
8350	The VARIANT data type contains no value
8352	Code generation error
8353	Code generation error
*The error codes can be displayed as integer or hexadecimal value in the program editor. For additional information on toggling display formats, refer to "See also".	

**See also**

Overview of the valid data types (Page 1077)

Basics of the EN/ENO mechanism (Page 1167)

Inserting additional inputs and outputs in LAD elements (Page 1289)

**WriteToArrayDBL: Write to array data block in load memory**

**Description**

You can use the "Write to array data block in load memory" instruction to write data to an array DB in load memory.

An array DB is a data block which consists of exactly one array of [data type]. The elements of the array can be UDT data type or any other elementary data type. The counting of the array always starts with the low limit "0", regardless of the later declaration of the array.

If the array DB is marked with the "Only store in load memory" block attribute, it is only stored in load memory.

The instruction is executed when a positive signal edge is detected at the REQ parameter. The BUSY parameter then has the signal state "1". If a negative signal edge is detected at the BUSY parameter, the instruction is terminated and the value at the VALUE parameter is written to the data block. The DONE parameter then has the signal state "1" for one program cycle.

When you insert the instruction in the program, the "Call options" dialog opens in which you can specify whether the block parameters will be stored in a separate data block (single instance) or as a local tag (multiple instance) in the block interface. If you create a separate data block, you will find it in the project tree in the "Program resources" folder under "Program blocks > System blocks". For additional information on this topic, refer to "See also".

The ENO enable output has the signal state "0" if one of the following conditions is fulfilled:

- The EN enable input has the signal state "0".
- If an error occurs during the execution of the instruction.



## Parameters

The following table shows the parameters of the "Write to array data block in load memory" instruction:

Parameter	Declaration	Data type	Memory area	Description
EN	Input	BOOL	I, Q, M, D, L	Enable input
ENO	Output	BOOL	I, Q, M, D, L	Enable output
REQ	Input	BOOL	I, Q, M, D, L	REQ = "1": Start writing into the array DB
DB	Input	DB_ANY	D	Data block to which data is written
INDEX	Input	DINT	I, Q, M, D, L	Element in the DB to which data is written
VALUE	Input	VARIANT	I, Q, M, D, L	Value to be written
BUSY	Output	BOOL	I, Q, M, D, L	BUSY = "1": The array DB is still being written
DONE	Output	BOOL	I, Q, M, D, L	DONE = "1": The instruction was executed successfully
RET_VAL	Output	INT	I, Q, M, D, L	Error information: If an error occurs during execution of the instruction, an error code is output on the RET_VAL parameter.

For additional information on valid data types, refer to "See also".

## Parameter

The following table shows the meaning of the values of the RET\_VAL parameter:

Error code* (W#16#...)	Explanation
0000	No error
80B4	Data types do not correspond
80B5	Copying process was interrupted
8131	The data block does not exist
8132	The data block is too short
8133	The data block is not located in the load memory
8134	The data block is write protected

Error code* (W#16#...)	Explanation
8135	The DB is not an array data block.
8282	The value at the INDEX parameter is outside the limit values of the array.
8350	The VARIANT data type contains no value
8352	Code generation error
8353	Code generation error
*The error codes can be displayed as integer or hexadecimal value in the program editor. For additional information on toggling display formats, refer to "See also".	

**See also**

Overview of the valid data types (Page 1077)

Basics of the EN/ENO mechanism (Page 1167)

Inserting additional inputs and outputs in LAD elements (Page 1289)

**Other**

**BLKMOV: Move block**

**Description**

You can use the "Move block" instruction to move the content of a memory area (source area) to another memory area (destination area). The move operation takes place in the direction of ascending addresses. You use VARIANT to define the source and destination area.

---

**Note**

The tags of the instruction can only be used in data blocks in which the "Optimized block access" attribute is not set. If the tag with the retentive setting "Set in IDB" has been declared, you can also use the tags "with optimized access".

---

The following figure shows the principle of the move operation:

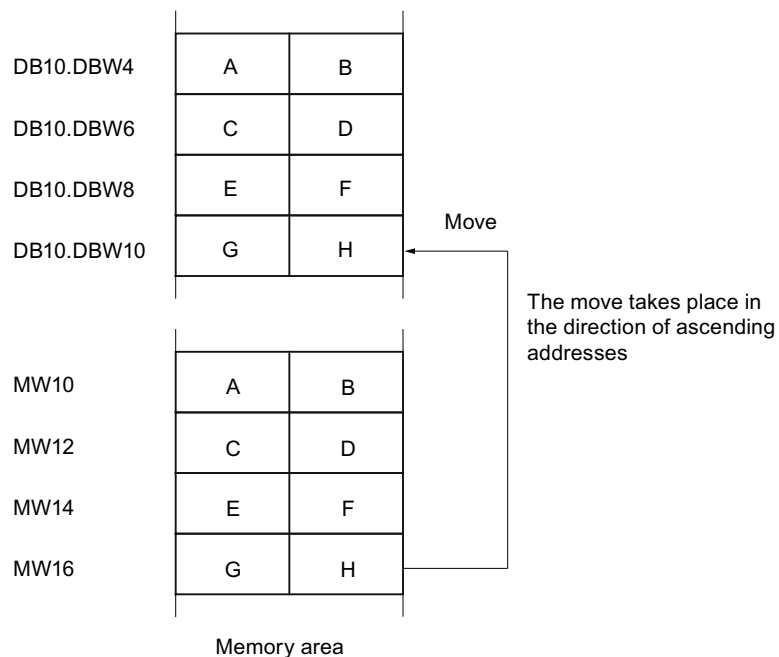

### Consistency of the source data and the target data

Make sure that the source data remain unchanged during execution of the instruction Move block instruction. Otherwise the consistency of the target data cannot be ensured.

### Interrupt ability

There is no limit to the nesting depth.

### Memory areas

You can use the "Move block" instruction to move the following memory areas:

- Areas of a data block
- Bit memory
- Process image of the inputs
- Process image of the outputs

### General rules for moving

The source and destination area must not overlap. If the source and destination area have different lengths, only the length of the smaller area will be moved.

If the source area is less than the destination area, the entire source area will be written to the destination area. The remaining bytes of the destination area remain unchanged.

If the destination area is less than the source area, the entire destination area will be written. The remaining bytes of the source area are ignored.

If a block of data type BOOL is moved, the tag must be addressed absolutely and the specified length of the area must be divisible by 8, otherwise the instruction cannot be executed.

### Rules for moving character strings

You can use the "Move block" instruction to also move source and destination areas of the STRING data type. If only the source area is STRING data type, the characters will be moved that are actually contained in the character string. Information on the actual and maximum length is also written to the destination area. If the source and destination area are each STRING data type, the current length of the character string in the destination area is set to the number of actually moved characters.

If you want to move the information on the maximum and actual length of a character string, specify the areas in bytes to the SRCBLK and DSTBLK parameters.

### Parameters

The following table lists the parameters of the "Move block" instruction:

Parameter	Declaration	Data type	Memory area	Description
EN	Input	BOOL	I, Q, M, D, L	Enable input
ENO	Output	BOOL	I, Q, M, D, L	Enable output
SRCBLK	Input	VARIANT	I, Q, M, D, L	Specifies the memory area to be moved (source area).
RET_VAL	Output	INT	I, Q, M, D, L, P	Error information: If an error occurs during execution of the instruction, an error code is output at the RET_VAL parameter.
DSTBLK	Output	VARIANT	I, Q, M, D, L	Specifies the memory area to which the block is to be moved (destination area).

### Parameter RET\_VAL

The following table shows the meaning of the values of the RET\_VAL parameter:

Error code* (W#16#...)	Explanation
0000	No error
8091	The permitted nesting depth was exceeded
8092	The instruction cannot be executed because a specified data block is write protection, non-executable or unloaded.
General error information	See also: "GET_ERR_ID: Get error ID locally"
*The error codes can be displayed as integer or hexadecimal value in the program editor. For information on toggling display formats, refer to "See also".	

## See also

Overview of the valid data types (Page 1077)

Basics of the EN/ENO mechanism (Page 1167)

GET\_ERR\_ID: Get error ID locally (Page 1787)

Inserting additional inputs and outputs in LAD elements (Page 1289)

## UBLKMOV: Move block uninterruptible

### Description

You can use the "Move block uninterruptible" instruction to move the content of a memory area (source area) to another memory area (destination area). The move operation takes place in the direction of ascending addresses. You use VARIANT to define the source and destination area.

The copy operation cannot be interrupted by other operating system activities. As a result the alarm reaction time of the CPU can increase during the execution of the "Move block uninterruptible" instruction.

---

#### Note

The tags of the instruction can only be used in data blocks in which the "Optimized block access" attribute is not set. If the tag with the retentive setting "Set in IDB" has been declared, you can also use the tags "with optimized access".

---

### Memory areas

You can use the "Move block uninterruptible" instruction to move the following memory areas:

- Areas of a data block
- Bit memory
- Process image of the inputs
- Process image of the outputs

### General rules for moving

The source and destination area must not overlap during the execution of the "Move block uninterruptible" instruction. If the source area is less than the destination area, the entire source area will be written to the destination area. The remaining bytes of the destination area remain unchanged.

If the destination area is less than the source area, the entire destination area will be written. The remaining bytes of the source area are ignored.

If a source or destination area defined as a formal parameter is less than a destination or source area specified on the SRCBLK or DSTBLK parameter, no data will be transferred.

If a block of data type BOOL is moved, the tag must be addressed absolutely and the specified length of the area must be divisible by 8, otherwise the instruction cannot be executed.

You can use the "Move block uninterruptible" instruction to move a maximum of 16 KB. Note the CPU-specific restrictions for this.

**Rules for moving character strings**

You can use the "Move block uninterruptible" instruction to also move source and destination areas of the STRING data type. If only the source area is STRING data type, the characters will be moved that are actually contained in the character string. Information on the actual and maximum length are not written in the destination area. If the source and destination area are each STRING data type, the current length of the character string in the destination area is set to the number of actually moved characters. If areas of the data type STRING are moved, you have to specify "1" as area length.

**Parameters**

The following table shows the parameters of the "Move block uninterruptible" instruction:

Parameter	Declaration	Data type	Memory area	Description
EN	Input	BOOL	I, Q, M, D, L	Enable input
ENO	Output	BOOL	I, Q, M, D, L	Enable output
SRCBLK	Input	VARIANT	I, Q, M, D, L	Specifies the memory area to be moved (source area).
RET_VAL	Output	INT	I, Q, M, D, L, P	Error information: If an error occurs during execution of the instruction, an error code is output at the RET_VAL parameter.
DSTBLK	Output	VARIANT	I, Q, M, D, L	Specifies the memory area to which the block is to be moved (destination area).

**Parameter RET\_VAL**

The following table shows the meaning of the values of the RET\_VAL parameter:

Error code* (W#16#...)	Explanation
0000	No error
8091	The source area is in a data block that is not relevant for program execution.
General error information	See also: "GET_ERR_ID: Get error ID locally"

\*The error codes can be displayed as integer or hexadecimal value in the program editor. For information on toggling display formats, refer to "See also".

**See also**

Overview of the valid data types (Page 1077)

Basics of the EN/ENO mechanism (Page 1167)

GET\_ERR\_ID: Get error ID locally (Page 1787)

Inserting additional inputs and outputs in LAD elements (Page 1289)

**FILL: Fill block****Description**

You can use the "Fill block" instruction to fill a memory area (destination area) with the content of another memory area (source area). The "Fill block" instruction moves the content of the source area to the destination area until the destination area is completely written. The move operation takes place in the direction of ascending addresses.

You use VARIANT to define the source and destination area.

**Note**

The tags of the instruction can only be used in data blocks in which the "Optimized block access" attribute is not set. If the tag with the retentive setting "Set in IDB" has been declared, you can also use the tags "with optimized access".

For blocks with the "Optimized block access" attribute, you can use the "FILL\_BLK: Fill block" instruction.

The following figure shows the principle of the move operation:

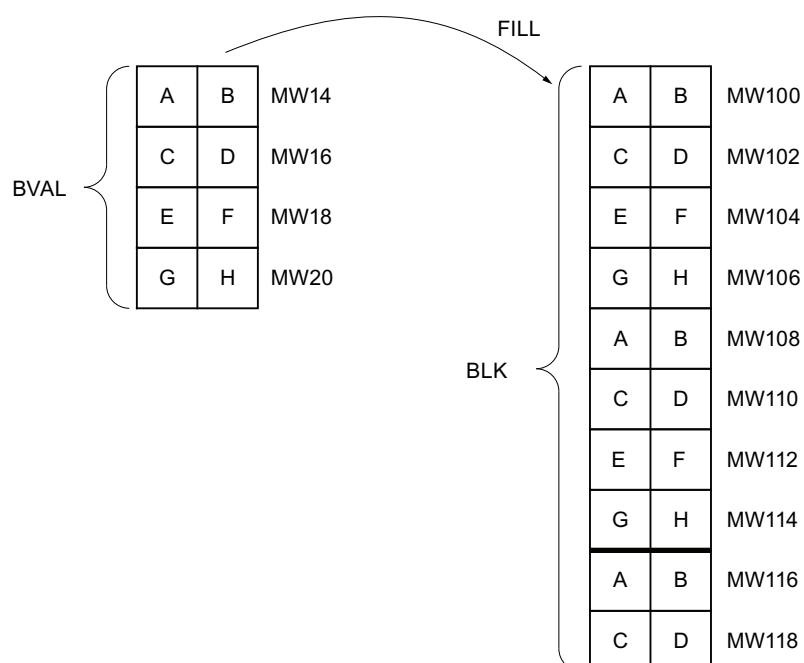

Example: The contents of the range MW100 to MW118 are to be preassigned with the contents of the memory words MW14 to MW20.

### Consistency of the source data and the target data

Please note that during execution of the instruction "Fill block" that the source data remain unchanged, otherwise the consistency of the target data is not ensured.

### Memory areas

You can use the "Fill block" instruction to move the following memory areas:

- Areas of a data block
- Bit memory
- Process image of the inputs
- Process image of the outputs

### General rules for moving

The source and destination area must not overlap. If the destination block to be preset is not an integer multiple of the length of the input parameter BVAL, the destination block is nevertheless written up to the last byte.

If the destination area to be preset is smaller than the source area, the function only copies as much data as can be written to the destination area.

If the destination or source block actually present is smaller than the assigned memory area for the source or destination block (BVAL BLK parameters), no data will be transferred.

If the ANY pointer (source or destination) is of the data type BOOL, it must be addressed absolutely and the length specified must be divisible by 8; otherwise the instruction is not executed.

If the destination block is of data type STRING, the instruction describes the entire string including the administration information.

### Parameters

The following table shows the parameters of the "Fill block" instruction:

Parameter	Declaration	Data type	Memory area	Description
EN	Input	BOOL	I, Q, M, D, L	Enable input
ENO	Output	BOOL	I, Q, M, D, L	Enable output
BVAL	Input	VARIANT	I, Q, M, D, L	Specification of the memory area (source area) with whose content the destination area on the BLK parameter will be filled.



Parameter	Declaration	Data type	Memory area	Description
RET_VAL	Output	INT	I, Q, M, D, L	Error information: If an error occurs during execution of the instruction, an error code is output at the RET_VAL parameter.
BLK	Output	VARIANT	I, Q, M, D, L	Specification of the memory area that will be filled with the content of the source area.

## Parameter RET\_VAL

The following table shows the meaning of the values of the RET\_VAL parameter:

Error code* (W#16#...)	Explanation
0000	No error
General error information	See also: "GET_ERR_ID: Get error ID locally"

\*The error codes can be displayed as integer or hexadecimal value in the program editor. For information on toggling display formats, refer to "See also".

## See also

Overview of the valid data types (Page 1077)

Basics of the EN/ENO mechanism (Page 1167)

GET\_ERR\_ID: Get error ID locally (Page 1787)

Inserting additional inputs and outputs in LAD elements (Page 1289)

## Conversion operations

### CONVERT: Convert value

#### Description

The "Convert value" instruction reads the content of the IN parameter and converts it according to the data types selected in the instruction box. The converted value is sent to the output OUT.

For information on possible conversions, refer to the "Explicit conversion" section at "See also".

The ENO enable output has the signal state "0" if one of the following conditions is fulfilled:

- The EN enable input has the signal state "0".
- Errors such as an overflow occur during execution.
- An operand of data type BYTE, WORD, DWORD or LWORD is specified at the IN input. This operand's most significant bit is set. A signed integer (SINT, INT, DINT, LINT) is specified at the OUT output. It has the same bit length as the operand at the IN input.

**Parameters**

The following table shows the parameters of the "Convert value" instruction:

Parameter	Declaration	Data type	Memory area	Description
EN	Input	BOOL	I, Q, M, D, L	Enable input
ENO	Output	BOOL	I, Q, M, D, L	Enable output
IN	Input	Bit strings, integers, floating-point numbers, CHAR, BCD16, BCD32	I, Q, M, D, L, P or constant	Value to be converted.
OUT	Output	Bit strings, integers, floating-point numbers, CHAR, BCD16, BCD32	I, Q, M, D, L, P	Result of the conversion

You can select the data type for the instruction from the "<???">" drop-down list of the instruction box.

Bit strings (BYTE, WORD, DWORD, LWORD) cannot be selected in the instruction box. If you have specified an operand of data type BYTE, WORD, DWORD or LWORD at a parameter of the instruction, the value of the operand is interpreted as an unsigned integer with the same bit length. In this case the data type BYTE is interpreted as USINT, WORD as UINT, DWORD as UDINT, and LWORD as LINT.

**Note**

For S7-1500 CPU: The data types DWORD and LWORD can be selected, if REAL or LREAL is selected as IN data type.

For additional information on valid data types, refer to "See also".

## Example

The following example shows how the instruction works:

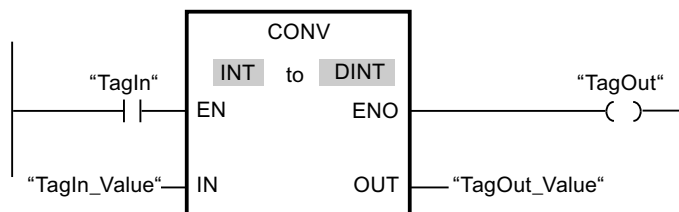

If operand "TagIn" has the signal state "1", the content of operand "TagIn\_Value" is read and converted to an integer (32-bit). The result is stored in operand "TagOut\_Value". The output "TagOut" is set to "1" if the instruction was executed without errors.

## See also

Overview of the valid data types (Page 1077)

Explicit conversion of CHAR (Page 1165)

## ROUND: Round numerical value

### Description

You can use the "Round numerical value" instruction to round the value at input IN to the nearest integer. The instruction interprets the value at input IN as a floating-point number and converts this to an integer of data type DINT. If the input value is exactly between an even and odd number, the even number is selected. The result of the instruction is sent to the OUT output and can be queried there.

The ENO enable output has the signal state "0" if one of the following conditions is fulfilled:

- The enable input EN has the signal state "0".
- Errors such as an overflow occur during execution.

### Parameters

The following table shows the parameters of the "Round numerical value" instruction:

Parameters	Declaration	Data type	Memory area	Description
EN	Input	BOOL	I, Q, M, D, L	Enable input
ENO	Output	BOOL	I, Q, M, D, L	Enable output
IN	Input	Floating-point numbers	I, Q, M, D, L, P or constant	Input value to be rounded.
OUT	Output	Integers, floating-point numbers	I, Q, M, D, L, P	Result of rounding

You can select the data type for the instruction from the "<???">" drop-down list of the instruction box.

For additional information on valid data types, refer to "See also".

**Example**

The following example shows how the instruction works:

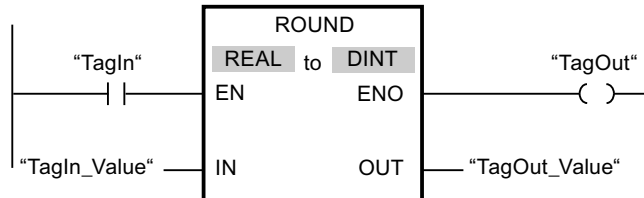

The following table shows how the instruction works using specific operand values:

Parameter	Operand	Value	
IN	TagIn_Value	1.50000000	-1.50000000
OUT	TagOut_Value	2	-2

If operand "TagIn" has the signal state "1", the "Round numerical value" instruction is executed. The floating-point number at input "TagIn\_Value" is rounded to the nearest even integer and sent to output "TagOut\_Value". If the instruction is executed without errors, the "TagOut" output is set.

**See also**

Overview of the valid data types (Page 1077)

**CEIL: Generate next higher integer from floating-point number**

**Description**

You can use the "Generate next higher integer from floating-point number" instruction to round the value at input IN to the next higher integer. The instruction interprets the value at the IN input as a floating-point number and converts this number to the next higher integer. The result of the instruction is sent to the OUT output and can be queried there. The output value can be greater than or equal to the input value.

The ENO enable output has the signal state "0" if one of the following conditions is fulfilled:

- The enable input EN has the signal state "0".
- Errors such as an overflow occur during execution.

## Parameters

The following table shows the parameters of the "Generate next higher integer from floating-point number" instruction:

Parameters	Declaration	Data type	Memory area	Description
EN	Input	BOOL	I, Q, M, D, L	Enable input
ENO	Output	BOOL	I, Q, M, D, L	Enable output
IN	Input	Floating-point numbers	I, Q, M, D, L, P or constant	Input value
OUT	Output	Integers, floating-point numbers	I, Q, M, D, L, P	Result with next higher integer

You can select the data type for the instruction from the "<???"> drop-down list of the instruction box.

For additional information on valid data types, refer to "See also".

## Example

The following example shows how the instruction works:

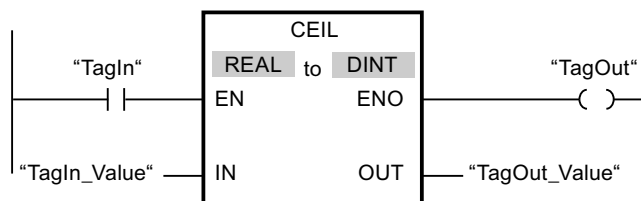

The following table shows how the instruction works using specific operand values:

Parameter	Operand	Value	
IN	TagIn_Value	0.50000000	-0.50000000
OUT	TagOut_Value	1	0

If operand "TagIn" has the signal state "1", the "Generate next higher integer from floating-point number" instruction is executed. The floating-point number at the "TagIn\_Value" input is rounded to the next higher integer and sent to the "TagOut\_Value" output. If the instruction is executed without errors, the "TagOut" output is set.

## See also

Overview of the valid data types (Page 1077)

## FLOOR: Generate next lower integer from floating-point number

### Description

You can use the "Generate next lower integer from floating-point number" instruction to round the value at input IN to the next lower integer. The instruction interprets the value at input IN as a floating-point number and converts this to the next lower integer. The result of the instruction is sent to the OUT output and can be queried there. The output value can be less than or equal to the input value.

The ENO enable output has the signal state "0" if one of the following conditions is fulfilled:

- The enable input EN has the signal state "0".
- Errors such as an overflow occur during execution.

### Parameters

The following table shows the parameters of the "Generate next lower integer from floating-point number" instruction:

Parameters	Declaration	Data type	Memory area	Description
EN	Input	BOOL	I, Q, M, D, L	Enable input
ENO	Output	BOOL	I, Q, M, D, L	Enable output
IN	Input	Floating-point numbers	I, Q, M, D, L, P or constant	Input value
OUT	Output	Integers, floating-point numbers	I, Q, M, D, L, P	Result with next lower integer

You can select the data type for the instruction from the "<???" drop-down list of the instruction box.

For additional information on valid data types, refer to "See also".

### Example

The following example shows how the instruction works:

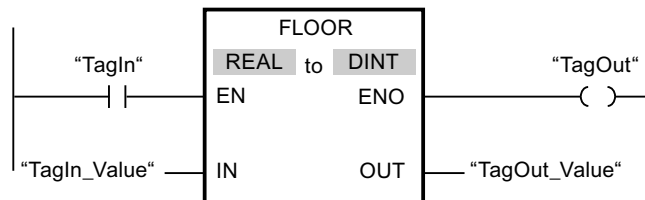

The following table shows how the instruction works using specific operand values:

Parameter	Operand	Value	
IN	TagIn_Value	0.50000000	-0.50000000
OUT	TagOut_Value	0	-1

If operand "TagIn" has the signal state "1", the "Generate next lower integer from floating-point number" instruction is executed. The floating-point number at input "TagIn\_Value" is rounded to the next lower integer and sent to output "TagOut\_Value". If the instruction is executed without errors, the "TagOut" output is set.

## See also

Overview of the valid data types (Page 1077)

## TRUNC: Truncate numerical value

### Description

You can use the "Truncate numerical value" instruction to form an integer from the value at the IN input. The value at the IN input is interpreted as a floating-point number. The instruction selects only the integer part of the floating-point number and sends this to the OUT output without decimal places.

The ENO enable output has the signal state "0" if one of the following conditions is fulfilled:

- The EN input has the signal state "0".
- Errors such as an overflow occur during execution.

### Parameters

The following table shows the parameters of the "Truncate numerical value" instruction:

Parameter	Declaration	Data type	Memory area	Description
EN	Input	BOOL	I, Q, M, D, L	Enable input
ENO	Output	BOOL	I, Q, M, D, L	Enable output
IN	Input	Floating-point numbers	I, Q, M, D, L or constant	Input value
OUT	Output	Integers, floating-point numbers	I, Q, M, D, L	Integer part of the input value

You can select the data type for the instruction from the "<???">" drop-down list of the instruction box.

For additional information on valid data types, refer to "See also".

**Example**

The following example shows how the instruction works:

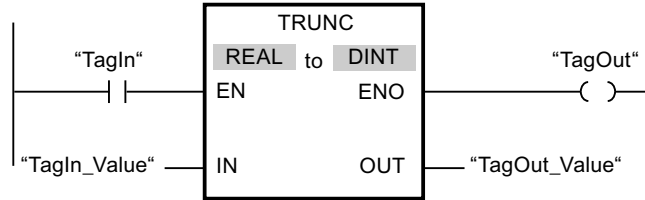

The following table shows how the instruction works using specific operand values:

Parameter	Operand	Value	
IN	TagIn_Value	1.50000000	-1.50000000
OUT	TagOut_Value	1	-1

If operand "TagIn" has the signal state "1", the "Truncate numerical value" instruction is executed. The integer part of the floating-point number at the "TagIn\_Value" input is converted to an integer and sent to the "TagOut\_Value" output. If the instruction is executed without errors, the "TagOut" output is set.

**See also**

Overview of the valid data types (Page 1077)

**SCALE\_X: Scale**

**Description**

You can use the "Scale" instruction to scale the value at the VALUE input by mapping it to a specified value range. When the "Scale" instruction is executed, the floating-point value at the VALUE input is scaled to the value range that was defined by the MIN and MAX parameters. The result of the scaling is an integer, which is stored in the OUT output.

The following figure shows an example of how values can be scaled:



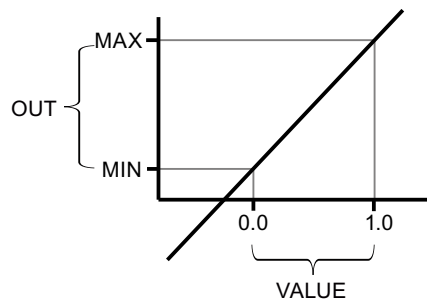

The "Scale" instruction works with the following equation:

$$\text{OUT} = [\text{VALUE} * (\text{MAX} - \text{MIN})] + \text{MIN}$$

The ENO enable output has the signal state "0" if one of the following conditions is fulfilled:

- The EN enable input has the signal state "0".
- The value at the MIN input is greater than or equal to the value at the MAX input.
- The value of a specified floating-point number is outside the range of the normalized numbers according to IEEE-754.
- An overflow occurs.
- The value at the VALUE input is NaN (Not a Number = result of an invalid arithmetic operation).

## Parameters

The following table shows the parameters of the "Scale" instruction:

Parameter	Declaration	Data type	Memory area	Description
EN	Input	BOOL	I, Q, M, D, L	Enable input
ENO	Output	BOOL	I, Q, M, D, L	Enable output
MIN	Input	Integers, floating-point numbers	I, Q, M, D, L or constant	Low limit of the value range
VALUE	Input	Floating-point numbers	I, Q, M, D, L or constant	Value to be scaled. If you enter a constant, you must declare it.

Parameter	Declaration	Data type	Memory area	Description
MAX	Input	Integers, floating-point numbers	I, Q, M, D, L or constant	High limit of the value range
OUT	Output	Integers, floating-point numbers	I, Q, M, D, L	Result of scaling

You can select the data type for the instruction from the "<???"> drop-down list of the instruction box.

For additional information on valid data types, refer to "See also".

For additional information on declaring constants, refer to "See also".

### Example

The following example shows how the instruction works:

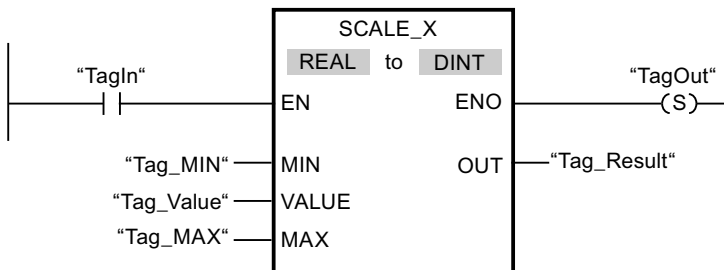

The following table shows how the instruction works using specific operand values:

Parameter	Operand	Value
MIN	Tag_MIN	10
VALUE	Tag_Value	0.5
MAX	Tag_MAX	30
OUT	Tag_Result	20

If operand "TagIn" has the signal state "1", the "Scale" instruction is executed. The value at the "Tag\_Value" input is scaled to the range of values defined by the values at the "Tag\_MIN" and "Tag\_MAX" inputs. The result is stored in the "Tag\_Result" output. If the instruction is executed without errors, the ENO enable output has the signal state "1" and the "TagOut" output is set.

### See also

Overview of the valid data types (Page 1077)

NORM\_X: Normalize (Page 1763)

Declaring constants (Page 1188)

## NORM\_X: Normalize

### Description

You can use the instruction "Normalize" to normalize the value of the tag at the VALUE input by mapping it to a linear scale. You can use the MIN and MAX parameters to define the limits of a value range that is applied to the scale. The result at the OUT output is calculated and stored as a floating-point number depending on the location of the value to be normalized within this value range. If the value to be normalized is equal to the value at the MIN input, the OUT output has the value "0.0". If the value to be normalized is equal to the value at input MAX, output OUT returns the value "1.0".

The following figure shows an example of how values can be normalized:

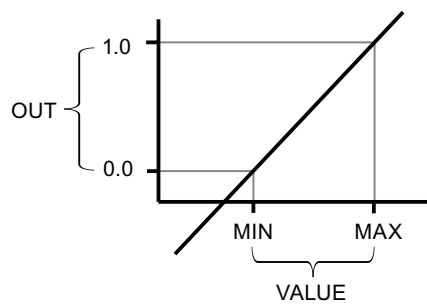

The "Normalize" instruction works with the following equation:

$$\text{OUT} = (\text{VALUE} - \text{MIN}) / (\text{MAX} - \text{MIN})$$

The ENO enable output has the signal state "0" if one of the following conditions is fulfilled:

- The EN enable input has the signal state "0".
- The value at the MIN input is greater than or equal to the value at the MAX input.
- The value of a specified floating-point number is outside the range of the normalized numbers according to IEEE-754.
- The value at the VALUE input is NaN (result of an invalid arithmetic operation).

### Parameter

The following table shows the parameters of the "Normalize" instruction:

Parameter	Declaration	Data type	Memory area	Description
EN	Input	BOOL	I, Q, M, D, L	Enable input
ENO	Output	BOOL	I, Q, M, D, L	Enable output
MIN <sup>1)</sup>	Input	Integers, floating-point numbers	I, Q, M, D, L or constant	Low limit of the value range
VALUE <sup>1)</sup>	Input	Integers, floating-point numbers	I, Q, M, D, L or constant	Value to be normalized.
MAX <sup>1)</sup>	Input	Integers, floating-point numbers	I, Q, M, D, L or constant	High limit of the value range
OUT	Output	Floating-point numbers	I, Q, M, D, L	Result of the normalization

<sup>1)</sup> If you use constants in these three parameters, you only need to declare one of them.

You can select the data type for the instruction from the "<???" drop-down list of the instruction box.

For additional information on valid data types, refer to "See also".

For additional information on declaring constants, refer to "See also".

### Example

The following example shows how the instruction works:

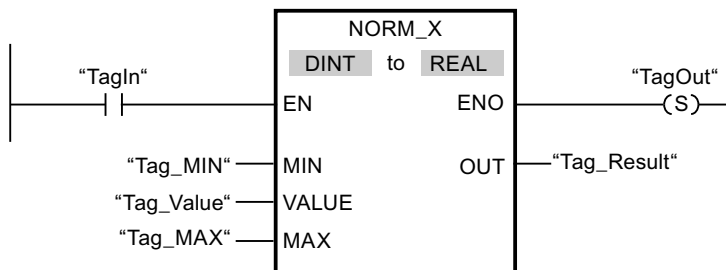

The following table shows how the instruction works using specific operand values:

Parameter	Operand	Value
MIN	Tag_MIN	10
VALUE	Tag_Value	20
MAX	Tag_MAX	30
OUT	Tag_Result	0.5

If operand "TagIn" has the signal state "1", the "Normalize" instruction is executed. The value at the "Tag\_Value" input is mapped to the range of values that were defined by the values at the "Tag\_MIN" and "Tag\_MAX" inputs. The tag value at the "Tag\_Value" input is normalized to the defined value range. The result is stored as a floating-point number in the "Tag\_Result" output. If the instruction is executed without errors, the ENO enable output has the signal state "1" and the "TagOut" output is set.

**See also**

Overview of the valid data types (Page 1077)

SCALE\_X: Scale (Page 1760)

Declaring constants (Page 1188)

**Other****SCALE: Scale****Description**

Use the "Scale" instruction to convert the integer at the IN parameter into a floating-point number, which can be scaled in physical units between a low limit value and a high limit value. You can use the LO\_LIM and HI\_LIM parameters to specify the low limit and high limit of the value range to which the input value is scaled. The result of the instruction is output on the OUT parameter.

The "Scale" instruction works with the following equation:

$$\text{OUT} = [((\text{FLOAT}(\text{IN}) - \text{K1}) / (\text{K2} - \text{K1})) * (\text{HI\_LIM} - \text{LO\_LIM})) + \text{LO\_LIM}]$$

The values of the constants "K1" and "K2" are determined by the signal state on the BIPOLAR parameter. The following signal states are possible on the BIPOLAR parameter:

- Signal state "1": It is assumed that the value at the IN parameter is bipolar and in a value range between -27648 and 27648. In this case the "K1" constant has the value "-27648.0" and the "K2" constant the value "+27648.0".
- Signal state "0": It is assumed that the value at the IN parameter is unipolar and in a value range between 0 and 27648. In this case the "K1" constant has the value "0,0" and the "K2" constant the value "+27648.0".

When the value at the IN parameter is greater than the value of the constant "K2", the result of the instruction is set to the value of the high limit (HI\_LIM) and an error is output.

When the value at the IN parameter is less than the value of the constant "K1", the result of the instruction is set to the value of the low limit value (LO\_LIM) and an error is output.

When the indicated low limit value is greater than the high limit value (LO\_LIM > HI\_LIM), the result is scaled in reverse proportion to the input value.

**Parameter**

The following table shows the parameters of the "Scale" instruction:

Parameter	Declaration	Data type	Memory area	Description
EN	Input	BOOL	I, Q, M, D, L	Enable input
ENO	Output	BOOL	I, Q, M, D, L	Enable output
IN	Input	INT	I, Q, M, D, L, P or constant	Input value to be scaled.

Parameter	Declaration	Data type	Memory area	Description
HI_LIM	Input	REAL	I, Q, M, D, L, P or constant	High limit
LO_LIM	Input	REAL	I, Q, M, D, L, P or constant	Low limit
BIPOLAR	Input	BOOL	I, Q, M, D, L or constant	Indicates if the value at IN parameter is to be interpreted as bipolar or unipolar. The parameter can assume the following values: 1: Bipolar 0: Unipolar
OUT	Output	REAL	I, Q, M, D, L, P	Result of the instruction
RET_VAL	Output	WORD	I, Q, M, D, L, P	Error information

### Parameter RET\_VAL

The following table shows the meaning of the values of the RET\_VAL parameter:

Error code* (W#16#...)	Explanation
0000	No error
0008	The value of the IN parameter is greater than the value of the constant "K2" or less than the value of the constant "K1"
General error information	See also: "GET_ERR_ID: Get error ID locally"

\*The error codes can be displayed as integer or hexadecimal value in the program editor. For information on toggling display formats, refer to "See also".

### Example

The following example shows how the instruction works:

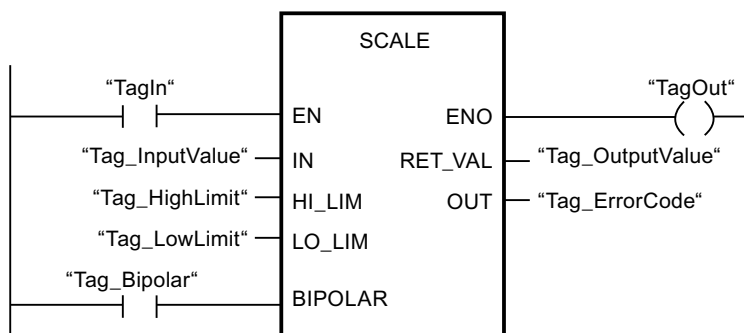

The following table shows how the instruction works using specific operand values:

Parameter	Operand	Value
IN	Tag_InputValue	22
HI_LIM	Tag_HighLimit	100.0
LO_LIM	Tag_LowLimit	0.0
BIPOLAR	Tag_Bipolar	1
OUT	Tag_OutputValue	50.03978588
RET_VAL	Tag_ErrorCode	W#16#0000

## See also

Overview of the valid data types (Page 1077)

Basics of the EN/ENO mechanism (Page 1167)

GET\_ERR\_ID: Get error ID locally (Page 1787)

## UNSCALE: Unscale

### Description

The "Unscale" instruction is used to unscale the floating-point number on the IN parameter into physical units between a low limit and a high limit and convert it into an integer. You can use the LO\_LIM and HI\_LIM parameters to specify the low limit and high limit of the value range to which the input value is unscaled. The result of the instruction is output on the OUT parameter.

The "Unscale" instruction works with the following equation:

$$\text{OUT} = [ ((\text{IN}-\text{LO\_LIM})/(\text{HI\_LIM}-\text{LO\_LIM})) * (\text{K2}-\text{K1}) ] + \text{K1}$$

The values of the constants "K1" and "K2" are determined by the signal state on the BIPOLAR parameter. The following signal states are possible on the BIPOLAR parameter:

- Signal state "1": It is assumed that the value at the IN parameter is bipolar and in a value range between -27648 and 27648. In this case the "K1" constant has the value "-27648.0" and the "K2" constant the value "+27648.0".
- Signal state "0": It is assumed that the value at the IN parameter is unipolar and in a value range between 0 and 27648. In this case the "K1" constant has the value "0.0" and the "K2" constant the value "+27648.0".

When the value at the IN parameter is greater than the value of the constant "HI\_LIM", the result of the instruction is set to the value of the constant (K2) and an error is output.

When the value at the IN parameter is less than the value of the constant of the low limit (LO\_LIM), the result of the instruction is set to the value of the constant (K1) and an error is output.

**Parameters**

The following table shows the parameters of the "Unscale" instruction:

Parameter	Declaration	Data type	Memory area	Description
EN	Input	BOOL	I, Q, M, D, L	Enable input
ENO	Input	BOOL	I, Q, M, D, L	Enable output
IN	Input	REAL	I, Q, M, D, L, P or constant	Input value to be unscaled to an integer value.
HI_LIM	Input	REAL	I, Q, M, D, L, P or constant	High limit
LO_LIM	Input	REAL	I, Q, M, D, L, P or constant	Low limit
BIPOLAR	Input	BOOL	I, Q, M, D, L or constant	Indicates if the value at IN parameter is to be interpreted as bipolar or unipolar. The parameter can assume the following values: 1: Bipolar 0: Unipolar
OUT	Output	INT	I, Q, M, D, L, P	Result of the instruction
RET_VAL	Output	WORD	I, Q, M, D, L, P	Error information

**Parameter RET\_VAL**

The following table shows the meaning of the values of the RET\_VAL parameter:

Error code* (W#16#...)	Explanation
0000	No error
0008	The value of the IN parameter is greater than the value of the high limit (HI_LIM) or less than the value of the low limit (LO_LIM).
General error information	See also: "GET_ERR_ID: Get error ID locally"

\*The error codes can be displayed as integer or hexadecimal value in the program editor. For information on toggling display formats, refer to "See also".



## Example

The following example shows how the instruction works:

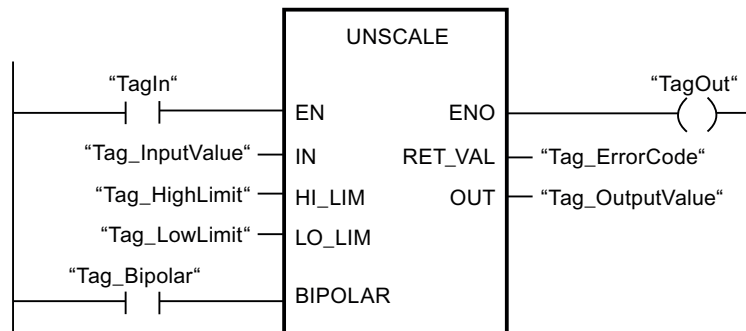

The following table shows how the instruction works using specific operand values:

Parameter	Operand	Value
IN	Tag_InputValue	50.03978588
HI_LIM	Tag_HighLimit	100.0
LO_LIM	Tag_LowLimit	0.0
BIPOLAR	Tag_Bipolar	1
OUT	Tag_OutputValue	22
RET_VAL	Tag_ErrorCode	W#16#0000

## See also

Overview of the valid data types (Page 1077)

Basics of the EN/ENO mechanism (Page 1167)

GET\_ERR\_ID: Get error ID locally (Page 1787)

## Program control operations

---( JMP ): Jump if RLO = 1

### Description

You can use the "Jump if RLO = 1" instruction to interrupt the linear execution of the program and resume it in another network. The destination network must be identified by a jump label (LABEL). The name of this jump label is specified in the placeholder above the instruction.

The specified jump label must be in the same block in which the instruction is executed. The name you specify can only occur once in the block. Only one jumping coil is permitted within a network.

If the result of logic operation (RLO) at the input of the instruction is "1", the jump to the network identified by the specified jump label is executed. The jump direction can be towards higher or lower network numbers.

If the condition at the input of the instruction is not fulfilled (RLO = 0), execution of the program continues in the next network.

**Example**

The following example shows how the instruction works:

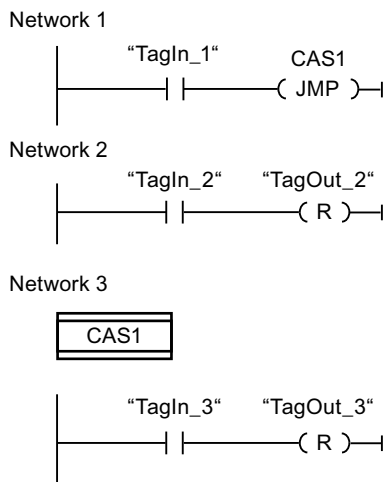

If operand "TagIn\_1" has the signal state "1", the "Jump if RLO = 1" instruction is executed. The linear execution of the program is interrupted and continues in Network 3, which is identified by the jump label CAS1. If the "TagIn\_3" input has the signal state "1", the "TagOut\_3" output is set.

**---( JMPN ): Jump if RLO = 0**

**Description**

You can use the instruction "Jump if RLO = 0" to interrupt the linear execution of the program and resume it in another network, when the result of logic operation at the input of the instruction is "0". The destination network must be identified by a jump label (LABEL). The name of this jump label is specified in the placeholder above the instruction.

The specified jump label must be in the same block in which the instruction is executed. The name you specify can only occur once in the block. Only one jumping coil is permitted within a network.

If the result of logic operation (RLO) at the input of the instruction is "0", the jump to the network identified by the specified jump label is executed. The jump direction can be towards higher or lower network numbers.

If the result of logic operation at the input of the instruction is "1", execution of the program continues in the next network.

## Example

The following example shows how the instruction works:

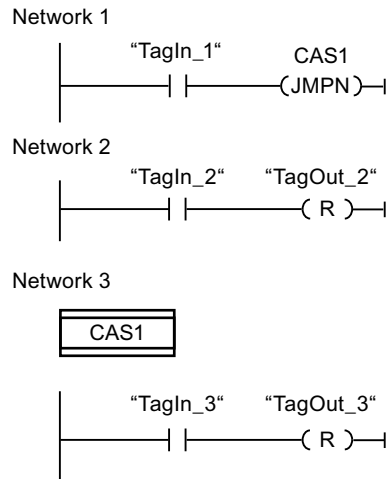

If operand "TagIn\_1" has the signal state "0", the "Jump if RLO = 0" instruction is executed. The linear execution of the program is interrupted and continues in Network 3, which is identified by the jump label CAS1. If the "TagIn\_3" input has the signal state "1", the "TagOut\_3" output is set.

## See also

Overview of the valid data types (Page 1077)

## LABEL: Jump label

### Description

You can use a jump label to identify a destination network, in which the program execution should resume when a jump is executed.

The jump label and the instruction in which the jump label is specified must be located in the same block. The name of a jump label can only be assigned once in a block. You can declare up to 32 jump labels when you use a CPU S7-1200 and a maximum of 256 jump labels when you use a CPU S7-1500.

Only one jump label can be placed in a network. Each jump label can jump to several locations.

**Example**

The following example shows how the instruction works:

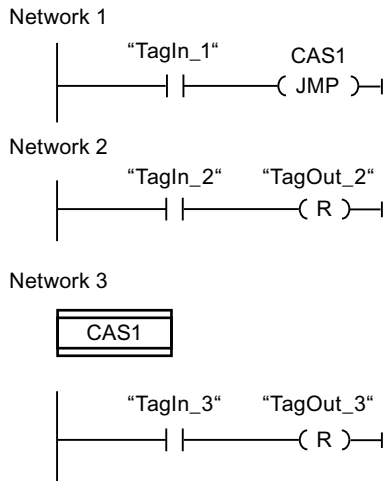

If operand "TagIn\_1" has the signal state "1", the "Jump if RLO = 1" instruction is executed. The linear execution of the program is interrupted and continues in Network 3, which is identified by the jump label CAS1. If the "TagIn\_3" input has the signal state "1", the "TagOut\_3" output is set.

**See also**

- Overview of the valid data types (Page 1077)
- Inserting additional inputs and outputs in LAD elements (Page 1289)
- Removing inputs and outputs (Page 1290)

**JMP\_LIST: Define jump list**

**Description**

You can use the "Define jump list" instruction to define several conditional jumps and continue the program execution in a specific network depending on the value of the K parameter.

You define the jumps with jump labels (LABEL), which you specify at the outputs of the instruction box. The number of outputs can be expanded in the instruction box. You can declare up to 32 outputs when you use a CPU S7-1200 and a maximum of 256 outputs when you use a CPU S7-1500.

The numbering of the outputs begins with the value "0" and continues in ascending order with each new output. Only jump labels can be specified at the outputs of the instruction. Instructions or operands cannot be specified.

The value of the K parameter specifies the number of the output and thus the jump label where the program execution is to be resumed. If the value in the K parameter is greater than the number of available outputs, the program execution is resumed in the next network of the block.

The "Define jump list" instruction is only executed if the signal state is "1" at the EN enable input.

## Parameter

The following table shows the parameters of the "Define jump list" instruction:

Parameters	Declaration	Data type	Memory area	Description
EN	Input	BOOL	I, Q, M, D, L	Enable input
K	Input	UINT	I, Q, M, D, L or constant	Specifies the number of the output and thus the jump that is to be made.
DEST0	-	-	-	First jump label
DEST1	-	-	-	Second jump label
DESTn	-	-	-	Optional jump labels

For additional information on valid data types, refer to "See also".

## Example

The following example shows how the instruction works:

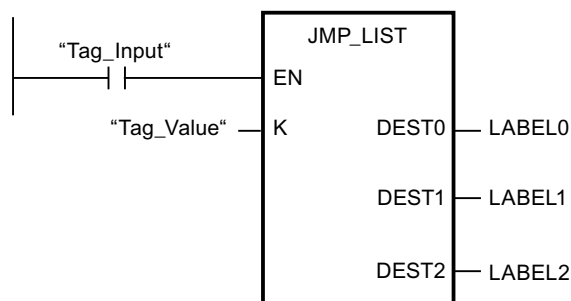

The following table shows how the instruction works using specific operand values:

Parameters	Operand/Jump label	Value
K	Tag_Value	1
Dest0	LABEL0	Jump to the network that is identified with the jump label "LABEL0".
Dest1	LABEL1	Jump to the network that is identified with the jump label "LABEL1".
Dest2	LABEL2	Jump to the network that is identified with the jump label "LABEL2".

If operand "Tag\_Input" has the signal state "1", the "Define jump list" instruction is executed. The program execution is resumed according to the value of operand "Tag\_Value" in the network that is identified with the jump label "LABEL1".

**See also**

Overview of the valid data types (Page 1077)

Inserting additional inputs and outputs in LAD elements (Page 1289)

Removing inputs and outputs (Page 1290)

**SWITCH: Jump distributor**

**Description**

You can use the "Jump distributor" instruction to define multiple program jumps to be executed depending on the result of one or more comparison instructions.

You specify the value to be compared in the K parameter. This value is compared with the values that are provided by the various inputs. You can select the comparison method for each individual input. The availability of the various comparison instructions depends on the data type of the instruction.

The following table shows the comparison instructions that are available depending on the selected data type:

Data type		Instruction	Syntax
S7-1200	S7-1500		
Bit strings	Bit strings	Equal	==
		Not equal	<>
Integers, floating-point numbers, TIME, DATE, TOD	Integers, floating-point numbers, TIME, LTIME, DATE, TOD, LTOD, LDT	Equal	==
		Not equal	<>
		Greater or equal	>=
		Less or equal	<=
		Greater than	>
		Less than	<

You can select the data type of the instruction from the "<???">" drop-down list of the instruction box. If you select a comparison instruction and the data type of the instruction is not yet defined, the "<???">" drop-down list only offers the data types that are permitted for the selected comparison instruction.

Execution of the instruction begins with the first comparison and runs until a comparison condition is met. If a comparison condition is met, the subsequent comparison conditions are not considered. If none of the specified comparison conditions are met, the jump at the ELSE output is executed. If no program jump is defined at the ELSE output, execution of the program continues in the next network.

The number of outputs can be expanded in the instruction box. The numbering of the outputs begins with the value "0" and continues in ascending order with each new output. Specify jump

labels (LABEL) at the outputs of the instruction. Instructions or operands cannot be specified at the outputs of the instruction.

An input is automatically inserted for each additional output. The jump programmed at an output is executed if the comparison condition of the corresponding input is fulfilled.

## Parameters

The following table shows the parameters of the "Jump distributor" instruction:

Parameter	Declaration	Data type		Memory area	Description
		S7-1200	S7-1500		
EN	Input	BOOL	BOOL	I, Q, M, D, L	Enable input
K	Input	UINT	UINT	I, Q, M, D, L or constant	Specifies the value to be compared.
<Comparison values>	Input	Bit strings, integers, floating-point numbers, TIME, DATE, TOD	Bit strings, integers, floating-point numbers, TIME, LTIME, DATE, TOD, LTOD, LDT	I, Q, M, D, L or constant	Input value with which the value of the K parameter is compared.
DEST0	-	-	-	-	First jump label
DEST1	-	-	-	-	Second jump label
DEST(n)	-	-	-	-	Optional jump labels(n = 2 to 99)
ELSE	-	-	-	-	Program jump that is executed when none of the comparison conditions are fulfilled.

For additional information on valid data types, refer to "See also".

**Example**

The following example shows how the instruction works:

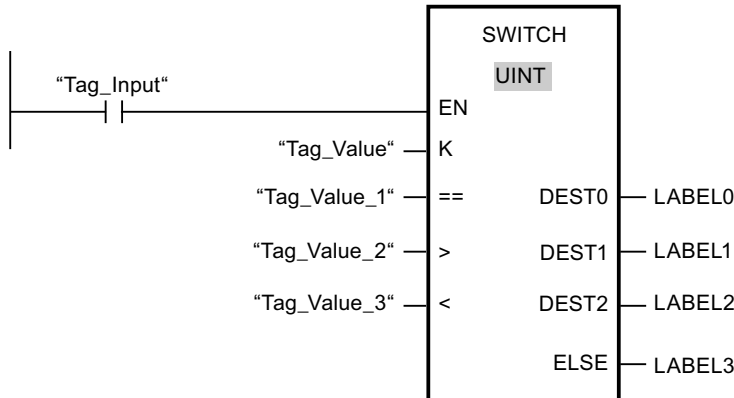

The following table shows how the instruction works using specific operand values:

Parameters	Operand/Jump label	Value
K	Tag_Value	23
==	Tag_Value_1	20
>	Tag_Value_2	21
<	Tag_Value_3	19
Dest 0	LABEL0	Jump to jump label "LABEL0", if the value of the K parameter equals 20.
Dest 1	LABEL1	Jump to jump label "LABEL1" if the value of the K parameter is greater than 21.
Dest 2	LABEL2	Jump to jump label "LABEL2", if the value of the K parameter is less than 19.
ELSE	LABEL 3	Jump to jump label "LABEL3", if the none of the comparison conditions are fulfilled.

If the operand "Tag\_Input" changes to signal state "1", the instruction "Jump distributor" is executed. The execution of the program is continued in the network that is identified with the jump label "LABEL1".

**See also**

Overview of the valid data types (Page 1077)

Inserting additional inputs and outputs in LAD elements (Page 1289)

Removing inputs and outputs (Page 1290)



**--(RET): Return****Description**

You can use the "Return" instruction to stop the execution of a block. The results is three types through which the block processing can be completed.

- Without call of the "Return" instruction  
The block is exited after execution of the last network. The ENO of the function call is set to the signal state "1".
- Call of the "Return" instruction with preceding logic operation (see example)  
If the left connector has the signal state "1", the block will be exited. The ENO of the function call corresponds to the operand.
- Call of the "Return" instruction without previous logic operation  
The block is exited. The ENO of the function call corresponds to the operand.

**Note**

Only one jumping coil may be used in a network ("Return", "Jump if RLO=1", "Jump if RLO=0").

If the result of logic operation (RLO) at the input of the "Return" instruction is "1", program execution is terminated in the currently called block and resumed after the call function in the calling block (for example, in the calling OB). The status (ENO) of the call function is determined by the parameter of the instruction. This can assume the following values:

- RLO
- TRUE/FALSE
- <Operand>

To set the parameter values, double-click the instruction and select the corresponding value in the drop-down list.

The following table shows the status of the call function if the "Return" instruction is programmed in a network within the called block:

RLO	Parameter value	ENO of the call function
1	RLO	1
	TRUE	1
	FALSE	0
	<Operand>	<Operand>
0	RLO	The program execution continues in the next network of the called block.
	TRUE	
	FALSE	
	<Operand>	

If an OB is completed, another block will be selected and started or executed by the priority class system:

- If the program cycle OB was completed, it will be restarted.
- If an OB is completed that has interrupted another block (for example, an alarm OB), then the interrupted block (for example, program cycle OB) will be executed.

### Parameters

The following table shows the parameters of the "Return" instruction:

Parameter	Declaration	Data type	Memory area	Description
Status of the calling function with RLO = 1:				
RLO	-	-		Is set to the signal status of the RLO.
TRUE	-	-		1
FALSE	-	-		0
<Operand>	Input	BOOL	I, Q, M, D, L	Signal state of the specified operand

### Example

The following example shows how the instruction works:

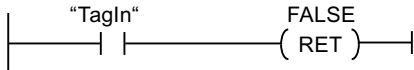

If operand "TagIn" has the signal state "1", the "Return" instruction is executed. Program execution is terminated in the called block and continues in the calling block. The ENO enable output of the call function is reset to signal state "0".

### See also

Overview of the valid data types (Page 1077)

### Runtime control

#### ENDIS\_PW: Limit and enable password legitimation

### Description

You can use the "Limit and enable password legitimation" instruction to specify whether or not legitimation is allowed for the CPU. You can prevent legitimated connections, even when the correct password is known. When you invoke the command and the REQ parameter has the signal state "0", only the currently set condition is displayed at the output parameters, but no setting is changed. If the REQ parameter has the signal state "1", the signal state is taken from the input parameters (F\_PWD, FULL\_PWD, R\_PWD, HMI\_PWD). FALSE means that

legitimation per password is not allowed; TRUE means the password can be used. Disable or enabling of the passwords can be allowed or prohibited individually. For example, all passwords can be prohibited, except the fail-safe password. You can thus limit access options to a small user group. The output parameters (F\_PWD\_ON, FULL\_PWD\_ON, R\_PWD\_ON, HMI\_PWD\_ON) always show the current status of the password use, regardless of the REQ parameter.

The same setting can be made on the front panel of the CPU and the CPU saves the most recent setting.

To prevent accidental lockout, the protection can be disabled by setting the mode switch to STOP with an S7-1500 CPU. The protection is automatically enabled again by setting mode selector to RUN without having to call the "Limit and enable password legitimation" instruction again or taking additional actions on the front panel.

The instruction must always be fully executed, in other words, the F\_PWD parameter must always have the signal state "0", for example, so that the settings can be saved.

Disabled passwords can be enabled again under the following conditions:

- The CPU is reset to its factory settings.
- The front panel of the S7-1500 CPU supports a dialog that allows you to navigate to the appropriate menu in which the passwords can be enabled again.
- When you call the "Limit and enable password legitimation" instruction, the input parameter of the desired password has the signal state "1".
- Set the mode selector to STOP. The restriction to password legitimation is re-established as soon as the switch is set back to RUN.
- Plugging a transfer module into an S7-1200 CPU.

---

**Note**

The "Limit and enable password legitimation" instruction blocks access to the HMI panel, if the HMI password has not been enabled.

---

**Note**

Existing legitimized connections retain their access rights and you cannot use the "Limit and enable password legitimation" instruction to restrict them.

---

### Procedure for lost passwords with an S7-1200 CPU

If you have lost the password for a password-protected S7-1200 CPU, delete the password-protected program with an empty transfer card. The empty transfer card deletes the internal

load memory of the CPU. You can then load a new user program from STEP 7 Basic in the CPU.

 <b>WARNING</b> <b>Inserting transfer card</b> When you insert a transfer card in a CPU during runtime, the CPU goes to STOP mode. If operating states are unstable, controllers may fail and thus cause the uncontrolled operation of the controlled devices. This leads to an unforeseen operation of the automation system which can cause deadly or serious injuries and/or damage to property.
--

You must remove the transfer card before you put the CPU into RUN mode.

### Effects of password use on the operating modes

The following table shows what effects the password use by means of the "Limit and enable password legitimization" instruction has on the operating modes and the corresponding user actions.

Action	Password protection by means of the instruction
Basic state after <ul style="list-style-type: none"> <li>• Operating mode switch to STOP</li> <li>• Reset memory manually (PG, switch, change of MC (Motion Control))</li> <li>• Reset to factory setting</li> </ul>	Not activated (no restrictions)
Basic state after POWER ON	Enabled (when a lock was activated before POWER OFF) The option of not allowing passwords is retentive.
Operating mode transition RUN/STARTUP/HOLD -> STOP (by terminating the instruction, an error or communication) or STOP -> STARTUP/RUN/HOLD	Activated Passwords still cannot be used.

### Parameters

The following table shows the parameters of the "Limit and enable password legitimization" instruction:

Parameter	Declaration	Data type	Memory area	Description
EN	Input	BOOL	I, Q, M, D, L	Enable input
ENO	Output	BOOL	I, Q, M, D, L	Enable output
REQ	Input	BOOL	I, Q, M, D, L	When the REQ parameter has the signal state "0", the currently set signal state of the passwords is queried.

Parameter	Declaration	Data type	Memory area	Description
F_PWD	Input	BOOL	I, Q, M, D, L	Read/write access including fail-safe <ul style="list-style-type: none"> <li>• F_PWD = "0": Do not allow password</li> <li>• F_PWD = "1": Allow password</li> </ul>
FULL_PWD	Input	BOOL	I, Q, M, D, L	Read/write access <ul style="list-style-type: none"> <li>• FULL_PWD = "0": Do not allow password</li> <li>• FULL_PWD = "1": Allow password</li> </ul>
R_PWD	Input	BOOL	I, Q, M, D, L	Read access <ul style="list-style-type: none"> <li>• R_PWD = "0": Do not allow password</li> <li>• R_PWD = "1": Allow password</li> </ul>
HMI_PWD	Input	BOOL	I, Q, M, D, L	HMI access <ul style="list-style-type: none"> <li>• HMI_PWD = "0": Do not allow password</li> <li>• HMI_PWD = "1": Allow password</li> </ul>
F_PWD_ON	Output	BOOL	I, Q, M, D, L	Read/write access including fail-safe <ul style="list-style-type: none"> <li>• F_PWD_ON = "0": Password not allowed</li> <li>• F_PWD_ON = "1": Password allowed</li> </ul>
FULL_PWD_ON	Output	BOOL	I, Q, M, D, L	Read/write access status <ul style="list-style-type: none"> <li>• FULL_PWD_ON = "0": Password not allowed</li> <li>• FULL_PWD_ON = "1": Password allowed</li> </ul>
R_PWD_ON	Output	BOOL	I, Q, M, D, L	Read-access status <ul style="list-style-type: none"> <li>• R_PWD_ON = "0": Password not allowed</li> <li>• R_PWD_ON = "1": Password allowed</li> </ul>

Parameter	Declaration	Data type	Memory area	Description
HMI_PWD_ON	Output	BOOL	I, Q, M, D, L	HMI-access status <ul style="list-style-type: none"> <li>• HMI_PWD_ON = "0": Password not allowed</li> <li>• HMI_PWD_ON = "1": Password allowed</li> </ul>
RET_VAL	Output	WORD	I, Q, M, D, L	Error information

For additional information on valid data types, refer to "See also".

### Parameter RET\_VAL

The following table shows the meaning of the values of the RET\_VAL parameter:

Error code* (W#16#...)	Explanation
0000	No error
8090	The "Limit and enable password legitimation" instruction is not supported
80D0	The password for fail-safe is not configured
80D1	The read/write access is not configured
80D2	The read access is not configured
80D3	The HMI access is not configured
*The error codes can be displayed as integer or hexadecimal value in the program editor. For information on toggling display formats, refer to "See also".	

### See also

Overview of the valid data types (Page 1077)

Basics of the EN/ENO mechanism (Page 1167)

### RE\_TRIGR: Restart cycle monitoring time

#### Description

You can use the "Restart cycle monitoring time" instruction to restart the cycle time monitoring of the CPU. The maximum cycle time then starts over again for the duration you have set in the CPU configuration.

The instruction "Restart cycle monitoring time" can be called regardless of the priority in all blocks.

If the instruction is called in a block with a higher priority, such as a hardware interrupt, diagnostic error interrupt, or cyclic interrupt, the instruction is not executed and the ENO enable output is set to signal state "0".

The instruction "Restart cycle monitoring time" can be called a maximum of 10 times in a program cycle.

### Parameter

The "Restart cycle monitoring time" instruction has no parameters.

### See also

Overview of the valid data types (Page 1077)

Basics of the EN/ENO mechanism (Page 1167)

### STP: Exit program

#### Description

You use the "Exit program" instruction to set the CPU to STOP mode and therefore to terminate the execution of the program. The effects of changing from RUN to STOP depend on the CPU configuration.

When the result of logic operation (RLO) at the input of the instruction is "1", the CPU changes to STOP mode and program execution is terminated. The signal state at the output of the instruction is not evaluated.

When the RLO is "0" at the input of the instruction, then the instruction will not be executed.

#### Parameters

The "Exit program" instruction has no parameters.

### See also

Overview of the valid data types (Page 1077)

### GET\_ERROR: Get error locally

#### Description

The "Get error locally" instruction is used to query the occurrence of errors within a block. If the system signals errors during block execution, detailed information about the first error that occurred is saved in the operand at the ERROR output.

Only operands of the "ErrorStruct" system data type can be specified at the ERROR output. The "ErrorStruct" system data type specifies the exact structure in which the information about the error is stored. Using additional instructions, you can evaluate this structure and program an appropriate response. When the first error has been eliminated, the instruction outputs information about the next error that occurred.

**Parameters**

The following table shows the parameters of the "Get error locally" instruction:

Parameter	Declaration	Data type	Memory area	Description
ERROR	Output	ErrorStruct	D, L	Error information

**Data type "ErrorStruct"**

The following table shows the structure of the "ErrorStruct" data type:

Structure component		Data type	Description					
ERROR_ID		WORD	Error ID					
FLAGS		BYTE	Shows if an error occurred during a block call. 16#01: Error during a block call 16#00: No error during a block call					
REACTION		BYTE	Default reaction: 0: Ignore (write error), 1: Continue with substitute value "0" (read error), 2: Skip instruction (system error)					
CODE_ADDRESS		CREF	Information about the address and type of block					
	BLOCK_TYPE	BYTE	Type of block where the error occurred: 1: OB 2: FC 3: FB					
	CB_NUMBER	UINT	Number of the code block					
	OFFSET	UDINT	Reference to the internal memory					
MODE		BYTE	Access mode: Depending on the type of access, the following information can be output:					
			Mode	(A)	(B)	(C)	(D)	(E)
			0					
			1					Offset
			2			Area		
			3	Location	Scope		Number	
			4			Area		Offset
			5			Area	DB no.	Offset
			6	PtrNo./ Acc		Area	DB no.	Offset
7	PtrNo./ Acc	Slot No. / Scope	Area	DB no.	Offset			
OPERAND_NUMBER		UINT	Operand number of the machine command					
POINTER_NUMBER_LOCATION		UINT	(A) Internal pointer					
SLOT_NUMBER_SCOPE		UINT	(B) Storage area in internal memory					



Structure component		Data type	Description
DATA_ADDRESS		NREF	Information about the address of an operand
	AREA	BYTE	(C) Memory area: L: 16#40 – 4E, 86, 87, 8E, 8F, C0 – CE E: 16#81 A: 16#82 M: 16#83 DB: 16#84, 85, 8A, 8B Range violations for a directly editable tag of data type DINT: 16#04
	DB_NUMBER	UINT	(D) Number of the data block
	OFFSET	UDINT	(E) Relative address of the operand

### Structure component "ERROR\_ID"

The following table shows the values that can be output on the structure component "ERROR\_ID":

ID* (hexadecimal)	ID* (decimal)	Description
0	0	No error
2503	9475	Invalid pointer
2520	9504	Invalid STRING
2522	9506	Read error: Operand outside the valid range
2523	9507	Write error: Operand outside the valid range
2524	9508	Read error: Invalid operand
2525	9509	Write error: Invalid operand
2528	9512	Read error: Data alignment
2529	9513	Write error: Data alignment
252C	9516	Invalid pointer
2530	9520	Write error: Data block
2533	9523	Invalid pointer used
2538	9528	Access error: DB does not exist
2539	9529	Access error: Wrong DB used
253A	9530	Global data block does not exist
253C	9532	Faulty information or the function does not exist
253D	9533	System function does not exist
253E	9534	Faulty information or the function block does not exist
253F	9535	System block does not exist
2550	9552	Access error: DB does not exist
2551	9553	Access error: Wrong DB used
2575	9589	Error in the program nesting depth
2577	9591	Die block property "Parameter assignment via register" is not selected.

ID* (hexadecimal)	ID* (decimal)	Description
2576	9590	Error in the local data distribution
25A0	9632	Internal error in TP
25A1	9633	Tag is write-protected
25A2	9634	Invalid numerical value of tag
2942	10562	Read error: Input
2943	10563	Write error: Output

\*The error codes can be displayed as integer or hexadecimal value in the program editor. For information on toggling display formats, refer to "See also".

The ENO enable output of the "Get error locally" instruction is only set if the EN enable input has the signal state "1" and error information is present. If one of these conditions is not fulfilled, the remaining program execution is not affected by the "Get error locally" instruction.

The "Get error locally" instruction can also be used to forward an alarm about the error status to the calling block. To do this, the instruction must be positioned in the last network of the called block.

**Note**

The "Get error locally" instruction enables local error handling within a block. If "Get error locally" is inserted in the program code of a block, any predefined system reactions are ignored if errors occur.

**Example**

The following example shows how the instruction works:

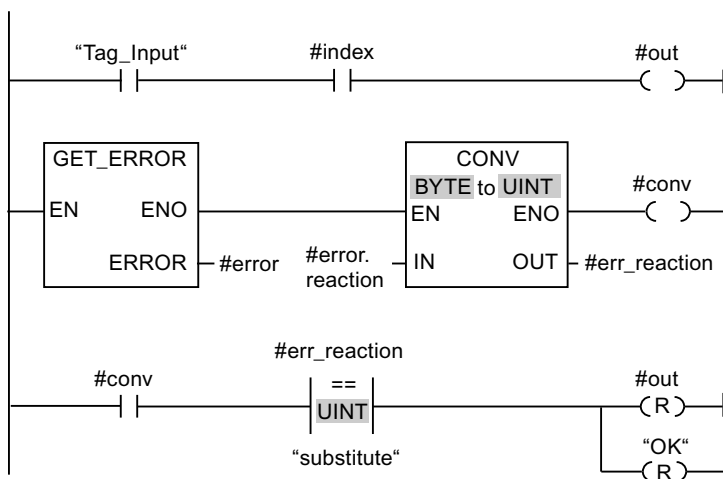

When an error occurs, the "Get error locally" instruction returns the error information to the locally created "#error" structure at the ERROR output. The error information is converted and evaluated using the "Equal" comparison instruction. Information about the type of error is the first comparison value assigned to the instruction. The value "1" is specified in operand "substitute" as the second comparison value. If the error is a read error, the condition of the comparison instruction is fulfilled. The "#out" and "OK" outputs are reset in this case.

## See also

- Overview of the valid data types (Page 1077)
- Basics of error handling (Page 1378)
- Principles of local error handling (Page 1380)
- Error output priorities (Page 1381)
- Enabling local error handling for a block (Page 1382)

## GET\_ERR\_ID: Get error ID locally

### Description

The "Get error ID locally" instruction is used to query the occurrence of errors within a block. If the system signals errors during block execution, the error ID of the first error that occurred is saved in the tag at output ID. Only operands of the WORD data type can be specified at the ID output. When the first error has been eliminated, the instruction outputs the error ID of the next error that occurred.

The output of the "Get error ID locally" instruction is only set if the input of the instruction has the signal state "1" and error information is present. If one of these conditions is not fulfilled, the remaining program execution is not affected by the "Get error ID locally" instruction.

The "Get error ID locally" instruction can also be used to forward an alarm about the error status to the calling block. To do this, the instruction must be positioned in the last network of the called block.

---

### Note

The "Get error ID locally" instruction enables local error handling within a block. If the "Get error ID locally" instruction is inserted in the program code of a block, any predefined system reactions are ignored if errors occur.

---

### Parameters

The following table shows the parameters of the "Get error ID locally" instruction:

Parameter	Declaration	Data type	Memory area	Description
ID	Output	WORD	I, Q, M, D, L	Error ID

**Parameter ID**

The following table shows the values that can be output at the ID parameter:

ID* (hexadecimal)	ID* (decimal)	Description
0	0	No error
2503	9475	Invalid pointer
2520	9504	Invalid STRING
2522	9506	Read error: Operand outside the valid range
2523	9507	Write error: Operand outside the valid range
2524	9508	Read error: Invalid operand
2525	9509	Write error: Invalid operand
2528	9512	Read error: Data alignment
2529	9513	Write error: Data alignment
252C	9516	Invalid pointer
2530	9520	Write error: Data block
2533	9523	Invalid pointer used
2538	9528	Access error: DB does not exist
2539	9529	Access error: Wrong DB used
253A	9530	Global data block does not exist
253C	9532	Faulty information or the function does not exist
253D	9533	System function does not exist
253E	9534	Faulty information or the function block does not exist
253F	9535	System block does not exist
2550	9552	Access error: DB does not exist
2551	9553	Access error: Wrong DB used
2575	9589	Error in the program nesting depth
2576	9590	Error in the local data distribution
2577	9591	Die block property "Parameter assignment via register" is not selected.
25A0	9632	Internal error in TP
25A1	9633	Tag is write-protected
25A2	9634	Invalid numerical value of tag
2942	10562	Read error: Input
2943	10563	Write error: Output
*The error codes can be displayed as integer or hexadecimal value in the program editor. For information on toggling display formats, refer to "See also".		

**See also**

- Overview of the valid data types (Page 1077)
- Basics of error handling (Page 1378)
- Principles of local error handling (Page 1380)
- Error output priorities (Page 1381)
- Enabling local error handling for a block (Page 1382)

**INIT\_RD: Initialize all retain data****Description**

You can use the "Initialize all retain data" instruction to reset the retain data of all data blocks, bit memories and SIMATIC timers and counters at the same time. The instruction can only be executed within a startup OB because the execution would exceed the program cycle duration.

**Parameter**

The following table shows the parameters of the "Initialize all retain data" instruction:

Parameter	Declaration	Data type	Memory area	Description
EN	Input	BOOL	I, Q, M, D, L	Enable input
ENO	Output	BOOL	I, Q, M, D, L	Enable output
REQ	Input	BOOL	I, Q, M, D, L, T, C or constant	If the input "REQ" has the signal state "1", all retain data are reset.
RET_VAL	Output	INT	I, Q, M, D, L	Error information: If an error occurs during execution of the instruction, an error code is output at the RET_VAL parameter.

For additional information on valid data types, refer to "See also".

**Parameters RET\_VAL**

The following table shows the meaning of the values of the RET\_VAL parameter:

Error code* (W#16#...)	Explanation
0000	No error
80B5	The instruction cannot be executed because it was not programmed within a startup OB.

Error code* (W#16#...)	Explanation
General error information	See also: "GET_ERR_ID: Get error ID locally"
*The error codes can be displayed as integer or hexadecimal value in the program editor. For information on toggling display formats, refer to "See also".	

**Example**

The following example shows how the instruction works:

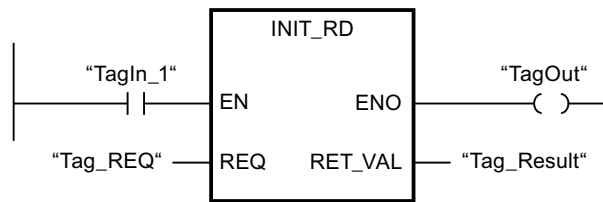

If the operands "TagIn\_1" and "Tag\_REQ" have signal state "1", the instruction is executed. The retain data of all data blocks, bit memories and SIMATIC timers and counters are reset. If the instruction is executed without errors, the ENO enable output has the signal state "1".

**See also**

- Overview of the valid data types (Page 1077)
- Basics of the EN/ENO mechanism (Page 1167)
- GET\_ERR\_ID: Get error ID locally (Page 1787)

**WAIT: Configure time delay**

**Description**

The "Configure time delay" instruction is used to halt the execution of the program for a set period of time. You indicate the period of time in microseconds on the WT parameter of the instruction.

You can configure time delays of up to 32767 microseconds (µs). The smallest possible delay time depends on the respective CPU and corresponds to the execution time of the "Configure time delay" instruction.

The execution of the instruction can be interrupted by higher priority events.

The "Configure time delay" instruction supplies no error information.

## Parameters

The following table shows the parameters of the "Configure time delay" instruction:

Parameter	Declaration	Data type	Memory area	Description
EN	Input	BOOL	I, Q, M, D, L	Enable input
ENO	Output	BOOL	I, Q, M, D, L	Enable output
WT	Input	INT	I, Q, M, D, L, P or constant	Time delay in microseconds ( $\mu$ s)

## See also

Overview of the valid data types (Page 1077)

Basics of the EN/ENO mechanism (Page 1167)

## Word logic operations

### AND: AND logic operation

#### Description

You can use the "AND logic operation" instruction to combine the value at the IN1 input and the value at the IN2 input bit-by-bit by AND logic and query the result at the OUT output.

When the instruction is executed, bit 0 of the value at the IN1 input and bit 0 of the value at the IN2 input are logically ANDed. The result is stored in bit 0 of output OUT. The same logic operation is executed for all other bits of the specified values.

The number of inputs can be expanded in the instruction box. The added inputs are numbered in ascending order in the box. When the instruction is executed, the values of all available input parameters are combined with AND logic (ANDed). The result is stored in the OUT output.

The result bit has signal state "1" only when both of the bits in the logic operation also have signal state "1". If one of the two bits of the logic operation has signal state "0", the corresponding result bit is reset.

## Parameters

The following table shows the parameters of the "AND logic operation" instruction:

Parameter	Declaration	Data type	Memory area	Description
EN	Input	BOOL	I, Q, M, D, L	Enable input
ENO	Output	BOOL	I, Q, M, D, L	Enable output
IN1	Input	Bit strings	I, Q, M, D, L, P or constant	First value for logic operation
IN2	Input	Bit strings	I, Q, M, D, L, P or constant	Second value for logic operation

Parameter	Declaration	Data type	Memory area	Description
INn	Input	Bit strings	I, Q, M, D, L, P or constant	Other inputs whose values are logically combined.
OUT	Output	Bit strings	I, Q, M, D, L, P	Result of the instruction

You can select the data type for the instruction from the "<???" drop-down list of the instruction box.

For additional information on valid data types, refer to "See also".

**Example**

The following example shows how the instruction works:

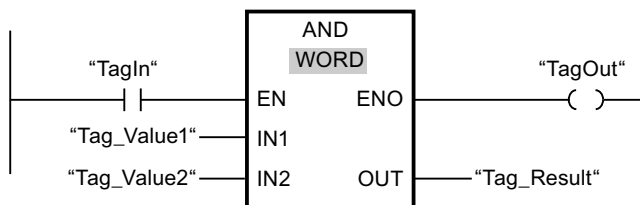

The following table shows how the instruction works using specific operand values:

Parameter	Operand	Value
IN1	Tag_Value1	0101 0101 0101 0101
IN2	Tag_Value2	0000 0000 0000 1111
OUT	Tag_Result	0000 0000 0000 0101

If operand "TagIn" has the signal state "1", the "AND logic operation" instruction is executed. The value of operand "Tag\_Value1" and the value of operand "Tag\_Value2" are ANDed. The result is mapped bit-for-bit and output in operand "Tag\_Result". The ENO enable output and the "TagOut" output are set to signal state "1".

**See also**

- Overview of the valid data types (Page 1077)
- Inserting additional inputs and outputs in LAD elements (Page 1289)
- Removing inputs and outputs (Page 1290)
- Basics of the EN/ENO mechanism (Page 1167)



## OR: OR logic operation

### Description

You can use the "OR logic operation" instruction to combine the value at the IN1 input and the value at the IN2 input bit-by-bit by OR logic and query the result at the OUT output.

When the instruction is executed, bit 0 of the value at the IN1 input and bit 0 of the value at the IN2 input are combined by OR logic operation. The result is stored in bit 0 of output OUT. The same logic operation is executed for all bits of the specified tags.

The number of inputs can be expanded in the instruction box. The added inputs are numbered in ascending order in the box. When the instruction is executed, the values of all available input parameters are combined with OR logic (ORed). The result is stored in the OUT output.

The result bit has signal state "1" when at least one of the two bits in the logic operation has the signal state "1". If both of the bits of the logic operation have signal state "0", the corresponding result bit is reset.

### Parameters

The following table shows the parameters of the "OR logic operation" instruction:

Parameter	Declaration	Data type	Memory area	Description
EN	Input	BOOL	I, Q, M, D, L	Enable input
ENO	Output	BOOL	I, Q, M, D, L	Enable output
IN1	Input	Bit strings	I, Q, M, D, L, P or constant	First value for logic operation
IN2	Input	Bit strings	I, Q, M, D, L, P or constant	Second value for logic operation
INn	Input	Bit strings	I, Q, M, D, L, P or constant	Other inputs whose values are logically combined.
OUT	Output	Bit strings	I, Q, M, D, L, P	Result of the instruction

You can select the data type for the instruction from the "<???">" drop-down list of the instruction box.

For additional information on valid data types, refer to "See also".

**Example**

The following example shows how the instruction works:

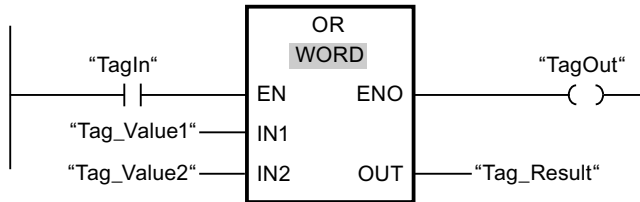

The following table shows how the instruction works using specific operand values:

Parameter	Operand	Value
IN1	Tag_Value1	0101 0101 0101 0101
IN2	Tag_Value2	0000 0000 0000 1111
OUT	Tag_Result	0101 0101 0101 1111

If operand "TagIn" has the signal state "1", the "OR logic operation" instruction is executed. The value of operand "Tag\_Value1" and the value of operand "Tag\_Value2" are ORed. The result is mapped bit-for-bit and output in operand "Tag\_Result". The ENO enable output and the "TagOut" output are set to signal state "1".

**See also**

- Overview of the valid data types (Page 1077)
- Inserting additional inputs and outputs in LAD elements (Page 1289)
- Removing inputs and outputs (Page 1290)
- Basics of the EN/ENO mechanism (Page 1167)

**XOR: EXCLUSIVE OR logic operation**

**Description**

You can use the "EXCLUSIVE OR logic operation" instruction to combine the value at the IN1 input and the value at the IN2 input bit-by-bit by EXCLUSIVE OR logic and query the result at the OUT output.

When the instruction is executed, bit 0 of the value at the IN1 input and bit 0 of the value at the IN2 input are combined by EXCLUSIVE OR logic operation. The result is stored in bit 0 of output OUT. The same logic operation is executed for all other bits of the specified value.

The number of inputs can be expanded in the instruction box. The added inputs are numbered in ascending order in the box. When the instruction is executed, the values of all available input parameters are combined with EXCLUSIVE OR logic. The result is stored in the OUT output.

The result bit has signal state "1" when one of the two bits in the logic operation has the signal state "1". If both of the bits of the logic operation have signal state "1" or "0", the corresponding result bit is reset.

## Parameters

The following table shows the parameters of the "EXCLUSIVE OR logic operation" instruction:

Parameter	Declaration	Data type	Memory area	Description
EN	Input	BOOL	I, Q, M, D, L	Enable input
ENO	Output	BOOL	I, Q, M, D, L	Enable output
IN1	Input	Bit strings	I, Q, M, D, L, P or constant	First value for logic operation
IN2	Input	Bit strings	I, Q, M, D, L, P or constant	Second value for logic operation
INn	Input	Bit strings	I, Q, M, D, L, P or constant	Other inputs whose values are logically combined.
OUT	Output	Bit strings	I, Q, M, D, L, P	Result of the instruction

You can select the data type for the instruction from the "<???">" drop-down list of the instruction box.

For additional information on valid data types, refer to "See also".

## Example

The following example shows how the instruction works:

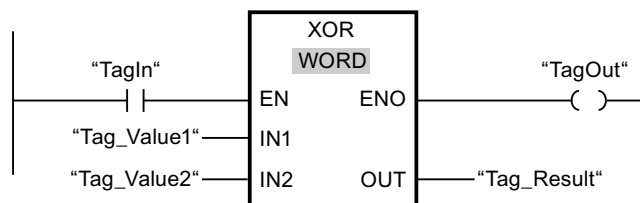

The following table shows how the instruction works using specific operand values:

Parameter	Operand	Value
IN1	Tag_Value1	0101 0101 0101 0101
IN2	Tag_Value2	0000 0000 0000 1111
OUT	Tag_Result	0101 0101 0101 1010

If operand "TagIn" has the signal state "1", the "EXCLUSIVE OR logic operation" instruction is executed. The value of operand "Tag\_Value1" and the value of operand "Tag\_Value2" are combined by EXCLUSIVE OR logic. The result is mapped bit-for-bit and output in operand "Tag\_Result". The ENO enable output and the "TagOut" output are set to signal state "1".

**See also**

- Overview of the valid data types (Page 1077)
- Inserting additional inputs and outputs in LAD elements (Page 1289)
- Removing inputs and outputs (Page 1290)
- Basics of the EN/ENO mechanism (Page 1167)

**INV: Create ones complement**

**Description**

You can use the "Create ones complement" instruction to invert the signal state of the bits at the IN input. When the instruction is processed, the value at the IN input and a hexadecimal template (W#16#FFFF for 16-bit numbers or DW#16#FFFF FFFF for 32-bit numbers) are combined by EXCLUSIVE OR logic. This inverts the signal state of the individual bits that are then stored at output OUT.

**Parameters**

The following table shows the parameters of the "Create ones complement" instruction:

Parameter	Declaration	Data type	Memory area	Description
EN	Input	BOOL	I, Q, M, D, L	Enable input
ENO	Output	BOOL	I, Q, M, D, L	Enable output
IN	Input	Bit strings, integers	I, Q, M, D, L, P or constant	Input value
OUT	Output	Bit strings, integers	I, Q, M, D, L, P	Ones complement of the value at input IN

You can select the data type for the instruction from the "<???">" drop-down list of the instruction box.

For additional information on valid data types, refer to "See also".

**Example**

The following example shows how the instruction works:

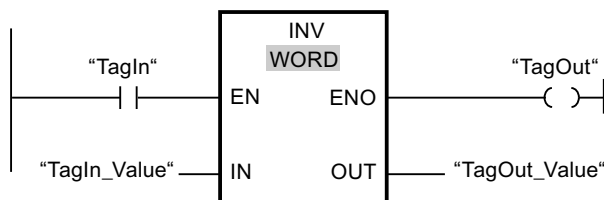

The following table shows how the instruction works using specific operand values:

Parameter	Operand	Value	
IN	TagIn_Value	W#16#000F	W#16#7E
OUT	TagOut_Value	W#16#FFF0	W#16#81

If operand "TagIn" has the signal state "1", the "Create ones complement" instruction is executed. The instruction inverts the signal state of the individual bits at input TagIn\_Value and writes the result to output "TagOut\_Value". The ENO enable output and the "TagOut" output are set to signal state "1".

## See also

Overview of the valid data types (Page 1077)

Basics of the EN/ENO mechanism (Page 1167)

## DECO: Decode

### Description

You can use the "Decode" instruction to set a bit in the output value specified by the input value.

The "Decode" instruction reads the value at the IN input and sets the bit in the output value whose bit position corresponds to the read value. The other bits in the output value are filled with zeroes. When the value at the IN input is greater than 31, a modulo 32 instruction is executed.

### Parameters

The following table shows the parameters of the "Decode" instruction:

Parameter	Declaration	Data type	Memory area	Description
EN	Input	BOOL	I, Q, M, D, L	Enable input
ENO	Output	BOOL	I, Q, M, D, L	Enable output
IN	Input	UINT	I, Q, M, D, L, P or constant	Position of the bit in the output value which is set.
OUT	Output	Bit strings	I, Q, M, D, L, P	Output value

You can select the data type for the instruction from the "<???">" drop-down list of the instruction box.

For additional information on valid data types, refer to "See also".

**Example**

The following example shows how the instruction works:

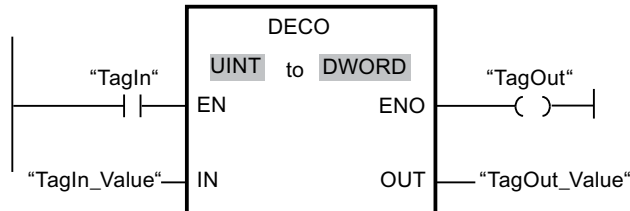

The following figure shows how the instruction works using specific operand values:

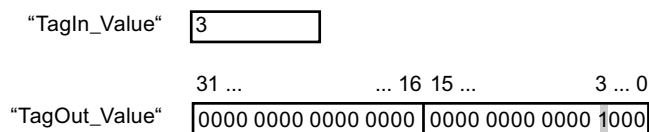

If operand "TagIn" has the signal state "1", the "Decode" instruction is executed. The instruction reads bit number "3" from the value of the operand "TagIn\_Value" at the input and sets the third bit to the value of the operand "TagOut\_Value" at the output.

If the instruction is executed without errors, the ENO enable output has the signal state "1" and the "TagOut" output is set.

**See also**

- Overview of the valid data types (Page 1077)
- Basics of the EN/ENO mechanism (Page 1167)

**ENCO: Encode**

**Description**

You can use the "Encode" instruction to read the bit number of the least significant bit in the input value and to send it to the OUT output.

The "Encode" instruction selects the least significant bit of the value at the IN input and writes its bit number to the tag in the OUT output.

**Parameters**

The following table shows the parameters of the "Encode" instruction:

Parameter	Declaration	Data type	Memory area	Description
EN	Input	BOOL	I, Q, M, D, L	Enable input
ENO	Output	BOOL	I, Q, M, D, L	Enable output

Parameter	Declaration	Data type	Memory area	Description
IN	Input	Bit strings	I, Q, M, D, L, P or constant	Input value
OUT	Output	INT	I, Q, M, D, L, P	Output value

You can select the data type for the instruction from the "<???"> drop-down list of the instruction box.

For additional information on valid data types, refer to "See also".

## Example

The following example shows how the instruction works:

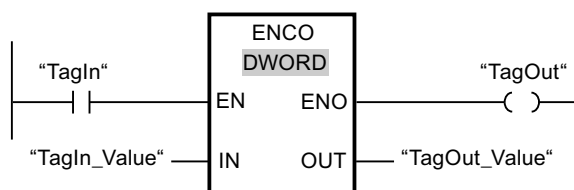

The following figure shows how the instruction works using specific operand values:

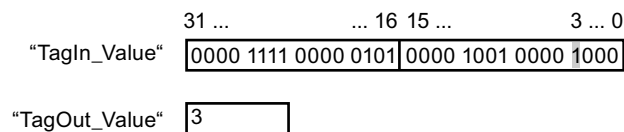

If operand "TagIn" has the signal state "1", the "Encode" instruction is executed. The instruction selects the least significant bit at the "TagIn\_Value" input and writes bit position "3" to the tag in the "TagOut\_Value" output.

If the instruction is executed without errors, the ENO enable output has the signal state "1" and the "TagOut" output is set.

## See also

Overview of the valid data types (Page 1077)

Basics of the EN/ENO mechanism (Page 1167)

## SEL: Select

### Description

Depending on a switch (G input), the "Select" instruction selects one of the inputs, IN0 or IN1 and copies its content to the OUT output. When the G input has the signal state "0", the value at the IN0 input is moved. When the G input has the signal state "1", the value at the IN1 input is moved to the OUT output.

All tags at all parameters must have the same data type.

**Parameters**

The following table shows the parameters of the "Select" instruction:

Parameter	Declaration	Data type		Memory area		Description
		S7-1200	S7-1500	S7-1200	S7-1500	
EN	Input	BOOL	BOOL	I, Q, M, D, L	I, Q, M, D, L	Enable input
ENO	Output	BOOL	BOOL	I, Q, M, D, L	I, Q, M, D, L	Enable output
G	Input	BOOL	BOOL	I, Q, M, D, L or constant	I, Q, M, D, L, T, C or constant	Switch
IN0	Input	Bit strings, integers, floating-point numbers, TIME, TOD, CHAR, DATE	Bit strings, integers, floating-point numbers, timers, TOD, LTOD, LDT, CHAR, DATE	I, Q, M, D, L, P or constant	I, Q, M, D, L, P or constant	First input value
IN1	Input	Bit strings, integers, floating-point numbers, TIME, TOD, CHAR, DATE	Bit strings, integers, floating-point numbers, timers, TOD, LTOD, LDT, CHAR, DATE	I, Q, M, D, L, P or constant	I, Q, M, D, L, P or constant	Second input value
OUT	Output	Bit strings, integers, floating-point numbers, TIME, TOD, CHAR, DATE	Bit strings, integers, floating-point numbers, timers, TOD, LTOD, LDT, CHAR, DATE	I, Q, M, D, L, P	I, Q, M, D, L, P	Result

You can select the data type for the instruction from the "<???" drop-down list of the instruction box.

For additional information on valid data types, refer to "See also".

**Example**

The following example shows how the instruction works:

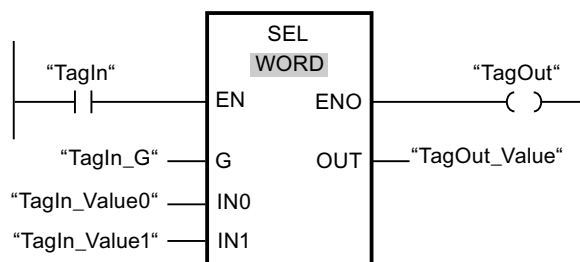



The following table shows how the instruction works using specific operand values:

Parameter	Operand	Value	
G	TagIn_G	0	1
IN0	TagIn_Value0	W#16#0000	W#16#4C
IN1	TagIn_Value1	W#16#FFFF	W#16#5E
OUT	TagOut_Value	W#16#0000	W#16#5E

If operand "TagIn" has the signal state "1", the "Select" instruction is executed. Based on the signal state at the "TagIn\_G" input, the value at the "TagIn\_Value0" or "TagIn\_Value1" input is selected and copied to the "TagOut\_Value" output. If the instruction is executed without errors, enable output ENO has the signal state "1" and the "TagOut" output is set.

### See also

Overview of the valid data types (Page 1077)

Basics of the EN/ENO mechanism (Page 1167)

### MUX: Multiplex

#### Description

You can use the "Multiplex" instruction to copy the content of a selected input to the OUT output. The number of selectable inputs of the instruction box can be expanded. You can declare a maximum of 32 inputs.

The inputs are automatically numbered in the box. Numbering starts at IN0 and continues consecutively with each new input. You use the K parameter to define the input whose content is to be copied to the OUT output. If the value of the K parameter is greater than the number of available inputs, the content of the ELSE parameter is copied to the OUT output and the ENO enable output is assigned the signal state "0".

The "Multiplex" instruction can only be executed, when the tags in all inputs and in the OUT output have the same data type. The K parameter is an exception, since only integers can be specified for it.

The ENO enable output is reset if one of the following conditions is fulfilled:

- The EN enable input has the signal state "0".
- The value of the K parameter is greater than the number of available inputs.
- Errors occurred during execution of the instruction.

Parameters

The following table shows the parameters of the "Multiplex" instruction:

Parameter	Declaration	Data type		Memory area	Description
		S7-1200	S7-1500		
EN	Input	BOOL	BOOL	I, Q, M, D, L	Enable input
ENO	Output	BOOL	BOOL	I, Q, M, D, L	Enable output
K	Input	Integers	Integers	I, Q, M, D, L, P or constant	Specifies the input whose content is to be copied. <ul style="list-style-type: none"> <li>• If K = 0 =&gt; Parameter IN0</li> <li>• If K = 1 =&gt; Parameter IN1, etc.</li> </ul>
IN0	Input	Binary numbers, integers, floating-point numbers, strings, TIME, TOD, DATE	Binary numbers, integers, floating-point numbers, strings, timers, TOD, LTOD, DATE, LDT	I, Q, M, D, L, P or constant	First input value
IN1	Input	Binary numbers, integers, floating-point numbers, strings, TIME, TOD, DATE	Binary numbers, integers, floating-point numbers, strings, timers, TOD, LTOD, DATE, LDT	I, Q, M, D, L, P or constant	Second input value
INn	Input	Binary numbers, integers, floating-point numbers, strings, TIME, TOD, DATE	Binary numbers, integers, floating-point numbers, strings, timers, TOD, LTOD, DATE, LDT	I, Q, M, D, L, P or constant	Optional input values

Parameter	Declaration	Data type		Memory area	Description
		S7-1200	S7-1500		
ELSE	Input	Binary numbers, integers, floating-point numbers, strings, TIME, TOD, DATE	Binary numbers, integers, floating-point numbers, strings, timers, TOD, LTOD, DATE, LDT	I, Q, M, D, L, P or constant	Specifies the value to be copied when $K > n$ .
OUT	Output	Binary numbers, integers, floating-point numbers, strings, TIME, TOD, DATE	Binary numbers, integers, floating-point numbers, strings, timers, TOD, LTOD, DATE, LDT	I, Q, M, D, L, P	Output to which the value is to be copied.

You can select the data type for the instruction from the "<???"> drop-down list of the instruction box.

For additional information on valid data types, refer to "See also".

## Example

The following example shows how the instruction works:

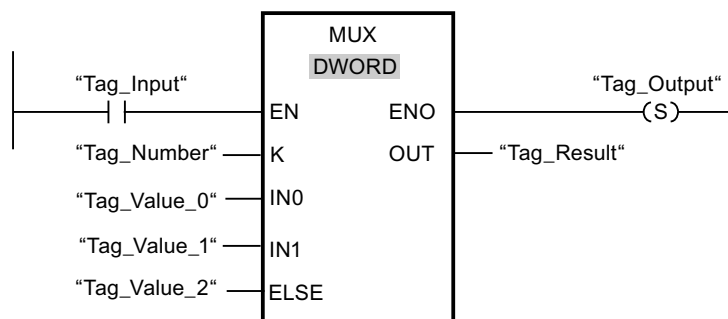

The following table shows how the instruction works using specific operand values:

Parameter	Operand	Value
K	Tag_Number	1
IN0	Tag_Value_0	DW#16#00000000
IN1	Tag_Value_1	DW#16#003E4A7D
ELSE	Tag_Value_2	DW#16#FFFF0000
OUT	Tag_Result	DW#16#003E4A7D

If operand "Tag\_Input" has the signal state "1", the "Multiplex" instruction is executed. Depending on the value of the operand "Tag\_Number", the value at input "Tag\_Value\_1" is copied and assigned to the operand at output "Tag\_Result". If the instruction is executed without errors, the "ENO" and "Tag\_Output" enable outputs are set.

**See also**

- Overview of the valid data types (Page 1077)
- Basics of the EN/ENO mechanism (Page 1167)

**DEMUX: Demultiplex**

**Description**

You can use the "Demultiplex" instruction to copy the content of the IN input to the selected output. The number of selectable outputs can be expanded in the instruction box. The outputs are automatically numbered in the box. Numbering starts at OUT0 and continues consecutively with each new output. You use the K parameter to define the output to which the content of the IN input is to be copied. The other outputs are not changed. If the value of the parameter K is greater than the number of available outputs, then the content of input IN in the parameter ELSE and the enable output ENO will be assigned to the signal state "0".

The "Demultiplex" instruction can only be executed if the tags in the IN input and in all outputs have the same data type. The K parameter is an exception, since only integers can be specified for it.

The ENO enable output is reset if one of the following conditions is fulfilled:

- The EN enable input has the signal state "0".
- The value of the K parameter is greater than the number of available outputs.
- Errors occurred during execution of the instruction.

**Parameters**

The following table shows the parameters of the "Demultiplex" instruction:

Parameter	Declaration	Data type		Memory area	Description
		S7-1200	S7-1500		
EN	Input	BOOL	BOOL	I, Q, M, D, L	Enable input
ENO	Output	BOOL	BOOL	I, Q, M, D, L	Enable output
K	Input	Integers	Integers	I, Q, M, D, L, P or constant	Specifies the output to which the input value (IN) is copied. <ul style="list-style-type: none"> <li>• If K = 0 =&gt; Parameter OUT0</li> <li>• If K = 1 =&gt; Parameter OUT1, etc.</li> </ul>

Parameter	Declaration	Data type		Memory area	Description
		S7-1200	S7-1500		
IN	Input	Binary numbers, integers, floating-point numbers, strings, TIME, TOD, DATE	Binary numbers, integers, floating-point numbers, strings, timers, TOD, LTOD, DATE, LDT	I, Q, M, D, L, P or constant	Input value
OUT0	Output	Binary numbers, integers, floating-point numbers, strings, TIME, TOD, DATE	Binary numbers, integers, floating-point numbers, strings, timers, TOD, LTOD, DATE, LDT	I, Q, M, D, L, P	First output
OUT1	Output	Binary numbers, integers, floating-point numbers, strings, TIME, TOD, DATE	Binary numbers, integers, floating-point numbers, strings, timers, TOD, LTOD, DATE, LDT	I, Q, M, D, L, P	Second output
OUTn	Output	Binary numbers, integers, floating-point numbers, strings, TIME, TOD, DATE	Binary numbers, integers, floating-point numbers, strings, timers, TOD, LTOD, DATE, LDT	I, Q, M, D, L, P	Optional outputs
ELSE	Output	Binary numbers, integers, floating-point numbers, strings, TIME, TOD, DATE	Binary numbers, integers, floating-point numbers, strings, timers, TOD, LTOD, DATE, LDT	I, Q, M, D, L, P	Output to which the input value (IN) at K > n is copied.

You can select the data type for the instruction from the "<???">" drop-down list of the instruction box.

For additional information on available data types, refer to "See also".

**Example**

The following example shows how the instruction works:

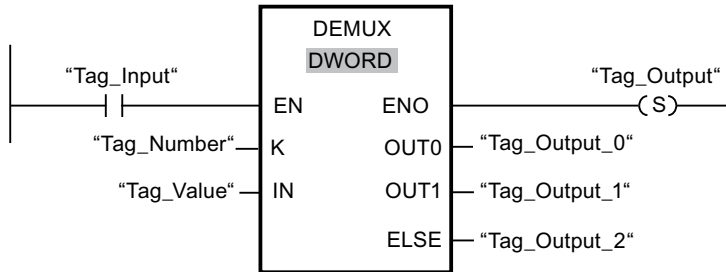

The following tables show how the instruction works using specific operand values:

Table 9-24 Input values of the "Demultiplex" instruction before network execution

Parameter	Operand	Values	
K	Tag_Number	1	4
IN	Tag_Value	DW#16#FFFFFFFF	DW#16#003E4A7D

Table 9-25 Output values of the "Demultiplex" instruction after network execution

Parameter	Operand	Values	
OUT0	Tag_Output_0	Unchanged	Unchanged
OUT1	Tag_Output_1	DW#16#FFFFFFFF	Unchanged
ELSE	Tag_Output_2	Unchanged	DW#16#003E4A7D

If the "Tag\_Input" input has the signal state "1", the "Demultiplex" instruction is executed. Depending on the value of operand "Tag\_Number", the value at the IN input is copied to the corresponding output.

**See also**

- Overview of the valid data types (Page 1077)
- Basics of the EN/ENO mechanism (Page 1167)

**Shift and rotate**

**SHR: Shift right**

**Description**

You can use the "Shift right" instruction to rotate the content of the operand at the input IN bit-by-bit to the right and query the result at the OUT output. You use the N parameter to specify the number of bit positions by which the specified value is to be shifted.

When the value at the N parameter is "0", the value at the IN input is copied to the operand at the OUT output.

When the value at the N parameter is greater than the number of available bit positions, the operand value at the IN input is shifted by the available number of bit positions to the right.

In the case of unsigned values, the freed bit positions in the left area of the operand are filled with zeroes when shifting occurs. If the specified value has a sign, the free bit positions are filled with the signal state of the sign bit.

The following figure show how the content of an operand of integer data type is shifted four bit positions to the right:

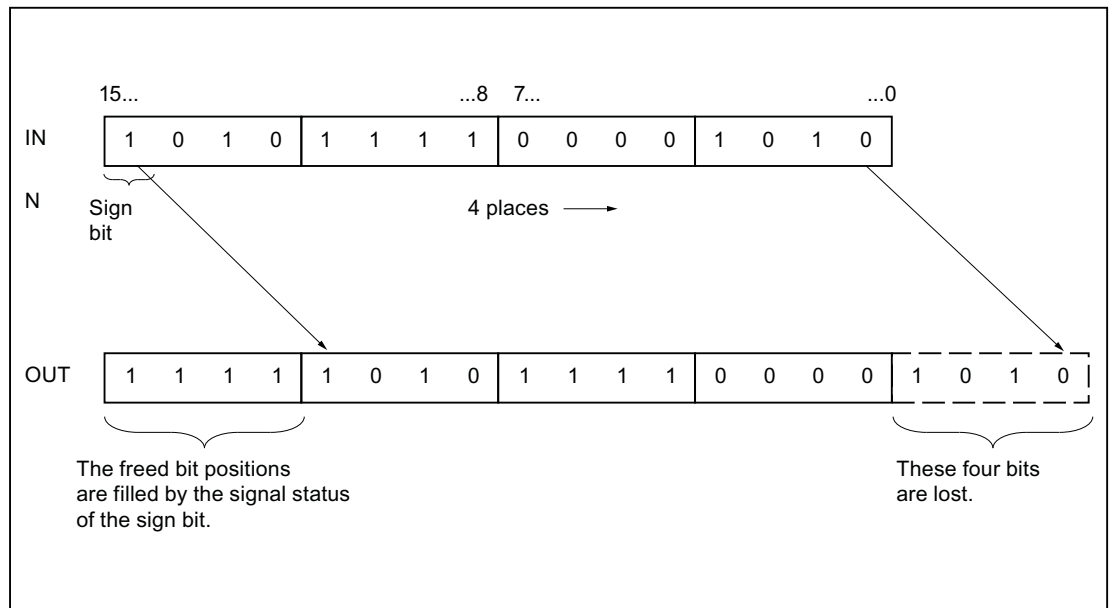

## Parameters

The following table shows the parameters of the "Shift right" instruction:

Parameter	Declaration	Data type		Memory area	Description
		S7-1200	S7-1500		
EN	Input	BOOL	BOOL	I, Q, M, D, L	Enable input
ENO	Output	BOOL	BOOL	I, Q, M, D, L	Enable output
IN	Input	Bit strings, integers	Bit strings, integers	I, Q, M, D, L or constant	Value to be shifted
N	Input	USINT, UINT, UDINT	USINT, UINT, UDINT, ULINT	I, Q, M, D, L or constant	Number of bit positions by which the value is shifted
OUT	Output	Bit strings, integers	Bit strings, integers	I, Q, M, D, L	Result of the instruction

You can select the data type for the instruction from the "<???" drop-down list of the instruction box.

For additional information on valid data types, refer to "See also".

**Example**

The following example shows how the instruction works:

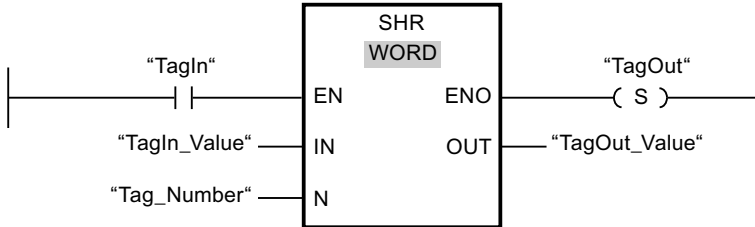

The following table shows how the instruction works using specific operand values:

Parameter	Operand	Value
IN	TagIn_Value	0011 1111 1010 1111
N	Tag_Number	3
OUT	TagOut_Value	0000 0111 1111 0101

If operand "TagIn" has the signal state "1", the "Shift right" instruction is executed. The content of operand "TagIn\_Value" is shifted three bit positions to the right. The result is sent to the "TagOut\_Value" output. If the instruction is executed without errors, the ENO enable output has the signal state "1" and the "TagOut" output is set.

**See also**

- Overview of the valid data types (Page 1077)
- Basics of the EN/ENO mechanism (Page 1167)

**SHL: Shift left**

**Description**

You can use the "Shift left" instruction to rotate the content of the operand at the IN input bit-by-bit to the left and query the result at the OUT output. You use the N parameter to specify the number of bit positions by which the specified value is to be shifted.

When the value at the N parameter is "0", the value at the IN input is copied to the operand at the OUT output.

When the value at the N parameter is greater than the number of available bit positions, the operand value at the IN input is shifted by the available number of bit positions to the left.

The bit positions in the right part of the operand freed by shifting are filled with zeros.

The following figure shows how the content of an operand of the WORD data type is shifted by six bit positions to the left:



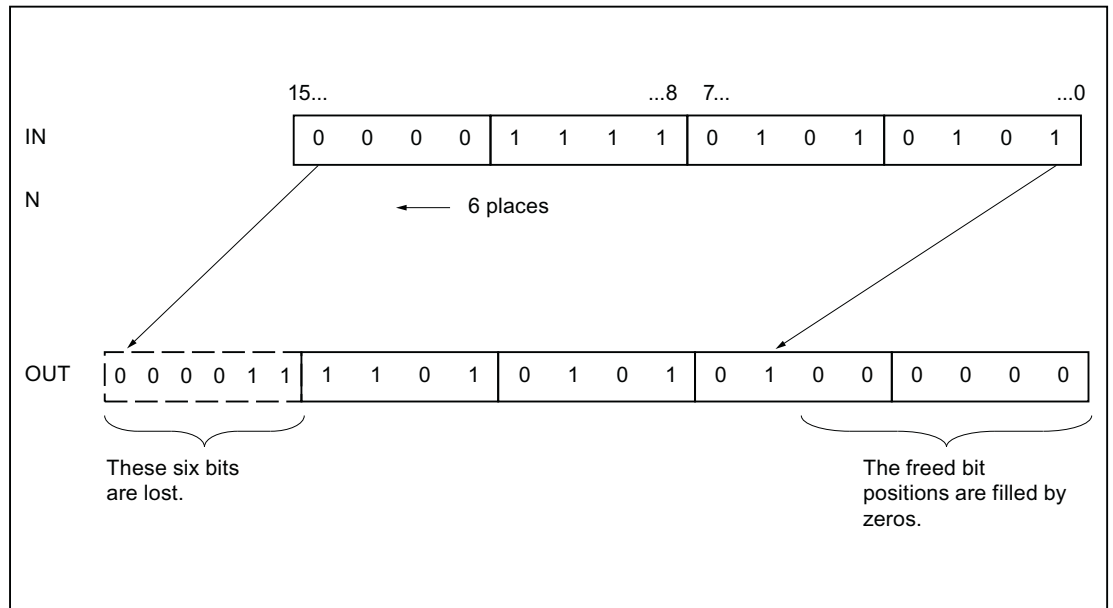

## Parameters

The following table shows the parameters of the "Shift left" instruction:

Parameter	Declaration	Data type		Memory area	Description
		S7-1200	S7-1500		
EN	Input	BOOL	BOOL	I, Q, M, D, L	Enable input
ENO	Output	BOOL	BOOL	I, Q, M, D, L	Enable output
IN	Input	Bit strings, integers	Bit strings, integers	I, Q, M, D, L or constant	Value to be shifted
N	Input	USINT, UINT, UDINT	USINT, UINT, UDINT, ULINT	I, Q, M, D, L or constant	Number of bit positions by which the value is shifted
OUT	Output	Bit strings, integers	Bit strings, integers	I, Q, M, D, L	Result of the instruction

You can select the data type for the instruction from the "<???"> drop-down list of the instruction box.

For additional information on valid data types, refer to "See also".

**Example**

The following example shows how the instruction works:

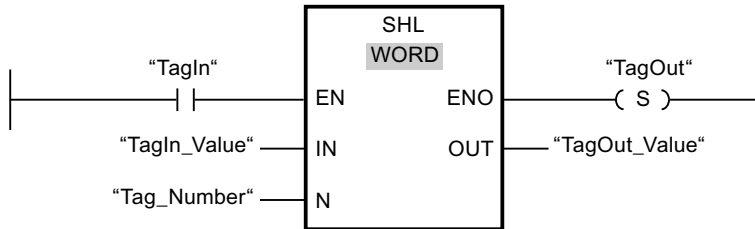

The following table shows how the instruction works using specific operand values:

Parameter	Operand	Value
IN	TagIn_Value	0011 1111 1010 1111
N	Tag_Number	4
OUT	TagOut_Value	1111 1010 1111 0000

If operand "TagIn" has the signal state "1", the "Shift left" instruction is executed. The content of operand "TagIn\_Value" is shifted four bit positions to the left. The result is sent to the "TagOut\_Value" output. If the instruction is executed without errors, the ENO enable output has the signal state "1" and the "TagOut" output is set.

**See also**

- Overview of the valid data types (Page 1077)
- Basics of the EN/ENO mechanism (Page 1167)

**ROR: Rotate right**

**Description**

You can use the "Rotate right" instruction to rotate the content of the operand at the IN input bit-by-bit to the right and query the result at the OUT output. You use the N parameter to specify the number of bit positions by which the specified value is to be rotated. The bit positions freed by rotating are filled with the bit positions that are pushed out.

When the value at the N parameter is "0", the value at the IN input is copied to the operand at the OUT output.

When the value at the N parameter is greater than the number of available bit positions, the operand value at the IN input is nevertheless rotated by the specified number of bit positions.

The following figure shows how the content of an operand of DWORD data type is rotated three positions to the right:

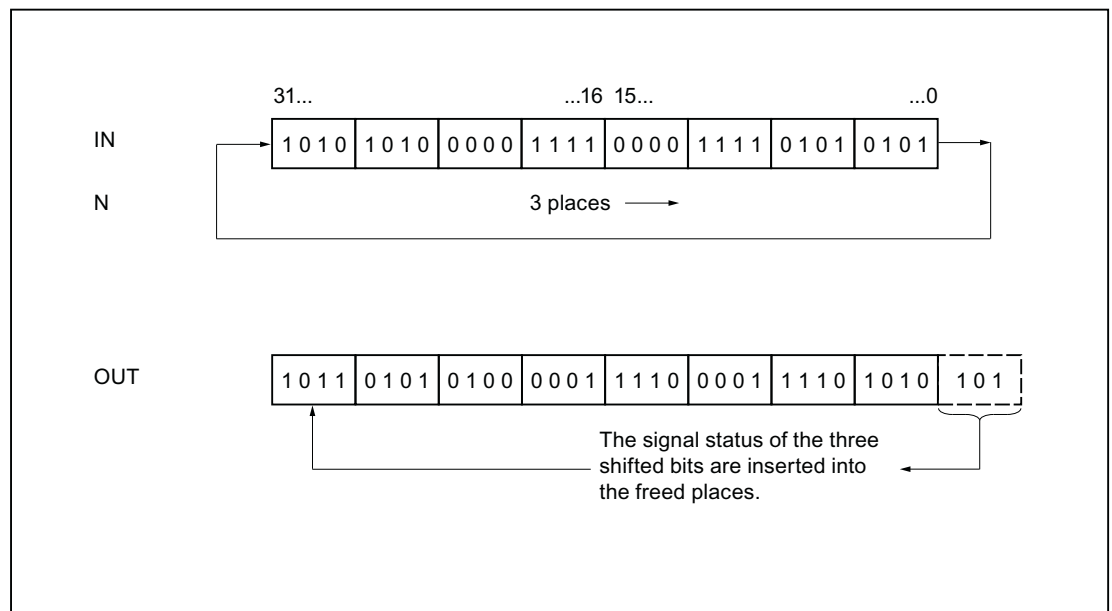

## Parameters

The following table shows the parameters of the "Rotate right" instruction:

Parameter	Declaration	Data type		Memory area	Description
		S7-1200	S7-1500		
EN	Input	BOOL	BOOL	I, Q, M, D, L	Enable input
ENO	Output	BOOL	BOOL	I, Q, M, D, L	Enable output
IN	Input	Bit strings, integers	Bit strings, integers	I, Q, M, D, L or constant	Value to be rotated
N	Input	USINT, UINT, UDINT	USINT, UINT, UDINT, ULINT	I, Q, M, D, L or constant	Number of bit positions by which the value is rotated
OUT	Output	Bit strings, integers	Bit strings, integers	I, Q, M, D, L	Result of the instruction

You can select the data type for the instruction from the "<???">" drop-down list of the instruction box.

For additional information on valid data types, refer to "See also".

**Example**

The following example shows how the instruction works:

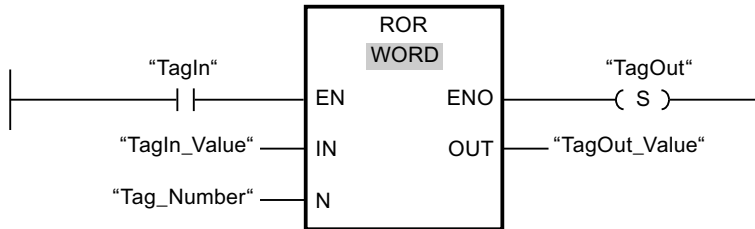

The following table shows how the instruction works using specific operand values:

Parameter	Operand	Value
IN	TagIn_Value	0000 1111 1001 0101
N	Tag_Number	5
OUT	TagOut_Value	1010 1000 0111 1100

If operand "TagIn" has the signal state "1", the "Rotate right" instruction is executed. The content of operand "TagIn\_Value" is rotated five bit positions to the right. The result is sent to the "TagOut\_Value" output. If the instruction is executed without errors, the ENO enable output has the signal state "1" and the "TagOut" output is set.

**See also**

- Overview of the valid data types (Page 1077)
- Basics of the EN/ENO mechanism (Page 1167)

**ROL: Rotate left**

**Description**

You can use the "Rotate left" instruction to rotate the content of the operand at the IN input bit-by-bit to the left and query the result at the OUT output. You use the N parameter to specify the number of bit positions by which the specified value is to be rotated. The bit positions freed by rotating are filled with the bit positions that are pushed out.

When the value at the N parameter is "0", the value at the IN input is copied to the operand at the OUT output.

When the value at the N parameter is greater than the number of available bit positions, the operand value at the IN input is nevertheless rotated by the specified number of bit positions.

The following figure shows how the content of an operand of DWORD data type is rotated three positions to the left:



**Example**

The following example shows how the instruction works:

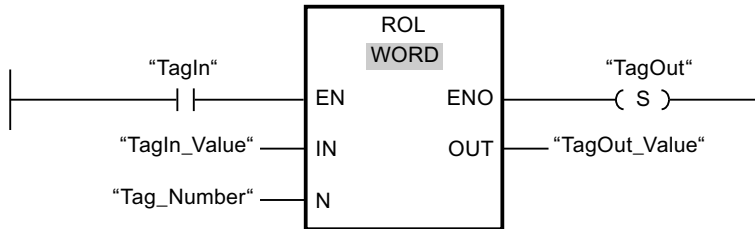

The following table shows how the instruction works using specific operand values:

Parameter	Operand	Value
IN	TagIn_Value	1010 1000 1111 0110
N	Tag_Number	5
OUT	TagOut_Value	0001 1110 1101 0101

If the "TagIn" input has the signal state "1", the "Rotate left" instruction is executed. The content of operand "TagIn\_Value" is rotated five bit positions to the left. The result is sent to the "TagOut\_Value" output. If the instruction is executed without errors, the ENO enable output has the signal state "1" and the "TagOut" output is set.

**See also**

- Overview of the valid data types (Page 1077)
- Basics of the EN/ENO mechanism (Page 1167)

**Additional instructions**

**DRUM: Implement sequencer**

**Description**

You can use the "Implement sequencer" instruction to assign the programmed values of the OUT\_VAL parameter of the corresponding step to the programmed output bits (OUT1 to OUT16) and the output word (OUT\_WORD). The specific step must thereby satisfy the conditions of the programmed enable mask on the S\_MASK parameter while the instruction remains at this step. The instruction advances to the next step if the event for the step is true and the programmed time for the current step elapses, or if the value at the JOG parameter changes from "0" to "1". The instruction is reset if the signal state on the RESET parameter changes to "1". The current step is hereby equated to the preset step (DSP).

The amount of time spent on a step is determined by the product of the preset timebase (DTBP) and the preset counter value (S\_PRESET) for each step. At the start of a new step, this calculated value is loaded into the DCC parameter, which contains the time remaining for the current step. If, for example the value at the DTBP parameter is "2" and the preset value for the first step is "100" (100 ms), the DCC parameter has the value "200" (200 ms).

A step can be programmed with a timer value, an event, or both. Steps that have an event bit and the timer value "0" advance to the next step as soon as the signal state of the event bit is "1". Steps that are programmed only with a timer value start the time immediately. Steps that are programmed with an event bit and a timer value greater than "0" start the time when the signal state of the event bit is "1". The event bits are initialized with a signal state of "1".

When the sequencer is on the last programmed step (LST\_STEP) and the time for this step has expired, the signal state on the Q parameter is set to "1"; otherwise it is set to "0". When the parameter Q is set, the instruction remains on the step until it is reset.

In the configurable mask (S\_MASK) you can selected the separate bits in the output word (OUT\_WORD) and set or reset the output bits (OUT1 to OUT16) by means of the output values (OUT\_VAL). If a bit of the configurable mask is in the signal state "1", the value OUT\_VAL sets or resets the corresponding bit. If the signal state of a bit of the configurable mask is "0", the corresponding bit is left unchanged. All the bits of the configurable mask for all 16 steps are initialized with a signal state of "1".

The output bit on the OUT1 parameter corresponds to the least significant bit of the output word (OUT\_WORD). The output bit on the OUT16 parameter corresponds to the most significant bit of the output word (OUT\_WORD).

When you insert the instruction in the program, the "Call options" dialog opens in which you can specify whether the block parameters will be stored in a separate data block (single instance) or as a local tag (multiple instance) in the block interface. If you create a separate data block, you will find it in the project tree in the "Program resources" folder under "Program blocks > System blocks". For additional information on this topic, refer to "See also".

## Parameters

The following table shows the parameters of the "Implement sequencer" instruction:

Parameter	Declaration	Data type	Memory area	Description
EN	Input	BOOL	I, Q, M, D, L	Enable input
ENO	Output	BOOL	I, Q, M, D, L	Enable output
RESET	Input	BOOL	I, Q, M, D, L or constant	A signal state of "1" indicates a reset condition.
JOG	Input	BOOL	I, Q, M, D, L or constant	When the signal state changes from "0" to "1", the instruction advances to the next step.
DRUM_EN	Input	BOOL	I, Q, M, D, L or constant	A signal state of "1" allows the sequencer to advance based on the event and time criteria.
LST_STEP	Input	BYTE	I, Q, M, D, L or constant	Step number of the last step programmed.

Parameter	Declaration	Data type	Memory area	Description
EVENT(i), 1 ≤ i ≤ 16	Input	BOOL	I, Q, M, D, L or constant	Event bit (i); Initial signal state is "1".
OUT(j), 1 ≤ j ≤ 16	Output	BOOL	I, Q, M, D, L	Output bit (j)
Q	Output	BOOL	I, Q, M, D, L	A signal state of "1" indicates that the time for the last step has elapsed.
OUT_WORD	Output	WORD	I, Q, M, D, L, P	Word address to which the sequencer writes the output values.
ERR_CODE	Output	WORD	I, Q, M, D, L, P	Error information
JOG_HIS	Static	BOOL	I, Q, M, D, L	JOG parameter history bit
EOD	Static	BOOL	I, Q, M, D, L	A signal state of "1" indicates that the time for the last step has elapsed.
DSP	Static	BYTE	I, Q, M, D, L, P	Preset step of the sequencer
DSC	Static	BYTE	I, Q, M, D, L, P	Current step of the sequencer
DCC	Static	DWORD	I, Q, M, D, L, P	Current numerical value of the sequencer
DTBP	Static	WORD	I, Q, M, D, L, P	Preset timebase of the sequencer
PREV_TIME	Static	DWORD	I, Q, M, D, L or constant	Previous system time
S_PRESET	Static	ARRAY of WORD	I, Q, M, D, L	Count preset for each step [1 to 16] where 1 count = 1 ms.
OUT_VAL	Static	ARRAY of BOOL	I, Q, M, D, L	Output values for each step [1 to 16, 0 to 15].
S_MASK	Static	ARRAY of BOOL	I, Q, M, D, L	Configurable mask for each step [1 to 16, 0 to 15]. Initial signal states are "1".

For additional information on valid data types, refer to "See also".



## Parameter ERR\_CODE

The following table shows the meaning of the values of the ERR\_CODE parameter:

ERR_CODE*	Explanation
W#16#0000	No error
W#16#000B	The value at the LST_STEP parameter is less than 1 or greater than 16.
W#16#000C	The value at the DSC parameter is less than 1 or greater than the value at the LST_STEP parameter.
W#16#000D	The value at the DSP parameter is less than 1 or greater than the value at the LST_STEP parameter.
*The error codes can be displayed as integer or hexadecimal value in the program editor. For additional information on toggling display formats, refer to "See also".	

## See also

Overview of the valid data types (Page 1077)

Basics of the EN/ENO mechanism (Page 1167)

## DCAT: Discrete control-timer alarm

### Description

The instruction "Discrete control-timer alarm" is used to accumulate the time from the point at which the CMD parameter issued the command to open or close. The time is accumulated until the preset time (PT) is exceeded or the information is received that the device was opened or closed (O\_FB or C\_FB) within the specified time. If the preset time is exceeded before the information on the opening or closing of the device is received, the corresponding alarm is activated. If the signal state on the command input changes state before the preset time, the time is restarted.

When you insert the instruction in the program, the "Call options" dialog opens in which you can specify whether the block parameters will be stored in a separate data block (single instance) or as a local tag (multiple instance) in the block interface. If you create a separate data block, you will find it in the project tree in the "Program resources" folder under "Program blocks > System blocks". For additional information on this topic, refer to "See also".

The "Discrete control-timer alarm" instruction has the following reactions to the input conditions:

- When the signal state of the CMD parameter changes from "0" to "1", the signal states of the parameters Q, CMD\_HIS, ET (only if ET < PT), OA and CA are influenced as follows:
  - The parameters Q and CMD\_HIS are set to "1".
  - The parameters ET, OA and CA are reset to "0".
- When the signal state on the parameter CMD changes from "1" to "0", the parameters Q, ET (only if ET < PT), OA, CA and CMD\_HIS are reset to "0".

- When the signal state of the parameters CMD and CMD\_HIS is "1" and the parameter O\_FB is set to "0", the time difference (ms) since the last execution of the instruction is added to the value at the parameter ET. If the value of the parameter ET exceeds the value of the parameter PT, the signal state on the parameter OA is set to "1". If the value of the parameter ET does not exceed the value of the parameter PT, the signal state on the parameter OA is reset to "0". The value at the parameter CMD\_HIS is reset to the value of the parameter CMD.
- If the signal state of the parameters CMD, CMD\_HIS and O\_FB are set to "1" and the parameter C\_FB has the value "0", the signal state of the parameter OA is set to "0". The value of the parameter ET is set to the value of the parameter PT. If the signal state of the parameter O\_FB changes to "0", the alarm is set the next time the instruction is executed. The value of the parameter CMD\_HIS is set to the value of the parameter CMD.
- If the parameters CMD, CMD\_HIS and C\_FB have the value "0", the time difference (ms) since the last execution of the instruction is added to the value of the parameter ET. If the value of the parameter ET exceeds the value of the parameter PT, the signal state of the parameter CA is reset to "1". If the value at the parameter PT is not exceeded, the parameter CA has the signal state "0". The value of the parameter CMD\_HIS is set to the value of the parameter CMD.
- If the parameters CMD, CMD\_HIS and O\_FB have the signal state "0" and the parameter C\_FB is set to "1", the parameter CA is set to "0". The value of the parameter ET is set to the value of the parameter PT. If the signal state of the parameter C\_FB changes to "0", the alarm is set the next time the instruction is executed. The value of the parameter CMD\_HIS is set to the value of the parameter CMD.
- If the parameters O\_FB and C\_FB simultaneously have the signal state "1", the signal states of both alarm outputs are set to "1".

The "Discrete control-timer alarm" instruction has no error information.

## Parameters

The following table shows the parameters of the "Discrete control-timer alarm" instruction:

Parameter	Declaration	Data type	Memory area	Description
EN	Input	BOOL	I, Q, M, D, L	Enable input
ENO	Output	BOOL	I, Q, M, D, L	Enable output
CMD	Input	BOOL	I, Q, M, D, L or constant	A signal state of "0" indicates a "close" command. A signal state of "1" indicates an "open" command.
O_FB	Input	BOOL	I, Q, M, D, L or constant	Feedback input when opening
C_FB	Input	BOOL	I, Q, M, D, L or constant	Feedback input when closing
Q	Output	BOOL	I, Q, M, D, L	Shows the status of the parameter CMD
OA	Output	BOOL	I, Q, M, D, L	Alarm output when opening

Parameter	Declaration	Data type	Memory area	Description
CA	Output	BOOL	I, Q, M, D, L	Alarm output when closing
ET	Static	DINT	D, L	Currently elapsed time, where 1 count = 1 ms
PT	Static	DINT	D, L	Preset timer value, where 1 count = 1 ms
PREV_TIME	Static	DWORD	D, L	Previous system time
CMD_HIS	Static	BOOL	D, L	CMD history bit

For additional information on valid data types, refer to "See also".

### Example

In the following example the parameter CMD changes from "0" to "1". After the execution of the instruction the parameter Q is set to "1" and the two alarm outputs OA and CA have the signal state "0". The parameter CMD\_HIS of the instance data block is set to the signal state "1" and the parameter ET is reset to "0".

### Note

You can initialize static parameters in the data block.

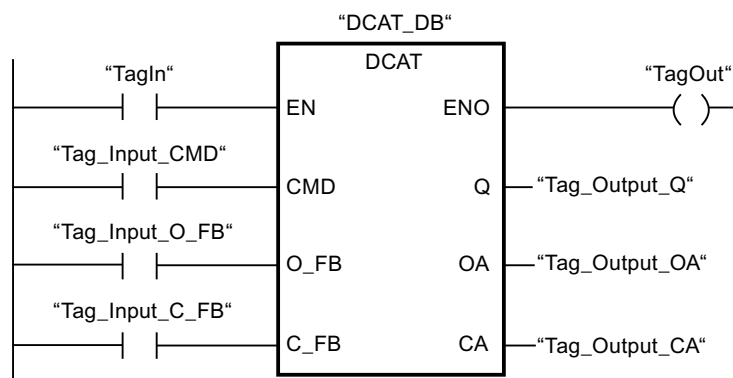

The following tables show how the instruction works using specific values.

### Before processing

In this example, the following values are used for the input and output parameters:

Parameter	Operand	Value
CMD	Tag_Input_CMD	TRUE
O_FB	Tag_Input_O_FB	FALSE
C_FB	Tag_Input_C_FB	FALSE
Q	Tag_Output_Q	FALSE
OA	Tag_Output_OA	FALSE
CA	Tag_Output_CA	FALSE

The following values are saved in the instance data block "DCAT\_DB" of the instruction:

Parameter	Address	Value
ET	DBD4	L#12
PT	DBD8	L#222
CMD_HIS	DBX16.0	FALSE

**After processing**

The following values are written to the output parameters after the instruction has been executed:

Parameter	Operand	Value
Q	Tag_Output_Q	TRUE
OA	Tag_Output_OA	FALSE
CA	Tag_Output_CA	FALSE

The following values are saved in the instance data block "DCAT\_DB" of the instruction:

Parameter	Address	Value
ET	DBD4	L#0
CMD_HIS	DBX16.0	TRUE

**See also**

- Overview of the valid data types (Page 1077)
- Basics of the EN/ENO mechanism (Page 1167)

**MCAT: Motor control-timer alarm**

**Description**

The instruction "Motor control-timer alarm" is used to accumulate the time from the point of time from which the one of the command inputs (opening or closing) is switched on. The time is accumulated until the preset time is exceeded or the relevant feedback input indicates that the device has executed the requested operation within the specified time. If the preset time is exceeded before the feedback is received, the corresponding alarm is triggered.

When you insert the instruction in the program, the "Call options" dialog opens in which you can specify whether the block parameters will be stored in a separate data block (single instance) or as a local tag (multiple instance) in the block interface. If you create a separate data block, you will find it in the project tree in the "Program resources" folder under "Program blocks > System blocks". For additional information on this topic, refer to "See also".

**Execution of the "Motor control-timer alarm" instruction**

The following table shows the reactions of the instruction "Motor control-timer alarm" to the various input conditions:

Input parameters								Output parameters								
ET	O_H IS	C_H IS	O_C MD	C_C MD	S_C MD	O_F B	C_F B	OO	CO	OA	CA	ET	O_H IS	C_H IS	Q	Status
X	1	1	X	X	X	X	X	0	0	1	1	PT	0	0	0	Alarm
X	X	X	X	X	X	1	1	0	0	1	1	PT	0	0	0	Alarm
X	X	X	X	X	1	X	X	0	0	0	0	X	0	0	1	Stop
X	X	X	1	1	X	X	X	0	0	0	0	X	0	0	1	Stop
X	0	X	1	0	0	X	X	1	0	0	0	0	1	0	1	Start opening
<PT	1	0	X	0	0	0	X	1	0	0	0	INC	1	0	1	Open
X	1	0	X	0	0	1	0	0	0	0	0	PT	1	0	1	Opened
>=PT	1	0	X	0	0	0	X	0	0	1	0	PT	1	0	0	Opening alarm
X	X	0	0	1	0	X	X	0	1	0	0	0	0	1	1	Start closing
<PT	0	1	0	X	0	X	0	0	1	0	0	INC	0	1	1	Close
X	0	1	0	X	0	0	1	0	0	0	0	PT	0	1	1	Closed
>=PT	0	1	0	X	0	X	0	0	0	0	1	PT	0	1	0	Closing alarm
X	0	0	0	0	0	X	X	0	0	0	0	X	0	0	1	Stopped
Legend:																
INC		Add the time difference (ms) since the last processing of the FB to ET														
PT		PT is set to the same value as ET														
X		Cannot be used														
<PT		ET < PT														
>=PT		ET >= PT														
If the input parameters O_HIS and C_HIS both have the signal state "1", they are immediately set to signal state "0". In this case, the last row in the table (X) mentioned above is valid. Because it is therefore no longer possible to check whether the input parameters O_HIS and C_HIS have the signal state "1", the output parameters are set as follows in this case:																
OO = FALSE																
CO = FALSE																
OA = FALSE																
CA = FALSE																
ET = PT																
Q = TRUE																

The "Motor control-timer alarm" instruction has no error information.

**Parameters**

The following table shows the reactions of the instruction "Motor control-timer alarm":

Parameter	Declaration	Data type	Memory area	Description
EN	Input	BOOL	I, Q, M, D, L	Enable input
ENO	Output	BOOL	I, Q, M, D, L	Enable output
O_CMD	Input	BOOL	I, Q, M, D, L or constant	"Open" command input
C_CMD	Input	BOOL	I, Q, M, D, L or constant	"Close" command input
S_CMD	Input	BOOL	I, Q, M, D, L or constant	"Stop" command input
O_FB	Input	BOOL	I, Q, M, D, L or constant	Feedback input when opening
C_FB	Input	BOOL	I, Q, M, D, L or constant	Feedback input when closing
OO	Output	BOOL	I, Q, M, D, L	"Open" output
CO	Output	BOOL	I, Q, M, D, L	"Close" output
OA	Output	BOOL	I, Q, M, D, L	Alarm output when opening
CA	Output	BOOL	I, Q, M, D, L	Alarm output when closing
Q	Output	BOOL	I, Q, M, D, L	A signal state of "0" indicates an error condition.
ET	Static	DINT	D, L	Currently elapsed time, where 1 count = 1 ms
PT	Static	DINT	D, L	Preset time value, where 1 count = 1 ms
PREV_TIME	Static	DWORD	D, L	Previous system time
O_HIS	Static	BOOL	D, L	"Open" history bit
C_HIS	Static	BOOL	D, L	"Close" history bit

For additional information on valid data types, refer to "See also".

**Example**

The following example shows how the instruction works:

**Note**

You can initialize static parameters in the data block.

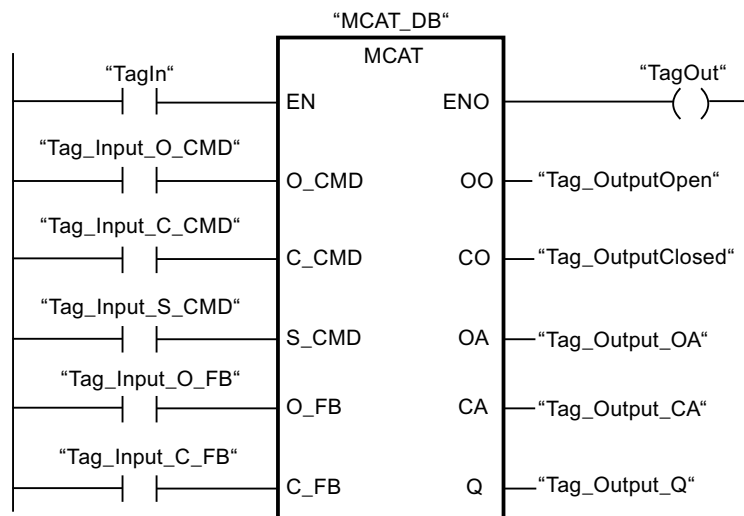

The following tables show how the instruction works using specific values.

**Before processing**

In this example, the following values are used for the input and output parameters:

Parameter	Operand	Value
O_CMD	Tag_Input_O_CMD	TRUE
C_CMD	Tag_Input_C_CMD	FALSE
S_CMD	Tag_Input_S_CMD	FALSE
O_FB	Tag_Input_O_FB	FALSE
C_FB	Tag_Input_C_FB	FALSE
OO	Tag_OutputOpen	FALSE
CO	Tag_OutputClosed	FALSE
OA	Tag_Output_OA	FALSE
CA	Tag_Output_CA	FALSE
Q	Tag_Output_Q	FALSE

The following values are saved in the instance data block "MCAT\_DB" of the instruction:

Parameter	Address	Value
ET	DBD4	L#2
PT	DBD8	L#22
O_HIS	DBX16.0	TRUE
C_HIS	DBX16.1	FALSE

**After processing**

The following values are written to the output parameters after the instruction has been executed:

Parameter	Operand	Value
OO	Tag_OutputOpen	TRUE
CO	Tag_OutputClosed	FALSE
OA	Tag_Output_OA	FALSE
CA	Tag_Output_CA	FALSE
Q	Tag_Output_Q	TRUE

The following values are saved in the instance data block "MCAT\_DB" of the instruction:

Parameter	Address	Value
ET	DBD4	L#0
O_HIS	DBX16.0	TRUE
CMD_HIS	DBX16.1	FALSE

**See also**

- Overview of the valid data types (Page 1077)
- Basics of the EN/ENO mechanism (Page 1167)

**IMC: Compare input bits with the bits of a mask**

**Description**

The instruction "Compare input bits with the bits of a mask" is used to compare the signal state of up to 16 programmed input bits (IN\_BIT0 to IN\_BIT15) with the corresponding bits of a mask. Up to 16 steps with masks can be programmed. The value of the IN\_BIT0 parameter is compared with the value of the mask CMP\_VAL[x,0], with "x" indicating the step number. On the CMP\_STEP parameter, you specify the step number of the mask that is used for the comparison. All programmed values are compared in the same manner. Unprogrammed input bits or unprogrammed bits of the mask have the default signal state FALSE.

If a match is found in the comparison, the signal state of the OUT parameter is set to "1". Otherwise, the OUT parameter is set to "0".

If the value of CMP\_STEP parameter is greater than 15, the instruction is not executed. An error message is output at the ERR\_CODE parameter.

When you insert the instruction in the program, the "Call options" dialog opens in which you can specify whether the block parameters will be stored in a separate data block (single instance) or as a local tag (multiple instance) in the block interface. If you create a separate data block, you will find it in the project tree in the "Program resources" folder under "Program blocks > System blocks". For additional information on this topic, refer to "See also".



## Parameters

The following table shows the parameters of the "Compare input bits with the bits of a mask" instruction:

Parameter	Declaration	Data type	Memory area	Description
EN	Input	BOOL	I, Q, M, D, L	Enable input
ENO	Output	BOOL	I, Q, M, D, L	Enable output
IN_BIT0	Input	BOOL	I, Q, M, D, L or constant	Input bit 0 to be compared with bit 0 of the mask.
IN_BIT1	Input	BOOL	I, Q, M, D, L or constant	Input bit 1 to be compared with bit 1 of the mask.
IN_BIT2	Input	BOOL	I, Q, M, D, L or constant	Input bit 2 to be compared with bit 2 of the mask.
IN_BIT3	Input	BOOL	I, Q, M, D, L or constant	Input bit 3 to be compared with bit 3 of the mask.
IN_BIT4	Input	BOOL	I, Q, M, D, L or constant	Input bit 4 to be compared with bit 4 of the mask.
IN_BIT5	Input	BOOL	I, Q, M, D, L or constant	Input bit 5 to be compared with bit 5 of the mask.
IN_BIT6	Input	BOOL	I, Q, M, D, L or constant	Input bit 6 to be compared with bit 6 of the mask.
IN_BIT7	Input	BOOL	I, Q, M, D, L or constant	Input bit 7 to be compared with bit 7 of the mask.
IN_BIT8	Input	BOOL	I, Q, M, D, L or constant	Input bit 8 to be compared with bit 8 of the mask.
IN_BIT9	Input	BOOL	I, Q, M, D, L or constant	Input bit 9 to be compared with bit 9 of the mask.
IN_BIT10	Input	BOOL	I, Q, M, D, L or constant	Input bit 10 to be compared with bit 10 of the mask.
IN_BIT11	Input	BOOL	I, Q, M, D, L or constant	Input bit 11 to be compared with bit 11 of the mask.
IN_BIT12	Input	BOOL	I, Q, M, D, L or constant	Input bit 12 to be compared with bit 12 of the mask.
IN_BIT13	Input	BOOL	I, Q, M, D, L or constant	Input bit 13 to be compared with bit 13 of the mask.
IN_BIT14	Input	BOOL	I, Q, M, D, L or constant	Input bit 14 to be compared with bit 14 of the mask.
IN_BIT15	Input	BOOL	I, Q, M, D, L or constant	Input bit 15 to be compared with bit 15 of the mask.
CMP_STEP	Input	BYTE	I, Q, M, D, L, P or constant	The step number of the mask used for the comparison.
OUT	Output	BOOL	I, Q, M, D, L	A signal state of "1" indicates that a match was found. A signal state of "0" indicates that a match was found.

Parameter	Declaration	Data type	Memory area	Description
ERR_CODE	Output	WORD	I, Q, M, D, L, P	Error information
CMP_VAL	Static	ARRAY OF WORD	I, Q, M, D, L	Comparison masks [0 to 15, 0 to 15]: The first number of the index is the step number and the second number is the bit number of the mask.

For additional information on valid data types, refer to "See also".

### Parameter ERR\_CODE

The following table shows the meaning of the values of the ERR\_CODE parameter:

Error code* (W#16#...)	Explanation
0000	No error
000A	The value at the CMP_STEP parameter is greater than 15.

\*The error codes can be displayed as integer or hexadecimal value in the program editor. For additional information on toggling display formats, refer to "See also".

### See also

Overview of the valid data types (Page 1077)

Basics of the EN/ENO mechanism (Page 1167)

### SMC: Compare scan matrix

#### Description

The "Compare scan matrix" instruction is used to compare the signal state of up to 16 programmed input bits (IN\_BIT0 to IN\_BIT15) with the corresponding bits of the comparison masks for each step. Processing starts at step 1 and is continued until the last programmed step (LAST) or until a match is found. The input bit of the IN\_BIT0 parameter is compared with the value of the mask CMP\_VAL[x,0], with "x" indicating the step number. All programmed values are compared in the same manner. If a match is found the signal state of the OUT parameter is set to "1" and the step number with the matching mask is written in the OUT\_STEP parameter. Unprogrammed input bits or unprogrammed bits of the mask have the default signal state FALSE. If more than one step has a matching mask, only the first one found is indicated in the OUT\_STEP parameter. If no match is found, the signal state of the OUT parameter is set to "0". In this case the value at the OUT\_STEP parameter is greater by "1" than the value at the LAST parameter.

When you insert the instruction in the program, the "Call options" dialog opens in which you can specify whether the block parameters will be stored in a separate data block (single instance) or as a local tag (multiple instance) in the block interface. If you create a separate

data block, you will find it in the project tree in the "Program resources" folder under "Program blocks > System blocks". For additional information on this topic, refer to "See also".

## Parameters

The following table shows the parameters of the "Compare scan matrix" instruction:

Parameter	Declaration	Data type	Memory area	Description
EN	Input	BOOL	I, Q, M, D, L	Enable input
ENO	Output	BOOL	I, Q, M, D, L	Enable output
IN_BIT0	Input	BOOL	I, Q, M, D, L or constant	Input bit 0 to be compared with bit 0 of the mask.
IN_BIT1	Input	BOOL	I, Q, M, D, L or constant	Input bit 1 to be compared with bit 1 of the mask.
IN_BIT2	Input	BOOL	I, Q, M, D, L or constant	Input bit 2 to be compared with bit 2 of the mask.
IN_BIT3	Input	BOOL	I, Q, M, D, L or constant	Input bit 3 to be compared with bit 3 of the mask.
IN_BIT4	Input	BOOL	I, Q, M, D, L or constant	Input bit 4 to be compared with bit 4 of the mask.
IN_BIT5	Input	BOOL	I, Q, M, D, L or constant	Input bit 5 to be compared with bit 5 of the mask.
IN_BIT6	Input	BOOL	I, Q, M, D, L or constant	Input bit 6 to be compared with bit 6 of the mask.
IN_BIT7	Input	BOOL	I, Q, M, D, L or constant	Input bit 7 to be compared with bit 7 of the mask.
IN_BIT8	Input	BOOL	I, Q, M, D, L or constant	Input bit 8 to be compared with bit 8 of the mask.
IN_BIT9	Input	BOOL	I, Q, M, D, L or constant	Input bit 9 to be compared with bit 9 of the mask.
IN_BIT10	Input	BOOL	I, Q, M, D, L or constant	Input bit 10 to be compared with bit 10 of the mask.
IN_BIT11	Input	BOOL	I, Q, M, D, L or constant	Input bit 11 to be compared with bit 11 of the mask.
IN_BIT12	Input	BOOL	I, Q, M, D, L or constant	Input bit 12 to be compared with bit 12 of the mask.
IN_BIT13	Input	BOOL	I, Q, M, D, L or constant	Input bit 13 to be compared with bit 13 of the mask.
IN_BIT14	Input	BOOL	I, Q, M, D, L or constant	Input bit 14 to be compared with bit 14 of the mask.
IN_BIT15	Input	BOOL	I, Q, M, D, L or constant	Input bit 15 to be compared with bit 15 of the mask.
OUT	Output	BOOL	I, Q, M, D, L	A signal state of "1" indicates that a match was found. A signal state of "0" indicates that no match was found.
ERR_CODE	Output	WORD	I, Q, M, D, L, P	Error information

Parameter	Declaration	Data type	Memory area	Description
OUT_STEP	Output	BYTE	I, Q, M, D, L, P	Contains the step number with the matching mask, or the step number which is greater by "1" than the value at the LAST parameter, provided no match is found.
LAST	Static	BYTE	I, Q, M, D, L, P	Specifies the step number of the last step to be scanned for a matching mask.
CMP_VAL	Static	ARRAY OF WORD	I, Q, M, D, L	Comparison masks [0 to 15, 0 to 15]: The first number of the index is the step number and the second number is the bit number of the mask.

For additional information on valid data types, refer to "See also".

### Parameter ERR\_CODE

The following table shows the meaning of the values of the ERR\_CODE parameter:

Error code* (W#16#...)	Explanation
0000	No error
000E	The value at the LAST parameter is greater than 15.

\*The error codes can be displayed as integer or hexadecimal value in the program editor. For additional information on toggling display formats, refer to "See also".

### See also

Overview of the valid data types (Page 1077)

Basics of the EN/ENO mechanism (Page 1167)

### LEAD\_LAG: Lead and lag algorithm

#### Description

The "Lead and lag algorithm" instruction is used to process signals with an analog tag. The gain value at the GAIN parameter must be greater than zero. The result of the instruction "Lead and lag algorithm" is calculated using the following equation:

$$OUT = \left[ \frac{LG\_TIME}{LG\_TIME + SAMPLE\_T} \right] PREV\_OUT + GAIN \left[ \frac{LD\_TIME + SAMPLE\_T}{LG\_TIME + SAMPLE\_T} \right] IN - GAIN \left[ \frac{LD\_TIME}{LG\_TIME + SAMPLE\_T} \right] * PREV\_IN$$

The "Lead and lag algorithm" instruction supplies plausible results only when processing is in fixed program cycles. The same units must be specified for the LD\_TIME, LG\_TIME, and

SAMPLE\_T parameters. At  $LG\_TIME > 4 + SAMPLE\_T$ , the instruction approaches the following function:

$$OUT = GAIN * ((1 + LD\_TIME * s) / (1 + LG\_TIME * s)) * IN$$

When the value of the GAIN parameter is less than or equal to zero, the calculation is not performed and an error information is output on the ERR\_CODE parameter.

You can use the "Lead and lag algorithm" instruction in conjunction with loops as a compensator in dynamic feed-forward control. The instruction consists of two operations. The "Lead" operation shifts the phase of the OUT output so that the output leads the input. The "Lag" operation, on the other hand, shifts the output so that the output lags behind the input. Because the "Lag" operation is equivalent to an integration, it can be used as a noise suppressor or as a low-pass filter. The "Lead" operation is equivalent to a differentiation and can therefore be used as a high-pass filter. The two operations together (Lead and Lag) result in the output phase lagging behind the the input at lower frequencies and leading it at higher frequencies. This means that the "Lead and lag algorithm" instruction can be used as a band pass filter.

When you insert the instruction in the program, the "Call options" dialog opens in which you can specify whether the block parameters will be stored in a separate data block (single instance) or as a local tag (multiple instance) in the block interface. If you create a separate data block, you will find it in the project tree in the "Program resources" folder under "Program blocks > System blocks". For additional information on this topic, refer to "See also".

## Parameters

The following table shows the parameters of the "Lead and lag algorithm" instruction:

Parameter	Declaration	Data type	Memory area	Description
EN	Input	BOOL	I, Q, M, D, L	Enable input
ENO	Output	BOOL	I, Q, M, D, L	Enable output
IN	Input	REAL	I, Q, M, D, L, P or constant	The input value of the current sample time (cycle time) to be processed. Constants can also be specified on the IN parameter.
SAMPLE_T	Input	INT	I, Q, M, D, L, P or constant	Sample time Constants can also be specified on the SAMPLE_T parameter.
OUT	Output	REAL	I, Q, M, D, L	Result of the instruction
ERR_CODE	Output	WORD	I, Q, M, D, L	Error information
LD_TIME	Static	REAL	I, Q, M, D, L, P or constant	Lead time in the same unit as sample time.

Parameter	Declaration	Data type	Memory area	Description
LG_TIME	Static	REAL	I, Q, M, D, L, P or constant	Lag time in in the same unit as sample time.
GAIN	Static	REAL	I, Q, M, D, L, P or constant	Gain as % / % (the ratio of the change in output to a change in input as a steady state).
PREV_IN	Static	REAL	I, Q, M, D, L, P or constant	Previous input
PREV_OUT	Static	REAL	I, Q, M, D, L, P or constant	Previous output

For additional information on valid data types, refer to "See also".

### Parameter ERR\_CODE

The following table shows the meaning of the values of the ERR\_CODE parameter:

Error code* (W#16#...)	Explanation
0000	No error
0009	The value at the GAIN parameter is less than or equal to zero.

\*The error codes can be displayed as integer or hexadecimal value in the program editor. For additional information on toggling display formats, refer to "See also".

### Example

The following example shows how the instruction works:

#### Note

You can initialize static parameters in the data block.

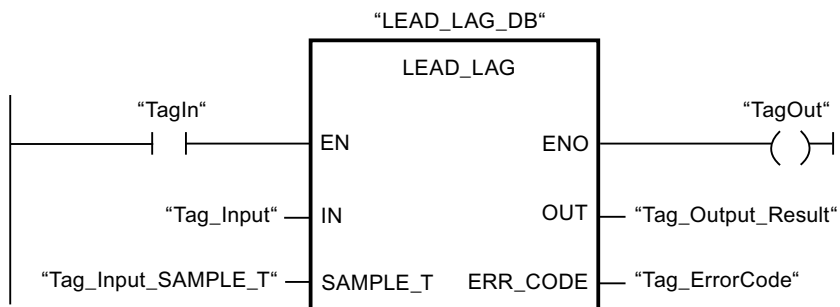

The following table shows how the instruction works using specific operand values:

#### Before processing

In this example the following values are used for the input parameters:

Parameter	Operand	Value
IN	Tag_Input	2.0
SAMPLE_T	Tag_InputSampleTime	10

The following values are saved in the instance data block "LEAD\_LAG\_DB" of the instruction:

Parameter	Address	Value
LD_TIME	DBD12	2.0
LG_TIME	DBD16	2.0
GAIN	DBD20	1.0
PREV_IN	DBD24	6.0
PREV_OUT	DBD28	6.0

#### After processing

The following values are written to the output parameters after the instruction has been executed:

Parameter	Operand	Value
OUT	Tag_Output_Result	2.0

The following values are saved in the instance data block "LEAD\_LAD\_DB" of the instruction:

Parameter	Operand	Value
PREV_IN	DBD24	2.0
PREV_OUT	DBD28	2.0

#### See also

Overview of the valid data types (Page 1077)

Basics of the EN/ENO mechanism (Page 1167)

### SEG: Create bit pattern for seven-segment display

#### Description

The instruction "Create bit pattern for seven-segment display" is used to convert each of the four hexadecimal digits of the specified source word (IN) into an equivalent bit pattern for a seven-segment display. The result of the instruction is output in the double word on the OUT parameter.

The following relation exists between the hexadecimal digits and the assignment of the 7 segments (a, b, c, d, e, f, g):

Input digit (Binary)	Assignment of the segments - g f e d c b a	Display (Hexadecimal)	Seven-segment display
0000	00111111	0	
0001	00000110	1	
0010	01011011	2	
0011	01001111	3	
0100	01100110	4	
0101	01101101	5	
0110	01111101	6	
0111	00000111	7	
1000	01111111	8	
1001	01100111	9	
1010	01110111	A	
1011	01111100	B	
1100	00111001	C	
1101	01011110	D	
1110	01111001	E	
1111	01110001	F	

**Parameter**

The following table shows the parameters of the "Create bit pattern for seven-segment display" instruction:

Parameter	Declaration	Data type	Memory area	Description
EN	Input	BOOL	I, Q, M, D, L	Enable input
ENO	Output	BOOL	I, Q, M, D, L	Enable output
IN	Input	WORD	I, Q, M, D, L, P or constant	Source word with four hexadecimal digits
OUT	Output	DWORD	I, Q, M, D, L, P	Bit pattern for the seven-segment display



## Example

The following example shows how the instruction works:

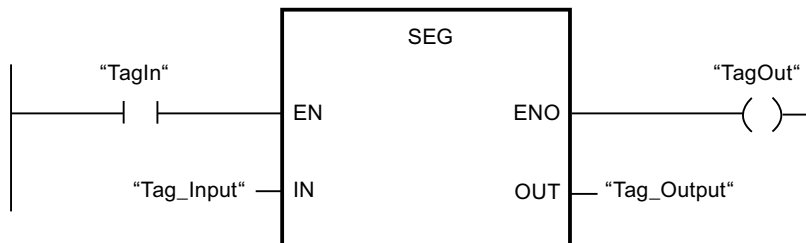

The following table shows how the instruction works using specific operand values:

Parameter	Operand	Value	
Hexadecimal	Binary		
IN	Tag_Input	W#16#1234	0001 0010 0011 0100
OUT	Tag_Output	DW#16065B4F66	000 00110 0101 1011 0100 1111 0110 0110 Display: 1234

## See also

Overview of the valid data types (Page 1077)

Basics of the EN/ENO mechanism (Page 1167)

## BCDCPL: Create tens complement

### Description

The "Create tens complement" instruction is used to create the tens complement of a seven-digit BCD number specified on the IN parameter. This instruction uses the following mathematical formula to calculate:

10000000 (as BCD)

– 7-digit BCD value

-----  
Tens complement (as BCD)

### Parameters

The following table shows the parameters of the "Create tens complement" instruction:

Parameter	Declaration	Data type	Memory area	Description
EN	Input	BOOL	I, Q, M, D, L	Enable input
ENO	Output	BOOL	I, Q, M, D, L	Enable output

Parameter	Declaration	Data type	Memory area	Description
IN	Input	DWORD	I, Q, M, D, L, P or constant	7-digit BCD number
ERR_CODE	Output	DWORD	I, Q, M, D, L, P	Result of the instruction

**Example**

The following example shows how the instruction works:

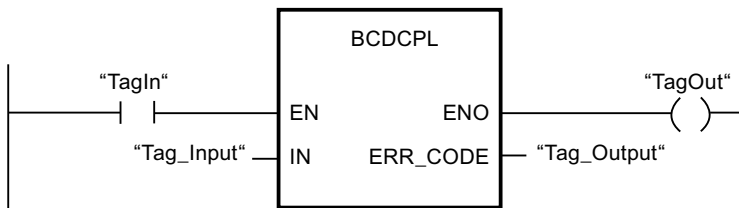

The following table shows how the instruction functions using specific values:

Parameter	Operand	Value*
IN	Tag_Input	DW#16#01234567
ERR_CODE	Tag_Output	DW#16#08765433

\*The error codes can be displayed as integer or hexadecimal value in the program editor. For additional information on toggling display formats, refer to "See also".

**See also**

- Overview of the valid data types (Page 1077)
- Basics of the EN/ENO mechanism (Page 1167)

**BITSUM: Count number of set bits**

**Description**

The "Count number of set bits" instruction is used to count the number of bits of an operand that is set to the signal state "1". The operand whose bits are to be counted is specified on the IN parameter. The result of the instruction is output on the RET\_VAL parameter.

**Parameters**

The following table shows the parameters of the "Count number of set bits" instruction:

Parameter	Declaration	Data type	Memory area	Description
EN	Input	BOOL	I, Q, M, D, L	Enable input
ENO	Output	BOOL	I, Q, M, D, L	Enable output

Parameter	Declaration	Data type	Memory area	Description
IN	Input	DWORD	I, Q, M, D, L, P or constant	Operand whose set bits are counted
RET_VAL	Output	INT	I, Q, M, D, L, P	Number of bits to be set

## Example

The following example shows how the instruction works:

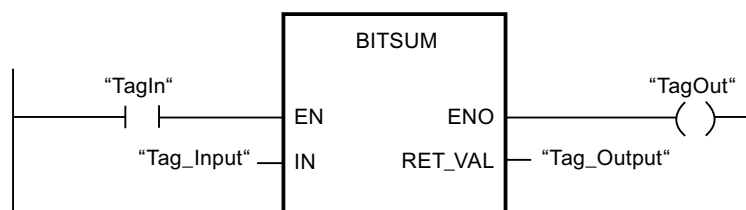

The following table shows how the instruction functions using specific values:

Parameter	Operand	Value*
IN	Tag_Input	DW#16#12345678
RET_VAL	Tag_Output	W#16#000D (13 Bits)

\*The error codes can be displayed as integer or hexadecimal value in the program editor. For additional information on toggling display formats, refer to "See also".

## See also

Overview of the valid data types (Page 1077)

Basics of the EN/ENO mechanism (Page 1167)

### 9.7.2.2 FBD

## Bit logic operations

### &: AND logic operation

## Description

You can use the instruction "AND logic operation" to query the signal states of two or more specified operands and evaluate them according to the AND truth table.

If the signal state of all the operands is "1", then the condition is fulfilled and the instruction returns the result "1". If the signal state of one of the operands is "0", then the condition is not fulfilled and the instruction generates the result "0".

**Parameters**

The following table shows the parameters of the instruction "AND logic operation":

Parameter	Declaration	Data type	Memory area		Description
			S7-1200	S7-1500	
<Operand>	Input	BOOL	I, Q, M, D, L	I, Q, M, D, L, T, C	The operand indicates the bit whose signal state will be queried.

**Example**

The following example shows how the instruction works:

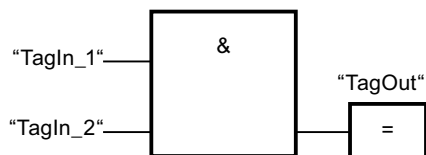

Output "TagOut" is set, when the signal state of the operands "TagIn\_1" and "TagIn\_2" is "1" and reset when the state of the operands "TagIn\_1" and "TagIn\_2" is "0".

**See also**

- AND truth table (Page 1836)
- Example of detecting the direction of a conveyor belt (Page 1560)
- Example of controlling room temperature (Page 1564)
- Overview of the valid data types (Page 1077)
- Adding additional inputs and outputs to FBD elements (Page 1329)
- Insert input (Page 1840)

**AND truth table**

**Results of the logic operation**

The following table shows the results that arise from the AND logic operation of two operands:

Signal state of the first operand	Signal state of the second operand	Result of the logic operation
1	1	1
0	1	0

Signal state of the first operand	Signal state of the second operand	Result of the logic operation
1	0	0
0	0	0

## See also

&: AND logic operation (Page 1835)

Overview of the valid data types (Page 1077)

## >=1: OR logic operation

### Description

You can use the instruction "OR logic operation" to query the signal states of two or more specified operands and evaluate them according to the OR truth table.

If the signal state of one of the operands is "1", then the condition is fulfilled and the instruction returns the result "1". If the signal state of all the operands is "0", then the condition is not fulfilled and the instruction generates the result "0".

### Parameters

The following table shows the parameters of the instruction "OR logic operation":

Parameter	Declaration	Data type	Memory area		Description
			S7-1200	S7-1500	
<Operand>	Input	BOOL	I, Q, M, D, L	I, Q, M, D, L, T, C	The operand indicates the bit whose signal state will be queried.

### Example

The following example shows how the instruction works:

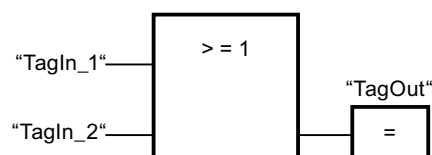

Output "TagOut" is set, when the signal state of the operands "TagIn\_1" or "TagIn\_2" is "1".

**See also**

- OR truth table (Page 1838)
- Example of controlling a conveyor belt (Page 1559)
- Adding additional inputs and outputs to FBD elements (Page 1329)
- Overview of the valid data types (Page 1077)
- Insert input (Page 1840)

**OR truth table**

**Results of the logic operation**

The following table shows the results that arise from the OR logic operation of two operands:

Signal state of the first operand	Signal state of the second operand	Result of the logic operation
1	0	1
0	1	1
1	1	1
0	0	0

**See also**

- >=1: OR logic operation (Page 1837)
- Overview of the valid data types (Page 1077)

**X: EXCLUSIVE OR logic operation**

**Description**

You can use the instruction "EXCLUSIVE OR logic operation" to query the result of a signal state query according to the EXCLUSIVE OR truth table.

With an instruction "EXCLUSIVE OR logic operation", the signal state is "1" when the signal state of one of the two specified operands is "1". When more than two operands are queried, the common RLO is "1" if an odd number of the queried operands returns the result "1".

## Parameters

The following table shows the parameters of the instruction "EXCLUSIVE OR logic operation":

Parameter	Declaration	Data type	Memory area		Description
			S7-1200	S7-1500	
<Operand>	Input	BOOL	I, Q, M, D, L	I, Q, M, D, L, T, C	The operand indicates the bit whose signal state will be queried.

## Example

The following example shows how the instruction works:

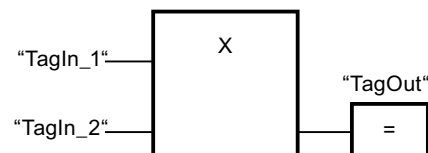

Output "TagOut" is set when the signal state of the operands "TagIn\_1" and "TagIn\_2" is "1". When both operands return the signal state "1" or "0", the output "TagOut" is reset.

## See also

EXCLUSIVE OR truth table (Page 1839)

Adding additional inputs and outputs to FBD elements (Page 1329)

Overview of the valid data types (Page 1077)

Insert input (Page 1840)

## EXCLUSIVE OR truth table

### Results of the logic operation

The following table shows the results that arise from the EXCLUSIVE OR logic operation of two operands:

Signal state of the first operand	Signal state of the second operand	Result of the logic operation
1	0	1
0	1	1
1	1	0
0	0	0

The following table shows the results that arise from the EXCLUSIVE OR logic operation of three operands:

Signal state of the first operand	Signal state of the second operand	Signal state of the third operand	Result of the logic operation
1	0	0	1
0	1	1	0
0	1	0	1
1	0	1	0
0	0	1	1
1	1	0	0
1	1	1	1
0	0	0	0

**See also**

X: EXCLUSIVE OR logic operation (Page 1838)

Overview of the valid data types (Page 1077)

**Insert input**

**Description**

The "Insert input" instruction is used to add an input to the box of one of the following instructions:

- "AND logic operation"
- "OR logic operation"
- "EXCLUSIVE OR logic operation"

You can query the signal state of several operands by the extension of an instruction box.

**Parameters**

The following table shows the parameters of the instruction "Insert input":

Parameter	Declaration	Data type	Memory area		Description
			S7-1200	S7-1500	
<Operand>	Input	BOOL	I, Q, M, D, L	I, Q, M, D, L, T, C	The operand indicates the bit whose signal state will be queried.



## Example

The following example shows how the instruction works:

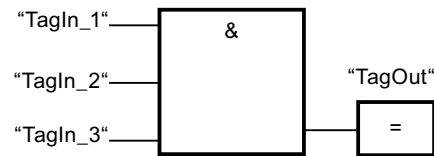

The box of the instruction "AND logic operation" was extended by an additional input at which the signal state of the operand "TagIn\_3" is queried. The output "TagOut" is set, when the signal state of the operands "TagIn\_1", "TagIn\_2" and "TagIn\_3" returns the signal state "1".

## See also

&: AND logic operation (Page 1835)

>=1: OR logic operation (Page 1837)

X: EXCLUSIVE OR logic operation (Page 1838)

Overview of the valid data types (Page 1077)

## Invert RLO

## Description

You use the "Invert RLO" instruction to invert the signal state of the result of logic operation (RLO).

## Example

The following example shows how the instruction works:

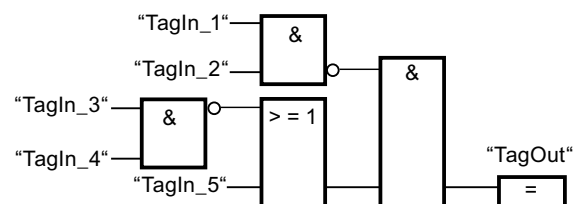

The output "TagOut" is set when the following conditions are fulfilled:

- The input "TagIn\_1" and/or "TagIn\_2" has signal state "0".
- The input "TagIn\_3" and/or "TagIn\_4" has signal state "0" or the input "TagIn\_5" has signal state "1".

## See also

Overview of the valid data types (Page 1077)

## =: Assignment

### Description

You can use the instruction "Assignment" to set the bit of a specified operand. If the result of logic operation (RLO) at the box input has the signal state "1", the specified operand is set to signal state "1". If the signal state at the box input is "0", the bit of the specified operand is reset to "0".

The instruction does not influence the RLO. The RLO at the box input is assigned directly to the operand above the assignment box.

### Parameters

The following table shows the parameters of the instruction "Assignment":

Parameters	Declaration	Data type	Memory area	Description
<Operand>	Output	BOOL	I, Q, M, D, L	Operand to which the RLO is assigned.

### Example

The following example shows how the instruction works:

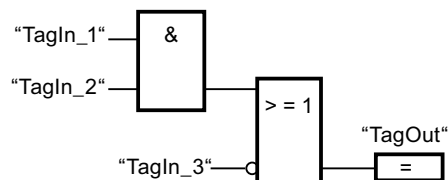

The operand "TagOut" is set at the output of the "Assignment" instruction when one of the following conditions is fulfilled:

- The inputs "TagIn\_1" and "TagIn\_2" have the signal state "1".
- The signal state at the input "TagIn\_3" is "0".

### See also

Overview of the valid data types (Page 1077)

Example of detecting the fill level of a storage area (Page 1561)

Example of controlling room temperature (Page 1564)

## /=: Negate assignment

### Description

The instruction "Negate assignment" inverts the result of logic operation (RLO) and assigns this to the operand above the box. If the RLO at the input of the box is "1", the binary operand is reset. If the RLO at the input of the box is "0", the operand is set to signal state "1".

### Parameters

The following table shows the parameters of the instruction "Negate assignment":

Parameters	Declaration	Data type	Memory area	Description
<Operand>	Output	BOOL	I, Q, M, D, L	Operand to which the negated RLO is assigned.

### Example

The following example shows how the instruction works:

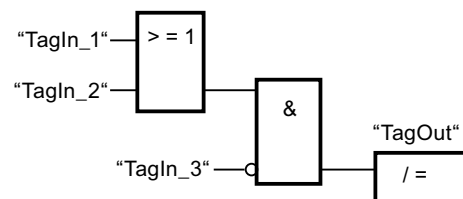

The operand "TagOut" is reset when the following conditions are fulfilled:

- The operand "TagIn\_1" or "TagIn\_2" has the signal state "1".
- The operand "TagIn\_3" has the signal state "0".

### See also

Overview of the valid data types (Page 1077)

## R: Reset output

### Description

You can use the "Reset output" instruction to reset the signal state of a specified operand to "0".

The instruction is only executed if the result of logic operation (RLO) at the box input is "1". If the box input has the signal state "1", the specified operand is reset to "0". If there is an RLO of "0" at the box input, the signal state of the specified operand remains unchanged.

**Parameters**

The following table shows the parameters of the "Reset output" instruction:

Parameters	Declaration	Data type	Memory area		Description
			S7-1200	S7-1500	
<Operand>	Output	BOOL	I, Q, M, D, L	I, Q, M, D, L, T, C	Operand that is reset if RLO = "1".

**Example**

The following example shows how the instruction works:

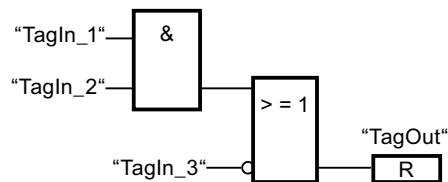

Operand "TagOut" is reset when one of the following conditions is fulfilled:

- The operands "TagIn\_1" and "TagIn\_2" have signal state "1".
- The operand "TagIn\_3" has the signal state "0".

**See also**

- Example of controlling a conveyor belt (Page 1559)
- Example of detecting the direction of a conveyor belt (Page 1560)
- Overview of the valid data types (Page 1077)

**S: Set output**

**Description**

You can use the instruction "Set output" to set the signal state of a specified operand to "1". The instruction is only executed if the result of logic operation (RLO) at the box input is "1". If the box input has the signal state "1", the specified operand is set to "1". If there is an RLO of "0" at the box input, the signal state of the specified operand remains unchanged.

## Parameters

The following table shows the parameters of the instruction "Set output":

Parameters	Declaration	Data type	Memory area	Description
<Operand>	Output	BOOL	I, Q, M, D, L	Operand which is set with RLO = "1".

## Example

The following example shows how the instruction works:

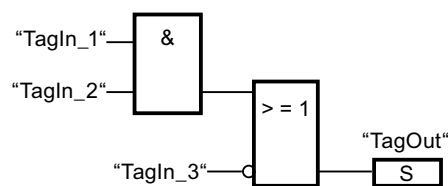

The "TagOut" operand is set when one of the following conditions is fulfilled:

- The operands "TagIn\_1" and "TagIn\_2" have signal state "1".
- The operand "TagIn\_3" has the signal state "0".

## See also

Overview of the valid data types (Page 1077)

## SET\_BF: Set bit field

### Description

You use the instruction "Set bit field" to set multiple bits starting from a certain address.

You use the input N to define the number of bits to be set. The address of the first bit to be set is defined by (<Operand>). If the value of the N input is greater than the number of bits in a selected byte, the bits of the next byte are set. The bits remain set until they are explicitly reset, for example, by another instruction.

### Parameters

The following table shows the parameters of the instruction "Set bit field":

Parameters	Declaration	Data type	Memory area	Description
EN	Input	BOOL	I, Q, M, D, L	Enable input
N	Input	UINT	Constant	Number of bits to be set
<Operand>	Output	BOOL	I, Q, M In the case of a DB or an IDB, an element of an ARRAY[.] of BOOL	Pointer to the first bit to be set.

### Example

The following example shows how the instruction works:

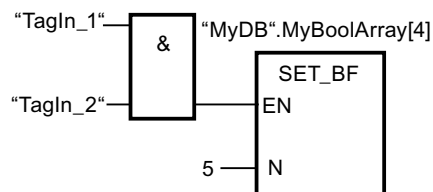

If the operands "TagIn\_1" and "TagIn\_2" have the signal state "1", 5 bits are set starting at the address of the operand "MyDB".MyBoolArray[4].

### See also

Overview of the valid data types (Page 1077)

### RESET\_BF: Reset bit field

#### Description

You use the instruction "Reset bit field" to reset several bits starting from a certain address. You use the value of the N input to define the number of bits to be reset. The address of the first bit to be reset is defined by (<Operand>). If the value of the input N is greater than the number of bits in a selected byte, the bits of the next byte are reset. The bits remain reset until they are explicitly set, for example, by another instruction.

## Parameters

The following table shows the parameters of the instruction "Reset bit field":

Parameters	Declaration	Data type	Memory area	Description
EN	Input	BOOL	I, Q, M, D, L	Enable input
N	Input	UINT	Constant	Number of bits to be reset.
<Operand>	Output	BOOL	I, Q, M In the case of a DB or an IDB, an element of an ARRAY[..] of BOOL	Pointer to the first bit to be reset.

## Example

The following example shows how the instruction works:

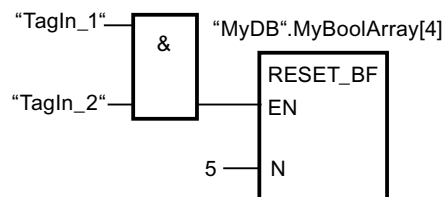

If the operands "TagIn\_1" and "TagIn\_2" have the signal state "1", 5 bits are reset starting at the address of the operand "MyDB".MyBoolArray[4].

## See also

Overview of the valid data types (Page 1077)

## SR: Set/reset flip-flop

### Description

You can use the instruction "Set/reset flip-flop" to set or reset the bit of a specified operand based on the signal state of the inputs S and R1. If the signal state is "1" at input S and "0" at input R1, the specified operand is set to "1". If the signal state is "0" at input S and "1" at input R1, the specified operand will be reset to "0".

Input R1 takes priority over input S. When the signal state is "1" on both inputs S and R1, the signal state of the specified operand is reset to "0".

The instruction is not executed if the signal state at the two inputs S and R1 is "0". The signal state of the operand then remains unchanged.

The current signal state of the operand is transferred to output Q and can be queried there.

### Parameters

The following table shows the parameters of the instruction "Set/reset flip-flop":

Parameter	Declaration	Data type	Memory area		Description
			S7-1200	S7-1500	
S	Input	BOOL	I, Q, M, D, L	I, Q, M, D, L, T, C	Enable setting
R1	Input	BOOL	I, Q, M, D, L	I, Q, M, D, L, T, C	Enable resetting
<Operand>	InOut	BOOL	I, Q, M, D, L	I, Q, M, D, L	Operand that is set or reset
Q	Output	BOOL	I, Q, M, D, L	I, Q, M, D, L	Signal state of the operand

### Example

The following example shows how the instruction works:

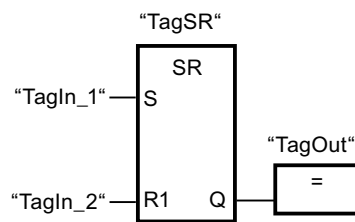

The operands "TagSR" and "TagOut" are set when the following conditions are fulfilled:

- The operand "TagIn\_1" has the signal state "1".
- The operand "TagIn\_2" has the signal state "0".

The operands "TagSR" and "TagOut" are reset when one of the following conditions is fulfilled:

- The operand "TagIn\_1" has signal state "0" and the operand "TagIn\_2" has signal state "1".
- The operands "TagIn\_1" and "TagIn\_2" have signal state "1".

### See also

Overview of the valid data types (Page 1077)

### RS: Reset/set flip-flop

#### Description

You can use the instruction "Reset/set flip-flop" to reset or set the bit of a specified operand based on the signal state of the inputs R and S1. If the signal state is "1" at input R and "0" at input S1, the specified operand will be reset to "0". If the signal state is "0" at input R and "1" at input S1, the specified operand is set to "1".



Input S1 takes priority over input R. When the signal state is "1" at both inputs R and S1, the signal state of the specified operand is set to "1".

The instruction is not executed if the signal state at the two inputs R and S1 is "0". The signal state of the operand then remains unchanged.

The current signal state of the operand is transferred to output Q and can be queried there.

## Parameters

The following table shows the parameters of the instruction "Reset/set flip-flop":

Parameter	Declaration	Data type	Memory area		Description
			S7-1200	S7-1500	
R	Input	BOOL	I, Q, M, D, L	I, Q, M, D, L, T, C	Enable resetting
S1	Input	BOOL	I, Q, M, D, L	I, Q, M, D, L, T, C	Enable setting
<Operand>	InOut	BOOL	I, Q, M, D, L	I, Q, M, D, L	Operand that is reset or set.
Q	Output	BOOL	I, Q, M, D, L	I, Q, M, D, L	Signal state of the operand

## Example

The following example shows how the instruction works:

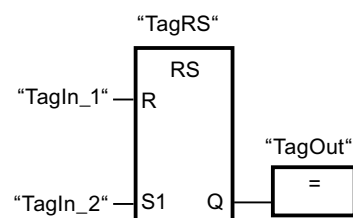

The operands "TagRS" and "TagOut" are reset when the following conditions are fulfilled:

- The operand "TagIn\_1" has the signal state "1".
- The operand "TagIn\_2" has the signal state "0".

The operands "TagRS" and "TagOut" are set when the following conditions are fulfilled:

- The operand "TagIn\_1" has signal state "0" and the operand "TagIn\_2" has signal state "1".
- The operands "TagIn\_1" and "TagIn\_2" have signal state "1".

## See also

Overview of the valid data types (Page 1077)

**P: Scan operand for positive signal edge**

**Description**

You can use the instruction "Scan operand for positive signal edge" to determine whether there is a "0" to "1" change in the signal state of a specified operand (<Operand1>). The instruction compares the current signal state of <Operand1> with the signal state of the previous scan, which is saved in an edge memory bit (<Operand2>). If the instruction detects a change in the result of logic operation (RLO) from "0" to "1", there is a positive, rising edge.

If a rising edge is detected, the output of the instruction has the signal state "1". In all other cases, the signal state at the output of the instruction is "0".

Specify the operand to be queried (<Operand1>) in the operand placeholder above the instruction. Specify the edge memory bit (<Operand2>) in the operand placeholder below the instruction.

**Note**

The address of the edge memory bit must not be used more than once in the program, otherwise the memory bit is overwritten. This would influence edge evaluation and the result would no longer be unequivocal. The memory area of the edge memory bit has to be located in a DB (static area for FB) or in the bit memory area.

**Parameters**

The following table shows the parameters of the "Scan operand for positive signal edge" instruction:

Parameter	Declaration	Data type	Memory area		Description
			S7-1200	S7-1500	
<Operand1>	Input	BOOL	I, Q, M, D, L	I, Q, M, D, L, T, C	Signal to be scanned
<Operand2>	InOut	BOOL	I, Q, M, D, L	I, Q, M, D, L	Edge memory bit in which the signal state of the previous query is saved.

**Example**

The following example shows how the instruction works:

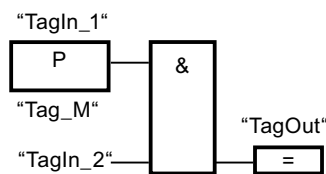

Output "TagOut" is set when the following conditions are fulfilled:

- There is a rising edge at input "TagIn\_1".
- The signal state of the operand "TagIn\_2" is "1".

## See also

Overview of the valid data types (Page 1077)

Example of detecting the direction of a conveyor belt (Page 1560)

## N: Scan operand for negative signal edge

### Description

You can use the instruction "Scan operand for negative signal edge" to determine whether there is a "1" to "0" change in the signal state of a specified operand (<Operand1>). The instruction compares the current signal state of <Operand1> with the signal state of the previous scan, which is saved in an edge memory bit (<Operand2>). If the instruction detects a change in the result of logic operation (RLO) from "1" to "0", there is a negative, falling edge.

If a falling edge is detected, the output of the instruction has the signal state "1". In all other cases, the signal state at the output of the instruction is "0".

Specify the operand to be queried (<Operand1>) in the operand placeholder above the instruction. Specify the edge memory bit (<Operand2>) in the operand placeholder below the instruction.

---

### Note

The address of the edge memory bit must not be used more than once in the program, otherwise the memory bit is overwritten. This would influence edge evaluation and the result would no longer be unequivocal. The memory area of the edge memory bit has to be located in a DB (static area for FB) or in the bit memory area.

---

## Parameters

The following table shows the parameters of the "Scan operand for negative signal edge" instruction:

Parameter	Declaration	Data type	Memory area		Description
			S7-1200	S7-1500	
<Operand1>	Input	BOOL	I, Q, M, D, L	I, Q, M, D, L, T, C	Signal to be scanned
<Operand2>	InOut	BOOL	I, Q, M, D, L	I, Q, M, D, L	Edge memory bit in which the signal state of the previous query is saved.

### Example

The following example shows how the instruction works:

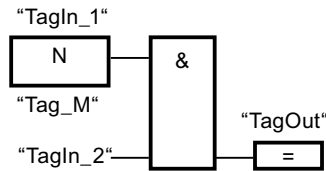

Output "TagOut" is set when the following conditions are fulfilled:

- There is a falling edge at input "TagIn\_1".
- The signal state of the operand "TagIn\_2" is "1".

### See also

Overview of the valid data types (Page 1077)

### P=: Set operand on positive signal edge

#### Description

You can use the instruction "Set operand on positive signal edge" to set a specified operand (<Operand2>) when there is a "0" to "1" change in the result of logic operation (RLO). The instruction compares the current RLO with the RLO from the previous query, which is saved in the edge memory bit (<Operand1>). If the instruction detects a change in the result of logic operation (RLO) from "0" to "1", there is a positive, rising edge.

When a positive edge is detected, <Operand2> is set to signal state "1" for one program cycle. In all other cases, the operand has the signal state "0".

You specify the operand (<Operand2>) to be set in the operand placeholder above the instruction. Specify the edge memory bit (<Operand1>) in the operand placeholder below the instruction.

---

#### Note

The address of the edge memory bit must not be used more than once in the program, otherwise the memory bit is overwritten. This would influence edge evaluation and the result would no longer be unequivocal. The memory area of the edge memory bit has to be located in a DB (static area for FB) or in the bit memory area.

---

## Parameters

The following table shows the parameters of the instruction "Set operand on positive signal edge":

Parameter	Declaration	Data type	Memory area	Description
<Operand2>	Output	BOOL	I, Q, M, D, L	Operand which is set when there is a positive signal edge.
<Operand1>	InOut	BOOL	I, Q, M, D, L	Edge memory bit

## Example

The following example shows the parameters of the instruction:

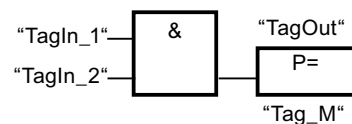

The "TagOut" output is set for one program cycle, when the signal state at the input of the instruction box switches from "0" to "1" (positive signal edge). In all other cases, the "TagOut" output has signal state "0".

## See also

Overview of the valid data types (Page 1077)

## N=: Set operand on negative signal edge

### Description

You can use the instruction "Set operand on negative signal edge" to set a specified operand (<Operand1>) when there is a "1" to "0" change in the result of logic operation (RLO). The instruction compares the current RLO with the RLO from the previous query, which is saved in the edge memory bit (<Operand2>). If the instruction detects a change in the result of logic operation (RLO) from "1" to "0", there is a negative, falling edge.

When a negative edge is detected, <Operand1> is set to signal state "1" for one program cycle. In all other cases, the operand has the signal state "0".

You specify the operand (<Operand1>) to be set in the operand placeholder above the instruction. Specify the edge memory bit (<Operand2>) in the operand placeholder below the instruction.

**Note**

The address of the edge memory bit must not be used more than once in the program, otherwise the memory bit is overwritten. This would influence edge evaluation and the result would no longer be unequivocal. The memory area of the edge memory bit has to be located in a DB (static area for FB) or in the bit memory area.

**Parameters**

The following table shows the parameters of the instruction "Set operand on negative signal edge":

Parameter	Declaration	Data type	Memory area	Description
<Operand1>	Output	BOOL	I, Q, M, D, L	Operand which is set when there is a negative signal edge.
<Operand2>	InOut	BOOL	I, Q, M, D, L	Edge memory bit

**Example**

The following example shows how the instruction works:

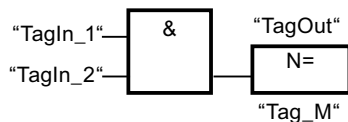

The operand "TagOut" is set for one program cycle if the signal state at the input of the instruction box changes from "1" to "0" (negative signal edge). In all other cases, the operand "TagOut" has the signal state "0".

**See also**

Overview of the valid data types (Page 1077)

**P\_TRIG: Scan RLO for positive signal edge**

**Description**

Use the instruction "Scan RLO for positive signal edge" to query a "0" to "1" change in the signal state of the result of logic operation (RLO). The instruction compares the current signal state of the RLO with the signal state of the previous query, which is saved in an edge memory

bit (<Operand>). If the instruction detects a change in the result of logic operation (RLO) from "0" to "1", there is a positive, rising edge.

If a rising edge is detected, the output of the instruction has the signal state "1". In all other cases, the signal state at the output of the instruction is "0".

#### Note

The address of the edge memory bit must not be used more than once in the program, otherwise the memory bit is overwritten. This would influence edge evaluation and the result would no longer be unequivocal. The memory area of the edge memory bit has to be located in a DB (static area for FB) or in the bit memory area.

## Parameters

The following table shows the parameters of the instruction "Scan RLO for positive signal edge":

Parameter	Declaration	Data type	Memory area	Description
CLK	Input	BOOL	I, Q, M, D, L	Current RLO
<Operand>	InOut	BOOL	M, D	Edge memory bit in which the RLO of the previous query is saved.
Q	Output	BOOL	I, Q, M, D, L	Result of edge evaluation

## Example

The following example shows how the instruction works:

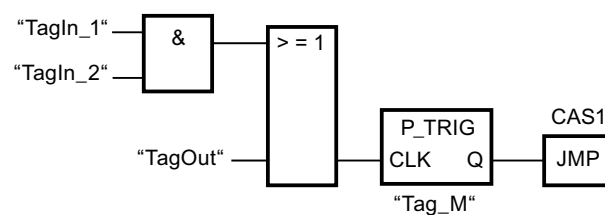

The RLO of the preceding bit logic operation is saved in the edge memory bit "Tag\_M". If a "0" to "1" change is detected in the signal state of the RLO, the program jumps to jump label CAS1.

## See also

Overview of the valid data types (Page 1077)

## N\_TRIG: Scan RLO for negative signal edge

### Description

Use the instruction "Scan RLO for negative signal edge" to query a "1" to "0" change in the signal state of the result of logic operation (RLO). The instruction compares the current signal state of the RLO with the signal state of the previous query saved in the edge memory bit (<Operand>). If the instruction detects a change in the result of logic operation (RLO) from "1" to "0", there is a negative, falling edge.

If a falling edge is detected, the output of the instruction has the signal state "1". In all other cases, the signal state at the output of the instruction is "0".

### Note

The address of the edge memory bit must not be used more than once in the program, otherwise the memory bit is overwritten. This would influence edge evaluation and the result would no longer be unequivocal. The memory area of the edge memory bit has to be located in a DB (static area for FB) or in the bit memory area.

### Parameters

The following table shows the parameters of the instruction "Scan RLO for negative signal edge":

Parameter	Declaration	Data type	Memory area	Description
CLK	Input	BOOL	I, Q, M, D, L	Current RLO
<Operand>	InOut	BOOL	M, D	Edge memory bit in which the RLO of the previous query is saved.
Q	Output	BOOL	I, Q, M, D, L	Result of edge evaluation

### Example

The following example shows how the instruction works:

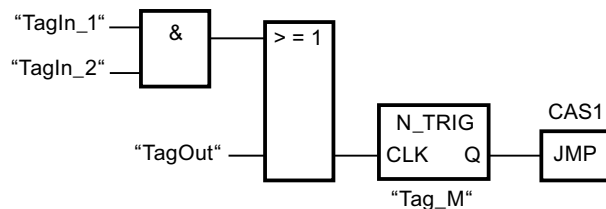

The RLO of the preceding bit logic operation is saved in the edge memory bit "Tag\_M". If a "1" to "0" change is detected in the signal state of the RLO, the program jumps to jump label CAS1.



**See also**

Overview of the valid data types (Page 1077)

**R\_TRIG: Set tag on positive signal edge****Description**

You can use the "Set tag on positive signal edge" instruction to set a specified tag in the instance DB when there is a "0" to "1" change in the result of logic operation (RLO). The instruction compares the current RLO at the input CLK with the RLO from the previous query, which is saved in the specified instance DB. If the instruction detects a change in the result of logic operation (RLO) from "0" to "1", there is a positive, rising edge.

If a positive edge is detected, the tag in the instance DB is set to signal state "1" and the output Q returns the signal state "1" In all other cases, the signal state at the output of the instruction is "0".

When you insert the instruction in the program, the "Call options" dialog opens automatically. In this dialog you can specify whether the edge memory bit is stored in its own data block (single instance) or as a local tag (multiple instance) in the block interface. If you create a separate data block, you will find this in the project tree in the "Program resources" folder under "Program blocks > System blocks". For additional information on this topic, refer to "See also".

**Parameters**

The following table shows the parameters of the instruction "Set tag on positive signal edge":

Parameter	Declaration	Data type	Memory area		Description
			S7-1200	S7-1500	
EN	Input	BOOL	I, Q, M, D, L	I, Q, M, D, L, T, C	Enable input
ENO	Output	BOOL	I, Q, M, D, L	I, Q, M, D, L	Enable output
CLK	Input	BOOL	I, Q, M, D, L or constant	I, Q, M, D, L, T, C or constant	Incoming signal, the edge of which is to be queried.
Q	Output	BOOL	I, Q, M, D, L	I, Q, M, D, L	Result of edge evaluation

**Example**

The following example shows how the instruction works:

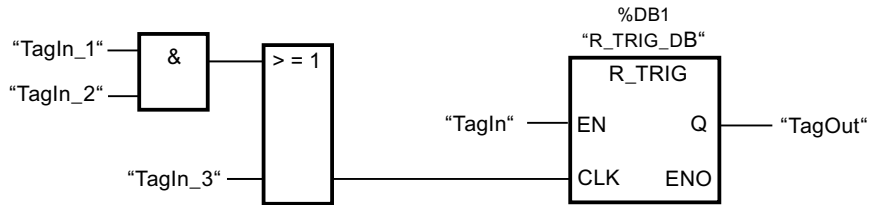

The RLO of the preceding query is saved in the instance DB "R\_TRIG\_DB". If a change in the signal state of the RLO from "0" to "1" is detected in the operands "TagIn\_1" and "TagIn\_2" or in the operand "TagIn\_3", the output "TagOut" has signal state "1".

**See also**

Overview of the valid data types (Page 1077)

**F\_TRIG: Set tag on negative signal edge**

**Description**

You can use the "Set tag on negative signal edge" instruction to set a specified tag in the instance DB when there is a "1" to "0" change in the result of logic operation (RLO). The instruction compares the current RLO at the input CLK with the RLO from the previous query, which is saved in the specified instance DB. If the instruction detects a change in the result of logic operation (RLO) from "1" to "0", there is a negative, falling edge.

If a negative edge is detected, the tag in the instance DB is set to signal state "1" and the output Q returns the signal state "1". In all other cases, the signal state at the output of the instruction is "0".

When you insert the instruction in the program, the "Call options" dialog opens automatically. In this dialog you can specify whether the edge memory bit is stored in its own data block (single instance) or as a local tag (multiple instance) in the block interface. If you create a separate data block, you will find this in the project tree in the "Program resources" folder under "Program blocks > System blocks". For additional information on this topic, refer to "See also".

**Parameters**

The following table shows the parameters of the instruction "Set tag on negative signal edge":

Parameter	Declaration	Data type	Memory area		Description
			S7-1200	S7-1500	
EN	Input	BOOL	I, Q, M, D, L	I, Q, M, D, L, T, C	Enable input
ENO	Output	BOOL	I, Q, M, D, L	I, Q, M, D, L	Enable output

Parameter	Declaration	Data type	Memory area		Description
			S7-1200	S7-1500	
CLK	Input	BOOL	I, Q, M, D, L or constant	I, Q, M, D, L, T, C or constant	Incoming signal, the edge of which is to be queried.
Q	Output	BOOL	I, Q, M, D, L	I, Q, M, D, L	Result of edge evaluation

## Example

The following example shows how the instruction works:

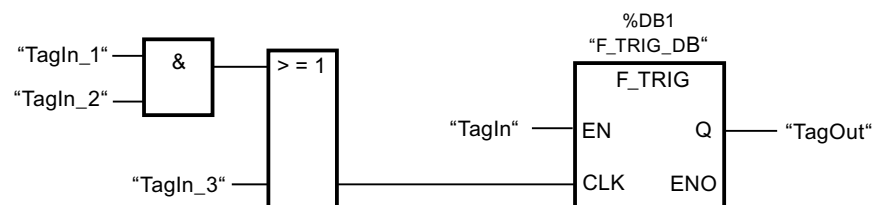

The RLO of the preceding query is saved in the instance DB "F\_TRIG\_DB". If a change in the signal state of the RLO from "1" to "0" is detected in the operands "TagIn\_1" and "TagIn\_2" or in the operand "TagIn\_3", the output "TagOut" has signal state "1".

## See also

Overview of the valid data types (Page 1077)

## Timer operations

### IEC Timers

### TP: Generate pulse

## Description

You can use the instruction "Generate pulse" to set output Q for the duration PT. The instruction is started when the result of logic operation (RLO) at input IN changes from "0" to "1" (positive signal edge). The configured time duration PT begins when the instruction starts. Output Q is set for the time duration PT, regardless of the subsequent course of the input signal (positive edge). Even when a new positive signal edge is detected, the signal state of the Q output is not affected as long as the PT duration is running.

The current time value can be queried at the output ET. The time value starts at T#0s and ends when the value of the time duration PT is reached. If the configured time duration PT is reached and the signal state at input IN is "0", the ET output is reset.

Each call of the "Generate pulse" instruction must be assigned an IEC Timer in which the instruction data is stored.

---

**Note**

If the timer is not called in the program because it is skipped, for example, output ET returns a constant value as soon as the timer has expired.

---

### For S7-1200 CPU

An IEC Timer is a structure of the data type IEC\_TIMER or TP\_TIME that you can declare as follows:

- Declaration of a data block of system data type IEC\_TIMER (for example, "MyIEC\_TIMER")
- Declaration as a local tag of the type TP\_TIME or IEC\_TIMER in the "Static" section of a block (for example, #MyIEC\_TIMER)

### For S7-1500 CPU

An IEC Timer is a structure of the data type IEC\_TIMER, IEC\_LTIMER, TP\_TIME or TP\_LTIME that you can declare as follows:

- Declaration of a data block of system data type IEC\_TIMER or IEC\_LTIMER (for example, "MyIEC\_TIMER")
- Declaration as a local tag of the type TP\_TIME, TP\_LTIME, IEC\_TIMER or IEC\_LTIMER in the "Static" section of a block (for example, #MyIEC\_TIMER)

When you insert the instruction in the program, the "Call options" dialog opens in which you can specify whether the IEC Timer is stored in its own data block (single instance) or as a local tag (multiple instance) in the block interface. If you create a separate data block, you will find this in the project tree in the "Program resources" folder under "Program blocks > System blocks". For additional information on this topic, refer to "See also".

The instruction data is updated both when the instruction is called and also each time the outputs Q or ET are accessed.

The execution of the "Generate pulse" instruction requires a preceding logic operation. It can be placed within or at the end of the network.

## Parameters

The following table shows the parameters of the "Generate pulse" instruction:

Parameter	Declaration	Data type		Memory area		Description
		S7-1200	S7-1500	S7-1200	S7-1500	
IN	Input	BOOL	BOOL	I, Q, M, D, L	I, Q, M, D, L, T, C, P	Start input
PT	Input	TIME	TIME, LTIME	I, Q, M, D, L or constant	I, Q, M, D, L, P or constant	Duration of the pulse. The value of the PT parameter must be positive.
Q	Output	BOOL	BOOL	I, Q, M, D, L	I, Q, M, D, L, P	Pulse output
ET	Output	TIME	TIME, LTIME	I, Q, M, D, L	I, Q, M, D, L, P	Current time value

For additional information on valid data types, refer to "See also".

## Pulse timing diagram

The following figure shows the pulse timing diagram of the "Generate pulse" instruction:

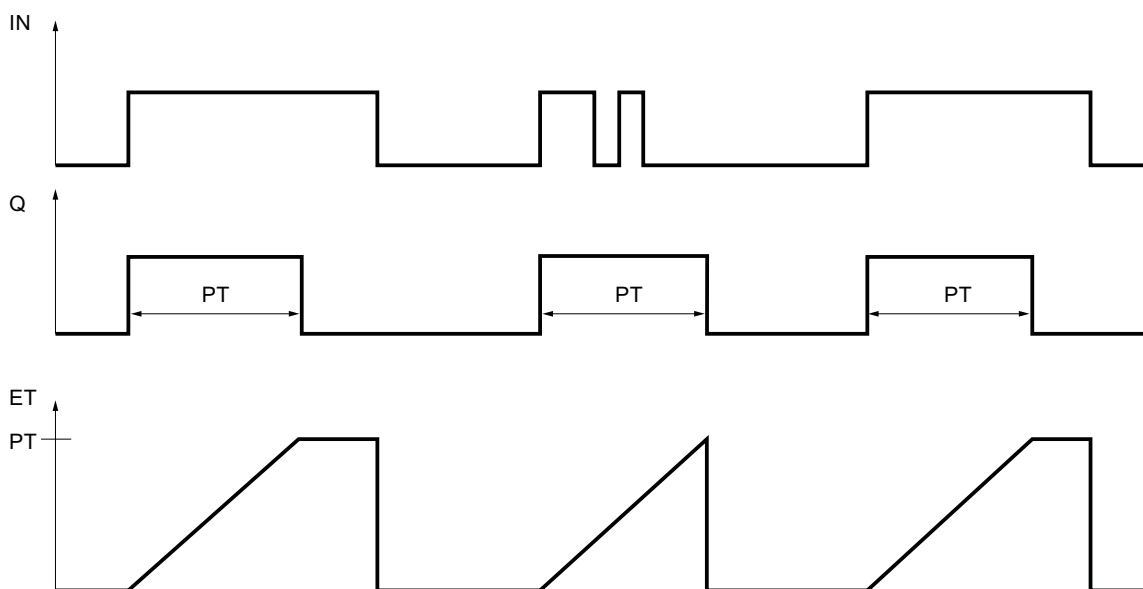

## See also

Overview of the valid data types (Page 1077)

Example of controlling room temperature (Page 1564)

## TON: Generate on-delay

### Description

You can use the instruction "Generate on-delay" to delay setting of the Q output by the time configured with the PT time. The instruction is started when the result of logic operation (RLO) at input IN changes from "0" to "1" (positive signal edge). The programmed time PT begins when the instruction starts. When the duration PT expires, output Q has the signal state "1". Output Q remains set as long as the start input is still "1". When the signal state at the start input changes from "1" to "0", the Q output is reset. The timer function is started again when a new positive signal edge is detected at the start input.

The current time value can be queried at the output ET. The time value starts at T#0s and ends when the value of the time duration PT is reached. The ET output is reset as soon as the signal state at the IN input changes to "0".

Each call of the "Generate on-delay" instruction must be assigned an IEC Timer in which the instruction data is stored.

---

#### Note

If the timer is not called in the program because it is skipped, for example, output ET returns a constant value as soon as the timer has expired.

---

### For S7-1200 CPU

An IEC Timer is a structure of the data type IEC\_TIMER or TON\_TIME that you can declare as follows:

- Declaration of a data block of system data type IEC\_TIMER (for example, "MyIEC\_TIMER")
- Declaration as a local tag of the type TON\_TIME or IEC\_TIMER in the "Static" section of a block (for example, #MyIEC\_TIMER)

### For S7-1500 CPU

An IEC Timer is a structure of the data type IEC\_TIMER, IEC\_LTIMER, TON\_TIME or TON\_LTIME that you can declare as follows:

- Declaration of a data block of system data type IEC\_TIMER or IEC\_LTIMER (for example, "MyIEC\_TIMER")
- Declaration as a local tag of the type TON\_TIME, TON\_LTIME, IEC\_TIMER or IEC\_LTIMER in the "Static" section of a block (for example, #MyIEC\_TIMER)

When you insert the instruction in the program, the "Call options" dialog opens in which you can specify whether the IEC Timer is stored in its own data block (single instance) or as a local tag (multiple instance) in the block interface. If you create a separate data block, it is saved to the "Program resources" folder in the "Program blocks > System blocks" path of the project tree. For additional information on this topic, refer to "See also".

The instruction data is updated both when the instruction is called and also each time the outputs Q or ET are accessed.

The execution of the "Generate on-delay" instruction requires a preceding logic operation. It can be placed within or at the end of the network.

## Parameters

The following table shows the parameters of the "Generate on-delay" instruction:

Parameter	Declaration	Data type		Memory area		Description
		S7-1200	S7-1500	S7-1200	S7-1500	
IN	Input	BOOL	BOOL	I, Q, M, D, L	I, Q, M, D, L, T, C, P	Start input
PT	Input	TIME	TIME, LTIME	I, Q, M, D, L or constant	I, Q, M, D, L, P or constant	Duration of the on delay. The value of the PT parameter must be positive.
Q	Output	BOOL	BOOL	I, Q, M, D, L	I, Q, M, D, L, P	Output that is set when the time PT expires.
ET	Output	TIME	TIME, LTIME	I, Q, M, D, L	I, Q, M, D, L, P	Current time value

For additional information on valid data types, refer to "See also".

## Pulse timing diagram

The following figure shows the pulse timing diagram of the "Generate on-delay" instruction:

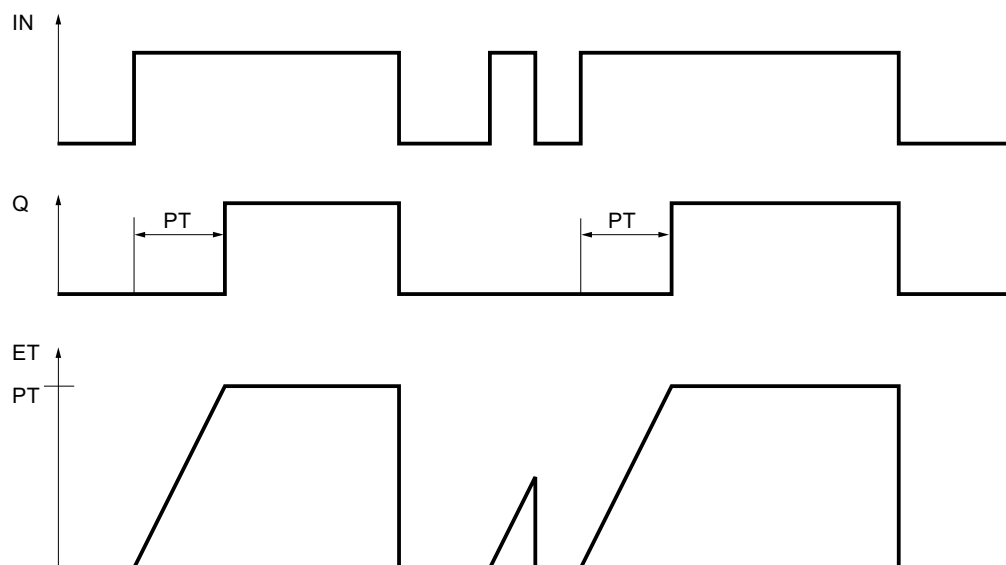

## See also

Overview of the valid data types (Page 1077)

## TOF: Generate off-delay

### Description

You can use the "Generate off-delay" instruction to delay setting of the Q output by the time configured with the PT time. The output Q is set when the result of logic operation (RLO) at input IN changes from "0" to "1" (positive signal edge). When the signal state at input IN changes back to "0" (positive signal edge), the configured time duration PT starts. Output Q remains set as long as the time duration PT is running. When the PT time duration expires, the Q output is reset. If the signal state at input IN changes to "1" before the PT time duration expires, the timer is reset. The signal state at the output Q will continue to be "1".

The current time value can be queried at the output ET. The time value starts at T#0s and ends when the value of the time duration PT is reached. When the time duration PT expires, the ET output remains set to the current value until input IN changes back to "1". If input IN changes to "1" before the time duration PT has expired, the ET output is reset to the value T#0s.

Each call of the "Generate off-delay" instruction must be assigned to an IEC Timer in which the instruction data is stored.

---

### Note

If the timer is not called in the program because it is skipped, for example, output ET returns a constant value as soon as the timer has expired.

---

### For S7-1200 CPU

An IEC Timer is a structure of the data type IEC\_TIMER or TOF\_TIME that you can declare as follows:

- Declaration of a data block of system data type IEC\_TIMER (for example, "MyIEC\_TIMER")
- Declaration as a local tag of the type TOF\_TIME or IEC\_TIMER in the "Static" section of a block (for example, #MyIEC\_TIMER)

### For S7-1500 CPU

An IEC Timer is a structure of the data type IEC\_TIMER, IEC\_LTIMER, TOF\_TIME or TOF\_LTIME that you can declare as follows:

- Declaration of a data block of system data type IEC\_TIMER or IEC\_LTIMER (for example, "MyIEC\_TIMER")
- Declaration as a local tag of the type TOF\_TIME, TOF\_LTIME, IEC\_TIMER or IEC\_LTIMER in the "Static" section of a block (for example, #MyIEC\_TIMER)

When you insert the instruction in the program, the "Call options" dialog opens in which you can specify whether the IEC Timer is stored in its own data block (single instance) or as a local



tag (multiple instance) in the block interface. If you create a separate data block, you will find this in the project tree in the "Program resources" folder under "Program blocks > System blocks". For additional information on this topic, refer to "See also".

The instruction data is updated both when the instruction is called and also each time the outputs Q or ET are accessed.

The execution of the "Generate off-delay" instruction requires a preceding logic operation. It can be placed within or at the end of the network.

## Parameters

The following table shows the parameters of the "Generate off-delay" instruction:

Parameter	Declaration	Data type		Memory area		Description
		S7-1200	S7-1500	S7-1200	S7-1500	
IN	Input	BOOL	BOOL	I, Q, M, D, L	I, Q, M, D, L, T, C, P	Start input
PT	Input	TIME	TIME, LTIME	I, Q, M, D, L or constant	I, Q, M, D, L, P or constant	Duration of the off delay  The value of the PT parameter must be positive.
Q	Output	BOOL	BOOL	I, Q, M, D, L	I, Q, M, D, L, P	Output that is reset when the timer PT expires.
ET	Output	TIME	TIME, LTIME	I, Q, M, D, L	I, Q, M, D, L, P	Current time value

For additional information on valid data types, refer to "See also".

### Pulse timing diagram

The following figure shows the pulse timing diagram of the "Generate off-delay" instruction:

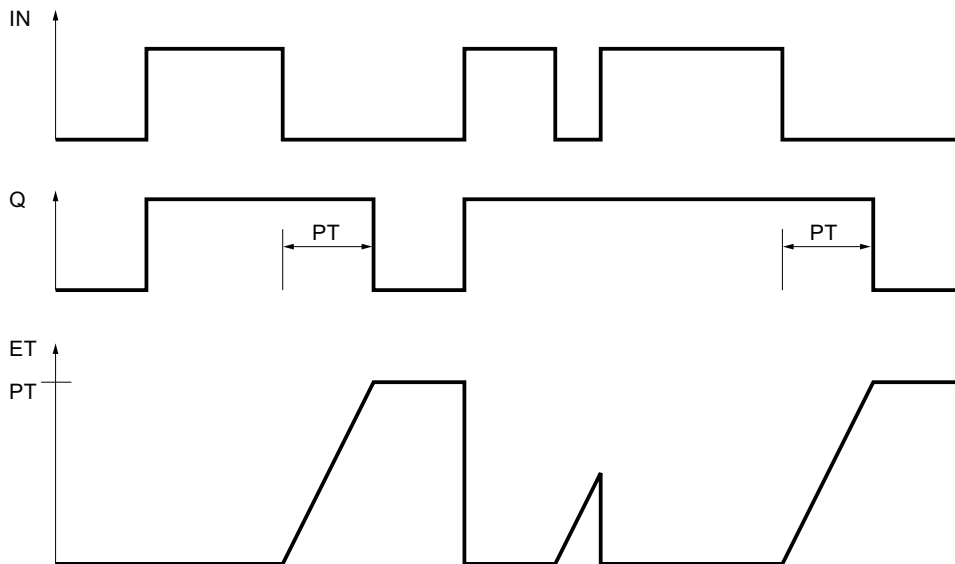

### See also

Overview of the valid data types (Page 1077)

### TONR: Time accumulator

#### Description

The instruction "Time accumulator" is used to accumulate time values within a period set by the parameter PT. The instruction is executed and the configured time duration PT is started when the result of logic operation (RLO) at input IN changes from "0" to "1" (positive edge). While the time set at PT is running, the time values are accumulated that are recorded at signal state "1" at input IN. The accumulated time is written to output ET and can be queried there. When the current time value PT is reached, the output Q has the signal state "1". Output Q remains set at "1", even when the signal state at input IN changes to "0".

The R input resets the outputs ET and Q regardless of the signal state at the start input.

Each call of the "Time accumulator" instruction must be assigned to an IEC Timer in which the instruction data is stored.

### For S7-1200 CPU

An IEC Timer is a structure of the data type IEC\_TIMER or TONR\_TIME that you can declare as follows:

- Declaration of a data block of system data type IEC\_TIMER (for example, "MyIEC\_TIMER")
- Declaration as a local tag of the type TONR\_TIME or IEC\_TIMER in the "Static" section of a block (for example, #MyIEC\_TIMER)

## For S7-1500 CPU

An IEC Timer is a structure of the data type IEC\_TIMER, IEC\_LTIMER, TONR\_TIME or TONR\_LTIME that you can declare as follows:

- Declaration of a data block of system data type IEC\_TIMER or IEC\_LTIMER (for example, "MyIEC\_TIMER")
- Declaration as a local tag of the type TONR\_TIME, TONR\_LTIME, IEC\_TIMER or IEC\_LTIMER in the "Static" section of a block (for example, #MyIEC\_TIMER)

When you insert the instruction in the program, the "Call options" dialog opens in which you can specify whether the IEC Timer is stored in its own data block (single instance) or as a local tag (multiple instance) in the block interface. If you create a separate data block, you will find this in the project tree in the "Program resources" folder under "Program blocks > System blocks". For additional information on this topic, refer to "See also".

The instruction data is updated both when the instruction is called and also each time the outputs Q or ET are accessed.

The execution of the "Time accumulator" instruction requires a preceding logic operation. It can be placed within or at the end of the network.

## Parameters

The following table shows the parameters of the "Time accumulator" instruction:

Parameter	Declaration	Data type		Memory area		Description
		S7-1200	S7-1500	S7-1200	S7-1500	
IN	Input	BOOL	BOOL	I, Q, M, D, L	I, Q, M, D, L, T, C, P	Start input
R	Input	BOOL	BOOL	I, Q, M, D, L or constant	I, Q, M, D, L, P or constant	Reset input
PT	Input	TIME	TIME, LTIME	I, Q, M, D, L or constant	I, Q, M, D, L, P or constant	Maximum duration of time recording. The value of the PT parameter must be positive.
Q	Output	BOOL	BOOL	I, Q, M, D, L	I, Q, M, D, L, P	Output that is set when the time PT expires.
ET	Output	TIME	TIME, LTIME	I, Q, M, D, L	I, Q, M, D, L, P	Current time value

For additional information on valid data types, refer to "See also".

### Pulse timing diagram

The following figure shows the pulse timing diagram of the "Time accumulator" instruction:

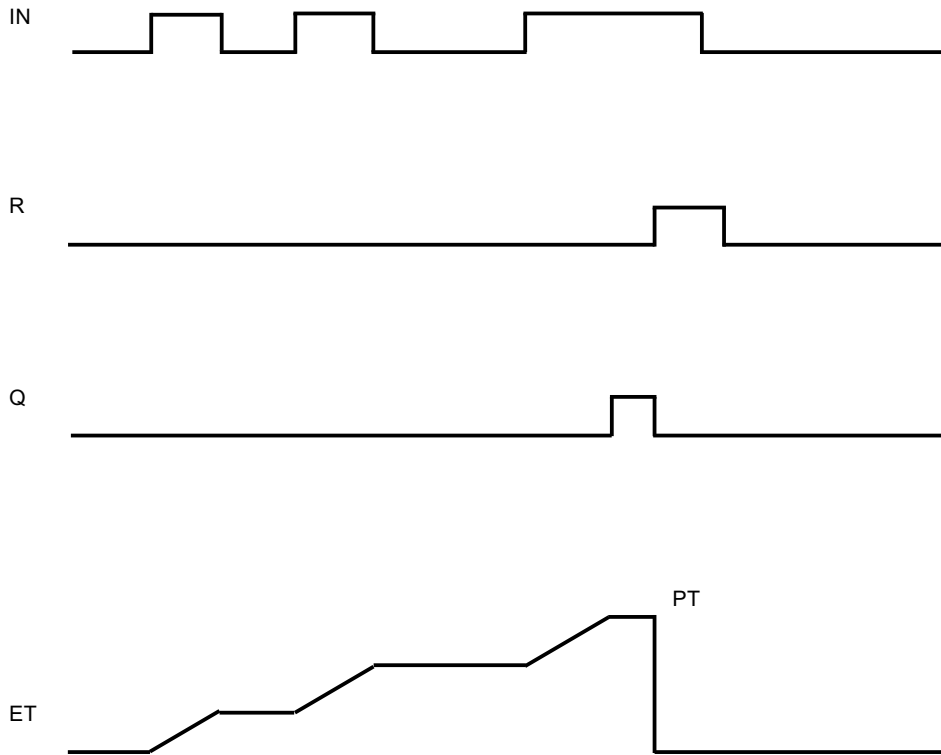

### See also

Overview of the valid data types (Page 1077)

### TP: Start pulse timer

#### Description

Use the instruction "Start pulse timer" to start an IEC Timer with a specified duration as pulse. The IEC Timer is started when the result of logic operation (RLO) changes from "0" to "1" (positive signal edge). The IEC Timer runs for the specified time duration regardless of the subsequent course of the RLO. The expiry of the IEC Timer is also not affected by the detection of a new rising edge. As long as the IEC Timer is running, the querying of the timer status for "1" returns the signal state "1". When the IEC Timer has expired, the timer status returns the signal state "0".

---

#### Note

The start and the query of the IEC Timer may be on different expiry levels as each query of the outputs Q or ET updates the IEC\_TIMER structure.

---

### For S7-1200 CPU

The instruction "Start pulse timer" stores its data in a structure of the data type IEC\_TIMER or TP\_TIME. You can declare the structure as follows:

- Declaration of a data block of system data type IEC\_TIMER (for example, "MyIEC\_TIMER")
- Declaration as a local tag of the type TP\_TIME or IEC\_TIMER in the "Static" section of a block (for example, #MyIEC\_TIMER)

### For S7-1500 CPU

The instruction "Start pulse timer" stores its data in a structure of the data type IEC\_TIMER, IEC\_LTIMER, TP\_TIME or TP\_LTIME. You can declare the structure as follows:

- Declaration of a data block of system data type IEC\_TIMER or IEC\_LTIMER (for example, "MyIEC\_TIMER")
- Declaration as a local tag of the type TP\_TIME, TP\_LTIME, IEC\_TIMER or IEC\_LTIMER in the "Static" section of a block (for example, #MyIEC\_TIMER)

The instruction data is updated both when the instruction is called and also each time the specified timer is accessed.

The current timer status is saved in the structure components Q of the IEC Timer. You can query the timer status with the help of a binary logic operation. The query for Q or ET (e. g. "MyTimer".Q or "MyTimer".ET) updates the IEC\_TIMER structure.

The execution of the instruction "Start pulse timer" assumes a preceding logic operation. It can be placed only at the end of the network.

### Parameters

The following table shows the parameters of the instruction "Start pulse timer":

Parameters	Declaration	Data type		Memory area	Description
		S7-1200	S7-1500		
VALUE	Input	TIME	TIME, LTIME	I, Q, M, D, L or constant	Duration with which the IEC Timer runs.
<IEC Timer>	InOut	IEC_TIMER, TP_TIME	IEC_TIMER, IEC_LTIMER, TP_TIME, TP_LTIME	D, L	IEC Timer which is started.

For additional information on valid data types, refer to "See also".

**Example**

The following example shows how the instruction works:

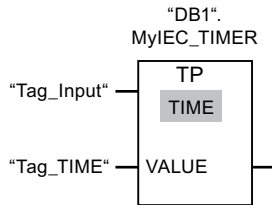

The instruction "Start pulse timer" is executed when the signal state of the operand "Tag\_Input" changes from "0" to "1". The timer "DB1".MyIEC\_TIMER is started for the time stored in the operand "TagTime".

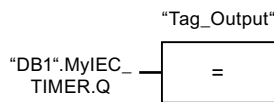

As long as the timer "DB1".MyIEC\_TIMER is running, the timer status ("DB1".MyIEC\_TIMER.Q) has signal state "1" and the operand "Tag\_Output" is set. When the IEC Timer has expired, the signal state of the time status changes back to "0" and the "Tag\_Output" operand is reset.

**See also**

Overview of the valid data types (Page 1077)

**TON: Start on-delay timer**

**Description**

Use the "Start on-delay timer" instruction to start an IEC Timer with a specified duration as on-delay. The IEC Timer is started when the result of logic operation (RLO) changes from "0" to "1" (positive signal edge). The IEC Timer runs for the specified time duration. The output returns the signal state "1" if the RLO at the input of the instruction has the signal state "1". If the RLO changes to "0" before the end of the timer, the running IEC Timer is reset. The query of the timer status for "1" returns the signal state "0". The IEC Timer restarts when the next rising signal edge is detected at the input of the instruction.

**Note**

The start and the query of the IEC Timer may be on different expiry levels as each query of the outputs Q or ET updates the IEC\_TIMER structure.

### For S7-1200 CPU

The instruction "Start on-delay timer" stores its data in a structure of the data type IEC\_TIMER or TON\_TIME. You can declare the structure as follows:

- Declaration of a data block of system data type IEC\_TIMER (for example, "MyIEC\_TIMER")
- Declaration as a local tag of the type TON\_TIME or IEC\_TIMER in the "Static" section of a block (for example, #MyIEC\_TIMER)

### For S7-1500 CPU

The "Start on-delay timer" instruction stores its data in a structure of the data type IEC\_TIMER, IEC\_LTIMER, TON\_TIME or TON\_LTIME. You can declare the structure as follows:

- Declaration of a data block of system data type IEC\_TIMER or IEC\_LTIMER (for example, "MyIEC\_TIMER")
- Declaration as a local tag of the type TON\_TIME, TON\_LTIME, IEC\_TIMER or IEC\_LTIMER in the "Static" section of a block (for example, #MyIEC\_TIMER)

The instruction data is updated both when the instruction is called and also each time the specified timer is accessed.

The current timer status is saved in the structure components ET of the IEC Timer. You can query the timer status with the help of a binary logic operation. The query for Q or ET (e. g. "MyTimer".Q or "MyTimer".ET) updates the IEC\_TIMER structure.

The execution of the "Start on-delay timer" instruction assumes a preceding logic operation. It can be placed only at the end of the network.

### Parameters

The following table shows the parameters of the instruction "Start on-delay timer":

Parameters	Declaration	Data type		Memory area	Description
		S7-1200	S7-1500		
VALUE	Input	TIME	TIME, LTIME	I, Q, M, D, L or constant	Duration with which the IEC Timer runs.
<IEC Timer>	InOut	IEC_TIMER, TON_TIME	IEC_TIMER, IEC_LTIMER, TON_TIME, TON_LTIME	D, L	IEC Timer which is started.

For additional information on valid data types, refer to "See also".

### Example

The following example shows how the instruction works:

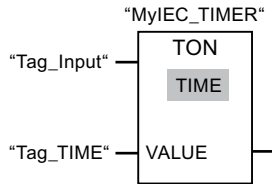

The "Start on-delay timer" instruction is executed when the signal state of the operand "Tag\_Input" changes from "0" to "1". The "MyIEC\_TIMER" timer is started for the time stored in the "Tag\_TIME" operand.

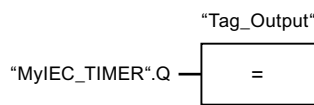

If the timer "MyIEC\_TIMER" has expired and the operand "Tag\_Input" has the signal state "1", querying the timer status ("MyIEC\_TIMER".Q) returns signal state "1" and the "Tag\_Output" operand is set. When the signal state of the operand "Tag\_Input" changes to "0", the querying of the timer status returns the signal state "0" and the operand "Tag\_Output" is reset.

### See also

Overview of the valid data types (Page 1077)

### TOF: Start off-delay timer

#### Description

Use the "Start off-delay timer" instruction to start an IEC Timer with a specified duration as off-delay. The query of the timer status for "1" returns the signal state "0" if the result of the logic operation (RLO) at the input of the instruction has the signal state "1". When the RLO changes from "1" to "0" (negative signal edge), the IEC Timer starts with the specified time duration. The timer status remains at signal state "1" as long as the IEC Timer is running. When the timer has run out and the RLO at the input of the instruction has the signal state "0", the timer status is set to the signal state "0". If the RLO changes to "1" before the end of the timer, the running IEC Timer is reset and the timer status remain at the signal state "1".

---

#### Note

The start and the query of the IEC Timer may be on different expiry levels as each query of the outputs Q or ET updates the IEC\_TIMER structure.

---



### For S7-1200 CPU

The instruction "Start off-delay timer" stores its data in a structure of the data type IEC\_TIMER or TOF\_TIME. You can declare the structure as follows:

- Declaration of a data block of system data type IEC\_TIMER (for example, "MyIEC\_TIMER")
- Declaration as a local tag of the type TOF\_TIME or IEC\_TIMER in the "Static" section of a block (for example, #MyIEC\_TIMER)

### For S7-1500 CPU

The "Start off-delay timer" instruction stores its data in a structure of the data type IEC\_TIMER, IEC\_LTIMER, TOF\_TIME or TOF\_LTIME. You can declare the structure as follows:

- Declaration of a data block of system data type IEC\_TIMER or IEC\_LTIMER (for example, "MyIEC\_TIMER")
- Declaration as a local tag of the type TOF\_TIME, TOF\_LTIME, IEC\_TIMER or IEC\_LTIMER in the "Static" section of a block (for example, #MyIEC\_TIMER)

The instruction data is updated both when the instruction is called and also each time the specified timer is accessed.

The current timer status is saved in the structure components ET of the IEC Timer. You can query the timer status with the help of a binary logic operation. The query for Q or ET (e. g. "MyTimer".Q or "MyTimer".ET) updates the IEC\_TIMER structure.

The execution of the "Start off-delay timer" instruction assumes a preceding logic operation. It can be placed only at the end of the network.

### Parameters

The following table shows the parameters of the instruction "Start off-delay timer":

Parameters	Declaration	Data type		Memory area	Description
		S7-1200	S7-1500		
VALUE	Input	TIME	TIME, LTIME	I, Q, M, D, L or constant	Duration with which the IEC Timer runs.
<IEC Timer>	InOut	IEC_TIMER, TOF_TIME	IEC_TIMER, IEC_LTIMER, TOF_TIME, TOF_LTIME	D, L	IEC Timer which is started.

For additional information on valid data types, refer to "See also".

**Example**

The following example shows how the instruction works:

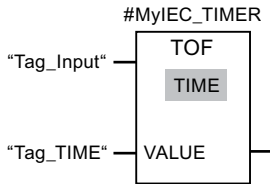

The "Start off-delay timer" instruction is executed when the signal state of the operand "Tag\_Input" changes from "1" to "0". The #MyIEC\_TIMER timer is started for the time stored in the operand "Tag\_TIME".

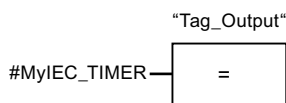

As long as timer #MyIEC\_TIMER is running, the query of the time status (#MyIEC\_TIMER.Q) returns the signal state "1" and operand "Tag\_Output" is set. If the timer has expired and the operand "Tag\_Input" has the signal state "0", the query of the timer status returns the signal state "0". If the signal state of the operand "Tag\_Input" changes to "1" before timer #MyIEC\_TIMER expires, the timer is reset. When the signal state of the operand "Tag\_Input" is "1", the query of the timer status returns the signal state "1".

**See also**

Overview of the valid data types (Page 1077)

**TONR: Time accumulator**

**Description**

You can use the "Time accumulator" instruction to record how long the signal is at the input of instruction "1". The instruction is started when the result of logic operation (RLO) changes from "0" to "1" (positive signal edge). The time is recorded as long at the RLO is "1". If the RLO changes to "0", the instruction is halted. If the RLO changes back to "1", the time recording is continued. The query of the timer status for "1" returns the signal state "1" if the recorded time exceeds the value of the specified time duration and the RLO at the input of coil is "1".

The timer status and the currently expired timer can be reset to "0" using the "Reset timer" instruction.

**Note**

The start and the query of the IEC Timer may be on different expiry levels as each query of the outputs Q or ET updates the IEC\_TIMER structure.

### For S7-1200 CPU

The "Time accumulator" instruction stores its data in a structure of the data type IEC\_TIMER or TONR\_TIME. You can declare the structure as follows:

- Declaration of a data block of system data type IEC\_TIMER (for example, "MyIEC\_TIMER")
- Declaration as a local tag of the type TONR\_TIME or IEC\_TIMER in the "Static" section of a block (for example, #MyIEC\_TIMER)

### For S7-1500 CPU

The "Time accumulator" instruction stores its data in a structure of the data type IEC\_TIMER, IEC\_LTIMER, TONR\_TIME or TONR\_LTIME. You can declare the structure as follows:

- Declaration of a data block of system data type IEC\_TIMER or IEC\_LTIMER (for example, "MyIEC\_TIMER")
- Declaration as a local tag of the type TONR\_TIME, TONR\_LTIME, IEC\_TIMER or IEC\_LTIMER in the "Static" section of a block (for example, #MyIEC\_TIMER)

The instruction data is updated both when the instruction is called and also each time the specified timer is accessed.

The current timer status is saved in the structure components ET of the IEC Timer. You can query the timer status with the help of a binary logic operation. The query for Q or ET (e. g. "MyTimer".Q or "MyTimer".ET) updates the IEC\_TIMER structure.

The execution of the "Time accumulator" instruction requires a preceding logic operation. It can be placed only at the end of the network.

### Parameters

The following table shows the parameters of the "Time accumulator" instruction:

Parameters	Declaration	Data type		Memory area	Description
		S7-1200	S7-1500		
VALUE	Input	TIME	TIME, LTIME	I, Q, M, D, L or constant	Duration with which the IEC Timer runs.
<IEC Timer>	InOut	IEC_TIMER, TONR_TIME	IEC_TIMER, IEC_LTIMER, TONR_TIME, TONR_LTIME	D, L	IEC Timer which is started.

For additional information on valid data types, refer to "See also".

**Example**

The following example shows how the instruction works:

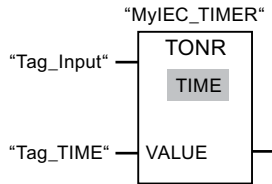

The "Time accumulator" instruction is executed if there is a positive signal edge in the RLO. The time is recorded as long as the operand "Tag\_Input" has the signal state "1".

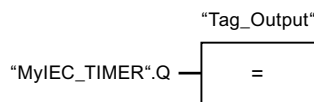

If the recorded time exceeds the value of the operand "Tag\_TIME", then the query of the timer status ("MyIEC\_TIMER".Q) will return the signal state "1" and the operand "Tag\_Output" will be set.

**See also**

Overview of the valid data types (Page 1077)

RT: Reset timer (Page 1876)

**RT: Reset timer**

**Description**

You can use the "Reset timer" instruction to reset an IEC Timer to "0". You specify the IEC Timer to be reset by entering the name of the data block that contains the structure of the IEC Timer in the placeholder above the instruction.

The instruction is only executed if the result of logic operation (RLO) at the box input is "1". When the instruction is executed the structure components of the IEC Timer are reset to "0" in the specified data block. If the RLO at box input is "0", the instruction is not executed.

The instruction does not influence the RLO. The RLO at the box input is transferred directly to the box output.

You must assign a IEC Timer declared in the program to the "Reset timer" instruction.

The instruction data is updated only when the instruction is called and not each time the assigned IEC Timer is accessed. The query of the data is only identical from the call of the instruction to the next call of the instruction.

## Parameters

The following table shows the parameters of the instruction "Reset timer":

Parameters	Declaration	Data type		Memory area	Description
		S7-1200	S7-1500		
<IEC Timer>	InOut	IEC_TIMER, TP_TIME, TON_TIME, TOF_TIME, TONR_TIME	IEC_TIMER, IEC_LTIMER, TP_TIME, TP_LTIME, TON_TIME, TON_LTIME, TOF_TIME, TOF_LTIME, TONR_TIME, TONR_LTIME	D, L	IEC Timer, which is reset.

For additional information on valid data types, refer to "See also".

## Example

The following example shows how the instruction works:

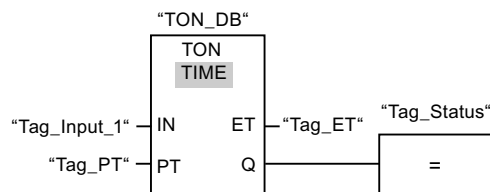

The "Generate on-delay" instruction executes when the signal state of the "Tag\_Input\_1" operand changes from "0" to "1". The IEC Timer stored in the instance data block "TON\_DB" is started with the time duration that is specified by the operand "Tag\_PT".

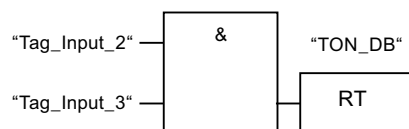

If the operands "Tag\_Input\_2" and "Tag\_Input\_3" have the signal state "1", the "Reset timer" instruction is executed and the IEC Timer stored in the data block "TON\_DB" is reset.

## See also

Overview of the valid data types (Page 1077)

**PT: Load time duration**

**Description**

Use the "Load time duration" instruction to set the time duration of an IEC Timer. The instruction is executed in every cycle when the result of logic operation (RLO) at the input of the instruction has the signal state "1". The instruction writes the specified time duration to the structure of the specified IEC Timer.

**Note**

If the specified IEC Timer is running during the execution, the instruction overwrites the current time duration of the specified IEC Timer. As a result, the timer status of the IEC Timer can change.

You must assign a IEC Timer declared in the program to the "Load time duration" instruction. The instruction data is updated when the instruction is called and each time the assigned IEC Timer is accessed. The query for Q or ET (e. g. "MyTimer".Q or "MyTimer".ET) updates the IEC\_TIMER structure.

**Parameters**

The following table shows the parameters of the instruction "Load time duration":

Parameters	Declaration	Data type		Memory area	Description
		S7-1200	S7-1500		
PT	Input	TIME	TIME, LTIME	I, Q, M, D, L or constant	Time duration
<IEC Timer>	InOut	IEC_TIMER, TP_TIME, TON_TIME, TOF_TIME, TONR_TIME	IEC_TIMER, IEC_LTIMER, TP_TIME, TP_LTIME, TON_TIME, TON_LTIME, TOF_TIME, TOF_LTIME, TONR_TIME, TONR_LTIME	D, L	IEC Timer, the duration of which is set.

For additional information on valid data types, refer to "See also".

## Example

The following example shows how the instruction works:

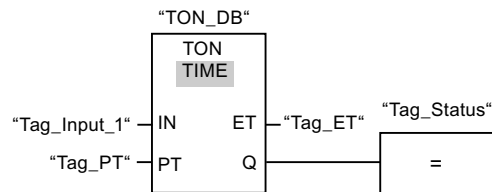

The "Generate on-delay" instruction executes when the signal state of the "Tag\_Input\_1" operand changes from "0" to "1". The IEC Timer stored in the instance data block "TON\_DB" is started with the time duration that is specified by the operand "Tag\_PT".

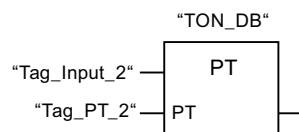

The "Load time duration" instruction is executed when the operand "Tag\_Input\_2" has the signal state "1". The instruction writes the time duration "Tag\_PT\_2" in the instance data block "TON\_DB" and at the same time overwrites the value of the operand "Tag\_PT" within the data block. As a result, the signal state of the timer status can change at the next query or upon access to "MyTimer".Q or "MyTimer".ET.

---

### Note

The "Tag\_Input\_2" is executed as pulse flag in order that the time duration is loaded only throughout one program cycle.

---

## See also

Overview of the valid data types (Page 1077)

## SIMATIC Timers

### S\_PULSE: Assign pulse timer parameters and start

#### Description

The "Assign pulse timer parameters and start" instruction starts a programmed timer when a transition from "0" to "1" (positive signal edge) is detected in the result of logic operation (RLO) at input S. The timer expires with the programmed duration (TV) as long as the signal state at input S is "1". If the signal state at input S changes to "0" before the programmed duration expires, the timer is stopped. In this case, the signal state at output Q is "0".

The duration is made up internally of a time value and a time base and is programmed at parameter TV. When the instruction is started, the programmed time value is counted down

to zero. The time base determines the time period of the time value. The current time value is output binary-coded at output BI and BCD-coded at output BCD.

If the timer is running and the signal state at input R changes to "1", the current time value and the time base are also set to zero. If the timer is not running, the signal state "1" at the R input has no effect.

The "Assign pulse timer parameters and start" instruction needs a preceding logic operation for the edge evaluation and can be placed within or at the end of the network.

The instruction data is updated with each access. It can therefore happen that the query of the data at the start of the cycle returns different values than at the end of the cycle.

**Note**

In the time cell, the operating system reduces the time value in an interval specified by the time base by one unit until the value equals "0". The decrementation is performed asynchronously to the user program. The resulting timer is therefore at maximum up to one time interval shorter than the desired time base.

You can find an example of how a time cell can be formed under: See also "L: Load timer value".

**Parameters**

The following table shows the parameters of the "Assign pulse timer parameters and start" instruction:

Parameter	Declaration	Data type	Memory area	Description
<Timer>	InOut/Input	TIMER	T	Time of the instruction The number of timers depends on the CPU.
S	Input	BOOL	I, Q, M, T, C, D, L, P	Start input
TV	Input	S5TIME, WORD	I, Q, M, D, L or constant	Time duration
R	Input	BOOL	I, Q, M, T, C, D, L, P or constant	Reset input
BI	Output	WORD	I, Q, M, D, L, P	Current time value (binary-coded)
BCD	Output	WORD	I, Q, M, D, L, P	Current time value (BCD format)
Q	Output	BOOL	I, Q, M, D, L, P	Status of the timer

For additional information on valid data types, refer to "See also".



### Pulse timing diagram

The following figure shows the pulse timing diagram of the "Assign pulse timer parameters and start" instruction:

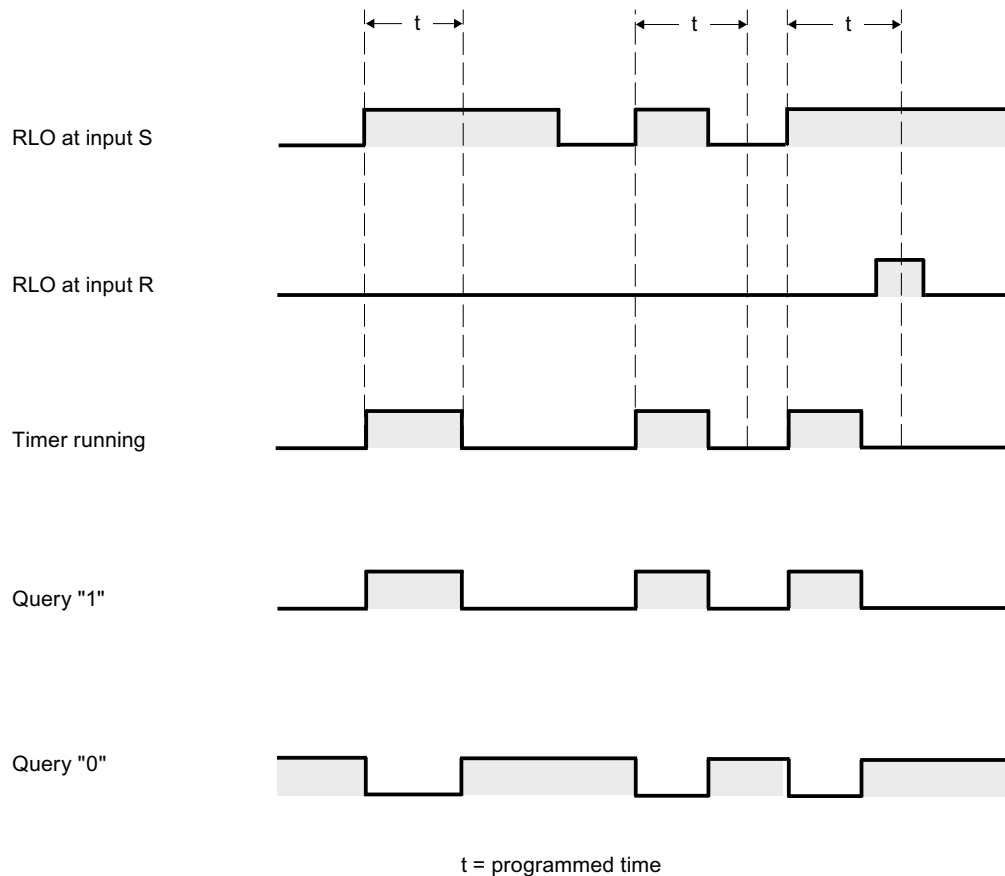

### Example

The following example shows how the instruction works:

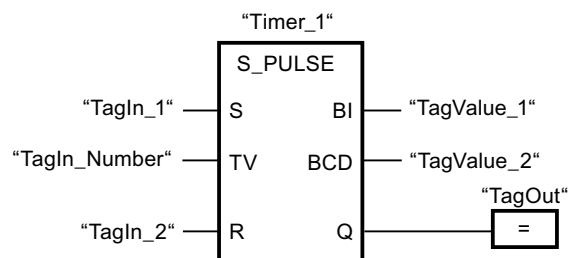

"Timer\_1" starts when the signal state of the "TagIn\_1" operand changes from "0" to "1". The timer runs for the time value of the "TagIn\_Number" operand as long as the "TagIn\_1" operand has the signal state "1". If the signal state of the operand "TagIn\_1" changes from "1" to "0" before the timer expires, the timer "Timer\_1" is stopped. The "TagOut" operand is reset to signal state "0".

The "TagOut" operand has the signal state "1" as long as the timer is running and the "TagIn\_1" operand has the signal state "1". When the time has expired or is reset, the "TagOut" operand is reset to "0".

### See also

Overview of the valid data types (Page 1077)

## S\_PEXT: Assign extended pulse timer parameters and start

### Description

The "Assign extended pulse timer parameters and start" instruction starts a programmed timer when a transition from "0" to "1" (positive signal edge) is detected in the result of logic operation (RLO) at input S. The timer expires with the programmed duration (TV), even if the signal state at input S changes to "0". As long as the timer is running, output Q has the signal state "1". When the timer has expired, output Q is reset to "0". If the signal state at input S changes from "0" to "1" while the timer is running, the timer is restarted with the duration programmed at input TV.

The duration is made up internally of a time value and a time base and is programmed at parameter TV. When the instruction is started, the programmed time value is counted down to zero. The time base determines the time period of the time value. The current time value is output binary-coded at output BI and BCD-coded at output BCD.

If the timer is running and the signal state at input R changes to "1", the current time value and the time base are also set to zero. If the timer is not running, the signal state "1" at the R input has no effect.

The "Assign extended pulse timer parameters and start" instruction needs a preceding logic operation for the edge evaluation and can be placed within or at the end of the network.

The instruction data is updated with each access. It can therefore happen that the query of the data at the start of the cycle returns different values than at the end of the cycle.

---

### Note

In the time cell, the operating system reduces the time value in an interval specified by the time base by one unit until the value equals "0". The decrementation is performed asynchronously to the user program. The resulting timer is therefore at maximum up to one time interval shorter than the desired time base.

---

You can find an example of how a time cell can be formed under: See also "L: Load timer value".

## Parameters

The following table shows the parameters of the "Assign extended pulse timer parameters and start" instruction:

Parameter	Declaration	Data type	Memory area	Description
<Timer>	InOut/Input	TIMER	T	Time of the instruction The number of timers depends on the CPU.
S	Input	BOOL	I, Q, M, T, C, D, L, P	Start input
TV	Input	S5TIME, WORD	I, Q, M, D, L or constant	Time duration
R	Input	BOOL	I, Q, M, T, C, D, L, P or constant	Reset input
BI	Output	WORD	I, Q, M, D, L, P	Current time value (binary-coded)
BCD	Output	WORD	I, Q, M, D, L, P	Current time value (BCD format)
Q	Output	BOOL	I, Q, M, D, L, P	Status of the timer

For additional information on valid data types, refer to "See also".

**Pulse timing diagram**

The following figure shows the pulse timing diagram of the "Assign extended pulse timer parameters and start" instruction:

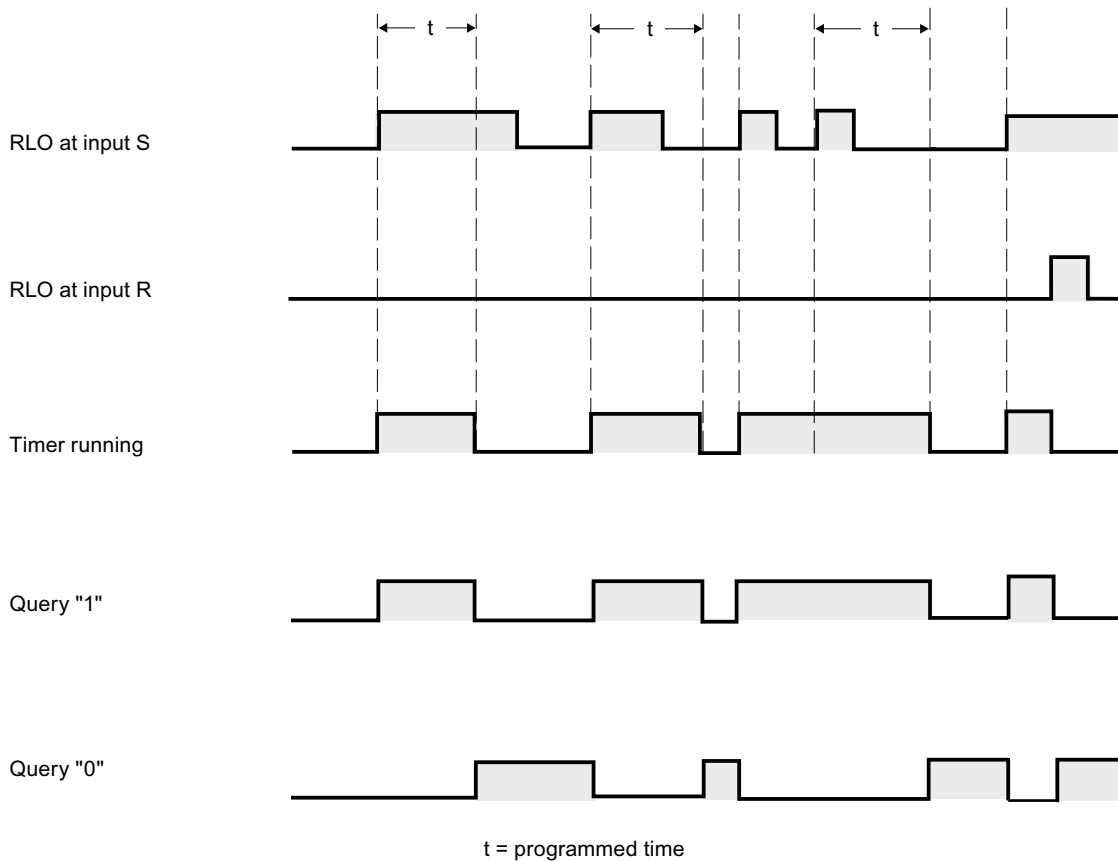

**Example**

The following example shows how the instruction works:

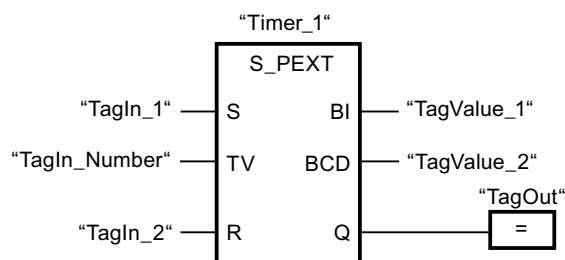

"Timer\_1" starts when the signal state of the "TagIn\_1" operand changes from "0" to "1". The timer runs for the time value of the "TagIn\_Number" operand without being affected by a negative edge at the S input. If the signal state at the "TagIn\_1" operand changes from "0" to "1" before the timer expires, the timer is restarted.

The "TagOut" operand has the signal state "1" as long as the timer is running. When the time has expired or is reset, the "TagOut" operand is reset to "0".

**See also**

Overview of the valid data types (Page 1077)

**S\_ODT: Assign on-delay timer parameters and start****Description**

The "Assign on-delay timer parameters and start" instruction starts a programmed timer when a transition from "0" to "1" (positive signal edge) is detected in the result of logic operation (RLO) at input S. The timer expires with the programmed duration (TV) as long as the signal state at input S is "1". If the timer expires correctly and input S still has signal state "1", output Q returns signal state "1". If the signal state at input S changes from "1" to "0" while the timer is running, the timer is stopped. In this case, output Q is reset to signal state "0".

The duration is made up internally of a time value and a time base and is programmed at parameter TV. When the instruction is started, the programmed time value is counted down to zero. The time base determines the time period of the time value. The current time value is output binary-coded at output BI and BCD-coded at output BCD.

If the time is running and the signal state at input R changes from "0" to "1", the current time value and the time base are also set to zero. In this case, the signal state at output Q is "0". The timer is reset if the signal state is "1" at the R input even if the timer is not running and the RLO at input S is "1".

The "Assign on-delay timer parameters and start" instruction needs a preceding logic operation for the edge evaluation and can be placed within or at the end of the network.

The instruction data is updated with each access. It can therefore happen that the query of the data at the start of the cycle returns different values than at the end of the cycle.

---

**Note**

In the time cell, the operating system reduces the time value in an interval specified by the time base by one unit until the value equals "0". The decrementation is performed asynchronously to the user program. The resulting timer is therefore at maximum up to one time interval shorter than the desired time base.

---

You can find an example of how a time cell can be formed under: See also "L: Load timer value".

**Parameters**

The following table shows the parameters of the "Assign on-delay timer parameters and start" instruction:

Parameter	Declaration	Data type	Memory area	Description
<Timer>	InOut/Input	TIMER	T	Time of the instruction The number of timers depends on the CPU.
S	Input	BOOL	I, Q, M, T, C, D, L, P	Start input
TV	Input	S5TIME, WORD	I, Q, M, D, L or constant	Time duration
R	Input	BOOL	I, Q, M, T, C, D, L, P or constant	Reset input
BI	Output	WORD	I, Q, M, D, L, P	Current time value (binary-coded)
BCD	Output	WORD	I, Q, M, D, L, P	Current time value (BCD format)
Q	Output	BOOL	I, Q, M, D, L, P	Status of the timer

For additional information on valid data types, refer to "See also".

### Pulse timing diagram

The following figure shows the pulse timing diagram of the "Assign on-delay timer parameters and start" instruction:

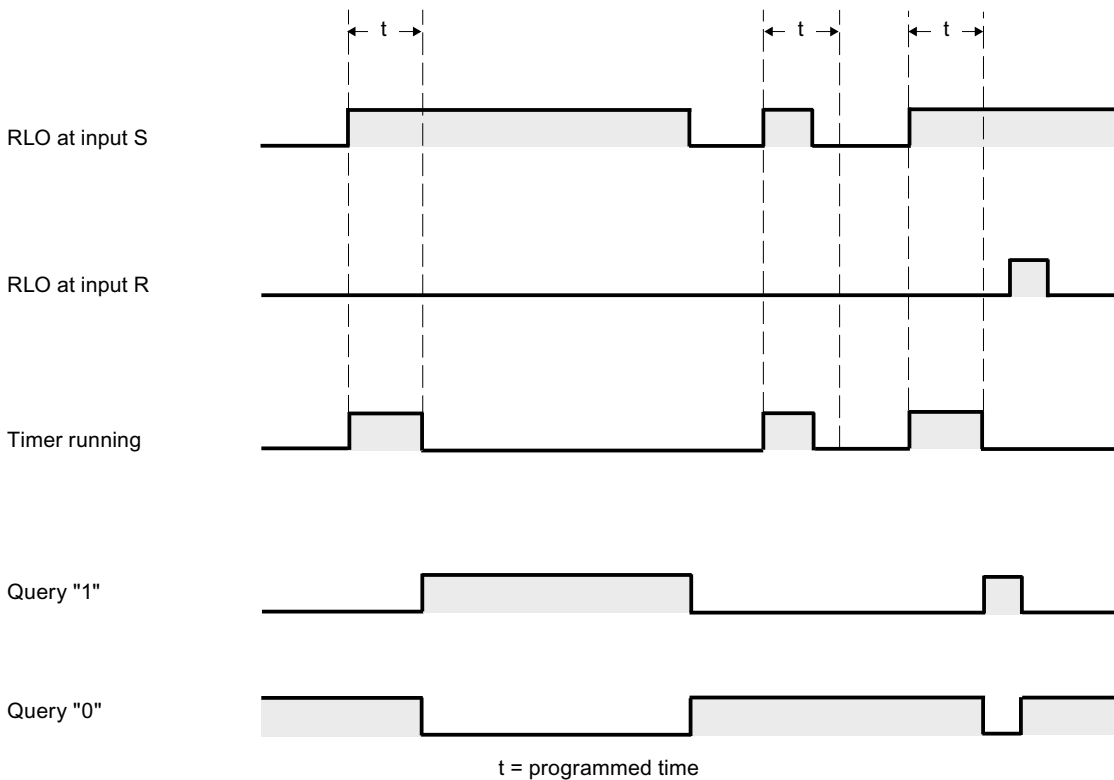

### Example

The following example shows how the instruction works:

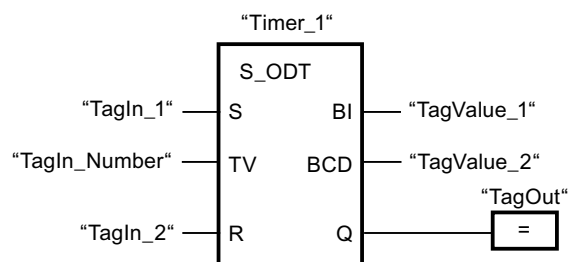

"Timer\_1" starts when the signal state of the "TagIn\_1" operand changes from "0" to "1". The timer expires with the value of operand "TagIn\_Number". If the timer expires and the signal state of the operand is "1", the "TagOut" operand is set to "1". If the signal state at the "TagIn\_1" operand changes from "1" to "0" before the timer expires, the timer is stopped. The "TagOut" operand has the signal state "0".

**See also**

Overview of the valid data types (Page 1077)

**S\_ODTS: Assign retentive on-delay timer parameters and start**

**Description**

The "Assign retentive on-delay timer parameters and start" instruction starts a programmed timer when a transition from "0" to "1" (positive signal edge) is detected in the result of logic operation (RLO) at input S. The timer expires with the programmed duration (TV), even if the signal state at input S changes to "0". If the timer expires, the "Q" output returns signal state "1" regardless of the signal state at input "S". If the signal state at input S changes from "0" to "1" while the timer is running, the timer is restarted with the duration programmed at input (TV).

The duration is made up internally of a time value and a time base and is programmed at parameter TV. When the instruction is started, the programmed time value is counted down to zero. The time base determines the time period of the time value. The current time value is output binary-coded at output BI and BCD-coded at output BCD.

Signal state "1" at input R resets the current time value and time base to "0" regardless of the signal state at start input S. In this case, the signal state at output Q is "0".

The "Assign retentive on-delay timer parameters and start" instruction needs a preceding logic operation for the edge evaluation and can be placed within or at the end of the network.

The instruction data is updated with each access. It can therefore happen that the query of the data at the start of the cycle returns different values than at the end of the cycle.

---

**Note**

In the time cell, the operating system reduces the time value in an interval specified by the time base by one unit until the value equals "0". The decrementation is performed asynchronously to the user program. The resulting timer is therefore at maximum up to one time interval shorter than the desired time base.

---

You can find an example of how a time cell can be formed under: See also "L: Load timer value".



## Parameters

The following table shows the parameters of the "Assign retentive on-delay timer parameters and start" instruction:

Parameter	Declaration	Data type	Memory area	Description
<Timer>	InOut/Input	TIMER	T	Time of the instruction The number of timers depends on the CPU.
S	Input	BOOL	I, Q, M, T, C, D, L, P	Start input
TV	Input	S5TIME, WORD	I, Q, M, D, L or constant	Time duration
R	Input	BOOL	I, Q, M, T, C, D, L, P or constant	Reset input
BI	Output	WORD	I, Q, M, D, L, P	Current time value (binary-coded)
BCD	Output	WORD	I, Q, M, D, L, P	Current time value (BCD format)
Q	Output	BOOL	I, Q, M, D, L, P	Status of the timer

For additional information on valid data types, refer to "See also".

## Pulse timing diagram

The following figure shows the pulse timing diagram of the "Assign retentive on-delay timer parameters and start" instruction:

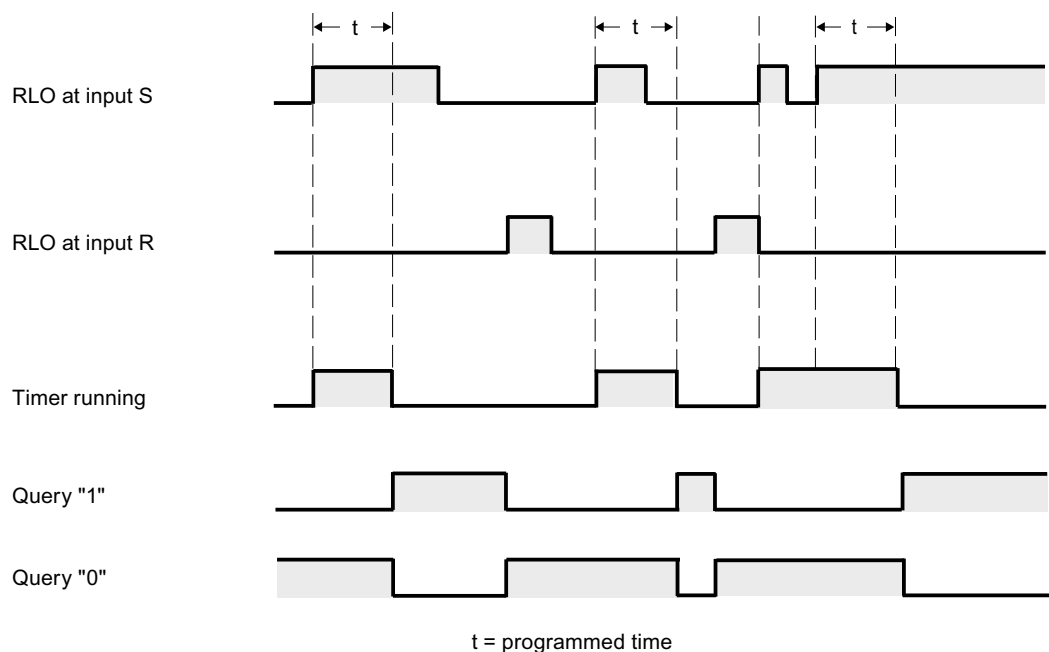

**Example**

The following example shows how the instruction works:

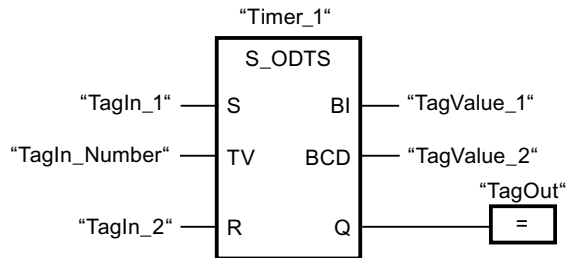

"Timer\_1" starts when the signal state of the "TagIn\_1" operand changes from "0" to "1". The timer expires with the time value of the "TagIn\_Number" operand, even when the signal state of the "TagIn\_1" operand changes to "0". When the time expires, the "TagOut" operand is reset to "1". If the signal state at the "TagIn\_1" operand changes from "0" to "1" while the timer is running, the timer is restarted.

**See also**

Overview of the valid data types (Page 1077)

**S\_OFFDT: Assign off-delay timer parameters and start**

**Description**

The "Assign off-delay timer parameters and start" instruction starts a programmed timer when a transition from "1" to "0" (negative signal edge) is detected in the result of logic operation (RLO) at input S. The timer expires with the programmed duration (TV). As long as the timer is running or input S returns signal state "1", output Q has signal state "1". If the timer expires and the signal state is "0", output Q is reset to signal state "0". If the signal state at input S changes from "0" to "1" while the timer is running, the timer is stopped. The timer is only restarted after a falling signal edge is detected at input S.

The duration is made up internally of a time value and a time base and is programmed at parameter TV. When the instruction is started, the programmed time value is counted down to zero. The time base determines the time period of the time value. The current time value is output binary-coded at output BI and BCD-coded at output BCD.

Signal state "1" at input R resets the current time value and time base to "0". In this case, the signal state at output Q is "0".

The "Assign off-delay timer parameters and start" instruction needs a preceding logic operation for the edge evaluation and can be placed within or at the end of the network.

The instruction data is updated with each access. It can therefore happen that the query of the data at the start of the cycle returns different values than at the end of the cycle.

#### Note

In the time cell, the operating system reduces the time value in an interval specified by the time base by one unit until the value equals "0". The decrementation is performed asynchronously to the user program. The resulting timer is therefore at maximum up to one time interval shorter than the desired time base.

You can find an example of how a time cell can be formed under: See also "L: Load timer value".

## Parameters

The following table shows the parameters of the "Assign off-delay timer parameters and start" instruction:

Parameter	Declaration	Data type	Memory area	Description
<Timer>	InOut/Input	TIMER	T	Time of the instruction The number of timers depends on the CPU.
S	Input	BOOL	I, Q, M, T, C, D, L, P	Start input
TV	Input	S5TIME, WORD	I, Q, M, D, L or constant	Time duration
R	Input	BOOL	I, Q, M, T, C, D, L, P or constant	Reset input
BI	Output	WORD	I, Q, M, D, L, P	Current time value (binary-coded)
BCD	Output	WORD	I, Q, M, D, L, P	Current time value (BCD format)
Q	Output	BOOL	I, Q, M, D, L, P	Status of the timer

For additional information on valid data types, refer to "See also".

**Pulse timing diagram**

The following figure shows the pulse timing diagram of the "Assign off-delay timer parameters and start" instruction:

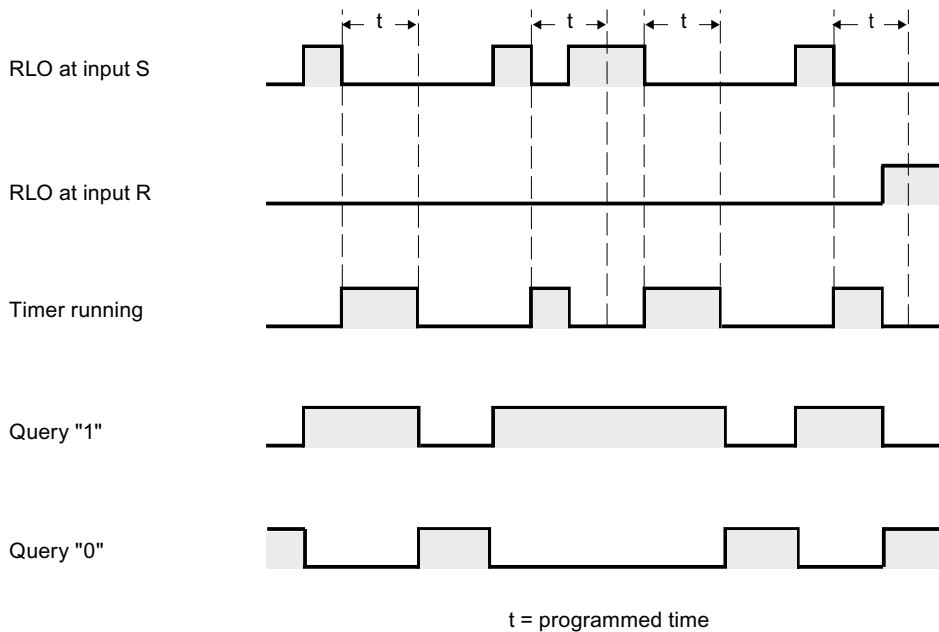

**Example**

The following example shows how the instruction works:

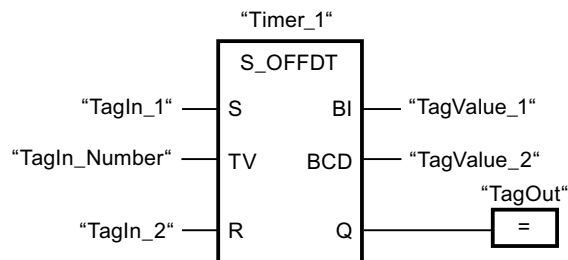

"Timer\_1" starts when the signal state of the "TagIn\_1" operand changes from "1" to "0". The timer expires with the value of operand "TagIn\_Number". The "TagOut" operand is set to "1" if the timer is running or the "TagIn\_1" operand has the signal state "0". If the signal state at the "TagIn\_1" operand changes from "0" to "1" while the timer is running, the timer is reset.

**See also**

Overview of the valid data types (Page 1077)

**SP: Start pulse timer****Description**

The instruction "Start pulse timer" starts a programmed timer when a change from "0" to "1" (positive signal edge) is detected in the result of logic operation (RLO) at the start input. The timer runs with the specified duration as long as the RLO has the signal state "1". As long as the timer is running, the query of timer status "1" returns the signal state "1". If there is a change from "1" to "0" in the RLO before the time value has elapsed, the timer stops. In this case, the query for timer status for "1" returns the signal state "0".

The duration is made up internally of a time value and a time base and is programmed at parameter TV. When the instruction is started, the programmed time value is counted down to zero. The time base determines the time period of the time value.

The "Start pulse timer" instruction needs a preceding logic operation for the edge evaluation and can only be placed on the right edge of the network.

**Note**

In the time cell, the operating system reduces the time value in an interval specified by the time base by one unit until the value equals "0". The decrementation is performed asynchronously to the user program. The resulting timer is therefore at maximum up to one time interval shorter than the desired time base.

You can find an example of how a time cell can be formed under: See also "L: Load timer value".

**Parameters**

The following table shows the parameters of the instruction "Start pulse timer":

Parameter	Declaration	Data type	Memory area	Description
<Operand>	Input	BOOL	I, Q, M, T, C, D, L, P	Start input
TV	Input	S5TIME, WORD	I, Q, M, D, L or constant	Time duration
<Timer>	InOut/Input	TIMER	T	Timer which is started.  The number of timers depends on the CPU.

For additional information on valid data types, refer to "See also".

**Example**

The following example shows how the instruction works:

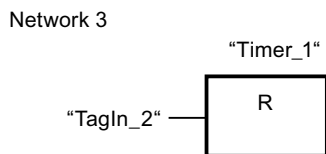
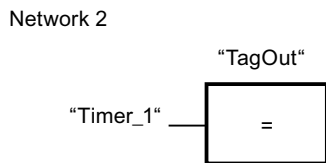
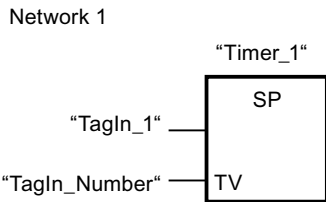

"Timer\_1" starts when the signal state of the "TagIn\_1" operand changes from "0" to "1". The timer expires with the time value of the "TagIn\_Number" operand as long as the signal state of the "TagIn\_1" operand is "1". If the signal state at the "TagIn\_1" operand changes from "1" to "0" before the timer expires, the timer is stopped. As long as the timer is running, the "TagOut" operand returns signal state "1". If the signal state of the "TagIn\_1" operand changes from "0" to "1", the timer is reset, i.e. the timer is stopped and the current time value is set to "0".

**See also**

Overview of the valid data types (Page 1077)

**SE: Start extended pulse timer**

**Description**

The "Start extended pulse timer" instruction starts a programmed timer when a change from "0" to "1" (positive signal edge) is detected in the result of logic operation (RLO) at the start input. The timer runs for the specified time period even when the RLO changes to signal state "0". As long as the timer is running, the query of timer status "1" returns the signal state "1". If the RLO changes from "0" to "1" while the timer is running, the timer is restarted with the programmed time period. When the timer expires, the query for timer status for "1" returns the signal state "0".

The duration is made up internally of a time value and a time base and is programmed at parameter TV. When the instruction is started, the programmed time value is counted down to zero. The time base determines the time period of the time value.

The "Start extended pulse timer" instruction needs a preceding logic operation for the edge evaluation and can only be placed on the right edge of the network.

---

#### Note

In the time cell, the operating system reduces the time value in an interval specified by the time base by one unit until the value equals "0". The decrementation is performed asynchronously to the user program. The resulting timer is therefore at maximum up to one time interval shorter than the desired time base.

---

You can find an example of how a time cell can be formed under: See also "L: Load timer value".

## Parameters

The following table shows the parameters of the instruction "Start extended pulse timer":

Parameter	Declaration	Data type	Memory area	Description
<Operand>	Input	BOOL	I, Q, M, T, C, D, L, P	Start input
TV	Input	S5TIME, WORD	I, Q, M, D, L or constant	Time duration
<Timer>	InOut/Input	TIMER	T	Timer which is started.  The number of timers depends on the CPU.

For additional information on valid data types, refer to "See also".

**Example**

The following example shows how the instruction works:

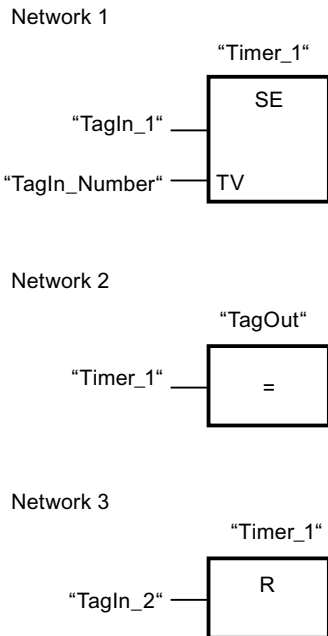

"Timer\_1" starts when the signal state of the "TagIn\_1" operand changes from "0" to "1". The timer expires with the time value of the "TagIn\_Number" operand without being affected by a negative edge at the RLO. As long as the timer is running, the "TagOut" operand returns signal state "1". If the signal state at the "TagIn\_1" operand changes from "0" to "1" before the timer expires, the timer is restarted.

**See also**

Overview of the valid data types (Page 1077)

**SD: Start on-delay timer**

**Description**

The "Start on-delay timer" instruction starts a programmed timer when a change from "0" to "1" (positive signal edge) is detected in the result of logic operation (RLO) at the start input. The timer runs for the specified period of time as long as the RLO is "1". If the timer expires and the RLO has the signal state "1", the query timer status "1" returns the signal state "1". If the RLO changes from "1" to "0" while the timer is running, the timer is stopped. In this case, querying the timer status for "1" returns the signal state "0".

The duration is made up internally of a time value and a time base and is programmed at parameter TV. When the instruction is started, the programmed time value is counted down to zero. The time base determines the time period of the time value.



The "Start on-delay timer" instruction needs a preceding logic operation for the edge evaluation and can only be placed on the right edge of the network.

---

#### Note

In the time cell, the operating system reduces the time value in an interval specified by the time base by one unit until the value equals "0". The decrementation is performed asynchronously to the user program. The resulting timer is therefore at maximum up to one time interval shorter than the desired time base.

---

You can find an example of how a time cell can be formed under: See also "L: Load timer value".

## Parameters

The following table shows the parameters of the instruction "Start on-delay timer":

Parameter	Declaration	Data type	Memory area	Description
<Operand>	Input	BOOL	I, Q, M, T, C, D, L, P	Start input
TV	Input	S5TIME, WORD	I, Q, M, D, L or constant	Time duration
<Timer>	InOut/Input	TIMER	T	Timer which is started.  The number of timers depends on the CPU.

For additional information on valid data types, refer to "See also".

**Example**

The following example shows how the instruction works:

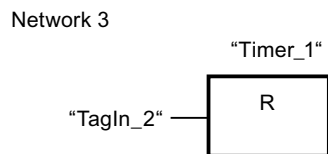
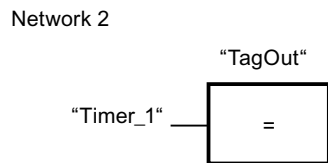
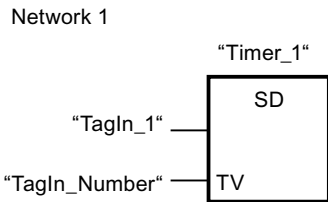

"Timer\_1" starts when the signal state of the "TagIn\_1" operand changes from "0" to "1". The timer expires with the value of operand "TagIn\_Number". If the timer expires and the RLO has the signal state "1", the "TagOut" operand is set to "1". If the signal state at the "TagIn\_1" operand changes from "1" to "0" before the timer expires, the timer is stopped. If the signal state of the "TagIn\_2" operand changes to "1", "Timer\_1" is reset, i.e. the timer is stopped and the current time value is set to "0".

**See also**

Overview of the valid data types (Page 1077)

**SS: Start retentive on-delay timer**

**Description**

The "Start retentive on-delay timer" instruction starts a programmed timer when a change from "0" to "1" (positive signal edge) is detected in the result of logic operation (RLO) at the start input. The timer runs for the specified time period even when the RLO changes to signal state "0". When the timer expires, the query for timer status for "1" returns the signal state "1". When the timer expires, the timer can only be restarted if it is explicitly reset.

The duration is made up internally of a time value and a time base and is programmed at parameter TV. When the instruction is started, the programmed time value is counted down to zero. The time base determines the time period of the time value.

The "Start retentive on-delay timer" instruction needs a preceding logic operation for the edge evaluation and can only be placed on the right edge of the network.

---

#### Note

In the time cell, the operating system reduces the time value in an interval specified by the time base by one unit until the value equals "0". The decrementation is performed asynchronously to the user program. The resulting timer is therefore at maximum up to one time interval shorter than the desired time base.

---

You can find an example of how a time cell can be formed under: See also "L: Load timer value".

## Parameters

The following table shows the parameters of the instruction "Start retentive on-delay timer":

Parameter	Declaration	Data type	Memory area	Description
<Operand>	Input	BOOL	I, Q, M, T, C, D, L, P	Start input
TV	Input	S5TIME, WORD	I, Q, M, D, L or constant	Time duration
<Timer>	InOut/Input	TIMER	T	Timer which is started.  The number of timers depends on the CPU.

For additional information on valid data types, refer to "See also".

**Example**

The following example shows how the instruction works:

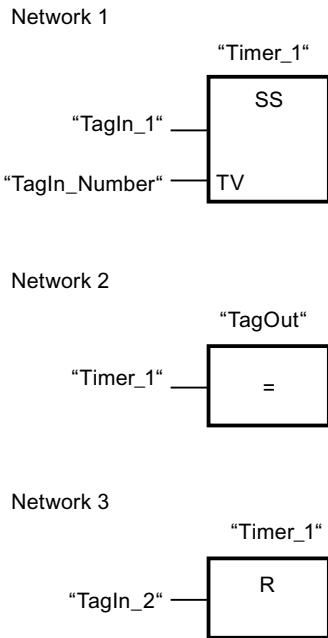

"Timer\_1" starts when the signal state of the "TagIn\_1" operand changes from "0" to "1". The timer expires with the value of operand "TagIn\_Number". When the time expires, the "TagOut" operand is reset to "1". If the signal state at the "TagIn\_1" operand changes from "0" to "1" while the timer is running, the timer is restarted. If the signal state of the "TagIn\_2" operand changes to "1", "Timer\_1" is reset, i.e. the timer is stopped and the current time value is set to "0".

**See also**

Overview of the valid data types (Page 1077)

**SF: Start off-delay timer**

**Description**

The "Start off-delay timer" instruction starts a programmed timer when a change from "1" to "0" (negative signal edge) is detected in the result of logic operation (RLO) at the start input. The timer runs for the specified time period. As long as the timer is running, the query of timer status "1" returns the signal state "1". If the RLO changes from "0" to "1" while the timer is running, the timer is reset. The timer is always restarted when the RLO changes from "1" to "0".

The duration is made up internally of a time value and a time base and is programmed at parameter TV. When the instruction is started, the programmed time value is counted down to zero. The time base determines the time period of the time value.

The "Start off-delay timer" instruction needs a preceding logic operation for the edge evaluation and can only be placed on the right edge of the network.

---

#### Note

In the time cell, the operating system reduces the time value in an interval specified by the time base by one unit until the value equals "0". The decrementation is performed asynchronously to the user program. The resulting timer is therefore at maximum up to one time interval shorter than the desired time base.

---

You can find an example of how a time cell can be formed under: See also "L: Load timer value".

## Parameters

The following table shows the parameters of the instruction "Start off-delay timer":

Parameter	Declaration	Data type	Memory area	Description
<Operand>	Input	BOOL	I, Q, M, T, C, D, L, P	Start input
TV	Input	S5TIME, WORD	I, Q, M, D, L or constant	Time duration
<Timer>	InOut/Input	TIMER	T	Timer which is started.  The number of timers depends on the CPU.

For additional information on valid data types, refer to "See also".

### Example

The following example shows how the instruction works:

Network 1

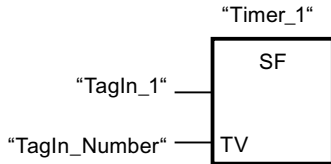

Network 2

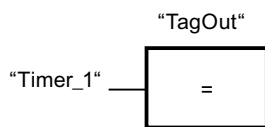

Network 3

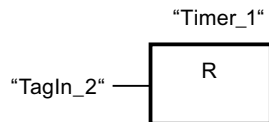

"Timer\_1" starts when the signal state of the "TagIn\_1" operand changes from "1" to "0". The timer expires with the value of operand "TagIn\_Number". As long as the timer is running, the "TagOut" operand is set to "1". If the signal state at the "TagIn\_1" operand changes from "1" to "0" while the timer is running, the timer is restarted. If the signal state of the "TagIn\_2" operand changes to "1", "Timer\_1" is reset, i.e. the timer is stopped and the current time value is set to "0".

### See also

Overview of the valid data types (Page 1077)

### Counter operations

#### IEC Counters

#### CTU: Count up

#### Description

You can use the "Count up" instruction to increment the value at output CV. When the signal state at the CU input changes from "0" to "1" (positive signal edge), the instruction is executed and the current counter value at the CV output is incremented by one. When the instruction executes for the first time, the current counter value at the CV output is set to zero. The counter is incremented each time a positive signal edge is detected, until it reaches the high limit for

the specified data type at output CV. When the high limit is reached, the signal state at the CU input no longer has an effect on the instruction.

You can scan the counter status at the Q output. The signal state at the Q output is determined by the PV parameter. If the current counter value is greater than or equal to the value of the PV parameter, the Q output is set to signal state "1". In all other cases, the Q output has signal state "0". You can also specify a constant for the PV parameter.

The value at the CV output is reset to "0" and saved to an edge memory bit when the signal state at input R changes to "1". As long as the R input has signal state "1", the signal state at the CU input has no effect on the instruction.

---

#### Note

Avoid using a counter at more than one point in the program (risk of counting errors).

---

Each call of the "Count up" instruction must be assigned to an IEC Counter in which the instruction data is stored. An IEC Counter is a structure with one of the following data types:

#### For S7-1200 CPU

Data block of system data type IEC_counter (global DB)	Local tag
<ul style="list-style-type: none"> <li>• IEC_SCOUNTER / IEC_USCOUNTER</li> <li>• IEC_COUNTER / IEC_UCOUNTER</li> <li>• IEC_DCOUNTER / IEC_UDCOUNTER</li> </ul>	<ul style="list-style-type: none"> <li>• CTU_SINT / CTU_USINT</li> <li>• CTU_INT / CTU_UINT</li> <li>• CTU_DINT / CTU_UDINT</li> <li>• IEC_SCOUNTER / IEC_USCOUNTER</li> <li>• IEC_COUNTER / IEC_UCOUNTER</li> <li>• IEC_DCOUNTER / IEC_UDCOUNTER</li> </ul>

#### For S7-1500 CPU

Data block of system data type IEC_counter (global DB)	Local tag
<ul style="list-style-type: none"> <li>• IEC_SCOUNTER / IEC_USCOUNTER</li> <li>• IEC_COUNTER / IEC_UCOUNTER</li> <li>• IEC_DCOUNTER / IEC_UDCOUNTER</li> <li>• IEC_LCOUNTER / IEC_ULCOUNTER</li> </ul>	<ul style="list-style-type: none"> <li>• CTU_SINT / CTU_USINT</li> <li>• CTU_INT / CTU_UINT</li> <li>• CTU_DINT / CTU_UDINT</li> <li>• CTU_LINT / CTU_ULINT</li> <li>• IEC_SCOUNTER / IEC_USCOUNTER</li> <li>• IEC_COUNTER / IEC_UCOUNTER</li> <li>• IEC_DCOUNTER / IEC_UDCOUNTER</li> <li>• IEC_LCOUNTER / IEC_ULCOUNTER</li> </ul>

You can declare an IEC Counter as follows:

- Declaration of a data block of system data type IEC\_COUNTER (for example, "MyIEC\_COUNTER")
- Declaration as a local tag of the type CTU or IEC\_COUNTER in the "Static" section of a block (for example, #MyIEC\_COUNTER)

When you insert the instruction in the program, the "Call options" dialog opens in which you can specify whether the IEC Counter is stored in its own data block (single instance) or as a local tag (multiple instance) in the block interface. If you create a separate data block, it is saved to the "Program resources" folder in the "Program blocks > System blocks" path of the project tree. For additional information on this topic, refer to "See also".

The execution of the "Count up" instruction requires a preceding logic operation. It can be placed within or at the end of the network.

### Parameters

The following table shows the parameters of the "Count up" instruction:

Parameters	Declaration	Data type	Memory area	Description
CU	Input	BOOL	I, Q, M, D, L or constant	Count input
R	Input	BOOL	I, Q, M, T, C, D, L, P or constant	Reset input
PV	Input	Integers	I, Q, M, D, L, P or constant	Value at which the output Q is set.
Q	Output	BOOL	I, Q, M, D, L	Counter status
CV	Output	Integers, CHAR, DATE	I, Q, M, D, L, P	Current counter value

You can select the data type of the instruction from the "<???" drop-down list of the instruction box.

For additional information on valid data types, refer to "See also".

### Example

The following example shows how the instruction works:

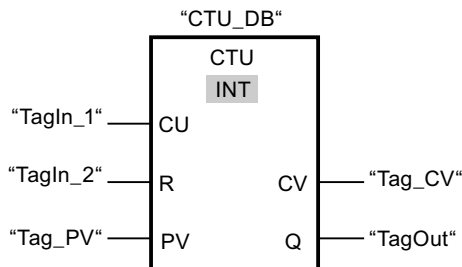

When the signal state of the "TagIn\_1" operand changes from "0" to "1", the "Count up" instruction executes and the current counter value of the "Tag\_CV" operand is incremented by one. With each additional positive signal edge, the counter value is incremented until the high limit of the specified data type (INT = 32767) is reached.



The value of the PV parameter is adopted as the limit for determining the "TagOut" output. The "TagOut" output has signal state "1" as long as the current counter value is greater than or equal to the value of the "Tag\_PV" operand. In all other cases, the "TagOut" output returns the signal state "0".

### See also

Overview of the valid data types (Page 1077)

### CTD: Count down

#### Description

You can use the "Count down" instruction to decrement the value at output CV. When the signal state at the CD input changes from "0" to "1" (positive signal edge), the instruction is executed and the current counter value at the CV output is decremented by one. When the instruction executes the first time, the counter value of the CV parameter will be set to the value of the PV parameter. Each time a positive signal edge is detected, the counter value is decremented until it reaches the low limit value of the specified data type. When the low limit is reached, the signal state at the CD input no longer has an effect on the instruction.

You can scan the counter status at the Q output. If the current counter value is less than or equal to "0", the Q output is set to signal state "1". In all other cases, the Q output has signal state "0". You can also specify a constant for the PV parameter.

The value at the CV output is set to the value of the PV parameter and saved to a edge memory bit when the signal state at the LD input changes from "0" to "1". As long as the LD input has signal state "1", the signal state at the CD input has no effect on the instruction.

---

#### Note

Avoid using a counter at more than one point in the program (risk of counting errors).

---

Each call of the "Count down" instruction must be assigned to an IEC Counter in which the instruction data is stored. An IEC Counter is a structure with one of the following data types:

#### For S7-1200 CPU

Data block of system data type IEC_counter (global DB)	Local tag
<ul style="list-style-type: none"> <li>• IEC_SCOUNTER / IEC_USCOUNTER</li> <li>• IEC_COUNTER / IEC_UCOUNTER</li> <li>• IEC_DCOUNTER / IEC_UDCOUNTER</li> </ul>	<ul style="list-style-type: none"> <li>• CTD_SINT / CTD_USINT</li> <li>• CTD_INT / CTD_UINT</li> <li>• CTD_DINT / CTD_UDINT</li> <li>• IEC_SCOUNTER / IEC_USCOUNTER</li> <li>• IEC_COUNTER / IEC_UCOUNTER</li> <li>• IEC_DCOUNTER / IEC_UDCOUNTER</li> </ul>

For S7-1500 CPU

Data block of system data type IEC_counter (global DB)	Local tag
<ul style="list-style-type: none"> <li>• IEC_SCOUNTER / IEC_USCOUNTER</li> <li>• IEC_COUNTER / IEC_UCOUNTER</li> <li>• IEC_DCOUNTER / IEC_UDCOUNTER</li> <li>• IEC_LCOUNTER / IEC_ULCOUNTER</li> </ul>	<ul style="list-style-type: none"> <li>• CTD_SINT / CTD_USINT</li> <li>• CTD_INT / CTD_UINT</li> <li>• CTD_DINT / CTD_UDINT</li> <li>• CTD_LINT / CTD_ULINT</li> <li>• IEC_SCOUNTER / IEC_USCOUNTER</li> <li>• IEC_COUNTER / IEC_UCOUNTER</li> <li>• IEC_DCOUNTER / IEC_UDCOUNTER</li> <li>• IEC_LCOUNTER / IEC_ULCOUNTER</li> </ul>

You can declare an IEC Counter as follows:

- Declaration of a data block of system data type IEC\_COUNTER (for example, "MyIEC\_COUNTER")
- Declaration as a local tag of the type CTD or IEC\_COUNTER in the "Static" section of a block (for example, #MyIEC\_COUNTER)

When you insert the instruction in the program, the "Call options" dialog opens in which you can specify whether the IEC Counter is stored in its own data block (single instance) or as a local tag (multiple instance) in the block interface. If you create a separate data block, it is saved to the "Program resources" folder in the "Program blocks > System blocks" path of the project tree. For additional information on this topic, refer to "See also".

The execution of the "Count down" instruction requires a preceding logic operation. It can be placed within or at the end of the network.

Parameters

The following table shows the parameters of the "Count down" instruction:

Parameters	Declaration	Data type	Memory area	Description
CD	Input	BOOL	I, Q, M, D, L or constant	Count input
LD	Input	BOOL	I, Q, M, T, C, D, L, P or constant	Load input
PV	Input	Integers	I, Q, M, D, L, P or constant	Value at which the output Q is set.
Q	Output	BOOL	I, Q, M, D, L	Counter status
CV	Output	Integers, CHAR, DATE	I, Q, M, D, L, P	Current counter value

You can select the data type of the instruction from the "<???" drop-down list of the instruction box.

For additional information on valid data types, refer to "See also".

## Example

The following example shows how the instruction works:

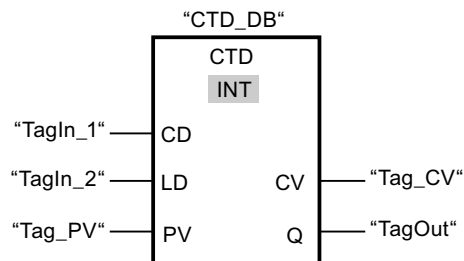

When the signal state of the "TagIn\_1" operand changes from "0" to "1", the "Count down" instruction executes and the value at the "Tag\_CV" output is decremented by one. With each additional positive signal edge, the counter value is decremented until the low limit of the specified data type (INT = -32768) is reached.

The value of the PV parameter is adopted as the limit for determining the "TagOut" output. The "TagOut" output has signal state "1" as long as the current counter value is less than or equal to "0". In all other cases, the "TagOut" output returns the signal state "0".

## See also

Overview of the valid data types (Page 1077)

## CTUD: Count up and down

### Description

You can use the "Count up and down" instruction to increment and decrement the counter value at the CV output. If the signal state at the CU input changes from "0" to "1" (positive signal edge), the current counter value is incremented by one and stored at the CV output. If the signal state at the CD input changes from "0" to "1" (positive signal edge), the current counter value at the CV output is decremented by one. If there is a positive signal edge at the CU and CD inputs in one program cycle, the current counter value at the CV output remains unchanged.

The counter can be incremented until it reaches the high limit value of the data type specified at output CV. When the high limit value is reached, the counter value is no longer incremented on a positive signal edge. When the low limit value of the specified data type is reached, the counter value is not decremented any further.

When the signal state at the LD input changes to "1", the counter value at the CV output is set to the value of the PV parameter and stored in an edge memory bit. As long as the LD input has signal state "1", the signal state at the CU and CD inputs has no effect on the instruction.

The counter value is set to "0" and stored in an edge memory bit when the signal state at input R changes to "1". As long as the R input has signal state "1", a change in the signal state of the CU, CD and LD inputs has no effect on the "Count up and down" instruction.

You can scan the current status of the up counter at the QU output. If the current counter value is greater than or equal to the value of the PV parameter, the QU output is set to signal state

"1". In all other cases, the QU output has signal state "0". You can also specify a constant for the PV parameter.

You can scan the current status of the down counter at the QD output. If the current counter value is less than or equal to zero, the QD output is set to signal state "1". In all other cases, the QD output has signal state "0".

**Note**

Avoid using a counter at more than one point in the program (risk of counting errors).

Each call of the "Count up and down" instruction must be assigned an IEC Counter in which the instruction data is stored. An IEC Counter is a structure with one of the following data types:

**For S7-1200 CPU**

Data block of system data type IEC_counter (global DB)	Local tag
<ul style="list-style-type: none"> <li>• IEC_SCOUNTER / IEC_USCOUNTER</li> <li>• IEC_COUNTER / IEC_UCOUNTER</li> <li>• IEC_DCOUNTER / IEC_UDCOUNTER</li> </ul>	<ul style="list-style-type: none"> <li>• CTUD_SINT / CTUD_USINT</li> <li>• CTUD_INT / CTUD_UINT</li> <li>• CTUD_DINT / CTUD_UDINT</li> <li>• IEC_SCOUNTER / IEC_USCOUNTER</li> <li>• IEC_COUNTER / IEC_UCOUNTER</li> <li>• IEC_DCOUNTER / IEC_UDCOUNTER</li> </ul>

**For S7-1500 CPU**

Data block of system data type IEC_counter (global DB)	Local tag
<ul style="list-style-type: none"> <li>• IEC_SCOUNTER / IEC_USCOUNTER</li> <li>• IEC_COUNTER / IEC_UCOUNTER</li> <li>• IEC_DCOUNTER / IEC_UDCOUNTER</li> <li>• IEC_LCOUNTER / IEC_ULCOUNTER</li> </ul>	<ul style="list-style-type: none"> <li>• CTUD_SINT / CTUD_USINT</li> <li>• CTUD_INT / CTUD_UINT</li> <li>• CTUD_DINT / CTUD_UDINT</li> <li>• CTUD_LINT / CTUD_ULINT</li> <li>• IEC_SCOUNTER / IEC_USCOUNTER</li> <li>• IEC_COUNTER / IEC_UCOUNTER</li> <li>• IEC_DCOUNTER / IEC_UDCOUNTER</li> <li>• IEC_LCOUNTER / IEC_ULCOUNTER</li> </ul>

You can declare an IEC Counter as follows:

- Declaration of a data block of system data type IEC\_COUNTER (for example, "MyIEC\_COUNTER")
- Declaration as a local tag of the type CTUD or IEC\_COUNTER in the "Static" section of a block (for example, #MyIEC\_COUNTER)

When you insert the instruction in the program, the "Call options" dialog opens in which you can specify whether the IEC Counter is stored in its own data block (single instance) or as a

local tag (multiple instance) in the block interface. If you create a separate data block, it is saved to the "Program resources" folder in the "Program blocks > System blocks" path of the project tree. For additional information on this topic, refer to "See also".

The execution of the "Count up and down" instruction requires a preceding logic operation. It can be placed within or at the end of the network.

## Parameters

The following table shows the parameters of the "Count up and down" instruction:

Parameters	Declaration	Data type	Memory area	Description
CU	Input	BOOL	I, Q, M, D, L or constant	Count up input
CD	Input	BOOL	I, Q, M, D, L or constant	Count down input
R	Input	BOOL	I, Q, M, T, C, D, L, P or constant	Reset input
LD	Input	BOOL	I, Q, M, T, C, D, L, P or constant	Load input
PV	Input	Integers	I, Q, M, D, L, P or constant	Value at which the output QU is set.
QU	Output	BOOL	I, Q, M, D, L	Up-counter status
QD	Output	BOOL	I, Q, M, D, L	Down-counter status
CV	Output	Integers, CHAR, DATE	I, Q, M, D, L, P	Current counter value

You can select the data type of the instruction from the "<???"> drop-down list of the instruction box.

For additional information on valid data types, refer to "See also".

## Example

The following example shows how the instruction works:

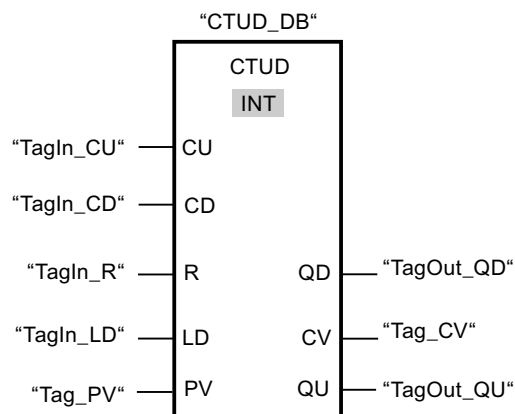

If the signal state at the "TagIn\_CU" or "TagIn\_CD" input changes from "0" to "1" (positive signal edge), the "Count up and down" instruction is executed. When there is a positive signal edge at the "TagIn\_CU" input, the current counter value is incremented by one and stored at the "Tag\_CV" output. When there is a positive signal edge at the "TagIn\_CD" input, the counter value is decremented by one and stored at the "Tag\_CV" output. When there is a positive edge at the CU input, the counter value is incremented until it reaches the high limit value (INT = 32767). If input CD has a positive signal edge, the counter value is decremented until it reaches the low limit value (INT = -32768).

The "TagOut\_GU" output has signal state "1" as long as the current counter value is greater than or equal to the value at the "Tag\_PV" input. In all other cases, the "TagOut\_QU" output returns the signal state "0".

The "TagOut\_QD" output has signal state "1" as long as the current counter value is less than or equal to "0". In all other cases, the "TagOut\_QD" output has signal state "0".

### See also

Overview of the valid data types (Page 1077)

Example of detecting the fill level of a storage area (Page 1561)

## SIMATIC counters

### S\_CUD: Assign parameters and count up / down

#### Description

You can use the "Assign parameters and count up / down" instruction to increment or decrement the value of a counter. If the signal state at the CU input changes from "0" to "1" (positive signal edge), the current counter value is incremented by one. If the signal state at the CD input changes from "0" to "1" (positive signal edge), the counter value is decremented by one. The current counter value is output as a hexadecimal value at output CV and BCD-coded at output CV\_BCD. If there is a positive signal edge at the CU and CD inputs in one program cycle, the counter value remains unchanged.

The counter value is incremented until the high limit of "999" is reached. When the high limit value is reached, the counter value is no longer incremented on a positive signal edge. When the low limit of "0" is reached, the counter value is no longer decremented.

When the signal state at input S changes from "0" to "1", the counter value is set to the value of the PV parameter. If the counter is set and if RLO is "1" at the inputs CU and CD, the counter counts accordingly in the next scan cycle, even if no change in the signal edge is detected.

The counter value is set to zero when the signal state at the R input changes to "1". As long as the R input has the signal state "1", processing of the signal state of the CU, CD and S inputs has no effect on the counter value.

The signal state at output Q is "1" if the counter value is greater than zero. If the counter value is equal to zero, output Q has the signal state "0".

#### Note

Avoid using a counter at more than one point in the program (risk of counting errors).

The "Assign parameters and count up / down" instruction needs a preceding logic operation for the edge evaluation and can be placed within or at the end of the network.

## Parameters

The following table shows the parameters of the "Assign parameters and count up / down" instruction:

Parameters	Declaration	Data type	Memory area	Description
<Counter>	InOut/Input	COUNTER	C	Counter of the instruction The number of counters depends on the CPU.
CU	Input	BOOL	I, Q, M, D, L, T, C	Count up input
CD	Input	BOOL	I, Q, M, D, L, T, C or constant	Count down input
S	Input	BOOL	I, Q, M, D, L, T, C or constant	Input for presetting counter
PV	Input	WORD	I, Q, M, D, L, C or constant	Preset counter value (C#0 to C#999)
R	Input	BOOL	I, Q, M, D, L, T, C or constant	Reset input
CV	Output	WORD, S5TIME, DATE	I, Q, M, D, L	Current counter value (hexadecimal)
CV_BCD	Output	WORD, S5TIME, DATE	I, Q, M, D, L	Current counter value (BCD format)
Q	Output	BOOL	I, Q, M, D, L	Status of the counter

For additional information on valid data types, refer to "See also".

**Example**

The following example shows how the instruction works:

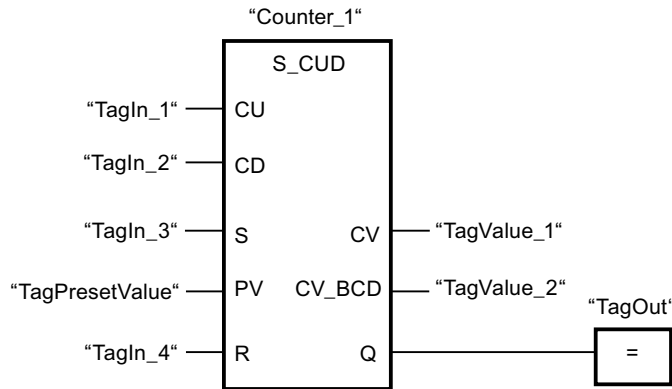

If the signal state at the "TagIn\_1" or "TagIn\_2" input changes from "0" to "1" (positive signal edge), the "Assign parameters and count up / down" instruction is executed. When there is a positive signal edge at the "TagIn\_1" input and the current counter value is less than "999", the counter value is incremented by one. When there is a positive signal edge at the "TagIn\_2" input and the current counter value is greater than "0", the counter value is decremented by one.

When the signal state at the "TagIn\_3" input changes from "0" to "1", the counter value is set to the value of the "TagPresetValue" operand. The counter value is reset to "0" when the "TagIn\_4" operand has signal state "1".

The current counter value is hexadecimal in the "TagValue\_1" operand and BCD-coded in the "TagValue\_2" operand.

The "TagOut" output has the signal state "1" as long as the current counter value is not equal to "0".

**See also**

Overview of the valid data types (Page 1077)

**S\_CU: Assign parameters and count up**

**Description**

You can use the "Assign parameters and count up" instruction to increment the value of a counter. If the signal state at the CU input changes from "0" to "1" (positive signal edge), the current counter value is incremented by one. The current counter value is output as a hexadecimal value at output CV and BCD-coded at output CV\_BCD. The count is incremented until the limit of "999" is reached. When the limit is reached, the counter value is no longer incremented on a positive signal edge.

When the signal state at input S changes from "0" to "1", the counter value is set to the value of the PV parameter. If the counter is set and if RLO at input CU is "1", the counter will count accordingly in the next scan cycle, even when no change has been detected in the signal edge.



The counter value is set to zero when the signal state at the R input changes to "1". As long as the R input has the signal state "1", processing of the signal state of the CU and S inputs has no effect on the counter value.

The signal state at output Q is "1" if the counter value is greater than zero. If the counter value is equal to zero, output Q has the signal state "0".

---

#### Note

Avoid using a counter at more than one point in the program (risk of counting errors).

---

The "Assign parameters and count up" instruction needs a preceding logic operation for the edge evaluation and can be placed within or at the end of the network.

## Parameters

The following table shows the parameters of the "Assign parameters and count up" instruction:

Parameters	Declaration	Data type	Memory area	Description
<Counter>	InOut/Input	COUNTER	C	Counter of the instruction The number of counters depends on the CPU.
CU	Input	BOOL	I, Q, M, D, L, T, C	Count up input
S	Input	BOOL	I, Q, M, D, L, T, C or constant	Input for presetting counter
PV	Input	WORD	I, Q, M, D, L, C or constant	Preset counter value (C#0 to C#999)
R	Input	BOOL	I, Q, M, D, L, T, C or constant	Reset input
CV	Output	WORD, S5TIME, DATE	I, Q, M, D, L	Current counter value (hexadecimal)
CV_BCD	Output	WORD, S5TIME, DATE	I, Q, M, D, L	Current counter value (BCD format)
Q	Output	BOOL	I, Q, M, D, L	Status of the counter

For additional information on valid data types, refer to "See also".

**Example**

The following example shows how the instruction works:

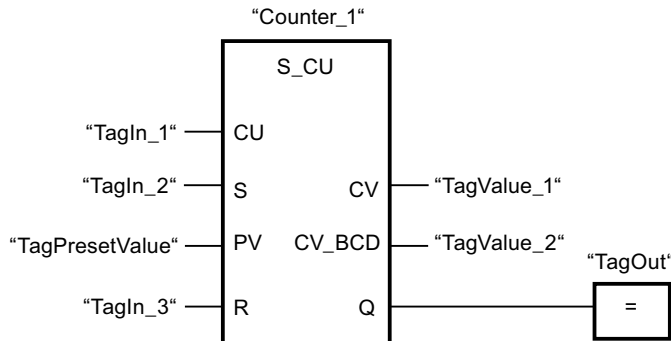

When the signal state at the "TagIn\_1" input changes from "0" to "1" (positive signal edge) and the current counter value is less than "999", the counter value is incremented by one. When the signal state at the "TagIn\_2" input changes from "0" to "1", the counter value is set to the value of the "TagPresetValue" operand. The counter value is reset to "0" when the "TagIn\_3" operand has signal state "1".

The current counter value is hexadecimal in the "TagValue\_1" operand and BCD-coded in the "TagValue\_2" operand.

The "TagOut" output has the signal state "1" as long as the current counter value is not equal to "0".

**See also**

Overview of the valid data types (Page 1077)

**S\_CD: Assign parameters and count down**

**Description**

You can use the "Assign parameters and count down" instruction to decrement the value of a counter. If the signal state at the CD input changes from "0" to "1" (positive signal edge), the counter value is decremented by one. The current counter value is output as a hexadecimal value at output CV and BCD-coded at output CV\_BCD. The count is decremented until the low limit of "0" is reached. When the low limit is reached, the counter value is no longer decremented on a positive signal edge.

When the signal state at input S changes from "0" to "1", the counter value is set to the value of the PV parameter. If the counter is set and if RLO at input CD is "1", the counter will count accordingly in the next scan cycle, even when no change has been detected in the signal edge.

The counter value is set to zero when the signal state at the R input changes to "1". As long as the R input has the signal state "1", processing of the signal state of the CD and S inputs has no effect on the counter value.

The signal state at output Q is "1" if the counter value is greater than zero. If the counter value is equal to zero, output Q has the signal state "0".

---

#### Note

Avoid using a counter at more than one point in the program (risk of counting errors).

---

The "Assign parameters and count down" instruction needs a preceding logic operation for the edge evaluation and can be placed within or at the end of the network.

## Parameters

The following table shows the parameters of the "Assign parameters and count down" instruction:

Parameters	Declaration	Data type	Memory area	Description
<Counter>	InOut/Input	COUNTER	C	Counter of the instruction The number of counters depends on the CPU.
CD	Input	BOOL	I, Q, M, D, L or constant	Count down input
S	Input	BOOL	I, Q, M, D, L, T, C or constant	Input for presetting counter
PV	Input	WORD	I, Q, M, D, L, C or constant	Preset counter value (C#0 to C#999)
R	Input	BOOL	I, Q, M, D, L, T, C or constant	Reset input
CV	Output	WORD, S5TIME, DATE	I, Q, M, D, L	Current counter value (hexadecimal)
CV_BCD	Output	WORD, S5TIME, DATE	I, Q, M, D, L	Current counter value (BCD format)
Q	Output	BOOL	I, Q, M, D, L	Status of the counter

For additional information on valid data types, refer to "See also".

**Example**

The following example shows how the instruction works:

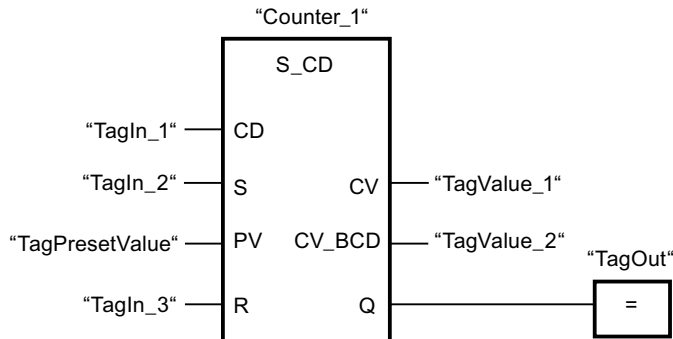

When the signal state at the "TagIn\_1" input changes from "0" to "1" (positive signal edge) and the current counter value is greater than "0", the counter value is decremented by one. When the signal state at the "TagIn\_2" input changes from "0" to "1", the counter value is set to the value of the "TagPresetValue" operand. The counter value is reset to "0" when the "TagIn\_3" operand has signal state "1".

The current counter value is hexadecimal in the "TagValue\_1" operand and BCD-coded in the "TagValue\_2" operand.

The "TagOut" output has the signal state "1" as long as the current counter value is not equal to "0".

**See also**

Overview of the valid data types (Page 1077)

**SC: Set counter value**

**Description**

You can use the "Set counter value" instruction to increment the value of a counter. The instruction is executed when the result of logic operation (RLO) at the start input of the instruction changes from "0" to "1". If the instruction is executed, the counter is set to the specified counter value.

The "Set counter value" instruction needs a preceding logic operation for the edge evaluation and can only be placed on the right edge of the network.

## Parameters

The following table shows the parameters of the "Set counter value" instruction:

Parameters	Declaration	Data type	Memory area	Description
<Operand>	Input	BOOL	I, Q, M, T, C, D, L	Start input
PV	Input	WORD	I, Q, M, D, L or constant	Value with which the counter is preset in the BCD format. (C#0 to C#999)
<Counter>	InOut/Input	COUNTER	C	Counter which is preset.

For additional information on valid data types, refer to "See also".

## Example

The following example shows how the instruction works:

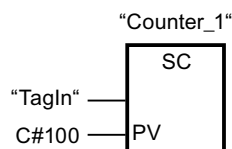

"Counter\_1" starts with the value "100" when the signal state of the "TagIn" operand changes from "0" to "1".

## See also

Overview of the valid data types (Page 1077)

## CU: Count up

### Description

You use the "Count up" instruction to increment the value of the specified counter by the count of one on a rising edge at the start input. The count is incremented until the limit of "999" is reached. When the limit is reached, the counter value is no longer incremented on a positive signal edge.

The "Count up" instruction needs a preceding logic operation for the edge evaluation and can only be placed on the right edge of the network.

### Parameters

The following table shows the parameters of the "Count up" instruction:

Parameters	Declaration	Data type	Memory area	Description
<Operand>	Input	BOOL	I, Q, M, T, C, D, L	Start input
<Counter>	InOut/Input	COUNTER	C	Counter whose value is incremented.

For additional information on valid data types, refer to "See also".

### Example

The following example shows how the instruction works:

Network 1

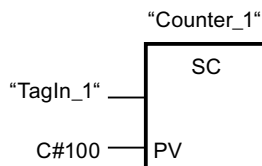

Network 2

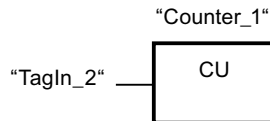

Network 3

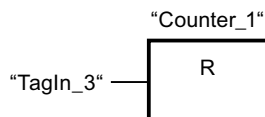

When the signal state of the operand "TagIn\_1" changes from "0" to "1" (positive signal edge), the counter "Counter\_1" is preset with the value "100".

The value of "Counter\_1" is incremented by the count of one when the signal state of the "TagIn\_2" operand changes from "0" to "1".

If the "TagIn\_3" operand returns signal state "1", the value of "Counter\_1" is reset to "0".

### See also

Overview of the valid data types (Page 1077)

## CD: Count down

### Description

You use the "Count down" instruction to decrement the value of the specified counter by the count of one on a rising edge at the start input. The count is decremented until the limit of "0" is reached. When the limit is reached, the counter value is no longer changed on a positive signal edge.

The "Count down" instruction needs a preceding logic operation for the edge evaluation and can only be placed on the right edge of the network.

### Parameters

The following table shows the parameters of the "Count down" instruction:

Parameters	Declaration	Data type	Memory area	Description
<Operand>	Input	BOOL	I, Q, M, T, C, D, L	Start input
<Counter>	InOut/Input	COUNTER	C	Counter whose value is decremented.

For additional information on valid data types, refer to "See also".

### Example

The following example shows how the instruction works:

Network 1

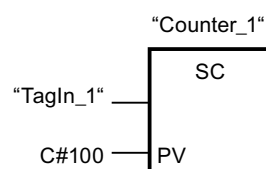

Network 2

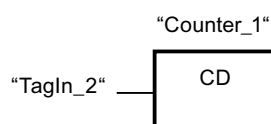

Network 3

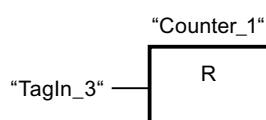

When the signal state of the operand "TagIn\_1" changes from "0" to "1" (positive signal edge), the counter "Counter\_1" is preset with the value "100".

The value of "Counter\_1" is incremented by the count of one when the signal state of the "TagIn\_2" operand changes from "0" to "1".

If the "TagIn\_3" operand returns signal state "1", the value of "Counter\_1" is reset to "0".

**See also**

Overview of the valid data types (Page 1077)

**Comparator operations**

**CMP ==: Equal**

**Description**

You can use the "Equal" instruction to query whether the value at input IN1 is equal to the value at input IN2.

If the condition of the comparison is satisfied, the instruction returns the result of logic operation (RLO) "1". If the comparison condition is not fulfilled, the instruction returns RLO "0".

The individual characters are compared by means of their ASCII code (for example, 'a' is greater than 'A') during the comparison of the strings. The comparison is performed from left to right. The first character to be different decides the result of the comparison.

The following table shows examples of string comparisons:

IN1	IN2	RLO of the instruction
'AA'	'AA'	1
'Hello World'	'HelloWorld'	0
'AA'	'aa'	0

The "Equal" instruction also compares individual characters of a string (STRING). The number of the character to be compared is specified in square brackets beside the operand name. "MyString[2]", for example, compares the second character of the "MyString" string.

If IEC check is enabled, the operands to be compared must be of the same data type. If IEC check is not enabled, the width (length) of the operands must be the same. If the floating-point numbers are being compared, the operands to be compared must be of the same data type regardless of the IEC check setting.

---

**Note**

**Comparison of floating-point numbers**

If you want to compare the data types REAL or LREAL, instead of the instruction "CMP ==: Equal", use the instruction "IN\_RANGE: Value within range".

---



## Parameters

The following table shows the parameters of the instruction "Equal":

Parameter	Declaration	Data type		Memory area	Description
		S7-1200	S7-1500		
IN1	Input	Bit strings, integers, floating-point numbers, character strings, TIME, DATE, TOD, DTL	Bit strings, integers, floating-point numbers, character strings, TIME, LTIME, DATE, TOD, LTOD, DTL, DT, LDT	I, Q, M, D, L, P or constant	First comparison value
IN2	Input	Bit strings, integers, floating-point numbers, character strings, TIME, DATE, TOD, DTL	Bit strings, integers, floating-point numbers, character strings, TIME, LTIME, DATE, TOD, LTOD, DTL, DT, LDT	I, Q, M, D, L, P or constant	Second value to compare

You can select the data type of the instruction from the "<???"> drop-down list of the instruction box.

For additional information on valid data types, refer to "See also":

## Example

The following example shows how the instruction works:

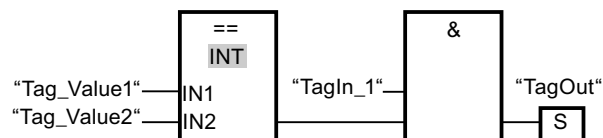

Output "TagOut" is set when the following conditions are fulfilled:

- The operand "TagIn\_1" has the signal state "1".
- The condition of the comparison instruction is fulfilled ("Tag\_Value1" = "Tag\_Value2").

## See also

Overview of the valid data types (Page 1077)

### CMP <>: Not equal

#### Description

You can use the "Not equal" instruction to query whether the value at input IN1 is not equal to the value at input IN2.

If the condition of the comparison is satisfied, the instruction returns the result of logic operation (RLO) "1". If the comparison condition is not fulfilled, the instruction returns RLO "0".

The individual characters are compared by means of their ASCII code (for example, 'a' is greater than 'A') during the comparison of the strings. The comparison is performed from left to right. The first character to be different decides the result of the comparison.

The following table shows examples of string comparisons:

IN1	IN2	RLO of the instruction
'AA'	'aa'	1
'Hello World'	'HelloWorld'	1
'AA'	'AA'	0

The "Not equal" instruction also compares individual characters of a string (STRING). The number of the character to be compared is specified in square brackets beside the operand name. "MyString[2]", for example, compares the second character of the "MyString" string.

If IEC check is enabled, the operands to be compared must be of the same data type. If IEC check is not enabled, the width (length) of the operands must be the same. If the floating-point numbers are being compared, the operands to be compared must be of the same data type regardless of the IEC check setting.

## Parameters

The following table shows the parameters of the instruction "Not equal":

Parameters	Declaration	Data type		Memory area	Description
		S7-1200	S7-1500		
IN1	Input	Bit strings, integers, floating-point numbers, character strings, TIME, DATE, TOD, DTL	Bit strings, integers, floating-point numbers, character strings, TIME, LTIME, DATE, TOD, LTOD, DTL, DT, LDT	I, Q, M, D, L, P or constant	First value to compare
IN2	Input	Bit strings, integers, floating-point numbers, character strings, TIME, DATE, TOD, DTL	Bit strings, integers, floating-point numbers, character strings, TIME, LTIME, DATE, TOD, LTOD, DTL, DT, LDT	I, Q, M, D, L, P or constant	Second value to compare

You can select the data type of the instruction from the "<???"> drop-down list of the instruction box.

For additional information on valid data types, refer to "See also".

## Example

The following example shows how the instruction works:

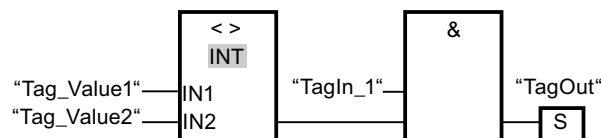

Output "TagOut" is set when the following conditions are fulfilled:

- The operand "TagIn\_1" has the signal state "1".
- The condition of the comparison instruction is fulfilled ("Tag\_Value1" <> "Tag\_Value2").

## See also

Overview of the valid data types (Page 1077)

### CMP >=: Greater or equal

#### Description

You can use the "Greater or equal" instruction to query whether the value at input IN1 is greater or equal to the value at input IN2. Both values to be compared must be of the same data type.

If the condition of the comparison is satisfied, the instruction returns the result of logic operation (RLO) "1". If the comparison condition is not fulfilled, the instruction returns RLO "0".

The individual characters are compared by means of their ASCII code (for example, 'a' is greater than 'A') during the comparison of the strings. The comparison is performed from left to right. The first character to be different decides the result of the comparison. If the left part of the longer string is identical to the shorter string, the longer string is considered greater.

The following table shows examples of string comparisons:

IN1	IN2	RLO of the instruction
'BB'	'AA'	1
'AAA'	'AA'	1
'Hello World'	'Hello World'	1
'Hello World'	'HelloWorld'	0
'AA'	'aa'	0
'AAA'	'a'	0

The "Greater or equal" instruction also compares individual characters of a string (STRING). The number of the character to be compared is specified in square brackets beside the operand name. "MyString[2]", for example, compares the second character of the "MyString" string.

In comparing timer values, the RLO of the instruction is "1" if the timer at input IN1 is greater (more recent) than or equal to the timer at input IN2.

## Parameters

The following table shows the parameters of the instruction "Greater or equal":

Parameters	Declaration	Data type		Memory area	Description
		S7-1200	S7-1500		
IN1	Input	Integers, floating-point numbers, character strings, TIME, DATE, TOD, DTL	Integers, floating-point numbers, character strings, TIME, LTIME, DATE, TOD, LTOD, DTL, DT, LDT	I, Q, M, D, L, P or constant	First value to compare
IN2	Input	Integers, floating-point numbers, character strings, TIME, DATE, TOD, DTL	Integers, floating-point numbers, character strings, TIME, LTIME, DATE, TOD, LTOD, DTL, DT, LDT	I, Q, M, D, L, P or constant	Second value to compare

You can select the data type of the instruction from the "<???"> drop-down list of the instruction box.

For additional information on valid data types, refer to "See also".

## Example

The following example shows how the instruction works:

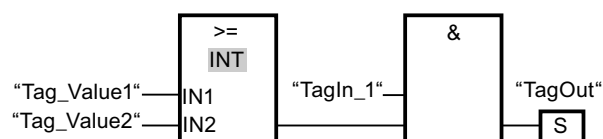

Output "TagOut" is set when the following conditions are fulfilled:

- The operand "TagIn\_1" has the signal state "1".
- The condition of the comparison instruction is fulfilled ("Tag\_Value1" >= "Tag\_Value2").

## See also

Overview of the valid data types (Page 1077)

Example of detecting the fill level of a storage area (Page 1561)

### CMP <=: Less or equal

#### Description

You can use the "Less or equal" instruction to query whether the value at input IN1 is less or equal to the value at input IN2. Both values to be compared must be of the same data type.

If the condition of the comparison is satisfied, the instruction returns the result of logic operation (RLO) "1". If the comparison condition is not fulfilled, the instruction returns RLO "0".

The individual characters are compared by means of their ASCII code (for example, 'a' is greater than 'A') during the comparison of the strings. The comparison is performed from left to right. The first character to be different decides the result of the comparison. If the left part of the longer string is identical to the shorter string, the shorter string is considered smaller.

The following table shows examples of string comparisons:

IN1	IN2	RLO of the instruction
'AA'	'aa'	1
'AAA'	'a'	1
'Hello World'	'Hello World'	1
'HelloWorld'	'Hello World'	0
'BB'	'AA'	0
'AAA'	'AA'	0

The "Less or equal" instruction also compares individual characters of a string (STRING). The number of the character to be compared is specified in square brackets beside the operand name. "MyString[2]", for example, compares the second character of the "MyString" string.

In comparing timer values, the RLO of the instruction is "1" if the timer at input IN1 is smaller (less recent) than or equal to the timer at input IN2.

## Parameters

The following table shows the parameters of the instruction "Less or equal":

Parameters	Declaration	Data type		Memory area	Description
		S7-1200	S7-1500		
IN1	Input	Integers, floating-point numbers, character strings, TIME, DATE, TOD, DTL	Integers, floating-point numbers, character strings, TIME, LTIME, DATE, TOD, LTOD, DTL, DT, LDT	I, Q, M, D, L, P or constant	First value to compare
IN2	Input	Integers, floating-point numbers, character strings, TIME, DATE, TOD, DTL	Integers, floating-point numbers, character strings, TIME, LTIME, DATE, TOD, LTOD, DTL, DT, LDT	I, Q, M, D, L, P or constant	Second value to compare

You can select the data type of the instruction from the "<???"> drop-down list of the instruction box.

For additional information on valid data types, refer to "See also".

## Example

The following example shows how the instruction works:

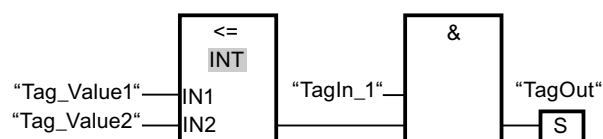

Output "TagOut" is set when the following conditions are fulfilled:

- The operand "TagIn\_1" has the signal state "1".
- The condition of the comparison instruction is fulfilled ("Tag\_Value1" <= "Tag\_Value2").

## See also

Overview of the valid data types (Page 1077)

**CMP >: Greater than**

**Description**

You can use the "Greater than" instruction to query whether the value at input IN1 is greater than the value at input IN2. Both values to be compared must be of the same data type.

If the condition of the comparison is satisfied, the instruction returns the result of logic operation (RLO) "1". If the comparison condition is not fulfilled, the instruction returns RLO "0".

The individual characters are compared by means of their ASCII code (for example, 'a' is greater than 'A') during the comparison of the strings. The comparison is performed from left to right. The first character to be different decides the result of the comparison. If the left part of the longer string is identical to the shorter string, the longer string is considered greater.

The following table shows examples of string comparisons:

IN1	IN2	RLO of the instruction
'BB'	'AA'	1
'AAA'	'AA'	1
'AA'	'aa'	0
'AAA'	'a'	0

The "Greater than" instruction also compares individual characters of a string (STRING). The number of the character to be compared is specified in square brackets beside the operand name. "MyString[2]", for example, compares the second character of the "MyString" string.

In comparing timer values, the RLO of the instruction is "1" if the timer at input IN1 is greater (more recent) than the timer at input IN2.

**Parameters**

The following table shows the parameters of the instruction "Greater than":

Parameters	Declaration	Data type		Memory area	Description
		S7-1200	S7-1500		
IN1	Input	Integers, floating-point numbers, character strings, TIME, DATE, TOD, DTL	Integers, floating-point numbers, character strings, TIME, LTIME, DATE, TOD, LTOD, DTL, DT, LDT	I, Q, M, D, L, P or constant	First value to compare
IN2	Input	Integers, floating-point numbers, character strings, TIME, DATE, TOD, DTL	Integers, floating-point numbers, character strings, TIME, LTIME, DATE, TOD, LTOD, DTL, DT, LDT	I, Q, M, D, L, P or constant	Second value to compare



You can select the data type of the instruction from the "<???"> drop-down list of the instruction box.

For additional information on valid data types, refer to "See also".

## Example

The following example shows how the instruction works:

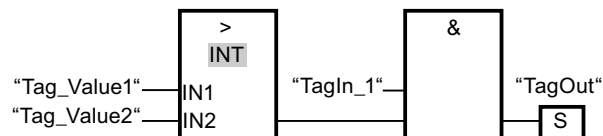

Output "TagOut" is set when the following conditions are fulfilled:

- The operand "TagIn\_1" has the signal state "1".
- The condition of the comparison instruction is fulfilled ("Tag\_Value1" > "Tag\_Value2").

## See also

Overview of the valid data types (Page 1077)

## CMP <: Less than

### Description

You can use the "Less than" instruction to query whether the value at input IN1 is less than the value at input IN2. Both values to be compared must be of the same data type.

If the condition of the comparison is satisfied, the instruction returns the result of logic operation (RLO) "1". If the comparison condition is not fulfilled, the instruction returns RLO "0".

The individual characters are compared by means of their ASCII code (for example, 'a' is greater than 'A') during the comparison of the strings. The comparison is performed from left to right. The first character to be different decides the result of the comparison. If the left part of the longer string is identical to the shorter string, the shorter string is considered smaller.

The following table shows examples of string comparisons:

<Operand1>	<Operand2>	RLO of the instruction
'AA'	'aa'	1
'AAA'	'a'	1
'BB'	'AA'	0
'AAA'	'AA'	0

The "Less than" instruction also compares individual characters of a string (STRING). The number of the character to be compared is specified in square brackets beside the operand name. "MyString[2]", for example, compares the second character of the "MyString" string.

In comparing timer values, the RLO of the instruction is "1" if the timer at input IN1 is less (less recent) than the timer at input IN2 .

**Parameters**

The following table shows the parameters of the instruction "Less than":

Parameters	Declaration	Data type		Memory area	Description
		S7-1200	S7-1500		
IN1	Input	Integers, floating-point numbers, character strings, TIME, DATE, TOD, DTL	Integers, floating-point numbers, character strings, TIME, LTIME, DATE, TOD, LTOD, DTL, DT, LDT	I, Q, M, D, L, P or constant	First value to compare
IN2	Input	Integers, floating-point numbers, character strings, TIME, DATE, TOD, DTL	Integers, floating-point numbers, character strings, TIME, LTIME, DATE, TOD, LTOD, DTL, DT, LDT	I, Q, M, D, L, P or constant	Second value to compare

You can select the data type of the instruction from the "<???" drop-down list of the instruction box.

For additional information on valid data types, refer to "See also".

**Example**

The following example shows how the instruction works:

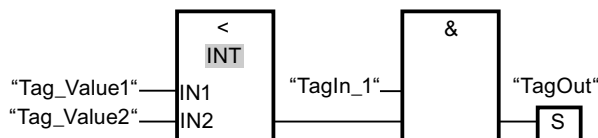

Output "TagOut" is set when the following conditions are fulfilled:

- The operand "TagIn\_1" has the signal state "1".
- The condition of the comparison instruction is fulfilled ("Tag\_Value1" < "Tag\_Value2").

**See also**

Overview of the valid data types (Page 1077)

Example of detecting the fill level of a storage area (Page 1561)

## IN\_RANGE: Value within range

### Description

You can use the "Value within range" instruction to query whether of the value at input VAL is within a specific value range.

You specify the limits of the value range with the MIN and MAX inputs. The "Value within range" instruction compares the value at input VAL with the values of the inputs MIN and MAX and sends the result to the box output. If the value at input VAL satisfies the comparison  $\text{MIN} \leq \text{VAL}$  or  $\text{VAL} \leq \text{MAX}$ , the box output has the signal state "1". If the comparison is not fulfilled, the signal state is "0" at the box output.

The comparison function can only execute if the values to be compared are of the same data type.

### Parameters

The following table shows the parameters of the "Value within range" instruction:

Parameters	Declaration	Data type	Memory area	Description
MIN	Input	Integers, floating-point numbers	I, Q, M, D, L or constant	Low limit of the value range
VAL	Input	Integers, floating-point numbers	I, Q, M, D, L or constant	Comparison value
MAX	Input	Integers, floating-point numbers	I, Q, M, D, L or constant	High limit of the value range
Box output	Output	BOOL	I, Q, M, D, L	Result of the comparison

You can select the data type of the instruction from the "<???">" drop-down list of the instruction box.

For additional information on valid data types, refer to "See also":

### Example

The following example shows how the instruction works:

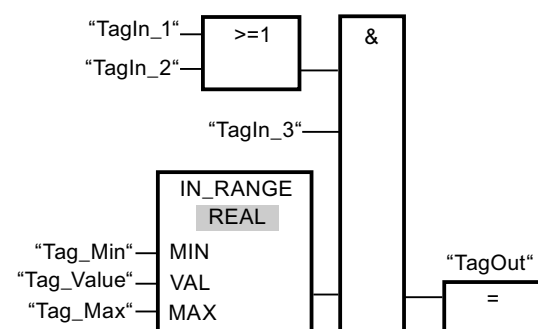

Output "TagOut" is set when the following conditions are fulfilled:

- The operands "TagIn\_1" or "TagIn\_2" have signal state "1".
- The operand "TagIn\_3" has the signal state "1".
- The value of the operand "Tag\_Value" is within the value range that is specified by the current values of the operands "Tag\_Min" and "Tag\_Max" ( $MIN \leq VAL$  or  $VAL \leq MAX$ ).

**See also**

Overview of the valid data types (Page 1077)

**OUT\_RANGE: Value outside range**

**Description**

You can use the "Value outside range" instruction to query whether of the value at input VAL is outside a specific value range.

You specify the limits of the value range with the MIN and MAX inputs. The "Value outside range" instruction compares the value at input VAL with the values of the inputs MIN and MAX and sends the result to the box output. If the value at input VAL satisfies the comparison  $MIN > VAL$  or  $VAL > MAX$ , the box output has the signal state "1". The box output has the signal state "1" if a specified operand of data type REAL has an invalid value.

The box output returns the signal state "0", if the value at input VAL does not satisfy the  $MIN > VAL$  or  $VAL > MAX$  condition.

The comparison function can only execute if the values to be compared are of the same data type.

**Parameters**

The following table shows the parameters of the "Value outside range" instruction:

Parameters	Declaration	Data type	Memory area	Description
MIN	Input	Integers, floating-point numbers	I, Q, M, D, L or constant	Low limit of the value range
VAL	Input	Integers, floating-point numbers	I, Q, M, D, L or constant	Comparison value
MAX	Input	Integers, floating-point numbers	I, Q, M, D, L or constant	High limit of the value range
Box output	Output	BOOL	I, Q, M, D, L	Result of the comparison

You can select the data type of the instruction from the "<???" drop-down list of the instruction box.

For additional information on valid data types, refer to "See also".

## Example

The following example shows how the instruction works:

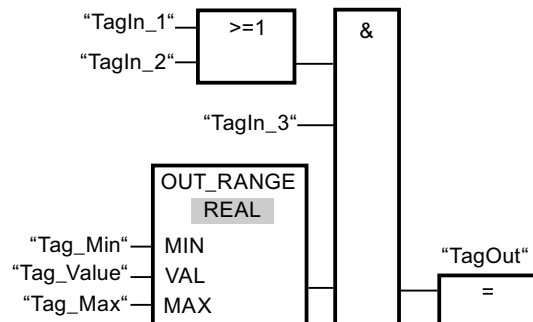

Output "TagOut" is set when the following conditions are fulfilled:

- The operands "TagIn\_1" and "TagIn\_2" have signal state "1".
- The operand "TagIn\_3" has the signal state "1".
- The value of the operand "Tag\_Value" is outside the value range that is specified by the values of the operands "Tag\_Min" and "Tag\_Max" ( $\text{MIN} > \text{VAL}$  or  $\text{VAL} > \text{MAX}$ ).

## See also

Overview of the valid data types (Page 1077)

## OK: Check validity

### Description

You can use the "Check validity" instruction to check if the value of an operand (<Operand>) is a valid floating-point number. The check is performed in every program cycle. If the operand value at the time of the query is a valid floating-point number, the output box will return the signal state "1". In all other cases, the signal state at the output of the "Check validity" instruction is "0".

You can use the "Check validity" instruction together with the EN mechanism. If you connect the instruction box to an EN enable input, the enable input is set only when the result of the validity query of the value is positive. You can use this function to ensure that an instruction is enabled only when the value of the specified operand is a valid floating-point number.

### Parameters

The following example shows how the "Check validity" instruction works:

Parameters	Declaration	Data type	Memory area	Description
<Operand>	Input	Floating-point numbers	I, Q, M, D, L	Value to be checked.

For additional information on valid data types, refer to "See also":

**Example**

The following example shows how the instruction works:

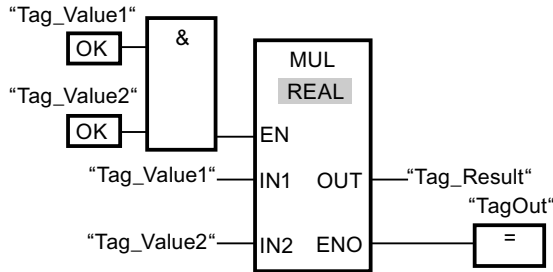

When the values of the operands "Tag\_Value1" and "Tag\_Value2" show valid floating-point numbers, the "Multiply" (MUL) instruction is activated and the ENO output is set. During the execution of the "Multiply" (MUL) instruction, the value of the operand "Tag\_Value1" is multiplied by the value of operand "Tag\_Value2". The product of the multiplication is then stored in the operand "Tag\_Result". If no errors occur during the execution of the instruction, the outputs ENO and "TagOut" are set to signal state "1".

**See also**

Overview of the valid data types (Page 1077)

**NOT\_OK: Check invalidity**

**Description**

You can use the "Check invalidity" instruction to check if the value of an operand (<Operand>) is an invalid floating-point number. The check is performed in every program cycle. If the operand value at the time of the query is a valid floating-point number, then the output box will return the signal state "1". In all other cases, the signal state on the output box is "0".

**Parameters**

The following table shows the parameters of the instruction "Check invalidity":

Parameters	Declaration	Data type	Memory area	Description
<Operand>	Input	Floating-point numbers	I, Q, M, D, L	Value to be checked.

For additional information on valid data types, refer to "See also":

## Example

The following example shows how the instruction works:

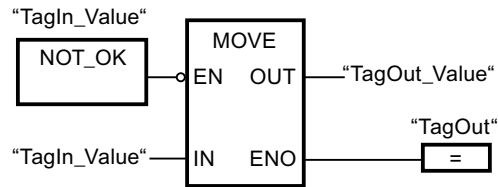

When the value of operand "TagIn\_Value" is an invalid floating-point number, the instruction "Move value" (MOVE) is not executed. The "TagOut" output is reset to signal state "0".

## See also

Overview of the valid data types (Page 1077)

## Math functions

### CALCULATE: Calculate

#### Description

The "Calculate" instruction is used to define and execute an expression (formula) for the calculation of mathematical operations or complex logic operations depending on the selected data type.

You can select the data type of the instruction from the "<???">" drop-down list of the instruction box. Depending on the selected data type, you can combine the functionality of specific instructions to execute a complex calculation. The expression to be calculated is specified via a dialog you can open via the "Calculator" icon at the top of the instruction box. The expression can contain the names of the input parameters and the syntax of the instructions. It is not permitted to specify operand names or operand addresses.

The following table shows the instructions that, depending on the selected data type, can be combined and executed in the expression of the "Calculate" instruction:

Data type	Instruction	Syntax	Example
Bit strings	AND: AND logic operation	AND	IN1 AND IN2 OR IN3
	OR: OR logic operation	OR	
	XOR: EXCLUSIVE OR logic operation	XOR	
	INV: Create ones complement	NOT	
	SWAP: Swap <sup>1)</sup>	SWAP	
Integers	ADD: Add	+	(IN1 + IN2) * IN3;
	SUB: Subtract	-	(ABS(IN2))*(ABS(IN1
	MUL: Multiply	*	))
	DIV: Divide	/	

Data type	Instruction	Syntax	Example
	MOD: Return remainder of division	MOD	
	INV: Create ones complement	NOT	
	NEG: Create twos complement	-(in1)	
	ABS: Form absolute value	ABS( )	
Floating-point numbers	ADD: Add	+	$((\text{SIN}(\text{IN}2) * \text{SIN}(\text{IN}2) + \text{SIN}(\text{IN}3) * \text{SIN}(\text{IN}3)) / \text{IN}3;$ $(\text{SQR}(\text{SIN}(\text{IN}2))) + (\text{SQR}(\text{COS}(\text{IN}3))) / \text{IN}2$
	SUB: Subtract	-	
	MUL: Multiply	*	
	DIV: Divide	/	
	EXPT: Exponentiate	**	
	ABS: Form absolute value	ABS( )	
	SQR: Form square	SQR( )	
	SQRT: Form square root	SQRT( )	
	LN: Form natural logarithm	LN( )	
	EXP: Form exponential value	EXP( )	
	FRAC: Return fraction	FRAC( )	
	SIN: Form sine value	SIN( )	
	COS: Form cosine value	COS( )	
	TAN: Form tangent value	TAN( )	
	ASIN: Form arcsine value	ASIN( )	
	ACOS: Form arccosine value	ACOS( )	
	ATAN: Form arctangent value	ATAN( )	
	NEG: Create twos complement	-(in1)	
	TRUNC: Truncate numerical value	TRUNC( )	
	ROUND: Round numerical value	ROUND( )	
	CEIL: Generate next higher integer from floating-point number	CEIL( )	
	FLOOR: Generate next lower integer from floating-point number	FLOOR( )	
<sup>1)</sup> Not possible for data type BYTE.			

In its initial state the instruction box contains at least 2 inputs (IN1 and IN2). The number of inputs can be extended. The inserted inputs are numbered in ascending order in the box.

The values of the inputs are used to execute the specified expression. Not all defined inputs have to be used in the expression. The result of the instruction is transferred to the box output OUT.

If, in the expression, you use inputs that are not available in the box, these inputs are automatically inserted. Provided that there are no gaps in the numbering of the inputs that are to be newly defined in the expression. You cannot, for example, use the input IN4 in the expression if the input IN3 is not defined.

Enable output ENO has the signal state "0" if one of the following conditions applies:

- Enable input EN has the signal state "0".
- The result or an interim result of the "Calculate" instruction is outside the range permitted for the data type specified at output OUT.



- A floating-point number has an invalid value.
- An error occurred during the execution of one of the instructions specified in the expression.

## Parameters

The following table shows the parameters of the instruction "Calculate":

Parameters	Declaration	Data type	Memory area		Description
			S7-1200	S7-1500	
EN	Input	BOOL	I, Q, M, D, L	I, Q, M, D, L, T, C	Enable input
ENO	Output	BOOL	I, Q, M, D, L	I, Q, M, D, L	Enable output
IN1	Input	Bit strings, integers, floating-point numbers	I, Q, M, D, L, P or constant	I, Q, M, D, L, P or constant	First available input
IN2	Input	Bit strings, integers, floating-point numbers	I, Q, M, D, L, P or constant	I, Q, M, D, L, P or constant	Second available input
INn	Input	Bit strings, integers, floating-point numbers	I, Q, M, D, L, P or constant	I, Q, M, D, L, P or constant	Additionally inserted inputs
OUT	Output	Bit strings, integers, floating-point numbers	I, Q, M, D, L, P	I, Q, M, D, L, P	Output to which the end result is to be transferred.

For additional information on valid data types, refer to "See also".

## Example

The following example shows how the instruction works:

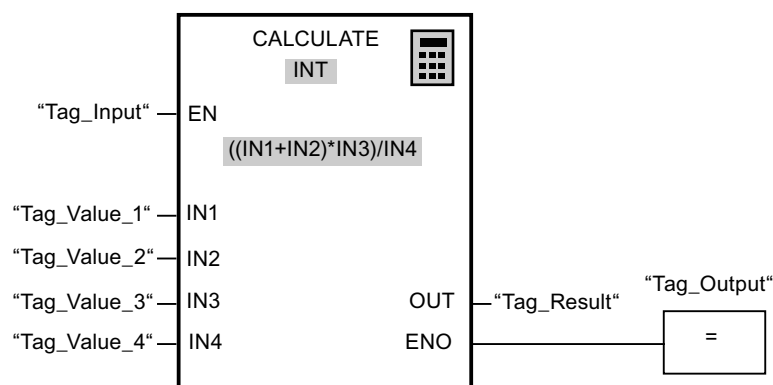

The following table shows how the instruction works using specific operand values:

Parameters	Operand	Value
IN1	Tag_Value_1	4
IN2	Tag_Value_2	4
IN3	Tag_Value_3	3
IN4	Tag_Value_4	2
OUT	Tag_Result	12

The "Calculate" instruction is executed when input "Tag\_Input" has the signal state "1". The value of operand "Tag\_Value\_1" is added to the value of operand "Tag\_Value\_2". The sum is multiplied with the value of the operand "Tag\_Value\_3". The product is divided by the value of the operand "Tag\_Value\_4". The quotient is transferred as end result to the operand "Tag\_Result" at the OUT output of the instruction. If no errors occur during the execution of the individual instructions, output ENO and the operand "Tag\_Output" are set to "1".

**See also**

Overview of the valid data types (Page 1077)

Adding additional inputs and outputs to FBD elements (Page 1329)

Removing instruction inputs and outputs (Page 1330)

Basics of the EN/ENO mechanism (Page 1167)

**ADD: Add**

**Description**

You can use the "Add" instruction to add the value at input IN1 to the value at input IN2 and query the sum at output OUT (OUT := IN1+IN2).

In its initial state the instruction box contains at least 2 inputs (IN1 and IN2). The number of inputs can be extended. The inserted inputs are numbered in ascending order in the box. During the execution of the instruction, the values of all available input parameters are added. The sum is stored at output OUT.

Enable output ENO has the signal state "0" if one of the following conditions applies:

- Enable input EN has the signal state "0".
- The result of the instruction is outside the range permitted for the data type specified at output OUT.
- A floating-point number has an invalid value.

## Parameters

The following table shows the parameters of the instruction "Add":

Parameters	Declaration	Data type	Memory area		Description
			S7-1200	S7-1500	
EN	Input	BOOL	I, Q, M, D, L	I, Q, M, D, L, T, C	Enable input
ENO	Output	BOOL	I, Q, M, D, L	I, Q, M, D, L	Enable output
IN1	Input	Integers, floating-point numbers	I, Q, M, D, L, P or constant	I, Q, M, D, L, P or constant	First number to be added
IN2	Input	Integers, floating-point numbers	I, Q, M, D, L, P or constant	I, Q, M, D, L, P or constant	Second number to be added
INn	Input	Integers, floating-point numbers	I, Q, M, D, L, P or constant	I, Q, M, D, L, P or constant	Optional input values, which are added.
OUT	Output	Integers, floating-point numbers	I, Q, M, D, L, P	I, Q, M, D, L, P	Sum

You can select the data type of the instruction from the "<???"> drop-down list of the instruction box.

For additional information on valid data types, refer to "See also":

## Example

The following example shows how the instruction works:

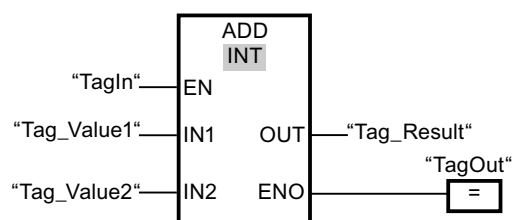

If the operand "TagIn" has the signal state "1", the "Add" instruction is executed. The value of operand "Tag\_Value1" is added to the value of operand "Tag\_Value2". The result of the addition is stored in the operand "Tag\_Result". If the instruction is executed without errors, the ENO enable output has the signal state "1" and the "TagOut" output is set.

**See also**

- Overview of the valid data types (Page 1077)
- Removing instruction inputs and outputs (Page 1330)
- Basics of the EN/ENO mechanism (Page 1167)
- Selecting a data type (Page 1315)
- Adding additional inputs and outputs to FBD elements (Page 1329)

**SUB: Subtract**

**Description**

You can use the "Subtract" instruction to subtract the value at input IN2 from the value at input IN1 and query the difference at output OUT (OUT := IN1-IN2).

Enable output ENO has the signal state "0" if one of the following conditions applies:

- Enable input EN has the signal state "0".
- The result of the instruction is outside the range permitted for the data type specified at output OUT.
- A floating-point number has an invalid value.

**Parameters**

The following table shows the parameters of the instruction "Subtract":

Parameters	Declaration	Data type	Memory area		Description
			S7-1200	S7-1500	
EN	Input	BOOL	I, Q, M, D, L	I, Q, M, D, L, T, C	Enable input
ENO	Output	BOOL	I, Q, M, D, L	I, Q, M, D, L	Enable output
IN1	Input	Integers, floating-point numbers	I, Q, M, D, L, P or constant	I, Q, M, D, L, P or constant	Minuend
IN2	Input	Integers, floating-point numbers	I, Q, M, D, L, P or constant	I, Q, M, D, L, P or constant	Subtrahend
OUT	Output	Integers, floating-point numbers	I, Q, M, D, L, P	I, Q, M, D, L, P	Difference

You can select the data type of the instruction from the "<???">" drop-down list of the instruction box.

For additional information on valid data types, refer to "See also".

## Example

The following example shows how the instruction works:

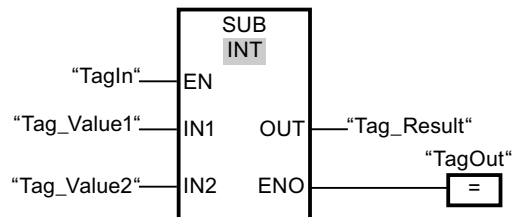

If the operand "TagIn" has the signal state "1", the "Subtract" instruction is executed. The value of operand "Tag\_Value2" is subtracted from the value of operand "Tag\_Value1". The result of the subtraction is stored in the operand "Tag\_Result". If the instruction is executed without errors, the ENO enable output has the signal state "1" and the "TagOut" output is set.

## See also

Overview of the valid data types (Page 1077)

Basics of the EN/ENO mechanism (Page 1167)

Selecting a data type (Page 1315)

## MUL: Multiply

### Description

You can use the "Multiply" instruction to multiply the value at input IN1 with the value at input IN2 and query the total at output OUT ( $OUT := IN1 * IN2$ ).

In its initial state the instruction box contains at least 2 inputs (IN1 and IN2). The number of inputs can be extended. The inserted inputs are numbered in ascending order in the box. When the instruction is executed, the values of all available input parameters are multiplied. The product is stored at the OUT output.

Enable output ENO has the signal state "0" if one of the following conditions applies:

- Enable input EN has the signal state "0".
- The result is outside the range permitted for the data type specified at output OUT.
- A floating-point number has an invalid value.

### Parameters

The following table shows the parameters of the instruction "Multiply":

Parameters	Declaration	Data type	Memory area		Description
			S7-1200	S7-1500	
EN	Input	BOOL	I, Q, M, D, L	I, Q, M, D, L, T, C	Enable input
ENO	Output	BOOL	I, Q, M, D, L	I, Q, M, D, L	Enable output
IN1	Input	Integers, floating-point numbers	I, Q, M, D, L, P or constant	I, Q, M, D, L, P or constant	First value for multiplication
IN2	Input	Integers, floating-point numbers	I, Q, M, D, L, P or constant	I, Q, M, D, L, P or constant	Second value for multiplication
INn	Input	Integers, floating-point numbers	I, Q, M, D, L, P or constant	I, Q, M, D, L, P or constant	Optional input values, which are multiplied.
OUT	Output	Integers, floating-point numbers	I, Q, M, D, L, P	I, Q, M, D, L, P	Product

You can select the data type of the instruction from the "<???" drop-down list of the instruction box.

For additional information on valid data types, refer to "See also".

### Example

The following example shows how the instruction works:

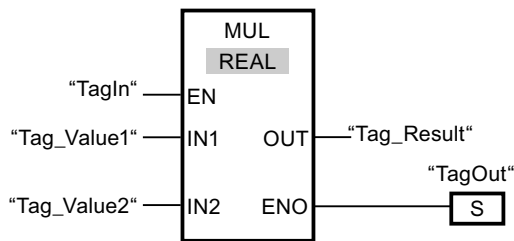

If the operand "TagIn" has the signal state "1", the "Multiply" instruction is executed. The value of operand "Tag\_Value1" is multiplied with the value of operand "Tag\_Value2". The result of the multiplication is stored in the operand "Tag\_Result". If the instruction is executed without errors, the ENO enable output has the signal state "1" and the "TagOut" output is set.

**See also**

- Overview of the valid data types (Page 1077)
- Removing instruction inputs and outputs (Page 1330)
- Basics of the EN/ENO mechanism (Page 1167)
- Selecting a data type (Page 1315)
- Adding additional inputs and outputs to FBD elements (Page 1329)

**DIV: Divide****Description**

You can use the "Divide" instruction to divide the value at input IN1 by the value at input IN2 and query the quotient at output OUT (OUT := IN1/IN2).

Enable output ENO has the signal state "0" if one of the following conditions applies:

- Enable input EN has the signal state "0".
- The result of the instruction is outside the range permitted for the data type specified at output OUT.
- A floating-point number has an invalid value.

**Parameters**

The following table shows the parameters of the instruction "Divide":

Parameters	Declaration	Data type	Memory area		Description
			S7-1200	S7-1500	
EN	Input	BOOL	I, Q, M, D, L	I, Q, M, D, L, T, C	Enable input
ENO	Output	BOOL	I, Q, M, D, L	I, Q, M, D, L	Enable output
IN1	Input	Integers, floating-point numbers	I, Q, M, D, L, P or constant	I, Q, M, D, L, P or constant	Dividend
IN2	Input	Integers, floating-point numbers	I, Q, M, D, L, P or constant	I, Q, M, D, L, P or constant	Divisor
OUT	Output	Integers, floating-point numbers	I, Q, M, D, L, P	I, Q, M, D, L, P	Quotient value

You can select the data type of the instruction from the "<???">" drop-down list of the instruction box.

For additional information on valid data types, refer to "See also".

**Example**

The following example shows how the instruction works:

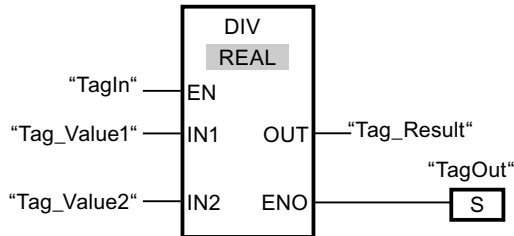

If the operand "TagIn" has the signal state "1", the "Divide" instruction is executed. The value of operand "Tag\_Value1" is divided by the value of operand "Tag\_Value2". The result of the division is stored in the operand "Tag\_Result". If the instruction is executed without errors, the ENO enable output has the signal state "1" and the "TagOut" output is set.

**See also**

- Overview of the valid data types (Page 1077)
- Basics of the EN/ENO mechanism (Page 1167)
- Selecting a data type (Page 1315)

**MOD: Return remainder of division**

**Description**

You can use the "Return remainder of division" instruction to divide the value at input IN1 by the value at input IN2 and query the quotient at output OUT.

**Parameters**

The following table shows the parameters of the instruction "Return remainder of division":

Parameters	Declaration	Data type	Memory area		Description
			S7-1200	S7-1500	
EN	Input	BOOL	I, Q, M, D, L	I, Q, M, D, L, T, C	Enable input
ENO	Output	BOOL	I, Q, M, D, L	I, Q, M, D, L	Enable output
IN1	Input	Integers	I, Q, M, D, L, P or constant	I, Q, M, D, L, P or constant	Dividend
IN2	Input	Integers	I, Q, M, D, L, P or constant	I, Q, M, D, L, P or constant	Divisor
OUT	Output	Integers	I, Q, M, D, L, P	I, Q, M, D, L, P	Remainder of division

You can select the data type of the instruction from the "<???">" drop-down list of the instruction box.



For additional information on valid data types, refer to "See also".

## Example

The following example shows how the instruction works:

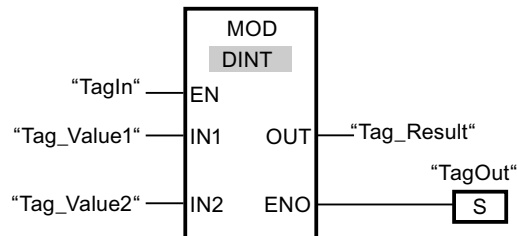

If the operand "TagIn" has the signal state "1", the "Return remainder of division" instruction is executed. The value of operand "Tag\_Value1" is divided by the value of operand "Tag\_Value2". The remainder of division is stored in operand "Tag\_Result". If the instruction is executed without errors, the ENO enable output has the signal state "1" and the "TagOut" output is set.

## See also

- Overview of the valid data types (Page 1077)
- Basics of the EN/ENO mechanism (Page 1167)
- Selecting a data type (Page 1315)

## NEG: Create twos complement

### Description

You can use the "Create twos complement" instruction to change the sign of the value at input IN and query the result at output OUT. If there is a positive value at input IN, for example, the negative equivalent of this value is sent to output OUT.

Enable output ENO has the signal state "0" if one of the following conditions applies:

- Enable input EN has the signal state "0".
- The result of the instruction is outside the range permitted for the data type specified at output OUT.
- A floating-point number has an invalid value.

### Parameters

The following table shows the parameters of the "Create twos complement" instruction:

Parameters	Declaration	Data type		Memory area		Description
		S7-1200	S7-1500	S7-1200	S7-1500	
EN	Input	BOOL	BOOL	I, Q, M, D, L	I, Q, M, D, L, T, C	Enable input
ENO	Output	BOOL	BOOL	I, Q, M, D, L	I, Q, M, D, L	Enable output
IN	Input	SINT, INT, DINT, Floating-point numbers	SINT, INT, DINT, LINT, Floating-point numbers	I, Q, M, D, L, P or constant	I, Q, M, D, L, P or constant	Input value
OUT	Output	SINT, INT, DINT, Floating-point numbers	SINT, INT, DINT, LINT, Floating-point numbers	I, Q, M, D, L, P	I, Q, M, D, L, P	Twos complement of the input value

You can select the data type of the instruction from the "<???" drop-down list of the instruction box.

For additional information on valid data types, refer to "See also".

### Example

The following example shows how the instruction works:

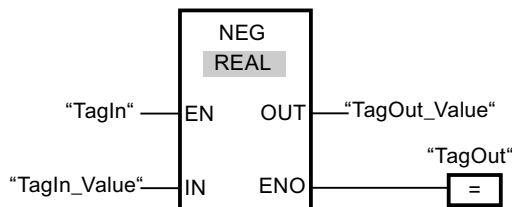

If the operand "TagIn" has the signal state "1", the "Create twos complement" instruction is executed. The sign of the value at input "TagIn\_Value" is changed and the result is stored at output "TagOut\_Value". If the instruction is executed without errors, the ENO enable output has the signal state "1" and the "TagOut" output is set.

### See also

Overview of the valid data types (Page 1077)

Basics of the EN/ENO mechanism (Page 1167)

Adding additional inputs and outputs to FBD elements (Page 1329)

## INC: Increment

### Description

You can use the "Increment" instruction to change the value of the operand at parameter IN/OUT to the next higher value and query the result.

Enable output ENO has the signal state "0" if one of the following conditions applies:

- Enable input EN has the signal state "0".
- A floating-point number has an invalid value.

### Parameters

The following table shows the parameters of the "Increment" instruction:

Parameters	Declaration	Data type	Memory area		Description
			S7-1200	S7-1500	
EN	Input	BOOL	I, Q, M, D, L	I, Q, M, D, L, T, C	Enable input
ENO	Output	BOOL	I, Q, M, D, L	I, Q, M, D, L	Enable output
IN/OUT	InOut	Integers	I, Q, M, D, L	I, Q, M, D, L	Value to be incremented.

You can select the data type of the instruction from the "<???"> drop-down list of the instruction box.

For additional information on valid data types, refer to "See also".

### Example

The following example shows how the instruction works:

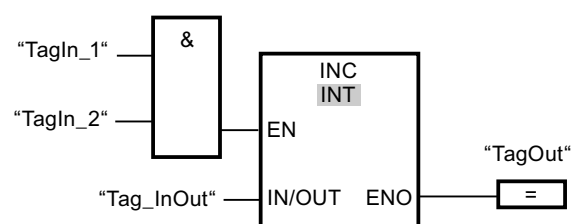

If the operands TagIn\_1 and TagIn\_2 have the signal state "1", the value of the operand "Tag\_InOut" is incremented by one and the output "TagOut" is set.

### See also

Overview of the valid data types (Page 1077)

Basics of the EN/ENO mechanism (Page 1167)

Adding additional inputs and outputs to FBD elements (Page 1329)

## DEC: Decrement

### Description

You can use the "Decrement" instruction to change the value of the operand at parameter IN/OUT to the next lower value and query the result.

Enable output ENO has the signal state "0" if one of the following conditions applies:

- Enable input EN has the signal state "0".
- A floating-point number has an invalid value.

### Parameters

The following table shows the parameters of the instruction "Decrement":

Parameters	Declaration	Data type	Memory area		Description
			S7-1200	S7-1500	
EN	Input	BOOL	I, Q, M, D, L	I, Q, M, D, L, T, C	Enable input
ENO	Output	BOOL	I, Q, M, D, L	I, Q, M, D, L	Enable output
IN/OUT	InOut	Integers	I, Q, M, D, L	I, Q, M, D, L	Value to be decremented.

You can select the data type of the instruction from the "<???" drop-down list of the instruction box.

For additional information on valid data types, refer to "See also".

### Example

The following example shows how the instruction works:

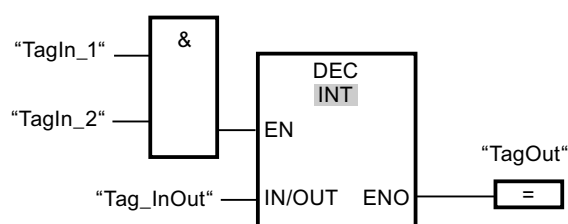

If the operands "TagIn\_1" and "TagIn\_2" have the signal state "1", the value of the operand "Tag\_InOut" is decremented by one and the output "TagOut" is set.

### See also

Overview of the valid data types (Page 1077)

Basics of the EN/ENO mechanism (Page 1167)

Adding additional inputs and outputs to FBD elements (Page 1329)

## ABS: Form absolute value

### Description

You can use the "Form absolute value" instruction to calculate the absolute value of the value specified at input IN. The result of the instruction is provided at output OUT and can be queried there.

Enable output ENO has the signal state "0" if one of the following conditions applies:

- Enable input EN has the signal state "0".
- A floating-point number has an invalid value.

### Parameters

The following table shows the parameters of the instruction "Form absolute value":

Parameters	Declaration	Data type		Memory area		Description
		S7-1200	S7-1500	S7-1200	S7-1500	
EN	Input	BOOL	BOOL	I, Q, M, D, L	I, Q, M, D, L, T, C	Enable input
ENO	Output	BOOL	BOOL	I, Q, M, D, L	I, Q, M, D, L	Enable output
IN	Input	SINT, INT, DINT, floating-point numbers	SINT, INT, DINT, LINT, floating-point numbers	I, Q, M, D, L, P or constant	I, Q, M, D, L, P or constant	Input value
OUT	Output	SINT, INT, DINT, floating-point numbers	SINT, INT, DINT, LINT, floating-point numbers	I, Q, M, D, L, P	I, Q, M, D, L, P	Absolute value of the input value

You can select the data type of the instruction from the "<???">" drop-down list of the instruction box.

For additional information on valid data types, refer to "See also".

### Example

The following example shows how the instruction works:

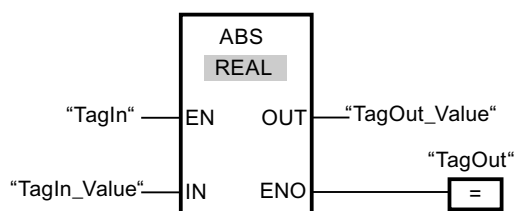

The following table shows how the instruction works using specific operand values:

Parameters	Operand	Value
IN	TagIn_Value	-6.234
OUT	TagOut_Value	6.234

If the operand "TagIn" has the signal state "1", the "Form absolute value" instruction is executed. The instruction calculates the absolute value of the value at input "TagIn\_Value" and sends the result to output "TagOut\_Value". If no errors occur during the execution of the instruction, the output "TagOut" is set.

**See also**

Overview of the valid data types (Page 1077)

Basics of the EN/ENO mechanism (Page 1167)

Adding additional inputs and outputs to FBD elements (Page 1329)

**MIN: Get minimum**

**Description**

The "Get minimum" instruction compares the values at the available inputs and writes the lowest value to the OUT output. The number of inputs can be expanded at the instruction box by additional inputs. The inputs are numbered in ascending order in the box.

In its initial state the instruction contains at least two inputs (IN1 and IN2) and no more than 100 inputs.

The ENO enable output has the signal state "0" if one of the following conditions is fulfilled:

- Enable input EN has the signal state "0".
- The implicit conversion of the data types fails during execution of the instruction.
- A floating-point number has an invalid value.

**Parameters**

The following table shows the parameters of the "Get minimum" instruction:

Parameter	Declaration	Data type		Memory area		Description
		S7-1200	S7-1500	S7-1200	S7-1500	
EN	Input	BOOL	BOOL	I, Q, M, D, L	I, Q, M, D, L, T, C	Enable input
ENO	Output	BOOL	BOOL	I, Q, M, D, L	I, Q, M, D, L	Enable output

Parameter	Declaration	Data type		Memory area		Description
		S7-1200	S7-1500	S7-1200	S7-1500	
IN1	Input	Integers, floating-point numbers, TIME, TOD, DATE	Integers, floating-point numbers, TIME, LTIME, TOD, LTOD, DATE, LDT	I, Q, M, D, L, P or constant	I, Q, M, D, L, P or constant	First input value
IN2	Input	Integers, floating-point numbers, TIME, TOD, DATE	Integers, floating-point numbers, TIME, LTIME, TOD, LTOD, DATE, LDT	I, Q, M, D, L, P or constant	I, Q, M, D, L, P or constant	Second input value
INn	Input	Integers, floating-point numbers, TIME, TOD, DATE	Integers, floating-point numbers, TIME, LTIME, TOD, LTOD, DATE, LDT	I, Q, M, D, L, P or constant	I, Q, M, D, L, P or constant	Additionally inserted inputs whose values are to be compared
OUT	Output	Integers, floating-point numbers, TIME, TOD, DATE	Integers, floating-point numbers, TIME, LTIME, TOD, LTOD, DATE, LDT	I, Q, M, D, L, P	I, Q, M, D, L, P	Result

You can select the data type of the instruction from the "<???" drop-down list of the instruction box.

For additional information on valid data types, refer to "See also".

### Example

The following example shows how the instruction works:

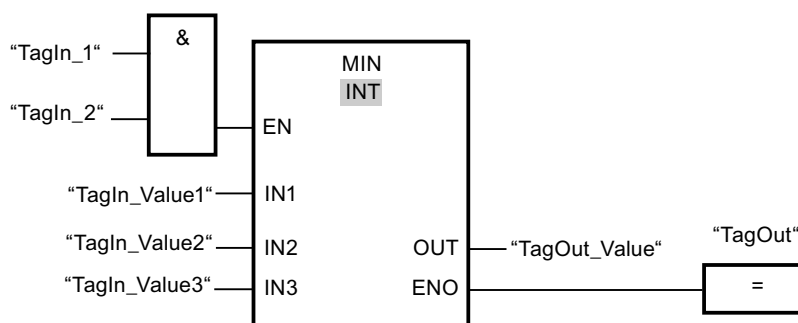

The following table shows how the instruction works using specific operand values:

Parameter	Operand	Value
IN1	TagIn_Value1	12222
IN2	TagIn_Value2	14444
IN3	TagIn_Value3	13333
OUT	TagOut_Value	12222

If the "TagIn\_1" and "TagIn\_2" operands have signal state "1", the "Get minimum" instruction is executed. The instruction compares the values of the specified operands and copies the lowest value ("TagIn\_Value1") to output "TagOut\_Value". If no errors occur during the execution of the instruction, the output "TagOut" is set.

**See also**

- Overview of the valid data types (Page 1077)
- Removing instruction inputs and outputs (Page 1330)
- Basics of the EN/ENO mechanism (Page 1167)
- Adding additional inputs and outputs to FBD elements (Page 1329)

**MAX: Get maximum**

**Description**

The "Get maximum" instruction compares the values at the available inputs and writes the highest value to the OUT output. The number of inputs can be expanded at the instruction box by additional inputs. The inputs are numbered in ascending order in the box.

In its initial state the instruction contains at least two inputs (IN1 and IN2) and no more than 100 inputs.

The ENO enable output has the signal state "0" if one of the following conditions is fulfilled:

- Enable input EN has the signal state "0".
- The implicit conversion of the data types fails during execution of the instruction.
- A floating-point number has an invalid value.



## Parameters

The following table shows the parameters of the "Get maximum" instruction:

Parameter	Declaration	Data type		Memory area		Description
		S7-1200	S7-1500	S7-1200	S7-1500	
EN	Input	BOOL	BOOL	I, Q, M, D, L	I, Q, M, D, L, T, C	Enable input
ENO	Output	BOOL	BOOL	I, Q, M, D, L	I, Q, M, D, L	Enable output
IN1	Input	Integers, floating-point numbers, TIME, TOD, DATE	Integers, floating-point numbers, TIME, LTIME, TOD, LTOD, DATE, LDT	I, Q, M, D, L, P or constant	I, Q, M, D, L, P or constant	First input value
IN2	Input	Integers, floating-point numbers, TIME, TOD, DATE	Integers, floating-point numbers, TIME, LTIME, TOD, LTOD, DATE, LDT	I, Q, M, D, L, P or constant	I, Q, M, D, L, P or constant	Second input value
INn	Input	Integers, floating-point numbers, TIME, TOD, DATE	Integers, floating-point numbers, TIME, LTIME, TOD, LTOD, DATE, LDT	I, Q, M, D, L, P or constant	I, Q, M, D, L, P or constant	Additionally inserted inputs whose values are to be compared.
OUT	Output	Integers, floating-point numbers, TIME, TOD, DATE	Integers, floating-point numbers, TIME, LTIME, TOD, LTOD, DATE, LDT	I, Q, M, D, L, P	I, Q, M, D, L, P	Result

You can select the data type of the instruction from the "<???"> drop-down list of the instruction box.

For additional information on valid data types, refer to "See also".

**Example**

The following example shows how the instruction works:

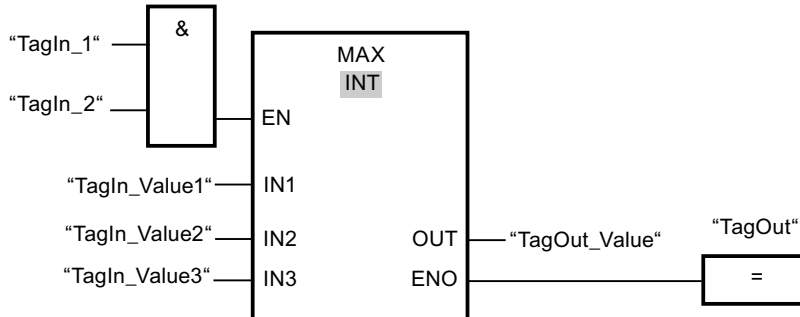

The following table shows how the instruction works using specific operand values:

Parameter	Operand	Value
IN1	TagIn_Value1	12222
IN2	TagIn_Value2	14444
IN3	TagIn_Value3	13333
OUT	TagOut_Value	14444

If the "TagIn\_1" and "TagIn\_2" operands have signal state "1", the "Get maximum" instruction is executed. The instruction compares the values of the specified operands and copies the highest value ("TagIn\_Value2") to output "TagOut\_Value". If no errors occur during the execution of the instruction, the output "TagOut" is set.

**See also**

- Overview of the valid data types (Page 1077)
- Removing instruction inputs and outputs (Page 1330)
- Basics of the EN/ENO mechanism (Page 1167)
- Adding additional inputs and outputs to FBD elements (Page 1329)

**LIMIT: Set limit value**

**Description**

You use the "Set limit value" instruction to limit the value at input IN to the values at the inputs MN and MX. If the value at the IN input meets the MN condition  $MN \leq IN \leq MX$ , it is copied to the OUT output. If the condition is not fulfilled and the input value IN is below the low limit MN, output OUT is set to the value of the input MN. If the high limit MX is exceeded, output OUT is set to the value of the input MX.

If the value at input MN is greater than that at input MX, the result is undefined and the enable output ENO is "0".

Enable output ENO has the signal state "0" if one of the following conditions applies:

- Enable input EN has the signal state "0".
- The specified tags are not of the same data type.
- An operand has an invalid value.
- The value at input MN is greater than the value at input MX.

## Parameters

The following table shows the parameters of the "Set limit value" instruction:

Parameter	Declaration	Data type		Memory area		Description
		S7-1200	S7-1500	S7-1200	S7-1500	
EN	Input	BOOL	BOOL	I, Q, M, D, L	I, Q, M, D, L, T, C	Enable input
ENO	Output	BOOL	BOOL	I, Q, M, D, L	I, Q, M, D, L	Enable output
MN	Input	Integers, floating-point numbers, TIME, TOD, DATE	Integers, floating-point numbers, TIME, LTIME, TOD, LTOD, DATE, LDT	I, Q, M, D, L, P or constant	I, Q, M, D, L, P or constant	Low limit
IN	Input	Integers, floating-point numbers, TIME, TOD, DATE	Integers, floating-point numbers, TIME, LTIME, TOD, LTOD, DATE, LDT	I, Q, M, D, L, P or constant	I, Q, M, D, L, P or constant	Input value
MX	Input	Integers, floating-point numbers, TIME, TOD, DATE	Integers, floating-point numbers, TIME, LTIME, TOD, LTOD, DATE, LDT	I, Q, M, D, L, P or constant	I, Q, M, D, L, P or constant	High limit
OUT	Output	Integers, floating-point numbers, TIME, TOD, DATE	Integers, floating-point numbers, TIME, LTIME, TOD, LTOD, DATE, LDT	I, Q, M, D, L, P	I, Q, M, D, L, P	Result

You can select the data type of the instruction from the "<???"> drop-down list of the instruction box.

For additional information on valid data types, refer to "See also".

**Example**

The following example shows how the instruction works:

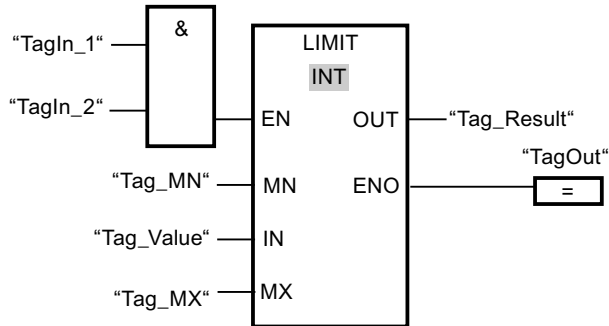

The following table shows how the instruction works using specific operand values:

Parameter	Operand	Value
MN	Tag_MN	12000
IN	Tag_Value	8000
MX	Tag_MX	16000
OUT	Tag_Result	12000

If the "TagIn\_1" and "TagIn\_2" operands have the signal state "1", the "Set limit value" instruction is executed. The value of operand "Tag\_Value" is compared with the values of operands "Tag\_MN" and "Tag\_MX". Since the value at the operand "Tag\_Value" is less than the low limit, the value of the operand "Tag\_MN" is copied to output "Tag\_Result". If no errors occur during the execution of the instruction, the output "TagOut" is set.

**See also**

- Overview of the valid data types (Page 1077)
- Basics of the EN/ENO mechanism (Page 1167)
- Adding additional inputs and outputs to FBD elements (Page 1329)

**SQR: Form square**

**Description**

You can use the "Form square" instruction to square the value at input IN and query the result at output OUT.

Enable output ENO has the signal state "0" if one of the following conditions applies:

- Enable input EN has the signal state "0".
- The value at input IN is not a valid floating-point number.

## Parameters

The following table shows the parameters of the instruction "Form square":

Parameters	Declaration	Data type	Memory area		Description
			S7-1200	S7-1500	
EN	Input	BOOL	I, Q, M, D, L	I, Q, M, D, L, T, C	Enable input
ENO	Output	BOOL	I, Q, M, D, L	I, Q, M, D, L	Enable output
IN	Input	Floating-point numbers	I, Q, M, D, L, P or constant	I, Q, M, D, L, P or constant	Input value
OUT	Output	Floating-point numbers	I, Q, M, D, L, P	I, Q, M, D, L, P	Square of the input value

You can select the data type of the instruction from the "<???" drop-down list of the instruction box.

For additional information on valid data types, refer to "See also".

## Example

The following example shows how the instruction works:

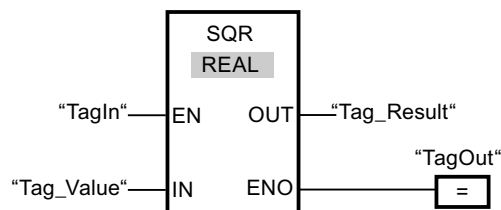

The following table shows how the instruction works using specific operand values:

Parameters	Operand	Value
IN	Tag_Value	5.0
OUT	Tag_Result	25.0

If the operand "TagIn" has the signal state "1", the "Form square" instruction is executed. The instruction squares the value of the operand "Tag\_Value" and sends the result to output "Tag\_Result". If no errors occur during the execution of the instruction, the output "TagOut" is set.

## See also

Overview of the valid data types (Page 1077)

Basics of the EN/ENO mechanism (Page 1167)

## SQRT: Form square root

### Description

You can use the "Form square root" instruction to form the square root of the value at input IN and query the result at output OUT. The instruction has a positive result if the input value is greater than zero. If input values are less than zero, output OUT returns an invalid floating-point number. If the value at input IN is "0", the result is also "0".

Enable output ENO has the signal state "0" if one of the following conditions applies:

- Enable input EN has the signal state "0".
- The value at input IN is not a valid floating-point number.
- The value at input IN is negative.

### Parameters

The following table shows the parameters of the instruction "Form square root":

Parameters	Declaration	Data type	Memory area		Description
			S7-1200	S7-1500	
EN	Input	BOOL	I, Q, M, D, L	I, Q, M, D, L, T, C	Enable input
ENO	Output	BOOL	I, Q, M, D, L	I, Q, M, D, L	Enable output
IN	Input	Floating-point numbers	I, Q, M, D, L, P or constant	I, Q, M, D, L, P or constant	Input value
OUT	Output	Floating-point numbers	I, Q, M, D, L	I, Q, M, D, L	Square root of the input value

You can select the data type of the instruction from the "<???" drop-down list of the instruction box.

For additional information on valid data types, refer to "See also".

### Example

The following example shows how the instruction works:

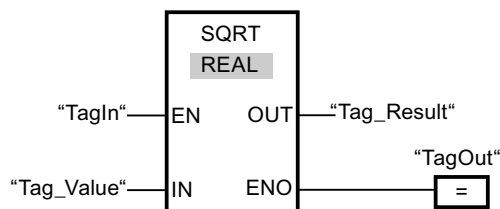

The following table shows how the instruction works using specific operand values:

Parameters	Operand	Value
IN	Tag_Value	25.0
OUT	Tag_Result	5.0

If the operand "TagIn" has the signal state "1", the "Form square root" instruction is executed. The instruction calculates the square root of the operand "Tag\_Value" and sends the result to output "Tag\_Result". If no errors occur during the execution of the instruction, the output "TagOut" is set.

## See also

Overview of the valid data types (Page 1077)

Basics of the EN/ENO mechanism (Page 1167)

## LN: Form natural logarithm

### Description

You can use the "Form natural logarithm" instruction to calculate the natural logarithm to base  $e$  ( $e = 2.718282$ ) of the value at input IN. The result is sent to output OUT and can be queried there. The instruction has a positive result if the input value is greater than zero. If input values are less than zero, output OUT returns an invalid floating-point number.

Enable output ENO has the signal state "0" if one of the following conditions applies:

- Enable input EN has the signal state "0".
- The value at input IN is not a valid floating-point number.
- The value at input IN is negative.

### Parameters

The following table shows the parameters of the instruction "Form natural logarithm":

Parameters	Declaration	Data type	Memory area		Description
			S7-1200	S7-1500	
EN	Input	BOOL	I, Q, M, D, L	I, Q, M, D, L, T, C	Enable input
ENO	Output	BOOL	I, Q, M, D, L	I, Q, M, D, L	Enable output
IN	Input	Floating-point numbers	I, Q, M, D, L, P or constant	I, Q, M, D, L, P or constant	Input value
OUT	Output	Floating-point numbers	I, Q, M, D, L, P	I, Q, M, D, L, P	Natural logarithm of the input value

You can select the data type of the instruction from the "<???">" drop-down list of the instruction box.

For additional information on valid data types, refer to "See also".

**Example**

The following example shows how the instruction works:

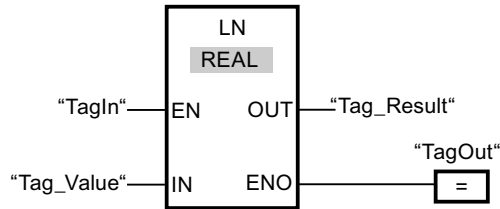

If the operand "TagIn" has the signal state "1", the "Form natural logarithm" instruction is executed. The instruction forms the natural logarithm of the value at input "Tag\_Value" and sends the result to output "Tag\_Result". If no errors occur during the execution of the instruction, the output "TagOut" is set.

**See also**

- Overview of the valid data types (Page 1077)
- Basics of the EN/ENO mechanism (Page 1167)

**EXP: Form exponential value**

**Description**

You can use the "Form exponential value" instruction to calculate the exponent from the base e (e = 2.718282 and the value specified at input IN. The result is provided at output OUT and can be queried there (OUT = e<sup>IN</sup>).

Enable output ENO has the signal state "0" if one of the following conditions applies:

- Enable input EN has the signal state "0".
- The value at input IN is not a valid floating-point number.

**Parameters**

The following table shows the parameters of the instruction "Form exponential value":

Parameters	Declaration	Data type	Memory area		Description
			S7-1200	S7-1500	
EN	Input	BOOL	I, Q, M, D, L	I, Q, M, D, L, T, C	Enable input
ENO	Output	BOOL	I, Q, M, D, L	I, Q, M, D, L	Enable output
IN	Input	Floating-point numbers	I, Q, M, D, L, P or constant	I, Q, M, D, L, P or constant	Input value
OUT	Output	Floating-point numbers	I, Q, M, D, L, P	I, Q, M, D, L, P	Exponential value of the input value IN



You can select the data type of the instruction from the "<???"> drop-down list of the instruction box.

For additional information on valid data types, refer to "See also".

## Example

The following example shows how the instruction works:

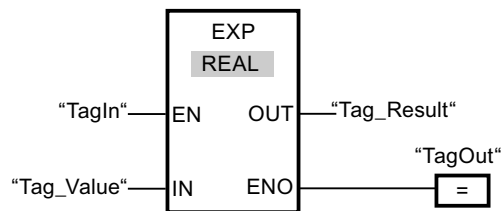

If the operand "TagIn" has the signal state "1", the "Form exponential value" instruction is executed. The instruction forms the exponent from base e and the value of the operand "Tag\_Value" and sends the result to output "Tag\_Result". If no errors occur during the execution of the instruction, the output "TagOut" is set.

## See also

Overview of the valid data types (Page 1077)

Basics of the EN/ENO mechanism (Page 1167)

## SIN: Form sine value

### Description

You can use the "Form sine value" instruction to calculate the sine of an angle. The size of the angle is specified in the radian measure at input IN. The result of the instruction is provided at output OUT and can be queried there.

Enable output ENO has the signal state "0" if one of the following conditions applies:

- Enable input EN has the signal state "0".
- The value at input IN is not a valid floating-point number.

### Parameters

The following table shows the parameters of the instruction "Form sine value":

Parameters	Declaration	Data type	Memory area		Description
			S7-1200	S7-1500	
EN	Input	BOOL	I, Q, M, D, L	I, Q, M, D, L, T, C	Enable input
ENO	Output	BOOL	I, Q, M, D, L	I, Q, M, D, L	Enable output

Parameters	Declaration	Data type	Memory area		Description
			S7-1200	S7-1500	
IN	Input	Floating-point numbers	I, Q, M, D, L, P or constant	I, Q, M, D, L, P or constant	Size of angle in the radian measure
OUT	Output	Floating-point numbers	I, Q, M, D, L, P	I, Q, M, D, L, P	Sine of the specified angle

You can select the data type of the instruction from the "<???" drop-down list of the instruction box.

For additional information on valid data types, refer to "See also".

**Example**

The following example shows how the instruction works:

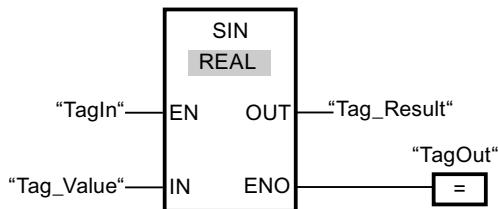

The following table shows how the instruction works using specific operand values:

Parameters	Operand	Value
IN	Tag_Value	+1.570796 ( $\pi/2$ )
OUT	Tag_Result	1.0

If the operand "TagIn" has the signal state "1", the "Form sine value" instruction is executed. The instruction calculates the sine of the angle specified at input "Tag\_Value" and sends the result to output "Tag\_Result". If no errors occur during the execution of the instruction, the output "TagOut" is set.

**See also**

- Overview of the valid data types (Page 1077)
- Basics of the EN/ENO mechanism (Page 1167)

**COS: Form cosine value**

**Description**

You can use the "Form cosine value" instruction to calculate the cosine of an angle. The size of the angle is specified in the radian measure at input IN. The result of the instruction is provided at output OUT and can be queried there.

Enable output ENO has the signal state "0" if one of the following conditions applies:

- Enable input EN has the signal state "0".
- The value at input IN is not a valid floating-point number.

## Parameters

The following table shows the parameters of the instruction "Form cosine value":

Parameters	Declaration	Data type	Memory area		Description
			S7-1200	S7-1500	
EN	Input	BOOL	I, Q, M, D, L	I, Q, M, D, L, T, C	Enable input
ENO	Output	BOOL	I, Q, M, D, L	I, Q, M, D, L	Enable output
IN	Input	Floating-point numbers	I, Q, M, D, L, P or constant	I, Q, M, D, L, P or constant	Size of angle in the radian measure
OUT	Output	Floating-point numbers	I, Q, M, D, L, P	I, Q, M, D, L, P	Cosine of the specified angle

You can select the data type of the instruction from the "<???" drop-down list of the instruction box.

For additional information on valid data types, refer to "See also".

## Example

The following example shows how the instruction works:

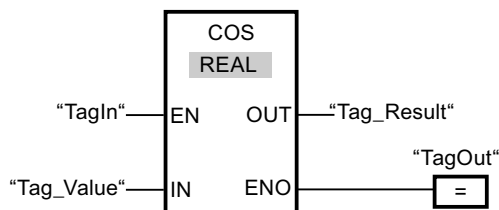

The following table shows how the instruction works using specific operand values:

Parameters	Operand	Value
IN	Tag_Value	+1.570796 ( $\pi/2$ )
OUT	Tag_Result	0

If the operand "TagIn" has the signal state "1", the "Form cosine value" instruction is executed. The instruction calculates the cosine of the angle specified at input "Tag\_Value" and sends the result to output "Tag\_Result". If no errors occur during the execution of the instruction, the output "TagOut" is set.

**See also**

- Overview of the valid data types (Page 1077)
- Basics of the EN/ENO mechanism (Page 1167)

**TAN: Form tangent value**

**Description**

You can use the "Form tangent value" instruction to calculate the tangent of an angle. The size of the angle is specified in the radian measure at input IN. The result of the instruction is provided at output OUT and can be queried there.

Enable output ENO has the signal state "0" if one of the following conditions applies:

- Enable input EN has the signal state "0".
- The value at input IN is not a valid floating-point number.

**Parameters**

The following table shows the parameters of the instruction "Form tangent value":

Parameters	Declaration	Data type	Memory area		Description
			S7-1200	S7-1500	
EN	Input	BOOL	I, Q, M, D, L	I, Q, M, D, L, T, C	Enable input
ENO	Output	BOOL	I, Q, M, D, L	I, Q, M, D, L	Enable output
IN	Input	Floating-point numbers	I, Q, M, D, L, P or constant	I, Q, M, D, L, P or constant	Size of angle in the radian measure
OUT	Output	Floating-point numbers	I, Q, M, D, L, P	I, Q, M, D, L, P	Tangent of the specified angle

You can select the data type of the instruction from the "<???" drop-down list of the instruction box.

For additional information on valid data types, refer to "See also".

**Example**

The following example shows how the instruction works:

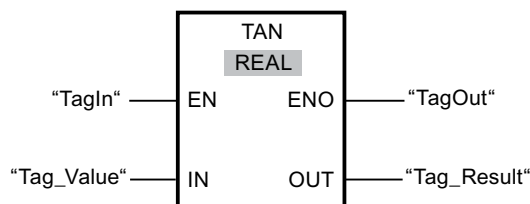

The following table shows how the instruction works using specific operand values:

Parameters	Operand	Value
IN	Tag_Value	+3.141593 ( $\pi$ )
OUT	Tag_Result	0

If the operand "TagIn" has the signal state "1", the "Form tangent value" instruction is executed. The instruction calculates the tangent of the angle specified at input "Tag\_Value" and stores the result at output "Tag\_Result". If no errors occur during the execution of the instruction, the output "TagOut" is set.

## See also

Overview of the valid data types (Page 1077)

Basics of the EN/ENO mechanism (Page 1167)

## ASIN: Form arcsine value

### Description

You can use the "Form arcsine value" instruction to calculate the size of the angle from the sine value specified at input IN, which corresponds to this value. Only valid floating-point numbers within the range -1 to +1 can be specified at input IN. The calculated angle size is output in radians at output OUT and can range in value from  $-\pi/2$  to  $+\pi/2$ .

Enable output ENO has the signal state "0" if one of the following conditions applies:

- Enable input EN has the signal state "0".
- The value at input IN is not a valid floating-point number.
- The value at input IN is outside the permitted range (-1 to +1).

### Parameters

The following table shows the parameters of the instruction "Form arcsine value":

Parameters	Declaration	Data type	Memory area		Description
			S7-1200	S7-1500	
EN	Input	BOOL	I, Q, M, D, L	I, Q, M, D, L, T, C	Enable input
ENO	Output	BOOL	I, Q, M, D, L	I, Q, M, D, L	Enable output
IN	Input	Floating-point numbers	I, Q, M, D, L, P or constant	I, Q, M, D, L, P or constant	Sine value
OUT	Output	Floating-point numbers	I, Q, M, D, L, P	I, Q, M, D, L, P	Size of angle in the radian measure

You can select the data type of the instruction from the "<???">" drop-down list of the instruction box.

For additional information on valid data types, refer to "See also".

**Example**

The following example shows how the instruction works:

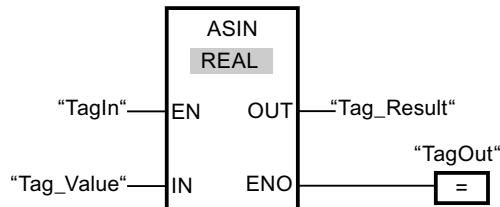

The following table shows how the instruction works using specific operand values:

Parameters	Operand	Value
IN	Tag_Value	1.0
OUT	Tag_Result	+1.570796 ( $\pi/2$ )

If the operand "TagIn" has the signal state "1", the "Form arcsine value" instruction is executed. The instruction calculates the size of the angle corresponding to the sine value at input "Tag\_Value". The result of the instruction is stored at output "Tag\_Result". If no errors occur during the execution of the instruction, the output "TagOut" is set.

**See also**

- Overview of the valid data types (Page 1077)
- Basics of the EN/ENO mechanism (Page 1167)

**ACOS: Form arccosine value**

**Description**

You can use the "Form arccosine value" instruction to calculate the size of the angle from the cosine value specified at input IN, which corresponds to this value. Only valid floating-point numbers within the range -1 to +1 can be specified at input IN. The calculated angle size is output in radians at output OUT and can range in value from 0 to  $\pi$ .

Enable output ENO has the signal state "0" if one of the following conditions applies:

- Enable input EN has the signal state "0".
- The value at input IN is not a valid floating-point number.
- The value at input IN is outside the permitted range (-1 to +1).

## Parameters

The following table shows the parameters of the instruction "Form arccosine value":

Parameters	Declaration	Data type	Memory area		Description
			S7-1200	S7-1500	
EN	Input	BOOL	I, Q, M, D, L	I, Q, M, D, L, T, C	Enable input
ENO	Output	BOOL	I, Q, M, D, L	I, Q, M, D, L	Enable output
IN	Input	Floating-point numbers	I, Q, M, D, L, P or constant	I, Q, M, D, L, P or constant	Cosine value
OUT	Output	Floating-point numbers	I, Q, M, D, L, P	I, Q, M, D, L, P	Size of angle in the radian measure

You can select the data type of the instruction from the "<???" drop-down list of the instruction box.

For additional information on valid data types, refer to "See also".

## Example

The following example shows how the instruction works:

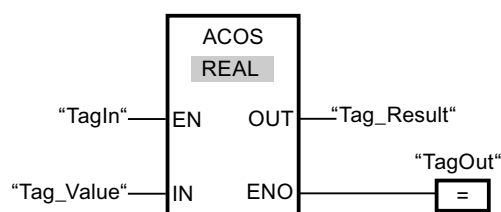

The following table shows how the instruction works using specific operand values:

Parameters	Operand	Value
IN	Tag_Value	0
OUT	Tag_Result	+1.570796 ( $\pi/2$ )

If the operand "TagIn" has the signal state "1", the "Form arccosine value" instruction is executed. The instruction calculates the size of the angle corresponding to the cosine value at input "Tag\_Value". The result of the instruction is stored at output "Tag\_Result". If no errors occur during the execution of the instruction, the output "TagOut" is set.

## See also

Overview of the valid data types (Page 1077)

Basics of the EN/ENO mechanism (Page 1167)

## ATAN: Form arctangent value

### Description

You can use the "Form arctangent value" instruction to calculate the size of the angle from the tangent value specified at input IN, which corresponds to this value. Only valid floating-point numbers may be specified at input IN. The calculated angle size is output in radians at the output OUT and can range in value from  $-\pi/2$  to  $+\pi/2$ .

Enable output ENO has the signal state "0" if one of the following conditions applies:

- Enable input EN has the signal state "0".
- The value at input IN is not a valid floating-point number.

### Parameters

The following table shows the parameters of the instruction "Form arctangent value":

Parameters	Declaration	Data type	Memory area		Description
			S7-1200	S7-1500	
EN	Input	BOOL	I, Q, M, D, L	I, Q, M, D, L, T, C	Enable input
ENO	Output	BOOL	I, Q, M, D, L	I, Q, M, D, L	Enable output
IN	Input	Floating-point numbers	I, Q, M, D, L, P or constant	I, Q, M, D, L, P or constant	Tangent value
OUT	Output	Floating-point numbers	I, Q, M, D, L, P	I, Q, M, D, L, P	Size of angle in the radian measure

You can select the data type of the instruction from the "<???" drop-down list of the instruction box.

For additional information on valid data types, refer to "See also".

### Example

The following example shows how the instruction works:

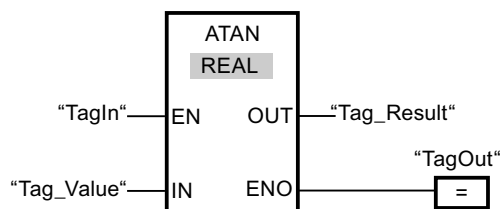

The following table shows how the instruction works using specific operand values:



Parameters	Operand	Value
IN	Tag_Value	1.0
OUT	Tag_Result	+0.785398 ( $\pi/4$ )

If the operand "TagIn" has the signal state "1", the "Form arc tangent value" instruction is executed. The instruction calculates the size of the angle corresponding to the tangent value at input "Tag\_Value". The result of the instruction is stored at output "Tag\_Result". If no errors occur during the execution of the instruction, the output "TagOut" is set.

## See also

Overview of the valid data types (Page 1077)

Basics of the EN/ENO mechanism (Page 1167)

## FRAC: Return fraction

### Description

You can use the "Return fraction" instruction to determine the decimal places of the value at the IN input. The result of the query is stored at output OUT and can be queried there. If the input IN has e.g. the value 123.4567, the output OUT has the value 0.4567.

Enable output ENO has the signal state "0" if one of the following conditions applies:

- Enable input EN has the signal state "0".
- Errors occur during the execution of the instruction, for example there is no valid floating-point number at the input.

### Parameters

The following table shows the parameters of the "Return fraction" instruction:

Parameters	Declaration	Data type	Memory area		Description
			S7-1200	S7-1500	
EN	Input	BOOL	I, Q, M, D, L	I, Q, M, D, L, T, C	Enable input
ENO	Output	BOOL	I, Q, M, D, L	I, Q, M, D, L	Enable output
IN	Input	Floating-point numbers	I, Q, M, D, L, P or constant	I, Q, M, D, L, P or constant	Input value, whose decimal places are to be determined.
OUT	Output	Floating-point numbers	I, Q, M, D, L, P	I, Q, M, D, L, P	Decimal places of the input value at input IN

You can select the data type of the instruction from the "<???">" drop-down list of the instruction box.

For additional information on valid data types, refer to "See also".

**Example**

The following example shows how the instruction works:

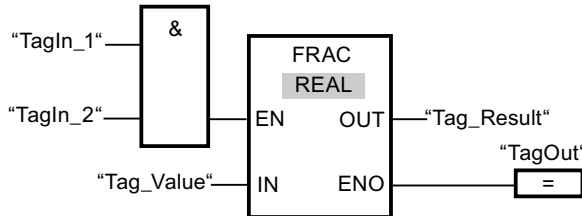

The following table shows how the instruction works using specific operand values:

Parameters	Operand	Value
IN	Tag_Value	2.555
OUT	Tag_Result	0.555

If the operands "TagIn\_1" and "TagIn\_2" have signal state "1", the "Return fraction" instruction is executed. The decimal places from the value at the operand "Tag\_Value" are copied to the operand "Tag\_Result". If the instruction is executed without errors, the ENO enable output has the signal state "1" and the "TagOut" output is set.

**See also**

Overview of the valid data types (Page 1077)

Basics of the EN/ENO mechanism (Page 1167)

Adding additional inputs and outputs to FBD elements (Page 1329)

**EXPT: Exponentiate**

**Description**

You can use the "Exponentiate" instruction to raise the value at the input IN1 by a power specified with the value at input IN2. The result of the instruction is stored at output OUT and can be queried there (OUT = IN1<sup>IN2</sup>).

The value at input IN1 must be a valid floating-point number. Integers are also allowed for setting the input IN2.

Enable output ENO has the signal state "0" if one of the following conditions applies:

- Enable input EN has the signal state "0".
- Errors occur during the instruction processing, for example, if there is an overflow.

## Parameters

The following table shows the parameters of the instruction "Exponentiate":

Parameters	Declaration	Data type	Memory area		Description
			S7-1200	S7-1500	
EN	Input	BOOL	I, Q, M, D, L	I, Q, M, D, L, T, C	Enable input
ENO	Output	BOOL	I, Q, M, D, L	I, Q, M, D, L	Enable output
IN1	Input	Floating-point numbers	I, Q, M, D, L, P or constant	I, Q, M, D, L, P or constant	Base value
IN2	Input	Integers, floating-point numbers	I, Q, M, D, L, P or constant	I, Q, M, D, L, P or constant	Value with which the base value is exponentiated
OUT	Output	Floating-point numbers	I, Q, M, D, L, P	I, Q, M, D, L, P	Result

You can select the data type of the instruction from the "<???" drop-down list of the instruction box.

For additional information on valid data types, refer to "See also".

## Example

The following example shows how the instruction works:

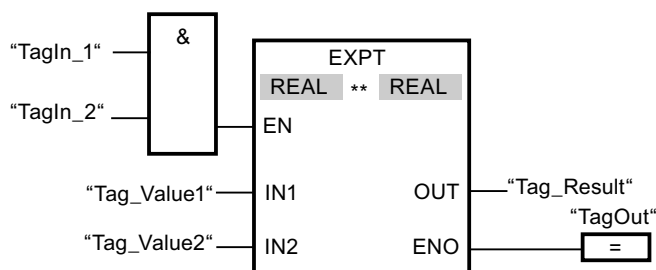

If the operands "TagIn\_1" and "TagIn\_2" have signal state "1", the "Exponentiate" instruction is executed. The value of operand "Tag\_Value1" is raised by the power of the value of the operand "Tag\_Value2". The result is stored at output "Tag\_Result". If the instruction is executed without errors, the ENO enable output has the signal state "1" and the "TagOut" output is set.

## See also

Overview of the valid data types (Page 1077)

Basics of the EN/ENO mechanism (Page 1167)

Adding additional inputs and outputs to FBD elements (Page 1329)

**Move operations**

**MOVE: Move value**

**Description**

You use the "Move value" instruction to transfer the content of the operand at the IN input to the operand at the OUT1 output. The transfer is always made in the direction of ascending addresses.

The following table shows the possible transfers for the S7-1200 CPU family:

Source (IN)	Destination (OUT1)	
	With IEC check	Without IEC check
BYTE	BYTE, WORD, DWORD	BYTE, WORD, DWORD, SINT, USINT, INT, UINT, DINT, UDINT, TIME, DATE, TOD, CHAR
WORD	WORD, DWORD	BYTE, WORD, DWORD, SINT, USINT, INT, UINT, DINT, UDINT, TIME, DATE, TOD, CHAR
DWORD	DWORD	BYTE, WORD, DWORD, SINT, USINT, INT, UINT, DINT, UDINT, REAL, TIME, DATE, TOD, CHAR
SINT	SINT	BYTE, WORD, DWORD, SINT, USINT, INT, UINT, DINT, UDINT, TIME, DATE, TOD
USINT	USINT, UINT, UDINT	BYTE, WORD, DWORD, SINT, USINT, INT, UINT, DINT, UDINT, TIME, DATE, TOD
INT	INT	BYTE, WORD, DWORD, SINT, USINT, INT, UINT, DINT, UDINT, TIME, DATE, TOD
UINT	UINT, UDINT	BYTE, WORD, DWORD, SINT, USINT, INT, UINT, DINT, UDINT, TIME, DATE, TOD
DINT	DINT	BYTE, WORD, DWORD, SINT, USINT, INT, UINT, DINT, UDINT, TIME, DATE, TOD
UDINT	UDINT	BYTE, WORD, DWORD, SINT, USINT, INT, UINT, DINT, UDINT, TIME, DATE, TOD
REAL	REAL	DWORD, REAL
LREAL	LREAL	LREAL
TIME	TIME	BYTE, WORD, DWORD, SINT, USINT, INT, UINT, DINT, UDINT, TIME
DATE	DATE	BYTE, WORD, DWORD, SINT, USINT, INT, UINT, DINT, UDINT, DATE
TOD	TOD	BYTE, WORD, DWORD, SINT, USINT, INT, UINT, DINT, UDINT, TOD
DTL	DTL	DTL
CHAR	CHAR	BYTE, WORD, DWORD, CHAR, Character of a string <sup>1)</sup>
Character of a string <sup>1)</sup>	Character of a string	Character of a string CHAR
ARRAY <sup>2)</sup>	ARRAY	ARRAY
STRUCT	STRUCT	STRUCT

Source (IN)	Destination (OUT1)	
	With IEC check	Without IEC check
PLC data type (UDT)	PLC data type (UDT)	PLC data type (UDT)
IEC_TIMER	IEC_TIMER	IEC_TIMER
IEC_SCOUNTER	IEC_SCOUNTER	IEC_SCOUNTER
IEC_USCOUNTER	IEC_USCOUNTER	IEC_USCOUNTER
IEC_COUNTER	IEC_COUNTER	IEC_COUNTER
IEC_UCOUNTER	IEC_UCOUNTER	IEC_UCOUNTER
IEC_DCOUNTER	IEC_DCOUNTER	IEC_DCOUNTER
IEC_UDCOUNTER	IEC_UDCOUNTER	IEC_UDCOUNTER

The following table shows the possible transfers for the S7-1500 CPU family:

Source (IN)	Destination (OUT1)	
	With IEC check	Without IEC check
BYTE	BYTE, WORD, DWORD, LWORD	BYTE, WORD, DWORD, LWORD, SINT, USINT, INT, UINT, DINT, UDINT, LINT, ULINT, TIME, LTIME, LDT, DATE, TOD, LTOD, CHAR
WORD	WORD, DWORD, LWORD	BYTE, WORD, DWORD, LWORD, SINT, USINT, INT, UINT, DINT, UDINT, LINT, ULINT, S5TIME, TIME, LTIME, LDT, DATE, TOD, LTOD, CHAR
DWORD	DWORD, LWORD	BYTE, WORD, DWORD, LWORD, SINT, USINT, INT, UINT, DINT, UDINT, LINT, ULINT, REAL, TIME, LTIME, LDT, DATE, TOD, LTOD, CHAR
LWORD	LWORD	BYTE, WORD, DWORD, LWORD, SINT, USINT, INT, UINT, DINT, UDINT, LINT, ULINT, LREAL, TIME, LTIME, LDT, DATE, TOD, LTOD, CHAR
SINT	SINT	BYTE, WORD, DWORD, LWORD, SINT, USINT, INT, UINT, DINT, UDINT, LINT, ULINT, TIME, LTIME, LDT, DATE, TOD, LTOD
USINT	USINT, UINT, UDINT, ULINT	BYTE, WORD, DWORD, LWORD, SINT, USINT, INT, UINT, DINT, UDINT, LINT, ULINT, TIME, LTIME, LDT, DATE, TOD, LTOD
INT	INT	BYTE, WORD, DWORD, LWORD, SINT, USINT, INT, UINT, DINT, UDINT, LINT, ULINT, TIME, LTIME, LDT, DATE, TOD, LTOD
UINT	UINT, UDINT, ULINT	BYTE, WORD, DWORD, LWORD, SINT, USINT, INT, UINT, DINT, UDINT, LINT, ULINT, TIME, LTIME, LDT, DATE, TOD, LTOD
DINT	DINT	BYTE, WORD, DWORD, LWORD, SINT, USINT, INT, UINT, DINT, UDINT, LINT, ULINT, TIME, LTIME, LDT, DATE, TOD, LTOD

Source (IN)	Destination (OUT1)	
	With IEC check	Without IEC check
UDINT	UDINT, ULINT	BYTE, WORD, DWORD, LWORD, SINT, USINT, INT, UINT, DINT, UDINT, LINT, ULINT, TIME, LTIME, LDT, DATE, TOD, LTOD
LINT	LINT	BYTE, WORD, DWORD, LWORD, SINT, USINT, INT, UINT, DINT, UDINT, LINT, ULINT, TIME, LTIME, LDT, DATE, TOD, LTOD
ULINT	ULINT	BYTE, WORD, DWORD, LWORD, SINT, USINT, INT, UINT, DINT, UDINT, LINT, ULINT, TIME, LTIME, LDT, DATE, TOD, LTOD
REAL	REAL	DWORD, REAL
LREAL	LREAL	LWORD, LREAL
S5TIME	S5TIME	WORD, S5TIME
TIME	TIME	BYTE, WORD, DWORD, LWORD, SINT, USINT, INT, UINT, DINT, UDINT, LINT, ULINT, TIME
LTIME	LTIME	BYTE, WORD, DWORD, LWORD, SINT, USINT, INT, UINT, DINT, UDINT, LINT, ULINT, LTIME
DATE	DATE	BYTE, WORD, DWORD, LWORD, SINT, USINT, INT, UINT, DINT, UDINT, LINT, ULINT, DATE
DT	DT	DT
LDT	LDT	BYTE, WORD, DWORD, LWORD, SINT, USINT, INT, UINT, DINT, UDINT, LINT, ULINT, LDT
TOD	TOD	BYTE, WORD, DWORD, LWORD, SINT, USINT, INT, UINT, DINT, UDINT, LINT, ULINT, TOD
LTOD	LTOD	BYTE, WORD, DWORD, LWORD, SINT, USINT, INT, UINT, DINT, UDINT, LINT, ULINT, LTOD
DTL	DTL	DTL
CHAR	CHAR	BYTE, WORD, DWORD, LWORD, CHAR, Character of a string <sup>1)</sup>
Character of a string <sup>1)</sup>	Character of a string	Character of a string CHAR
ARRAY <sup>2)</sup>	ARRAY	ARRAY
STRUCT	STRUCT	STRUCT
COUNTER	COUNTER, WORD, INT	WORD, DWORD, INT, UINT, DINT, UDINT
TIMER	TIMER, WORD, INT	WORD, DWORD, INT, UINT, DINT, UDINT
PLC data type (UDT)	PLC data type (UDT)	PLC data type (UDT)
IEC_TIMER	IEC_TIMER	IEC_TIMER
IEC_LTIMER	IEC_LTIMER	IEC_LTIMER
IEC_SCOUNTER	IEC_SCOUNTER	IEC_SCOUNTER
IEC_USCOUNTER	IEC_USCOUNTER	IEC_USCOUNTER
IEC_COUNTER	IEC_COUNTER	IEC_COUNTER
IEC_UCOUNTER	IEC_UCOUNTER	IEC_UCOUNTER

Source (IN)	Destination (OUT1)	
	With IEC check	Without IEC check
IEC_DCOUNTER	IEC_DCOUNTER	IEC_DCOUNTER
IEC_UDCOUNTER	IEC_UDCOUNTER	IEC_UDCOUNTER
IEC_LCOUNTER	IEC_LCOUNTER	IEC_LCOUNTER
IEC_ULCOUNTER	IEC_ULCOUNTER	IEC_ULCOUNTER

<sup>1)</sup> You can also use the "Move value" instruction to transfer individual characters of a string (STRING) to operands of CHAR data type. The number of the character to be transferred is specified in square brackets beside the operand name. "MyString[2]", for example, transfers the second character of the "MyString" string. It is also possible to transfer from operands of the data type CHAR to the individual characters of a string. You can also replace a specific character of a string with a character of another string.

<sup>2)</sup> Transferring entire arrays (ARRAY) is possible only when the array components of the operands at input IN and at output OUT1 are of the same data type.

If the bit length of the data type at input IN exceeds the bit length of the data type at output OUT1, the higher-order bits of the source value are lost. If the bit length of the data type at input IN is less than the bit length of the data type at output OUT1, the higher-order bits of the destination value will be overwritten with zeros.

In its initial state the instruction box contains 1 output (OUT1). The number of outputs can be extended. The added outputs are numbered in ascending order on the box. During the execution of the instruction the content of the operand at the input IN is transferred to all available outputs. The instruction box cannot be extended if structured data types (DTL, STRUCT, ARRAY) or characters of a string (STRING) are transferred.

You can also use the "Move block" (MOVE\_BLK) and "Move block uninterruptible" (UMOVE\_BLK) instructions to move operands of the ARRAY data type. You can move operands of the STRING data type with the instruction "Move character string" (S\_MOVE).

## Parameters

The following table shows the parameters of the "Move value" instruction:

Parameters	Declaration	Data type		Memory area		Description
		S7-1200	S7-1500	S7-1200	S7-1500	
EN	Input	BOOL	BOOL	I, Q, M, D, L	I, Q, M, D, L, T, C	Enable input
ENO	Output	BOOL	BOOL	I, Q, M, D, L	I, Q, M, D, L	Enable output

Parameters	Declaration	Data type		Memory area		Description
		S7-1200	S7-1500	S7-1200	S7-1500	
IN	Input	Bit strings, integers, floating-point numbers, DATE, TIME, TOD, DTL, CHAR, STRUCT, ARRAY, IEC data types, PLC data type (UDT)	Bit strings, integers, floating-point numbers, DATE, DT, LDT, S5TIME, TIME, LTIME, TOD, LTOD, DTL, CHAR, STRUCT, ARRAY, TIMER, COUNTER, IEC data types, PLC data type (UDT)	I, Q, M, D, L or constant	I, Q, M, D, L or constant	Element used to overwrite the destination address.
OUT1	Output	Bit strings, integers, floating-point numbers, DATE, TIME, TOD, DTL, CHAR, STRUCT, ARRAY, IEC data types, PLC data type (UDT)	Bit strings, integers, floating-point numbers, DATE, DT, LDT, S5TIME, TIME, LTIME, TOD, LTOD, DTL, CHAR, STRUCT, ARRAY, TIMER, COUNTER, IEC data types, PLC data type (UDT)	I, Q, M, D, L	I, Q, M, D, L	Destination address

For additional information on valid data types, refer to "See also".



## Example

The following example shows how the instruction works:

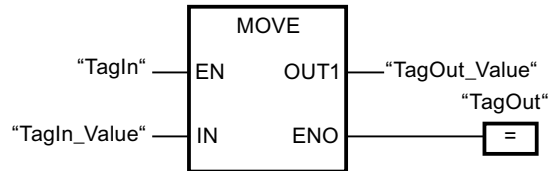

The following table shows how the instruction works using specific operand values:

Parameters	Operand	Value
IN	TagIn_Value	0011 1111 1010 1111
OUT1	TagOut_Value	0011 1111 1010 1111

If the operand "TagIn" has the signal state "1", the "Move value" instruction is executed. The instruction copies the content of the operand "TagIn\_Value" to the operand "TagOut\_Value" and set output "TagOut" to signal state "1".

## See also

Overview of the valid data types (Page 1077)

Basics of the EN/ENO mechanism (Page 1167)

Removing instruction inputs and outputs (Page 1330)

MOVE\_BLK: Move block (Page 1981)

UMOVE\_BLK: Move block uninterruptible (Page 1987)

S\_MOVE: Move character string (Page 2294)

Adding additional inputs and outputs to FBD elements (Page 1329)

## FieldRead: Read field

### Description

You can use the "Read field" instruction to read out a specific component from the field specified in the MEMBER parameter and transfer its content to the tag in the VALUE parameter. You use the parameter INDEX to define the index of the field components that are to be read. At the parameter MEMBER you specify the first component of the field to be read.

The data types of the field component at parameter MEMBER and the tags at parameter VALUE must correspond to the data type of the instruction "Read field".

Enable output ENO has the signal state "0" if one of the following conditions applies:

- Enable input EN has the signal state "0".
- The field component specified at the parameter INDEX is not defined in the field specified at the parameter MEMBER.
- Errors, such as an overflow, occur during execution.

## Parameters

The following table shows the parameters of the instruction "Read field":

Parameters	Declaration	Data type		Memory area		Description
		S7-1200	S7-1500	S7-1200	S7-1500	
EN	Input	BOOL	BOOL	I, Q, M, D, L	I, Q, M, D, L, T, C	Enable input
ENO	Output	BOOL	BOOL	I, Q, M, D, L	I, Q, M, D, L	Enable output
INDEX	Input	DINT	DINT	I, Q, M, D, L, P or constant	I, Q, M, D, L, P or constant	Index of field components whose content is read out
MEMBER	Input	Binary numbers, integers, floating-point numbers, TIME, DATE, TOD and CHAR as components of an ARRAY tag	Binary numbers, integers, floating-point numbers, timers, DATE, TOD, LTOD and CHAR as components of an ARRAY tag	D, L	D, L	First component of the field from which will be read
VALUE	Output	Bit strings, integers, floating-point numbers, TIME, DATE, TOD and CHAR	Bit strings, integers, floating-point numbers, timers, DATE, TOD, LTOD and CHAR	I, Q, M, D, L, P	I, Q, M, D, L, P	Operand to which the contents of the field component are transferred.

You can select the data type of the instruction from the "<???">" drop-down list of the instruction box.

For additional information on valid data types, refer to "See also".

## Example

The following example shows how the instruction works:

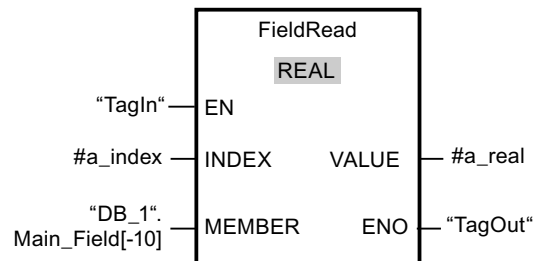

The following table shows how the instruction works using specific operand values:

Parameters	Tag	Value
INDEX	a_index	4
MEMBER	"DB_1".Main_Field[-10]	First component of the field "Main_Field[-10..10] of REAL" in the data block "DB_1"
VALUE	a_real	Component with Index 4 of the field "Main_Field[-10..10] of REAL"

The field component with index 4 is read out from the field "Main\_Field[-10...10] of REAL" and written to the tag "a\_real". The field component to be read is defined by the value at the parameter INDEX.

## See also

Overview of the valid data types (Page 1077)

Basics of the EN/ENO mechanism (Page 1167)

## FieldWrite: Write field

### Description

The "Write field" instruction is used to transfer the content of the tag at the VALUE input to a specific component of the field at the MEMBER output. You use the value at the INDEX input to specify the index of the field component that is described. At the MEMBER output, enter the first component of the field which is to be written to.

The data types of the field component specified at the MEMBER output and the tags at the VALUE input have to match the data type of the "Write field" instruction.

Enable output ENO has the signal state "0" if one of the following conditions applies:

- Enable input EN has the signal state "0".
- The field component specified at the input INDEX is not defined in the field specified at the output MEMBER.
- Errors, such as an overflow, occur during execution.

**Parameters**

The following table shows the parameters of the instruction "Write field":

Parameters	Declaration	Data type		Memory area		Description
		S7-1200	S7-1500	S7-1200	S7-1500	
EN	Input	BOOL	BOOL	I, Q, M, D, L	I, Q, M, D, L, T, C	Enable input
ENO	Output	BOOL	BOOL	I, Q, M, D, L	I, Q, M, D, L	Enable output
INDEX	Input	DINT	DINT	I, Q, M, D, L, P or constant	I, Q, M, D, L, P or constant	Index of field component that is written with the content of VALUE
VALUE	Input	Bit strings, integers, floating-point numbers, TIME, DATE, TOD and CHAR	Bit strings, integers, floating-point numbers, timers, DATE, TOD, LTOD and CHAR	I, Q, M, D, L, P or constant	I, Q, M, D, L, P or constant	Operand whose contents are copied
MEMBER	Output	Binary numbers, integers, floating-point numbers, TIME, DATE, TOD and CHAR as components of an ARRAY tag	Binary numbers, integers, floating-point numbers, timers, DATE, TOD, LTOD and CHAR as components of an ARRAY tag	D, L	D, L	First component of the field to which the content of VALUE is written.

You can select the data type of the instruction from the "<???">" drop-down list of the instruction box.

For additional information on valid data types, refer to "See also".

## Example

The following example shows how the instruction works:

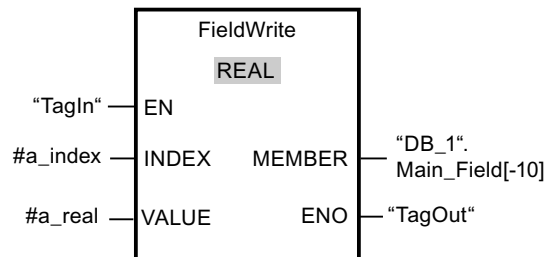

The following table shows how the instruction works using specific operand values:

Parameters	Operand	Value
INDEX	a_index	4
VALUE	a_real	10.54
MEMBER	"DB_1".Main_Field[-10]	First component of the field "Main_Field[-10..10] of REAL" in the data block "DB_1"

The value "10.54" of the "a\_real" tag is written to the field component with index 4 of the "Main\_Field[-10 ... 10] of REAL" field. The index of the field component to which the content of the tag "a\_real" is transferred is specified by the value at the input INDEX.

## See also

Overview of the valid data types (Page 1077)

Basics of the EN/ENO mechanism (Page 1167)

## MOVE\_BLK: Move block

### Description

You can use the "Move block" instruction to move the content of a memory area (source area) to another memory area (destination area). The number of elements to be moved to the destination area is specified with the COUNT parameter. The width of the elements to be moved is defined by the width of the element at input IN.

The instruction can only be executed if the source area and the destination area are of the same data type.

The ENO enable output has the signal state "0" if one of the following conditions is fulfilled:

- The EN enable input has the signal state "0".
- More data is moved than is made available at input IN or output OUT.

When a Array of BOOL is copied, the enable output ENO for an overflow is set to "1" until the byte limit of the Array structure is exceeded. If the byte limit of the Array structure is exceeded by the value at the COUNT input, the ENO enable output is reset to "0".

**Parameters**

The following table lists the parameters of the "Move block" instruction:

Parameter	Declaration	Data type		Memory area		Description
		S7-1200	S7-1500	S7-1200	S7-1500	
EN	Input	BOOL	BOOL	I, Q, M, D, L	I, Q, M, D, L, T, C	Enable input
ENO	Output	BOOL	BOOL	I, Q, M, D, L	I, Q, M, D, L	Enable output
IN <sup>1)</sup>	Input	Binary numbers, integers, floating-point numbers, TIME, DATE, CHAR, TOD	Binary numbers, integers, floating-point numbers, timers, DATE, CHAR, TOD, LTOD	D, L	D, L	The first element of the source area that is being copied
COUNT	Input	USINT, UINT, UDINT	USINT, UINT, UDINT, ULINT	I, Q, M, D, L, P or constant	I, Q, M, D, L, P or constant	Number of elements to be copied from the source area to the destination area
OUT <sup>1)</sup>	Output	Binary numbers, integers, floating-point numbers, TIME, DATE, CHAR, TOD	Binary numbers, integers, floating-point numbers, timers, DATE, CHAR, TOD, LTOD	D, L	D, L	The first element of the destination area to which the contents of the source area are being copied
<sup>1)</sup> The specified data types can only be used as elements of an Array structure.						

For additional information on valid data types, refer to "See also".

## Example

The following example shows how the instruction works:

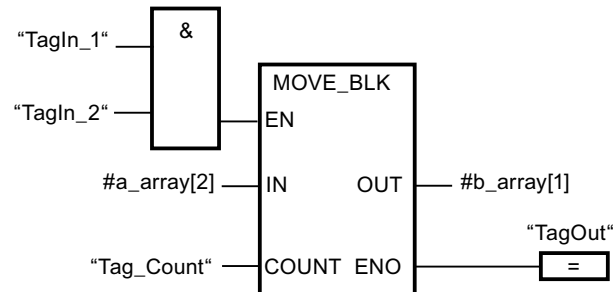

The following table shows how the instruction works using specific operand values:

Parameter	Operand	Value
IN	a_array[2]	The data type of the a_array operand is Array [0..5] of INT. It consists of six elements of data type INT.
COUNT	Tag_Count	3
OUT	b_array[1]	The data type of the b_array operand is Array [0..6] of INT. It consists of seven elements of data type INT.

If the operands "TagIn\_1" and "TagIn\_2" have signal state "1", the "Move block" instruction is executed. Starting from the third element, the instruction selects three INT elements from the #a\_array tag and copies their contents to the #b\_array output tag, beginning with the second element. If the instruction is executed without errors, the ENO enable output has the signal state "1" and the "TagOut" output is set.

## See also

Overview of the valid data types (Page 1077)

Basics of the EN/ENO mechanism (Page 1167)

## MOVE\_BLK\_VARIANT: Move block

### Description

You can use the "Move block" instruction to move the content of a memory area (source area) to another memory area (destination area). You can copy elements of an array to another array of the same data type. The size (number of elements) of the source and destination array may be different. You can copy several elements within an array or individual elements.

If you are using the instruction, the array must not yet be known at the time the block is created, as the source and the destination are transferred using VARIANT.

The counting at the parameters SRC\_INDEX and DEST\_INDEX always starts with the low limit "0", regardless of the later declaration of the array.

The ENO enable output has the signal state "0" if one of the following conditions is fulfilled:

- The EN enable input has the signal state "0".
- More data is copied than is made available.

### Parameters

The following table lists the parameters of the "Move block" instruction:

Parameter	Declaration	Data type	Memory area	Description
EN	Input	BOOL	I, Q, M, D, L	Enable input
ENO	Output	BOOL	I, Q, M, D, L	Enable output
SRC	Input	VARIANT (array or single element)	I, Q, D, L	The first element of the source area that is being copied
COUNT	Input	UDINT	I, Q, M, D, L or constant	Specifies the number of elements that will be copied.  Set the value at the parameter COUNT to "1", if no Array is specified at the parameter SRC or the parameter DEST.
SRC_INDEX	Input	UDINT	I, Q, M, D, L or constant	<ul style="list-style-type: none"> <li>• If an Array is specified at parameter SRC, the parameter SRC_INDEX specifies the first element at the parameter SRC, which is to be copied.</li> <li>• If no Array is specified at the parameter SRC, then enter the value "0" at the parameter SRC_INDEX.</li> </ul>



Parameter	Declaration	Data type	Memory area	Description
DEST_INDEX	Input	UDINT	I, Q, M, D, L or constant	<ul style="list-style-type: none"> <li>If an Array is specified at parameter DEST, the parameter DEST_INDEX specifies the first element at the parameter DEST, which is to be copied.</li> <li>If no Array is specified at the parameter DEST, then enter the value "0" at the parameter DEST_INDEX.</li> </ul>
DEST	InOut	VARIANT	I, Q, D, L	The first element of the source area that is being copied
RET_VAL	Output	INT	I, Q, M, D, L	Error information: If an error occurs during execution of the instruction, an error code is output on the RET_VAL parameter.

For additional information on valid data types, refer to "See also".

### Parameter RET\_VAL

The following table shows the meaning of the values of the RET\_VAL parameter:

Error code* (W#16#...)	Explanation
0000	No error
8082	Data types do not correspond
80B4	Data types do not correspond
8151	Code generation error at SRC parameter
8152	Code generation error at SRC parameter
8153	Code generation error at SRC parameter
8251	The COUNT parameter has an invalid value
8254	The COUNT parameter has an invalid value
8281	The COUNT parameter has an invalid value
8282	The COUNT parameter has an invalid value
8382	The value at the SRC_INDEX parameter is outside the limit of the VARIANT
8383	The value at the SRC_INDEX parameter is outside the high limit of the array.
8482	The value at the DEST_INDEX parameter is outside the limit of the VARIANT

Error code* (W#16#...)	Explanation
8483	The value at the DEST_INDEX parameter is outside the high limit of the array.
8534	The DEST parameter is write protected.
8551	Code generation error at DEST parameter
8552	Code generation error at DEST parameter
8553	Code generation error at DEST parameter
85A2	The DEST parameter is write protected.

\*The error codes can be displayed as integer or hexadecimal value in the program editor. For additional information on toggling display formats, refer to "See also".

**Example**

The following example shows how the instruction works:

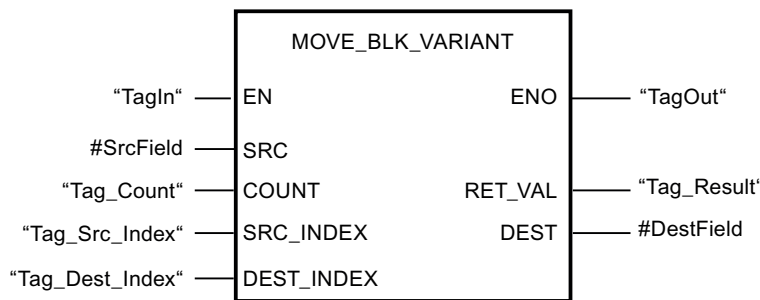

The following table shows how the instruction works using specific operand values:

Parameter	Operand	Value
SRC	#SrcField	The local operand #SrcField uses a UDT that was still unknown at the time when the block was programmed.
COUNT	Tag_Count	3
SRC_INDEX	Tag_Src_Index	4
DEST_INDEX	Tag_Dest_Index	2
DEST	#DestField	The local operand #DestField uses a UDT that was still unknown at the time when the block was programmed.

If the operand "TagIn" has the signal state "1", the "Move block" instruction is executed. If the instruction is executed without errors, the ENO enable output has the signal state "1" and the "TagOut" output is set.

**See also**

Overview of the valid data types (Page 1077)

Basics of the EN/ENO mechanism (Page 1167)

**UMOVE\_BLK: Move block uninterruptible****Description**

You can use the "Move block uninterruptible" instruction to move the content of a memory area (source area) to another memory area (destination area). The number of elements to be moved to the destination area is specified with the COUNT parameter. The width of the elements to be moved is defined by the width of the element at input IN.

The instruction can only be executed if the source area and the destination area have the same data type.

**Note**

The move operation cannot be interrupted by other operating system activities. This is why the alarm reaction times of the CPU increase during the execution of the "Move block uninterruptible" instruction.

The ENO enable output has the signal state "0" if one of the following conditions is fulfilled:

- The EN enable input has the signal state "0".
- More data is moved than is made available at input IN or output OUT.

When a Array of BOOL is copied, the enable output ENO for an overflow is set to "1" until the byte limit of the Array structure is exceeded. If the byte limit of the Array structure is exceeded by the value at the COUNT input, the ENO enable output is reset to "0".

You can use the "Move block uninterruptible" instruction to move a maximum of 16 KB. Note the CPU-specific restrictions for this.

**Parameters**

The following table shows the parameters of the "Move block uninterruptible" instruction:

Parameter	Declaration	Data type		Memory area		Description
		S7-1200	S7-1500	S7-1200	S7-1500	
EN	Input	BOOL	BOOL	I, Q, M, D, L	I, Q, M, D, L, T, C	Enable input
ENO	Output	BOOL	BOOL	I, Q, M, D, L	I, Q, M, D, L	Enable output

Parameter	Declaration	Data type		Memory area		Description
		S7-1200	S7-1500	S7-1200	S7-1500	
IN <sup>1)</sup>	Input	Binary numbers, integers, floating-point numbers, TIME, DATE, CHAR, TOD	Binary numbers, integers, floating-point numbers, timers, DATE, CHAR, TOD, LTOD	D, L	D, L	The first element of the source area that is being copied
COUNT	Input	USINT, UINT, UDINT	USINT, UINT, UDINT, ULINT	I, Q, M, D, L, P or constant	I, Q, M, D, L, P or constant	Number of elements to be copied from the source area to the destination area
OUT <sup>1)</sup>	Output	Binary numbers, integers, floating-point numbers, TIME, DATE, CHAR, TOD	Binary numbers, integers, floating-point numbers, timers, DATE, CHAR, TOD, LTOD	D, L	D, L	The first element of the destination area to which the contents of the source area are being copied

<sup>1)</sup> The specified data types can only be used as elements of an array structure.

For additional information on valid data types, refer to "See also".

### Example

The following example shows how the instruction works:

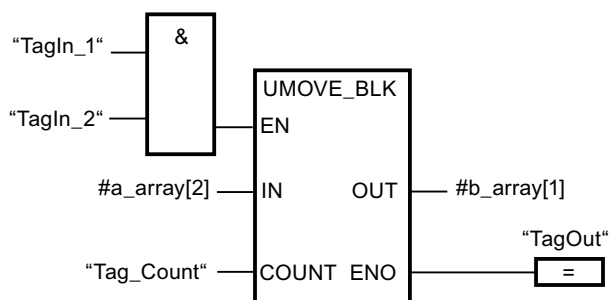

The following table shows how the instruction works using specific operand values:

Parameter	Operand	Value
IN	a_array[2]	The data type of the a_array operand is Array [0..5] of INT. It consists of six elements of data type INT.
COUNT	Tag_Count	3
OUT	b_array[1]	The data type of the b_array operand is Array [0..6] of INT. It consists of seven elements of data type INT.

If the operands "TagIn\_1" and "TagIn\_2" have signal state "1", the "Move block uninterruptible" instruction is executed. Starting from the third element, the instruction selects three INT elements from the #a\_array tag and copies their contents to the #b\_array output tag, beginning with the second element. The move operation cannot be interrupted by other operating system activities. If the instruction is executed without errors, the ENO enable output has the signal state "1" and the "TagOut" output is set.

### See also

Overview of the valid data types (Page 1077)

Basics of the EN/ENO mechanism (Page 1167)

### FILL\_BLK: Fill block

#### Description

You can use the "Fill block" instruction to fill a memory area (destination area) with the value of input IN. The destination area is filled beginning with the address specified at the OUT output. The number of repeated move operations is specified with the COUNT parameter. When the instruction is executed, the value at the input IN is selected and moved to the destination area as often as specified by the value of the COUNT parameter.

The instruction can only be executed if the source area and the destination area are of the same data type.

The ENO enable output has the signal state "0" if one of the following conditions is fulfilled:

- The EN enable input has the signal state "0".
- More data is moved than is made available at input IN or output OUT.

When a Array of BOOL is copied, the enable output ENO for an overflow is set to "1" until the byte limit of the Array structure is exceeded. If the byte limit of the Array structure is exceeded by the value at the COUNT input, the ENO enable output is reset to "0".

Parameters

The following table shows the parameters of the "Fill block" instruction:

Parameter	Declaration	Data type		Memory area		Description
		S7-1200	S7-1500	S7-1200	S7-1500	
EN	Input	BOOL	BOOL	I, Q, M, D, L	I, Q, M, D, L, T, C	Enable input
ENO	Output	BOOL	BOOL	I, Q, M, D, L	I, Q, M, D, L	Enable output
IN <sup>1)</sup>	Input	Binary numbers, integers, floating-point numbers, TIME, DATE, TOD, CHAR	Binary numbers, integers, floating-point numbers, timers, DATE, CHAR, TOD, LTOD	I, Q, M, D, L, P or constant	I, Q, M, D, L, P or constant	Element used to fill the destination area
COUNT	Input	USINT, UINT, UDINT	USINT, UINT, UDINT, ULINT	I, Q, M, D, L, P or constant	I, Q, M, D, L, P or constant	Number of repeated move operations
OUT <sup>2)</sup>	Output	Binary numbers, integers, floating-point numbers, TIME, DATE, TOD, CHAR	Binary numbers, integers, floating-point numbers, timers, DATE, CHAR, TOD, LTOD	D, L	D, L	Address in destination area from which filling starts.

<sup>1)</sup> The specified data types can also be used as elements of an Array structure.  
<sup>2)</sup> The specified data types can only be used as elements of an Array structure.

For additional information on valid data types, refer to "See also".

Example

The following example shows how the instruction works:

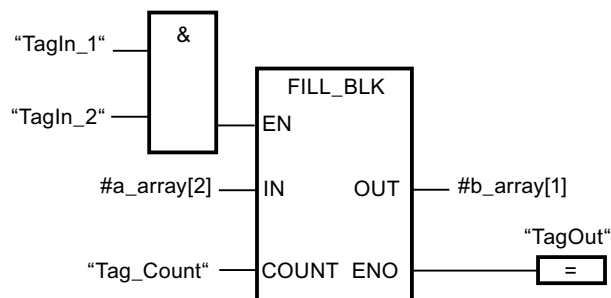

The following table shows how the instruction works using specific operand values:

Parameter	Operand	Value
IN	a_array[2]	The data type of the a_array operand is Array [0..5] of INT. It consists of six elements of data type INT.
COUNT	Tag_Count	3
OUT	b_array[1]	The data type of the b_array operand is Array [0..6] of INT. It consists of seven elements of data type INT.

If the operands "TagIn\_1" and "TagIn\_2" have signal state "1", the "Fill block" instruction is executed. The instruction copies the third element (#a\_array[2]) of the #a\_array tag three times to the #b\_array output tag. If no errors occur during the execution of the instruction, the outputs ENO and "TagOut" are set to signal state "1".

### See also

Overview of the valid data types (Page 1077)

Basics of the EN/ENO mechanism (Page 1167)

## UFILL\_BLK: Fill block uninterruptible

### Description

You can use the instruction "Fill block uninterruptible" to fill a memory area (destination area) with the value of input IN uninterruptibly. The destination area is filled beginning with the address specified at the OUT output. The number of repeated move operations is specified with the COUNT parameter. When the instruction is executed, the value at the input IN is selected and moved to the destination area as often as specified by the value of the COUNT parameter.

The instruction can only be executed if the source area and the destination area have the same data type.

### Note

The move operation cannot be interrupted by other operating system activities. This is why the alarm reaction times of the CPU increase during the execution of the "Fill block uninterruptible" instruction.

The ENO enable output has the signal state "0" if one of the following conditions is fulfilled:

- The EN enable input has the signal state "0".
- More data is moved than is made available at input IN or output OUT.

When a Array of BOOL is copied, the enable output ENO for an overflow is set to "1" until the byte limit of the Array structure is exceeded. If the byte limit of the Array structure is exceeded by the value at the COUNT input, the ENO enable output is reset to "0".

You can use the "Fill block uninterruptible" instruction to move a maximum of 16 KB. Note the CPU-specific restrictions for this.

**Parameters**

The following table shows the parameters of the "Fill block uninterruptible" instruction:

Parameter	Declaration	Data type		Memory area		Description
		S7-1200	S7-1500	S7-1200	S7-1500	
EN	Input	BOOL	BOOL	I, Q, M, D, L	I, Q, M, D, L, T, C	Enable input
ENO	Output	BOOL	BOOL	I, Q, M, D, L	I, Q, M, D, L	Enable output
IN <sup>1)</sup>	Input	Binary numbers, integers, floating-point numbers, TIME, DATE, CHAR, TOD	Binary numbers, integers, floating-point numbers, timers, DATE, CHAR, TOD, LTOD	I, Q, M, D, L, P or constant	I, Q, M, D, L, P or constant	Element used to fill the destination area
COUNT	Input	USINT, UINT, UDINT	USINT, UINT, UDINT, ULINT	I, Q, M, D, L, P or constant	I, Q, M, D, L, P or constant	Number of repeated move operations
OUT <sup>2)</sup>	Output	Binary numbers, integers, floating-point numbers, TIME, DATE, CHAR, TOD	Binary numbers, integers, floating-point numbers, timers, DATE, CHAR, TOD, LTOD	D, L	D, L	Address in destination area from which filling starts.
<sup>1)</sup> The specified data types can also be used as elements of an Array structure. <sup>2)</sup> The specified data types can only be used as elements of an Array structure.						

For additional information on valid data types, refer to "See also".



## Example

The following example shows how the instruction works:

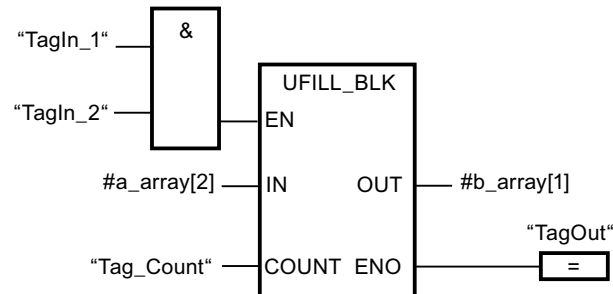

The following table shows how the instruction works using specific operand values:

Parameter	Operand	Value
IN	a_array[2]	The data type of the a_array operand is Array [0..5] of INT. It consists of six elements of data type INT.
COUNT	Tag_Count	3
OUT	b_array[1]	The data type of the b_array operand is Array [0..6] of INT. It consists of seven elements of data type INT.

If the operands "TagIn\_1" and "TagIn\_2" have signal state "1", the "Fill block uninterruptible" instruction is executed. The instruction copies the third element (#a\_array[2]) of the #a\_array tag three times to the #b\_array output tag. The move operation cannot be interrupted by other operating system activities. If no errors occur during the execution of the instruction, the outputs ENO and "TagOut" are set to signal state "1".

## See also

Overview of the valid data types (Page 1077)

Basics of the EN/ENO mechanism (Page 1167)

## SWAP: Swap

### Description

You can use the instruction "Swap" to change the order of the bytes within the tag at input IN and query the result at output OUT.

The following figure shows how the bytes of a DWORD data type operand are swapped using the "Swap" instruction:

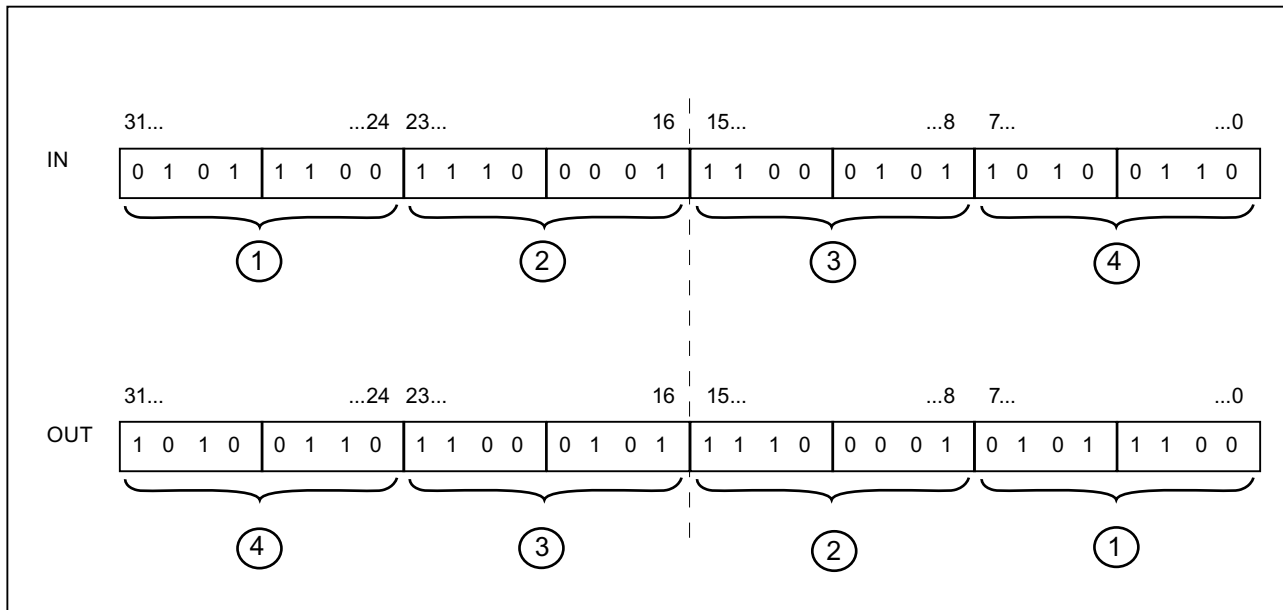

Parameters

The following table shows the parameters of the "Swap" instruction:

Parameters	Declaration	Data type		Memory area		Description
		S7-1200	S7-1500	S7-1200	S7-1500	
EN	Input	BOOL	BOOL	I, Q, M, D, L	I, Q, M, D, L, T, C	Enable input
ENO	Output	BOOL	BOOL	I, Q, M, D, L	I, Q, M, D, L	Enable output
IN	Input	WORD, DWORD	WORD, DWORD, LWORD	I, Q, M, D, L, P or constant	I, Q, M, D, L, P or constant	Operand whose bytes are swapped.
OUT	Output	WORD, DWORD	WORD, DWORD, LWORD	I, Q, M, D, L, P	I, Q, M, D, L, P	Result

You can select the data type of the instruction from the "<???" drop-down list of the instruction box.

For additional information on valid data types, refer to "See also".

## Example

The following example shows how the instruction works:

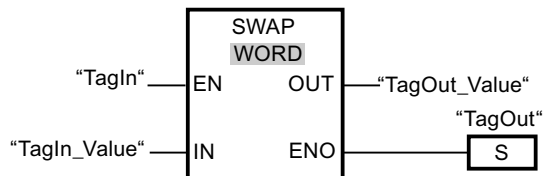

The following table shows how the instruction works using specific operand values:

Parameters	Operand	Value
IN	TagIn_Value	0000 1111 0101 0101
OUT	TagOut_Value	0101 0101 0000 1111

If the operand "TagIn" has the signal state "1", the "Swap" instruction is executed. The arrangement of the bytes is changed and stored in the operand "TagOut\_Value".

## See also

Overview of the valid data types (Page 1077)

Basics of the EN/ENO mechanism (Page 1167)

## Array data blocks

### ReadFromArrayDB: Read from array data block

#### Description

You can use the "Read from array data block" instruction to read data from an array DB.

An array DB is a data block which consists of exactly one array of [data type]. The elements of the array can be UDT data type or any other elementary data type. The counting of the array always starts with the low limit "0", regardless of the later declaration of the array.

The ENO enable output has the signal state "0" if one of the following conditions is fulfilled:

- The EN enable input has the signal state "0".
- If an error occurs during the execution of the instruction.

#### Parameters

The following table shows the parameters of the "Read from array data block" instruction:

Parameter	Declaration	Data type	Memory area	Description
EN	Input	BOOL	I, Q, M, D, L	Enable input
ENO	Output	BOOL	I, Q, M, D, L	Enable output

Parameter	Declaration	Data type	Memory area	Description
DB	Input	DB_ANY	I, Q, M, D, L	Data block that is read
INDEX	Input	DINT	I, Q, M, D, L	Element that is read
VALUE	InOut	VARIANT	I, Q, M, D, L	Value that is read
RET_VAL	Output	INT	I, Q, M, D, L	Error information: If an error occurs during execution of the instruction, an error code is output on the RET_VAL parameter.

For additional information on valid data types, refer to "See also".

### Parameter RET\_VAL

The following table shows the meaning of the values of the RET\_VAL parameter:

Error code* (W#16#...)	Explanation
0000	No error
80B4	Data types do not correspond
80B5	Copying process was interrupted
8131	The data block does not exist
8132	The data block is too short
8133	The data block is located in the load memory
8134	The data block is write protected
8135	The DB is not an array data block.
8282	The value at the INDEX parameter is outside the limit values of the array.
8350	The VARIANT data type contains no value
8352	Code generation error
8353	Code generation error

\*The error codes can be displayed as integer or hexadecimal value in the program editor. For additional information on toggling display formats, refer to "See also".

### See also

Overview of the valid data types (Page 1077)

Basics of the EN/ENO mechanism (Page 1167)

## WriteToArrayDB: Write to array data block

### Description

You can use the "Write to array data block" instruction to write data to an array DB.

An array DB is a data block which consists of exactly one array of [data type]. The elements of the array can be UDT data type or any other elementary data type. The counting of the array always starts with the low limit "0", regardless of the later declaration of the array.

The ENO enable output has the signal state "0" if one of the following conditions is fulfilled:

- The EN enable input has the signal state "0".
- If an error occurs during the execution of the instruction.

### Parameters

The following table shows the parameters of the "Write to array data block" instruction:

Parameter	Declaration	Data type	Memory area	Description
EN	Input	BOOL	I, Q, M, D, L	Enable input
ENO	Output	BOOL	I, Q, M, D, L	Enable output
DB	Input	DB_ANY	I, Q, M, D, L	Data block to which data is written
INDEX	Input	DINT	I, Q, M, D, L	Element in the DB to which data is written
VALUE	Input	VARIANT	I, Q, M, D, L	Value to be written
RET_VAL	Output	INT	I, Q, M, D, L	Error information: If an error occurs during execution of the instruction, an error code is output on the RET_VAL parameter.

For additional information on valid data types, refer to "See also".

### Parameter RET\_VAL

The following table shows the meaning of the values of the RET\_VAL parameter:

Error code* (W#16#...)	Explanation
0000	No error
80B4	Data types do not correspond
80B5	Copying process was interrupted

Error code* (W#16#...)	Explanation
8131	The data block does not exist
8132	The data block is too short
8133	The data block is located in the load memory
8134	The data block is write protected
8135	The DB is not an array data block.
8282	The value at the INDEX parameter is outside the limit values of the array.
8350	The VARIANT data type contains no value
8352	Code generation error
8353	Code generation error
*The error codes can be displayed as integer or hexadecimal value in the program editor. For additional information on toggling display formats, refer to "See also".	

**See also**

- Overview of the valid data types (Page 1077)
- Basics of the EN/ENO mechanism (Page 1167)

**ReadFromArrayDBL: Read from array data block in load memory**

**Description**

You can use the "Read from array data block in load memory" instruction to read data from an array DB in load memory.

An array DB is a data block which consists of exactly one array of [data type]. The elements of the array can be UDT data type or any other elementary data type. The counting of the array always starts with the low limit "0", regardless of the later declaration of the array.

If the array DB is marked with the "Only store in load memory" block attribute, it is only stored in load memory.

The instruction is executed when a positive signal edge is detected at the REQ parameter. The BUSY parameter then has the signal state "1". The instruction is terminated if a negative signal edge is detected at the BUSY parameter. The DONE parameter has the signal state "1" for one program cycle and the read value is output at the VALUE parameter within this cycle. With all other program cycles, the value at the VALUE parameter is not changed.

When you insert the instruction in the program, the "Call options" dialog opens in which you can specify whether the block parameters will be stored in a separate data block (single instance) or as a local tag (multiple instance) in the block interface. If you create a separate data block, you will find it in the project tree in the "Program resources" folder under "Program blocks > System blocks". For additional information on this topic, refer to "See also".

The ENO enable output has the signal state "0" if one of the following conditions is fulfilled:

- The EN enable input has the signal state "0".
- If an error occurs during the execution of the instruction.

## Parameters

The following table shows the parameters of the "Read from array data block in load memory" instruction:

Parameter	Declaration	Data type	Memory area	Description
EN	Input	BOOL	I, Q, M, D, L	Enable input
ENO	Output	BOOL	I, Q, M, D, L	Enable output
REQ	Input	BOOL	I, Q, M, D, L	REQ = "1": Starting with the reading of the array DB
DB	Input	DB_ANY	I, Q, M, D, L	Data block that is read
INDEX	Input	DINT	I, Q, M, D, L	Element that is read
BUSY	Output	BOOL	I, Q, M, D, L	BUSY = "1": The array DB is still being read
DONE	Output	BOOL	I, Q, M, D, L	DONE = "1": The instruction was executed successfully
VALUE	InOut	VARIANT	I, Q, M, D, L	Value that is read
RET_VAL	Output	INT	I, Q, M, D, L	Error information: If an error occurs during execution of the instruction, an error code is output on the RET_VAL parameter.

For additional information on valid data types, refer to "See also".

## Parameter

The following table shows the meaning of the values of the RET\_VAL parameter:

Error code* (W#16#...)	Explanation
0000	No error
80B4	Data types do not correspond
80B5	Copying process was interrupted
8131	The data block does not exist
8132	The data block is too short
8133	The data block is not located in the load memory
8134	The data block is write protected
8135	The DB is not an array data block.

Error code* (W#16#...)	Explanation
8282	The value at the INDEX parameter is outside the limit values of the array.
8350	The VARIANT data type contains no value
8352	Code generation error
8353	Code generation error
*The error codes can be displayed as integer or hexadecimal value in the program editor. For additional information on toggling display formats, refer to "See also".	

**See also**

- Overview of the valid data types (Page 1077)
- Basics of the EN/ENO mechanism (Page 1167)

**WriteToArrayDBL: Write to array data block in load memory**

**Description**

You can use the "Write to array data block in load memory" instruction to write data to an array DB in load memory.

An array DB is a data block which consists of exactly one array of [data type]. The elements of the array can be UDT data type or any other elementary data type. The counting of the array always starts with the low limit "0", regardless of the later declaration of the array.

If the array DB is marked with the "Only store in load memory" block attribute, it is only stored in load memory.

The instruction is executed when a positive signal edge is detected at the REQ parameter. The BUSY parameter then has the signal state "1". If a negative signal edge is detected at the BUSY parameter, the instruction is terminated and the value at the VALUE parameter is written to the data block. The DONE parameter then has the signal state "1" for one program cycle.

When you insert the instruction in the program, the "Call options" dialog opens in which you can specify whether the block parameters will be stored in a separate data block (single instance) or as a local tag (multiple instance) in the block interface. If you create a separate data block, you will find it in the project tree in the "Program resources" folder under "Program blocks > System blocks". For additional information on this topic, refer to "See also".

The ENO enable output has the signal state "0" if one of the following conditions is fulfilled:

- The EN enable input has the signal state "0".
- If an error occurs during the execution of the instruction.



## Parameters

The following table shows the parameters of the "Write to array data block in load memory" instruction:

Parameter	Declaration	Data type	Memory area	Description
EN	Input	BOOL	I, Q, M, D, L	Enable input
ENO	Output	BOOL	I, Q, M, D, L	Enable output
REQ	Input	BOOL	I, Q, M, D, L	REQ = "1": Start writing into the array DB
DB	Input	DB_ANY	D	Data block to which data is written
INDEX	Input	DINT	I, Q, M, D, L	Element in the DB to which data is written
VALUE	Input	VARIANT	I, Q, M, D, L	Value to be written
BUSY	Output	BOOL	I, Q, M, D, L	BUSY = "1": The array DB is still being written
DONE	Output	BOOL	I, Q, M, D, L	DONE = "1": The instruction was executed successfully
RET_VAL	Output	INT	I, Q, M, D, L	Error information: If an error occurs during execution of the instruction, an error code is output on the RET_VAL parameter.

For additional information on valid data types, refer to "See also".

## Parameter

The following table shows the meaning of the values of the RET\_VAL parameter:

Error code* (W#16#...)	Explanation
0000	No error
80B4	Data types do not correspond
80B5	Copying process was interrupted
8131	The data block does not exist
8132	The data block is too short
8133	The data block is not located in the load memory
8134	The data block is write protected

Error code* (W#16#...)	Explanation
8135	The DB is not an array data block.
8282	The value at the INDEX parameter is outside the limit values of the array.
8350	The VARIANT data type contains no value
8352	Code generation error
8353	Code generation error
*The error codes can be displayed as integer or hexadecimal value in the program editor. For additional information on toggling display formats, refer to "See also".	

**See also**

- Overview of the valid data types (Page 1077)
- Basics of the EN/ENO mechanism (Page 1167)

**Other**

**BLKMOV: Move block**

**Description**

You can use the "Move block" instruction to move the content of a memory area (source area) to another memory area (destination area). The move operation takes place in the direction of ascending addresses. You use VARIANT to define the source and destination area.

---

**Note**

The tags of the instruction can only be used in data blocks in which the "Optimized block access" attribute is not set. If the tag with the retentive setting "Set in IDB" has been declared, you can also use the tags "with optimized access".

---

The following figure shows the principle of the move operation:

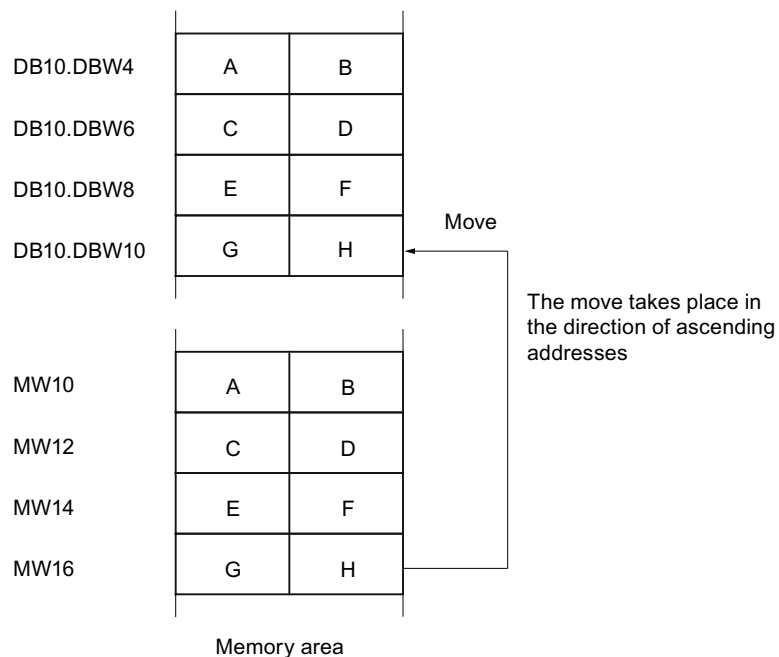

### Consistency of the source data and the target data

Make sure that the source data remain unchanged during the execution of the instruction "Move block". Otherwise the consistency of the target data cannot be ensured.

### Interruptibility

There is no limit to the nesting depth.

### Memory areas

You can use the "Move block" instruction to move the following memory areas:

- Areas of a data block
- Bit memory
- Process image of the inputs
- Process image of the outputs

### General rules for moving

The source and destination area must not overlap. If the source and destination area have different lengths, only the length of the smaller area will be moved.

If the source area is less than the destination area, the entire source area will be written to the destination area. The remaining bytes of the destination area remain unchanged.

If the destination area is less than the source area, the entire destination area will be written. The remaining bytes of the source area are ignored.

If a block of data type BOOL is moved, the tag must be addressed absolutely and the specified length of the area must be divisible by 8, otherwise the instruction cannot be executed.

### Rules for moving character strings

You can use the "Move block" instruction to also move source and destination areas of the STRING data type. If only the source area is STRING data type, the characters will be moved that are actually contained in the character string. Information on the actual and maximum length is also written to the destination area. If the source and destination area are each STRING data type, the current length of the character string in the destination area is set to the number of actually moved characters.

If you want to move the information on the maximum and actual length of a character string, specify the areas in bytes to the SRCBLK and DSTBLK parameters.

### Parameters

The following table shows the parameters of the "Move block" instruction:

Parameter	Declaration	Data type	Memory area		Description
			S7-1200	S7-1500	
EN	Input	BOOL	I, Q, M, D, L	I, Q, M, D, L, T, C	Enable input
ENO	Output	BOOL	I, Q, M, D, L	I, Q, M, D, L	Enable output
SRCBLK	Input	VARIANT	I, Q, M, D, L	I, Q, M, D, L	Specifies the memory area to be moved (source area).
RET_VAL	Output	INT	I, Q, M, D, L, P	I, Q, M, D, L, P	Error information: If an error occurs during execution of the instruction, an error code is output at the RET_VAL parameter.
DSTBLK	Output	VARIANT	I, Q, M, D, L	I, Q, M, D, L	Specifies the memory area to which the block is to be moved (destination area).

### Parameter RET\_VAL

The following table shows the meaning of the values of the RET\_VAL parameter:

Error code* (W#16#...)	Explanation
0000	No error
8091	The permitted nesting depth was exceeded

Error code* (W#16#...)	Explanation
8092	The instruction cannot be executed because a specified data block is write protection, non-executable or unloaded.
General error information	See also: "GET_ERR_ID: Get error ID locally"

\*The error codes can be displayed as integer or hexadecimal value in the program editor. For information on toggling display formats, refer to "See also".

### See also

- Overview of the valid data types (Page 1077)
- Basics of the EN/ENO mechanism (Page 1167)
- GET\_ERR\_ID: Get error ID locally (Page 2044)

### UBLKMOV: Move block uninterruptible

#### Description

You can use the "Move block uninterruptible" instruction to move the content of a memory area (source area) to another memory area (destination area). The move operation takes place in the direction of ascending addresses. You use VARIANT to define the source and destination area.

The move operation cannot be interrupted by other operating system activities. As a result the alarm reaction time of the CPU can increase during the execution of the "Move block uninterruptible" instruction.

---

#### Note

The tags of the instruction can only be used in data blocks in which the "Optimized block access" attribute is not set. If the tag with the retentive setting "Set in IDB" has been declared, you can also use the tags "with optimized access".

---

### Memory areas

You can use the "Move block uninterruptible" instruction to move the following memory areas:

- Areas of a data block
- Bit memory
- Process image of the inputs
- Process image of the outputs

### General rules for moving

The source and destination area must not overlap during the execution of the "Move block uninterruptible" instruction. If the source area is less than the destination area, the entire source area will be written to the destination area. The remaining bytes of the destination area remain unchanged.

If the destination area is less than the source area, the entire destination area will be written. The remaining bytes of the source area are ignored.

If a source or destination area defined as a formal parameter is less than a destination or source area specified on the SRCBLK or DSTBLK parameter, no data will be transferred.

If a block of data type BOOL is moved, the tag must be addressed absolutely and the specified length of the area must be divisible by 8, otherwise the instruction cannot be executed.

You can use the "Move block uninterruptible" instruction to move a maximum of 16 KB. Note the CPU-specific restrictions for this.

### Rules for moving character strings

You can use the "Move block uninterruptible" instruction to also move source and destination areas of the STRING data type. If only the source area is STRING data type, the characters will be moved that are actually contained in the character string. Information on the actual and maximum length are not written in the destination area. If the source and destination area are each STRING data type, the current length of the character string in the destination area is set to the number of actually moved characters. If areas of the data type STRING are moved, you have to specify "1" as area length.

### Parameters

The following table shows the parameters of the "Move block uninterruptible" instruction:

Parameter	Declaration	Data type	Memory area		Description
			S7-1200	S7-1500	
EN	Input	BOOL	I, Q, M, D, L	I, Q, M, D, L, T, C	Enable input
ENO	Output	BOOL	I, Q, M, D, L	I, Q, M, D, L	Enable output
SRCBLK	Input	VARIANT	I, Q, M, D, L	I, Q, M, D, L	Specifies the memory area to be moved (source area).
RET_VAL	Output	INT	I, Q, M, D, L, P	I, Q, M, D, L, P	Error information: If an error occurs during execution of the instruction, an error code is output at the RET_VAL parameter.
DSTBLK	Output	VARIANT	I, Q, M, D, L	I, Q, M, D, L	Specifies the memory area to which the block is to be moved (destination area).

## Parameter RET\_VAL

The following table shows the meaning of the values of the RET\_VAL parameter:

Error code (W#16#...)	Explanation
0000	No error
8091	The source area is in a data block that is not relevant for program execution.
General error information	See also: "GET_ERR_ID: Get error ID locally"

\*The error codes can be displayed as integer or hexadecimal value in the program editor. For information on toggling display formats, refer to "See also".

## See also

Overview of the valid data types (Page 1077)

Basics of the EN/ENO mechanism (Page 1167)

GET\_ERR\_ID: Get error ID locally (Page 2044)

## FILL: Fill block

### Description

You can use the "Fill block" instruction to fill a memory area (destination area) with the content of another memory area (source area). The "Fill block" instruction moves the content of the source area to the destination area until the destination area is completely written. The move operation takes place in the direction of ascending addresses.

You use VARIANT to define the source and destination area.

#### Note

The tags of the instruction can only be used in data blocks in which the "Optimized block access" attribute is not set. If the tag with the retentive setting "Set in IDB" has been declared, you can also use the tags "with optimized access".

For blocks with the "Optimized block access" attribute, you can use the "FILL\_BLK: Fill block" instruction.

The following figure shows the principle of the move operation:

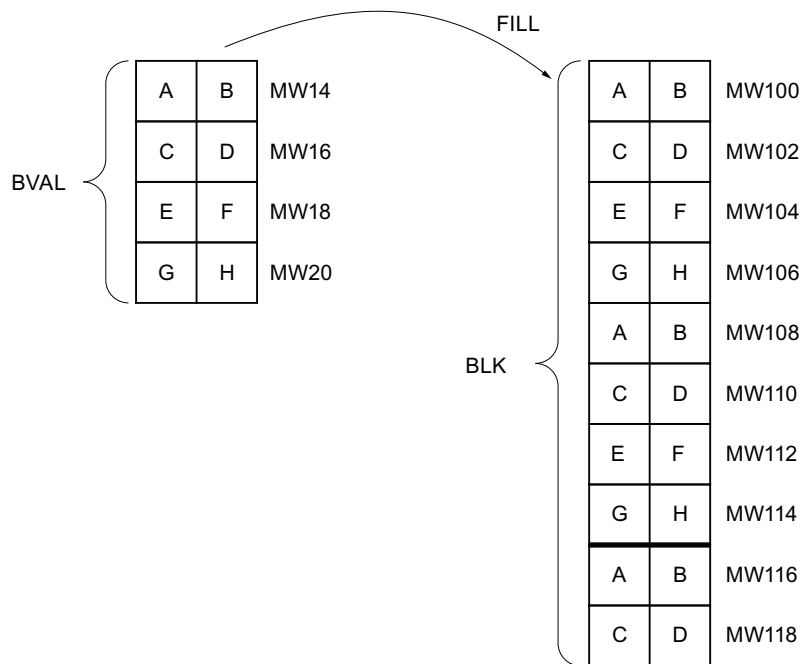

### Consistency of the source data and the target data

Please note that during execution of the instruction "Fill block" that the source data remain unchanged, otherwise the consistency of the target data is not ensured.

### Memory areas

You can use the "Fill block" instruction to move the following memory areas:

- Areas of a data block
- Bit memory
- Process image of the inputs
- Process image of the outputs

### General rules for moving

The source and destination area must not overlap. If the destination block to be preset is not an integer multiple of the length of the input parameter BVAL, the destination block is nevertheless written up to the last byte.

If the destination area to be preset is smaller than the source area, the function only copies as much data as can be written to the destination area.

If the destination or source block actually present is smaller than the assigned memory area for the source or destination block (BVAL, BLK parameters), no data is transferred.

If the ANY pointer (source or destination) is of the data type BOOL, it must be addressed absolutely and the length specified must be divisible by 8; otherwise the instruction is not executed.



If the destination block is of data type STRING, the instruction describes the entire string including the administration information.

## Parameters

The following table shows the parameters of the "Fill block" instruction:

Parameter	Declaration	Data type	Memory area	Description
EN	Input	BOOL	I, Q, M, D, L	Enable input
ENO	Output	BOOL	I, Q, M, D, L	Enable output
BVAL	Input	VARIANT	I, Q, M, D, L	Specification of the memory area (source area) with whose content the destination area on the BLK parameter is filled.
RET_VAL	Output	INT	I, Q, M, D, L	Error information: If an error occurs during execution of the instruction, an error code is output at the RET_VAL parameter.
BLK	Output	VARIANT	I, Q, M, D, L	Specification of the memory area that is filled with the content of the source area.

## Parameter RET\_VAL

The following table shows the meaning of the values of the RET\_VAL parameter:

Error code* (W#16#...)	Explanation
0000	No error
General error information	See also: "GET_ERR_ID: Get error ID locally"

\*The error codes can be displayed as integer or hexadecimal value in the program editor. For information on toggling display formats, refer to "See also".

## See also

- Overview of the valid data types (Page 1077)
- Basics of the EN/ENO mechanism (Page 1167)
- GET\_ERR\_ID: Get error ID locally (Page 2044)

## Conversion operations

### CONVERT: Convert value

#### Description

The "Convert value" instruction reads the content of the IN parameter and converts it according to the data types configured in the instruction box. The converted value is provided at output OUT.

For information on possible conversions, refer to the "Explicit conversion" section at "See also".

Enable output ENO has the signal state "0" if one of the following conditions applies:

- Enable input EN has the signal state "0".
- Errors, such as an overflow, occur during execution.
- For the input IN, an operand of data type BYTE, WORD, DWORD or LWORD is configured, whose highest value bit is set. A signed integer of data type (SINT, INT, DINT, LINT) is configured in the instruction box for the output OUT, which has the same bit length as the operand at input IN.

#### Parameters

The following table shows the parameters of the "Convert value" instruction:

Parameters	Declaration	Data type	Memory area		Description
			S7-1200	S7-1500	
EN	Input	BOOL	I, Q, M, D, L	I, Q, M, D, L, T, C	Enable input
ENO	Output	BOOL	I, Q, M, D, L	I, Q, M, D, L	Enable output
IN	Input	Bit strings, integers, floating-point numbers, CHAR, BCD16, BCD32	I, Q, M, D, L, P or constant	I, Q, M, D, L, P or constant	Value to be converted.
OUT	Output	Bit strings, integers, floating-point numbers, CHAR, BCD16, BCD32	I, Q, M, D, L, P	I, Q, M, D, L, P	Result of the conversion

You can select the data type of the instruction from the "<???" drop-down list of the instruction box.

Bit strings (BYTE, WORD, DWORD, LWORD) cannot be selected in the instruction box. If you have specified an operand of data type BYTE, WORD, or DWORD or LWORD at a parameter of the instruction, the value of the operand is interpreted as an unsigned integer with the same

bit length. In this case the data type BYTE is interpreted as USINT, WORD as UINT, and DWORD as UDINT and LWORD as LINT.

### Note

For S7-1500 CPU applies: As data types DWORD and LWORD can be selected if REAL or LREAL were selected as IN data type.

For additional information on valid data types, refer to "See also".

### Example

The following example shows how the instruction works:

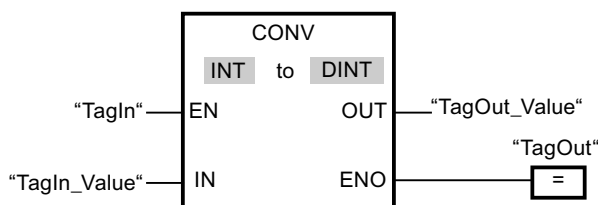

If the operand "TagIn" has the signal state "1", the content of the operand "TagIn\_Value" is read and converted to an integer (16 bits). The result is stored in the operand "TagOut\_Value". The output "TagOut" is set to "1" if the instruction was executed without errors.

### See also

Overview of the valid data types (Page 1077)

Basics of the EN/ENO mechanism (Page 1167)

## ROUND: Round numerical value

### Description

You can use the "Round numerical value" instruction to round the value at input IN to the nearest integer. The instruction interprets the value at input IN as a floating-point number and converts this to the nearest integer. If the input value is exactly between an even and odd number, then the even number is converted. The result of the instruction is provided at output OUT and can be queried there.

Enable output ENO has the signal state "0" if one of the following conditions applies:

- Enable input EN has the signal state "0".
- Errors, such as an overflow, occur during execution.

### Parameters

The following table shows the parameters of the "Round numerical value" instruction:

Parameters	Declaration	Data type	Memory area		Description
			S7-1200	S7-1500	
EN	Input	BOOL	I, Q, M, D, L	I, Q, M, D, L, T, C	Enable input
ENO	Output	BOOL	I, Q, M, D, L	I, Q, M, D, L	Enable output
IN	Input	Floating-point numbers	I, Q, M, D, L, P or constant	I, Q, M, D, L, P or constant	Input value to be rounded.
OUT	Output	Integers, floating-point numbers	I, Q, M, D, L, P	I, Q, M, D, L, P	Result of the rounding

You can select the data type of the instruction from the "<???" drop-down list of the instruction box.

For additional information on valid data types, refer to "See also".

### Example

The following example shows how the instruction works:

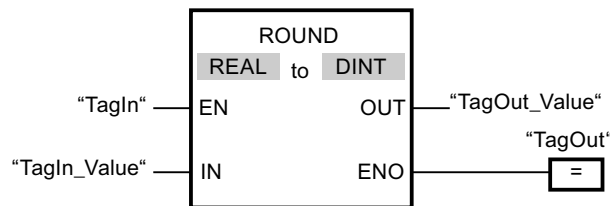

The following table shows how the instruction works using specific operand values:

Parameters	Operand	Value	
IN	TagIn_Value	1.50000000	-1.50000000
OUT	TagOut_Value	2	-2

If the operand "TagIn" has the signal state "1", the "Round numerical value" instruction is executed. The floating-point number at input "TagIn\_Value" is rounded to the nearest even integer and sent to output "TagOut\_Value". If no errors occur during the execution of the instruction, the output "TagOut" is set.

### See also

Overview of the valid data types (Page 1077)

Basics of the EN/ENO mechanism (Page 1167)

## CEIL: Generate next higher integer from floating-point number

### Description

You can use the "Generate next higher integer from floating-point number" instruction to round the value at input IN to the next higher integer. The instruction interprets the value at input IN as a floating-point number and converts this to the next higher integer. The result of the instruction is provided at output OUT and can be queried there. The output value can be greater than or equal to the input value.

Enable output ENO has the signal state "0" if one of the following conditions applies:

- Enable input EN has the signal state "0".
- Errors, such as an overflow, occur during execution.

### Parameters

The following table shows the parameters of the instruction "Generate next higher integer from floating-point number":

Parameters	Declaration	Data type	Memory area		Description
			S7-1200	S7-1500	
EN	Input	BOOL	I, Q, M, D, L	I, Q, M, D, L, T, C	Enable input
ENO	Output	BOOL	I, Q, M, D, L	I, Q, M, D, L	Enable output
IN	Input	Floating-point numbers	I, Q, M, D, L, P or constant	I, Q, M, D, L, P or constant	Input value as floating-point number
OUT	Output	Integers, floating-point numbers	I, Q, M, D, L, P	I, Q, M, D, L, P	Result with the next higher integer

You can select the data type of the instruction from the "<???"> drop-down list of the instruction box.

For additional information on valid data types, refer to "See also".

### Example

The following example shows how the instruction works:

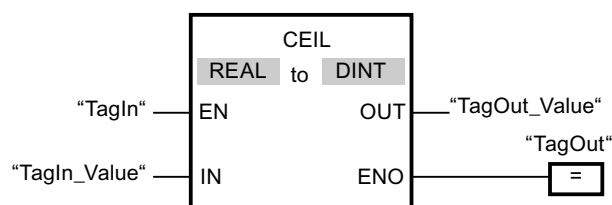

The following table shows how the instruction works using specific operand values:

Parameters	Operand	Value	
IN	TagIn_Value	0.50000000	-0.50000000
OUT	TagOut_Value	1	0

If the operand "TagIn" has the signal state "1", the instruction "Generate next higher integer from floating-point number" is executed. The floating-point number at input "TagIn\_Value" is rounded to the next higher integer and sent to output "TagOut\_Value". If no errors occur during the execution of the instruction, the output "TagOut" is set.

**See also**

- Overview of the valid data types (Page 1077)
- Basics of the EN/ENO mechanism (Page 1167)

**FLOOR: Generate next lower integer from floating-point number**

**Description**

You can use the "Generate next lower integer from floating-point number" instruction to round the value at input IN to the next lower integer. The instruction interprets the value at input IN as a floating-point number and converts this to the next lower integer. The result of the instruction is provided at output OUT and can be queried there. The output value can be less than or equal to the input value.

Enable output ENO has the signal state "0" if one of the following conditions applies:

- Enable input EN has the signal state "0".
- Errors, such as an overflow, occur during execution.

**Parameters**

The following table shows the parameters of the instruction "Generate next lower integer from floating-point number":

Parameters	Declaration	Data type	Memory area		Description
			S7-1200	S7-1500	
EN	Input	BOOL	I, Q, M, D, L	I, Q, M, D, L, T, C	Enable input
ENO	Output	BOOL	I, Q, M, D, L	I, Q, M, D, L	Enable output
IN	Input	Floating-point numbers	I, Q, M, D, L, P or constant	I, Q, M, D, L, P or constant	Input value as floating-point number
OUT	Output	Integers, floating-point numbers	I, Q, M, D, L, P	I, Q, M, D, L, P	Result with the next lower integer

You can select the data type of the instruction from the "<???">" drop-down list of the instruction box.

For additional information on valid data types, refer to "See also".

## Example

The following example shows how the instruction works:

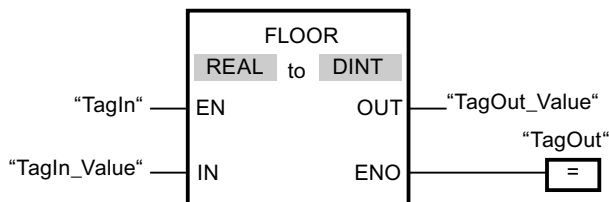

The following table shows how the instruction works using specific operand values:

Parameters	Operand	Value	
IN	TagIn_Value	0.50000000	-0.50000000
OUT	TagOut_Value	0	-1

If the operand "TagIn" has the signal state "1", the instruction "Generate next lower integer from floating-point number" is executed. The floating-point number at input "TagIn\_Value" is rounded to the next lower integer and displayed at output "TagOut\_Value". If no errors occur during the execution of the instruction, the output "TagOut" is set.

## See also

Overview of the valid data types (Page 1077)

Basics of the EN/ENO mechanism (Page 1167)

## TRUNC: Truncate numerical value

### Description

You can use the "Truncate numerical value" instruction to form an integer from the value at input IN. The value at input IN is interpreted as a floating-point number. The instruction selects only the integer part of the floating-point number and sends this to output OUT without decimal places.

Enable output ENO has the signal state "0" if one of the following conditions applies:

- Enable input EN has the signal state "0".
- Errors, such as an overflow, occur during execution.

### Parameters

The following table shows the parameters of the instruction "Truncate numerical value":

Parameters	Declaration	Data type	Memory area	Description
EN	Input	BOOL	I, Q, M, D, L	Enable input
ENO	Output	BOOL	I, Q, M, D, L	Enable output
IN	Input	Floating-point numbers	I, Q, M, D, L or constant	Input value as floating-point number
OUT	Output	Integers, floating-point numbers	I, Q, M, D, L	Result with integer part of the floating-point number

You can select the data type of the instruction from the "<???" drop-down list of the instruction box.

For additional information on valid data types, refer to "See also".

### Example

The following example shows how the instruction works:

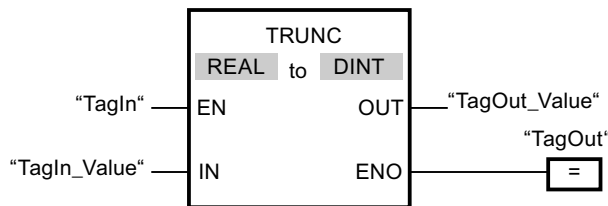

The following table shows how the instruction works using specific operand values:

Parameters	Operand	Value	
IN	TagIn_Value	1.50000000	-1.50000000
OUT	TagOut_Value	1	-1

If the operand "TagIn" has the signal state "1", the "Truncate numerical value" instruction is executed. The integer part of the floating-point number at input "TagIn\_Value" is converted to an integer and sent to output "TagOut\_Value". If no errors occur during the execution of the instruction, the output "TagOut" is set.

### See also

- Overview of the valid data types (Page 1077)
- Basics of the EN/ENO mechanism (Page 1167)



## SCALE\_X: Scale

### Description

You can use the "Scale" instruction to scale the value at the VALUE input by mapping it to a specified value range. When the instruction "Scale" is executed, the floating-point value at input VALUE is scaled to the value range, which is defined by the parameters MIN and MAX. The result of the scaling is an integer, which is stored at output OUT.

The following figure shows an example of how values can be scaled:

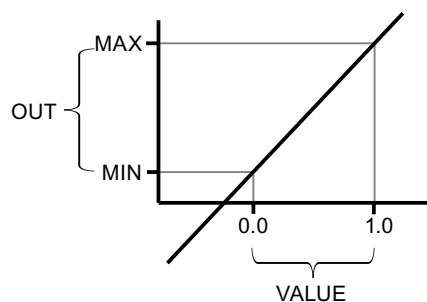

The "Scale" instruction works with the following equation:

$$\text{OUT} = [\text{VALUE} * (\text{MAX} - \text{MIN})] + \text{MIN}$$

Enable output ENO has the signal state "0" if one of the following conditions applies:

- Enable input EN has the signal state "0".
- The value at input MIN is greater than or equal to the value at input MAX.
- The value of a specified floating-point number is outside the range of the normalized numbers according to IEEE-754.
- An overflow occurs.
- The value at input VALUE is NaN (Not a number = result of an invalid arithmetic operation).

### Parameters

The following table shows the parameters of the "Scale" instruction:

Parameter	Declaration	Data type	Memory area	Description
EN	Input	BOOL	I, Q, M, D, L	Enable input
ENO	Output	BOOL	I, Q, M, D, L	Enable output
MIN	Input	Integers, floating-point numbers	I, Q, M, D, L or constant	Low limit of the value range
VALUE	Input	Floating-point numbers	I, Q, M, D, L or constant	Value to be scaled. If you enter a constant, you must declare it.
MAX	Input	Integers, floating-point numbers	I, Q, M, D, L or constant	High limit of the value range
OUT	Output	Integers, floating-point numbers	I, Q, M, D, L	Result of scaling

You can select the data type of the instruction from the "<???">" drop-down list of the instruction box.

For additional information on valid data types, refer to "See also".

For additional information on declaring constants, refer to "See also".

### Example

The following example shows how the instruction works:

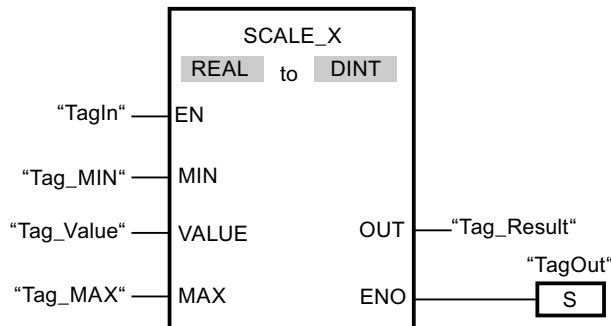

The following table shows how the instruction works using specific operand values:

Parameter	Operand	Value
MIN	Tag_MIN	10
VALUE	Tag_Value	0.5
MAX	Tag_MAX	30
OUT	Tag_Result	20

If the operand "TagIn" has the signal state "1", the "Scale" instruction is executed. The value at input "Tag\_Value" is scaled to the range of values defined by the values at inputs "Tag\_MIN"

and "Tag\_MAX". The result is stored at output "Tag\_Result". If the instruction is executed without errors, the ENO enable output has the signal state "1" and the "TagOut" output is set.

## See also

Overview of the valid data types (Page 1077)

Basics of the EN/ENO mechanism (Page 1167)

NORM\_X: Normalize (Page 2019)

Declaring constants (Page 1188)

## NORM\_X: Normalize

### Description

You can use the instruction "Normalize" to normalize the value of the tag at the VALUE input by mapping it to a linear scale. You can use the parameters MIN and MAX to define the limits of a value range that is applied to the scale. Depending on the location of the normalized value in this value range, the result at output OUT is calculated and stored as a floating-point number. If the value to be normalized is equal to the value at input MIN, output OUT returns the value "0.0". If the value to be normalized is equal to the value at input MAX, output OUT returns the value "1.0".

The following figure shows an example of how values can be normalized:

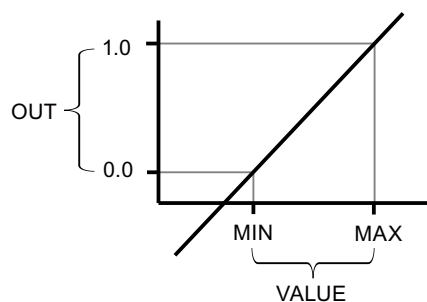

The "Normalize" instruction works with the following equation:

$$\text{OUT} = (\text{VALUE} - \text{MIN}) / (\text{MAX} - \text{MIN})$$

Enable output ENO has the signal state "0" if one of the following conditions applies:

- Enable input EN has the signal state "0".
- The value at input MIN is greater than or equal to the value at input MAX.
- The value of a specified floating-point number is outside the range of the normalized numbers according to IEEE-754.
- The value at input VALUE is NaN (result of an invalid arithmetic operation).

**Parameters**

The following table shows the parameters of the instruction "Normalize":

Parameter	Declaration	Data type	Memory area	Description
EN	Input	BOOL	I, Q, M, D, L	Enable input
ENO	Output	BOOL	I, Q, M, D, L	Enable output
MIN <sup>1)</sup>	Input	Integers, floating-point numbers	I, Q, M, D, L or constant	Low limit of the value range
VALUE <sup>1)</sup>	Input	Integers, floating-point numbers	I, Q, M, D, L or constant	Value to be normalized.
MAX <sup>1)</sup>	Input	Integers, floating-point numbers	I, Q, M, D, L or constant	High limit of the value range
OUT	Output	Floating-point numbers	I, Q, M, D, L	Result of the normalization

<sup>1)</sup> If you use constants in these three parameters, you only need to declare one of them.

You can select the data type of the instruction from the "<???" drop-down list of the instruction box.

For additional information on valid data types, refer to "See also".

For additional information on declaring constants, refer to "See also".

**Example**

The following example shows how the instruction works:

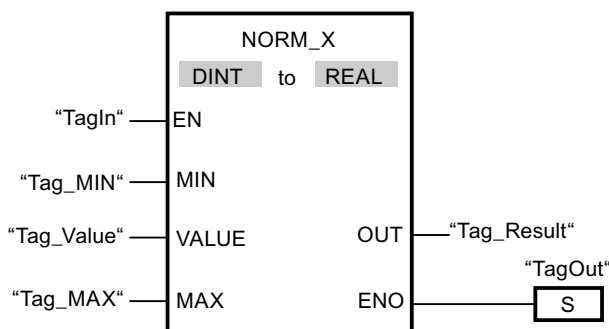

The following table shows how the instruction works using specific operand values:

Parameter	Operand	Value
MIN	Tag_MIN	10
VALUE	Tag_Value	20
MAX	Tag_MAX	30
OUT	Tag_Result	0.5

If the operand "TagIn" has the signal state "1", the "Normalize" instruction is executed. The value at input "Tag\_Value" is assigned to the range of values defined by the values at inputs "Tag\_MIN" and "Tag\_MAX". The tag value at input "Tag\_Value" is normalized corresponding to the defined value range. The result is stored as a floating-point number at output "Tag\_Result". If the instruction is executed without errors, the ENO enable output has the signal state "1" and the "TagOut" output is set.

## See also

Overview of the valid data types (Page 1077)

Basics of the EN/ENO mechanism (Page 1167)

SCALE\_X: Scale (Page 2017)

Declaring constants (Page 1188)

## Other

### SCALE: Scale

#### Description

Use the Scale instruction to convert the integer at the IN parameter into a floating-point number, which can be scaled in physical units between a low limit value and a high limit value. You can use the LO\_LIM and HI\_LIM parameters to specify the low limit and high limit of the value range to which the input value is scaled. The result of the instruction is output at the OUT parameter.

The "Scale" instruction works with the following equation:

$$\text{OUT} = [((\text{FLOAT}(\text{IN}) - \text{K1}) / (\text{K2} - \text{K1})) * (\text{HI\_LIM} - \text{LO\_LIM})) + \text{LO\_LIM}]$$

The values of the constants "K1" and "K2" are determined by the signal state on the BIPOLAR parameter. The following signal states are possible on the BIPOLAR parameter:

- Signal state "1": It is assumed that the value at the IN parameter is bipolar and in a value range between -27648 and 27648. In this case the "K1" constant has the value "-27648.0" and the "K2" constant the value "+27648.0".
- Signal state "0": It is assumed that the value at the IN parameter is unipolar and in a value range between 0 and 27648. In this case the "K1" constant has the value "0.0" and the "K2" constant the value "+27648.0".

When the value at the IN parameter is greater than the value of the constant "K2", the result of the instruction is set to the value of the high limit (HI\_LIM) and an error is output.

When the value at the IN parameter is less than the value of the constant "K1", the result of the instruction is set to the value of the low limit value (LO\_LIM) and an error is output.

When the indicated low limit value is greater than the high limit value (LO\_LIM > HI\_LIM), the result is scaled in reverse proportion to the input value.

### Parameters

The following table shows the parameters of the "Scale" instruction:

Parameter	Declaration	Data type	Memory area		Description
			S7-1200	S7-1500	
EN	Input	BOOL	I, Q, M, D, L	I, Q, M, D, L, T, C	Enable input
ENO	Output	BOOL	I, Q, M, D, L	I, Q, M, D, L	Enable output
IN	Input	INT	I, Q, M, D, L, P or constant	I, Q, M, D, L, P or constant	Input value to be scaled.
HI_LIM	Input	REAL	I, Q, M, D, L, P or constant	I, Q, M, D, L, P or constant	High limit
LO_LIM	Input	REAL	I, Q, M, D, L, P or constant	I, Q, M, D, L, P or constant	Low limit
BIPOLAR	Input	BOOL	I, Q, M, D, L or constant	I, Q, M, D, L or constant	Indicates if the value at IN parameter is to be interpreted as bipolar or unipolar. The parameter can assume the following values: 1: Bipolar 0: Unipolar
OUT	Output	REAL	I, Q, M, D, L, P	I, Q, M, D, L, P	Result of the instruction
RET_VAL	Output	WORD	I, Q, M, D, L, P	I, Q, M, D, L, P	Error information

### Parameters RET\_VAL

The following table shows the meaning of the values of the RET\_VAL parameter:

Error code* (W#16#...)	Explanation
0000	No error
0008	The value of the IN parameter is greater than the value of the "K2" constant or less than the value of the "K1" constant.
General error information	See also: "GET_ERR_ID: Get error ID locally"
*The error codes can be displayed as integer or hexadecimal value in the program editor. For information on toggling display formats, refer to "See also".	

## Example

The following example shows how the instruction works:

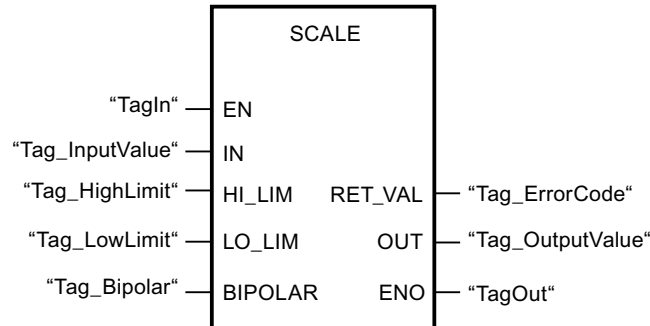

The following table shows how the instruction works using specific operand values:

Parameter	Operand	Value
IN	Tag_InputValue	22
HI_LIM	Tag_HighLimit	100.0
LO_LIM	Tag_LowLimit	0.0
BIPOLAR	Tag_Bipolar	1
OUT	Tag_OutputValue	50.03978588
RET_VAL	Tag_ErrorCode	W#16#0000

## See also

Overview of the valid data types (Page 1077)

Basics of the EN/ENO mechanism (Page 1167)

GET\_ERR\_ID: Get error ID locally (Page 2044)

## UNSCALE: Unscale

### Description

The "Unscale" instruction unscales the floating-point number at the IN parameter into physical units between a low limit value and a high limit and converts them into integers. You can use the LO\_LIM and HI\_LIM parameters to specify the low limit and high limit of the value range to which the input value is unscaled. The result of the instruction is output at the OUT parameter.

The "Unscale" instruction works with the following equation:

$$\text{OUT} = [ ((\text{IN} - \text{LO\_LIM}) / (\text{HI\_LIM} - \text{LO\_LIM})) * (\text{K2} - \text{K1}) ] + \text{K1}$$

The values of the constants "K1" and "K2" are determined by the signal state on the BIPOLAR parameter. The following signal states are possible on the BIPOLAR parameter:

- Signal state "1": It is assumed that the value at the IN parameter is bipolar and in a value range between -27648 and 27648. In this case the "K1" constant has the value "-27648.0" and the "K2" constant the value "+27648.0".
- Signal state "0": It is assumed that the value at the IN parameter is unipolar and in a value range between 0 and 27648. In this case the "K1" constant has the value "0.0" and the "K2" constant the value "+27648.0".

When the value at the IN parameter is greater than the value of the constant "HI\_LIM", the result of the instruction is set to the value of the constant (K2) and an error is output.

When the value at the IN parameter is less than the value of the constant of the low limit (LO\_LIM), the result of the instruction is set to the value of the constant (K1) and an error is output.

## Parameters

The following table shows the parameters of the "Unscale" instruction:

Parameter	Declaration	Data type	Memory area		Description
			S7-1200	S7-1500	
EN	Input	BOOL	I, Q, M, D, L	I, Q, M, D, L, T, C	Enable input
ENO	Input	BOOL	I, Q, M, D, L	I, Q, M, D, L	Enable output
IN	Input	REAL	I, Q, M, D, L, P or constant	I, Q, M, D, L, P or constant	Input value to be unscaled to an integer value.
HI_LIM	Input	REAL	I, Q, M, D, L, P or constant	I, Q, M, D, L, P or constant	High limit
LO_LIM	Input	REAL	I, Q, M, D, L, P or constant	I, Q, M, D, L, P or constant	Low limit
BIPOLAR	Input	BOOL	I, Q, M, D, L or constant	I, Q, M, D, L or constant	Indicates if the value at the IN parameter is to be interpreted as bipolar or unipolar. The parameter can assume the following values: 1: Bipolar 0: Unipolar
OUT	Output	INT	I, Q, M, D, L, P	I, Q, M, D, L, P	Result of the instruction
RET_VAL	Output	WORD	I, Q, M, D, L, P	I, Q, M, D, L, P	Error information



## Parameters RET\_VAL

The following table shows the meaning of the values of the RET\_VAL parameter:

Error code* (W#16#...)	Explanation
0000	No error
0008	The value of the IN parameter is greater than the value of the high limit (HI_LIM) or less than the value of the low limit (LO_LIM).
General error information	See also: "GET_ERR_ID: Get error ID locally"

\*The error codes can be displayed as integer or hexadecimal value in the program editor. For information on toggling display formats, refer to "See also".

## Example

The following example shows how the instruction works:

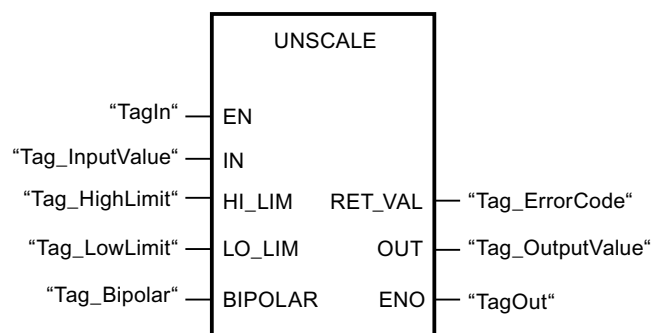

The following table shows how the instruction works using specific operand values:

Parameter	Operand	Value
IN	Tag_InputValue	50.03978588
HI_LIM	Tag_HighLimit	100.0
LO_LIM	Tag_LowLimit	0.0
BIPOLAR	Tag_Bipolar	1
OUT	Tag_OutputValue	22
RET_VAL	Tag_ErrorCode	W#16#0000

## See also

Overview of the valid data types (Page 1077)

Basics of the EN/ENO mechanism (Page 1167)

GET\_ERR\_ID: Get error ID locally (Page 2044)

## Program control operations

### JMP: Jump if RLO = 1

#### Description

You can use the "Jump if RLO = 1" instruction to interrupt the linear execution of the program and resume it in another network. The target network must be identified by a jump label (LABEL). The jump label description is entered in the placeholder above the instruction box.

The specified jump label must be in the same block in which the instruction is executed. The name you specify can only occur once in the block. Only one jumping coil can occur in a network.

If the result of logic operation (RLO) at the input of the instruction is "1", the jump to the network identified by the jump label is executed. The jump direction can be towards higher or lower network numbers.

If the condition at the input of the instruction is not fulfilled (RLO = 0), execution of the program continues in the next network.

#### Example

The following example shows how the instruction works:

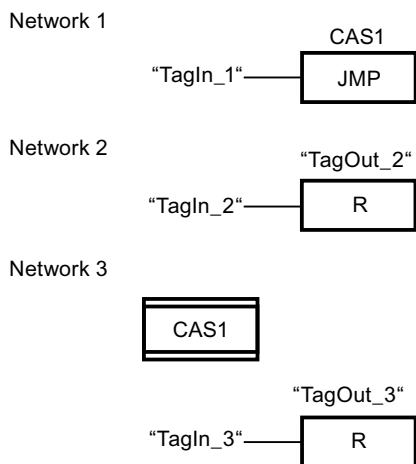

If the operand "TagIn\_1" has the signal state "1", the instruction "Jump if RLO = 1" is executed. The linear execution of the program is interrupted and continues in Network 3, which is identified by the jump label CAS1. If input "TagIn\_3" has the signal state "1", output "TagOut\_3" is reset.

#### See also

Overview of the valid data types (Page 1077)

## JMPN: Jump if RLO = 0

### Description

You can use the instruction "Jump if RLO = 0" to interrupt the linear execution of the program and resume it in another network, when the result of logic operation at the input of the instruction is "0". The target network must be identified by a jump label (LABEL). The jump label description is entered in the placeholder above the instruction box.

The specified jump label must be in the same block in which the instruction is executed. The name you specify can only occur once in the block. Only one jumping coil can occur in a network.

If the result of logic operation (RLO) at the input of the instruction is "0", the jump to the network identified by the jump label is executed. The jump direction can be towards higher or lower network numbers.

If the result of the logic operation RLO at the input of the instruction is "1", execution of the program continues in the next network.

### Example

The following example shows how the instruction works:

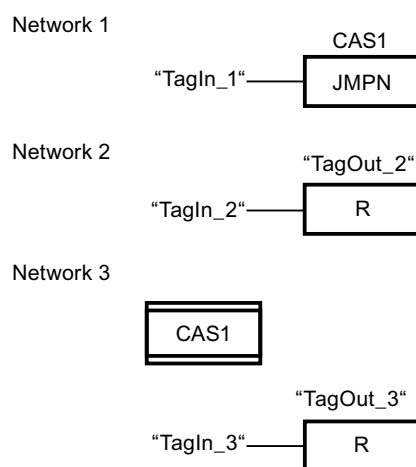

If the operand "TagIn\_1" has the signal state "0", the instruction "Jump if RLO = 0" is executed. The linear execution of the program is interrupted and continues in Network 3, which is identified by the jump label CAS1. If input "TagIn\_3" has the signal state "1", output "TagOut\_3" is reset.

### See also

Overview of the valid data types (Page 1077)

## LABEL: Jump label

### Description

The jump label identifies a destination network in which the execution of the program can be resumed after the execution of a jump instruction.

The jump label and the instruction in which the jump label is specified must be located in the same block. The name of a jump label can only be assigned once in a block. You can declare up to 32 jump labels when you use a CPU S7-1200 and a maximum of 256 jump labels when you use a CPU S7-1500.

Only one jump label can be placed in a network. Each jump label can jump to several locations.

### Example

The following example shows how the instruction works:

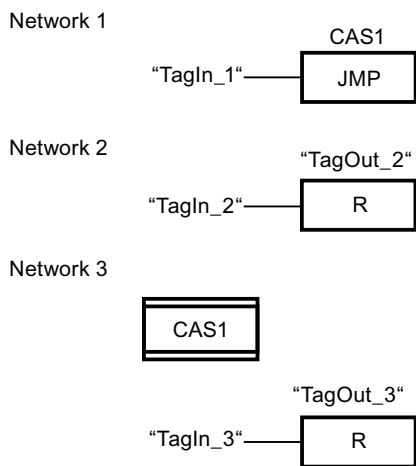

If the operand "TagIn\_1" has the signal state "1", the instruction "Jump if RLO = 1" is executed. The linear execution of the program is interrupted and continues in Network 3, which is identified by the jump label CAS1. If input "TagIn\_3" has the signal state "1", output "TagOut\_3" is reset.

### See also

Overview of the valid data types (Page 1077)

Adding additional inputs and outputs to FBD elements (Page 1329)

Removing instruction inputs and outputs (Page 1330)

## JMP\_LIST: Define jump list

### Description

The instruction "Define jump list" is used to define several conditional jumps and to resume the program execution in a defined network depending on the value of the parameter K.

You define the jumps with jump labels (LABEL), which you specify at the outputs of the instruction box. In its initial state the instruction box contains at least 2 outputs (DEST0 and DEST1). The number of outputs can be extended. You can declare up to 32 outputs when you use a CPU S7-1200 and a maximum of 256 outputs when you use a CPU S7-1500.

The numbering of the outputs begins with the value "0" and is continued in ascending order with each new output. Only jump labels can be specified at the outputs of the instruction. It is not permitted to specify instructions or operands.

You use the value of the parameter K to specify the number of the output and, accordingly, the jump label at which the program execution is continued. If the value at the parameter K is greater than the number of available outputs, the linear execution of the program is not interrupted but instead continued in the next network.

### Parameters

The following table shows the parameters of the "Define jump list" instruction:

Parameter	Declaration	Data type	Memory area	Description
EN	Input	BOOL	I, Q, M, L, D	Enable input
K	Input	UINT	I, Q, M, L, D or constant	Specifies the number of the output and thus the jump that is executed.
DEST0	-	-	-	First jump label
DEST1	-	-	-	Second jump label
DESTn	-	-	-	Optional jump labels

For additional information on valid data types, refer to "See also".

**Example**

The following example shows how the instruction works:

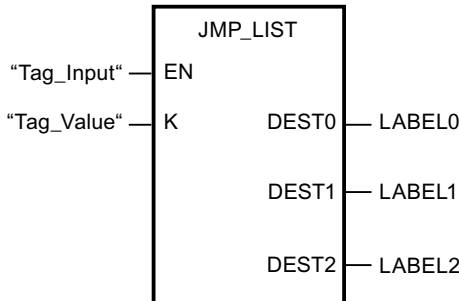

The following table shows how the instruction works using specific operand values:

Parameters	Operand/Jump label	Value
K	Tag_Value	1
DEST0	LABEL0	Jump in the network that is identified with the jump label "LABEL0".
DEST1	LABEL1	Jump in the network that is identified with the jump label "LABEL1".
DEST2	LABEL2	Jump in the network that is identified with the jump label "LABEL2".

If the operand "Tag\_Input" has the signal state "1", the instruction "Define jump list" is executed. The execution of the program is continued according to the value of the operand "Tag\_Value" in the network that is identified with the jump label "LABEL1".

**See also**

- Overview of the valid data types (Page 1077)
- Adding additional inputs and outputs to FBD elements (Page 1329)
- Removing instruction inputs and outputs (Page 1330)

**SWITCH: Jump distributor**

**Description**

You can use the "Jump distributor" instruction to define multiple program jumps to be executed depending on the result of one or more comparison instructions.

At the parameter K, you specify the value to be compared. This value is compared with the values that the individual inputs return. You select the type of comparison for each input. The availability of various comparison instructions depends on the data type of the instruction.

The following table shows the comparison instructions that are available depending on the selected data type:

Data type		Instruction	Syntax
S7-1200	S7-1500		
Bit strings	Bit strings	Equal	==
		Not equal	<>
Integers, floating-point numbers, TIME, DATE, TOD	Integers, floating-point numbers, TIME, LTIME, DATE, TOD, LTOD, LDT	Equal	==
		Not equal	<>
		Greater or equal	>=
		Less or equal	<=
		Greater than	>
		Less than	<

You can select the data type of the instruction from the "<???">" drop-down list of the instruction box. If you select a comparison instruction and the data type of the instruction is not yet defined, then the "<???">" drop-down list will only list those data types that are permitted for the selected comparison instruction.

The execution of the instruction begins with the first comparison and is executed until a comparison condition is fulfilled. When a comparison condition is fulfilled the subsequent comparison conditions are not considered. If none of the specified comparison conditions are fulfilled, the jump is executed at output ELSE. If not jump label is defined at output ELSE, the linear execution of the program is not interrupted but instead continued in the next network.

In its initial state the instruction box contains at least 2 outputs (DEST0 and DEST1). The number of outputs can be extended. The numbering of the outputs begins with the value "0" and is continued in ascending order with each new output. Specify jump labels (LABEL) at the outputs of the instruction. It is not permitted to specify instructions or operands at the outputs of the instruction.

An input is automatically inserted to each additional output. The jump programmed at an output is executed when the comparison condition of the corresponding is fulfilled.

## Parameters

The following table shows the parameters of the instruction "Jump distributor":

Parameters	Declaration	Data type		Memory area	Description
		S7-1200	S7-1500		
EN	Input	BOOL	BOOL	I, Q, M, D, L	Enable input
K	Input	UINT	UINT	I, Q, M, D, L or constant	Specifies the value to be compared.

Parameters	Declaration	Data type		Memory area	Description
		S7-1200	S7-1500		
<Comparison values>	Input	Bit strings, integers, floating-point numbers, TIME, DATE, TOD	Bit strings, integers, floating-point numbers, TIME, LTIME, DATE, TOD, LTOD, LDT	I, Q, M, D, L or constant	Input values with which the value of the parameter K is compared.
DEST0	-	-	-	-	First jump label
DEST1	-	-	-	-	Second jump label
DEST(n)	-	-	-	-	Optional jump labels (n = 2 to 99)
ELSE	-	-	-	-	Program jump which is executed if none of the comparison conditions are fulfilled.

For additional information on valid data types, refer to "See also".

### Example

The following example shows how the instruction works:

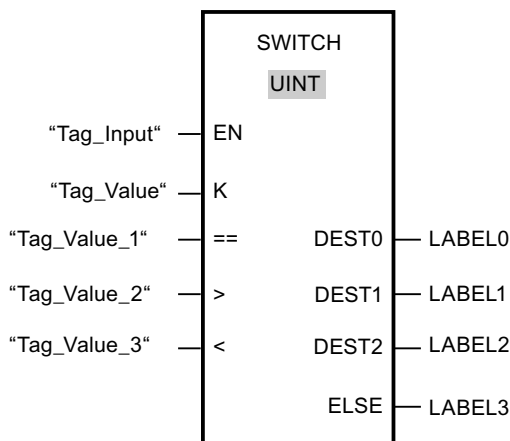

The following table shows how the instruction works using specific operand values:

Parameters	Operand/Jump label	Value
K	Tag_Value	23
==	Tag_Value_1	20
>	Tag_Value_2	21
<	Tag_Value_3	19



Parameters	Operand/Jump label	Value
DEST0	LABEL0	Jump to jump label "LABEL0", if the value of parameter K is equal to 20.
DEST1	LABEL1	Jump to jump label "LABEL1", if the value of parameter K is greater than 21.
DEST2	LABEL2	Jump to jump label "LABEL2", if the value of parameter K is less than 19.
ELSE	LABEL 3	Jump to jump label "LABEL3", if none of the comparison conditions are fulfilled.

If the operand "Tag\_Input" changes to signal state "1", the instruction "Jump distributor" is executed. The execution of the program is continued in the network that is identified with the jump label "LABEL1".

### See also

Overview of the valid data types (Page 1077)

Adding additional inputs and outputs to FBD elements (Page 1329)

Removing instruction inputs and outputs (Page 1330)

### RET: Return

#### Description

You can use the instruction "Return" to stop the execution of a block. This results in three types, in which the block processing can be completed:

- Without call of the "Return" instruction  
The block is exited after the execution of the last network. The ENO of the call function is set to the signal state "1".
- Call of the "Return" instruction with logic operation (see example)  
If the left connector has the signal state "1", then the block is exited. The ENO of the function call corresponds to the operand.
- Call of the "Return" instruction without logic operation  
The block is exited. The ENO of the function call corresponds to the operand.

---

#### Note

Only one jumping coil may be used in a network ("Return", "Jump if RLO = 1", "Jump if RLO = 0").

---

If the result of logic operation (RLO) at the input of the instruction "Return" is "1", the execution of the program is terminated in the currently called block and continued after the call function in the calling block (for example, in the calling OB). The status (ENO) of the call function is determined by the parameter of the instruction. This can assume the following values:

9.7 References

- RLO
- TRUE/FALSE
- <Operand>

To set the parameter values, double-click the instruction and select the corresponding value in the drop-down list.

The following table shows the status of the call function when the instruction "Return" is programmed in a network within the called block:

RLO	Parameter value	ENO of the call function
1	RLO	1
	TRUE	1
	FALSE	0
	<Operand>	<Operand>
0	RLO	In this case, the execution of the program continues in the next network of the called block.
	TRUE	
	FALSE	
	<Operand>	

If an OB is completed, another block is selected by the priority class system and started or re-executed.

- If the OB program cycle was completed, it is restarted.
- If an OB, which interrupted another block (e.g. an Alarm OB), is completed, then the interrupted block (e.g. OB program cycle) is executed.

Parameters

The following table shows the parameters of the instruction "Return":

Parameters	Declaration	Data type	Memory area	Description
Status of the calling function when RLO = 1:				
RLO	-	-	-	Is set to the signal state of the RLO.
TRUE	-	-	-	1
FALSE	-	-	-	0
<Operand>	Input	BOOL	I, Q, M, D, L	Signal state of the specified operand

## Example

The following example shows how the instruction works:

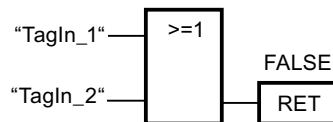

If the operands "TagIn\_1" or "TagIn\_2" have signal state "1", the instruction "Return" is executed. Program execution in the called block is terminated and continues in the calling block. The enable output ENO of the call function is reset to signal state "0".

## See also

Overview of the valid data types (Page 1077)

## Runtime control

### ENDIS\_PW: Limit and enable password legitimation

#### Description

You can use the "Limit and enable password legitimation" instruction to specify whether or not legitimation is allowed for the CPU. You can prevent legitimated connections, even when the correct password is known. When you invoke the command and the REQ parameter has the signal state "0", only the currently set condition is displayed at the output parameters, but no setting is changed. If the REQ parameter has the signal state "1", the signal state is taken from the input parameters (F\_PWD, FULL\_PWD, R\_PWD, HMI\_PWD). FALSE means that legitimation per password is not allowed; TRUE means the password can be used. Disable or enabling of the passwords can be allowed or prohibited individually. For example, all passwords can be prohibited, except the fail-safe password. You can thus limit access options to a small user group. The output parameters (F\_PWD\_ON, FULL\_PWD\_ON, R\_PWD\_ON, HMI\_PWD\_ON) always show the current status of the password use, regardless of the REQ parameter.

The same setting can be made on the front panel of the CPU and the CPU saves the most recent setting.

To prevent accidental lockout, the protection can be disabled by setting the mode switch to STOP with an S7-1500 CPU. The protection is automatically enabled again by setting mode selector to RUN without having to call the "Limit and enable password legitimation" instruction again or taking additional actions on the front panel.

The instruction must always be fully executed, in other words, the F\_PWD parameter must always have the signal state "0", for example, so that the settings can be saved.

Disabled passwords can be enabled again under the following conditions:

- The CPU is reset to its factory settings.
- The front panel of the S7-1500 CPU supports a dialog that allows you to navigate to the appropriate menu in which the passwords can be enabled again.

- When you call the "Limit and enable password legitimation" instruction, the input parameter of the desired password has the signal state "1".
- Set the mode selector to STOP. The restriction to password legitimation is re-established as soon as the switch is set back to RUN.
- Plugging a transfer module into an S7-1200 CPU.

---

**Note**

The "Limit and enable password legitimation" instruction blocks access to the HMI panel, if the HMI password has not been enabled.

---

**Note**

Existing legitimized connections retain their access rights and you cannot use the "Limit and enable password legitimation" instruction to restrict them.

---

### Procedure for lost passwords with an S7-1200 CPU

If you have lost the password for a password-protected CPU, delete the password-protected program with an empty transfer card. The empty transfer card deletes the internal load memory of the CPU. You can then load a new user program from STEP 7 Basic in the CPU.

 **WARNING**

**Inserting transfer card**

When you insert a transfer card in a CPU during runtime, the CPU goes to STOP mode. If operating states are unstable, controllers may fail and thus cause the uncontrolled operation of the controlled devices. This leads to an unforeseen operation of the automation system which can cause deadly or serious injuries and/or damage to property.

You must remove the transfer card before you put the CPU into RUN mode.

## Effects of password use on the operating modes

The following table shows what effects the password use by means of the "Limit and enable password legitimation" instruction has on the operating modes and the corresponding user actions.

Action	Password protection by means of the instruction
Basic state after <ul style="list-style-type: none"> <li>Operating mode switch to STOP</li> <li>Reset memory manually (PG, switch, change of MC (Motion Control))</li> <li>Reset to factory setting</li> </ul>	Not activated (no restrictions)
Basic state after POWER ON	Enabled (when a lock was activated before POWER OFF)  The option of not allowing passwords is retentive.
Operating mode transition RUN/STARTUP/HOLD -> STOP (by terminating the instruction, an error or communication) or STOP -> STARTUP/RUN/HOLD	Activated  Passwords still cannot be used.

## Parameters

The following table shows the parameters of the "Limit and enable password legitimation" instruction:

Parameter	Declaration	Data type	Memory area	Description
EN	Input	BOOL	I, Q, M, D, L	Enable input
ENO	Output	BOOL	I, Q, M, D, L	Enable output
REQ	Input	BOOL	I, Q, M, D, L	When the REQ parameter has the signal state "0", the currently set signal state of the passwords is queried.
F_PWD	Input	BOOL	I, Q, M, D, L	Read/write access including fail-safe <ul style="list-style-type: none"> <li>F_PWD = "0": Do not allow password</li> <li>F_PWD = "1": Allow password</li> </ul>
FULL_PWD	Input	BOOL	I, Q, M, D, L	Read/write access <ul style="list-style-type: none"> <li>FULL_PWD = "0": Do not allow password</li> <li>FULL_PWD = "1": Allow password</li> </ul>

Parameter	Declaration	Data type	Memory area	Description
R_PWD	Input	BOOL	I, Q, M, D, L	Read access <ul style="list-style-type: none"> <li>• R_PWD = "0": Do not allow password</li> <li>• R_PWD = "1": Allow password</li> </ul>
HMI_PWD	Input	BOOL	I, Q, M, D, L	HMI access <ul style="list-style-type: none"> <li>• HMI_PWD = "0": Do not allow password</li> <li>• HMI_PWD = "1": Allow password</li> </ul>
F_PWD_ON	Output	BOOL	I, Q, M, D, L	Read/write access including fail-safe <ul style="list-style-type: none"> <li>• F_PWD_ON = "0": Password not allowed</li> <li>• F_PWD_ON = "1": Password allowed</li> </ul>
FULL_PWD_ON	Output	BOOL	I, Q, M, D, L	Read/write access status <ul style="list-style-type: none"> <li>• FULL_PWD_ON = "0": Password not allowed</li> <li>• FULL_PWD_ON = "1": Password allowed</li> </ul>
R_PWD_ON	Output	BOOL	I, Q, M, D, L	Read-access status <ul style="list-style-type: none"> <li>• R_PWD_ON = "0": Password not allowed</li> <li>• R_PWD_ON = "1": Password allowed</li> </ul>
HMI_PWD_ON	Output	BOOL	I, Q, M, D, L	HMI-access status <ul style="list-style-type: none"> <li>• HMI_PWD_ON = "0": Password not allowed</li> <li>• HMI_PWD_ON = "1": Password allowed</li> </ul>
RET_VAL	Output	WORD	I, Q, M, D, L	Error information

For additional information on valid data types, refer to "See also".

## Parameter RET\_VAL

The following table shows the meaning of the values of the RET\_VAL parameter:

Error code* (W#16#...)	Explanation
0000	No error
8090	The "Limit and enable password legitimation" instruction is not supported
80D0	The password for fail-safe is not configured
80D1	The read/write access is not configured
80D2	The read access is not configured
80D3	The HMI access is not configured
*The error codes can be displayed as integer or hexadecimal value in the program editor. For information on toggling display formats, refer to "See also".	

## See also

Overview of the valid data types (Page 1077)

Basics of error handling (Page 1378)

Principles of local error handling (Page 1380)

Error output priorities (Page 1381)

Enabling local error handling for a block (Page 1382)

## RE\_TRIGR: Restart cycle monitoring time

### Description

You can use the "Restart cycle monitoring time" instruction to restart the cycle time monitoring of the CPU. The cycle monitoring time then starts over for the duration you have set in the CPU configuration.

The instruction "Restart cycle monitoring time" can be called regardless of the priority in all blocks.

If the instruction is called in a block with a higher priority, such as a hardware interrupt, a diagnostics interrupt or a cyclic interrupt, the instruction is not executed and the ENO enable output is set to signal state "0".

The instruction "Restart cycle monitoring time" can be called a maximum of 10 times in a program cycle.

### Parameters

The instruction "Restart cycle monitoring time" has no parameters.

### See also

- Overview of the valid data types (Page 1077)
- Basics of error handling (Page 1378)
- Principles of local error handling (Page 1380)
- Error output priorities (Page 1381)
- Enabling local error handling for a block (Page 1382)

### STP: Exit program

#### Description

The instruction "Exit program" instruction is used to set the CPU to STOP mode and therefore to terminate the execution of the program. The effects of changing from RUN to STOP depend on the CPU configuration.

When the (RLO) at the input of the instruction is "1", the CPU changes to STOP mode and the execution of the program is terminated. The signal state at the output of the instruction is not evaluated.

If the RLO at the input of the instruction is "0", then the instruction will not be executed.

#### Parameters

The instruction "Exit program" has no parameters.

### See also

- Overview of the valid data types (Page 1077)

### GET\_ERROR: Get error locally

#### Description

The "Get error locally" instruction is used to query the occurrence of errors within a block. If the system signals errors during block execution, detailed information about the first error that occurred is saved in the operand at output ERROR.

Only operands of the system data type "ErrorStruct" can be specified at output ERROR. The system data type "ErrorStruct" specifies the exact structure in which the information about the error is stored. Using additional instructions, you can evaluate this structure and program an appropriate response. When the first error has been eliminated, the instruction outputs information about the next error that occurred.



## Parameters

The following table shows the parameters of the "Get error locally" instruction:

Parameter	Declaration	Data type	Memory area	Description
ERROR	Output	ErrorStruct	D, L	Error information

## Data type "ErrorStruct"

The following table shows the structure of the data type ErrorStruct:

Structure component		Data type	Description					
ERROR_ID		WORD	Error ID					
FLAGS		BYTE	Shows if an error occurred during a block call. 16#01: Error during a block call. 16#00: No error during a block call.					
REACTION		BYTE	Default reaction: 0: Ignore (write error), 1: Continue with substitute value "0" (read error), 2: Skip instruction (system error)					
CODE_ADDRESS		CREF	Information on address and type of block					
	BLOCK_TYPE	BYTE	Type of block where the error occurred: 1: OB 2: FC 3: FB					
	CB_NUMBER	UINT	Number of the code block					
	OFFSET	UDINT	Reference to the internal memory					
MODE		BYTE	Access mode: Depending on the type of access, the following information can be output:					
			Mode	(A)	(B)	(C)	(D)	(E)
			0					
			1					Offset
			2			Area		
			3	Location	Scope		Number	
			4			Area		Offset
			5			Area	DB no.	Offset
			6	PtrNo./ Acc		Area	DB no.	Offset
			7	PtrNo./ Acc	Slot No. / Scope	Area	DB no.	Offset
OPERAND_NUMBER		UINT	Operand number of the machine command					
POINTER_NUMBER_LOCATION		UINT	(A) Internal pointer					
SLOT_NUMBER_SCOPE		UINT	(B) Storage area in internal memory					

Structure component		Data type	Description
DATA_ADDRESS		NREF	Information about the address of an operand
	AREA	BYTE	(C) Memory area: L: 16#40 – 4E, 86, 87, 8E, 8F, C0 – CE I: 16#81 Q: 16#82 M: 16#83 DB: 16#84, 85, 8A, 8B Range violations for a directly editable tag of data type DINT: 16#04
	DB_NUMBER	UINT	(D) Number of the data block
	OFFSET	UDINT	(E) Relative address of the operand

**Structure components "ERROR\_ID"**

The following table shows the values that can be output on the structure components "ERROR\_ID":

ID* (hexadecimal)	ID* (decimal)	Description
0	0	No error
2503	9475	Invalid pointer
2520	9504	Invalid STRING
2522	9506	Read error: Operand outside the valid range
2523	9507	Write error: Operand outside the valid range
2524	9508	Read error: Invalid operand
2525	9509	Write error: Invalid operand
2528	9512	Read error: Data alignment
2529	9513	Write error: Data alignment
252C	9516	Invalid pointer
2530	9520	Write error: Data block
2533	9523	Invalid pointer used
2538	9528	Access error: DB does not exist
2539	9529	Access error: Wrong DB used
253A	9530	Global data block does not exist
253C	9532	Faulty information or the function does not exist
253D	9533	System function does not exist
253E	9534	Faulty information or the function block does not exist
253F	9535	System block does not exist
2550	9552	Access error: DB does not exist
2551	9553	Access error: Wrong DB used
2575	9589	Error in the program nesting depth
2576	9590	Error in the local data distribution

ID* (hexadecimal)	ID* (decimal)	Description
2577	9591	Die block property "Parameter assignment via register" is not selected.
25A0	9632	Internal error in TP
25A1	9633	Tag is write-protected
25A2	9634	Invalid numerical value of tag
2942	10562	Read error: Input
2943	10563	Write error: Output
*The error codes can be displayed as integer or hexadecimal values in the program editor. For information on toggling display formats, refer to "See also".		

The enable output ENO of the instruction "Get error locally" instruction is set only if the enable input EN returns signal state "1" and error information is present. If one of these conditions does not apply, the remaining program execution is not affected by the instruction "Get error locally".

The "Get error locally" instruction can also be used to forward an alarm about the error status to the calling block. To do this, the instruction must be positioned in the last network of the called block.

#### Note

The "Get error locally" instruction enables local error handling within a block. When "Get error locally" is inserted in the program code of a block, any predefined system reactions are ignored if errors occur.

### Example

The following example shows how the instruction works:

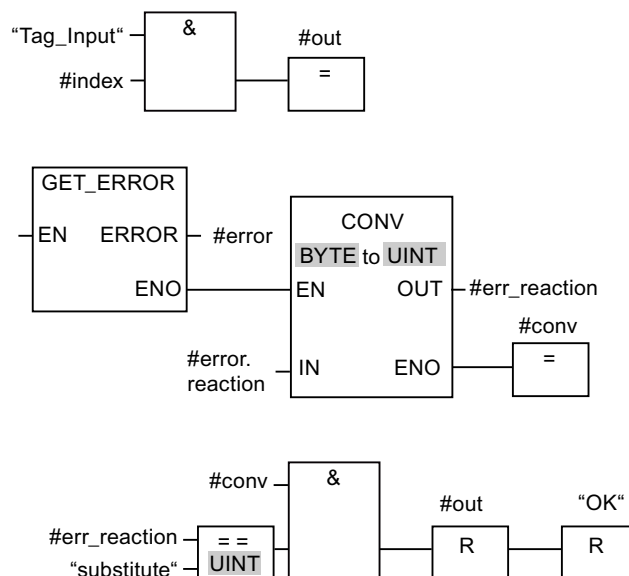

If an error occurs, the instruction "Get error locally" returns the error information to the locally created structure "#error" at output ERROR. The error information is converted and evaluated with the comparison instruction "Equal to". Information about the type of error is the first comparison value assigned to the instruction. For the second comparison value, a value of "1" is specified in the operand "substitute". If the error is a read error, the condition of the comparison instruction is satisfied. In this case the outputs "#out" and "OK" are reset.

**See also**

- Overview of the valid data types (Page 1077)
- Basics of error handling (Page 1378)
- Principles of local error handling (Page 1380)
- Error output priorities (Page 1381)
- Enabling local error handling for a block (Page 1382)

**GET\_ERR\_ID: Get error ID locally**

**Description**

The "Get error ID locally" instruction is used to query the occurrence of errors within a block. If the system signals errors during block execution, the error ID of the first error that occurred is saved in the tag at output ID. Only tags of the WORD data type can be specified at the ID output. When the first error has been eliminated, the instruction outputs the error ID of the next error that occurred.

The output of the instruction "Get error ID locally" is only set if the input of the instruction returns signal state "1" and error information is present. If one of these conditions does not apply, the remaining program execution is not affected by the instruction "Get error ID locally".

The "Get error ID locally" instruction can also be used to forward an alarm about the error status to the calling block. To do this, the instruction must be positioned in the last network of the called block.

---

**Note**

The "Get error ID locally" instruction enables local error handling within a block. When the instruction "Get error ID locally" is inserted in the program code of a block, any predefined system reactions are ignored if errors occur.

---

**Parameters**

The following table shows the parameters of the instruction "Get error ID locally":

Parameter	Declaration	Data type	Memory area	Description
ID	Output	WORD	I, Q, M, D, L	Error ID

## Parameter ID

The following table shows the values that can be output at the ID parameter:

ID* (hexadecimal)	ID* (decimal)	Description
0	0	No error
2503	9475	Invalid pointer
2520	9504	Invalid STRING
2522	9506	Read error: Operand outside the valid range
2523	9507	Write error: Operand outside the valid range
2524	9508	Read error: Invalid operand
2525	9509	Write error: Invalid operand
2528	9512	Read error: Data alignment
2529	9513	Write error: Data alignment
252C	9516	Invalid pointer
2530	9520	Write error: Data block
2533	9523	Invalid pointer used
2538	9528	Access error: DB does not exist
2539	9529	Access error: Wrong DB used
253A	9530	Global data block does not exist
253C	9532	Faulty information or the function does not exist
253D	9533	System function does not exist
253E	9534	Faulty information or the function block does not exist
253F	9535	System block does not exist
2550	9552	Access error: DB does not exist
2551	9553	Access error: Wrong DB used
2575	9589	Error in the program nesting depth
2576	9590	Error in the local data distribution
2577	9591	Die block property "Parameter assignment via register" is not selected.
25A0	9632	Internal error in TP
25A1	9633	Tag is write-protected
25A2	9634	Invalid numerical value of tag
2942	10562	Read error: Input
2943	10563	Write error: Output
*The error codes can be displayed as integer or hexadecimal values in the program editor. For information on toggling display formats, refer to "See also".		

**See also**

- Overview of the valid data types (Page 1077)
- Basics of error handling (Page 1378)
- Principles of local error handling (Page 1380)
- Error output priorities (Page 1381)
- Enabling local error handling for a block (Page 1382)

**INIT\_RD: Initialize all retain data**

**Description**

The "Initialize all retain data" instruction is used to reset the retentive data of all data blocks, bit memories and SIMATIC timers and counters at the same time. The instruction can only be executed within a startup OB because the execution exceeds the program cycle duration.

**Parameters**

The following table shows the parameters of the "Initialize all retain data" instruction:

Parameter	Declaration	Data type	Memory area	Description
EN	Input	BOOL	I, Q, M, D, L, T, C	Enable input
ENO	Output	BOOL	I, Q, M, D, L	Enable output
REQ	Input	BOOL	I, Q, M, D, L, T, C or constant	If the input "REQ" has the signal state "1", all retentive data are reset.
RET_VAL	Output	INT	I, Q, M, D, L	Error information: If an error occurs during the execution of the instruction, an error code is output at the RET_VAL parameter.

For additional information on valid data types, refer to "See also".

## Parameters RET\_VAL

The following table shows the meaning of the values of the RET\_VAL parameter:

Error code* (W#16#...)	Explanation
0000	No error
80B5	The instruction cannot be executed because it was not programmed within a startup OB.
General error information	See also: "GET_ERR_ID: Get error ID locally"

\*The error codes can be displayed as integer or hexadecimal values in the program editor. For information on toggling display formats, refer to "See also".

## Example

The following example shows how the instruction works:

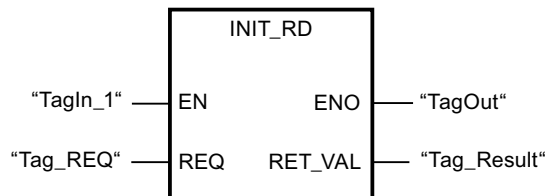

If the operands "TagIn\_1" and "Tag\_REQ" have signal state "1", the instruction is executed. All retentive data of all data blocks, bit memories and SIMATIC timers and counters are reset. If the instruction is executed without errors, the ENO enable output has the signal state "1".

## See also

- Overview of the valid data types (Page 1077)
- Basics of error handling (Page 1378)
- Principles of local error handling (Page 1380)
- Error output priorities (Page 1381)
- Enabling local error handling for a block (Page 1382)
- Basics of the EN/ENO mechanism (Page 1167)
- GET\_ERR\_ID: Get error ID locally (Page 2044)

## WAIT: Configure time delay

### Description

The "Configure time delay" instruction is used to halt the execution of the program for a set period of time. You indicate the period of time in microseconds on the WT parameter of the instruction.

You can configure time delays of up to 32767 microseconds ( $\mu\text{s}$ ). The smallest possible delay time depends on the respective CPU and corresponds to the execution time of the "Configure time delay" instruction.

The execution of the instruction can be interrupted by higher priority events.

The "Configure time delay" instruction supplies no error information.

## Parameters

The following table shows the parameters of the "Configure time delay" instruction:

Parameters	Declaration	Data type	Memory area	Description
EN	Input	BOOL	I, Q, M, D, L, T, C	Enable input
ENO	Output	BOOL	I, Q, M, D, L	Enable output
WT	Input	INT	I, Q, M, D, L, P or constant	Time delay in microseconds ( $\mu\text{s}$ )

## See also

Overview of the valid data types (Page 1077)

Basics of the EN/ENO mechanism (Page 1167)

## Word logic operations

### AND: AND logic operation

#### Description

You can use the instruction "AND logic operation" to link the value at input IN1 to the value at input IN2 bit-by-bit by AND logic and query the result at the output OUT.

When the instruction is executed, bit 0 of the value at input IN1 is linked by AND logic to bit 0 of the value at input IN2. The result is stored in bit 0 of output OUT. The same logic operation is executed for all other bits of the specified values.

In its initial state the instruction box contains at least 2 inputs (IN1 and IN2). The number of inputs can be extended. The inserted inputs are numbered in ascending order in the box. During the execution of the instruction, the values of all available input parameters are linked by AND logic. The result is stored at output "OUT".

The result bit has the signal state "1" only when both of the bits in the logic operation also have signal state "1". If one of the two bits of the logic operation has signal state "0", the corresponding result bit is reset.



## Parameters

The following table shows the parameters of the instruction "AND logic operation":

Parameters	Declaration	Data type	Memory area		Description
			S7-1200	S7-1500	
EN	Input	BOOL	I, Q, M, D, L	I, Q, M, D, L, T, C	Enable input
ENO	Output	BOOL	I, Q, M, D, L	I, Q, M, D, L	Enable output
IN1	Input	Bit strings	I, Q, M, D, L, P or constant	I, Q, M, D, L, P or constant	First value for logic operation
IN2	Input	Bit strings	I, Q, M, D, L, P or constant	I, Q, M, D, L, P or constant	Second value for logic operation
INn	Input	Bit strings	I, Q, M, D, L, P or constant	I, Q, M, D, L, P or constant	Optional input values
OUT	Output	Bit strings	I, Q, M, D, L, P	I, Q, M, D, L, P	Result of the instruction

You can select the data type of the instruction from the "<???"> drop-down list of the instruction box.

For additional information on valid data types, refer to "See also".

## Example

The following example shows how the instruction works:

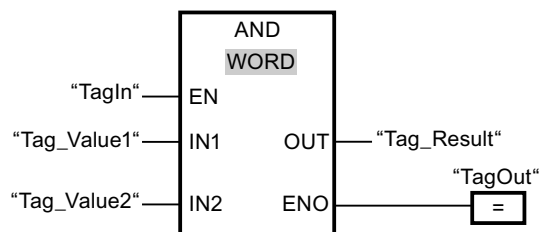

The following table shows how the instruction works using specific operand values:

Parameters	Operand	Value
IN1	Tag_Value1	0101 0101 0101 0101
IN2	Tag_Value2	0000 0000 0000 1111
OUT	Tag_Result	0000 0000 0000 0101

If the operand "TagIn" has the signal state "1", the instruction "AND logic operation" is executed. The value of operand "Tag\_Value1" is linked by AND to the value of the operand "Tag\_Value2". The result is mapped bit-for-bit and sent to the operand "Tag\_Result". The enable output ENO and the output "TagOut" are set to signal state "1".

**See also**

- Overview of the valid data types (Page 1077)
- Adding additional inputs and outputs to FBD elements (Page 1329)
- Removing instruction inputs and outputs (Page 1330)
- Basics of the EN/ENO mechanism (Page 1167)

**OR: OR logic operation**

**Description**

You can use the instruction "OR logic operation" to link the value at input IN1 to the value at input IN2 bit-by-bit by OR logic and query the result at the output OUT.

When the instruction is executed, bit 0 of the value at input IN1 is linked by OR logic to bit 0 of the value at input IN2. The result is stored in bit 0 of output OUT. The same logic operation is executed for all bits of the specified tags.

In its initial state the instruction box contains at least 2 inputs (IN1 and IN2). The number of inputs can be extended in the instruction box. The inserted inputs are numbered in ascending order in the box. During the execution of the instruction, the values of all available input parameters are linked by OR logic. The result is stored at output "OUT".

The result bit has the signal state "1" when at least one of the two bits in the logic operation has the signal state "1". If both of the bits of the logic operation have signal state "0", the corresponding result bit is reset.

**Parameters**

The following table shows the parameters of the instruction "OR logic operation":

Parameters	Declaration	Data type	Memory area		Description
			S7-1200	S7-1500	
EN	Input	BOOL	I, Q, M, D, L	I, Q, M, D, L, T, C	Enable input
ENO	Output	BOOL	I, Q, M, D, L	I, Q, M, D, L	Enable output
IN1	Input	Bit strings	I, Q, M, D, L, P or constant	I, Q, M, D, L, P or constant	First value for logic operation
IN2	Input	Bit strings	I, Q, M, D, L, P or constant	I, Q, M, D, L, P or constant	Second value for logic operation
INn	Input	Bit strings	I, Q, M, D, L, P or constant	I, Q, M, D, L, P or constant	Optional input values
OUT	Output	Bit strings	I, Q, M, D, L, P	I, Q, M, D, L, P	Result of the instruction

You can select the data type of the instruction from the "<???" drop-down list of the instruction box.

For additional information on valid data types, refer to "See also".

## Example

The following example shows how the instruction works:

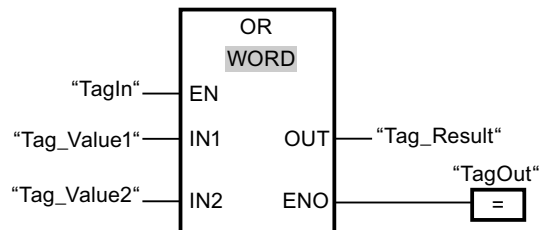

The following table shows how the instruction works using specific operand values:

Parameters	Operand	Value
IN1	Tag_Value1	0101 0101 0101 0101
IN2	Tag_Value2	0000 0000 0000 1111
OUT	Tag_Result	0101 0101 0101 1111

If the operand "TagIn" has the signal state "1", the instruction "OR logic operation" is executed. The value of operand "Tag\_Value1" is linked by OR to the value of the operand "Tag\_Value2". The result is mapped bit-for-bit and sent to the operand "Tag\_Result". The enable output ENO and the output "TagOut" are set to signal state "1".

## See also

Overview of the valid data types (Page 1077)

Adding additional inputs and outputs to FBD elements (Page 1329)

Removing instruction inputs and outputs (Page 1330)

Basics of the EN/ENO mechanism (Page 1167)

## XOR: EXCLUSIVE OR logic operation

### Description

You can use the instruction "EXCLUSIVE OR logic operation" to link the value at input IN1 to the value at input IN2 bit-by-bit by EXCLUSIVE OR logic and query the result at the output OUT.

When the instruction is executed, bit 0 of the value at input IN1 is linked by EXCLUSIVE OR logic to bit 0 of the value at input IN2. The result is stored in bit 0 of output OUT. The same logic operation is executed for all other bits of the specified value.

In its initial state the instruction box contains at least 2 inputs (IN1 and IN2). The number of inputs can be extended in the instruction box. The inserted inputs are numbered in ascending order in the box. During the execution of the instruction, the values of all available input parameters are linked by EXCLUSIVE OR logic. The result is stored at output "OUT".

The result bit has the signal state "1" when one of the two bits in the logic operation has the signal state "1". If both of the bits of the logic operation have signal state "1" or "0", the corresponding result bit is reset.

### Parameters

The following table shows the parameters of the instruction "EXCLUSIVE OR logic operation":

Parameters	Declaration	Data type	Memory area		Description
			S7-1200	S7-1500	
EN	Input	BOOL	I, Q, M, D, L	I, Q, M, D, L, T, C	Enable input
ENO	Output	BOOL	I, Q, M, D, L	I, Q, M, D, L	Enable output
IN1	Input	Bit strings	I, Q, M, D, L, P or constant	I, Q, M, D, L, P or constant	First value for logic operation
IN2	Input	Bit strings	I, Q, M, D, L, P or constant	I, Q, M, D, L, P or constant	Second value for logic operation
INn	Input	Bit strings	I, Q, M, D, L, P or constant	I, Q, M, D, L, P or constant	Optional input values
OUT	Output	Bit strings	I, Q, M, D, L, P	I, Q, M, D, L, P	Result of the instruction

You can select the data type of the instruction from the "<??>" drop-down list of the instruction box.

For additional information on valid data types, refer to "See also".

### Example

The following example shows how the instruction works:

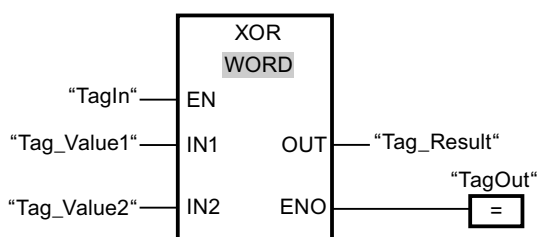

The following table shows how the instruction works using specific operand values:

Parameters	Operand	Value
IN1	Tag_Value1	0101 0101 0101 0101
IN2	Tag_Value2	0000 0000 0000 1111
OUT	Tag_Result	0101 0101 0101 1010

If the operand "TagIn" has the signal state "1", the instruction "EXCLUSIVE OR logic operation" is executed. The value of operand "Tag\_Value1" is linked by EXCLUSIVE OR to the value of

the operand "Tag\_Value2". The result is mapped bit-for-bit and sent to the operand "Tag\_Result". The enable output ENO and the output "TagOut" are set to signal state "1".

## See also

Overview of the valid data types (Page 1077)

Adding additional inputs and outputs to FBD elements (Page 1329)

Removing instruction inputs and outputs (Page 1330)

Basics of the EN/ENO mechanism (Page 1167)

## INV: Create ones complement

### Description

You can use the instruction "Create ones complement" to invert the signal status of the bits at input IN. When the instruction is processed, the value at input IN is linked to EXCLUSIVE OR by a hexadecimal mask (W#16#FFFF for 16-bit numbers or DW#16#FFFF FFFF for 32-bit number). This inverts the signal state of the individual bits that are then stored at output OUT.

### Parameters

The following table shows the parameters of the instruction "Create ones complement":

Parameters	Declaration	Data type	Memory area		Description
			S7-1200	S7-1500	
EN	Input	BOOL	I, Q, M, D, L	I, Q, M, D, L, T, C	Enable input
ENO	Output	BOOL	I, Q, M, D, L	I, Q, M, D, L	Enable output
IN	Input	Bit strings, integers	I, Q, M, D, L, P or constant	I, Q, M, D, L, P or constant	Input value
OUT	Output	Bit strings, integers	I, Q, M, D, L, P	I, Q, M, D, L, P	Ones complement of the value at input IN

You can select the data type of the instruction from the "<???">" drop-down list of the instruction box.

For additional information on valid data types, refer to "See also".

**Example**

The following example shows how the instruction works:

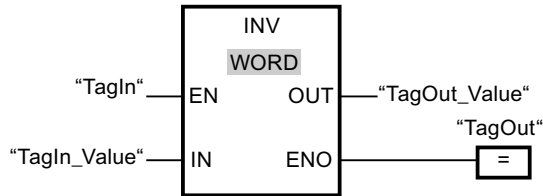

The following table shows how the instruction works using specific operand values:

Parameters	Operand	Value	
IN	TagIn_Value	W#16#000F	W#16#7E
OUT	TagOut_Value	W#16#FFF0	W#16#81

If the operand "TagIn" has the signal state "1", the "Create ones complement" instruction is executed. The instruction inverts the signal state of the individual bits at input "TagIn\_Value" and writes the result to output "TagOut\_Value". The enable output ENO and the output "TagOut" are set to signal state "1".

**See also**

- Overview of the valid data types (Page 1077)
- Basics of the EN/ENO mechanism (Page 1167)

**DECO: Decode**

**Description**

You can use the "Decode" instruction to set a bit in the output value specified by the input value.

The "Decode" instruction reads the value at the IN input and sets the bit in the output value whose bit position corresponds to the read value. The other bits in the output value are filled with zeroes. If the value at input IN is greater than 31, a modulo 32 instruction is executed.

**Parameters**

The following table shows the parameters of the "Decode" instruction:

Parameters	Declaration	Data type	Memory area		Description
			S7-1200	S7-1500	
EN	Input	BOOL	I, Q, M, D, L	I, Q, M, D, L, T, C	Enable input
ENO	Output	BOOL	I, Q, M, D, L	I, Q, M, D, L	Enable output

Parameters	Declaration	Data type	Memory area		Description
			S7-1200	S7-1500	
IN	Input	UINT	I, Q, M, D, L, P or constant	I, Q, M, D, L, P or constant	Position of the bit in the output value which is set.
OUT	Output	Bit strings	I, Q, M, D, L, P	I, Q, M, D, L, P	Output value

You can select the data type of the instruction from the "<???"> drop-down list of the instruction box.

For additional information on valid data types, refer to "See also".

## Example

The following example shows how the instruction works:

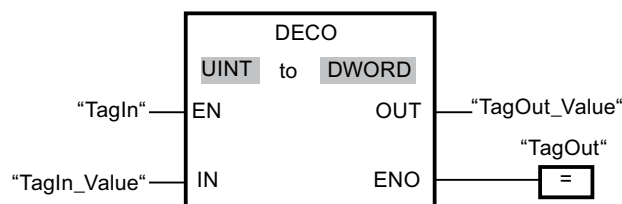

The following figure shows how the instruction works using specific operand values:

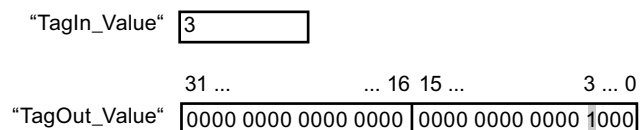

If the operand "TagIn" has the signal state "1", the "Decode" instruction is executed. The instruction reads bit number "3" from the value of the operand "TagIn\_Value" and sets the third bit to the value of the operand "TagOut\_Value".

If no errors occur during the execution of the instruction, the output ENO has the signal state "1" and the output "TagOut" is set.

## See also

Overview of the valid data types (Page 1077)

Basics of the EN/ENO mechanism (Page 1167)

## ENCO: Encode

### Description

The instruction "Encode" is used to read the bit number of the lowest bit in the input value and output it to the output OUT.

The instruction "Encode" selects the least significant bit of the value at the IN input and writes its bit number to the tag in the output OUT.

### Parameters

The following table shows the parameters of the instruction "Encode":

Parameters	Declaration	Data type	Memory area		Description
			S7-1200	S7-1500	
EN	Input	BOOL	I, Q, M, D, L	I, Q, M, D, L, T, C	Enable input
ENO	Output	BOOL	I, Q, M, D, L	I, Q, M, D, L	Enable output
IN	Input	Bit strings	I, Q, M, D, L, P or constant	I, Q, M, D, L, P or constant	Input value
OUT	Output	INT	I, Q, M, D, L, P	I, Q, M, D, L, P	Output value

You can select the data type of the instruction from the "<???" drop-down list of the instruction box.

For additional information on valid data types, refer to "See also".

### Example

The following example shows how the instruction works:

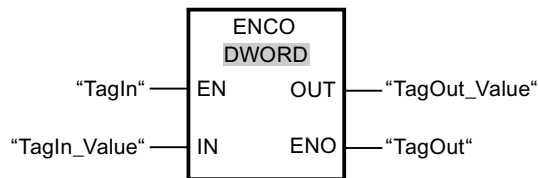

The following figure shows how the instruction works using specific operand values:

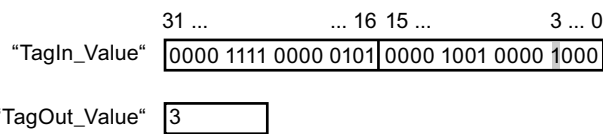

If the operand "TagIn" has the signal state "1", the "Encode" instruction is executed. The instruction selects bit position "3" as the least significant bit at input "TagIn\_Value" and writes the value "3" to the tag at the output "TagOut\_Value".

If the instruction is executed without errors, the ENO enable output has the signal state "1" and the "TagOut" output is set.

### See also

- Overview of the valid data types (Page 1077)
- Basics of the EN/ENO mechanism (Page 1167)



**SEL: Select****Description**

Depending on the signal state at switch (input G), the "Select" instruction selects one of the inputs IN0 or IN1 and moves its content to the output OUT. When the input G has the signal state "0", the value at the input IN0 is moved. When the input G has the signal state "1", the value at the input IN1 is moved to the output OUT.

The instruction can only be executed if the enable input EN has the signal state "1" and the tags at all parameters have the same data type.

**Parameters**

The following table shows the parameters of the "Select" instruction:

Parameter	Declaration	Data type		Memory area		Description
		S7-1200	S7-1500	S7-1200	S7-1500	
EN	Input	BOOL	BOOL	I, Q, M, D, L	I, Q, M, D, L	Enable input
ENO	Output	BOOL	BOOL	I, Q, M, D, L	I, Q, M, D, L	Enable output
G	Input	BOOL	BOOL	I, Q, M, D, L or constant	I, Q, M, D, L, T, C or constant	Switch
IN0	Input	Bit strings, integers, floating-point numbers, TIME, TOD, DATE, CHAR	Bit strings, integers, floating-point numbers, timers, TOD, LTOD, DATE, CHAR	I, Q, M, D, L, P or constant	I, Q, M, D, L, P or constant	First input value
IN1	Input	Bit strings, integers, floating-point numbers, TIME, TOD, DATE, CHAR	Bit strings, integers, floating-point numbers, timers, TOD, LTOD, DATE, CHAR	I, Q, M, D, L, P or constant	I, Q, M, D, L, P or constant	Second input value
OUT	Output	Bit strings, integers, floating-point numbers, TIME, TOD, DATE, CHAR	Bit strings, integers, floating-point numbers, timers, TOD, LTOD, DATE, CHAR	I, Q, M, D, L, P	I, Q, M, D, L, P	Result

You can select the data type of the instruction from the "<???">" drop-down list of the instruction box.

For additional information on valid data types, refer to "See also".

**Example**

The following example shows how the instruction works:

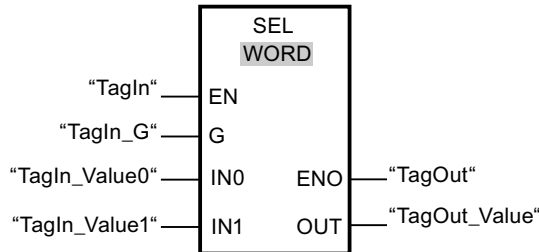

The following table shows how the instruction works using specific operand values:

Parameter	Operand	Value	
G	TagIn_G	0	1
IN0	TagIn_Value0	W#16#0000	W#16#4C
IN1	TagIn_Value1	W#16#FFFF	W#16#5E
OUT	TagOut_Value	W#16#0000	W#16#5E

If the operand "TagIn" has the signal state "1", the instruction "Select" is executed. Based on the signal state at the "TagIn\_G" input, the value of the "TagIn\_Value0" or "TagIn\_Value1" input is selected and moved to the "TagOut\_Value" output. If the instruction is executed without errors, the enable output ENO has the signal state "1" and the output "TagOut" is set.

**See also**

- Overview of the valid data types (Page 1077)
- Basics of the EN/ENO mechanism (Page 1167)

**MUX: Multiplex**

**Description**

You can use the instruction "Multiplex" to copy the content of a selected input to output OUT. In its initial state the instruction box contains at least 2 inputs (IN0 and IN1). The number of selectable inputs of the instruction box can be expanded. You can declare a maximum of 32 inputs.

The inputs are numbered automatically in the box. Numbering starts at IN0 and is incremented continuously with each new input. You can use the parameter K to determine the input whose content should be copied to output OUT. If the value of the parameter K is greater than the number of available inputs, the content of the parameter ELSE is copied to output OUT and enable output ENO is assigned the signal state "0".

The "Multiplex" instruction can only be executed if the tags have the same data type in all inputs and in the OUT output. The exception here is the parameter K, which can only be specified as an integer.

The enable output ENO is reset if one of the following conditions applies:

- Enable input EN has the signal state "0".
- The value of the parameter K is greater than the number of available inputs.
- Errors occurred during the execution of the instruction.

## Parameters

The following table shows the parameters of the "Multiplex" instruction:

Parameter	Declaring	Data type		Memory area		Description
		S7-1200	S7-1500	S7-1200	S7-1500	
EN	Input	BOOL	BOOL	I, Q, M, D, L	I, Q, M, D, L, T, C	Enable input
ENO	Output	BOOL	BOOL	I, Q, M, D, L	I, Q, M, D, L	Enable output
K	Input	Integers	Integers	I, Q, M, D, L, P or constant	I, Q, M, D, L, P or constant	Specifies the input whose content is to be copied. <ul style="list-style-type: none"> <li>• If K = 0 =&gt; Parameter IN0</li> <li>• If K = 1 =&gt; Parameter IN1, etc.</li> </ul>
IN0	Input	Binary numbers, integers, floating-point numbers, strings, TIME, TOD, DATE	Binary numbers, integers, floating-point numbers, strings, timers, TOD, LTOD, DATE, LDT	I, Q, M, D, L, P or constant	I, Q, M, D, L, P or constant	First input value
IN1	Input	Binary numbers, integers, floating-point numbers, strings, TIME, TOD, DATE	Binary numbers, integers, floating-point numbers, strings, timers, TOD, LTOD, DATE, LDT	I, Q, M, D, L, P or constant	I, Q, M, D, L, P or constant	Second input value

Parameter	Declaring	Data type		Memory area		Description
		S7-1200	S7-1500	S7-1200	S7-1500	
INn	Input	Binary numbers, integers, floating-point numbers, strings, TIME, TOD, DATE	Binary numbers, integers, floating-point numbers, strings, timers, TOD, LTOD, DATE, LDT	I, Q, M, D, L, P or constant	I, Q, M, D, L, P or constant	Optional input values
ELSE	Input	Binary numbers, integers, floating-point numbers, strings, TIME, TOD, DATE	Binary numbers, integers, floating-point numbers, strings, timers, TOD, LTOD, DATE, LDT	I, Q, M, D, L, P or constant	I, Q, M, D, L, P or constant	Specifies the value to be copied when K > n.
OUT	Output	Binary numbers, integers, floating-point numbers, strings, TIME, TOD, DATE	Binary numbers, integers, floating-point numbers, strings, timers, TOD, LTOD, DATE, LDT	I, Q, M, D, L, P	I, Q, M, D, L, P	Output to which the value is to be copied.

You can select the data type for the instruction from the "<???" drop-down list of the instruction box.

For additional information on valid data types, refer to "See also".

## Example

The following example shows how the instruction works:

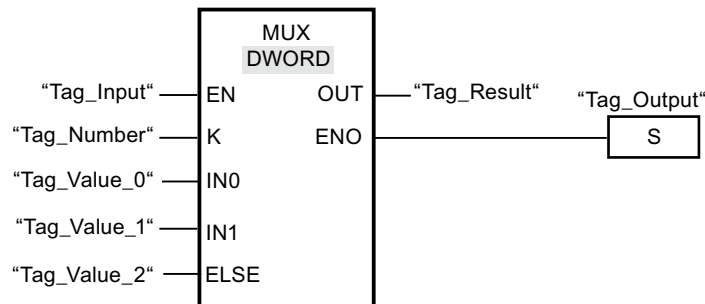

The following table shows how the instruction works using specific operand values:

Parameter	Operand	Value
K	Tag_Number	1
IN0	Tag_Value_0	DW#16#00000000
IN1	Tag_Value_1	DW#16#003E4A7D
ELSE	Tag_Value_2	DW#16#FFFF0000
OUT	Tag_Result	DW#16#003E4A7D

If the operand "Tag\_Input" has the signal state "1", the "Multiplex" instruction is executed. Depending on the value of the operand "Tag\_Number", the value at input "Tag\_Value\_1" is copied and assigned to the operand at output "Tag\_Result". If no errors occur during the execution of the instruction, the outputs ENO and "Tag\_Output" are set.

## See also

Overview of the valid data types (Page 1077)

Basics of the EN/ENO mechanism (Page 1167)

## DEMUX: Demultiplex

### Description

You can use the instruction "Demultiplex" to copy the content of the input IN to a selected output. In its initial state the instruction box contains at least 2 outputs (OUT0 and OUT1). The number of selectable outputs can be extended in the instruction box. The outputs are numbered automatically in the box. Numbering starts at OUT0 and continues consecutively with each new output. You can use the parameter K to define the output to which the content of input IN will be copied. The other outputs will not be changed. If the value of the parameter K is greater than the number of available outputs, then the content of input IN in the parameter ELSE and the enable output ENO will be assigned to the signal state "0".

The instruction "Demultiplex" can only be executed if the tags at the input IN and at all outputs are of the same data type. The exception here is the parameter K, which can only be specified as an integer.

The enable output ENO is reset if one of the following conditions applies:

- Enable input EN has the signal state "0".
- The value of the parameter K is greater than the number of available outputs.
- Errors occurred during the execution of the instruction.

### Parameters

The following table shows the parameters of the instruction "Demultiplex":

Parameter	Declaration	Data type		Memory area		Description
		S7-1200	S7-1500	S7-1200	S7-1500	
EN	Input	BOOL	BOOL	I, Q, M, D, L	I, Q, M, D, L, T, C	Enable input
ENO	Output	BOOL	BOOL	I, Q, M, D, L	I, Q, M, D, L	Enable output
K	Input	Integers	Integers	I, Q, M, D, L, P or constant	I, Q, M, D, L, P or constant	Specifies the output to which the input value (IN) will be copied. <ul style="list-style-type: none"> <li>• If K = 0 =&gt; Parameter OUT0</li> <li>• If K = 1 =&gt; Parameter OUT1, etc.</li> </ul>
IN	Input	Binary numbers, integers, floating-point numbers, strings, TIME, TOD, DATE	Binary numbers, integers, floating-point numbers, strings, timers, TOD, LTOD, DATE, LDT	I, Q, M, D, L, P or constant	I, Q, M, D, L, P or constant	Input value
OUT0	Output	Binary numbers, integers, floating-point numbers, strings, TIME, TOD, DATE	Binary numbers, integers, floating-point numbers, strings, timers, TOD, LTOD, DATE, LDT	I, Q, M, D, L, P	I, Q, M, D, L, P	First output

Parameter	Declaration	Data type		Memory area		Description
		S7-1200	S7-1500	S7-1200	S7-1500	
OUT1	Output	Binary numbers, integers, floating-point numbers, strings, TIME, TOD, DATE	Binary numbers, integers, floating-point numbers, strings, timers, TOD, LTOD, DATE, LDT	I, Q, M, D, L, P	I, Q, M, D, L, P	Second output
OUTn	Output	Binary numbers, integers, floating-point numbers, strings, TIME, TOD, DATE	Binary numbers, integers, floating-point numbers, strings, timers, TOD, LTOD, DATE, LDT	I, Q, M, D, L, P	I, Q, M, D, L, P	Optional outputs
ELSE	Output	Binary numbers, integers, floating-point numbers, strings, TIME, TOD, DATE	Binary numbers, integers, floating-point numbers, strings, timers, TOD, LTOD, DATE, LDT	I, Q, M, D, L, P	I, Q, M, D, L, P	Output to which the input value (IN) at K > n is copied.

You can select the data type for the instruction from the "<???"> drop-down list of the instruction box.

For additional information on available data types, refer to "See also".

**Example**

The following example shows how the instruction works:

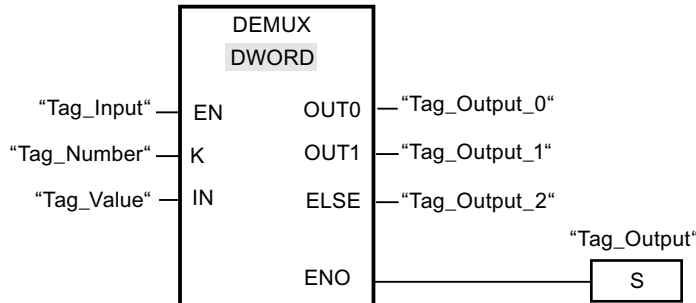

The following tables show how the instruction works using specific operand values:

Table 9-26 Input values of the "Demultiplex" instruction before network execution

Parameter	Operand	Values	
K	Tag_Number	1	4
IN	Tag_Value	DW#16#FFFFFFFF	DW#16#003E4A7D

Table 9-27 Output values of the "Demultiplex" instruction after network execution

Parameter	Operand	Values	
OUT0	Tag_Output_0	Unchanged	Unchanged
OUT1	Tag_Output_1	DW#16#FFFFFFFF	Unchanged
ELSE	Tag_Output_2	Unchanged	DW#16#003E4A7D

The "Demultiplex" instruction is executed when input "Tag\_Input" has the signal state "1". Depending on the value of the operand "Tag\_Number", the value at input "IN" is copied to the corresponding output.

**See also**

- Overview of the valid data types (Page 1077)
- Basics of the EN/ENO mechanism (Page 1167)

**Shift and rotate**

**SHR: Shift right**

**Description**

You can use the "Shift right" instruction to shift the content of the operand at the input IN bit-by-bit to the right and query the result at the OUT output. The input N is used to specify the number of bit positions by which the specified value should be moved.



If the value at the input N is "0", the value at input IN is copied unchanged to the operand at output OUT.

If the value at the input N is greater than the number of available bit positions, the operand value at input IN is shifted to the right by the available number of bit positions.

The freed bit positions in the left area of the operand are filled by zeroes when values without signs are shifted. If the specified value has a sign, the free bit positions are filled with the signal state of the sign bit.

The following figure show how the content of an integer data type operand is shifted four bit positions to the right:

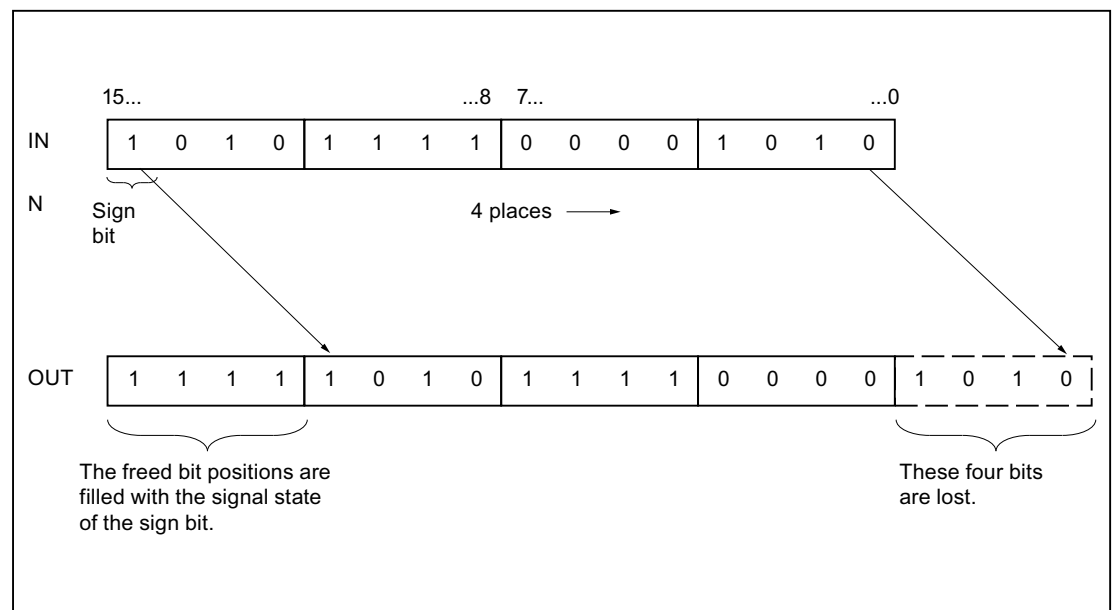

## Parameters

The following table shows the parameters of the instruction "Shift right":

Parameter	Declaration	Data type		Memory area		Description
		S7-1200	S7-1500	S7-1200	S7-1500	
EN	Input	BOOL	BOOL	I, Q, M, D, L	I, Q, M, D, L, T, C	Enable input
ENO	Output	BOOL	BOOL	I, Q, M, D, L	I, Q, M, D, L	Enable output
IN	Input	Bit strings, integers	Bit strings, integers	I, Q, M, D, L or constant	I, Q, M, D, L or constant	Value to be shifted
N	Input	USINT, UINT, UDINT	USINT, UINT, UDINT, ULINT	I, Q, M, D, L or constant	I, Q, M, D, L or constant	Number of bit positions by which the value is shifted
OUT	Output	Bit strings, integers	Bit strings, integers	I, Q, M, D, L	I, Q, M, D, L	Result of the instruction

You can select the data type for the instruction from the "<???" drop-down list of the instruction box.

For additional information on valid data types, refer to "See also".

**Example**

The following example shows how the instruction works:

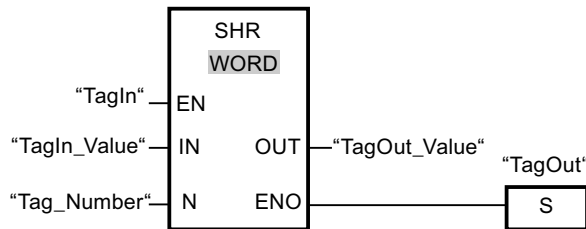

The following table shows how the instruction works using specific operand values:

Parameter	Operand	Value
IN	TagIn_Value	0011 1111 1010 1111
N	Tag_Number	3
OUT	TagOut_Value	0000 0111 1111 0101

If the operand "TagIn" has the signal state "1", the instruction "Shift right" is executed. The content of the operand "TagIn\_Value" is shifted three bit positions to the right. The result is sent at output "TagOut\_Value". If the instruction is executed without errors, the ENO enable output has the signal state "1" and the "TagOut" output is set.

**See also**

- Overview of the valid data types (Page 1077)
- Basics of the EN/ENO mechanism (Page 1167)

**SHL: Shift left**

**Description**

You can use the "Shift left" instruction to shift the content of the operand at the input IN bit-by-bit to the left and query the result at the OUT output. The input N is used to specify the number of bit positions by which the specified value should be moved.

If the value at the input N is "0", the value at input IN is copied unchanged to the operand at output OUT.

If the value at the input N is greater than the number of available bit positions, the operand value at input IN is shifted to the left by the available number of bit positions.

The bit positions in the right part of the operand freed by shifting are filled with zeros.

The following figure show how the content of an operand of the data type WORD is shifted six bit positions to the left:

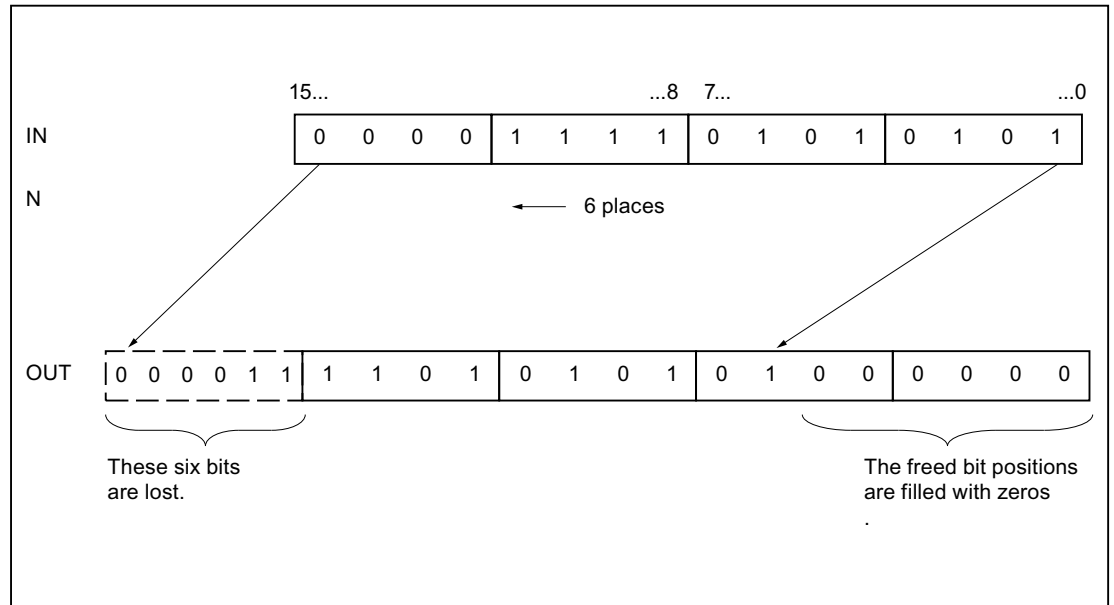

## Parameters

The following table shows the parameters of the instruction "Shift left":

Parameter	Declaration	Data type		Memory area		Description
		S7-1200	S7-1500	S7-1200	S7-1500	
EN	Input	BOOL	BOOL	I, Q, M, D, L	I, Q, M, D, L, T, C	Enable input
ENO	Output	BOOL	BOOL	I, Q, M, D, L	I, Q, M, D, L	Enable output
IN	Input	Bit strings, integers	Bit strings, integers	I, Q, M, D, L or constant	I, Q, M, D, L or constant	Value to be shifted.
N	Input	USINT, UINT, UDINT	USINT, UINT, UDINT, ULINT	I, Q, M, D, L or constant	I, Q, M, D, L or constant	Number of bit positions by which the value is shifted.
OUT	Output	Bit strings, integers	Bit strings, integers	I, Q, M, D, L	I, Q, M, D, L	Result of the instruction

You can select the data type for the instruction from the "<???">" drop-down list of the instruction box.

For additional information on valid data types, refer to "See also".

**Example**

The following example shows how the instruction works:

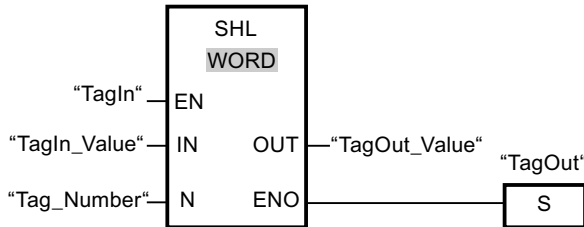

The following table shows how the instruction works using specific operand values:

Parameter	Operand	Value
IN	TagIn_Value	0011 1111 1010 1111
N	Tag_Number	4
OUT	TagOut_Value	1111 1010 1111 0000

If the operand "TagIn" has the signal state "1", the instruction "Shift left" is executed. The content of the operand "TagIn\_Value" is shifted four bit positions to the left. The result is sent at output "TagOut\_Value". If the instruction is executed without errors, the ENO enable output has the signal state "1" and the "TagOut" output is set.

**See also**

- Overview of the valid data types (Page 1077)
- Basics of the EN/ENO mechanism (Page 1167)

**ROR: Rotate right**

**Description**

You can use the "Rotate right" instruction to rotate the content of the operand at the input IN bit-by-bit to the right and query the result at the OUT output. The input N is used to specify the number of bit positions by which the specified value should be rotated. The bit positions freed by rotating on the left-hand side are filled true-to-position with the bit positions that are pushed out from the left-hand side.

If the value at the input N is "0", the value at input IN is copied unchanged to the operand at output OUT.

If the value at the parameter N is greater than the number of available bit positions, the operand value at input IN is nevertheless rotated by the specified number of bit positions.

The following figure shows how the content of an operand of the data type DWORD is rotated three bit positions to the right:

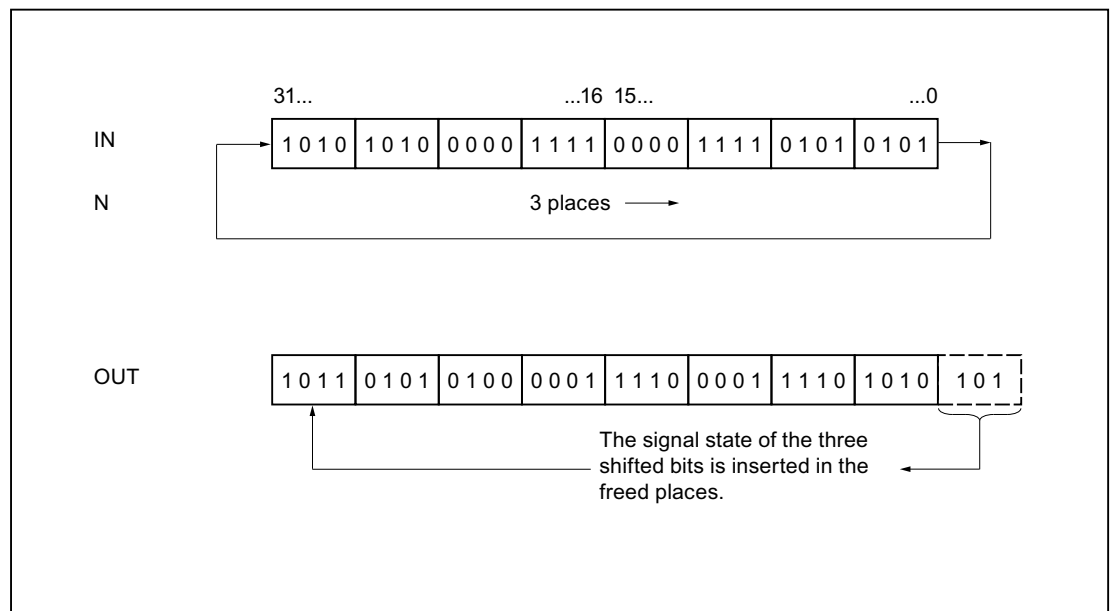

## Parameters

The following table shows the parameters of the instruction "Rotate right":

Parameter	Declaration	Data type		Memory area		Description
		S7-1200	S7-1500	S7-1200	S7-1500	
EN	Input	BOOL	BOOL	I, Q, M, D, L	I, Q, M, D, L, T, C	Enable input
ENO	Output	BOOL	BOOL	I, Q, M, D, L	I, Q, M, D, L	Enable output
IN	Input	Bit strings, integers	Bit strings, integers	I, Q, M, D, L or constant	I, Q, M, D, L or constant	Value to be rotated
N	Input	USINT, UINT, UDINT	USINT, UINT, UDINT, ULINT	I, Q, M, D, L or constant	I, Q, M, D, L or constant	Number of bit positions by which the value is rotated
OUT	Output	Bit strings, integers	Bit strings, integers	I, Q, M, D, L	I, Q, M, D, L	Result of the instruction

You can select the data type for the instruction from the "<???"> drop-down list of the instruction box.

For additional information on valid data types, refer to "See also".

**Example**

The following example shows how the instruction works:

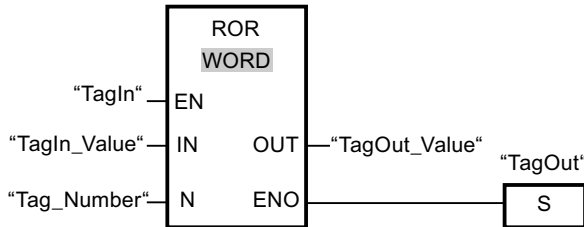

The following table shows how the instruction works using specific operand values:

Parameter	Operand	Value
IN	TagIn_Value	0000 1111 1001 0101
N	Tag_Number	5
OUT	TagOut_Value	1010 1000 0111 1100

If the operand "TagIn" has the signal state "1", the instruction "Rotate right" is executed. The content of the operand "TagIn\_Value" is rotated five bit positions to the right. The result is sent at output "TagOut\_Value". If the instruction is executed without errors, the ENO enable output has the signal state "1" and the "TagOut" output is set.

**See also**

- Overview of the valid data types (Page 1077)
- Basics of the EN/ENO mechanism (Page 1167)

**ROL: Rotate left**

**Description**

You can use the "Rotate left" instruction to rotate the content of the operand at the input IN bit-by-bit to the left and query the result at the OUT output. The input N is used to specify the number of bit positions by which the specified value should be rotated. The bit positions freed by rotating on the right-hand side are filled true-to-position with the bit positions that are pushed out from the left-hand side.

If the value at the input N is "0", the value at input IN is copied to the operand at output OUT.

If the value at the parameter N is greater than the number of available bit positions, the operand value at input IN is nevertheless rotated by the specified number of bit positions.

The following figure shows how the content of an operand of the data type DWORD is rotated three bit positions to the left:

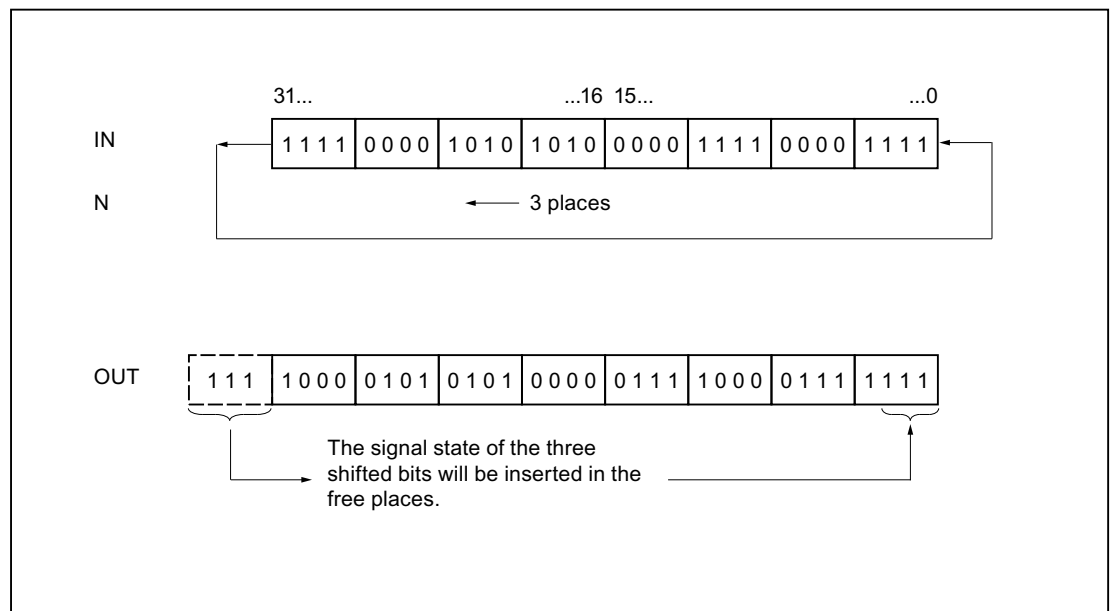

## Parameters

The following table shows the parameters of the instruction "Rotate left":

Parameter	Declaration	Data type		Memory area		Description
		S7-1200	S7-1500	S7-1200	S7-1500	
EN	Input	BOOL	BOOL	I, Q, M, D, L	I, Q, M, D, L, T, C	Enable input
ENO	Output	BOOL	BOOL	I, Q, M, D, L	I, Q, M, D, L	Enable output
IN	Input	Bit strings, integers	Bit strings, integers	I, Q, M, D, L or constant	I, Q, M, D, L or constant	Value to be rotated.
N	Input	USINT, UINT, UDINT	USINT, UINT, UDINT, ULINT	I, Q, M, D, L or constant	I, Q, M, D, L or constant	Number of bit positions by which the value is rotated.
OUT	Output	Bit strings, integers	Bit strings, integers	I, Q, M, D, L	I, Q, M, D, L	Result of the instruction

You can select the data type for the instruction from the "<???"> drop-down list of the instruction box.

For additional information on valid data types, refer to "See also".

**Example**

The following example shows how the instruction works:

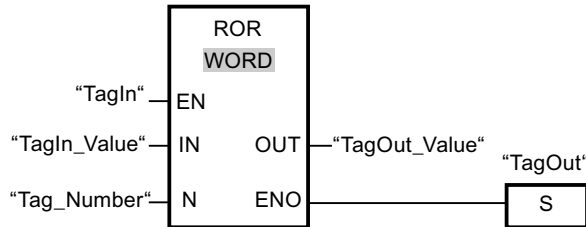

The following table shows how the instruction works using specific operand values:

Parameter	Operand	Value
IN	TagIn_Value	1010 1000 1111 0110
N	Tag_Number	5
OUT	TagOut_Value	0001 1110 1101 0101

If input "TagIn" has the signal state "1", the instruction "Rotate left" is executed. The content of the operand "TagIn\_Value" is rotated five bit positions to the left. The result is sent at output "TagOut\_Value". If the instruction is executed without errors, the ENO enable output has the signal state "1" and the "TagOut" output is set.

**See also**

- Overview of the valid data types (Page 1077)
- Basics of the EN/ENO mechanism (Page 1167)

**Additional instructions**

**DRUM: Implement sequencer**

**Description**

You can use the "Implement sequencer" instruction to assign the programmed values of the OUT\_VAL parameter of the corresponding step to the programmed output bits (OUT1 to OUT16) and the output word (OUT\_WORD). The specific step must thereby satisfy the conditions of the programmed enable mask on the S\_MASK parameter while the instruction remains at this step. The instruction advances to the next step if the event for the step is true and the programmed time for the current step elapses, or if the value at the JOG parameter changes from "0" to "1". The instruction is reset if the signal state on the RESET parameter changes to "1". The current step is hereby equated to the preset step (DSP).

The amount of time spent on a step is determined by the product of the preset timebase (DTBP) and the preset counter value (S\_PRESET) for each step. At the start of a new step, this calculated value is loaded into the DCC parameter, which contains the time remaining for the current step. If, for example the value at the DTBP parameter is "2" and the preset value for the first step is "100" (100 ms), the DCC parameter has the value "200" (200 ms).



A step can be programmed with a timer value, an event, or both. Steps that have an event bit and the timer value "0" advance to the next step as soon as the signal state of the event bit is "1". Steps that are programmed only with a timer value start the time immediately. Steps that are programmed with an event bit and a timer value greater than "0" start the time when the signal state of the event bit is "1". The event bits are initialized with a signal state of "1".

When the sequencer is on the last programmed step (LST\_STEP) and the time for this step has expired, the signal state on the Q parameter is set to "1"; otherwise it is set to "0". When the parameter Q is set, the instruction remains on the step until it is reset.

In the configurable mask (S\_MASK) you can select the separate bits in the output word (OUT\_WORD) and set or reset the output bits (OUT1 to OUT16) by means of the output values (OUT\_VAL). If a bit of the configurable mask is in the signal state "1", the value OUT\_VAL sets or resets the corresponding bit. If the signal state of a bit of the configurable mask is "0", the corresponding bit is left unchanged. All the bits of the configurable mask for all 16 steps are initialized with a signal state of "1".

The output bit on the OUT1 parameter corresponds to the least significant bit of the output word (OUT\_WORD). The output bit on the OUT16 parameter corresponds to the most significant bit of the output word (OUT\_WORD).

When you insert the instruction in the program, the "Call options" dialog opens in which you can specify whether the block parameters will be stored in a separate data block (single instance) or as a local tag (multiple instance) in the block interface. If you create a separate data block, you will find it in the project tree in the "Program resources" folder under "Program blocks > System blocks". For additional information on this topic, refer to "See also".

## Parameters

The following table shows the parameters of the "Implement sequencer" instruction:

Parameter	Declaration	Data type	Memory area	Description
EN	Input	BOOL	I, Q, M, D, L, T, C	Enable input
ENO	Output	BOOL	I, Q, M, D, L	Enable output
RESET	Input	BOOL	I, Q, M, D, L or constant	A signal state of "1" indicates a reset condition.
JOG	Input	BOOL	I, Q, M, D, L or constant	When the signal state changes from "0" to "1", the instruction advances to the next step.
DRUM_EN	Input	BOOL	I, Q, M, D, L or constant	A signal state of "1" allows the sequencer to advance based on the event and time criteria.
LST_STEP	Input	BYTE	I, Q, M, D, L or constant	Number of the last programmed step

Parameter	Declaration	Data type	Memory area	Description
EVENT(i), 1 ≤ i ≤ 16	Input	BOOL	I, Q, M, D, L or constant	Event bit (i); Initial signal state is "1".
OUT(j), 1 ≤ j ≤ 16	Output	BOOL	I, Q, M, D, L	Output bit (j)
Q	Output	BOOL	I, Q, M, D, L	A signal state of "1" indicates that the time for the last step has elapsed.
OUT_WORD	Output	WORD	I, Q, M, D, L, P	Word address to which the sequencer writes the output values.
ERR_CODE	Output	WORD	I, Q, M, D, L, P	Error information
JOG_HIS	Static	BOOL	I, Q, M, D, L	JOG parameter history bit
EOD	Static	BOOL	I, Q, M, D, L	A signal state of "1" indicates that the time for the last step has elapsed.
DSP	Static	BYTE	I, Q, M, D, L, P	Preset step of the sequencer
DSC	Static	BYTE	I, Q, M, D, L, P	Current step of the sequencer
DCC	Static	DWORD	I, Q, M, D, L, P	Current numerical value of the sequencer
DTBP	Static	WORD	I, Q, M, D, L, P	Preset timebase of the sequencer
PREV_TIME	Static	DWORD	I, Q, M, D, L or constant	Previous system time
S_PRESET	Static	ARRAY of WORD	I, Q, M, D, L	Count preset for each step [1 to 16]; whereby 1 count = 1 ms.
OUT_VAL	Static	ARRAY of BOOL	I, Q, M, D, L	Output values for each step [1 to 16, 0 to 15].
S_MASK	Static	ARRAY of BOOL	I, Q, M, D, L	Configurable mask for each step [1 to 16, 0 to 15]. Initial signal states are "1".

For additional information on valid data types, refer to "See also".

## Parameter ERR\_CODE

The following table shows the meaning of the values of the ERR\_CODE parameter:

ERR_CODE*	Explanation
W#16#0000	No error
W#16#000B	The value at the LST_STEP parameter is less than 1 or greater than 16.
W#16#000C	The value at the DSC parameter is less than 1 or greater than the value at the LST_STEP parameter.
W#16#000D	The value at the DSP parameter is less than 1 or greater than the value at the LST_STEP parameter.
*The error codes can be displayed as integer or hexadecimal value in the program editor. For additional information on toggling display formats, refer to "See also".	

## See also

Overview of the valid data types (Page 1077)

Basics of the EN/ENO mechanism (Page 1167)

## DCAT: Discrete control-timer alarm

### Description

The "Discrete control-timer alarm" instruction is used to accumulate the time from the point at which the CMD parameter issued the command to open or close. The time is accumulated until the preset time (PT) is exceeded or the information is received that the device was opened or closed (O\_FB or C\_FB) within the specified time. If the preset time is exceeded before the information on the opening or closing of the device is received, the corresponding alarm is activated. If the signal state on the command input changes state before the preset time, the time is restarted.

When you insert the instruction in the program, the "Call options" dialog opens in which you can specify whether the block parameters will be stored in a separate data block (single instance) or as a local tag (multiple instance) in the block interface. If you create a separate data block, you will find it in the project tree in the "Program resources" folder under "Program blocks > System blocks". For additional information on this topic, refer to "See also".

The "Discrete control-timer alarm" instruction has the following reactions to the input conditions:

- When the signal state of the CMD parameter changes from "0" to "1", the signal states of the parameters Q, CMD\_HIS, ET (only if ET is < PT) OA and CA are influenced as follows:
  - The parameters Q and CMD\_HIS are set to "1".
  - The parameters ET, OA and CA are reset to "0".
- When the signal state on the parameter CMD changes from "1" to "0", the parameters Q, ET (only if ET is < PT), OA, CA and CMD\_HIS are reset to "0".

- When the signal state of the CMD and CMD\_HIS parameters is "1" and the parameter O\_FB is set to "0", the time difference (ms) since the last execution of the instruction is added to the value at the parameter ET. If the value of the parameter ET exceeds the value of the parameter PT, the signal state on the parameter OA is set to "1". If the value of the parameter ET does not exceed the value of the parameter PT, the signal state on the parameter OA is reset to "0". The value at the parameter CMD\_HIS is reset to the value of the parameter CMD.
- If the signal state of the parameters CMD, CMD\_HIS and O\_FB are set to "1" and the parameter C\_FB has the value "0", the signal state of the parameter OA is set to "0". The value of the parameter ET is set to the value of the parameter PT. If the signal state of the parameter O\_FB changes to "0", the alarm is set the next time the instruction is executed. The value of the parameter CMD\_HIS is set to the value of the parameter CMD.
- If the CMD, CMD\_HIS and C\_FB parameters return signal state "0", the time difference (ms) since the last execution of the instruction is added to the value of the ET parameter. If the value of the parameter ET exceeds the value of the parameter PT, the signal state of the parameter CA is reset to "1". If the value at the parameter PT is not exceeded, the parameter CA has the signal state "0". The value of the parameter CMD\_HIS is set to the value of the parameter CMD.
- If the parameters CMD, CMD\_HIS and O\_FB have the signal state "0" and the parameter C\_FB is set to "1", the parameter CA is set to "0". The value of the parameter ET is set to the value of the parameter PT. If the signal state of the parameter C\_FB changes to "0", the alarm is set the next time the instruction is executed. The value of the parameter CMD\_HIS is set to the value of the parameter CMD.
- If the parameters O\_FB and C\_FB simultaneously have the signal state "1", the signal states of both alarm outputs are set to "1".

The "Discrete control-timer alarm" instruction has no error information.

## Parameters

The following table shows the parameters of the "Discrete control-timer alarm" instruction:

Parameter	Declaration	Data type	Memory area	Description
EN	Input	BOOL	I, Q, M, D, L, T, C	Enable input
ENO	Output	BOOL	I, Q, M, D, L	Enable output
CMD	Input	BOOL	I, Q, M, D, L or constant	A signal state of "0" indicates a "close" command. A signal state of "1" indicates an "open" command.
O_FB	Input	BOOL	I, Q, M, D, L or constant	Feedback input when opening
C_FB	Input	BOOL	I, Q, M, D, L or constant	Feedback input when closing

Parameter	Declaration	Data type	Memory area	Description
Q	Output	BOOL	I, Q, M, D, L	Shows the status of the parameter CMD
OA	Output	BOOL	I, Q, M, D, L	Alarm output when opening
CA	Output	BOOL	I, Q, M, D, L	Alarm output when closing
ET	Static	DINT	D, L	Currently elapsed time, where one count = 1 ms.
PT	Static	DINT	D, L	Preset timer value, where one count = 1 ms.
PREV_TIME	Static	DWORD	D, L	Previous system time
CMD_HIS	Static	BOOL	D, L	CMD history bit

For additional information on valid data types, refer to "See also".

### Example

In the following example the parameter CMD changes from "0" to "1". After the execution of the instruction the parameter Q is set to "1" and the two alarm outputs OA and CA have the signal state "0". The parameter CMD\_HIS of the instance data block is set to the signal state "1" and the parameter ET is reset to "0".

### Note

You can initialize static parameters in the data block.

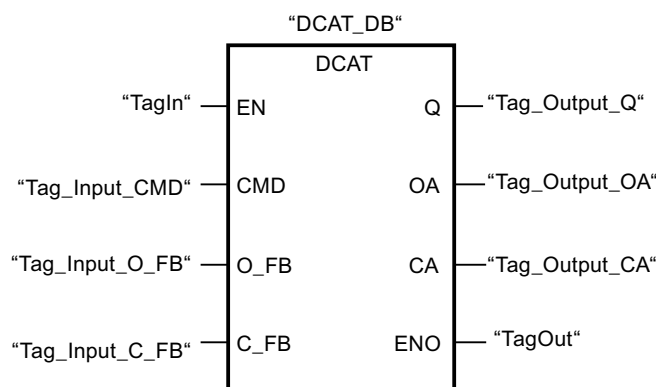

The following tables show how the instruction works using specific values.

### Before processing

In this example, the following values are used for the input and output parameters:

Parameter	Operand	Value
CMD	Tag_Input_CMD	TRUE
O_FB	Tag_Input_O_FB	FALSE
C_FB	Tag_Input_C_FB	FALSE
Q	Tag_Output_Q	FALSE
OA	Tag_Output_OA	FALSE
CA	Tag_Output_CA	FALSE

The following values are saved in the instance data block "DCAT\_DB" of the instruction:

Parameter	Address	Value
ET	DBD4	L#12
PT	DBD8	L#222
CMD_HIS	DBX16.0	FALSE

**After processing**

The following values are written to the output parameters after the instruction has been executed:

Parameter	Operand	Value
Q	Tag_Output_Q	TRUE
OA	Tag_Output_OA	FALSE
CA	Tag_Output_CA	FALSE

The following values are saved in the instance data block "DCAT\_DB" of the instruction:

Parameter	Address	Value
ET	DBD4	L#0
CMD_HIS	DBX16.0	TRUE

**See also**

Overview of the valid data types (Page 1077)

Basics of the EN/ENO mechanism (Page 1167)

**MCAT: Motor control-timer alarm**

**Description**

The instruction "Motor control-timer alarm" is used to accumulate the time from the point of time from which the one of the command inputs (opening or closing) is switched on. The time is accumulated until the preset time is exceeded or the relevant feedback input indicates that the device has executed the requested operation within the specified time. If the preset time is exceeded before the feedback is received, the corresponding alarm is triggered.

When you insert the instruction in the program, the "Call options" dialog opens in which you can specify whether the block parameters will be stored in a separate data block (single instance) or as a local tag (multiple instance) in the block interface. If you create a separate data block, you will find it in the project tree in the "Program resources" folder under "Program blocks > System blocks". For additional information on this topic, refer to "See also".

The "Motor control-timer alarm" instruction returns no error information.

### Execution of the "Motor control-timer alarm" instruction

The following table shows the reactions of the instruction "Motor control-timer alarm" to the various input conditions:

Input parameters								Output parameters								
ET	O_H IS	C_H IS	O_C MD	C_C MD	S_C MD	O_F B	C_F B	OO	CO	OA	CA	ET	O_H IS	C_H IS	Q	Status
X	1	1	X	X	X	X	X	0	0	1	1	PT	0	0	0	Alarm
X	X	X	X	X	X	1	1	0	0	1	1	PT	0	0	0	Alarm
X	X	X	X	X	1	X	X	0	0	0	0	X	0	0	1	Stop
X	X	X	1	1	X	X	X	0	0	0	0	X	0	0	1	Stop
X	0	X	1	0	0	X	X	1	0	0	0	0	1	0	1	Start opening
<PT	1	0	X	0	0	0	X	1	0	0	0	INC	1	0	1	Open
X	1	0	X	0	0	1	0	0	0	0	0	PT	1	0	1	Opened
>=PT	1	0	X	0	0	0	X	0	0	1	0	PT	1	0	0	Opening alarm
X	X	0	0	1	0	X	X	0	1	0	0	0	0	1	1	Start closing
<PT	0	1	0	X	0	X	0	0	1	0	0	INC	0	1	1	Close
X	0	1	0	X	0	0	1	0	0	0	0	PT	0	1	1	Closed
>=PT	0	1	0	X	0	X	0	0	0	0	1	PT	0	1	0	Closing alarm
X	0	0	0	0	0	X	X	0	0	0	0	X	0	0	1	Stopped

Legend:

INC Add the time difference (ms) since the last processing of the FB to ET

PT PT is set to the same value as ET

X Cannot be used

<PT ET < PT

>=PT ET >= PT

If the input parameters O\_HIS and C\_HIS both have the signal state "1", they are immediately set to signal state "0". In this case, the last row of the above-named table (X) is valid. Because it is therefore no longer possible to check whether the input parameters O\_HIS and C\_HIS have the signal state "1", the output parameters are set as follows in this case:

OO = FALSE

CO = FALSE

OA = FALSE

CA = FALSE

ET = PT

Q = TRUE

**Parameters**

The following table shows the parameters of the "Motor control-timer alarm" instruction:

Parameter	Declaration	Data type	Memory area	Description
EN	Input	BOOL	I, Q, M, D, L, T, C	Enable input
ENO	Output	BOOL	I, Q, M, D, L	Enable output
O_CMD	Input	BOOL	I, Q, M, D, L or constant	"Open" command input
C_CMD	Input	BOOL	I, Q, M, D, L or constant	"Close" command input
S_CMD	Input	BOOL	I, Q, M, D, L or constant	"Stop" command input
O_FB	Input	BOOL	I, Q, M, D, L or constant	Feedback input when opening
C_FB	Input	BOOL	I, Q, M, D, L or constant	Feedback input when closing
OO	Output	BOOL	I, Q, M, D, L	"Open" output
CO	Output	BOOL	I, Q, M, D, L	"Close" output
OA	Output	BOOL	I, Q, M, D, L	Alarm output when opening
CA	Output	BOOL	I, Q, M, D, L	Alarm output when closing
Q	Output	BOOL	I, Q, M, D, L	A signal state of "0" indicates an error condition.
ET	Static	DINT	D, L	Currently elapsed time, where one count = 1 ms
PT	Static	DINT	D, L	Preset timer value, where one count = 1 ms
PREV_TIME	Static	DWORD	D, L	Previous system time
O_HIS	Static	BOOL	D, L	"Open" history bit
C_HIS	Static	BOOL	D, L	"Close" history bit

For additional information on valid data types, refer to "See also".

**Example**

The following example shows how the instruction works:

**Note**

You can initialize static parameters in the data block.



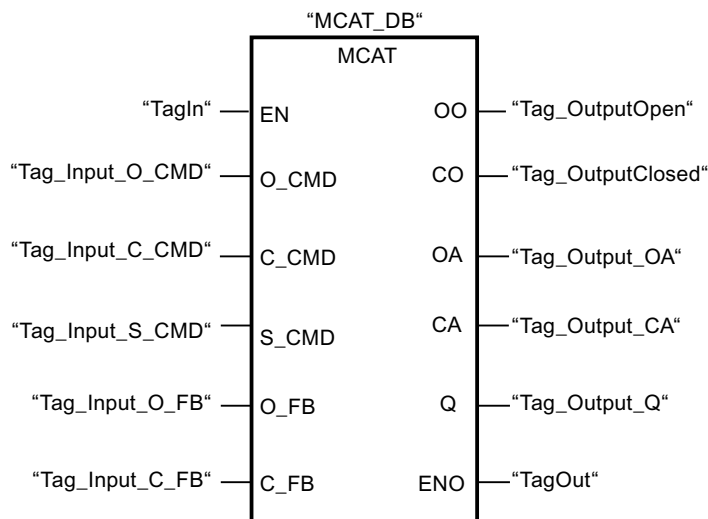

The following tables show how the instruction works using specific values.

#### Before processing

In this example, the following values are used for the input and output parameters:

Parameter	Operand	Value
O_CMD	Tag_Input_O_CMD	TRUE
C_CMD	Tag_Input_C_CMD	FALSE
S_CMD	Tag_Input_S_CMD	FALSE
O_FB	Tag_Input_O_FB	FALSE
C_FB	Tag_Input_C_FB	FALSE
OO	Tag_OutputOpen	FALSE
CO	Tag_OutputClosed	FALSE
OA	Tag_Output_OA	FALSE
CA	Tag_Output_CA	FALSE
Q	Tag_Output_Q	FALSE

The following values are saved in the instance data block "MCAT\_DB" of the instruction:

Parameter	Address	Value
ET	DBD4	L#2
PT	DBD8	L#22
O_HIS	DBX16.0	TRUE
C_HIS	DBX16.1	FALSE

#### After processing

The following values are written to the output parameters after the instruction has been executed:

Parameter	Operand	Value
OO	Tag_OutputOpen	TRUE
CO	Tag_OutputClosed	FALSE
OA	Tag_Output_OA	FALSE
CA	Tag_Output_CA	FALSE
Q	Tag_Output_Q	TRUE

The following values are saved in the instance data block "MCAT\_DB" of the instruction:

Parameter	Address	Value
ET	DBD4	L#0
O_HIS	DBX16.0	TRUE
CMD_HIS	DBX16.1	FALSE

**See also**

- Overview of the valid data types (Page 1077)
- Basics of the EN/ENO mechanism (Page 1167)

**IMC: Compare input bits with the bits of a mask**

**Description**

The instruction "Compare input bits with the bits of a mask" is used to compare the signal state of up to 16 programmed input bits (IN\_BIT0 to IN\_BIT15) with the corresponding bits of a mask. Up to 16 steps with masks can be programmed. The value of the IN\_BIT0 parameter is compared with the value of the mask CMP\_VAL[x,0], with "x" indicating the step number. At the CMP\_STEP parameter, specify the step number of the mask that is used for the comparison. All programmed values are compared in the same manner. Unprogrammed input bits or unprogrammed bits of the mask have a default signal state of FALSE.

If a match is found in the comparison, the signal state of the OUT parameter is set to "1". Otherwise the OUT parameter is set to "0".

If the value of CMP\_STEP parameter is greater than 15, the instruction is not executed. An error message is output at the ERR\_CODE parameter.

When you insert the instruction in the program, the "Call options" dialog opens in which you can specify whether the block parameters will be stored in a separate data block (single instance) or as a local tag (multiple instance) in the block interface. If you create a separate data block, you will find it in the project tree in the "Program resources" folder under "Program blocks > System blocks". For additional information on this topic, refer to "See also".

## Parameters

The following table shows the parameters of the "Compare input bits with the bits of a mask" instruction:

Parameter	Declaration	Data type	Memory area	Description
EN	Input	BOOL	I, Q, M, D, L, T, C	Enable input
ENO	Output	BOOL	I, Q, M, D, L	Enable output
IN_BIT0	Input	BOOL	I, Q, M, D, L or constant	Input bit 0 to be compared with bit 0 of the mask.
IN_BIT1	Input	BOOL	I, Q, M, D, L or constant	Input bit 1 to be compared with bit 1 of the mask.
IN_BIT2	Input	BOOL	I, Q, M, D, L or constant	Input bit 2 to be compared with bit 2 of the mask.
IN_BIT3	Input	BOOL	I, Q, M, D, L or constant	Input bit 3 to be compared with bit 3 of the mask.
IN_BIT4	Input	BOOL	I, Q, M, D, L or constant	Input bit 4 to be compared with bit 4 of the mask.
IN_BIT5	Input	BOOL	I, Q, M, D, L or constant	Input bit 5 to be compared with bit 5 of the mask.
IN_BIT6	Input	BOOL	I, Q, M, D, L or constant	Input bit 6 to be compared with bit 6 of the mask.
IN_BIT7	Input	BOOL	I, Q, M, D, L or constant	Input bit 7 to be compared with bit 7 of the mask.
IN_BIT8	Input	BOOL	I, Q, M, D, L or constant	Input bit 8 to be compared with bit 8 of the mask.
IN_BIT9	Input	BOOL	I, Q, M, D, L or constant	Input bit 9 to be compared with bit 9 of the mask.
IN_BIT10	Input	BOOL	I, Q, M, D, L or constant	Input bit 10 to be compared with bit 10 of the mask.
IN_BIT11	Input	BOOL	I, Q, M, D, L or constant	Input bit 11 to be compared with bit 11 of the mask.
IN_BIT12	Input	BOOL	I, Q, M, D, L or constant	Input bit 12 to be compared with bit 12 of the mask.
IN_BIT13	Input	BOOL	I, Q, M, D, L or constant	Input bit 13 to be compared with bit 13 of the mask.
IN_BIT14	Input	BOOL	I, Q, M, D, L or constant	Input bit 14 to be compared with bit 14 of the mask.
IN_BIT15	Input	BOOL	I, Q, M, D, L or constant	Input bit 15 to be compared with bit 15 of the mask.
CMP_STEP	Input	BYTE	I, Q, M, D, L, P or constant	The step number of the mask used for the comparison.
OUT	Output	BOOL	I, Q, M, D, L	A signal state of "1" indicates that a match was found. A signal state of "0" indicates that no match was found.

Parameter	Declaration	Data type	Memory area	Description
ERR_CODE	Output	WORD	I, Q, M, D, L, P	Error information
CMP_VAL	Static	ARRAY OF WORD	I, Q, M, D, L	Comparison masks [0 to 15, 0 to 15]: The first number of the index is the step number and the second number is the bit number of the mask.

For additional information on valid data types, refer to "See also".

### Parameters ERR\_CODE

The following table shows the meaning of the values of the ERR\_CODE parameter:

Error code* (W#16#...)	Explanation
0000	No error
000A	The value at the CMP_STEP parameter is greater than 15.

\*The error codes can be displayed as integer or hexadecimal value in the program editor. For additional information on toggling display formats, refer to "See also".

### See also

- Overview of the valid data types (Page 1077)
- Basics of the EN/ENO mechanism (Page 1167)

### SMC: Compare scan matrix

#### Description

The instruction "Compare scan matrix" is used to compare the signal state of up to 16 programmed input bits (IN\_BIT0 to IN\_BIT15) with the corresponding bits of the comparison masks for each step. Processing starts at step 1 and is continued until the last programmed step (LAST), or until a match is found. The input bit of the IN\_BIT0 parameter is compared with the value of the mask CMP\_VAL[x,0], with "x" indicating the step number. All programmed values are compared in the same manner. If a match is found, the signal state of the OUT parameter is set to "1" and the step number with the matching mask is written to the OUT\_STEP parameter. Unprogrammed input bits or unprogrammed bits of the mask have the default signal state FALSE. If more than one step has a matching mask, only the first one found is indicated in the OUT\_STEP parameter. If no match is found, the signal state of the OUT parameter is set to "0". In this case the value at the OUT\_STEP parameter is greater by "1" than the value at the LAST parameter.

When you insert the instruction in the program, the "Call options" dialog opens in which you can specify whether the block parameters will be stored in a separate data block (single instance) or as a local tag (multiple instance) in the block interface. If you create a separate data block, you will find it in the project tree in the "Program resources" folder under "Program blocks > System blocks". For additional information on this topic, refer to "See also".

## Parameters

The following table shows the parameters of the "Compare scan matrix" instruction:

Parameter	Declaration	Data type	Memory area	Description
EN	Input	BOOL	I, Q, M, D, L, T, C	Enable input
ENO	Output	BOOL	I, Q, M, D, L	Enable output
IN_BIT0	Input	BOOL	I, Q, M, D, L or constant	Input bit 0 to be compared with bit 0 of the mask.
IN_BIT1	Input	BOOL	I, Q, M, D, L or constant	Input bit 1 to be compared with bit 1 of the mask.
IN_BIT2	Input	BOOL	I, Q, M, D, L or constant	Input bit 2 to be compared with bit 2 of the mask.
IN_BIT3	Input	BOOL	I, Q, M, D, L or constant	Input bit 3 to be compared with bit 3 of the mask.
IN_BIT4	Input	BOOL	I, Q, M, D, L or constant	Input bit 4 to be compared with bit 4 of the mask.
IN_BIT5	Input	BOOL	I, Q, M, D, L or constant	Input bit 5 to be compared with bit 5 of the mask.
IN_BIT6	Input	BOOL	I, Q, M, D, L or constant	Input bit 6 to be compared with bit 6 of the mask.
IN_BIT7	Input	BOOL	I, Q, M, D, L or constant	Input bit 7 to be compared with bit 7 of the mask.
IN_BIT8	Input	BOOL	I, Q, M, D, L or constant	Input bit 8 to be compared with bit 8 of the mask.
IN_BIT9	Input	BOOL	I, Q, M, D, L or constant	Input bit 9 to be compared with bit 9 of the mask.
IN_BIT10	Input	BOOL	I, Q, M, D, L or constant	Input bit 10 to be compared with bit 10 of the mask.
IN_BIT11	Input	BOOL	I, Q, M, D, L or constant	Input bit 11 to be compared with bit 11 of the mask.
IN_BIT12	Input	BOOL	I, Q, M, D, L or constant	Input bit 12 to be compared with bit 12 of the mask.
IN_BIT13	Input	BOOL	I, Q, M, D, L or constant	Input bit 13 to be compared with bit 13 of the mask.
IN_BIT14	Input	BOOL	I, Q, M, D, L or constant	Input bit 14 to be compared with bit 14 of the mask.
IN_BIT15	Input	BOOL	I, Q, M, D, L or constant	Input bit 15 to be compared with bit 15 of the mask.
OUT	Output	BOOL	I, Q, M, D, L	A signal state of "1" indicates that a match was found. A signal state of "0" indicates that no match was found.
ERR_CODE	Output	WORD	I, Q, M, D, L, P	Error information

Parameter	Declaration	Data type	Memory area	Description
OUT_STEP	Output	BYTE	I, Q, M, D, L, P	Contains the step number with the matching mask, or the step number which is greater by "1" than the value at the LAST parameter, provided no match is found.
LAST	Static	BYTE	I, Q, M, D, L, P	Specifies the step number of the last step to be scanned for a matching mask.
CMP_VAL	Static	ARRAY OF WORD	I, Q, M, D, L	Comparison masks [0 to 15, 0 to 15]: The first number of the index is the step number and the second number is the bit number of the mask.

For additional information on valid data types, refer to "See also".

### Parameters ERR\_CODE

The following table shows the meaning of the values of the ERR\_CODE parameter:

Error code* (W#16#...)	Explanation
0000	No error
000E	The value at the LAST parameter is greater than 15.

\*The error codes can be displayed as integer or hexadecimal value in the program editor. For additional information on toggling display formats, refer to "See also".

### See also

- Overview of the valid data types (Page 1077)
- Basics of the EN/ENO mechanism (Page 1167)

### LEAD\_LAG: Lead and lag algorithm

#### Description

The "Lead and lag algorithm" instruction is used to process signals with an analog tag. The gain value at the GAIN parameter must be greater than zero. The result of the instruction "Lead and lag algorithm" is calculated using the following equation:

$$OUT = \left[ \frac{LG\_TIME}{LG\_TIME + SAMPLE\_T} \right] PREV\_OUT + GAIN \left[ \frac{LD\_TIME + SAMPLE\_T}{LG\_TIME + SAMPLE\_T} \right] IN - GAIN \left[ \frac{LD\_TIME}{LG\_TIME + SAMPLE\_T} \right] * PREV\_IN$$

The "Lead and lag algorithm" instruction supplies plausible results only when processing is in fixed program cycles. The same units must be specified for the LD\_TIME, LG\_TIME, and SAMPLE\_T parameters. At  $LG\_TIME > 4 + SAMPLE\_T$ , the instruction approaches the following function:

$$OUT = GAIN * ((1 + LD\_TIME * s) / (1 + LG\_TIME * s)) * IN$$

When the value of the GAIN parameter is less than or equal to zero, the calculation is not performed and an error information is output on the ERR\_CODE parameter.

You can use the "Lead and lag algorithm" instruction in conjunction with loops as a compensator in dynamic feed-forward control. The instruction consists of two operations. The "Lead" operation shifts the phase of the OUT output so that the output leads the input. The "Lag" operation, on the other hand, shifts the output so that the output lags behind the input. Because the "Lag" operation is equivalent to an integration, it can be used as a noise suppressor or as a low-pass filter. The "Lead" operation is equivalent to a differentiation and can therefore be used as a high-pass filter. The two instructions together (Lead and Lag) result in the output phase lagging behind the the input at lower frequencies and leading it at higher frequencies. This means that the "Lead and lag algorithm" instruction can be used as a band pass filter.

When you insert the instruction in the program, the "Call options" dialog opens in which you can specify whether the block parameters will be stored in a separate data block (single instance) or as a local tag (multiple instance) in the block interface. If you create a separate data block, you will find this in the project tree in the "Program resources" folder under "Program blocks > System blocks". For additional information on this topic, refer to "See also".

## Parameters

The following table shows the parameters of the "Lead and lag algorithm" instruction:

Parameter	Declaration	Data type	Memory area	Description
EN	Input	BOOL	I, Q, M, D, L, T, C	Enable input
ENO	Output	BOOL	I, Q, M, D, L	Enable output
IN	Input	REAL	I, Q, M, D, L, P or constant	The input value of the current sample time (cycle time) to be processed.
SAMPLE_T	Input	INT	I, Q, M, D, L, P or constant	Sample time
OUT	Output	REAL	I, Q, M, D, L, P	Result of the instruction
ERR_CODE	Output	WORD	I, Q, M, D, L, P	Error information
LD_TIME	Static	REAL	I, Q, M, D, L, P or constant	Lead time in the same unit as sample time.
LG_TIME	Static	REAL	I, Q, M, D, L, P or constant	Lag time in the same unit as sample time

Parameter	Declaration	Data type	Memory area	Description
GAIN	Static	REAL	I, Q, M, D, L, P or constant	Gain as % / % (the ratio of the change in output to a change in input as a steady state).
PREV_IN	Static	REAL	I, Q, M, D, L, P or constant	Previous input
PREV_OUT	Static	REAL	I, Q, M, D, L, P or constant	Previous output

For additional information on valid data types, refer to "See also".

### Parameters ERR\_CODE

The following table shows the meaning of the values of the ERR\_CODE parameter:

Error code* (W#16#...)	Explanation
0000	No error
0009	The value at the GAIN parameter is less than or equal to zero.

\*The error codes can be displayed as integer or hexadecimal value in the program editor. For additional information on toggling display formats, refer to "See also".

### Example

The following example shows how the instruction works:

#### Note

You can initialize static parameters in the data block.

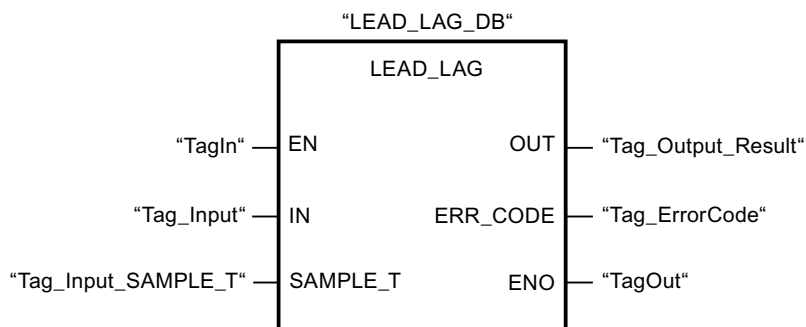

The following table shows how the instruction works using specific operand values:

#### Before processing

In this example the following values are used for the input parameters:



Parameters	Operand	Value
IN	Tag_Input	2.0
SAMPLE_T	Tag_InputSampleTime	10

The following values are saved in the instance data block "LEAD\_LAG\_DB" of the instruction:

Parameters	Address	Value
LD_TIME	DBD12	2.0
LG_TIME	DBD16	2.0
GAIN	DBD20	1.0
PREV_IN	DBD24	6.0
PREV_OUT	DBD28	6.0

#### After processing

The following values are written to the output parameters after the instruction has been executed:

Parameters	Operand	Value
OUT	Tag_Output_Result	2.0

The following values are saved in the instance data block "LEAD\_LAD\_DB" of the instruction:

Parameters	Operand	Value
PREV_IN	DBD24	2.0
PREV_OUT	DBD28	2.0

#### See also

Overview of the valid data types (Page 1077)

Basics of the EN/ENO mechanism (Page 1167)

### SEG: Create bit pattern for seven-segment display

#### Description

The instruction "Create bit pattern for seven-segment display" is used to convert each of the four hexadecimal digits of the specified source word (IN) into an equivalent bit pattern for a seven-segment display. The result of the instruction is output in the double word on the OUT parameter.

The following relation exists between the hexadecimal digits and the assignment of the 7 segments (a, b, c, d, e, f, g):

Input digit (Binary)	Assignment of the segments - g f e d c b a	Display (Hexadecimal)	Seven-segment display
0000	00111111	0	
0001	00000110	1	
0010	01011011	2	
0011	01001111	3	
0100	01100110	4	
0101	01101101	5	
0110	01111101	6	
0111	00000111	7	
1000	01111111	8	
1001	01100111	9	
1010	01110111	A	
1011	01111100	B	
1100	00111001	C	
1101	01011110	D	
1110	01111001	E	
1111	01110001	F	

Parameters

The following table shows the parameters of the "Create bit pattern for seven-segment display" instruction:

Parameter	Declaration	Data type	Memory area	Description
EN	Input	BOOL	I, Q, M, D, L, T, C	Enable input
ENO	Output	BOOL	I, Q, M, D, L	Enable output
IN	Input	WORD	I, Q, M, D, L, P or constant	Source word with four hexadecimal digits
OUT	Output	DWORD	I, Q, M, D, L, P	Bit pattern for the seven-segment display

Example

The following example shows how the instruction works:

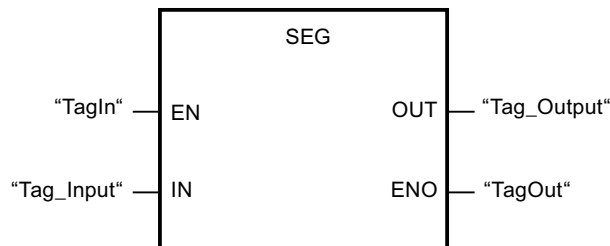

The following table shows how the instruction functions using specific values:

Parameters	Operand	Value	
Hexadecimal	Binary		
IN	Tag_Input	W#16#1234	0001 0010 0011 0100
OUT	Tag_Output	DW#16065B4F66	00000110 01011011 01001111 01100110 Display: 1234

### See also

Overview of the valid data types (Page 1077)

Basics of the EN/ENO mechanism (Page 1167)

### BCDCPL: Create tens complement

#### Description

You use the "Create tens complement" instruction to create the tens complement of a seven-digit BCD number specified in the IN parameter. This instruction uses the following mathematical formula to calculate:

10000000 (as BCD)

– 7-digit BCD value

-----  
Tens complement (as BCD)

#### Parameters

The following table shows the parameters of the "Create tens complement" instruction:

Parameter	Declaration	Data type	Memory area	Description
EN	Input	BOOL	I, Q, M, D, L, T, C	Enable input
ENO	Output	BOOL	I, Q, M, D, L	Enable output
IN	Input	DWORD	I, Q, M, D, L, P or constant	7-digit BCD number
ERR_CODE	Output	DWORD	I, Q, M, D, L, P	Result of the instruction

**Example**

The following example shows how the instruction works:

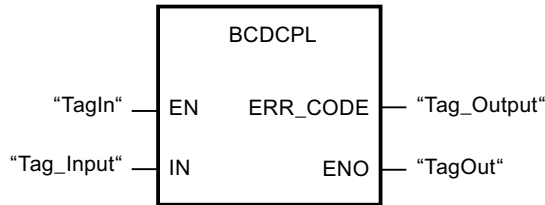

The following table shows how the instruction functions using specific values:

Parameter	Operand	Value*
IN	Tag_Input	DW#16#01234567
ERR_CODE	Tag_Output	DW#16#08765433

\*The error codes can be displayed as integer or hexadecimal value in the program editor. For additional information on toggling display formats, refer to "See also".

**See also**

- Overview of the valid data types (Page 1077)
- Basics of the EN/ENO mechanism (Page 1167)

**BITSUM: Count number of set bits**

**Description**

The "Count number of set bits" instruction is used to count the number of bits of an operand that is set to the signal state "1". The operand whose bits are to be counted is specified on the IN parameter. The result of the instruction is output at the RET\_VAL parameter.

**Parameters**

The following table shows the parameters of the "Count number of set bits" instruction:

Parameter	Declaration	Data type	Memory area	Description
EN	Input	BOOL	I, Q, M, D, L, T, C	Enable input
ENO	Output	BOOL	I, Q, M, D, L	Enable output
IN	Input	DWORD	I, Q, M, D, L, P or constant	Operand whose set bits are counted.
RET_VAL	Output	INT	I, Q, M, D, L, P	Number of bits to be set

## Example

The following example shows how the instruction works:

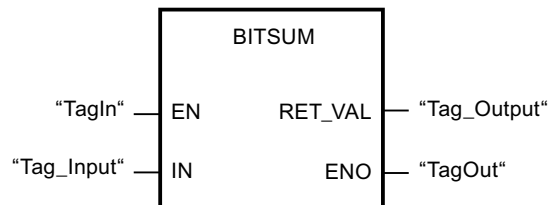

The following table shows how the instruction functions using specific values:

Parameter	Operand	Value*
IN	Tag_Input	DW#16#12345678
RET_VAL	Tag_Output	W#16#000D (13 Bits)
*The error codes can be displayed as integer or hexadecimal value in the program editor. For additional information on toggling display formats, refer to "See also".		

## See also

Overview of the valid data types (Page 1077)

Basics of the EN/ENO mechanism (Page 1167)

### 9.7.2.3 SCL

#### Bit logic operations

#### R\_TRIG: Set tag on positive signal edge

#### Description

You can use the "Set tag on positive signal edge" instruction to set a specified tag in the instance DB when there is a "0" to "1" change in the result of logic operation (RLO). The instruction compares the current RLO at the input CLK with the RLO from the previous query, which is saved in the specified instance DB. If the instruction detects a change in the result of logic operation (RLO) from "0" to "1", there is a positive, rising edge.

If a positive edge is detected, the tag in the instance DB is set to signal state "1" and the output Q returns the signal state "1" In all other cases, the signal state at the output of the instruction is "0".

When you insert the instruction in the program, the "Call options" dialog opens automatically. In this dialog you can specify whether the edge memory bit is stored in its own data block (single instance) or as a local tag (multiple instance) in the block interface. If you create a separate data block, you will find it in the project tree in the "Program resources" folder under "Program blocks > System blocks". For additional information on this topic, refer to "See also".

**Syntax**

Use the following syntax for the "Set tag on positive signal edge" instruction:

```
SCL
<Instance_DB>(CLK := <Operand>,
              Q => <Operand>)
```

**Parameter**

The following table shows the parameters of the instruction "Set tag on positive signal edge":

Parameter	Declaration	Data type	Description
CLK	Input	BOOL	Incoming signal, the edge of which is to be queried
Q	Output	BOOL	Result of edge evaluation

**Example**

The following example shows how the instruction works:

```
SCL
"R_TRIG_DB"(CLK := "TagIn",
            Q => "TagOut");
```

The RLO of the preceding query is saved in the instance DB "R\_TRIG\_DB". If a change in the signal state of the RLO from "0" to "1" is detected in the operand "TagIn", the output "TagOut" has signal state "1".

**See also**

- Overview of the valid data types (Page 1077)
- Expressions (Page 1341)
- Operators and operator precedence (Page 1347)
- Entering SCL instructions (Page 1357)
- Editing SCL instructions (Page 1374)

**F\_TRIG: Set tag on negative signal edge**

**Description**

You can use the "Set tag on negative signal edge" instruction to set a specified tag in the instance DB when there is a "1" to "0" change in the result of logic operation (RLO). The instruction compares the current RLO at the input CLK with the RLO from the previous query,

which is saved in the specified instance DB. If the instruction detects a change in the result of logic operation (RLO) from "1" to "0", there is a negative, falling edge.

If a negative edge is detected, the tag in the instance DB is set to signal state "1" and the output Q returns the signal state "1". In all other cases, the signal state at the output of the instruction is "0".

When you insert the instruction in the program, the "Call options" dialog opens automatically. In this dialog you can specify whether the edge memory bit is stored in its own data block (single instance) or as a local tag (multiple instance) in the block interface. If you create a separate data block, you will find it in the project tree in the "Program resources" folder under "Program blocks > System blocks". For additional information on this topic, refer to "See also".

## Syntax

Use the following syntax for the "Set tag on negative signal edge" instruction:

```
SCL
<Instance_DB>(CLK := <Operand>,
               Q => <Operand>)
```

## Parameter

The following table shows the parameters of the instruction "Set tag on negative signal edge":

Parameter	Declaration	Data type	Description
CLK	Input	BOOL	Incoming signal, the edge of which is to be queried
Q	Output	BOOL	Result of edge evaluation

## Example

The following example shows how the instruction works:

```
SCL
"F_TRIG_DB"(CLK := "TagIn",
             Q => "TagOut");
```

The RLO of the preceding query is saved in the instance DB "F\_TRIG\_DB". If a change in the signal state of the RLO from "1" to "0" is detected in the operand "TagIn", the output "TagOut" has signal state "1".

## See also

- Overview of the valid data types (Page 1077)
- Expressions (Page 1341)
- Operators and operator precedence (Page 1347)
- Entering SCL instructions (Page 1357)
- Editing SCL instructions (Page 1374)

## Timer operations

### IEC Timers

#### TP: Generate pulse

#### Description

You can use the "Generate pulse" instruction to set the Q parameter for the duration PT. The instruction starts when the result of logic operation (RLO) of the IN parameter changes from "0" to "1" (positive signal edge). The programmed time PT begins when the instruction starts. The Q parameter is set for the time PT, regardless of the subsequent changes in the input signal. Even when a new positive signal edge is detected, the signal state of the Q parameter is not affected as long as the time duration PT is active.

The current time value can be queried in the ET parameter. The time value starts at T#0s and ends when the value of the time duration PT is reached. When the time duration PT is reached and the signal state at the IN parameter is "0", the ET parameter is reset.

---

#### Note

If the timer is not called in the program because it is skipped, for example, output ET returns a constant value as soon as the timer has expired.

---

Each call of the "Generate pulse" instruction must be assigned to an IEC timer in which the instruction data is stored.

#### For S7-1200 CPU

An IEC Timer is a structure of the data type IEC\_TIMER or TP\_TIME that you can declare as follows:

- Declaration of a data block of system data type IEC\_TIMER (for example, "MyIEC\_TIMER")
- Declaration as a local tag of the TP\_TIME type in the "Static" section of a block (for example, #MyTP\_TIMER)



## For S7-1500 CPU

An IEC timer is a structure of the data type IEC\_TIMER, IEC\_LTIMER, TP\_TIME or TP\_LTIME that you can declare as follows:

- Declaration of a data block of system data type IEC\_TIMER or IEC\_LTIMER (for example, "MyIEC\_TIMER")
- Declaration as a local tag of the type TP\_TIME or TP\_LTIME in the "Static" section of a block (for example #MyTP\_TIMER)

When you insert the instruction in the program, the "Call options" dialog opens in which you can specify whether the IEC timer is stored in its own data block (single instance) or as a local tag (multiple instance) in the block interface. If you create a separate data block, you will find it in the project tree in the "Program resources" folder under "Program blocks > System blocks". For additional information on this topic, refer to "See also".

The instruction data is updated both when an instruction is called and also at each access to the Q or ET outputs.

## Syntax

Use the following syntax for the "Generate pulse" instruction:

- Data block of system data type IEC\_Timer (global DB):

### SCL

```
<IEC_Timer_DB> TP(IN := <Operand>,
                 PT := <Operand>,
                 Q => <Operand>,
                 ET => <Operand>)
```

- Local tag:

### SCL

```
#myLocal_timer(IN := <Operand>,
               PT := <Operand>,
               Q => <Operand>,
               ET => <Operand>)
```

The syntax of the instruction consists of the following parts:

Parameter	Declaration	Data type		Description
		S7-1200	S7-1500	
IN	Input	BOOL	BOOL	Start input
PT	Input	TIME	TIME, LTIME	Duration of the pulse. The value of the PT parameter must be positive.

Parameter	Declaration	Data type		Description
		S7-1200	S7-1500	
Q	Output	BOOL	BOOL	Operand that is set for the PT duration.
ET	Output	TIME	TIME, LTIME	Current time value

For additional information on valid data types, refer to "See also".

### Pulse timing diagram

The following figure shows the pulse timing diagram of the "Generate pulse" instruction:

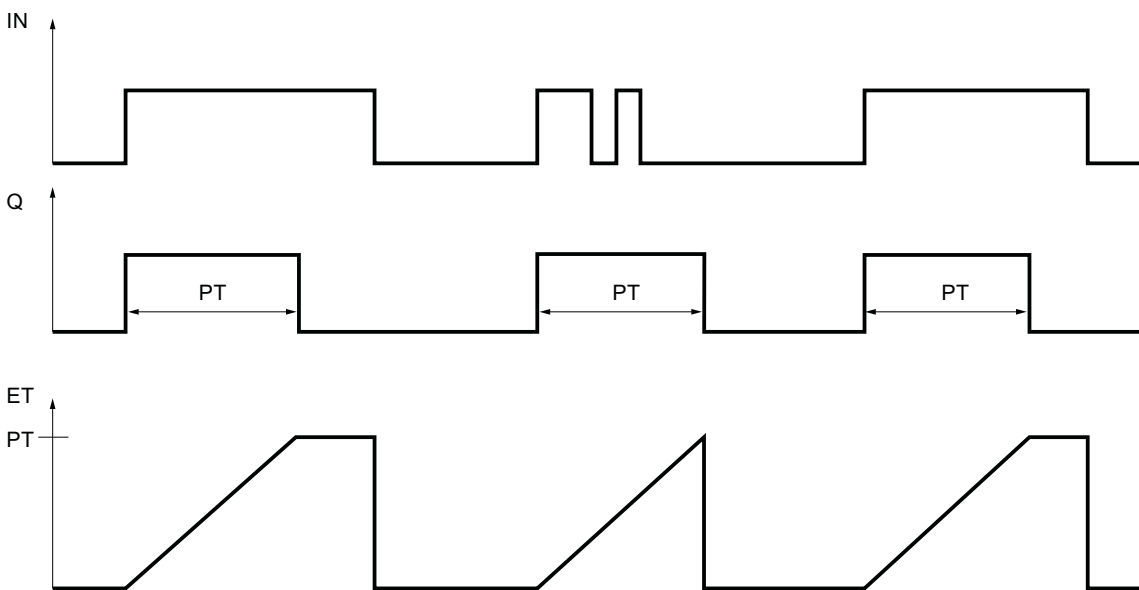

### Example

The following example shows how the instruction works:

```

SCI
"TP_DB".TP(IN := "Tag_Start",
           PT := "Tag_PresetTime",
           Q => "Tag_Status",
           ET => "Tag_ElapsedTime");
    
```

When the signal state of the "Tag\_Start" operand changes from "0" to "1", the time period programmed for the PT parameter is started and the "Tag\_Status" operand is set to "1". The current time value is stored in the "Tag\_ElapsedTime" operand.

## See also

Overview of the valid data types (Page 1077)

Entering SCL instructions (Page 1357)

Editing SCL instructions (Page 1374)

## TON: Generate on-delay

### Description

You can use the "Generate on-delay" instruction to delay the setting of the Q parameter for the programmed duration PT. The instruction starts when the result of logic operation (RLO) of the IN parameter changes from "0" to "1" (positive signal edge). The programmed time PT begins when the instruction starts. When the duration PT has expired, the Q parameter returns signal state "1". The Q parameter remains set as long as the start input is still "1". If the signal state of the IN parameter changes from "1" to "0", the parameter Q will be reset. The timer function is restarted when a new positive signal edge is detected at the IN parameter.

The current time value can be queried in the ET parameter. The time value starts at T#0s and ends when the value of the time duration PT is reached. The ET parameter is reset as soon as the signal state of the IN parameter changes to "0".

---

#### Note

If the timer is not called in the program because it is skipped, for example, output ET returns a constant value as soon as the timer has expired.

---

Each call of the "Generate on-delay" instruction must be assigned to an IEC timer in which the instruction data is stored.

### For S7-1200 CPU

An IEC Timer is a structure of the data type IEC\_TIMER or TON\_TIME that you can declare as follows:

- Declaration of a data block of system data type IEC\_TIMER (for example, "MyIEC\_TIMER")
- Declaration as a local tag of the TON\_TIME type in the "Static" section of a block (for example, #MyTON\_TIMER)

### For S7-1500 CPU

An IEC timer is a structure of the data type IEC\_TIMER, IEC\_LTIMER, TON\_TIME or TON\_LTIME that you can declare as follows:

- Declaration of a data block of system data type IEC\_TIMER or IEC\_LTIMER (for example, "MyIEC\_TIMER")
- Declaration as a local tag of the type TON\_TIME or TON\_LTIME in the "Static" section of a block (for example #MyTON\_TIMER)

When you insert the instruction in the program, the "Call options" dialog opens in which you can specify whether the IEC timer is stored in its own data block (single instance) or as a local tag (multiple instance) in the block interface. If you create a separate data block, you will find it in the project tree in the "Program resources" folder under "Program blocks > System blocks". For additional information on this topic, refer to "See also".

The instruction data is updated both when an instruction is called and also at each access to the Q or ET outputs.

### Syntax

Use the following syntax for the "Generate on-delay" instruction:

- Data block of system data type IEC\_Timer (global DB):

**SCL**

```
<IEC_Timer_DB> TON(IN := <Operand>,
                 PT := <Operand>,
                 Q => <Operand>,
                 ET => <Operand>)
```

- Local tag:

**SCL**

```
#myLocal_timer(IN := <Operand>,
               PT := <Operand>,
               Q => <Operand>,
               ET => <Operand>)
```

The syntax of the instruction consists of the following parts:

Parameter	Declaration	Data type		Description
		S7-1200	S7-1500	
IN	Input	BOOL	BOOL	Start input
PT	Input	TIME	TIME, LTIME	Duration of the on delay. The value of the PT parameter must be positive.
Q	Output	BOOL	BOOL	Operand that is set when the timer PT expires.
ET	Output	TIME	TIME, LTIME	Current time value

For additional information on valid data types, refer to "See also".

## Pulse timing diagram

The following figure shows the pulse timing diagram of the "Generate on-delay" instruction:

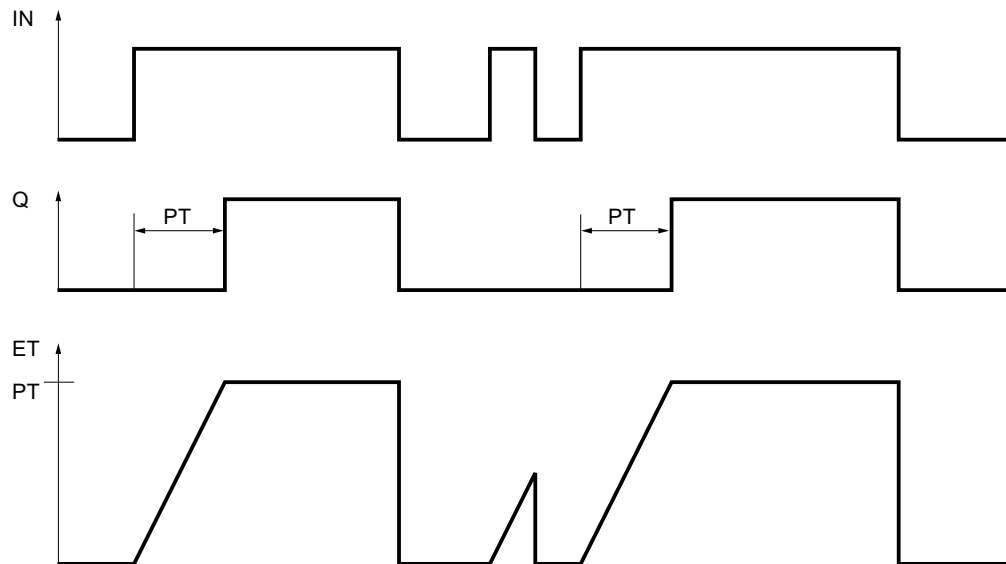

## Example

The following example shows how the instruction works:

```
SCL
"TON_DB".TON(IN := "Tag_Start",
             PT := "Tag_PresetTime",
             Q => "Tag_Status",
             ET => "Tag_ElapsedTime");
```

When the signal state of the "Tag\_Start" operand changes from "0" to "1", the time programmed for the PT parameter is started. After the end of the period the "Tag\_Status" operand is set to the signal state "1". The operand Tag\_Status remains set to signal state "1" as long as the operand Tag\_Start has signal state "1". The current time value is stored in the operand "Tag\_ElapsedTime". When the signal state at the operand "Tag\_Start" changes from "1" to "0", the "Tag\_Status" operand is reset.

## See also

Overview of the valid data types (Page 1077)

Entering SCL instructions (Page 1357)

Editing SCL instructions (Page 1374)

## TOF: Generate off-delay

### Description

You can use the "Generate off-delay" instruction to delay the resetting of the Q parameter for the programmed duration PT. The Q parameter is set when the result of logic operation (RLO) of the IN parameter changes from "0" to "1" (positive signal edge). When the signal state of the IN parameter changes back to "0", the programmed time PT starts. The Q parameter remains set as long the time duration PT is running. When the time PT expires, the Q parameter is reset. If the signal state of the IN parameter changes to "1" before the time duration PT has expired, the timer is reset. The signal state of the Q parameter remains set to "1".

The current time value can be queried in the ET parameter. The time value starts at T#0s and ends when the value of the time duration PT is reached. When the time duration PT expires, the ET parameter remains set to the current value until the IN parameter changes back to "1". If the IN parameter changes to "1" before the time PT has expired, the ET parameter is reset to the value T#0s.

---

#### Note

If the timer is not called in the program because it is skipped, for example, output ET returns a constant value as soon as the timer has expired.

---

Each call of the "Generate off-delay" instruction must be assigned to an IEC timer in which the instruction data is stored.

### For S7-1200 CPU

An IEC Timer is a structure of the data type IEC\_TIMER or TOF\_TIME that you can declare as follows:

- Declaration of a data block of system data type IEC\_TIMER (for example, "MyIEC\_TIMER")
- Declaration as a local tag of the TOF\_TIME type in the "Static" section of a block (for example, #MyTOF\_TIMER)

### For S7-1500 CPU

An IEC timer is a structure of the data type IEC\_TIMER, IEC\_LTIMER, TOF\_TIME or TOF\_LTIME that you can declare as follows:

- Declaration of a data block of system data type IEC\_TIMER or IEC\_LTIMER (for example, "MyIEC\_TIMER")
- Declaration as a local tag of the type TOF\_TIME or TOF\_LTIME in the "Static" section of a block (for example #MyTOF\_TIMER)

When you insert the instruction in the program, the "Call options" dialog opens in which you can specify whether the IEC timer is stored in its own data block (single instance) or as a local tag (multiple instance) in the block interface. If you create a separate data block, you will find it in the project tree in the "Program resources" folder under "Program blocks > System blocks". For additional information on this topic, refer to "See also".

The instruction data is updated both when an instruction is called and also at each access to the Q or ET outputs.

## Syntax

Use the following syntax for the "Generate off-delay" instruction:

- Data block of system data type IEC\_Timer (global DB):

### SCL

```
<IEC_Timer_DB> TOF(IN := <Operand>,
                  PT := <Operand>,
                  Q => <Operand>,
                  ET => <Operand>)
```

- Local tag:

### SCL

```
#myLocal_timer(IN := <Operand>,
               PT := <Operand>,
               Q => <Operand>,
               ET => <Operand>)
```

The syntax of the instruction consists of the following parts:

Parameter	Declaration	Data type		Description
		S7-1200	S7-1500	
IN	Input	BOOL	BOOL	Start input
PT	Input	TIME	TIME, LTIME	Duration of the off delay. The value of the PT parameter must be positive.
Q	Output	BOOL	BOOL	Operand that is reset when the time PT expires.
ET	Output	TIME	TIME, LTIME	Current time value

For additional information on valid data types, refer to "See also".

### Pulse timing diagram

The following figure shows the pulse timing diagram of the instruction "Generate off-delay":

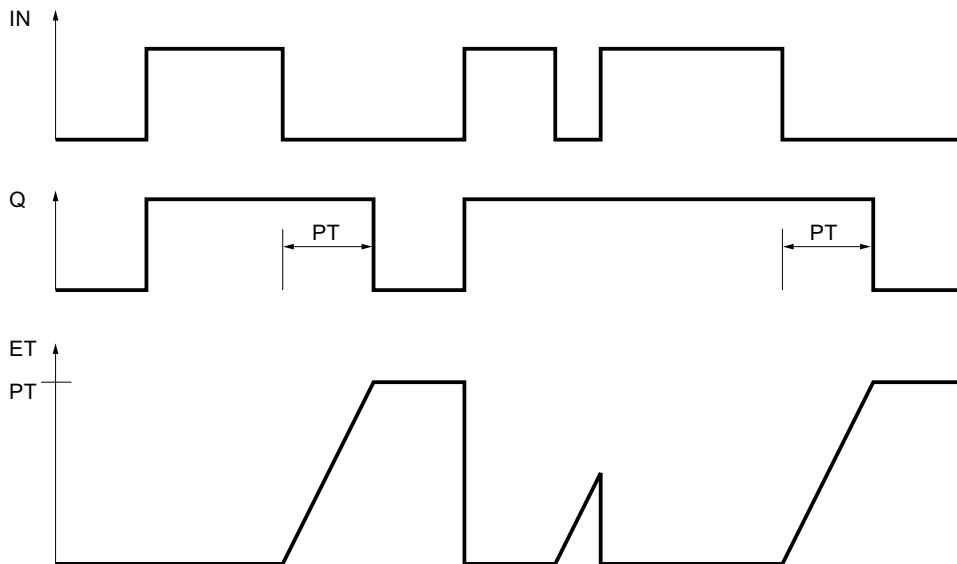

### Example

The following example shows how the instruction works:

```

SCL
"TOF_DB".TOF(IN := "Tag_Start",
             PT := "Tag_PresetTime",
             Q => "Tag_Status",
             ET => "Tag_ElapsedTime");
    
```

With a change in the signal state of the "Tag\_Start" operand from "0" to "1", the "Tag\_Status" operand is set. When the signal state of the "Tag\_Start" operand changes from "1" to "0", the time programmed for the PT parameter is started. As long as the time is running, the "Tag\_Status" operand remains set. When the time has expired, the "Tag\_Status" operand is reset. The current time value is stored in the operand "Tag\_ElapsedTime".

### See also

Overview of the valid data types (Page 1077)

Entering SCL instructions (Page 1357)

Editing SCL instructions (Page 1374)



## TONR: Time accumulator

### Description

The "Time accumulator" instruction is used to accumulate time values within a period set by the PT parameter. When the signal state of the IN parameter changes to "1", the instruction executes and the time duration PT starts. While the time duration PT is running, the time values that are recorded when the IN parameter has signal state "1" are accumulated. The accumulated time is output in the ET parameter and can be queried there. When the time duration PT is reached, the Q parameter has signal state "1". The Q parameter remains set to "1", even when the signal state at the IN parameter changes to "0".

The R parameter resets the ET and Q parameters regardless of the signal state at the IN parameter.

Each call of the "Time accumulator" instruction must be assigned to an IEC timer in which the instruction data is stored.

### For S7-1200 CPU

An IEC Timer is a structure of the data type IEC\_TIMER or TONR\_TIME that you can declare as follows:

- Declaration of a data block of system data type IEC\_TIMER (for example, "MyIEC\_TIMER")
- Declaration as a local tag of the TONR\_TIME type in the "Static" section of a block (for example, #MyTONR\_TIMER)

### For S7-1500 CPU

An IEC timer is a structure of the data type IEC\_TIMER, IEC\_LTIMER, TONR\_TIME or TONR\_LTIME that you can declare as follows:

- Declaration of a data block of system data type IEC\_TIMER or IEC\_LTIMER (for example, "MyIEC\_TIMER")
- Declaration as a local tag of the type TONR\_TIME or TONR\_LTIME in the "Static" section of a block (for example #MyTONR\_TIMER)

When you insert the instruction in the program, the "Call options" dialog opens in which you can specify whether the IEC timer is stored in its own data block (single instance) or as a local tag (multiple instance) in the block interface. If you create a separate data block, you will find it in the project tree in the "Program resources" folder under "Program blocks > System blocks". For additional information on this topic, refer to "See also".

The instruction data is updated both when an instruction is called and also at each access to the Q or ET outputs.

**Syntax**

Use the following syntax for the "Time accumulator" instruction:

- Data block of system data type IEC\_Timer (global DB):

```

SCL
<IEC_Timer_DB> TONR(IN := <Operand>,
                    R := <Operand>,
                    PT := <Operand>,
                    Q => <Operand>,
                    ET => <Operand>)
    
```

- Local tag:

```

SCL
#myLocal_timer(IN := <Operand>,
               R := <Operand>,
               PT := <Operand>,
               Q => <Operand>,
               ET => <Operand>)
    
```

The syntax of the instruction consists of the following parts:

Parameter	Declaration	Data type		Description
		S7-1200	S7-1500	
IN	Input	BOOL	BOOL	Start input
R	Input	BOOL	BOOL	Reset of the ET and Q parameters
PT	Input	TIME	TIME, LTIME	Maximum duration of time recording. The value of the PT parameter must be positive.
Q	Output	BOOL	BOOL	Operand that remains set when the timer PT has expired.
ET	Output	TIME	TIME, LTIME	Accumulated time

For additional information on valid data types, refer to "See also".

## Pulse timing diagram

The following figure shows the pulse timing diagram of the "Time accumulator" instruction:

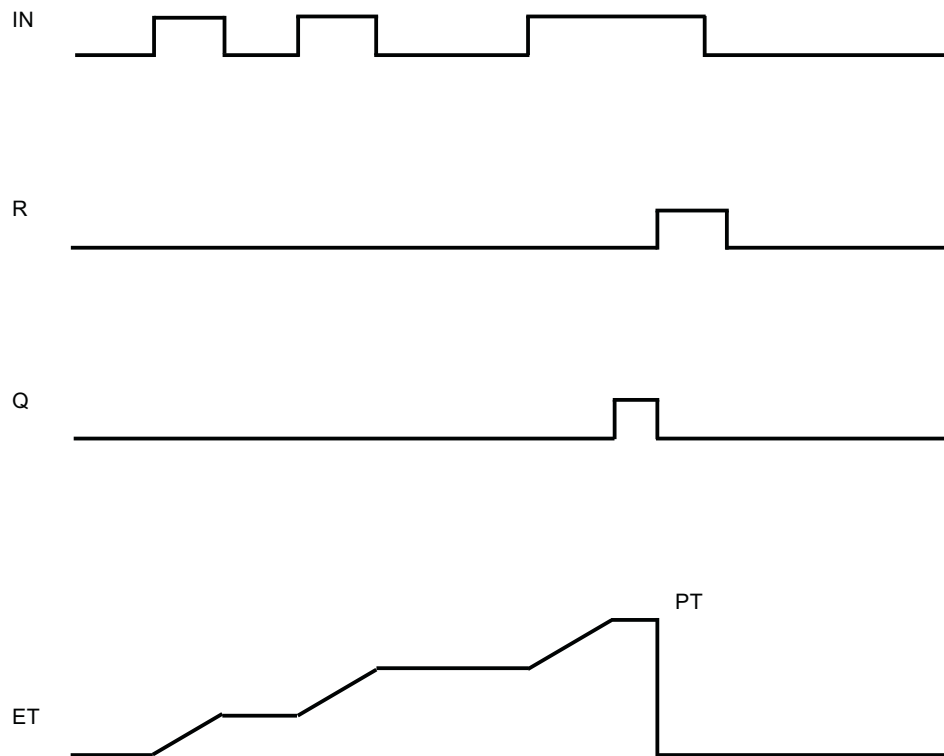

## Example

The following example shows how the instruction works:

```
SCL
"TONR_DB".TONR(IN := "Tag_Start",
               R := "Tag_Reset",
               PT := "Tag_PresetTime",
               Q => "Tag_Status",
               ET => "Tag_Time");
```

When the signal state of the "Tag\_Start" operand changes from "0" to "1", the time programmed for the PT parameter is started. While the timer is running, the time values that are recorded at signal state "1" of the operand "Tag\_Start" is accumulated. The accumulated times is stored in the "Tag\_Time" operand. When the time value displayed at the PT parameter is reached, the "Tag\_Status" operand is set to the signal state "1". The current time value is stored in the operand "Tag\_Time".

**See also**

Overview of the valid data types (Page 1077)

Entering SCL instructions (Page 1357)

Editing SCL instructions (Page 1374)

**RESET\_TIMER: Reset timer**

**Description**

You can use the "Reset timer" instruction to reset an IEC timer to "0". The structure components of the timer in the specified data block are reset to "0".

The instruction does not influence the RLO. At the TIMER parameter, the "Reset timer" instruction is assigned an IEC timer declared in the program.

The instruction data is updated only when the instruction is called and not each time the assigned IEC timer is accessed. Querying the data is only identical from the call of the instruction to the next call of the instruction.

**Syntax**

Use the following syntax for the "Reset timer" instruction:

```
SCL
RESET_TIMER(TIMER := <IEC timer>)
```

**Parameters**

The following table shows the parameters of the "Reset timer" instruction:

Parameter	Declaration	Data type	Description
<IEC timer>	Output	IEC_TIMER, IEC_LTIMER, TP_TIME, TP_LTIME, TON_TIME, TON_LTIME, TOF_TIME, TOF_LTIME, TONR_TIME, TONR_LTIME	IEC timer that is reset

For more information on valid data types, refer to "See also".

## Example

The following example shows how the instruction works:

### SCL

```
IF #started = false THEN
"TON_DB".TON(IN := "Tag_Start",
             PT := "Tag_PresetTime",
             Q => "Tag_Status",
             ET => "Tag_ElapsedTime");
#started := true;
END_IF;

IF "TON_DB".ET < T#25s THEN
RESET_TIMER(TIMER := "TON_DB");
#started := false;
END_IF;
```

When the tag #started has the signal state "0", the instruction "Generate on-delay" is executed when there is positive signal edge on the operand "Tag\_Start". The IEC timer stored in the instance data block "TON\_DB" is started with the time duration that is specified by the operand "Tag\_PresetTime". The operand "Tag\_Status" is set if the time duration specified by the operand "Tag\_PresetTime" has expired. The parameter Q remains set as long as the operand "Tag\_Start" still has the signal state "1". When the signal state of the start input changes from "1" to "0", the operand on the Q parameter is reset.

If the expired time of the IEC timer "TON\_DB" is less than 25s, the "Reset timer" instruction is executed and the timer stored in the "TON\_DB" instance data block is reset.

## See also

Overview of the valid data types (Page 1077)

Entering SCL instructions (Page 1357)

Editing SCL instructions (Page 1374)

## PRESET\_TIMER: Load time duration

### Description

You can use the "Load time duration" instruction to set the time for an IEC timer. The instruction is executed in every cycle when the result of logic operation (RLO) at the input of the instruction

has the signal state "1". The instruction writes the specified time to the structure of the specified IEC timer.

**Note**

If the specified IEC timer is running while the instruction executes, the instruction overwrites the current time of the specified IEC timer. This can change the timer status of the IEC timer.

You assign an IEC timer declared in the program to the "Load time duration" instruction.

The instruction data is updated only when the instruction is called and each time the assigned IEC timer is accessed. The query on Q or ET (for example, "MyTimer".Q or "MyTimer".ET) updates the IEC\_TIMER structure.

**Syntax**

Use the following syntax for the "Load time duration" instruction:

```
SCL
PRESET_TIMER(PT := <Operand>,
             TIMER := <IEC timer>)
```

**Parameter**

The following table shows the parameters of the "Load time duration" instruction:

Parameter	Declaration	Data type	Description
<Time duration>	Input	TIME, LTIME	Duration with which the IEC timer runs.
<IEC timer>	Output	IEC_TIMER, IEC_LTIMER, TP_TIME, TP_LTIME, TON_TIME, TON_LTIME, TOF_TIME, TOF_LTIME, TONR_TIME, TONR_LTIME	IEC timer whose duration of which is set.

For more information on valid data types, refer to "See also".

**Example**

The following example shows how the instruction works:

```
SCL
IF #started = false THEN
"TON_DB".TON(IN := "Tag_Start",
             PT := "Tag_PresetTime",
```

**SCL**

```

        Q => "Tag_Status",
        ET => "Tag_ElapsedTime");

#started := true;
#preset = true
END_IF;

IF "TON_DB".ET < T#10s AND #preset = true THEN
PRESET_TIMER(PT := T#25s,
             TIMER := "TON_DB");
#preset := false;
END_IF;

```

When the tag `#started` has the signal state "0" and the operand "Tag\_Start" has a positive signal edge, the instruction "Generate on-delay" is executed. The IEC timer stored in the instance data block "TON\_DB" is started with the time duration that is specified by the operand "Tag\_PresetTime". The operand "Tag\_Status" is set if the time duration PT specified by the operand "Tag\_PresetTime" has expired. The parameter Q remains set as long as the operand "Tag\_Start" still has the signal state "1". When the signal state of the start input changes from "1" to "0", the operand on the Q parameter is reset.

The instruction "Load time duration" is executed when the expired time of the IEC timer "TON\_DB" is less than 10s and the tag `#preset` has the signal state "1". The instruction writes the time duration that is specified at the parameter "PT" in the instance data block "TON\_DB", thereby overwriting the time value of the operand "Tag\_PresetTime" within the instance data block. The signal state of the timer status may therefore change at the next query or when "TON\_DB".Q or "TON\_DB".ET are accessed.

**See also**

Overview of the valid data types (Page 1077)

Entering SCL instructions (Page 1357)

Editing SCL instructions (Page 1374)

**SIMATIC Timers****S\_PULSE: Assign pulse timer parameters and start****Description**

The "Assign pulse timer parameters and start" instruction starts the time programmed in the T\_NO parameter when a change from "0" to "1" (positive signal edge) is detected in the result of logic operation (RLO) of the S parameter. The timer runs for the programmed time (TV) as long as the signal state of the S parameter is "1".

When the signal state of the S parameter changes to "0" before the programmed time has expired, the timer is stopped and the "Q" parameter is reset to "0".

Internally, the time is made up of a time value and a time base and is programmed in the TV parameter. When the instruction starts, the programmed time value counts down to zero. The time base specifies the time increment by which the time value changes. The current time value is provided at the parameter BI.

If the timer is running and the signal state at input R changes to "1" then the current time value and the time base are also set to zero. If the timer is not running, the signal state "1" at the R input has no effect.

Parameter Q returns signal state "1" as long as the timer is running and the signal state at parameter S is "1". When the signal state of the S parameter changes to "0" before the programmed time has expired, the Q parameter returns signal state "0". If the timer is reset by parameter R or if the timer has expired then parameter Q also returns signal state "0".

The instruction data is updated with each access. It is therefore possible that the query of the data at the start of the cycle returns different values from those at the end of the cycle.

**Note**

In the time cell, the operating system reduces the time value in an interval specified by the time base by one unit until the value equals "0". The decrementation is performed asynchronously to the user program. The resulting timer is therefore at maximum up to one time interval shorter than the desired time base.

You can find an example of how a time cell can be formed under: See also "L: Load timer value".

**Syntax**

Use the following syntax for the "Assign pulse timer parameters and start" instruction:

```
SCL
S_PULSE(T_NO := <Operand>,
        S := <Operand>,
        TV := <Operand>,
        R := <Operand>,
        Q => <Operand>,
        BI => <Operand>)
```

The syntax of the instruction consists of the following parts:

Parameter	Declaration	Data type	Description
T_NO	Input	TIMER, INT	The timer that is started. The number of timers depends on the CPU.
S	Input	BOOL	Start input
TV	Input	S5TIME, WORD	Preset time value
R	Input	BOOL	Reset input
Q	Output	BOOL	Status of the timer
BI	Output	WORD	Current dual-coded timer value
Function value		S5TIME	Current time value



For additional information on valid data types, refer to "See also".

### Pulse timing diagram

The following figure shows the pulse timing diagram of the "Assign pulse timer parameters and start" instruction:

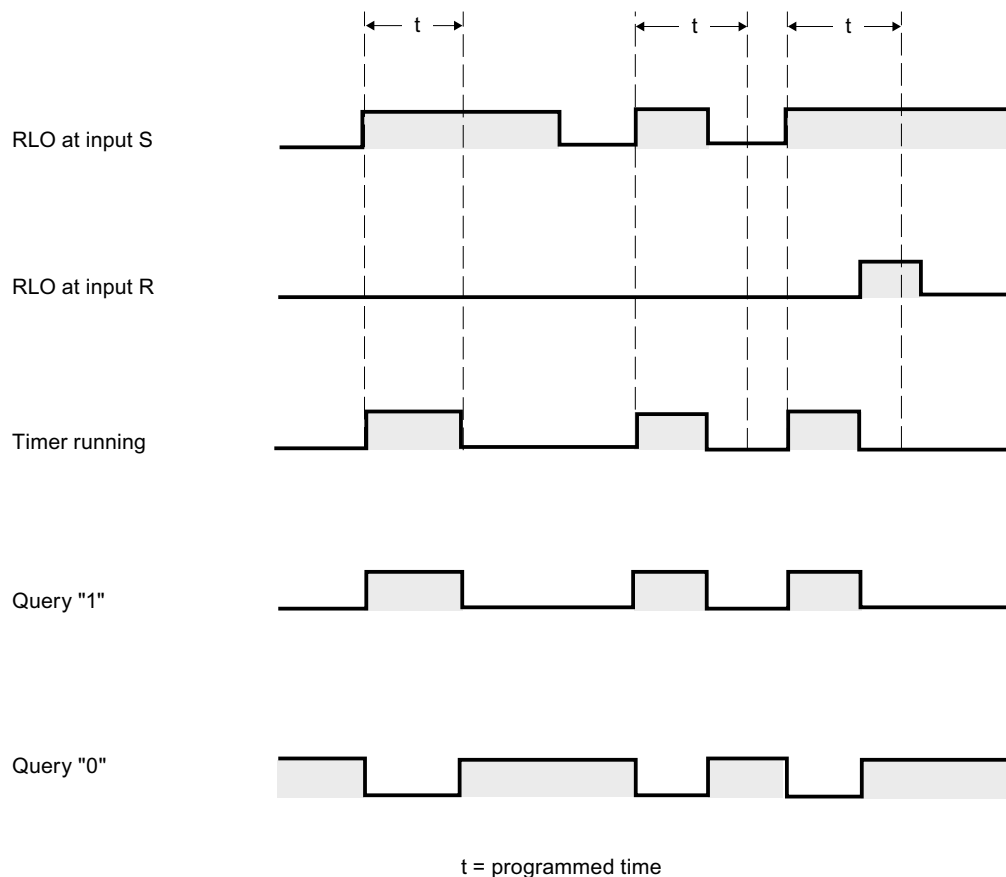

### Example

The following example shows how the instruction works:

```
SCL
"Tag_Result" := S_PULSE(T_NO := "Timer_1",
                        S := "Tag_1",
                        TV := "Tag_Number",
                        R := "Tag_Reset",
                        Q := "Tag_Status",
                        BI := "Tag_Value");
```

"Timer\_1" starts when the signal state of the "Tag\_1" operand changes from "0" to "1". The timer counts down with the time value of the operand "Tag\_Number" until operand "Tag\_1" returns signal state "1".

If the signal state at the S parameter changes to "0" before the programmed time has elapsed, the "Tag\_Status" operand is reset to "0". If the timer is reset by the R parameter or if the timer has expired, the "Tag\_Status" operand also returns signal state "0".

The current time value is stored both dual-coded at the "Tag\_Value" operand and returned as a function value.

### See also

Overview of the valid data types (Page 1077)

Entering SCL instructions (Page 1357)

Editing SCL instructions (Page 1374)

## S\_PEXT: Assign extended pulse timer parameters and start

### Description

The "Assign extended pulse timer parameters and start" instruction starts a programmed timer when a positive signal edge is detected at the S parameter. The timer runs for the programmed time (TV) even if the signal state at the S parameter changes to "0". As long as the timer runs, parameter Q returns the signal state "1".

When the timer has expired, parameter Q is reset to "0". If the signal state at the S parameter changes from "0" to "1" while the timer is running, the timer is restarted with the time programmed in the TV parameter.

Internally, the time is made up of a time value and a time base and is programmed in the TV parameter. When the instruction starts, the programmed time value counts down to zero. The time base specifies the time increment by which the time value changes. The current time value is provided at the parameter BI.

If the timer is running and the signal state at parameter R changes to "1" then the current time value and the time base are also set to zero. If the timer is not running then signal state "1" at parameter R has no effect.

The instruction data is updated with each access. It is therefore possible that the query of the data at the start of the cycle returns different values from those at the end of the cycle.

---

### Note

In the time cell, the operating system reduces the time value in an interval specified by the time base by one unit until the value equals "0". The decrementation is performed asynchronously to the user program. The resulting timer is therefore at maximum up to one time interval shorter than the desired time base.

---

You can find an example of how a time cell can be formed under: See also "L: Load timer value".

## Syntax

Use the following syntax for the "Assign extended pulse timer parameters and start" instruction:

```
SCL
S_PEXT(T_NO := <Operand>,
      S := <Operand>,
      TV := <Operand>,
      R := <Operand>,
      Q => <Operand>,
      BI => <Operand>)
```

The syntax of the instruction consists of the following parts:

Parameter	Declaration	Data type	Description
T_NO	Input	TIMER, INT	The timer that is started. The number of timers depends on the CPU.
S	Input	BOOL	Start input
TV	Input	S5TIME, WORD	Preset time value
R	Input	BOOL	Reset input
Q	Output	BOOL	Status of the timer
BI	Output	WORD	Current dual-coded timer value
Function value		S5TIME	Current time value

For additional information on valid data types, refer to "See also".

**Pulse timing diagram**

The following figure shows the pulse timing diagram of the "Assign extended pulse timer parameters and start" instruction:

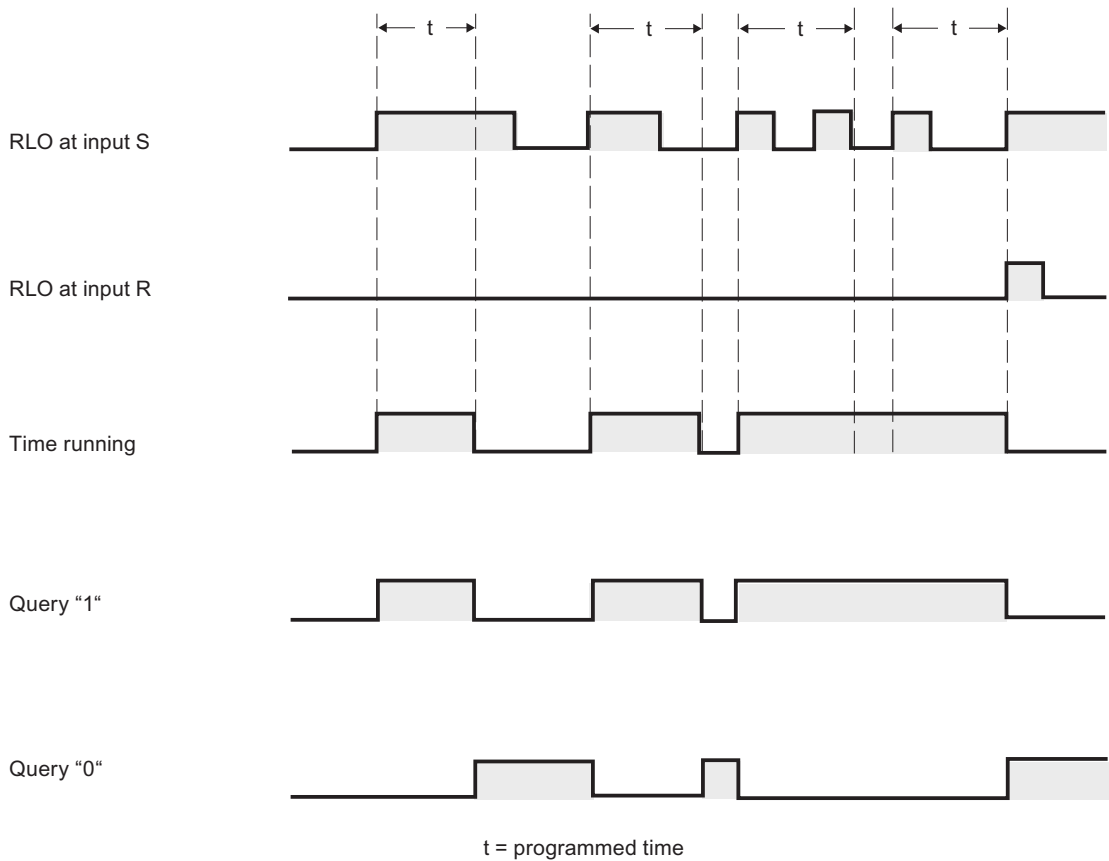

**Example**

The following example shows how the instruction works:

```

SCL
"Tag_Result" := S_PEXT(T_NO := "Timer_1",
                      S := "Tag_1",
                      TV := "Tag_Number",
                      R := "Tag_Reset",
                      Q := "Tag_Status",
                      BI := "Tag_Value");
    
```

"Timer\_1" starts when the signal state of the "Tag\_1" operand changes from "0" to "1". As long as the timer runs, operand "Tag\_Status" returns the signal state "1". When the timer has expired, operand "Tag\_Status" is reset to "0". If the signal state at the S input changes from "0" to "1" while the timer is running, the timer is restarted with the time "Tag\_Number".

The current time value is stored both dual-coded at the "Tag\_Value" operand and returned as a function value.

## See also

Overview of the valid data types (Page 1077)

Entering SCL instructions (Page 1357)

Editing SCL instructions (Page 1374)

## S\_ODT: Assign on-delay timer parameters and start

### Description

The "Assign on-delay timer parameters and start" instruction starts a programmed timer as on-delay when a positive signal edge is detected at the S parameter. The timer runs for the programmed time (TV) as long as the signal state of the S parameter is "1".

If the timer expires correctly and parameter S still has signal state "1" then parameter Q returns signal state "1". If the signal state at the S parameter changes from "1" to "0" while the timer is running, the timer is stopped. In this case, output Q is reset to signal state "0".

Internally, the time is made up of a time value and a time base and is programmed in the TV parameter. When the instruction starts, the programmed time value counts down to zero. The time base specifies the time increment by which the time value changes. The current time value is provided at the parameter BI.

If the time is running and the signal state at input R changes from "0" to "1" then the current time value and the time base are also set to zero. In this case, the signal state at parameter Q is "0". The timer is reset if the signal state at the R parameter is "1", even if the timer is not running and the result of logic operation (RLO) at the S parameter is "1".

The instruction data is updated with each access. It is therefore possible that the query of the data at the start of the cycle returns different values from those at the end of the cycle.

---

### Note

In the time cell, the operating system reduces the time value in an interval specified by the time base by one unit until the value equals "0". The decrementation is performed asynchronously to the user program. The resulting timer is therefore at maximum up to one time interval shorter than the desired time base.

---

You can find an example of how a time cell can be formed under: See also "L: Load timer value".

### Syntax

Use the following syntax for the "Assign on-delay timer parameters and start" instruction:

```
SCL
S_ODT(T_NO := <Operand>,
      S := <Operand>,
      TV := <Operand>,
      R := <Operand>,
      Q => <Operand>);
```

**SCL**

BI => <Operand>

The syntax of the instruction consists of the following parts:

Parameter	Declaration	Data type	Description
T_NO	Input	TIMER, INT	The timer that is started. The number of timers depends on the CPU.
S	Input	BOOL	Start input
TV	Input	S5TIME, WORD	Preset time value
R	Input	BOOL	Reset input
Q	Output	BOOL	Status of the timer
BI	Output	WORD	Current dual-coded timer value
Function value		S5TIME	Current time value

For additional information on valid data types, refer to "See also".

**ulse timing diagram**

The following figure shows the pulse timing diagram of the "Assign on-delay timer parameters and start" instruction:

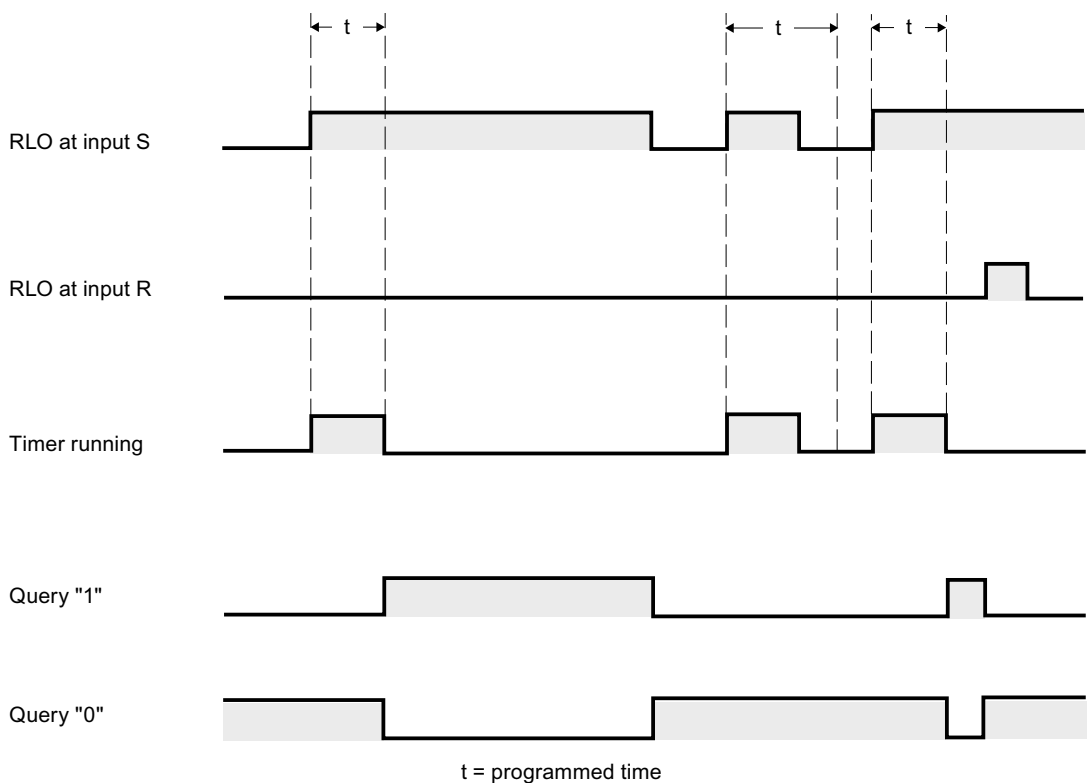

## Example

The following example shows how the instruction works:

```
SCL  
"Tag_Result" := S_ODT(T_NO := "Timer_1",  
                      S := "Tag_1",  
                      TV := "Tag_Number",  
                      R := "Tag_Reset",  
                      Q := "Tag_Status",  
                      BI := "Tag_Value");
```

"Timer\_1" starts when the signal state of the "Tag\_1" operand changes from "0" to "1". The timer runs for the duration "Tag\_Number" as long as the signal state of operand "Tag\_1" is "1".

If the timer expires correctly and operand "Tag\_Status" has signal state "1" then operand "Tag\_Status" is reset to "1". If the signal state of the "Tag\_1" operand changes from "1" to "0" while the timer is running, the timer is stopped. In this case, operand "Tag\_Status" returns signal state "0".

The current time value is stored both dual-coded at the "Tag\_Value" operand and returned as a function value.

## See also

[Overview of the valid data types \(Page 1077\)](#)

[Entering SCL instructions \(Page 1357\)](#)

[Editing SCL instructions \(Page 1374\)](#)

## S\_ODTS: Assign retentive on-delay timer parameters and start

### Description

The "Assign retentive on-delay timer parameters and start" instruction starts a programmed timer when a positive signal edge is detected at the S parameter. The timer runs for the programmed time (TV) even if the signal state at the S parameter changes to "0".

If the timer expires, the "Q" parameter returns signal state "1" regardless of the signal state of the "S" parameter. If the signal state at the S parameter changes from "0" to "1" while the timer is running, the timer is restarted with the programmed time TV.

Internally, the time is made up of a time value and a time base and is programmed in the TV parameter. When the instruction starts, the programmed time value counts down to zero. The time base specifies the time increment by which the time value changes. The current time value is provided at the parameter BI.

Signal state "1" at parameter R resets the current time value and time base to "0", independent of the signal state at parameter S. In this case, the signal state at parameter Q is "0".

The instruction data is updated with each access. It is therefore possible that the query of the data at the start of the cycle returns different values from those at the end of the cycle.

**Note**

In the time cell, the operating system reduces the time value in an interval specified by the time base by one unit until the value equals "0". The decrementation is performed asynchronously to the user program. The resulting timer is therefore at maximum up to one time interval shorter than the desired time base.

You can find an example of how a time cell can be formed under: See also "L: Load timer value".

**Syntax**

Use the following syntax for the "Assign retentive on-delay timer parameters and start" instruction:

```

SCL
S_ODTS (T_NO := <Operand>,
        S := <Operand>,
        TV := <Operand>,
        R := <Operand>,
        Q => <Operand>,
        BI =><Operand>)
    
```

The syntax of the instruction consists of the following parts:

Parameter	Declaration	Data type	Description
T_NO	Input	TIMER, INT	The timer that is started. The number of timers depends on the CPU.
S	Input	BOOL	Start input
TV	Input	S5TIME, WORD	Preset time value
R	Input	BOOL	Reset input
Q	Output	BOOL	Status of the timer
BI	Output	WORD	Current dual-coded timer value
Function value		S5TIME	Current time value

For additional information on valid data types, refer to "See also".



## Pulse timing diagram

The following figure shows the pulse timing diagram of the "Assign retentive on-delay timer parameters and start" instruction:

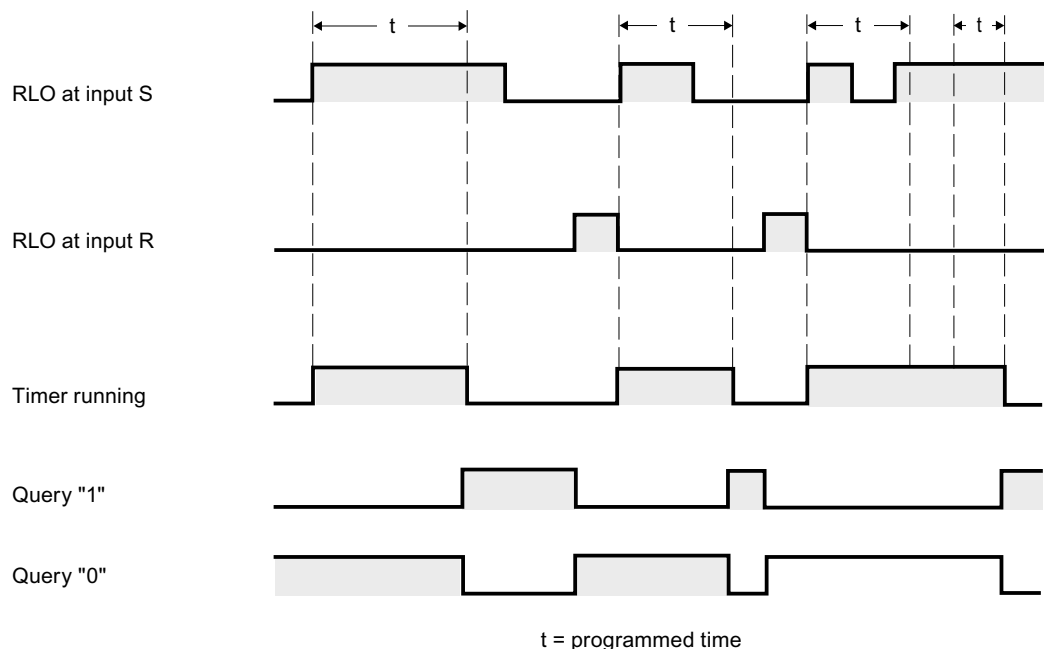

## Example

The following example shows how the instruction works:

```
SCL
"Tag_Result" := S_ODTS(T_NO := "Timer_1",
                      S := "Tag_1",
                      TV := "Tag_Number",
                      R := "Tag_Reset",
                      Q := "Tag_Status",
                      BI := "Tag_Value");
```

"Timer\_1" starts when the signal state of the "Tag\_1" operand changes from "0" to "1". The timer runs for the duration "Tag\_Number".

If the timer expires, operand "Tag\_Status" returns signal state "1" independent of the signal state of operand "Tag\_1". If the signal state of the "Tag\_1" operand changes from "0" to "1" while the timer is running, the timer is restarted with the time "Tag\_Number".

The current time value is stored both dual-coded at the "Tag\_Value" operand and returned as a function value.

## See also

Overview of the valid data types (Page 1077)

Entering SCL instructions (Page 1357)

Editing SCL instructions (Page 1374)

## S\_OFFDT: Assign off-delay timer parameters and start

### Description

The "Assign off-delay timer parameters and start" instruction starts a programmed timer when a negative signal edge is detected at the S parameter. The timer runs for the programmed time (TV). As long as the timer is running or parameter S returns signal state "1", then parameter Q has signal state "1".

If the timer expires and the signal state is "0" then parameter Q is reset to signal state "0". If the signal state at parameter S changes from "0" to "1" while the timer is running, the timer is stopped. The timer is only restarted after a falling signal edge is detected at parameter S.

Internally, the time is made up of a time value and a time base and is programmed in the TV parameter. When the instruction starts, the programmed time value counts down to zero. The time base specifies the time increment by which the time value changes. The current time value is provided at the parameter BI.

Signal state "1" at parameter R resets the current time value and time base to "0". In this case, the signal state at parameter Q is "0".

The instruction data is updated with each access. It is therefore possible that the query of the data at the start of the cycle returns different values from those at the end of the cycle.

---

### Note

In the time cell, the operating system reduces the time value in an interval specified by the time base by one unit until the value equals "0". The decrementation is performed asynchronously to the user program. The resulting timer is therefore at maximum up to one time interval shorter than the desired time base.

---

You can find an example of how a time cell can be formed under: See also "L: Load timer value".

### Syntax

Use the following syntax for the "Assign off-delay timer parameters and start" instruction:

```
SCL  
S_OFFDT(T_NO := <Operand>,  
        S := <Operand>,  
        TV := <Operand>,  
        R := <Operand>,  
        Q => <Operand>,  
        BI =><Operand>)
```

The syntax of the instruction consists of the following parts:

Parameter	Declaration	Data type	Description
T_NO	Input	TIMER, INT	The timer that is started. The number of timers depends on the CPU.
S	Input	BOOL	Start input
TV	Input	S5TIME, WORD	Preset time value
R	Input	BOOL	Reset input
Q	Output	BOOL	Status of the timer
BI	Output	WORD	Current dual-coded timer value
Function value		S5TIME	Current time value

For additional information on valid data types, refer to "See also".

### Pulse timing diagram

The following figure shows the pulse timing diagram of the "Assign off-delay timer parameters and start" instruction:

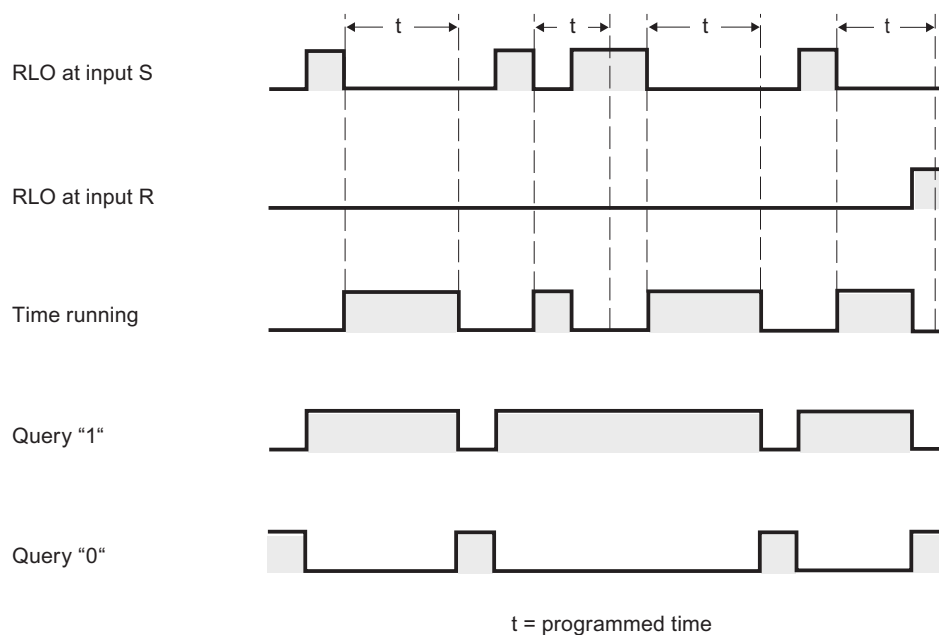

### Example

The following example shows how the instruction works:

```

SCL
"Tag_Result" := S_OFFDT(T_NO := "Timer_1",
                        S := "Tag_1",
                        TV := "Tag_Number",

```

**SCL**

```
R := "Tag_Reset",  
Q := "Tag_Status",  
BI := "Tag_Value");
```

"Timer\_1" starts when the signal state of the "Tag\_1" operand changes from "0" to "1". The timer runs for the duration "Tag\_Number". As long as the timer is running or operand "Tag\_1" returns signal state "1", then operand "Tag\_Status" has signal state "1".

If the timer expires and the signal state of operand "Tag\_1" is "0" then operand "Tag\_Status" is reset to signal state "0". If the signal state of the "Tag\_1" operand changes from "0" to "1" while the timer is running, the timer is reset. The timer is only restarted after a falling edge is detected at parameter S.

The current time value is stored both dual-coded at the "Tag\_Value" operand and returned as a function value.

**See also**

Overview of the valid data types (Page 1077)

Entering SCL instructions (Page 1357)

Editing SCL instructions (Page 1374)

**Counter operations**

**IEC Counters**

**CTU: Count up**

**Description**

You can use the "Count up" instruction to increment the value at the CV parameter. When the signal state of the CU parameter changes from "0" to "1" (positive signal edge), the instruction is executed and the current counter value of the CV parameter is incremented by one. When the instruction is executed for the first time the the current count of the CV parameter is set to zero. The counter value is incremented each time a positive signal edge is detected, until it reaches the high limit of the data type specified for the CV parameter. When the high limit is reached, the signal state of the CU parameter no longer has an effect on the instruction.

You can query the count status of the Q parameter. The signal state of the Q parameter is determined by the PV parameter. When the current counter value is greater than or equal to the value of the PV parameter, the Q parameter is set to signal state "1". In all other cases, the signal state of the Q parameter is "0". You can also specify a constant for the PV parameter.

The value of the CV parameter is reset to zero when the signal state at the R parameter changes to "1". As long as the signal state of the R parameter is "1", the signal state of the CU parameter has no effect on the instruction.

---

#### Note

Only use a counter at a single location in the program to avoid risk of counting errors.

---

Each call of the "Count up" instruction must be assigned an IEC counter in which the instruction data is stored. An IEC counter is a structure with one of the following data types:

#### For S7-1200 CPU

Data block of system data type IEC_counter (global DB)	Local tag
<ul style="list-style-type: none"> <li>• IEC_SCOUNTER / IEC_USCOUNTER</li> <li>• IEC_COUNTER / IEC_UCOUNTER</li> <li>• IEC_DCOUNTER / IEC_UDCOUNTER</li> </ul>	<ul style="list-style-type: none"> <li>• CTU_SINT / CTU_USINT</li> <li>• CTU_INT / CTU_UINT</li> <li>• CTU_DINT / CTU_UDINT</li> </ul>

#### For S7-1500 CPU

Data block of system data type IEC_counter (global DB)	Local tag
<ul style="list-style-type: none"> <li>• IEC_SCOUNTER / IEC_USCOUNTER</li> <li>• IEC_COUNTER / IEC_UCOUNTER</li> <li>• IEC_DCOUNTER / IEC_UDCOUNTER</li> <li>• IEC_LCOUNTER / IEC_ULCOUNTER</li> </ul>	<ul style="list-style-type: none"> <li>• CTU_SINT / CTU_USINT</li> <li>• CTU_INT / CTU_UINT</li> <li>• CTU_DINT / CTU_UDINT</li> <li>• CTU_LINT / CTU_ULINT</li> </ul>

You can declare an IEC counter as follows:

- Declaration of a data block of system data type IEC\_COUNTER (for example, "MyIEC\_COUNTER")
- Declaration as a local tag of the CTU type in the "Static" section of a block (for example, #MyCTU\_COUNTER)

When you insert the instruction in the program, the "Call options" dialog opens in which you can specify whether the IEC counter is stored in its own data block (single instance) or as a local tag (multiple instance) in the block interface. If you create a separate data block, you will find it in the project tree in the "Program resources" folder under "Program blocks > System blocks". For additional information on this topic, refer to "See also".

**Syntax**

The following syntax is used for the "Count up" instruction:

Table 9-28 Data block of system data type IEC\_counter (global DB)

```
SCL
<IEC_Counter_DB>.CTU(CU := <Operand>,
                    R := <Operand>,
                    PV := <Operand>,
                    Q => <Operand>,
                    CV => <Operand>)
```

Table 9-29 Local tag

```
SCL
#myLocal_counter(CU := <Operand>,
                R := <Operand>,
                PV := <Operand>,
                Q => <Operand>,
                CV => <Operand>)
```

The syntax of the instruction consists of the following parts:

Parameter	Declaration	Data type	Description
CU	Input	BOOL	Count input
R	Input	BOOL	Reset input
PV	Input	Integers	Value at which the output Q is set
Q	Output	BOOL	Counter status
CV	Output	Integers, CHAR, DATE	Current counter value

For additional information on valid data types, refer to "See also".

**Example**

The following example shows how the instruction works:

```
SCL
"IEC_COUNTER_DB".CTU(CU := "Tag_Start",
                    R := "Tag_Reset",
                    PV := "Tag_PresetValue",
                    Q => "Tag_Status",
                    CV => "Tag_CounterValue");
```

When the signal state of the "Tag\_Start" operand changes from "0" to "1", the "Count up" instruction executes and the current counter value of the "Tag\_CounterValue" operand is incremented by one. With each additional positive signal edge, the counter value is incremented until the high limit value of the specified data type (INT = 32767) is reached.

The "Tag\_Status" output has signal state "1" as long as the current counter value is greater than or equal to the value of the "Tag\_PresetValue" operand. In all other cases, the

"Tag\_Status" output has signal state "0". The current counter value is stored in the "Tag\_CounterValue" operand.

### See also

Overview of the valid data types (Page 1077)

Entering SCL instructions (Page 1357)

Editing SCL instructions (Page 1374)

### CTD: Count down

#### Description

The "Count down" instruction is used to decrement the value at the parameter CV. When the signal state of the CD parameter changes from "0" to "1" (positive signal edge), the instruction is executed and the current counter value of the CV parameter is decremented by one. When the instruction is executed the first time, the counter value of the CV parameter will be set to the value of the PV parameter. Each time a positive signal edge is detected, the counter is decremented until it reaches the low limit value of the specified data type. When the low limit is reached, the signal state of the CD parameter no longer has an effect on the instruction.

You can query the count status of the Q parameter. If the current counter value is less than or equal to zero, the Q parameter is set to signal state "1". In all other cases, the signal state of the Q parameter is "0". You can also specify a constant for the PV parameter.

The value of the CV parameter is set to the value of the PV parameter when the signal state of the LD parameter changes to "1". As long as the signal state of the LD parameter is "1", the signal state of the CD parameter has no effect on the instruction.

---

#### Note

Only use a counter at a single location in the program to avoid risk of counting errors.

---

Each call of the "Count down" instruction must be assigned an IEC counter in which the instruction data is stored. An IEC counter is a structure with one of the following data types:

#### For S7-1200 CPU

Data block of system data type IEC_counter (global DB)	Local tag
<ul style="list-style-type: none"> <li>• IEC_SCOUNTER / IEC_USCOUNTER</li> <li>• IEC_COUNTER / IEC_UCOUNTER</li> <li>• IEC_DCOUNTER / IEC_UDCOUNTER</li> </ul>	<ul style="list-style-type: none"> <li>• CTD_SINT / CTD_USINT</li> <li>• CTD_INT / CTD_UINT</li> <li>• CTD_DINT / CTD_UDINT</li> </ul>

For S7-1500 CPU

Data block of system data type IEC_counter (global DB)	Local tag
<ul style="list-style-type: none"> <li>• IEC_SCOUNTER / IEC_USCOUNTER</li> <li>• IEC_COUNTER / IEC_UCOUNTER</li> <li>• IEC_DCOUNTER / IEC_UDCOUNTER</li> <li>• IEC_LCOUNTER / IEC_ULCOUNTER</li> </ul>	<ul style="list-style-type: none"> <li>• CTD_SINT / CTD_USINT</li> <li>• CTD_INT / CTD_UINT</li> <li>• CTD_DINT / CTD_UDINT</li> <li>• CTD_LINT / CTD_ULINT</li> </ul>

You can declare an IEC counter as follows:

- Declaration of a data block of system data type IEC\_COUNTER (for example, "MyIEC\_COUNTER")
- Declaration as a local tag of the CTD type in the "Static" section of a block (for example, #MyCTD\_COUNTER)

When you insert the instruction in the program, the "Call options" dialog opens in which you can specify whether the IEC counter is stored in its own data block (single instance) or as a local tag (multiple instance) in the block interface. If you create a separate data block, you will find it in the project tree in the "Program resources" folder under "Program blocks > System blocks". For additional information on this topic, refer to "See also".

Syntax

The following syntax is used for the "Count down" instruction:

Table 9-30 Data block of system data type IEC\_counter (global DB)

```

SCL
<IEC_Counter_DB>.CTD(CD := <Operand>,
                    LD := <Operand>,
                    PV := <Operand>,
                    Q => <Operand>,
                    CV => <Operand>)
    
```

Table 9-31 Local tag

```

SCL
#myLocal_counter(CD := <Operand>,
                LD := <Operand>,
                PV := <Operand>,
                Q => <Operand>,
                CV => <Operand>)
    
```

The syntax of the instruction consists of the following parts:

Parameter	Declaration	Data type	Description
CD	Input	BOOL	Count input
LD	Input	BOOL	Load input
PV	Input	Integers	Value at which the output Q is set



Parameter	Declaration	Data type	Description
Q	Output	BOOL	Counter status
CV	Output	Integers, CHAR, DATE	Current counter value

For additional information on valid data types, refer to "See also".

## Example

The following example shows how the instruction works:

```

SCL
"IEC_SCOUNTER_DB".CTD(CD := "Tag_Start",
                      LD := "Tag_Load",
                      PV := "Tag_PresetValue",
                      Q => "Tag_Status",
                      CV => "Tag_CounterValue");

```

When the signal state of the "Tag\_Start" changes from "0" to "1", the "Count down" instruction executes and the value of the "Tag\_CounterValue" operand is decremented by one. With each additional positive signal edge, the counter value is decremented until it reaches the low limit of the specified data type (-128).

The operand "Tag\_Status" has the signal state "1" as long as the current counter value is less than or equal to zero. In all other cases, the "Tag\_Status" output has signal state "0". The current counter value is stored in the "Tag\_CounterValue" operand.

## See also

Overview of the valid data types (Page 1077)

Entering SCL instructions (Page 1357)

Editing SCL instructions (Page 1374)

## CTUD: Count up and down

### Description

Use the "Count up and down" instruction to increment or decrement the counter value at the CV parameter. When the signal state of the CU parameter changes from "0" to "1" (positive signal edge), the current counter value of the CV parameter is incremented by one. When the signal state of the CD parameter changes from "0" to "1" (positive signal edge), the counter value of the CV parameter is decremented by one. If there is a positive signal edge at the CU and CD inputs in one program cycle, the current counter value of the CV parameter remains unchanged.

The counter value can be incremented until it reaches the high limit value of the data type specified for the CV parameter. When the high limit value is reached, the counter value is no longer incremented on a positive signal edge. When the low limit value of the specified data type is reached, the counter value is not decremented any further.

When the signal state of the LD parameter changes to "1", the counter value of the CV parameter is set to the value of the PV parameter. As long as the LD parameter has the signal state "1", the signal state of the CU and CD parameters has no effect on the instruction.

The counter value is set to zero when the signal state of the parameter R changes to "1". As long as the parameter R has signal state "1", a change in the the signal state of the parameters CU, CD and LD has no effect on the "Count up and down" instruction.

You can scan the current status of the up counter based on the value of the QU parameter. When the current counter value is greater than or equal to the value of the PV parameter, the QU parameter is set to signal state "1". In all other cases, the signal state of the QU parameter is "0". You can also specify a constant for the PV parameter.

You can scan the current status of the down counter based on the value of the QD parameter. If the current counter value is less than or equal to zero, the QD parameter is set to signal state "1". In all other cases, the signal state of the QD parameter is "0".

**Note**

Only use a counter at a single location in the program to avoid risk of counting errors.

Each call of the "Count up and down" instruction must be assigned an IEC counter in which the instruction data is stored. An IEC counter is a structure with one of the following data types:

**For S7-1200 CPU**

Data block of system data type IEC_counter (global DB)	Local tag
<ul style="list-style-type: none"> <li>• IEC_SCOUNTER / IEC_USCOUNTER</li> <li>• IEC_COUNTER / IEC_UCOUNTER</li> <li>• IEC_DCOUNTER / IEC_UDCOUNTER</li> </ul>	<ul style="list-style-type: none"> <li>• CTUD_SINT / CTUD_USINT</li> <li>• CTUD_INT / CTUD_UINT</li> <li>• CTUD_DINT / CTUD_UDINT</li> </ul>

**For S7-1500 CPU**

Data block of system data type IEC_counter (global DB)	Local tag
<ul style="list-style-type: none"> <li>• IEC_SCOUNTER / IEC_USCOUNTER</li> <li>• IEC_COUNTER / IEC_UCOUNTER</li> <li>• IEC_DCOUNTER / IEC_UDCOUNTER</li> <li>• IEC_LCOUNTER / IEC_ULCOUNTER</li> </ul>	<ul style="list-style-type: none"> <li>• CTUD_SINT / CTUD_USINT</li> <li>• CTUD_INT / CTUD_UINT</li> <li>• CTUD_DINT / CTUD_UDINT</li> <li>• CTUD_LINT / CTUD_ULINT</li> </ul>

You can declare an IEC counter as follows:

- Declaration of a data block of system data type IEC\_COUNTER (for example, "MyIEC\_COUNTER")
- Declaration as a local tag of the CTUD type in the "Static" section of a block (for example, #MyCTUD\_COUNTER)

When you insert the instruction in the program, the "Call options" dialog opens in which you can specify whether the IEC counter is stored in its own data block (single instance) or as a

local tag (multiple instance) in the block interface. If you create a separate data block, you will find it in the project tree in the "Program resources" folder under "Program blocks > System blocks". For additional information on this topic, refer to "See also".

## Syntax

The following syntax is used for the "Count up and down" instruction:

Table 9-32 Data block of system data type IEC\_counter (global DB)

### SCL

```
<IEC_Counter_DB>.CTUD(CU := <Operand>,
                      CD := <Operand>,
                      R := <Operand>,
                      LD := <Operand>,
                      PV := <Operand>,
                      QU=> <Operand>,
                      QD := <Operand>,
                      CV=> <Operand>)
```

Table 9-33 Local tag

### SCL

```
myLocal_counter(CU := <Operand>,
                CD := <Operand>,
                R := <Operand>,
                LD := <Operand>,
                PV := <Operand>,
                QU=> <Operand>,
                QD := <Operand>,
                CV=> <Operand>)
```

The syntax of the instruction consists of the following parts:

Parameter	Declaration	Data type	Description
CU	Input	BOOL	Count up input
CD	Input	BOOL	Count down input
R	Input	BOOL	Reset input
LD	Input	BOOL	Load input
PV	Input	Integers	Value at which the output QU is set.
QU	Output	BOOL	Status of the counter up
QD	Output	BOOL	Status of the counter down
CV	Output	Integers, CHAR, DATE	Current counter value

For additional information on valid data types, refer to "See also".

## Example

The following example shows how the instruction works:

```
SCL
"IEC_COUNTER_DB".CTUD(CU := "Tag_Start1",
                      CD := "Tag_Start2",
                      LD := "Tag_Load",
                      R := "Tag_Reset",
                      PV := "Tag_PresetValue",
                      QU => "Tag_CU_Status",
                      QD => "Tag_CD_Status",
                      CV => "Tag_CounterValue");
```

If the "Tag\_Start1" operand has a positive signal edge in the signal state, the current counter value is incremented by one and stored in the "Tag\_CounterValue" operand. If the "Tag\_Start2" operand has a positive signal edge in the signal state, the counter value is decremented by one and is also stored in the "Tag\_CounterValue" operand. The counter value is incremented on the positive signal edge of the CU parameter until it reaches the high limit of the specified data type (INT). If the CD parameter has a positive signal edge, the counter value is decremented until it reaches the low limit of the specified data type (INT).

The operand "Tag\_CU\_Status" has the signal state "1" as long as the current counter value is greater than or equal to the value of the operand "Tag\_PresetValue". In all other cases, the "Tag\_CU\_Status" output has signal state "0".

The operand "Tag\_CD\_Status" has the signal state "1" as long as the current counter value is less than or equal to zero. In all other cases, the "Tag\_CD\_Status" output has signal state "0".

## See also

[Overview of the valid data types \(Page 1077\)](#)

[Entering SCL instructions \(Page 1357\)](#)

[Editing SCL instructions \(Page 1374\)](#)

## SIMATIC Counters

### S\_CU: Assign parameters and count up

#### Description

You can use the "Assign parameters and count up" instruction to increment the value of a counter. When the signal state of the parameter CU changes from "0" to "1" (positive signal edge), the current counter value is incremented by one. The current counter value is provided at the parameter CV. The counter value is incremented until the limit of "999" is reached. When the limit value is reached, the counter value is no longer incremented on a positive signal edge.

When the signal state of the parameter S changes from "0" to "1", the counter value is set to the value of the parameter PV. If the counter is set and if the result of logic operation (RLO) at the CU input is "1", the counter counts once in the next cycle, even when no signal edge change is detected.

The counter value is set to zero when the signal state of the parameter R changes to "1". As long as the parameter R has the signal state "1", a change in the signal state of the parameters CU and S has no effect on the counter value.

The signal state at parameter Q is "1" if the counter value is greater than zero. When the counter value equals zero, parameter Q returns signal state "0".

---

#### Note

Only use a counter at a single location in the program to avoid risk of counting errors.

---

## Syntax

The following syntax is used for the "Assign parameters and count up" instruction:

#### SCL

```
S_CU(C_NO := <Operand>,
      CU:= <Operand>,
      S := <Operand>,
      PV := <Operand>,
      R := <Operand>,
      Q => <Operand>,
      CV=> <Operand>)
```

The syntax of the instruction consists of the following parts:

Parameter	Declaration	Data type	Description
C_NO	Input	COUNTER, INT	Counters The number of counters depends on the CPU.
CU	Input	BOOL	Count up input
S	Input	BOOL	Input for presetting the counter
PV	Input	WORD	Preset counter value (C#0 to C#999) in BCD format
R	Input	BOOL	Reset input
Q	Output	BOOL	Status of the counter
CV	Output	WORD, S5TIME, DATE	Current counter value
Function value		WORD, S5TIME, DATE	Current counter value in BCD format

For additional information on valid data types, refer to "See also".

## Example

The following example shows how the instruction works:

```
SCL  
"Tag_Result" := S_CU(C_NO := "Counter_1",  
                    CU := "Tag_Start",  
                    S := "Tag_1",  
                    PV := "Tag_PresetValue",  
                    R := "Tag_Reset",  
                    Q => "Tag_Status",  
                    CV => "Tag_Value");
```

If the signal state of the parameter "Tag\_Start" changes from "0" to "1" (positive signal edge) and the current counter value is less than "999", the counter value is incremented by one. If the signal state of the input "Tag\_1" changes from "0" to "1", the counter value in BCD format is set to the value of the operand "Tag\_PresetValue". The counter value is reset to "0" when the operand "Tag\_Reset" has signal state "1".

The current counter value is stored in hexadecimal form in the operand "Tag\_Value".

The output "Tag\_Status" has the signal state "1" as long as the current counter value is not equal to "0". The current counter value is returned in the "Tag\_Value" operand and as a function value.

## See also

Overview of the valid data types (Page 1077)

Entering SCL instructions (Page 1357)

Editing SCL instructions (Page 1374)

## S\_CD: Assign parameters and count down

### Description

You can use the "Assign parameters and count down" instruction to decrement the value of a counter. When the signal state of the parameter CD changes from "0" to "1" (positive signal edge), the current counter value is decreased by one. The current counter value is provided at the parameter CV. The counter value is decreased until the low limit of "0" is reached. When the low limit value is reached, the counter value is no longer decreased on a positive signal edge.

When the signal state of the parameter S changes from "0" to "1", the counter value is set to the value of the parameter PV. If the counter is set and if the result of logic operation (RLO) at the parameter CD is "1", the counter counts once in the next cycle, even when no signal edge change is detected.

The counter value is set to zero when the signal state of the parameter R changes to "1". As long as the parameter R has the signal state "1", a change in the signal state of the parameters CD and S has no effect on the counter value.

The signal state at parameter Q is "1" if the counter value is greater than zero. When the counter value equals zero, parameter Q returns signal state "0".

### Note

Only use a counter at a single location in the program to avoid risk of counting errors.

## Syntax

The following syntax is used for the "Assign parameters and count down" instruction:

```

SCL
S_CD(C_NO:= <Operand>,
      CD:= <Operand>,
      S:= <Operand>,
      PV:= <Operand>,
      R:= <Operand>,
      Q=> <Operand>,
      CV=> <Operand>)

```

The syntax of the instruction consists of the following parts:

Parameter	Declaration	Data type	Description
C_NO	Input	COUNTER, INT	Counters The number of counters depends on the CPU.
CD	Input	BOOL	Count down input
S	Input	BOOL	Input for presetting the counter
PV	Input	WORD	Preset counter value (C#0 to C#999) in BCD format
R	Input	BOOL	Reset input
Q	Output	BOOL	Status of the counter
CV	Output	WORD, S5TIME, WORD	Current counter value
Function value		WORD, S5TIME, DATE	Current counter value in BCD format

For additional information on valid data types, refer to "See also".

## Example

The following example shows how the instruction works:

```

SCL
"Tag_Result" := S_CD(C_NO := "Counter_1",

```

```
SCL
CD := "Tag_Start",
S := "Tag_1",
PV := "Tag_PresetValue",
R := "Tag_Reset",
Q => "Tag_Status",
CV => "Tag_Value");
```

When the signal state of the operand "Tag\_Start" changes from "0" to "1" (positive signal edge) and the current counter value is greater than "0", the counter value is decreased by one. If the signal state of the operand "Tag\_1" changes from "0" to "1", the counter value is set to the value of the operand "Tag\_PresetValue". The counter value is reset to "0" when the operand "Tag\_Reset" has signal state "1".

The current counter value is stored in the operand "Tag\_Value".

The operand "Tag\_Status" returns signal state "1" as long as the current counter value is not equal to "0". The current counter value is returned in the "Tag\_Value" operand and as a function value.

**See also**

Overview of the valid data types (Page 1077)

Entering SCL instructions (Page 1357)

Editing SCL instructions (Page 1374)

**S\_CUD: Assign parameters and count up / down**

**Description**

You can use the "Assign parameters and count up / down" instruction to increment and decrement the value of a counter. When the signal state of the parameter CU changes from "0" to "1" (positive signal edge), the current counter value is incremented by one. When the signal state of the parameter CD changes from "0" to "1" (positive signal edge), the counter value is decreased by one. The current counter value is provided at the parameter CV. If there is a positive signal edge at the parameters CU and CD in one program cycle, the counter value remains unchanged.

The counter value is incremented until the high limit value of "999" is reached. When the high limit value is reached, the counter value is no longer incremented on a positive signal edge. When the low limit value "0" is reached, the counter value is not decremented any further.

When the signal state of the parameter S changes from "0" to "1", the counter value is set to the value of the parameter PV. If the counter is set and if the result of logic operation (RLO) of the parameters CU and CD is "1", the counter will count once in the next cycle, even if no signal edge change was detected.

The counter value is set to zero when the signal state of the parameter R changes to "1". As long as the parameter R has the signal state "1", processing of the signal state of the parameters CU, CD and S has no effect on the counter value.



The signal state at parameter Q is "1" if the counter value is greater than zero. When the counter value equals zero, parameter Q returns signal state "0".

### Note

Only use a counter at a single location in the program to avoid risk of counting errors.

## Syntax

The following syntax is used for the "Assign parameters and count up / down" instruction:

```

SCL
S_CUD(C_NO:= <Operand>,
      CU:= <Operand>,
      CD:= <Operand>,
      S:= <Operand>,
      PV:= <Operand>,
      R:= <Operand>,
      Q=> <Operand>,
      CV=> <Operand>)

```

The syntax of the instruction consists of the following parts:

Parameter	Declaration	Data type	Description
C_NO	Input	COUNTER, INT	Counters The number of counters depends on the CPU.
CU	Input	BOOL	Count up input
CD	Input	BOOL	Count down input
S	Input	BOOL	Input for presetting the counter
PV	Input	WORD	Preset counter value (C#0 to C#999) in BCD format
R	Input	BOOL	Reset input
Q	Output	BOOL	Status of the counter
CV	Output	WORD, S5TIME, DATE	Current counter value (hexadecimal)
Function value		WORD, S5TIME, DATE	Current counter value in BCD format

For additional information on valid data types, refer to "See also".

## Example

The following example shows how the instruction works:

```
SCL
"Tag_Result" := S_CD(C_NO := "Counter_1",
                    CU := "Tag_CU",
                    CD := "Tag_CD",
                    S := "Tag_1",
                    PV := "Tag_PresetValue",
                    R := "Tag_Reset",
                    Q => "Tag_Status",
                    CV => "Tag_Value");
```

When a positive signal edge is detected in the signal state of the operand "Tag\_CU" and the current counter value is less than "999", the counter value is incremented by one. When a positive signal edge is detected in the signal state of the operand "Tag\_CD" and the current counter value is greater than "0", the counter value is decremented by one.

If the signal state of the operand "Tag\_1" changes from "0" to "1", the counter value is set to the value of the operand "Tag\_PresetValue". The counter value is reset to "0" when the operand "Tag\_Reset" has signal state "1".

The current counter value is stored in the operand "Tag\_Value".

The operand "Tag\_Status" returns signal state "1" as long as the current counter value is not equal to "0". The current counter value is returned in the "Tag\_Value" operand and as a function value.

## See also

[Overview of the valid data types \(Page 1077\)](#)

[Entering SCL instructions \(Page 1357\)](#)

[Editing SCL instructions \(Page 1374\)](#)

## Math functions

### ABS: Form absolute value

#### Description

Use the "Form absolute value" instruction to calculate the absolute value of an input value and to save the result in the specified operands.

## Syntax

Use the following syntax for the "Form absolute value" instruction:

```
SCL
ABS (<Expression>)
```

The syntax of the instruction consists of the following parts:

Parameter	Declaration	Data type		Description
		S7-1200	S7-1500	
<Expression>	Input	SINT, INT, DINT, floating-point numbers	SINT, INT, DINT, LINT, floating-point numbers	Input value
Function value		SINT, INT, DINT, floating-point numbers	SINT, INT, DINT, LINT, floating-point numbers	Absolute value of the input value

For additional information on valid data types, refer to "See also".

## Example

The following example shows how the instruction works:

```
SCL
"Tag_Result1" := ABS("Tag_Value");
"Tag_Result2" := ABS("Tag_Value1"*"Tag_Value2");
```

The absolute value of the input value is returned in the format of the input value as a function value.

The following table shows how the instruction works using specific operand values:

Operand	Value
Tag_Value	-2
Tag_Result1	2
Tag_Value1	4
Tag_Value2	-1
Tag_Result2	4

## See also

- Overview of the valid data types (Page 1077)
- Expressions (Page 1341)
- Operators and operator precedence (Page 1347)
- Entering SCL instructions (Page 1357)
- Editing SCL instructions (Page 1374)

## MIN: Get minimum

### Description

The "Get minimum" instruction compares the values of the available inputs and returns the lowest value as the result.

A minimum of two and a maximum of 32 inputs can be specified at the instruction.

The result is invalid if any of the following conditions are met:

- The implicit conversion of the data types fails during execution of the instruction.
- A floating-point number has an invalid value.

### Syntax

The following syntax is used for the "Get minimum" instruction:

```

SCL
MIN(IN1 := <Operand>,
    IN2 := <Operand>)
    
```

### Parameter

The following table shows the parameters of the "Get minimum" instruction:

Parameter	Declaration	Data type		Description
		S7-1200	S7-1500	
IN1	Input	Integers, floating-point numbers, TIME, TOD, DATE, DTL	Integers, floating-point numbers, TIME, LTIME, TOD, LTOD, DATE, LDT, DT, DTL	First input value
IN2	Input	Integers, floating-point numbers, TIME, TOD, DATE, DTL	Integers, floating-point numbers, TIME, LTIME, TOD, LTOD, DATE, LDT, DT, DTL	Second input value

Parameter	Declaration	Data type		Description
		S7-1200	S7-1500	
INn	Input	Integers, floating-point numbers, TIME, TOD, DATE, DTL	Integers, floating-point numbers, TIME, LTIME, TOD, LTOD, DATE, LDT, DT, DTL	Additionally inserted inputs whose values are to be compared
Function value		Integers, floating-point numbers, TIME, TOD, DATE, DTL	Integers, floating-point numbers, TIME, LTIME, TOD, LTOD, DATE, LDT, DT, DTL	Result of the instruction

For more information on valid data types, refer to "See also".

## Example

The following example shows how the instruction works:

```
SCL
"Tag_Result" := MIN(IN1 := "Tag_Value1",
                    IN2 := "Tag_Value2",
                    IN3 := "Tag_Value3");
```

The following table shows how the instruction works using specific operand values:

Parameter	Operand	Value
IN1	Tag_Value1	12222
IN2	Tag_Value2	14444
IN3	Tag_Value3	13333
Function value	Tag_Result	12222

The instruction compares the values of the available inputs and copies the lowest value ("Tag\_Value1") to operand "Tag\_Result".

## See also

Overview of the valid data types (Page 1077)

Expressions (Page 1341)

Operators and operator precedence (Page 1347)

Entering SCL instructions (Page 1357)

Editing SCL instructions (Page 1374)

## MAX: Get maximum

### Description

The "Get maximum" instruction compares the values of the available inputs and returns the greatest value as the result.

A minimum of two and a maximum of 32 inputs can be specified at the instruction.

The result is invalid if any of the following conditions are met:

- The implicit conversion of the data types fails during execution of the instruction.
- A floating-point number has an invalid value.

### Syntax

The following syntax is used for the "Get maximum" instruction:

```

SCL
MAX(IN1 := <Operand>,
    IN2 := <Operand>)
    
```

### Parameter

The following table shows the parameters of the "Get maximum" instruction:

Parameter	Declaration	Data type		Description
		S7-1200	S7-1500	
IN1	Input	Integers, floating-point numbers, TIME, TOD, DATE, DTL	Integers, floating-point numbers, TIME, LTIME, TOD, LTOD, DATE, LDT, DT, DTL	First input value
IN2	Input	Integers, floating-point numbers, TIME, TOD, DATE, DTL	Integers, floating-point numbers, TIME, LTIME, TOD, LTOD, DATE, LDT, DT, DTL	Second input value

Parameter	Declaration	Data type		Description
		S7-1200	S7-1500	
INn	Input	Integers, floating-point numbers, TIME, TOD, DATE, DTL	Integers, floating-point numbers, TIME, LTIME, TOD, LTOD, DATE, LDT, DT, DTL	Additionally inserted inputs whose values are to be compared
Function value		Integers, floating-point numbers, TIME, TOD, DATE, DTL	Integers, floating-point numbers, TIME, LTIME, TOD, LTOD, DATE, LDT, DT, DTL	Result of the instruction

For more information on valid data types, refer to "See also".

## Example

The following example shows how the instruction works:

```
SCL
"Tag_Result" := MAX(IN1 := "Tag_Value1",
                   IN2 := "Tag_Value2",
                   IN3 := "Tag_Value3");
```

The following table shows how the instruction works using specific operand values:

Parameter	Operand	Value
IN1	Tag_Value1	12 222
IN2	Tag_Value2	14 444
IN3	Tag_Value3	13 333
Function value	Tag_Result	14 444

The instruction compares the values of the specified operands and copies the greatest value ("Tag\_Value2") to the operand "Tag\_Result".

## See also

Overview of the valid data types (Page 1077)

Expressions (Page 1341)

Operators and operator precedence (Page 1347)

Entering SCL instructions (Page 1357)

Editing SCL instructions (Page 1374)

**LIMIT: Set limit value**

**Description**

The "Set limit value" instruction limits the value of the parameter IN to the values of the parameters MN and MX. The value of the parameter MN may not be greater than the value of the parameter MX.

If the value of the parameter IN fulfills the MN condition  $\leq IN \leq MX$ , it is returned as the result of the instruction. If the condition is not fulfilled and the IN input value is less than the MN low limit, the value of the MN parameter is returned as the result. If the high limit MX is exceeded, the value of the MX parameter is returned as the result.

If the value of the MN input is greater than the value of the MX input, the result is undefined.

The instruction is only executed if the operands of all parameters are of the same data type.

**Syntax**

The following syntax is used for the "Set limit value" instruction:

**SCL**

```
LIMIT (MN := <Operand>,
       IN := <Operand>,
       MX := <Operand>)
```

The syntax of the instruction consists of the following parts:

Parameter	Declaration	Data type		Description
		S7-1200	S7-1500	
MN	Input	Integers, floating-point numbers, TIME, TOD, DATE, DTL	Integers, floating-point numbers, TIME, LTIME, TOD, LTOD, DATE, LDT, DT, DTL	Low limit
IN	Input	Integers, floating-point numbers, TIME, TOD, DATE, DTL	Integers, floating-point numbers, TIME, LTIME, TOD, LTOD, DATE, LDT, DT, DTL	Input value



Parameter	Declaration	Data type		Description
		S7-1200	S7-1500	
MX	Input	Integers, floating-point numbers, TIME, TOD, DATE, DTL	Integers, floating-point numbers, TIME, LTIME, TOD, LTOD, DATE, LDT, DT, DTL	High limit
Function value		Integers, floating-point numbers, TIME, TOD, DATE, DTL	Integers, floating-point numbers, TIME, LTIME, TOD, LTOD, DATE, LDT, DT, DTL	Result of the instruction

For more information on valid data types, refer to "See also".

## Example

The following example shows how the instruction works:

```
SCL
"Tag_Result" := LIMIT(MN := "Tag_Minimum",
                     IN := "Tag_Value",
                     MX := "Tag_Maximum");
```

The following table shows how the instruction works using specific operand values:

Parameter	Operand	Value
MN	Tag_Minimum	12 000
IN	Tag_Value	8 000
MX	Tag_Maximum	16 000
Function value	Tag_Result	12 000

The value of operand "Tag\_Value" is compared with the values of operands "Tag\_Minimum" and "Tag\_Maximum". Because the value of the operand "Tag\_Value" is less than the low limit value, the value of operand "Tag\_Minimum" will be copied to operand "Tag\_Result".

## See also

Overview of the valid data types (Page 1077)

Expressions (Page 1341)

Operators and operator precedence (Page 1347)

Entering SCL instructions (Page 1357)

Editing SCL instructions (Page 1374)

## SQR: Form square

### Description

Use the "Form square" instruction to square the input value and save the result in the specified operand.

### Syntax

Use the following syntax for the instruction "Form square":

<b>SCL</b>
SQR(<Expression>)

The syntax of the instruction consists of the following parts:

Parameter	Declaration	Data type	Description
<Expression>	Input	Floating-point numbers	Input value
Function value		Floating-point numbers	Square of the input value

For additional information on valid data types, refer to "See also".

### Example

The following example shows how the instruction works:

<b>SCL</b>
"Tag_Result1" := SQR("Tag_Value");
"Tag_Result2" := SQR(SQR("Tag_Value1"))*"Tag_Value2";

The square of the input value is returned in the operand "Tag\_Result" as a function value.

The following table shows how the instruction works using specific operand values:

Operand	Value
Tag_Value	2.5
Tag_Result1	6.25
Tag_Value1	6.0
Tag_Value2	2.0
Tag_Result2	5184.0

**See also**

Overview of the valid data types (Page 1077)  
 Expressions (Page 1341)  
 Operators and operator precedence (Page 1347)  
 Entering SCL instructions (Page 1357)  
 Editing SCL instructions (Page 1374)

**SQRT: Form square root****Description**

Use the "Form square root" instruction to calculate the square root of the the input value and save the result in the specified operand. The instruction has a positive result if the input value is greater than zero. If input values are less than zero, the instruction returns an invalid floating-point number. If the input value is "-0", the result is also "-0".

**Syntax**

Use the following syntax for the "Form square root" instruction:

```
SCL
SQRT (<Expression>)
```

The syntax of the instruction consists of the following parts:

Parameter	Declaration	Data type	Description
<Expression>	Input	Floating-point numbers	Input value
Function value		Floating-point numbers	Square root of the input value

For additional information on valid data types, refer to "See also".

**Example**

The following example shows how the instruction works:

```
SCL
"Tag_Result1" := SQRT("Tag_Value");
"Tag_Result2" := SQRT((SQR("Tag_Value1"))+"Tag_Value2");
```

The square root of the input value is returned in the operand "Tag\_Result" as a function value.

The following table shows how the instruction works using specific operand values:

Operand	Value
Tag_Value	4.0
Tag_Result1	2.0
Tag_Value1	3.0
Tag_Value2	16.0
Tag_Result2	5.0

**See also**

- Overview of the valid data types (Page 1077)
- Expressions (Page 1341)
- Operators and operator precedence (Page 1347)
- Entering SCL instructions (Page 1357)
- Editing SCL instructions (Page 1374)

**LN: Form natural logarithm**

**Description**

You can use the "Form natural logarithm" instruction to calculate the natural logarithm to base e (e=2.718282) of the input value. The instruction has a positive result if the input value is greater than zero. If input values are less than zero, the instruction returns an invalid floating-point number.

**Syntax**

Use the following syntax for the "Form natural logarithm" instruction:

```

scl
LN(<Expression>
    
```

The syntax of the instruction consists of the following parts:

Parameter	Declaration	Data type	Description
<Expression>	Input	Floating-point numbers	Input value
Function value		Floating-point numbers	Natural logarithm of the input value

For additional information on valid data types, refer to "See also".

## Example

The following example shows how the instruction works:

```
SCL
"Tag_Result1" := LN("Tag_Value");
"Tag_Result2" := LN("Tag_Value1"+"Tag_Value2");
```

The result of the instruction is returned in the operand "Tag\_Result" as a function value.

The following table shows how the instruction works using specific operand values:

Operand	Value
Tag_Value	2.5
Tag_Result1	0.916
Tag_Value1	1.5
Tag_Value2	3.2
Tag_Result2	1.548

## See also

Overview of the valid data types (Page 1077)

Expressions (Page 1341)

Operators and operator precedence (Page 1347)

Entering SCL instructions (Page 1357)

Editing SCL instructions (Page 1374)

## EXP: Form exponential value

### Description

The "Form exponential value" instruction calculates the exponent from the base e (e = 2.718282) and the input value and saves the result in the specified operand.

### Syntax

The following syntax is used for the "Form exponential value" instruction:

```
SCL
EXP(<Expression>)
```

The syntax of the instruction consists of the following parts:

Parameter	Declaration	Data type	Description
<Expression>	Input	Floating-point numbers	Input value
Function value		Floating-point numbers	Exponential value of the input value

For additional information on valid data types, refer to "See also".

### Example

The following example shows how the instruction works:

```

SCL
"Tag_Result1" := EXP("Tag_Value");
"Tag_Result2" := EXP("Tag_Value1"/"Tag_Value2");
    
```

The result of the instruction is returned in the operand "Tag\_Result" as a function value.

The following table shows how the instruction works using specific operand values:

Operand	Value
Tag_Value	20.5
Tag_Result1	799 902 200
Tag_Value1	15.5
Tag_Value2	30.2
Tag_Result2	1.671

### See also

- Overview of the valid data types (Page 1077)
- Expressions (Page 1341)
- Operators and operator precedence (Page 1347)
- Entering SCL instructions (Page 1357)
- Editing SCL instructions (Page 1374)

### SIN: Form sine value

#### Description

Use the "Form sine value" instruction to calculate the sine of the input value. The input value must be given in the radian measure.

## Syntax

Use the following syntax for the "Form sine value" instruction:

<b>SCL</b>
SIN(<Expression>)

The syntax of the instruction consists of the following parts:

Parameter	Declaration	Data type	Description
<Expression>	Input	Floating-point numbers	Input value (size of an angle in the radian measure)
Function value		Floating-point numbers	Result of the instruction

For additional information on valid data types, refer to "See also".

## Example

The following example shows how the instruction works:

<b>SCL</b>
"Tag_Result" := SIN("Tag_Value");

The result of the instruction is returned in the "Tag\_Result" operand as a function value.

The following table shows how the instruction works using specific operand values:

Operand	Value
Tag_Value	+1.570796 ( $\pi/2$ )
Tag_Result	1.0

## See also

Overview of the valid data types (Page 1077)

Expressions (Page 1341)

Operators and operator precedence (Page 1347)

Entering SCL instructions (Page 1357)

Editing SCL instructions (Page 1374)

## COS: Form cosine value

### Description

Use the "Form cosine value" instruction to calculate the cosine of the input value. The input value must be given in the radian measure.

**Syntax**

Use the following syntax for the "Form cosine value" instruction:

```
SCL
COS (<Expression>)
```

The syntax of the instruction consists of the following parts:

Parameter	Declaration	Data type	Description
<Expression>	Input	Floating-point numbers	Input value (size of an angle in the radian measure)
Function value		Floating-point numbers	Result of the instruction

For additional information on valid data types, refer to "See also".

**Example**

The following example shows how the instruction works:

```
SCL
"Tag_Result" := COS("Tag_Value");
```

The result of the instruction is returned in the operand "Tag\_Result" as a function value.

The following table shows how the instruction works using specific operand values:

Operand	Value
Tag_Value	+1.570796 ( $\pi/2$ )
Tag_Result	0

**See also**

- Overview of the valid data types (Page 1077)
- Expressions (Page 1341)
- Operators and operator precedence (Page 1347)
- Entering SCL instructions (Page 1357)
- Editing SCL instructions (Page 1374)

**TAN: Form tangent value**

**Description**

Use the "Form tangent value" instruction to calculate the sine of the input value. The input value must be given in the radian measure.



## Syntax

Use the following syntax for the "Form tangent value" instruction:

<b>SCL</b>
TAN(<Expression>)

The syntax of the instruction consists of the following parts:

Parameter	Declaration	Data type	Description
<Expression>	Input	Floating-point numbers	Input value (size of an angle in the radian measure)
Function value		Floating-point numbers	Result of the instruction

For additional information on valid data types, refer to "See also".

## Example

The following example shows how the instruction works:

<b>SCL</b>
"Tag_Result" := TAN("Tag_Value");

The result of the instruction is returned in the operand "Tag\_Result" as a function value.

The following table shows how the instruction works using specific operand values:

Operand	Value
Tag_Value	+3.141593 ( $\pi$ )
Tag_Result	0

## See also

Overview of the valid data types (Page 1077)

Expressions (Page 1341)

Operators and operator precedence (Page 1347)

Entering SCL instructions (Page 1357)

Editing SCL instructions (Page 1374)

## ASIN: Form arcsine value

### Description

You can use the "Form arcsine value" instruction to calculate the size of the angle from a sine value, which corresponds to this value. Only valid floating-point numbers within the range -1

to +1 can be specified as input values. The calculated angle size is given in the radian measure and can range in value from  $-\pi/2$  to  $+\pi/2$ .

### Syntax

Use the following syntax for the "Form arcsine value" instruction:

```
SCL
ASIN(<Expression>)
```

The syntax of the instruction consists of the following parts:

Parameter	Declaration	Data type	Description
<Expression>	Input	Floating-point numbers	Sine value
Function value		Floating-point numbers	Size of angle in the radian measure

For additional information on valid data types, refer to "See also".

### Example

The following example shows how the instruction works:

```
SCL
"Tag_Result" := ASIN("Tag_Value");
```

The result of the instruction is returned in the operand "Tag\_Result" as a function value.

The following table shows how the instruction works using specific operand values:

Operand	Value
Tag_Value	1.0
Tag_Result	+1.570796 ( $\pi/2$ )

### See also

- Overview of the valid data types (Page 1077)
- Expressions (Page 1341)
- Operators and operator precedence (Page 1347)
- Entering SCL instructions (Page 1357)
- Editing SCL instructions (Page 1374)

## ACOS: Form arccosine value

### Description

You can use the "Form arccosine value" instruction to calculate the size of the angle from a cosine value, which corresponds to this value. Only valid floating-point numbers within the range -1 to +1 can be specified as input values. The calculated angle size is given in the radian measure and can range in value from 0 to  $+\pi$ .

### Syntax

Use the following syntax for the "Form arccosine value" instruction:

<b>SCL</b>
ACOS (<Expression>)

The syntax of the instruction consists of the following parts:

Parameter	Declaration	Data type	Description
<Expression>	Input	Floating-point numbers	Cosine value
Function value		Floating-point numbers	Size of angle in the radian measure

For additional information on valid data types, refer to "See also".

### Example

The following example shows how the instruction works:

<b>SCL</b>
"Tag_Result" := ACOS("Tag_Value");

The result of the instruction is returned in the "Tag\_Result" operand as a function value.

The following table shows how the instruction works using specific operand values:

Operand	Value
Tag_Value	0
Tag_Result	+1.570796 ( $\pi/2$ )

**See also**

- Overview of the valid data types (Page 1077)
- Expressions (Page 1341)
- Operators and operator precedence (Page 1347)
- Entering SCL instructions (Page 1357)
- Editing SCL instructions (Page 1374)

**ATAN: Form arctangent value**

**Description**

You can use the "Form arctangent value" instruction to calculate the size of the angle from a tangent value, which corresponds to this value. Only valid floating-point numbers may be specified as input values. The calculated angle size is given in the radian measure and can range in value from  $-\pi/2$  to  $+\pi/2$ .

**Syntax**

Use the following syntax for the "Form arctangent value" instruction:

```
SCL
ATAN(<Expression>)
```

The syntax of the instruction consists of the following parts:

Parameter	Declaration	Data type	Description
<Expression>	Input	Floating-point numbers	Tangent value
Function value		Floating-point numbers	Size of angle in the radian measure

For additional information on valid data types, refer to "See also".

**Example**

The following example shows how the instruction works:

```
SCL
"Tag_Result" := ATAN("Tag_Value");
```

The result of the instruction is returned in the operand "Tag\_Result" as a function value.

The following table shows how the instruction works using specific operand values:

Operand	Value
Tag_Value	1.0
Tag_Result	+0.785398 ( $\pi/4$ )

## See also

Overview of the valid data types (Page 1077)

Expressions (Page 1341)

Operators and operator precedence (Page 1347)

Entering SCL instructions (Page 1357)

Editing SCL instructions (Page 1374)

## FRAC: Return fraction

### Description

The result of the instruction "Return fraction" returns the decimal places of a value. Input value 123.4567, for example, returns the value 0.4567.

### Syntax

The following syntax is used for the instruction "Return fraction":

```
SCL
FRAC (<Expression>)
FRAC_<Data type> (<Expression>)
```

The syntax of the instruction consists of the following parts:

Parameter	Declaration	Data type	Description
<Expression>	Input	Floating-point numbers	Input value
_<Data type>		Floating-point numbers Default: REAL	Data type of the function value: <ul style="list-style-type: none"> <li>You do not need to specify the data type if using the default.</li> <li>Any other valid data type you may use must be declared explicitly.</li> </ul>
Function value		Floating-point numbers	Decimal places of the input value

For additional information on valid data types, refer to "See also".

### Example

The following example shows how the instruction works:

```
SCL
"Tag_Result1" := FRAC("Tag_Value");
"Tag_Result2" := FRAC_LREAL("Tag_Value");
```

The following table shows how the instruction works using specific operand values:

Operand	Value	
Tag_Value	2.555	-1.4421
Tag_Result1	0.555	-0.4421

### See also

- Overview of the valid data types (Page 1077)
- Expressions (Page 1341)
- Operators and operator precedence (Page 1347)
- Entering SCL instructions (Page 1357)
- Editing SCL instructions (Page 1374)

### Move operations

#### MOVE\_BLK: Move block

#### Description

The instruction "Move block" copies the contents of a memory area (source area) to another memory area (destination area). The number of elements to be copied to the destination area is specified with the COUNT parameter. The width of the elements to be moved is defined by the width of the first element in the source area.

The instruction can only be executed if the source area and the destination area are of the same data type.

The value of the OUT output is invalid if the following condition is met:

- More data is moved than is made available at the IN parameter or OUT parameter.

#### Syntax

The following syntax is used for the instruction "Move block":

```
SCL
MOVE_BLK(IN := <Operand> ,
```

**SCL**

```
COUNT := <Operand>,
OUT => <Operand>
```

**Parameter**

The following table shows the parameters of the "Move block" instruction:

Parameter	Declaration	Data type		Description
		S7-1200	S7-1500	
IN <sup>1)</sup>	Input	Binary numbers, integers, floating-point numbers, TIME, DATE, CHAR, TOD	Binary numbers, integers, floating-point numbers, timers, DATE, CHAR, TOD, LTOD	The first element of the source area that is being copied
COUNT	Input	USINT, UINT, UDINT	USINT, UINT, UDINT, ULINT	Number of elements to be copied from the source area to the destination area
OUT <sup>1)</sup>	Output	Binary numbers, integers, floating-point numbers, TIME, DATE, CHAR, TOD	Binary numbers, integers, floating-point numbers, timers, DATE, CHAR, TOD, LTOD	The first element of the destination area to which the contents of the source area are being copied
<sup>1)</sup> The specified data types can only be used as elements of an ARRAY structure.				

For more information on valid data types, refer to "See also".

**Example**

The following example shows how the instruction works:

**SCL**

```
MOVE_BLK(IN := #a_array[2],
COUNT := "Tag_Count",
OUT => #b_array[1]);
```

The following table shows how the instruction works using specific operand values:

Parameter	Operand	Value
IN	a_array[2]	The data type of the a_array operand is Array [0..5] of INT. It consists of six elements of data type INT.
COUNT	Tag_Count	3
OUT	b_array[1]	The data type of the b_array operand is Array [0..6] of INT. It consists of seven elements of data type INT.

Starting from the third element, the instruction selects three INT elements from the #a\_array tag and copies their contents to the #b\_array output tag, beginning with the second element.

**See also**

- Overview of the valid data types (Page 1077)
- Entering SCL instructions (Page 1357)
- Editing SCL instructions (Page 1374)

**MOVE\_BLK\_VARIANT: Move block**

**Description**

The instruction "Move block" copies the contents of a memory area (source area) to another memory area (destination area). You can copy elements of an array to another array of the same data type. The size (number of elements) of the source and destination array may be different. You can copy several elements within an array or individual elements.

If you are using the instruction, the array must not yet be known at the time the block is created, as the source and the destination are transferred using VARIANT.

The counting at the parameters SRC\_INDEX and DEST\_INDEX always starts with the low limit "0", regardless of the later declaration of the array.

The instruction is not executed if more data is copied than is made available.

**Syntax**

The following syntax is used for the instruction "Move block":

```

SCL
MOVE_BLK_VARIANT (SRC := <Operand>,
                  COUNT := <Operand>,
                  SRC_INDEX := <Operand>,
                  DEST_INDEX := <Operand>,
                  DEST := <Operand>,
                  RET_VAL => <Operand>)
    
```



## Parameter

The following table shows the parameters of the "Move block" instruction:

Parameter	Declaration	Data type	Description
SRC	Input	VARIANT (array or single element)	The first element of the source area that is being copied
COUNT	Input	UDINT	Specifies the number of elements that will be copied. Set the value at the parameter COUNT to "1", if no Array is specified at the parameter SRC or the parameter DEST.
SRC_INDEX	Input	UDINT	<ul style="list-style-type: none"> <li>• If an Array is specified at parameter SRC, the parameter SRC_INDEX specifies the first element at the parameter SRC, which is to be copied.</li> <li>• If no Array is specified at the parameter SRC, then enter the value "0" at the parameter SRC_INDEX.</li> </ul>
DEST_INDEX	Input	UDINT	<ul style="list-style-type: none"> <li>• If an Array is specified at parameter DEST, the parameter DEST_INDEX specifies the first element at the parameter DEST, which is to be copied.</li> <li>• If no Array is specified at the parameter DEST, then enter the value "0" at the parameter DEST_INDEX.</li> </ul>
DEST	InOut	VARIANT	The first element of the source area that is being copied
RET_VAL	Output	INT	Error information: If an error occurs during the execution of the instruction, an error code is output at the RET_VAL parameter.

For more information on valid data types, refer to "See also".

**Parameter RET\_VAL**

The following table shows the meaning of the values of the RET\_VAL parameter:

Error code* (W#16#...)	Explanation
0000	No error
8082	Data types do not correspond
80B4	Data types do not correspond
8151	Code generation error at SRC parameter
8152	Code generation error at SRC parameter
8153	Code generation error at SRC parameter
8251	The COUNT parameter has an invalid value
8254	The COUNT parameter has an invalid value
8281	The COUNT parameter has an invalid value
8282	The COUNT parameter has an invalid value
8382	The value at the SRC_INDEX parameter is outside the limit of the VARIANT
8383	The value at the SRC_INDEX parameter is outside the high limit of the array.
8482	The value at the DEST_INDEX parameter is outside the limit of the VARIANT
8483	The value at the DEST_INDEX parameter is outside the high limit of the array.
8534	The DEST parameter is write protected
8551	Code generation error at DEST parameter
8552	Code generation error at DEST parameter
8553	Code generation error at DEST parameter
85A2	The DEST parameter is write protected
*The error codes can be displayed as integer or hexadecimal value in the program editor. For more information on toggling display formats, refer to "See also".	

**Example**

The following example shows how the instruction works:

**SCL**

```
MOVE_BLK_VARIANT(SRC := #SrcField,
                 COUNT := "Tag_Count",
                 SRC_INDEX := "Tag_Src_Index",
                 DEST_INDEX := "Tag_Dest_Index",
                 DEST := #DestField,
                 RET_VAL := "Tag_Result");
```

The following table shows how the instruction works using specific operand values:

Parameter	Operand	Value
SRC	#SrcField	The local operand #SrcField uses a UDT that was still unknown at the time when the block was programmed.
COUNT	Tag_Count	3
SRC_INDEX	Tag_Src_Index	4
DEST_INDEX	Tag_Dest_Index	2
DEST	#DestField	The local operand #DestField uses a UDT that was still unknown at the time when the block was programmed.

### See also

Overview of the valid data types (Page 1077)

Entering SCL instructions (Page 1357)

Editing SCL instructions (Page 1374)

### UMOVE\_BLK: Move block uninterruptible

#### Description

The instruction "Move block uninterruptible" copies the contents of a memory area (source area) to another memory area (destination area) without interruption. The number of elements to be copied to the destination area is specified with the COUNT parameter. The width of the elements to be moved is defined by the width of the first element in the source area.

The instruction can only be executed if the source area and the destination area have the same data type.

---

#### Note

The copy operation cannot be interrupted by other operating system activities. This is why the alarm reaction times of the CPU increase during the execution of the instruction "Move block uninterruptible".

---

The value of the OUT output is invalid if the following condition is met:

- More data is moved than is made available at the IN parameter or OUT parameter.

You can use the "Move block uninterruptible" instruction to move a maximum of 16 KB. Note the CPU-specific restrictions for this.

### Syntax

The following syntax is used for the instruction "Move block uninterruptible":

```

SCL
UMOVE_BLK(IN := <Operand>,
          COUNT := <Operand>,
          OUT => <Operand>)
    
```

### Parameter

The following table shows the parameters of the "Move block uninterruptible" instruction:

Parameter	Declaration	Data type		Description
		S7-1200	S7-1500	
IN <sup>1)</sup>	Input	Binary numbers, integers, floating-point numbers, TIME, DATE, CHAR, TOD	Binary numbers, integers, floating-point numbers, timers, DATE, CHAR, TOD, LTOD	The first element of the source area that is being copied
COUNT	Input	USINT, UINT, UDINT	USINT, UINT, UDINT, ULINT	Number of elements to be copied from the source area to the destination area
OUT <sup>1)</sup>	Output	Binary numbers, integers, floating-point numbers, TIME, DATE, CHAR, TOD	Binary numbers, integers, floating-point numbers, timers, DATE, CHAR, TOD, LTOD	The first element of the destination area to which the contents of the source area are being copied
<sup>1)</sup> The specified data types can only be used as elements of an ARRAY structure.				

For additional information on valid data types, refer to "See also".

### Example

The following example shows how the instruction works:

```

SCL
UMOVE_BLK(IN := #a_array[2],
          COUNT := "Tag_Count",
          OUT => #b_array[1]);
    
```

The following table shows how the instruction works using specific operand values:

Parameter	Operand	Value
IN	a_array[2]	The data type of the a_array operand is Array [0..5] of INT. It consists of six elements of data type INT.
COUNT	Tag_Count	3
OUT	b_array[1]	The data type of the b_array operand is Array [0..6] of INT. It consists of seven elements of data type INT.

Starting from the third element, the instruction selects three INT elements from the #a\_array tag and copies their contents to the #b\_array output tag, beginning with the second element. The copy operation cannot be interrupted by other operating system activities.

### See also

Overview of the valid data types (Page 1077)

Entering SCL instructions (Page 1357)

Editing SCL instructions (Page 1374)

### FILL\_BLK: Fill block

#### Description

The "Fill block" instruction is used to copy the content of a memory area (source area) to a selected memory area (target area). The number of repeated copy operations is specified with the COUNT parameter. When the instruction is executed, the source area is selected and moved to the destination area as often as specified by the value of the COUNT parameter.

The instruction can only be executed if the source area and the destination area are of the same data type.

The value of the OUT output is invalid if the following condition is met:

- More data is moved than is made available at input IN or output OUT.

#### Syntax

The following syntax is used for the instruction "Fill block":

```
SCL
FILL_BLK(IN := <Operand>,
         COUNT := <Operand>,
         OUT => <Operand>)
```

**Parameter**

The following table shows the parameters of the "Fill block" instruction:

Parameter	Declaration	Data type		Description
		S7-1200	S7-1500	
IN <sup>1)</sup>	Input	Binary numbers, integers, floating-point numbers, TIME, TOD, DATE, CHAR	Binary numbers, integers, floating-point numbers, timers, DATE, CHAR, TOD, LTOD	Element used to fill the destination area
COUNT	Input	USINT, UINT, UDINT	USINT, UINT, UDINT, ULINT	Number of repeated copy operations
OUT <sup>2)</sup>	Output	Binary numbers, integers, floating-point numbers, TIME, TOD, DATE, CHAR	Binary numbers, integers, floating-point numbers, timers, DATE, CHAR, TOD, LTOD	Address in destination area from which filling starts
<sup>1)</sup> The specified data types can also be used as elements of an ARRAY structure. <sup>2)</sup> The specified data types can only be used as elements of an ARRAY structure.				

For more information on valid data types, refer to "See also".

**Example**

The following example shows how the instruction works:

```

SCL
FILL_BLK(IN := #a_array[2],
         COUNT := "Tag_Count",
         OUT => #b_array[1]);
    
```

The following table shows how the instruction works using specific operand values:

Parameter	Operand	Value
IN	a_array[2]	The data type of the a_array operand is Array [0..5] of INT. It consists of six elements of data type INT.
COUNT	Tag_Count	3
OUT	b_array[1]	The data type of the b_array operand is Array [0..6] of INT. It consists of seven elements of data type INT.

The instruction copies the third element (#a\_array[2]) of the #a\_array tag three times to the #b\_array output tag.

**See also**

Overview of the valid data types (Page 1077)

Entering SCL instructions (Page 1357)

Editing SCL instructions (Page 1374)

**UFILL\_BLK: Fill block uninterruptible****Description**

The instruction "Fill block uninterruptible" is used to copy the content of a memory area (source area) to a selected memory area (target area). The number of repeated copy operations is specified with the COUNT parameter. When the instruction is executed, the value at the IN input is selected and copied to the destination area as often as specified by the value in the COUNT parameter.

The instruction can only be executed if the source area and the destination area have the same data type.

---

**Note**

The copy operation cannot be interrupted by other operating system activities. This is why the alarm reaction times of the CPU increase during the execution of the "Fill block uninterruptible" instruction.

---

The value of the OUT output is invalid if the following condition is met:

- More data is moved than is made available at input IN or output OUT.

You can use the "Fill block uninterruptible" instruction to move a maximum of 16 KB. Note the CPU-specific restrictions for this.

**Syntax**

The following syntax is used for the "Fill block uninterruptible" instruction:

```
SCL  
UFILL_BLK(IN := <Operand>,  
          COUNT := <Operand>,  
          OUT => <Operand>)
```

**Parameter**

The following table shows the parameters of the "Fill block uninterruptible" instruction:

Parameter	Declaration	Data type		Description
		S7-1200	S7-1500	
IN <sup>1)</sup>	Input	Binary numbers, integers, floating-point numbers, TIME, DATE, CHAR, TOD	Binary numbers, integers, floating-point numbers, timers, DATE, CHAR, TOD, LTOD	Element used to fill the destination area
COUNT	Input	USINT, UINT, UDINT	USINT, UINT, UDINT, ULINT	Number of repeated copy operations
OUT <sup>2)</sup>	Output	Binary numbers, integers, floating-point numbers, TIME, TOD, DATE, CHAR	Binary numbers, integers, floating-point numbers, timers, DATE, CHAR, TOD, LTOD	Address in destination area from which filling starts
<sup>1)</sup> The specified data types can also be used as elements of an ARRAY structure. <sup>2)</sup> The specified data types can only be used as elements of an ARRAY structure.				

For additional information on valid data types, refer to "See also".

**Example**

The following example shows how the instruction works:

```

SCL
UFILL_BLK(IN := #a_array[2],
          COUNT := "Tag_Count",
          OUT => #b_array[1]);
    
```

The following table shows how the instruction works using specific operand values:

Parameter	Operand	Value
IN	a_array[2]	The data type of the a_array operand is Array [0..5] of INT. It consists of six elements of data type INT.
COUNT	Tag_Count	3
OUT	b_array[1]	The data type of the b_array operand is Array [0..6] of INT. It consists of seven elements of data type INT.

The instruction copies the third element (#a\_array[2]) of the #a\_array tag three times to the #b\_array output tag. The copy operation cannot be interrupted by other operating system activities.



**See also**

Overview of the valid data types (Page 1077)

Entering SCL instructions (Page 1357)

Editing SCL instructions (Page 1374)

**SWAP: Swap****Description**

You can use the "Swap" instruction to change the arrangement of the bytes of an input value and save the result in the specified operand.

The following figure shows how the bytes of an operand of the DWORD data type are swapped using the "Swap" instruction:

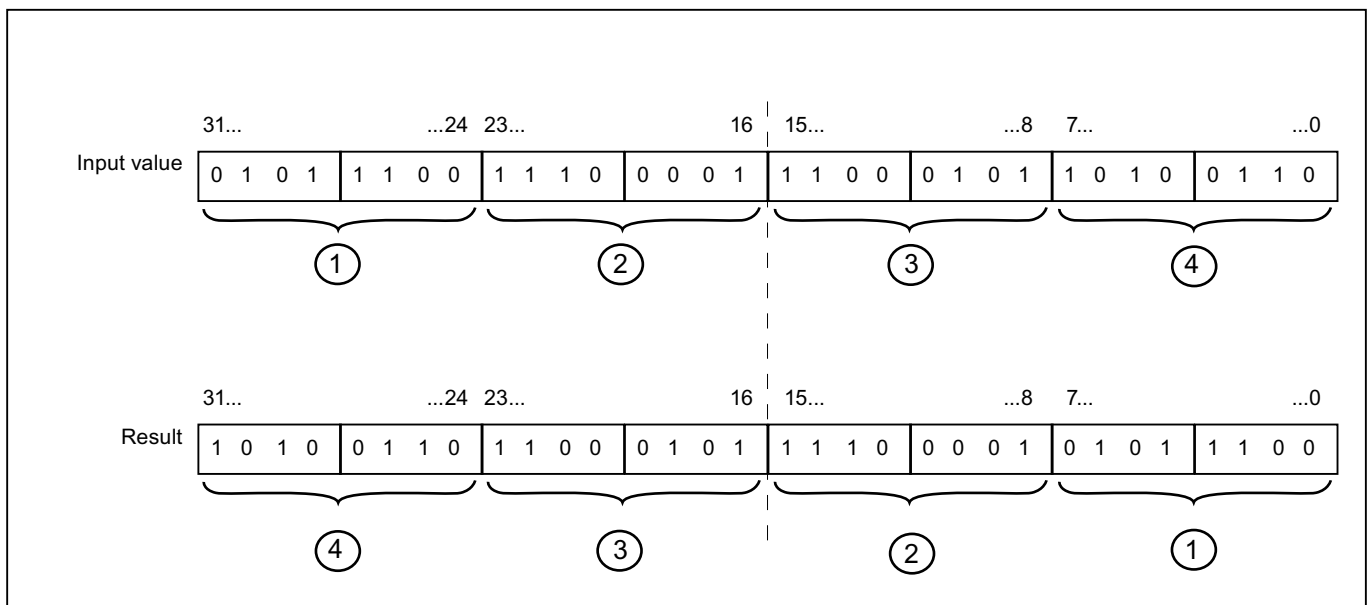
**Syntax**

The following syntax is used for the "Swap" instruction:

SCL
SWAP (<Expression>)

The syntax of the instruction consists of the following parts:

Parameter	Declaration	Data type		Description
		S7-1200	S7-1500	
<Expression>	Input	WORD, DWORD	WORD, DWORD, LWORD	Input value
Function value		WORD, DWORD	WORD, DWORD, LWORD	Result of the instruction

For additional information on valid data types, refer to "See also".

### Example

The following example shows how the instruction works:

```
SCL
"Tag_Result" := SWAP("Tag_Value");
```

The result of the instruction is returned as a function value.

The following table shows how the instruction works using specific operand values:

Operand	Value
Tag_Value	0000 1111 0101 0101
Tag_Result	0101 0101 0000 1111

### See also

Overview of the valid data types (Page 1077)

Entering SCL instructions (Page 1357)

Editing SCL instructions (Page 1374)

### Array data blocks

#### ReadFromArrayDB: Read from array data block

#### Description

You can use the "Read from array data block" instruction to read data from an array DB.

An array DB is a data block which consists of exactly one array of [data type]. The elements of the array can be UDT data type or any other elementary data type. The counting of the array always starts with the low limit "0", regardless of the later declaration of the array.

The ENO enable output has the signal state "0" if one of the following conditions is fulfilled:

- The EN enable input has the signal state "0".
- If an error occurs during the execution of the instruction.

## Parameter

The following table shows the parameters of the "Read from array data block" instruction:

Parameter	Declaration	Data type	Memory area	Description
DB	Input	DB_ANY	I, Q, M, D, L	Data block that is read
INDEX	Input	DINT	I, Q, M, D, L	Element that is read
VALUE	InOut	VARIANT	I, Q, M, D, L	Value that is read
RET_VAL	Output	INT	I, Q, M, D, L	Error information: If an error occurs during the execution of the instruction, an error code is output at the RET_VAL parameter.

For more information on valid data types, refer to "See also".

## Parameter RET\_VAL

The following table shows the meaning of the values of the RET\_VAL parameter:

Error code* (W#16#...)	Explanation
0000	No error
80B4	Data types do not correspond
80B5	Copying process was interrupted
8131	The data block does not exist
8132	The data block is too short
8133	The data block is located in the load memory
8134	The data block is write protected
8135	The DB is not an array data block.
8282	The value at the INDEX parameter is outside the limit values of the array.
8350	The VARIANT data type contains no value
8352	Code generation error
8353	Code generation error
*The error codes can be displayed as integer or hexadecimal value in the program editor. For more information on toggling display formats, refer to "See also".	

**See also**

- Overview of the valid data types (Page 1077)
- Entering SCL instructions (Page 1357)
- Editing SCL instructions (Page 1374)

**WriteToArrayDB: Write to array data block**

**Description**

You can use the "Write to array data block" instruction to write data to an array DB.

An array DB is a data block which consists of exactly one array of [data type]. The elements of the array can be UDT data type or any other elementary data type. The counting of the array always starts with the low limit "0", regardless of the later declaration of the array.

The ENO enable output has the signal state "0" if one of the following conditions is fulfilled:

- The EN enable input has the signal state "0".
- If an error occurs during the execution of the instruction.

**Parameter**

The following table shows the parameters of the "Write to array data block" instruction:

Parameter	Declaration	Data type	Memory area	Description
DB	Input	DB_ANY	I, Q, M, D, L	Data block to which data is written
INDEX	Input	DINT	I, Q, M, D, L	Element in the DB to which data is written
VALUE	Input	VARIANT	I, Q, M, D, L	Value to be written
RET_VAL	Output	INT	I, Q, M, D, L	Error information: If an error occurs during the execution of the instruction, an error code is output at the RET_VAL parameter.

For more information on valid data types, refer to "See also".

## Parameter RET\_VAL

The following table shows the meaning of the values of the RET\_VAL parameter:

Error code* (W#16#...)	Explanation
0000	No error
80B4	Data types do not correspond
80B5	Copying process was interrupted
8131	The data block does not exist
8132	The data block is too short
8133	The data block is located in the load memory
8134	The data block is write protected
8135	The DB is not an array data block.
8282	The value at the INDEX parameter is outside the limit values of the array.
8350	The VARIANT data type contains no value
8352	Code generation error
8353	Code generation error
*The error codes can be displayed as integer or hexadecimal value in the program editor. For more information on toggling display formats, refer to "See also".	

## See also

Overview of the valid data types (Page 1077)

Entering SCL instructions (Page 1357)

Editing SCL instructions (Page 1374)

## ReadFromArrayDBL: Read from array data block in load memory

### Description

You can use the "Read from array data block in load memory" instruction to read data from an array DB in load memory.

An array DB is a data block which consists of exactly one array of [data type]. The elements of the array can be UDT data type or any other elementary data type. The counting of the array always starts with the low limit "0", regardless of the later declaration of the array.

If the array DB is marked with the "Only store in load memory" block attribute, it is only stored in load memory.

The instruction is executed when a positive signal edge is detected at the REQ parameter. The BUSY parameter then has the signal state "1". The instruction is terminated if a negative signal edge is detected at the BUSY parameter. The DONE parameter has the signal state "1" for one program cycle and the read value is output at the VALUE parameter within this cycle. With all other program cycles, the value at the VALUE parameter is not changed.

When you insert the instruction in the program, the "Call options" dialog opens in which you can specify whether the block parameters will be stored in a separate data block (single instance) or as a local tag (multiple instance) in the block interface. If you create a separate data block, you will find it in the project tree in the "Program resources" folder under "Program blocks > System blocks". For more information on this topic, refer to "See also".

The ENO enable output has the signal state "0" if one of the following conditions is fulfilled:

- The EN enable input has the signal state "0".
- If an error occurs during the execution of the instruction.

### Parameter

The following table shows the parameters of the "Read from array data block in load memory" instruction:

Parameter	Declaration	Data type	Memory area	Description
REQ	Input	BOOL	I, Q, M, D, L	REQ = "1": Starting with the reading of the array DB
DB	Input	DB_ANY	I, Q, M, D, L	Data block that is read
INDEX	Input	DINT	I, Q, M, D, L	Element that is read
BUSY	Output	BOOL	I, Q, M, D, L	BUSY = "1": The array DB is still being read
DONE	Output	BOOL	I, Q, M, D, L	DONE = "1": The instruction was executed successfully
VALUE	InOut	VARIANT	I, Q, M, D, L	Value that is read
RET_VAL	Output	INT	I, Q, M, D, L	Error information: If an error occurs during the execution of the instruction, an error code is output at the RET_VAL parameter.

For more information on valid data types, refer to "See also".

## Parameter

The following table shows the meaning of the values of the RET\_VAL parameter:

Error code* (W#16#...)	Explanation
0000	No error
80B4	Data types do not correspond
80B5	Copying process was interrupted
8131	The data block does not exist
8132	The data block is too short
8133	The data block is not located in the load memory
8134	The data block is write protected
8135	The DB is not an array data block.
8282	The value at the INDEX parameter is outside the limit values of the array.
8350	The VARIANT data type contains no value
8352	Code generation error
8353	Code generation error
*The error codes can be displayed as integer or hexadecimal value in the program editor. For more information on toggling display formats, refer to "See also".	

## See also

Overview of the valid data types (Page 1077)

Entering SCL instructions (Page 1357)

Editing SCL instructions (Page 1374)

## WriteToArrayDBL: Write to array data block in load memory

### Description

You can use the "Write to array data block in load memory" instruction to write data to an array DB in load memory.

An array DB is a data block which consists of exactly one array of [data type]. The elements of the array can be UDT data type or any other elementary data type. The counting of the array always starts with the low limit "0", regardless of the later declaration of the array.

If the array DB is marked with the "Only store in load memory" block attribute, it is only stored in load memory.

The instruction is executed when a positive signal edge is detected at the REQ parameter. The BUSY parameter then has the signal state "1". If a negative signal edge is detected at the BUSY parameter, the instruction is terminated and the value at the VALUE parameter is written to the data block. The DONE parameter then has the signal state "1" for one program cycle.

When you insert the instruction in the program, the "Call options" dialog opens in which you can specify whether the block parameters will be stored in a separate data block (single instance) or as a local tag (multiple instance) in the block interface. If you create a separate data block, you will find it in the project tree in the "Program resources" folder under "Program blocks > System blocks". For more information on this topic, refer to "See also".

The ENO enable output has the signal state "0" if one of the following conditions is fulfilled:

- The EN enable input has the signal state "0".
- If an error occurs during the execution of the instruction.

### Parameter

The following table shows the parameters of the "Write to array data block in load memory" instruction:

Parameter	Declaration	Data type	Memory area	Description
REQ	Input	BOOL	I, Q, M, D, L	REQ = "1": Start writing to the array DB
DB	Input	DB_ANY	D	Data block to which data is written
INDEX	Input	DINT	I, Q, M, D, L	Element in the DB to which data is written
VALUE	Input	VARIANT	I, Q, M, D, L	Value to be written
BUSY	Output	BOOL	I, Q, M, D, L	BUSY = "1": The array DB is still being written
DONE	Output	BOOL	I, Q, M, D, L	DONE = "1": The instruction was executed successfully
RET_VAL	Output	INT	I, Q, M, D, L	Error information: If an error occurs during the execution of the instruction, an error code is output at the RET_VAL parameter.

For more information on valid data types, refer to "See also".



## Parameter

The following table shows the meaning of the values of the RET\_VAL parameter:

Error code* (W#16#...)	Explanation
0000	No error
80B4	Data types do not correspond
80B5	Copying process was interrupted
8131	The data block does not exist
8132	The data block is too short
8133	The data block is not located in the load memory
8134	The data block is write protected
8135	The DB is not an array data block.
8282	The value at the INDEX parameter is outside the limit values of the array.
8350	The VARIANT data type contains no value
8352	Code generation error
8353	Code generation error
*The error codes can be displayed as integer or hexadecimal value in the program editor. For additional information on toggling display formats, refer to "See also".	

## See also

Overview of the valid data types (Page 1077)

Entering SCL instructions (Page 1357)

Editing SCL instructions (Page 1374)

## Read/write access

### PEEK: Read memory address

## Description

The "Read memory address" instruction is used to read a memory address from a memory area without specifying a data type.

If you specify the 16#84 area at the AREA parameter for a data block, you can only access data blocks with the "Standard" block property.

**Syntax**

The following syntax is used for the "Read memory address" instruction:

**SCL**

```
PEEK (AREA:= <Operand>,
      DBNUMBER:= <Operand>,
      BYTEOFFSET:= <Operand>)
```

**SCL**

```
PEEK_<Data type>(AREA := <Operand>,
                 DBNUMBER := <Operand>,
                 BYTEOFFSET:= <Operand>)
```

The syntax of the instruction consists of the following parts:

Parameter	Declaration	Data type	Description
AREA	Input	BYTE	The following areas can be selected: <ul style="list-style-type: none"> <li>• 16#81: Input</li> <li>• 16#82: Output</li> <li>• 16#83: Bit memory</li> <li>• 16#84: DB</li> <li>• 16#1: Peripheral input (S7-1500 only)</li> </ul>
DBNUMBER	Input	DINT, DB_ANY	Number of the data block if AREA = DB, otherwise "0"
BYTEOFFSET	Input	DINT	Address to read from
_<Data type>		Bit strings default: BYTE	Data type of the function value: <ul style="list-style-type: none"> <li>• You do not need to specify the data type if using the default.</li> <li>• Any other valid data type you may use must be declared explicitly.</li> </ul>
Function value		Bit strings	Result of the instruction

For additional information on valid data types, refer to "See also".

**Note**

If you read the memory address of the input, output or bit memory areas, you will need to set the "DBNUMBER" parameter with the value "0", as the instruction is faulty otherwise.

## Example

The following example shows how the instruction works:

### SCL

```
"Tag_Result1" := PEEK(AREA := "Tag_Area",
                      DBNUMBER := "Tag_DBNumber",
                      BYTEOFFSET := "Tag_Byte");
```

### SCL

```
"Tag_Result2" := PEEK_WORD(AREA := "Tag_Area",
                             DBNUMBER := "Tag_DBNumber",
                             BYTEOFFSET := "Tag_Byte");
```

The following table shows how the instruction works using specific operand values:

Parameter	Operand	Value
AREA	Tag_Area	16#84
DBNUMBER	Tag_DBNumber	5
BYTEOFFSET	Tag_Byte	20
Function value	Tag_Result1	Byte value "20"
Function value	Tag_Result2	Word value "20"

The instruction reads the value of address "20" from the "Tag\_Byte" operand at data block "5" and returns the result as a function value at the "Tag\_Result" operand.

## See also

Entering SCL instructions (Page 1357)

Editing SCL instructions (Page 1374)

Overview of the valid data types (Page 1077)

## PEEK\_BOOL: Read memory bit

### Description

The "Read memory bit" instruction is used to read a memory bit from a memory area without specifying a data type.

If you specify the 16#84 area at the AREA parameter for a data block, you can only access data blocks with the "Standard" block property.

### Note

The instruction can only be used to access "Standard" memory areas.

**Syntax**

The following syntax is used for the "Read memory bit" instruction:

**SCL**

```
PEEK_BOOL(AREA := <Operand>,
          DBNumber := <Operand>,
          BYTEOFFSET := <Operand>,
          BITOFFSET := <Operand>)
```

The syntax of the instruction consists of the following parts:

Parameter	Declaration	Data type	Description
AREA	Input	BYTE	The following areas can be selected: <ul style="list-style-type: none"> <li>• 16#81: Input</li> <li>• 16#82: Output</li> <li>• 16#83: Bit memory</li> <li>• 16#84: DB</li> <li>• 16#1: Peripheral input (S7-1500 only)</li> </ul>
DBNUMBER	Input	DINT, DB_ANY	Number of the data block if AREA = DB, otherwise "0"
BYTEOFFSET	Input	DINT	Address to read from
BITOFFSET	Input	INT	Bit to be read from
Function value		BOOL	Result of the instruction

For additional information on valid data types, refer to "See also".

**Note**

If you read the memory bit from the input, output or bit memory areas, you will need to set the "DBNUMBER" parameter with the value "0", as the instruction is faulty otherwise.

**Example**

The following example shows how the instruction works:

**SCL**

```
"Tag_Result" := PEEK_BOOL(AREA := "Tag_Area",
                          DBNUMBER := "Tag_DBNumber",
                          BYTEOFFSET := "Tag_Byte",
                          BITOFFSET := "Tag_Bit");
```

The following table shows how the instruction works using specific operand values:

Parameter	Operand	Value
AREA	Tag_Area	16#84
DBNUMBER	Tag_DBNumber	5
BYTEOFFSET	Tag_Byte	20
BITOFFSET	Tag_Bit	3
Function value	Tag_Result	3

The instruction reads the value of memory bit "3" from the "Tag\_Bit" operand at byte "20" of data block "5" and returns the result at the "Tag\_Result" operand as function value.

### See also

Entering SCL instructions (Page 1357)

Editing SCL instructions (Page 1374)

Overview of the valid data types (Page 1077)

### POKE: Write memory address

#### Description

The "Write memory address" instruction is used to write a memory address to a memory area without specifying a data type.

If you specify the 16#84 area at the AREA parameter for a data block, you can only access data blocks with the "Standard" block property.

---

#### Note

The instruction can only be used to access "Standard" memory areas.

---

#### Syntax

The following syntax is used for the "Write memory address" instruction:

```
SCL
POKE (AREA := <Operand>,
      DBNUMBER := <Operand>,
      BYTEOFFSET := <Operand>,
      VALUE := <Operand>)
```

The syntax of the instruction consists of the following parts:

Parameter	Declaration	Data type	Description
AREA	Input	BYTE	The following areas can be selected: <ul style="list-style-type: none"> <li>• 16#81: Input</li> <li>• 16#82: Output</li> <li>• 16#83: Bit memory</li> <li>• 16#84: DB</li> <li>• 16#2: Peripheral output (S7-1500 only)</li> </ul>
DBNUMBER	Input	DINT, DB_ANY	Number of the data block if AREA = DB, otherwise "0"
BYTEOFFSET	Input	DINT	Address to be written
VALUE	Input	Bit strings	Value to be written

For additional information on valid data types, refer to "See also".

**Note**

If you write the memory address in the input, output or bit memory areas, you will need to set the "DBNUMBER" parameter with the value "0", as the instruction is faulty otherwise.

**Example**

The following example shows how the instruction works:

```

SCL
POKE (AREA := "Tag_Area",
      DBNUMBER := "Tag_DBNumber",
      BYTEOFFSET := "Tag_Byte"),
VALUE := "Tag_Value";
    
```

The following table shows how the instruction works using specific operand values:

Parameter	Operand	Value
AREA	Tag_Area	16#84
DBNUMBER	Tag_DBNumber	5
BYTEOFFSET	Tag_Byte	20
VALUE	Tag_Value	16#11

The instruction overwrites the memory address "20" in the data block "5" with value "16#11".

**See also**

Overview of the valid data types (Page 1077)

Entering SCL instructions (Page 1357)

Editing SCL instructions (Page 1374)

**POKE\_BOOL: Write memory bit****Description**

The "Write memory bit" instruction is used to write a memory bit to a memory area without specifying a data type.

If you specify the 16#84 area at the AREA parameter for a data block, you can only access data blocks with the "Standard" block property.

**Note**

The instruction can only be used to access "Standard" memory areas.

**Syntax**

The following syntax is used for the "Write memory bit" instruction:

**SCL**

```
POKE_BOOL (AREA := <Operand>,
           DBNUMBER := <Operand>,
           BYTEOFFSET := <Operand>,
           BITOFFSET := <Operand>,
           VALUE := <Operand>)
```

The syntax of the instruction consists of the following parts:

Parameter	Declaration	Data type	Description
AREA	Input	BYTE	The following areas can be selected: <ul style="list-style-type: none"> <li>• 16#81: Input</li> <li>• 16#82: Output</li> <li>• 16#83: Bit memory</li> <li>• 16#84: DB</li> <li>• 16#2: Peripheral input (S7-1500 only)</li> </ul>
DBNUMBER	Input	DINT, DB_ANY	Number of the data block if AREA = DB, otherwise "0"
BYTEOFFSET	Input	DINT	Address to be written

Parameter	Declaration	Data type	Description
BITOFFSET	Input	INT	Bit to be written
VALUE	Input	BOOL	Value to be written

For additional information on valid data types, refer to "See also".

**Note**

If you write the memory bit in the input, output or bit memory areas, you need to set the "DBNUMBER" parameter with the value "0", as the instruction is faulty otherwise.

**Example**

The following example shows how the instruction works:

```

SCL
POKE_BOOL (AREA := "Tag_Area",
           DBNUMBER := "Tag_DBNumber",
           BYTEOFFSET := "Tag_Byte",
           BITOFFSET := "Tag_Bit",
           VALUE := "Tag_Value");
    
```

The following table shows how the instruction works using specific operand values:

Parameter	Operand	Value
AREA	Tag_Area	16#84
DBNUMBER	Tag_DBNumber	5
BYTEOFFSET	Tag_Byte	20
BITOFFSET	Tag_Bit	3
VALUE	Tag_Value	M0.0

The instruction overwrites the memory bit "3" in data block "5" in byte "20" with the value "M0.0".

**See also**

- Entering SCL instructions (Page 1357)
- Editing SCL instructions (Page 1374)
- Overview of the valid data types (Page 1077)

**POKE\_BLK: Write memory area**

**Description**

The "Write memory area" instruction copies the content a memory area to a different memory area without specifying a data type.



If you specify the 16#84 area at the AREA parameter for a data block, you can only access data blocks with the "Standard" block property.

### Note

The instruction can only be used to access "Standard" memory areas.

## Syntax

The following syntax is used for the "Write memory area" instruction:

### SCL

```
POKE_BLK (AREA_SRC:= <Operand>,
          DBNUMBER_SRC:= <Operand>,
          BYTEOFFSET_SRC:= <Operand>,
          AREA_DEST:= <Operand>,
          DBNUMBER_DEST:= <Operand>,
          BYTEOFFSET_DEST:= <Operand>,
          COUNT:= <Operand>)
```

The syntax of the instruction consists of the following parts:

Parameter	Declaration	Data type	Description
AREA_SRC	Input	BYTE	The following areas can be selected in the source memory area: <ul style="list-style-type: none"> <li>• 16#81: Input</li> <li>• 16#82: Output</li> <li>• 16#83: Bit memory</li> <li>• 16#84: DB</li> </ul>
DBNUMBER_SRC	Input	DINT, DB_ANY	Number of the data block in the source memory area, if AREA = DB, otherwise "0"
BYTEOFFSET_SRC	Input	DINT	Address in the source memory area to be written
AREA_DEST	Input	BYTE	The following areas can be selected in the destination memory area: <ul style="list-style-type: none"> <li>• 16#81: Input</li> <li>• 16#82: Output</li> <li>• 16#83: Bit memory</li> <li>• 16#84: DB</li> </ul>
DBNUMBER_DEST	Input	DINT, DB_ANY	Number of the data block in the destination memory area, if AREA = DB, otherwise "0"

Parameter	Declaration	Data type	Description
BYTEOFFSET_DEST	Input	DINT	Address in the destination memory area to be written
COUNT	Input	DINT	Number of bytes which are copied

For additional information on valid data types, refer to "See also".

**Note**

If you write the memory address in the input, output or bit memory areas, you will need to set the "DBNUMBER" parameter with the value "0", as the instruction is faulty otherwise.

**Example**

The following example shows how the instruction works:

**SCL**

```
POKE_BLK(AREA_SRC := "Tag_Source_Area",
         DBNUMBER_SRC := "Tag_Source_DBNumber",
         BYTEOFFSET_SRC := "Tag_Source_Byte"),
        AREA_DEST := "Tag_Destination_Area",
        DBNUMBER_DEST := "Tag_Destination_DBNumber",
        BYTEOFFSET_DEST := "Tag_Destination_Byte",
        COUNT := "Tag_Count");
```

The following table shows how the instruction works using specific operand values:

Parameter	Operand	Value
AREA_SRC	Tag_Source_Area	16#84
DBNUMBER_SRC	Tag_Source_DBNumber	5
BYTEOFFSET_SRC	Tag_Source_Byte	20
AREA_DEST	Tag_Destination_Area	16#83
DBNUMBER_DEST	Tag_Destination_DBNumber	0
BYTEOFFSET_DEST	Tag_Destination_Byte	30
COUNT	Tag_Count	100

The instruction writes 100 byte from data block "5" starting with address "20" in the memory area of the bit memory starting at address "30".

**See also**

Entering SCL instructions (Page 1357)

Editing SCL instructions (Page 1374)

Overview of the valid data types (Page 1077)

## Other

### BLKMOV: Move block

#### Description

The instruction "Move block" copies the contents of a memory area (source area) to another memory area (destination area). The move operation takes place in the direction of ascending addresses. You use VARIANT to define the source and destination areas.

#### Note

The tags of the instruction can only be used in data blocks in which the attribute "Optimized block access" is not set. If the tag with the retentive setting "Set in IDB" has been declared, you can also use the tags "with optimized access".

The following figure shows the principle of the move operation:

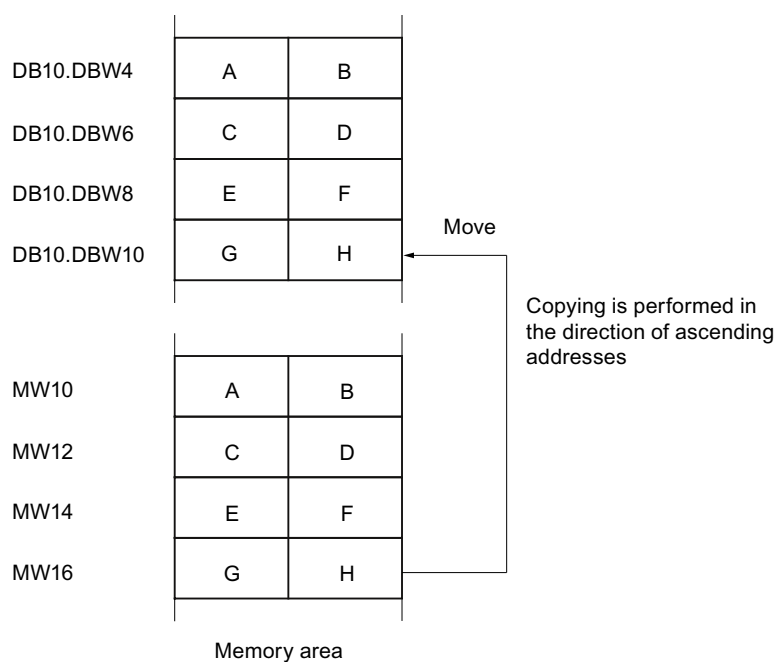

#### Consistency of the source data and destination data

Note that while the instruction "Move block" is being executed, the source data remains unchanged; otherwise the consistency of the destination data cannot be guaranteed.

#### Interruptibility

There is no limit to the nesting depth.

## Memory areas

The instruction "Move block" moves the following memory areas:

- Areas of a data block
- Bit memory
- Process image of the inputs
- Process image of the outputs

## General rules when copying

The source and destination areas must not overlap. If the source and destination areas have different lengths, only the length of the smaller area will be moved.

If the source area is smaller than the destination area, the entire source area will be written to the destination area. The remaining bytes of the destination area remain unchanged.

If the destination area is smaller than the source area, the entire destination area will be written. The remaining bytes of the source area are ignored.

If a block of data type BOOL is moved, the tag must be addressed absolutely and the specified length of the area must be divisible by 8, otherwise the instruction cannot be executed.

## Rules for moving character strings

You can use the "Move block" instruction to also move source and destination areas of the STRING data type. If only the source area is of the data type STRING, the characters that are actually contained in the character string are moved. Information on the actual and maximum length is also written to the destination area. If the source and destination area are both STRING data type, the current length of the character string in the destination area is set to the number of characters actually moved.

If you want to move the information on the maximum and actual length of a character string, specify the areas in bytes in the SRCBLK and DSTBLK parameters.

## Syntax

The following syntax is used for the instruction "Move block":

```
SCL  
BLKMOV (SRCBLK:= <Operand>,  
        DSTBLK => <Operand>)
```

## Parameter

The following table shows the parameters of the "Move block" instruction:

Parameter	Declaration	Data type	Description
SRCBLK	Input	VARIANT	Specifies the memory area to be moved (source area).
DSTBLK	Output	VARIANT	Specifies the memory area to which the data will be moved (destination area).
Function value (RET_VAL)		INT	Error information

For additional information on valid data types, refer to "See also".

## RET\_VAL Parameter

The following table shows the meaning of the values of the RET\_VAL parameter:

Error code* (W#16#...)	Explanation
0000	No error
8091	The permitted nesting depth was exceeded
8092	The instruction cannot be executed because a specified data block is write protected, non-executable, or not loaded.
General error information	See also: "GET_ERR_ID: Get error ID locally"

\*The error codes can be displayed as integer or hexadecimal value in the program editor. For information on toggling display formats, refer to "See also".

## See also

Overview of the valid data types (Page 1077)

Entering SCL instructions (Page 1357)

Editing SCL instructions (Page 1374)

GET\_ERR\_ID: Get error ID locally (Page 2237)

## UBLKMOV: Move block uninterruptible

### Description

The instruction "Move block uninterruptible" copies the contents of a memory area (source area) to another memory area (destination area). The move operation takes place in the direction of ascending addresses. You use VARIANT to define the source and destination areas.

The copy operation cannot be interrupted by other operating system activities. As a result the alarm reaction time of the CPU can increase during the execution of the instruction "Move block uninterruptible".

---

**Note**

The tags of the instruction can only be used in data blocks in which the attribute "Optimized block access" is not set. If the tag with the retentive setting "Set in IDB" has been declared, you can also use the tags "with optimized access".

---

## Memory areas

You can use the "Move block uninterruptible" instruction to move the following memory areas:

- Areas of a data block
- Bit memory
- Process image of the inputs
- Process image of the outputs

## General rules when copying

The source and destination area must not overlap during the execution of the instruction "Move block uninterruptible". If the source area is smaller than the destination area, the entire source area will be written to the destination area. The remaining bytes of the destination area remain unchanged.

If the destination area is smaller than the source area, the entire destination area will be written. The remaining bytes of the source area are ignored.

If a source or destination area defined as a formal parameter is less than a destination or source area specified on the SRCBLK or DSTBLK parameter, No data is transferred.

If a block of data type BOOL is moved, the tag must be addressed absolutely and the specified length of the area must be divisible by 8, otherwise the instruction cannot be executed.

You can use the "Move block uninterruptible" instruction to move a maximum of 16 KB. Note the CPU-specific restrictions for this.

## Rules for moving character strings

The instruction "Move block uninterruptible" copies source and destination areas of the data type STRING. If only the source area is of the data type STRING, the characters that are actually contained in the character string are moved. Information on the actual and maximum length are not written in the destination area. If the source and destination area are both STRING data type, the current length of the character string in the destination area is set to the number of characters actually moved. If areas of the STRING data type are moved, specify "1" as the area length.

## Syntax

The following syntax is used for the instruction "Move block uninterruptible":

```
SCL
UBLKMOV (SRCBLK:= <Operand>,
        DSTBLK => <Operand>)
```

## Parameter

The following table shows the parameters of the "Move block uninterruptible" instruction:

Parameter	Declaration	Data type	Description
SRCBLK	Input	VARIANT	Specifies the memory area to be moved (source area).
DSTBLK	Output	ANY	Specifies the memory area to which the data will be moved (destination area).
Function value (RET_VAL)		VARIANT	Error information

For additional information on valid data types, refer to "See also".

## RET\_VAL Parameter

The following table shows the meaning of the values of the RET\_VAL parameter:

Error code (W#16#...)	Explanation
0000	No error
8091	The source area is in a data block that is not relevant for program execution.
General error information	See also: "GET_ERR_ID: Get error ID locally"
*The error codes can be displayed as integer or hexadecimal value in the program editor. For information on toggling display formats, refer to "See also".	

## See also

Overview of the valid data types (Page 1077)

Entering SCL instructions (Page 1357)

Editing SCL instructions (Page 1374)

GET\_ERR\_ID: Get error ID locally (Page 2237)

**FILL: Fill block**

**Description**

The instruction "Fill block" fills a memory area (destination area) with the content of another memory area (source area). The instruction "Fill block" copies the content of the source area to the destination area until the destination area is completely written. The move operation takes place in the direction of ascending addresses.

You use VARIANT to define the source and destination areas.

**Note**

The tags of the instruction can only be used in data blocks in which the attribute "Optimized block access" is not set. If the tag with the retentive setting "Set in IDB" has been declared, you can also use the tags "with optimized access".

For blocks with the "Optimized block access" attribute, you can use the "FILL\_BLK: Fill block" instruction.

The following figure shows the principle of the move operation:

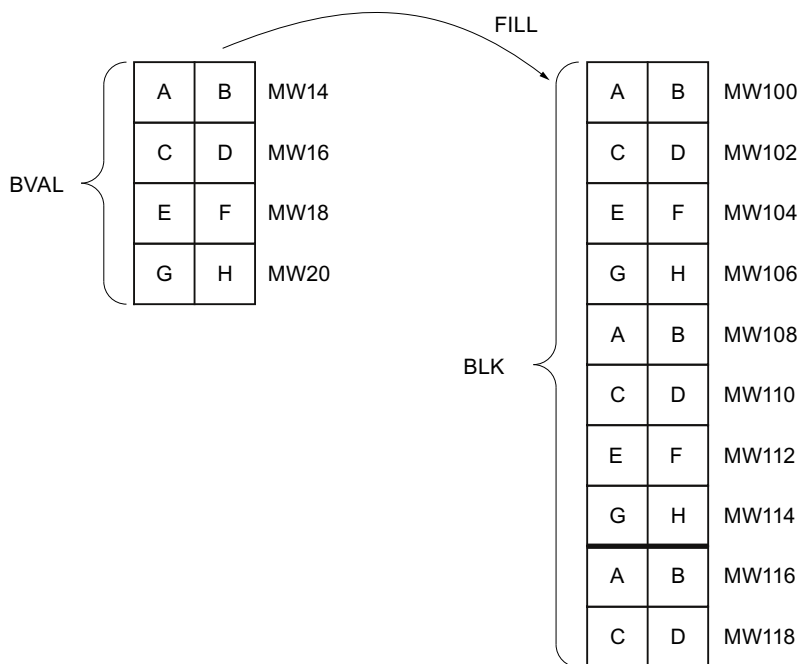

Example: The contents of the range MW100 to MW118 are to be preassigned with the contents of the memory words MW14 to MW20.

**Consistency of the source data and destination data**

Note that while the instruction "Fill block" is being executed, the source data remains unchanged; otherwise the consistency of the destination data cannot be guaranteed.



## Memory areas

The instruction "Fill block" copies the following memory areas:

- Areas of a data block
- Bit memory
- Process image of the inputs
- Process image of the outputs

The instruction "Fill block" copies the following memory areas:

- Instructions, system data blocks
- Counters
- Timers
- Memory areas of the I/O area

## General rules when copying

The source and destination areas must not overlap. If the destination area to be preset is not an integer multiple of the length of the BVAL input parameter, the destination area is nevertheless written up to the last byte.

If the destination area to be preset is smaller than the source area, the function only copies as much data as can be written to the destination area.

If the actually present destination or source area is smaller than the assigned memory area for the source or destination area (BVAL, BLK parameters), No data is transferred.

If the ANY pointer (source or destination) is of the data type BOOL, it must be addressed absolutely and the length specified must be divisible by 8; otherwise the instruction is not executed.

If the destination area is STRING data type, the instruction writes the entire string including the administration information.

## Syntax

The following syntax is used for the instruction "Fill block":

```
SCL  
FILL(BVAL:= <Operand>,  
      BLK => <Operand>)
```

**Parameter**

The following table shows the parameters of the "Fill block" instruction:

Parameter	Declaration	Data type	Description
BVAL	Input	VARIANT	Specification of the memory area (source area) with whose content the destination area on the BLK parameter will be filled.
BLK	Output	VARIANT	Specification of the memory area that will be filled with the content of the source area.
Function value (RET_VAL)		INT	Error information

For additional information on valid data types, refer to "See also".

**BVAL Parameter**

When you transfer a structure as an input parameter, remember that the length of a structure is always based on an even number of bytes. The structure will need one byte of additional memory space if you declare a structure with an odd number of bytes.

**RET\_VAL Parameter**

The following table shows the meaning of the values of the RET\_VAL parameter:

Error code (W#16#...)	Explanation
0000	No error
General error information	See also: "GET_ERR_ID: Get error ID locally"
*The error codes can be displayed as integer or hexadecimal value in the program editor. For information on toggling display formats, refer to "See also".	

**See also**

- Overview of the valid data types (Page 1077)
- Entering SCL instructions (Page 1357)
- Editing SCL instructions (Page 1374)
- GET\_ERR\_ID: Get error ID locally (Page 2237)

## Conversion operations

### CONVERT: Convert value

#### Description

Use the "Convert value" instruction to program explicit conversions. You determine the data types to be converted in a dialogue box with opens automatically when you insert the instruction. When executed, the instruction reads the source value and converts it into the specified target value.

For information on possible conversions, refer to the "Explicit conversion" section at "See also".

#### Note

For S7-1500 CPU: You can select the data types DWORD and LWORD if REAL or LREAL were selected as IN data type.

#### Syntax

Use the following syntax for the "Convert value" instruction:

```
SCL
<Target_value> := <Conversion_function>(<Source_value>);
```

The syntax of the instruction consists of the following parts:

Parameter	Declaration	Data type		Description
		S7-1200	S7-1500	
<Source_value>	Input, constant	Bit strings, integers, floating-point numbers, TIME, DATE, TOD, DTL, strings	Bit strings, integers, floating-point numbers, TIME, LTIME, DATE, TOD, LTOD, DTL, strings	Value to be converted.
<Conversion_function >	-	-	-	Function that specifies the data type to be converted .
<Target_value>	Output	Bit strings, integers, floating-point numbers, TIME, DATE, TOD, DTL, strings	Bit strings, integers, floating-point numbers, TIME, LTIME, DATE, TOD, LTOD, DTL, strings	Result of the conversion

For additional information on valid data types, refer to "See also".

**Example**

The following example shows how the instruction works:

```
SCL
"Tag_INT" := REAL_TO_INT("Tag_REAL");
```

The following table shows how the instruction works using specific operand values:

Operand	Data type	Value
Tag_REAL	REAL	20.56
Tag_INT	INT	21

During the conversion, the value of the "Tag\_REAL" operand will be rounded to the nearest integer and saved in the "Tag\_INT" operand.

**See also**

- Overview of the valid data types (Page 1077)
- Operators and operator precedence (Page 1347)
- Entering SCL instructions (Page 1357)
- Editing SCL instructions (Page 1374)

**ROUND: Round numerical value**

**Description**

The "Round numerical value" instruction is used to round the value at input IN to the nearest integer. The instruction interprets the value at input IN as a floating-point number and converts it into an integer or floating-point number. If the input value is exactly between an even and odd number, the even number is selected.

**Syntax**

The following syntax is used for the "Round numerical value" instruction:

```
SCL
ROUND(<Expression>)
```

The syntax of the instruction consists of the following parts:

Parameter	Declaration	Data type	Description
<Expression>	Input	Floating-point numbers	Input value to be rounded.
Function value		Integers, floating-point numbers	Result of the rounding

For additional information on valid data types, refer to "See also".

## Example

The following example shows how the instruction works:

```
SCL
"Tag_Result" := ROUND("Tag_Value");
```

The result of the instruction is returned in the operand "Tag\_Result" as a function value.

The following table shows how the instruction works using specific operand values:

Operand	Value	
Tag_Value	1.50000000	-1.50000000
Tag_Result	2	-2

## See also

Overview of the valid data types (Page 1077)

Operators and operator precedence (Page 1347)

Entering SCL instructions (Page 1357)

Editing SCL instructions (Page 1374)

## CEIL: Generate next higher integer from floating-point number

### Description

Use the "Generate next higher integer from floating-point number" instruction to round the value to the nearest integer. The instruction interprets the input value as floating-point number and converts it to the next higher integer. The function value can be greater than or equal to the input value.

### Syntax

The following syntax is used for the "Generate next higher integer from floating-point number" instruction:

```
SCL
CEIL(<Expression>)
CEIL_<Data type>(<Expression>)
```

The syntax of the instruction consists of the following parts:

Parameter	Declaration	Data type	Description
<Expression>	Input	Floating-point numbers	Input value
_<Data type>		Integers, floating-point numbers. Default: DINT	Data type of the function value: <ul style="list-style-type: none"> <li>You do not need to specify the data type if using the default.</li> <li>Any other valid data type you may use must be declared explicitly.</li> </ul>
Function value		Integers, floating-point numbers	Input value rounded up

For additional information on valid data types, refer to "See also".

### Example

The following example shows how the instruction works:

```
SCL
"Tag_Result1" := CEIL("Tag_Value");
"Tag_Result2" := CEIL_REAL("Tag_Value");
```

The following table shows how the instruction works using specific operand values:

Operand	Value	
Tag_Value	0.5	-0.5
Tag_Result1	1	0
Tag_Result2	1.0	0.0

The result of the instruction is returned in the operand "Tag\_Result" as a function value.

### See also

- Overview of the valid data types (Page 1077)
- Expressions (Page 1341)
- Operators and operator precedence (Page 1347)
- Entering SCL instructions (Page 1357)
- Editing SCL instructions (Page 1374)

## FLOOR: Generate next lower integer from floating-point number

### Description

Use the "Generate next lower integer from floating-point number" instruction to round the value of a floating point number to the next lower integer. The instruction interprets the input value as floating-point number and converts it to the next lower integer. The function value can be equal or less than the input value.

## Syntax

Use the following syntax for the "Generate next lower integer from floating-point number" instruction:

```
SCL
FLOOR(<Expression>)
FLOOR_<data type>(<expression>)
```

The syntax of the instruction consists of the following parts:

Parameter	Declaration	Data type	Description
<Expression>	Input	Floating-point numbers	Input value
_<Data type>		Integers, floating-point numbers. Default: DINT	Data type of the function value: <ul style="list-style-type: none"> <li>You do not need to specify the data type if using the default.</li> <li>Any other valid data type you may use must be declared explicitly.</li> </ul>
Function value		Integers, floating-point numbers	Input value rounded

For additional information on valid data types, refer to "See also".

## Example

The following example shows how the instruction works:

```
SCL
"Tag_Result1" := FLOOR("Tag_Value");
"Tag_Result2" := FLOOR_REAL("Tag_Value");
```

The following table shows how the instruction works using specific operand values:

Operand	Value	
Tag_Value	0.5	-0.5
Tag_Result1	0	-1
Tag_Result2	0.0	-1.0

The result of the instruction is returned in the operand "Tag\_Result" as a function value.

**See also**

- Overview of the valid data types (Page 1077)
- Expressions (Page 1341)
- Operators and operator precedence (Page 1347)
- Entering SCL instructions (Page 1357)
- Editing SCL instructions (Page 1374)

**TRUNC: Truncate numerical value**

**Description**

The "Truncate numerical value" instruction is used to generate an integer from the input value without rounding. The instruction selects only the integer part of the input value and returns this part without decimal places as the function value.

**Syntax**

The following syntax is used for the "Truncate numerical value" instruction:

**SCL**

```
TRUNC (<Expression>)
TRUNC_<Data type> (<Expression>)
```

The syntax of the instruction consists of the following parts:

Parameter	Declaration	Data type	Description
<Expression>	Input	Floating-point numbers	Input value
_<Data type>		Integers, floating-point numbers Default: DINT	Data type of the function value: <ul style="list-style-type: none"> <li>• You do not need to specify the data type if using the default.</li> <li>• Any other valid data type you may use must be declared explicitly.</li> </ul>
Function value		Integers, floating-point numbers	Integer component of the input value

For additional information on valid data types, refer to "See also".

**Example**

The following example shows how the instruction works:

**SCL**

```
"Tag_Result1" := TRUNC ("Tag_Value1");
"Tag_Result2" := TRUNC ("Tag_Value2"+"Tag_Value3");
```



**SCL**

```
"Tag_Result3" := TRUNC_SINT("Tag_Value4");
```

The result of the instruction is returned in the operand "Tag\_Result" as a function value.

The following table shows how the instruction works using specific operand values:

Operand	Value
Tag_Value1	-1.5
Tag_Result1	-1
Tag_Value2	2.1
Tag_Value3	3.2
Tag_Result2	5
Tag_Result3	2
Tag_Value4	2.4

**See also**

Overview of the valid data types (Page 1077)

Operators and operator precedence (Page 1347)

Entering SCL instructions (Page 1357)

Editing SCL instructions (Page 1374)

**SCALE\_X: Scale****Description**

Use the "Scale" instruction to scale a floating-point number by mapping it to a specific value range. You specify the value range with the MIN and MAX parameters. The result of the scaling is an integer.

The following figure shows an example of how values can be scaled:

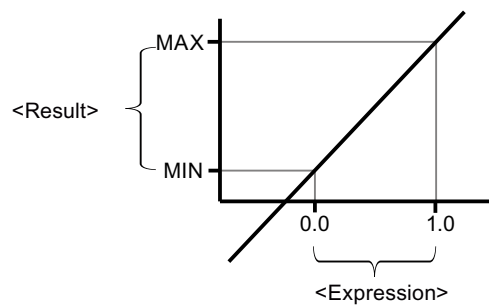

The instruction "Scale" works with the following equation:

$$OUT = [VALUE * (MAX - MIN)] + MIN$$

### Syntax

The following syntax is used for the "Scale" instruction:

**SCL**

```
SCALE_X(MIN := <Operand>,
        VALUE := <Operand>,
        MAX := <Operand>)
SCALE_X_<Data type>(MIN := <Operand>,
                    VALUE := <Operand>,
                    MAX := <Operand>)
```

The syntax of the instruction consists of the following parts:

Parameter	Declaration	Data type	Description
MIN	Input	Integers, floating-point numbers	Low limit of the value range
VALUE	Input	Floating-point numbers	Value to be scaled. If you enter a constant, you must declare it.
MAX	Input	Integers, floating-point numbers	High limit of the value range

Parameter	Declaration	Data type	Description
_<Data type>		Integers, floating-point numbers Default: INT	Data type of the function value: <ul style="list-style-type: none"> <li>You do not need to specify the data type if using the default.</li> <li>Any other valid data type you may use must be declared explicitly.</li> </ul>
Function value		Integers, floating-point numbers	Result of scaling

For additional information on valid data types, refer to "See also".

For additional information on declaring constants, refer to "See also".

## Example

The following example shows how the instruction works:

```
SCL
"Tag_Result1" := SCALE_X(MIN := "Tag_Value1",
                        VALUE := "Tag_Real",
                        MAX := "Tag_Value2");

"Tag_Result2" := SCALE_X_REAL(MIN := "Tag_Value1",
                              VALUE := "Tag_Real",
                              MAX := "Tag_Value2");
```

The result of the instruction is returned in the operand "Tag\_Result" as a function value.

The following table shows how the instruction works using specific operand values:

Operand	Value
Tag_Real	0.5
Tag_Value1	10
Tag_Value2	30
Tag_Result1	20
Tag_Result2	20.0

## See also

Overview of the valid data types (Page 1077)

Operators and operator precedence (Page 1347)

Entering SCL instructions (Page 1357)

Editing SCL instructions (Page 1374)

Declaring constants (Page 1188)

## NORM\_X: Normalize

### Description

You can use the instruction "Normalize" to normalize the value of the tag at the VALUE input by mapping it to a linear scale. You can use the parameters MIN and MAX to define the limits of a value range that is applied to the scale. Depending on the location of the normalized value in this value range, the result at output OUT is calculated and stored as a floating-point number. If the value to be normalized equals the value at input MIN, the instruction returns the result "0.0". If the value to be normalized equals the value at input MAX, the instruction returns the result "1.0".

The following figure shows an example of how values can be normalized:

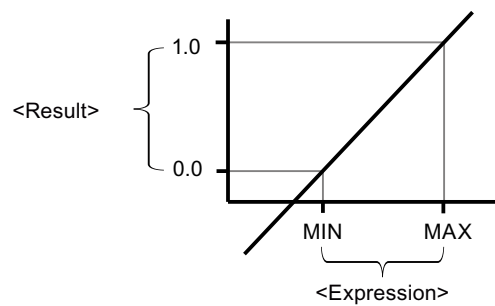

The "Normalize" instruction works with the following equation:

$$OUT = (VALUE - MIN) / (MAX - MIN)$$

### Syntax

The following syntax is used for the "Normalize" instruction:

```

SCL
NORM_X (MIN := <Operand>,
        VALUE := <Operand>,
        MAX := <Operand>)
NORM_X_<Data type> (MIN := <Operand>,
                    VALUE := <Operand>,
                    MAX := <Operand>)
    
```

The syntax of the instruction consists of the following parts:

Parameter	Declaration	Data type	Description
MIN <sup>1)</sup>	Input	Integers, floating-point numbers	Low limit of the value range
VALUE <sup>1)</sup>	Input	Integers, floating-point numbers	Value to be normalized.
MAX <sup>1)</sup>	Input	Integers, floating-point numbers	High limit of the value range
_<Data type>		Floating-point numbers Default: REAL	Data type of the function value: <ul style="list-style-type: none"> <li>You do not need to specify the data type if using the default.</li> <li>Any other valid data type you may use must be declared explicitly.</li> </ul>
Function value		Floating-point numbers	Result of the normalization
<sup>1)</sup> If you use constants in these three parameters, you only need to declare one of them.			

For additional information on valid data types, refer to "See also".

For additional information on declaring constants, refer to "See also".

## Example

The following example shows how the instruction works:

```

SCL
"Tag_Result1" := NORM_X(MIN := "Tag_Value1",
                       VALUE := "Tag_InputValue",
                       MAX := "Tag_Value2");
"Tag_Result2" := NORM_X_LREAL(MIN := "Tag_Value1",
                              VALUE := "Tag_InputValue",
                              MAX := "Tag_Value2");

```

The result of the instruction is returned in the operand "Tag\_Result" as a function value.

The following table shows how the instruction works using specific operand values:

Operand	Value
Tag_InputValue	20
Tag_Value1	10
Tag_Value2	30
Tag_Result1	0.5
Tag_Result2	0.5

**See also**

- Overview of the valid data types (Page 1077)
- Operators and operator precedence (Page 1347)
- Entering SCL instructions (Page 1357)
- Editing SCL instructions (Page 1374)
- Declaring constants (Page 1188)

**VARIANT**

**VARIANT\_TO\_DB\_ANY: Convert VARIANT to DB\_ANY**

**Description**

The instruction "Convert VARIANT to DB\_ANY" is used to read the number of the data block from a VARIANT and convert it to the data type DB\_ANY.

**Requirements**

If the conditions are met, the instruction is executed. If the conditions are not met, "0" is output as data block number.

The output tag...	homed...	Conversion options
VARIANT	...a data block which is an instance data block of an UDT or SDT	The output tag can be converted to a data block number.
VARIANT	...an Array DB	The output tag can be converted to a data block number.
VARIANT	...an object with an elementary data type	It is not possible to convert the output tag to a database number because a data block can never comprise only one elementary data type.
VARIANT	...a structure within a data block	It is not possible to convert the output tags to a database number because it is only a part within the data block.

**Syntax**

The following syntax is used for the "Convert VARIANT To DB\_ANY" instruction:

```

SCL
VARIANT_TO_DB_ANY(IN := <Operand>,
                  ERR => <Operand>)
    
```

## Parameter

The following table shows the parameters of the "Convert VARIANT to DB\_ANY" instruction:

Parameter	Declaration	Data type	Memory area	Description
IN	Input	VARIANT	I, Q, M, D, L	Tag to be read
ERR	Output	INT	I, Q, M, D, L	Error information
Function value		DB_ANY	I, Q, M, D, L	Result: Number of the DB

For more information on valid data types, refer to "See also".

## ERR parameter

The following table shows the meaning of the values of the ERR parameter:

Error code* (W#16#...)	Explanation
0000	No error
252C	The VARIANT data type has the value "0"
8130	The number of the data block is "0"
8131	The data block does not exist
8132	The data block is too short
8134	The data block is write protected
8150	The VARIANT data type has the value "0"
8154	The data type is not correctly declared
*The error codes can be displayed as integer or hexadecimal value in the program editor. For more information on toggling display formats, refer to "See also".	

## See also

Overview of the valid data types (Page 1077)

Operators and operator precedence (Page 1347)

Entering SCL instructions (Page 1357)

Editing SCL instructions (Page 1374)

## DB\_ANY\_TO\_VARIANT: Convert DB\_ANY to VARIANT

### Description

The instruction "Convert DB\_ANY to VARIANT" is used to read the number of the data block from a DB\_ANY and convert it to the data type VARIANT.

**Requirements**

If the conditions are met, the instruction is executed. If the conditions are not met or the data block does not exist, the value "0" is output. All additional accesses to this value "0" fail.

The output tag...	homed...	Conversion options
DB_ANY	...a data block which is an instance data block of an UDT or SDT	It is possible to convert the output tag to the VARIANT data type.
DB_ANY	...a DB which is an ARRAY DB	It is possible to convert the output tag to the VARIANT data type.
DB_ANY	...a data block which is an instance data block of a function block or a global data block	It is not possible to convert the output tags to the VARIANT data type.

**Syntax**

The following syntax is used for the "Convert DB\_ANY to VARIANT" instruction:

**SCL**

```
DB_ANY_TO_VARIANT(IN := <Operand>,
                  ERR => <Operand>)
```

**Parameter**

The following table shows the parameters of the "Convert DB\_ANY to VARIANT" instruction:

Parameter	Declaration	Data type	Memory area	Description
IN	Input	DB_ANY	I, Q, M, D, L	Tag to be read
ERR	Output	INT	I, Q, M, D, L	Error information
Function value		VARIANT	L	Result

For more information on valid data types, refer to "See also".

**ERR parameter**

The following table shows the meaning of the values of the parameter ERR:

Error code* (W#16#...)	Explanation
0000	No error
8130	The number of the data block is "0"
8131	The data block does not exist
8132	The data block is too short
8134	The data block is write protected



Error code* (W#16#...)	Explanation
8154	The data type is not correctly declared
*The error codes can be displayed as integer or hexadecimal value in the program editor. For more information on toggling display formats, refer to "See also".	

## See also

Overview of the valid data types (Page 1077)  
 Operators and operator precedence (Page 1347)  
 Entering SCL instructions (Page 1357)  
 Editing SCL instructions (Page 1374)

## Other

## SCALE: Scale

### Description

The instruction "Scale" converts the integer on the parameter IN into a floating-point number, which can be scaled in physical units between a low and a high limit. You can use the LO\_LIM and HI\_LIM parameters to specify the low limit and high limit of the value range to which the input value is scaled. The result of the instruction is output on the OUT parameter.

The instruction "Scale" works with the following equation:

$$\text{OUT} = [((\text{FLOAT}(\text{IN}) - \text{K1})/(\text{K2} - \text{K1})) * (\text{HI\_LIM} - \text{LO\_LIM})) + \text{LO\_LIM}]$$

The values of the "K1" and "K2" constants are determined by the signal state on the BIPOLAR parameter. The following signal states are possible on the BIPOLAR parameter:

- Signal state "1": It is assumed that the value at the IN parameter is bipolar and in a value range between -27648 and 27648. In this case the "K1" constant has the value "-27648.0" and the "K2" constant the value "+27648.0".
- Signal state "0": It is assumed that the value at the IN parameter is unipolar and in a value range between 0 and 27648. In this case the "K1" constant has the value "0.0" and the "K2" constant the value "+27648.0".

When the value at the IN parameter is greater than the value of the "K2" constant, the result of the instruction is set to the value of the high limit (HI\_LIM) and an error is output.

When the value at the IN parameter is less than the value of the "K1" constant, the result of the instruction is set to the value of the low limit value (LO\_LIM) and an error is output.

When the indicated low limit is greater than the high limit (LO\_LIM > HI\_LIM), the result is scaled in reverse proportion to the input value.

**Syntax**

The following syntax is used for the "Scale" instruction:

```

SCL
SCALE (IN:= <Expression>,
      HI_LIM := <Operand>,
      LO_LIM := <Operand>,
      BIPOLAR := <Operand>,
      OUT => <Operand>)
    
```

The syntax of the instruction consists of the following parts:

Parameter	Declaration	Data type	Description
IN	Input	INT	Input value to be scaled.
HI_LIM	Input	REAL	High limit
LO_LIM	Input	REAL	Low limit
BIPOLAR	Input	BOOL	Indicates if the value at the IN parameter is to be interpreted as bipolar or unipolar. The parameter can assume the following values: 1: Bipolar 0: Unipolar
OUT	Output	REAL	Result of the instruction
Function value (RET_VAL)		WORD	Error information

For additional information on valid data types, refer to "See also".

**RET\_VAL Parameter**

The following table shows the meaning of the values of the parameter RET\_VAL:

Error code (W#16#...)	Explanation
0000	No error
0008	The value of the parameter IN is greater than 27 648 or is less than 0 (unipolar) or -27 648 (bipolar).
General error information	See also: "GET_ERR_ID: Get error ID locally"
*The error codes can be displayed as integer or hexadecimal value in the program editor. For information on toggling display formats, refer to "See also".	

## Example

The following example shows how the instruction works:

```
"Tag_ErrorCode" := SCALE(IN := "Tag_InputValue",
                          HI_LIM := "Tag_HighLimit"
                          LO_LIM := "Tag_LowLimit"
                          BIPOLAR := "Tag_Bipolar",
                          OUT => "Tag_Result");
```

The error information is returned in the operand "Tag\_ErrorCode" as a function value.

The following table shows how the instruction works using specific operand values:

Parameter	Operand	Value
IN	Tag_InputValue	22
HI_LIM	Tag_HighLimit	100.0
LO_LIM	Tag_LowLimit	0.0
BIPOLAR	Tag_Bipolar	1
OUT	Tag_Result	50.03978588
RET_VAL	Tag_ErrorCode	W#16#0000

## See also

Overview of the valid data types (Page 1077)

Entering SCL instructions (Page 1357)

Editing SCL instructions (Page 1374)

Expressions (Page 1341)

Operators and operator precedence (Page 1347)

GET\_ERR\_ID: Get error ID locally (Page 2237)

## UNSCALE: Unscale

### Description

The instruction "Unscale" unscales the floating-point number on the IN parameter in physical units between a low and a high limit and converts them into an integer. You can use the LO\_LIM and HI\_LIM parameters to specify the low limit and high limit of the value range to which the input value is unscaled. The result of the instruction is output on the OUT parameter.

The instruction "Unscale" works with the following equation:

$$\text{OUT} = [((\text{IN} - \text{LO\_LIM}) / (\text{HI\_LIM} - \text{LO\_LIM})) * (\text{K2} - \text{K1})] + \text{K1}$$

The values of the "K1" and "K2" constants are determined by the signal state on the BIPOLAR parameter. The following signal states are possible on the BIPOLAR parameter:

- Signal state "1": It is assumed that the value at the IN parameter is bipolar and in a value range between -27648 and 27648. In this case the "K1" constant has the value "-27648.0" and the "K2" constant the value "+27648.0".
- Signal state "0": It is assumed that the value at the IN parameter is unipolar and in a value range between 0 and 27648. In this case the "K1" constant has the value "0.0" and the "K2" constant the value "+27648.0".

When the value at the IN parameter is greater than the value of the "HI\_LIM" constant, the result of the instruction is set to the value of the constant (K2) and an error is output.

When the value at the IN parameter is less than the value of the constant of the low limit (LO\_LIM), the result of the instruction is set to the value of the constant (K1) and an error is output.

### Syntax

The following syntax is used for the instruction "Unscale":

```

SCL
UNSCALE (IN := <Expression>,
         HI_LIM := <Operand>,
         LO_LIM := <Operand>,
         BIPOLAR := <Operand>,
         OUT => <Operand>)
    
```

The syntax of the instruction consists of the following parts:

Parameter	Declaration	Data type	Description
IN	Input	REAL	Input value to be unscaled to an integer value.
HI_LIM	Input	REAL	High limit
LO_LIM	Input	REAL	Low limit
BIPOLAR	Input	BOOL	Indicates if the value at the IN parameter is to be interpreted as bipolar or unipolar. The parameter can assume the following values: 1: Bipolar 0: Unipolar
OUT	Output	INT	Result of the instruction
Function value (RET_VAL)		WORD	Error information

For additional information on valid data types, refer to "See also".

## RET\_VAL Parameter

The following table shows the meaning of the values of the parameter RET\_VAL:

Error code (W#16#...)	Explanation
0000	No error
0008	The value of the IN parameter is greater than the value of the high limit (HI_LIM) or less than the value of the low limit (LO_LIM).
General error information	See also: "GET_ERR_ID: Get error ID locally"

\*The error codes can be displayed as integer or hexadecimal value in the program editor. For information on toggling display formats, refer to "See also".

## Example

The following example shows how the instruction works:

```
SCL
"Tag_ErrorCode" := UNSCALE(IN := "Tag_InputValue",
                           HI_LIM := "Tag_HighLimit",
                           LO_LIM := "Tag_LowLimit",
                           BIPOLAR := "Tag_Bipolar",
                           OUT => "Tag_Result");
```

The error information is returned in the operand "Tag\_ErrorCode" as a function value.

The following table shows how the instruction works using specific operand values:

Parameter	Operand	Value
IN	Tag_InputValue	50.03978588
HI_LIM	Tag_HighLimit	100.0
LO_LIM	Tag_LowLimit	0.0
BIPOLAR	Tag_Bipolar	1
OUT	Tag_Result	22
RET_VAL	Tag_ErrorCode	W#16#0000

## See also

Overview of the valid data types (Page 1077)

Entering SCL instructions (Page 1357)

Editing SCL instructions (Page 1374)

Expressions (Page 1341)

Operators and operator precedence (Page 1347)

GET\_ERR\_ID: Get error ID locally (Page 2237)

## Program control operations

### IF: Run conditionally

#### Description

The instruction "Run conditionally" branches the program flow depending on a condition. The condition is an expression with Boolean value (TRUE or FALSE). Logical expression or comparative expressions can be stated as conditions.

When the instruction is executed, the stated expressions are evaluated. If the value of an expression is TRUE, the condition is fulfilled; if the value is FALSE, it is not fulfilled.

#### Syntax

Depending on the type of branch, you can program the following forms of the instruction:

- Branch through IF:

```
SCL
IF <Condition> THEN <Instructions>
END_IF;
```

If the condition is satisfied, the instructions programmed after the THEN are executed. If the condition is not satisfied, the execution of the program continues with the next instruction after the END\_IF.

- Branch through IF and ELSE:

```
SCL
IF <Condition> THEN <Instructions1>
ELSE <Instructions0>;
END_IF;
```

If the condition is satisfied, the instructions programmed after the THEN are executed. If the condition is not satisfied, the instructions programmed after the ELSE are executed. Then the execution of the program continues with the next instruction after the END\_IF.

- Branch through IF, ELSIF and ELSE:

```
SCL
IF <Condition1> THEN <Instructions1>
ELSIF <Condition2> THEN <Instruction2>
ELSE <Instructions0>;
END_IF;
```

If the first condition (<Condition1>) is satisfied, the instructions (<Instructions1>) after the THEN are executed. After execution of the instructions, the execution of the program continues after the END\_IF.

If the first condition is not satisfied, the second condition (<Condition2>) is checked. If the second condition (<Condition2>) is fulfilled, the instructions (<Instructions2>) after the THEN are executed. After execution of the instructions, the execution of the program continues after the END\_IF.

If none of the conditions are fulfilled, the instructions (<Instructions0>) after ELSE are executed followed by the execution of the program after END\_IF.

You can nest as many combinations of ELSIF and THEN as you like within the IF instruction. The programming of an ELSE branch is optional.

The syntax of the IF instruction consists of the following parts:

Parameter	Data type	Description
<Condition>	BOOL	Expression to be evaluated
<Instructions>	-	Instructions to be executed with satisfied condition. An exception are instructions programmed after the ELSE. These are executed if no condition within the program loop is satisfied.

For additional information on valid data types, refer to "See also".

## Example

The following example shows how the instruction works:

```

SCL
IF "Tag_1" = 1
THEN "Tag_Value" := 10;
ELSIF "Tag_2" = 1
THEN "Tag_Value" := 20;
ELSIF "Tag_3" = 1
THEN "Tag_Value" := 30;
ELSE "Tag_Value" := 0;
END_IF;

```

The following table shows how the instruction works using specific operand values:

Operand	Value			
	1	0	0	0
Tag_1	1	0	0	0
Tag_2	0	1	0	0
Tag_3	0	0	1	0
Tag_Value	10	20	30	0

## See also

- Operators and operator precedence (Page 1347)
- Entering SCL instructions (Page 1357)
- Editing SCL instructions (Page 1374)
- Overview of the valid data types (Page 1077)

## CASE: Create multiway branch

### Description

The instruction "Create multiway branch" executes one of several instruction sequences depending on the value of a numerical expression.

The value of the expression must be an integer. When the instruction is executed, the value of the expression is compared with the values of several constants. If the value of the expression agrees with the value of a constant, the instructions programmed directly after this constant are executed. The constants can assume the following values:

- An integer (for example, 5)
- A range of integers (for example, 15..20)
- An enumeration consisting of integers and ranges (for example, 10, 11, 15..20)

### Syntax

The following syntax is used for the "Create multiway branch" instruction:

```
SCL  
CASE <expression> OF  
<Constant1>: <Instructions1>  
<Constant2>: <Instructions2>  
<ConstantX>: <InstructionsX>; // X >=3  
ELSE <Instructions0>;  
END_CASE;
```

The syntax of the instruction consists of the following parts:



Parameter	Data type	Description
<expression>	Integers	Value which is compared to the programmed constant values.
<Constant>	Integers	Constant values which form the condition for the execution of an instruction sequence. The constants can assume the following values: <ul style="list-style-type: none"> <li>• An integer (for example, 5)</li> <li>• A range of integers (for example, 15..20)</li> <li>• An enumeration consisting of integers and ranges (for example, 10, 11, 15..20)</li> </ul>
<Instruction>	-	Any instructions which are executed if the value of the expression agrees with the value of a constant. An exception are instructions programmed after the ELSE. These instructions are executed if the values do not agree.

For additional information on valid data types, refer to "See also".

If the value of the expression agrees with the value of the first constant (<Constant1>), the instructions (<Instructions1>) which are programmed directly after the first constant are executed. Program execution subsequently resumes after the END\_CASE.

If the value of the expression does not agree with the value of the first constant (<Constant1>), this value is compared to the value of the constant which is programmed next. In this way, the CASE instruction is executed until the values agree. If the value of the expression does not correspond to any of the programmed constant values, the instructions (<Instructions0>) which are programmed after the ELSE are executed. ELSE is an optional part of the syntax and can be omitted.

The CASE instruction can also be nested by replacing an instruction block with CASE. END\_CASE represents the end of the CASE instruction.

## Example

The following example shows how the instruction works:

```

SCL
CASE "Tag_Value" OF
  0 :
    "Tag_1" := 1;
  1,3,5 :
    "Tag_2" :=1;
  6..10 :
    "Tag_3" := 1;
  16,17,20..25 :
    "Tag_4" := 1;
ELSE "Tag_5" := 1;
END_CASE;

```

The following table shows how the instruction works using specific operand values:

Operand	Values				
Tag_Value	0	1, 3, 5	6, 7, 8, 9, 10	16,17, 20, 21, 22, 23, 24, 25	2
Tag_1	1	-	-	-	-
Tag_2	-	1	-	-	-
Tag_3	-	-	1	-	-
Tag_4	-	-	-	1	-
Tag_5	-	-	-	-	1
1: The operand is set to the signal state "1". -: The signal state of the operand remains unaltered.					

**See also**

- CONTINUE: Recheck loop condition (Page 2223)
- Overview of the valid data types (Page 1077)
- Operators and operator precedence (Page 1347)
- Entering SCL instructions (Page 1357)
- Editing SCL instructions (Page 1374)
- EXIT: Exit loop immediately (Page 2224)

**FOR: Run in counting loop**

**Description**

The instruction "Run in counting loop" causes repeated execution of a program loop until a loop variable lies within a specified value range.

Program loops can also be nested. Within a program loop, you can program additional program loops with other loop variables.

The current continuous run of a program loop can be ended by the instruction "Recheck loop condition" (CONTINUE). The instruction "Exit loop immediately" (EXIT) ends the entire loop execution. For additional information on this topic, refer to "See also".

**Limit values for FOR statements**

To program "safe" FOR statements that do not run endlessly, observe the following rules and limit values:

**Rule**

FOR ii := Start TO End BY Step DO

If ...	... then	Note
start < end	end < (PMAX step)	Run tag ii runs in a positive direction
start > end AND step < 0	end > (NMAX step)	Run tag ii runs in a negative direction

### Limit values

Different limit values apply to the possible data types:

Data type	PMAX	NMAX
ii of type SINT	127	-128
ii of type INT	32767	-32768
ii of type DINT	2147483647	-2147483648
ii of type LINT	9223372036854775807	-9223372036854775808

### Syntax

The following syntax is used for the "Run in counting loop" instruction:

#### SCL

```
FOR<Run_tag> := <Start_value> TO<End_value> BY<Increment> DO<Instructions>
END_FOR;
```

### Parameter

The following table shows the parameters of the "Run in counting loop" instruction:

Parameter	Data type		Description
	S7-1200	S7-1500	
<Run tag>	SINT, INT, DINT	SINT, INT, DINT, LINT	Operand whose value is evaluated with the loop execution. The data type of the loop variable determines the data type of the other parameters.
<Start value>	SINT, INT, DINT	SINT, INT, DINT, LINT	Expression whose value is allocated at the start of the loop execution of the loop variables.
<End value>	SINT, INT, DINT	SINT, INT, DINT, LINT	Expression whose value defines the last run of the program loop. The value of the loop variable is checked before each loop: <ul style="list-style-type: none"> <li>End value not reached: The instructions according to DO are executed</li> <li>End value is reached: The FOR loop is executed one last time</li> <li>End value exceeded: The FOR loop is completed</li> </ul> An alteration to the end value is not permitted during execution of the instruction.

Parameter	Data type		Description
	S7-1200	S7-1500	
<Increment>	SINT, INT, DINT	SINT, INT, DINT, LINT	Expression by whose value the loop variable is increased (positive increment) or decreased (negative increment) after each loop. Specification of the increment is optional. If no increment is given, the value of the loop variable is increased by 1 after each loop. An alteration of the increment is not permitted during execution of the instruction.
<Instructions>	-	-	Instructions which are carried out with each loop, as long as the value of the loop variable lies within the value range. The value range is defined by the start and end values.

For additional information on valid data types, refer to "See also".

### Example

The following example shows how the instruction works:

```

SCL
FOR i := 2 TO 8 BY 2
    DO "a_array[i] := "Tag_Value"*"b_array[i]";
END_FOR;
    
```

The operand "Tag\_Value" is multiplied with the elements (2, 4, 6, 8) of the ARRAY tag "b\_array". The result is read in to the elements (2, 4, 6, 8) of the ARRAY tag "a\_array".

### See also

- CONTINUE: Recheck loop condition (Page 2223)
- EXIT: Exit loop immediately (Page 2224)
- Overview of the valid data types (Page 1077)
- Operators and operator precedence (Page 1347)
- Entering SCL instructions (Page 1357)
- Editing SCL instructions (Page 1374)

### WHILE: Run if condition is met

#### Description

The instruction "Run if condition is met" causes a program loop to be repeatedly executed until the implementation condition is satisfied. The condition is an expression with Boolean value ((TRUE or FALSE). Logical expression or comparative expressions can be stated as conditions.

When the instruction is executed, the stated expressions are evaluated. If the value of an expression is TRUE, the condition is fulfilled; if the value is FALSE, it is not fulfilled.

Program loops can also be nested. Within a program loop, you can program additional program loops with other run variables.

The current continuous run of a program loop can be ended by the instruction "Recheck loop condition" (CONTINUE). The instruction "Exit loop immediately" (EXIT) ends the entire loop execution. For additional information on this topic, refer to "See also".

## Syntax

The following syntax is used for the "Run if condition is met" instruction:

```
SCL
-----
WHILE <Condition> DO <Instructions>
END_WHILE;
```

The syntax of the WHILE instruction consists of the following parts:

Parameter	Data type	Description
<Condition>	BOOL	Expression which is evaluated before each loop.
<Instructions>	-	Instructions to be executed with satisfied condition. If the condition has not been satisfied, program execution continues after END_WHILE.

For additional information on valid data types, refer to "See also".

## Example

The following example shows how the instruction works:

```
SCL
-----
WHILE
    "Tag_Value1" <> "Tag_Value2"
DO "Tag_Result"
    := "Tag_Input";
END_WHILE;
```

As long as the values of the operands "Tag\_Value1" and "Tag\_Value2" do not match, the value of the operand "Tag\_Input" is allocated to the operand "Tag\_Result".

**See also**

- EXIT: Exit loop immediately (Page 2224)
- Operators and operator precedence (Page 1347)
- Entering SCL instructions (Page 1357)
- Editing SCL instructions (Page 1374)
- CONTINUE: Recheck loop condition (Page 2223)
- Overview of the valid data types (Page 1077)

**REPEAT: Run if condition is not met**

**Description**

The instruction "Run if condition is not met" causes a program loop to be repeatedly executed until a termination condition is met. The condition is an expression with Boolean value (TRUE or FALSE). Logical expression or comparative expressions can be stated as conditions.

When the instruction is executed, the stated expressions are evaluated. If the value of an expression is TRUE, the condition is fulfilled; if the value is FALSE, it is not fulfilled.

The instructions are executed once, even if the termination condition is fulfilled.

Program loops can also be nested. Within a program loop, you can program additional program loops with other run variables.

The current continuous run of a program loop can be ended by the instruction "Recheck loop condition" (CONTINUE). The instruction "Exit loop immediately" (EXIT) ends the entire loop execution. For additional information on this topic, refer to "See also".

**Syntax**

The following syntax is used for the "Run if condition is not met" instruction:

```

SCL
REPEAT <Instructions>
UNTIL <Condition> END_REPEAT;
    
```

The syntax of the REPEAT instruction consists of the following parts:

Parameter	Data type	Description
<Instructions>	-	Instructions that are executed as long as the programmed condition has the value FALSE. The instructions are executed once, even if the termination condition is fulfilled.
<Condition>	BOOL	Expression which is evaluated after each loop. If the expression has the value FALSE, the program loop is executed once again. If the expression has the value TRUE, the program loop continues after END_REPEAT.

For additional information on valid data types, refer to "See also".

## Example

The following example shows how the instruction works:

```
SCL
REPEAT "Tag_Result"
    := "Tag_Value";
UNTIL "Tag_Error"
END_REPEAT;
```

As long as the value of the operand "Tag\_Error" has the signal state "0", the value of the operand "Tag\_Value" is allocated to the operand "Tag\_Result".

## See also

CONTINUE: Recheck loop condition (Page 2223)

EXIT: Exit loop immediately (Page 2224)

Operators and operator precedence (Page 1347)

Entering SCL instructions (Page 1357)

Editing SCL instructions (Page 1374)

Overview of the valid data types (Page 1077)

## CONTINUE: Recheck loop condition

### Description

The "Recheck loop condition" instruction ends the current program run of a FOR, WHILE or REPEAT loop.

After execution of the instruction, the conditions for the continuation of the program loop are evaluated again. The instruction affects the program loop which directly contains the instruction.

### Syntax

The following syntax is used for the "Recheck loop condition" instruction:

```
SCL
CONTINUE;
```

## Example

The following example shows how the instruction works:

```
SCL
FOR i
```

```
SCL
:= 1 TO 15 BY 2 DO
  IF (i < 5) THEN
    CONTINUE;
  END_IF;
  "DB10".Test[i] := 1;
END_FOR;
```

For additional information on valid data types, refer to "See also".

If the condition  $i < 5$  is satisfied, then the subsequent value allocation ("DB10".Test[i] := 1) will not be executed. The run variable (i) is increased by the increment of "2" and checked to see whether its current value lies in the programmed value range. If the run variable lies in the value range, the IF condition is evaluated again.

If the condition  $i < 5$  is not satisfied, then the subsequent value allocation ("DB10".Test[i] := 1) will be executed and a new loop started. In this case, the run variable is also increased by the increment "2" and checked.

**See also**

- Operators and operator precedence (Page 1347)
- Entering SCL instructions (Page 1357)
- Editing SCL instructions (Page 1374)
- EXIT: Exit loop immediately (Page 2224)
- Overview of the valid data types (Page 1077)

**EXIT: Exit loop immediately**

**Description**

The instruction "Exit loop immediately" cancels the execution of a FOR, WHILE or REPEAT loop at any point regardless of conditions. The execution of the program is continued after the end of the loop (END\_FOR, END\_WHILE, END\_REPEAT).

The instruction affects the program loop which directly contains the instruction.

**Syntax**

The following syntax is used for the "Exit loop immediately" instruction:

```
SCL
EXIT;
```



## Example

The following example shows how the instruction works:

```
SCL
FOR i := 15 TO 1 BY -2 DO
IF (i < 5)
THEN EXIT;
END_IF;
"DB10".Test[i] := 1;
END_FOR;
```

For additional information on valid data types, refer to "See also".

If the condition  $i < 5$  is satisfied, then the execution of the loop will be cancelled. Program execution resumes after the END\_FOR.

If the condition  $i < 5$  is not satisfied, then the subsequent value allocation ("DB10".Test[i] := 1) will be executed and a new loop started. The run tag (i) is decreased by the increment of "-2" and it is checked whether its current value lies in the programmed value range. If the (i) run variable lies within the value range, the IF condition is evaluated again.

## See also

Operators and operator precedence (Page 1347)

Entering SCL instructions (Page 1357)

Editing SCL instructions (Page 1374)

CONTINUE: Recheck loop condition (Page 2223)

Overview of the valid data types (Page 1077)

## GOTO: Jump

### Description

Use the instruction "Jump" to resume the execution of a program at a given point marked with a jump label.

The jump labels and the instruction "Jump" must be in the same block. The name of a jump label can only be assigned once within a block. Each jump label can be the target of several jump instructions.

A jump from the "outside" into a program loop is not permitted, but a jump from a loop to the "outside" is possible.

**Syntax**

Use the following syntax for the "Jump" instruction:

```

SCL
GOTO <Jump label>
...
<Jump label>: <Instructions>
    
```

The syntax of the GOTO instruction consists of the following parts:

Parameter	Data type	Description
<jump label>	-	Jump label to be jumped to
<Instructions>	-	Instructions which are executed after the jump.

**Example**

The following example shows how the instruction works:

```

SCL
CASE "Tag_Value" OF
1 : GOTO MyLABEL1;
2 : GOTO MyLABEL2;
3 : GOTO MyLABEL3;
ELSE GOTO MyLABEL4;
END_CASE;
MyLABEL1: "Tag_1" := 1;
MyLABEL2: "Tag_2" := 1;
MyLABEL3: "Tag_3" := 1;
MyLABEL4: "Tag_4" := 1;
    
```

Depending on the value of the "Tag\_Value" operand, the execution of the program will resume at the point identified by the corresponding jump label. If the operand "Tag\_Value" has the value 2, for example, program execution will resume at the jump label "MyLABEL2". The program line identified by the jump label "MyLABEL1" will be skipped in this case.

**See also**

- Operators and operator precedence (Page 1347)
- Entering SCL instructions (Page 1357)
- Editing SCL instructions (Page 1374)
- Overview of the valid data types (Page 1077)

## RETURN: Exit block

### Description

The instruction "Exit block" exits the program execution in the currently edited block and continues in the calling block.

The instruction can be omitted at the end of the block.

### Syntax

The following syntax is used for the "Exit block" instruction:

```
SCL  
RETURN;
```

### Example

The following example shows how the instruction works:

```
SCL  
IF "Tag_Error" <>0 THEN RETURN;  
END_IF;
```

If the signal state of the "Tag\_Error" operand is not zero, execution of the program ends in the block currently being processed.

### See also

Operators and operator precedence (Page 1347)

Entering SCL instructions (Page 1357)

Editing SCL instructions (Page 1374)

Overview of the valid data types (Page 1077)

### (\*...\*): Inserting a comment section

### Description

You can use the "Insert comment section" instruction to add a comment section. The text within the parenthesis "(\*...\*)" is handled as a comment.

## Syntax

The following syntax is used for the "Insert comment section" instruction:

```
SCL  
(*...*)
```

## Example

The following example shows how the instruction works:

```
SCL  
(*This is a comment section.*)
```

## See also

[Operators and operator precedence \(Page 1347\)](#)

[Entering SCL instructions \(Page 1357\)](#)

[Editing SCL instructions \(Page 1374\)](#)

[Overview of the valid data types \(Page 1077\)](#)

## Runtime control

### ENDIS\_PW: Limit and enable password legitimation

#### Description

You can use the "Limit and enable password legitimation" instruction to specify whether or not legitimation is allowed for the CPU. You can prevent legitimated connections, even when the correct password is known. When you invoke the command and the REQ parameter has the signal state "0", only the currently set condition is displayed at the output parameters, but no setting is changed. If the REQ parameter has the signal state "1", the signal state is taken from the input parameters (F\_PWD, FULL\_PWD, R\_PWD, HMI\_PWD). FALSE means that legitimation per password is not allowed; TRUE means the password can be used. Disable or enabling of the passwords can be allowed or prohibited individually. For example, all passwords can be prohibited, except the fail-safe password. You can thus limit access options to a small user group. The output parameters (F\_PWD\_ON, FULL\_PWD\_ON, R\_PWD\_ON, HMI\_PWD\_ON) always show the current status of the password use, regardless of the REQ parameter.

The same setting can be made on the front panel of the CPU and the CPU saves the most recent setting.

To prevent accidental lockout, the protection can be disabled by setting the mode switch to STOP with an S7-1500 CPU. The protection is automatically enabled again by setting mode selector to RUN without having to call the "Limit and enable password legitimation" instruction again or taking additional actions on the front panel.

The instruction must always be fully executed, in other words, the F\_PWD parameter must always have the signal state "0", for example, so that the settings can be saved.

Disabled passwords can be enabled again under the following conditions:

- The CPU is reset to its factory settings.
- The front panel of the S7-1500 CPU supports a dialog that allows you to navigate to the appropriate menu in which the passwords can be enabled again.
- When you call the "Limit and enable password legitimation" instruction, the input parameter of the desired password has the signal state "1".
- Set the mode selector to STOP. The restriction to password legitimation is re-established as soon as the switch is set back to RUN.
- Plugging a transfer module into an S7-1200 CPU.

---

**Note**

The "Limit and enable password legitimation" instruction blocks access to the HMI panel, if the HMI password has not been enabled.

---

---

**Note**

Existing legitimized connections retain their access rights and you cannot use the "Limit and enable password legitimation" instruction to restrict them.

---

### Procedure for lost passwords with an S7-1200 CPU

If you have lost the password for a password-protected CPU, delete the password-protected program with an empty transfer card. The empty transfer card deletes the internal load memory of the CPU. You can then load a new user program from STEP 7 Basic in the CPU.

 <b>WARNING</b>
<b>Inserting transfer card</b>
When you insert a transfer card in a CPU during runtime, the CPU goes to STOP mode. If operating states are unstable, controllers may fail and thus cause the uncontrolled operation of the controlled devices. This leads to an unforeseen operation of the automation system which can cause deadly or serious injuries and/or damage to property.

You must remove the transfer card before you put the CPU into RUN mode.

### Effects of password use on the operating modes

The following table shows what effects the password use by means of the "Limit and enable password legitimation" instruction has on the operating modes and the corresponding user actions.

Action	Password protection by means of the instruction
Basic state after <ul style="list-style-type: none"> <li>• Operating mode switch to STOP</li> <li>• Reset memory manually (PG, switch, change of MC (Motion Control))</li> <li>• Reset to factory setting</li> </ul>	Not activated (no restrictions)
Basic state after POWER ON	Enabled (when a lock was activated before POWER OFF) The option of not allowing passwords is retentive.
Operating mode transition RUN/STARTUP/HOLD -> STOP (by terminating the instruction, an error or communication) or STOP -> STARTUP/RUN/HOLD	Activated Passwords still cannot be used.

### Syntax

Use the following syntax for the "Limit and enable password legitimation" instruction:

#### SCL

```

ENDIS_PW (REQ := <Operand>,
          F_PWD := <Operand>,
          FULL_PWD := <Operand>,
          R_PWD := <Operand>,
          HMI_PWD := <Operand>,
          F_PWD_ON => <Operand>,
          FULL_PWD_ON => <Operand>,
          R_PWD_ON => <Operand>,
          HMI_PWD_ON => <Operand>,
          RET_VAL => <Operand>)
    
```

## Parameter

The following table shows the parameters of the "Limit and enable password legitimation" instruction:

Parameter	Declaration	Data type	Memory area	Description
REQ	Input	BOOL	I, Q, M, D, L	When the REQ parameter has the signal state "0", the currently set signal state of the passwords is queried.
F_PWD	Input	BOOL	I, Q, M, D, L	Read/write access including fail-safe <ul style="list-style-type: none"> <li>• F_PWD = "0": Do not allow password</li> <li>• F_PWD = "1": Allow password</li> </ul>
FULL_PWD	Input	BOOL	I, Q, M, D, L	Read/write access <ul style="list-style-type: none"> <li>• FULL_PWD = "0": Do not allow password</li> <li>• FULL_PWD = "1": Allow password</li> </ul>
R_PWD	Input	BOOL	I, Q, M, D, L	Read access <ul style="list-style-type: none"> <li>• R_PWD = "0": Do not allow password</li> <li>• R_PWD = "1": Allow password</li> </ul>
HMI_PWD	Input	BOOL	I, Q, M, D, L	HMI access <ul style="list-style-type: none"> <li>• HMI_PWD = "0": Do not allow password</li> <li>• HMI_PWD = "1": Allow password</li> </ul>
F_PWD_ON	Output	BOOL	I, Q, M, D, L	Read/write access including fail-safe <ul style="list-style-type: none"> <li>• F_PWD_ON = "0": Password not allowed</li> <li>• F_PWD_ON = "1": Password allowed</li> </ul>
FULL_PWD_ON	Output	BOOL	I, Q, M, D, L	Read/write access status <ul style="list-style-type: none"> <li>• FULL_PWD_ON = "0": Password not allowed</li> <li>• FULL_PWD_ON = "1": Password allowed</li> </ul>

Parameter	Declaration	Data type	Memory area	Description
R_PWD_ON	Output	BOOL	I, Q, M, D, L	Read-access status <ul style="list-style-type: none"> <li>• R_PWD_ON = "0": Password not allowed</li> <li>• R_PWD_ON = "1": Password allowed</li> </ul>
HMI_PWD_ON	Output	BOOL	I, Q, M, D, L	HMI-access status <ul style="list-style-type: none"> <li>• HMI_PWD_ON = "0": Password not allowed</li> <li>• HMI_PWD_ON = "1": Password allowed</li> </ul>
RET_VAL	Output	WORD	I, Q, M, D, L	Error information

For additional information on valid data types, refer to "See also".

### Parameter RET\_VAL

The following table shows the meaning of the values of the RET\_VAL parameter:

Error code* (W#16#...)	Explanation
0000	No error
8090	The "Limit and enable password legitimation" instruction is not supported
80D0	The password for fail-safe is not configured
80D1	The read/write access is not configured
80D2	The read access is not configured
80D3	The HMI access is not configured

\*The error codes can be displayed as integer or hexadecimal value in the program editor. For information on toggling display formats, refer to "See also".

### See also

Entering SCL instructions (Page 1357)

Editing SCL instructions (Page 1374)

### RE\_TRIGR: Restart cycle monitoring time

#### Description

The instruction "Restart cycle monitoring time" restarts the cycle monitoring of the CPU. The cycle time monitoring then restarts with the time you have set in the CPU configuration.

The instruction "Restart cycle monitoring time" can be called, regardless of the priority, in all blocks.



If the instruction is called in a block with a higher priority, such as a hardware interrupt, diagnostic interrupt, or cyclic interrupt, the instruction is not executed and the ENO enable output is set to signal state "0".

The instruction "Restart cycle monitoring time" can be called a maximum of 10 times in a program cycle.

---

**Note**

If the instruction "Restart cycle monitoring time" is started more than 30 times within a LOOP instruction, the CPU switches to STOP because of a runtime error.

---

**Syntax**

The following syntax is used for the "Restart cycle monitoring time" instruction:

```
SCL
RE_TRIGR()
```

**See also**

Entering SCL instructions (Page 1357)

Editing SCL instructions (Page 1374)

**STP: Exit program****Description**

The "Exit program" instruction is used to set the CPU to STOP mode and therefore to terminate the execution of the program. The effects of changing from RUN to STOP depend on the CPU configuration.

**Syntax**

The following syntax is used for the instruction "Exit program":

```
SCL
STP()
```

---

**See also**

Entering SCL instructions (Page 1357)

Editing SCL instructions (Page 1374)

## GET\_ERROR: Get error locally

### Description

The instruction "Get error locally" queries the occurrence of errors within a block. If the system signals errors during block execution, the instruction gives detailed information about the first error that occurred.

The error information can only be saved in operands of the "ErrorStruct" system data type. The system data type "ErrorStruct" specifies the exact structure in which the information about the error is stored. Use additional instructions to evaluate this structure and program an appropriate response. When the first error has been eliminated, the instruction issues additional information about the next error that has occurred.

#### Note

The "Get error locally" instruction enables local error handling within a block. If "Get error locally" is inserted into the program code of a block, any predefined system reactions are ignored if errors occur.

### Syntax

The following syntax is used for the instruction "Get error locally":

#### SCL

```
<Error information> := GET_ERROR(<Operand>)
```

### Parameter

The following table shows the parameters of the "Get error locally" instruction:

Parameter	Data type	Description
Function value	ErrorStruct	Information about errors that have occurred

### Data type "ErrorStruct"

The following table shows the structure of the data type ErrorStruct:

Structure component	Data type	Description
ERROR_ID	WORD	Error ID
FLAGS	BYTE	Shows if an error occurred during a block call. 16#01: Error during a block call. 16#00: No error during a block call.

Structure component		Data type	Description					
REACTION		BYTE	Default reaction: 0: Ignore (write error), 1: Continue with substitute value "0" (read error), 2: Skip instruction (system error)					
CODE_ADDRESS		CREF	Information on address and type of block					
	BLOCK_TYPE	BYTE	Type of block where the error occurred: 1: OB 2: FC 3: FB					
	CB_NUMBER	UINT	Number of the code block					
	OFFSET	UDINT	Reference to the internal memory					
MODE		BYTE	Access mode: Depending on the type of access, the following information can be output:					
			Mode	(A)	(B)	(C)	(D)	(E)
			0					
			1					Offset
			2			Area		
			3	Location	Scope		Number	
			4			Area		Offset
			5			Area	DB no.	Offset
			6	PtrNo./ Acc		Area	DB no.	Offset
			7	PtrNo./ Acc	Slot No. / Scope	Area	DB no.	Offset
OPERAND_NUMBER		UINT	Operand number of the machine command					
POINTER_NUMBER_LOCATION		UINT	(A) Internal pointer					
SLOT_NUMBER_SCOPE		UINT	(B) Storage area in internal memory					
DATA_ADDRESS		NREF	Information about the address of an operand					
	AREA	BYTE	(C) Memory area: L: 16#40 – 4E, 86, 87, 8E, 8F, C0 – CE E: 16#81 A: 16#82 M: 16#83 DB: 16#84, 85, 8A, 8B Range violations for a directly editable tag of data type DINT: 16#04					
	DB_NUMBER	UINT	(D) Number of the data block					
	OFFSET	UDINT	(E) Relative address of the operand					

**Structure component "ERROR\_ID"**

The following table shows the values that can be output at the structure component "ERROR\_ID":

ID* (hexadecimal)	ID* (decimal)	Description
0	0	No error
2503	9475	Invalid pointer
2520	9504	Invalid STRING
2522	9506	Read error: Operand outside the valid range
2523	9507	Write error: Operand outside the valid range
2524	9508	Read error: Invalid operand
2525	9509	Write error: Invalid operand
2528	9512	Read error: Data alignment
2529	9513	Write error: Data alignment
252C	9516	Invalid pointer
2530	9520	Write error: Data block
2533	9523	Invalid pointer used
2538	9528	Access error: DB does not exist
2539	9529	Access error: Wrong DB used
253A	9530	Global data block does not exist
253C	9532	Faulty information or the function does not exist
253D	9533	System function does not exist
253E	9534	Faulty information or the function block does not exist
253F	9535	System block does not exist
2550	9552	Access error: DB does not exist
2551	9553	Access error: Wrong DB used
2575	9589	Error in the program nesting depth
2576	9590	Error in the local data distribution
2577	9591	Die block property "Parameter assignment via register" is not selected.
25A0	9632	Internal error in TP
25A1	9633	Tag is write-protected
25A2	9634	Invalid numerical value of tag
2942	10562	Read error: Input
2943	10563	Write error: Output
*The error codes can be displayed as integer or hexadecimal value in the program editor. For information on toggling display formats, refer to "See also".		

The "Get error locally" instruction can also be used to forward an alarm about the error status to the calling block. To do this, you have to program the instruction at the end of the called block.

**See also**

Entering SCL instructions (Page 1357)

Editing SCL instructions (Page 1374)

**GET\_ERR\_ID: Get error ID locally****Description**

The instruction "Get error ID locally" queries the occurrence of errors within a block. If the system signals errors during block execution, the error ID of the first error that has occurred is given. The error ID can only be saved in operands of the WORD data type. When the first error has been eliminated, the instruction outputs the error ID of the next error that occurred.

The "Get error ID locally" instruction can also be used to forward an alarm about the error status to the calling block. To do this, you have to program the instruction at the end of the called block.

**Note**

The "Get error ID locally" instruction enables local error handling within a block. If the instruction "Get error ID locally" is inserted in the program code of a block, any predefined system reactions are ignored if errors occur.

**Syntax**

The following syntax is used for the instruction "Get error ID locally":

**SCL**

```
<Error_ID> := GET_ERR_ID(<Operand>)
```

**Parameter**

The following table shows the parameters of the "Get error ID locally" instruction:

Parameter	Data type	Description
Function value	WORD	Error ID

**Error ID**

The following table shows the values that can be output:

ID* (hexadecimal)	ID* (decimal)	Description
0	0	No error
2503	9475	Invalid pointer

ID* (hexadecimal)	ID* (decimal)	Description
2520	9504	Invalid STRING
2522	9506	Read error: Operand outside the valid range
2523	9507	Write error: Operand outside the valid range
2524	9508	Read error: Invalid operand
2525	9509	Write error: Invalid operand
2528	9512	Read error: Data alignment
2529	9513	Write error: Data alignment
252C	9516	Invalid pointer
2530	9520	Write error: Data block
2533	9523	Invalid pointer used
2538	9528	Access error: DB does not exist
2539	9529	Access error: Wrong DB used
253A	9530	Global data block does not exist
253C	9532	Faulty information or the function does not exist
253D	9533	System function does not exist
253E	9534	Faulty information or the function block does not exist
253F	9535	System block does not exist
2550	9552	Access error: DB does not exist
2551	9553	Access error: Wrong DB used
2575	9589	Error in the program nesting depth
2576	9590	Error in the local data distribution
2577	9591	Die block property "Parameter assignment via register" is not selected.
25A0	9632	Internal error in TP
25A1	9633	Tag is write-protected
25A2	9634	Invalid numerical value of tag
2942	10562	Read error: Input
2943	10563	Write error: Output
*The error codes can be displayed as integer or hexadecimal value in the program editor. For information on toggling display formats, refer to "See also".		

**See also**

Entering SCL instructions (Page 1357)

Editing SCL instructions (Page 1374)

**INIT\_RD: Initialize all retain data****Description**

The "Initialize all retain data" instruction is used to reset the retentive data of all data blocks, bit memories and SIMATIC timers and counters at the same time. The instruction can only be executed within a startup OB because the execution exceeds the program cycle duration.

**Syntax**

Use the following syntax for the "Initialize all retain data" instruction:

**SCL**

```
INIT_RD(REQ := <Operand>
        RET_VAL := <Operand>)
```

**Parameter**

The following table shows the parameters of the "Initialize all retain data" instruction:

Parameter	Declaration	Data type	Description
REQ	Input	BOOL	If the input "REQ" has the signal state "1", all retentive data are reset.
RET_VAL	Output	INT	Error information: If an error occurs during the execution of the instruction, an error code is output at the RET_VAL parameter.

For additional information on valid data types, refer to "See also".

**RET\_VAL Parameter**

The following table shows the meaning of the values of the parameter RET\_VAL:

Error code* (W#16#...)	Explanation
0000	No error
80B5	The instruction cannot be executed because it was not programmed within a startup OB.
General error information	See also: "GET_ERR_ID: Get error ID locally"

\*The error codes can be displayed as integer or hexadecimal value in the program editor. For information on toggling display formats, refer to "See also".

### Example

The following example shows how the instruction works:

```
SCL  
INIT_RD (REQ := "Tag_REQ",  
         RET_VAL := "Tag_Result");
```

If the operand "Tag\_REQ" has the signal state "1", the instruction is executed. All retentive data of all data blocks, bit memories and SIMATIC timers and counters are reset.

### See also

- Entering SCL instructions (Page 1357)
- Editing SCL instructions (Page 1374)
- Overview of the valid data types (Page 1077)
- GET\_ERR\_ID: Get error ID locally (Page 2237)

### WAIT: Configure time delay

#### Description

The instruction "Configure time delay" pauses the program execution for a specific period of time. You indicate the period of time in microseconds on the WT parameter of the instruction.

You can configure time delays of up to 32 767 microseconds (µs). The shortest possible time delay depends on the respective CPU and corresponds to the execution time of the instruction "Configure time delay".

The execution of the instruction can be interrupted by higher priority events.

The instruction "Configure time delay" supplies no error information.

#### Syntax

The following syntax is used for the instruction "Configure time delay":

```
SCL  
WAIT (WT:= <Operand>)
```

The syntax of the instruction consists of the following parts:

Parameter	Declaration	Data type	Description
WT	Input	INT	Time delay in microseconds (µs)



**See also**

Overview of the valid data types (Page 1077)

Entering SCL instructions (Page 1357)

Editing SCL instructions (Page 1374)

**RUNTIME: Measure program runtime****Description**

The "Measure program runtime" instruction is used to measure the runtime of the entire program, individual blocks or command sequences.

If you want to measure the runtime of your entire program, call the instruction "Measure program runtime" in OB1. Measurement of the runtime is started with the first call and the output RET\_VAL returns the runtime of the program after the second call. The measured runtime includes all CPU processes that can occur during the program execution, for example, interruptions caused by higher-level events or communication. The instruction "Measure program runtime" reads an internal counter of the CPU and writes the value to the in/out parameter. The instruction calculates the current program runtime according to the internal counter frequency and writes it to output RET\_VAL.

If you want to measure the runtime of individual blocks or individual command sequences, you need three separate networks. Call the instruction "Measure program runtime" in an individual network within your program. You set the starting point of the runtime measurement with this first call of the instruction. Then you call the required program block or the command sequence in the next network. In another network, call the "Measure program runtime" instruction a second time and assign the same memory to the in/out parameter as you did during the first call of the instruction. The "Measure program runtime" instruction in the third network reads an internal CPU counter and calculates the current runtime of the program block or the command sequence according to the internal counter frequency and writes it to the output RET\_VAL.

The "Measure program runtime" instruction uses an internal high-frequency counter to calculate the time. If the counter overruns, the instruction returns values  $\leq 0.0$ . Ignore these runtime values.

---

**Note**

The runtime of a command sequence cannot be determined exactly, because the sequence of instructions within a command sequence is changed during optimized compilation of the program.

---

The "Measure program runtime" instruction has no error information.

**Syntax**

The following syntax is used for the "Measure program runtime" instruction:

```
SCL
RUNTIME (<Operand>)
```

The syntax of the instruction consists of the following parts:

Parameter	Declaration	Data type	Description
<Operand>	InOut	LREAL	Saves the starting point of the runtime measurement.
Function value		LREAL	Returns the measured runtime in seconds

For additional information on valid data types, refer to "See also".

**Example**

The following example shows the how the instruction works based on the runtime calculation of a program block:

```
SCL
"Tag_Result" := RUNTIME("Tag_Memory");

"Best_before_date_DB" ();

"Tag_Result" := RUNTIME("Tag_Memory");
```

The starting point for the runtime measurement is set with the first call of the instruction and buffered as reference for the second call of the instruction in the "TagMemory" operand.

The "Best\_before\_date" program block FB1 is called.

When the program block FB1 has been processed, the instruction is executed a second time. The second call of the instruction calculates the runtime of the program block and writes the result to the output "Tag\_Result".

**See also**

- Entering SCL instructions (Page 1357)
- Editing SCL instructions (Page 1374)
- Overview of the valid data types (Page 1077)

## Word logic operations

### DECO: Decode

#### Description

The instruction "Decode" sets a bit specified by the input value in the output value.

The instruction "Decode" reads the value of the parameter IN and sets the bit in the output value, whose bit position corresponds to the read value. The other bits in the output value are filled with zeroes. If the value of the IN parameter is greater than 31, a modulo 32 instruction is executed.

#### Syntax

The following syntax is used for the instruction "Decode":

##### SCL

```
DECO(IN := <Expression>)
DECO_WORD(IN := <Expression>)
```

The syntax of the instruction consists of the following parts:

Parameter	Declaration	Data type	Description
IN	Input	UINT	Position of the bit in the output value which is set.
_<Data type>		Bit strings default: DWORD	Data type of the function value: <ul style="list-style-type: none"> <li>You do not need to specify the data type if using the default.</li> <li>Any other valid data type you may use must be declared explicitly.</li> </ul>
Function value		Bit strings	Current output value

For additional information on valid data types, refer to "See also".

#### Example

The following example shows how the instruction works:

##### SCL

```
"Tag_Result" := DECO(IN := "Tag_Value");
"Tag_Result2" := DECO_BYTE(IN := "Tag_Value2");
```

The following figure shows how the instruction works using specific operand values:

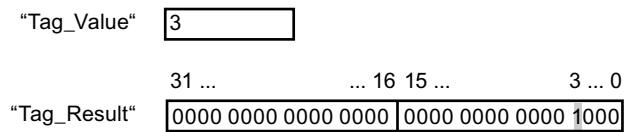

The instruction reads the number "3" from the value of the operand "Tag\_Value" and sets the third bit to the value of the operand "Tag\_Result".

**See also**

- Overview of the valid data types (Page 1077)
- Operators and operator precedence (Page 1347)
- Entering SCL instructions (Page 1357)
- Editing SCL instructions (Page 1374)

**ENCO: Encode**

**Description**

The instruction "Encode" reads the bit number of the lowest-value bit set in the input value and issues this as a result.

**Syntax**

The following syntax is used for the instruction "Encode":

```
SCL
ENCO(IN := <Expression>)
```

The syntax of the instruction consists of the following parts:

Parameter	Declaration	Data type	Description
IN	Input	Bit strings	Input value
Function value		INT	Bit number of the bit in the input value that is read out.

For additional information on valid data types, refer to "See also".

## Example

The following example shows how the instruction works:

```
SCL
"Tag_Result" := ENCO(IN := "Tag_Value");
```

The following figure shows how the instruction works using specific operand values:

	31 ...	... 16 15 ...	3 ... 0
"Tag_Value"	0000 1111 0000 0101 0000 1001 0000 1000		
"Tag_Result"	3		

The instruction reads the lowest-value set bit of the operand "Tag\_Value" and writes the bit position "3" in the operand "Tag\_Result".

## See also

- Overview of the valid data types (Page 1077)
- Operators and operator precedence (Page 1347)
- Entering SCL instructions (Page 1357)
- Editing SCL instructions (Page 1374)

## SEL: Select

### Description

The instruction "Select" selects one of the parameters IN0 or IN1 depending on a switch (G parameter) and issues its content as a result. When the parameter G has the signal status "0", the value at parameter IN0 is moved. When the parameter G has the signal status "1", the value at parameter IN1 is moved and returned as a function value.

The instruction is only executed if the tags of all parameters have the same data type class.

### Syntax

The following syntax is used for the instruction "Select":

```
SCL
SEL(G:= <Expression>,
  IN0 := <Expression>,
  IN1 := <Expression>)
```

The syntax of the instruction consists of the following parts:

Parameter	Declaration	Data type		Description
		S7-1200	S7-1500	
G	Input	BOOL	BOOL	Switch
IN0	Input	Bit strings, integers, floating-point numbers, TIME, TOD, DATE, CHAR, DT	Bit strings, integers, floating-point numbers, CHAR, timers, DATE, TOD, LTOD, DT, LDT	First input value
IN1	Input	Bit strings, integers, floating-point numbers, TIME, TOD, DATE, CHAR, DT	Bit strings, integers, floating-point numbers, CHAR, timers, DATE, TOD, LTOD, DT, LDT	Second input value
Function value		Bit strings, integers, floating-point numbers, TIME, TOD, DATE, CHAR, DT	Bit strings, integers, floating-point numbers, CHAR, timers, DATE, TOD, LTOD, DT, LDT	Result of the instruction

For additional information on valid data types, refer to "See also".

**Example**

The following example shows how the instruction works:

```

SCL
"Tag_Result" := SEL(G := "Tag_Value",
                    IN0 := "Tag_0",
                    IN1 := "Tag_1");
    
```

The result of the instruction is returned in the operand "Tag\_Result" as a function value.

The following table shows how the instruction works using specific operand values:

Operand	Value	
Tag_Value	0	1
Tag_0	W#16#0000	W#16#4C
Tag_1	W#16#FFFF	D#16#5E
Tag_Result	W#16#0000	D#16#5E

**See also**

- Overview of the valid data types (Page 1077)
- Operators and operator precedence (Page 1347)
- Entering SCL instructions (Page 1357)
- Editing SCL instructions (Page 1374)

## MUX: Multiplex

### Description

The "Multiplex" instruction copies the value of a selected input parameter and issues it. Use the parameter K to determine the number of the input parameter whose value will be moved. Numbering starts at IN0 and is incremented continuously with each new input. You can declare a maximum of 32 inputs.

If the value of the K parameter is greater than the number of inputs and the INELSE parameter is not set, the instruction function value is invalid and the ENO enable output is set to 0.

Numerical data types and time data types are permitted at the inputs. All tags with assigned parameters must be of the same data type.

The function value is invalid if any of the following conditions are met:

- The value of the parameter K is greater than the number of available inputs.
- Errors occurred during the execution of the instruction.

### Syntax

The following syntax is used for the instruction "Multiplex":

#### SCL

```
MUX(K := <Expression>,
    IN0 := <Expression>,
    IN1 := <Expression>,
    INELSE := <Expression>)
```

### Parameter

The following table shows the parameters of the "Multiplex" instruction:

Parameter	Declaration	Data type		Description
		S7-1200	S7-1500	
K	Input	Integers	Integers	Specifies the parameter whose content is to be transferred. <ul style="list-style-type: none"> <li>• If K = 0 =&gt; Parameter IN0</li> <li>• If K = 1 =&gt; Parameter IN1, etc.</li> </ul>
IN0	Input	Binary numbers, integers, floating-point numbers, strings, TOD, DATE, TIME, DT	Binary numbers, integers, floating-point numbers, strings, TOD, LTOD, DATE, timers, DT, LDT	First input value

Parameter	Declaration	Data type		Description
		S7-1200	S7-1500	
IN1	Input	Binary numbers, integers, floating-point numbers, strings, TOD, DATE, TIME, DT	Binary numbers, integers, floating-point numbers, strings, TOD, LTOD, DATE, timers, DT, LDT	Second input value
INn	Input	Binary numbers, integers, floating-point numbers, strings, TOD, DATE, TIME, DT	Binary numbers, integers, floating-point numbers, strings, TOD, LTOD, DATE, timers, DT, LDT	Optional input values
INELSE	Input	Binary numbers, integers, floating-point numbers, strings, TOD, DATE, TIME, DT	Binary numbers, integers, floating-point numbers, strings, TOD, LTOD, DATE, timers, DT, LDT	Specifies the value to be copied when K <> n.
Function value		Binary numbers, integers, floating-point numbers, strings, TOD, DATE, TIME, DT	Binary numbers, integers, floating-point numbers, strings, TOD, LTOD, DATE, timers, DT, LDT	Result of the instruction

For more information on valid data types, refer to "See also".

### Example

The following example shows how the instruction works:

```

SCI
"Tag_Result" := MUX(K := "Tag_Number",
    IN0 := "Tag_1",
    IN1 := "Tag_2",
    INELSE := "Tag_3");
    
```

The result of the instruction is returned in the operand "Tag\_Result" as a function value.

The following table shows how the instruction works using specific operand values:

Operand	Value	
Tag_Number	2	4
Tag_1	DW#16#00000000	DW#16#00000000
Tag_2	DW#16#003E4A7D	DW#16#003E4A7D
Tag_3	DW#16#FFFF0000	DW#16#FFFF0000
Tag_Result	DW#16#003E4A7D	DW#16#FFFF0000



## See also

Overview of the valid data types (Page 1077)  
Operators and operator precedence (Page 1347)  
Entering SCL instructions (Page 1357)  
Editing SCL instructions (Page 1374)

## DEMUX: Demultiplex

### Description

The "Demultiplex" instruction transfers the value of the input parameter IN to a selected output parameter. The selection of the input parameter takes place independently of the parameter value K. The K parameter specifies the output parameter number to which the value of the input parameter IN is transferred. The other output parameters are not changed. Numbering starts at OUT0 and continues consecutively with each new output. You can declare a maximum of 32 output parameters.

If the value of the K parameter is greater than the number of output parameters, the value of the input parameter IN is transferred to the output parameter OUTELSE.

### Syntax

The following syntax is used for the instruction "Demultiplex":

```
SCL  
DEMUX(K := <Expression>,  
      IN := <Expression>,  
      OUT0 := <Operand>,  
      OUT1 := <Operand>,  
      OUTELSE := <Operand>)
```

**Parameter**

The following table shows the parameters of the instruction "Demultiplex":

Parameter	Declaration	Data type		Description
		S7-1200	S7-1500	
K	Input	Integers	Integers	Specifies the output to which the input value (IN) will be copied. <ul style="list-style-type: none"> <li>• If K = 0 =&gt; Parameter OUT0</li> <li>• If K = 1 =&gt; Parameter OUT1, etc.</li> </ul>
IN	Input	Binary numbers, integers, floating-point numbers, strings, TIME, TOD, DATE, DT	Binary numbers, integers, floating-point numbers, strings, timers, TOD, LTOD, DATE, DT, LDT	Input value
OUT0	Output	Binary numbers, integers, floating-point numbers, strings, TIME, TOD, DATE, DT	Binary numbers, integers, floating-point numbers, strings, timers, TOD, LTOD, DATE, DT, LDT	First output
OUT1	Output	Binary numbers, integers, floating-point numbers, strings, TIME, TOD, DATE, DT	Binary numbers, integers, floating-point numbers, strings, timers, TOD, LTOD, DATE, DT, LDT	Second output
OUTn	Output	Binary numbers, integers, floating-point numbers, strings, TIME, TOD, DATE, DT	Binary numbers, integers, floating-point numbers, strings, timers, TOD, LTOD, DATE, DT, LDT	Optional outputs
OUTELSE	Output	Binary numbers, integers, floating-point numbers, strings, TIME, TOD, DATE, DT	Binary numbers, integers, floating-point numbers, strings, timers, TOD, LTOD, DATE, DT, LDT	Output to which the value at input IN is copied if K > n.

For more information on available data types, refer to "See also".

## Example

The following example shows how the instruction works:

```
SCL
DEMUX(K := "Tag_Number",
      IN := "Tag_Value",
      OUT0 := "Tag_1",
      OUT1 := "Tag_2",
      OUTELSE := "Tag_3");
```

The following tables show how the instruction works using specific operand values:

Input values of the "Demultiplex" instruction before the network execution

Parameter	Operand	Values	
K	Tag_Number	2	4
IN	Tag_Value	DW#16#FFFFFFFF	DW#16#003E4A7D

Output values of the "Demultiplex" instruction after the network execution

Parameter	Operand	Values	
OUT0	Tag_1	Unchanged	Unchanged
OUT1	Tag_2	DW#16#FFFFFFFF	Unchanged
OUTELSE	Tag_3	Unchanged	DW#16#003E4A7D

## See also

Overview of the valid data types (Page 1077)

Operators and operator precedence (Page 1347)

Entering SCL instructions (Page 1357)

Editing SCL instructions (Page 1374)

## Shift and rotate

### SHR: Shift right

#### Description

The "Shift right" instruction shifts the contents of the IN parameter bit-by-bit to the right and returns it as a function value. The parameter N is used to specify the number of bit positions by which the specified value should be shifted.

If the value of the N parameter is "0", the value of the IN parameter is given as a result.

If the value of the N parameter is greater than the number of available bit positions, then the value of the IN parameter is shifted to the right by the available number of bit positions.

The bit positions that are freed by shifting in the left operand area are filled with zeros.

The following figure shows how the content of an integer data type operand is shifted by four bit positions to the right:

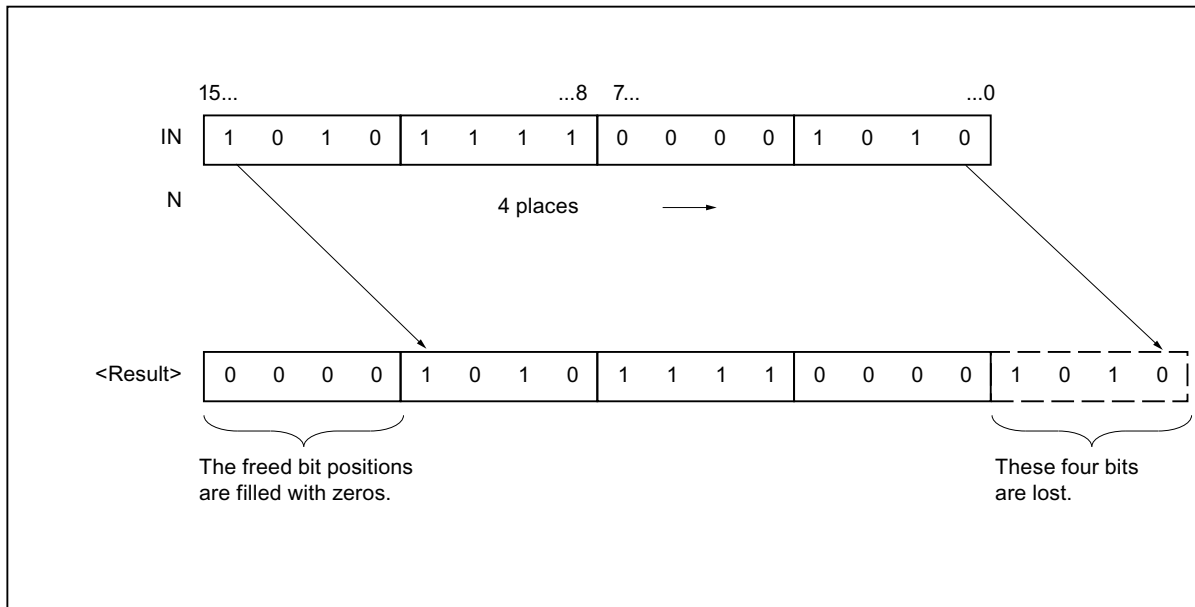

**Syntax**

The following syntax is used for the instruction "Shift right":

```

SCL
SHR(IN := <Operand>,
     N := <Operand>)
    
```

**Parameter**

The following table shows the parameters of the "Shift right" instruction:

Parameter	Declaration	Data type		Description
		S7-1200	S7-1500	
IN	Input	Bit strings, integers	Bit strings, integers	Value to be shifted
N	Input	USINT, UINT, UDINT	USINT, UINT, UDINT, ULINT	Number of bits by which the value (IN) is shifted
Function value		Bit strings, integers	Bit strings, integers	Result of the instruction

For more information on valid data types, refer to "See also".

## Example

The following example shows how the instruction works:

```
SCL
"Tag_Result" := SHR(IN := "Tag_Value",
                    N := "Tag_Number");
```

The following table shows how the instruction works using specific operand values:

Parameter	Operand	Value
IN	Tag_Value	0011 1111 1010 1111
N	Tag_Number	3
Function value	Tag_Result	0000 0111 1111 010 1

The content of the "Tag\_Value" operand is shifted by three bit positions to the right. The result of the instruction is returned in the operand "Tag\_Result" as a function value.

## See also

Overview of the valid data types (Page 1077)

Operators and operator precedence (Page 1347)

Entering SCL instructions (Page 1357)

Editing SCL instructions (Page 1374)

## SHL: Shift left

### Description

The "Shift left" instruction shifts the contents of the IN parameter bit-by-bit to the left and returns it as a function value. The parameter N is used to specify the number of bit positions by which the specified value should be shifted.

If the value of the N parameter is "0", the value of the IN parameter is given as a result.

If the value of the N parameter is greater than the number of bit positions, the value of the IN parameter is shifted to the left by the available number of bit positions.

The bit positions freed by the shift are filled with zeros in the result value.

The following figure shows how the content of an operand of the WORD data type is shifted six bit positions to the left:

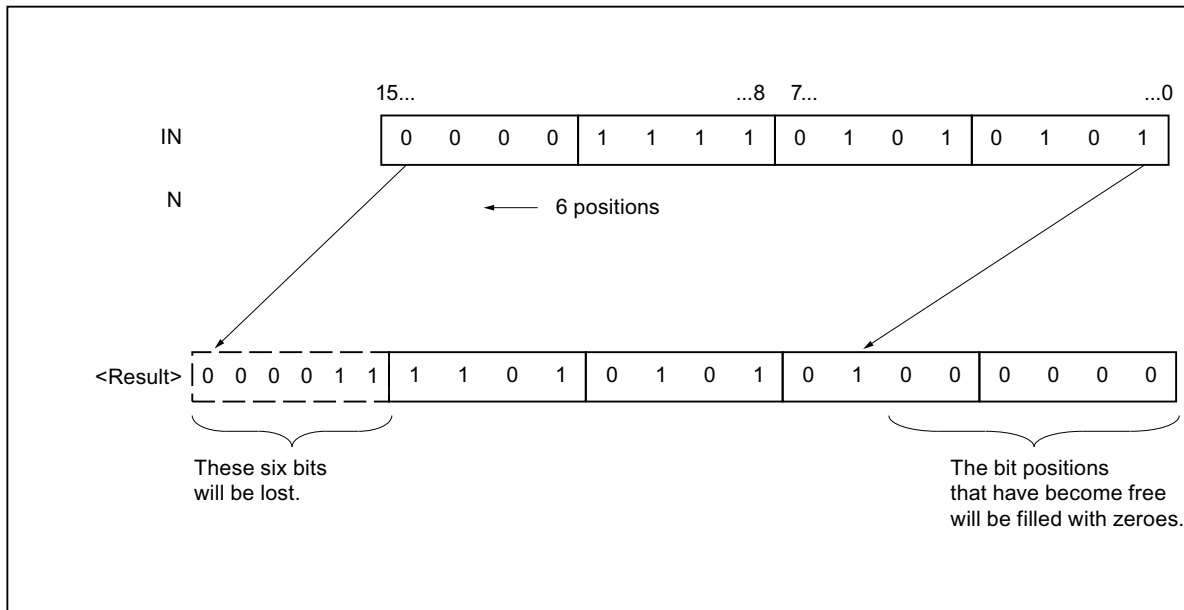

**Syntax**

The following syntax is used for the instruction "Shift left":

```

SCL
SHL(IN := <Operand>,
     N := <Operand>)
    
```

**Parameter**

The following table shows the parameters of the "Shift left" instruction:

Parameter	Declaration	Data type		Description
		S7-1200	S7-1500	
IN	Input	Bit strings, integers	Bit strings, integers	Value to be shifted
N	Input	USINT, UINT, UDINT	USINT, UINT, UDINT, ULINT	Number of bits by which the value (IN) is shifted
Function value		Bit strings, integers	Bit strings, integers	Result of the instruction

For more information on valid data types, refer to "See also".

## Example

The following example shows how the instruction works:

```
SCL
"Tag_Result" := SHL(IN := "Tag_Value",
                    N := "Tag_Number");
```

The following table shows how the instruction works using specific operand values:

Parameter	Operand	Value
IN	Tag_Value	0011 1111 1010 1111
N	Tag_Number	4
Function value	Tag_Result	1111 1010 1111 0000

The value of the "Tag\_Value" operand is shifted by four bit positions to the left. The result of the instruction is returned in the operand "Tag\_Result" as a function value.

## See also

Overview of the valid data types (Page 1077)

Operators and operator precedence (Page 1347)

Entering SCL instructions (Page 1357)

Editing SCL instructions (Page 1374)

## ROR: Rotate right

### Description

The "Rotate right" instruction rotates the content of the IN parameter bit-by-bit to the right and assigns the result to the specified operand. The parameter N is used to specify the number of bit positions by which the specified value should be rotated. The bit positions freed by rotating are filled with the bit positions that are pushed out.

If the value of the N parameter is "0", the value at input IN is given as a result.

If the value at the N parameter is greater than the number of available bit positions, the operand value at the IN input is still rotated by the specified number of bit positions.

The following figure shows how the content of an operand of the DWORD data type is rotated three bit positions to the right:

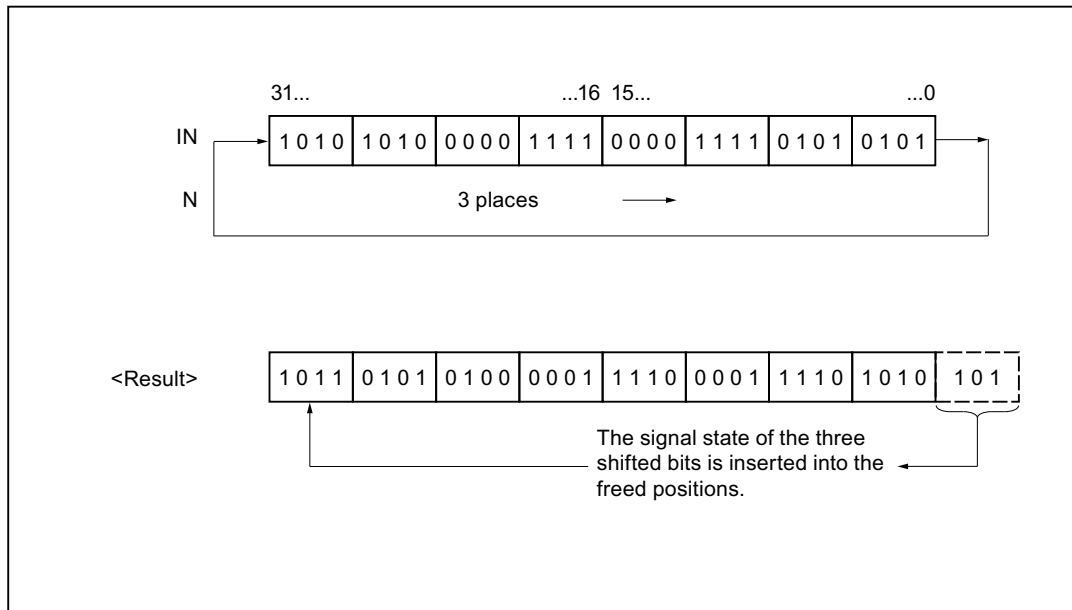

**Syntax**

The following syntax is used for the instruction "Rotate right":

```

SCL
ROR(IN := <Operand>,
     N := <Operand>)
    
```

**Parameter**

The following table shows the parameters of the "Rotate right" instruction:

Parameter	Declaration	Data type		Description
		S7-1200	S7-1500	
IN	Input	Bit strings, integers	Bit strings, integers	Value to be rotated
N	Input	USINT, UINT, UDINT	USINT, UINT, UDINT, ULINT	Number of bit positions by which the value (IN) is rotated
Function value		Bit strings, integers	Bit strings, integers	Result of the instruction

For more information on valid data types, refer to "See also".



## Example

The following example shows how the instruction works:

```
SCL
"Tag_Result" := ROR(IN := "Tag_Value",
                   N := "Tag_Number");
```

The following table shows how the instruction works using specific operand values:

Parameter	Operand	Value
IN	Tag_Value	0000 1111 1001 0101
N	Tag_Number	5
Function value	Tag_Result	1010 1000 0111 1100

The content of the "Tag\_Value" operand is rotated by five bit positions to the right. The result of the instruction is returned in the operand "Tag\_Result" as a function value.

## See also

Overview of the valid data types (Page 1077)

Operators and operator precedence (Page 1347)

Entering SCL instructions (Page 1357)

Editing SCL instructions (Page 1374)

## ROL: Rotate left

### Description

The "Rotate left" instruction rotates the contents of the IN parameter bit-by-bit to the left and returns it as a function value. The parameter N is used to specify the number of bit positions by which the specified value should be rotated. The bit positions freed by rotating are filled with the bit positions that are pushed out.

If the value of the N parameter is "0", the value at input IN is given as a result.

If the value at the N parameter is greater than the number of available bit positions, the operand value at the IN input is still rotated by the specified number of bit positions.

The following figure shows how the content of an operand of the DWORD data type is rotated three bit positions to the left:

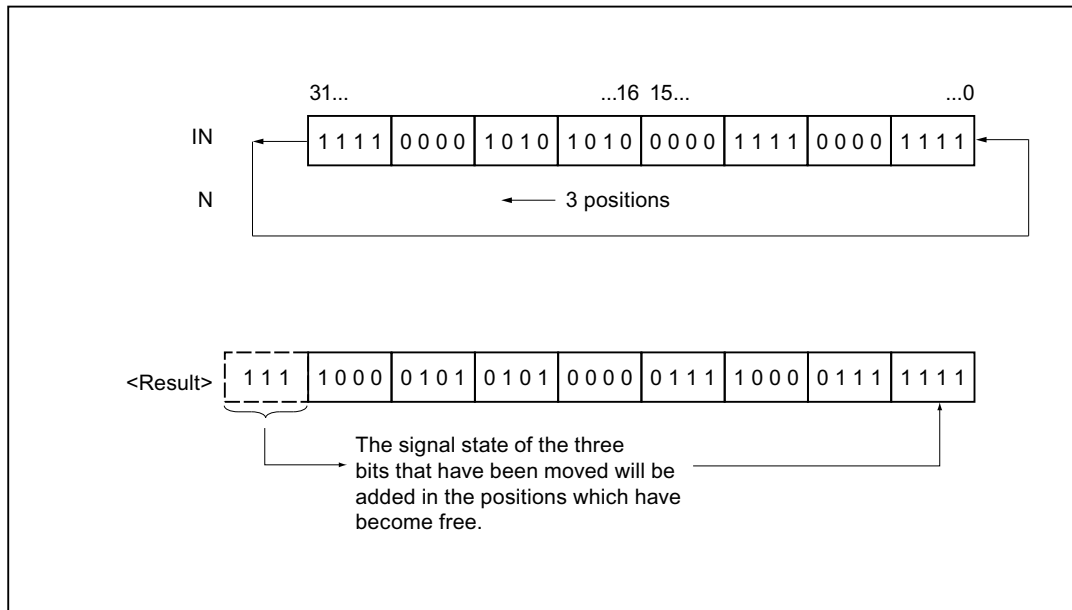

**Syntax**

The following syntax is used for the "Rotate left" instruction:

```

SCL
ROL(IN := <Operand>,
     N := <Operand>)
    
```

**Parameter**

The following table shows the parameters of the "Rotate left" instruction:

Parameter	Declaration	Data type		Description
		S7-1200	S7-1500	
IN	Input	Bit strings, integers	Bit strings, integers	Value to be rotated
N	Input	USINT, UINT, UDINT	USINT, UINT, UDINT, ULINT	Number of bit positions by which the value (IN) is rotated
Function value		Bit strings, integers	Bit strings, integers	Result of the instruction

For more information on valid data types, refer to "See also".

## Example

The following example shows how the instruction works:

```
SCL
"Tag_Result" := ROL(IN := "Tag_Value",
                    N := "Tag_Number");
```

The following table shows how the instruction works using specific operand values:

Parameters	Operand	Value
IN	Tag_Value	1010 1000 1111 0110
N	Tag_Number	5
Function value	Tag_Result	0001 1110 1101 0101

The content of the operand "Tag\_Value" is rotated five bit positions to the left. The result of the instruction is returned in the operand "Tag\_Result" as a function value.

## See also

Overview of the valid data types (Page 1077)

Operators and operator precedence (Page 1347)

Entering SCL instructions (Page 1357)

Editing SCL instructions (Page 1374)

## Additional instructions

### DRUM: Implement sequencer

#### Description

The "Implement sequencer" instruction is used to assign the programmed values of the OUT\_VAL parameter of the corresponding step to the programmed output bits (OUT1 to OUT16) and the output word (OUT\_WORD). The specific step must thereby satisfy the conditions of the programmed enable mask on the S\_MASK parameter while the instruction remains at this step. The instruction advances to the next step if the event for the step is true and the programmed time for the current step elapses, or if the value at the JOG parameter changes from "0" to "1". The instruction is reset if the signal state on the RESET parameter changes to "1". The current step is hereby equated to the preset step (DSP).

The amount of time spent on a step is determined by the product of the preset timebase (DTBP) and the preset counter value (S\_PRESET) for each step. At the start of a new step, this calculated value is loaded into the DCC parameter, which contains the time remaining for the current step. If, for example the value at the DTBP parameter is "2" and the preset value for the first step is "100" (100 ms), the DCC parameter has the value "200" (200 ms).

A step can be programmed with a time value, an event, or both. Steps that have an event bit and the time value "0" advance to the next step as soon as the signal state of the event bit is

"1". Steps that are programmed only with a time value start the time immediately. Steps that are programmed with an event bit and a time value greater than "0" start the time when the signal state of the event bit is "1". The event bits are initialized with a signal state of "1".

When the sequencer is on the last programmed step (LST\_STEP) and the time for this step has expired, the signal state on the Q parameter is set to "1"; otherwise it is set to "0". When the parameter Q is set, the instruction remains on the step until it is reset.

In the configurable mask (S\_MASK) you can selected the separate bits in the output word (OUT\_WORD) and set or reset the output bits (OUT1 to OUT16) by means of the output values (OUT\_VAL). If a bit of the configurable mask is in the signal state "1", the value OUT\_VAL sets or resets the corresponding bit. If the signal state of a bit of the configurable mask is "0", the corresponding bit is left unchanged. All the bits of the configurable mask for all 16 steps are initialized with a signal state of "1".

The output bit on the OUT1 parameter corresponds to the least significant bit of the output word (OUT\_WORD). The output bit on the OUT16 parameter corresponds to the most significant bit of the output word (OUT\_WORD).

When you insert the instruction in the program, the "Call options" dialog opens in which you can specify whether the block parameters will be stored in a separate data block (single instance) or as a local tag (multiple instance) in the block interface. If you create a separate data block, you will find it in the project tree in the "Program resources" folder under "Program blocks > System blocks". For more information on this topic, refer to "See also".

## Syntax

The following syntax is used for the "Implement sequencer" instruction:

### SCL

```
<Instance>RESET:= <Operand>,  
    JOG := <Operand>,  
    DRUM_EN := <Operand>,  
    LST_STEP := <Operand>,  
    EVENT1 - 16 := <Operand>,  
    OUT1 - 16 => <Operand>,  
    Q => <Operand>,  
    OUT_WORD => <Operand>,  
    ERR_CODE => <Operand>
```

## Parameter

The following table shows the parameters of the "Implement sequencer" instruction:

Parameter	Declaration	Data type	Description
RESET	Input	BOOL	A signal state of "1" indicates a reset condition.
JOG	Input	BOOL	When the signal state changes from "0" to "1", the instruction advances to the next step.
DRUM_EN	Input	BOOL	A signal state of "1" allows the sequencer to advance based on the event and time criteria.
LST_STEP	Input	BYTE	Step number of the last step programmed.
EVENT(i), 1 ≤ i ≤ 16	Input	BOOL	Event bit (i); Initial signal state is "1".
OUT(j), 1 ≤ j ≤ 16	Output	BOOL	Output bit (j)
Q	Output	BOOL	A signal state of "1" indicates that the time for the last step has elapsed.
OUT_WORD	Output	WORD	Word address to which the sequencer writes the output values.
ERR_CODE	Output	WORD	Error information
JOG_HIS	Static	BOOL	JOG parameter history bit
EOD	Static	BOOL	A signal state of "1" indicates that the time for the last step has elapsed.
DSP	Static	BYTE	Preset step of the sequencer
DSC	Static	BYTE	Current step of the sequencer
DCC	Static	DWORD	Current numerical value of the sequencer
DTBP	Static	WORD	Preset timebase of the sequencer
PREV_TIME	Static	DWORD	Previous system time
S_PRESET	Static	ARRAY of WORD	Count preset for each step [1 to 16] where 1 count = 1 ms.

Parameter	Declaration	Data type	Description
OUT_VAL	Static	ARRAY of BOOL	Output values for each step [1 to 16, 0 to 15].
S_MASK	Static	ARRAY of BOOL	Configurable mask for each step [1 to 16, 0 to 15]. Initial signal states are "1".

For more information on valid data types, refer to "See also".

The static parameters are not visible when calling the instruction in the program. These are saved in the instance of the instruction.

### ERR\_CODE Parameter

The following table shows the meaning of the values of the parameter ERR\_CODE:

ERR_CODE*	Explanation
W#16#0000	No error
W#16#000B	The value at the LST_STEP parameter is less than 1 or greater than 16.
W#16#000C	The value at the DSC parameter is less than 1 or greater than the value at the LST_STEP parameter.
W#16#000D	The value at the DSP parameter is less than 1 or greater than the value at the LST_STEP parameter.

\*The error codes can be displayed as integer or hexadecimal value in the program editor. For more information on toggling display formats, refer to "See also".

### See also

Overview of the valid data types (Page 1077)

Entering SCL instructions (Page 1357)

Editing SCL instructions (Page 1374)

### DCAT: Discrete control-timer alarm

#### Description

The "Discrete control-timer alarm" instruction is used to accumulate the time from the point at which the CMD parameter issues the command to open or close. The time is accumulated until the preset time (PT) is exceeded or the information is received that the device was opened or closed (O\_FB or C\_FB) within the specified time. If the preset time is exceeded before the information on the opening or closing of the device is received, the corresponding alarm is activated. If the signal state on the command input changes state before the preset time, the time is restarted.

When you insert the instruction in the program, the "Call options" dialog opens in which you can specify whether the block parameters will be stored in a separate data block (single instance) or as a local tag (multiple instance) in the block interface. If you create a separate

data block, you will find it in the project tree in the "Program resources" folder under "Program blocks > System blocks". For more information on this topic, refer to "See also".

The "Discrete control-timer alarm" instruction has the following reactions to the input conditions:

- When the signal state of the CMD parameter changes from "0" to "1", the signal states of the parameters Q, CMD\_HIS, ET (only if ET < PT), OA and CA are influenced as follows:
  - The parameters Q and CMD\_HIS are set to "1".
  - The parameters ET, OA and CA are reset to "0".
- When the signal state on the parameter CMD changes from "1" to "0", the parameters Q, ET (only if ET < PT), OA, CA and CMD\_HIS are reset to "0".
- When the signal state of the parameters CMD and CMD\_HIS is "1" and the parameter O\_FB is set to "0", the time difference (ms) since the last execution of the instruction is added to the value at the parameter ET. If the value of the parameter ET exceeds the value of the parameter PT, the signal state on the parameter OA is set to "1". If the value of the parameter ET does not exceed the value of the parameter PT, the signal state on the parameter OA is reset to "0". The value at the parameter CMD\_HIS is set to the value of the parameter CMD.
- If the signal state of the parameters CMD, CMD\_HIS and O\_FB are set to "1" and the parameter C\_FB has the value "0", the signal state of the parameter OA is set to "0". The value of parameter ET is set to the value of parameter PT. If the signal state of the parameter O\_FB changes to "0", the alarm is set the next time the instruction is executed. The value of parameter CMD\_HIS is set to the value of parameter CMD.
- If the parameters CMD, CMD\_HIS and C\_FB have the value "0", the time difference (ms) since the last execution of the instruction is added to the value of the parameter ET. If the value of the parameter ET exceeds the value of the parameter PT, the signal state of the parameter CA is set to "1". If the value at the parameter PT is not exceeded, the parameter CA has the signal state "0". The value of parameter CMD\_HIS is set to the value of parameter CMD.
- If the parameters CMD, CMD\_HIS and O\_FB have the signal state "0" and the parameter C\_FB is set to "1", the parameter CA is set to "0". The value of parameter ET is set to the value of parameter PT. If the signal state of the parameter C\_FB changes to "0", the alarm is set the next time the instruction is executed. The value of parameter CMD\_HIS is set to the value of parameter CMD.
- If the parameters O\_FB and C\_FB simultaneously have the signal state "1", the signal states of both alarm outputs are set to "1".

The "Discrete control-timer alarm" instruction has no error information.

## Syntax

The following syntax is used for the "Discrete control-timer alarm" instruction:

```
SCL
<Instance>CMD:= <Operand>,
    O_FB := <Operand>,
    C_FB := <Operand>,
    Q => <Operand>,
    OA => <Operand>,
```

**SCL**

CA => <Operand>

**Parameter**

The following table shows the parameters of the instruction:

Parameter	Declaration	Data type	Description
CMD	Input	BOOL	A signal state of "0" indicates a "close" command. A signal state of "1" indicates an "open" command.
O_FB	Input	BOOL	Feedback input when opening
C_FB	Input	BOOL	Feedback input when closing
Q	Output	BOOL	Shows the status of the parameter CMD
OA	Output	BOOL	Alarm output when opening
CA	Output	BOOL	Alarm output when closing
ET	Static	DINT	Currently elapsed time, where one count = 1 ms.
PT	Static	DINT	Preset time value, where one count = 1 ms.
PREV_TIME	Static	DWORD	Previous system time
CMD_HIS	Static	BOOL	CMD history bit

For more information on valid data types, refer to "See also".

The static parameters are not visible when calling the instruction in the program. These are saved in the instance of the instruction.

**Example**

In the following example the parameter CMD changes from "0" to "1". After the execution of the instruction the parameter Q is set to "1" and the two alarm outputs OA and CA have the signal state "0". The parameter CMD\_HIS of the instance data block is set to the signal state "1" and the parameter ET is reset to "0".

**Note**

You can initialize static parameters in the data block.

**SCL**

```
"DCAT_DB" (CMD := "Tag_Input_CMD",
           O_FB := "Tag_Input_O_FB",
           C_FB := "Tag_Input_C_FB",
           Q => "Tag_Output_Q",
           OA => "Tag_Output_OA",
           CA => "Tag_Output_CA");
```

The following tables show how the instruction works using specific values:



**Before processing**

In this example the following values are used for the input and output parameters:

Parameter	Operand	Value
CMD	Tag_Input_CMD	TRUE
O_FB	Tag_Input_O_FB	FALSE
C_FB	Tag_Input_C_FB	FALSE
Q	Tag_Output_Q	FALSE
OA	Tag_Output_OA	FALSE
CA	Tag_Output_CA	FALSE

The following values are saved in the instance data block "DCAT\_DB" of the instruction:

Parameter	Address	Value
ET	DBD4	L#12
PT	DBD8	L#222
CMD_HIS	DBX16.0	FALSE

**After processing**

The following values are written to the output parameters after the instruction has been executed:

Parameter	Operand	Value
Q	Tag_Output_Q	TRUE
OA	Tag_Output_OA	FALSE
CA	Tag_Output_CA	FALSE

The following values are saved in the instance data block "DCAT\_DB" of the instruction:

Parameter	Address	Value
ET	DBD4	L#0
CMD_HIS	DBX16.0	TRUE

**See also**

Overview of the valid data types (Page 1077)

Entering SCL instructions (Page 1357)

Editing SCL instructions (Page 1374)

**MCAT: Motor control-timer alarm**

**Description**

The "Motor control-timer alarm" instruction is used to accumulate the time from the point at which one of the command inputs (opening or closing) is switched on. The time is accumulated until the preset time is exceeded or the relevant feedback input indicates that the device has executed the requested operation within the specified time. If the preset time is exceeded before the feedback is received, the corresponding alarm is triggered.

When you insert the instruction in the program, the "Call options" dialog opens in which you can specify whether the block parameters will be stored in a separate data block (single instance) or as a local tag (multiple instance) in the block interface. If you create a separate data block, you will find it in the project tree in the "Program resources" folder under "Program blocks > System blocks". For additional information on this topic, refer to "See also".

**Execution of the "Motor control-timer alarm" instruction**

The following table shows the reactions of the "Motor control-timer alarm" instruction to the various input conditions:

Input parameters								Output parameters								
ET	O_H IS	C_H IS	O_C MD	C_C MD	S_C MD	O_F B	C_F B	OO	CO	OA	CA	ET	O_H IS	C_H IS	Q	State
X	1	1	X	X	X	X	X	0	0	1	1	PT	0	0	0	Alarm
X	X	X	X	X	X	1	1	0	0	1	1	PT	0	0	0	Alarm
X	X	X	X	X	1	X	X	0	0	0	0	X	0	0	1	Stop
X	X	X	1	1	X	X	X	0	0	0	0	X	0	0	1	Stop
X	0	X	1	0	0	X	X	1	0	0	0	0	1	0	1	Start opening
<PT	1	0	X	0	0	0	X	1	0	0	0	INC	1	0	1	Open
X	1	0	X	0	0	1	0	0	0	0	0	PT	1	0	1	Opened
>=PT	1	0	X	0	0	0	X	0	0	1	0	PT	1	0	0	Opening alarm
X	X	0	0	1	0	X	X	0	1	0	0	0	0	1	1	Start closing
<PT	0	1	0	X	0	X	0	0	1	0	0	INC	0	1	1	Close
X	0	1	0	X	0	0	1	0	0	0	0	PT	0	1	1	Closed
>=PT	0	1	0	X	0	X	0	0	0	0	1	PT	0	1	0	Closing alarm
X	0	0	0	0	0	X	X	0	0	0	0	X	0	0	1	Stopped
Legend:																
INC	Add the time difference (ms) since the last processing of the FB to ET															
PT	PT is set to the same value as ET															
X	Cannot be used															
<PT	ET < PT															

Input parameters		Output parameters
>=PT	ET >= PT	
<p>If the input parameters O_HIS and C_HIS both have the signal state "1", they are immediately set to the signal state "0". In this case, the last row in the table (X) mentioned above is valid. Because it is therefore not possible to check whether the input parameters O_HIS and C_HIS have the signal state "1", the output parameters are set as follows in this case:</p> <p>OO = FALSE  CO = FALSE  OA = FALSE  CA = FALSE  ET = PT  Q = TRUE</p>		

## Syntax

The following syntax is used for the "Motor control-timer alarm" instruction:

```

SCL
<Instance>O_CMD:= <Operand>,
          C_CMD := <Operand>,
          S_CMD := <Operand>,
          O_FB := <Operand>,
          C_FB := <Operand>,
          OO => <Operand>,
          CO => <Operand>,
          OA => <Operand>,
          CA => <Operand>,
          Q => <Operand>

```

## Parameter

The following table shows the parameters of the "Motor control-timer alarm" instruction:

Parameter	Declaration	Data type	Description
O_CMD	Input	BOOL	"Open" command input
C_CMD	Input	BOOL	"Close" command input
S_CMD	Input	BOOL	"Stop" command input
O_FB	Input	BOOL	Feedback input when opening
C_FB	Input	BOOL	Feedback input when closing
OO	Output	BOOL	"Open" output
CO	Output	BOOL	"Close" output
OA	Output	BOOL	Alarm output when opening
CA	Output	BOOL	Alarm output when closing

Parameter	Declaration	Data type	Description
Q	Output	BOOL	A signal state of "0" indicates an error condition.
ET	Static	DINT	Currently elapsed time, where one count = 1 ms
PT	Static	DINT	Preset time value, where one count = 1 ms
PREV_TIME	Static	DWORD	Previous system time
O_HIS	Static	BOOL	"Open" history bit
C_HIS	Static	BOOL	"Close" history bit

For additional information on valid data types, refer to "See also".

The static parameters are not visible when calling the instruction in the program. These are saved in the instance of the instruction.

### Example

The following example shows how the instruction works:

---

#### Note

You can initialize static parameters in the data block.

---

#### SCL

```
"MCAT_DB" (O_CMD := "Tag_Input_O_CMD",
            C_CMD := "Tag_Input_C_CMD",
            S_CMD := "Tag_Input_S_CMD",
            O_FB := "Tag_Input_O_FB",
            C_FB := "Tag_Input_C_FB",
            OO => "Tag_OutputOpen",
            CO => "Tag_OutputClosed",
            OA => "Tag_Output_OA",
            CA => "Tag_Output_CA",
            Q => "Tag_Output_Q");
```

The following tables show how the instruction works using specific values:

#### Before processing

In this example the following values are used for the input and output parameters:

Parameter	Operand	Value
O_CMD	Tag_Input_O_CMD	TRUE
C_CMD	Tag_Input_C_CMD	FALSE
S_CMD	Tag_Input_S_CMD	FALSE
O_FB	Tag_Input_O_FB	FALSE
C_FB	Tag_Input_C_FB	FALSE
OO	Tag_OutputOpen	FALSE

Parameter	Operand	Value
CO	Tag_OutputClosed	FALSE
OA	Tag_Output_OA	FALSE
CA	Tag_Output_CA	FALSE
Q	Tag_Output_Q	FALSE

The following values are saved in the instance data block "MCAT\_DB" of the instruction:

Parameter	Address	Value
ET	DBD4	L#2
PT	DBD8	L#22
O_HIS	DBX16.0	TRUE
C_HIS	DBX16.1	FALSE

#### After processing

The following values are written to the output parameters after the instruction has been executed:

Parameter	Operand	Value
OO	Tag_OutputOpen	TRUE
CO	Tag_OutputClosed	FALSE
OA	Tag_Output_OA	FALSE
CA	Tag_Output_CA	FALSE
Q	Tag_Output_Q	TRUE

The following values are saved in the instance data block "MCAT\_DB" of the instruction:

Parameter	Address	Value
ET	DBD4	L#0
O_HIS	DBX16.0	TRUE
CMD_HIS	DBX16.1	FALSE

#### See also

Overview of the valid data types (Page 1077)

Entering SCL instructions (Page 1357)

Editing SCL instructions (Page 1374)

### IMC: Compare input bits with the bits of a mask

#### Description

The "Compare input bits with the bits of a mask" instruction is used to compare the signal state of up to 16 programmed input bits (IN\_BIT0 to IN\_BIT15) with the corresponding bit of a mask. Up to 16 steps with masks can be programmed. The value of the IN\_BIT0 parameter is

compared with the value of the mask CMP\_VAL[x,0], with "x" indicating the step number. On the CMP\_STEP parameter, you specify the step number of the mask that is used for the comparison. All programmed values are compared in the same manner. Unprogrammed input bits or unprogrammed bits of the mask have a default signal state FALSE.

If a match is found in the comparison, the signal state of the OUT parameter is set to "1". Otherwise the OUT parameter is set to "0".

If the value of CMP\_STEP parameter is greater than 15, the instruction is not executed. An error message is output at the ERR\_CODE parameter.

When you insert the instruction in the program, the "Call options" dialog opens in which you can specify whether the block parameters will be stored in a separate data block (single instance) or as a local tag (multiple instance) in the block interface. If you create a separate data block, you will find it in the project tree in the "Program resources" folder under "Program blocks > System blocks". For more information on this topic, refer to "See also".

### Syntax

The following syntax is used for the "Compare input bits with the bits of a mask" instruction:

```

SCL
<Instance>(IN_BIT0 - 15 := <Operand>,
           CMP_STEP := <Operand>,
           OUT => <Operand>,
           ERR_CODE => <Operand>)
    
```

### Parameters

The following table shows the parameters of the "Compare input bits with the bits of a mask" instruction:

Parameter	Declaration	Data type	Description
IN_BIT0	Input	BOOL	Input bit 0 is compared with bit 0 of the mask.
IN_BIT1	Input	BOOL	Input bit 1 is compared with bit 1 of the mask.
IN_BIT2	Input	BOOL	Input bit 2 is compared with bit 2 of the mask.
IN_BIT3	Input	BOOL	Input bit 3 is compared with bit 3 of the mask.
IN_BIT4	Input	BOOL	Input bit 4 is compared with bit 4 of the mask.
IN_BIT5	Input	BOOL	Input bit 5 is compared with bit 5 of the mask.
IN_BIT6	Input	BOOL	Input bit 6 is compared with bit 6 of the mask.
IN_BIT7	Input	BOOL	Input bit 7 is compared with bit 7 of the mask.
IN_BIT8	Input	BOOL	Input bit 8 is compared with bit 8 of the mask.
IN_BIT9	Input	BOOL	Input bit 9 is compared with bit 9 of the mask.
IN_BIT10	Input	BOOL	Input bit 10 is compared with bit 10 of the mask.
IN_BIT11	Input	BOOL	Input bit 11 is compared with bit 11 of the mask.
IN_BIT12	Input	BOOL	Input bit 12 is compared with bit 12 of the mask.

Parameter	Declaration	Data type	Description
IN_BIT13	Input	BOOL	Input bit 13 is compared with bit 13 of the mask.
IN_BIT14	Input	BOOL	Input bit 14 is compared with bit 14 of the mask.
IN_BIT15	Input	BOOL	Input bit 15 is compared with bit 15 of the mask.
CMP_STEP	Input	BYTE	The step number of the mask used for the comparison.
OUT	Output	BOOL	A signal state of "1" indicates that a match was found. A signal state of "0" indicates that no match was found.
ERR_CODE	Output	WORD	Error information
CMP_VAL	Static	ARRAY OF WORD	Comparison masks [0 to 15, 0 to 15]: The first number of the index is the step number and the second number is the bit number of the mask.

For more information on valid data types, refer to "See also".

The static parameters are not visible when calling the instruction in the program. These are saved in the instance of the instruction.

## ERR\_CODE Parameter

The following table shows the meaning of the values of the ERR\_CODE parameter:

Error code* (W#16#...)	Explanation
0000	No error
000A	The value at the CMP_STEP parameter is greater than 15.

\*The error codes can be displayed as integer or hexadecimal value in the program editor. For more information on toggling display formats, refer to "See also".

## See also

Overview of the valid data types (Page 1077)

Entering SCL instructions (Page 1357)

Editing SCL instructions (Page 1374)

## SMC: Compare scan matrix

### Description

You can use the "Compare scan matrix" instruction to compare the signal state of up to 16 programmed input bits (IN\_BIT0 to IN\_BIT15) with the corresponding bit of the comparison

masks for each step. Processing starts at step 1 and is continued until the last programmed step (LAST) or until a match is found. The input bit of the IN\_BIT0 parameter is compared with the value of the mask CMP\_VAL[x,0], with "x" indicating the step number. All programmed values are compared in the same manner. If a match is found the signal state of the OUT parameter is set to "1" and the step number with the matching mask is written in the OUT\_STEP parameter. Unprogrammed input bits or unprogrammed bits of the mask have a default signal state FALSE. If more than one step has a matching mask, only the first one found is indicated in the OUT\_STEP parameter. If no match is found, the signal state of the OUT parameter is set to "0". In this case the value at the OUT\_STEP parameter is greater by "1" than the value at the LAST parameter.

When you insert the instruction in the program, the "Call options" dialog opens in which you can specify whether the block parameters will be stored in a separate data block (single instance) or as a local tag (multiple instance) in the block interface. If you create a separate data block, you will find it in the project tree in the "Program resources" folder under "Program blocks > System blocks". For more information on this topic, refer to "See also".

**Syntax**

The following syntax is used for the "Compare scan matrix" instruction:

```

SCL
<Instance>(IN_BIT0 - 15 := <Operand>,
           OUT => <Operand>,
           OUT_STEP => <Operand>,
           ERR_CODE => <Operand>)
    
```

**Syntax**

The following table shows the parameters of the "Compare scan matrix" instruction:

Parameter	Declaration	Data type	Description
IN_BIT0	Input	BOOL	Input bit 0 is compared with bit 0 of the mask.
IN_BIT1	Input	BOOL	Input bit 1 is compared with bit 1 of the mask.
IN_BIT2	Input	BOOL	Input bit 2 is compared with bit 2 of the mask.
IN_BIT3	Input	BOOL	Input bit 3 is compared with bit 3 of the mask.
IN_BIT4	Input	BOOL	Input bit 4 is compared with bit 4 of the mask.
IN_BIT5	Input	BOOL	Input bit 5 is compared with bit 5 of the mask.
IN_BIT6	Input	BOOL	Input bit 6 is compared with bit 6 of the mask.
IN_BIT7	Input	BOOL	Input bit 7 is compared with bit 7 of the mask.
IN_BIT8	Input	BOOL	Input bit 8 is compared with bit 8 of the mask.
IN_BIT9	Input	BOOL	Input bit 9 is compared with bit 9 of the mask.
IN_BIT10	Input	BOOL	Input bit 10 is compared with bit 10 of the mask.
IN_BIT11	Input	BOOL	Input bit 11 is compared with bit 11 of the mask.
IN_BIT12	Input	BOOL	Input bit 12 is compared with bit 12 of the mask.



Parameter	Declaration	Data type	Description
IN_BIT13	Input	BOOL	Input bit 13 is compared with bit 13 of the mask.
IN_BIT14	Input	BOOL	Input bit 14 is compared with bit 14 of the mask.
IN_BIT15	Input	BOOL	Input bit 15 is compared with bit 15 of the mask.
OUT	Output	BOOL	A signal state of "1" indicates that a match was found. A signal state of "0" indicates that no match was found.
OUT_STEP	Output	BYTE	Contains the step number with the matching mask, or the step number which is greater by "1" than the value at the LAST parameter, provided no match is found.
ERR_CODE	Output	WORD	Error information
LAST	Static	BYTE	Specifies the step number of the last step to be scanned for a matching mask.
CMP_VAL	Static	ARRAY OF WORD	Comparison masks [0 to 15, 0 to 15]: The first number of the index is the step number and the second number is the bit number of the mask.

For more information on valid data types, refer to "See also".

The static parameters are not visible when calling the instruction in the program. These are saved in the instance of the instruction.

### ERR\_CODE Parameter

The following table shows the meaning of the values of the parameter ERR\_CODE:

Error code* (W#16#...)	Explanation
0000	No error
000E	The value at the LAST parameter is greater than 15.

\*The error codes can be displayed as integer or hexadecimal value in the program editor. For more information on toggling display formats, refer to "See also".

### See also

Overview of the valid data types (Page 1077)

Entering SCL instructions (Page 1357)

Editing SCL instructions (Page 1374)

## LEAD\_LAG: Lead and lag algorithm

### Description

Use the "Lead and lag algorithm" instruction to process signals with an analog tag. The gain value at the GAIN parameter must be greater than zero. The result of the "Lead and lag algorithm" instruction is calculated using the following equation:

$$\text{OUT} = \left[ \frac{\text{LG\_TIME}}{\text{LG\_TIME} + \text{SAMPLE\_T}} \right] \text{PREV\_OUT} + \text{GAIN} \left[ \frac{\text{LD\_TIME} + \text{SAMPLE\_T}}{\text{LG\_TIME} + \text{SAMPLE\_T}} \right] \text{IN} - \text{GAIN} \left[ \frac{\text{LD\_TIME}}{\text{LG\_TIME} + \text{SAMPLE\_T}} \right] * \text{PREV\_IN}$$

The instruction "Lead and lag algorithm" supplies plausible results only when processing is in fixed program cycles. The same units must be specified at the parameters LD\_TIME, LG\_TIME and SAMPLE\_T. At LG\_TIME > 4 + SAMPLE\_T, the instruction approaches the following function:

$$\text{OUT} = \text{GAIN} * ((1 + \text{LD\_TIME} * s) / (1 + \text{LG\_TIME} * s)) * \text{IN}$$

When the value of the GAIN parameter is less than or equal to zero, the calculation is not performed and an error information is output on the ERR\_CODE parameter.

You can use the "Lead and lag algorithm" instruction in conjunction with loops as a compensator in dynamic feed-forward control. The instruction consists of two operations. The "Lead" operation shifts the phase of output OUT so that the output leads the input. The "Lag" operation, on the other hand, shifts the output so that the output lags behind the input. Because the "Lag" operation is equivalent to an integration, it can be used as a noise suppressor or as a low-pass filter. The "Lead" operation is equivalent to a differentiation and can therefore be used as a high-pass filter. The two instructions together (Lead and Lag) result in the output phase lagging behind the the input at lower frequencies and leading it at higher frequencies. This means that the "Lead and lag algorithm" instruction can be used as a band pass filter.

When you insert the instruction in the program, the "Call options" dialog opens in which you can specify whether the block parameters will be stored in a separate data block (single instance) or as a local tag (multiple instance) in the block interface. If you create a separate data block, you will find it in the project tree in the "Program resources" folder under "Program blocks > System blocks". For more information on this topic, refer to "See also".

### Syntax

The following syntax is used for the "Lead and lag algorithm" instruction:

```
SCL
<Instance>(IN:= <Operand>,
           SAMPLE_T := <Operand>,
           OUT => <Operand>,
           ERR_CODE => <Operand>)
```

The following table shows the parameters of the instruction:

Parameter	Declaration	Data type	Description
IN	Input	REAL	The input value of the current sample time (cycle time) to be processed. Constants can also be specified on the IN parameter.
SAMPLE_T	Input	INT	Sample time Constants can also be specified on the SAMPLE_T parameter.
OUT	Output	REAL	Result of the instruction
ERR_CODE	Output	WORD	Error information
LD_TIME	Static	REAL	Lead time in the same unit as sample time.
LG_TIME	Static	REAL	Lag time in the same unit as sample time
GAIN	Static	REAL	Gain as % / % (the ratio of the change in output to a change in input as a steady state).
PREV_IN	Static	REAL	Previous input
PREV_OUT	Static	REAL	Previous output

For more information on valid data types, refer to "See also".

The static parameters are not visible when calling the instruction in the program. These are saved in the instance of the instruction.

### ERR\_CODE Parameter

The following table shows the meaning of the values of the parameter ERR\_CODE:

Error code* (W#16#...)	Explanation
0000	No error
0009	The value at the GAIN parameter is less than or equal to zero.

\*The error codes can be displayed as integer or hexadecimal value in the program editor. For more information on toggling display formats, refer to "See also".

### Example

The following example shows how the instruction works:

---

#### Note

You can initialize static parameters in the data block.

---

**SCL**

```
"LEAD_LAG_DB"(IN := "Tag_Input",
              SAMPLE_T := "Tag_Input_SAMPLE_T",
              OUT => "Tag_Output_Result",
              ERR_CODE => "Tag_ErrorCode");
```

The following tables show how the instruction works using specific values:

**Before processing**

In this example the following values are used for the input parameters:

Parameter	Operand	Value
IN	Tag_Input	2.0
SAMPLE_T	Tag_Input_SAMPLE_T	10

The following values are saved in the instance data block "LEAD\_LAG\_DB" of the instruction:

Parameter	Address	Value
LD_TIME	DBD12	2.0
LG_TIME	DBD16	2.0
GAIN	DBD20	1.0
PREV_IN	DBD24	6.0
PREV_OUT	DBD28	6.0

**After processing**

The following values are written to the output parameters after the instruction has been executed:

Parameter	Operand	Value
OUT	Tag_Output_Result	2.0

The following values are saved in the instance data block "LEAD\_LAD\_DB" of the instruction:

Parameter	Operand	Value
PREV_IN	DBD24	2.0
PREV_OUT	DBD28	2.0

**See also**

- Overview of the valid data types (Page 1077)
- Entering SCL instructions (Page 1357)
- Editing SCL instructions (Page 1374)

**SEG: Create bit pattern for seven-segment display****Description**

The "Create bit pattern for seven-segment display" instruction is used to convert each of the four hexadecimal digits of the specified source word (IN) into an equivalent bit pattern for a 7-segment display. The result of the instruction is output in the double word on the OUT parameter.

The following relation exists between the hexadecimal digits and the assignment of the 7 segments (a, b, c, d, e, f, g):

Input digit (Binary)	Assignment of the segments - g f e d c b a	Display (Hexadecimal)	Seven-segment display
0000	00111111	0	
0001	00000110	1	
0010	01011011	2	
0011	01001111	3	
0100	01100110	4	
0101	01101101	5	
0110	01111101	6	
0111	00000111	7	
1000	01111111	8	
1001	01100111	9	
1010	01110111	A	
1011	01111100	B	
1100	00111001	C	
1101	01011110	D	
1110	01111001	E	
1111	01110001	F	

**Syntax**

Use the following syntax for the "Create bit pattern for seven-segment display" instruction:

```
SCL
SEG (IN := <Operand>,
     OUT => <Operand>)
```

**Parameter**

The following table shows the parameters of the "Create bit pattern for seven-segment display" instruction:

Parameter	Declaration	Data type	Description
IN	Input	WORD	Source word with four hexadecimal digits
OUT	Output	DWORD	Bit pattern for the seven-segment display
Function value		VOID	Empty function value

**Example**

The following example shows how the instruction works:

```
SCL
SEG(IN := "Tag_Input",
    OUT => "Tag_Output");
```

The following table shows how the instruction works using specific operand values:

Parameter	Operand	Value	
		Hexadecimal	Binary
IN	Tag_Input	W#16#1234	0001 0010 0011 0100
OUT	Tag_Output	DW16#065B4F66	00000110 01011011 01001111 01100110 Display: 1234

**See also**

- Entering SCL instructions (Page 1357)
- Editing SCL instructions (Page 1374)
- Overview of the valid data types (Page 1077)

**BCDCPL: Create tens complement**

**Description**

The "Create tens complement" instruction is used to create the tens complement of a seven-digit BCD number specified by the operand. This instruction uses the following mathematical formula to calculate:

$$10000000 \text{ (as BCD)} \\ - 7\text{-digit BCD value} \\ \text{-----}$$

Tens complement (as BCD)

## Syntax

The following syntax is used for the "Create tens complement" instruction:

```
SCL
BCDCPL (<Operand>)
```

## Parameter

The following table shows the parameters of the "Create tens complement" instruction:

Parameter	Declaration	Data type	Description
<Operand>	Input	DWORD	7-digit BCD number
Function value		DWORD	Result of the instruction

For more information on valid data types, refer to "See also".

## Example

The following example shows how the instruction works:

```
SCL
"Tag_Result" := BCDCPL("Tag_Input");
```

The following table shows how the instruction functions using specific values:

Operand	Value*
Tag_Input	DW#16#01234567
Tag_Result	DW#16#08765433

\*The error codes can be displayed as integer or hexadecimal value in the program editor. For more information on toggling display formats, refer to "See also".

## See also

Overview of the valid data types (Page 1077)

Entering SCL instructions (Page 1357)

Editing SCL instructions (Page 1374)

## BITSUM: Count number of set bits

### Description

The "Count number of set bits" instruction is used to count the number of bits of an operand that are set to the signal state "1".

### Syntax

The following syntax is used for the "Count number of set bits" instruction:

```
SCL
BITSUM(<Operand>)
```

### Parameter

The following table shows the parameters of the "Count number of set bits" instruction:

Parameter	Declaration	Data type	Description
<Operand>	Input	DWORD	Operand whose set bits are counted
Function value		INT	Result of the instruction

### Example

The following example shows how the instruction works:

```
SCL
"Tag_Result" := BITSUM("Tag_Input");
```

The following table shows how the instruction functions using specific values:

Operand	Value*
Tag_Input	DW#16#12345678
Tag_Result	W#16#000D (13 bits)
*The error codes can be displayed as integer or hexadecimal value in the program editor. For more information on toggling display formats, refer to "See also".	

### See also

- Overview of the valid data types (Page 1077)
- Entering SCL instructions (Page 1357)
- Editing SCL instructions (Page 1374)



## 9.7.3 Extended instructions

### 9.7.3.1 Date and time-of-day

#### T\_COMP: Compare time tags

##### Description

This instruction is used to compare the contents of two tags of the data types "Timers" or "Date and time".

The instruction supports comparisons of the following data types: DATE, TIME, LTIME, TOD (TIME\_OF\_DAY), LTOD (LTIME\_OF\_DAY), DT (DATE\_AND\_TIME), LDT (DATE\_AND\_LTIME), DTL. Before you can execute a comparison, the data types must have the same length and format.

The comparison result is output at the OUT parameter as a return value. The parameter OUT is set to "1" if the comparison condition applied has been satisfied.

The following comparison options can be used:

Symbol	Description
EQ	The return value has the signal state "1" if the time is the same at the parameter IN1 and IN2.
NE	The return value has the signal state "1" if the time at parameters IN1 and IN2 is not identical.
GE	The return value has the signal state "1" if the time at parameter IN1 is greater (more recent) than or equal to the time at parameter IN2 .
LE	The return value has the signal state "1" if the time at parameter IN1 is less (less recent) than or equal to the time at parameter IN2.
GT	The return value has the signal state "1" if the time at parameter IN1 is greater (more recent) than the time at parameter IN2.
LT	The return value has the signal state "1" if the time at parameter IN1 is less (less recent) than the time at parameter IN2 .

##### Parameter

The following table shows the parameters of the instruction "T\_COMP":

Parameter	Declaration	Data type	Memory area	Description
IN1	Input	DATE, TIME, LTIME, TOD, LTOD, DT, LDT, DTL	I, Q, M, D, L or constant	First value to be compared.
IN2	Input	DATE, TIME, LTIME, TOD, LTOD, DT, LDT, DTL	I, Q, M, D, L or constant	Second value to be compared.
OUT	Output	BOOL	I, Q, M, D, L	Return value

For additional information on valid data types, refer to "Overview of the valid data types (Page 1077)".

### T\_CONV: Convert times and extract

#### Description

You use the instruction "T\_CONV" to convert the data type of the IN input parameter to the data type that is output at the OUT output. You select the data formats for the conversion from the instruction boxes of the input and output.

#### Parameters

The following table shows the parameters of the instruction "T\_CONV". If an input and output parameter of the same data type is used, the instruction copies the corresponding value.

Parameter	Declaration	Data type		Memory area	Description
		S7-1200	S7-1500		
IN	Input	Integers, TIME, date and time*	WORD, integers, timers, date and time*	I, Q, M, D, L or constant	Value to be converted
OUT	Return	Integers, TIME, date and time*	WORD, integers, timers, date and time*	I, Q, M, D, L	Result of the conversion

\* The range of supported data types depends on the CPU. Please refer to the overviews of valid data types for information on the data types supported by the S7-1200 and S7-1500 modules.

You will find more detailed information on valid data types in "Overview of the valid data types (Page 1077)".

### T\_ADD: Add times

#### Description

You use this instruction to add the time information in the IN1 input to the time information in the IN2 input. You can query the result in the OUT output parameter. You can add the following formats:

- Addition of a time period to another time period.  
Example: Addition of a TIME data type to another TIME data type.
- Addition of a time period to a time.  
Example: Addition of a TIME data type to the DTL data type.

The data type for the value at input parameter IN1 and output parameter OUT is defined by the selection in the instruction boxes of the input and output. You can only specify time information in TIME format in the IN2 input parameter (for S7-1500 modules also LTIME).

## Parameters

The following tables show the parameters of the "T\_ADD" instruction, according to the possible conversions:

Table 9-34 Addition of a time period to another time period

Parameter	Declaration	Data type		Memory area	Description
		S7-1200	S7-1500		
IN1	Input	TIME	TIME, LTIME	I, Q, M, D, L or constant	First number to be added
IN2	Input	TIME	TIME, LTIME	I, Q, M, D, L or constant	Second number to be added
OUT	Return	DINT, DWORD, TIME, TOD	TIME, LTIME,	I, Q, M, D, L	Result of addition The data type selection depends on the data types selected for the IN1 and IN2 input parameters.

Table 9-35 Addition of a time period to a time

Parameter	Declaration	Data type		Memory area	Description
		S7-1200	S7-1500		
IN1	Input	DTL, TOD	DT, TOD, LTOD, LDT, DTL	I, Q, M, D, L or constant	First number to be added
IN2	Input	TIME	TIME, LTIME	I, Q, M, D, L or constant	Second number to be added
OUT	Return	DINT, DWORD, TIME, TOD, UDINT, DTL	DT, DTL, LDT, TOD, LTOD	I, Q, M, D, L	Result of addition The data type selection depends on the data types selected for the IN1 and IN2 input parameters.

You will find more detailed information on valid data types in "Overview of the valid data types (Page 1077)".

## T\_SUB: Subtract times

### Description

You use this instruction to subtract the time information in the IN2 input parameter from the time information in the IN1 input parameter. You can query the difference in the OUT output parameter. You can subtract the following formats:

- Subtraction of a time period from another time period  
Example: Subtraction of a time period of the data type TIME from another time period of the data type TIME. The result can be output to a tag with the TIME format.
- Subtraction of a time period from a time  
Example: Subtraction of a time period of the data type TIME from a time of the data type DTL. The result can be output to a tag with the DTL format.

You decide the formats of the values in the IN1 input parameter and the OUT output parameter by selecting the data types for the input and output parameters of the instruction.

### Parameters

The following tables show the parameters of the "T\_SUB" instruction, according to the possible conversions:

Table 9-36 Subtraction of a time period from another time period

Parameter	Declaration	Data type		Memory area	Description
		S7-1200	S7-1500		
IN1	Input	TIME	TIME, LTIME	I, Q, M, D, L or constant	Minuend
IN2	Input	TIME	TIME, LTIME	I, Q, M, D, L or constant	Subtrahend
OUT	Return	DINT, DWORD, TIME, TOD, UDINT	TIME, LTIME	I, Q, M, D, L	Result of subtraction

Table 9-37 Subtraction of a time period from a time

Parameter	Declaration	Data type		Memory area	Description
		S7-1200	S7-1500		
IN1	Input	DTL, TOD	TOD, LTOD, DTL, DT, LDT	I, Q, M, D, L or constant	Minuend
IN2	Input	TIME	TIME, LTIME	I, Q, M, D, L or constant	Subtrahend
OUT	Return	DTL, DINT, DWORD, TIME, TOD, UDINT	TOD, LTOD, DTL, DT, LDT	I, Q, M, D, L	Result of subtraction

You will find more detailed information on valid data types in "Overview of the valid data types (Page 1077)".

## T\_DIFF: Time difference

### Description

You use this instruction to subtract the time information in the IN2 input parameter from the time information in the IN1 input parameter. The result is stored in the OUT output parameter in TIME format.

- If the time information at the IN2 input parameter is greater than the time information at the IN1 input parameter, the result is output as a negative value at the OUT output parameter.
- If the result of the subtraction is outside the TIME range, the result is set to "0" (0:00) and the enable output ENO = "0".

### Parameters

The following table shows the parameters of the "T\_DIFF" instruction:

Parameter	Declaration	Data type		Memory area	Description
		S7-1200	S7-1500		
IN1	Input	DTL	DTL, DATE, DT, TOD, LTOD, LDT	I, Q, M, D, L or constant	Minuend
IN2	Input	DTL	DTL, DATE, DT, TOD, LTOD, LDT	I, Q, M, D, L or constant	Subtrahend
OUT	Return	TIME	TIME, LTIME, INT	I, Q, M, D, L	Difference in TIME format

You will find more detailed information on valid data types in "Overview of the valid data types (Page 1077)".

## T\_COMBINE: Combine times

### Description

The instruction combines the value of a date with the value of a time and converts this into a combined date and time value.

- The date is output at the input parameter IN1. A value of between 1990-01-01 and 2089-12-31 must be used for the data type DATE (this is not checked).
- The time is input at the IN2 input value (TOD/LTOD data type).
- The combined data type for the date and time value is output at the OUT output value.

**Parameter**

The following table shows the parameters of the instruction "T\_COMBINE":

Parameter	Declaration	Data type		Memory area	Description
		S7-1200	S7-1500		
IN1	Input	DATE	DATE, WORD, UINT, INT	I, Q, M, D, L or constant	Input tag of the date
IN2	Input	TOD	TOD, LTOD	I, Q, M, D, L or constant	Input tag of the time
OUT	Return	DTL	DT, DTL, LDT	I, Q, M, D, L	Return value of the date and time

For additional information on valid data types, refer to "Overview of the valid data types (Page 1077)".

**Time-of-day functions**

**WR\_SYS\_T: Set time-of-day**

**Description**

You use this instruction to set the date and time-of-day of the CPU clock. You specify the date and time information at the IN input parameter of the instruction. You can query whether errors have occurred during execution of the instruction in the RET\_VAL output parameter.

The "WR\_SYS\_T" instruction cannot be used to pass information about the local time zone or daylight saving time.

**Parameters**

The following table shows the parameters of the "WR\_SYS\_T" instruction:

Parameter	Declaration	Data type		Memory area	Description
		S7-1200	S7-1500		
IN	Input	DTL	DT, DTL, LDT	I, Q, M, D, L or constant	Date and time
RET_VAL	Return	INT, REAL, DINT	INT	I, Q, M, D, L	Status of the instruction

You will find more detailed information on valid data types in "Overview of the valid data types (Page 1077)".

**RET\_VAL parameter**

Error code* (W#16#...)	Description
0000	No error
8080	Error in date
8081	Error in time
* The error codes can be displayed as integer or hexadecimal values in the program editor. For additional information on toggling display formats, refer to "See also".	

**RD\_SYS\_T: Read time-of-day****Description**

You use this instruction to read out the current date and current time-of-day of the CPU clock.

The read out dates are output at the OUT output parameter of the instruction. The provided value does not include information about the local time zone or daylight saving time.

You can query whether errors have occurred during execution of the instruction in the RET\_VAL output.

**Parameters**

The following table shows the parameters of the "RD\_SYS\_T" instruction:

Parameter	Declaration	Data type		Memory area	Description
		S7-1200	S7-1500		
RET_VAL	Return	INT	INT	I, Q, M, D, L	Status of the instruction
OUT	Output	DTL	DT, DTL, LDT	I, Q, M, D, L	Date and time of CPU

You will find more detailed information on valid data types in "Overview of the valid data types (Page 1077)".

**Parameter RET\_VAL**

Error code* (W#16#...)	Description
0000	No error
8081	Time value specified at the LOCTIME parameter is outside the valid value range: With DTL: min. DTL#1970-01-01-00:00:00.0, max. DTL#2200-12-31-23:59:59.999999999 With LDT: min. LDT#1970-1-1-0:0:0.000000000, max. LDT#2200-12-31-23:59:59.999999999
* The error codes can be displayed as integer or hexadecimal values in the program editor. For additional information on toggling display formats, refer to "See also".	

## RD\_LOC\_T: Read local time

### Description

You use this instruction to read out the current local time from the CPU clock and output this at the OUT output. Information on the time zone and the start of daylight saving time and standard time, which you have set in the configuration of the CPU clock, is used to output the local time.

### Parameter

The following table shows the parameters of the "RD\_LOC\_T" instruction:

Parameter	Declaration	Data type		Memory area	Description
		S7-1200	S7-1500		
RET_VAL	Return	INT	INT	M, D, L	Status of the instruction
OUT	Output	DTL	DT, LDT, DTL	D	Local time

You will find more detailed information on valid data types in "Overview of the valid data types (Page 1077)".

### RET\_VAL parameter

Error code* (W#16#....)	Description
0000	No error
0001	No error. Local time is output as daylight saving time.
8080	Local time cannot be read out.
8081	Time value specified at the LOCTIME parameter is outside the valid value range:  With DTL: min. DTL#1970-01-01-00:00:00.0, max. DTL#2554-12-31-23:59:59.999999999  With LDT: min. LDT#1970-1-1-0:0:0.000000000, max. LDT#2262-04-11-23:47:16.854775807
* The error codes can be displayed as integer or hexadecimal values in the program editor. For additional information on toggling display formats, refer to "See also".	

## WR\_LOC\_T: Write local time

### Description

The instruction "WR\_LOC\_T" is used to set the date and time of the CPU clock. You specify the date and time information as local time at the LOCTIME input parameter of the instruction.

The instruction uses the "TimeTransformationRule" structure to calculate the system time. The granularity of the time information for local time and system time is product-specific and is at least one millisecond. Input values at the LOCTIME parameter which are less than those supported by the CPU are rounded up during system time calculation.



You can query whether errors have occurred during execution of the instruction in the RET\_VAL output parameter.

## Parameter

The following table shows the parameters of the "WR\_LOC\_T" instruction:

Parameter	Declaration	Data type	Memory area	Description
LOCTIME	Input	DTL, LDT	I, Q, M, D, L or constant	Local time
DST	Input	BOOL	I, Q, M, D, L or constant	<b>Daylight Saving Time</b> Only evaluated during the "double hour" when the clocks change to daylight saving time. <ul style="list-style-type: none"> <li>• TRUE = daylight saving time (first hour)</li> <li>• FALSE = standard time (second hour)</li> </ul>
RET_VAL	Return	INT	I, Q, M, D, L	Error message (see "RET_VAL parameter")

You will find more detailed information on valid data types in "Overview of the valid data types (Page 1077)".

## RET\_VAL parameter

Error code* (W#16#...)	Description
0000	No error.
8080	The LOCTIME parameter has an invalid value.
8081	Time value specified at the LOCTIME parameter is outside the valid value range: <ul style="list-style-type: none"> <li>• With DTL: min. DTL#1970-01-01-00:00:00.0, max. DTL#2554-12-31-23:59:59.999999999</li> <li>• With LDT: min. LDT#1970-1-1-0:0:0.000000000, max. LDT#2262-04-11-23:47:16.854775807</li> </ul>
8082**	Invalid value specified for the month (byte 2 in DTL format).
8083**	Invalid value specified for the day (byte 3 in DTL format).
8084**	Invalid value specified for the hour (byte 5 in DTL format).
8085**	Invalid value specified for the minute (byte 5 in DTL format).
8086**	Invalid value specified for the second (byte 7 in DTL format).
8087**	Invalid value specified for the nanosecond (byte 8 to 11 in DTL format).
8089	Time value does not exist (hour already passed upon changeover to daylight saving time).
80B0	The real-time clock has failed.
80B1	The "TimeTransformationRule" structure has not been defined.
* The error codes can be displayed as integer or hexadecimal values in the program editor. For additional information on toggling display formats, refer to "See also".	
** Only for local time information at the LOCTIME parameter in DTL format.	

## SET\_TIMEZONE: Set time zone

### Description

You use this instruction to calculate the local time based on the module time. The module time of the CPU is the UTC time. The module time is used exclusively for communication within the system. The rule for conversion to local time is defined in the "TimeTransformationRule" attribute that you specify in the TimeZone parameter. The rule defines the time zone calculation as well as the automatic changeover between daylight saving time and standard time.

### Parameters

The following table shows the parameters of the "SET\_TIMEZONE" instruction:

Parameter	Declaration	Data type	Memory area	Description
REQ	Input	BOOL	I, Q, M, D, L or constant	REQ=1: Conversion of module time to local time
TimeZone	Input	Time Transformation Rule (Page 2291)	D	Rule for conversion of module time to local time.
DONE	Output	BOOL	I, Q, M, D, L	<ul style="list-style-type: none"> <li>0: Job not yet started or is still executing</li> <li>1: Job completed error-free</li> </ul>
BUSY	Output	BOOL	I, Q, M, D, L	<ul style="list-style-type: none"> <li>0: Job not yet started or already completed</li> <li>1: Job not yet completed. A new job cannot be started.</li> </ul>
ERROR	Output	BOOL	I, Q, M, D, L	<ul style="list-style-type: none"> <li>0: No error</li> <li>1: Error occurred</li> </ul>
STATUS	Output	DINT, DWORD, UDINT, WORD	I, Q, M, D, L	Error message

For additional information on valid data types, refer to "Overview of the valid data types (Page 1077)".

### STATUS parameter

Error code* (W#16#....)	Description
7000	No job processing active.
7001	Start of job processing. Parameter BUSY = 1, DONE = 0
7002	Intermediate call (REQ irrelevant): Instruction already active; BUSY has the value "1".

\* The error codes can be displayed as integer or hexadecimal values in the program editor. For additional information on toggling display formats, refer to "See also".

## TimeTransformationRule

### Description

The times for changeover to daylight saving time and standard time are defined in the TimeTransformationRule structure. The structure is as follows:

Name	Data type	Description
TimeTransformationRule	STRUCT	
Bias	INT	// Time difference between local time and UTC [min]
DaylightBias	INT	// Time difference between daylight saving and standard time [min]
DaylightStartMonth	USINT	// Month of conversion to daylight saving time
DaylightStartWeek	USINT	// Week of conversion to daylight saving time // 1 = First occurrence of the weekday in the month, ..., // 5 = Last occurrence of the weekday in the month
DaylightStartWeekday	USINT	// Weekday of daylight saving time changeover: // 1 = Sunday
DaylightStartHour	USINT	// Hour of daylight saving time changeover
DaylightStartMinute	USINT	// Minute of daylight saving time changeover
StandardStartMonth	USINT	// Month of conversion to standard time
StandardStartWeek	USINT	// Week of conversion to standard time // 1 = First occurrence of the weekday in the month, ..., // 5 = Last occurrence of the weekday in the month
StandardStartWeekday	USINT	// Weekday of standard time changeover: // 1 = Sunday
StandardStartHour	USINT	// Hour of standard time changeover
StandardStartMinute	USINT	// Minute of standard time changeover
TimeZoneName	STRING[80]	// Name of time zone: "(GMT+01:00) Amsterdam, Berlin, Bern, Rome, Stockholm, Vienna"

## SNC\_RTCB: Synchronize slave clocks

### Definition: Synchronization of slave clocks

The synchronization of clock slaves refers to the transfer of the date and time-of-day from the clock master of a bus segment to all clock slaves of this bus segment.

### Description

You use this instruction to synchronize all slave clocks present on a bus segment independent of the assigned synchronization interval. Successful synchronization is only possible if "SNC\_RTCB" is called on a CPU whose real-time clock was assigned as the master clock for at least one bus segment.

### Parameters

The following table shows the parameters of the "SNC\_RTCB" instruction:

Parameter	Declaration	Data type	Memory area	Description
RET_VAL	Output	INT	I, Q, M, D, L	If an error occurs while the instruction is being executed, the return value contains an error code.

For additional information on valid data types, refer to "Overview of the valid data types (Page 1077)".

### Parameter RET\_VAL

Error code* (W#16#...)	Explanation
0000	No error occurred during synchronization.
0001	The existing clock was not assigned the master clock function for any of the bus segments.
General error information	See also: GET_ERR_ID: Get error ID locally (Page 1787)

\* The error codes can be displayed as integer or hexadecimal values in the program editor. For additional information on toggling display formats, refer to "See also".

### TIME\_TCK: Read system time

#### Description

With the "TIME\_TCK" instruction, you read the system time of the CPU. The system time is a time counter that counts from 0 to a maximum of 2147483647 ms. In case of an overflow, the system time is counted again starting with "0". The time scale and the accuracy of the system time is 1 ms. The system time is only influenced by the operating modes of the CPU. You can use the system time, for example, to measure the duration of processes by comparing the results of two "TIME\_TCK" calls. The instruction does not provide any error information.

The following table provides an overview of how the system time changes depending on the operating modes of the CPU.

Mode	System time ...
Startup	... is constantly updated
RUN	
STOP	... is stopped and retains the current value
Warm restart	... is deleted and restarts with "0"

## Parameter

The following table shows the parameters of the instruction "TIME\_TCK":

Parameters	Declaration	Data type	Memory area	Description
RET_VAL	Return	TIME	I, Q, M, D, L	The RET_VAL parameter contains the read system time in the range from 0 to $2^{31} - 1$ ms.

You will find more detailed information on valid data types in "Overview of the valid data types (Page 1077)".

## RTM: Runtime meters

### Description

You can use this instruction to set, start, stop, and read out a 32-bit runtime meter of your CPU.

Ensure that the runtime meter can also be stopped or restarted during execution of the user program, which may render the saved values incorrect.

### Parameters

The following table shows the parameters of the instruction "RTM":

Parameter	Declaration	Data type	Memory area	Description
NR	Input	RTM (UINT)	I, Q, M, D, L or constant	Number of the runtime meter Numbering starts with 0. For information on the number of runtime meters of your CPU, refer to the technical data.
MODE	Input	BYTE	I, Q, M, D, L or constant	Job ID: <ul style="list-style-type: none"> <li>• 0: Read out (the status is then written to CQ and the current value to CV). After the runtime meter has reached <math>(2E31) - 1</math> hours, it stops at the highest value that can be displayed and outputs an "Overflow" error message.</li> <li>• 1: start (at the last counter value)</li> <li>• 2: stop</li> <li>• 4: set (to the value specified in PV)</li> <li>• 5: set (to the value specified in PV) and then start</li> <li>• 6: set (to the value specified in PV) and then stop</li> </ul>
PV	Input	DINT	I, Q, M, D, L or constant	New value for the runtime meter

9.7 References

Parameter	Declaration	Data type	Memory area	Description
RET_VAL	Return	INT	I, Q, M, D, L	If an error occurs while the instruction is being executed, the return value contains an error code.
CQ	Output	BOOL	I, Q, M, D, L	Status of the runtime meter (1: running)
CV	Output	DINT	I, Q, M, D, L	Current value of the runtime meter

You will find more detailed information on valid data types in "Overview of the valid data types (Page 1077)".

Parameter RET\_VAL

Error code (W#16#...)	Explanation
0000	No error
8080	Wrong number for the runtime meter
8081	A negative value was passed to the PV parameter.
8082	Overflow of the runtime meter
8091	The MODE input parameter contains an invalid value.
General error information	See also: Evaluating errors with GET_ERR_ID (Page 2237)

9.7.3.2 String + Char

S\_MOVE: Move character string

Description

You can use this instruction to move the content of a character string (STRING). The character string in the IN input parameter is copied to the OUT output parameter.

You can insert additional outputs for the S\_MOVE instruction. In this case, the content of the operand in the IN input parameter is transferred to all available outputs.

You can use the "MOVE\_BLK" and "UMOVE\_BLK" instructions to copy tags of data type ARRAY.

Parameters

The following table shows the parameters of the "S\_MOVE" instruction:

Parameter	Declaration	Data type	Memory area	Description
IN	Input	STRING	D, L	Source value
OUT	Output	STRING	D, L	Destination address

For additional information on valid data types, refer to "Overview of the valid data types (Page 1077)".

## S\_COMP: Compare character strings

### Description

The instruction compares the contents of two tags in the STRING format and outputs the result of the comparison as a return value. The tags that are to be compared will be interconnected at the IN1 and IN2 inputs. You can only assign a symbolically defined tag for the input parameters.

Use the instruction box to select the comparison condition. If the comparison condition (for example, greater than or equal to) is satisfied, the signal state is set to "1" at the output parameter OUT .

The following comparison options can be used:

Symbol	Description
EQ	The return value has the signal state "1" if the string at the IN1 parameter is the same as the string at the IN2 parameter.
NE	The return value has the signal state "1" if the string at the IN1 parameter is not equal to the string at the IN2 parameter.
GT <sup>(1)</sup>	The return value has the signal state "1" if the string at the IN1 parameter is greater than the string at the IN2 parameter.
LT <sup>(1)</sup>	The return value has the signal state "1" if the string at the IN1 parameter is less than the string at the IN2 parameter.
GE <sup>(1)</sup>	The return value has the signal state "1" if the string at the IN1 parameter is greater than or equal to the string at the IN2 parameter.
LE <sup>(1)</sup>	The return value has the signal state "1" if the string at the IN1 parameter is less than or equal to the string at the IN2 parameter.
<sup>(1)</sup> The characters are compared by their ASCII code (for example, 'a' is greater than 'A'), starting from the left. The first character to be different decides the result of the comparison. If the first characters are the same, the longer string is greater.	

### Parameters

The following table shows the parameters of the instruction "S\_COMP":

Parameters	Declaration	Data type	Memory area	Description
IN1	Input	STRING*	D, L	Input tag in the STRING format.
IN2	Input	STRING*	D, L	Input tag in the STRING format.
OUT	Output	BOOL	I, Q, M, D, L	Result of comparison
* Define the maximum length of the character string if you use the data type STRING in the interface declaration for a temporary variable (you will find further information in the description of the data type).				

For additional information on valid data types, refer to "Overview of the valid data types (Page 1077)".

## S\_CONV: Convert character string

### Description

You use this instruction to convert the value at the IN input to the data format you have specified in the OUT output. The following conversions are possible:

- Conversion of a character string (STRING) to a numerical value:  
The conversion is performed for all characters of the character string specified in the IN input parameter. Permitted characters are the digits "0" to "9", the decimal point, and the plus and minus signs. The first character of the string may be a valid number or a sign. Leading spaces and exponential notations are ignored. Character conversion can be interrupted by invalid characters. You decide the output format of the conversion by selecting a data type for the OUT output parameter.
- Conversion of a numerical value to a character string (STRING):  
You decide the format of the numeric value to be converted by selecting a data type for the IN input. A valid tag of the STRING data type must be specified in the OUT output. The length of the character string after conversion depends on the value at the IN input. The conversion result is saved as a string starting at the third byte. The first byte of the string records the maximum length and the second byte the actual length of the character string. Positive numeric value are output without a sign.

---

#### Note

When you convert zero (e.g. INT\_TO\_STRING(0)), the string will be 6 characters long.

---

- Copying a character string:  
If you enter the STRING data type in the input and output parameters of the instruction, the character string in the IN input will be copied to the OUT output. If the actual length of the character string in the IN input exceeds the maximum character string length in the OUT output; only the part of the character string that exactly fits into the character string of OUT will be copied to IN.

---

#### Note

##### Exponential notation during conversion from floating-point numbers

Do not use exponential notation ("e" or "E") for the conversion from floating-point numbers with the instruction "S\_CONV". Instead, use the instruction "STRG\_VAL (Page 2297)" for the conversion of floating-point numbers with exponential notation. You can use the FORMAT parameter of the instruction to select exponential notation as input format.

---



## Parameters

The following tables show the parameters of the "S\_CONV" instruction, according to the possible conversions:

Table 9-38 Parameters for converting a character string to a numeric value:

Parameters	Declaration	Data type	Memory area	Description
IN	Input	STRING	D, L	Value to be converted
OUT	Output	CHAR, USINT, UINT, UDINT, ULINT, SINT, INT, DINT, LINT, REAL, LREAL	I, Q, M, D, L	Result of the conversion

Table 9-39 Parameters for converting a numeric value to a character string:

Parameter	Declaration	Data type	Memory area	Description
IN	Input	CHAR, USINT, UINT, UDINT, ULINT, SINT, INT, DINT, LINT, REAL, LREAL	I, Q, M, D, L or constant	Value to be converted
OUT	Output	STRING	D, L	Result of the conversion

Table 9-40 Parameters for copying a character string:

Parameters	Declaration	Data type	Memory area	Description
IN	Input	STRING	D, L	Value to be copied
OUT	Output	STRING	D, L	Result of the copy operation

For additional information on valid data types, refer to "Overview of the valid data types (Page 1077)".

## STRG\_VAL: Convert character string to numerical value

### Description

The "STRG\_VAL" instruction converts a numeric character string to the corresponding integer or floating-point notation:

- You specify the character string to be converted in the IN input parameter.
- You define the format of the output value by selecting a data type for the OUT output parameter. You can query the result in the OUTOutput parameter.

Permitted characters for the conversion are the digits "0" to "9", the decimal point, the decimal comma, notations "E" and "e" and the plus and minus characters. The conversion can be interrupted by invalid characters.

### Parameters

The following table shows the parameters of the "STRG\_VAL" instruction:

Parameter	Declaration	Data type		Memory area	Description
		S7-1200	S7-1500		
IN	Input	STRING	STRING	D, L or constant	Numeric character string to be converted
FORMAT	Input	WORD	WORD	I, Q, M, D, L or constant	Output format of the characters
P	Input	UINT	UINT	I, Q, M, D, L or constant	Reference to the first character to be converted (first character = 1, the value "0" or a value > length of the string is invalid)
OUT	Output	USINT, SINT, UINT, INT, UDINT, DINT, REAL, LREAL	USINT, SINT, UINT, INT, UDINT, DINT, ULINT, LINT, REAL, LREAL	I, Q, M, D, L	Result of the conversion

For additional information on valid data types, refer to "Overview of the valid data types (Page 1077)".

### Parameter FORMAT

You use the FORMAT parameter to specify how the characters of a character string are to be interpreted. Exponential values can also be converted and represented with the "STRG\_VAL" instruction. Only tags of the USINT data type can be specified in the FORMAT parameter.

The following table shows the possible values of the FORMAT parameter and their meaning:

Value (W#16#...)	Notation	Decimal representation
0000	Decimal fraction	"."
0001		"."
0002	Exponential	"."
0003		"."
0004 to FFFF	Invalid values	

### Parameter P

The conversion starts at the character whose position you specified in the P parameter. If, for example, the value "1" is specified in the P parameter, the conversion starts at the first character of the specified character string.

## Example

The following table shows examples of the conversion of a character string to a numeric value:

IN (STRING)	FORMAT (W#16#....)	OUT (data type)	OUT (value)	ENO status
'123'	0000	INT/DINT	123	1
'-00456'	0000	INT/DINT	-456	1
'123.45'	0000	INT/DINT	123	1
'+2345'	0000	INT/DINT	2345	1
'00123AB'	0000	INT/DINT	123	1
'123'	0000	REAL	123.0	1
'-00456'	0001	REAL	-456.0	1
'+00456'	0001	REAL	456.0	1
'123.45'	0000	REAL	123.45	1
'123.45'	0001	REAL	12345.0	1
'123,45'	0000	REAL	12345.0	1
'123,45'	0001	REAL	123.45	1
'.00123AB'	0001	REAL	123.0	1
'1.23e-4'	0000	REAL	1.23	1
'1.23E-4'	0000	REAL	1.23	1
'1.23E-4'	0002	REAL	1.23E-4	1
'12,345.67'	0000	REAL	12345.67	1
'12,345.67'	0001	REAL	12.345	1
'3.4e39'	0002	REAL	W#16#7F800000	1
'-3.4e39'	0002	REAL	W#16#FF800000	1
'1.1754943e-38'	0002	REAL	0.0	1
'12345'	-/-	SINT	0	0
'A123'	-/-	-/-	0	0
'	-/-	-/-	0	0
'++123'	-/-	-/-	0	0
'+-123'	-/-	-/-	0	0

## VAL\_STRG: Convert numerical value to character string

### Description

The "VAL\_STRG" instruction is used to convert a numerical value into a character string.

- You specify the value to be converted in the IN input parameter. You decide the format of the numeric value by selecting a data type.
- You query the result of the conversion in the OUT output parameter.

Permitted characters for the conversion are the digits "0" to "9", the decimal point, the decimal comma, notations "E" and "e", and the plus and minus characters. The conversion can be interrupted by invalid characters.

### Parameters

The following table shows the parameters of the "VAL\_STRG" instruction:

Parameter	Declaration	Data type		Memory area	Description
		S7-1200	S7-1500		
IN	Input	USINT, SINT, UINT, INT, UDINT, DINT, REAL, LREAL	USINT, SINT, UINT, INT, UDINT, DINT, ULINT, LINT, REAL, LREAL	I, Q, M, D, L or constant	Value to be converted
SIZE	Input	USINT	USINT	I, Q, M, D, L or constant	Number of character positions
PREC	Input	USINT	USINT	I, Q, M, D, L or constant	Number of decimal places
FORMAT	Input	WORD	WORD	I, Q, M, D, L or constant	Output format of the characters
P	InOut	UINT	UINT	I, Q, M, D, L or constant	Character starting at which the result is written.
OUT	Output	STRING	STRING	D, L	Result of the conversion

For additional information on valid data types, refer to "Overview of the valid data types (Page 1077)".

### Parameter P

With the P parameter, you specify the character in the string starting at which the result is written. If, for example, the value "2" is specified in the P parameter, the converted value is saved starting at the second character of the string.

### Parameter SIZE and P

Use the SIZE parameter to specify how many characters of the character string will be written. This is counted starting from the character specified in the P parameter. If the output value is shorter than the specified length, the result is written to the character string right-justified. The empty character positions are filled with blanks.

### Parameter FORMAT

Use the FORMAT parameter to specify how the numerical value is interpreted during conversion and written to the character string. You can specify only tags of the FORMAT data type in the USINT parameter.

The following table shows the possible values of the FORMAT parameter and their meaning:

Value (W#16#....)	Notation	Sign	Decimal representation
0000	Decimal fraction	"-"	"."
0001			","

Value (W#16#...)	Notation	Sign	Decimal representation
0002	Exponential	"+" and "-"	"."
0003			","
0004	Decimal fraction		"."
0005			","
0006	Exponential		"."
0007			","
0008 to FFFF	Invalid values		

## Parameter PREC

Use the PREC parameter to define the number of decimal places when converting floating-point numbers. A maximum precision of seven numbers is supported for numerical values of the REAL data type. If the value to be converted is an integer, you use the PREC parameter to specify the position where the decimal point will be placed.

## Example

The following table shows examples of the conversion of numeric values to a character string.

IN (value)	IN (data type)	P	SIZE	FORMAT (W#16#...)	PREC	OUT (STRING)	ENO status
123	UINT	16	10	0000	0	xxxxxxxx123 C	1
0	UINT	16	10	0000	2	xxxxxx0.00 C	1
12345678	UDINT	16	10	0000	3	x12345.678 C	1
12345678	UDINT	16	10	0001	3	x12345.678 C	1
123	INT	16	10	0004	0	xxxxxxx+123 C	1
-123	INT	16	10	0004	0	xxxxxxx-123 C	1
-0.00123	REAL	16	10	0004	4	xxx-0.0012 C	1
-0.00123	REAL	16	10	0006	4	-1.2300E-3 C	1
-Inf <sup>1)</sup>	REAL	16	10	-/-	4	xxxxxxx-INF C	0
+Inf <sup>2)</sup>	REAL	16	10	-/-	4	xxxxxxx+INF C	0
NaN <sup>3)</sup>	REAL	16	10	-/-	4	xxxxxxxNaN C	0
12345678	UDINT	16	6	-/-	3	xxxxxxxxxxx C	0

"x" represents blanks  
<sup>1)</sup>-Inf: Floating-point number representing a negative infinite value.  
<sup>2)</sup>+Inf: Floating-point number representing a positive infinite value.  
<sup>3)</sup>NaN: Value returned as the result of invalid math operations.

## Strg\_TO\_Chars: Convert character string to Array of CHAR

### Description

Use this instruction to copy characters from a character string STRING to a field of several characters of the data type CHAR or BYTE (Array of CHAR / BYTE).

- Specify the character string from which characters are to be copied at the input parameter STRG.
- The characters are written to a data type Array of CHAR or Array of BYTE at the parameter CHARS. With the PCHARS parameter, you specify the position starting at which the characters are to be written to the field Array of CHAR / BYTE. The low limit of the array is used as standard (example: "0" with Array[1 .. 10] of CHAR).
- The number of characters in the field Array of CHAR must be at least as many characters as are to be copied from the character string STRING.

Only ASCII characters are valid for data types STRING, BYTE and CHAR.

### Parameters

The following table shows the parameters of the instruction "Strg\_TO\_Chars":

Parameter	Declaration	Data type	Memory area	Description
STRG	Input	STRING	D, L or constant	Source: Character string
PCHARS	Input	DINT	I, Q, M, D, L or constant	Position in the destination character string from which the characters will be written. PCHARS = "0" addresses the first index of the character string.
CHARS	InOut	VARIANT	D, L	Destination: Field in which the characters will be copied. The characters are copied to a field of data type Array of CHAR or Array of BYTE.
CNT	Output	UINT	I, Q, M, D, L	Number of copied characters.

For additional information on valid data types, refer to "Overview of the valid data types (Page 1077)".

## Chars\_TO\_Strg: Convert Array of CHAR to character string

### Description

Use the instruction "Chars\_TO\_Strg" to copy characters from a field of multiple characters of the data type CHAR or BYTE (Array of CHAR / BYTE) to a character string STRING.

- Specify the characters of the field Array of CHAR / BYTE to be copied to a character string at the input parameter CHARS. Use the PCHARS parameter to specify the position starting at which the characters of the Array are to be copied. The low limit of the array is used as standard (example: "0" with Array[1 .. 10] of CHAR).
- The characters are written to a data type STRING at the parameter STRG. The number of characters in the character string STRING must be at least as many characters as are to be copied from the field Array of CHAR.

Only ASCII characters are valid for data types STRING, CHAR and BYTE.

### Parameters

The following table shows the parameters of the instruction "Chars\_TO\_Strg":

Parameter	Declaration	Data type	Memory area	Description
CHARS	Input	VARIANT	D, L	Source: Field from which the characters will be copied.
PCHARS	Input	DINT	I, Q, M, D, L or constant	Position in the field Array of CHAR / Array of BYTE from which the characters will be copied. PCHARS = "0" addresses the first index of the field.
CNT	Input	UINT	I, Q, M, D, L or constant	Number of characters to be copied. Use "0" to copy all characters.
STRG	Output	STRING	D, L	Destination: Character string

For additional information on valid data types, refer to "Overview of the valid data types (Page 1077)".

## MAX\_LEN: Determine the length of a character string

### Description

A tag of the STRING data type contains two lengths: the maximum length and the current length (this is the number of currently valid characters).

- The maximum length of the character string is specified for each tag in the STRING keyword in square brackets. The number of bytes occupied by a string is 2 greater than the maximum length.
- The current length represents the number of the character places actually used. The current length must be less than or equal to the maximum length.

You use the "MAX\_LEN" instruction to query the maximum length of the character string specified at the IN input parameter and output this information as a numerical value at the OUT output parameter.

If errors occur during processing of the instruction, then an empty string will be output.

---

**Note**

**Reading out the current length**

You can also use the LEN (Page 2308) instruction to read out the current length of a string.

---

**Parameter**

The following table shows the parameters of the "MAX\_LEN" instruction:

Parameter	Declaration	Data type	Memory area	Description
IN	Input	STRING	D, L or constant	Character string
OUT	Return	DINT	I, Q, M, D, L	Maximum number of characters

For additional information on valid data types, refer to "Overview of the valid data types (Page 1077)".

**ATH: Convert ASCII string to hexadecimal number**

**Description**

You use the instruction "ATH" to convert the ASCII character string specified at the IN input parameter into a hexadecimal number. The result of the conversion is output to the OUT output parameter.

- You can reference the following data types using the pointer in the IN parameter (ASCII): STRING, Array of CHAR, Array of BYTE.
- You can reference the following data types using the pointer in the OUT parameter (hexadecimal): Bit strings, integers, STRING, Array of CHAR, Array of BYTE.

With the N parameter, you specify the number of ASCII characters to be converted. A maximum of 32767 valid ASCII characters can be converted. Only digits "0" to "9", upper case letters "A" to "F", and lower case letters "a" to "f" can be interpreted. All other characters are converted to zeros.

Since 8 bits are required for the ASCII character and only 4 bits for the hexadecimal digit, the output word length is only half of the input word length. The ASCII characters are converted and positioned in the output in the same order as they are read in. If there is an odd number of ASCII characters, the hexadecimal number is padded with zeros in the nibble to the right of the last converted hexadecimal number.



## Parameters

The following table shows the parameters of the "ATH" instruction:

Parameter	Declaration	Data type	Memory area	Description
IN	Input	VARIANT	I, Q, M, D, L	Pointer to ASCII character string
N	Input	UINT	I, Q, M, D, L or constant	Number of ASCII characters to be converted
RET_VAL	Return	WORD	I, Q, M, D, L	Status of the instruction
OUT	Output	VARIANT	I, Q, M, D, L	Hexadecimal number

For additional information on valid data types, refer to "Overview of the valid data types (Page 1077)".

## Parameter RET\_VAL

Error code (W#16#...)*	Description
0000	No error
0007	Invalid character. Only the following ASCII characters may be used: Digits "0" to "9", upper case letters "A" to "F", lower case letters "a" to "f".
8101	Invalid pointer in the IN parameter, e.g., because a non-existing data block is referenced.
8182	Input buffer is too small for data in the N parameter.
8120	Invalid format in the IN parameter.
8151	Non-supported data type in the IN parameter.
8401	Invalid pointer in the OUT parameter, e.g., because a non-existing data block is referenced.
8482	Output buffer is too small for data in the N parameter.
8420	Invalid format in the OUT parameter.
8451	Non-supported data type in the OUT parameter.

\* The error codes can be displayed as integer or hexadecimal values in the program editor. For additional information on toggling display formats, refer to "See also".

## ASCII characters and hexadecimal values

The following table shows the ASCII characters and the corresponding hexadecimal values:

	ASCII-coded hexadecimal value	Hexadecimal digit
"0"	30	0
"1"	31	1
"2"	32	2
"3"	33	3
"4"	34	4
"5"	35	5
"6"	36	6
"7"	37	7

	ASCII-coded hexadecimal value	Hexadecimal digit
"8"	38	8
"9"	39	9
"A"	41	A
"B"	42	B
"C"	43	C
D	44	D
E	45	E
F	46	F

**Example**

The following table shows examples of the conversion of ASCII character strings to hexadecimal numbers:

IN	N	OUT	ENO status
'0123'	4	16#0123	1
'123AFx1a23'	10	16#123AF01a23	0

**HTA: Convert hexadecimal number to ASCII string**

**Description**

You use the instruction "HTA" to convert the hexadecimal number specified at the IN input into an ASCII character string. The result of the conversion is stored at the address specified in the OUT parameter.

- You can reference the following data types using the pointer in the IN parameter (hexadecimal): Bit strings, integers, STRING, Array of CHAR, Array of BYTE.
- You can reference the following data types using the pointer in the OUT parameter (ASCII): STRING, Array of CHAR, Array of BYTE.

With the N parameter, you specify the number of hexadecimal bytes to be converted. Since 8 bits are required for the ASCII character and only 4 bits for the hexadecimal digit, the output value is twice as long as the input value. Each nibble of the hexadecimal number is converted to a character while maintaining the original order.

A maximum of 32767 characters can be written to the ASCII character string. The result of the conversion is represented by the digits "0" to "9" and upper-case letters "A" to "F".

If the complete result of the conversion cannot be displayed in the OUT parameter, the result is will only be partially written to the parameter.

## Parameters

The following table shows the parameters of the "HTA" instruction:

Parameter	Declaration	Data type	Memory area	Description
IN	Input	VARIANT	I, Q, M, D, L	Start address of the hexadecimal digits
N	Input	UINT	I, Q, M, D, L or constant	Number of hexadecimal bytes to be converted
RET_VAL	Return	WORD	I, Q, M, D, L	Error message
OUT	Output	VARIANT	I, Q, M, D, L	Address at which the result is stored.

For additional information on valid data types, refer to "Overview of the valid data types (Page 1077)".

## Parameter RET\_VAL

Error code* (W#16#...)	Description
0000	No error
8101	Invalid pointer at the IN parameter, e.g., because a non-existing data block is referenced.
8182	Input buffer is too small for data in the N parameter.
8120	Invalid format in the IN parameter.
8151	Non-supported data type in the IN parameter.
8401	Invalid pointer in the OUT parameter, e.g., because a non-existing data block is referenced.
8482	Output buffer is too small for data in the N parameter.
8420	Invalid format in the OUT parameter.
8451	Non-supported data type in the OUT parameter.

\* The error codes can be displayed as integer or hexadecimal values in the program editor. For additional information on toggling display formats, refer to "See also".

## ASCII characters and hexadecimal values

The following table shows the ASCII characters and the corresponding hexadecimal values:

Hexadecimal digit	ASCII-coded hexadecimal value	ASCII character
0	30	"0"
1	31	"1"
2	32	"2"
3	33	"3"
4	34	"4"
5	35	"5"
6	36	"6"
7	37	"7"

Hexadecimal digit	ASCII-coded hexadecimal value	ASCII character
8	38	"8"
9	39	"9"
A	41	"A"
B	42	"B"
C	43	"C"
D	44	"D"
E	45	"E"
F	46	"F"

**Example**

The following table shows examples of the conversion of hexadecimal numbers to ASCII character strings:

IN	N	OUT	ENO status
W#16#0123	2	'0123'	1
16#123AF01023	4	'123AF010'	0

**Other instructions**

**LEN: Determine the length of a character string**

**Description**

A tag of the STRING data type contains two lengths: the maximum length and the current length (this is the number of currently valid characters).

- The maximum length of the character string is specified for each tag in the STRING keyword in square brackets. The number of bytes occupied by a string is 2 greater than the maximum length.
- The current length represents the number of the character places actually used. The current length must be less than or equal to the maximum length.

You use the instruction "LEN" to query the current length of the character string specified at the IN input parameter and output this information as a numerical value at the OUT output parameter. An empty string ("") has the length zero.

If errors occur during processing of the instruction, then an empty string will be output.

---

**Note**

**Reading out the maximum length**

You can also use the MAX\_LEN (Page 2303) instruction to read out the current length of a string.

---

## Parameters

The following table shows the parameters of the "LEN" instruction:

Parameter	Declaration	Data type	Memory area	Description
IN	Input	STRING	D, L or constant	Character string
OUT	Return	INT, DINT, REAL, LREAL	I, Q, M, D, L	Number of valid characters

For additional information on valid data types, refer to "Overview of the valid data types (Page 1077)".

## CONCAT: Combine character strings

### Description

You use the instruction "CONCAT" to combine the character string at the IN1 input parameter with the character string at the IN2 input parameter. The result is output in the OUT output parameter with the STRING format. If the resulting character string is longer than the tag specified in the OUT output parameter, then the resulting character string will be limited to the available length.

If errors occur during processing of the instruction and the OUT output parameter can be written, an empty string will be output.

### Parameters

The following table shows the parameters of the "CONCAT" instruction:

Parameter	Declaration	Data type	Memory area	Description
IN1	Input	STRING	D, L or constant	Character string
IN2	Input	STRING	D, L or constant	Character string
OUT	Return	STRING	D, L	Resulting character string

For additional information on valid data types, refer to "Overview of the valid data types (Page 1077)".

## LEFT: Read the left character of a character string

### Description

You use the instruction "LEFT" to extract a partial string beginning with the first character of the string at the IN input parameter. You specify the number of characters to be extracted in the L parameter. The extracted characters are output in the OUT output parameter with STRING format.

If the number of characters to be extracted is greater than the current length of the character string, the OUT output parameter returns the input character string as a result. If the L

parameter contains the value "0" or the input value is an empty string, an empty string will be returned. If the value in the L parameter is negative, an empty string will be output.

If errors occur during processing of the instruction and the OUT output parameter can be written, an empty string will be output.

**Parameters**

The following table shows the parameters of the "LEFT" instruction:

Parameter	Declaration	Data type	Memory area	Description
IN	Input	STRING	D, L or constant	Character string
L	Input	BYTE, INT, SINT, USINT	I, Q, M, D, L or constant	Number of characters to be extracted
OUT	Return	STRING	D, L	Extracted partial string

For additional information on valid data types, refer to "Overview of the valid data types (Page 1077)".

**RIGHT: Read the right characters of a character string**

**Description**

You use this instruction to extract the last L character in a character string in the input parameter IN. You specify the number of characters to be extracted in the L parameter. The extracted characters are output in the OUT output parameter with STRING format.

If the number of characters to be extracted is greater than the current length of the character string, the OUT output parameter returns the input character string as a result. If the L parameter contains the value "0" or the input value is an empty string, an empty string will be returned. If the value in the L parameter is negative, an empty string will be output.

If errors occur during processing of the instruction and the OUT output parameter can be written, an empty string will be output.

**Parameters**

The following table shows the parameters of the "RIGHT" instruction:

Parameter	Declaration	Data type	Memory area	Description
IN	Input	STRING	D, L or constant	Character string
L	Input	BYTE, INT, SINT, USINT	I, Q, M, D, L or constant	Number of characters to be extracted
OUT	Return	STRING	D, L	Extracted partial string

For additional information on valid data types, refer to "Overview of the valid data types (Page 1077)".

## MID: Read middle characters of a character string

### Description

You use this instruction to extract a portion of the character string in the IN input parameter. With the P parameter, you specify the position of the first character to be extracted. With the L parameter, you define the length of the character string to be extracted. The extracted partial character string is output to the OUT output parameter.

The following rules must be observed when executing the instruction:

- If the number of characters to be extracted exceeds the current length of the character string in the IN input parameter, a partial character string will be output, starting from character position P and continuing to the end of the character string.
- If the character position specified in the P parameter falls outside the current character string length in the IN input parameter, an empty character string will be output in the OUT output parameter.
- If the value of the P or L parameter equals zero or is negative, an empty character string will be output in the OUT output parameter.

If errors occur during processing of the instruction and the OUT output parameter can be written, an empty string will be output.

### Parameters

The following table shows the parameters of the "MID" instruction:

Parameter	Declaration	Data type	Memory area	Description
IN	Input	STRING	D, L or constant	Character string
L	Input	BYTE, INT, SINT, USINT	I, Q, M, D, L or constant	Length of the string to be extracted
P	Input	BYTE, INT, SINT, USINT	I, Q, M, D, L or constant	Position of the first character to be extracted (first character = 1)
OUT	Return	STRING	D, L	Extracted partial string

For additional information on valid data types, refer to "Overview of the valid data types (Page 1077)".

## DELETE: Delete characters in a character string

### Description

You use this instruction to delete a portion of the character string in the IN input parameter. With the P parameter, you specify the position of the first character to be deleted. You specify the number of characters to be deleted in the L parameter. The remaining partial character string is output to the OUT output parameter with STRING format.

The following rules must be observed when executing the instruction:

- If the value in the P parameter is less than or equals zero, an empty character string will be output in the OUT output parameter.
- If the value in the P parameter is greater than the current length of the character string in the IN input, the input character string will be returned in the OUT output parameter.
- If the value in the L parameter equals zero, the input character string will be returned in the OUT output parameter.
- If the number of characters to be deleted at the L parameter is greater than the length of the character string in the IN parameter, an empty character string will be output.
- If the value in the L parameter is negative, an empty character string will be output.

If errors occur during processing of the instruction and the OUT output parameter can be written, an empty string will be output.

### Parameter

The following table shows the parameters of the "DELETE" instruction:

Parameter	Declaration	Data type	Memory area	Description
IN	Input	STRING	D, L or constant	Character string
L	Input	BYTE, INT, SINT, USINT	I, Q, M, D, L or constant	Number of characters to be deleted
P	Input	BYTE, INT, SINT, USINT	I, Q, M, D, L or constant	Position of first character to be deleted
OUT	Return	STRING	D, L	Resulting character string

For additional information on valid data types, refer to "Overview of the valid data types (Page 1077)".

### INSERT: Insert characters in a character string

#### Description

You use this instruction to insert the character string in the IN2 input parameter to the character string in the IN1 input parameter. With the P parameter, you specify the position of the character starting at which the characters are inserted. The result is output in the OUT output parameter with the STRING format.

The following rules must be observed when executing the instruction:

- If the value in the P parameter exceeds the current length of the character string in the IN1 input parameter, the character string of the IN2 input parameter will be appended to the character string of the IN1 input parameter.
- If the value at the P parameter is zero, the character string at the IN2 parameter followed by the character string at the IN1 parameter will be output in the OUT output parameter.



- If the value in the P parameter is negative, an empty character string will be output in the OUT output parameter.
- If the resulting character string is longer than the tag specified in the OUT output parameter, the resulting character string will be limited to the available length.

## Parameter

The following table shows the parameters of the "INSERT" instruction:

Parameter	Declaration	Data type	Memory area	Description
IN1	Input	STRING	D, L or constant	Character string
IN2	Input	STRING	D, L or constant	String to insert
P	Input	BYTE, INT, SINT, USINT	I, Q, M, D, L or constant	Insert position
OUT	Return	STRING	D, L	Resulting character string

For additional information on valid data types, refer to "Overview of the valid data types (Page 1077)".

## REPLACE: Replace characters in a character string

### Description

You use this instruction to replace a portion of the character string in the IN1 input with the character string in the IN2 input. You specify the position of the first character to be replaced in the P parameter. You specify the number of characters to be replaced in the L parameter. The result is output in the OUT output parameter with the STRING format.

The following rules must be observed when executing the instruction:

- If the value in the P parameter is less than or equals zero, an empty character string will be output in the OUT output parameter.
- If the value in the L parameter is less than zero, an empty character string will be output in the OUT output parameter.
- If P equals one, the character string in the IN1 input will be replaced beginning with (and including) the first character.
- If the value in the P parameter exceeds the current length of the character string in the IN1 input parameter, the character string of the IN2 input parameter will be appended to the character string of the IN1 input parameter.
- If the resulting character string is longer than the tag specified in the OUT output parameter, the resulting character string will be limited to the available length.
- If the value at parameter L is zero, characters are not replaced but inserted. The same conditions apply as with the instruction INSERT. See also: INSERT: Insert characters in a character string (Page 2312)

### Parameters

The following table shows the parameters of the "REPLACE" instruction:

Parameter	Declaration	Data type	Memory area	Description
IN1	Input	STRING	D, L or constant	String with characters to be replaced.
IN2	Input	STRING	D, L or constant	String with characters to be inserted.
L	Input	BYTE, INT, SINT, USINT	I, Q, M, D, L or constant	Number of characters to be replaced
P	Input	BYTE, INT, SINT, USINT	I, Q, M, D, L or constant	Position of first character to be replaced
OUT	Return	STRING	D, L	Resulting character string

For additional information on valid data types, refer to "Overview of the valid data types (Page 1077)".

### FIND: Find characters in a character string

#### Description

You can use this instruction to search through the character string in the IN1 input parameter for a specific character or a specific string of characters.

- You specify the value to be searched for in the IN2 input parameter. The search is made from left to right.
- The position of the first occurrence is output in the OUT output parameter. If the search returns no match, the value "0" will be output in the OUT output parameter.

If errors occur during processing of the instruction, an empty string will be output.

### Parameters

The following table shows the parameters of the "FIND" instruction:

Parameter	Declaration	Data type	Memory area	Description
IN1	Input	STRING	D, L or constant	String searched through
IN2	Input	STRING, CHAR	D, L or constant (For CHAR also I, Q, M)	Characters to search for
OUT	Return	DINT, INT, LREAL, REAL	I, Q, M, D, L	Character position

For additional information on valid data types, refer to "Overview of the valid data types (Page 1077)".

### 9.7.3.3 Process image

#### UPDAT\_PI: Update the process image inputs

##### Description

With the instruction, you update the OB 1 process image (=process image partition 0) of the inputs or a process image partition of the inputs of the inputs defined by configuration.

If you have configured repeated signaling of I/O access errors for the system-side process image update, then the selected process image will be updated constantly.

Otherwise, this update will only be performed if the selected process image partition is not updated by the system, in other words:

- If you have not assigned this process image partition to an interrupt OB or
- If you selected process image partition 0 and have disabled updating of the OB 1 process image partition during configuration.

##### Note

Each logical address that you have assigned to a process image partition of the inputs per configuration no longer belongs to the OB 1 process image of the inputs.

When you update a process image partition with "UPDAT\_PI", you must not perform a simultaneous update with the "SYNC\_PI (Page 2318)" instruction.

System-side updating of the OB 1 process image of the inputs and the process image partitions of inputs that you have assigned to an interrupt OB takes place independently of "UPDAT\_PI" calls.

##### Parameters

The following table shows the parameters of the "UPDAT\_PI" instruction:

Parameter	Declaration	Data type	Memory area	Description
PART	Input	PIP	I, Q, M, D, L or constant	Number of the process image partition of the inputs to be updated. Maximum value range (depending on the CPU): 0 to 31 (0 means OB 1 process image, n where $1 \leq n \leq 31$ means process image partition n).
RET_VAL	Return	INT	I, Q, M, D, L	Error information
FLADDR	Output	WORD	I, Q, M, D, L	Address of the first byte to cause an error if an access error has occurred.

For additional information on valid data types, refer to "Overview of the valid data types (Page 1077)".

**Parameter RET\_VAL**

Error code* (W#16#...)	Explanation
0000	No error occurred.
8090	Illegal value for PART parameter
8091	The specified process image partition was not yet defined or is not located in the permitted process image area on the CPU.
8092	The process image partition is being updated by the system and cannot be used for the PART parameter.
8093	The process image partition update is being processed in another OB.
80A0	An access error was detected when accessing the I/O.
General error information	See also: GET_ERR_ID: Get error ID locally (Page 1787)
* The error codes can be displayed as integer or hexadecimal values in the program editor. For additional information on toggling display formats, refer to "See also".	

**Note**

If you use the instruction for process image partitions of DP standard slaves for which you have defined a consistency area greater than 32 bytes, the error codes of the "DPRD\_DAT (Page 2363)" instruction are also possible.

**UPDAT\_PO: Update the process image outputs**

**Description**

You use the instruction to transfer the signal states of the OB 1 process image (= process image partition 0) of the outputs or a process image partition of the outputs defined per configuration to the output modules.

If you have specified a consistency range for the selected process image partition, corresponding data is transferred as consistent data to the respective I/O module.

**Note**

Each logical address you have assigned to a process image partition of the outputs during configuration no longer belongs to the OB 1 process image of the outputs.

Outputs that you update with "UPDAT\_PO" must not be updated simultaneously with the "SYNC\_PO (Page 2319)" instruction.

The OB 1 process image of the outputs and the process image partitions of the outputs that you have assigned to an interrupt OB are transferred by the system to the output modules independently of "UPDAT\_PO" calls.

## Parameters

The following table shows the parameters of the "UPDAT\_PO" instruction:

Parameter	Declaration	Data type	Memory area	Description
PART	Input	PIP	I, Q, M, D, L or constant	Number of the process image partition of the outputs to be transferred. Maximum value range (depending on the CPU): 0 to 31. (0 means OB 1 process image, n where $1 \leq n \leq 31$ means process image partition n)
RET_VAL	Return	INT	I, Q, M, D, L	Error information
FLADDR	Output	WORD	I, Q, M, D, L	Address of the first byte to cause an error if an access error has occurred.

For additional information on valid data types, refer to "Overview of the valid data types (Page 1077)".

## Parameter RET\_VAL

Error code* (W#16#...)	Explanation
0000	No error occurred.
8090	Illegal value for PART parameter
8091	The specified process image partition was not yet defined or is not located in the permitted process image area on the CPU.
8092	The process image partition is being updated by the system and cannot be used for the PART parameter.
8093	The process image partition update is being processed in another OB.
80A0	An access error was detected when accessing the I/O.
General error information	See also: GET_ERR_ID: Get error ID locally (Page 1787)

\* The error codes can be displayed as integer or hexadecimal values in the program editor. For additional information on toggling display formats, refer to "See also".

### Note

If you use the instruction for process image partitions of DP standard slaves for which you have defined a consistency area greater than 32 bytes, the error codes of the "DPWR\_DAT (Page 2365)" instruction are also possible.

## SYNC\_PI: Synchronize the process image inputs

### Description

The "SYNC\_PI" is used to update the process image partition of inputs in isochronous mode. A user program linked to a DP cycle or PN send cycle can use this instruction to update input data acquired in a process image partition of the inputs isochronously and consistently.

### Call

"SYNC\_PI" is interruptible and can only be called in OBs 61, 62, 63 and 64.

#### Note

A call of the "SYNC\_PI" instruction in OBs 61 to 64 is only permitted if you have assigned the affected process image partition to the associated OB in the HW configuration.

A process image partition that you update with "SYNC\_PI" must not be updated simultaneously with the "UPDAT\_PI (Page 2315)" instruction.

### Parameters

The following table shows the parameters of the "SYNC\_PI" instruction:

Parameter	Declaration	Data type	Memory area	Range of values	Description
PART	Input	PIP	I, Q, M, D, L or constant	1 to 31	Number of the process image partition of the inputs to be updated isochronously.
RET_VAL	Return	INT	I, Q, M, D, L	-	Error information
FLADDR	Output	WORD	I, Q, M, D, L		Address of the first byte to cause an error if an access error has occurred.

For additional information on valid data types, refer to "Overview of the valid data types (Page 1077)".

### Parameter RET\_VAL

Event class Error code (W#16#...)*	Explanation
0000	No error occurred.
0001	Consistency warning. The update of the process image partition was distributed over two DP or PN cycles. However, the data in one slave or IO device were consistently transferred.
8090	Illegal value on PART parameter or updating the specified process image partition of the inputs is not permitted in this OB. The process image partition of the inputs was not updated.
8091	The specified process image partition was not yet defined or is not located in the permitted process image area on the CPU. The process image partition of the inputs was not updated.
8092	The process image partition is being updated by the system and cannot be used for the PART parameter.

Event class Error code (W#16#...)*	Explanation
8093	The process image partition update is being processed in another OB.
80A0	During updating an access error was detected. The affected inputs were set to "0".
80A1	The update time is after the permitted access window. The process image partition of the inputs was not updated. The DP or PN cycle is too short to ensure enough time for processing the instruction. You must therefore increase the TDP (also known as T_DC), Ti and To timers.
80A2	Access error with consistency warning In the case of update of the specified process image partition an access error with simultaneous consistency warning was detected. <ul style="list-style-type: none"> <li>• The data of the incorrect inputs was not read by the I/O. In the process image partition of the inputs the involved inputs are set to zero.</li> <li>• The update of the process image partition of the not involved by an access error input data was distributed over two DP and PN cycles.</li> </ul>
80C1	The update time is before the permitted access window. The process image partition of the inputs was not updated.
General error information	See also: GET_ERR_ID: Get error ID locally (Page 1787)
* The error codes can be displayed as integer or hexadecimal values in the program editor. For additional information on toggling display formats, refer to "See also".	

---

#### Note

If you use the "SYNC\_PI" instruction for process image partitions of DP standard slaves for which you have defined a consistency area greater than 32 bytes, the error codes of the "DPRD\_DAT (Page 2363)" instruction are also possible.

---

## SYNC\_PO: Synchronize the process image outputs

### Description

The instruction "SYNC\_PO" is used to update a process image partition of outputs in isochronous mode. A user program linked to a DP cycle can use this instruction to transfer the calculated output data of a process image partition outputs to the I/O isochronously and consistently.

**Call**

"SYNC\_PO" is interruptible and can only be called in OBs 61, 62, 63 and 64.

**Note**

A call of the "SYNC\_PO" instruction in OBs 61 to 64 is only permitted if you have assigned the affected process image partition to the associated OB in the HW configuration.

A process image partition that you update with "SYNC\_PO" must not be updated simultaneously with the "UPDAT\_PO (Page 2316)" instruction.

**Parameters**

The following table shows the parameters of the "SYNC\_PO" instruction:

Parameter	Declaration	Data type	Memory area	Range of values	Description
PART	Input	PIP	I, Q, M, D, L or constant	1 to 31	Number of the process image partition of the outputs to be updated isochronously.
RET_VAL	Return	INT	I, Q, M, D, L	-	If an error occurs while the instruction is being executed, the return value contains an error code.
FLADDR	Output	WORD	I, Q, M, D, L	-	Address of the first byte that has caused the error.

For additional information on valid data types, refer to "Overview of the valid data types (Page 1077)".

**Parameter RET\_VAL**

Error code (W#16#...)*	Explanation
0000	No error occurred.
0001	Consistency warning. The update of the process image partition was distributed over two DP or PN cycles. However, the data in one slave or IO device were consistently transferred.
8090	Illegal value in PART parameter, or updating the specified process image partition of the outputs is not permitted in this OB. Outputs were not transferred to the I/O. The process image partition of the outputs remains unchanged.
8091	The specified process image partition was not yet defined or is not located in the permitted process image area on the CPU. Outputs were not transferred to the I/O. The process image partition of the outputs remains unchanged.
8092	The process image partition is being updated by the system and cannot be used for the PART parameter.
8093	The process image partition update is being processed in another OB.
80A0	In the case of update of the specified process image partition of the outputs an access error was detected. Incorrect outputs were not transferred to the I/O. During process image partition of the outputs, these outputs remain unchanged.



Error code (W#16#...)*	Explanation
80A1	<p>Access error with consistency warning</p> <p>In the case of update of the specified process image partition of the outputs an access error with simultaneous consistency warning was detected.</p> <ul style="list-style-type: none"> <li>• The data of the incorrect outputs were not transferred to the I/O. During process image partition of the outputs, the involved outputs remain unchanged.</li> <li>• The update of the process image partition of the not involved by an access error input data was distributed over two DP and PN cycles.</li> </ul>
80A2	The update time is after the permitted access window. Outputs were not transferred to the I/O. The process image partition of the outputs remains unchanged.
80C1	The update time is before the permitted access window. Outputs were not transferred to the I/O. The process image partition of the outputs remains unchanged.
General error information	See also: GET_ERR_ID: Get error ID locally (Page 1787)
* The error codes can be displayed as integer or hexadecimal values in the program editor. For additional information on toggling display formats, refer to "See also".	

#### Note

If you use the "SYNC\_PO" instruction for process image partitions of DP standard slaves for which you have defined a consistency area greater than 32 bytes, the error codes of the "DPWR\_DAT (Page 2365)" instruction are also possible.

### 9.7.3.4 Distributed I/O

#### RDREC: Read data record

##### Description

You use the instruction "RDREC" to read the data record with the number INDEX from the component addressed using the ID. This may be a module in a central rack or a distributed component (PROFIBUS DP or PROFINET IO).

- Use MLEN to specify the maximum number of bytes you want to read. If length "0" is selected at the parameter MLEN, the complete data record is written at the parameter RECORD.
- The target range RECORD should have at least the length of MLEN bytes.
- The value TRUE for the output parameter VALID indicates that the data record was successfully transferred to the target range RECORD. In this case, the LEN output parameter contains the length of the read data in bytes.
- If an error has occurred during transfer of the data record, this is indicated by the output parameter ERROR. In this case, the output parameter STATUS contains the error information.

**Note**

The interface of the "RDREC" instruction is identical to the "RDREC" FB defined in "PROFIBUS Guideline PROFIBUS Communication and Proxy Function Blocks according to IEC 61131-3".

**Functional description**

"RDREC" works asynchronously, which means its execution extends over multiple calls. You start the data record transfer by calling "RDREC" with REQ= 1.

The job status is displayed via the output parameter BUSY and the two central bytes of output parameter STATUS. The two central bytes of STATUS correspond to the RET\_VAL output parameter of the instructions that operate asynchronously.

See also: Meaning of the parameters REQ, RET\_VAL and BUSY with asynchronous instructions (Page 1582).

The transfer of the data record is complete when the output parameter BUSY has the value FALSE .

**Parameter**

The following table shows the parameters of the instruction "RDREC":

Parameter	Declaration	Data type*	Memory area	Description
REQ	Input	BOOL	I, Q, M, D, L, T, C or constant	REQ = 1: Transfer data record
ID	Input	HW_IO	I, Q, M, L or constant	Hardware identifier of the hardware component (DP/PROFINET IO) The number is assigned automatically and is stored in the properties of the component or of the interface in the hardware configuration.
INDEX	Input	BYTE, DINT, INT, SINT, UINT, USINT, WORD	I, Q, M, D, L or constant	Data record number
MLEN	Input	BYTE, UINT, USINT	I, Q, M, D, L or constant	Maximum length in bytes of the data record information to be read
VALID	Output	BOOL	I, Q, M, D, L	New data record was received and is valid
BUSY	Output	BOOL	I, Q, M, D, L	BUSY = 1: The reading process is not yet complete.
ERROR	Output	BOOL	I, Q, M, D, L	ERROR = 1: An error occurred during the reading process.
STATUS	Output	DWORD	I, Q, M, D, L	Block status or error information
LEN	Output	UINT	I, Q, M, D, L	Length of the read data record information
RECORD	InOut	VARIANT	I, Q, M, D, L	Target range for the data record read.

\* There is no implicit conversion in STL, which is why the range of valid data types may be limited. During programming in STL, please note the valid data types. These are displayed in the parameter tooltip.

You will find more detailed information on valid data types in "Overview of the valid data types (Page 1077)".

---

**Note**

If you use "RDREC" to read a data record for PROFINET IO, then negative values in the INDEX, MLEN, and LEN parameters will be interpreted as an unsigned 16-bit integer.

---

**STATUS parameter**

For interpretation of the STATUS parameter, see Parameter STATUS (Page 2330).

**See also**

Basics of block access (Page 1027)

**WRREC: Write data record****Description**

The instruction "WRREC" is used to transfer the RECORD data record to the component addressed using ID. This may be a module in a central rack or a distributed component (PROFIBUS DP or PROFINET IO).

- Use LEN to specify the length of the data record to be transmitted in bytes. The selected length of the source range RECORD should have at least the length of LEN bytes.
- The value TRUE at output parameter DONE indicates that the data record has been successfully transferred.
- If an error has occurred during transfer of the data record, this is indicated by the output parameter ERROR. In this case, the output parameter STATUS contains the error information.

---

**Note**

The interface of the "WRREC" instruction is identical to the "WRREC" FB defined in "PROFIBUS Guideline PROFIBUS Communication and Proxy Function Blocks according to IEC 61131-3".

---

**Functional description**

"The WRREC" instruction works asynchronously, that is, its execution extends over multiple calls. You start the data record transfer by calling "WRREC" with REQ = 1.

The job status is displayed via the output parameter BUSY and the two central bytes of output parameter STATUS. The two central bytes of STATUS correspond to the RET\_VAL output parameter of the instructions that operate asynchronously.

See also: Meaning of the parameters REQ, RET\_VAL and BUSY with asynchronous instructions (Page 1582).

Note that you must assign the same value to the actual parameter of RECORD for all "WRREC" calls that belong to one and the same job. The same applies to the actual parameters of LEN.

The transfer of the data record is complete when the output parameter BUSY has the value FALSE.

**Parameter**

The following table shows the parameters of the instruction "WRREC":

Parameter	Declaration	Data type	Memory area	Description
REQ	Input	BOOL	I, Q, M, D, L, T, C or constant	REQ= 1: Transfer data record
ID	Input	HW_IO	I, Q, M, L or constant	ID number of the hardware component (DP/ PROFINET IO) The number is assigned automatically and is stored in the properties of the component or of the interface in the hardware configuration.
INDEX	Input	DINT	I, Q, M, D, L or constant	Data record number
LEN	Input	BYTE, UINT, USINT	I, Q, M, D, L or constant	(hidden) Maximum length of the data record to be transferred in bytes
DONE	Output	BOOL	I, Q, M, D, L	Data record was transferred
BUSY	Output	BOOL	I, Q, M, D, L	BUSY= 1: The writing process is not yet complete.
ERROR	Output	BOOL	I, Q, M, D, L	ERROR = 1: An error occurred during the writing process.
STATUS	Output	DWORD	I, Q, M, D, L	Block status or error information For interpretation of the STATUS parameter, see Parameter STATUS (Page 2330).
RECORD	InOut	VARIANT	I, Q, M, D, L	Data record

For additional information on valid data types, refer to "Overview of the valid data types (Page 1077)".

**Note**

If you use "WRREC" to write a data record for PROFINET IO, negative values in the INDEX and LEN parameters will be interpreted as an unsigned 16-bit integer.

**STATUS parameter**

For interpretation of the STATUS parameter, see Parameter STATUS (Page 2330).

## GETIO: Read process image

### Description

You use the instruction "GETIO" to consistently read out all inputs of a DP standard slave/ PROFINET IO device. The instruction "GETIO" calls the instruction "DPRD\_DAT (Page 2363)". If there was no error during the data transmission, the data that have been read are entered in the target range indicated by INPUTS .

The target range must have the same length that you configured for the selected component.

If you read from a DP standard slave with a modular configuration or with several DP identifiers, you can only access the data of one component/DP identifier at the configured start address with a "GETIO" call.

### Parameter

The following table shows the parameters of the instruction "GETIO":

Parameter	Declaration	Data type	Memory area	Description
ID	Input	HW_SUBMOD ULE	I, Q, M, D, L or constant	Hardware ID of the DP standard slave / PROFINET IO device.
STATUS	Output	DWORD	I, Q, M, D, L	Contains the error information of "DPRD_DAT (Page 2363)" in the form DW#16#40xxxx00.
LEN	Output	INT	I, Q, M, D, L	Amount of data read in bytes
INPUTS	InOut	VARIANT	I, Q, M, D	Target range for the read data. It must have the same length as the range that you configured for the selected DP standard slave / PROFINET IO device. Only the BYTE data type is permitted.

You will find more detailed information on valid data types in "Overview of the valid data types (Page 1077)".

### STATUS parameter

See also: DPRD\_DAT: Read consistent data of a DP standard slave (Page 2363).

## SETIO: Transfer process image

### Description

You use the instruction "SETIO" to consistently transfer data from the source range defined by the parameter OUTPUTS to the addressed DP standard slave / PROFINET IO device, and, if necessary, to the process image (if you have configured the relevant address area of the DP standard slave / PROFINET IO device as a consistent range in a process image). "SETIO" calls the instruction "DPWR\_DAT (Page 2365)".

The source range must have the same length that you configured for the selected component.

In the case of a DP standard slave / PROFINET IO device with modular configuration or with several DP identifiers, you can only access one DP identifier / component per "SETIO" call.

### Parameters

The following table shows the parameters of the "SETIO" instruction:

Parameter	Declaration	Data type	Memory area	Description
ID	Input	HW_SUBMODU LE	I, Q, M, D, L or constant	Hardware ID of the DP standard slave / PROFINET IO device.
STATUS	Output	DWORD	I, Q, M, D, L	Contains the error information of "DPWR_DAT (Page 2365)" in the form DW#16#40xxx00.
OUTPUTS	InOut	VARIANT	I, Q, M, D	Source range for the data to be written. It must have the same length as the range that you configured for the selected DP standard slave / PROFINET IO device. Only the BYTE data type is permitted.

For additional information on valid data types, refer to "Overview of the valid data types (Page 1077)".

### Parameter STATUS

See also: DPWR\_DAT: Write consistent data of a DP standard slave (Page 2365).

### GETIO\_PART: Read process image area

#### Description

You use the instruction "GETIO\_PART" to consistently read out a related part of the inputs of an IO module. "GETIO\_PART" calls the instruction "DPWR\_DAT (Page 2363)".

Use the ID input parameter to select the IO module by means of the hardware ID.

You use the OFFSET and LEN parameters to specify the portion of the process image area to be read. If the input area spanned by OFFSET and LEN is not completely covered by the module, the block returns the error code DW#16#4080B700.

The length of the target range must be larger than or equal to the amount of bytes to be read:

- If there was no error during the data transmission, ERROR receives the value FALSE. The data that are read are written to the target range defined at the INPUTS parameter.
- If there was no error during the data transmission, ERROR receives the value TRUE. The STATUS parameter receives the error information from "DPRD\_DAT".
- If the target range is greater than LEN, then the first LEN bytes of the target range will be written. ERROR receives the value FALSE.

## Parameters

The following table shows the parameters of the "GETIO\_PART" instruction:

Parameter	Declaration	Data type	Memory area	Description
ID	Input	HW_SUBMOD ULE	I, Q, M, D, L or constant	Hardware identifier of the module
OFFSET	Input	INT	I, Q, M, D, L or constant	Number of the first byte to be read in the process image for the component (smallest possible value: 0).
LEN	Input	INT	I, Q, M, D, L or constant	Number of bytes to be read.
STATUS	Output	DWORD	I, Q, M, D, L	Contains the error information of "DPRD_DAT" in the form DW#16#40xxx00, if ERROR = TRUE.
ERROR	Output	BOOL	I, Q, M, D, L	Error display: ERROR = TRUE if an error occurs when "DPRD_DAT" is called.
INPUTS	InOut	VARIANT	I, Q, M, D	Target range for read data: If the target range is greater than LEN, the first LEN bytes of the target range are written.

For additional information on valid data types, refer to "Overview of the valid data types (Page 1077)".

## Parameter STATUS

See "RET\_VAL" parameter of the "DPRD\_DAT (Page 2363)" instruction.

## SETIO\_PART: Transfer process image area

### Description

You can use the "SETIO\_PART" instruction to consistently write data from the source area spanned by OUTPUTS to the outputs of an IO module. "SETIO\_PART" calls the instruction "DPWR\_DAT (Page 2365)".

Use the ID input parameter to select the IO module by means of the hardware ID. You use the OFFSET and LEN parameters to specify the portion of the process image area to be written for the components addressed by means of ID. If the output area spanned by OFFSET and LEN is not completely covered by the module, the block returns the error code DW#16#4080B700.

The length of the source range must be greater than or equal to the number of bytes to be written:

- If there was no error during the data transmission, ERROR receives the value FALSE.
- If there was an error during the data transmission, ERROR receives the value TRUE, and STATUS receives the error information of "DPWR\_DAT".
- If the source range is greater than LEN, the first LEN bytes from OUTPUTS are transferred. ERROR receives the value FALSE.

**Parameter**

The following table shows the parameters of the instruction "SETIO\_PART":

Parameter	Declaration	Data type	Memory area	Description
ID	Input	HW_SUBMODULE	I, Q, M, D, L or constant	Hardware identifier of the IO module.
OFFSET	Input	INT	I, Q, M, D, L or constant	Number of the first byte to be written in the process image for the component (smallest possible value: 0).
LEN	Input	INT	I, Q, M, D, L or constant	Number of bytes to be written.
STATUS	Output	DWORD	I, Q, M, D, L	Contains the error information of "DPWR_DAT" in the form DW#16#40xxx00, if ERROR = TRUE.
ERROR	Output	BOOL	I, Q, M, D, L	Error display: ERROR = TRUE if an error occurs when "DPWR_DAT" is called.
OUTPUTS	InOut	VARIANT	I, Q, M, D	Source range for the data to be written: If the source range is greater than LEN, the first LEN bytes are transferred from OUTPUTS.

You will find more detailed information on valid data types in "Overview of the valid data types (Page 1077)".

**Parameters STATUS and ERROR**

See instruction "DPWR\_DAT (Page 2365)".

**RALRM: Receive interrupt**

**Description RALRM**

**Description**

The instruction receives an interrupt with all corresponding information from an I/O module (centralized configuration) or from a module of a DP slave or PROFINET IO device and supplies this information to its output parameters.

The information in the output parameters contains the start information of the called OB as well as information of the interrupt source.



For a central configuration, the configuration of the data structure of the target range AINFO corresponds to the data structure of PROFINET IO.

Call "RALRM" only within the interrupt OB started by the CPU operating system as a result of the I/O interrupt that is to be examined.

---

#### Note

If you call "RALRM" in an OB whose start event is not an I/O interrupt, the instruction will provide correspondingly reduced information in its outputs.

Make sure to use different instance DBs when you call "RALRM" in different OBs. If you evaluate data resulting from an "RALRM" call outside of the associated interrupt OB, you should moreover use a separate instance DB per OB start event.

---

#### Note

The interface of the "RALRM" instruction is identical to the "RALRM" FB defined in "PROFIBUS Guideline PROFIBUS Communication and Proxy Function Blocks according to IEC 61131-3".

---

## Calling RALRM

"RALRM" can be called in three operating modes (MODE parameter). These are explained in the table below.

MODE	RALRM ...
0	... shows the component that triggered the interrupt in the ID output parameter and writes TRUE in the NEW output parameter.
1	... writes all output parameters, independent of the interrupt triggering component.
2	... checks whether the component specified in the F_ID input parameter has triggered the interrupt. <ul style="list-style-type: none"> <li>• If not, NEW = FALSE</li> <li>• If yes, NEW = TRUE and all other output parameters are written.</li> </ul>

## Parameters

The following table shows the parameters of the "RALRM" instruction:

Parameter	Declaration	Data type	Memory area	Description
MODE	Input	INT	I, Q, M, D, L or constant	Mode
F_ID	Input	HW_IO	D, L or constant	Hardware identifier of the module. The number is assigned automatically and is stored in the hardware configuration properties of the component or interface.
MLEN	Input	UINT	I, Q, M, D, L or constant	Maximum length of the interrupt information to be received in bytes. With MLEN = 0, all data specified at the AINFO parameter are read.

Parameter	Declaration	Data type	Memory area	Description
NEW	Output	BOOL	I, Q, M, D, L	A new interrupt was received.
STATUS (Page 2330)	Output	DWORD	I, Q, M, D, L	Error code
ID	Output	HW_IO	I, Q, M, D, L	Hardware identifier of the module from which the interrupt was received.
LEN	Output	UINT	I, Q, M, D, L	Length of the received interrupt information
TINFO (Page 2334)	InOut	VARIANT	I, Q, M, D, L	Destination area for OB start and management information
AINFO (Page 2346)	InOut	VARIANT	I, Q, M, D, L	Destination area for header information and additional interrupt information For AINFO , you should provide a length of at least MLEN bytes.

For additional information on valid data types, refer to "Overview of the valid data types (Page 1077)".

**Note**

If you select a target range (Page 2352)TINFO or AINFO that is too short, RALRM cannot enter the full information.

**Parameter STATUS**

**Description**

The STATUS output parameter contains error information. If it is interpreted as ARRAY[1...4] of BYTE, the error information has the following structure:

Array element	Name	Meaning
STATUS[1]	Function_Num	<ul style="list-style-type: none"> <li>B#16#00, if no error</li> <li>Function ID from DPV1-PDU: In the event of an error, B#16#80 is output (in the event of an error reading a data record B#16#DE and writing a data record B#16#DF). If no DPV1 protocol element is used, then B#16#C0 will be output.</li> </ul>
STATUS[2]	Error Decode	Location of the error ID
STATUS[3]	Error_Code_1	Error ID
STATUS[4]	Error_Code_2	Manufacturer-specific error ID extension

**Array element STATUS[2]**

STATUS[2] can have the following values:

Error Decode (B#16#...)	Source	Meaning
00 to 7F	CPU	No error or no warning
80	DPV1	Error according to IEC 61158-6
81 to 8F	CPU	B#16#8x shows an error in the xth call parameter of the instruction.
FE, FF	DP profile	Profile-specific error

**Array element STATUS[3]**

STATUS[3] can have the following values:

Error Decode (B#16#...)	Error_Code_1 (B#16#...)	Explanation according to DVP1	Meaning
00	00		No error, no warning
70	00	reserved, reject	Initial call; no active data record transfer
	01	reserved, reject	Initial call; data record transfer has started
	02	reserved, reject	Intermediate call; data record transfer already active
80	90	reserved, pass	Invalid logical start address
	92	reserved, pass	Illegal type for VARIANT pointer
	93	reserved, pass	The DP component addressed via ID or F_ID is not configured.
	96		The "RALRM (Page 2328)" cannot supply the OB start information, management information, header information, or additional interrupt information. For OBs 4x, 55, 56, 57, 82 and 83, you can use the "DPNRM_DG (Page 2378)" instruction to read the current diagnostic frame of the relevant DP slave asynchronously (address information from OB start information).
	A0	read error	Negative acknowledgment while reading the module
	A1	write error	Negative acknowledgement when writing to the module
	A2	module failure	DP protocol error at layer 2 (e.g., slave failure or bus problems)
	A3	reserved, pass	<ul style="list-style-type: none"> <li>• PROFIBUS DP: DP protocol error with Direct-Data-Link-Mapper or User-Interface/User</li> <li>• PROFINET IO: General CM error</li> </ul>
	A4	reserved, pass	Communication on PBUS+ disrupted
	A5	reserved, pass	–
	A7	reserved, pass	DP slave or module is occupied (temporary error)
	A8	version conflict	DP slave or module reports non-compatible versions

9.7 References

Error_Decode (B#16#...)	Error_Code_1 (B#16#...)	Explanation according to DVP1	Meaning
	A9	feature not supported	Function is not supported by DP slave or module
	AA to AF	user specific	DP slave or module reports a manufacturer-specific error in its application. Please check the documentation from the manufacturer of the DP slave or module.
	B0	invalid index	Data record not known in module  Illegal data record number $\geq 256$
	B1	write length error	The length information in the RECORD parameter is incorrect  With "RALRM (Page 2328)": length error in AINFO (Page 2346), with "RDREC (Page 2321)" and "WRREC (Page 2323)": length error in MLEN
	B2	invalid slot	The configured slot is not assigned.
	B3	type conflict	Actual module type does not match specified module type
	B4	invalid area	DP slave or module reports access to an invalid area
	B5	state conflict	DP slave or module not ready
	B6	access denied	DP slave or module denies access
	B7	invalid range	DP slave or module reports an invalid range for a parameter or value
	B8	invalid parameter	DP slave or module reports an invalid parameter
	B9	invalid type	DP slave or module reports an invalid type  With "RDREC (Page 2321)": buffer too small (subsets cannot be read)  With "WRREC (Page 2323)": buffer too small (subsets cannot be written)
	BA to BF	user specific	DP slave or module reports a manufacturer-specific error when accessing. Please check the documentation from the manufacturer of the DP slave or module.
	C0	read constrain conflict	With "WRREC (Page 2323)": the data can only be written when the CPU is in STOP mode. Note: this means that writing by the user program is not possible. You can only write the data online with PG/PC.  With "RDREC (Page 2321)": the module routes the data record, but either no data is present or the data can only be read when the CPU is in STOP mode. Note: if data can only be read when the CPU is in STOP mode, then an evaluation by the user program is not possible. In this case, you can only read the data online with PG/PC.
	C1	write constrain conflict	The data of the previous write job on the module for the same data record have not yet been processed by the module.
	C2	resource busy	The module is currently processing the maximum possible number of jobs for a CPU.

Error Decode (B#16#...)	Error_Code_1 (B#16#...)	Explanation according to DVP1	Meaning
	C3	resource unavailable	The required operating resources are currently occupied.
	C4		Internal temporary error. Job could not be executed. Repeat the job. If this error occurs often, check your installation for sources of electrical interference.
	C5		DP slave or module not available.
	C6		Data record transfer was canceled due to priority class cancellation
	C7		Job aborted due to warm or cold restart on the DP master
	C8 to CF		DP slave or module reports a manufacturer-specific resource error. Please check the documentation from the manufacturer of the DP slave or module.
	Dx	user specific	DP slave specific. Refer to the description of the DP slave.
81	00 to FF		Error in the initial call parameter (with "RALRM (Page 2328)": MODE)
	00		Illegal operating mode
82	00 to FF		Error in the second call parameter
:	:		:
88	00 to FF		Error in the eighth call parameter (with "RALRM (Page 2328)": TINFO (Page 2334))
	01		Wrong syntax ID
	23		Quantity structure exceeded or target range too small
	24		Wrong range ID
	32		DB/DI no. out of user range
	3A		DB/DI no. is NULL for area ID DB/DI or specified DB/DI does not exist
89	00 to FF		Error in the ninth call parameter (with "RALRM (Page 2328)": AINFO (Page 2346))
	01		Wrong syntax ID
	23		Quantity structure exceeded or target range too small
	24		Wrong range ID
	32		DB/DI no. out of user range
	3A		DB/DI no. is NULL for area ID DB/DI or specified DB/DI does not exist
8A	00 to FF		Error in the 10th call parameter
:	:		:
8F	00 to FF		Error in the 15th call parameter
FE, FF	00 to FF		Profile-specific error

### Array element STATUS[4]

With DPV1 errors, the DP master passes on STATUS[4] to the CPU and the instruction. Without DPV1 error, this value is set to 0, with the following exceptions for "RDREC":

- STATUS[4] contains the target range length from RECORD, if MLEN > the target range length from RECORD
- STATUS[4]=MLEN, if the actual data record length < MLEN < the target range length from RECORD
- STATUS[4]=0, if STATUS[4]> 255 would have to be set

In PROFINET IO, STATUS[4] has the value "0".

### Parameter TINFO

#### Data structure of the destination area TINFO

The data structure of the destination area TINFO contains the start information of the organization block in which "RALRM" is currently being called.

The TINFO destination area can contain the start information with standard access or optimized access. The format of the start information in the TINFO destination area must always match the start information of the corresponding organization block.

- The start information of an OB with standard access is always stored in the first 20 bytes of the "Temp" section in the block interface. Use the "TI\_Classic" data structure for this.
- The start information of an OB with optimized access is always written to the "Input" section. Use a data structure for the specific OB type for these OBs.

Changing the block access (standard/optimized) also changes the block interface.

The following table provides an overview of the data structures that are used depending on the organization block at the TINFO parameter.

Name of the data structure	S7-1200 CPUs as of version	S7-1500 CPUs as of version	Data structure used for:
Data structure for organization blocks with standard access			
TI_Classic	-	V1	Organization blocks without optimized block access.
Data structure for organization blocks with optimized block access			
TI_ProgramCycle	V2	V1	Cycle OB (program cycle)
TI_Startup	V2	V1	Startup OB (startup)
TI_Delay	V2	V1	Time delay interrupt
TI_Cyclic	V2	V1	Cyclic interrupt OB
TI_HWInterrupt	V2	V1	Hardware interrupt OB
TI_TimeError	V2	V1	Time error OB
TI_DiagnosticInterrupt	V2	V1	Diagnostic error interrupt OB
TI_PlugPullModule	V2	V1	Pull/plug of modules OB
TI_StationFailure	V2	V1	Rack or station failure OB

Name of the data structure	S7-1200 CPUs as of version	S7-1500 CPUs as of version	Data structure used for:
TI_ProgIOAccessError	V2	V1	<ul style="list-style-type: none"> <li>Programming error OB</li> <li>I/O access error OB</li> </ul>
TI_TimeOfDay	V2	V1	Time-of-day interrupt OB
TI_SynchCycle	-	V1	Synchronous cycle interrupt OB
TI_Submodule	V2	V1	<ul style="list-style-type: none"> <li>Status interrupt OB</li> <li>Update interrupt OB</li> <li>OB for manufacturer or profile-specific interrupt</li> </ul>

### Data structure for organization blocks with standard access

The following shows the TI\_Classic data structure:

Parameter	Data type	Byte	Description
TI_Classic			Data structure for organization blocks with optimized block access.
Bytes 0 to 19: Start information of the OB in which "RALRM" is currently being called.*			
EV_CLASS	BYTE	0	Event class Example OB1: <ul style="list-style-type: none"> <li>Bits 0-3: ID of the event (1 = incoming event)</li> <li>Bits 4-7: Event class (1 = Event class 1)</li> </ul>
EV_NUM	BYTE	1	Event number (depending on OB type) Example OB1 (SCAN_1): <ul style="list-style-type: none"> <li>SCAN_1 = 1 for first call</li> <li>SCAN_1 = 3 for all additional calls</li> </ul>
PRIORITY	BYTE	2	Priority class
NUM	BYTE	3	OB number
TYP2_3	BYTE	4	Additional information Different information is stored in the BYTES "TYP2_3" and "TYPE 1" depending on the OB type used. What these are is described in the documentation for the organization blocks. Example (OB1): <ul style="list-style-type: none"> <li>TYP2_3: OB1_RESERVED_1 (reserved)</li> <li>TYP1: OB1_RESERVED_2 (reserved)</li> </ul>
TYP1	BYTE	5	
ZI1	WORD	6 to 7	Additional information Different information is stored in "ZI1" depending on the OB type used. What these are is described in the documentation for the organization blocks. Example (OB1): <ul style="list-style-type: none"> <li>ZI1: OB1_PREV_CYCLE (runtime of previous cycle in ms)</li> </ul>

9.7 References

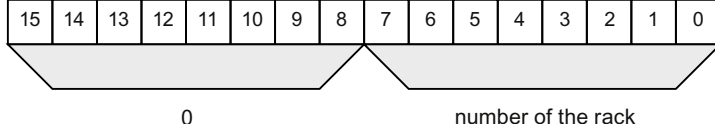
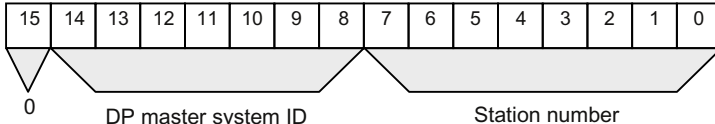
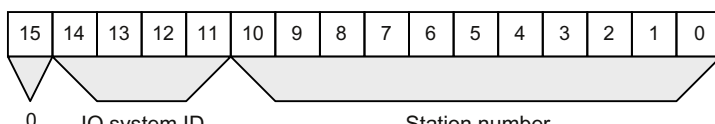
Parameter	Data type	Byte	Description																																																
ZI2_3	DWORD	8 to 11	Additional information Different information is stored in "ZI2_3" depending on the OB type used. What these are is described in the documentation for the organization blocks. Example (OB1): <ul style="list-style-type: none"> <li>• ZI2: OB1_MIN_CYCLE (minimum cycle time (ms) since the last startup)</li> <li>• ZI3: OB1_MAX_CYCLE (maximum cycle time (ms) since the last startup)</li> </ul>																																																
OB_DATE_TIME	DATE_AND_TIME (DT)	12 to 19	Date and time-of-day when the OB was called.																																																
Bytes 20 and 21: Address information																																																			
address	WORD	20 and 21	Address information like S7-300/400 CPUs: <ul style="list-style-type: none"> <li>• In a central configuration, the rack number (0-31):                             <div style="margin-left: 20px;">                                 Bit: <table border="1" style="display: inline-table; border-collapse: collapse; text-align: center;"> <tr><td>15</td><td>14</td><td>13</td><td>12</td><td>11</td><td>10</td><td>9</td><td>8</td><td>7</td><td>6</td><td>5</td><td>4</td><td>3</td><td>2</td><td>1</td><td>0</td></tr> </table>  </div> </li> <li>• For a distributed configuration with PROFIBUS DP:                             <ul style="list-style-type: none"> <li>- DP master system ID (1-31)</li> <li>- Station number (0-127).</li> </ul> <div style="margin-left: 20px;">                                 Bit: <table border="1" style="display: inline-table; border-collapse: collapse; text-align: center;"> <tr><td>15</td><td>14</td><td>13</td><td>12</td><td>11</td><td>10</td><td>9</td><td>8</td><td>7</td><td>6</td><td>5</td><td>4</td><td>3</td><td>2</td><td>1</td><td>0</td></tr> </table>  </div> </li> <li>• In a distributed configuration with PROFINET IO:                             <ul style="list-style-type: none"> <li>- The last two positions in the PROFINET IO system ID (0-15). To obtain the complete PROFINET IO system ID, you must add 100 (decimal) to it.</li> <li>- Station number (0-2047).</li> </ul> <div style="margin-left: 20px;">                                 Bit: <table border="1" style="display: inline-table; border-collapse: collapse; text-align: center;"> <tr><td>15</td><td>14</td><td>13</td><td>12</td><td>11</td><td>10</td><td>9</td><td>8</td><td>7</td><td>6</td><td>5</td><td>4</td><td>3</td><td>2</td><td>1</td><td>0</td></tr> </table>  </div> </li> </ul>	15	14	13	12	11	10	9	8	7	6	5	4	3	2	1	0	15	14	13	12	11	10	9	8	7	6	5	4	3	2	1	0	15	14	13	12	11	10	9	8	7	6	5	4	3	2	1	0
15	14	13	12	11	10	9	8	7	6	5	4	3	2	1	0																																				
15	14	13	12	11	10	9	8	7	6	5	4	3	2	1	0																																				
15	14	13	12	11	10	9	8	7	6	5	4	3	2	1	0																																				
Bytes 22 to 31: Management information																																																			
slv_prfl	BYTE	22	Slave profile like S7-300/400 CPUs: <ul style="list-style-type: none"> <li>• In a central configuration: 0 (data record 0 or data record 1)</li> <li>• In a distributed configuration:                             <ul style="list-style-type: none"> <li>- Bit 0 to 3: Slave type                                     <ul style="list-style-type: none"> <li>- 0000: DP (structure data record 0)</li> <li>- 0001: DPS7 (structure data record 0 or data record 1)</li> <li>- 0010: DPS7 V1 (structure data record 0 or data record 1)</li> <li>- 0011: DPV1 (structure according to PROFIBUS DP standard)</li> <li>- 0100 – 0111: Reserved</li> <li>- 1000: PROFINET IO (structure according to PROFINET IO standard)</li> <li>- from 1001: Reserved</li> </ul> </li> <li>- Bit 4 to 7: Profile type (reserved)</li> </ul> </li> </ul>																																																



Parameter	Data type	Byte	Description
intr_type	BYTE	23	Interrupt info type like S7-300/400 CPUs: <ul style="list-style-type: none"> <li>• In a central configuration: 0</li> <li>• In a distributed configuration: <ul style="list-style-type: none"> <li>– Bit 0 to 3: Interrupt info type <ul style="list-style-type: none"> <li>- 0000: Interrupt comes from a configured remote module</li> <li>- 0001: Interrupt comes from a non-DPV1 slav / non IO device or a slot that is not configured</li> <li>- 0010: Interrupt generated in the CPU</li> <li>- from 0011: Reserved</li> </ul> </li> <li>– Bit 4 to 7: Structure version <ul style="list-style-type: none"> <li>- 0000: Initial</li> <li>- from 0001: Reserved</li> </ul> </li> </ul> </li> </ul>
flags1	BYTE	24	Flags of the PROFIBUS DP master interface module / PROFINET IO controller interface module like S7-300/400 CPUs: <ul style="list-style-type: none"> <li>• In a central configuration: 0</li> <li>• In a distributed configuration: <ul style="list-style-type: none"> <li>– Bit 0 = 0: Interrupt originating from an integrated interface module (PROFINET IO or PROFIBUS DP)</li> <li>– Bit 0 = 1: Interrupt originating from an external interface module (PROFINET IO or PROFIBUS DP)</li> <li>– Bit 1 to 7: Reserved</li> </ul> </li> </ul>
flags2	BYTE	25	Flags of the PROFIBUS DP master interface module / PROFINET IO controller interface module like S7-300/400 CPUs: <ul style="list-style-type: none"> <li>• In a central configuration: 0</li> <li>• For a distributed configuration with PROFIBUS DP: <ul style="list-style-type: none"> <li>– Bit 0: EXT_DIAG_FLAG from the diagnostics message frame, or 0 if this bit does not exist in the interrupt The bit is 1 if the DP slave is faulty.</li> <li>– Bit 1 to 7: Reserved</li> </ul> </li> <li>• In a distributed configuration with PROFINET IO: <ul style="list-style-type: none"> <li>– Bit 0: ARDiagnosisState or 0 if there is no information in the interrupt. The bit is 1 if the IO device is faulty.</li> <li>– Bit 1 to 7: Reserved</li> </ul> </li> </ul>
id	UINT	26 and 27	Management information <ul style="list-style-type: none"> <li>• In a central configuration: 0</li> <li>• For a distributed configuration with PROFIBUS DP: PROFIBUS ID number as unique identifier of the PROFIBUS DP slave</li> <li>• In a distributed configuration with PROFINET IO: PROFINET IO device ID number as unique identifier of the PROFINET IO device</li> </ul>
manufacturer	UINT	28 and 29	Manufacturer ID (only in a distributed configuration with PROFINET IO).
instance	UINT	30 and 31	Ident number of the instance (only in a distributed configuration with PROFINET IO).

\*The start information depends on the OB used. You can find the start information of each OB type at the interface or in the documentation of the OB.

**Data structures for organization blocks with optimized block access**

The data structures for organization blocks with optimized block access have the following format:

- Bytes 0 to 3: Format of the start information, class and number of the called OB (same structure for all data structures).
- Bytes 4 to 19: Optimized start information (structure depends on the OB type). The data in bytes 4 to 19 correspond to the structure and content of the corresponding OB interface.
- Bytes 20 to 31: In addition, the address and management information for certain OBs. The data in bytes 20 to 31 correspond to the data of 20 to 31 bytes of the TI\_Classic data structure.

The format of the data structures is described in the following tables.

Table 9-41 Cycle OB: Data structure TI\_ProgramCycle

Parameter	Data type	Byte	Description
TI_ProgramCycle			Data structure for cycle OB
SI_Format	USINT	0	Format of the start information: <ul style="list-style-type: none"> <li>• 16#FF: None</li> <li>• 16#FE: Optimized start information</li> </ul>
OB_Class	USINT	1	OB class (=1)
OB_Nr	UINT	2	OB number (1...32767).
Initial_Call	BOOL	4	= TRUE in the first call of this OB: <ul style="list-style-type: none"> <li>• Transition from STOP or HOLD to RUN</li> <li>• After reloading</li> </ul>
Remanence	BOOL	5	= TRUE, if retentive data are available.

Table 9-42 Startup OB: Data structure TI\_Startup

Parameter	Data type	Byte	Description
TI_Startup			Data structure for startup OB
SI_Format	USINT	0	Format of the start information: <ul style="list-style-type: none"> <li>• 16#FF: None</li> <li>• 16#FE: Optimized start information</li> </ul>
OB_Class	USINT	1	OB class (=100)
OB_Nr	UINT	2	OB number (1...32767).
LostRetentive	BOOL	4	=TRUE, if the contents of retentive data areas have been lost.
LostRTC	BOOL	5	=TRUE, if the time-of-day of the real-time clock has been lost.

Table 9-43 Time delay interrupt OB: Data structure TI\_Delay

Parameter	Data type	Byte	Description
TI_Delay			Data structure for time delay interrupt OB
SI_Format	USINT	0	Format of the start information: <ul style="list-style-type: none"> <li>• 16#FF: None</li> <li>• 16#FE: Optimized start information</li> </ul>

Parameter	Data type	Byte	Description
OB_Class	USINT	1	OB class (=20)
OB_Nr	UINT	2	OB number (1...32767).
Sign	WORD	4	User ID: Input parameter SIGN from the call of the "SRT_DINT (Page 2453)" instruction.

Table 9-44 Cyclic interrupt OB: Data structure TI\_Cyclic

Parameter	Data type	Byte	Description
TI_Cyclic			Data structure for cyclic interrupt OB
SI_Format	USINT	0	Format of the start information: <ul style="list-style-type: none"> <li>• 16#FF: None</li> <li>• 16#FE: Optimized start information</li> </ul>
OB_Class	USINT	1	OB class (=30)
OB_Nr	UINT	2	OB number (1...32767).
Initial_Call	BOOL	4	= TRUE in the first call of this OB <ul style="list-style-type: none"> <li>• At the transition from STOP or HOLD to RUN</li> <li>• After reloading</li> </ul>
Event_Count	INT	6	Number of discarded start events since the last start of this OB.

Table 9-45 Hardware interrupt OB: Data structure TI\_HWInterrupt

Parameter	Data type	Byte	Description
TI_HWInterrupt			Data structure for hardware interrupt OB
SI_Format	USINT	0	Format of the start information: <ul style="list-style-type: none"> <li>• 16#FF: None</li> <li>• 16#FE: Optimized start information</li> </ul>
OB_Class	USINT	1	OB class (=40)
OB_Nr	UINT	2	OB number (1...32767).
LADDR	HW_IO	4	Hardware identifier of the module that triggers the hardware interrupt.
USI	WORD	6	Identifier for future extensions (not user-relevant).
IChannel	USINT	8	Number of the channel that triggered the hardware interrupt.
EventType	BYTE	9	Identifier for the event type associated with the event triggering the interrupt (e.g., rising edge). You can find this ID in the description of the respective module.
address	WORD	20	See "address" parameter for the TI_Cassic. data structure
slv_prfl	BYTE	22	See "slv_prfl" parameter for the TI_Cassic data structure.
intr_type	BYTE	23	See "intr_type" parameter for the TI_Cassic data structure.
flags1	BYTE	24	See "flags1" parameter for the TI_Cassic data structure.
flags2	BYTE	25	See "flags2" parameter for the TI_Cassic data structure.
id	UNIT	26	See "id" parameter for the TI_Cassic data structure.
manufacturer	UNIT	28	See "manufacturer" parameter for the TI_Cassic data structure.
instance	UNIT	30	See "instance" parameter for the TI_Cassic data structure.

Table 9-46 Time error OB: Data structure TI\_TimeError

Parameter	Data type	Byte	Description
TI_TimeError			Data structure for time error OB
SI_Format	USINT	0	Format of the start information: <ul style="list-style-type: none"> <li>• 16#FF: None</li> <li>• 16#FE: Optimized start information</li> </ul>
OB_Class	USINT	1	OB class (=80)
OB_Nr	UINT	2	OB number (1...32767).
Csg_OBnr	OB_ANY	4	Number of the OB that was being executed when the time error occurred.
Fault_ID	BYTE	7	Error code. Possible values: <ul style="list-style-type: none"> <li>• B#16#01: Cycle time exceeded</li> <li>• B#16#02: The requested OB is still being processed.</li> <li>• B#16#05: Expired time-of-day interrupt due to time jump.</li> <li>• B#16#06: Expired time-of-day interrupt upon re-entry into RUN after HOLD.</li> <li>• B#16#07: Overflow of the OB request buffer for the current priority class.</li> <li>• B#16#08: Isochronous mode interrupt - time error.</li> <li>• B#16#09: Interrupt loss due to high interrupt load</li> <li>• B#16#0B: Technology synchronization interrupt - time error</li> </ul>
Csg_Prio	UNIT	8	Priority of the OB that was being executed when the time error occurred.

Table 9-47 Diagnostic interrupt OB: Data structure TI\_DiagnosticInterrupt

Parameter	Data type	Byte	Description
TI_DiagnosticInterrupt			Data structure for diagnostic interrupt OB
SI_Format	USINT	0	Format of the start information: <ul style="list-style-type: none"> <li>• 16#FF: None</li> <li>• 16#FE: Optimized start information</li> </ul>
OB_Class	USINT	1	OB class (=82)
OB_Nr	UINT	2	OB number (1...32767).
LADDR	HW_ANY	4	Hardware identifier of the hardware object that triggered the diagnostic interrupt.
IO_State	WORD	6	Status of the hardware object: <ul style="list-style-type: none"> <li>• Bit 0: Good</li> <li>• Bit 1: Disabled</li> <li>• Bit 2: Maintenance required</li> <li>• Bit 3: Maintenance demanded</li> <li>• Bit 4: Error</li> <li>• Bit 5: Not accessible</li> <li>• Bit 6: Qualified</li> <li>• Bit 7: Not available</li> </ul>
Channel	UINT	8	Channel number
MultiError	BOOL	10	=TRUE, if there is more than one error.
address	WORD	20	See "address" parameter for the TI_Cassic. data structure
slv_prfl	BYTE	22	See "slv_prfl" parameter for the TI_Cassic data structure.
intr_type	BYTE	23	See "intr_type" parameter for the TI_Cassic data structure.

Parameter	Data type	Byte	Description
flags1	BYTE	24	See "flags1" parameter for the TI_Cassic data structure.
flags2	BYTE	25	See "flags2" parameter for the TI_Cassic data structure.
id	UINT	26	See "id" parameter for the TI_Cassic data structure.
manufacturer	UINT	28	See "manufacturer" parameter for the TI_Cassic data structure.
instance	UINT	30	See "instance" parameter for the TI_Cassic data structure.

Table 9-48 Pull/plug interrupt OB: Data structure TI\_PlugPullModule

Parameter	Data type	Byte	Description
TI_PlugPullModule			Data structure for pull/plug interrupt OB
SI_Format	USINT	0	Format of the start information: <ul style="list-style-type: none"> <li>• 16#FF: None</li> <li>• 16#FE: Optimized start information</li> </ul>
OB_Class	USINT	1	OB class (=83)
OB_Nr	UINT	2	OB number (1...32767).
LADDR	HW_IO	4	Hardware identifier of the affected module or submodule
Event_Class	BYTE	6	<ul style="list-style-type: none"> <li>• B#16#38: (Sub)module plugged</li> <li>• B#16#39: (Sub)module pulled or not responding</li> </ul>
Fault_ID	BYTE	7	<p>Error code</p> <p>The following table shows the events that cause the start of the pull/plug interrupt OB.</p> <ul style="list-style-type: none"> <li>• With Event_Class = B#16#38 - (sub-)module plugged: <ul style="list-style-type: none"> <li>– B#16#54: PROFINET IO submodule inserted and matches configured submodule</li> <li>– B#16#55: PROFINET IO submodule inserted, but does not match configured submodule</li> <li>– B#16#56: PROFINET IO submodule inserted; but error in module parameter assignment</li> <li>– B#16#57: PROFINET IO submodule or module inserted, but with a problem or maintenance</li> <li>– B#16#58: PROFINET IO submodule, access error corrected</li> </ul> </li> <li>• With Event_Class = B#16#39 - (sub-)module pulled or cannot be reached: <ul style="list-style-type: none"> <li>– B#16#51: PROFINET IO module removed</li> <li>– B#16#54: PROFINET IO submodule removed</li> </ul> </li> </ul>
address	WORD	20	See "address" parameter for the TI_Cassic. data structure
slv_prfl	BYTE	22	See "slv_prfl" parameter for the TI_Cassic data structure.
intr_type	BYTE	23	See "intr_type" parameter for the TI_Cassic data structure.
flags1	BYTE	24	See "flags1" parameter for the TI_Cassic data structure.
flags2	BYTE	25	See "flags2" parameter for the TI_Cassic data structure.
id	UINT	26	See "id" parameter for the TI_Cassic data structure.
manufacturer	UINT	28	See "manufacturer" parameter for the TI_Cassic data structure.
instance	UINT	30	See "instance" parameter for the TI_Cassic data structure.

Table 9-49 Rack error OB: Data structure TI\_StationFailure

Parameter	Data type	Byte	Description
<b>TI_StationFailure</b>			Data structure for rack error OB
SI_Format	USINT	0	Format of the start information: <ul style="list-style-type: none"> <li>• 16#FF: None</li> <li>• 16#FE: Optimized start information</li> </ul>
OB_Class	USINT	1	OB class (=86)
OB_Nr	UINT	2	OB number (1...32767).
LADDR	HW_Device	4	Hardware identifier of the defective hardware object.
Event_Class	BYTE	6	<ul style="list-style-type: none"> <li>• B#16#38: (Sub)module plugged</li> <li>• B#16#39: (Sub)module pulled or not responding</li> </ul>
Fault_ID	BYTE	7	Error code The following table shows the events that cause the start of the pull/plug interrupt OB. <ul style="list-style-type: none"> <li>• With Event_Class = B#16#38 - (sub-)module plugged:                             <ul style="list-style-type: none"> <li>- B#16#54: PROFINET IO submodule inserted and matches configured submodule</li> <li>- B#16#55: PROFINET IO submodule inserted, but does not match configured submodule</li> <li>- B#16#56: PROFINET IO submodule inserted; but error in module parameter assignment</li> <li>- B#16#57: PROFINET IO submodule or module inserted, but with a problem or maintenance</li> <li>- B#16#58: PROFINET IO submodule, access error corrected</li> </ul> </li> <li>• With Event_Class = B#16#39 - (sub-)module pulled or cannot be reached:                             <ul style="list-style-type: none"> <li>- B#16#51: PROFINET IO module removed</li> <li>- B#16#54: PROFINET IO submodule removed</li> </ul> </li> </ul>
address	WORD	20	See "address" parameter for the TI_Cassic. data structure
slv_prfl	BYTE	22	See "slv_prfl" parameter for the TI_Cassic data structure.
intr_type	BYTE	23	See "intr_type" parameter for the TI_Cassic data structure.
flags1	BYTE	24	See "flags1" parameter for the TI_Cassic data structure.
flags2	BYTE	25	See "flags2" parameter for the TI_Cassic data structure.
id	UINT	26	See "id" parameter for the TI_Cassic data structure.
manufacturer	UINT	28	See "manufacturer" parameter for the TI_Cassic data structure.
instance	UINT	30	See "instance" parameter for the TI_Cassic data structure.

Table 9-50 Programming error OB / I/O access error OB: Data structure TI\_ProgIOAccessError

Parameter	Data type	Byte	Description*
<b>TI_ProgIOAccessError</b>			Data structure for programming error OB and I/O access error OB
SI_Format	USINT	0	Format of the start information: <ul style="list-style-type: none"> <li>• 16#FF: None</li> <li>• 16#FE: Optimized start information</li> </ul>

Parameter	Data type	Byte	Description*
OB_Class	USINT	1	OB class: <ul style="list-style-type: none"> <li>• =121 for programming error OB</li> <li>• =122 for I/O access error OB</li> </ul>
OB_Nr	UINT	2	OB number (1...32767).
BlockNr	UINT	4	Number of the block in which the programming error occurred.
Reaction	USINT	6	<ul style="list-style-type: none"> <li>• 0: Ignore error</li> <li>• 1: Substitute bad value</li> <li>• 2: Skip command</li> </ul>
Fault_ID	BYTE	7	<p>Error code</p> <ul style="list-style-type: none"> <li>• B#16#21: BCD conversion error</li> <li>• B#16#22: Area length error when reading</li> <li>• B#16#23: Area length error when writing</li> <li>• B#16#24: Range error when reading</li> <li>• B#16#25: Range error when writing</li> <li>• B#16#26: Error in timer no.</li> <li>• B#16#27: Error in counter no.</li> <li>• B#16#28: Read access to a byte, word or double word with a pointer whose bit address is not zero</li> <li>• B#16#29: Write access to a byte, word or double word with a pointer whose bit address is not zero</li> <li>• B#16#30: Write access to a write-protected global DB</li> <li>• B#16#31: Write access to a write-protected instance DB</li> <li>• B#16#32: DB number error when accessing a global DB</li> <li>• B#16#33: DB number error when accessing an instance DB</li> <li>• B#16#34: Number error during FC call</li> <li>• B#16#35: Number error during FB call</li> <li>• B#16#42: I/O access error, reading</li> <li>• B#16#43: I/O access error, writing</li> <li>• B#16#3A: Access to a DB that is not loaded; the DB number is located in the permitted area</li> <li>• B#16#3C: Access to an FC that is not loaded; the FC number is within the permissible range</li> <li>• B#16#3D: Access to an instruction (SFC) that is not loaded; the SFC number is within the permissible range</li> <li>• B#16#3E: Access to an FB that is not loaded; the FB number is within the permissible range</li> <li>• B#16#3F: Access to an SFB that is not available; the SFB number is within the permissible range</li> </ul>
BlockType	USINT	8	<p>Type of block in which the error has occurred:</p> <ul style="list-style-type: none"> <li>• OB: B#16#88</li> <li>• FC: B#16#8C</li> <li>• FB: B#16#8E</li> </ul>

9.7 References

Parameter	Data type	Byte	Description*
Area	USINT	9	Memory area in which the incorrect access occurred: <ul style="list-style-type: none"> <li>• Local data: B#16#40 to 4E, 86, 87, 8E, 8F, C0 to CE</li> <li>• Process image input: B#16#01</li> <li>• Process image output: B#16#02</li> <li>• Technology DB: B#16#04</li> <li>• I: B#16#81</li> <li>• Q: B#16#82</li> <li>• M: B#16#83</li> <li>• DB: B#16#84, 85, 8A, 8B</li> </ul>
DBNr	DB_ANY	10	DB no. if AREA = DB (global DB or instance DB) Only relevant for programming error OB.
Csg_OBNr	OB_ANY	12	OB number: <ul style="list-style-type: none"> <li>• 121: Programming error OB</li> <li>• 122: I/O access error OB</li> </ul>
Csg_Prio	USINT	14	OB priority
Width	USINT	15	Type of access during which the error occurred: <ul style="list-style-type: none"> <li>• Bit: B#16#00</li> <li>• Byte: B#16#01</li> <li>• Word: B#16#02</li> <li>• DWord: B#16#03</li> <li>• LWord: B#16#04</li> </ul>

\* Only certain output values are possible depending on the OB (I/O access error OB or programming error OB) from which information is read.

Table 9-51 Time-of-day interrupt OB: Data structure TI\_TimeOfDay

Parameter	Data type	Byte	Description
TI_TimeOfDay			Data structure for time-of-day interrupt OB
SI_Format	USINT	0	Format of the start information: <ul style="list-style-type: none"> <li>• 16#FF: None</li> <li>• 16#FE: Optimized start information</li> </ul>
OB_Class	USINT	1	OB class (=10)
OB_Nr	UINT	2	OB number (1...32767).
CaughtUp	BOOL	4	=TRUE if an OB call was executed subsequently because time was adjusted ahead
SecondTime	BOOL	5	=TRUE if an OB was called a second time because time was adjusted back. Note: SecondTime is set only once in situations in which the time is set back.

Table 9-52 Isochronous mode interrupt OB: Data structure TI\_SynchCycle

Parameter	Data type	Byte	Description
TI_SynchCycle			Data structure for isochronous mode interrupt OB
SI_Format	USINT	0	Format of the start information: <ul style="list-style-type: none"> <li>• 16#FF: None</li> <li>• 16#FE: Optimized start information</li> </ul>



Parameter	Data type	Byte	Description
OB_Class	USINT	1	OB class (=61)
OB_Nr	UINT	2	OB number (1...32767).
Initial_Call	BOOL	4	= TRUE in the first call of this OB: <ul style="list-style-type: none"> <li>• Transition from STOP or HOLD to RUN</li> <li>• After reloading</li> </ul>
IO_System	USINT	5	Number of the distributed I/O system triggering the interrupt
Event_Count	INT	6	<ul style="list-style-type: none"> <li>• = n: Number of lost cycles</li> <li>• = -1: An unknown number of cycles has been lost (e.g., because cycle has changed).</li> </ul>
PIP_Input	BOOL	10	=TRUE: The associated process image of the inputs is up-to-date
PIP_Output	BOOL	11	=TRUE: The associated process image of the outputs was transferred to the outputs in good time after the last cycle
SyncCycleTime	LTIME	16	Calculated cycle time

Table 9-53 Status interrupt OB / update interrupt OB for manufacturer or profile-specific interrupt: Data structure TI\_Submodule

Parameter	Data type	Byte	Description
TI_Submodule			Data structure for status interrupt OB / update interrupt OB for manufacturer or profile-specific interrupt
SI_Format	USINT	0	Format of the start information: <ul style="list-style-type: none"> <li>• 16#FF: None</li> <li>• 16#FE: Optimized start information</li> </ul>
OB_Class	USINT	1	OB class <ul style="list-style-type: none"> <li>• =55 for status interrupt OB</li> <li>• =56 for update interrupt OB</li> <li>• =57 for manufacturer or profile-specific interrupt OB</li> </ul>
OB_Nr	UINT	2	OB number (1...32767).
LADDR	HW_IO	4	Hardware address of the component triggering the interrupt
Slot	UINT	6	Slot number of the component triggering the interrupt
Specifier	WORD	8	Interrupt specifier from the interrupt frame
address	WORD	20	See "address" parameter for the TI_Cassic. data structure
slv_prfl	BYTE	22	See "slv_prfl" parameter for the TI_Cassic data structure.
intr_type	BYTE	23	See "intr_type" parameter for the TI_Cassic data structure.
flags1	BYTE	24	See "flags1" parameter for the TI_Cassic data structure.
flags2	BYTE	25	See "flags2" parameter for the TI_Cassic data structure.
id	UINT	26	See "id" parameter for the TI_Cassic data structure.
manufacturer	UINT	28	See "manufacturer" parameter for the TI_Cassic data structure.
instance	UINT	30	See "instance" parameter for the TI_Cassic data structure.

Parameter AINFO

Data structure of the destination area AINFO with interrupts from PROFIBUS DP

Byte	Meaning
0 to 3	Header information, for exact description, see below
4 to 63	Additional interrupt information: data for the respective interrupt:
	distributed: ARRAY[0] to ARRAY[59]

Structure of the header information with interrupts from PROFIBUS DP

Byte	Data type	Meaning
0	BYTE	Length of the received interrupt information in bytes
		central: 4 to 224
		distributed: 4 to 63
1	BYTE	central: Reserved
		distributed: ID for the interrupt type
		1: Diagnostics interrupt
		2: Process interrupt
		3: Pull interrupt
4: Plug interrupt		
5: Status interrupt		
6: Update interrupt		
31: Failure of an expansion device, DP master system or DP station		
32 to 126: Manufacturer-specific interrupt		
2	BYTE	Slot number of the component that triggered the interrupt
3	BYTE	central: Reserved
		distributed: Specifier
		Bits 0 and 1: 0: No further information; 1: Incoming event, fault at slot
		2: Outgoing event, fault at slot cleared
		3: Outgoing event, slot still faulty
Bit 2: Add_Ack		
Bits 3 to 7: Sequence number		

**Data structure of the destination area AINFO with interrupts from PROFINET IO or central I/O devices**

Byte	Meaning
0 to 25	Header information, for exact description, see below
26 to 1431	Additional interrupt information: Standardized diagnostic data for the respective interrupt: ARRAY[0] to ARRAY[1405] Note: The additional interrupt information may also be omitted.

**Structure of the header information with interrupts from PROFINET IO or central I/O devices**

Byte	Data type	Meaning
0 and 1	WORD	<ul style="list-style-type: none"> <li>• Bits 0 to 7: Block type</li> <li>• Bits 8 to 15: Reserved</li> </ul>
2 and 3	WORD	Block length
4 and 5	WORD	Version: <ul style="list-style-type: none"> <li>• Bits 0 to 7: low byte</li> <li>• Bits 8 to 15: high byte</li> </ul>
6 and 7	WORD	ID for interrupt type: <ul style="list-style-type: none"> <li>• 1: Diagnostics interrupt (incoming)</li> <li>• 2: Process interrupt</li> <li>• 3: Remove module interrupt</li> <li>• 4: Insert module interrupt</li> <li>• 5: Status interrupt</li> <li>• 6: Update interrupt</li> <li>• 7: Redundancy interrupt</li> <li>• 8: Controlled by supervisor</li> <li>• 9: Released by supervisor</li> <li>• 10: Configured module not inserted</li> <li>• 11: Return of the sub-module</li> <li>• 12: Diagnostics interrupt (outgoing)</li> <li>• 13: Slave-to-slave connection alarm</li> <li>• 14: Neighborhood change alarm</li> <li>• 15: Clock synchronization message (bus end)</li> <li>• 16: Clock synchronization alarm (device end)</li> <li>• 17: Network component alarm</li> <li>• 18: Time synchronization alarm (bus end)</li> <li>• 19 to 31: Reserved</li> <li>• 32 to 127: Manufacturer-specific interrupt</li> <li>• 128 to 65535: Reserved</li> </ul>
8 to 11	DWORD	API (Application Process Identifier)
12 to 13	WORD	Slot number of the component triggering the interrupt (value range 0 to 65535)
14 to 15	WORD	Submodule slot number of the component triggering the interrupt (value range 0 to 65535)
16 to 19	DWORD	Module identification; specific information on the source of the interrupt

Byte	Data type	Meaning
20 to 23	DWORD	Submodule identification; specific information on the source of the interrupt
24 to 25	WORD	Interrupt specifier: <ul style="list-style-type: none"> <li>• Bits 0 to 10: Sequence number (value range 0 to 2047)</li> <li>• Bit 11: Channel diagnostics: 0: No channel diagnostics available 1: Channel diagnostic information exists</li> <li>• Bit 12: Status of manufacturer-specific diagnostics: 0: No manufacturer-specific status information available 1: Manufacturer-specific status information available</li> <li>• Bit 13: Status of diagnostics for sub-module: 0: No status information available, all errors have been corrected 1: At least one item of channel diagnostics and/or status information is available</li> <li>• Bit 14: Reserved</li> <li>• Bit 15: Application relationship diagnosis state:                             <ul style="list-style-type: none"> <li>– 0: None of the modules configured within this application relationship reports diagnostic information</li> <li>– 1: At least one of the modules configured in this AR is reporting diagnostic information</li> </ul> </li> </ul>

**Structure of the additional interrupt information for interrupts from PROFINET IO or central I/O**

The additional interrupt information for PROFINET IO depends on the format identifier. It can comprise multiple data blocks with the same or different format identifier. The following format identifiers are available:

- W#16#0000 to W#16#7FFF: Manufacturer-specific diagnostics

Byte	Data type	Meaning
0 to 1	WORD	Format identifier for the structure of the following data serving as additional interrupt information W#16#0000 to W#16#7FFF: Manufacturer-specific diagnostics
2 to n	BYTE	See manufacturer's manual.

- W#16#8000: Channel diagnostics

Channel diagnostics is output in blocks of 6 bytes each. The additional interrupt information (without format identifier) is only output for disrupted channels.

Byte	Data type	Meaning
0 to 1	WORD	Format identifier for the structure of the following data serving as additional interrupt information W#16#8000: Channel diagnostics
2 to 3	WORD	Channel number of the component triggering the interrupt (value range: 0 to 65535): <ul style="list-style-type: none"> <li>• W#16#0000 to W#16#7FFF: Channel number of the interface module/sub-module</li> <li>• W#16#8000: The generic substitute for the entire sub-module</li> <li>• W#16#8001 to W#16#FFFF: Reserved</li> </ul>
4	BYTE	Bits 0 to 2: Reserved
		Bits 3 to 4: Type of error: <ul style="list-style-type: none"> <li>• 0: Reserved</li> <li>• 1: Incoming error</li> <li>• 2: Outgoing error</li> <li>• 3: Outgoing error, other errors present</li> </ul>
		Bits 5 to 7: Type of channel: <ul style="list-style-type: none"> <li>• 0: Reserved</li> <li>• 1: Input channel</li> <li>• 2: Output channel</li> <li>• 3: Input/output channel</li> </ul>

Byte	Data type	Meaning
5	BYTE	Data format: <ul style="list-style-type: none"> <li>• B#16#00: Free data format</li> <li>• B#16#01: Bit</li> <li>• B#16#02: 2 bits</li> <li>• B#16#03: 4 bits</li> <li>• B#16#04: Byte</li> <li>• B#16#05: Word</li> <li>• B#16#06: Double word</li> <li>• B#16#07: 2 double words</li> <li>• B#16#08 to B#16#FF: Reserved</li> </ul>
6 to 7	WORD	Type of error: <ul style="list-style-type: none"> <li>• W#16#0000: Reserved</li> <li>• W#16#0001: Short circuit</li> <li>• W#16#0002: Undervoltage</li> <li>• W#16#0003: Overvoltage</li> <li>• W#16#0004: Overload</li> <li>• W#16#0005: Overtemperature</li> <li>• W#16#0006: Wire break</li> <li>• W#16#0007: High limit exceeded</li> <li>• W#16#0008: Low limit exceeded</li> <li>• W#16#0009: Error</li> <li>• W#16#000A to W#16#000F: Reserved</li> <li>• W#16#0010 to W#16#001F: Manufacturer-specific</li> <li>• W#16#0020 to W#16#00FF: Reserved</li> <li>• W#16#0100 to w#16#7FFF: Manufacturer-specific</li> <li>• W#16#8000: Device diagnostics available</li> <li>• W#16#8001 to W#16#FFFF: Reserved</li> </ul> Not all channels support every error type. For detailed information, refer to the description of the diagnostic data for the specific device.

**Note**

The section from "channel number" to "type of error" can occur from 0 to n times.

- W#16#8001: MULTIPLE (different types of diagnostic information are transmitted). In this case, the additional interrupt information is transmitted as blocks of variable length.

Byte	Data type	Meaning
0 to 1	WORD	Format identifier for the structure of the following data serving as additional interrupt information W#16#8001: Manufacturer-specific diagnostics and/or channel diagnostics
2 to 3	WORD	Block type
4 to 5	WORD	Block length
6	BYTE	Version: high byte
7	BYTE	Version: low byte
8 to 11	DWORD	API (only if low byte of version = 1)
12 to 13	WORD	Slot number
14 to 15	WORD	Subslot number
16 to 17	WORD	Channel number
18 to 19	WORD	Channel properties
20 to 21	WORD	Format identifier: <ul style="list-style-type: none"> <li>• W#16#0000 to W#16#7FFF: Manufacturer-specific diagnostics</li> <li>• W#16#8000: Channel diagnostics</li> <li>• W#16#8002: Extended channel diagnostics</li> <li>• W#16#8003: Stepped extended channel diagnostics</li> <li>• W#16#8004 to W#16#80FF: Reserved</li> </ul>
22 to n	BYTE	Data depend on the format identifier

#### Note

The section starting from "block type" can occur from 1 to n times.

- W#16#8002: Extended channel diagnostics

Byte	Meaning
0 to 1	Format identifier W#16#8002
2 to 3	Channel number
4 to 5	Channel properties
6 to 7	Error type
8 to 9	Additional error value
10 to 13	Additional error information

- W#16#8003: Stepped extended channel diagnostics

Byte	Meaning
0 to 1	Format identifier W#16#8003
2 to 3	Channel number
4 to 5	Channel properties
6 to 7	Error type
8 to 9	Additional error value
10 to 13	Additional error information
14 to 17	Qualified channel qualifier

- W#16#8100: Maintenance information

Byte	Meaning
0 to 1	Format identifier W#16#8100
2 to 3	Block type
4 to 5	Block length
6 to 7	Block version
8 to 9	Reserved
10 to 13	Maintenance status

**Note**

You can find more detailed information about the structure of the additional alarm information in the *Programming Manual SIMATIC PROFINET IO from PROFIBUS DP to PROFINET IO* and the current version of IEC 61158-6-10-1.

**Destination area TINFO and AINFO**

**Destination area TINFO and AINFO**

Depending on the respective OB in which "RALRM (Page 2328)" is called, the destination areas TINFO and AINFO are only partially written. Refer to the table below to find out which information is entered respectively.

Interrupt type	OB class	TINFO OB start information	TINFO Management information	AINFO Header information	AINFO Additional interrupt information	
Process interrupt	4x	Yes	Yes	Yes	central:	No
					distributed:	as supplied by PROFIBUS DP slave/ PROFINET IO device
Status interrupt	55	Yes	Yes	Yes	Yes	Yes
Update interrupt	56	Yes	Yes	Yes	Yes	Yes
Manufacturer-specific interrupt	57	Yes	Yes	Yes	Yes	Yes



Interrupt type	OB class	TINFO OB start information	TINFO Management information	AINFO Header information	AINFO Additional interrupt information	
I/O redundancy error	70	Yes	Yes	No	No	No
Diagnostics interrupt	82	Yes	Yes	Yes	central:	Data record 1
					distributed:	as supplied by PROFIBUS DP slave/PROFINET IO device
Insert/remove interrupt	83	Yes	Yes	Yes	central:	No
					distributed:	as supplied by PROFIBUS DP slave/PROFINET IO device
Special form of the remove module interrupt: Controlled by supervisor	83	Yes	Yes	Yes	PROFINET IO only	
Special form of the insert module interrupt: Enabled by supervisor	83	Yes	Yes	Yes	PROFINET IO only	
Unconfigured module inserted	83	Yes	Yes	Yes	PROFINET IO only	
Rack failure/ station failure	86	Yes	Yes	No	No	
... all other OBs		Yes	No	No	No	

## D\_ACT\_DP: Enable/disable DP slaves

### Description

Use the "D\_ACT\_DP" instruction to specifically deactivate and reactivate configured DP slaves/PROFINET IO devices. In addition, you can determine whether each assigned DP slave or PROFINET IO device is currently activated or deactivated.

If you use the instruction to deactivate an IE/PB Link PN IO type of gateway, then all connected PROFIBUS DP slaves will also cease to function. These failures will be reported.

The instruction cannot be used on PROFIBUS PA field devices that are connected by a DP/PA link to a DP master system.

---

### Note

As long as one or more "D\_ACT\_DP" jobs are active, you cannot load a changed configuration from the programming device to the CPU (within the scope of CiR).

If a changed configuration is being loaded from the programming device to the CPU during ongoing operation (CiR), the CPU will reject activation of a "D\_ACT\_DP" job.

Several runs through the cycle control point are required to perform the disabling or enabling job. Therefore, you cannot wait for the end of such a job in a programmed loop.

---

### Functional description

"D\_ACT\_DP" works asynchronously, that is, its execution extends over multiple calls. You start the job by calling D\_ACT\_DP with REQ = 1.

The output parameters RET\_VAL and BUSY indicate the status of the job.

See also: Meaning of the parameters REQ, RET\_VAL and BUSY with asynchronous instructions (Page 1582).

### Application

If you configure DP slaves/PROFINET IO devices in a CPU which are not actually present or not currently required, the CPU will nevertheless continue to access these DP slaves/PROFINET IO devices at regular intervals. After the slaves are deactivated, further CPU accessing will stop. With PROFIBUS DP, the fastest possible DP bus cycle can be achieved in this manner and the corresponding error events no longer occur.

### Examples

From a machine OEM's point of view, there are numerous device options possible in series production of machines. However, each delivered machine includes only one combination of selected options.

Every one of these possible machine options is configured as a DP slave/PROFINET IO device by the manufacturer in order to create and maintain a common user program having all possible options. Use "D\_ACT\_DP" to deactivate all DP slaves/PROFINET IO devices not present at machine startup.

A similar situation exists for machine tools having numerous tooling options available but actually using only a few of them at any given time. These tools are implemented as DP slaves/PROFINET IO devices. With "D\_ACT\_DP", the user program activates the tools currently needed and deactivates those required later.

### Identification of a job

If you have started a deactivation or activation job and you call "D\_ACT\_DP" again before the job is complete, the behavior of the instruction depends on whether or not the new call involves the same job. If the input parameter LADDR matches, then the call will be interpreted as a follow-on call.

### Deactivating DP slaves/PROFINET IO devices

When you deactivate a DP slave/PROFINET IO device with "D\_ACT\_DP", its process outputs are set to the configured substitute values or to 0 (safe state). The assigned DP master/PROFINET IO controller does not continue to address this component. Deactivated DP slaves/PROFINET IO devices are not identified as faulty or missing by the error LEDs on the DP master/PROFINET IO controller or CPU.

The process image of the inputs of deactivated DP slaves/PROFINET IO devices is updated with 0, that is, it is handled just as it is for failed DP slaves/PROFINET IO devices.

If you are using your program to directly access the user data of a previously deactivated DP slave/PROFINET IO device, the I/O access error OB is called and the corresponding start

event is entered in the diagnostic buffer. If you attempt to access a deactivated DP slave/PROFINET IO device via an instruction (such as "RD\_REC (Page 2358)"), you will receive the same error information in RET\_VAL as for an unavailable DP slave/PROFINET IO device.

Deactivating a DP slave/PROFINET IO device does not start the program error OB, even if its inputs or outputs belong to the system-side process image to be updated. Also there is no entry in the diagnostic buffer.

If a DP station/PNIO station fails after you have deactivated it with "D\_ACT\_DP", the operating system does not detect the failure.

Applies to PROFIBUS DP: If you wish to deactivate DP slaves functioning as transmitters in slave-to-slave communication, we recommend that you first deactivate the receivers (listeners) that detect which input data the transmitter is transferring to its DP master. Deactivate the transmitter only after you have performed this step.

### Activating DP slaves/PROFINET IO devices

When you reactivate a DP slave/PROFINET IO device with "D\_ACT\_DP", this component is configured and assigned parameters by the associated DP master/PROFINET IO controller (as with the return of a failed DP station/PROFINET IO station). This activation is complete when the component is able to transfer user data.

Activating a DP slave/PROFINET IO device does not start the program error OB, even if its inputs or outputs belong to the system-side process image to be updated. Also there is no entry in the diagnostic buffer.

If you try to activate a DP slave/PROFINET IO device with "D\_ACT\_DP" that cannot be accessed (for example, because it was physically separated from the bus), the instruction returns the error code W#16#80A7 after expiration of the configured parameter assignment time for distributed I/O. The DP slave/PROFINET IO device is activated and the fact that the activated DP slave/PROFINET IO device cannot be accessed results in a corresponding display in the system diagnostics.

If the DP slave/PROFINET IO device is accessible again afterwards, this results in standard system behavior (for example, a call of the OB configured for this purpose).

---

#### Note

Activating a DP slave/PROFINET IO device may be time-consuming. If you wish to cancel a current activation job, start "D\_ACT\_DP" again with the same value for LADDR and MODE = 2. Repeat the call of "D\_ACT\_DP" with MODE = 2 until successful cancellation of the activation job is indicated by RET\_VAL = 0.

---

If you wish to activate DP slaves which take part in the slave-to-slave communication, we recommend that you first activate the transmitters and then the receivers (listeners).

**Parameters**

The following table shows the parameters of the "D\_ACT\_DP" instruction:

Parameter	Declaration	Data type	Memory area	Description
REQ	Input	BOOL	I, Q, M, D, L	Level-triggered control parameter REQ=1: Execute activation or deactivation
MODE	Input	USINT	I, Q, M, D, L or constant	Job identifier Possible values: <ul style="list-style-type: none"> <li>• 0: Request information on whether the addressed component is activated or deactivated (output via RET_VAL parameter)</li> <li>• 1: Activate the DP slave/PROFINET IO device</li> <li>• 2: Deactivate the DP slave/PROFINET IO device</li> </ul>
LADDR	Input	HW_DEVICE	I, Q, M, D, L or constant	Hardware identifier of the DP slave (HW_DPSlave)/PROFINET IO device (HW_Device)  The number can be taken from the properties of the DP slave / PROFINET IO device in the Network view or from the "System constants" tab of the standard tag table.
RET_VAL	Return	INT	I, Q, M, D, L	If an error occurs while the instruction is being executed, the return value contains an error code.
BUSY	Output	BOOL	I, Q, M, D, L	Active code: <ul style="list-style-type: none"> <li>• BUSY = 1: The job is still active.</li> <li>• BUSY = 0: The job was terminated.</li> </ul>

For additional information on valid data types, refer to "Overview of the valid data types (Page 1077)".

**Parameter RET\_VAL**

Error code* (W#16#...)	Explanation
0000	Job completed without error.
0001	The DP slave/PROFINET IO device is active (this error code is possible only with MODE = 0.)
0002	The DP slave/PROFINET IO device is deactivated (this error code is possible only with MODE = 0.)
7000	First call with REQ=0. The job specified with LADDR is not active; BUSY has the value "0".
7001	First call with REQ=1. The job specified with LADDR was initiated. BUSY has the value "1".
7002	Intermediate call (REQ irrelevant). The activated job is still active; BUSY has the value "1".
8090	<ul style="list-style-type: none"> <li>• You have not configured a module with the address specified in LADDR.</li> <li>• You operate your CPU as I-Slave and you have specified in LADDR an address of this I-Slave.</li> </ul>

Error code* (W#16#...)	Explanation
8092	The deactivation of the currently addressed DP slave/PROFINET IO device (MODE=2) cannot be canceled by being activated (MODE=1). Activate the component at a later time.
8093	No DP slave / PROFINET IO device that can be activated or deactivated is assigned to the address specified in LADDR.
8094	You have attempted to activate a device which is potential partner for a tool change port. However, another device is already activated on this tool change port at this time. The activated device will remain activated.
80A0	Error during the communication between the CPU and the IO controller.
80A1	Parameters could not be assigned for the addressed component. (This error code is only available when MODE = 1.) Note: "D_ACT_DP" returns this error information only if the activated slaves/devices of this component fails again during parameter assignment. If the parameter assignment of a single module was unsuccessful, "D_ACT_DP" returns the error information W#16#0000.
80A2	The addressed DP slave does not return an acknowledgment. (This error information is not available with PROFINET IO devices. The process is not time-monitored by PROFINET.)
80A3	The DP master/PROFINET IO controller concerned does not support this function.
80A4	The CPU does not support this function for external DP masters/PROFINET IO controller.
80A6	Slot error in the DP slave/PROFINET IO device; not all user data can be accessed (this error code is only available when MODE=1). Note: "D_ACT_DP" returns this error information only if the activated component fails again after parameter assignment and before the end of "D_ACT_DP". If only a single module is unavailable, "D_ACT_DP" returns the error information W#16#0000.
80A7	Activation of a non-accessible device.
80AA	Activation with errors in the DP slave/PROFINET IO device: Differences in the configuration
80AB	Activation with errors in the DP slave/PROFINET IO device: Parameter assignment error
80AC	Activation with errors in the DP slave/PROFINET IO device: Maintenance required
80C1	"D_ACT_DP" has been started and is being continued with another address (this error code is possible when MODE=1 and MODE=2).
80C3	<ul style="list-style-type: none"> <li>Temporary resource error: The CPU is currently processing the maximum possible activation and deactivation jobs. (This error code is available only when MODE = 1 and MODE = 2.)</li> <li>The CPU is busy receiving a modified configuration. Currently you can not enable/disable DP slaves/ PROFINET IO devices.</li> </ul>
80C5	DP: Jobs not collected by the user are discarded at restart.
80C6	PROFINET: Jobs not collected by the user are discarded at restart.
General error information	See also: GET_ERR_ID: Get error ID locally (Page 1787)
* The error codes can be displayed as integer or hexadecimal values in the program editor. For additional information on toggling display formats, refer to "See also".	

**Others**

**RD\_REC: Read data record from I/O**

**Description**

Use the instruction to read the data record with the number RECNUM from the addressed module. You start the read process by assigning the value "1" to the input parameter REQ during the call. If the read process could be executed immediately, the instruction returns the value "0" at the output parameter BUSY . If BUSY has the value "1", reading is not yet complete.

See also: Meaning of the parameters REQ, RET\_VAL and BUSY with asynchronous instructions (Page 1582). The data record read is entered in the target range spanned by the RECORD parameter, providing the data transfer was free of errors.

**Note**

When you read out a data record with a number greater than one from an FM or a CP you have purchased prior to February 1997 (below referred to as "old modules"), "RD\_REC" responds differently than it does in new modules. This special situation is covered in the section "Using old S7-300 FMs and CPs with data record numbers >1" (see below).

If a DPV1 slave is configured via GSD file (GSD rev. 3 and higher) and the DP interface of the DP master is set to "S7 compatible", then you may not read any data records from the I/O modules in the user program with "RD\_REC". In this case, the DP master addresses the wrong slot (configured slot + 3).

Remedy: Set the interface of the DP master to "DPV1".

**Parameters**

The following table shows the parameters of the "RD\_REC" instruction:

Parameter	Declaration	Data type	Memory area	Description
REQ	Input	BOOL	I, Q, M, D, L or constant	REQ = 1: Read request
LADDR	Input	HW_IO (WORD)	I, Q, M, D, L or constant	Hardware identifier of the module.
RECNUM	Input	BYTE	I, Q, M, D, L or constant	Data record number (permitted values: 0 to 240)
RET_VAL	Return	INT	I, Q, M, D, L	If an error occurs while the instruction is being executed, the return value contains an error code. In addition: the length of the data record actually transferred in bytes (possible values: +1 to +240), if the target range is greater than the transferred data record and if no error occurred during the transfer.

Parameter	Declaration	Data type	Memory area	Description
BUSY	Output	BOOL	I, Q, M, D, L	BUSY = 1: The reading process is not yet complete.
RECORD	Output	ANY	I, Q, M, D, L	Target range for the data record read. With asynchronous execution of "RD_REC", make sure that the actual parameters of RECORD have the same length information for all calls. Only the BYTE data type is permitted. Note: Note that for S7-300 CPUs the parameter RECORD always requires the full specification of the DB parameters (for example, P#DB13.DBX0.0 byte 100). The omission of an explicit DB number is only permitted for S7-300 CPUs and leads to an error message in the user program.

For additional information on valid data types, refer to "Overview of the valid data types (Page 1077)".

## Parameter RECORD

### Note

If you want to ensure that the entire data record is always read, select a target range with a length of 241 bytes. If the data transfer is without error, RET\_VAL contains the actual data record length.

## Using old S7-300 FMs and CPs with data record numbers > 1

If you want to use the instruction "RD\_REC" to read out a data record with a number greater than one from an old S7-300 FM or old S7-300 CP, remember the following points:

- If the target range is greater than the actual length of the required data record, no data is entered in RECORD . RET\_VAL is written with W#16#80B1.
- If the target range is smaller than the actual length of the required data record, the CPU reads as many bytes beginning at the start of the record as are specified in the length information of RECORD and enters this number of bytes in RECORD . RET\_VAL has the value "0".
- If the length specified in RECORD is the same as the actual length of the required data record, the CPU reads the data record and enters it in RECORD . RET\_VAL is written with "0".

**Parameter RET\_VAL**

- If an error has occurred while the function was being executed, the return value contains an error code.
- If no error occurred during the transfer, RET\_VAL contains the following:
  - 0, if the entire target range was filled with data from the selected data record (the data record can also be incomplete).
  - The length of the data record actually transferred in bytes (possible values: +1 to +240) if the target range is greater than the transferred data record.

**Note**

If the general error W#16#8745 occurs, this only indicates that access to at least one byte of the process image was blocked. The data record was read by the module correctly and written to the I/O memory area.

When looking at the "real" error information (error codes W#16#8xyz) in the following table, we distinguish between two cases:

- Temporary errors (error codes W#16#80A2 to 80A3, 80Cx):  
This type of error can possibly be eliminated without user action, meaning it is helpful to call the instruction again (multiple calls, if necessary).  
Example of a temporary error: Resources required are currently in use (W#16#80C3).
- Permanent errors (error codes W#16#809x, 80A0, 80A1, 80Bx):  
This type of error does not correct itself. A new call of the instruction will not be successful until you have eliminated the error. Example of a permanent error: Wrong length specification in RECORD (W#16#80B1).

**Note**

If you transfer data records to a DPV1 slave with "WR\_REC (Page 2362)" or if you read data records from a DPV1 slave with RD\_REC and if this DPV1 slave operates in DPV1 mode, the DP master evaluates the error information it received from the slave as follows:

If the error information lies within the range from W#16#8000 to W#16#80FF or W#16#F000 to W#16#FFFF, the DP master passes the error information to the instruction. If the error information is outside this range, the DP master passes the value W#16#80A2 to the instruction and suspends the slave.

For a description of the error information originating from DPV1 slaves, refer to STATUS[3] Parameter STATUS (Page 2330).

**Parameter RET\_VAL for WR\_REC and RD\_REC**

Error code* (W#16#...)	Explanation	Restriction
0000	No error	-
7000	First call with REQ=0: No data transfer active; BUSY has the value 0.	-
7001	First call with REQ=1: Data transfer started; BUSY has the value 1.	Distributed I/O



Error code* (W#16#...)	Explanation	Restriction
7002	Intermediate call (REQ irrelevant): Data transfer already active; BUSY has the value 1.	Distributed I/O
8090	Specified logical base address invalid: There is no assignment in SDB1/SDB2x or there is no base address.	-
8092	A type other than BYTE is specified in the ANY reference.	-
8093	This instruction is not permitted for the module selected by means of LADDR and IOID . (permitted are S7-300 modules for an S7-300, S7-400 modules for an S7-400, S7-DP modules for an S7-300 and S7-400).	-
80A0	Negative acknowledgement when reading from the module: Module was removed during the reading process or is defective	With "RD_REC" only
80A1	Negative acknowledgement when writing to the module: Module was removed during the writing process or is defective	With "WR_REC (Page 2362)" only
80A2	<ul style="list-style-type: none"> <li>DP protocol error at layer 2 (for example, slave failure or bus problems)</li> <li>For ET200S, data record cannot be read in DPV0 mode.</li> </ul>	Distributed I/O
80A3	DP protocol error with user interface/user	Distributed I/O
80A4	Communication on PBUS+ disrupted	-
80B0	<ul style="list-style-type: none"> <li>Instruction not possible for module type.</li> <li>The module does not recognize the data record.</li> <li>Data record number 241 not permitted.</li> <li>With "WR_REC (Page 2362)", data records 0 and 1 are not permitted.</li> </ul>	-
80B1	The length specified in parameter RECORD is incorrect.	<ul style="list-style-type: none"> <li>With "WR_REC (Page 2362)": Length incorrect</li> <li>With "RD_REC" (only when using old S7-300 FMs and S7-300 CPs): specified length &gt; data record length</li> <li>With DPNRM_DG: specified length &lt; data record length</li> </ul>
80B2	The configured slot is not assigned.	-
80B3	Actual module type does not match the specified module type in SDB1.	-
80B7	DP slave or module reports an invalid range for a parameter or value.	With "RD_REC" only

Error code* (W#16#...)	Explanation	Restriction
80C0	<p>With "WR_REC (Page 2362)": the data can only be written when the CPU is in STOP mode. Note: this means that writing by the user program is not possible. You can only write the data online with PG/PC.</p> <p>With "RD_REC": the module routes the data record, but either no data is present or the data can only be read when the CPU is in STOP mode. Note: if data can only be read when the CPU is in STOP mode, then an evaluation by the user program is not possible. In this case, you can only read the data online with PG/PC.</p> <p>With "DPNRM_DG (Page 2378)": There are no diagnostic data available.</p>	With "WR_REC (Page 2362)" or "RD_REC" or "DPNRM_DG (Page 2378)"
80C1	The data of the previous write job on the module for the same data record have not yet been processed by the module.	-
80C2	The module is currently processing the maximum possible number of jobs for a CPU.	-
80C3	The required resources (memory, etc.) are currently occupied.	-
80C4	<p>Internal temporary error. Job could not be executed.</p> <p>Repeat the job. If this error occurs often, check your installation for sources of electrical interference.</p>	-
80C5	Distributed I/O not available.	Distributed I/O
80C6	Data record transfer stopped due to priority class abort (restart or background)	Distributed I/O
General error information	See also: GET_ERR_ID: Get error ID locally (Page 1787)	-
* The error codes can be displayed as integer or hexadecimal values in the program editor. For additional information on toggling display formats, refer to "See also".		

## WR\_REC: Write data record to I/O

### Description

Use the instruction "WR\_REC" to transfer the data record RECORD to the addressed module.

You start the writing process by assigning the value "1" to the input parameter REQ during the call. If the writing process could be executed immediately, the instruction returns the value "0" at the output parameter BUSY. If BUSY has the value "1", writing is not yet complete.

#### Note

If a DPV1 slave is configured via GSD file (GSD rev. 3 and higher) and the DP interface of the DP master is set to "S7 compatible", then you may not write any data records from the I/O modules to the user program with "WR\_REC". In this case, the DP master addresses the wrong slot (configured slot + 3).

Remedy: set the interface of the DP master to "DPV1".

## Parameters

The following table shows the parameters of the instruction "WR\_REC":

Parameter	Declaration	Data type	Memory area	Description
REQ	Input	BOOL	I, Q, M, D, L or constant	REQ = 1: Write request
LADDR	Input	HW_IO (WORD)	I, Q, M, D, L or constant	Hardware identifier of the module.
RECNUM	Input	BYTE	I, Q, M, D, L or constant	Data record number
RECORD	Input	ANY	I, Q, M, D, L	Data record. Only the BYTE data type is permitted.
RET_VAL	Return	INT	I, Q, M, D, L	If an error occurs while the instruction is being executed, the return value contains an error code.
BUSY	Output	BOOL	I, Q, M, D, L	BUSY = 1: The writing process is not yet completed.

You will find more detailed information on valid data types in "Overview of the valid data types (Page 1077)".

### Parameter RECORD

The data to be transferred are read from the RECORD parameter during the first call. If the transfer of the data record takes longer than the duration of one call, the contents of the RECORD parameter are no longer relevant for the subsequent instruction calls (for the same job).

### Parameter RET\_VAL

See also: RD\_REC: Read data record from I/O (Page 2358)

---

#### Note

If the general error W#16#8544 occurs, it only indicates that access to at least one byte of the I/O memory area containing the data record was denied. The data transfer was continued.

---

## DPRD\_DAT: Read consistent data of a DP standard slave

### Description

You use the "DPRD\_DAT" instruction to read out consistent data of a DP standard slave/ PROFINET IO device.

You require "DPRD\_DAT" because you can only read out a maximum of four continuous bytes using the load commands that access the I/O or the process image input table. If required, you can also read consistent data via the process image of the inputs. Refer to the related documentation to find out if your CPU supports this functionality. For additional information on

consistent data of a DP standard slave/PROFINET IO device, refer to Section "Data consistency (Page 2826)".

If necessary, the instruction "DPRD\_DAT" can also be used for a data area of 1 byte or larger. For information on the maximum length of the data, refer to the documentation of your CPU (e.g. 64 bytes for an S7-1214).

- Use the LADDR parameter to select the DP standard slave / PROFINET IO device. If an access error occurs, the error code W#16#8090 is output.
- Use the RECORD parameter to define the target range of the read data:
  - The target range has to be at least as long as the inputs of the selected module. Only the inputs are transferred, the other bytes are not considered. If you read from a DP standard slave with a modular configuration or with several DP identifiers, you can only access the data of a module of the configured hardware identifier per "DPRD\_DAT" call. If you select a target range that is too small, the error code 80B1 is output at the RET\_VAL parameter.
  - All bit strings and all integers can be used as data type. It is also possible to use these data types in a data structure of the ARRAY type . The data type STRING is not supported.
- If there was no error during the data transmission, the data that have been read are entered in the target range defined at the RECORD parameter.

## Parameters

The following table shows the parameters of the instruction "DPRD\_DAT":

Parameter	Declaration	Data type	Memory area	Description
LADDR	Input	HW_IO	I, Q, M, L or constant	Hardware identifier of the DP standard slave / PROFINET IO device from which it is to be read.
RET_VAL	Return	DINT, INT, LREAL, REAL	I, Q, M, D, L	If an error occurs while the instruction is being executed, the return value contains an error code.
RECORD	Output	VARIANT	I, Q, M, D, L	Destination area for the user data that were read.

For additional information on valid data types, refer to "Overview of the valid data types (Page 1077)".

## Parameter RET\_VAL

Error code* (W#16#...)	Explanation
0000	No error occurred.
8090	<ul style="list-style-type: none"> <li>• You have not configured a module for the specified hardware identifier or</li> <li>• You have ignored the restriction concerning the length of consistent data, or</li> <li>• you have not specified a hardware identifier as an address at parameter LADDR .</li> </ul>
8092	A data type other than (Array of) bit string or integer was specified at the RECORD parameter.

Error code* (W#16#...)	Explanation
8093	No DP module/PROFINET IO device from which you can read consistent data exists for the hardware identifier specified in LADDR . This error code also occurs if the module addressed by means of LADDR does not have inputs.
80A0	An access error was detected when accessing the I/O.
80B1	The length of the specified target range at parameter RECORD is shorter than the configured user data length.
80C0	The data have not been read yet.
General error information	See also: GET_ERR_ID: Get error ID locally (Page 1787)
* The error codes can be displayed as integer or hexadecimal values in the program editor. For additional information on toggling display formats, refer to "See also".	

## See also

Parameter STATUS (Page 2330)

## DPWR\_DAT: Write consistent data of a DP standard slave

### Description

You use the "DPWR\_DAT" instruction to consistently transfer the data at the RECORD parameter to the addressed DP standard slave / PROFINET IO device, and, if applicable, to the process image (if you have configured the relevant address area of the DP standard slave as a consistent range in a process image).

You require "DPWR\_DAT" because you can only write a maximum of four continuous bytes using the transfer commands that access the I/O or process image output. If required, you can also write consistent data via the process image outputs. Refer to the related documentation to find out if your CPU supports this functionality. Do not use both possibilities concurrently when writing consistent data: Either use "DPWR\_DAT" or write via the process image output table. For additional information on consistent data of a DP standard slave/PROFINET IO device, refer to Section "Data consistency (Page 2826)". If the DP standard slave has a modular design, you can only access one module of the DP slave.

### CAUTION

#### I/O access

When using "DPWR\_DAT", avoid accessing I/O areas that have process image partitions with OB6x connections (isochronous mode interrupts) assigned to them.

If necessary, the instruction "DPRD\_DAT" can also be used for a data area of 1 byte or larger. For information on the maximum length of the data, refer to the documentation of your CPU (e.g. 64 bytes for an S7-1214).

9.7 References

- Use the LADDR parameter to select the DP standard slave / PROFINET IO device. If an access error occurs on the addressed module, the error code 8090 is output.
- Use the RECORD parameter to define the source range of the data to be written:
  - The source range has to be at least as long as the outputs of the selected module. Only the outputs are transferred, the other bytes are not considered. If the source range at parameter RECORD is longer than the outputs of the configured module, only the data up to the maximum length of the outputs is transferred. If the source range at parameter RECORD is shorter than the outputs of the configured module, the error code 80B1 is output.
  - All bit strings and all integers can be used as data type. It is also possible to use these data types in a data structure of the ARRAY type . The data type STRING is not supported.

The data is transferred synchronously, that is, the write process is completed when the instruction is completed.

**Parameters**

The following table shows the parameters of the instruction "DPWR\_DAT":

Parameter	Declaration	Data type	Memory area	Description
LADDR	Input	HW_IO	I, Q, M, L or constant	Hardware identifier of the DP standard slave / PROFINET IO device to those PIQ range it is to be written.
RECORD	Input	VARIANT	I, Q, M, D, L	Source area for the user data to be written.
RET_VAL	Return	INT	I, Q, M, D, L	If an error occurs while the instruction is being executed, the return value contains an error code.

For additional information on valid data types, refer to "Overview of the valid data types (Page 1077)".

**Parameter RET\_VAL**

Error code* (W#16#...)	Explanation
0000	No error occurred.
8090	<ul style="list-style-type: none"> <li>• You have not configured a module for the specified hardware identifier or</li> <li>• You have ignored the restriction concerning the length of consistent data, or</li> <li>• you have not specified a hardware identifier at parameter LADDR .</li> </ul>
8092	A data type other than (Array of) bit string or integer was specified at the RECORD parameter.
8093	No DP module /PROFINET IO device to which you can write consistent data exists at the HW ID specified in LADDR . This error code also occurs if the DP standard slave / PROFINET IO device addressed via LADDR does not have outputs.
80A1	Access error detected while I/O devices were being accessed.

Error code* (W#16#...)	Explanation
80B1	The length of the specified source range at the RECORD parameter is shorter than the outputs of the configured DP standard slave / PROFINET IO device.
80C1	The data of the previous write job have not yet been processed by the DP standard slave / PROFINET IO device.
General error information	See also: GET_ERR_ID: Get error ID locally (Page 1787)
* The error codes can be displayed as integer or hexadecimal values in the program editor. For additional information on toggling display formats, refer to "See also".	

**See also**

Parameter STATUS (Page 2330)

**iDevice / iSlave****RCVREC: Receive data record****Description**

An I-device can receive a data record from a superordinate controller. The receipt takes place in the user program with the instruction "RCVREC" (receive record).

The instruction has the following operating modes:

- Check whether the I-device has a request for a data record receipt.
- Make the data record available to the output parameters.
- Send an answer to the superordinate controller.

You can determine the operating mode executed by the instruction using the input parameter MODE (see below).

The I-device must be in the RUN or STARTUP mode.

With MLEN, you specify the maximum number of bytes you want to receive. The selected length of the target range RECORD should have at least the length of MLEN bytes.

If a data record was received (MODE=1 or MODE=2), the output parameter NEW will indicate that the data record was stored in RECORD. Note that RECORD has a sufficient length. The output parameter LEN contains the actual length of the data record received in bytes.

Set CODE1 and CODE2 to zero for the positive answer to the superordinate controller. If the received data record is to be rejected, enter the negative answer to the superordinate controller in Error Code 1 of the CODE1 and in Error Code 2 of the CODE2.

**Note**

If the I-device has received a request for a data record receipt, you must recognize the delivery of this request within a certain duration. After recognition, you must send an answer to the superordinate controller within this time period. Otherwise the I-device will experience a timeout error which causes the operating system of the I-device to send a negative answer to the superordinate controller. For information on the value for the time period, refer to the specifications of your CPU.

The output parameter STATUS receives the error information after the occurrence of an error.

**Operating modes**

You can determine the operating mode of the instruction "RCVREC" with the input parameter MODE. This step will be explained in the following table.

MODE	Meaning
0	Check whether a request for a data record receipt exists If a data record from a higher-level controller exists on the I-device, the instruction will only write the output parameters NEW, SLOT, SUBSLOT, INDEX and LEN. If you call the instruction several times with MODE=0, then the output parameter will only refer to one and the same request.
1	Receiving a data record for any subplot of the I-device If a data record from a superordinate controller exists on the I-device for any subplot of the I-device, the instruction will write the output parameter and transfer the data record to the parameter RECORD.
2	Receiving a data record for a specific subplot of the I-device If a data record from a superordinate controller exists on the I-device for a specific subplot of the I-device, the instruction will write the output parameter and transfer the data record to the parameter RECORD.
3	Sending a positive answer to the superordinate controller The instruction checks the request of the superordinate controller to receive a data record, accepts the existing data record and sends a positive acknowledgement to the superordinate controller.
4	Sending a negative answer to the superordinate controller The instruction checks the request of the superordinate controller to receive a data record, rejects the existing data record and sends a negative acknowledgement to the superordinate controller. Enter the reason for the rejection in the input parameters CODE1 and CODE2.

**Note**

After the receipt of a data record (NEW=1) you must call "RCVREC" twice to ensure complete processing. You must do this in the following order:

- First call with MODE=1 or MODE=2
- Second call with MODE=3 or MODE=4



## Parameters

The following table shows the parameters of the "RCVREC" instruction:

Parameter	Declaration	Data type	Memory area	Description
MODE	Input	INT	I, Q, M, D, L or constant	Mode
F_ID	Input	HW_SUBMODULE (DWORD)	I, Q, M, D, L or constant	Subslot in the transfer area of the I-device for the data record to be received (only relevant for MODE=2). The high word is always set to zero.
MLEN	Input	INT	I, Q, M, D, L or constant	Maximum length of the data record to be received in bytes
CODE1	Input	BYTE	I, Q, M, D, L or constant	Zero (for MODE=3) and/or Error Code 1 (for MODE=4)
CODE2	Input	BYTE	I, Q, M, D, L or constant	Zero (for MODE=3) and/or Error Code 2 (for MODE=4)
NEW	Output	BOOL	I, Q, M, D, L	<ul style="list-style-type: none"> <li>• MODE = 0: New data record was received</li> <li>• MODE=1 or 2: Data record was transferred to RECORD</li> </ul>
STATUS	Output	DWORD	I, Q, M, D, L	Error information
SLOT	Output	HW_SUBMODULE	I, Q, M, D, L	Identical to F_ID
SUBSLOT	Output	HW_SUBMODULE	I, Q, M, D, L	Identical to F_ID
INDEX	Output	UINT	I, Q, M, D, L	Number of the data record received
LEN	Output	UINT	I, Q, M, D, L	Length of the data record received
RECORD	InOut	VARIANT	I, Q, M, D, L	Target range for the data record received. Note: Note that for S7-300 CPUs the parameter RECORD always requires the full specification of the DB parameters (for example, P#DB13.DBX0.0 Byte 100). The omission of an explicit DB number is not permitted for S7-300 CPUs and results in an error message in the user program.

For additional information on valid data types, refer to "Overview of the valid data types (Page 1077)".

## Parameter STATUS

For interpretation of the parameter STATUS refer to section: Parameter STATUS (Page 2330)

## PRVREC: Make data record available

### Description

An I-device can receive a request from a superordinate controller to make a data record available. The I-device makes the data record available in the user program with the instruction "PRVREC" (provide record).

The instruction has the following operating modes:

- Check whether the I-device has a request for making a data record available.
- Transfer the requested data record to the superordinate controller.
- Sending an answer to the superordinate controller.

You can determine the operating mode executed by the instruction using the input parameter MODE (see below).

The I-device must be in the RUN or STARTUP mode.

Enter the maximum number of bytes the data record to be sent should have with LEN. The selected length of the target range RECORD should have at least the length of LEN bytes.

If a request to make a data record available exists, (MODE=0), the output parameter NEW will be set to TRUE.

If the request for making a data record available is accepted, write RECORD for the positive answer to the superordinate controller with the requested data record and write zero for CODE1 and CODE2. If the request for making a data record available is to be rejected, enter the negative answer to the superordinate controller in Error Code 1 of the CODE1 and in Error Code 2 of the CODE2.

---

### Note

If the I-device has received a request for making a data record available, you must recognize the delivery of this request within a certain time period. After recognition, you must send an answer to the superordinate controller within this time period. Otherwise the I-device will experience a timeout error which causes the operating system of the I-device to send a negative answer to the superordinate controller. For information on the value for the time period, refer to the specifications of your CPU.

---

The output parameter STATUS receives the error information after the occurrence of an error.

## Operating modes

You can determine the operating mode of the instruction "PRVREC" with the input parameter MODE. This step will be explained in the following table.

MODE	Meaning
0	Check whether a request for making a data record available exists If a request from a higher-level controller for making a data record available exists on the I-device, the instruction will only write the output parameters NEW, SLOT, SUBSLOT, INDEX and RLEN. If you call the instruction several times with MODE=0, then the output parameter will only refer to one and the same request.
1	Receiving a request for making a data record available for any subslot of the I-device If such a request from a superordinate controller for any subslot of the I-device exists on the I-device, the instruction will write the output parameter.
2	Receiving a request for making a data record available for a specific subslot of the I-device If such a request from a superordinate controller for a specific subslot of the I-device exists on the I-device, the instruction will write the output parameter.
3	Make the data record available and send a positive answer to the superordinate controller The instruction checks the request of the superordinate controller to make a data record available, makes the request data record available to RECORD and sends a positive acknowledgement to the superordinate controller.
4	Sending a negative answer to the superordinate controller The instruction checks the request of the superordinate controller to make a data record available, rejects this request and sends a negative acknowledgement to the superordinate controller. Enter the reason for the rejection in the input parameters CODE1 and CODE2.

### Note

After the receipt of a request (NEW=1) you must call the instruction twice to ensure complete processing. You must do this in the following order:

- First call with MODE=1 or MODE=2
- Second call with MODE=3 or MODE=4

## Parameters

The following table shows the parameters of the "PRVREC" instruction:

Parameter	Declaration	Data type	Memory area	Description
MODE	Input	INT	I, Q, M, D, L or constant	Mode
F_ID	Input	HW_SUBMODULE (DWORD)	I, Q, M, D, L or constant	Subslot in the transfer area of the I-device for the data record to be sent (only relevant for MODE=2). The high word is always set to zero.
CODE1	Input	BYTE	I, Q, M, D, L or constant	Zero (for MODE=3) and/or Error Code 1 (for MODE=4)
CODE2	Input	BYTE	I, Q, M, D, L or constant	Zero (for MODE=3) and/or Error Code 2 (for MODE=4)
LEN	Input	UINT	I, Q, M, D, L or constant	Maximum length of the data record to be sent in bytes

Parameter	Declaration	Data type	Memory area	Description
NEW	Output	BOOL	I, Q, M, D, L	The new data record was requested by the superordinate controller.
STATUS	Output	DWORD	I, Q, M, D, L	Error information
SLOT	Output	HW_SUBMODULE	I, Q, M, D, L	Identical to F_ID
SUBSLOT	Output	HW_SUBMODULE	I, Q, M, D, L	Identical to F_ID
INDEX	Output	UINT	I, Q, M, D, L	Number of the data record to be sent
RLEN	Output	UINT	I, Q, M, D, L	Length of the data record to be sent
RECORD	InOut	VARIANT	I, Q, M, D, L	Data record made available Note: Note that for S7-300 CPUs the parameter RECORD always requires the full specification of the DB parameters (for example, P#DB13.DBX0.0 Byte 100). The omission of an explicit DB number is not permitted for S7-300 CPUs and results in an error message in the user program.

For additional information on valid data types, refer to "Overview of the valid data types (Page 1077)".

### Parameter STATUS

For interpretation of the parameter STATUS refer to section: Parameter STATUS (Page 2330)

### PROFIBUS

#### DPSYC\_FR: Synchronize DP slaves / Freeze inputs

#### Description

You use the instruction to synchronize one or more groups of DP slaves.

The function involves sending one of the control commands below, or a combination of them, to the relevant groups:

- SYNC (simultaneous output and freezing of output states on the DP slaves)
- UNSYNC (cancels the SYNC control command)
- FREEZE (freeze the input states on the DP slaves and read in the frozen inputs)
- UNFREEZE (cancels the FREEZE control command)

Before you send the control commands listed above, you must assign the DP slaves to groups per configuration. You must know which DP slave is assigned to which group, with which number and know the reactions of the various groups to SYNC/FREEZE.

---

**Note**

Note that the control commands SYNC and FREEZE also remain valid when you perform a warm/cold restart.

Please note also that you may initiate only one SYNC/UNSYNC job or only one FREEZE/UNFREEZE job at a time.

---

### Functional description

"DPSYC\_FR" works asynchronously, that is, its execution extends over multiple calls. You start the job by calling "DPSYC\_FR" with REQ=1.

The output parameters RET\_VAL and BUSY indicate the status of the job.

See also: Meaning of the parameters REQ, RET\_VAL and BUSY with asynchronous instructions (Page 1582).

### Identification of a job

If you have triggered a SYNC/FREEZE job and called "DPSYC\_FR" again before the first job was completed, the response of the instruction depends on whether the new call is for the same job. If the input parameters LADDR, GROUP and MODE match, the call is interpreted as a follow-on call.

### Writing outputs of DP modules

The writing of outputs of DP modules is triggered as follows:

- By transfer commands to the DP I/O
- By writing the process image of the outputs to the modules (by the operating system at the end of OB 1 or by calling the instruction "UPDAT\_PO (Page 2316)")
- Calling the "DPWR\_DAT (Page 2365)" instruction.

In normal operation, the DP master transfers the output bytes cyclically (within the cycle of the PROFIBUS DP bus) to the outputs of the DP slaves.

If you want to have certain output data (possibly distributed on several slaves) applied to the outputs to the process at exactly the same time, you can send the SYNC control command to the relevant DP master using the "DPSYC\_FR" instruction.

### What are the effects of SYNC?

With the SYNC control command, the DP slaves of the selected groups are switched to Sync mode. In other words, the DP master transfers the current output data and instructs the DP slaves involved to freeze their outputs. With the following output message frames, the DP

slaves enter the output data in an internal buffer and the state of the outputs remains unchanged.

Following each SYNC control command, the DP slaves of the selected groups apply the output data of their internal buffer to the outputs on the process.

The outputs are only updated cyclically again when you send the UNSYNC control command using the "DPSYC\_FR" instruction.

---

**Note**

If the DP slaves of the selected group(s) are not currently connected to the network or have failed when the control command was sent, they will not be switched to SYNC mode. This information will not be communicated in the return value of the instruction.

---

### Reading input data of DP modules

The input data of the DP modules are read as follows:

- Using load commands to the DP I/O
- When the process image of the inputs is updated (by the operating system at the start of OB 1 or by calling the "UPDAT\_PI (Page 2315)" instruction)
- By calling the "DPRD\_DAT (Page 2363)" instruction.

In normal operation, the DP master receives this input data cyclically (within the cycle of the PROFIBUS DP bus) from its DP slaves and makes them available to the CPU.

If you want to have certain input data (possibly distributed on several slaves) to be read from the process at exactly the same time, send the FREEZE control command to the relevant DP master using the "DPSYC\_FR" instruction.

### What are the effects of FREEZE?

With the FREEZE control command, the DP slaves involved are switched to Freeze mode, in other words the DP master instructs the DP slaves to freeze the current state of the inputs. It then transfers the frozen data to the input area of the CPU.

Following each FREEZE control command, the DP slaves freeze the state of their inputs again.

The DP master only receives the current state of the inputs cyclically again after you have sent the UNFREEZE control command with the "DPSYC\_FR" instruction.

---

**Note**

If the DP slaves of the selected group(s) are not currently connected to the network or have failed when the control command has been sent, they will not be switched to FREEZE mode. This information will not be communicated in the return value of the instruction.

---

## Data consistency

Because the DPSYC\_FR functions are asynchronous and can be interrupted by higher priority classes, you should make sure that the process images are consistent with the actual inputs and outputs of the I/O when using the "DPSYC\_FR" instruction.

This is guaranteed if you comply with the following consistency rules:

- Define suitable process image partitions for the "SYNC outputs" and the "FREEZE inputs" (only possible on the S7-400). Call the "UPDAT\_PO (Page 2316)" instruction immediately before each first call of a SYNC job. Call the "UPDAT\_PI (Page 2315)" instruction immediately after the respective last call of a FREEZE job.
- As an alternative: Use only direct I/O access for outputs involved in a SYNC job and for inputs involved in a FREEZE job. Do not write to these outputs when a SYNC job is active and do not read in these inputs when a FREEZE job is active.

## Use of DPWR\_DAT and DPRD\_DAT

If you use the "DPWR\_DAT (Page 2365)" instruction, it must be complete before you send a SYNC job for the outputs involved.

If you use the "DPRD\_DAT (Page 2363)" instruction, it must be complete before you send a FREEZE job for the inputs involved.

## Startup and "DPSYC\_FR"

The user alone must take responsibility for sending the SYNC and FREEZE control commands in the startup OBs.

If you want the outputs of one or more groups to be in SYNC mode when the user program starts, you must initialize these outputs during startup and completely execute the "DPSYC\_FR" instruction with the SYNC control command.

If you want the inputs of one or more groups to be in FREEZE mode when the user program starts, you must execute the "DPSYC\_FR" instruction with the FREEZE control command completely for these inputs during startup.

## Parameters

The following table shows the parameters of the "DPSYC\_FR" instruction:

Parameter	Declaration	Data type	Memory area	Description
REQ	Input	BOOL	I, Q, M, D, L	Level-triggered control parameter REQ = 1: Triggering of the SYNC/FREEZE job
LADDR	Input	HW_DPMASTER (WORD)	I, Q, M, D, L or constant	Hardware identifier of the DP master interface The number can be taken from the properties of the DP master interface in the Network view or from the "System constants" tab of the standard tag table.

9.7 References

Parameter	Declaration	Data type	Memory area	Description
GROUP	Input	BYTE	I, Q, M, D, L or constant	Group selection Bit 0 = 1: group 1 selected Bit 1 = 1: group 2 selected : Bit 7 = 1: group 8 selected You can select several groups per job. The value B#16#0 is invalid.
MODE	Input	BYTE	I, Q, M, D, L or constant	Job ID (coding complies with EN 50 170 Volume 2, PROFIBUS) Bit 0: reserved (value 0) Bit 1: reserved (value 0) Bit 2: <ul style="list-style-type: none"> <li>• = 1: UNFREEZE will be executed</li> <li>• = 0: no meaning</li> </ul> Bit 3: <ul style="list-style-type: none"> <li>• = 1: FREEZE will be executed</li> <li>• = 0: no meaning</li> </ul> Bit 4: <ul style="list-style-type: none"> <li>• = 1: UNSYNC will be executed</li> <li>• = 0: no meaning</li> </ul> Bit 5: <ul style="list-style-type: none"> <li>• = 1: SYNC will be executed</li> <li>• = 0: no meaning</li> </ul> Bit 6: reserved (value 0) Bit 7: reserved (value 0)  Possible values: <ul style="list-style-type: none"> <li>• with exactly one ID per job:                             <ul style="list-style-type: none"> <li>– B#16#04 (UNFREEZE)</li> <li>– B#16#08 (FREEZE)</li> <li>– B#16#10 (UNSYNC)</li> <li>– B#16#20 (SYNC)</li> </ul> </li> <li>• with more than one ID per job:                             <ul style="list-style-type: none"> <li>– B#16#14 (UNSYNC, UNFREEZE)</li> <li>– B#16#18 (UNSYNC, FREEZE)</li> <li>– B#16#24 (SYNC, UNFREEZE)</li> <li>– B#16#28 (SYNC, FREEZE)</li> </ul> </li> </ul>
RET_VAL	Return	INT	I, Q, M, D, L	If an error occurs while the instruction is being executed, the return value contains an error code. Make sure that you evaluate RET_VAL each time the block has been executed.
BUSY	Output	BOOL	I, Q, M, D, L	BUSY=1: The SYNC/FREEZE job is not yet complete.



For additional information on valid data types, refer to "Overview of the valid data types (Page 1077)".

## Parameter RET\_VAL

### Note

If you access DPV1 slaves, error information of these slaves can be forwarded from the DP master to the instruction. For a description of this error information, refer to STATUS[3], STATUS (Page 2330) parameter.

Error code* (W#16#...)	Explanation
0000	Job completed without error.
7000	First call with REQ=0. The job specified with LADDR, GROUP and MODE is not active; BUSY has the value 0.
7001	First call with REQ=1. The job specified with LADDR, GROUP and MODE was triggered; BUSY has the value 1.
7002	Intermediate call (REQ irrelevant). The activated SYNC/FREEZE job is still running; BUSY has the value 1.
8090	The module selected with LADDR is not a DP master.
8093	This instruction is not permitted for the module selected with LADDR (configuration or version of the DP master).
8094	GROUP parameter is incorrect
8095	MODE parameter is incorrect
80B0	The group selected with GROUP is not configured.
80B1	The group selected with GROUP is not assigned to this CPU.
80B2	The SYNC job specified with MODE is not permitted on the group selected with GROUP.
80B3	The FREEZE job specified with MODE is not permitted on the group selected with GROUP.
80C2	Temporary shortage of resources on the DP master: The DP master is currently processing the maximum number of jobs for a CPU.
80C3	This SYNC/UNSYNC job cannot be activated at present because only one SYNC/UNSYNC job can be triggered at a time. Check your user program.
80C4	This FREEZE/UNFREEZE job cannot be activated at present because only one FREEZE/UNFREEZE job can be triggered at a time. Check your user program.
80C5	Short circuit directly at DP interface
80C6	Job aborted due to I/O disconnection by CPU
80C7	Job aborted due to warm or cold restart on the DP master
General error information	See also: GET_ERR_ID: Get error ID locally (Page 1787)
* The error codes can be displayed as integer or hexadecimal values in the program editor. For additional information on toggling display formats, refer to "See also".	

### DPNRM\_DG: Read diagnostics data from a DP slave

#### Description

You use the "DPNRM\_DG" instruction to read the current diagnostic data of a DP slave in the form specified in EN 50 170 Volume 2, PROFIBUS.

Refer to the following table for the basic structure of the slave diagnostic data and to the manuals of the DP slaves for further information.

Byte	Meaning
0	Station status 1
1	Station status 2
2	Station status 3
3	Master station number
4	Vendor ID (high byte)
5	Vendor ID (low byte)
6 ...	Additional slave-specific diagnostic information

The data that has been read is entered in the target range indicated by RECORD following without error data transfer. You start the read process by assigning the value "1" to the REQ input parameter when the "DPNRM\_DG" instruction is called.

#### Functional description

The reading process is executed asynchronously, in other words, it can extend over several calls. The output parameters RET\_VAL and BUSY indicate the status of the job.

See also: Meaning of the parameters REQ, RET\_VAL and BUSY with asynchronous instructions (Page 1582).

#### Parameters

The following table shows the parameters of the "DPNRM\_DG" instruction:

Parameter	Declaration	Data type	Memory area	Description
REQ	Input	BOOL	I, Q, M, D, L or constant	REQ = 1: Read request
LADDR	Input	HW_DPSLAVE (WORD)	D, L or constant	Configured diagnostic address of the DP slave Note: Address must be specified in hexadecimal form, for example, diagnostic address 1022 means: LADDR:=W#16#3FE.
RET_VAL	Return	DINT, INT, LREAL, REAL	I, Q, M, D, L	If an error occurs while the instruction is being executed, the return value contains an error code. If no error has occurred, the length of the data actually transferred is entered in RET_VAL.

Parameter	Declaration	Data type	Memory area	Description
RECORD	Output	VARIANT	I, Q, M, D, L	Destination area for the diagnostic data that were read. Only the BYTE data type is permitted. The minimum length of the data record to be read or the target range is 6. The maximum length of the data record to be sent is 240. Standard slaves can provide more than 240 bytes of diagnostic data up to a maximum of 244 bytes. In this case, the first 240 bytes are transferred to the target range and the overflow bit is set in the data.
BUSY	Output	BOOL	I, Q, M, D, L	BUSY = 1: The reading process is not yet complete.

For additional information on valid data types, refer to "Overview of the valid data types (Page 1077)".

You can find information on data type conversion in the different programming languages under "Auto-Hotspot".

### Parameter RECORD

The CPU evaluates the actual length of the read diagnostic data:

If the length specified for RECORD

- is less than the number of data bytes supplied, the data is discarded and a corresponding error code is entered in RET\_VAL.
- is greater than or equal to the number of data bytes supplied, the data is accepted in the destination area and the actual length is entered in RET\_VAL as a positive value.

---

#### Note

You must ensure that the actual parameters of RECORD correspond in all calls belonging to a job.

A job is uniquely identified by the LADDR input parameter.

---

### Standard slaves with more than 240 bytes of diagnostic data

With standard slaves on which the number of standard diagnostic data is between 241 and 244 bytes, note the following points:

If the length specified for RECORD

- is less than 240 bytes, the data is discarded and a corresponding error code is entered in RET\_VAL.
- If the length specified for RECORD is greater than or equal to 240 bytes, the first 240 bytes of the standard diagnostic data is transferred to the target range and the overflow bit is set in the data.

**Parameter RET\_VAL**

- If an error occurs while the function is being executed, the return value contains an error code.
- If no errors have occurred during data transfer, RET\_VAL contains the length of the data read in bytes as a positive number.

**Note**

The amount of data read in a DP slave depends on its diagnostics status.

For the evaluation of the error information of the RET\_VAL parameter, refer to the following table.

Error code (W#16#...)	Explanation	Restriction
7000	First call with REQ = 0: No data transfer active; BUSY has the value "0".	-
7001	First call with REQ = 1: Data transfer triggered; BUSY has the value "1".	Distributed I/O
7002	Intermediate call (REQ irrelevant): Data transfer already active; BUSY has the value "1".	Distributed I/O
8090	Specified logical base address invalid: There is no assignment in SDB1/SDB2x or there is no base address.	-
8093	This instruction is not permitted for the module selected by means of LADDR and IOID.	-
80A2	<ul style="list-style-type: none"> <li>• DP protocol error at layer 2 (for example, slave failure or bus problems)</li> <li>• For ET200S, data record cannot be read in DPV0 mode.</li> </ul>	Distributed I/O
80A3	DP protocol error with user interface/user	Distributed I/O
80A4	Communication on PBUS+ disrupted	Distributed I/O
80B0	<ul style="list-style-type: none"> <li>• Instruction not possible for module type.</li> <li>• The module does not recognize the data record.</li> <li>• Data record number 241 not permitted.</li> <li>• With "WR_REC (Page 2323)", data records 0 and 1 are not permitted.</li> </ul>	-
80B1	The length specified in parameter RECORD is incorrect.	specified length < data record length
80B2	The configured slot is not assigned.	-
80B3	Actual module type does not match the specified module type in SDB1.	-
80C0	There are no diagnostic data available.	-
80C1	The data of the previous write job on the module for the same data record have not yet been processed by the module.	-
80C2	The module is currently processing the maximum possible number of jobs for a CPU.	-
80C3	The required resources (memory, etc.) are currently occupied.	-

Error code (W#16#...)	Explanation	Restriction
80C4	Internal temporary error. Job could not be executed. Repeat the job. If this error occurs often, check your installation for sources of electrical interference.	-
80C5	Distributed I/O not available.	Distributed I/O
80C6	Data record transfer stopped due to priority class abort (restart or background)	Distributed I/O
General error information	See also: GET_ERR_ID: Get error ID locally (Page 1787)	-
* The error codes can be displayed as integer or hexadecimal values in the program editor. For additional information on toggling display formats, refer to "See also".		

## DP\_TOPOL: Determine topology for DP master system

### Description

You use the instruction to trigger the topology determination for a selected DP master system. Calling the instruction will address all diagnostics repeaters on a DP master system.

---

#### Note

The topology can only be determined for one DP master system at a time.

---

Topology determination is the prerequisite for the detailed display of the error location if line errors occur. After configuration and after every change to the physical configuration of a DP master system, you must repeat the topology determination with "DP\_TOPOL".

Changes to the physical configuration are:

- Changes in line lengths
- Adding or removing stations or components with repeater function
- Changing station addresses

If an error is reported by a diagnostics repeater, "DP\_TOPOL" writes the DPR and DPRI outputs for the duration of one "DP\_TOPOL" pass. If errors are reported by multiple diagnostics repeaters of the selected DP master system, "DP\_TOPOL" writes DPR and DPRI with information regarding the first diagnostics repeater reporting the error. You can read out the entire diagnostic information on the programming device or using the "DPNRM\_DG (Page 2378)" instruction. If no diagnostics repeater reports an error, the DPR and DPRI outputs have the value NULL.

If you want to repeat a topology determination after an error occurs, you must first reset "DP\_TOPOL". This is done by calling "DP\_TOPOL" with REQ=0 and R=1.

### Functional description

"DP\_TOPOL" works asynchronously, that is, its execution extends over multiple calls. You start determining the bus topology by calling "DP\_TOPOL" with REQ=1. If you want to cancel the process, call "DP\_TOPOL" with R=1.

The output parameters RET\_VAL and BUSY indicate the status of the job.

See also: Meaning of the parameters REQ, RET\_VAL and BUSY with asynchronous instructions (Page 1582).

**Note**

Determining the topology may take several minutes.

**Identification of a job**

The input parameter DP\_ID uniquely specifies a job.

If you have called "DP\_TOPOL" and you call this instruction again before the topology is re-determined, the manner in which the instruction reacts depends on whether the new call involves the same job: If the DP\_ID parameter matches a job that has not yet been completed, then the call is interpreted as a follow-up call and the value W#16#7002 will be entered in RET\_VAL. On the other hand, if another job is involved, the CPU rejects it.

**Parameters**

The following table shows the parameters of the "DP\_TOPOL" instruction:

Parameter	Declaration	Data type	Memory area	Description
REQ	Input	BOOL	I, Q, M, D, L or constant	REQ=1: Trigger topology determination
R	Input	BOOL	I, Q, M, D, L or constant	R=1: Cancel topology determination
DP_ID	Input	HW_IOSYST EM	I, Q, M, D, L or constant	DP master system ID of those master systems for which the topology will be determined
RET_VAL	Return	INT	I, Q, M, D, L	If an error occurs while the instruction is being executed, the return value contains an error code.
BUSY	Output	BOOL	I, Q, M, D, L	BUSY=1: Topology determination is not yet complete.
DPR	Output	BYTE	I, Q, M, D, L	PROFIBUS address of the diagnostics repeater reporting the error.
DPRI	Output	BYTE	I, Q, M, D, L	Measuring segment diagnostics repeater reporting the error: <ul style="list-style-type: none"> <li>• Bit 0 = 1: Temporary faults on segment DP2</li> <li>• Bit 1 = 1: Permanent faults on segment DP2</li> <li>• Bit 4 = 1: Temporary faults on segment DP3</li> <li>• Bit 5 = 1: Permanent faults on segment DP3</li> </ul>

For additional information on valid data types, refer to "Overview of the valid data types (Page 1077)".

## Parameter RET\_VAL

When looking at the "real" error information (error codes W#16#8xyz) in the following table, we distinguish between two cases:

- Temporary errors (error codes W#16#80A2 to 80A4, 80C3, 80C5):  
It is possible to eliminate this type of error without user action; in other words, it is advisable to call "DP\_TOPOL" again (multiple calls, if necessary).  
Example of a temporary error: Resources required are currently in use (W#16#80C3).
- Permanent errors (error codes W#16#8082, 80B0, 80B2):  
This type of error does not correct itself. A new call of "DP\_TOPOL" is only advisable after you have eliminated the error. Example of a permanent error: The DP master/CPU does not support this service. (W#16#80B0).

Error code* (W#16#...)	Explanation
0000	Job completed without error.
7000	First call with REQ=0. Topology determination is not triggered. BUSY has the value "0".
7001	First call with REQ=1. The request to execute topology determination was sent. BUSY has the value "1".
7002	Intermediate call (REQ irrelevant): Topology determination is not yet complete. BUSY has the value "1".
7010	You have attempted to cancel topology identification. But there is no running job with the specified DP_ID. BUSY has the value "0".
7011	First call with R=1. The cancellation of the topology determination was triggered. BUSY has the value "1".
7012	Intermediate call: The cancellation of the topology determination is not yet complete. BUSY has the value "1".
7013	Final call: The topology determination was cancelled. BUSY has the value "0".
8082	No DP master system is configured with the specified DP_ID.
80A2	Error during topology determination; for more detailed information, refer to output parameters DPR and DPRI.
80A3	Error during topology determination: Monitoring time has elapsed (timeout).
80A4	Communication on PBUS+ disrupted
80B0	The DP master/CPU does not support this service.
80B2	Error during topology determination: No diagnostics repeater was found at the selected DP master system.
80C3	Resources required are currently in use. Possible cause: You have initiated a second topology determination (only one topology determination is permitted at one time).
80C5	The DP master system is currently not available.
General error information	See also: GET_ERR_ID: Get error ID locally (Page 1787)
* The error codes can be displayed as integer or hexadecimal values in the program editor. For additional information on toggling display formats, refer to "See also".	

## ASi

### ASI\_CTRL: Controlling ASi master behavior

#### Description of ASI\_CTRL

#### Description

Using the instruction "ASI\_CTRL", you can control the behavior of the AS-i master from the user program of the PLC. The instruction processes the command protocol automatically. It also enables parameter assignment on SIMATIC AS-i masters and reading out information data. The functions and operation of the command interface are detailed in the manual for the AS-i master.

Both centrally inserted AS-i masters and distributed AS-i masters via PROFIBUS DP are supported. Combinations with PROFINET IO (e.g. IE/PB Link PN IO) are also possible.

The schematic diagram below shows the functions of the "ASI\_CTRL" instruction:

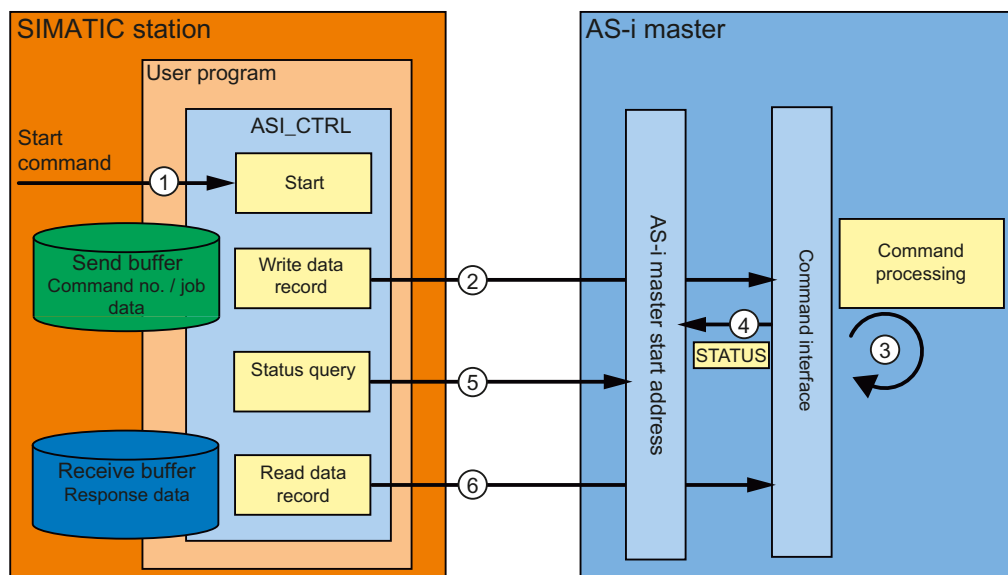

- ① Start of processing at the REQ parameter.
- ② The program sends the required command to the AS-i master via the instruction "RDREC".
- ③ The AS-i master processes the command.
- ④ The current status of the AS-i master is stored in the input area of the binary data (logical start address).
- ⑤ The instruction "ASI\_CTRL" cyclically queries and evaluates the 4 status bits.
- ⑥ Once command processing is complete, the command job is completed with "RDREC". Depending on the command, the data field of "RDREC" may contain the response data for the command or additional status information.



## Differences in the command call between IE/ AS-i Link and DP/AS-i Links

There are significant differences in how a controller exchanges commands with an AS-i master.

- **IE/AS-i Link** (PROFINET) used the data record interface. The different commands are called with either "Write data record" ("WRREC" instruction) or "Read data record" ("RDREC" instruction) by various data record numbers.
- **DP/AS-i Links** (PROFIBUS) use the command interface. All commands are called by data record number 2 with "Write data record" ("WRREC" instruction) plus "Read data record" ("RDREC" instruction). The type of command is defined by the data content in the write job.

## Changes compared to the instruction "ASi\_3422".

The instruction "ASI\_CTRL" is a revised version of the instruction "ASi\_3422" (S7-300/400) and provides improved functionality and compatibility. The specific changes are as follows:

- For writing and reading diagnostic data records, the instructions "WR\_REC (Page 2362)" and "RD\_REC (Page 2358)" have been replaced by the instructions "RDREC (Page 2321)" and "WRREC (Page 2323)". Their function is identical; however, they support data transfer via PROFINET IO.
- The block type of the instruction has been changed from a function (FC) to a function block (FB). "ASI\_CTRL" has an instance data block and is multi-instance-capable.
- The designation of the formal parameters of "ASI\_CTRL" complies with the SIMATIC system blocks. There is no STARTUP input parameter. The definition of the STATUS parameter is based on the instructions "RDREC (Page 2321)" and "WRREC (Page 2323)". The status identifiers for the parameter DONE and the new parameter BUSY have also been adjusted.

## Operation of the "ASI\_CTRL" instruction

The instruction "ASI\_CTRL" is an asynchronous function block; in other words, its processing extends over multiple calls.

- A job is started with REQ = TRUE.
- The job status is displayed via the BUSY output parameters and the two central bytes of the output parameter STATUS.
- The BUSY parameter is set during job processing. Upon the first call, STATUS is assigned the value 00700100<sub>H</sub>. Upon all subsequent calls for this job, it is assigned the value 00700200<sub>H</sub>. When the job is complete, the result is output at the parameters DONE or ERROR.
  - If no errors have occurred, DONE is set. For jobs with response data from the AS-i master, this data is provided in the specified receive buffer. In such cases, the STATUS parameter also displays the volume of data supplied in bytes. For jobs without response data, the value 00000000<sub>H</sub> is entered in STATUS.
  - If an error occurs during job processing, ERROR is set. The content of the receive buffer is invalid in such a case. An error code is entered in the STATUS parameter for a more detailed description of the error which has occurred.

**Number of command calls**

If you use the instruction "ASI\_CTRL" to send commands, you may not simultaneously send other commands to the same AS-i master with "RDREC (Page 2321)" or "WRREC (Page 2323)". This also applies to multiple calls of the instruction for the same AS-i master.

The instruction "ASI\_CTRL" cannot be run with interruptions. Calls therefore cannot be programmed in program priority classes which interrupt each other (for example with calls in OB 1 and in OB 35).

**Parameter**

The following table shows the parameters of the instruction "ASI\_CTRL":

Parameter	Declaration	Data type	Memory area	Description
REQ	Input	BOOL	I, Q, M, D, L, constant	REQ = TRUE starts a new job unless a job is already in progress. No edge evaluation takes place.
LADDR	Input	WORD	I, Q, M, D, L, constant	Start address of the AS-i master in the S7 address space (logical base address). The start address is defined in the hardware configuration when the master is configured.
SD	Input	VARIANT	I, Q, M, D, L	Send buffer The parameter refers to a memory area in which the command is to be specified (see "ASi commands (Page 2387)"). Example: P#DB101.DBX 0.0 BYTE 223
RD	Input	VARIANT	I, Q, M, D, L	Receive buffer This buffer is only relevant for commands which deliver answer data. The parameter refers to a memory area in which a command response is stored (see "ASi commands (Page 2387)"). Example: P#DB102.DBX 224.0 BYTE 221
DONE	Output	BOOL	Q, M, D, L	DONE = TRUE: Job completed without errors.
BUSY	Output	BOOL	Q, M, D, L	BUSY = TRUE: Job in progress.
ERROR	Output	BOOL	Q, M, D, L	ERROR = TRUE: Job aborted with error.
STATUS	Output	DWORD	M, D	Job status / error code See the "STATUS parameter" description.

For additional information on valid data types, refer to "Overview of the valid data types (Page 1077)".

**Note**

**Parameters LADDR, SD, and RD**

The parameters LADDR, SD, and RD must not be changed in any block cycle when a job is in progress: they must remain constant.

**STATUS parameter**

The following table shows the possible STATUS displays dependent upon DONE and ERROR.

DONE	ERROR	STATUS	Meaning
0	0	00700000 <sub>H</sub>	First call with REQ = FALSE; no active job.
0	0	00700100 <sub>H</sub>	First call with REQ = TRUE; job has started.
0	0	00700200 <sub>H</sub>	Subsequent call (REQ irrelevant); job is still in progress.
1	0	00000000 <sub>H</sub>	Job completed without errors. No response data.
1	0	0000xx00 <sub>H</sub>	Job completed without errors. Number of xx bytes of response data.
0	1	C0818400 <sub>H</sub>	Data type of formal operand RD invalid.
0	1	C0818500 <sub>H</sub>	Error in communication with AS-i master (incorrect address configured at the LADDR parameter).
0	1	C0838100 <sub>H</sub>	Incorrect AS-i slave address.
0	1	C0838200 <sub>H</sub>	AS-i slave is not enabled (not in LAS).
0	1	C0838300 <sub>H</sub>	Error at the AS interface (the SD parameter may have been set too small).
0	1	C0838400 <sub>H</sub>	The command is not valid with the current AS-i master status.
0	1	C0838500 <sub>H</sub>	There is no AS-i slave with the address "0".
0	1	C0838600 <sub>H</sub>	The AS-i slave has invalid configuration data (I/O or ID codes).
0	1	C083A100 <sub>H</sub>	The AS-i slave addressed has not been found at the AS interface.
0	1	C083A200 <sub>H</sub>	There is no AS-i slave with the address "0".
0	1	C083A300 <sub>H</sub>	There is already an AS-i slave with the new address at the AS interface.
0	1	C083A400 <sub>H</sub>	The AS-i slave address cannot be deleted.
0	1	C083A500 <sub>H</sub>	The AS-i slave address cannot be set.
0	1	C083A600 <sub>H</sub>	The AS-i slave address cannot be permanently saved.
0	1	C083A700 <sub>H</sub>	Error during reading of the extended ID1 code.
0	1	C083A800 <sub>H</sub>	The target address is not plausible (e.g. a B slave address has been used for a standard slave).
0	1	C083B100 <sub>H</sub>	A length error has occurred during string transfer.
0	1	C083B200 <sub>H</sub>	A protocol error has occurred during string transfer.
0	1	C083F800 <sub>H</sub>	Unknown job number or job parameter.
0	1	C083F900 <sub>H</sub>	The AS-i master has detected an EEPROM error.

**ASi commands****Description**

The command interface allows the controller and AS-i master to exchange parameter assignment and information data.

These commands

- provide the complete functionality of the M4 master profile of the AS-i master specifications.
- enable the AS-i master to be completely configured from the controller.

**Note**

**AS-i commands supported**

Please see the manual of the relevant AS-i master for the AS-i commands supported and a detailed description.

**General structure of the send buffer**

The general structure of the send buffer for commands and job data is set out in the table below. The area for the command number must always be filled. The number of bytes for the job data can be found in the description of the command (see AS-i master documentation). "q" is the start address of the send buffer.

Byte	Bit 7	Bit 6	Bit 5	Bit 4	Bit 3	Bit 2	Bit 1	Bit 0
	<b>Meaning</b>							
q + 0	Command number							
q + 1	Job data							
q + 2	Job data							
q + ...	Job data							

**General structure of the receive buffer**

The general structure of the receive buffer for the command response data is set out in the table below. The number of bytes for the response data depends on the command. Some commands do not return response data, and therefore only require the definition of a virtual receive buffer which is not filled with data. "n" is the start address of the receive buffer.

Byte	Bit 7	Bit 6	Bit 5	Bit 4	Bit 3	Bit 2	Bit 1	Bit 0
	<b>Meaning</b>							
n + 0	Command number (echo)							
n + 1	Response data							
n + 2	Response data							
n + ...	Response data							

**CAUTION****Memory areas can be overwritten**

If the receive buffer of the "ASI\_CTRL" instruction is too short, neighboring memory areas may be overwritten. The length specified in the ANY pointer of the RD parameter when the instruction "ASI\_CTRL" is called is irrelevant. The required length for the receive buffer can be found in the description of the command.

The following applies for command numbers 39<sub>H</sub>, 41<sub>H</sub>, 42<sub>H</sub>, 43<sub>H</sub> and 44<sub>H</sub>:

The receive buffer must be 221 bytes long (bytes 0 to 220), even if the command returns less data. Depending on the command, the highest bytes in the receive buffer may be overwritten with zero values by the AS-i master.

**AS-i commands**

A selection of possible AS-i commands is set out in the table below.

Name	Parameter	Return	Coding
Set_permanent_parameter (Set_Permanent_Parameter)	Slave address, parameter		00 <sub>H</sub>
Get_permanent_parameter (Get_Permanent_Parameter)	Slave address	Parameter	01 <sub>H</sub>
Write_parameter (Write_Parameter)	Slave address, parameter	Parameter echo	02 <sub>H</sub>
Read_parameter (Read_Parameter)	Slave address	Parameter value	03 <sub>H</sub>
Store_actual_parameters (Store_Actual_Parameters)			04 <sub>H</sub>
Set_configuration_data	Slave address, configuration		25 <sub>H</sub>
Get_configuration_data	Slave address	set configuration data	26 <sub>H</sub>
Store_actual_configuration (Store_Actual_Configuration)			07 <sub>H</sub>
Get_actual_configuration	Slave address	Actual configuration data	28 <sub>H</sub>
Configure_LPS	LPS		29 <sub>H</sub>
Set_offline_mode	Mode		0A <sub>H</sub>
Select_auto-program	Mode		0B <sub>H</sub>
Set_mode	Mode		0C <sub>H</sub>
Change_AS-iSlave_address (Change_AS-iSlave_Address)	Address1, Address2		0D <sub>H</sub>
Get_AS-iSlave_status	Slave address	Error record of the AS-i slave	0F <sub>H</sub>
Read_lists_and_flags		LDS, LAS, LPS, flags	30 <sub>H</sub>

Name	Parameter	Return	Coding
Get_overall_configuration		Actual configuration data, current parameters, LAS, flags	39 <sub>H</sub>
Set_overall_configuration	Overall configuration		3A <sub>H</sub>
Write_parameter_list	Parameter list		3C <sub>H</sub>
Read_parameter_echo_list		Parameter echo list	33 <sub>H</sub>
Write_CTT2_request	Slave address CTT2 string	CTT2 string	44 <sub>H</sub>
Read_version_identifier		Version string	14 <sub>H</sub>
Read_AS-i_slave	Slave address	ID code	17 <sub>H</sub>
Read_AS-i_slave_extended_ID1	Slave address	Extended ID1 code	37 <sub>H</sub>
Write_AS-iSlave_extended_ID1	Extended ID1 code		3F <sub>H</sub>
Read_AS-iSlave_extended_ID2	Slave address	Extended ID2 code	38 <sub>H</sub>
Read_AS-iSlave_IO	Slave address	I/O configuration	18 <sub>H</sub>
Read_I/O_error_list		LPF	3E <sub>H</sub>
Write_AS-i-slave_parameter_string	Slave address, parameter string		40 <sub>H</sub>
Read_AS-iSlave_parameter_string	Slave address	Parameter string	41 <sub>H</sub>
Read_AS-iSlave_ID_string	Slave address	ID string	42 <sub>H</sub>
Read_AS-iSlave_diagnostic_string	Slave address	Diagnostic string	43 <sub>H</sub>
Read_AS-i_line_error_counter			4A <sub>H</sub>
Read_and_clear_AS-i_line_error_counter			4B <sub>H</sub>
Read_AS-iSlave_error_counter	Slave address		4C <sub>H</sub>
Read_and_clear_AS-iSlave_error_counter	Slave address		4D <sub>H</sub>
Additional command for DP/ AS-i F-Link:			
AS-i_status/diag_of_F_slaves		Status/diagnostics of all AS-i safe slaves	51 <sub>H</sub>

**Note**

**Re-initializing the AS-i master command interface**

Another command which is not mentioned in the table is command 77<sub>H</sub>. This call re-initializes the command interface of the AS-i master. Any command which the AS-i master specified is currently processing will be terminated.

As of version V2.1.20 of DP/AS-i LINK Advanced, command 0E<sub>H</sub> is also available. This call enables you to release and block the ground fault monitoring function for a line.

### 9.7.3.5 PROFlenergy

#### Description of PROFlenergy

#### PROFlenergy

PROFlenergy is a manufacturer- and device-neutral profile for energy management with PROFINET. PROFlenergy enables central, coordinated device shutdown to reduce electricity consumption during breaks in production and unplanned interruptions.

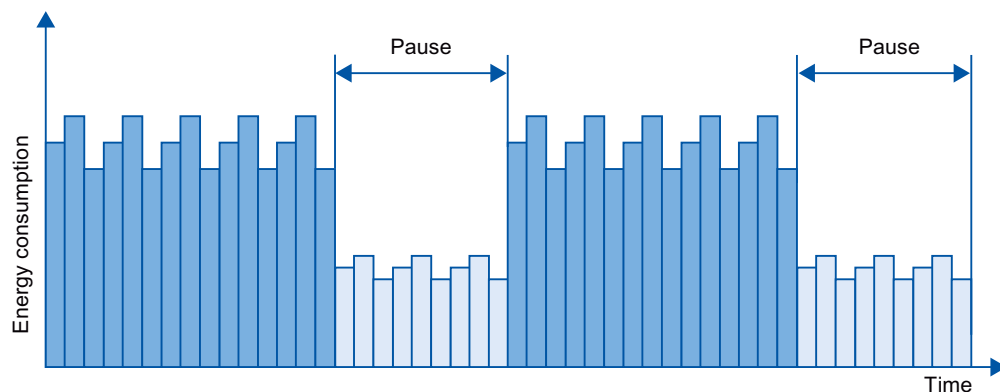

The PROFINET devices/power modules are switched off via special commands in the user program of the PROFINET IO controller. No additional hardware is required. The PROFINET devices interpret the PROFlenergy commands directly.

#### PROFlenergy controller (PE controller)

The PE controller is a PLC which enables/disables the idle state in lower-level devices. Individual production components and entire production lines are switched off and reactivated from the user program. Commands (e.g. "Start\_Pause" and "End\_Pause") are sent to the lower-level device using corresponding instructions (function blocks). The commands are sent via the PROFINET communication protocol.

#### PROFlenergy entity (PE entity)

The PE entity receives the PROFlenergy commands of the PE controller and executes these accordingly (for example, by returning a measured value or activating an energy saving mode). Implementation of the PE entity in a PROFlenergy-capable device is device- and manufacturer-specific.

The PE entity can, for example, be executed:

- Within the proxy of a submodule: The PE commands are valid for the addressed submodule and any existing lower-level submodules.
- Within the proxy of a module: The PE commands are valid for different submodules within the module.

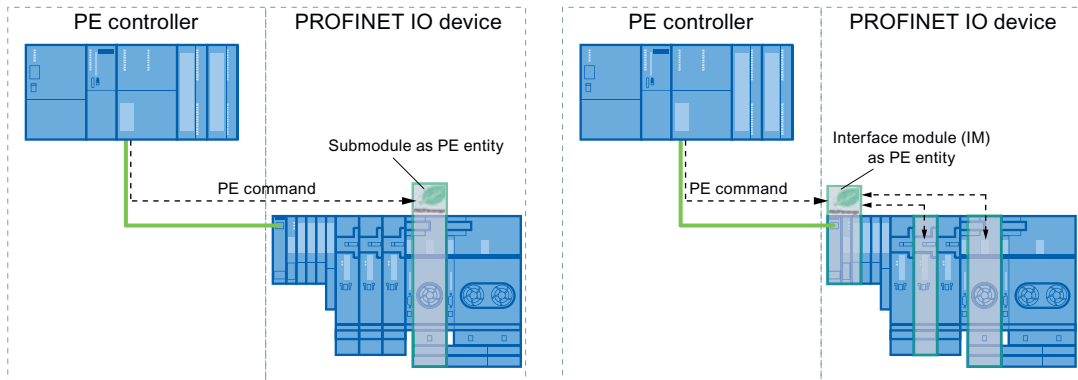

- For networked submodules without a proxy function: The PE commands in this case are only valid for the respective submodule.

## PROFenergy instructions

- Instructions for IO controller
  - The "PE\_START\_END (Page 2393)" instruction represents the simplest way to activate or deactivate the idle state of the PROFINET devices (PROFenergy commands "Start\_Pause" and "End\_Pause"). This is done using a positive and negative signal edge in the instruction.
  - The "PE\_CMD (Page 2397)" instruction allows you to transmit all PROFenergy commands, including "Start\_Pause" and "End\_Pause". With other commands, you can query the current status of the PROFINET devices or the behavior during breaks, for example.
  - The instruction "PE\_DS3\_Write\_ET200S (Page 2402)" is used to define the switching characteristic of up to 8 slots of ET 200S. The instruction is not a PROFenergy instruction; however, it supplements the PROFenergy functions for an ET 200S.
- Instruction for iDevices
 

The "PE\_I\_DEV (Page 2415)" instruction allows you to implement PROFenergy on iDevices as well. The instruction receives PROFenergy commands on the iDevice and forwards these to the user program for processing. After processing the command, the user program calls the "PE\_I\_DEV (Page 2415)" instruction again in order to send the acknowledgement to the IO controller. For these replies, each command offers you a corresponding auxiliary block that supplies the response data to the instruction "PE\_I\_DEV (Page 2415)".



## PROFenergy commands (PE commands)

The PE controller transmits PE commands to the PE entity. The PE command can be either a control command to switch a PE entity to the energy-saving mode, or a command to read a status or measured value:

- PI commands for control  
PROFenergy supports two control commands that can be executed using either the "PE\_Start\_End (Page 2393)" instruction or the "PE\_CMD (Page 2397)" instruction:
  - Start\_Pause: Starting a suitable energy-saving mode (PE Energy-saving mode)
  - End\_Pause: Exiting the energy-saving mode (switch to PE\_ready\_to\_operate mode)
- PI commands for reading a status or measured value  
Certain condition information can be read by the control system using the following status commands with the instruction "PE\_CMD (Page 2397)":
  - PE\_Identify: Read out which PE commands are supported by the PE entity.
  - PEM\_Status: Read out the currently active mode of a PE entity (e. g. PE\_ready\_to\_operate).
  - Query\_Modes: Output an overview of all supported energy-saving modes, including the time and energy information
  - Query\_Measurement: Output the measured values of a PE entity

## Example applications

Examples for use of PROFenergy instructions can be found in the Industry Online Support in the entry "PROFenergy - Saving Energy with SIMATIC S7 (<http://support.automation.siemens.com/WW/view/en/41986454>)".

## See also

Service and Support (<http://support.automation.siemens.com/>)

## IO controller

### PE\_START\_END: Start and exit energy-saving mode

#### Description

The instruction "PE\_START\_END" is used to start and exit the energy-saving mode of a specified PE entity (e.g. ET 200S).

The instruction "PE\_START\_END" is used in the PE controller, preferably when only field devices from which energy data does not need to be read out are connected to the corresponding PE devices. Alternatively, the instruction "PE\_CMD (Page 2397)" can be used to read energy data.

The energy-saving modes are configured in the user program of the PE controller. On completion of the "PE\_START\_END" instruction, the PE entity reports its current energy-saving mode and outputs this data at parameter PE\_MODE\_ID.

**Write and read jobs of the "PE\_START\_END" instruction.**

The instruction "PE\_START\_END" sends a PROFlenergy command internally as a write job to the PE entity using "WRREC (Page 2323)". "PE\_START\_END" then waits for acknowledgement from the PE entity. The acknowledgement data record is read with the instruction "RDREC (Page 2321)" every 100 milliseconds. Until acknowledgment is received from the PE entity, the function repeats the read job for 10 seconds at intervals of 100 milliseconds. The response data returned by the PE entity is also read with the instruction "RDREC (Page 2321)".

Below is a flowchart of the write and read jobs:

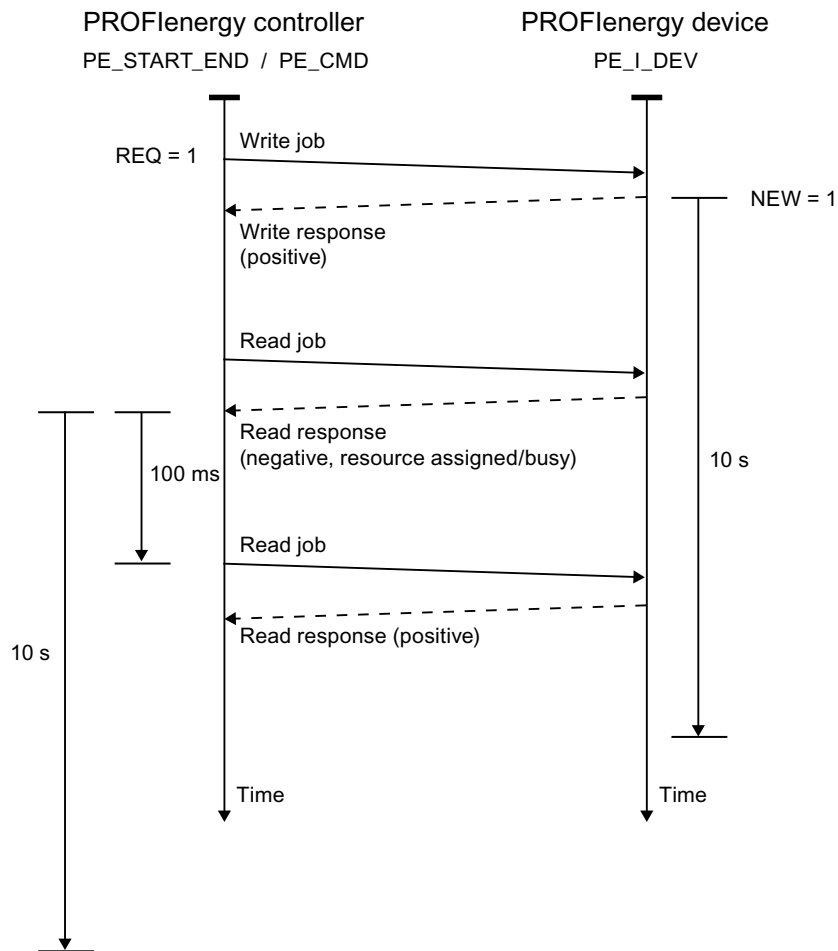

## Parameter

The following table shows the parameters of the instruction "PE\_START\_END":

Parameter	Declaration	Data type	Memory area	Description
START	Input	BOOL	I, Q, M, D, L or constant	Transmitting the PE command "Start_Pause" to the PE entity with the address set at parameter ID.
END	Input	BOOL	I, Q, M, D, L or constant	Transmitting the PE command "End_Pause" to the PE entity with the address set at parameter ID.
ID	Input	HW_SUBMODULE	I, Q, M, D, L or constant	Address of the PE entity (e.g., ET 200S). The address may be taken from the hardware configuration.
PAUSE_TIME	Input	TIME	I, Q, M, D, L or constant	Planned pause duration. <ul style="list-style-type: none"> <li>• Range: T#1MS to T#24D20H31M23S647MS</li> <li>• Start value: T#0MS</li> </ul>
VALID	Output	BOOL	I, Q, M, D, L	PE command successfully sent.
BUSY	Output	BOOL	I, Q, M, D, L	PE command still being processed.
ERROR	Output	BOOL	I, Q, M, D, L	Error occurred during processing. The error message is output at the STATUS parameter.
STATUS	Output	DWORD	I, Q, M, D, L	Block status / error number (see "STATUS parameter")
PE_MODE_ID	Output	BYTE	I, Q, M, D, L	Identification number of energy-saving mode (energy-saving level for the duration of the pause).

For additional information on valid data types, refer to "Overview of the valid data types (Page 1077)".

## PAUSE\_TIME parameter

The parameter PAUSE\_TIME is used to set the default duration of the energy-saving period at the PE entity. The PE entity checks whether the pause period is of sufficient length and whether it can be implemented. The minimum pause duration (Time\_min\_Pause) must be

greater than the sum of the times the device needs to switch to energy-saving mode (Time\_to\_Pause) and to switch back to operating mode (Time\_to\_Operate).

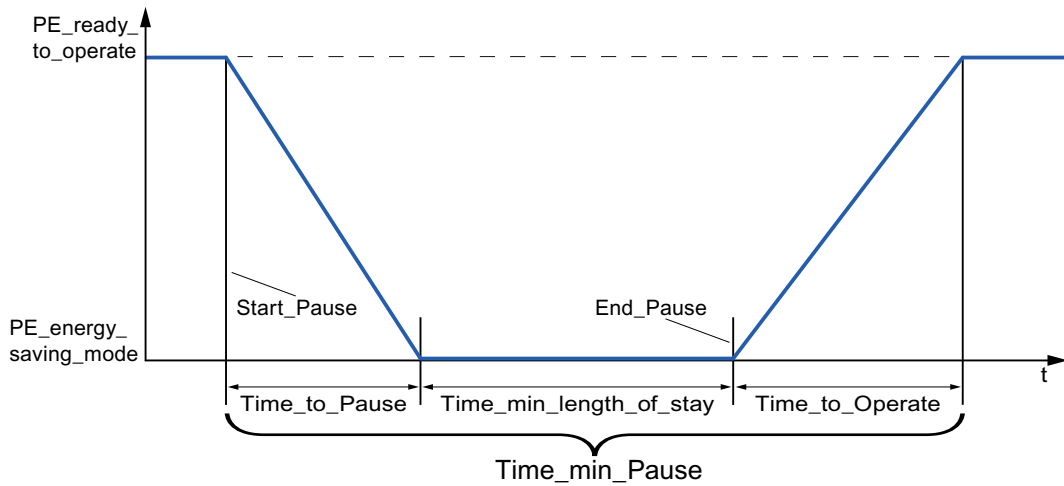

ET 200S checks whether the scheduled pause duration is greater than or equal to the minimum pause duration (PM-E\_Pause\_Min) saved on the ET 200S. This is fixed at 10 seconds. If a shorter pause is used, the power modules (PM-E) of the ET 200S will remain on.

The module does not switch back on automatically at the end of the pause; it remains in OFF mode until the "END" command is sent. This prevents uncoordinated switch-on, which can cause undesired peak loads.

**STATUS parameter**

Error information is output at the STATUS output parameter. If it is interpreted as ARRAY[1...4] of BYTE, the error information has the following structure:

Field element	Name	Meaning
STATUS[1]	Function_Num	Cause of the error <ul style="list-style-type: none"> <li>• B#16#00: No error</li> <li>• B#16#DE: Error during reading of data record</li> <li>• B#16#DF: Error during writing of data record</li> <li>• B#16#C0: Error message from the instruction or from the communication instructions "RDREC (Page 2321)" and "WRREC (Page 2323)" used internally.</li> </ul>
STATUS[2]	Error Decode	Location of the error ID <ul style="list-style-type: none"> <li>• 80: DPV1 error as defined in IEC 61158-6 or application-specific</li> <li>• FE: DP/PNIO profiles - PROFIenergy-specific error</li> </ul>

Field element	Name	Meaning
STATUS[3]	Error_Code_1	Error ID <ul style="list-style-type: none"> <li>• When Error_Decode = <b>80</b>:               <ul style="list-style-type: none"> <li>– <b>80</b>: Simultaneous rising edge at the input parameters START and END.</li> <li>– <b>81</b>: Length conflict at the CMD_PARAM and CMD_PARAM_LEN parameters.</li> <li>– <b>82-8F</b>: Other error messages (reserved)</li> </ul> </li> <li>• When Error_Decode = <b>FE</b>:               <ul style="list-style-type: none"> <li>– <b>01</b>: "Service Request ID" invalid</li> <li>– <b>02</b>: Incorrect "Request_Reference"</li> <li>– <b>03</b>: "Modifier" invalid</li> <li>– <b>04</b>: "Data Structure Identifier RQ" invalid</li> <li>– <b>05</b>: "Data Structure Identifier RS" invalid</li> <li>– <b>06</b>: "PE energy-saving modes" are not supported</li> <li>– <b>07</b>: "Response" is too long (maximum transmissible length exceeded)</li> <li>– <b>08</b>: "Count" invalid</li> <li>– <b>50</b>: No suitable "energy mode" is available.</li> <li>– <b>51</b>: Time value specified is not supported.</li> <li>– <b>52</b>: "PE_Mode_ID" invalid</li> </ul> </li> </ul>
STATUS[4]	Error_Code_2	Manufacturer-specific error ID extension

**Note****Error messages of the instructions RDREC and WRREC**

The instruction "PE\_START\_END" uses the instructions "WRREC (Page 2323)" and "RDREC (Page 2321)" for communication. Error messages for these instructions are output in the field elements STATUS[1] to STATUS[4].

Please see the description of the corresponding STATUS (Page 2330) parameter for an explanation of the error codes of the "WRREC (Page 2323)" and "RDREC (Page 2321)" instructions.

**See also**

Description of PROFlenergy (Page 2391)

**PE\_CMD: Start and exit energy-saving mode / Read out status information****Description**

The instruction "PE\_CMD" is used in the PE controller to start or terminate a pause in the energy-saving mode in the PE entity. Additional information and energy measurements can also be read out from a PE entity using "PE\_CMD".

The instruction is best used with PE controllers to which assigned PE devices are connected from which energy measurements are to be read out. If this is not the case, the instruction "PE\_START\_END (Page 2393)" can also be used to start and end the pauses.

### Transfer of the PROFlenergy commands (PE commands)

The instruction "PE\_CMD" transfers a PROFlenergy command to a PE entity.

The instruction can also be used if additional commands are to be added to the PROFlenergy profile in future. The commands which can be used with the current PROFlenergy profile are listed in the description of the CMD and CMD\_MODIFIER parameters (see the "CMD and CMD\_MODIFIER parameters" table).

- The individual PE commands which are transferred to the PE entity using the instruction are assigned defined "Service\_Request\_IDs". The Service\_Request\_IDs 01 to 05 and 16 are assigned at the CMD parameter.
- The two PE commands 04 (Query\_Modes) and 16 (Query\_Measurement) are defined in more detail with the CMD\_MODIFIER parameter.
- Additional values are transferred at the CMD\_PARA parameter for individual PE commands (see the description of the individual PE commands). The parameter CMD\_PARA\_LEN defines the length of the data at the parameter CMD\_PARA.

The commands are transferred without plausibility test. The response data of the PE entity is saved to the RESPONSE\_DATA data area that is addressed by VARIANT pointer (for information about the response frame contents, refer to the description of the respective PE command).

### Write and read jobs of the "PE\_CMD" instruction.

The instruction "PE\_CMD" uses "WRREC (Page 2323)" internally to transmit a PROFlenergy command as a write job to the PE entity. "PE\_CMD" then waits for acknowledgement from the PE entity. The acknowledgement data record is read with the instruction "RDREC (Page 2321)" every 100 milliseconds. Until acknowledgment is received from the PE entity, the function repeats the read job for 10 seconds at intervals of 100 milliseconds. The response data of the PE entity is also read with the instruction "RDREC (Page 2321)".

Below is a flowchart of the write and read jobs:

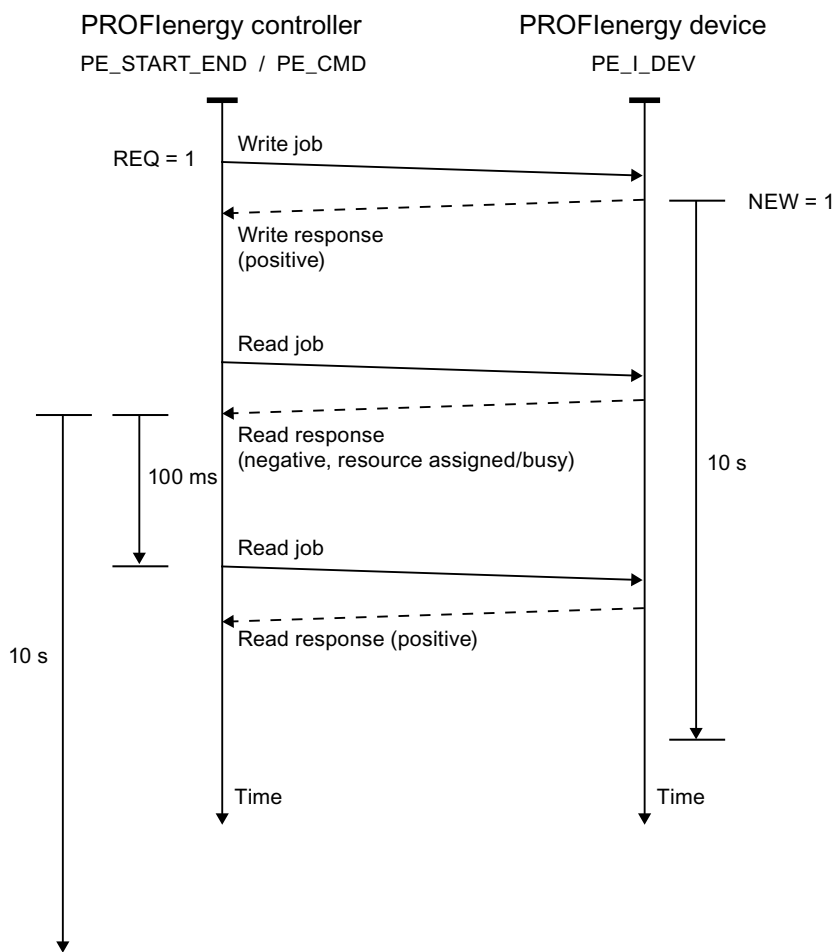

### Parameter

The following table shows the parameters of the instruction "PE\_CMD":

Parameter	Declaration	Data type	Memory area	Description
REQ	Input	BOOL	I, Q, M, D, L or constant	Starts transferring the PE command upon a positive edge.
ID	Input	HW_SUBMODULE	I, Q, M, D, L or constant	Address of the PE entity For PROFINET IO devices, you can apply the address from the hardware configuration.
CMD	Input	BYTE	I, Q, M, D, L or constant	Service-Request-ID of the PROFlenergy command in accordance with the PROFlenergy profile (see "CMD and CMD_MODIFIER parameters"). Further service request IDs are possible following extensions of the PROFlenergy profile.

9.7 References

Parameter	Declaration	Data type	Memory area	Description
CMD_MODIFIER	Input	BYTE	I, Q, M, D, L or constant	PROFenergy sub-command (only when CMD=3 or CMD=16, see "CMD and CMD_MODIFIER parameters") Further sub-commands are possible following extensions of the PROFenergy profile.
CMD_PARA	Input	VARIANT	I, Q, M, D, L	Parameters for the PE commands: <ul style="list-style-type: none"> <li>Get mode: PE_mode_ID</li> <li>Get measurement values: List of Measurement_Ids</li> </ul> The complete Service Data Request is entered.
CMD_PARA_LEN	Input	INT	I, Q, M, D, L	The actual length of the command parameters (<= length defined in CMD_PARA; is verified by the instruction).
RESPONSE_DATA	InOut	VARIANT	I, Q, M, D, L	PROFenergy information May be complete response frame including block header, depending on the command. Note: If the buffer is too small, only the number of bytes which is specified in the VARIANT pointer will be entered.
VALID	Output	BOOL	I, Q, M, D, L	Command successfully sent.
BUSY	Output	BOOL	I, Q, M, D, L	Command still being processed.
ERROR	Output	BOOL	I, Q, M, D, L	Error occurred during processing.
STATUS	Output	DWORD	I, Q, M, D, L	Block status / error number (see "STATUS parameter"):

For additional information on valid data types, refer to "Overview of the valid data types (Page 1077)".

Parameters CMD and CMD\_MODIFIER

CMD	CMD_MODIFIER	PROFenergy command	Description
01	0	Start_Pause (Page 2405)	Start energy-saving mode or switch to a different energy-saving mode.
02	0	End_Pause (Page 2405)	End energy-saving mode.
03	1	Query_Modes - List of energy-saving modes (Page 2406)	Output the energy-saving modes supported.
	2	Query_Modes - Get mode (Page 2407)	Output attributes of the energy-saving mode currently enabled.
04	0	PEM_Status (Page 2409)	Query status of energy-saving mode.
05	0	PE_Identify (Page 2410)	Read out the number and description of PE commands supported.



CMD	CMD_MODIFIER	PROFenergy command	Description
16	1	Query_Measurement - Get_Measurement_List (Page 2411)	List the measured values supported by the PE entity.
	2	Query_Measurement - Get_Measurement_Values (Page 2413)	Output the measured values of the PE entity.

### STATUS parameter

Error information is output at the STATUS output parameter. If it is interpreted as ARRAY[1..4] of BYTE, the error information has the following structure:

Field element	Name	Meaning
STATUS[1]	Function_Num	Cause of the error <ul style="list-style-type: none"> <li>• B#16#00: No error</li> <li>• B#16#DE: Error during reading of data record</li> <li>• B#16#DF: Error during writing of data record</li> <li>• B#16#C0: Error message from the internal communication instructions "RDREC (Page 2321)" and "WRREC (Page 2323)".</li> </ul>
STATUS[2]	Error Decode	Location of the error ID <ul style="list-style-type: none"> <li>• <b>80</b>: DPV1 error as defined in IEC 61158-6 or application-specific</li> <li>• <b>FE</b>: DP/PNIO profiles - PROFenergy-specific error</li> </ul>
STATUS[3]	Error_Code_1	Error ID <ul style="list-style-type: none"> <li>• When Error_Decode = <b>80</b>: <ul style="list-style-type: none"> <li>– <b>81</b>: Length conflict at the CMD_PARA and CMD_PARA_LEN parameters, or maximum data record length (4095 bytes) exceeded.</li> <li>– <b>82-8F</b>: Other error messages (reserved)</li> </ul> </li> <li>• When Error_Decode = <b>FE</b>: <ul style="list-style-type: none"> <li>– <b>01</b>: "Service Request ID" invalid</li> <li>– <b>02</b>: Incorrect "Request_Reference"</li> <li>– <b>03</b>: "Modifier" invalid</li> <li>– <b>04</b>: "Data Structure Identifier RQ" invalid</li> <li>– <b>05</b>: "Data Structure Identifier RS" invalid</li> <li>– <b>06</b>: "PE energy-saving modes" are not supported</li> <li>– <b>07</b>: "Response" is too long (maximum transmissible length exceeded)</li> <li>– <b>08</b>: "Count" invalid</li> <li>– <b>50</b>: No suitable energy-saving mode (energy mode) is available.</li> <li>– <b>51</b>: Time value specified is not supported.</li> <li>– <b>52</b>: "PE_Mode_ID" invalid</li> </ul> </li> </ul>
STATUS[4]	Error_Code_2	Manufacturer-specific error ID extension

---

**Note**

**Error messages of the instructions RDREC and WRREC**

The "PE\_CMD" instructions use the "WRREC (Page 2323)" and "RDREC (Page 2321)" instructions for communication. Error messages for these instructions are output in the field elements STATUS[1] to STATUS[4].

Please see the description of the corresponding STATUS (Page 2330) parameter for an explanation of the error codes of the "WRREC (Page 2323)" and "RDREC (Page 2321)" instructions.

---

**See also**

Description of PROFlenergy (Page 2391)

**PE\_DS3\_Write\_ET200S: Set power module switching behavior**

**Description**

The instruction "PE\_DS3\_Write\_ET200S" sends basic settings for power module switching behavior to the ET 200S. The switching behavior of up to 8 slots in the ET 200S (e.g. for power modules) can be defined with the instruction "PE\_DS3\_Write\_ET200S".

---

**Note**

This instruction is not part of the PROFlenergy profile, but supplements SIMATIC-specific functions.

---

**Parameter**

The following table shows the parameters of the instruction "PE\_DS3\_Write\_ET200S":

Parameter	Declaration	Data type	Memory area	Description
ENABLE	Input	BOOL	I, Q, M, D, L or constant	A positive edge triggers the transfer of the data record. The data record must be transferred again after voltage OFF/ON.
ID	Input	HW_SUBMODULE	I, Q, M, D, L or constant	Address of the ET 200S The address may be taken from the hardware configuration.
SLOT_NO_X	Input	INT	I, Q, M, D, L or constant	Slot number of switchable power module X.

Parameter	Declaration	Data type	Memory area	Description
FUNC_X	Input	INT	I, Q, M, D, L or constant	Function of the module in this slot. The switching behavior of the PM-E (ET 200S power module) is defined using the FUNC_X parameter: <ul style="list-style-type: none"> <li>• FALSE: <ul style="list-style-type: none"> <li>- With "PAUSE_START": <ul style="list-style-type: none"> <li>-No effect on PM-E</li> <li>-PM-E remains on</li> </ul> </li> <li>- With "PAUSE_STOP": <ul style="list-style-type: none"> <li>-Switches PM_E back on</li> </ul> </li> </ul> </li> <li>• TRUE: <ul style="list-style-type: none"> <li>- With "PAUSE_START": <ul style="list-style-type: none"> <li>-Switches PM_E off</li> </ul> </li> <li>- With "PAUSE_STOP": <ul style="list-style-type: none"> <li>-Switches PM-E back on</li> </ul> </li> </ul> </li> </ul>
BUSY	Output	BOOL	I, Q, M, D, L	Transfer not yet complete.
DONE	Output	BOOL	I, Q, M, D, L	Transfer completed without errors.
ERROR	Output	BOOL	I, Q, M, D, L	Transfer completed with error.
STATUS	Output	DWORD	I, Q, M, D, L	Error number (see STATUS parameter of the instruction "PE_Start_End (Page 2393)")

For additional information on valid data types, refer to "Overview of the valid data types (Page 1077)".

## See also

Description of PROFlenergy (Page 2391)

## PROFlenergy commands

### Structure of the message frames

### Structure of the response frame in accordance with the PROFlenergy profile

The table below shows the basic structure of the response frame in accordance with the PROFlenergy profile. The response frame consists of a general section (Header) and a specific section (Service Data Response). The contents of the specific section of the response frame can be found in the description of the relevant PROFlenergy command.

Block definition	Attributes	Value	Data type	Description
BlockHeader	BlockType	801 <sub>hex</sub>	WORD	
	BlockLength		WORD	Number of bytes without consideration of the fields BlockType and BlockLength.
	BlockVersionHigh	1 <sub>hex</sub>	BYTE	
	BlockVersionLow	0 <sub>hex</sub>	BYTE	

9.7 References

Block definition	Attributes	Value	Data type	Description
Response Header	Service_Request_ID	1 <sub>hex</sub> to FF <sub>hex</sub>	BYTE	ID of the PI command executed. The ID of the PE command processed by the PE entity is returned in the response frame: <ul style="list-style-type: none"> <li>• 01: Start_Pause</li> <li>• 02: End_Pause</li> <li>• 03: Query_Modes</li> <li>• 04: PEM_Status</li> <li>• 05: PE_Identify</li> <li>• 06 to 09: Reserved</li> <li>• 16: Query_Measurement</li> <li>• 11 to CF: Reserved</li> <li>• D0 to FF: Manufacturer-specific</li> </ul>
	Request_Reference	1 <sub>hex</sub> to FF <sub>hex</sub>	BYTE	Unique number to identify the query/response pair (returned by the server in the response).
Service Header Response	Status	1 <sub>hex</sub> to FF <sub>hex</sub>	BYTE	Information whether or not the PI command was executed: <ul style="list-style-type: none"> <li>• 00: Reserved</li> <li>• 01: Completed</li> <li>• 02: Completed with error</li> <li>• 03: Data incomplete</li> <li>• 04 to CF: Reserved</li> <li>• D0 to FF: Depends on the Service_Request_ID</li> </ul>
	Data_Structure_Identifier_RS	1 <sub>hex</sub> to FF <sub>hex</sub>	BYTE	<ul style="list-style-type: none"> <li>• 00: Reserved</li> <li>• 01 to FF: Data structure depends on the Service_Request_ID</li> <li>• 0xFF - Error</li> </ul>
Service Data Response				Depends on the Service-Request-ID: <ul style="list-style-type: none"> <li>• For the service request IDs, see the CMD and CMD_MODIFIER parameters of the instruction "PE_CMD (Page 2397)".</li> <li>• The specific contents of the response frame can be found in the description of the PE command (see for example the "Start_Pause (Page 2405)" command).</li> </ul>

## PI Command "Start\_Pause"

### Description

Use the PE command "Start\_Pause" to start the energy-saving mode. The command Start\_Pause can be used to:

- Switch the PE from "ready" state (PE\_ready\_to\_operate) to an energy-saving mode (PE\_energy\_saving\_mode).
- The PE entity can automatically switch between the energy-saving modes. Energy consumption can increase or decrease when you switch energy-saving mode.

### Calling the PI command "Start\_Pause"

The command "Start\_Pause" is called with the instruction "PE\_CMD (Page 2397)" with the following parameters:

Parameter	Value	Description
CMD	1	Call of PE command "Start_Pause".
CMD_MODIFIER	0	There are no additional specifications of the command call for command "Start_Pause".
CMD_PARA_LEN	4	Length of the CMD_PARA parameter of 4 bytes.
CMD_PARA	VARIANT	VARIANT pointer to the value for "Pause_Time" (TIME).

### Response frame (Service Data Response)

The following response frame data of the PE entity is written to the data block that is referenced at parameter RESPONSE\_DATA (see instruction "PE\_CMD (Page 2397)"):

Attribute	Value	Data type	Description
PE_Mode_ID	1 to 255	BYTE	Identification number of the energy-saving mode
Reserved	0	BYTE	-

## PI Command "End\_Pause"

### Description

The PE command "End\_Pause" is used to end the energy-saving mode of the PE entity.

**Calling the PE command "End\_Pause"**

The command "End\_Pause" is called with the instruction "PE\_CMD (Page 2397)" with the following parameters:

Parameter	Value	Description
CMD	2	Call of PE command "End_Pause".
CMD_MODIFIER	0	There are no additional specifications of the command call for command "End_Pause".
CMD_PARA_LEN	0	Length of the CMD_PARA parameter of 0 bytes.
CMD_PARA	irrelevant	-

**Response frame (Service Data Response)**

The following data of the PE entity response frame is written to the data block referenced at the RESPONSE\_DATA parameter (see "PE\_CMD (Page 2397)"):

Attribute	Value	Data type	Description
Time_to_operate	-	DWORD	Expected time it takes to switch to the "PE_ready_to_operate" mode.

**PI command "Query\_modes" - "List\_Energy\_Saving\_Modes"**

**Description**

Use PE command "Query\_modes" and sub-command (modifier) "List\_Energy\_Saving\_Modes" to output all energy-saving modes (PE\_Mode\_ID) supported by the PE entity.

The query result is written in the form of a response frame to the data block referenced by the RESPONSE\_DATA parameter.

**Calling the PE command "Query\_modes" - "List\_Energy\_Saving\_Modes"**

The command "List\_Energy\_Saving\_Modes" is called with the instruction "PE\_CMD (Page 2397)" with the following parameters:

Parameter	Value	Description
CMD	3	Call of PE command "Query_modes".
CMD_MODIFIER	1	Specification of the command call: Select the sub-command "List_Energy_Saving_Modes" to output the number and types of energy-saving modes supported.
CMD_PARA_LEN	0	Length of the CMD_PARA parameter of 0 bytes.
CMD_PARA	irrelevant	-

### Response frame (Service Data Response)

The following data of the PE entity response frame is written to the data block referenced at the RESPONSE\_DATA parameter (see "PE\_CMD (Page 2397)"):

Attribute	Value	Data type	Description
Number_of_PE_Mode_IDs	1	BYTE	The number of energy-saving modes.
PE_Mode_IDs	-	Array [...] of BYTE	Array with the IDs of the supported energy-saving modes. The meaning of the individual IDs depends on the PE entity.

### PI command "Query\_modes" - "Get\_Mode"

#### Description

You use the PE command "Query\_modes" and the sub-command (modifier) "Get\_Mode" to output the attributes of the energy-saving mode which is currently enabled.

### Calling the PE command "Query\_modes" - "Get\_Mode"

The call of the command with the instruction "PE\_CMD" occurs with the following parameters:

Parameter	Value	Description
CMD	3	Call of the PE command "Query_modes"
CMD_MODIFIER	2	Specification of the command call: Select the sub-command "Get_Mode" to output the status of the mode which is currently enabled.
CMD_PARA_LEN	1	Length of the CMD_PARA parameter of 1 byte.
CMD_PARA	VARIANT	VARIANT pointer to the value for PE_MODE_ID.

**Response frame (Service Data Response)**

The following data of the PE entity response frame is written to the data block referenced at the RESPONSE\_DATA parameter (see "PE\_CMD (Page 2397)"):

Attribute	Value	Data type	Description
PE_Mode_ID	<ul style="list-style-type: none"> <li>• 0 "PE_power_off" mode</li> <li>• 1...254 Energy-saving mode of the PE entity (manufacturer-specific)</li> <li>• 255 "PE_ready_to_operate" mode</li> </ul>	BYTE	ID of the energy-saving mode currently enabled.
PE_Mode_Attributes	Bit 0: <ul style="list-style-type: none"> <li>• = 0: Only static energy consumer and time values are available.</li> <li>• = 1: Dynamic energy consumer and time values are available.</li> </ul> Bit 1 to 7: <ul style="list-style-type: none"> <li>• Reserved</li> </ul>	BYTE	
Time_min_Pause <sup>1</sup>	Time difference without date	DWORD	Minimum pause time for the PI mode. The minimum pause time is the sum of the values of the following attributes: <ul style="list-style-type: none"> <li>• Time_to_Pause</li> <li>• Time_to_operate</li> <li>• Time_min_length_of_stay</li> </ul> See the description "PAUSE_TIME parameter" of the instruction "PE_START_END: Start and exit energy-saving mode (Page 2393)".
Time_to_Pause <sup>1</sup>	Time difference without date	DWORD	Switch off time: Duration from call of energy-saving mode to start of energy-saving mode (transition duration of PE_ready_to_operate to PE_energy_saving_mode). The switch-off time depends on the PE entity.
Time_to_operate <sup>1</sup>	Time difference without date	DWORD	Switch-on time: Duration of the transition from energy-saving mode (PE_energy_saving_mode) to ready to operate mode (PE_ready_to_operate). The PE entity calculates the duration dynamically in the output operation.
Time_min_length_of_stay <sup>1</sup>		DWORD	Minimum active period of the energy-saving mode on the PE entity.
Time_max_length_of_stay <sup>1</sup>		DWORD	Maximum active period of the energy-saving mode on the PE entity.
Mode_Power_Consumption <sup>2</sup>		REAL	Power consumption of the PE entity in active energy-saving mode. Unit: kW



Attribute	Value	Data type	Description
Energy_Consumption_to_pause <sup>2</sup>		REAL	Energy consumption of the PE entity during transition from ready-to-operate mode (PE_ready_to_operate) to energy-saving mode (PE_energy_saving_mode) Unit: kWh
Energy_Consumption_to_operate <sup>2</sup>		REAL	Energy consumption of the PE entity during transition from energy-saving mode (PE_energy_saving_mode) to ready-to-operate mode (PE_ready_to_operate) Unit: kWh

<sup>1</sup> If the duration is infinite, 0xFFFFFFFF will be output. If the duration is zero, "0" will be output.

<sup>2</sup> If the data for energy and power consumption is not defined by the PE entity, "0.0" will be output as the value.

## PI command "PEM\_Status"

### Description

The PE command "PEM\_Status" is used to query the status of a PE entity energy-saving mode that is currently enabled.

### Calling the PE command "PEM\_Status"

The command "PEM\_Status" is called with the instruction "PE\_CMD" with the following parameters:

Parameter	Value	Description
CMD	4	Call of PE command "PEM_Status".
CMD_MODIFIER	0	There are no other specifications of the command call for command "PEM_Status".
CMD_PARA_LEN	0	Length of the CMD_PARA parameter of 0 bytes.
CMD_PARA	irrelevant	-

**Response frame (Service Data Response)**

The following data of the PE entity response frame is written to the data block referenced at the RESPONSE\_DATA parameter (see "PE\_CMD (Page 2397)"):

Attribute	Value	Data type	Description
PE_Mode_ID_Source	<ul style="list-style-type: none"> <li>• 0 "PE_power_off" mode</li> <li>• 1 to 254 Energy-saving mode of the PE entity (manufacturer-specific)</li> <li>• 255 "PE_ready_to_operate" mode</li> </ul>	BYTE	Mode of the PE entity before a PE command is sent.
PE_Mode_ID_Destination	<ul style="list-style-type: none"> <li>• 0 "PE_power_off" mode</li> <li>• 1 to 254 Energy-saving mode of the PE entity (manufacturer-specific)</li> <li>• 255 "PE_ready_to_operate" mode</li> </ul>	BYTE	Mode of the PE entity after a PE command is executed.
Time_to_operate	Time difference without date	DWORD	Switch-on time: Duration of the transition from energy-saving mode (PE_energy_saving_mode) to ready to operate mode (PE_ready_to_operate). The PE entity calculates the duration dynamically during output.
Remaining_time_to_destination	Time difference without date	DWORD	Remaining time to switch to another mode.
Mode_Power_Consumption		REAL	Power consumption of the PE entity in active energy-saving mode. Unit: kW
Energy_Consumption_to_Destination		REAL	Energy consumption for the current PI transition Unit: kWh
Energy_Consumption_to_operate		REAL	Energy consumption of the PE entity during transition from energy-saving mode (PE_energy-saving mode) to ready-to-operate mode (PE_ready_to_operate) Unit: kWh

**PI command "PE\_Identify"**

**Description**

The PE command "PE\_Identify" is used to read out the number and description of PE commands supported by the PE entity. The number of specific commands supported depends on the PE entity. As PE\_Identify is itself a PE command, at least three supported PE commands will be output upon a positive response: Start\_Pause, End\_Pause and PE\_Identify.

### Calling the PE command "PE\_Identify"

The command "PE\_Identify" is called with the instruction "PE\_CMD (Page 2397)" with the following parameters:

Parameter	Value	Description
CMD	5	Call of the command "PE_Identify".
CMD_MODIFIER	0	There are no other specifications of the command call for command "PE_Identify".
CMD_PARA_LEN	0	Length of the CMD_PARA parameter of 0 bytes.
CMD_PARA	irrelevant	-

### Response frame (Service Data Response)

The following data of the PE entity response frame is written to the data block referenced at the RESPONSE\_DATA parameter (see "PE\_CMD (Page 2397)"):

Attribute	Value	Data type	Description
Count <sup>1</sup>	6	BYTE	Number of supported PROFINergy commands
Start_Pause	1	BYTE	First PE command supported (Service_Request_ID)
End_Pause	2	BYTE	...
Query_Modes	3	BYTE	...
PEM_Status	4	BYTE	...
PE_Identify	5	BYTE	...
Query_Measurement	16	BYTE	Last PE command supported (Service_Request_ID)

<sup>1</sup> The number of commands supported is manufacturer-specific and depends on the PE entity used. The values given are an example of a response frame where all 6 PE commands are supported.

### PI Command "Query\_Measurement" - "Get\_Measurement\_list"

#### Description

Use the PE command "Query\_Measurement" and sub-command (modifier) "Get\_measurement\_list" to query the specific measured values supported by the PE entity. The supported measured values are output as a list in the data block referenced by the RESPONSE\_DATA parameter.

**Calling the PE command "Query\_Measurement" - "Get\_Measurement\_list"**

The command is called with the instruction "PE\_CMD (Page 2397)" with the following parameters:

Parameter	Value	Description
CMD	16	Call of the command "Query_Measurement".
CMD_MODIFIER	1	Specification of the command call: Select the sub-command "Get_Measurement_List" to output a list of supported measured values.
CMD_PARA_LEN	0	Length of the CMD_PARA parameter of 0 bytes.
CMD_PARA	irrelevant	-

**Response frame (Service Data Response)**

The following data of the PE entity response frame is written to the data block referenced at the RESPONSE\_DATA parameter (see "PE\_CMD (Page 2397)"):

Attribute	Value	Data type	Description
Count	-	BYTE	Number of measurement IDs
reserved	-	BYTE	
...			
Measurement_ID	-	WORD	First supported Measurement_ID The Measurement_ID is manufacturer-specific. For more information, refer to the manual of the respective PE entity.
Accuracy_Domain	-	BYTE	See "accuracy domain" table.
Accuracy_Class	-	BYTE	See "accuracy classes" table.
Range	-	REAL	Specifies the scale end value of the measured value (only for accuracy domain 1). The attribute range uses the same unit as defined using attribute Measurement_ID (only one unit is used for each Measurement_ID).
...			
Measurement_ID	-	WORD	Last supported Measurement_ID
Accuracy_Domain	-	BYTE	See "accuracy domain" table.
Accuracy_Class	-	BYTE	See "accuracy classes" table.
Range	-	REAL	Specifies the scale end value of the measurement value (only for accuracy domain 1). The attribute range uses the same unit as defined using attribute Measurement_ID (only one unit is used for each Measurement_ID).

**Accuracy domains**

Accuracy domain	Description
0	Reserved
1	The accuracy deviation is output in percentages of the scale end value. The percentage of the possible deviation is divided into accuracy classes (see table: Accuracy classes of the accuracy domains 1 and 2).

Accuracy domain	Description
2	The accuracy deviation is output in percentages of the current measurement value. The percentage of the possible deviation is divided into accuracy classes (see table: Accuracy classes of the accuracy domains 1 and 2).
3	The measuring accuracy adheres to the standard IEC 61557-12. The function performance classes for performance measurement and monitoring devices (PMD) without external sensors, and the system performance classes for PMD with external sensors, are coded as set out in the "Accuracy classes of accuracy domain 3" table.
4	The entry of the accuracy adheres to the standard EN 50470-3, chapter 8 (see also table: Accuracy classes of accuracy domain 4).

## Accuracy classes

Table 9-54 Accuracy classes of the accuracy domains 1 and 2

Accuracy class	0	1	2	3	4	5	6	7	8
Meaning	Reserved	0.01%	0.02%	0.05%	0.1%	0.2%	0.5%	1%	1.5%

Accuracy class	9	10	11	12	13	14	15	>15
Meaning	2%	2.5%	3%	5%	10%	20%	>20%	Not defined

Table 9-55 Accuracy classes of accuracy domain 3

Accuracy class	0	1	2	3	4	5	6	7	8
Meaning	Reserved	0,02	0,05	0,1	0,2	0,5	1	1,5	2

Accuracy class	9	10	11	12	13	14	>13
Meaning	2,5	3	5	10	20	20%	Not defined

Table 9-56 Accuracy classes of accuracy domain 4

Accuracy class	0	1	2	3	4	5	6	>7
Meaning	Reserved	0,5	1,0	1,5	2,0	2,5	3,0	Not defined

## PI Command "Query\_Measurement" - "Get\_Measurement\_values"

### Description

Use the PE command "Query\_Measurement" and sub-command (modifier) "Get\_measurement\_values" to output a list of measured values supported by the PE entity. The measured values are output as a list in the data block referenced by the RESPONSE\_DATA parameter.

### Calling the PE command "Query\_Measurement" - "Get\_Measurement\_values"

The command is called with the instruction "PE\_CMD (Page 2397)" with the following parameters:

Parameter	Value	Description
CMD	16	Call of the command "Query_Measurement".
CMD_MODIFIER	2	Specification of the command call: Select the command "Get_Measurement_Values" to output a list of supported measurement values.
CMD_PARA_LEN	0	Depends on the number of measurement values. The length of the parameters results from the attribute count and the sum of the lengths of the attributes for the transferred measurement values.
CMD_PARA	VARIANT	VARIANT pointer to data structure with list of measured values to be queried (see "CMD_PARA parameter").

#### Parameter CMD\_PARA

The structure specified with the VARIANT pointer at the CMD\_PARA parameter must have the following setup:

Attribute	Value	Data type	Description
Count	-	BYTE	Number of measured values (Measurement-IDs)
reserved	0	BYTE	Not used
Measurement_ID	-	WORD	First measured value queried
...			
Measurement_ID	-	WORD	Last measured value queried

#### Response frame (Service Data Response)

The following response frame data of the PE entity is written to the data block that is referenced at parameter RESPONSE\_DATA (see "PE\_CMD (Page 2397)"):

Attribute	Value	Data type	Description
Count <sup>1</sup>	-	BYTE	Number of measured values (Measurement-IDs)
reserved	0	BYTE	Not used
Length_of_Structure	2 to 65535	WORD	Length of the structure in bytes
Measurement_Data_Structure_ID	1 = simple value	BYTE	Defines the following structure.
Measurement_ID	0 to 65535	WORD	ID of the supported measurement value.
Status_of_Measurement_Value	1 to 3	BYTE	Status of the measurement value: <ul style="list-style-type: none"> <li>• 1: Valid</li> <li>• 2: Not supported</li> <li>• 3: Invalid</li> </ul>
Transmission_Data_Type	-	REAL	

Attribute	Value	Data type	Description
End_of_demand	-	TOD	Optional time stamping with data type TimeOfDay.
...			
Length_of_Structure	-	WORD	Length of the structure in bytes
Measurement_Data_Structure_ID	-	BYTE	Defines the following structure.
Measurement_ID	-	WORD	ID of the supported measurement value.
Status_of_Measurement_Value	-	BYTE	Status of the measurement value: <ul style="list-style-type: none"> <li>• 1: Valid</li> <li>• 2: Not supported</li> <li>• 3: Invalid</li> </ul>
Transmission_Data_Type	-	REAL	
End_of_demand	-	TOD	Optional time stamping with data type TimeOfDay.

<sup>1</sup> If the data length of the measurement values queried exceeds the size of the PDU (Protocol Data Unit) of the protocol layer, the data will not be completely transferred and only the supported measurement values will be output.

## iDevice / iSlave

### PE\_I\_DEV: Control PROFIenergy commands in the I-Device

#### Description

The instruction "PE\_I\_DEV" is used to process the PROFIenergy profile in the intelligent IO device (iDevice). The functions which are executed by the firmware in standard PROFIenergy-compatible IO devices, such as the ET 200S, are implemented in the iDevice by the instruction "PE\_I\_DEV" and the corresponding auxiliary blocks:

- The instruction "PE\_I\_DEV" is called cyclically by the user program of the iDevice and receives all PROFIenergy commands.
- The PROFIenergy response is generated by configuring an auxiliary block. The response in the pause is fully programmable. The response data must be provided within 10 seconds; otherwise, "State conflict 0x80B5" will occur at the STATUS parameter of the instruction in the IO controller.

No specific knowledge of the PROFIenergy standard is required to use the instruction.

**PROFenergy auxiliary blocks (PE auxiliary blocks)**

The PE auxiliary blocks are used to generate the response frame. Enter the response data (in plain text) at the input parameters of the relevant block.

- For each PROFenergy command, there is a corresponding auxiliary block for a positive response:
  - PE command "Start\_Pause": PE\_Start\_RSP (Page 2420)
  - PE command "End\_Pause": PE\_End\_RSP (Page 2421)
  - PE command "Query\_modes" - "List\_Energy\_Saving\_Modes": PE\_List\_Modes\_RSP (Page 2423)
  - PE command "Query\_modes" - "Get\_Mode": PE\_Get\_Mode\_RSP (Page 2424)
  - PE command "PEM\_Status": PE\_PEM\_Status\_RSP (Page 2426)
  - PE command "PE\_Identify": PE\_Identify\_RSP (Page 2427)
  - PE command "Query\_Measurement" - "Get\_Measurement\_list": PE\_Measurement\_List\_RSP (Page 2429)
  - PE command "Query\_Measurement" - "Get\_Measurement\_values": PE\_Measurement\_Value\_RSP (Page 2430)
- Irrespective of the PROFenergy command, there is an additional shared auxiliary block for a negative response (see PE\_Error\_RSP (Page 2419)).

**Interconnection of the auxiliary blocks**

The instruction "PE\_I\_DEV" and the auxiliary blocks are coordinated. Some of the parameters are simply interconnected. The diagram below shows which of the parameters need to be interconnected.

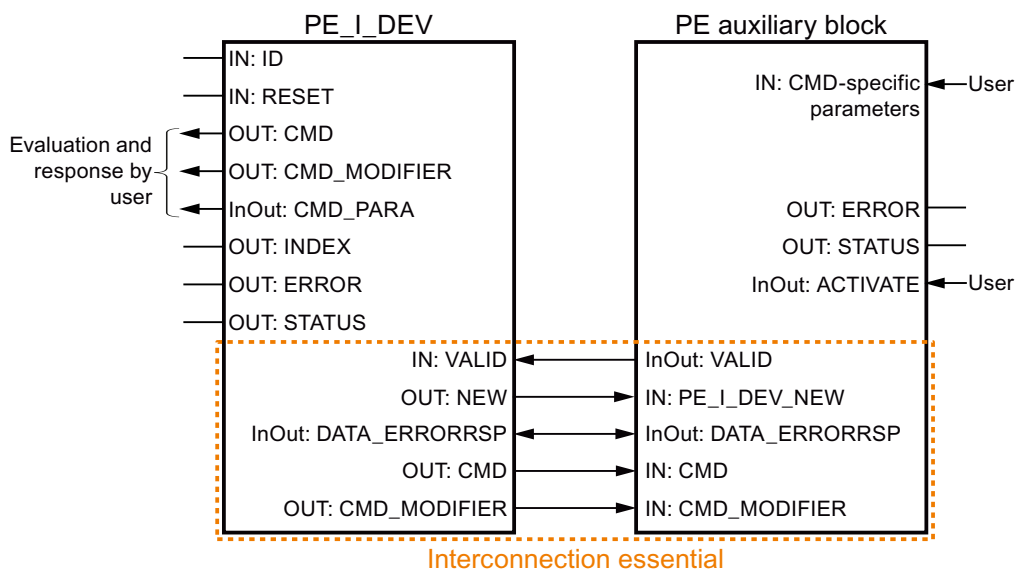



## Parameters

The following table shows the parameters of the instruction "PE\_I\_DEV":

Parameter	Declaration	Data type	Memory area	Description
RESET	Input	BOOL	I, Q, M, D, L or constant	Resets the instruction.
ID	Input	DWORD	I, Q, M, D, L	Address of the iDevice The address may be taken from the hardware configuration.
VALID	Input	BOOL	I, Q, M, D, L	The response data for the PROFinergy controller is ready and can be sent.
CMD_PARA	Output	VARIANT	I, Q, M, D, L	Parameters for: <ul style="list-style-type: none"> <li>Get mode: PE_mode_ID</li> <li>Get measurement values: List of Measurement_IDs (list of IDs of the tags to be read; either one tag or multiple tags may be read at any given time).</li> </ul> Maximum length: 234 bytes
DATA_ERRO RRSP	InOut	VARIANT	I, Q, M, D, L	Pointer to the data area containing the acknowledgement data for the PROFinergy controller. This must correspond to the pointer which is also used with the auxiliary blocks.
INDEX	Output	INT	I, Q, M, D, L or constant	Data record number of the PROFinergy record (set at 0x80A0)
CMD	Output	INT	I, Q, M, D, L or constant	Service-Request-ID of the PROFinergy command in accordance with the PROFinergy profile (see "CMD and CMD_MODIFIER parameters"). Further PE commands (Service-Request-IDs) are possible following extensions of the PROFinergy profile.
CMD_ MODIFIER	Output	INT	I, Q, M, D, L or constant	PROFinergy sub-command: <ul style="list-style-type: none"> <li>Only when CMD=3 or CMD=16; see "CMD and CMD_MODIFIER parameters".</li> <li>For all other commands: "0".</li> </ul> Further sub-commands are possible following extensions of the PROFinergy profile.
NEW	Output	BOOL	I, Q, M, D, L	New data available from the PROFinergy controller.
ERROR	Output	BOOL	I, Q, M, D, L	Command completed with error.
STATUS	Output	DWORD	I, Q, M, D, L	Error information (see "STATUS parameter").

For additional information on valid data types, refer to "Overview of the valid data types (Page 1077)".

Parameters CMD and CMD\_MODIFIER

CMD	CMD_MODIFIER	PROFenergy command	Description
01	0	Start_Pause	Start energy-saving mode or switch to a different energy-saving mode.
02	0	End_Pause	End energy-saving mode.
03	1	Query_Modes - List energy saving Modes	Output the energy-saving modes supported.
	2	Query_Modes - Get Mode	Output attributes of the energy-saving mode currently enabled.
04	0	PEM_Status	Query status of energy-saving mode.
05	0	PE_Identify	Read out the number and description of PE commands supported.
16	1	Query_Measurement - Get_Measurement_List	List of the measured values supported by the PE entity.
	2	Query_Measurement - Get_Measurement_Values	Output of the measured values of the PE entity.

STATUS parameter

Error information is output at the STATUS output parameter. If it is interpreted as ARRAY[1...4] of BYTE, the error information has the following structure:

Field element	Name	Meaning
STATUS[1]	Function_Num	Cause of the error <ul style="list-style-type: none"> <li>• B#16#00: No error</li> <li>• B#16#DE: Error during reading of data record</li> <li>• B#16#DF: Error during writing of data record</li> <li>• B#16#C0: Error message from the instruction "PE_I_DEV" or from the internal communication instructions "RDREC (Page 2321)" and "WRREC (Page 2323)".</li> </ul>
STATUS[2]	Error Decode	Location of the error ID <ul style="list-style-type: none"> <li>• 80: DPV1 error as defined in IEC 61158-6 or application-specific</li> </ul>
STATUS[3]	Error_Code_1	Error ID (when Error Decode = 80): <ul style="list-style-type: none"> <li>• B1: Write length error (error in write length or insufficient length information with the data type VARIANT).</li> </ul>
STATUS[4]	Error_Code_2	For PROFINET errors: Output of IO controller error message If no PROFINET error has occurred, the value in STATUS[4] = "0".

**Note****Error messages of the instructions RDREC and WRREC**

The instruction "PE\_I\_DEV" uses the instructions "WRREC (Page 2323)" and "RDREC (Page 2321)" for communication. Error messages for these instructions are output in the field elements STATUS[1] to STATUS[4].

Please see the description of the corresponding STATUS (Page 2330) parameter for an explanation of the error codes of the "WRREC (Page 2323)" and "RDREC (Page 2321)" instructions.

**See also**

Description of PROFIenergy (Page 2391)

**Auxiliary blocks of the instruction PE\_I\_DEV****PE\_Error\_RSP: Generate negative answer to command****Description**

The auxiliary block "PE\_Error\_RSP" (Response with failure) generates a negative response if the command requested is not supported (either in general or temporarily). Response generation does not depend on the command requested.

**Parameter**

The following table shows the parameters of the "PE\_Error\_RSP" auxiliary block:

Parameter	Declaration	Data type	Initial value	Description
PE_I_DEV_NEW	Input	BOOL	0	The parameter must be interconnected with output parameter NEW of the "PE_I_DEV (Page 2415)" instruction. The auxiliary block is only processed if the parameter value is set to "1".
ERROR_CODE	Input	BYTE	0	Error number
ACTIVATE	InOut	BOOL	0	The instruction copies the input parameters to the DATA_ERROR_RSP data area at a positive edge at input ACTIVATE. The parameter is then reset by the instruction. The parameter must be set within 10 seconds after a positive edge is detected at parameter NEW of the "PE_I_DEV (Page 2415)" instruction.

Parameter	Declaration	Data type	Initial value	Description
VALID	InOut	BOOL	1	The parameter must be interconnected with input VALID of the "PE_I_DEV (Page 2415)" instruction. The parameter is set by the auxiliary block when the response data for the PROFIenergy controller is ready and can be sent.
DATA_ERRORRSP	InOut	VARIANT	0	Pointer on the data area in which the response data is stored. The parameter is identical to the pointer with DATA_ERRORRSP of the instruction "PE_I_DEV (Page 2415)". The addressed data area contains the complete PROFIenergy frame. Minimum length: 244 bytes
ERROR	Output	BOOL	0	<ul style="list-style-type: none"> <li>"0": No error</li> <li>"1": Error occurred.</li> </ul>
STATUS	Output	WORD	0	<ul style="list-style-type: none"> <li>"0": No error</li> <li>"0x80B1": Error in VARIANT setting, e.g. incorrect range</li> </ul>

For additional information on valid data types, refer to "Overview of the valid data types (Page 1077)".

### PE\_Start\_RSP: Generate answer to command at start of pause

#### Description

The auxiliary block "PE\_Start\_RSP" (Start Pause) generates the response to the PE command Start\_Pause (Page 2405). The instruction returns the energy-saving mode to which the device has switched (PE\_MODE\_ID parameter).

If the response differs depending on the length of the pause, you can return this fact in the feedback on the energy-saving mode (PE\_Mode\_ID = 1 for a brief pause, PE\_Mode\_ID = 2 for a longer pause, etc.).

#### Parameter

The following table shows the parameters of the "PE\_Start\_RSP" auxiliary block:

Parameter	Declaration	Data type	Initial value	Description
PE_I_DEV_NEW	Input	BOOL	0	The parameter must be interconnected with output parameter NEW of the "PE_I_DEV (Page 2415)" instruction. The auxiliary block is only processed if the parameter value is set to "1".
CMD	Input	INT	0	Service-Request-ID of the PROFIenergy command The parameter must be interconnected with output parameter CMD of the "PE_I_DEV (Page 2415)" instruction.

Parameter	Declaration	Data type	Initial value	Description
PE_MODE_ID	Input	BYTE	0	PE mode that the process assumes
ACTIVATE	InOut	BOOL	0	The instruction copies the input parameters to the DATA_ERROR_RSP data area at a positive edge at input ACTIVATE. The parameter is then reset by the instruction. The parameter must be set within 10 seconds after a positive edge is detected at parameter NEW of the "PE_I_DEV (Page 2415)" instruction.
VALID	InOut	BOOL	1	The parameter must be interconnected to the VALID input of the instruction "PE_I_DEV (Page 2415)". The parameter is set by the auxiliary block when the response data for the PROFlenergy controller is ready and can be sent.
DATA_ERROR_RSP	InOut	VARIANT	0	Pointer on the data area in which the response data is stored. The parameter is identical to the pointer with DATA_ERROR_RSP of the instruction "PE_I_DEV (Page 2415)". The addressed data area contains the complete PROFlenergy frame. Minimum length: 244 bytes
ERROR	Output	BOOL	0	<ul style="list-style-type: none"> <li>"0": No error</li> <li>"1": Error occurred.</li> </ul>
STATUS	Output	WORD	0	<ul style="list-style-type: none"> <li>"0": No error</li> <li>"0x80B1": Error in VARIANT setting, e.g. incorrect range</li> </ul>

For additional information on valid data types, refer to "Overview of the valid data types (Page 1077)".

## PE\_End\_RSP: Generate answer to command at end of pause

### Description

Auxiliary block "PE\_End\_RSP" generates the response to PE command End\_Pause (Page 2405). The response returned is the time required to switch from the current mode to "Ready\_To\_Operate" mode.

**Parameter**

The following table shows the parameters of the "PE\_End\_RSP" auxiliary block:

Parameter	Declaration	Data type	Initial value	Description
PE_I_DEV_NEW	Input	BOOL	0	The parameter must be interconnected with output parameter NEW of the "PE_I_DEV (Page 2415)" instruction. The auxiliary block is only processed if the parameter value is set to "1".
CMD	Input	INT	0	Service-Request-ID of the PROFIenergy command The parameter must be interconnected with output parameter CMD of the "PE_I_DEV (Page 2415)" instruction.
Time_to_Operate	Input	DWORD	0	Time required to switch from the current mode to "Ready_To_Operate".
ACTIVATE	InOut	BOOL	0	The instruction copies the input parameters to the DATA_ERROR_RSP data area at a positive edge at input ACTIVATE. The parameter is then reset by the instruction. The parameter must be set within 10 seconds after a positive edge is detected at parameter NEW of the "PE_I_DEV (Page 2415)" instruction.
VALID	InOut	BOOL	1	The parameter must be interconnected to the VALID input of the instruction "PE_I_DEV (Page 2415)". The parameter is set by the auxiliary block when the response data for the PROFIenergy controller is ready and can be sent.
DATA_ERROR_RSP	InOut	VARIANT	0	Pointer on the data area in which the response data is stored. The parameter is identical to the pointer with DATA_ERROR_RSP of the instruction "PE_I_DEV (Page 2415)". The addressed data area contains the complete PROFIenergy frame. Minimum length: 244 bytes
ERROR	Output	BOOL	0	<ul style="list-style-type: none"> <li>"0": No error</li> <li>"1": Error occurred.</li> </ul>
STATUS	Output	WORD	0	<ul style="list-style-type: none"> <li>"0": No error</li> <li>"0x80B1": Error in VARIANT setting, e.g. incorrect range</li> </ul>

For additional information on valid data types, refer to "Overview of the valid data types (Page 1077)".

**PE\_List\_Modes\_RSP: Generate queried energy savings modes as answer****Description**

The auxiliary block "PE\_List\_Modes\_RSP" generates the response to the PE command List\_Energy\_Saving\_Modes (Page 2406). The response generated includes the number and the IDs of energy-saving modes supported.

**Parameter**

The following table shows the parameters of the "PE\_List\_Modes\_RSP" auxiliary block:

Parameter	Declaration	Data type	Initial value	Description
PE_I_DEV_NEW	Input	BOOL	0	The parameter must be interconnected with output parameter NEW of the "PE_I_DEV (Page 2415)" instruction. The auxiliary block is only processed if the parameter value is set to "1".
CMD	Input	INT	0	Service-Request-ID of the PROFlenergy command The parameter must be interconnected with output parameter CMD of the "PE_I_DEV (Page 2415)" instruction.
CMD_MODIFIER	Input	INT	0	PROFlenergy sub-command (evaluated only if CMD=3, or CMD=16). The parameter must be interconnected to the CMD_MODIFIER output parameter of the instruction "PE_I_DEV".
Number_of_PE_Mode_IDs	Input	BYTE	0	Number of energy-saving modes supported. Permitted values: 1 to 254
PE_MODE_ID	Input	VARIANT	0	Points to the area in which the IDs of the energy-saving modes supported (PE_Mode_ID) are stored. Valid range: 1 to 254.
ACTIVATE	InOut	BOOL	0	The instruction copies the input parameters to the DATA_ERROR_RSP data area at a positive edge at input ACTIVATE. The parameter is then reset by the instruction. The parameter must be set within 10 seconds after a positive edge is detected at parameter NEW of the "PE_I_DEV (Page 2415)" instruction.
VALID	InOut	BOOL	1	The parameter must be interconnected to the VALID input of the instruction "PE_I_DEV (Page 2415)". The parameter is set by the auxiliary block when the response data for the PROFlenergy controller is ready and can be sent.

Parameter	Declaration	Data type	Initial value	Description
DATA_ERRORRSP	InOut	VARIANT	0	Pointer on the data area in which the response data is stored. The parameter is identical to the pointer with DATA_ERRORRSP of the instruction "PE_I_DEV (Page 2415)". The addressed data area contains the complete PROFIenergy frame. Minimum length: 244 bytes
ERROR	Output	BOOL	0	<ul style="list-style-type: none"> <li>"0": No error</li> <li>"1": Error occurred.</li> </ul>
STATUS	Output	WORD	0	<ul style="list-style-type: none"> <li>"0": No error</li> <li>"0x80B1": Error in VARIANT setting, e.g. incorrect range</li> </ul>

For additional information on valid data types, refer to "Overview of the valid data types (Page 1077)".

### PE\_Get\_Mode\_RSP: Generate queried energy data as answer

#### Description

The auxiliary block "PE\_Get\_Mode\_RSP" generates the response to the command Get\_Mode (Page 2407). The response contains the times and the performance/energy data of the individual energy-saving states.

#### Parameter

The following table shows the parameters of the "PE\_Get\_Mode\_RSP" auxiliary block:

Parameter	Declaration	Data type	Memory area	Description
PE_I_DEV_NEW	Input	BOOL	0	The parameter must be interconnected with output parameter NEW of the "PE_I_DEV (Page 2415)" instruction. The auxiliary block is only processed if the parameter value is set to "1".
CMD	Input	INT	0	Service-Request-ID of the PROFIenergy command The parameter must be interconnected with output parameter CMD of the "PE_I_DEV (Page 2415)" instruction.
CMD_MODIFIER	Input	INT	0	PROFIenergy sub-command (evaluated only if CMD=3, or CMD=16). The parameter must be interconnected to the CMD_MODIFIER output parameter of the instruction "PE_I_DEV".
PE_Mode_ID	Input	BYTE	I, Q, M, D, L	ID of the energy-saving mode currently enabled.



Parameter	Declaration	Data type	Memory area	Description
Time_min_Pause	Input	DWORD	I, Q, M, D, L	Minimum pause duration for this PE energy-saving mode. This is the sum of the following three parameters: <ul style="list-style-type: none"> <li>• Time_to_Pause</li> <li>• Time_to_operate</li> <li>• Time_min_length_of_stay</li> </ul>
Time_to_Pause	Input	DWORD	I, Q, M, D, L	Time between the edge at the START parameter (see "PE_I_DEV (Page 2415)") and the requested PE energy-saving mode being reached.
Time_to_Operate	Input	DWORD	I, Q, M, D, L	Maximum switch-on time to "PE_ready_to_operate". The "Time_to_operate" parameter can be used directly for the relevant calculations. The value may be a static maximum, or be calculated dynamically by the PE entity.
Time_min_Lenght_of_stay	Input	DWORD	I, Q, M, D, L	Minimum dwell time of the PE entity in this PE mode.
Time_max_Lenght_of_stay	Input	DWORD	I, Q, M, D, L	Maximum dwell time of the PE entity in this PE mode.
Mode_Power_Consumption	Input	DWORD	I, Q, M, D, L	Energy consumption in the current PE mode in [kW].
Energy_Consum_to_Pause	Input	DWORD	I, Q, M, D, L	Energy consumption from "PE_ready_to_operate" to the current PE mode in [kWh].
Energy_Consum_to_operate	Input	DWORD	I, Q, M, D, L	Energy consumption from the current PE mode to "PE_ready_to_operate" in [kWh].
ACTIVATE	InOut	BOOL	0	The instruction copies the input parameters to the DATA_ERROR_RSP data area at a positive edge at input ACTIVATE. The parameter is then reset by the instruction.  The parameter must be set within 10 seconds after a positive edge is detected at parameter NEW of the "PE_I_DEV (Page 2415)" instruction.
VALID	InOut	BOOL	1	The parameter must be interconnected to the VALID input of the instruction "PE_I_DEV (Page 2415)".  The parameter is set by the auxiliary block when the response data for the PROFIenergy controller is ready and can be sent.
DATA_ERROR_RSP	InOut	VARIANT	0	Pointer on the data area in which the response data is stored. The parameter is identical to the pointer with DATA_ERROR_RSP of the instruction "PE_I_DEV (Page 2415)". The addressed data area contains the complete PROFIenergy frame.  Minimum length: 244 bytes

Parameter	Declaration	Data type	Memory area	Description
ERROR	Output	BOOL	0	<ul style="list-style-type: none"> <li>"0": No error</li> <li>"1": Error occurred.</li> </ul>
STATUS	Output	WORD	0	<ul style="list-style-type: none"> <li>"0": No error</li> <li>"0x80B1": Error in VARIANT setting, e.g. incorrect range</li> </ul>

For additional information on valid data types, refer to "Overview of the valid data types (Page 1077)".

**PE\_PEM\_Status\_RSP: Generate PEM status as answer**

**Description**

The auxiliary block "PE\_PEM\_Status\_RSP" generates the response to the command PEM\_Status (Page 2409).

**Parameter**

The following table shows the parameters of the "PE\_PEM\_Status\_RSP" auxiliary block:

Parameter	Declaration	Data type	Memory area	Description
PE_I_DEV_NEW	Input	BOOL	0	The parameter must be interconnected with output parameter NEW of the "PE_I_DEV (Page 2415)" instruction. The auxiliary block is only processed if the parameter value is set to "1".
CMD	Input	INT	0	Service-Request-ID of the PROFIenergy command The parameter must be interconnected with output parameter CMD of the "PE_I_DEV (Page 2415)" instruction.
PE_MODE_ID_Source	Input	BYTE	I, Q, M, D, L	Source and Destination for PEM_STATUS. Values: <ul style="list-style-type: none"> <li>0x00: PE_POWER_OFF</li> <li>0x01 – 0xFE: manufacturer-specific</li> <li>0xFF: PE_READY_TO_OPERATE</li> </ul>
PE_MODE_ID_Destination	Input	BYTE	I, Q, M, D, L	
Time_to_Operate <sup>1</sup>	Input	DWORD	I, Q, M, D, L	Maximum switch-on time to "PE_ready_to_operate". "Time_to_operate" can be used directly for the relevant calculations. The value may be a static maximum, or be calculated dynamically by the PE entity.
Remaining_time_to_destination <sup>1</sup>	Input	DWORD	I, Q, M, D, L	Optional: Time remaining until the requested PE mode. Dynamic value or static maximum value
Mode_Power_Consumption <sup>2</sup>	Input	DWORD	I, Q, M, D, L	Energy consumption in the current PE mode in [kW].

Parameter	Declaration	Data type	Memory area	Description
Energy_Consumption_to_Destination <sup>2</sup>	Input	DWORD	I, Q, M, D, L	Energy consumption in the time until the requested PE mode in [kW].
Energy_Consumption_to_operate <sup>2</sup>	Input	DWORD	I, Q, M, D, L	Energy consumption from the current PE mode to "PE_ready_to_operate" in [kWh].
ACTIVATE	InOut	BOOL	0	The instruction copies the input parameters to the DATA_ERROR_RSP data area at a positive edge at input ACTIVATE. The parameter is then reset by the instruction.  The parameter must be set within 10 seconds after a positive edge is detected at parameter NEW of the "PE_I_DEV (Page 2415)" instruction.
VALID	InOut	BOOL	1	The parameter must be interconnected to the VALID input of the instruction "PE_I_DEV (Page 2415)".  The parameter is set by the auxiliary block when the response data for the PROFenergy controller is ready and can be sent.
DATA_ERROR_RSP	InOut	VARIANT	0	Pointer on the data area in which the response data is stored. The parameter is identical to the pointer with DATA_ERROR_RSP of the instruction "PE_I_DEV (Page 2415)". The addressed data area contains the complete PROFenergy frame.  Minimum length: 244 bytes
ERROR	Output	BOOL	0	<ul style="list-style-type: none"> <li>"0": No error</li> <li>"1": Error occurred.</li> </ul>
STATUS	Output	WORD	0	<ul style="list-style-type: none"> <li>"0": No error</li> <li>"0x80B1": Error in VARIANT setting, e.g. incorrect range</li> </ul>
<p><sup>1</sup> If the time period is unlimited, the maximum value "0xFFFFFFFF" can be specified. If the time period is "Zero", "0x00" can be used.</p> <p><sup>2</sup> If no energy consumption value has been defined, "0.0" can be specified.</p>				

For additional information on valid data types, refer to "Overview of the valid data types (Page 1077)".

## PE\_Identify\_RSP: Generate supported PROFenergy commands as answer

### Description

The auxiliary block "PE\_Identify\_RSP" generates the response to the command PE\_Identify (Page 2410). In the response to the command, specify which PROFenergy commands are supported. Please note that PE\_IDENTIFY is itself a PE command and has to be included in the response.

**Parameter**

The following table shows the parameters of the "PE\_Identify\_RSP" auxiliary block:

Parameter	Declaration	Data type	Memory area	Description
PE_I_DEV_NEW	Input	BOOL	0	The parameter must be interconnected with output parameter NEW of the "PE_I_DEV (Page 2415)" instruction. The auxiliary block is only processed if the parameter value is set to "1".
CMD	Input	INT	0	Service-Request-ID of the PROFIenergy command The parameter must be interconnected with output parameter CMD of the "PE_I_DEV (Page 2415)" instruction.
Start_Pause	Input	BOOL	I, Q, M, D, L	One parameter for each of the relevant PROFIenergy commands: <ul style="list-style-type: none"> <li>• 0: PE command is not supported</li> <li>• 1: PE command is supported</li> </ul>
End_Pause	Input	BOOL	I, Q, M, D, L	
Query_Modes	Input	BOOL	I, Q, M, D, L	
PEM_Status	Input	BOOL	I, Q, M, D, L	
PE_Identify	Input	BOOL	I, Q, M, D, L	
Query_Measurement	Input	BOOL	I, Q, M, D, L	
ACTIVATE	InOut	BOOL	0	The instruction copies the input parameters to the DATA_ERROR_RSP data area at a positive edge at input ACTIVATE. The parameter is then reset by the instruction. The parameter must be set within 10 seconds after a positive edge is detected at parameter NEW of the "PE_I_DEV (Page 2415)" instruction.
VALID	InOut	BOOL	1	The parameter must be interconnected to the VALID input of the instruction "PE_I_DEV (Page 2415)". The parameter is set by the auxiliary block when the response data for the PROFIenergy controller is ready and can be sent.
DATA_ERROR_RSP	InOut	VARIANT	0	Pointer on the data area in which the response data is stored. The parameter is identical to the pointer with DATA_ERROR_RSP of the instruction "PE_I_DEV (Page 2415)". The addressed data area contains the complete PROFIenergy frame. Minimum length: 244 bytes
ERROR	Output	BOOL	0	<ul style="list-style-type: none"> <li>• "0": No error</li> <li>• "1": Error occurred.</li> </ul>
STATUS	Output	WORD	0	<ul style="list-style-type: none"> <li>• "0": No error</li> <li>• "0x80B1": Error in VARIANT setting, e.g. incorrect range</li> </ul>

For additional information on valid data types, refer to "Overview of the valid data types (Page 1077)".

**PE\_Measurement\_List\_RSP: Generate list of supported measured values as answer****Description**

The auxiliary block "PE\_Measurement\_List\_RSP" generates the response to the command Get\_measurement\_list (Page 2411). In the response, specify which measured values (Measurement-IDs) are supported.

**Parameter**

The following table shows the parameters of the "PE\_Measurement\_List\_RSP" auxiliary block:

Parameter	Declaration	Data type	Memory area	Description
PE_I_DEV_NEW	Input	BOOL	0	The parameter must be interconnected with output parameter NEW of the "PE_I_DEV (Page 2415)" instruction. The auxiliary block is only processed if the parameter value is set to "1".
CMD	Input	INT	0	Service-Request-ID of the PROFIenergy command The parameter must be interconnected with output parameter CMD of the "PE_I_DEV (Page 2415)" instruction.
CMD_MODIFIER	Input	INT	0	PROFIenergy sub-command (evaluated only if CMD=3, or CMD=16). The parameter must be interconnected to the CMD_MODIFIER output parameter of the instruction "PE_I_DEV".
Count	Input	BYTE	I, Q, M, D, L	Number of measured values supported (measurement IDs)
Measurement_List	Input	VARIANT	D	Pointer to the array with the Measurement_IDs supported. For information on the structure of the array in accordance with the PROFIenergy profile, please see: PI Command "Query_Measurement" - "Get_Measurement_list" (Page 2411)
ACTIVATE	InOut	BOOL	0	The instruction copies the input parameters to the DATA_ERROR_RSP data area at a positive edge at input ACTIVATE. The parameter is then reset by the instruction. The parameter must be set within 10 seconds after a positive edge is detected at parameter NEW of the "PE_I_DEV (Page 2415)" instruction.
VALID	InOut	BOOL	1	The parameter must be interconnected to the VALID input of the instruction "PE_I_DEV (Page 2415)". The parameter is set by the auxiliary block when the response data for the PROFIenergy controller is ready and can be sent.

Parameter	Declaration	Data type	Memory area	Description
DATA_ERRORRRSP	InOut	VARIANT	0	Pointer on the data area in which the response data is stored. The parameter is identical to the pointer with DATA_ERRORRRSP of the instruction "PE_I_DEV (Page 2415)". The addressed data area contains the complete PROFinergy frame. Minimum length: 244 bytes
ERROR	Output	BOOL	0	<ul style="list-style-type: none"> <li>"0": No error</li> <li>"1": Error occurred.</li> </ul>
STATUS	Output	WORD	0	<ul style="list-style-type: none"> <li>"0": No error</li> <li>"0x80B1": Error in VARIANT setting, e.g. incorrect range</li> </ul>

For additional information on valid data types, refer to "Overview of the valid data types (Page 1077)".

### PE\_Measurement\_Value\_RSP: Generate queried measured values as answer

#### Description

The auxiliary block "PE\_Measurement\_Value\_RSP" generates the response to the command Get\_measurement\_values (Page 2413). In the response, return the values of the requested measurements.

#### Parameter

The following table shows the parameters of the "PE\_Measurement\_Value\_RSP" auxiliary block:

Parameter	Declaration	Data type	Memory area	Description
PE_I_DEV_NEW	Input	BOOL	0	The parameter must be interconnected with output parameter NEW of the "PE_I_DEV (Page 2415)" instruction. The auxiliary block is only processed if the parameter value is set to "1".
CMD	Input	INT	0	Service-Request-ID of the PROFinergy command The parameter must be interconnected with output parameter CMD of the "PE_I_DEV (Page 2415)" instruction.
CMD_MODIFIER	Input	INT	0	PROFinergy sub-command (evaluated only if CMD=3, or CMD=16). The parameter must be interconnected to the CMD_MODIFIER output parameter of the instruction "PE_I_DEV".
Count	Input	BYTE	I, Q, M, D, L	Number of measured values (Measurement_Values).

Parameter	Declaration	Data type	Memory area	Description
Measurement_Values	Input	VARIANT	D	Pointer to the array with the measured values (Measurement_IDs). For information on the structure of the array in accordance with the PROFIenergy profile, please see PI Command "Query_Measurement" - "Get_Measurement_values" (Page 2413)
ACTIVATE	InOut	BOOL	0	The instruction copies the input parameters to the DATA_ERROR_RSP data area at a positive edge at input ACTIVATE. The parameter is then reset by the instruction. The parameter must be set within 10 seconds after a positive edge is detected at parameter NEW of the "PE_I_DEV (Page 2415)" instruction.
VALID	InOut	BOOL	1	The parameter must be interconnected to the VALID input of the instruction "PE_I_DEV (Page 2415)". The parameter is set by the auxiliary block when the response data for the PROFIenergy controller is ready and can be sent.
DATA_ERROR_RSP	InOut	VARIANT	0	Pointer on the data area in which the response data is stored. The parameter is identical to the pointer with DATA_ERROR_RSP of the instruction "PE_I_DEV (Page 2415)". The addressed data area contains the complete PROFIenergy frame. Minimum length: 244 bytes
ERROR	Output	BOOL	0	<ul style="list-style-type: none"> <li>"0": No error</li> <li>"1": Error occurred.</li> </ul>
STATUS	Output	WORD	0	<ul style="list-style-type: none"> <li>"0": No error</li> <li>"0x80B1": Error in VARIANT setting, e.g. incorrect range</li> </ul>

For additional information on valid data types, refer to "Overview of the valid data types (Page 1077)".

### 9.7.3.6 Module parameter assignment

#### Writing and reading data records

##### Principle

Some modules have a write-only system data area to which your program can transfer data records. This area contains data records with numbers from 0 to a maximum of 240. Not every module contains all of the data records (see following table).

Modules can also have a read-only system data area in which your program can read data records. This area contains data records with numbers from 0 to a maximum of 240. Not every module contains all of the data records (see following table).

**Note**

There are modules that have both system data areas. These are physically separate areas and the only thing they have in common is their logical structure.

**Write-only system data area**

The following table shows the structure of the write-only system data area. This table also shows how the permitted size of the individual data records and which instructions can be used to write them.

Data record number	Contents	Size	Can be written with instruction
0	Parameter	-	WR_DPARM (Page 2439)
1	Parameter	-	WR_DPARM (Page 2439)
2 to 127	User data	Each ≤ 240 bytes	WR_DPARM (Page 2439) WR_REC (Page 2362)
128 to 240	Parameter	Each ≤ 240 bytes	WR_DPARM (Page 2439) WR_REC (Page 2362)

**Read-only system data area**

The following table shows the structure of the read-only system data area. This table also shows the permitted size of the individual data records and which instructions can be used to read them.

Data record number	Contents	Size	Can be read with instruction
0	Module-specific diagnostics data (set as standard for the entire system)	4 bytes	RD_REC (Page 2358)
1	Channel-specific diagnostics data (incl. data record 0)	4 to 220 Bytes	RD_REC (Page 2358)
2 to 127	User data	Each ≤ 240 bytes	RD_REC (Page 2358)
128 to 240	Diagnostics data	Each ≤ 240 bytes	RD_REC (Page 2358)



## System resources

If you start several asynchronous data record transfers one after the other with only short intervals between them, the allocation of system resources by the operating system ensures that all the jobs are executed and that they do not interfere with each other.

If the limits of the system resources are reached, this is indicated in RET\_VAL. You can remedy this temporary error situation by simply repeating the job.

The maximum number of "simultaneously" active jobs of a single instruction type depends on the CPU.

## RD\_DPAR: Read module data record

### Description

You use the instruction to read the data record with the number INDEX of the addressed component from the configured system data. This may be a module in a central rack or a distributed component (PROFIBUS DP or PROFINET IO).

The value TRUE for the output parameter VALID indicates that the data record was successfully transferred to the target range RECORD. In this case, the LEN output parameter contains the length of the read data in bytes.

If an error has occurred during transfer of the data record, this is indicated by the output parameter ERROR. In this case, the output parameter STATUS contains the error information.

### Functional description

The "RD\_DPAR" instruction works asynchronously, that is, its execution extends over multiple calls. You start the data record transfer by calling "RD\_DPAR" with REQ = 1.

The output parameter BUSY and bytes 2 and 3 of the output parameter STATUS show the status of the job. Bytes 2 and 3 of STATUS match the output parameter RET\_VAL of the instructions that operate asynchronously.

See also: Meaning of the parameters REQ, RET\_VAL and BUSY with asynchronous instructions (Page 1582).

The transfer of the data record is complete when the output parameter BUSY has the value FALSE.

**Parameter**

The following table shows the parameters of the instruction "RD\_DPAR":

Parameter	Declaration	Data type	Memory area	Description
REQ	Input	BOOL	I, Q, M, D, L or constant	REQ = 1: Read request
LADDR	Input	HW_IO	I, Q, M, D, L or constant	Identification number of the CPU or the interface. The number is assigned automatically and is stored in the properties of the CPU or of the interface of the hardware configuration.
INDEX	Input	INT	I, Q, M, D, L or constant	Data record number
RECORD	InOut	VARIANT	I, Q, M, D, L	Target range for the read data record
VALID	Output	BOOL	I, Q, M, D, L	New data record was received and is valid
BUSY	Output	BOOL	I, Q, M, D, L	BUSY = 1: The job is not yet completed.
ERROR	Output	BOOL	I, Q, M, D, L	ERROR = 1: An error occurred during the reading process.
STATUS	Output	DWORD	I, Q, M, D, L	<ul style="list-style-type: none"> <li>• Call ID (bytes 2 and 3) or error code</li> <li>• Byte 1: B#16#00, if no error. Otherwise function ID from DPV1-PDU: In the case of error for data record reading B#16#DE, in the case of error for data record writing B#16#DF. If no DPV1 protocol element is used: B#16#C0.</li> <li>• Byte 4: Manufacturer-specific error ID extension</li> </ul>
LEN	Output	INT	I, Q, M, D, L	Length of the read data record information

For additional information on valid data types, refer to "Overview of the valid data types (Page 1077)".

**Parameter STATUS**

Error code* (W#16#...)	Explanation	Restriction
0000	No error	-
7000	First call with REQ=0: No data transfer active; BUSY has the value 0.	-
7001	First call with REQ=1: Data transfer triggered; BUSY has the value "1".	Distributed I/O
7002	Intermediate call (REQ irrelevant): Data transfer already active; BUSY has the value "1".	Distributed I/O
8090	Specified logical base address invalid.	-
8092	A data type other than (Array of) bit string or integer was specified at the RECORD parameter.	-
8093	This instruction is not valid for the module selected with LADDR.	-
80A1	Negative acknowledgement during sending of data record to module (module defective or unplugged during sending).	-

Error code* (W#16#...)	Explanation	Restriction
80A2	DP protocol error at layer 2, possible hardware/interface error in DP slave.	Distributed I/O
80A3	DP protocol error at user interface/user.	Distributed I/O
80A4	Communication problem on com bus.	Error occurs between CPU and external DP interface module
80B0	Instruction for module type not possible, or module does not recognize the data record.	-
80B1	The length of the data record to be sent is incorrect.	-
80B2	The configured slot is not assigned.	-
80B3	Actual module type does not correspond to specified module type.	-
80C1	The data of the previous write job on the module for the same data record have not yet been processed by the module.	-
80C2	The module is currently processing the maximum possible number of jobs for a CPU.	-
80C3	The required resources (memory, etc.) are currently occupied.	-
80C4	Internal temporary error. Job could not be executed. Repeat the job. If this error occurs often, check your installation for sources of electrical interference.	-
80C5	Distributed I/O not available or deactivated.	Distributed I/O
80C6	Data record transfer cancelled due to priority class abort (restart or background).	Distributed I/O
80D0	There is no entry for the module.	-
80D1	The data record number is not configured for the module (data record numbers > 241 are rejected).	-
80D2	The module cannot be assigned parameters according to its type identifier.	-
80D5	The data record is static.	-
General error information	See also: GET_ERR_ID: Get error ID locally (Page 1787)	-

\* The error codes can be displayed as integer or hexadecimal values in the program editor. For additional information on toggling display formats, refer to "See also".

**See also**

RD\_DPARM: Read data record from configured system data (Page 2438)

## RD\_DPARA: Read module data record asynchronously

### Description

You use the instruction to read the data record with the number RECNUM of a selected module from the configured system data. The read data record is entered in the target range defined by the parameter RECORD .

### Functional description

The "RD\_DPARA" instruction works asynchronously, that is, its execution extends over multiple calls. You start the job by calling the instruction with REQ = 1.

The output parameters RET\_VAL and BUSY indicate the status of the job.

See also: Meaning of the parameters REQ, RET\_VAL and BUSY with asynchronous instructions (Page 1582).

### Parameters

The following table shows the parameters of the "RD\_DPARA" instruction:

Parameter	Declaration	Data type	Memory area	Description
REQ	Input	BOOL	I, Q, M, D, L or constant	REQ = 1: Read request
LADDR	Input	HW_IO	I, Q, M, D, L or constant	Identification number of the CPU or the interface. The number is assigned automatically and is stored in the properties of the CPU or of the interface of the hardware configuration.
RECNUM	Input	BYTE	I, Q, M, D, L or constant	Data record number (permitted values: 0 to 240)
RET_VAL	Return	INT	I, Q, M, D, L	If an error occurs while the instruction is being executed, the return value contains an error code. If no error occurred during the transmission, the following two cases are distinguished: <ul style="list-style-type: none"> <li>RET_VAL contains the length of the actually read data record in bytes if the target range is larger than the read data record.</li> <li>RET_VAL contains "0" if the length of the read data record is equal to the length of the target range.</li> </ul>
BUSY	Output	BOOL	I, Q, M, D, L	BUSY = 1: The job is not yet completed.
RECORD	Output	VARIANT	I, Q, M, D, L	Target range for the data record read.

For additional information on valid data types, refer to "Overview of the valid data types (Page 1077)".

## Parameter RET\_VAL

Error code* (W#16#...)	Explanation	Restriction
0000	No error	-
7000	First call with REQ=0: No data transfer active; BUSY has the value 0.	-
7001	First call with REQ=1: Data transfer triggered; BUSY has the value "1".	Distributed I/O
7002	Intermediate call (REQ irrelevant): Data transfer already active; BUSY has the value "1".	Distributed I/O
8090	Specified logical base address invalid.	-
8092	A data type other than (Array of) bit string or integer was specified at the RECORD parameter.	-
8093	This instruction is not valid for the module selected with LADDR.	-
80A1	Negative acknowledgement during sending of data record to module (module defective or unplugged during sending).	-
80A2	DP protocol error at layer 2, possible hardware/interface error in DP slave.	Distributed I/O
80A3	DP protocol error at user interface/user.	Distributed I/O
80A4	Communication on PBUS+ disrupted	-
80B0	Instruction for module type not possible, or module does not recognize the data record.	-
80B1	The length of the data record to be sent is incorrect. With RD_DPARM (Page 2438): The target range spanned by RECORD is too short.	-
80B2	The configured slot is not assigned.	-
80B3	Actual module type does not correspond to specified module type.	-
80C1	The data of the previous write job on the module for the same data record have not yet been processed by the module.	-
80C2	The module is currently processing the maximum possible number of jobs for a CPU.	-
80C3	The required resources (memory, etc.) are currently occupied.	-
80C4	Internal temporary error. Job could not be executed. Repeat the job. If this error occurs often, check your installation for sources of electrical interference.	-
80C5	Distributed I/O not available or deactivated.	Distributed I/O
80C6	Data record transfer cancelled due to priority class abort (restart or background).	Distributed I/O
80D0	There is no entry for the module.	-
80D1	The data record number is not configured for the module (data record numbers > 241 are rejected).	-
80D2	The module cannot be assigned parameters according to its type identifier.	-

Error code* (W#16#...)	Explanation	Restriction
80D5	The data record is static.	-
General error information	See also: GET_ERR_ID: Get error ID locally (Page 1787)	-

\* The error codes can be displayed as integer or hexadecimal values in the program editor. For additional information on toggling display formats, refer to "See also".

### RD\_DPARM: Read data record from configured system data

#### Description

You use instruction to read the data record with the number RECNUM of the addressed module from the configured system data. The read data record is entered into the target range spanned by the RECORD parameter.

#### Parameters

The following table shows the parameters of the instruction "RD\_DPARM":

Parameter	Declaration	Data type	Memory area	Description
IOID	Input	BYTE	I, Q, M, D, L or constant	Address area identifier: <ul style="list-style-type: none"> <li>• B#16#54 = Peripheral input (PI)</li> <li>• B#16#55 = Peripheral output (PQ)</li> </ul> If the module is a mixed module, the area identifier of the lower address must be specified. If the addresses are identical, specify B#16#54.
LADDR	Input	HW_IO	I, Q, M, D, L or constant	Identification number of the CPU or the interface. The number is assigned automatically and is stored in the properties of the CPU or of the interface of the hardware configuration.
RECNUM	Input	BYTE	I, Q, M, D, L or constant	Data record number (permitted values: 0 to 240)
RET_VAL	Return	INT	I, Q, M, D, L	Length of the data record read in bytes if the read data record fits in the target range and no error occurred in the transfer. If an error occurs while the instruction is being executed, the return value contains an error code.
RECORD	Output	VARIANT	I, Q, M, D, L	Target range for the data record read.

For additional information on valid data types, refer to "Overview of the valid data types (Page 1077)".

**Parameter RET\_VAL**

Error code* (W#16#...)	Explanation	Restriction
0000	No error	-
7000	First call with REQ=0: No data transfer active; BUSY has the value 0.	-
7001	First call with REQ=1: Data transfer triggered; BUSY has the value "1".	Distributed I/O
7002	Intermediate call (REQ irrelevant): Data transfer already active; BUSY has the value "1".	Distributed I/O
8090	Specified logical base address invalid.	-
8092	A type other than BYTE is specified in the VARIANT reference at the RECORD parameter.	-
8093	This instruction is not valid for the module selected with LADDR.	-
80B1	The target range spanned by RECORD is too short.	-
80C3	The required resources (memory, etc.) are currently occupied.	-
80D0	There is no entry for the module.	-
80D1	The data record number is not configured for the module (data record numbers > 241 are rejected).	-
80D2	The module cannot be assigned parameters according to its type identifier.	-
80D5	The data record is static.	-
General error information	See also: GET_ERR_ID: Get error ID locally (Page 1787)	-

\* The error codes can be displayed as integer or hexadecimal values in the program editor. For additional information on toggling display formats, refer to "See also".

**WR\_DPARM: Transfer data record****Description**

You use the instruction "WR\_DPARM" to transfer the data record with the number RECNUM from the configuration data to the addressed module. With this instruction, it is irrelevant whether the data record is static or dynamic.

**Parameters**

The following table shows the parameters of the "WR\_DPARM" instruction:

Parameter	Declaration	Data type	Memory area	Description
REQ	Input	BOOL	I, Q, M, D, L	REQ = 1: Write request
LADDR	Input	HW_IO	I, Q, M, D, L or constant	Identification number of the CPU or the interface. The number is assigned automatically and is stored in the properties of the CPU or of the interface in the hardware configuration. Please see the relevant module manual for the possible DB number bands.
RECNUM	Input	BYTE	I, Q, M, D, L or constant	Data record number
RET_VAL	Return	INT	I, Q, M, D, L	If an error occurs while the instruction is being executed, the return value contains an error code.
BUSY	Output	BOOL	I, Q, M, D, L	BUSY = 1: The writing process is not yet completed.

For additional information on valid data types, refer to "Overview of the valid data types (Page 1077)".

**Parameter RET\_VAL**

Error code* (W#16#...)	Explanation	Restriction
0000	No error	-
7000	First call with REQ=0: No data transfer active; BUSY has the value 0.	-
7001	First call with REQ=1: Data transfer triggered; BUSY has the value "1".	Distributed I/O
7002	Intermediate call (REQ irrelevant): Data transfer already active; BUSY has the value "1".	Distributed I/O
8090	Specified logical base address invalid.	-
8093	This instruction is not valid for the module selected with LADDR.	-
80A1	Negative acknowledgement during sending of data record to module (module defective or unplugged during sending).	-
80A2	DP protocol error at layer 2, possible hardware/interface error in DP slave.	Distributed I/O
80A3	DP protocol error at user interface/user.	Distributed I/O
80A4	Communication on PBUS+ disrupted	-
80B0	Instruction for module type not possible, or module does not recognize the data record.	-
80B1	The length of the data record to be sent is incorrect.	-
80B2	The configured slot is not assigned.	-



Error code* (W#16#...)	Explanation	Restriction
80B3	Actual module type does not correspond to specified module type.	-
80C1	The data of the previous write job on the module for the same data record have not yet been processed by the module.	-
80C2	The module is currently processing the maximum possible number of jobs for a CPU.	-
80C3	The required resources (memory, etc.) are currently occupied.	-
80C4	Internal temporary error. Job could not be executed. Repeat the job. If this error occurs often, check your installation for sources of electrical interference.	-
80C5	Distributed I/O not available or deactivated.	Distributed I/O
80C6	Data record transfer cancelled due to priority class abort (restart or background).	Distributed I/O
80D0	There is no entry for the module.	-
80D1	The data record number is not configured for the module (data record numbers > 241 are rejected).	-
80D2	The module cannot be assigned parameters according to its type identifier.	-
80D5	The data record is static.	-
General error information	See also: GET_ERR_ID: Get error ID locally (Page 1787)	-
* The error codes can be displayed as integer or hexadecimal values in the program editor. For additional information on toggling display formats, refer to "See also".		

### 9.7.3.7 Interrupts

#### ATTACH: Attach an OB to an interrupt event

##### Description

You use the instruction "ATTACH" to assign an organization block (OB) to an event.

You enter the symbolic or numeric name of the organization block in the OB\_NR parameter. This will then be assigned to the event specified in the EVENT parameter.

If the event in the EVENT parameter occurs following error-free execution of the "ATTACH" instruction, the organization block in the OB\_NR parameter will be called and its program executed.

With the ADD parameter, you specify whether previous assignments of the organization block to other events should be canceled or retained. If the ADD parameter has the value "0", the existing assignments will be replaced by the current assignment.

### Parameters

The following table shows the parameters of the "ATTACH" instruction:

Parameter	Declaration	Data type	Memory area	Description
OB_NR	Input	OB_ATT (INT)	I, Q, M, D, L or constant	Organization block (numbers up to 32767 are supported.)
EVENT	Input	EVENT_ATT (DWORD)	D, L or constant	Event, e.g., creation of a process event (failure of a hardware module; read hardware ID (16#C0xyyzz) and query at block)
ADD	Input	BOOL	I, Q, M, D, L or constant	Effects on previous assignments: <ul style="list-style-type: none"> <li>• ADD=0 (default): This event replaces all previous event assignments for this OB.</li> <li>• ADD=1: This event is added to the previous event assignments for this OB.</li> </ul>
RET_VAL	Return	INT	I, Q, M, D, L	Status of the instruction

You will find more detailed information on valid data types in "Overview of the valid data types (Page 1077)".

### RET\_VAL parameter

Error code* (W#16#....)	Description
0	No error
8090	OB does not exist
8091	OB is incorrect type
8093	Event does not exist

\* The error codes can be displayed as integer or hexadecimal values in the program editor. For additional information on toggling display formats, refer to "See also".

### DETACH: Detach an OB from an interrupt event

#### Description

You use this instruction to cancel the existing assignment of an organization block to one or more events during runtime.

- If you have selected a single event, the assignment of the OB to this event will be cancelled. All other currently existing assignments remain active. You can select an individual event using the drop-down list of the operand placeholder at the EVENT parameter.
- If you have not selected an event, all currently existing assignments of the organization block to events will be canceled.

You enter the symbolic or numeric name of the organization block in the OB\_NR parameter. The assignment of this organization block to the event specified in the EVENT parameter will then be canceled.

## Parameters

The following table shows the parameters of the "DETACH" instruction:

Parameter	Declaration	Data type	Memory area	Description
OB_NR	Input	OB_ATT (INT)	I, Q, M, D, L or constant	Organization block (numbers up to 32768 are supported.)
EVENT	Input	EVENT_ATT (DWORD)	D, L or constant	Event
RET_VAL	Return	INT	I, Q, M, D, L	Status of the instruction

For additional information on valid data types, refer to "Overview of the valid data types (Page 1077)".

## Parameter RET\_VAL

Error code* (W#16#...)	Description
0	No error
1	No assignment exists (warning)
8090	OB does not exist
8091	OB has incorrect type
8093	Event does not exist
* The error codes can be displayed as integer or hexadecimal values in the program editor. For additional information on toggling display formats, refer to "See also".	

## Cyclic interrupt

### SET\_CINT: Set cyclic interrupt parameters

#### Description

You use this instruction to set the parameters for a cyclic interrupt OB. The start time for a cyclic interrupt OB is generated from the respective time interval of the OB and the phase offset.

- The time interval of an OB is the interval at which the OB is periodically called. For example, if the time interval is 100 µs, the OB will be called every 100 µs during program execution.
- The phase offset is a time interval by which the call of a cyclic interrupt OB is offset. You can use the phase offset to process low priority organization blocks in a precise time base.

If the OB does not exist or if the time interval used is not supported, a corresponding error alarm is output in the RET\_VAL parameter.

A time interval in the CYCLE parameter of "0" means that the OB will not be called.

**Functional description**

If a lower priority OB and a higher priority OB are called in the same time interval, the lower priority OB will only be called once the higher priority OB has been executed. The call time for the lower priority OB can be offset according to the length of time to execute the higher-priority OB.

OB call without phase offset

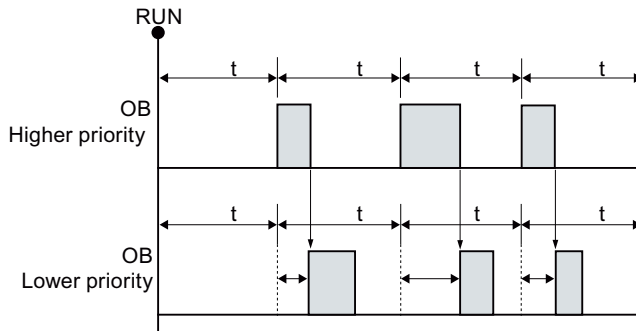

If a phase offset is configured for the lower priority OB and the phase offset is greater than the current execution time of the respective higher priority OB, then the block will be called in a fixed time base.

OB call with phase offset

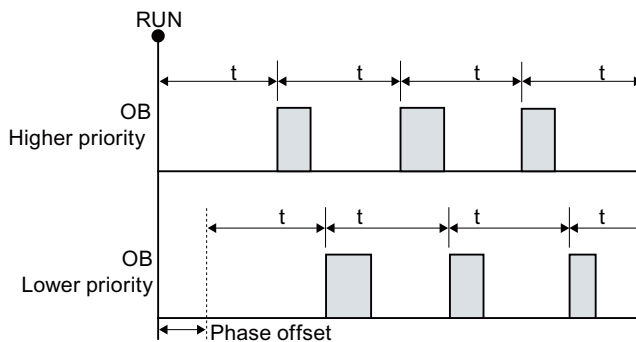

**Parameters**

The following table shows the parameters of the "SET\_CINT" instruction:

Parameter	Declaration	Data type	Memory area	Description
OB_NR	Input	OB_CYCLIC	I, Q, M, D, L or constant	OB number (<32768)
CYCLE	Input	UDINT	I, Q, M, D, L or constant	Time interval in microseconds
PHASE	Input	UDINT	I, Q, M, D, L or constant	Phase offset
RET_VAL	Return	INT	I, Q, M, D, L	Status of the instruction

For additional information on valid data types, refer to "Overview of the valid data types (Page 1077)".

## Parameter RET\_VAL

Error code* (W#16#...)	Description
0	No error
8090	OB does not exist or is of the wrong type
8091	Incorrect time interval
8092	Incorrect phase offset
80B2	No event assigned to OB
* The error codes can be displayed as integer or hexadecimal values in the program editor. For additional information on toggling display formats, refer to "See also".	

## QRY\_CINT: Query cyclic interrupt parameters

### Description

You can use this instruction to query the current parameters of a cyclic interrupt OB. The cyclic interrupt OB is identified using the OB\_NR parameter.

The values of the queried cyclic interrupt parameters correspond to those at the time the "QRY\_CINT" instruction is executed.

### Parameters

The following table shows the parameters of the "QRY\_CINT" instruction:

Parameter	Declaration	Data type	Memory area	Description
OB_NR	Input	OB_CYCLIC (INT)	I, Q, M, D, L or constant	OB number (<32768) or symbolic addressing via the name of the OB (e.g. OB_MyOB)
CYCLE	Output	UDINT	I, Q, M, D, L	Time interval in microseconds
PHASE	Output	UDINT	I, Q, M, D, L	Phase offset
STATUS	Output	WORD	I, Q, M, D, L	Status of the cyclic interrupt: <ul style="list-style-type: none"> <li>• Bit 0 to bit 4: see parameter STATUS</li> <li>• Other bits: Always "0"</li> </ul>
RET_VAL	Return	INT	I, Q, M, D, L	Status of the instruction

For additional information on valid data types, refer to "Overview of the valid data types (Page 1077)".

## Parameter STATUS

Bit	Value	Meaning
0	0	The CPU is in RUN mode.
	1	The CPU is in startup.

9.7 References

Bit	Value	Meaning
1	0	The cyclic interrupt is enabled.
	1	The cyclic interrupt is delayed.
2	0	The cyclic interrupt is not enabled or has expired.
	1	The cyclic interrupt is enabled.
3	0	-
	1	-
4	0	An OB with the specified number does not exist.
	1	An OB with the specified number exists.
Other bits		Always "0"

**Parameter RET\_VAL**

If an error occurs, the relevant error code will be displayed in the RET\_VAL parameter and the STATUS parameter is set to "0".

Error code* (W#16#...)	Description
0	No error
8090	OB does not exist or is of the wrong type
80B2	No event assigned to OB
* The error codes can be displayed as integer or hexadecimal values in the program editor. For additional information on toggling display formats, refer to "See also".	

**Time-of-day interrupt**

**SET\_TINT: Set time-of-day interrupt**

**Description**

With the instruction, you can set the start date and time of the time-of-day interrupt organization blocks. The seconds and milliseconds of the specified start time are ignored and set to "0".

## Parameters

The following table shows the parameters of the "SET\_TINT" instruction:

Parameter	Declaration	Data type	Memory area	Description
OB_NR	Input	OB_TOD (INT)	I, Q, M, D, L or constant	Number of the OB started at the time SDT + multiple of PERIOD (OB 10 to OB 17 and from OB 123).
SDT	Input	DT	D, L	Start date and time: the seconds and milliseconds of the specified start time are ignored and set to 0.  If you want to set a monthly start of a time-of- day interrupt OB, you can only use the days 1, 2, ... 28 as a start date.
PERIOD	Input	WORD	I, Q, M, D, L or constant	Period from starting point SDT onwards: <ul style="list-style-type: none"> <li>• W#16#0000 = once</li> <li>• W#16#0201 = once every minute</li> <li>• W#16#0401 = once hourly</li> <li>• W#16#1001 = once daily</li> <li>• W#16#1201 = once weekly</li> <li>• W#16#1401 = once monthly</li> <li>• W#16#1801 = once yearly</li> <li>• W#16#2001 = at month's end</li> </ul>
RET_VAL	Return	INT	I, Q, M, D, L	If an error occurs during execution of the instruction, the actual parameter of RET_VAL contains an error code.

For additional information on valid data types, refer to "Overview of the valid data types  
(Page 1077)".

## Parameter RET\_VAL

Error code* (W#16#...)	Description
0000	No error occurred.
8090	Incorrect parameter OB_NR
8091	Incorrect parameter SDT
8092	Incorrect parameter PERIOD
80A1	The set start time is in the past. (This error code occurs only when PERIOD = W#16#0000.)
General error information	See also: GET_ERR_ID: Get error ID locally (Page 1787)
* The error codes can be displayed as integer or hexadecimal values in the program editor. For additional information on toggling display formats, refer to "See also".	

## SET\_TINTL: Set time-of-day interrupt

### Description

The instruction "SET\_TINTL" is used to set the start data and time of the time-of-day interrupt organization blocks from the user program, without having to make settings in the hardware configuration.

With the SDT parameter, you specify the start date and time-of-day. With the PERIOD parameter, you can specify the cycle at which the instruction call is to be repeated (e.g., daily, once per week). If you set the repetition period to "monthly", you may only specify a day between 1. and 28. for the start date. It is not permitted to assign parameters for day 29 to 31, as no hardware interrupt would be called, for example, in February. If you want to initiate the time-of-day interrupt at the end of each month, use the "End of month" function.

With the ACTIVATE parameter, you specify whether the settings made for the organization block are to be applied directly (ACTIVATE = true) or only after "ACT\_TINT (Page 2450)" for the time-of-day interrupt organization block is called (ACTIVATE = false).

---

### Note

When calling time-delay interrupt organization blocks with a start time within the second hour during changeover from daylight saving time to standard time, also use a time-delay interrupt during the first hour of the time changeover.

---

### Parameters

The following table shows the parameters of the "SET\_TINTL" instruction:

Parameter	Declaration	Data type	Memory area	Description
OB_NR	Input	OB_TOD (INT)	I, Q, M, D, L or constant	Number of the OB started at the time SDT + multiple of PERIOD (OB 10 to OB 17 and from OB 123).
SDT	Input	DTL	D, L	Start date and start time: The seconds and milliseconds of the specified start time are ignored and set to "0".
LOCAL	Input	BOOL	I, Q, M, D, L or constant	<ul style="list-style-type: none"> <li>LOCAL = true: Use local time</li> <li>LOCAL = false: Use system time</li> </ul>
PERIOD	Input	WORD	I, Q, M, D, L or constant	Period from starting point SDT onwards: <ul style="list-style-type: none"> <li>W#16#0000 = Once</li> <li>W#16#0201 = Once every minute</li> <li>W#16#0401 = Once hourly</li> <li>W#16#1001 = once daily</li> <li>W#16#1201 = once weekly</li> <li>W#16#1401 = once monthly</li> <li>W#16#1801 = once yearly</li> <li>W#16#2001 = at month's end</li> </ul>



Parameter	Declaration	Data type	Memory area	Description
ACTIVATE	Input	BOOL	I, Q, M, D, L or constant	<ul style="list-style-type: none"> <li>ACTIVATE = true: Execute instruction</li> <li>ACTIVATE = false: Execute instruction only when "ACT_TINT (Page 2450)" is called</li> </ul>
RET_VAL	Return	INT	I, Q, M, D, L	If an error occurs during execution of the instruction, the actual parameter of RET_VAL contains an error code.

For additional information on valid data types, refer to "Overview of the valid data types (Page 1077)".

## Parameter RET\_VAL

Error code* (W#16#...)	Description
0000	No error occurred.
8090	Incorrect parameter OB_NR
8091	Incorrect parameter SDT
8092	Incorrect parameter PERIOD
80A1	The set start time is in the past. (This error code occurs only when PERIOD = W#16#0000.)
General error information	See also: GET_ERR_ID: Get error ID locally (Page 1787)

\* The error codes can be displayed as integer or hexadecimal values in the program editor. For additional information on toggling display formats, refer to "See also".

## CAN\_TINT: Cancel time-of-day interrupt

### Description

The instruction "CAN\_TINT" is used to delete the start data and start time of a specified time-of-day interrupt organization block. This deactivates the time-of-day interrupt, and the organization block is no longer called.

If you want to use the time-of-day interrupt again, you must first reset the start time ("SET\_TINTL (Page 2448)" instruction) and then activate the time-of-day interrupt ("ACT\_TINT (Page 2450)" interrupt).

### Parameters

The following table shows the parameters of the instruction "CAN\_TINT":

Parameter	Declaration	Data type	Memory area	Description
OB_NR	Input	OB_TOD (INT)	I, Q, M, D, L or constant	Number of the OB whose start data and start time are to be deleted.
RET_VAL	Return	INT	I, Q, M, D, L	If an error occurs during execution of the instruction, the actual parameter of RET_VAL contains an error code.

For additional information on valid data types, refer to "Overview of the valid data types (Page 1077)".

**Parameter RET\_VAL**

Error code* (W#16#...)	Description
0000	No error occurred.
8090	Incorrect parameter OB_NR
80A0	No start date/time specified for the time-of-day interrupt OB
General error information	See also: GET_ERR_ID: Get error ID locally (Page 1787)

\* The error codes can be displayed as integer or hexadecimal values in the program editor. For additional information on toggling display formats, refer to "See also".

**ACT\_TINT: Enable time-of-day interrupt**

**Description**

You use the instruction to activate a time-of-day interrupt organization block.

**Parameters**

The following table shows the parameters of the instruction "ACT\_TINT":

Parameter	Declaration	Data type	Memory area	Description
OB_NR	Input	OB_TOD (INT)	I, Q, M, D, L or constant	Number of the OB to be activated.
RET_VAL	Return	INT	I, Q, M, D, L	If an error occurs during execution of the instruction, the actual parameter of RET_VAL contains an error code.

For additional information on valid data types, refer to "Overview of the valid data types (Page 1077)".

**Parameter RET\_VAL**

Error code* (W#16#...)	Description
0000	No error occurred.
8090	Incorrect parameter OB_NR
80A0	Start date and time-of day not set for the relevant time-of-day interrupt OB.
80A1	The activated time lies in the past; error occurs for execution "once".

Error code* (W#16#...)	Description
General error information	See also: GET_ERR_ID: Get error ID locally (Page 1787)
* The error codes can be displayed as integer or hexadecimal values in the program editor. For additional information on toggling display formats, refer to "See also".	

## QRY\_TINT: Query status of time-of-day interrupt

### Description

You can use this instruction to display the status of a time-of-day interrupt organization block in the STATUS output parameter.

### Parameters

The following table shows the parameters of the "QRY\_TINT" instruction:

Parameter	Declaration	Data type	Memory area	Description
OB_NR	Input	OB_TOD (INT)	I, Q, M, D, L or constant	Number of the OB that will be queried for status (OB 10 to OB 17 and from OB 123).
RET_VAL	Return	INT	I, Q, M, D, L	If an error occurs during execution of the instruction, the actual parameter of RET_VAL contains an error code.
STATUS	Output	WORD	I, Q, M, D, L	Status of the time-of-day interrupt; see following table.

For additional information on valid data types, refer to "Overview of the valid data types (Page 1077)".

### Parameter STATUS

If an error occurs (see RET\_VAL parameter), "0" is output in the STATUS parameter.

Bit	Value	Meaning
0	0	In Run.
	1	During startup.
1	0	The time-of-day interrupt is enabled.
	1	The time-of-day interrupt is disabled.
2	0	Time-of-day interrupt is not activated or has elapsed.
	1	The time-of-day interrupt is activated.
4	0	An OB with an OB number as specified at OB_NR parameter does not exist.
	1	An OB with an OB number as specified at OB_NR parameter does exist.
6	0	Base for the time-of-day interrupt is the basic time

Bit	Value	Meaning
	1	Base for the time-of-day interrupt is the local time
Other		Always "0"

### Parameter RET\_VAL

Error code* (W#16#...)	Description
0000	No error occurred.
8090	Incorrect parameter OB_NR
General error information	See also: GET_ERR_ID: Get error ID locally (Page 1787)
* The error codes can be displayed as integer or hexadecimal values in the program editor. For additional information on toggling display formats, refer to "See also".	

### Time-delay interrupt

#### Using time-delay interrupts

#### Definition

After you have called the "SRT\_DINT (Page 2453)" instruction, the operating system generates an interrupt after the specified delay time has elapsed, in other words, the assigned time-delay interrupt OB is called.

#### Prerequisites for the call

Before a time-delay interrupt can be called by the operating system, the following conditions must be met:

- The time-delay interrupt OB must be started by the "SRT\_DINT (Page 2453)" instruction.
- The time-delay interrupt OB must not be deselected during configuration.
- The time-delay interrupt OB must exist in the CPU.

#### Purpose of the instructions "SRT\_DINT", "CAN\_DINT" and "QRY\_DINT"

You use the instructions to

- Start time-delay interrupts ("SRT\_DINT (Page 2453)")
- Cancel time-delay interrupts ("CAN\_DINT (Page 2454)")
- Query time-delay interrupts ("QRY\_DINT (Page 2455)")

## Effects on the time-delay interrupt

The following table lists a number of different situations and explains the effect they have on a time-delay interrupt.

If ...	and ...	Then ...
A time-delay interrupt is started (by calling "SRT_DINT (Page 2453)")	The time-delay interrupt has already started,	The delay time is overwritten; the time-delay interrupt is started again.
	The time-delay interrupt OB does not exist at the time of the call,	The operating system generates a priority class error (calls OB 85). If OB 85 does not exist, the CPU changes to STOP.
	The interrupt is started in a startup OB and the delay time elapses before the CPU changes to RUN,	The call of the time-delay interrupt OB is delayed until the CPU is in RUN mode.
The delay time has elapsed,	A previously started time-delay interrupt OB is still being executed,	The operating system generates a time error (calls OB 80). If OB 80 does not exist, the CPU changes to STOP.

## Response to warm restart and cold restart

During a warm restart or a cold restart, all the time-delay interrupt settings made in the user program by means of instructions are cleared.

## Starting in a startup OB

A time-delay interrupt can be started in a startup OB. Two conditions must be satisfied to call the time-delay OB:

- The delay time must have elapsed.
- The CPU must be in the RUN mode.

If the delay time has elapsed and the CPU is not yet in the RUN mode, the time-delay interrupt OB call is delayed until the CPU is in RUN mode. The time-delay interrupt OB is then called before the first instruction in OB Main [OB 1] is executed.

## SRT\_DINT: Start time-delay interrupt

### Description

The instruction "SRT\_DINT" is used to start a time-delay interrupt, which calls a time-delay interrupt OB after the expiry of the delay time specified at the parameter DTIME. The delay time is started when a negative edge is generated in the EN enable input. The signal state of enable input EN must be "0" during delay time countdown. If the delay time countdown is interrupted, the OB configured in the OB\_NR parameter is not executed.

### Accuracy

The maximum time between the call of the "SRT\_DINT" instruction and the start of the time-delay interrupt OB is one millisecond longer than the configured delay time, provided that no interruption events delay the call.

### Parameters

The following table shows the parameters of the instruction "SRT\_DINT":

Parameter	Declaration	Data type	Memory area	Description
OB_NR	Input	OB_DELAY (INT)	I, Q, M, D, L or constant	Number of the OB to be executed after a delay time
DTIME	Input	TIME	I, Q, M, D, L or constant	Delay time (1 to 60000 ms) You can realize longer times, for example, by using a counter in a time-delay interrupt OB.
SIGN	Input	WORD	I, Q, M, D, L or constant	Identifier that appears when the time-delay interrupt OB is called in the start event information of the OB.
RET_VAL	Return	INT	I, Q, M, D, L	Status of the instruction

For additional information on valid data types, refer to "Overview of the valid data types (Page 1077)".

### Parameter RET\_VAL

Error code* (W#16#...)	Description
0000	No error
8090	Incorrect parameter OB_NR
8091	Incorrect parameter DTIME
General error information	See also: GET_ERR_ID: Get error ID locally (Page 1787)

\* The error codes can be displayed as integer or hexadecimal values in the program editor. For additional information on toggling display formats, refer to "See also".

### CAN\_DINT: Cancel time-delay interrupt

#### Description

You use this instruction to cancel a started time-delay interrupt and, thus, also cancel the call of the time delay interrupt OB that is to be executed after the configured delay time. You specify the number of the organization block whose call is to be canceled in the OB\_NR parameter.

## Parameters

The following table shows the parameters of the "CAN\_DINT" instruction:

Parameter	Declaration	Data type	Memory area	Description
OB_NR	Input	OB_DELAY (INT)	I, Q, M, D, L or constant	Number of the OB whose call will be canceled
RET_VAL	Return	INT	I, Q, M, D, L	Status of the instruction

For additional information on valid data types, refer to "Overview of the valid data types (Page 1077)".

## Parameter RET\_VAL

Error code* (W#16#...)	Description
0000	No error
8090	Incorrect parameter OB_NR
80A0	Time-delay interrupt has not started.
* The error codes can be displayed as integer or hexadecimal values in the program editor. For additional information on toggling display formats, refer to "See also".	

## QRY\_DINT: Query time-delay interrupt status

### Description

The instruction "QRY\_DINT" is used to query the status of the time-delay interrupt.

### Parameters

The following table shows the parameters of the instruction "QRY\_DINT":

Parameter	Declaration	Data type	Memory area	Description
OB_NR	Input	OB_DELAY (INT)	I, Q, M, D, L or constant	Number of the OB whose status is being queried.
RET_VAL	Return	INT	I, Q, M, D, L	If an error occurs during execution of the instruction, the actual parameter of RET_VAL contains an error code. The value "0" is displayed in the STATUS parameter.
STATUS	Output	WORD	I, Q, M, D, L	Status of the time-delay interrupt, see following table.

For additional information on valid data types, refer to "Overview of the valid data types (Page 1077)".

### Parameter STATUS

Bit	Value	Meaning
0	0	Operating system in RUN
	1	Operating system in startup
1	0	Time-delay interrupt is enabled by the operating system.
	1	Time-delay interrupt is disabled.
2	0	Time-delay interrupt is not activated or has elapsed.
	1	Time-delay interrupt is activated.
3	-	-
4	0	Time-delay interrupt OB with the specified number does not exist.
	1	Time-delay interrupt OB with the specified number exists.
Other bits		Always "0"

### Parameter RET\_VAL

Error code* (W#16#...)	Description
0000	No error occurred.
8090	Incorrect information in the OB_NR parameter
General error information	See also: GET_ERR_ID: Get error ID locally (Page 1787)
* The error codes can be displayed as integer or hexadecimal values in the program editor. For additional information on toggling display formats, refer to "See also".	

### Synchronous errors

#### Mask synchronous error events

#### Introduction

Synchronous errors are programming and access errors. Such errors occur as a result of programming with incorrect operand areas or numbers, or incorrect addresses. **Masking** these synchronous errors means the following:

- Masked synchronous errors do not trigger an error OB call and do not lead to a programmed alternative reaction.
- The CPU "records" the masked errors that have occurred in an error status register.

Masking is carried out by calling the "MSK\_FLT (Page 2463)" instruction.

**Unmasking** errors means canceling a previously set mask and clearing the corresponding bit in the event status register of the current priority class. Masking is canceled as follows:



- By calling the "DMSK\_FLT (Page 2464)" instruction.
- Once the current priority class has been completed.

If an error event occurs after it has been unmasked, then the operating system will start the associated error OB. You program OB 121 for the reaction to programming errors and OB 122 for the reaction to access errors.

You can use the "READ\_ERR (Page 2464)" instruction to read the masked errors that have occurred.

---

#### Note

With the S7-300 (except CPU 318), regardless of whether an error is masked or unmasked, the error is entered in the diagnostic buffer and the group error LED of the CPU is illuminated.

---

## Handling errors in general

If programming and access errors occur in a user program, you can react to them in different ways:

- You can program an error OB that is called by the operating system when the corresponding error occurs.
- You can disable the error OB call individually for each priority class. In this case, the CPU does not change to STOP when an error of this type occurs in the particular priority class. The CPU enters the error in an error register. From this entry, however, you cannot recognize when or how often the error occurred.

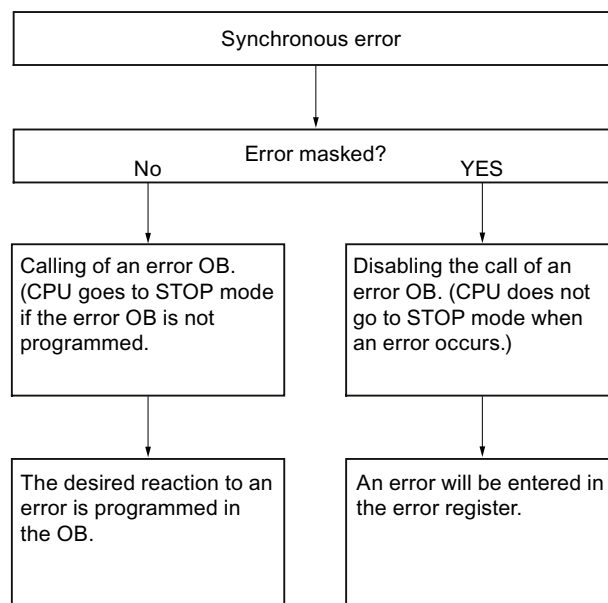

### Error filter

Synchronous errors are assigned to a particular bit pattern known as the **error filter**. You can find this error filter in the input and output parameters of the "MSK\_FLT (Page 2463)", "DMSK\_FLT (Page 2464)", and "READ\_ERR (Page 2464)" instructions.

Synchronous errors are divided into programming and access errors that you can mask using two error filters. The error filters are illustrated in the following figures.

### Programming error filter

The following figure shows the bit pattern of the error filter for programming errors. The error filter for the programming errors is available in the "PRGFLT\_..." parameters (see below "Programming errors, Low-Word" or "Programming errors, High-Word").

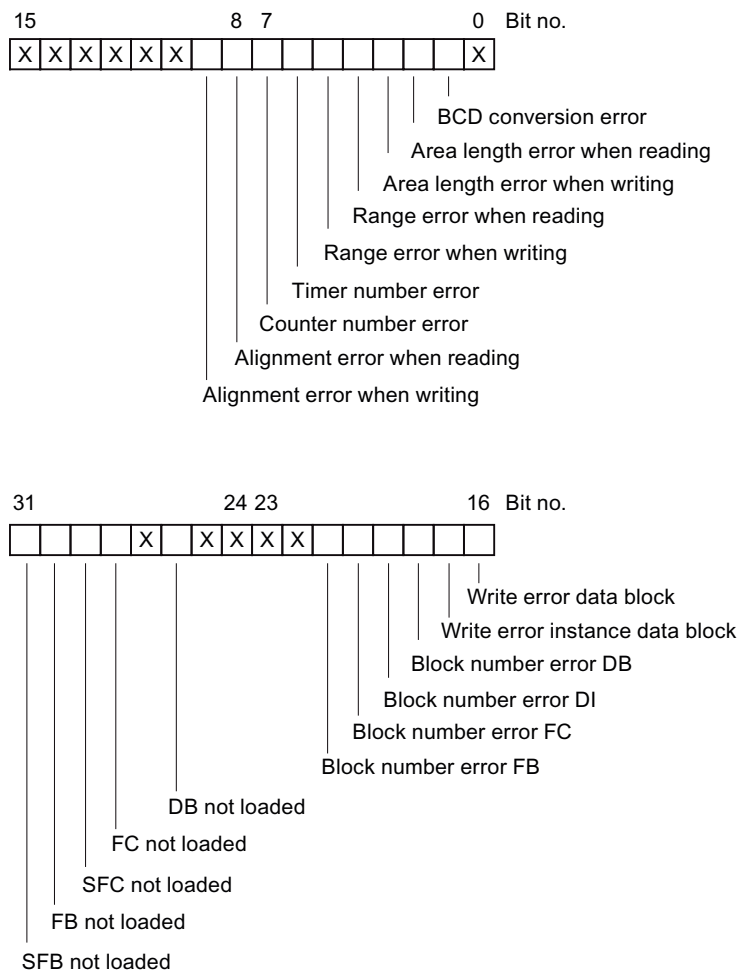

Legend:  Not relevant

### Non-relevant bits

In the figure above, x means ...

• ... Input parameters	For "MSK_FLT (Page 2463)", "DMSK_FLT (Page 2464)", "READ_ERR (Page 2464)"	= "0"
• ... Output parameters	For "MSK_FLT (Page 2463)", "DMSK_FLT (Page 2464)"	= "1" for S7-300 = "0" for S7-400
	For "READ_ERR (Page 2464)"	= "0"

### Access error filter for all CPUs

The following figure shows you the bit pattern of the error filter for access errors. The filter for access errors is in the parameters ACCFLT\_... For an explanation of the access errors, refer to the table "Possible causes of errors for all CPUs 31x except CPU 318" or "Possible causes of errors for all CPUs 41x and CPU 318".

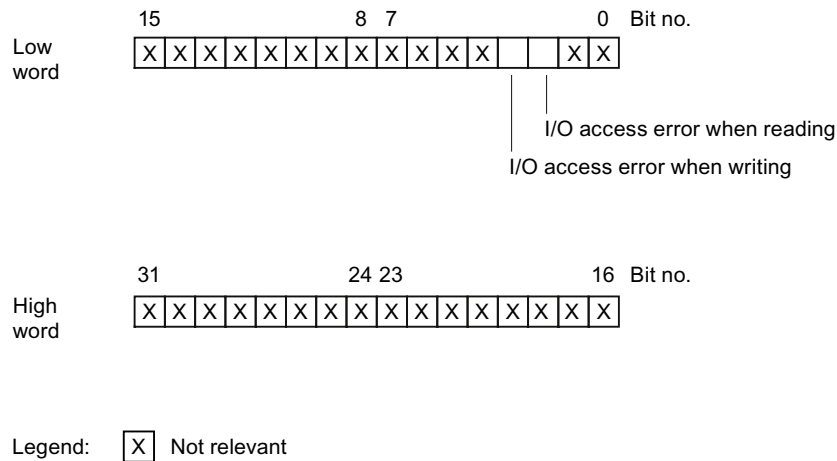

**Example**

The following figure shows the low word of the error filter for access errors with all masked errors for all CPUs.

- As input parameters for "MSK\_FLT (Page 2463)"
- As output parameters for "MSK\_FLT (Page 2463)"

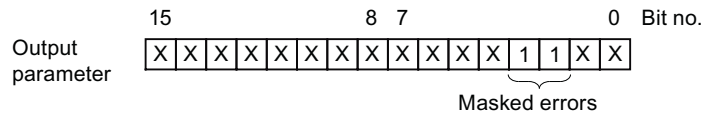
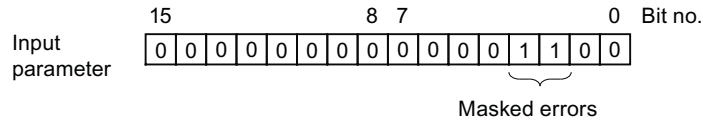

- Legend:
- X Not relevant
  - 0 Not masked
  - 1 Masked

**Programming error low word**

The following table lists the errors assigned to the low word of the error filter for programming errors. The possible causes of the errors are also listed.

Possible causes of programming errors, low word

Error	Event ID (W#16#...)	Error occurs ...
BCD conversion error	2521	... when the value to be converted is not a BCD number (for example, 5E8).
Area length error when reading	2522	... when an addressed operand is being used that is not completely within the possible operand area. Example: MW 320 should be read although the memory area is only 256 bytes long.
Area length error when writing	2523	... when an addressed operand is being used that is not completely within the possible operand area. Example: A value should be written to MW 320 although the memory area is only 256 bytes long.

Error	Event ID (W#16#...)	Error occurs ...
Range error when reading	2524	... when an incorrect area identifier is specified for the operand when using indirect, area-overlapping addressing. Example: Correct: LAR1 P#E 12.0 L W[AR1, P#0.0] Incorrect: LAR1 P#12.0 L W[AR1, P#0.0] For this operation the area length error is signaled.
Range error when writing	2525	... when an incorrect area identifier is specified for the operand when using indirect, area-overlapping addressing. Example: Correct: LAR1 P#E 12.0 T W[AR1, P#0.0] Incorrect: LAR1 P#12.0 T W[AR1, P#0.0] For this operation the area length error is signaled.
Timer number error	2526	... when a non-existent timer is accessed. Example: SP T [MW 0] where MW 0 = 129; timer 129 should be started although there are only 128 timers available.
Counter number error	2527	... when a non-existent counter is accessed. Example: CU C [MW 0] where MW 0 = 600; counter 600 must be accessed although there are only 512 counters available (CPU 416-1).
Alignment error when reading	2528	... when a byte, word, or double word operand is addressed with a bit address $\neq$ 0. Example: Correct: LAR1 P#M12.0 L B[AR1, P#0.0] Incorrect: LAR1 P#M12.4 L B[AR1, P#0.0]
Alignment error when writing	2529	... when a byte, word, or double word operand is addressed with a bit address $\neq$ 0. Example: Correct: LAR1 P#M12.0 T B[AR1, P#0.0] Incorrect: LAR1 P#M12.4 T B[AR1, P#0.0]

### Programming error high word

The following table lists the errors assigned to the high word of the error filter for programming errors. The possible causes of the errors are also listed.

Possible causes of programming errors, high word

Error	Event ID (W#16#...)	Error occurs ...
Write error data block	2530	... when the data block to be written to is read-only.
Write error instance data block	2531	... when the instance data block to be written to is read-only.
Block number error DB	2532	... when a data block must be opened whose number is higher than the highest permitted number.
Block number error DI	2533	... when an instance data block must be opened whose number is higher than the highest permitted number.
Block number error FC	2534	... when a function is called whose number is higher than the highest permitted number.
Block number error FB	2535	... when a function block is called whose number is higher than the highest permitted number.
DB not loaded	253A	... when the data block to be opened is not loaded.
Instruction not loaded	253C to 253F	... when the called instruction is not loaded.

### Access error

The following table lists the errors assigned to the error filter for access errors for all CPUs. The possible causes of the errors are also listed.

Error	Event ID (W#16#...)	Error occurs ...
I/O access error when reading	2942	... when a signal module is not assigned to the address in the I/O area. Or ... when access to this I/O area is not acknowledged within the specified module monitoring time (timeout).
I/O access error when writing	2943	... when a signal module is not assigned to the address in the I/O area. Or ... when access to this I/O area is not acknowledged within the specified module monitoring time (timeout).

## MSK\_FLT: Mask synchronous error events

### Description

You use the instruction to control the reaction of the CPU to synchronous errors. This is done by masking the respective synchronous errors (for error filters, see Mask synchronous error events (Page 2456)). When you call "MSK\_FLT", you mask the synchronous errors in the current priority class.

If you set individual bits of the synchronous error filter to "1" in the input parameters, other bits that were set previously retain their value of "1". You obtain new error filters that you can read out using the output parameters. The synchronous errors you have masked do not call an OB but are simply entered in an error register. You can read the error register with the "READ\_ERR (Page 2464)" instruction.

### Parameters

The following table shows the parameters of the instruction "MSK\_FLT":

Parameter	Declaration	Data type	Memory area	Description
PRGFLT_SET_MASK	Input	DWORD	I, Q, M, D, L or constant	Programming error to be masked
ACCFLT_SET_MASK	Input	DWORD	I, Q, M, D, L or constant	Access error to be masked
RET_VAL	Return	INT	I, Q, M, D, L	Error information
PRGFLT_MASKED	Output	DWORD	I, Q, M, D, L	Masked programming errors
ACCFLT_MASKED	Output	DWORD	I, Q, M, D, L	Masked access errors

You will find more detailed information on valid data types in "Overview of the valid data types (Page 1077)".

### Parameter RET\_VAL

Error code* (W#16#...)	Description
0000	None of the errors were already masked.
0001	At least one of the errors was already masked. Nevertheless the other errors will be masked.
-	General error information See also: Getting error ID locally with GetErrorID (Page 2237)

\* The error codes can be displayed as integer or hexadecimal values in the program editor. For additional information on toggling display formats, refer to "See also".

### See also

Evaluating errors with output parameter RET\_VAL (Page 1584)

## DMSK\_FLT: Unmask synchronous error events

### Description

You use the instruction to unmask the errors masked with "MSK\_FLT (Page 2463)". To do this, you must set the corresponding bits of the error filter to "1" in the input parameters. With the "DMSK\_FLT" call, you unmask the corresponding synchronous errors of the current priority class. At the same time, the queried entries are cleared in the error register. You can read out the new error filters using the output parameters.

### Parameters

The following table shows the parameters of the instruction "DMSK\_FLT":

Parameter	Declaration	Data type	Memory area	Description
PRGFLT_RESET_MASK	Input	DWORD	I, Q, M, D, L or constant	Programming errors to be unmasked
ACCFLT_RESET_MASK	Input	DWORD	I, Q, M, D, L or constant	Access errors to be unmasked
RET_VAL	Return	INT	I, Q, M, D, L	Error information
PRGFLT_MASKE D	Output	DWORD	I, Q, M, D, L	Still masked programming errors
ACCFLT_MASKE D	Output	DWORD	I, Q, M, D, L	Still masked access errors

You will find more detailed information on valid data types in "Overview of the valid data types (Page 1077)".

### Parameter RET\_VAL

Error code* (W#16#...)	Description
0000	All specified errors were unmasked.
0001	At least one of the errors was not masked. Nevertheless the other errors will be unmasked.
-	General error information See also: GET_ERR_ID: Get error ID locally (Page 2237)

\* The error codes can be displayed as integer or hexadecimal values in the program editor. For additional information on toggling display formats, refer to "See also".

## READ\_ERR: Read out event status register

### Description

You use the instruction to read the error register. The structure of the error register corresponds to that of the programming and access error filters, which you can program as input parameters with "MSK\_FLT (Page 2463)" and "DMSK\_FLT (Page 2464)".



In the input parameters, you enter the synchronous errors you want to read from the error register. When you call "READ\_ERR", you read the required entries from the error register and at the same time clear these entries.

The error register contains information that tells you which of the masked synchronous errors in the current priority class occurred at least once. If a bit is set, this means that the corresponding masked synchronous error occurred at least once.

## Parameters

The following table shows the parameters of the instruction "READ\_ERR":

Parameter	Declaration	Data type	Memory area	Description
PRGFLT_QUERY	Input	DWORD	I, Q, M, D, L or constant	Query programming error
ACCFLT_QUERY	Input	DWORD	I, Q, M, D, L or constant	Query access error
RET_VAL	Return	INT	I, Q, M, D, L	Error information
PRGFLT_CLR	Output	DWORD	I, Q, M, D, L	Programming errors that occurred
ACCFLT_CLR	Output	DWORD	I, Q, M, D, L	Access errors that occurred

You will find more detailed information on valid data types in "Overview of the valid data types (Page 1077)".

## Parameter RET\_VAL

Error code* (W#16#...)	Description
0000	All queried errors are masked.
0001	At least one of the queried errors is not masked.
-	General error information See also: Getting error ID locally with GetErrorID (Page 2237)

\* The error codes can be displayed as integer or hexadecimal values in the program editor. For additional information on toggling display formats, refer to "See also".

## See also

Evaluating errors with output parameter RET\_VAL (Page 1584)

## Asynchronous error event

### DIS\_IRT: Disable interrupt event

#### Description

The instruction "DIS\_IRT" is used to disable the processing of new interrupts and asynchronous error events. Disabling means that if an interrupting event occurs, the operating system of the CPU reacts as follows:

- It **neither** calls an interrupt OB nor an asynchronous error OB,
- **nor** does it trigger the normal reaction if an interrupt OB or asynchronous error OB is not programmed.

If you disable interrupts and asynchronous error events, this remains in effect for all priority classes. The disable can only be canceled with the "EN\_IRT (Page 2467)" instruction or by a warm or a cold restart.

Whether the operating system writes interrupts and asynchronous error events to the diagnostics buffer when they occur depends on the input parameter setting you select for MODE.

---

#### Note

Remember that when you program the "DIS\_IRT" instruction, all interrupts that occur will be discarded.

---

#### Parameters

The following table shows the parameters of the instruction "DIS\_IRT":

Parameter	Declaration	Data type	Memory area	Description
MODE	Input	BYTE	I, Q, M, D, L or constant	Specifies which interrupts and asynchronous errors are disabled.
OB_NR	Input	INT	I, Q, M, D, L or constant	OB number
RET_VAL	Return	INT	I, Q, M, D, L	If an error occurs while the instruction is being executed, the return value contains an error code.

You will find more detailed information on valid data types in "Overview of the valid data types (Page 1077)".

## Parameter MODE

MODE (B#16#...)	Meaning
00	All newly occurring interrupts and asynchronous error events are disabled. (Synchronous errors are not disabled.) Assign the value "0" to the OB_NR parameter. Entries continue to be made in the diagnostics buffer.
01	All newly occurring events belonging to a specified interrupt class are disabled. Identify the interrupt class by specifying it as follows: <ul style="list-style-type: none"> <li>• Time-of-day interrupts: 10</li> <li>• Time-delay interrupts: 20</li> <li>• Cyclic interrupts: 30</li> <li>• Process interrupts: 40</li> <li>• Interrupts for DPV1: 50</li> <li>• Multicomputing interrupt: 60</li> <li>• Redundancy error interrupts: 70</li> <li>• Asynchronous error interrupts: 80</li> </ul> Entries continue to be made in the diagnostics buffer.
02	All new occurrences of a specified interrupt are disabled. You designate the interrupt using the OB number. Entries continue to be made in the diagnostics buffer.

## Parameter RET\_VAL

Error code* (W#16#...)	Description
0000	No error occurred.
8090	The OB_NR input parameter contains an invalid value.
8091	The MODE input parameter contains an invalid value.
General error information	See also: GET_ERR_ID: Get error ID locally (Page 1787)
* The error codes can be displayed as integer or hexadecimal values in the program editor. For additional information on toggling display formats, refer to "See also".	

## EN\_IRT: Enable interrupt event

### Description

You use the instruction to enable the processing of new interrupts and asynchronous error events that you have previously disabled with the "DIS\_IRT (Page 2466)" instruction. This means that if an interrupting event occurs, the operating system of the CPU reacts in one of the following ways:

- It calls an interrupt OB or asynchronous error OB.  
or
- It triggers the standard reaction if the interrupt OB or asynchronous error OB is not programmed.

**Parameters**

The following table shows the parameters of the instruction "EN\_IRT":

Parameter	Declaration	Data type	Memory area	Description
MODE	Input	BYTE	I, Q, M, D, L or constant	Specifies which interrupts and asynchronous error events will be enabled.
OB_NR	Input	INT	I, Q, M, D, L or constant	OB number
RET_VAL	Return	INT	I, Q, M, D, L	If an error occurs while the instruction is being executed, the return value contains an error code.

For additional information on valid data types, refer to "Overview of the valid data types (Page 1077)".

**Parameter MODE**

MODE	Meaning
0	All newly occurring interrupts and asynchronous error events are enabled.
1	All newly occurring events belonging to a specified interrupt class are enabled. Identify the interrupt class by specifying it as follows: <ul style="list-style-type: none"> <li>• Time-of-day interrupts: 10</li> <li>• Time-delay interrupts: 20</li> <li>• Cyclic interrupts: 30</li> <li>• Process interrupts: 40</li> <li>• Interrupts for DPV1: 50</li> <li>• Multicomputing interrupt: 60</li> <li>• Redundancy error interrupts: 70</li> <li>• Asynchronous error interrupts: 80</li> </ul>
2	All newly occurring events of a specified interrupt are enabled. You designate the interrupt using the OB number.

**Parameter RET\_VAL**

Error code* (W#16#...)	Description
0000	No error occurred.
8090	The OB_NR input parameter contains an invalid value.
8091	The MODE input parameter contains an invalid value.
General error information	See also: GET_ERR_ID: Get error ID locally (Page 1787)
* The error codes can be displayed as integer or hexadecimal values in the program editor. For additional information on toggling display formats, refer to "See also".	

## DIS\_AIRT: Delay execution of higher priority interrupts and asynchronous error events

### Description

You use "DIS\_AIRT" to delay the processing of interrupt OBs whose priority are higher than the priority of the current organization block.

You can call "DIS\_AIRT" multiple times in an organization block. The "DIS\_AIRT" calls are counted by the operating system. Processing is delayed more and more each time "DIS\_AIRT" is executed. To cancel a delay, you must execute the "EN\_AIRT (Page 2469)" instruction. To cancel all delays, the number of "EN\_AIRT (Page 2469)" executions must be equal to the number of "DIS\_AIRT" calls.

You can query the number of delays in the RET\_VAL parameter of the "DIS\_AIRT" instruction. If the value in the RET\_VAL parameter is "0", there are no delays.

### Parameters

The following table shows the parameters of the "DIS\_AIRT" instruction:

Parameter	Declaration	Data type	Memory area	Description
RET_VAL	Return	INT	I, Q, M, D, L	Number of delays

For additional information on valid data types, refer to "Overview of the valid data types (Page 1077)".

## EN\_AIRT: Enable execution of higher priority interrupts and asynchronous error events

### Description

You use "EN\_AIRT" to enable processing of organization blocks when interrupts occur that have been delayed by the "DIS\_AIRT (Page 2469)" instruction.

When "EN\_AIRT" is executed, you cancel a processing delay that was registered by the operating system when "DIS\_AIRT (Page 2469)" was called. To cancel all delays, the number of "EN\_AIRT" executions must be equal to the number of "DIS\_AIRT (Page 2469)" calls. If, for example, you have called "DIS\_AIRT (Page 2469)" five times and thereby also delayed the processing five times, you must call the "EN\_AIRT" instruction five times in order to cancel all five delays.

You can query the number of interrupt delays that have not yet been enabled after the execution of "EN\_AIRT" in the RET\_VAL parameter of the "EN\_AIRT" instruction. The value "0" in the RET\_VAL parameter means that all delays enabled by "DIS\_AIRT (Page 2469)" have been cancelled.

## Parameters

The following table shows the parameters of the "EN\_AIRT" instruction:

Parameter	Declaration	Data type	Memory area	Description
RET_VAL	Return	INT	I, Q, M, D, L	Number of configured delays

For additional information on valid data types, refer to "Overview of the valid data types (Page 1077)".

### 9.7.3.8 Alarms

#### Program\_Alarm: Generate program alarm with associated values

##### Description

The instruction "Program\_Alarm" monitors a signal and generates a program alarm when a signal change occurs at the SIG parameter (for definition, see also: Auto-Hotspot). An incoming alarm is generated if the signal changes from 0 to 1 and an outgoing program alarm if the signal changes from 1 to 0. The program alarm is triggered synchronously to program execution.

You can append up to ten associated values to the program alarm at the parameters SD\_i (0 ≤ i ≤ 10). The associated values are detected at the time of signal change at parameter SIG and assigned to the program alarm. For more information on configuring associated values, refer to the following sections: Auto-Hotspot, Auto-Hotspot, Auto-Hotspot.

Each incoming or outgoing alarm is assigned a time stamp:

- The current system time of the PLC when the signal change occurs is used by default (default value at the TIMESTAMP parameter).
- If you wish to specify a different time stamp, you can create one at the TIMESTAMP parameter.  
The time value must always be specified in system time (i.e. UTC), as this is the time used for time synchronization throughout the plant.
- If an alarm is to be time-stamped with a local time, a conversion module, which converts the local time to system time, must be connected in series. This is the only way to make sure that the time stamp is shown properly in the alarm display.

To use the current system time of the CPU, set the TIMESTAMP parameter to its default value (LDT#1970-1-1-0:0:0.0).

#### Calling the "Program\_Alarm" instruction

The instruction "Program\_Alarm" can only be called in a function block (FB).

Once the instruction has been inserted in the FB, a multiple instance of the data type "Program\_Alarm" is created in the "Static" section of the FB interfaces. You can choose any name for this multiple instance in the dialog which appears. The name of the multiple instance is also the name of the program alarm.

Finally, add the parameters of the "Program\_Alarm" instruction in line with your requirements (see the "Parameters" table).

### Configuring the program alarm

The program alarm settings are displayed in the "Properties" window when you select the name of the program alarm in the "Static" section or in the network of the FB. In this window, you can select the alarm class, priority, etc. and edit the alarm text.

The settings that are made here can be edited in the project tree. Go to "PLC alarms" and open the "Program alarms" tab. All existing program alarms are then displayed in the "Alarm types" table.

### Parameters

The following table shows the parameters of the "Program\_Alarm" instruction:

Parameter	Declaration	Data type	Memory area	Description
SIG	Input	BOOL	I, Q, M, D, L or constant	The signal to be monitored.
TIMESTAMP	Input	LDT	M, D, L or constant	<p>This parameter is used to assign an alarm a time stamp, for example, from an input signal with a distributed stamp. The time value must always be specified in system time (i.e. UTC), as this is the time used for time synchronization throughout the plant.</p> <ul style="list-style-type: none"> <li>• "Not assigned" means that the system time of the CPU will be used as the interrupt time stamp when a signal change occurs (default).</li> <li>• Any system time input will be used as the interrupt time stamp when a signal change occurs.</li> </ul> <p>Note: If an interrupt is to be time-stamped with a local time, a conversion module must be connected in series to convert the local time to system time. This is the only way to make sure that the time stamp is shown correctly in the interrupt display.</p>
SD_i	Input	LREAL, REAL, DINT, INT, DWORD, WORD, BYTE, BOOL, STRING or CHAR	I, Q, M, D, T, C	i-th associated value ( $0 \leq i \leq 10$ )

Parameter	Declaration	Data type	Memory area	Description
ERROR	Input	BOOL	I, Q, M, D, L	Status parameter ERROR ERROR = TRUE indicates that an error has occurred during processing. The possible error cause is displayed at the STATUS parameter.
STATUS	Input	WORD	I, Q, M, D, L	Status parameter STATUS Display of error information (see "ERROR and STATUS parameters").

For additional information on valid data types, refer to "Overview of the valid data types (Page 1077)".

### Parameters ERROR and STATUS

The following table contains all specific error information that can be output via the ERROR and STATUS parameters.

ERROR	STATUS*	Explanation
0	0000	No error
0	7001	Alarm is generated.
1	8001	Invalid static alarm information.
1	8002	No valid static alarm information.
1	8004	Maximum size of 512 bytes for the alarm has been reached.
1	8005	Incoming alarm.
1	8007	Outgoing alarm, preceded by no incoming alarm.
1	8087	Deactivate static alarms.
1	8089	Length of the alarm is too large.
1	80Ax	The parameter nr. x has an invalid value.
1	80C1	The CPU cannot generate any alarms at this time because initialization routines are running (this is the case after download in RUN, for example). Try again later.
1	80C2	The maximum number of alarms per time unit has been sent. Try again later.
1	80C3	All dynamic alarm instances are being used. Try again later.
1	80C4	Alarm is being output and cannot be overwritten. Try again later.

\* The error codes can be displayed as integer or hexadecimal values in the program editor. For additional information on toggling display formats, refer to "See also".

### Get\_AlarmState: Output alarm status

#### Description

The "Get\_AlarmState" instruction outputs the alarm status of a program alarm. The output of the alarm status always refers to a program alarm that was created using the "Program\_Alarm (Page 2470)" instruction.

The program alarm is selected with the Alarm input parameter. Specify the instance DB of the "Program\_Alarm" instruction at the Alarm parameter.



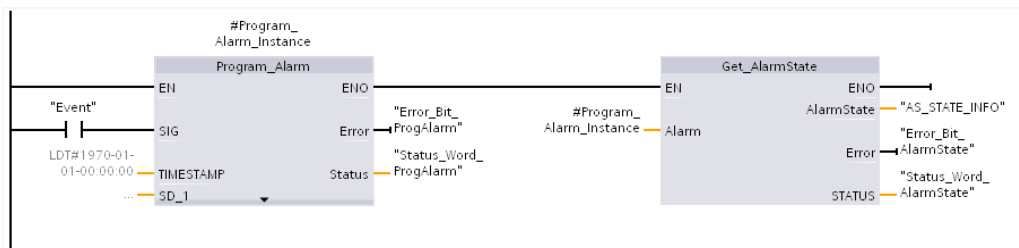

The alarm status is returned in a byte via the AlarmState output parameter. The meaning of the individual bits is shown in the following figure:

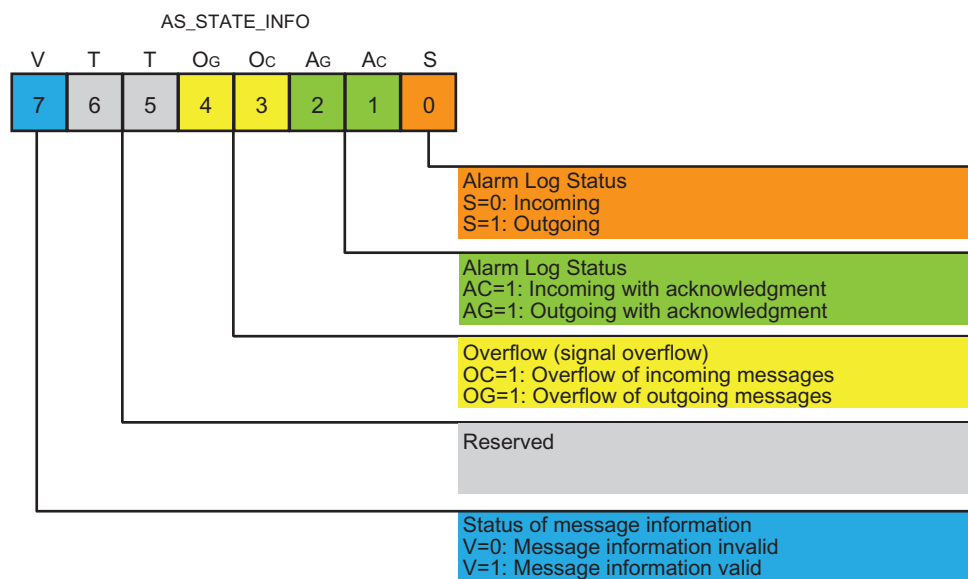

You can find more information about the possible alarm states in the section "Auto-Hotspot".

The execution status of the instruction is shown with the output parameters ERROR and STATUS.

## Parameters

The following table shows the parameters of the "Get\_AlarmState" instruction:

Parameter	Declaration	Data type	Memory area	Description
Alarm	Input	ALARM_BASE	D	Instance of the "Program_Alarm (Page 2470)" instruction.
AlarmState	Output	BYTE	I, Q, M, D, L	Status of the alarm as a bit array.

Parameter	Declaration	Data type	Memory area	Description
ERROR	Output	BOOL	I, Q, M, D, L	Status parameter <ul style="list-style-type: none"> <li>0: No error</li> <li>1: An error occurred during execution of the instruction.</li> </ul> Detailed information is output via the STATUS parameter.
STATUS	Output	WORD	I, Q, M, D, L	Status parameter The parameter is only set for the duration of one call. To display the status, you should therefore copy STATUS to a free data area.

For additional information on valid data types, refer to "Overview of the valid data types (Page 1077)".

### Parameter STATUS

Error code* (W#16#...)	Explanation
8001	Invalid static alarm instance.
8002	ID of the alarm is invalid.
8003	No active alarms within the message class.
* The error codes can be displayed as integer or hexadecimal values in the program editor. For additional information on toggling display formats, refer to "See also".	

### Gen\_UsrMsg: Generate user diagnostic alarms

#### Description

You use the "Gen\_UsrMsg" instruction to generate a user diagnostic alarm. By means of user diagnostic alarms, you can write a user entry to the diagnostics buffer and send a corresponding alarm.

The entry to the diagnostics buffer and the query of the Send parameter take place at the same time. The info report is transmitted asynchronously.

You define the contents of the user entry to the diagnostics buffer with the parameters TextID, TextListID, AlarmDomain and AssocValues.

## Parameters

The following table shows the parameters of the "Gen\_UsrMsg" instruction:

Parameter	Declaration	Data type	Memory area	Description
Mode	Input	UInt	I, Q, M, D, L or constant	<ul style="list-style-type: none"> <li>• 1: Incoming alarm</li> <li>• 2: Outgoing alarm</li> </ul>
Send	Input	Bool	I, Q, M, D, L or constant	<ul style="list-style-type: none"> <li>• 0: Do not send info report</li> <li>• 1: Send info report</li> </ul>
TextID	Input	UInt	I, Q, M, D, L or constant	ID of the user-defined text
TextListID	Input	UInt	I, Q, M, D, L or constant	ID of the user-defined text list
AlarmDomain	Input	UInt	I, Q, M, D, L or constant	Used alarm domain
Ret_Val	Return	Int	I, Q, M, D, L	Error code of the instruction
AssocValues	InOut	Array [0..7] of UInt	I, Q, M, D, L	Associated values

For additional information on valid data types, refer to "Overview of the valid data types (Page 1077)".

## Parameter RET\_VAL

The following table contains all specific error information that can be output via the RET\_VAL parameter.

Error code* (W#16#...)	Explanation
0000	No error
8080	Value in the MODE parameter is not supported.
80C1	Resource bottleneck due to too many parallel calls.

\* The error codes can be displayed as integer or hexadecimal values in the program editor. For additional information on toggling display formats, refer to "See also".

### 9.7.3.9 Diagnostics

#### RD\_SINFO: Read current OB start information

##### Description

You use the instruction "RD\_SINFO" to read the start information

- of the last OB called that has not yet been completely executed, and
- of the last startup OB started.

9.7 References

There is no time stamp in either case. If the call is in OB 100, OB 101 or OB 102, two identical start information messages will be returned.

**Parameter**

The following table shows the parameters of the "RD\_SINFO" instruction:

Parameter	Declaration	Data type	Memory area	Description
RET_VAL	Return	INT	I, Q, M, D, L	Error information
TOP_SI	Output	VARIANT	D, L	Start information of the current OB
START_UP_SI	Output	VARIANT	D, L	Start information of the startup OB last started

You will find more detailed information on valid data types in "Overview of the valid data types (Page 1077)".

**SDTs of the TOP\_SI parameter**

The following table shows the possible SDTs for the TOP\_SI parameter:

Organization blocks (OB)	System data types (SDT)	System data type numbers
Any	SI_classic	592
	SI_none	593
ProgramCycleOB	SI_ProgramCycle	594
TimeOfDayOB	SI_TimeOfDay	595
TimeDelayOB	SI_Delay	596
CyclicOB	SI_Cyclic	597
ProcessEventOB	SI_HWInterrupt	598
ProfileEventOB	SI_Submodule	601
StatusEventOB		
UpdateEventOB		
SynchronousCycleOB	SI_SynchCycle	602
IOredundancyErrorOB	SI_IORedundancyError	604
CPUredundancyErrorOB	SI_CPURedundancyError	605
TimeErrorOB	SI_TimeError	606
DiagnosticErrorOB	SI_DiagnosticInterrupt	607
PullPlugEventOB	SI_PlugPullModule	608
PeripheralAccessErrorOB	SI_AccessError	609
RackStationFailureOB	SI_StationFailure	610
ServoOB	SI_Servo	611
IpoOB	SI_Ipo	612
StartupOB	SI_Startup	613
ProgrammingErrorOB	SI_ProgIOAccessError	614
IOaccessErrorOB		

## SDTs of the START\_UP\_SI parameter

The following table shows the possible SDTs for the START\_UP\_SI parameter:

System data types (SDT)	System data type numbers
SI_classic	592
SI_none	593
SI_Startup	613

## Structures

The following tables set out the meaning of the structure elements of the individual structures:

Table 9-57 SI\_classic structure

Structure element	Data type	Description
EV_CLASS	BYTE	<ul style="list-style-type: none"> <li>Bits 0 to 3: Event ID</li> <li>Bits 4 to 7: Event class</li> </ul>
EV_NUM	BYTE	Event number
PRIORITY	BYTE	Priority class number (Meaning of B#16#FE: OB not available or disabled or cannot be started in current operating mode)
NUM	BYTE	OB number
TYP2_3	BYTE	Data ID 2_3: Identifies the information entered in ZI2_3
TYP1	BYTE	Data ID 1: Identifies the information entered in ZI1
ZI1	WORD	Additional information 1
ZI2_3	DWORD	Additional information 2_3

Table 9-58 SI\_none structure

Structure element	Data type	Description
SI_Format	USINT	<ul style="list-style-type: none"> <li>16#FF = No information</li> <li>16#FE = Optimized start information</li> </ul>
OB_Class	USINT	OB class for "No information" or "Optimized start information"
OB_Nr	UINT	OB number (1 ... 32767)

Table 9-59 SI\_ProgramCycle structure

Structure element	Data type	Description
SI_Format	USINT	<ul style="list-style-type: none"> <li>16#FF = No information</li> <li>16#FE = Optimized start information</li> </ul>
OB_Class	USINT := 1	OB class for "No information" or "Optimized start information"
OB_Nr	UINT	OB number (1 ... 32767)

9.7 References

Structure element	Data type	Description
Initial_Call	BOOL	For OB_Class = 1, 30, 52, 61, 65
Remanence	BOOL	For OB_Class = 1

Table 9-60 SI\_TimeOfDay structure

Structure element	Data type	Description
SI_Format	USINT	<ul style="list-style-type: none"> <li>• 16#FF = No information</li> <li>• 16#FE = Optimized start information</li> </ul>
OB_Class	USINT := 10	OB class for "No information" or "Optimized start information"
OB_Nr	UINT	OB number (1 ... 32767)
CaughtUp	BOOL	For OB_Class = 10
SecondTime	BOOL	For OB_Class = 10

Table 9-61 SI\_Delay structure

Structure element	Data type	Description
SI_Format	USINT	<ul style="list-style-type: none"> <li>• 16#FF = No information</li> <li>• 16#FE = Optimized start information</li> </ul>
OB_Class	USINT := 20	OB class for "No information" or "Optimized start information"
OB_Nr	UINT	OB number (1 ... 32767)
Sign	WORD	For OB_Class = 20

Table 9-62 SI\_Cyclic structure

Structure element	Data type	Description
SI_Format	USINT	<ul style="list-style-type: none"> <li>• 16#FF = No information</li> <li>• 16#FE = Optimized start information</li> </ul>
OB_Class	USINT := 30	OB class for "No information" or "Optimized start information"
OB_Nr	UINT	OB number (1 ... 32767)
Initial_Call	BOOL	For OB_Class = 1, 30, 52, 61, 65
Event_Count	INT	For OB_Class = 30, 51, 52, 61, 65, 91, 92

Table 9-63 SI\_HWInterrupt structure

Structure element	Data type	Description
SI_Format	USINT	<ul style="list-style-type: none"> <li>• 16#FF = No information</li> <li>• 16#FE = Optimized start information</li> </ul>
OB_Class	USINT := 40	OB class for "No information" or "Optimized start information"
OB_Nr	UINT	OB number (1 ... 32767)
LADDR	HW_IO	For OB_Class = 40, 51, 55, 56, 57, 70, 82, 83, 85, 86, 91, 92
USI	WORD	For OB_Class = 40
IChannel	USINT	For OB_Class = 40
EventType	BYTE	For OB_Class = 40

Table 9-64 SI\_Submodule structure

Structure element	Data type	Description
SI_Format	USINT	<ul style="list-style-type: none"> <li>• 16#FF = No information</li> <li>• 16#FE = Optimized start information</li> </ul>
OB_Class	USINT	OB class for "No information" or "Optimized start information"
OB_Nr	UINT	OB number (1 ... 32767)
LADDR	HW_IO	For OB_Class = 40, 51, 55, 56, 57, 70, 82, 83, 85, 86, 91, 92
Slot	UINT	For OB_Class = 55, 56, 57
Specifier	WORD	For OB_Class = 55, 56, 57

Table 9-65 SI\_SynchCycle structure

Structure element	Data type	Description
SI_Format	USINT	<ul style="list-style-type: none"> <li>• 16#FF = No information</li> <li>• 16#FE = Optimized start information</li> </ul>
OB_Class	USINT := 61	OB class for "No information" or "Optimized start information"
OB_Nr	UINT	OB number (1 ... 32767)
Initial_Call	BOOL	For OB_Class = 1, 30, 52, 61, 65
PIP_Input	BOOL	For OB_Class = 61, 91, 92
PIP_Output	BOOL	For OB_Class = 61, 91, 92
IO_System	USINT	For OB_Class = 61, 91, 92
Event_Count	INT	For OB_Class = 30, 51, 52, 61, 65, 91, 92
SyncCycleTime	LTIME	Calculated cycle time

Table 9-66 SI\_IORedundancyError structure

Structure element	Data type	Description
SI_Format	USINT	<ul style="list-style-type: none"> <li>• 16#FF = No information</li> <li>• 16#FE = Optimized start information</li> </ul>
OB_Class	USINT := 70	OB class for "No information" or "Optimized start information"
OB_Nr	UINT	OB number (1 ... 32767)
LADDR	HW_ANY	For OB_Class = 40, 51, 55, 56, 57, 70, 82, 83, 85, 86, 91, 92
Event_Class	BYTE	For OB_Class = 70, 83, 85, 86
Fault_ID	BYTE	For OB_Class = 70, 80, 83, 85, 86

Table 9-67 SI\_CPURedundancyError structure

Structure element	Data type	Description
SI_Format	USINT	<ul style="list-style-type: none"> <li>• 16#FF = No information</li> <li>• 16#FE = Optimized start information</li> </ul>
OB_Class	USINT := 72	OB class for "No information" or "Optimized start information"
OB_Nr	UINT	OB number (1 ... 32767)
Switch_Over	BOOL	For OB_Class = 72

9.7 References

Table 9-68 SI\_TimeError structure

Structure element	Data type	Description
SI_Format	USINT	<ul style="list-style-type: none"> <li>• 16#FF = No information</li> <li>• 16#FE = Optimized start information</li> </ul>
OB_Class	USINT := 80	OB class for "No information" or "Optimized start information"
OB_Nr	UINT	OB number (1 ... 32767)
Fault_ID	BYTE	For OB_Class = 70, 80, 83, 85, 86
Csg_OBnr	OB_ANY	For OB_Class = 80
Csg_Prio	UINT	For OB_Class = 80

Table 9-69 SI\_DiagnosticInterrupt structure

Structure element	Data type	Description
SI_Format	USINT	<ul style="list-style-type: none"> <li>• 16#FF = No information</li> <li>• 16#FE = Optimized start information</li> </ul>
OB_Class	USINT := 82	OB class for "No information" or "Optimized start information"
OB_Nr	UINT	OB number (1 ... 32767)
IO_State	WORD	For OB_Class = 82
LADDR	HW_ANY	For OB_Class = 40, 51, 55, 56, 57, 70, 82, 83, 85, 86, 91, 92
Channel	UINT	For OB_Class = 82
MultiError	BOOL	For OB_Class = 82

Table 9-70 SI\_PlugPullModule structure

Structure element	Data type	Description
SI_Format	USINT	<ul style="list-style-type: none"> <li>• 16#FF = No information</li> <li>• 16#FE = Optimized start information</li> </ul>
OB_Class	USINT := 83	OB class for "No information" or "Optimized start information"
OB_Nr	UINT	OB number (1 ... 32767)
LADDR	HW_IO	For OB_Class = 40, 51, 55, 56, 57, 70, 82, 83, 85, 86, 91, 92
Event_Class	BYTE	For OB_Class = 70, 83, 85, 86
Fault_ID	BYTE	For OB_Class = 70, 80, 83, 85, 86

Table 9-71 SI\_AccessError structure

Structure element	Data type	Description
SI_Format	USINT	<ul style="list-style-type: none"> <li>• 16#FF = No information</li> <li>• 16#FE = Optimized start information</li> </ul>
OB_Class	USINT := 85	OB class for "No information" or "Optimized start information"
OB_Nr	UINT	OB number (1 ... 32767)
LADDR	HW_IO	For OB_Class = 40, 51, 55, 56, 57, 70, 82, 83, 85, 86, 91, 92
Event_Class	BYTE	For OB_Class = 70, 83, 85, 86
Fault_ID	BYTE	For OB_Class = 70, 80, 83, 85, 86
IO_Addr	UINT	For OB_Class = 85
IO_LEN	UINT	For OB_Class = 85



Table 9-72 SI\_StationFailure structure

Structure element	Data type	Description
SI_Format	USINT	<ul style="list-style-type: none"> <li>• 16#FF = No information</li> <li>• 16#FE = Optimized start information</li> </ul>
OB_Class	USINT := 86	OB class for "No information" or "Optimized start information"
OB_Nr	UINT	OB number (1 ... 32767)
LADDR	HW_IO	For OB_Class = 40, 51, 55, 56, 57, 70, 82, 83, 85, 86, 91, 92
Event_Class	BYTE	For OB_Class = 70, 83, 85, 86
Fault_ID	BYTE	For OB_Class = 70, 80, 83, 85, 86

Table 9-73 SI\_Servo structure

Structure element	Data type	Description
SI_Format	USINT	<ul style="list-style-type: none"> <li>• 16#FF = No information</li> <li>• 16#FE = Optimized start information</li> </ul>
OB_Class	USINT := 91	OB class for "No information" or "Optimized start information"
OB_Nr	UINT	OB number (1 ... 32767)
Initial_Call	BOOL	For OB_Class = 1, 30, 52, 61, 65
PIP_Input	BOOL	For OB_Class = 61, 91, 92
PIP_Output	BOOL	For OB_Class = 61, 91, 92
IO_System	USINT	For OB_Class = 61, 91, 92
Event_Count	INT	For OB_Class = 30, 51, 52, 61, 65, 91, 92
Synchronous	BOOL	

Table 9-74 SI\_lpo structure

Structure element	Data type	Description
SI_Format	USINT	<ul style="list-style-type: none"> <li>• 16#FF = No information</li> <li>• 16#FE = Optimized start information</li> </ul>
OB_Class	USINT := 92	OB class for "No information" or "Optimized start information"
OB_Nr	UINT	OB number (1 ... 32767)
Initial_Call	BOOL	For OB_Class = 1, 30, 52, 61, 65
PIP_Input	BOOL	For OB_Class = 61, 91, 92
PIP_Output	BOOL	For OB_Class = 61, 91, 92
IO_System	USINT	For OB_Class = 61, 91, 92
Event_Count	INT	For OB_Class = 30, 51, 52, 61, 65, 91, 92
Reduction	UINT	For OB_Class = 92

Table 9-75 SI\_Startup structure

Structure element	Data type	Description
SI_Format	USINT	<ul style="list-style-type: none"> <li>• 16#FF = No information</li> <li>• 16#FE = Optimized start information</li> </ul>
OB_Class	USINT := 100	OB class for "No information" or "Optimized start information"
OB_Nr	UINT	OB number (1 ... 32767)

Structure element	Data type	Description
LostRetentive	BOOL	For OB_Class = 100
LostRTC	BOOL	For OB_Class = 100

Table 9-76 SI\_ProgIOAccessError structure

Structure element	Data type	Description
SI_Format	USINT	<ul style="list-style-type: none"> <li>16#FF = No information</li> <li>16#FE = Optimized start information</li> </ul>
OB_Class	USINT	OB class for "No information" or "Optimized start information"
OB_Nr	UINT	OB number (1 ... 32767)
BlockNr	UINT	For OB_Class = 121, 122
Reaction	USINT	For OB_Class = 121, 122
Fault_ID	BYTE	For OB_Class = 121, 122
BlockType	USINT	For OB_Class = 121, 122
Area	USINT	For OB_Class = 121, 122
DBNr	DB_ANY	For OB_Class = 121, 122
Csg_OBNr	OB_ANY	For OB_Class = 121, 122
Csg_Prio	USINT	For OB_Class = 121, 122
Width	USINT	For OB_Class = 121, 122

**Note**

The structure elements specified for the SI\_classic structure are identical in content to the temporary tags of any OB created with the block property "Default".

Please note, however, that temporary tags of the individual OBs can have different names and different data types. Also note that the call interface of each OB includes additional information regarding the date and the time of the OB request.

Bits 4 to 7 of the EV\_CLASS structure element contain the event class. The following values are possible here:

- 1: Start events from standard OBs
- 2: Start events from synchronous error OBs
- 3: Start events from asynchronous error OBs

The PRIORITY structure element supplies the priority class belonging to the current OB.

Apart from these two elements, NUM is also relevant. NUM contains the number of the current OB or the startup OB that was started last.

**RET\_VAL parameter**

The following table shows the meaning of the values of the RET\_VAL parameter:

Error code* (W#16#...)	Explanation
8080	Start information of the current OB does not correspond to the specified user-defined data type
8081	Start information of the current OB does not correspond to the specified system data type
8082	Start information of the last startup OB started does not correspond to the specified user-defined data type
8083	Start information of the last startup OB started does not correspond to the specified system data type

**Example**

OB 80 is the OB that was called last and that has not yet been completely processed and OB 100 is the start-up OB that was started last.

The following table shows the assignment between the structure elements of the TOP\_SI parameter of the "RD\_SINFO" instruction and the associated local tags of OB 80.

TOP_SI structure element	Data type	OB 80 - Associated local tag	Data type
EV_CLASS	BYTE	OB80_EV_CLASS	BYTE
EV_NUM	BYTE	OB80_FLT_ID	BYTE
PRIORITY	BYTE	OB80_PRIORITY	BYTE
NUM	BYTE	OB80_OB_NUMBR	BYTE
TYP2_3	BYTE	OB80_RESERVED_1	BYTE
TYP1	BYTE	OB80_RESERVED_2	BYTE
ZI1	WORD	OB80_ERROR_INFO	WORD
ZI2_3	DWORD	OB80_ERR_EV_CLASS	BYTE
		OB80_ERR_EV_NUM	BYTE
		OB80_OB_PRIORITY	BYTE
		OB80_OB_NUM	BYTE

The following table shows the assignment between the structure elements of the START\_UP\_SI parameter of the "RD\_SINFO" instruction and the associated local tags of OB 100.

START_UP_SI structure element	Data type	OB 100 - Local tag	Data type
EV_CLASS	BYTE	OB100_EV_CLASS	BYTE
EV_NUM	BYTE	OB100_STRTUP	BYTE
PRIORITY	BYTE	OB100_PRIORITY	BYTE
NUM	BYTE	OB100_OB_NUMBR	BYTE
TYP2_3	BYTE	OB100_RESERVED_1	BYTE
TYP1	BYTE	OB100_RESERVED_2	BYTE
ZI1	WORD	OB100_STOP	WORD
ZI2_3	DWORD	OB100_STRT_INFO	DWORD

**See also**

Evaluating errors with output parameter RET\_VAL (Page 1584)

**LED: Read LED status**

**Description**

You can use the "LED" instruction to read out the status (e.g., "On" or "Off") of a particular module LED.

- With the LADDR parameter, you address the CPU or the interface.
- With the LED parameter, you select the module LED whose current status is to be read out using the instruction.
- The RET\_VAL parameter outputs the status of the selected LED when the instruction is called. Depending on the LED selected, only certain status information may be displayed. For example, some LEDs have only color information. Refer to the hardware documentation of the respective module for the available status information of a particular LED.

**Parameters**

The following table shows the parameters of the "LED" instruction:

Parameter	Declaration	Data type	Memory area	Description
LADDR	Input	HW_IO	I, Q, M, L or constant	Identification number of the CPU or interface. The number is automatically assigned and stored in the CPU properties or the interface in the hardware configuration.
LED	Input	UINT	I, Q, M, D, L or constant	Identification number of the LED: <ul style="list-style-type: none"> <li>• 1: STOP/RUN</li> <li>• 2: ERROR</li> <li>• 3: MAINT (maintenance)</li> <li>• 4: Redundant</li> <li>• 5: Link (green)</li> <li>• 6: Rx/Tx (yellow)</li> </ul>
RET_VAL	Return	INT	I, Q, M, D, L	Status of LED

For additional information on valid data types, refer to "Overview of the valid data types (Page 1077)".

## Parameter RET\_VAL

RET_VAL	Description
0 to 9	LED status: <ul style="list-style-type: none"> <li>• 0 = LED does not exist</li> <li>• 1 = Permanently switched off</li> <li>• 2 = Color 1 (e.g., for LED STOP/RUN: green) permanently ON</li> <li>• 3 = Color 2 (e.g., for LED STOP/RUN: orange) permanently ON</li> <li>• 4 = Color 1 flashing at 2 Hz</li> <li>• 5 = Color 2 flashing at 2 Hz</li> <li>• 6 = Colors 1 and 2 flashing alternately at 2 Hz</li> <li>• 7 = LED is active, color 1</li> <li>• 8 = LED is active, color 2</li> <li>• 9 = LED exists, but status information not available</li> </ul>
8091	Module addressed with the LADDR parameter does not exist.
8092	A module that does not support LEDs was addressed with the LADDR parameter.
8093	The identification number specified in the LED parameter is not defined.
80Bx	The CPU specified in the LADDR parameter does not support the "LED" instruction.

## Get\_IM\_Data: Reading identification and maintenance data

### Description

The "Get\_IM\_Data" instruction reads the identification and maintenance data (I&M) data from a device. Use the LADDR parameter to select the device from which you want to read the I&M via the hardware identifier.

You select the data to be read via the instruction using the IM\_TYPE parameter. Reading the I&M 0 data is supported for TIA Portal V12 SP1 (IM\_TYPE = 0). The I&M 0 data are the device-specific basic information of a device and contain information such as the manufacturer ID, order number, serial number and the hardware and firmware version. This information is also displayed with the "Online & Diagnostics" view of a device.

The I&M 0 data read are written to the addressed area defined at the DATA parameter. You can use a STRING, or an ARRAY of CHAR/BYTE or STRUCT data structure to store the data:

- If you address a string (STRING data type) at the the DATA parameter, the length of the string automatically adjusts the length of the read I&M data (up to 254 characters).
- If you crate a data structure with a STRUCT data type at the DATA parameter, use a data block without optimized block access (see category "Attributes" of the block properties).
- If you address a data structure (ARRAY of CHAR/BYTE or STRUCT) a the DATA parameter, the I&M data read are written to the individual components of the data type used. If the addressed data structure is longer than the read data, the remaining components are filled with zeros.

- The "luM0\_data" structure can also be used to read the I&M 0 data (parameter IM\_TYPE = 0).
- Other data types are not permissible. If a data type other than STRING, ARRAY of BYTE/CHAR or STRUCT is used at the DATA parameter, the STATUS parameter generates error code 8093.

The execution status of the read job is displayed via the BUSY, DONE, ERROR output parameters and the two middle bytes of the STATUS output parameter.

**Definition: Identification and maintenance data (I&M)**

Identification and maintenance (I&M) data refers to information stored in a module, which assists you in checking the plant configuration, locating hardware changes in a plant and eliminating errors.

- Identification data (I data) are static information about a device that can only be read.
- Maintenance data (M-data) refers to plant-dependent information, such as the installation location or date. Maintenance data are created during configuration and written to the module.

**Parameters**

The following table shows the parameters of the "Get\_IM\_Data" instruction:

Parameter	Declaration	Data type	Memory area	Description
LADDR	Input	HW_IO	I, Q, M, D, L or constant	Hardware ID of the device The number is assigned automatically and is stored in the properties of the device or in the hardware configuration.
IM_TYPE	Input	UINT	I, Q, M, D, L or constant	Identification and maintenance data number Connect this parameter to the value "0".
DATA	InOut	VARIANT	I, Q, M, D, L	Area for storing the read identification and maintenance data.
DONE	Output	BOOL	I, Q, M, D, L	The instruction was executed successfully. The I&M data were transferred to the DATA parameter.
BUSY	Output	BOOL	I, Q, M, D, L	Status parameter <ul style="list-style-type: none"> <li>• 0: Execution of the instruction complete.</li> <li>• 1: Execution of the instruction not yet complete.</li> </ul>

Parameter	Declaration	Data type	Memory area	Description
ERROR	Output	BOOL	I, Q, M, D, L	Status parameter <ul style="list-style-type: none"> <li>• 0: No error.</li> <li>• 1: An error occurred during execution of the instruction.</li> </ul> Detailed information is output via the STATUS parameter.
STATUS	Output	WORD	I, Q, M, D, L	Status parameter The parameter is only set for the duration of one call. To display it, you should therefore copy STATUS to a free data area.

You can find more information on the data types in "Overview of the valid data types (Page 1077)".

## Parameter DATA

The "luM0\_data" structure can also be used to read and store the I&M 0 data (parameter IM\_TYPE = 0).

Parameter	Data type	Bytes	Description																
Manufacturer_ID	UINT	2	Manufacturer ID (e.g. "42" for SIEMENS)																
Order_ID	CHAR[20]	20	Order number																
Serial_Number	CHAR[16]	16	Serial number																
Hardware_Revision	UNIT	2	Hardware revision																
Software_Revision	STRUCT	4	Firmware revision																
<table border="1"> <tr> <td>Type</td> <td>CHAR</td> <td>1</td> <td>-</td> </tr> <tr> <td>Functional</td> <td>UNIT8</td> <td>1</td> <td>-</td> </tr> <tr> <td>Bugfix</td> <td>UNIT8</td> <td>1</td> <td>-</td> </tr> <tr> <td>Internal</td> <td>UINT8</td> <td>1</td> <td>-</td> </tr> </table>	Type	CHAR	1	-	Functional	UNIT8	1	-	Bugfix	UNIT8	1	-	Internal	UINT8	1	-			
	Type	CHAR	1	-															
	Functional	UNIT8	1	-															
	Bugfix	UNIT8	1	-															
Internal	UINT8	1	-																
Revision_Counter	UINT	2	Revision counter																
Profile_ID	UNIT	2	Profile																
Profile_Specific_Type	UNIT	2	Device class																
IM_Version	UNIT	2	-																
I&M_Supported	UNIT	2	-																

## Parameter STATUS

Error code* (W#16#...)	Description
0	No error
7000	No job in progress.
7001	First call of the asynchronous instruction "Get_IM_Data". Execution of the instruction not yet complete (BUSY = 1, DONE = 0).

Error code* (W#16#...)	Description
7002	Additional call of the asynchronous instruction "Get_IM_Data". Execution of the instruction not yet complete (BUSY = 1, DONE = 0).
8091	The device addressed at the LADDR parameter does not exist.
8092	LADDR addresses a device that does not support the output of the I&M data.
8093	Data type at the DATA parameter is not supported.
80B1	The "Get_IM_Data" instruction is not supported by the CPU used.
80B2	Invalid value at the IM_TYPE parameter or the selected IM_TYPE is not supported by the CPU or the addressed device.
8752	The memory area specified at the DATA parameter is too small to store all the I&M data. The read I&M data are stored only up to the maximum length of the specified memory area.

\* The error codes can be displayed as integer or hexadecimal values in the program editor. For additional information on toggling display formats, refer to "See also".

### GET\_NAME: Reading the name of a module

#### Description

The instruction "GET\_NAME" reads the name of an IO device. The name is displayed in the network view and in the properties of the IO device:

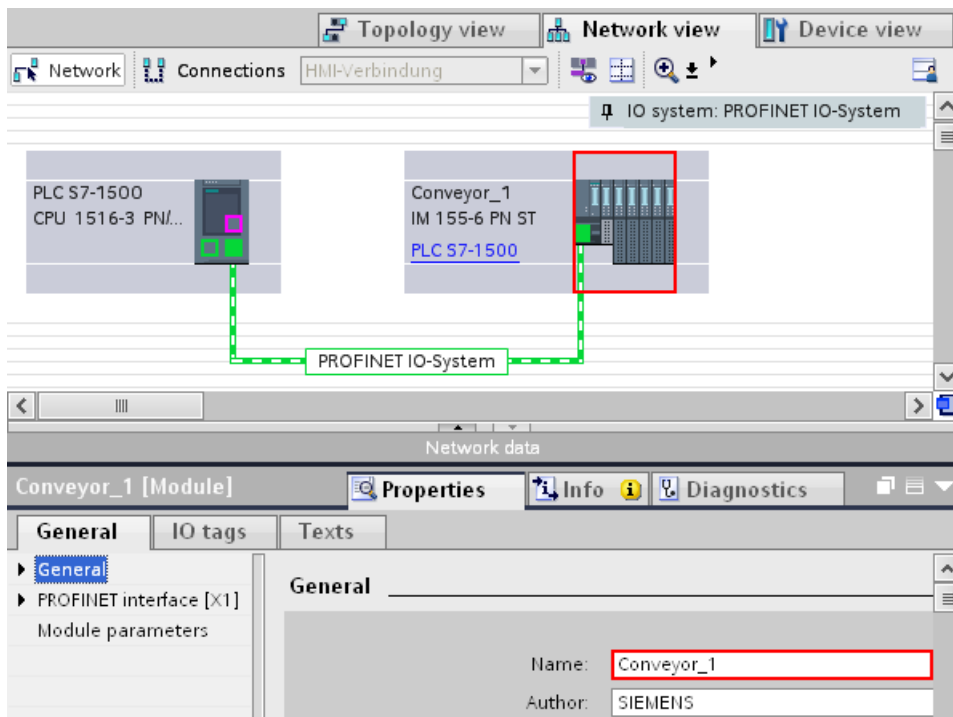

You select the IO device by using the hardware identifier of the PROFINET IO system (at the LADDR parameter) and the device number of the IO device (STATION\_NR parameter).



Once the instruction has been executed, the name of the IO device is written to the area addressed with the DATA parameter.

The length of the name is output at the LEN parameter. If the name is longer than the area specified at the DATA parameter, only that section which corresponds to the maximum length of the addressed area will be written.

## Parameters

The following table shows the parameters of the "GET\_NAME" instruction:

Parameter	Declaration	Data type	Memory area	Description
LADDR	Input	HW_IOSYSTEM	I, Q, M, D, L or constant	Hardware identifier of the PROFINET IO system. The number from the PROFINET IO system properties can be applied in the network view.
STATION_NR	Input	UINT	I, Q, M, D, L or constant	Device number of the IO device. The device number can be applied in the Network view from the properties of the IO device under "Ethernet addresses".
DATA	InOut	VARIANT	I, Q, M, D, L	Pointer to the area to which the name of the module is written.
DONE	Output	BOOL	I, Q, M, D, L	The instruction was executed successfully. Name of the module transferred to the area at the DATA parameter.
BUSY	Output	BOOL	I, Q, M, D, L	Status parameter <ul style="list-style-type: none"> <li>• 0: Execution of the instruction complete.</li> <li>• 1: Execution of the instruction not yet complete.</li> </ul>
ERROR	Output	BOOL	I, Q, M, D, L	Status parameter <ul style="list-style-type: none"> <li>• 0: No error.</li> <li>• 1: An error occurred during execution of the instruction.</li> </ul> Detailed information is output via the STATUS parameter.
LEN	Output	DINT	I, Q, M, D, L	Length of the name of the IO device (number of characters).
STATUS	Output	WORD	I, Q, M, D, L	Status parameter The parameter is only set for the duration of one call. To display the status, you should therefore copy STATUS to a free data area.

For additional information on valid data types, refer to "Overview of the valid data types (Page 1077)".

**Parameter STATUS**

Error code* (W#16#...)	Explanation
0	No error
7000	No job in progress.
7001	First call of the asynchronous instruction "GET_NAME". Execution of the instruction not yet complete (BUSY = 1, DONE = 0).
7002	Additional call of the asynchronous instruction "GET_NAME". Execution of the instruction not yet complete (BUSY = 1, DONE = 0).
8090	The LADDR input parameter contains an invalid value. Possible causes: <ul style="list-style-type: none"> <li>• The specified number is not a hardware identifier of a PROFINET IO system.</li> <li>• You have not specified a number at the LADDR parameter.</li> </ul>
8092	The value at the LADDR parameter does not address a PROFINET IO system.
8093	Instruction does not support data type at the DATA parameter.
8095	Device number (STATION_NR parameter) does not exist in the selected PROFINET IO system.
80B1	The CPU used does not support the instruction.
80C3	Temporary resource error: The CPU is currently processing the maximum possible number of simultaneous block calls. "GET_NAME" cannot be executed unless at least one of the block calls is finished.
8852	The area specified at the DATA parameter is too short for the full name of the IO device. The name will be written up to the maximum possible length.  To read the full name, use a longer data area at the DATA parameter. The area must have at least as many characters as there are at the LEN parameter.
* The error codes can be displayed as integer or hexadecimal values in the program editor. For additional information on toggling display formats, refer to "See also".	

**GetStationInfo: Read information of an IO device**

**Description**

You can use the "GetStationInfo" instruction to read information of a PROFINET IO device. The instruction also enables you to read the information of an IO device located in a lower-level IO system (connected via CP/CM).

The IO device is addressed via the hardware identifier of the station at the LADDR parameter. The hardware identifier is displayed in the "Devices & Networks" view in the station properties.

Use the MODE parameter to select the information to be read. The instruction supports reading the IP address parameters according IPv4 in TIA V12 SP1 (MODE = 1).

At the DATA parameter, specify the data area to which you want to write the read address data. Use the "IF\_CONF\_v4" structure to store the IP address.

Enable reading of the address data using the REQ control parameter. This requires the IO device to be accessible.

The execution status of the read job is displayed via the BUSY, DONE, ERROR output parameters and the STATUS output parameter.

### Note

#### Address the IO device using only the hardware identifier of the station

The station, the IO device and PROFINET interface have their own hardware identifier. Use only the hardware identifier of the station for the "GetStationInfo" instruction.

If a PROFINET is addressed via the LADDR parameter, for example, the address data is not read and the error code 8092 is generated.

To read the address data of an integrated PROFINET interface or a CM/CP in the central configuration, use the "RDREC" instruction.

## Parameters

The following table shows the parameters of the "GetStationInfo" instruction:

Parameter	Declaration	Data type	Memory area	Description
REQ	Input	BOOL	I, Q, M, D, L	Control parameter Request Activates the reading of the information with REQ = "1".
LADDR	Input	HW_DEVICE	I, Q, M, D, L or constant	Hardware identifier of the station of the IO device The number can be taken from the properties of the station in the Network view or from the "System constants" tab of the standard tag table.
DETAIL	Input	HW_SUBMODULE	I, Q, M, D, L or constant	The DETAIL parameter is not used. Leave the parameter unconnected.
MODE	Input	UNIT	I, Q, M, D, L or constant	Selection of address data to be read Connect the MODE parameter with "1" (read address parameter according to IPv4).
DATA	InOut	VARIANT	D, L	Pointer to the area to which the address data of the IO device is written. Use the "IF_CONF_v4" structure for MODE = 1.
DONE	Output	BOOL	I, Q, M, D, L	The instruction was executed successfully. The address data was transferred to the DATA parameter.
BUSY	Output	BOOL	I, Q, M, D, L	Status parameter <ul style="list-style-type: none"> <li>0: Execution of the instruction complete.</li> <li>1: Execution of the instruction not yet complete.</li> </ul>

Parameter	Declaration	Data type	Memory area	Description
ERROR	Output	BOOL	I, Q, M, D, L	Status parameter <ul style="list-style-type: none"> <li>0: No error.</li> <li>1: An error occurred during execution of the instruction.</li> </ul> Detailed information is output via the STATUS parameter.
STATUS	Output	WORD	I, Q, M, D, L	Status parameter The parameter is only set for the duration of one call. To display the status, you should therefore copy STATUS to a free data area.

You can find more information on the data types in "Overview of the valid data types (Page 1077)".

### Parameter DATA

Use the "IF\_CONF\_v4" structure at the DATA parameter to store the address parameter according to IPv4.

Byte	Parameter	Data type	Start value	Description
0 ... 1	Id	UINT	30	ID of the "IF_CONF_v4" structure.
2 ... 3	Length	UNIT	18	Length of data read in BYTE.
4 ... 5	Mode	UNIT	0	Not relevant for the "GetStationInfo" instruction (left at "0").
6 ... 9	InterfaceAddress	ARRAY [1..4] of BYTE	-	IP address of the IO device in the format IP_V4, e.g. for 192.168.3.10: <ul style="list-style-type: none"> <li>addr[1] = 192</li> <li>addr[2] = 168</li> <li>addr[3] = 3</li> <li>addr[4] = 10</li> </ul>
10 ... 13	SubnetMask	ARRAY [1..4] of BYTE	-	Subnet mask of the IO device in the format IP_V4, e.g. for 255.255.255.0: <ul style="list-style-type: none"> <li>addr[1] = 255</li> <li>addr[2] = 255</li> <li>addr[3] = 255</li> <li>addr[4] = 0</li> </ul>
14 ... 17	DefaultRouter	ARRAY [1..4] of BYTE	-	IP address of the router in the format IP_V4, e.g. for 192.168.3.1: <ul style="list-style-type: none"> <li>addr[1] = 192</li> <li>addr[2] = 168</li> <li>addr[3] = 3</li> <li>addr[4] = 1</li> </ul>

## Parameter STATUS

Error code* (W#16#...)	Explanation
0	No error
7000	No job in progress.
7001	First call of the asynchronous instruction "GetStationInfo". Execution of the instruction not yet complete (BUSY = 1, DONE = 0).
7002	Additional call of the asynchronous instruction "GetStationInfo". Execution of the instruction not yet complete (BUSY = 1, DONE = 0).
8080	Value at the MODE parameter is not supported.
8090	The hardware identifier specified at the LADDR parameter is not configured.
8092	The LADDR parameter does not address a PROFINET IO device.
8093	Invalid data type at the DATA parameter.
80A0	Cannot read requested information.
80C0	Addressed IO device is not reachable.
80C3	The maximum number of simultaneous calls of the "GetStationInfo" instruction (10 instances) has been reached.
* The error codes can be displayed as integer or hexadecimal values in the program editor. For additional information on toggling display formats, refer to "See also".	

## DeviceStates: Read module status information in an IO system

### Description

You use the instruction "DeviceStates" to query specific status information for all modules in an IO system, which means:

- Either for all IO devices in a PROFINET IO system
- Or for all DP slaves in a DP master system

The Boolean value that is output indicates the modules to which the selected status applies. You can, for example, read which IO devices are currently disabled in a PROFINET IO system.

Information is also displayed as to whether the status information to be read applies to at least one of the IO devices or DP slaves.

The instruction can be called in a cyclic OB as well as in an interrupt OB (e.g. OB82 - diagnostic interrupt).

## Parameters

The following table shows the parameters of the "DeviceStates" instruction:

Parameter	Declaration	Data type	Memory area	Description
LADDR	Input	HW_IOSYSTEM	I, Q, M, L or constant	Hardware identifier of the PROFINET IO or DP master system (see description below)
MODE	Input	UINT	I, Q, M, D, L or constant	Selection of status information to be read (see description below)
RET_VAL	Return	INT	I, Q, M, D, L	Status of instruction (see description below)
STATE	InOut	VARIANT	I, Q, M, D, L	Buffer for status of the IO devices or the DP slaves (see description below)

You will find more detailed information on valid data types in "Overview of the valid data types (Page 1077)".

### Parameter LADDR

You select the PROFINET IO or DP master system at the LADDR parameter by means of the hardware identifier.

The hardware identifier is available:

- Either in the Network view of the properties of the PROFINET IO or DP master system.
- Or in the PLC tag table in the listed system constants with the data type HW\_IOSYSTEM.

### Parameter MODE

You use the MODE parameter to read out status information. You can read out one of the following status information items for the entire PROFINET IO or DP master system:

- 1: IO devices/DP slaves are configured
- 2: IO devices/DP slaves are faulty
- 3: IO devices/DP slaves are disabled
- 4: IO devices/DP slaves exist
- 5: IO devices/DP slaves for which a problem has occurred. For example:
  - Maintenance demanded or recommended
  - Not accessible
  - Not available
  - Error occurred

### Parameter STATE

With the STATE parameter, the status of the IO devices/DP slaves that was selected with the MODE parameter is output.

If the status selected using MODE applies to an IO device/DP slave, the following bits are set to "1" at the STATE parameter:

- Bit 0 = 1: Group display. The bit n of at least one IO device/DP slave was set to "1".
- Bit n = 1: The status selected with MODE applies to the IO device/DP slave.
  - With a PROFINET IO system, bit n corresponds to the device number of the respective IO device (see properties of the PROFINET interface in the device view and network view)
  - With a PROFIBUS DP system, bit n corresponds to the PROFIBUS address of the DP slave (see properties of the DP slave in the device view and network view)

Use "BOOL" or "Array of BOOL" as data type:

- To only output the bit for group display of the status information, you can use the data type BOOL at the STATE parameter.
- To output the status information for all IO devices/DP slaves, use Array of BOOL with the following length:
  - With PROFINET IO system: 1024 bits
  - With DP master system: 128 bits

## Parameter RET\_VAL

Error code* (W#16#...)	Description
0	No error
8091	Hardware identifier of the LADDR parameter does not exist. Check (for example, in the system constants) whether the value for LADDR exists in the project.
8092	LADDR does not address a PROFINET IO or DP master system.
8093	Invalid data type at the STATE parameter.
80B1	Instruction "DeviceStates" is not supported by the CPU.
80B2	The selected MODE parameter is not supported by the used CPU for the IO system specified in the LADDR parameter.
8452	The complete status information does not fit in the tag configured in the STATE parameter.
* The error codes can be displayed as integer or hexadecimal values in the program editor. For additional information on toggling display formats, refer to "See also".	

### Example - Reading the faulty stations of a PROFINET IO master system

A PROFINET IO system consists of 4 IO devices with the device numbers 1, 2, 3 and 4. The IO device with number 2 is faulty.

The instruction "DeviceStates" is executed for the PROFINET IO system with MODE = 2 (faulty/not faulty).

The following bits are set in the STATE parameter:

- Bit 0 = 1: A fault exists for at least one of the IO devices.
- Bit 1 = 0: IO device with device number 1 is not faulty.

- Bit 2 = 1: IO device with device number 2 is faulty.
- Bit 3 = 0: IO device with device number 3 is not faulty.
- Bit 4 = 0: IO device with device number 4 is not faulty.
- Bit 5 = 0: irrelevant
- Bit 6 = 0: irrelevant
- ...

### Example - Reading the faulty stations of a PROFIBUS DP master system

A DP master system consists of 4 DP slaves with the PROFIBUS addresses 3, 4, 5 and 6. The DP slave with address 4 is faulty.

The instruction "DeviceStates" is executed for the DP master system with MODE = 2 (faulty/not faulty).

The following bits are set in the STATE parameter:

- Bit 0 = 1: A fault exists for at least one of the DP slaves.
- Bit 1 = 0: irrelevant
- Bit 2 = 0: irrelevant
- Bit 3 = 0: DP slave with address 3 is not faulty.
- Bit 4 = 1: DP slave with address 4 is faulty.
- Bit 5 = 0: DP slave with address 5 is not faulty.
- Bit 6 = 0: DP slave with address 6 is not faulty.
- Bit 7 = 0: irrelevant
- Bit 8 = 0: irrelevant
- ...

### ModuleStates: Read module status information of a module

#### Description

You can use the "ModuleStates" instruction to read the status information of the modules of a PROFINET IO device or PROFIBUS DP slave.

The Boolean value that is output indicates the modules to which the selected status applies. You can, for example, read which modules are currently disabled in a PROFINET IO device.

Information is also displayed as to whether the status information to be read applies to at least one of the modules.

The instruction can be called in a cyclic OB as well as in an interrupt OB (e.g. OB82 - diagnostic interrupt).



## Parameters

The following table shows the parameters of the "ModuleStates" instruction:

Parameter	Declaration	Data type	Memory area	Description
LADDR	Input	HW_DEVICE	I, Q, M, D, L or constant	Hardware identifier of the station (see description below)
MODE	Input	UINT	I, Q, M, D, L or constant	Selection of module status information to be read (see description below)
RET_VAL	Return	INT	I, Q, M, D, L	Status of instruction (see description below)
STATE	InOut	VARIANT	I, Q, M, D, L	Buffer for the module status (see description below)

You will find more detailed information on valid data types in "Overview of the valid data types (Page 1077)".

### Parameter LADDR

You select the IO device or the DP slave at the LADDR parameter by means of the hardware identifier of the station.

The hardware identifier is available:

- Either in the network view of the properties of the IO device station or DP slave station.
- Or in the PLC tag table for the listed system constants with the data type HW\_DEVICE (for an IO device) or with the data type HW\_DPSLAVE (for a DP slave).

### Parameter MODE

You use the MODE parameter to read out status information. One of the following status information items can be read for the modules:

- 1: Modules are configured
- 2: Modules are faulty
- 3: Modules are disabled
- 4: Modules exist
- 5: There is a problem in the modules. For example:
  - Maintenance demanded or recommended
  - Not accessible
  - Not available
  - Error occurred

### Parameter STATE

The STATE parameter outputs the status of the modules selected with the MODE parameter.

If the status selected using MODE applies to a module, the following bits are set to "1":

9.7 References

- Bit 0 = 1: Group display. The bit n of at least one module was set to "1".
- Bit n = 1: The status selected with MODE applies to the module in slot n-1 (example: bit 3 = slot 2).

Use "BOOL" or "Array of BOOL" as data type:

- To only output the bit for group display of the status information, you can use the data type BOOL at the STATE parameter.
- To output the status information for all modules, use Array of BOOL with a length of 128 bits.

Parameter RET\_VAL

Error code* (W#16#...)	Description
0	No error
8091	Hardware identifier of the LADDR parameter does not exist. Check (for example, in the system constants) whether the value for LADDR exists in the project.
8092	LADDR does not address an IO device or DP slave.
8093	Invalid data type at the STATE parameter.
80B1	The instruction "ModuleStates" is not supported by the CPU.
80B2	The selected MODE parameter is not supported by the used CPU for the IO device/the DP slave in the LADDR parameter.
8452	The complete status information does not fit in the tag configured in the STATE parameter.
* The error codes can be displayed as integer or hexadecimal values in the program editor. For additional information on toggling display formats, refer to "See also".	

Example

An IO device includes 4 modules in slots 1 to 4. The module in slot 2 is faulty.

The instruction "ModuleStates" is executed for the IO device with MODE = 2 (faulty/not faulty).

The following bits are set in the STATE parameter:

- Bit 0 = 1: A fault exists for at least one module.
- Bit 1 = 0: Slot number 0 (used by IO device)
- Bit 2 = 0: Module in slot number 1 is not faulty.
- Bit 3 = 1: Module in slot number 2 is faulty.
- Bit 4 = 0: Module in slot number 3 is not faulty.
- Bit 5 = 0: Module in slot number 4 is not faulty.
- Bit 6 = 0: irrelevant
- Bit 7 = 0: irrelevant

## GEN\_DIAG: Generate diagnostics information

### Description

The "GEN\_DIAG" instruction generates diagnostics information for hardware components from other manufacturers for use in TIA Portal diagnostics. The GSD(GSDL/GSDML) file supplied by the manufacturer must first be installed before the instruction can be used.

The instruction generates all diagnostic events (including those for maintenance).

- Use the LADDR parameter to select the hardware component for which you want to generate a diagnostic event.
- Use the MODE parameter to specify whether the event is to be outgoing or incoming.
- Use the DiagEvent parameter to define the diagnostic event in the DiagnosticDetail structure. The structure is created automatically in the local interface of the block when you define a tag at the DiagEvent parameter.

The diagnostics information is provided synchronously. Diagnostics information transfer and alarm output are asynchronous.

#### NOTICE

##### Failsafe-specific errors messages are not valid

If you define failsafe-specific diagnostics information at the DiagEvent parameter, the instruction will check this information and output the error code 80A1.

### Parameters

The following table shows the parameters of the "GEN\_DIAG" instruction:

Parameter	Declaration	Data type	Memory area	Description
LADDR	Input	HW_ANY	I, Q, M, D, L or constant	Identification number of the hardware component
MODE	Input	UINT	I, Q, M, D, L or constant	Selection of incoming/outgoing information: <ul style="list-style-type: none"> <li>• 1: The diagnostic event specified is an incoming event</li> <li>• 2: The diagnostic event specified is an outgoing event</li> <li>• 3: All diagnostic events are outgoing. There are therefore no hardware component faults (green diagnostics symbol). The DiagEvent parameter is not evaluated when MODE = 3.</li> </ul>

Parameter	Declaration	Data type	Memory area	Description
DiagEvent	InOut	DiagnosticDetail	L	Specifies the diagnostic event (see "DiagEvent parameter").
RET_VAL	Return	INT	I, Q, M, D, L	Status of instruction / error message (see "RET_VAL parameter")

You will find more detailed information on valid data types in "Overview of the valid data types (Page 1077)".

### DiagEvent parameter

The structure DiagnosticDetail is a system data type for specifying the diagnostic event. Its structure is as follows:

Parameter	Data type	Description
DiagnosticDetail	Struct	
ChannelInfo	WORD	Channel properties (0...7)
ALID	UINT	Local ID of the alarm. The ID uniquely identifies the alarm.
TextID	UINT	ID of an alarm text in a text list.
Channel Number	UINT	Manufacturer-specific channel number (0x0000 — 0x7FFF)
Addval_0	DWORD	Placeholder for additional information The value / list of values depends on the connection error.
TextID2	UINT	Texts for CPU response (mode, OB calls, etc.).
LADDR	HW_ANY	Identical to the LADDR parameter.
TextListId	UINT	<ul style="list-style-type: none"> <li>0: No text list</li> <li>≠0: ID of the text list</li> </ul>
Channel Direction	UINT	<ul style="list-style-type: none"> <li>0000: irrelevant</li> <li>FFF1: Input</li> <li>FFF2: Output</li> <li>FFF3: Input/Output</li> </ul>
Addval_1	DWORD	Placeholder for additional information on the channel error (depends on the GSD file). For channel error types, see also: IEC 61158 (PROFINET IO Type 10 and PROFIBUS DP Type 3).

### Parameter RET\_VAL

Error code* (W#16#...)	Explanation
0	No error
8080	Value in the MODE parameter is not supported.
8090	Identification for hardware component not available at the LADDR parameter.

Error code* (W#16#...)	Explanation
8091	Diagnostics information cannot be generated for the hardware component addressed at the LADDR parameter.
80A1	<ul style="list-style-type: none"> <li>Content of the DiagnosticsDetail structure at the DiagEvent parameter is invalid or inconsistent.</li> <li>Failsafe-specific diagnostics information defined at the DiagEvent parameter (not valid).</li> </ul>
80A4	Hardware component addressed cannot be accessed.
80C1	Insufficient resources for parallel execution.
* The error codes can be displayed as integer or hexadecimal values in the program editor. For additional information on toggling display formats, refer to "See also".	

## GET\_DIAG: Read diagnostic information

### Description

You can use the "GET\_DIAG" instruction to read out the diagnostic information of a hardware object. The hardware object is selected using the parameter LADDR. With the MODE parameter, you select which diagnostic information is to be read out.

### Parameters

The following table shows the parameters of the "GET\_DIAG" instruction:

Parameter	Declaration	Data type	Memory area	Description
MODE	Input	UINT	I, Q, M, D, L or constant	Use the MODE parameter to select which diagnostic data is to be output.
LADDR	Input	HW_ANY (WORD)	I, Q, M, L or constant	Hardware identifier of the device.
RET_VAL	Return	INT	I, Q, M, D, L	Status of the instruction
CNT_DIAG	Output	UINT	I, Q, M, D, L	Number of output diagnostic details
DIAG	InOut	VARIANT	I, Q, M, D, L	Diagnostic information corresponds to the selected mode, see table below
DETAIL	InOut	VARIANT	I, Q, M, D, L	Diagnostics details correspond with the selected mode. Parameter is hidden (only used for MODE = 3).

For additional information on valid data types, refer to "Overview of the valid data types (Page 1077)".

**Parameter MODE**

Depending on the value at the MODE parameter, different diagnostic data is output at the DIAG, CNT\_DIAG and DETAIL output parameters.

MODE	Description	DIAG	CNT_DIAG	DETAIL
0	Output of all supported diagnostic information for a module as DWORD, where Bit X=1 indicates that mode X is supported.	Bit string of the supported modes as DWORD, where Bit X=1 indicates that mode X is supported.	0	-
1	Output of the inherent status of the addressed hardware object.	Diagnostics status. Output of the inherent status of the addressed hardware object in accordance with the DIS structure.	0	-
2	Output of the status of all subordinate modules of the addressed hardware object.	Diagnostics status. Output in accordance with the DNN structure.	0	-
3	Output of the inherent status of the addressed hardware object and detailed information on channel diagnostics.	Output of the inherent status of the addressed hardware object in accordance with the DIS structure.	Number of module status information.	Module status information in accordance with the DiagnosticDetail structure.

**DIS structure**

With parameter MODE = 1 or = 3, the diagnostic information is output in accordance with the DIS structure. In this case, enter the system data type "DIS" as data type for the tag declaration.

The following table shows the meaning of the individual parameter values.

Parameter	Data type	Value	Description
MaintenanceState	DWORD	Enum	
		0	No maintenance required
		1	The module or device is disabled.
		2	-
		3	-
		4	-
		5	Maintenance required
		6	Maintenance demanded
		7	Error
		8	Status unknown / error in subordinate module
		9	-
ComponentStateDetail	DWORD	Bit array	Status of the module sub-modules: <ul style="list-style-type: none"> <li>• Bit 0 to 15: Status message of the module</li> <li>• Bit 16 to 31: Status message of the CPU</li> </ul>

Parameter	Data type	Value	Description
		0 to 2 (enum)	Additional information: <ul style="list-style-type: none"> <li>• Bit 0: No additional information</li> <li>• Bit 1: Transfer not permitted</li> </ul>
		3	Bit 3 = 1: At least one channel supports qualifiers for diagnostics
		4	Bit 4 = 1: Maintenance required for at least one channel or one component.
		5	Bit 5 = 1: Maintenance demanded for at least one channel or one component.
		6	Bit 6 = 1: Error in at least one channel or one component.
		7 to 10	Reserved (always = 0)
		11 to 14	<ul style="list-style-type: none"> <li>• Bit 11 = 1: PNIO - sub-module correct</li> <li>• Bit 12 = 1: PNIO - replacement module</li> <li>• Bit 13 = 1: PNIO - incorrect module</li> <li>• Bit 14 = 1: PNIO - module disconnected</li> </ul>
		15	Reserved (always = 0)
		16 to 31	Status information for modules generated by the CPU: <ul style="list-style-type: none"> <li>• Bit 16 = 1: Module disabled</li> <li>• Bit 17 = 1: CiR operation active</li> <li>• Bit 18 = 1: Input not available</li> <li>• Bit 19 = 1: Output not available bit</li> <li>• 20 = 1: Overflow diagnostics buffer bit</li> <li>• 21 = 1: Diagnostics not available bit</li> <li>• 22 - 31: Reserved (always 0)</li> </ul>
OwnState	UINT	Enum	The value of the parameter Ownstate describes the maintenance status of the module.
		0	No fault
		1	The module or device is disabled.
		2	Maintenance required
		3	Maintenance demanded
		4	Error
		5	The module or the device cannot be reached from the CPU (valid for modules and devices below a CPU).
		6	Inputs/outputs are not available.
IOState	WORD	Bit array	I/O status of the module
		0	Bit 0 = 1: No maintenance required
		1	Bit 1 = 1: The module or device is disabled.
		2	Bit 2 = 1: Maintenance required
		3	Bit 3 = 1: Maintenance demanded
		4	Bit 4 = 1: Error
		5	Bit 5 = 1: The module or the device cannot be reached from the CPU (valid for modules and devices below a CPU).
		6	Inputs/outputs are not available.
		7	Qualifier; bit 7 = 1, if bit 0, 2, or 3 are set

9.7 References

Parameter	Data type	Value	Description
		8 to 15	Reserved (always = 0)
OperatingState	UINT	Enum	
		0	-
		1	In STOP / Firmware update
		2	In STOP / reset memory
		3	In STOP / self start
		4	In STOP
		5	Memory reset
		6	In START
		7	In RUN
		8	-
		9	In HOLD
		10	-
		11	-
		12	Module defective
		13	-
		14	No power
		15	CiR
		16	In STOP / without ODIS
		17	In
18			
19			
20			

**DNN structure**

With parameter MODE = 2, the diagnostic information details are output in accordance with the DNN structure. In this case, enter the system data type "DNN" as data type for the tag declaration.

The following table shows the meaning of the individual parameter values.

Parameter	Data type	Value	Description
SubordinateState	UINT	Enum	Status of the subordinate module (see parameter OwnState of the DIS structure)
SubordinateIOState	WORD	Bitarray	Status of the inputs and outputs of the subordinate module (see parameter IO State of the DIS structure)
DNNmode	WORD	Bitarray	<ul style="list-style-type: none"> <li>• Bit 0 = 0: Diagnostics enabled</li> <li>• Bit 0 = 1: Diagnostics disabled</li> <li>• Bit 1 to 15: Reserved</li> </ul>



## DiagnosticDetail structure

With parameter MODE = 3, the diagnostic information details are output in accordance with the DiagnosticDetail structure. In this case, enter the system data type "DiagnosticDetail" as data type for the tag declaration.

The following table shows the meaning of the individual parameter values.

Parameter	Data type	Description
ChannelInfo	WORD	Channel properties (0...7)
ALID	UInt	Identification ID of alarm
TextID	UNIT	ID of an alarm text in a text list.
ChannelNumber	UINT	Manufacturer-specific channel number (0x0000 — 0x7FFF)
Addval_0	DWORD	Placeholder for additional information The value / list of values depends on the connection error.
TextID2	UInt	Texts for CPU response (mode, OB calls, etc.).
LADDR	HW_ANY	Identical to the LADDR parameter.
TextListId	UInt	<ul style="list-style-type: none"> <li>• 0: No text list</li> <li>• ≠0: ID of the text list</li> </ul>
ChannelDirection	UInt	<ul style="list-style-type: none"> <li>• 000: Manufacturer-specific</li> <li>• 001: Input</li> <li>• 002: Output</li> <li>• 003: Input/Output</li> <li>• 004 - 007: Reserved</li> </ul>
AddVal_1	DWORD	Placeholder for additional information on the channel error (depends on the GSD file). For channel error types, see also: IEC 61158 (PROFINET IO Type 10 and PROFIBUS DP Type 3).

## Parameter RET\_VAL

Error code* (W#16#...)	Description
0	No error
n	The data area at the DETAIL parameter is too small. Not all details of the diagnostic data can be output.
8080	Value in the MODE parameter is not supported.
8081	Type at the DIAG parameter is not supported with the selected mode (parameter MODE).
8082	Type at the DETAIL parameter is not supported by the selected mode (parameter MODE).
8090	LADDR does not exist
80C1	Insufficient resources for parallel execution.
* The error codes can be displayed as integer or hexadecimal values in the program editor. For additional information on toggling display formats, refer to "See also".	

### 9.7.3.10 Pulse

#### CTRL\_PWM: Pulse-width modulation

##### Description

You can use the "CTRL\_PWM" instruction to enable and disable a pulse output supported by the CPU using the software.

---

##### Note

Pulse output parameters are assigned exclusively in the device configuration and not using the "CTRL\_PWM" instruction. Any change of parameters that is intended to have an effect on the CPU must therefore be made while the CPU is in STOP mode.

---

You enter the hardware ID of the pulse output you want to control with the instruction in the PWM input. Error-free execution of the instruction is possible only when the specified pulse output is enabled in the hardware configuration.

Only tags of "HW\_PWM" data type can be specified in the PWM input. The hardware data type HW\_PWM has a length of one WORD.

The pulse output is enabled when the bit in the ENABLE input of the instruction is set. If ENABLE has the value TRUE, the pulse output generates pulses that have the properties defined in the device configuration. When the bit in the ENABLE input is reset or the CPU changes to STOP, the pulse output is disabled and no more pulses are generated.

The "CTRL\_PWM " instruction is only executed if the signal state in the EN input is "1".

Since the S7-1200 enables the pulse output when the "CTRL\_PWM" instruction is executed, BUSY at S7-1200 always has the value FALSE.

The ENO enable output is set only when the EN enable input has signal state "1" and no errors have occurred during execution of the instruction.

---

##### Note

##### Use of the force table for PWM and PTO

Digital inputs and outputs that are used for PWM and PTO cannot be forced. Digital inputs and outputs that were assigned via device configuration cannot be controlled by either the force table or the monitoring table.

---

## Parameters

The following table shows the parameters of the "CTRL\_PWM" instruction:

Parameter	Declaration	Data type	Memory area	Description
PWM	Input	HW_PWM (WORD)	I, Q, M, L or constant	Hardware ID of the pulse generator
ENABLE	Input	BOOL	I, Q, M, D, L or constant	The pulse output is enabled when ENABLE = TRUE and disabled when ENABLE = FALSE.
BUSY	Output	BOOL	I, Q, M, D, L	Processing status
STATUS	Output	WORD	I, Q, M, D, L	Status of the instruction

For additional information on valid data types, refer to "Overview of the valid data types (Page 1077)".

## Parameter STATUS

Error code* (W#16#...)	Description
0	No error
80A1	Hardware ID of the pulse generator is invalid

\* The error codes can be displayed as integer or hexadecimal values in the program editor. For additional information on toggling display formats, refer to "See also".

### 9.7.3.11 Recipes and data logging

#### Recipe functions

#### RecipeExport: Exporting recipes

##### Description

The "RecipeExport" instruction exports the recipe data from a data block to a CSV file on the memory card of the CPU.

The export is triggered by the "REQ" parameter. The BUSY parameter is set to "1" during the export. During the export, the CSV file is created in the "Recipes" folder in the main directory of the memory card. The name of the data block is used as file name of the created CSV file. If a CSV file with an identical name already exists, it is overwritten during the export.

After the execution of the instruction, BUSY is reset to "0" and the completion of the operation is indicated with "1" at the DONE parameter. If an error occurs during execution, this is signaled by the parameters ERROR and STATUS.

### Parameters

The following table shows the parameters of the "RecipeExport" instruction:

Parameter	Declaration	Data type	Memory area	Description
REQ	Input	BOOL	I, Q, M, D, L, T, C or constant (T and C are only available in LAD and FBD)	Control parameter REQUEST: Activates the export on a rising edge.
RECIPE_DB	InOut	VARIANT		Pointer to the recipe data block. For information on the structure of the data block, refer to: Structure of a recipe DB (Page 2511)
DONE	Output	BOOL	I, Q, M, D, L	Status parameter <ul style="list-style-type: none"> <li>• 0: Job not yet started or still executing.</li> <li>• 1: Job executed without errors.</li> </ul>
BUSY	Output	BOOL	I, Q, M, D, L	Status parameter <ul style="list-style-type: none"> <li>• 0: The instruction is not executed.</li> <li>• 1: The instruction is executed.</li> </ul>
ERROR	Output	BOOL	I, Q, M, D, L	Status parameter <ul style="list-style-type: none"> <li>• 0: Neither warning nor error.</li> <li>• 1: An error has occurred. STATUS supplies detailed information on the type of error.</li> </ul>
STATUS	Output	WORD	I, Q, M, D, L	Status parameter See the "STATUS" parameter table.

For additional information on valid data types, refer to "Overview of the valid data types (Page 1077)".

### Parameter STATUS

Error code* (W#16#...)	Explanation
0	No error occurred
7000	No job processing active
7001	Start of job processing. Parameter BUSY = 1, DONE = 0
7002	Intermediate call (REQ irrelevant): Instruction already active; BUSY has the value "1".
8090	File name of the CSV file contains invalid characters. The file name of the CSV file is identical to the name of the data block.
8091	The data structure referenced with RECIPE_DB cannot be processed.
8092	Data structure at RECIPE_DB parameter exceeds 5000 bytes.
80B3	Insufficient memory space on the memory card or the internal load memory.
80B4	The memory card is write-protected.
80C0	CSV files is temporarily locked.

Error code* (W#16#...)	Explanation
80C1	Data block temporarily locked.
* The error codes can be displayed as integer or hexadecimal values in the program editor. For additional information on toggling display formats, refer to "See also".	

## RecipeImport: Importing recipes

### Description

The "RecipeImport" instruction imports the recipe data from a CSV file on the memory card into the data block at the RECIPE\_DB parameter. The values in the data block are overwritten in the process.

Note the following when importing the CSV file:

- The CSV file must be located in the "Recipes" directory of the memory card.
- The name of the CSV file must match the name of the data block at the RECIPE\_DB parameter.
- The first line (header) of the CSV file contains the name of the recipe components (see also: Structure of a recipe DB (Page 2511)). The first line is ignored during import. The names of the recipe components in the CSV file and the data block are not reconciled during import.
- In each case the first value in each line of the CSV file is the index number of the recipe. The individual recipes are imported in the order of the index. For this, the index in the CSV file has to be in ascending order and may contain no gaps (if this is not the case, the error message 80B0 is output at the STATUS parameter).
- The CSV file may not contain more recipe data records than provided for in the data block. The maximum number of data records is indicated by the array limits in the data block.

The import is triggered by the "REQ" parameter. The BUSY parameter is set to "1" during the import. After the execution of the instruction, BUSY is reset to "0" and the completion of the operation is indicated with "1" at the DONE parameter. If an error occurs during execution, this is signaled by the parameters ERROR and STATUS.

### Parameters

The following table shows the parameters of the "RecipeImport" instruction:

Parameter	Declaration	Data type	Memory area	Description
REQ	Input	BOOL	I, Q, M, D, L, T, C or constant (T and C are only available in LAD and FBD)	Control parameter REQUEST: Activates the import on a rising edge.
RECIPE_DB	InOut	VARIANT	D	Pointer to the recipe data block. For information on the structure of the data block, refer to:

Parameter	Declaration	Data type	Memory area	Description
DONE	Output	BOOL	I, Q, M, D, L	Status parameter <ul style="list-style-type: none"> <li>0: Job not yet started or still executing.</li> <li>1: Job completed without error.</li> </ul>
BUSY	Output	BOOL	I, Q, M, D, L	Status parameter <ul style="list-style-type: none"> <li>0: The instruction is not executed.</li> <li>1: The instruction is executed.</li> </ul>
ERROR	Output	BOOL	I, Q, M, D, L	Status parameter <ul style="list-style-type: none"> <li>0: Neither warning nor error.</li> <li>1: An error has occurred. STATUS supplies detailed information on the type of error.</li> </ul>
STATUS	Output	WORD	I, Q, M, D, L	Status parameter See the "STATUS" parameter table.

For additional information on valid data types, refer to "Overview of the valid data types (Page 1077)".

### Parameter STATUS

Error code* (W#16#...)	Explanation
0	No error occurred
7000	No job processing active
7001	Start of job processing. Parameter BUSY = 1, DONE = 0
7002	Intermediate call (REQ irrelevant): Instruction already active; BUSY has the value "1".
8090	The file name contains invalid characters.
8092	No matching CSV file found for the import. Possible cause: The name of the CSV file does not match the name of the recipe DB.
80C0	CSV file is temporarily locked.
80C1	Data block is temporarily locked.
80B0	Numbering in the index of the CSV file is not continuous, not ascending or exceeds the maximum number (array limit) in the data block.
80B1	Structure of the recipe data block and the CSV file do not match: The CSV file contains too many fields.
80B2	Structure of the recipe data block and the CSV file do not match: The CSV file contains too few fields.
80D0 +n	Structure of the recipe data block and the CSV file do not match: Data type in field n does not match (n<=46).
80FF	Structure of the recipe data block and the CSV file do not match: Data type in field n does not match (n>46).

\* The error codes can be displayed as integer or hexadecimal values in the program editor. For additional information on toggling display formats, refer to "See also".

## Structure of a recipe DB

### Introduction

The following sections describes the structure of a recipe DB based on a simple example. The recipe DB consists of five data records, three of which are used. The fourth and fifth data records are left free for later expansions. Each data record contains one recipe, which is made up of the recipe name and eight ingredients.

product name	water	barley	wheat	hops	yeast	waterT mp	mashT mp	mashTi me	QTest
Pils	10	9	3	280	39	40	30	100	0
Lager	10	9	3	150	33	50	30	120	0
BlackBeer	10	9	3	410	47	60	30	90	1
Not_used	0	0	0	0	0	0	0	0	0
Not_used	0	0	0	0	0	0	0	0	0

### Structure of the recipe data block

The recipe data are implemented as follows in a global data block:

- The template for all recipes is the PLC data type "Beer\_Recipe" with the recipe components "procutname", "water", etc. with the corresponding data types.
- In a global data block, the PLC data type is used as Array [1.. 5] of "Beer\_Recipe". The array limits (1 to 5 in this case) indicate the maximum number of recipes that the DB may contain.
- The values for the recipe components are added as start value in the data block.
- The global DB is interconnected with the instruction via the InOut parameter RECIPE\_DB.

Recipe_DB				
	Name	Data type	Offset	Start value
1	Static			
2	Products	Array [1.. 5] of "Beer_Recipe"	...	
3	Products[1]	"Beer_Recipe"	...	
4	Products[2]	"Beer_Recipe"	...	
5	Products[3]	"Beer_Recipe"	...	
6	productname	String[20]	...	'BlackBeer'
7	water	UInt	...	10
8	barley	UInt	...	9
9	wheat	UInt	...	3
10	hops	UInt	...	410
11	yeast	UInt	...	47
12	waterTmp	UInt	...	60
13	mashTmp	UInt	...	30
14	mashTime	UInt	...	90
15	QTest	UInt	...	1
16	Products[4]	"Beer_Recipe"	...	
17	Products[5]	"Beer_Recipe"	...	

### Exporting to CSV file

After the execution of the "RecipeExport (Page 2507)" instruction the data of the DB are written to a CSV file with the following structure:

#### Recipe\_DB.csv

```
index,productname,water,barley,wheat,hops,yeast,waterTmp,mashTmp,mashTime,QTest
1,"Pils",10,9,3,280,39,40,30,100,0
2,"Lager",10,9,3,150,33,50,30,120,0
3,"BlackBeer",10,9,3,410,47,60,30,90,1
4,"Not_used",0,0,0,0,0,0,0,0,0
5,"Not_used",0,0,0,0,0,0,0,0,0
```

The CSV file can be uploaded to the PC/programming device by means of the Web browser and edited:

- If the data are to be reloaded in the DB, not changes may be made to the structure (for example, by adding ingredients in a new column).
- If you add data records to the file, make sure when importing into the data block that the array limits through which you specify the maximum number of data records correspond to at least the number of data records.
- An index is automatically generated during export to the CSV file. If you create additional data records, add consecutive index numbers accordingly.

After editing, the modified file can be reloaded in the CPU. The original CSV file is overwritten in the process. You can use the "RecipeImport (Page 2509)" instruction to re-import the modified data from the CSV file into the data block.

#### Display in Excel

The CSV file can be opened in Excel to make reading and editing easier. If the commas are not recognized as decimal separators, use the Excel import function to output the data in structured form.

	A	B	C	D	E	F	G	H	I	J	K
1	index	product	water	barley	wheat	hops	yeast	waterTmp	mashTmp	mashTime	QTest
2	1	"Pils"	10	9	3	280	39	40	30	100	0
3	2	"Lager"	10	9	3	150	33	50	30	120	0
4	3	"BlackBeer"	10	9	3	410	47	60	30	90	1
5	4	"Not_used"	0	0	0	0	0	0	0	0	0
6	5	"Not_used"	0	0	0	0	0	0	0	0	0

### Data logging

#### Data logging - Overview

#### Saving process values

The data logging instructions are used in the user program to save process values to data logs. Data logs can be saved on the Memory Card (MC) or in the internal load memory. The data logs are saved in CSV format (Comma Separated Value).



The data logging instructions are used in your program to create or open a data log, to write an entry and to close the data log file.

You decide by the creation of the data buffer which program values are stored in the data log during the creation of the data buffer. The data buffer is used as a memory for new data log entries. New values have to be written to the buffer before "DataLogWrite (Page 2524)" is called. During execution of the "DataLogWrite (Page 2524)" instruction, data is written from the buffer to a data log record.

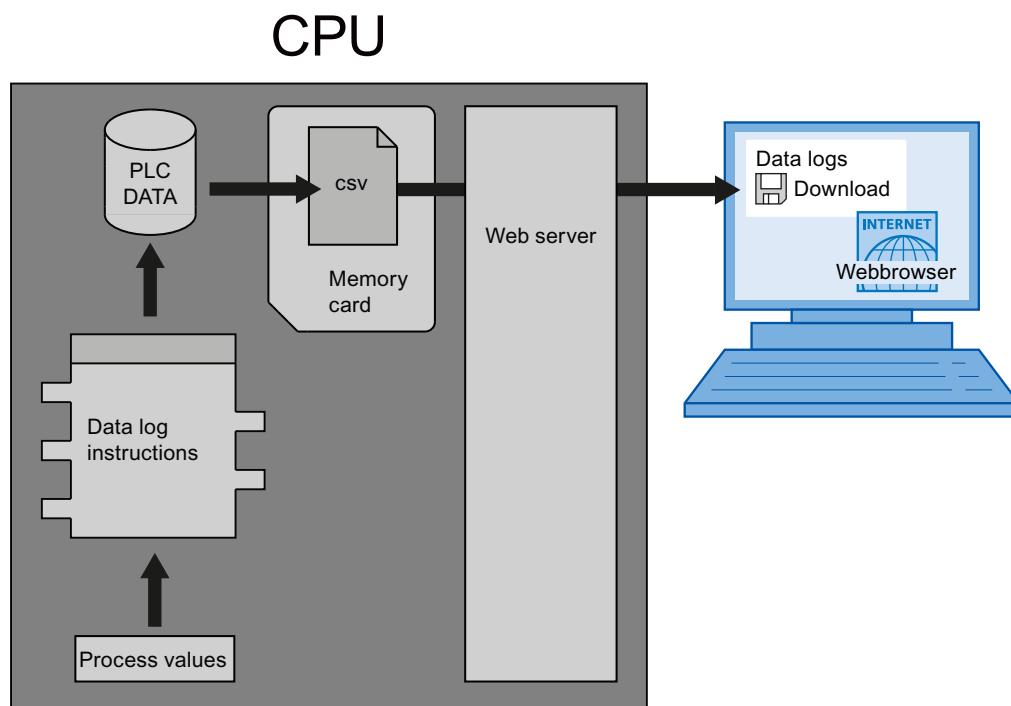

Data log files can be copied to the PC as follows:

- If the PROFINET interface is connected to the PC, you use a Web browser to access the data logs via the Web server. The CPU can be in RUN or STOP mode for this. If the CPU is in "RUN" mode, the program continues running while the Web server is transferring data.
- If there is a memory card in the CPU, you can remove this card and insert it into a standard slot for SD (Secure Digital) cards or MMC (MultiMediaCard) cards on a PC or programming device. Use File Manager to transfer the data log files from the memory card to the PC. The CPU goes to "STOP" when you remove the memory card.

### Properties of the data log

Writing of the data records of a data log is carried out in accordance with the principle of a ring buffer. New data records are added until the maximum number of data records is reached (RECORD parameter). The next data record then overwrites the "oldest" data record of the data log.

If you want to prevent data records from being overwritten, use the "DataLogNewFile (Page 2529)" instruction to create a new data log file based on the current data log. New data records are then written into the new data log.

### Creating data logs

With the "DataLogCreate (Page 2515)" instruction, you can create a new data log file in the "\\DataLogs" directory of the load memory.

- The name assigned at the NAME parameter is the designation for the data log and is also used the file name for the CSV file. The file is stored in the directory "DataLogs".
- The block parameter DATA specifies the data buffer for the new data log object and the columns and data types in the data log. The columns and data types of a data record in the data log are generated by the elements in the structure declaration or the array declaration of this data buffer. Each element of a structure or of an array corresponds to a column in a line in the data log.
- You can use the HEADER block parameter to assign a header text in the header to each column.
- The "DataLogCreate (Page 2515)" instruction returns an ID. This ID is used by the other data logging instructions as a reference for the created data log.

### Opening data logs

You use the instructions "DataLogOpen" (S7-1200) and "DataLogTypedOpen" (S7-1500) to open an existing data log on the memory card. A data log must be open before you can write new data records to it.

The data log opens automatically when you execute the instructions "DataLogCreate (Page 2515)" and "DataLogNewFile (Page 2529)".

Up to 10 data logs can be open simultaneously. You can select the data log to be opened using the ID or name of the data log.

- If you specify the ID and the name of the data log in the ID and NAME parameters, respectively, the data log will be identified based on the ID. The data log name will not be compared.
- If you select the data log using the NAME parameter and no ID is specified, the ID will be displayed in the ID parameter when the data log is opened.
- If you select the data log using the ID parameter and no name is specified, the name will be displayed in the NAME parameter when the data log is opened.

You use the MODE parameter to specify whether the data records of the data log are to be deleted upon opening.

### Writing to data logs

A data log must be open ("DataLogOpen (Page 2519)" instruction) before a data record can be written to a data log. The "DataLogWrite (Page 2524)" instruction writes a data record to the data log.

### Closing data logs

You use the "DataLogClose (Page 2526)" instruction to close an open data log. You select the data log using the ID parameter.

The data log is closed automatically when the CPU switches to STOP and upon restart.

## Deleting data logs

You use the instruction "DataLogDelete (Page 2528)" (S7-1500) to delete a data log file from the memory card. The data log and the data records it contains can only be deleted if the log was created with the instruction "DataLogCreate (Page 2515)".

Select the data log to be deleted using the NAME and ID parameters. The ID parameter is evaluated first. If there is a data log with the relevant ID, the NAME parameter will not be evaluated. If the value "0" is used at the ID parameter, a value with the data type STRING must be used at the NAME parameter.

## Clearing data logs

You use the instruction "DataLogClear (Page 2522)" (S7-1500) to delete all the data records in an existing data log. The instruction does not delete the optional header of the CSV file (see the description of the HEADER parameter of the instruction "DataLogCreate (Page 2515)").

You use the ID parameter to select the data log whose data records are to be deleted. Before you can delete data records, the data log must be open.

## New file for data logs

You use the instruction "DataLogNewFile (Page 2529)" (S7-1200) or "DataLogTypedNewFile (Page 2531)" (S7-1500) to create a new data log with the same properties as an existing data log. This allows you to retain the contents of an existing data log.

When called, the instruction creates a new data log on the memory card or in the internal load memory with the name defined at the NAME parameter. You use the ID parameter to specify the ID of the old data log whose properties you want to apply to the new data log. The ID of the new data log is then output via the ID parameter.

You specify the file size of the new data log with the RECORDS parameter of the instruction.

You can run a consistency check for "DataLogTypedNewFile (Page 2531)" (S7-1500).

## DataLogCreate: Create data log

### Description

You use the "DataLogCreate" instruction to create a data log. The data log is saved to the memory card / the internal load memory in the "DataLogs" folder. You can use the data logging instructions to save the process data. The amount of data that can be stored in a data log depends on the memory space available on the memory card or the available internal load memory of the CPU used.

You specify the maximum number of data records that can be stored in a data log in the RECORDS parameter. If the specified maximum number of data records in the data log is reached, the oldest data record will be overwritten. To avoid overwriting of existing data records, use the "DataLogNewFile (Page 2529)" instruction. The instruction can be used to create a new data log with the same structure when the number specified at the RECORDS parameter is reached (return value 1 at the STATUS parameter of the "DataLogWrite (Page 2524)" instruction). The data records are then saved in the new data log.

You can specify the name for the data log in the NAME parameter. The data log is created in CSV (Comma Separated Value) format. With the HEADER parameter, you can create an (optional) header for the data log. A comma has to be used as the separator.

Once the data log is created, it is opened automatically.

### Parameters

The following table shows the parameters of the "DataLogCreate" instruction:

Parameter	Declaration	Data type	Memory area	Description
REQ	Input	BOOL	I, Q, M, L, D, T, C or constant (T and C are only available in LAD and FBD)	Execution of the instruction upon a rising edge.
RECORDS	Input	UDInt	I, Q, M, L, D or constant	Number of data records in the data log
FORMAT	Input	UInt	I, Q, M, L, D or constant	Data format: <ul style="list-style-type: none"> <li>• 0: Internal (not supported)</li> <li>• 1: CSV (Comma separated values)</li> </ul>
TIMESTAMP	Input	UInt	I, Q, M, L, D or constant	Time stamp: <ul style="list-style-type: none"> <li>• 0: No time stamp</li> <li>• 1: Date and time</li> </ul> With the time stamp, an additional header is not required for the data log.
NAME	Input	VARIANT	L, D	Name of the data log. The specified name is also used as a file name for the csv file. The restrictions for Windows file names apply when assigning the name. The following characters must not be used: "\", "/", ":", ":", ":", ":", ":", "<", ">", " ", "space"
ID	InOut	DWORD	I, Q, M, L, D	Object ID of the data log (output only). The ID of the data log is required for the additional data logging instructions.
HEADER	InOut	VARIANT	L, D	Header of the CSV file (optional). The parameter is hidden once the instruction has been inserted.
DATA	InOut	VARIANT	L, D	Data buffer for a data log data record.
DONE	Output	BOOL	I, Q, M, L, D	The instruction was executed successfully.
BUSY	Output	BOOL	I, Q, M, L, D	Creation of the data log is not yet complete.
ERROR	Output	BOOL	I, Q, M, L, D	<ul style="list-style-type: none"> <li>• 0: No error.</li> <li>• 1: An error occurred during execution of the instruction.</li> </ul> Detailed information is output via the STATUS parameter.
STATUS	Output	WORD	I, Q, M, L, D	Status parameter The parameter is only set for the duration of one call. To display the status, you should therefore copy the STATUS parameter to a free data area.

For additional information on valid data types, refer to "Overview of the valid data types (Page 1077)".

### Parameter HEADER

The HEADER parameter is a VARIANT pointer to a data block that defines a header for the CSV file (header). The header is always the first line in the CSV file representation. When creating a header, remember that the individual columns must be separated by a comma (S7-1200) or a semicolon (S7-1500). A STRING, Array of BYTE, or Array of CHAR data type can be used for the individual column names. A longer character string is possible with the Array [...] of type data type than with the STRING data type. When the STRING data type is used, the length is limited to 254 bytes.

If no header is to be created, do not specify a value in the HEADER parameter.

### Parameter DATA

The DATA parameter is a VARIANT pointer to a structure or an array in a data block. An element of a structure or an array corresponds to a column in the data log with a specific data type.

Note the following when creating the data block:

- The number of columns must correspond to the number of columns defined in the HEADER parameter.
- If the STRUCT data type is used, structure nestings (STRUCT in STRUCT) may not be used.
- Arrays (only 1-dimensional) can be configured as a single element or as a structure component. Each element in the array generates a separate column in the data log.
- The tags of the data block can be set as retentive or non-retentive tags. However, the retentive setting must be the same for all tags of the data block.

### Parameter STATUS (S7-1200)

Error code* (W#16#...)	Description
0	No errors.
7000	No job processing active.
7001	Start of job processing. Parameter BUSY = 1, DONE = 0
7002	Intermediate call (REQ irrelevant): Instruction already active; BUSY has the value "1".
8070	Complete internal instance memory is assigned.
8090	Invalid file name (see description of the NAME parameter).
8093	Data log already exists.
8097	File length exceeds the file system limit.
80B3	Insufficient memory space on the memory card.
80B4	The memory card is write-protected.

Error code* (W#16#...)	Description
80C1	Too many files open.
8453	Invalid format selection.
8553	Invalid time stamp.
8B51	Invalid data type at HEADER parameter.
8C20	String with length specification other than 254 used.
8C51	Invalid data type at DATA parameter.
* The error codes can be displayed as integer or hexadecimal values in the program editor. For additional information on toggling display formats, refer to "See also".	

### Parameter STATUS (S7-1500)

Error code* (W#16#...)	Description
0	No errors.
7000	No job processing active.
7001	Start of job processing. Parameter BUSY = 1, DONE = 0
8070	Complete internal instance memory is assigned.
8090	Invalid file name (see description of the NAME parameter).
8091	"NAME" parameter is not a string.
8093	Data log already exists.
8097	File length exceeds the file system limit.
80B3	Insufficient memory space on the memory card.
80B4	The memory card is write-protected.
80C0	Access currently not possible.
80C1	Too many files open.
8253	Invalid value at RECORDS parameter.
8353	Invalid format selection.
8453	Invalid time stamp.
8B51	Invalid data type at HEADER parameter.
* The error codes can be displayed as integer or hexadecimal values in the program editor. For additional information on toggling display formats, refer to "See also".	

### See also

Data logging - Overview (Page 2512)

**DataLogOpen: Open data log****DataLogOpen: Open data log****Description**

You use the "DataLogOpen" instruction to open an existing data log on the memory card. A data log must be open before you can write new data records to it.

Data log opens automatically when you execute the instructions "DataLogCreate (Page 2515)" and "DataLogNewFile (Page 2529)".

Up to 10 data logs can be open simultaneously. You can select the data log to be opened using the ID or name of the data log.

- If you specify the ID and the name of the data log in the ID and NAME parameters, respectively, the data log will be identified based on the ID. The data log name will not be compared.
- If you select the data log using the NAME parameter and no ID is specified, the ID will be displayed in the ID parameter when the data log is opened.
- If you select the data log using the ID parameter and no name is specified, the name will be displayed in the NAME parameter when the data log is opened.

You use the MODE parameter to specify whether the data records of the data log are to be deleted upon opening.

**Parameters**

The following table shows the parameters of the "DataLogOpen" instruction:

Parameter	Declaration	Data type	Memory area	Description
REQ	Input	BOOL	I, Q, M, L, D, T, C or constant (T and C are only available in LAD and FBD)	Execution of the instruction upon a rising edge.
MODE	Input	UInt	I, Q, M, L, D or constant	Mode for opening the data log: <ul style="list-style-type: none"> <li>• MODE= "0" Data records of the data log are retained</li> <li>• MODE= "1" Data records of the data log are deleted, but the header is retained</li> </ul>
NAME	Input	VARIANT	L, D	(File) name of the data log.
ID	InOut	DWORD	I, Q, M, L, D	Object ID of the data log.
DONE	Output	BOOL	I, Q, M, L, D	Instruction was executed successfully.
BUSY	Output	BOOL	I, Q, M, L, D	Execution of instruction not yet complete.

Parameter	Declaration	Data type	Memory area	Description
ERROR	Output	BOOL	I, Q, M, L, D	<ul style="list-style-type: none"> <li>0: No error.</li> <li>1: An error occurred during execution of the instruction.</li> </ul> Detailed information is output via the STATUS parameter.
STATUS	Output	WORD	I, Q, M, L, D	Status parameter The parameter is only set for the duration of one call. To display the status, you should therefore copy the STATUS parameter to a free data area.

For additional information on valid data types, refer to "Overview of the valid data types (Page 1077)".

### Parameter STATUS

Error code* (W#16#...)	Description
0	No errors.
2	Warning: Data log file has already been opened by this application.
7000	No job processing active.
7001	Start of job processing. Parameter BUSY = 1, DONE = 0
7002	Intermediate call (REQ irrelevant): Instruction already active; BUSY has the value "1".
8070	Complete internal instance memory is assigned.
8090	There are inconsistencies between the data log definition and existing data log data.
8091	A data type other than String was used at the NAME parameter.
8092	Data log does not exist.
80B4	The memory card is write-protected.
80C0	The data log file is locked.

\* The error codes can be displayed as integer or hexadecimal values in the program editor. For additional information on toggling display formats, refer to "See also".

### See also

Data logging - Overview (Page 2512)

### DataLogOpen: Open data log

#### Description

You use the "DataLogOpen" instruction to open an existing data log on the memory card. A data log must be open to write new data records to it.

Data log opens automatically when you execute the instructions "DataLogCreate (Page 2515)" and "DataLogNewFile (Page 2529)".



Up to 10 data logs can be open simultaneously. You can select the data log to be opened using the ID or name of the data log.

- If you specify the ID and the name of the data log in the ID and NAME parameters, respectively, the data log will be identified based on the ID. The data log name will not be compared.
- If you select the data log using the NAME parameter and no ID is specified, the ID will be displayed in the ID parameter when the data log is opened.
- If you select the data log using the ID parameter and no name is specified, the name will be displayed in the NAME parameter when the data log is opened.

You use the MODE parameter to specify whether the data records of the data log are to be deleted upon opening.

The parameter DATA enables a consistency check between the data log to be opened and the definition of the data log of the instruction "DataLogCreate (Page 2515)". The consistency check can only be executed if the data log was created with the instruction "DataLogCreate (Page 2515)":

- If you are using the same pointer at the DATA parameter as at the DATA parameter of the "DataLogCreate (Page 2515)" instruction, a check is performed to determine whether the data types match. If the data types do not match, the error code W#16#80A0 is output at the STATUS parameter.
- If the data log to be opened was not created with "DataLogCreate (Page 2515)", a consistency check is not possible. In this case, enter the value "NULL" in the DATA parameter.

## Parameters

The following table shows the parameters of the "DataLogOpen" instruction:

Parameter	Declaration	Data type	Memory area	Description
REQ	Input	BOOL	I, Q, M, L, D, T, C or constant (T and C are only available in LAD and FBD)	Execution of the instruction upon a rising edge.
MODE	Input	UInt	I, Q, M, L, D or constant	Mode for opening the data log: <ul style="list-style-type: none"> <li>• MODE= "0" Data records of the data log are retained</li> <li>• MODE= "1" Data records of the data log are deleted, but the header is retained</li> </ul>
NAME	Input	VARIANT	L, D	(File) name of the data log.
ID	InOut	DWORD	I, Q, M, L, D	Object ID of the data log.
DATA	InOut	VARIANT	L, D	With consistency check: Pointer to the data area at the DATA parameter of the "DataLogCreate (Page 2515)" instruction.
DONE	Output	BOOL	I, Q, M, L, D	Instruction was executed successfully.
BUSY	Output	BOOL	I, Q, M, L, D	Execution of instruction not yet complete.

Parameter	Declaration	Data type	Memory area	Description
ERROR	Output	BOOL	I, Q, M, L, D	<ul style="list-style-type: none"> <li>• 0: No error.</li> <li>• 1: An error occurred during execution of the instruction.</li> </ul> Detailed information is output via the STATUS parameter.
STATUS	Output	WORD	I, Q, M, L, D	Status parameter The parameter is only set for the duration of one call. To display the status, you should therefore copy the STATUS parameter to a free data area.

For additional information on valid data types, refer to "Overview of the valid data types (Page 1077)".

### Parameter STATUS

Error code* (W#16#...)	Description
0	No errors.
2	Warning: Data log file has already been opened by this application.
7000	No job processing active.
7001	Start of job processing. Parameter BUSY = 1, DONE = 0
7002	Intermediate call (REQ irrelevant): Instruction already active; BUSY has the value "1".
8070	Complete internal instance memory is assigned.
8090	There are inconsistencies between the data log definition and existing data log data.
8091	A data type other than String was used at the NAME parameter.
8092	Data log does not exist.
80A0	Data types inconsistent. The data log at the ID parameter uses different data types than specified in the DATA parameter.
80B4	The memory card is write-protected.
80C1	Too many files open.

\* The error codes can be displayed as integer or hexadecimal values in the program editor. For additional information on toggling display formats, refer to "See also".

### See also

Data logging - Overview (Page 2512)

### DataLogClear: Empty data log

#### Description

The "DataLogClear" instruction deletes all data records in an existing data log. The instruction does not delete the optional header of the CSV file (see the description of the HEADER parameter of the instruction "DataLogCreate (Page 2515)").

You use the ID parameter to select the data log whose data records are to be deleted.

## Requirement

Before you can delete data records, the data log must be open (see "DataLogOpen (Page 2519) instruction").

## Parameters

The following table shows the parameters of the "DataLogClear" instruction:

Parameter	Declaration	Data type	Memory area	Description
REQ	Input	BOOL	I, Q, M, L, D, T, C or constant (T and C are only available in LAD and FBD)	Execution of the instruction upon a rising edge.
ID	InOut	DWORD	I, Q, M, D, L	Object ID of the data log
DONE	Output	BOOL	I, Q, M, D, L	Instruction was executed successfully.
BUSY	Output	BOOL	I, Q, M, D, L	Execution of the instruction not yet complete.
ERROR	Output	BOOL	I, Q, M, D, L	<ul style="list-style-type: none"> <li>0: No error.</li> <li>1: An error occurred during execution of the instruction.</li> </ul> Detailed information is output at the STATUS parameter.
STATUS	Output	WORD	I, Q, M, D, L	Status parameter The parameter is only set for the duration of one call. To display the status, you should therefore copy the STATUS parameter to a free data area.

For additional information on valid data types, refer to "Overview of the valid data types (Page 1077)".

## Parameter STATUS

Error code* (W#16#...)	Explanation
0000	No error.
7000	No job processing active.
7001	Start of job processing. Parameter BUSY = 1, DONE = 0
7002	Intermediate call (REQ irrelevant): Instruction already active; BUSY has the value "1".
8080	Data log file does not correspond to instruction.
8092	Data log does not exist.
80B0	Data log is not open.

Error code* (W#16#...)	Explanation
80B4	The memory card is write-protected.
* The error codes can be displayed as integer or hexadecimal values in the program editor. For additional information on toggling display formats, refer to "See also".	

**See also**

Data logging - Overview (Page 2512)

**DataLogWrite: Write data log**

**Description**

The instruction "DataLogWrite" is used to write a data record to an existing data log. The ID parameter is used to select the data log to which the data record is to be written. To create a new data record, the data log must be open. The instruction creates a new data record in the format that was specified in the DATA parameter when the data log was created.

Before calling the "DataLogWrite" instruction, transfer the data to the tag that you interconnected at the DATA parameter of the "DataLogCreate" instruction. When the "DataLogWrite" instruction is executed, the transferred data is copied to the data log.

NOTICE
<b>Data log data loss when the power supply to the CPU is interrupted</b>
If the power supply is interrupted during execution of the "DataLogWrite" instruction, the data record to be transferred is lost.

**Parameters**

The following table shows the parameters of the "DataLogWrite" instruction:

Parameter	Declaration	Data type	Memory area	Description
REQ	Input	BOOL	I, Q, M, L, D, T, C or constant (T and C are only available in LAD and FBD)	Execution of the instruction upon a rising edge.
ID	InOut	DWORD	I, Q, M, L, D	Object ID of the data log
DONE	Output	BOOL	I, Q, M, L, D	Instruction was executed successfully.
BUSY	Output	BOOL	I, Q, M, L, D	Execution of the instruction not yet complete.

Parameter	Declaration	Data type	Memory area	Description
ERROR	Output	BOOL	I, Q, M, L, D	<ul style="list-style-type: none"> <li>0: No error.</li> <li>1: An error occurred during execution of the instruction.</li> </ul> Detailed information is output via the STATUS parameter.
STATUS	Output	WORD	I, Q, M, L, D	Status parameter The parameter is only set for the duration of one call. To display the status, you should therefore copy the STATUS parameter to a free data area.

For additional information on valid data types, refer to "Overview of the valid data types (Page 1077)".

### Parameter STATUS (S7-1200)

Error code* (W#16#...)	Description
0	No errors
0001	Last possible data record created at the end of the file. Creating another data record will overwrite an older data record.
7000	No job processing active.
7001	Start of job processing. Parameter BUSY = 1, DONE = 0
7002	Intermediate call (REQ irrelevant): Instruction already active; BUSY has the value "1".
8070	Complete internal instance memory is assigned.
8092	Data log does not exist.
80B0	Data log is not open.
80B3	Insufficient memory space on the memory card.
80B4	The memory card is write-protected.
80C0	Data log is locked.

\* The error codes can be displayed as integer or hexadecimal values in the program editor. For additional information on toggling display formats, refer to "See also".

### Parameter STATUS (S7-1500)

Error code* (W#16#...)	Description
0	No errors
0001	Last possible data record created at the end of the file. Creating another data record will overwrite an older data record.
7000	No job processing active.
7001	Start of job processing. Parameter BUSY = 1, DONE = 0
8070	Complete internal instance memory is assigned.
8092	Data log does not exist.

Error code* (W#16#...)	Description
80B0	Data log is not open.
80B3	Insufficient memory space on the memory card.
80B4	The memory card is write-protected.
80C0	Data log is locked.
* The error codes can be displayed as integer or hexadecimal values in the program editor. For additional information on toggling display formats, refer to "See also".	

**See also**

Data logging - Overview (Page 2512)

**DataLogClose: Close data log**

**Description**

You use the "DataLogClose" instruction to close an open data log. You select the data log using the ID parameter.

**Note**

**Closing data logs automatically**

The data log is closed automatically when the CPU goes to STOP or if there is a restart.

**Parameters**

The following table shows the parameters of the "DataLogClose" instruction:

Parameter	Declaration	Data type	Memory area	Description
REQ	Input	BOOL	I, Q, M, L, D, T, C or constant (T and C are only available in LAD and FBD)	Execute function on a rising edge.
ID	InOut	DWORD	I, Q, M, L, D	Object ID of the data log
DONE	Output	BOOL	I, Q, M, L, D	Instruction was executed successfully.
BUSY	Output	BOOL	I, Q, M, L, D	Execution of the instruction not yet complete.

Parameter	Declaration	Data type	Memory area	Description
ERROR	Output	BOOL	I, Q, M, L, D	<ul style="list-style-type: none"> <li>0: No error.</li> <li>1: An error occurred during execution of the instruction.</li> </ul> Detailed information is output via the STATUS parameter.
STATUS	Output	WORD	I, Q, M, L, D	Status parameter The parameter is only set for the duration of one call. To display the status, you should therefore copy the STATUS parameter to a free data area.

For additional information on valid data types, refer to "Overview of the valid data types (Page 1077)".

### Parameter STATUS (S7-1200)

Error code* (W#16#...)	Description
0	No errors
1	Data log is not open
7000	No job processing active.
7001	Start of job processing. Parameter BUSY = 1, DONE = 0
7002	Intermediate call (REQ irrelevant): Instruction already active; BUSY has the value "1".
8092	Data log does not exist.
* The error codes can be displayed as integer or hexadecimal values in the program editor. For additional information on toggling display formats, refer to "See also".	

### Parameter STATUS (S7-1500)

Error code* (W#16#...)	Description
0	No errors
1	Data log is not open
7000	No job processing active.
7001	Start of job processing. Parameter BUSY = 1, DONE = 0
8092	Data log does not exist.
80B4	The memory card is write-protected.
80C0	Access currently not possible.
* The error codes can be displayed as integer or hexadecimal values in the program editor. For additional information on toggling display formats, refer to "See also".	

## DataLogDelete: Delete data log

### Description

You use the "DataLogDelete" instruction to delete a data log file from the memory card. The data log and the data records it contains can only be deleted if the log was created with the instruction "DataLogCreate (Page 2515)".

### Parameters

The following table shows the parameters of the "DataLogDelete" instruction:

Parameter	Declaration	Data type	Memory area	Description
REQ	Input	BOOL	I, Q, M, L, D, T, C or constant (T and C are only available in LAD and FBD)	Execution of the instruction upon a rising edge.
NAME	Input	VARIANT	L, D	File name of the data log
DELFILE	Input	BOOL	I, Q, M, D, L	<ul style="list-style-type: none"> <li>0: Data log is retained.</li> <li>1: Data log is deleted.</li> </ul> Detailed information is output at the STATUS parameter.
ID	InOut	DWORD	I, Q, M, D, L	Object ID of the data log
DONE	Output	BOOL	I, Q, M, D, L	Instruction was executed successfully.
BUSY	Output	BOOL	I, Q, M, D, L	Deletion of the data log is not yet complete.
ERROR	Output	BOOL	I, Q, M, D, L	<ul style="list-style-type: none"> <li>0: No error.</li> <li>1: An error occurred during execution of the instruction.</li> </ul> Detailed information is output at the STATUS parameter.
STATUS	Output	WORD	I, Q, M, D, L	Status parameter The parameter is only set for the duration of one call. To display the status, you should therefore copy the STATUS parameter to a free data area.

For additional information on valid data types, refer to "Overview of the valid data types (Page 1077)".

### Parameters NAME and ID

Select the data log to be deleted using the NAME and ID parameters. The ID parameter is evaluated first. If there is a data log with the relevant ID, the NAME parameter will not be evaluated. If the value "0" is used at the ID parameter, a value with the data type STRING must be used at the NAME parameter.



## Parameter RET\_VAL

Error code* (W#16#...)	Explanation
0	No error.
7000	No job processing active.
7001	Start of job processing. Parameter BUSY = 1, DONE = 0
7002	Intermediate call (REQ irrelevant): Instruction already active; BUSY has the value "1".
8091	A data type other than STRING is being used at the NAME parameter.
8092	Data log does not exist.
80A2	Write error
80B4	The memory card is write-protected.
* The error codes can be displayed as integer or hexadecimal values in the program editor. For additional information on toggling display formats, refer to "See also".	

### DataLogNewFile: Data log in new file

### DataLogNewFile: Data log in new file

#### Description

You use the "DataLogNewFile" instruction to create a new data log with the same properties as an existing data log. This allows the contents of an existing data log to be retained.

When called, the instruction creates a new data log on the memory card or in the internal load memory with the name defined at the NAME parameter. You use the ID parameter to specify the ID of the old data log whose properties you want to apply to the new data log. The ID of the new data log is then output via the ID parameter.

You specify the file size of the new data log with the RECORDS parameter of the instruction.

#### Parameters

The following table shows the parameters of the "DataLogNewFile" instruction:

Parameter	Declaration	Data type	Memory area	Description
REQ	Input	BOOL	I, Q, M, L, D, T, C or constant (T and C are only available in LAD and FBD)	Execution of the instruction upon a rising edge.
RECORDS	Input	UDInt	I, Q, M, L, D or constant	Number of data records in the data log.
NAME	Input	VARIANT	L, D	File name of the new data log.

9.7 References

Parameter	Declaration	Data type	Memory area	Description
ID	InOut	DWORD	I, Q, M, L, D	Object ID of the data log <ul style="list-style-type: none"> <li>In: ID of the existing data log</li> <li>Out: ID of the new data log</li> </ul>
DONE	Output	BOOL	I, Q, M, L, D	Instruction was executed successfully.
BUSY	Output	BOOL	I, Q, M, L, D	Execution of the instruction not yet complete.
ERROR	Output	BOOL	I, Q, M, L, D	<ul style="list-style-type: none"> <li>0: No error.</li> <li>1: An error occurred during execution of the instruction.</li> </ul> Detailed information is output via the STATUS parameter.
STATUS	Output	WORD	I, Q, M, L, D	Status parameter The parameter is only set for the duration of one call. To display the status, you should therefore copy the STATUS parameter to a free data area.

For additional information on valid data types, refer to "Overview of the valid data types (Page 1077)".

Parameter STATUS

Error code* (W#16#...)	Description
0	No errors.
7000	No job processing active.
7001	Start of job processing. Parameter BUSY = 1, DONE = 0
7002	Intermediate call (REQ irrelevant): Instruction already active; BUSY has the value "1".
8070	Complete internal instance memory is assigned.
8090	Invalid file name.
8091	Path does not exist.
8092	Source data log does not exist.
8093	New data log already exists.
8097	File length exceeds the file system limit.
80B3	Load memory not sufficient.
80B4	The memory card is write-protected.
80C1	Too many files open.

\* The error codes can be displayed as integer or hexadecimal values in the program editor. For additional information on toggling display formats, refer to "See also".

## DataLogNewFile: Data log in new file

### Description

You use the "DataLogNewFile" instruction to create a new data log with the same properties as an existing data log. This allows the contents of an existing data log to be retained.

When called, the instruction creates a new data log on the memory card or in the internal load memory with the name defined at the NAME parameter. You use the ID parameter to specify the ID of the old data log whose properties you want to apply to the new data log. The ID of the new data log is then output via the ID parameter.

You specify the file size of the new data log with the RECORDS parameter of the instruction.

The parameter DATA enables a consistency check between the new data log to be created and the definition of the data log of the instruction "DataLogCreate (Page 2515)". The consistency check can only be executed if the data log was created with the instruction "DataLogCreate (Page 2515)":

- If you are using the same pointer at the DATA parameter as at the DATA parameter of the "DataLogCreate (Page 2515)" instruction, a check is performed to determine whether the data types match. If the data types do not match, the error code W#16#80A0 is output at the STATUS parameter.
- If the data log to be opened was not created with "DataLogCreate (Page 2515)", a consistency check is not possible. In this case, enter the value "NULL" in the DATA parameter.

### Parameters

The following table shows the parameters of the "DataLogNewFile" instruction:

Parameter	Declaration	Data type	Memory area	Description
REQ	Input	BOOL	I, Q, M, L, D, T, C or constant (T and C are only available in LAD and FBD)	Execution of the instruction upon a rising edge.
RECORDS	Input	UDInt	I, Q, M, L, D or constant	Number of data records in the data log.
NAME	Input	VARIANT	L, D	File name of the new data log.
ID	InOut	DWORD	I, Q, M, L, D	Object ID of the data log <ul style="list-style-type: none"> <li>• In: ID of the existing data log</li> <li>• Out: ID of the new data log</li> </ul>
DATA	InOut	VARIANT	L, D	Data type for consistency check
DONE	Output	BOOL	I, Q, M, L, D	Instruction was executed successfully.
BUSY	Output	BOOL	I, Q, M, L, D	Execution of the instruction not yet complete.

Parameter	Declaration	Data type	Memory area	Description
ERROR	Output	BOOL	I, Q, M, L, D	<ul style="list-style-type: none"> <li>• 0: No error.</li> <li>• 1: An error occurred during execution of the instruction.</li> </ul> Detailed information is output via the STATUS parameter.
STATUS	Output	WORD	I, Q, M, L, D	Status parameter The parameter is only set for the duration of one call. To display the status, you should therefore copy the STATUS parameter to a free data area.

For additional information on valid data types, refer to "Overview of the valid data types (Page 1077)".

### Parameter STATUS

Error code* (W#16#...)	Description
0	No errors.
7000	No job processing active.
7001	Start of job processing. Parameter BUSY = 1, DONE = 0
7002	Intermediate call (REQ irrelevant): Instruction already active; BUSY has the value "1".
8070	Complete internal instance memory is assigned.
8090	Invalid file name.
8091	Path does not exist.
8092	Source data log does not exist.
8093	New data log already exists.
8097	File length exceeds the file system limit.
80A0	Data types inconsistent. The data log at the ID parameter uses different data types than specified in the DATA parameter.
80B3	Load memory not sufficient.
80B4	The memory card is write-protected.
80C0	Access currently not possible.
80C1	Too many files open.

\* The error codes can be displayed as integer or hexadecimal values in the program editor. For additional information on toggling display formats, refer to "See also".

### 9.7.3.12 Data block functions

#### CREATE\_DB: Create data block

##### Description

The instruction "CREATE\_DB" is used to create a new data block in the load and/or work memory.

The instruction "CREATE\_DB" does not change the checksum of the user program.

##### Number of the data block

The data block created is assigned a number from the range defined at the LOW\_LIMIT (low limit) and UP\_LIMIT (high limit) parameters. "CREATE\_DB" assigns the smallest possible number from the specified range to the DB. You cannot assign the numbers of the DBs already contained in the user program.

To create a DB with a specific number, enter the same number for the high and low limit of the range to be specified. If a DB with the same number already exists in the work memory and/or load memory, or if the DB exists as a copied version, the instruction will be terminated and an error message will be generated at the RET\_VAL parameter.

##### Start values of the data block

Using the SRCBLK parameter, you can define start values for the DB to be created. The SRCBLK parameter is a pointer to a DB or a DB area from which you apply the start values. The DB addressed at the SRCBLK parameter must have been generated with standard access ("Optimized block access" attribute disabled).

- If the area specified at the SRCBLK parameter is larger than the DB generated, the values up to the length of the DB generated will be applied as start values.
- If the area specified at the SRCBLK parameter is smaller than the DB generated, the remaining values will be filled with "0".

To ensure data consistency, you must not change this data area while "CREATE\_DB" is being executed (which means as long as the BUSY parameter has the value TRUE).

##### Parameters

The following table shows the parameters of the "CREATE\_DB" instruction:

Parameter	Declaration	Data type	Memory area	Description
REQ	Input	BOOL	I, Q, M, D, L or constant	REQ= 1: Request to create the DB
LOW_LIMIT	Input	UINT	I, Q, M, D, L or constant	Low limit of the area ### used by "CREATE_DB" to assign a number to your DB (60000)
UP_LIMIT	Input	UINT	I, Q, M, D, L or constant	High limit of the area ### used by "CREATE_DB" to assign a number to your DB (largest possible DB number: 60999)

Parameter	Declaration	Data type	Memory area	Description															
COUNT	Input	UDINT	I, Q, M, D, L or constant	The count value specifies the number of bytes which you want to reserve for the DB generated. The number of bytes must be an even number. The maximum length is 65534 bytes.															
ATTRIB	Input	BYTE	I, Q, M, D, L or constant	The first 4 bits of the byte at the ATTRIB parameter define the properties of the data block:															
				<ul style="list-style-type: none"> <li>• Bit 0 = 0: DB only in the work memory</li> <li>• Bit 0 = 1: DB only in the load memory</li> </ul>															
				<ul style="list-style-type: none"> <li>• Bit 1 = 0: DB is not write-protected.</li> <li>• Bit 1 = 1: DB is write-protected</li> </ul>															
				<ul style="list-style-type: none"> <li>• Bit 2 = 0: DB is retentive (only for DBs generated in the load memory)</li> <li>• Bit 2 = 1: DB is not retentive</li> </ul>															
				<ul style="list-style-type: none"> <li>• Bit 3 = 0: DB generated either in load or in work memory</li> <li>• Bit 3 = 1: DB generated both in load and in work memory</li> </ul>															
				To ensure compatibility with STEP7 V5.x, bits 1 and 3 must be used in combination:															
				<table border="1"> <thead> <tr> <th>Bit 0</th> <th>Bit 3</th> <th>DB generation</th> </tr> </thead> <tbody> <tr> <td>0</td> <td>0</td> <td>In work memory only</td> </tr> <tr> <td>1</td> <td>0</td> <td>In load memory only</td> </tr> <tr> <td>0</td> <td>1</td> <td>Work and load memory</td> </tr> <tr> <td>1</td> <td>1</td> <td>Work and load memory</td> </tr> </tbody> </table>	Bit 0	Bit 3	DB generation	0	0	In work memory only	1	0	In load memory only	0	1	Work and load memory	1	1	Work and load memory
				Bit 0	Bit 3	DB generation													
0	0	In work memory only																	
1	0	In load memory only																	
0	1	Work and load memory																	
1	1	Work and load memory																	
<ul style="list-style-type: none"> <li>• Bit 4 = 0 - No start values specified (input values at the SRCBLK parameter will be ignored).</li> <li>• Bit 4 = 1 - Specify start values (values correspond to the DB addressed by the SRCBLK parameter).</li> </ul>																			
SRCBLK	Input	VARIANT	D	Pointer to the data block whose values will be used to initialize the data block to be generated.															
RET_VAL	Return	INT	I, Q, M, D, L	Error information															
BUSY	Output	BOOL	I, Q, M, D, L	BUSY= 1: The process is not yet complete.															
DB_NUM	Output	DB_DYN (UINT)	I, Q, M, D, L	Number of the DB created.															

For additional information on valid data types, refer to "Overview of the valid data types (Page 1077)".

### Parameter RET\_VAL

Error code* (W#16#...)	Description
0000	No error
0081	The target range is greater than the source range. The complete source range is written to the target range. The remaining bytes of the target range are filled with 0.
7000	First call with REQ = 0: No data transfer active; BUSY has the value "0".
7001	First call with REQ = 1: Data transfer triggered; BUSY has the value "1".

Error code* (W#16#...)	Description
7002	Intermediate call (REQ irrelevant): Data transfer already active; BUSY has the value "1".
8081	The source range is larger than the target range. The complete target range is written. The remaining bytes of the source range are ignored.
8091	You have called "CREATE_DB" as a nested instruction.
8092	The "Create data block" function is currently unavailable because <ul style="list-style-type: none"> <li>• The "Compress user memory" function is currently active.</li> <li>• The maximum number of blocks on your CPU has already been reached.</li> </ul>
8093	No data block or a data block that is not in the work memory is specified for the SRCBLK parameter.
8094	A not yet supported attribute was specified for the ATTRIBparameter.
80A1	DB number error: <ul style="list-style-type: none"> <li>• The number is "0"</li> <li>• Low limit &gt; high limit</li> </ul>
80A2	DB length error: <ul style="list-style-type: none"> <li>• The length is "0"</li> <li>• The length is an odd number</li> <li>• The length is greater than permitted by the CPU</li> </ul>
80A3	The data block at the SRCBLK parameter was not created with standard access.
80B1	There is no DB number free.
80B2	Not enough work memory.
80B4	The memory card is write-protected.
80BB	Not enough load memory.
80C0	The destination is currently being processed by another instruction or a communication function.
80C1	A DB with this DB number is currently being deleted.
80C3	The maximum number of simultaneously active "CREATE_DB" instructions has already been reached.
* The error codes can be displayed as integer or hexadecimal values in the program editor. For additional information on toggling display formats, refer to "See also".	

## READ\_DBL: Read from data block in the load memory

### Description

With the instruction you copy a DB or an area of a DB in load memory (Micro Memory Card) to the data area of a destination DB. The destination DB must be relevant for execution; that is, it must not be created with the attribute UNLINKED. The content of the load memory is not changed during the copy process.

To ensure data consistency, you must not change the target range while "READ\_DBL" is being executed (i.e., as long as the BUSY parameter has the value TRUE).

The following restrictions apply to the SRCBLK and DSTBLK parameters (source and destination blocks):

- You must be able to divide the length of the VARIANT pointer by eight.
- For a VARIANT pointer of type STRING, the length must be equal to 1.
- The source and destination block must have been created with the same block access, i.e. both must use either the access type "Optimized" or "Standard".

**Note**

""READ\_DBL" is processed asynchronously. Therefore, it is not suitable for frequent (or cyclical) reading of tags in the load memory.

Once started, a job is always completed. If the maximum number of simultaneously active "READ\_DBL" instructions is reached and you call "READ\_DBL" once again at this time in a priority class having higher priority, error code W#16#80C3 will be returned. Consequently it does not make sense to restart the high-priority job right away.

**Functional description**

The "READ\_DBL" instruction works asynchronously, that is, its execution extends over multiple calls. You start the job by calling "READ\_DBL" with REQ = 1.

The output parameters RET\_VAL and BUSY indicate the status of the job.

See also: Meaning of the parameters REQ, RET\_VAL and BUSY with asynchronous instructions (Page 1582)

**Parameters**

The following table shows the parameters of the "READ\_DBL" instruction:

Parameter	Declaration	Data type	Memory area	Description
REQ	Input	BOOL	I, Q, M, D, L or constant	REQ = 1: Read request
SRCBLK	Input	VARIANT	D	Pointer to data block in the load memory that is to be read from
RET_VAL	Return	INT	I, Q, M, D, L	Error information
BUSY	Output	BOOL	I, Q, M, D, L	BUSY = 1: The reading process is not yet complete.
DSTBLK	Output	VARIANT	D	Pointer to the data block in the work memory that is to be written to

For additional information on valid data types, refer to "Overview of the valid data types (Page 1077)".



## Parameter RET\_VAL

Error code* (W#16#...)	Description
0000	No error
0081	The target range is greater than the source range. The source range is written completely to the target range; the remaining bytes of the target range will not be changed.
7000	First call with REQ = 0: No data transfer active; BUSY has the value "0".
7001	First call with REQ=1: Data transfer triggered; BUSY has the value "1".
7002	Intermediate call (REQ irrelevant): Data transfer already active; BUSY has the value "1".
8081	The source range is larger than the target range. The complete target range is written. The remaining bytes of the source range are ignored.
8082	Destination DB type different from source DB type (optimized/standard access).
8093	No data block or a data block that is not in the work memory is specified for the DSTBLK parameter.
80B1	No data block is specified for the SRCBLK parameter, or the data block specified there is not a load memory object.
80B4	DB with F-attribute must not be read.
80C3	The maximum number of simultaneously active "READ_DBL" instructions has already been reached.
80C0	The destination DB is currently being processed by another instruction or a communication function.
* The error codes can be displayed as integer or hexadecimal values in the program editor. For additional information on toggling display formats, refer to "See also".	

### See also

GET\_ERR\_ID: Get error ID locally (Page 2237)

## WRIT\_DBL: Write to data block in the load memory

### Description

The instruction "WRIT\_DBL" is used to transfer the contents of a DB or a DB area from the work memory to a DB or a DB area in the load memory (Micro Memory Card). The source DB must be relevant for execution, which means it must not be created with the attribute UNLINKED.

To ensure data consistency, it is not permitted to change the source range while "WRIT\_DBL" is being executed (i.e., as long as the BUSY parameter has the value TRUE).

The following restrictions apply to the SRCBLK and DSTBLK parameters (source and destination blocks):

- For a VARIANT pointer of type BOOL, the length must be divisible by 8.
- For a VARIANT pointer of type STRING, the length must be equal to 1.
- The source and destination block must have been created with the same block access, i.e. both must use either the access type "Optimized" or "Standard - compatible with S7-300/400".

The "WRIT\_DBL" instruction does not change the checksum of the user program if you write a DB that was created using an instruction. However, when a loaded DB is written, the first entry in this DB changes the checksum of the user program.

**Note**

"WRIT\_DBL" is not suitable for frequent (or cyclical) writing of tags in the load memory. This is because the Micro Memory Card technology limits the number of write accesses that can be made to a Micro Memory Card.

**Functional description**

The "WRIT\_DBL" instruction works asynchronously, that is, its execution extends over multiple calls. You start the job by calling "WRIT\_DBL" with REQ=1.

The output parameters RET\_VAL and BUSY indicate the status of the job.

See also: Meaning of the parameters REQ, RET\_VAL and BUSY with asynchronous instructions (Page 1582).

**Parameters**

The following table shows the parameters of the instruction "WRIT\_DBL":

Parameter	Declaration	Data type	Memory area	Description
REQ	Input	BOOL	I, Q, M, D, L or constant	REQ = 1: Write request
SRCBLK	Input	VARIANT	D	Pointer to the DB in the work memory that is to be read from
RET_VAL	Return	INT	I, Q, M, D, L	Error information
BUSY	Output	BOOL	I, Q, M, D, L	BUSY = 1: The writing process is not yet completed.
DSTBLK	Output	VARIANT	D	Pointer to the data block in the load memory that is to be written to

For additional information on valid data types, refer to "Overview of the valid data types (Page 1077)".

**Parameter RET\_VAL**

Error code* (W#16#...)	Description
0000	No error
0081	The target range is greater than the source range. The source range is written completely to the target range; the remaining bytes of the target range will not be changed.
7000	First call with REQ = 0: No data transfer active; BUSY has the value "0".
7001	First call with REQ = 1: Data transfer triggered; BUSY has the value "1".

Error code* (W#16#...)	Description
7002	Intermediate call (REQ irrelevant): Data transfer already active; BUSY has the value "1".
8081	The source range is larger than the target range. <b>The complete target range is written. The remaining bytes of the source range are ignored.</b>
8082	Destination DB type different from source DB type (optimized/non-optimized access).
8092	Incorrect operating mode: While "WRIT_DBL" was active, the CPU went into STOP mode. This error code is supplied at the next transition to RUN. Call "WRIT_DBL" again.
8093	No data block or a data block that is not in the work memory is specified for the SRCBLK parameter.
80B1	No data block has been specified for the DSTBLK parameter, or the data block specified there is not a load memory object.
80B4	DB with F-attribute must not be read.
80C3	The maximum number of simultaneously active "WRIT_DBL" instructions has already been reached.
80C0	The destination DB is currently being processed by another instruction or a communication function.
General error codes	See also: GET_ERR_ID: Get error ID locally (Page 1787)
* The error codes can be displayed as integer or hexadecimal values in the program editor. For additional information on toggling display formats, refer to "See also".	

## ATTR\_DB: Read data block attribute

### Description

You use the instruction "ATTR\_DB" to obtain information about a data block (DB) located in the work memory of the CPU. The instruction determines the attributes set at the ATTRIB parameter for the DB selected.

The length cannot be read out for data blocks with optimized access, the DB\_LENGTH parameter contains the length "0" for DBs with optimized access.

Data blocks for Motion Control cannot be read out with the "ATTR\_DB" instruction. The error code 80B2 is output for this.

### Parameters

The following table shows the parameters of the "ATTR\_DB" instruction:

Parameter	Declaration	Data type	Memory area	Description
REQ	Input	BOOL	I, Q, M, D, L or constant	REQ = 1: Read request for block attributes
DB_NUMBE R	Input	DB_ANY (UINT)	I, Q, M, D, L or constant	Number of the DB to be tested
RET_VAL	Output	INT	I, Q, M, D, L	Error information
DB_LENGTH	Output	UDINT	I, Q, M, D, L	Number of data bytes which the selected DB contains.

Parameter	Declaration	Data type	Memory area	Description
ATTRIB	Output	BYTE	I, Q, M, D, L	DB properties: <ul style="list-style-type: none"> <li>• Bit 0*= 0: LINKED - The DB only exists in the work memory</li> <li>• Bit 0*= 1: UNLINKED - The DB only exists in the load memory</li> <li>• Bit 1 = 0: READ_ONLY - The DB is not write-protected.</li> <li>• Bit 1 = 1: READ_ONLY - The DB is write-protected.</li> <li>• Bit 2 = 0: RETAIN - The DB is retentive.</li> <li>• Bit 2 = 1: NON_RETAIN - The DB is not retentive.</li> <li>• Bit 3*= 0: The DB exists either in the load or the work memory</li> <li>• Bit 3*= 1: The DB is generated in both the load and the work memory</li> </ul>
* The relationship between bit 0 and bit 3 is explained in the parameters of the instruction "CREATE_DB: Create data block (Page 2533)".				

You will find more detailed information on valid data types in "Overview of the valid data types (Page 1077)".

### Parameter RET\_VAL

Error code* (W#16#...)	Explanation
0000	No error occurred.
80A1	Error in input parameter DB_NUMBER: the actual parameter selected <ul style="list-style-type: none"> <li>• Is "0"</li> <li>• Is greater than the maximum permitted DB number for the CPU used.</li> </ul>
80B1	The DB with the specified number does not exist on the CPU.
80B2	Data blocks of Motion Control technology objects cannot be read out with the "ATTR_DB" instruction.
* The error codes can be displayed as integer or hexadecimal values in the program editor. For additional information on toggling display formats, refer to "See also".	

### DELETE\_DB: Delete data block

#### Description

You use the instruction "DELETE\_DB" to delete a data block (DB) that was created from the user program by calling the instruction "CREATE\_DB (Page 2533)".

If the data block was not created with "CREATE\_DB", the error code W#16#80B5 is output at the RET\_VAL parameter.

The DB to be deleted may not be located in the current or in a lower priority class. Otherwise, the CPU starts OB 121 when the "DELETE\_DB" instruction is called. If OB 121 is not present, the CPU switches to STOP mode. The instruction "DELETE\_DB" can be interrupted by higher

priority classes. If the instruction is called again there, then this second call will be aborted and W#16#8091 will be entered in RET\_VAL .

## Parameters

The following table shows the parameters of the "DELETE\_DB" instruction:

Parameter	Declaration	Data type	Memory area	Description
REQ	Input	BOOL	I, Q, M, D, L or constant	REQ =1: Request to delete the DB with the number in parameter DB_NUMBER
DB_NUMBER	Input	UINT	I, Q, M, D, L or constant	Number of the DB to be deleted
RET_VAL	Output	INT	I, Q, M, D, L	Error information (see "RET_VAL parameter")
BUSY	Output	BOOL	I, Q, M, D, L	BUSY= 1: The process is not yet complete.

You will find more detailed information on valid data types in "Overview of the valid data types (Page 1077)".

## Parameter RET\_VAL

Error code* (W#16#...)	Explanation
0000	No error occurred.
8091	"DELETE_DB" calls were nested and the maximum nesting level of the CPU used was exceeded.
8092	The instruction can currently not be executed because: <ul style="list-style-type: none"> <li>• The "Compress user memory" function is currently active.</li> <li>• You are copying the DB to be deleted from the CPU to an offline project.</li> </ul>
80A1	Error in input parameter DB_NUMBER: <ul style="list-style-type: none"> <li>• The value at the parameter is "0".</li> <li>• The value at the parameter is greater than the maximum permitted DB number for the CPU used.</li> </ul>
80B1	The DB with the specified number does not exist on the CPU.
80B4	The DB cannot be deleted because the memory card of the CPU is write-protected.
80B5	The DB was not created using "CREATE_DB".
80C1	The "Delete a DB" function cannot be executed at this time due to a temporary resource bottleneck.
General error information	See also: GET_ERR_ID: Get error ID locally (Page 1787)
* The error codes can be displayed as integer or hexadecimal values in the program editor. For additional information on toggling display formats, refer to "See also".	

### 9.7.3.13 Addressing

#### Instructions for address conversion

##### Description

There are different options for addressing a module (IO address, hardware identifier, slot).

You can convert the address data with the following instructions:

- GEO2LOG: Determine hardware identifier from slot (Page 2543)
- LOG2GEO: Determine slot from hardware identifier (Page 2545)
- LOG2MOD: Determine the hardware identifier from addressing of STEP 7 V5.5 SPx (Page 2546)
- IO2MOD: Determine hardware identifier from an IO address (Page 2547)
- RD\_ADDR: Determine IO addresses from the hardware identifier (Page 2548)

The following instructions are supported in addition for migrated projects:

- GEO\_LOG: Determine hardware identifier from slot (Page 2549)
- LOG\_GEO: Determine slot from hardware identifier (Page 2551)
- RD\_LGADR: Determine IO addresses from the hardware identifier (Page 2552)
- GADR\_LGC: Determine hardware identifier from slot and offset in the user data address area (Page 2553)
- LGC\_GADR: Determine slot from hardware identifier (Page 2555)

## Type of address conversion

The figure below shows which instruction runs which address conversion.

Name	Type	IO address(es)	Hardware identifier	Slot
GEO2LOG	SFC		←	●
LOG2GEO	SFC		●	→
LOG2MOD	SFC	●	→	
IO2MOD	SFC	●	→	
RD_ADDR	SFC	←	←	●
GEO_LOG	FC		←	●
LOG_GEO	FC		●	→
RD_LGADR	FC	←	←	●
GADR_LGC	FC		←	●
LGC_GADR	FC		●	→

## GEO2LOG: Determine hardware identifier from slot

### Description

You use the "LOG2GEO" instruction to determine the logical address based on slot information that you define using the system data type GEOADDR.

Depending on the hardware type that you define at the HWTYPE parameter, the following information is evaluated from the other parameters of GEOADDR:

- With HWTYPE = 1 (PROFINET IO system):
  - Only IOSYSTEM is evaluated. The other parameters of GEOADDR are not taken into consideration.
  - The hardware identifier of the PROFINET IO system is output.
- With HWTYPE = 2 (PROFINET IO device):
  - IOSYSTEM and STATION are evaluated. The other parameters of GEOADDR are not taken into consideration.
  - The hardware identifier of the PROFINET IO device is output.
- With HWTYPE = 3 (rack):
  - Only IOSYSTEM and STATION are evaluated. The other parameters of GEOADDR are not taken into consideration.
  - The hardware identifier of the rack is output.

9.7 References

- With HWTYPE = 4 (module):
  - IOSYSTEM, STATION and SLOT are evaluated. The SUBSLOT parameter of GEOADDR is not taken into consideration.
  - The hardware identifier of the module is output.
- With HWTYPE = 5 (submodule):
  - All parameters of GEOADDR are evaluated.
  - The hardware identifier of the submodule is output.

The AREA parameter of the GEOADDR system data type is not evaluated.

**Parameter**

The following table shows the parameters of the "GEO2LOG" instruction:

Parameter	Declaration	Data type	Memory area	Description
GEOADDR	Input	VARIANT	D, L	Pointer to the structure of the GEOADDR system data type.
RET_VAL	Return	INT	I, Q, M, D, L	Output of error information.
LADDR	Output	HW_ANY	I, Q, M, D, L	Hardware identifier of the module or the submodule. The number is assigned automatically and is stored in the properties of the CPU or of the interface in the hardware configuration.

You will find more detailed information on valid data types in "Overview of the valid data types (Page 1077)".

**GEOADDR system data type**

The GEOADDR system data type is a structure with the following configuration:

Parameter name	Data type	Description
GEOADDR	STRUCT	
HWTYPE	UNIT	Hardware type: <ul style="list-style-type: none"> <li>• 1: PROFINET IO system</li> <li>• 2: PROFINET IO device</li> <li>• 3: Rack</li> <li>• 4: Module</li> <li>• 5: Submodule</li> </ul> If a hardware type is not supported by the instruction, a HWTYPE "0" is output.
AREA	UNIT	Area identifier (0 = central module)
IOSYSTEM	UNIT	PROFINET IO system (0 = central device in rack 0-3)
STATION	UNIT	<ul style="list-style-type: none"> <li>• Number of the rack if the area identifier AREA = 0.</li> <li>• Station number if area identifier AREA &gt; 0.</li> </ul>



Parameter name	Data type	Description
SLOT	UNIT	Slot number
SUBSLOT	UNIT	Number of the submodule. If no submodule can be inserted, this parameter has the value "0".

### RET\_VAL parameter

Error code* (W#16#...)	Explanation
0	No error occurred.
8091	Invalid value for in GEOADDR for HWTYPE.
8094	Invalid value for in GEOADDR for IOSYSTEM.
8095	Invalid value for in GEOADDR for STATION.
8096	Invalid value for in GEOADDR for SLOT.
8097	Invalid value for in GEOADDR for SUBSLOT.

\* The error codes can be displayed as integer or hexadecimal values in the program editor. For additional information on toggling display formats, refer to "See also".

### See also

Instructions for address conversion (Page 2542)

### LOG2GEO: Determine slot from hardware identifier

#### Description

You use the "LOG2GEO" instruction to determine the module slot belonging to a hardware identifier.

#### Parameters

The following table shows the parameters of the "LOG2GEO" instruction:

Parameter	Declaration	Data type	Memory area	Description
LADDR	Input	HW_ANY	I, Q, M, D, L or constant	Hardware identifier of the IO system or the module. The number is assigned automatically and is stored in the hardware configuration properties of the CPU or the interface.
RET_VAL	Output	INT	I, Q, M, D, L	Output of error information.
GEOADDR	InOut	VARIANT	D	Pointer to the GEOADDR system data type.

You will find more detailed information on valid data types in "Overview of the valid data types (Page 1077)".

### GEOADDR system data type

The GEOADDR system data type is a structure with the following configuration:

Parameter name	Data type	Description
GEOADDR	STRUCT	
HWTYPE	UNIT	Hardware type: <ul style="list-style-type: none"> <li>• 1: IO system (PROFINET/PROFIBUS)</li> <li>• 2: IO device/DP slave</li> <li>• 3: Rack</li> <li>• 4: Module</li> <li>• 5: Submodule</li> </ul> If a hardware type is not supported by the instruction, a HWTYPE "0" is output.
AREA	UNIT	Area ID: <ul style="list-style-type: none"> <li>• 0 = CPU</li> <li>• 1 = PROFINET IO</li> <li>• 2 = PROFIBUS DP</li> </ul>
IOSYSTEM	UNIT	PROFINET IO system (0 = central device in rack 0-3)
STATION	UNIT	<ul style="list-style-type: none"> <li>• Number of the rack if the area identifier AREA = 0.</li> <li>• Station number if area identifier AREA &gt; 0.</li> </ul>
SLOT	UNIT	Slot number
SUBSLOT	UNIT	Number of the submodule. If no submodule can be inserted, this parameter has the value "0".

### Parameter RET\_VAL

Error code* (W#16#...)	Explanation
0	No error occurred.
8090	The address specified at the LADDR parameter is invalid.

\* The error codes can be displayed as integer or hexadecimal values in the program editor. For additional information on toggling display formats, refer to "See also".

### LOG2MOD: Determine the hardware identifier from addressing of STEP 7 V5.5 SPx

#### Description

You use the "LOG2MOD" instruction to determine the hardware identifier for an IO (sub)module from the addressing of STEP 7 5.5 SPx (IO data address or diagnostic address).

The hardware identifier is used at the LADDR input parameter for addressing of various instructions. You can convert the addressing parameters from STEP 7 5.5 SPx by calling "LOG2MOD" beforehand.

## Parameter

The following table shows the parameters of the "LOG2MOD" instruction:

Parameter	Declaration	Data type	Memory area	Description
IOID	Input	BYTE	I, Q, M, D, L or constant	Identifier of the address area as in STEP 7 5.5 SPx: <ul style="list-style-type: none"> <li>• B#16#00: Bit15 of ADDR specifies whether an input (Bit15=0) or output address (Bit15=1) exists.</li> <li>• B#16#54= Peripheral input (PI)</li> <li>• B#16#55= Peripheral output (PQ)</li> </ul>
ADDR	Input	WORD	I, Q, M, D, L or constant	Logical address of the IO data of the module as offset (corresponding addressing in STEP 7 5.5 SPx) or diagnostic address.
RET_VAL	Return	INT	I, Q, M, D, L	Error code of the instruction.
HWID	Output	HW_IO	I, Q, M, D, L	Determined hardware identifier (logical address) of the IO (sub)module.

You will find more detailed information on valid data types in "Overview of the valid data types (Page 1077)".

## RET\_VAL parameter

Error code* (W#16#...)	Explanation
0	No error occurred.
8093	<ul style="list-style-type: none"> <li>• Specified address is not used by any hardware components.</li> <li>• Specified value at IOID parameter is invalid.</li> </ul>

\* The error codes can be displayed as integer or hexadecimal values in the program editor. For additional information on toggling display formats, refer to "See also".

## IO2MOD: Determine hardware identifier from an IO address

### Description

The "IO2MOD" instruction determines the hardware identifier of the module from an IO address (I, Q, PI, PQ) of a (sub)module.

Enter the IO address at the ADDR parameter. If a series of IO addresses is used at this parameter, only the first address is evaluated to determine the hardware identifier. If the first address is correctly specified, the length for the address specification at the ADDR is of no significance. If an address area is used that encompasses several modules or non-used addresses, the hardware identifier of the first module can also be determined.

If no IO address of a sub(module) is specified at the ADDR parameter, the error code 8090 is output at the RET\_VAL parameter.

**Parameter**

The following table shows the parameters of the "IO2MOD" instruction:

Parameter	Declaration	Data type	Memory area	Description
ADDR	Input	VARIANT	I, Q, M, D, L	IO address (I, Q, PI, PQ) within a (sub)module.
RET_VAL	Return	INT	I, Q, M, D, L	Error code of the instruction.
LADDR	Output	HW_IO	I, Q, M, D, L	Determined hardware identifier (logical address) of the IO (sub)module.

You will find more detailed information on valid data types in "Overview of the valid data types (Page 1077)".

**RET\_VAL parameter**

Error code* (W#16#...)	Explanation
0	No error occurred.
8090	IO address specified at ADDR parameter is not used by any hardware component.
* The error codes can be displayed as integer or hexadecimal values in the program editor. For additional information on toggling display formats, refer to "See also".	

**RD\_ADDR: Determine IO addresses from the hardware identifier**

**Description**

The "RD\_ADDR" instruction determines the length and the start address of the inputs or outputs based on the hardware identifier of a sub(module).

- Use the LADDR parameter to select the input or output module based on the hardware identifier.
- The following output parameters are used depending on whether it is an input module or output module:
  - In the case of an input module the determined values are output at the PIADDR and PICOUNT parameters.
  - In the case of an output module the determined values are output at the PQADDR and PQCOUNT parameters.
- The PIADDR and PQADDR parameters each contain the start address of the I/O addresses of the module.
- The PICOUNT and PQCOUNT parameters each contain the number of bytes of the inputs our outputs (1 byte for 8 inputs/outputs, 2 bytes for 16 inputs/outputs).

**Note****Addressing packed modules**

If packed modules (not the first module of the packed module group) are addressed, the displayed data deviates from the hardware configuration. "0" is returned for PIADDR or PQADDR and PICOOUNT or PQCOUNT. RET\_VAL does not indicate an error (16#0000).

**Parameters**

The following table shows the parameters of the "RD\_ADDR" instruction:

Parameter	Declaration	Data type	Memory area	Description
LADDR	Input	HW_IO	I, Q, M, D, L or constant	Hardware identifier of the (sub)module.
RET_VAL	Return	INT	I, Q, M, D, L	Error code of the instruction.
PIADDR	Output	UDINT	I, Q, M, D, L	Start address of the input module.
PICOOUNT	Output	UINT	I, Q, M, D, L	Number of bytes of the inputs.
PQADDR	Output	UDINT	I, Q, M, D, L	Start address of the output module.
PQCOUNT	Output	UINT	I, Q, M, D, L	Number of bytes of the outputs.

You will find more detailed information on valid data types in "Overview of the valid data types (Page 1077)".

**Parameter RET\_VAL**

Error code* (W#16#...)	Explanation
0	No error occurred.
8090	Hardware identifier of the module at the LADDR parameter is invalid.

\* The error codes can be displayed as integer or hexadecimal values in the program editor. For additional information on toggling display formats, refer to "See also".

**Other****GEO\_LOG: Determine hardware identifier from slot****Description**

The associated module slot of the module is known from the channel of a signal module. Use the "GEO\_LOG" instruction to determine the corresponding hardware identifier of the module from this.

If you use the "GEO\_LOG" instruction on power modules or modules with packed addresses (ET 200S), then the diagnostics address will be returned.

### Parameters

The following table shows the parameters of the instruction "GEO\_LOG":

Parameter	Declaration	Data type	Memory area	Description
MASTER	Input	INT	I, Q, M, D, L or constant	Area ID: <ul style="list-style-type: none"> <li>• 0, if the slot is located in a centralized configuration.</li> <li>• 1 to 32: DP master system ID of the associated field device if the slot is located in a field device on PROFIBUS</li> <li>• 100 to 115: PROFINET IO system ID of the associated field device if the slot is located in a field device on PROFINET</li> </ul>
STATION	Input	INT	I, Q, M, D, L or constant	<ul style="list-style-type: none"> <li>• If MASTER = 0: Number of the rack</li> <li>• If MASTER &gt; 0: Station number of the field device</li> </ul>
SLOT	Input	INT	I, Q, M, D, L or constant	Slot number
SUBSLOT	Input	INT	I, Q, M, D, L or constant	The SUBLOT parameter is not evaluated by the instruction.
RET_VAL	Return	INT	I, Q, M, D, L	Error information
LADDR	Output	HW_IO	I, Q, M, D, L	Hardware identifier or diagnostic address of the module

You will find more detailed information on valid data types in "Overview of the valid data types (Page 1077)".

### Parameter RET\_VAL

Error code* (W#16#...)	Explanation
0000	No error occurred.
8094	No subnet was configured with the specified SUBNETID .
8095	Illegal value for STATION parameter
8096	Illegal value for SLOT parameter
8099	The slot is not configured.
809A	The number is not configured for the selected slot.
General error information	See also: GET_ERR_ID: Get error ID locally (Page 1787)

\* The error codes can be displayed as integer or hexadecimal values in the program editor. For additional information on toggling display formats, refer to "See also".

### See also

Instructions for address conversion (Page 2542)

**LOG\_GEO: Determine slot from hardware identifier****Description**

You use the "LOG\_GEO" instruction to determine the module slot belonging to a hardware identifier.

**Parameters**

The following table shows the parameters of the instruction "LOG\_GEO":

Parameter	Declaration	Data type	Memory area	Description
LADDR	Input	HW_IO	I, Q, M, D, L or constant	Hardware identifier of the module for which the slot is to be determined.
RET_VAL	Return	INT	I, Q, M, D, L	Error information
AREA	Output	INT	I, Q, M, D, L	Area ID: indicates how the remaining output parameters are to be interpreted: <ul style="list-style-type: none"> <li>• 0: central device</li> <li>• 2: PROFIBUS DP / PROFINET IO</li> </ul>
MASTER	Output	INT	I, Q, M, D, L or constant	With AREA = 0: <ul style="list-style-type: none"> <li>• 0: If the slot is located in one of the racks (central device).</li> </ul> With AREA = 2: <ul style="list-style-type: none"> <li>• 1 to 32: DP master system ID of the associated field device if the slot is located in a field device on PROFIBUS</li> <li>• 100 to 115: PROFINET IO system ID of the associated field device if the slot is located in a field device on PROFINET</li> </ul>
STATION	Output	INT	I, Q, M, D, L	<ul style="list-style-type: none"> <li>• With MASTER = 0: Number of the rack</li> <li>• With MASTER &gt; 0: Station number of the field device</li> </ul>
SLOT	Output	INT	I, Q, M, D, L	Slot number
SUBSLOT	Output	INT	I, Q, M, D, L	The SUBSLOT parameter is not output by the instruction (always "0").
OFFSET	Output	INT	I, Q, M, D, L	The OFFSET parameter is not output by the instruction (always "0").

You will find more detailed information on valid data types in "Overview of the valid data types (Page 1077)".

**Parameter RET\_VAL**

Error code* (W#16#...)	Explanation
0000	No error occurred.
8090	Specified logical address invalid
General error information	See also: GET_ERR_ID: Get error ID locally (Page 1787)
* The error codes can be displayed as integer or hexadecimal values in the program editor. For additional information on toggling display formats, refer to "See also".	

**See also**

Instructions for address conversion (Page 2542)

**RD\_LGADR: Determine IO addresses from the hardware identifier**

**Description**

You use a hardware identifier of a module, central submodule or a submodule for PNIO. You use the instruction to determine all the declared logical addresses of this module and the submodule. The "RD\_LGADR" instruction enters the determined logical addresses in the PEADDR or PAADDR parameter in ascending order.

**Parameters**

The following table shows the parameters of the instruction "RD\_LGADR":

Parameter	Declaration	Data type	Memory area	Description
IOID	Input	BYTE	I, Q, M, D, L or constant	Address area identifier: <ul style="list-style-type: none"> <li>• B#16#54 = Peripheral input (PI)</li> <li>• B#16#55 = Peripheral output (PQ)</li> </ul>
LADDR	Input	HW_ANY	I, Q, M, D, L or constant	Hardware identifier of the module or the submodule.
RET_VAL	Return	INT	I, Q, M, D, L	Error information
PEADDR	Output	ANY	I, Q, M, D, L	Array for the PI addresses, array elements must be of the WORD data type.
PECOUNT	Output	INT	I, Q, M, D, L	Number of returned PI addresses
PAADDR	Output	ANY	I, Q, M, D, L	Array for the PQ addresses, array elements must be of the WORD data type.
PACOUNT	Output	INT	I, Q, M, D, L	Number of returned PQ addresses

You will find more detailed information on valid data types in "Overview of the valid data types (Page 1077)".



**Parameter RET\_VAL**

<b>Error code (W#16#...)</b>	<b>Explanation</b>
0000	No error occurred.
8090	Specified logical address invalid or illegal value for the IOID parameter.
80A0	Error in the output parameter PEADDR: The data type of the array elements is not WORD.
80A1	Error in the output parameter PAADDR: The data type of the array elements is not WORD.
80A2	Error in the output parameter PEADDR: The specified array could not accommodate all the logical addresses.
80A3	Error in the output parameter PAADDR: The specified array could not accommodate all the logical addresses.
General error information	See also: GET_ERR_ID: Get error ID locally (Page 1787)

**See also**

Instructions for address conversion (Page 2542)

**GADR\_LGC: Determine hardware identifier from slot and offset in the user data address area****Description**

You use the "GADR\_LGC" instruction to determine the hardware identifier of a signal module. The hardware identifier is determined from the module slot and the offset in the user data address area of the module.

If you use the "GADR\_LGC" instruction on power modules or modules with packed addresses (ET 200S), then the diagnostics address will be returned.

**Parameters**

The following table shows the parameters of the instruction "GADR\_LGC":

Parameter	Declaration	Data type	Memory area	Description
SUBNETID	Input	BYTE	I, Q, M, D, L or constant	Area ID: <ul style="list-style-type: none"> <li>• 0: If the slot is located in the central module</li> <li>• 1 to 32: DP master system ID of the corresponding distributed I/O system if the slot is in a distributed I/O device.</li> <li>• 100 to 115: PROFINET IO system ID of the associated field device if the slot is located in a field device on PROFINET</li> </ul>
RACK	Input	WORD	I, Q, M, D, L or constant	<ul style="list-style-type: none"> <li>• Number of the rack, if area identifier is 0</li> <li>• Device number of the distributed I/O device if the area identifier &gt; 0</li> </ul>
SLOT	Input	WORD	I, Q, M, D, L or constant	Slot no.
SUBSLOT	Input	BYTE	I, Q, M, D, L or constant	Sub-module slot (if no sub-module can be inserted, 0 must be entered here)
SUBADDR	Input	WORD	I, Q, M, D, L or constant	Offset in the user data address area of the module
RET_VAL	Return	INT	I, Q, M, D, L	Error information
IOID	Output	BYTE	I, Q, M, D, L	The IOID output parameter is not written (always "0").
LADDR	Output	HW_MODULE	I, Q, M, D, L	Hardware identifier of the module

You will find more detailed information on valid data types in "Overview of the valid data types (Page 1077)".

**Parameter RET\_VAL**

Error code* (W#16#...)	Explanation
0000	No error occurred.
8089	Illegal value for SUBADDR parameter.
8093	Illegal value for SUBNETID parameter
8094	No subnet was configured with the specified SUBNETID .
8095	Illegal value for RACK parameter.
8096	Illegal value for SLOT parameter.
8097	Illegal value for SUBSLOT parameter.
8099	The slot is not configured.
809A	The sub-address of the selected slot is not configured (only possible with central I/O for CPU and IM).

Error code* (W#16#...)	Explanation
General error information	See also: GET_ERR_ID: Get error ID locally (Page 1787)
* The error codes can be displayed as integer or hexadecimal values in the program editor. For additional information on toggling display formats, refer to "See also".	

## See also

Instructions for address conversion (Page 2542)

## LGC\_GADR: Determine slot from hardware identifier

### Description

You use the "LGC\_GADR" instruction to determine the module slot belonging to a hardware identifier.

#### Note

The "LGC\_GADR" instruction cannot be used on a module with packed addresses (ET 200S).

### Parameters

The following table shows the parameters of the instruction "LGC\_GADR":

Parameter	Declaration	Data type	Memory area	Description
IOID	Input	BYTE	I, Q, M, D, L or constant	Is not evaluated.
LADDR	Input	HW_MODULE	I, Q, M, D, L or constant	Hardware identifier of the module
RET_VAL	Return	INT	I, Q, M, D, L	Error information
AREA	Output	BYTE	I, Q, M, D, L	Area ID: indicates how the remaining output parameters are to be interpreted: <ul style="list-style-type: none"> <li>• 0: Central module</li> <li>• 2: PROFIBUS DP</li> </ul>
RACK	Output	WORD	I, Q, M, D, L	Rack number: <ul style="list-style-type: none"> <li>• With central module (AREA= 0): <ul style="list-style-type: none"> <li>– Rack number</li> </ul> </li> <li>• For PROFIBUS DP (AREA=2): <ul style="list-style-type: none"> <li>– Low byte: Station number</li> <li>– High byte: DP master system ID</li> </ul> </li> </ul>

Parameter	Declaration	Data type	Memory area	Description
SLOT	Output	WORD	I, Q, M, D, L	Slot number: <ul style="list-style-type: none"> <li>• With central module AREA= 0):  <ul style="list-style-type: none"> <li>– Slot number</li> </ul> </li> <li>• For PROFIBUS DP (AREA=2):  <ul style="list-style-type: none"> <li>– Slot no. in the station</li> </ul> </li> </ul>
SUBADDR	Output	WORD	I, Q, M, D, L	Is not output (always "0").

You will find more detailed information on valid data types in "Overview of the valid data types (Page 1077)".

### Parameter RET\_VAL

Error code* (W#16#...)	Explanation
0000	No error occurred.
8090	Specified logical address invalid or illegal value for the IOID parameter.
8093	This instruction is not permitted for the module selected by the parameters IOID and LADDR .
General error information	See also: GET_ERR_ID: Get error ID locally (Page 1787)

\* The error codes can be displayed as integer or hexadecimal values in the program editor. For additional information on toggling display formats, refer to "See also".

### See also

Instructions for address conversion (Page 2542)

## 9.7.4 Technology

### 9.7.4.1 S7-1200 Motion Control

#### MC\_Power

#### MC\_Power: Enable, disable axis

#### Description

The Motion Control instruction "MC\_Power" releases or locks an axis.

## Requirements

- The technology object "Axis" has been configured correctly.
- There is no pending enable-inhibiting error.

## Override response

Execution of "MC\_Power" cannot be aborted by a motion control command.

Disabling the axis (input parameter "Enable" = FALSE ) aborts all motion control commands for the associated technology object in accordance with the selected "StopMode".

## Parameter

Parameter	Declaration	Data type	Default value	Description	
Axis	INPUT	TO_Axis_1	-	Axis technology object	
Enable	INPUT	BOOL	FALSE	TRUE	Motion Control attempts to enable the axis.
				FALSE	All active commands are aborted according to the configured "StopMode" and the axis is stopped.
StopMode	INPUT	INT	0	0	Emergency stop If a request to disable the axis is pending, the axis brakes at the configured emergency stop deceleration. The axis is disabled after reaching standstill.
				1	Immediate stop If a request to disable the axis is pending, this axis is disabled without deceleration. The pulse output is stopped immediately.
				2	Emergency stop with jerk control If a request to disable the axis is pending, the axis brakes at the configured emergency stop deceleration. If the jerk control is activated, the configured jerk is taken into account. The axis is disabled after reaching standstill.
Status	OUTPUT	BOOL	FALSE	Status of axis enable	
				FALSE	The axis is disabled. The axis does not execute motion control commands and does not accept any new commands (exception: MC_Reset command). The axis is not homed. Upon disabling, the status does not change to FALSE until the axis reaches a standstill.

Parameter	Declaration	Data type	Default value	Description
				TRUE The axis is enabled. The axis is ready to execute motion control commands. Upon axis enabling, the status does not change to TRUE until the signal "Drive ready" is pending. If the "Drive ready" drive interface was not configured in the axis configuration, the status changes to TRUE immediately.
Busy	OUTPUT	BOOL	FALSE	TRUE MC Power is active
Error	OUTPUT	BOOL	FALSE	TRUE An error occurred in motion control instruction "MC_Power" or in the associated technology object. The cause of the error can be found in parameters "ErrorID" and "ErrorInfo".
ErrorID	OUTPUT	WORD	16#0000	Error ID (Page 6109) for parameter "Error"
ErrorInfo	OUTPUT	WORD	16#0000	Error info ID (Page 6109) for parameter "ErrorID"

**Note**

If the axis is switched off due to an error, it will be enabled again automatically after the error has been eliminated and acknowledged. This requires that input parameter "Enable" has retained the value TRUE during this process.

**Enabling an axis with configured drive interface**

To enable the axis, follow these steps:

1. Check the requirements indicated above.
2. Initialize input parameter "StopMode" with the desired value. Set input parameter "Enable" to TRUE.  
The enable output for "Drive enabled" changes to TRUE to enable the power to the drive. The CPU waits for the "Drive ready" signal of the drive.  
When the "Drive ready" signal is available at the configured ready input of the CPU, the axis becomes enabled. Output parameter "Status" and tag of technology object <Axis name>.StatusBits.Enable indicate the value TRUE.

**Enabling an axis without configured drive interface**

To enable the axis, follow these steps:

1. Check the requirements indicated above.
2. Initialize input parameter "StopMode" with the desired value. Set input parameter "Enable" to TRUE. The axis is enabled. Output parameter "Status" and tag of technology object <Axis name>.StatusBits.Enable indicate the value TRUE.

## Disabling an axis

To disable an axis, you can follow the steps described below:

1. Bring the axis to a standstill.  
You can identify when the axis is at a standstill in the tag of the technology object <Axis name>.StatusBits.StandStill.
2. Set input parameter "Enable" to FALSE after standstill is reached.
3. If output parameters "Busy" and "Status" and tag of technology object <Axis name>.StatusBits.Enable indicate the value FALSE, disabling of the axis is complete.

## See also

List of ErrorIDs and ErrorInfos (technology objects as of V2.0) (Page 6109)

MC\_Power: Function chart (Page 2560)

MC\_Reset: Acknowledge error (Page 2561)

MC\_Home: Home axes, set home position (Page 2562)

MC\_Halt: Halt axis (Page 2566)

MC\_MoveAbsolute: Absolute positioning of axes (Page 2569)

MC\_MoveRelative: Relative positioning of axes (Page 2572)

MC\_MoveVelocity: Move axes at preset rotational speed (Page 2576)

MC\_MoveJog: Move axes in jogging mode (Page 2580)

MC\_ChangeDynamic: Changing the dynamic settings for the axis (as of technology object "Axis" V2.0) (Page 2586)

MC\_CommandTable: Run axis jobs as movement sequence (as of technology object "Axis" V2.0) (Page 2584)

MC\_Power: Function chart

Function chart

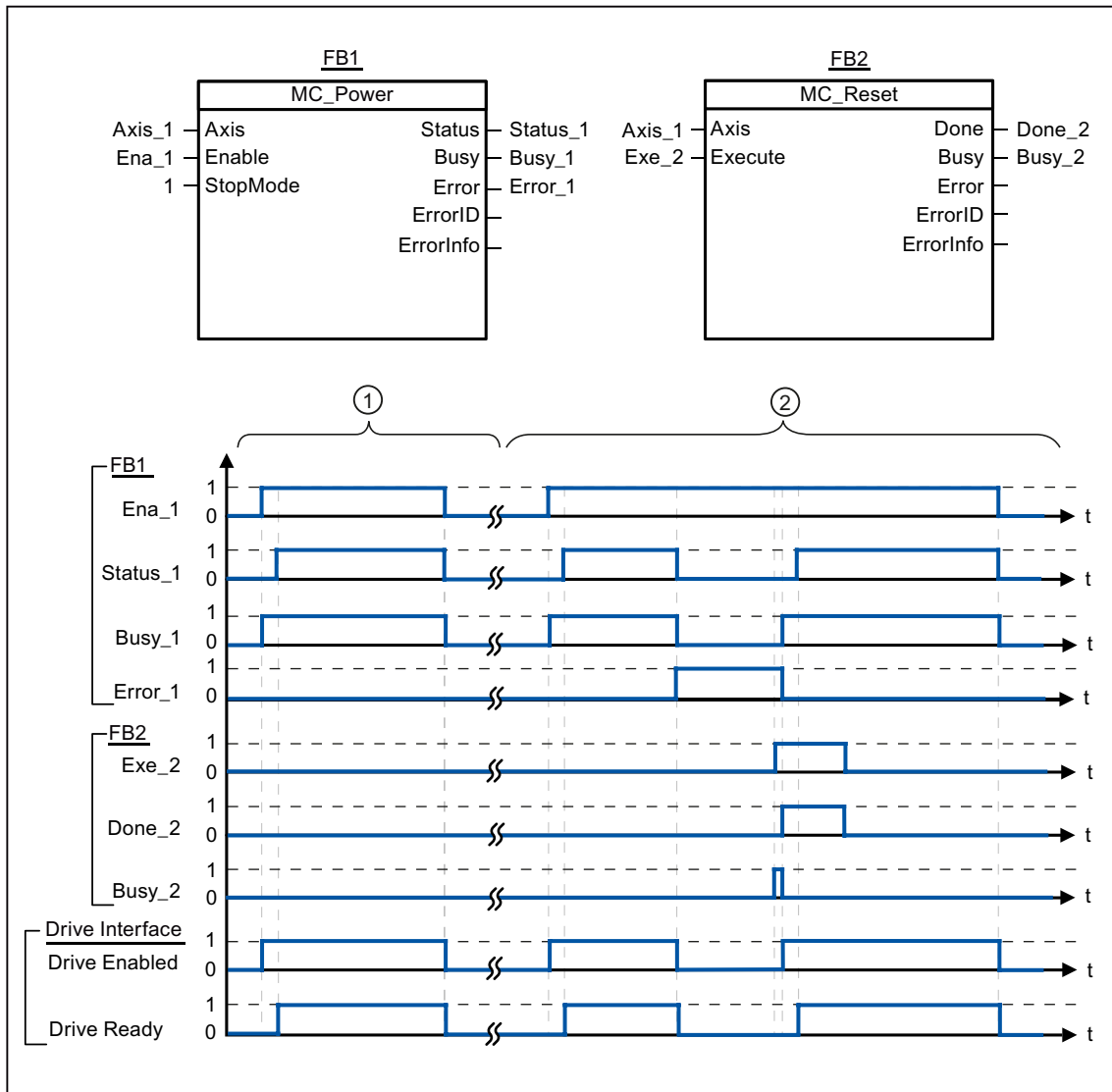

- ① An axis is enabled and then disabled again. When the drive has signaled "Drive ready" back to the CPU, the successful enable can be read out via "Status\_1".
- ② Following an axis enable, an error has occurred that caused the axis to be disabled. The error is eliminated and acknowledged with "MC\_Reset". The axis is then enabled again.

See also

MC\_Power: Enable, disable axis (Page 2556)



## MC\_Reset

### MC\_Reset: Acknowledge error

#### Description

Motion Control instruction "MC\_Reset" can be used to acknowledge "Operating error with axis stop" and "Configuration error". The errors that require acknowledgement can be found in the "List of ErrorIDs and ErrorInfos" under "Remedy".

From version V3.0, the axis configuration can be downloaded to the work memory in RUN operating mode.

#### Requirements

- The technology object "Axis" has been configured correctly.
- The cause of a pending configuration error requiring acknowledgement has been eliminated (for example, acceleration in "Axis" technology object has been changed to a valid value).

#### Override response

The MC\_Reset command cannot be aborted by any other motion control command.

The new MC\_Reset command does not abort any other active motion control commands.

#### Parameter

Parameter	Declaration	Data type	Default value	Description	
Axis	INPUT	TO_Axis_1	-	Axis technology object	
Execute	INPUT	BOOL	FALSE	Start of the command with a positive edge	
Restart	INPUT	BOOL	FALSE	(From version V3.0)	
				TRUE	Download the axis configuration from the load memory to the work memory. The command can only be executed when the axis is disabled. Please refer to the notes on Download to the CPU (Page 6068).
				FALSE	Acknowledges pending errors
Done	OUTPUT	BOOL	FALSE	TRUE Error has been acknowledged.	
Busy	OUTPUT	BOOL	FALSE	TRUE The command is being executed.	
Error	OUTPUT	BOOL	FALSE	TRUE An error occurred during execution of the command. The cause of the error can be found in parameters "ErrorID" and "ErrorInfo".	
ErrorID	OUTPUT	WORD	16#0000	Error ID (Page 6109) for parameter "Error"	
ErrorInfo	OUTPUT	WORD	16#0000	Error info ID (Page 6109) for parameter "ErrorID"	

## Acknowledging an error requiring acknowledgement with MC\_Reset

To acknowledge an error, follow these steps:

1. Check the requirements indicated above.
2. Start the acknowledgement of the error with a rising edge at input parameter "Execute".
3. If output parameter "Done" indicates the value TRUE and tag of technology object <Axis name>.StatusBits.Error the value FALSE, the error has been acknowledged.

## See also

Download to CPU (Page 6068)

List of ErrorIDs and ErrorInfos (technology objects as of V2.0) (Page 6109)

MC\_Power: Enable, disable axis (Page 2556)

MC\_Home: Home axes, set home position (Page 2562)

MC\_Halt: Halt axis (Page 2566)

MC\_MoveAbsolute: Absolute positioning of axes (Page 2569)

MC\_MoveRelative: Relative positioning of axes (Page 2572)

MC\_MoveVelocity: Move axes at preset rotational speed (Page 2576)

MC\_MoveJog: Move axes in jogging mode (Page 2580)

MC\_CommandTable: Run axis jobs as movement sequence (as of technology object "Axis" V2.0) (Page 2584)

MC\_ChangeDynamic: Changing the dynamic settings for the axis (as of technology object "Axis" V2.0) (Page 2586)

## MC\_Home

### MC\_Home: Home axes, set home position

#### Description

Use the motion control instruction "MC\_Home" to match the axis coordinates to the real, physical drive position. Homing is required for absolute positioning of the axis. The following types of homing can be executed:

- Active homing (Mode = 3)  
The homing procedure is executed automatically.
- Passive homing (Mode = 2)  
During passive homing, the motion control instruction "MC\_Home" does not carry out any homing motion. The traversing motion required for this step must be implemented by the user via other motion control instructions. When the homing switch is detected, the axis is homed.

- Direct homing absolute (Mode = 0)  
The current axis position is set to the value of parameter "Position".
- Direct homing relative (Mode = 1)  
The current axis position is offset by the value of parameter "Position".

## Requirements

- The technology object "Axis" has been configured correctly.
- The axis is enabled.
- No MC\_CommandTable command may be active upon start with Mode = 0, 1 or 2.

## Override response

The override response is dependent on the selected mode:

### Mode = 0, 1

The MC\_Home command cannot be aborted by any other motion control command.

The MC\_Home command does not abort any active motion control commands. Position-related motion commands are resumed after homing according to the new homing position (value at input parameter: "Position").

### Mode = 2

The MC\_Home command can be aborted by the following motion control commands:

- MC\_Home command Mode = 2, 3

The new MC\_Home command aborts the following active motion control command.

- MC\_Home command Mode = 2

Position-related motion commands are resumed after homing according to the new homing position (value at input parameter: "Position").

### Mode = 3

The MC\_Home command can be aborted by the following motion control commands:

- MC\_Home command Mode = 3
- MC\_Halt command
- MC\_MoveAbsolute command
- MC\_MoveRelative command
- MC\_MoveVelocity command
- MC\_MoveJog command

The new MC\_Home command aborts the following active motion control commands:

- MC\_Home command Mode = 2, 3
- MC\_Halt command
- MC\_MoveAbsolute command
- MC\_MoveRelative command

9.7 References

- MC\_MoveVelocity command
- MC\_MoveJog command

Parameter

Parameter	Declaration	Data type	Default value	Description	
Axis	INPUT	TO_Axis_1	-	Axis technology object	
Execute	INPUT	BOOL	FALSE	Start of the command with a positive edge	
Position	INPUT	REAL	0.0	<ul style="list-style-type: none"> <li>• Mode = 0, 2, and 3 Absolute position of axis after completion of the homing operation</li> <li>• Mode = 1 Correction value for the current axis position</li> </ul> Limit values: $-1.0e^{12} \leq \text{Position} \leq 1.0e^{12}$	
Mode	INPUT	INT	0	Homing mode	
				0	Direct homing absolute New axis position is the position value of parameter "Position".
				1	Direct homing relative New axis position is the current axis position + position value of parameter "Position".
				2	Passive homing Homing according to the axis configuration. Following homing, the value of parameter "Position" is set as the new axis position.
3	Active homing Home position approach in accordance with the axis configuration. Following homing, the value of parameter "Position" is set as the new axis position.				
Done	OUTPUT	BOOL	FALSE	TRUE	Command completed
Busy	OUTPUT	BOOL	FALSE	TRUE	The command is being executed.
CommandAborted	OUTPUT	BOOL	FALSE	TRUE	During execution the command was aborted by another command.
Error	OUTPUT	BOOL	FALSE	TRUE	An error occurred during execution of the command. The cause of the error can be found in parameters "ErrorID" and "ErrorInfo".
ErrorID	OUTPUT	WORD	16#0000		Error ID for parameter "Error"
ErrorInfo	OUTPUT	WORD	16#0000		Error info ID for parameter "ErrorID"

**Note**

Axis homing is lost under the following conditions:

- Disabling of axis by motion control instruction "MC\_Power"
  - Changeover between automatic mode and manual control
  - Upon start of active homing. After successful completion of the homing operation, axis homing is again available.
  - After POWER OFF -> POWER ON of the CPU
  - After CPU restart (RUN-STOP -> STOP-RUN)
- 

**Homing an axis**

To home the axis, follow these steps:

1. Check the requirements indicated above.
2. Initialize the necessary input parameters with values, and start the homing operation with a rising edge at input parameter "Execute"
3. If output parameter "Done" and technology object tag <Axis name>.StatusBits.HomingDone indicate the value TRUE, homing is complete.

**See also**

List of ErrorIDs and ErrorInfos (technology objects as of V2.0) (Page 6109)

MC\_Power: Enable, disable axis (Page 2556)

MC\_Reset: Acknowledge error (Page 2561)

MC\_Halt: Halt axis (Page 2566)

MC\_MoveAbsolute: Absolute positioning of axes (Page 2569)

MC\_MoveRelative: Relative positioning of axes (Page 2572)

MC\_MoveVelocity: Move axes at preset rotational speed (Page 2576)

MC\_MoveJog: Move axes in jogging mode (Page 2580)

MC\_CommandTable: Run axis jobs as movement sequence (as of technology object "Axis" V2.0) (Page 2584)

MC\_ChangeDynamic: Changing the dynamic settings for the axis (as of technology object "Axis" V2.0) (Page 2586)

## MC\_Halt

### MC\_Halt: Halt axis

#### Description

The "MC\_Halt" motion control instruction stops all movements and brings the axis to a standstill with the configured deceleration. The standstill position is not defined.

#### Requirements

- The technology object "Axis" has been configured correctly.
- The axis is enabled.

#### Override response

The MC\_Halt command can be aborted by the following motion control jobs:

- MC\_Home command Mode = 3
- MC\_Halt command
- MC\_MoveAbsolute command
- MC\_MoveRelative command
- MC\_MoveVelocity command
- MC\_MoveJog command

The new MC\_Halt command aborts the following active motion control jobs:

- MC\_Home command Mode = 3
- MC\_Halt command
- MC\_MoveAbsolute command
- MC\_MoveRelative command
- MC\_MoveVelocity command
- MC\_MoveJog command

#### Parameter

Parameter	Declaration	Data type	Default value	Description
Axis	INPUT	TO_Axis_1	-	Axis technology object
Execute	INPUT	BOOL	FALSE	Start of the command with a positive edge
Done	OUTPUT	BOOL	FALSE	TRUE Zero velocity reached
Busy	OUTPUT	BOOL	FALSE	TRUE The command is being executed.
CommandAborted	OUTPUT	BOOL	FALSE	TRUE During execution the command was aborted by another command.

Parameter	Declaration	Data type	Default value	Description
Error	OUTPUT	BOOL	FALSE	TRUE An error occurred during execution of the command. The cause of the error can be found in parameters "ErrorID" and "ErrorInfo".
ErrorID	OUTPUT	WORD	16#0000	Error ID (Page 6109) for parameter "Error"
ErrorInfo	OUTPUT	WORD	16#0000	Error info ID (Page 6109) for parameter "ErrorID"

## See also

MC\_Halt: Function chart (Page 2568)

List of ErrorIDs and ErrorInfos (technology objects as of V2.0) (Page 6109)

MC\_Power: Enable, disable axis (Page 2556)

MC\_Reset: Acknowledge error (Page 2561)

MC\_Home: Home axes, set home position (Page 2562)

MC\_MoveAbsolute: Absolute positioning of axes (Page 2569)

MC\_MoveRelative: Relative positioning of axes (Page 2572)

MC\_MoveVelocity: Move axes at preset rotational speed (Page 2576)

MC\_MoveJog: Move axes in jogging mode (Page 2580)

MC\_CommandTable: Run axis jobs as movement sequence (as of technology object "Axis" V2.0) (Page 2584)

MC\_ChangeDynamic: Changing the dynamic settings for the axis (as of technology object "Axis" V2.0) (Page 2586)

MC\_Halt: Function chart

Function chart

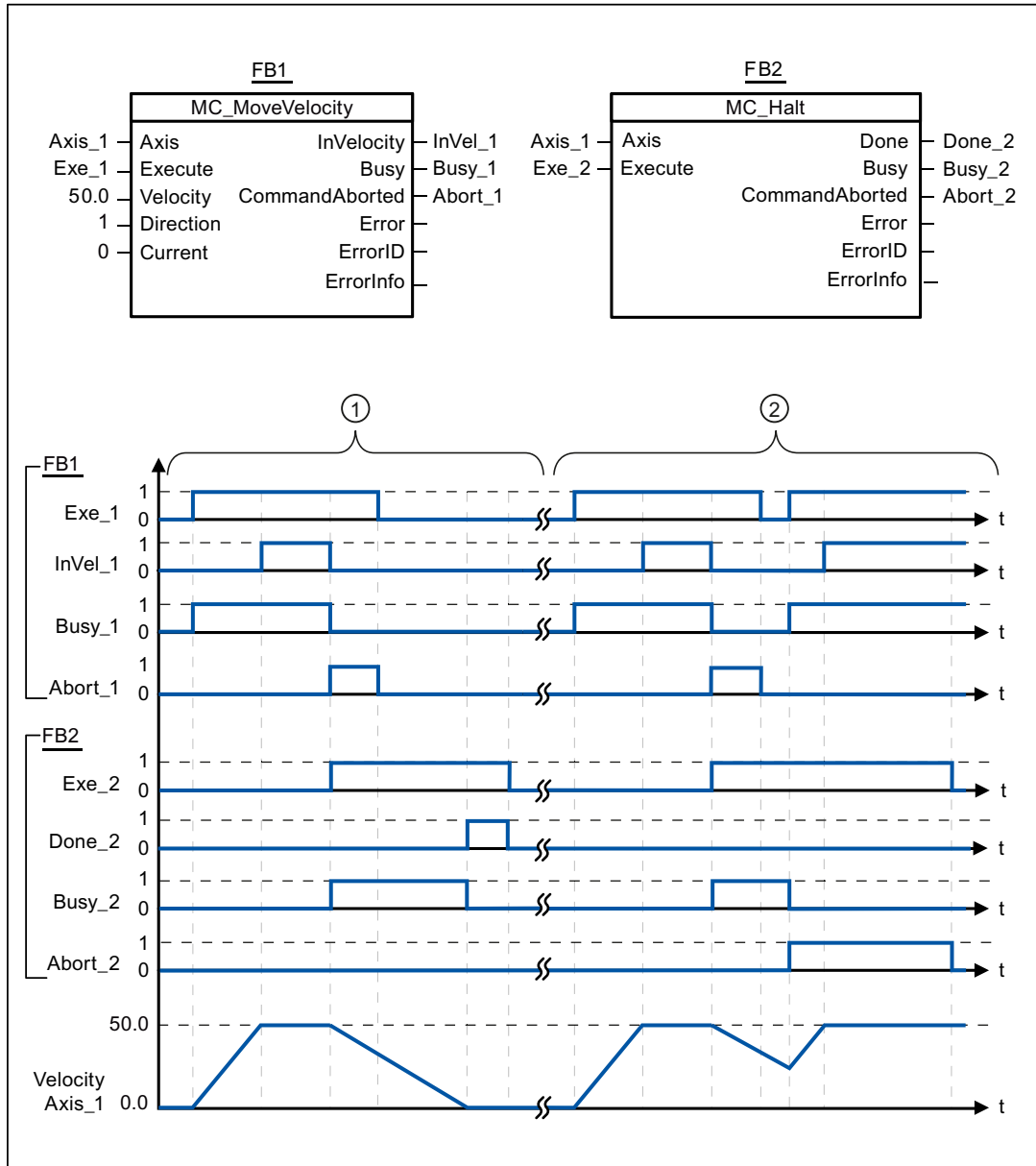

The following values were configured in the configuration window **Dynamics > General**:

- Acceleration: 10.0
- Deceleration: 5.0

①	The axis is braked by an MC_Halt command until it comes to a standstill. The axis standstill is signaled via "Done_2".
②	While an MC_Halt command is braking the axis, this command is aborted by another motion command. The abort is signaled via "Abort_2".



**See also**

MC\_Halt: Halt axis (Page 2566)

**MC\_MoveAbsolute****MC\_MoveAbsolute: Absolute positioning of axes****Description**

The "MC\_MoveAbsolute" motion control instruction starts an axis positioning motion to move it to an absolute position.

**Requirements**

- The technology object "Axis" has been configured correctly.
- The axis is enabled.
- The axis is homed.

**Override response**

The MC\_MoveAbsolute command can be aborted by the following motion control commands:

- MC\_Home command Mode = 3
- MC\_Halt command
- MC\_MoveAbsolute command
- MC\_MoveRelative command
- MC\_MoveVelocity command
- MC\_MoveJog command

The new MC\_MoveAbsolute command aborts the following active motion control commands:

- MC\_Home command Mode = 3
- MC\_Halt command
- MC\_MoveAbsolute command
- MC\_MoveRelative command
- MC\_MoveVelocity command
- MC\_MoveJog command

**Parameter**

Parameter	Declaration	Data type	Default value	Description
Axis	INPUT	TO_Axis_1	-	Axis technology object
Execute	INPUT	BOOL	FALSE	Start of the command with a positive edge
Position	INPUT	REAL	0.0	Absolute target position Limit values: $-1.0e^{12} \leq \text{Position} \leq 1.0e^{12}$
Velocity	INPUT	REAL	10.0	Velocity of axis This velocity is not always reached on account of the configured acceleration and deceleration and the target position to be approached. Limit values: Start/stop velocity $\leq$ Velocity $\leq$ maximum velocity
Done	OUTPUT	BOOL	FALSE	TRUE Absolute target position reached
Busy	OUTPUT	BOOL	FALSE	TRUE The command is being executed.
CommandAborted	OUTPUT	BOOL	FALSE	TRUE During execution the command was aborted by another command.
Error	OUTPUT	BOOL	FALSE	TRUE An error occurred during execution of the command. The cause of the error can be found in parameters "ErrorID" and "ErrorInfo".
ErrorID	OUTPUT	WORD	16#0000	Error ID (Page 6109) for parameter "Error"
ErrorInfo	OUTPUT	WORD	16#0000	Error info ID (Page 6109) for parameter "ErrorID"

**See also**

MC\_MoveAbsolute: Function chart (Page 2571)

List of ErrorIDs and ErrorInfos (technology objects as of V2.0) (Page 6109)

MC\_Power: Enable, disable axis (Page 2556)

MC\_Reset: Acknowledge error (Page 2561)

MC\_Home: Home axes, set home position (Page 2562)

MC\_Halt: Halt axis (Page 2566)

MC\_MoveRelative: Relative positioning of axes (Page 2572)

MC\_MoveVelocity: Move axes at preset rotational speed (Page 2576)

MC\_MoveJog: Move axes in jogging mode (Page 2580)

MC\_CommandTable: Run axis jobs as movement sequence (as of technology object "Axis" V2.0) (Page 2584)

MC\_ChangeDynamic: Changing the dynamic settings for the axis (as of technology object "Axis" V2.0) (Page 2586)

### MC\_MoveAbsolute: Function chart

#### Function chart

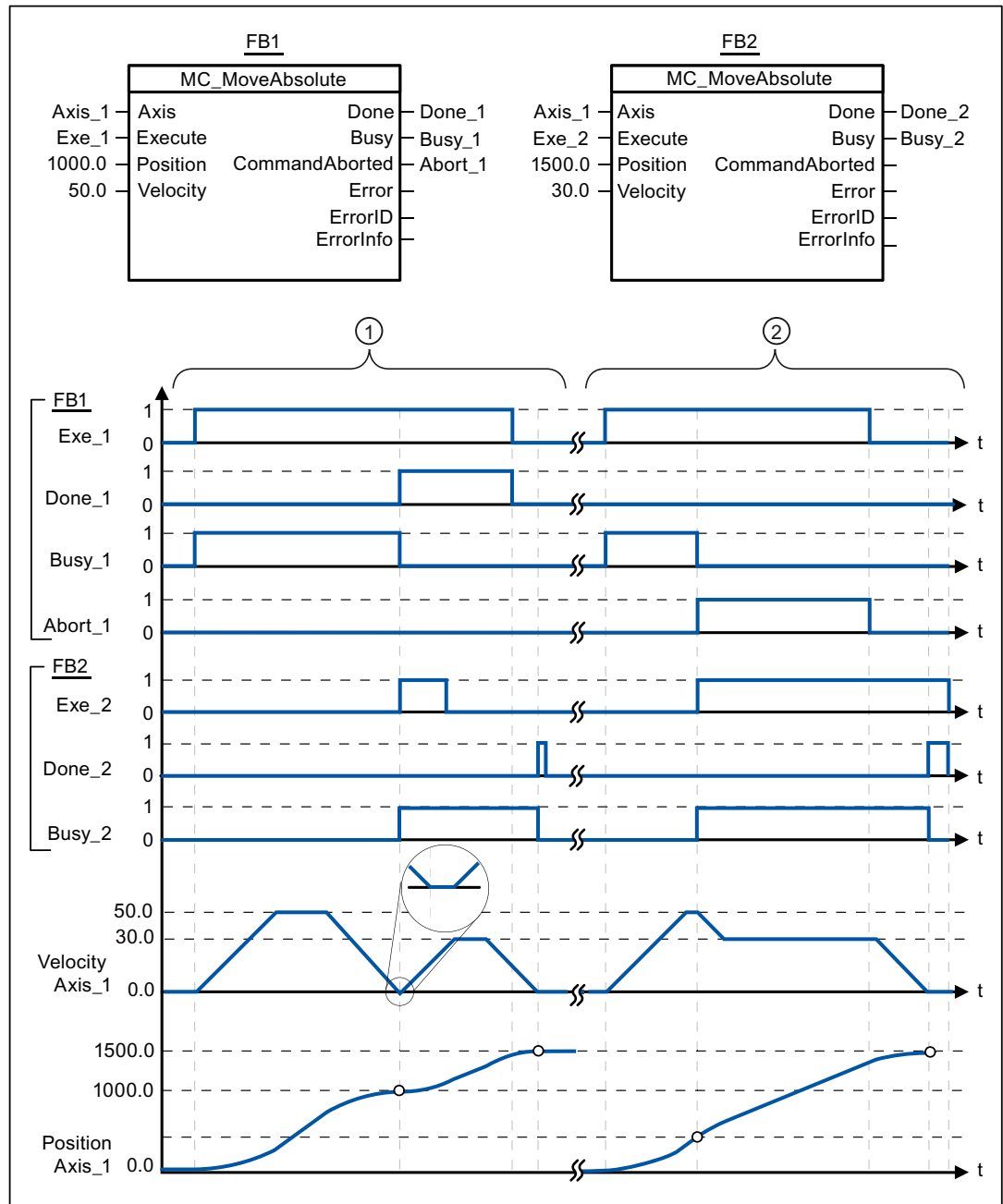

The following values were configured in the configuration window **Dynamics > General**:

- Acceleration: 10.0
- Deceleration: 10.0

①	An axis is moved to absolute position 1000.0 with an MC_MoveAbsolute command. When the axis reaches the target position, this is signaled via "Done_1". When "Done_1" = TRUE, another MC_MoveAbsolute command, with target position 1500.0, is started. Because of the response times (e.g., cycle time of user program, etc.), the axis comes to a standstill briefly (see zoomed-in detail). When the axis reaches the new target position, this is signaled via "Done_2".
②	An active MC_MoveAbsolute command is aborted by another MC_MoveAbsolute command. The abort is signaled via "Abort_1". The axis is then moved at the new velocity to the new target position 1500.0. When the new target position is reached, this is signaled via "Done_2".

**See also**

MC\_MoveAbsolute: Absolute positioning of axes (Page 2569)

**MC\_MoveRelative**

**MC\_MoveRelative: Relative positioning of axes**

**Description**

The "MC\_MoveRelative" motion control instruction starts a positioning motion relative to the start position.

**Requirements**

- The technology object "Axis" has been configured correctly.
- The axis is enabled.

**Override response**

The MC\_MoveRelative command can be aborted by the following motion control jobs:

- MC\_Home command Mode = 3
- MC\_Halt command
- MC\_MoveAbsolute command
- MC\_MoveRelative command
- MC\_MoveVelocity command
- MC\_MoveJog command

The new MC\_MoveRelative command aborts the following active motion control jobs:

- MC\_Home command Mode = 3
- MC\_Halt command
- MC\_MoveAbsolute command
- MC\_MoveRelative command

- MC\_MoveVelocity command
- MC\_MoveJog command

## Parameter

Parameter	Declaration	Data type	Default value	Description
Axis	INPUT	TO_Axis_1	-	Axis technology object
Execute	INPUT	BOOL	FALSE	Start of the command with a positive edge
Distance	INPUT	REAL	0.0	Travel distance for the positioning operation Limit values: $-1.0e^{12} \leq \text{Distance} \leq 1.0e^{12}$
Velocity	INPUT	REAL	10.0	Velocity of axis This velocity is not always reached on account of the configured acceleration and deceleration and the distance to be traveled. Limit values: $\text{Start/stop velocity} \leq \text{Velocity} \leq \text{maximum velocity}$
Done	OUTPUT	BOOL	FALSE	TRUE   Target position reached
Busy	OUTPUT	BOOL	FALSE	TRUE   The command is being executed.
CommandAborted	OUTPUT	BOOL	FALSE	TRUE   During execution the command was aborted by another command.
Error	OUTPUT	BOOL	FALSE	TRUE   An error occurred during execution of the command. The cause of the error can be found in parameters "ErrorID" and "ErrorInfo".
ErrorID	OUTPUT	WORD	16#0000	Error ID (Page 6109) for parameter "Error"
ErrorInfo	OUTPUT	WORD	16#0000	Error info ID (Page 6109) for parameter "ErrorID"

**See also**

MC\_MoveRelative: Function chart (Page 2575)

List of ErrorIDs and ErrorInfos (technology objects as of V2.0) (Page 6109)

MC\_Power: Enable, disable axis (Page 2556)

MC\_Reset: Acknowledge error (Page 2561)

MC\_Home: Home axes, set home position (Page 2562)

MC\_Halt: Halt axis (Page 2566)

MC\_MoveAbsolute: Absolute positioning of axes (Page 2569)

MC\_MoveVelocity: Move axes at preset rotational speed (Page 2576)

MC\_MoveJog: Move axes in jogging mode (Page 2580)

MC\_CommandTable: Run axis jobs as movement sequence (as of technology object "Axis" V2.0) (Page 2584)

MC\_ChangeDynamic: Changing the dynamic settings for the axis (as of technology object "Axis" V2.0) (Page 2586)

### MC\_MoveRelative: Function chart

#### Function chart

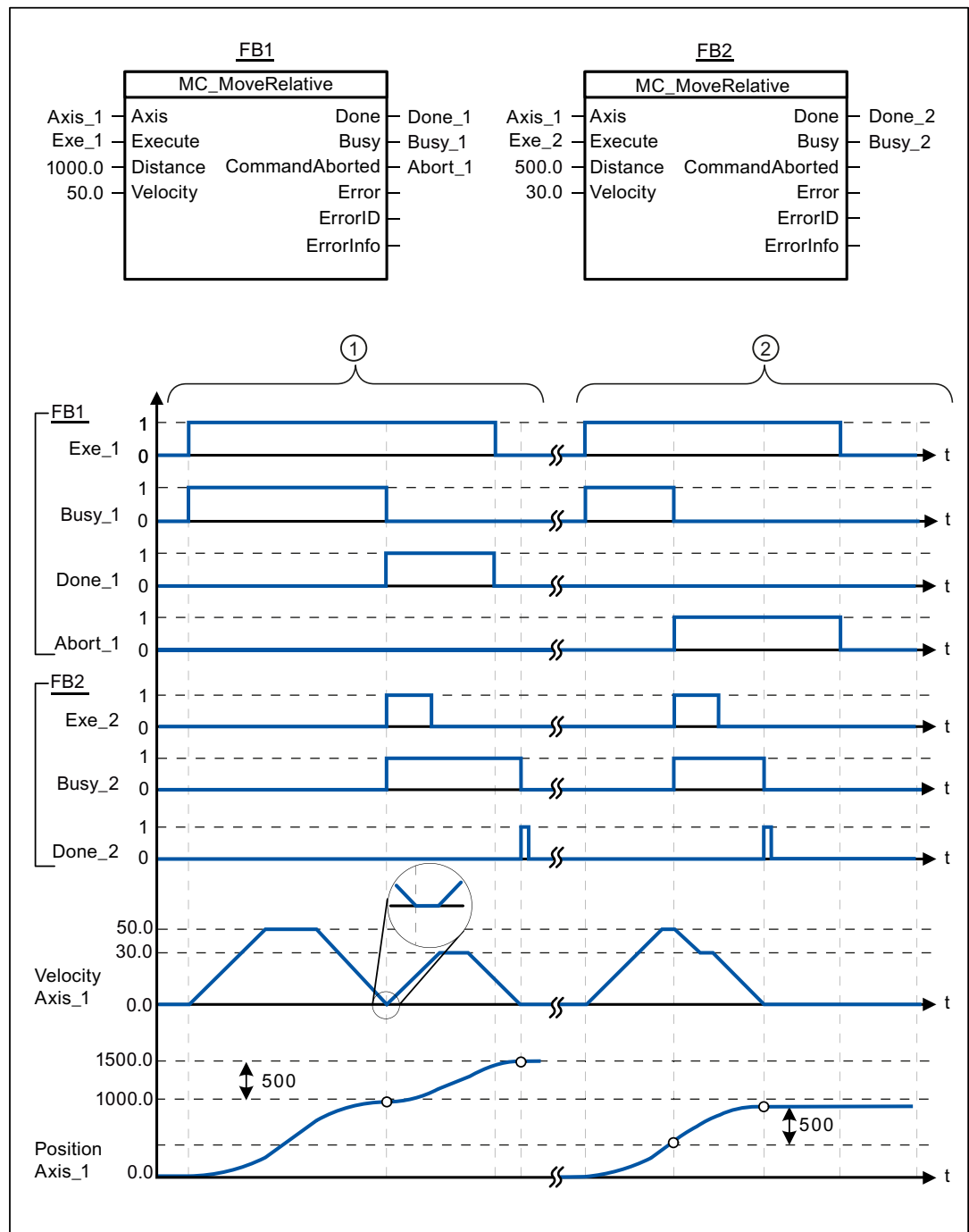

The following values were configured in the configuration window **Dynamics > General**:

- Acceleration: 10.0
- Deceleration: 10.0

①	The axis is moved by an MC_MoveRelative command by the distance ("Distance") 1000.0. When the axis reaches the target position, this is signaled via "Done_1". When "Done_1" = TRUE, another MC_MoveRelative command, with travel distance 500.0, is started. Because of the response times (e.g., cycle time of user program, etc.), the axis comes to a standstill briefly (see zoomed-in detail). When the axis reaches the new target position, this is signaled via "Done_2".
②	An active MC_MoveRelative command is aborted by another MC_MoveRelative command. The abort is signaled via "Abort_1". The axis is then moved at the new velocity by the new distance ("Distance") 500.0. When the new target position is reached, this is signaled via "Done_2".

**See also**

MC\_MoveRelative: Relative positioning of axes (Page 2572)

**MC\_MoveVelocity**

**MC\_MoveVelocity: Move axes at preset rotational speed**

**Description**

Motion control instruction "MC\_MoveVelocity" moves the axis constantly at the specified velocity.

**Requirements**

- The technology object "Axis" has been configured correctly.
- The axis is enabled.

**Override response**

MC\_MoveVelocity can be aborted by the following motion control commands:

- MC\_Home command Mode = 3
- MC\_Halt command
- MC\_MoveAbsolute command
- MC\_MoveRelative command
- MC\_MoveVelocity command
- MC\_MoveJog command

The new MC\_MoveVelocity command aborts the following active motion control commands:

- MC\_Home command Mode = 3
- MC\_Halt command
- MC\_MoveAbsolute command



- MC\_MoveRelative command
- MC\_MoveVelocity command
- MC\_MoveJog command

## Parameter

Parameter	Declaration	Data type	Default value	Description	
Axis	INPUT	TO_Axis_1	-	Axis technology object	
Execute	INPUT	BOOL	FALSE	Start of the command with a positive edge	
Velocity	INPUT	REAL	10.0	Velocity specification for axis motion Limit values: Start/stop velocity ≤  Velocity  ≤ maximum velocity (Velocity = 0.0 is permitted)	
Direction	INPUT	INT	0	Direction specification	
				0	Direction of rotation corresponds to the sign of the value in parameter "Velocity"
				1	Positive direction of rotation (The sign of the value in parameter "Velocity" is ignored)
				2	Negative direction of rotation (The sign of the value in parameter "Velocity" is ignored)
Current	INPUT	BOOL	FALSE	Maintain current velocity	
				FALSE	"Maintain current velocity" is deactivated. The values of parameters "Velocity" and "Direction" are used.
				TRUE	"Maintain current velocity" is activated. The values in parameters "Velocity" and "Direction" are not taken into account. When the axis resumes motion at the current velocity, the "InVelocity" parameter returns the value TRUE.
InVelocity	OUTPUT	BOOL	FALSE	TRUE <ul style="list-style-type: none"> <li>• "Current" = FALSE: The velocity specified in parameter "Velocity" was reached.</li> <li>• "Current" = TRUE: The axis travels at the current velocity at the start time.</li> </ul>	
Busy	OUTPUT	BOOL	FALSE	TRUE	The command is being executed.
CommandAborted	OUTPUT	BOOL	FALSE	TRUE	During execution the command was aborted by another command.
Error	OUTPUT	BOOL	FALSE	TRUE	An error occurred during execution of the command. The cause of the error can be found in parameters "ErrorID" and "ErrorInfo".
ErrorID	OUTPUT	WORD	16#0000		Error ID (Page 6109) for parameter "Error"
ErrorInfo	OUTPUT	WORD	16#0000		Error info ID (Page 6109) for parameter "ErrorID"

### Behavior with zero set velocity (Velocity = 0.0)

An MC\_MoveVelocity command with "Velocity" = 0.0 (such as an MC\_Halt command) aborts active motion commands and stops the axis with the configured deceleration.

When the axis comes to a standstill, output parameter "InVelocity" indicates TRUE for at least one program cycle.

"Busy" indicates the value TRUE during the deceleration process and changes to FALSE together with "InVelocity". If parameter "Execute" = TRUE is set, "InVelocity" and "Busy" are latched.

When the "MC\_MoveVelocity" command is started, status bit "SpeedCommand" is set in the technology object. Status bit "ConstantVelocity" is set upon axis standstill. Both bits are adapted to the new situation when a new motion command is started.

### See also

MC\_MoveVelocity: Function chart (Page 2579)

List of ErrorIDs and ErrorInfos (technology objects as of V2.0) (Page 6109)

MC\_Power: Enable, disable axis (Page 2556)

MC\_Reset: Acknowledge error (Page 2561)

MC\_Home: Home axes, set home position (Page 2562)

MC\_Halt: Halt axis (Page 2566)

MC\_MoveAbsolute: Absolute positioning of axes (Page 2569)

MC\_MoveRelative: Relative positioning of axes (Page 2572)

MC\_MoveJog: Move axes in jogging mode (Page 2580)

MC\_CommandTable: Run axis jobs as movement sequence (as of technology object "Axis" V2.0) (Page 2584)

MC\_ChangeDynamic: Changing the dynamic settings for the axis (as of technology object "Axis" V2.0) (Page 2586)

## MC\_MoveVelocity: Function chart

### Function chart

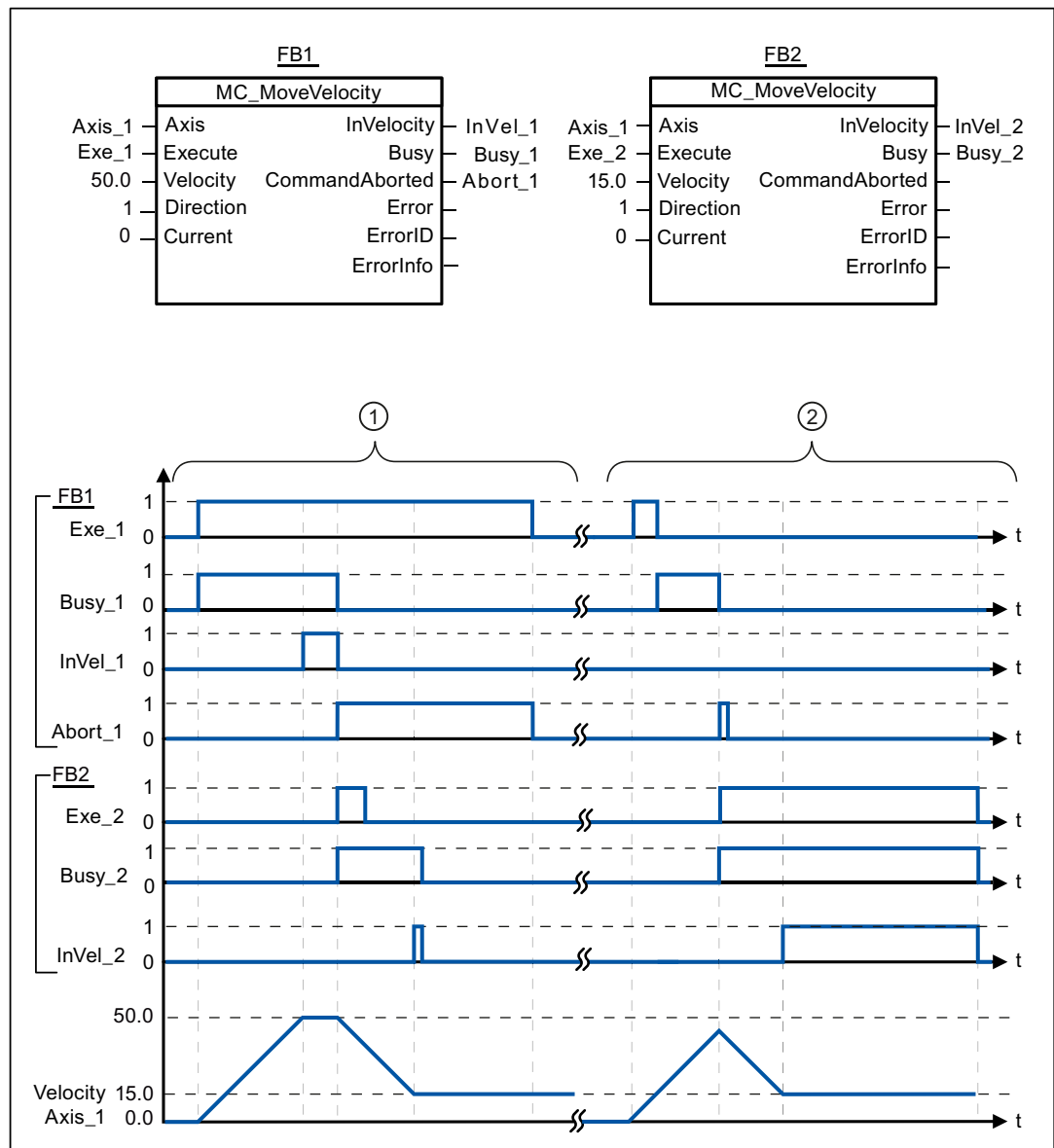

The following values were configured in the configuration window **Dynamics > General**:

- Acceleration: 10.0
- Deceleration: 10.0

①	An active MC_MoveVelocity command signals via "InVel_1" that its target velocity has been reached. It is then aborted by another MC_MoveVelocity command. The abort is signaled via "Abort_1". When the new target velocity 15.0 is reached, this is signaled via "InVel_2". The axis then continues moving at the new constant velocity.
②	An active MC_MoveVelocity command is aborted by another MC_MoveVelocity command prior to reaching its target velocity. The abort is signaled via "Abort_1". When the new target velocity 15.0 is reached, this is signaled via "InVel_2". The axis then continues moving at the new constant velocity.

**See also**

MC\_MoveVelocity: Move axes at preset rotational speed (Page 2576)

**MC\_MoveJog**

**MC\_MoveJog: Move axes in jogging mode**

**Description**

Motion control instruction "MC\_MoveJog" moves the axis constantly at the specified velocity in jog mode. You use this motion control instruction, for example, for testing and commissioning purposes.

**Requirements**

- The technology object "Axis" has been configured correctly.
- The axis is enabled.

**Override response**

The MC\_MoveJog command can be aborted by the following motion control commands:

- MC\_Home command Mode = 3
- MC\_Halt command
- MC\_MoveAbsolute command
- MC\_MoveRelative command
- MC\_MoveVelocity command
- MC\_MoveJog command

The new MC\_MoveJog command aborts the following active motion control commands:

- MC\_Home command Mode = 3
- MC\_Halt command
- MC\_MoveAbsolute command
- MC\_MoveRelative command

- MC\_MoveVelocity command
- MC\_MoveJog command

## Parameter

Parameter	Declaration	Data type	Default value	Description
Axis	INPUT	TO_Axis_1	-	Axis technology object
JogForward	INPUT	BOOL	FALSE	As long as the parameter is TRUE, the axis moves in the positive direction at the velocity specified in parameter "Velocity".
JogBackward	INPUT	BOOL	FALSE	As long as the parameter is TRUE, the axis moves in the negative direction at the velocity specified in parameter "Velocity".
If both parameters are simultaneously TRUE, the axis stops with the configured deceleration. An error is indicated in parameters "Error", "ErrorID", and "ErrorInfo".				
Velocity	INPUT	REAL	10.0	Preset velocity for jog mode
				Limit values, instruction version V1.0: Start/stop velocity ≤  Velocity  ≤ maximum velocity
				Limits, instruction version V2.0: Start/stop velocity ≤ velocity ≤ maximum velocity
InVelocity	OUTPUT	BOOL	FALSE	TRUE The velocity specified in parameter "Velocity" was reached.
Busy	OUTPUT	BOOL	FALSE	TRUE The command is being executed.
CommandAborted	OUTPUT	BOOL	FALSE	TRUE During execution the command was aborted by another command.
Error	OUTPUT	BOOL	FALSE	TRUE An error occurred during execution of the command. The cause of the error can be found in parameters "ErrorID" and "ErrorInfo".
ErrorID	OUTPUT	WORD	16#0000	Error ID (Page 6109) for parameter "Error"
ErrorInfo	OUTPUT	WORD	16#0000	Error info ID (Page 6109) for parameter "ErrorID"

**See also**

MC\_MoveJog: Function chart (Page 2583)

List of ErrorIDs and ErrorInfos (technology objects as of V2.0) (Page 6109)

MC\_Power: Enable, disable axis (Page 2556)

MC\_Reset: Acknowledge error (Page 2561)

MC\_Home: Home axes, set home position (Page 2562)

MC\_Halt: Halt axis (Page 2566)

MC\_MoveAbsolute: Absolute positioning of axes (Page 2569)

MC\_MoveRelative: Relative positioning of axes (Page 2572)

MC\_MoveVelocity: Move axes at preset rotational speed (Page 2576)

MC\_CommandTable: Run axis jobs as movement sequence (as of technology object "Axis" V2.0) (Page 2584)

MC\_ChangeDynamic: Changing the dynamic settings for the axis (as of technology object "Axis" V2.0) (Page 2586)

## MC\_MoveJog: Function chart

### Function chart

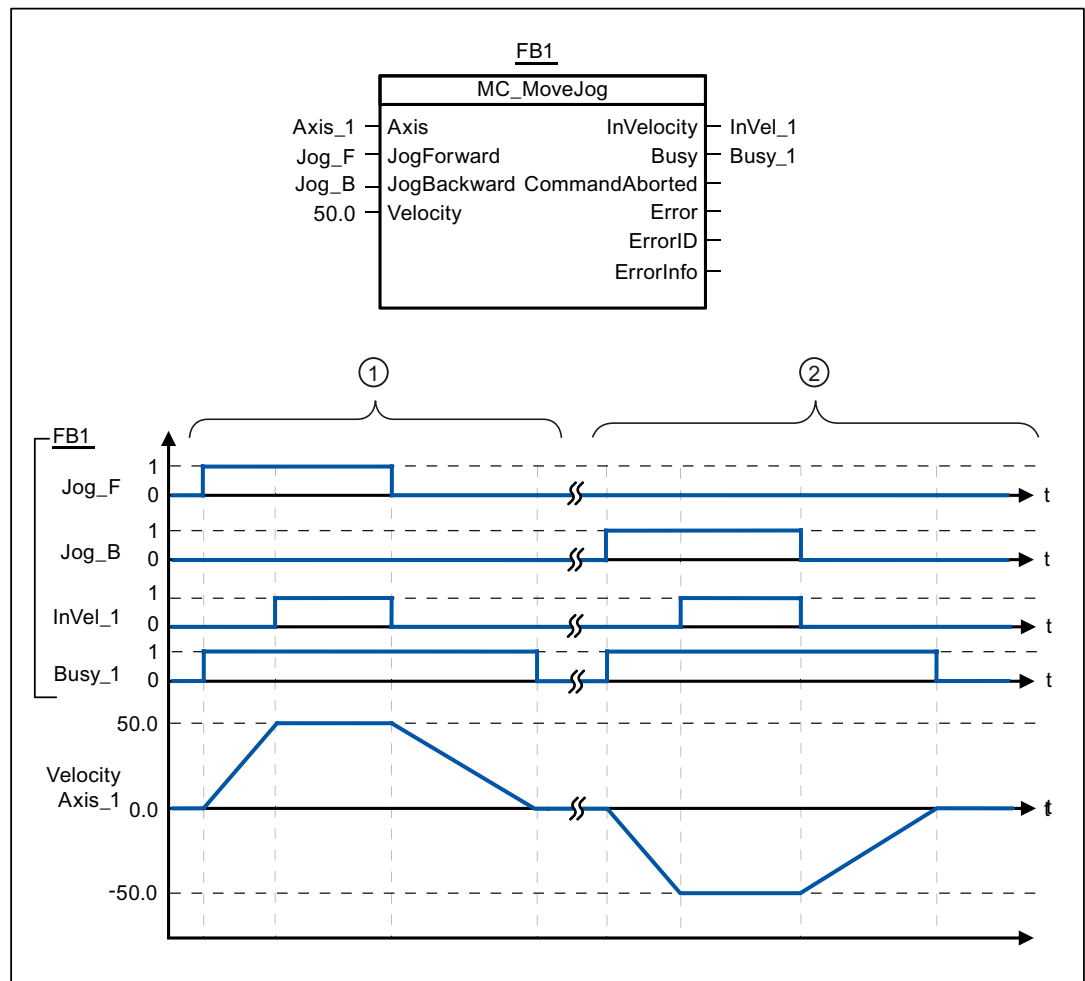

The following values were configured in the configuration window **Dynamics > General**:

- Acceleration: 10.0
- Deceleration: 5.0

①	The axis is moved in the positive direction in jog mode via "Jog_F". When the target velocity 50.0 is reached, this is signaled via "InVelo_1". The axis brakes to a standstill again after Jog_F is reset.
②	The axis is moved in the negative direction in jog mode via "Jog_B". When the target velocity 50.0 is reached, this is signaled via "InVelo_1". The axis brakes to a standstill again after Jog_B is reset.

### See also

MC\_MoveJog: Move axes in jogging mode (Page 2580)

## MC\_CommandTable

### MC\_CommandTable: Run axis jobs as movement sequence (as of technology object "Axis" V2.0)

#### Description

The Motion Control instruction "MC\_CommandTable" combines multiple individual axis control commands in one movement sequence.

#### Requirements

- The technology object "Axis" has been added to Version V2.0 and correctly configured.
- The technology object "Command table" has been added and correctly configured.
- The axis is enabled.

#### Override response

The MC\_CommandTable command can be aborted by the following motion control commands:

- MC\_Home command (Mode = 3)
- MC\_Halt command
- MC\_MoveAbsolute command
- MC\_MoveRelative command
- MC\_MoveVelocity command
- MC\_MoveJog command
- MC\_CommandTable command

The new MC\_CommandTable command aborts the following active motion control commands:

- MC\_Home command (Mode = 3)
- MC\_Halt command
- MC\_MoveAbsolute command
- MC\_MoveRelative command
- MC\_MoveVelocity command
- MC\_MoveJog command
- MC\_CommandTable command

The active motion control command is cancelled by the start of the first "Positioning Relative", "Positioning Absolute", "Velocity set point" or "Halt" command.



## Parameter

Parameter	Declaration	Data type	Default value	Description
Axis	INPUT	TO_Axis_1	-	Axis technology object
CommandTable	INPUT	TO_CommandTable_1	-	Command table technology object
Execute	INPUT	BOOL	FALSE	Command table start with positive edge
StartStep	INPUT	INT	1	Defines the step at which the execution of the command table should begin Limit values: $1 \leq \text{StartStep} \leq \text{EndStep}$
EndStep	INPUT	INT	32	Defines the step up to which the execution of command table should take place Limit values: $\text{StartStep} \leq \text{EndStep} \leq 32$
Done	OUTPUT	BOOL	FALSE	TRUE Command table has been successfully executed
Busy	OUTPUT	BOOL	FALSE	TRUE The command table is being executed.
CommandAborted	OUTPUT	BOOL	FALSE	TRUE The command table was cancelled by another command.
Error	OUTPUT	BOOL	FALSE	TRUE An error occurred during execution of the command table. The cause of the error can be found in parameters "ErrorID" and "ErrorInfo".
ErrorID	OUTPUT	WORD	16#0000	Error ID (Page 6109) for parameter "Error"
ErrorInfo	OUTPUT	WORD	16#0000	Error info ID (Page 6109) for parameter "ErrorID"
CurrentStep	OUTPUT	INT	0	Step in command table currently being executed
StepCode	OUTPUT	WORD	16#0000	User-defined numerical value / bit pattern of the step currently being executed

## See also

List of ErrorIDs and ErrorInfos (technology objects as of V2.0) (Page 6109)

Overview of the Motion Control statements (Page 6072)

MC\_Power: Enable, disable axis (Page 2556)

MC\_Reset: Acknowledge error (Page 2561)

MC\_Home: Home axes, set home position (Page 2562)

MC\_Halt: Halt axis (Page 2566)

MC\_MoveAbsolute: Absolute positioning of axes (Page 2569)

MC\_MoveRelative: Relative positioning of axes (Page 2572)

MC\_MoveVelocity: Move axes at preset rotational speed (Page 2576)

MC\_MoveJog: Move axes in jogging mode (Page 2580)

MC\_ChangeDynamic: Changing the dynamic settings for the axis (as of technology object "Axis" V2.0) (Page 2586)

## MC\_ChangeDynamic

### MC\_ChangeDynamic: Changing the dynamic settings for the axis (as of technology object "Axis" V2.0)

#### Description

Motion Control instruction "MC\_ChangeDynamic" allows you to change the following settings of the axis:

- Change the ramp-up time (acceleration) value
- Change the ramp-down time (deceleration) value
- Change the emergency stop ramp-down time (emergency stop deceleration) value
- Change the smoothing time (jerk) value

The effectiveness of the change is shown in the description of the tag (Page 6118).

#### Requirements

- The technology object "Axis" has been added to Version V2.0.
- The technology object "Axis" has been configured correctly.

#### Override response

A MC\_ChangeDynamic command cannot be aborted by any other Motion Control command.

A new MC\_ChangeDynamic command does not abort any active Motion Control commands.

#### Parameter

Parameter	Declaration	Data type	Default value	Description
Axis	INPUT	TO_Axis_1	-	Axis technology object
Execute	INPUT	BOOL	FALSE	Start of the command with a positive edge
ChangeRampUp	INPUT	BOOL	FALSE	TRUE   Change ramp-up time in line with input parameter "RampUpTime"
RampUpTime	INPUT	REAL	5.00	Time (in seconds) to accelerate axis from standstill to configured maximum velocity without jerk limit. The change will influence the tag <Axis name>. Config.DynamicDefaults.Acceleration. The effectiveness of the change is shown in the description of this tag.
ChangeRampDown	INPUT	BOOL	FALSE	TRUE   Change ramp-down time in line with input parameter "RampDownTime"
RampDownTime	INPUT	REAL	5.00	Time (in seconds) to decelerate axis from the configured maximum velocity to standstill without jerk limiter. The change will influence the tag <Axis name>. Config.DynamicDefaults.Deceleration . The effectiveness of the change is shown in the description of this tag.

Parameter	Declaration	Data type	Default value	Description
ChangeEmergency	INPUT	BOOL	FALSE	TRUE   Change emergency stop ramp-down time in line with input parameter "EmergencyRampTime"
EmergencyRampTime	INPUT	REAL	2.00	Time (in seconds) to decelerate the axis from configured maximum velocity to standstill without jerk limiter in emergency stop mode. The change will influence the tag <Axis name>. Config.DynamicDefaults.EmergencyDeceleration . The effectiveness of the change is shown in the description of this tag.
ChangeJerkTime	INPUT	BOOL	FALSE	TRUE   Change smoothing time according to the input parameter "JerkTime"
JerkTime	INPUT	REAL	0.25	Smoothing time (in seconds) used for the axis acceleration and deceleration ramps The change will influence the tag <Axis name>. Config.DynamicDefaults.Jerk . The effectiveness of the change is shown in the description of this tag.
Done	OUTPUT	BOOL	FALSE	TRUE   The changed values have been written to the technology data block. The description of the tags will show when the change becomes effective.
Error	OUTPUT	BOOL	FALSE	TRUE   An error occurred during execution of the command. The cause of the error can be found in parameters "ErrorID" and "ErrorInfo".
ErrorID	OUTPUT	WORD	16#0000	Error ID (Page 6109) for parameter "Error"
ErrorInfo	OUTPUT	WORD	16#0000	Error info ID (Page 6109) for parameter "ErrorID"

---

### Note

At the input parameters "RampUpTime", "RampDownTime", "EmergencyRampTime" and "JerkTime", values can be entered which exceed the admissible limits of the resulting parameters: "Acceleration", "Deceleration", "Emergency stop deceleration" and "Jerk".

Please note the equations and limit values in "Axis technology object" -> "Configuring the technology object" -> "Dynamics" and ensure that the values you input are within the valid range.

---

**See also**

- List of ErrorIDs and ErrorInfos (technology objects as of V2.0) (Page 6109)
- Overview of the Motion Control statements (Page 6072)
- Changing the configuration of dynamics in the user program (Page 6042)
- Changing the homing configuration in the user program (Page 6049)
- MC\_Power: Enable, disable axis (Page 2556)
- MC\_Reset: Acknowledge error (Page 2561)
- MC\_Home: Home axes, set home position (Page 2562)
- MC\_Halt: Halt axis (Page 2566)
- MC\_MoveAbsolute: Absolute positioning of axes (Page 2569)
- MC\_MoveRelative: Relative positioning of axes (Page 2572)
- MC\_MoveVelocity: Move axes at preset rotational speed (Page 2576)
- MC\_MoveJog: Move axes in jogging mode (Page 2580)
- MC\_CommandTable: Run axis jobs as movement sequence (as of technology object "Axis" V2.0) (Page 2584)
- Tag of the Axis technology object (Page 6118)

**9.7.4.2 High-speed counters**

**CTRL\_HSC: Control high-speed counters**

**Parameter**

Parameter	Data type	Memory area	Description
EN	BOOL	I, Q, M, D, L	Enable input
ENO	BOOL	I, Q, M, D, L	Enable output
HSC	HW_HSC	I, Q, M or constant	Hardware address of the high-speed counter (HW-ID)
DIR	BOOL	I, Q, M, D, L or constant	Enables the new count direction (see NEW_DIR)
CV	BOOL	I, Q, M, D, L or constant	Enables the new count value (see NEW_CV)
RV	BOOL	I, Q, M, D, L or constant	Enables the new reference value (see NEW_RV)
PERIOD	BOOL	I, Q, M, D, L or constant	Enables the new period of a frequency measurement (see NEW_PERIOD)

Parameter	Data type	Memory area	Description
NEW_DIR	INT	I, Q, M, D, L or constant	Count direction loaded when DIR = TRUE.
NEW_CV	DINT	I, Q, M, D, L or constant	Count value loaded when CV = TRUE.
NEW_RV	DINT	I, Q, M, D, L or constant	Reference value loaded when RV = TRUE.
NEW_PERIOD	INT	I, Q, M, D, L or constant	Period of the frequency measurement loaded when PERIOD = TRUE.
BUSY	BOOL	I, Q, M, D, L	Processing status
STATUS	WORD	I, Q, M, D, L	Status of the operation

## Description

With the "Control high-speed counters" instruction, you can make parameter settings and control the high-speed counters supported by the CPU by loading new values into the counter. Execution of the instruction requires that the high-speed counter to be controlled is enabled. You cannot execute multiple "Control high-speed counters" instructions simultaneously in the program for a given high-speed counter.

You can load the following parameter values into a high-speed counter using the "Control high-speed counters" instruction:

- **Count direction (NEW\_DIR):** The count direction defines whether a high-speed counter counts up or down. The count direction is defined by the following values at the NEW\_DIR input: 1 = up, -1 = down.  
A change to the count direction with the "Control high-speed counters" instruction is only possible when direction control is set in the parameters by the program. The count direction specified at the NEW\_DIR input is loaded into a high-speed counter when the bit at the DIR input is set.
- **Count value (NEW\_CV):** The count value is the initial value at which a high-speed counter starts counting. The count value can be in the range -2147483648 to 2147483647. The count value specified at the NEW\_CV input is loaded into a high-speed counter when the bit at the CV input is set.
- **Reference value (NEW\_RV):** You can compare the reference value with the current counter value to trigger an alarm. Similar to the counter value, the reference value can be in the range -2147483648 to 2147483647. The reference value specified at the NEW\_RV input is loaded into a high-speed counter when the bit at the RV input is set.
- **Period of the frequency measurement (NEW\_PERIOD):** The period of the frequency measurement is specified by the following values at the NEW\_PERIOD input: 10 = 0.01s, 100 = 0.1s, 1000 = 1s.  
The time period can be updated if the "Measure frequency" function for the specified high-speed counter is configured. The time period specified at the NEW\_PERIOD input is loaded into a high-speed counter when the bit at the PERIOD input is set.

The "Control high-speed counters" instruction is only executed if the signal state at the EN input is "1". As long as the operation is executing, the bit at the BUSY output is set. Once the operation has executed completely, the bit at the BUSY output is reset.

9.7 References

The ENO enable output is set only when the EN enable input has signal state "1" and no errors occur during execution of the operation.

When inserting the "Control high-speed counters" instruction, an instance data block is created in which the operation data is saved.

**Parameter STATUS**

At the STATUS output, you can query whether errors occurred during execution of the "Control high-speed counters" instruction. The following table shows the meaning of the values output at the STATUS output:

Error code (hexadecimal)	Description
0	No error
80A1	Hardware identifier of the high-speed counter invalid
80B1	Count direction (NEW_DIR) invalid
80B2	Count value (NEW_CV) invalid
80B3	Reference value (NEW_RV) invalid
80B4	Period of the frequency measurement (NEW_PERIOD) invalid
80C0	Multiple access to the high-speed counter
80D0	The high-speed counter (HSC) is not enabled in the CPU hardware configuration.

### 9.7.4.3 PID Control

#### PID\_Compact

#### New features of PID\_Compact

##### PID\_Compact V2.1

- **Use with S7-1200**  
As of PID\_Compact V2.1, the instruction with V2 functionality can also be used on S7-1200 with firmware version 4.0 or higher.

##### PID\_Compact V2.0

- **Reaction to error**  
The reaction to error has been completely overhauled. PID\_Compact now reacts in a more fault-tolerant manner in the default setting. This reaction is set when copying PID\_Compact V1.X from an S7-1200 CPU to an S7-1500 CPU.

NOTICE
<p><b>Your system may be damaged.</b></p> <p>If you use the default setting, PID_Compact remains in automatic mode when the process value limits are exceeded. This may damage your system.</p> <p>It is essential to configure how your controlled system reacts in the event of an error to protect your system from damage.</p>

The Error parameter indicates if an error is pending. When the error is no longer pending, Error = FALSE. The ErrorBits parameter shows which errors have occurred. Use ErrorAck to acknowledge the errors and warnings without restarting the controller or clearing the integral action. Switching operating modes no longer clears errors that are no longer pending.

You can configure the reaction to error with SetSubstituteOutput and ActivateRecoverMode.

- **Substitute output value**  
You can configure a substitute output value that is to be output if an error occurs.
- **Switching the operating mode**  
You specify the operating mode at the Mode in/out parameter and use a rising edge at ModeActivate to start the operating mode. The sRet.i\_Mode tag has been omitted.
- **Multi-instance capability**  
You can call up PID\_Compact as multi-instance DB. No technology object is created in this case and no parameter assignment interface or commissioning interface is available. You must assign parameters for PID\_Compact directly in the multi-instance DB and commission it via a watch table.
- **Startup characteristics**  
The operating mode specified at the Mode parameter is also started on a falling edge at Reset and during a CPU cold restart, if RunModeByStartup = TRUE.

- **ENO characteristics**  
ENO is set depending on the operating mode.  
If State = 0, then ENO = FALSE.  
If State ≠ 0, then ENO = TRUE.
- **Setpoint value specification during tuning**  
You configure the permitted fluctuation of the setpoint during tuning at the CancelTuningLevel tag.
- **Value range for output value limits**  
The value 0.0 no longer has to fall within the output value limits.
- **Pre-assigning the integral action**  
Using the tags IntegralResetMode and OverwriteInitialOutputValue, you can determine the pre-assignment of the integral action when switching from "Inactive" operating mode to "Automatic mode".
- **Switching a disturbance variable on**  
You can switch a disturbance variable on at the Disturbance parameter.
- **Default value of PID parameters**  
The following default settings have been changed:
  - Proportional action weighting (PWeighting) from 0.0 to 1.0
  - Derivative action weighting (DWeighting) from 0.0 to 1.0
  - Coefficient for derivative delay (TdFiltRatio) from 0.0 to 0.2
- **Renaming tags**  
The static tags have been given new names that are compatible with PID\_3Step.

## PID\_Compact V1.2

- **Manual mode on CPU startup**  
If ManualEnable = TRUE when the CPU starts, PID\_Compact starts in manual mode. A rising edge at ManualEnable is not necessary.
- **Pretuning**  
If the CPU is switched off during pretuning, pretuning starts again when the CPU is switched back on.

## PID\_Compact V1.1

- **Manual mode on CPU startup**  
When the CPU starts up, PID\_Compact only switches to manual mode with a rising edge at ManualEnable. Without rising edge, PID\_Compact starts in the last operating mode in which ManualEnable was FALSE.
- **Reaction to reset**  
A rising edge at Reset resets the errors and warnings and clears the integral action. A falling edge at Reset triggers a switchover to the most recently active operating mode.
- **Pre-assignment of process value high limit**  
The pre-assigned value of r\_Pv\_HIm has been changed to 120.0.



- **Monitoring the sampling time**
  - An error is no longer output when the current sampling time is  $\geq 1.5 \times$  current mean value or when the current sampling time is  $\leq 0.5 \times$  current mean value. The sampling time may deviate much more in automatic mode.
  - PID\_Compact is compatible with FW, V2.0 or higher.
- **Access to tags**  
The following tags can now be used in the user program.
  - i\_Event\_SUT
  - i\_Event\_TIR
  - r\_Ctrl\_loutv
- **Troubleshooting**  
PID\_Compact now outputs the correct pulses when the shortest ON time is not equal to the shortest OFF time.

### Compatibility with CPU and FW

The following table shows which version of PID\_Compact can be used on which CPU.

CPU	FW	PID_Compact
S7-1200	V4.x	V2.1 V1.2
S7-1200	V3.X	V1.2 V1.1
S7-1200	V2.X	V1.2 V1.1
S7-1200	V1.X	V1.0
S7-1500	V1.1	V2.1 V2.0
S7-1500	V1.0	V2.0

### PID\_Compact V2

#### Description of PID\_Compact V2

##### Description

The PID\_Compact instruction provides a PID controller with integrated tuning for actuators with proportional action.

The following operating modes are possible:

- Inactive
- Pretuning

9.7 References

- Fine tuning
- Automatic mode
- Manual mode
- Substitute output value with error monitoring

For a more detailed description of the operating modes, see the State parameter.

**PID algorithm**

PID\_Compact is a PIDT1 controller with anti-windup and weighting of the proportional and derivative actions. The PID algorithm operates according to the following equation:

$$y = K_p \left[ (b \cdot w - x) + \frac{1}{T_i \cdot s} (w - x) + \frac{T_D \cdot s}{a \cdot T_D \cdot s + 1} (c \cdot w - x) \right]$$

Symbol	Description
y	Output value of the PID algorithm
K <sub>p</sub>	Proportional gain
s	Laplace operator
b	Proportional action weighting
w	Setpoint
x	Process value
T <sub>i</sub>	Integral action time
T <sub>D</sub>	Derivative action time
a	Derivative delay coefficient (derivative delay T1 = a × T <sub>D</sub> )
c	Derivative action weighting

**Block diagram of PID\_Compact**

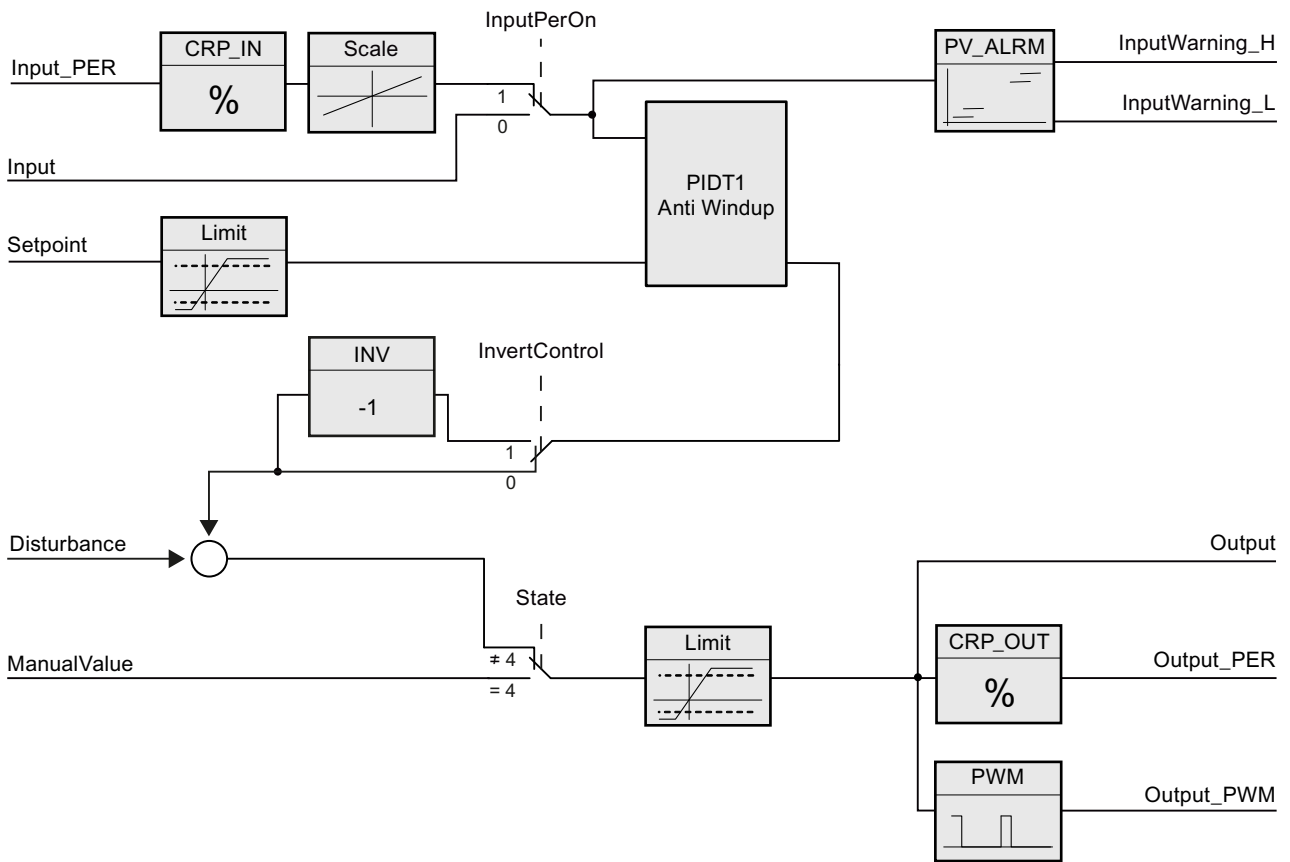

**Block diagram of PIDT1 with anti-windup**

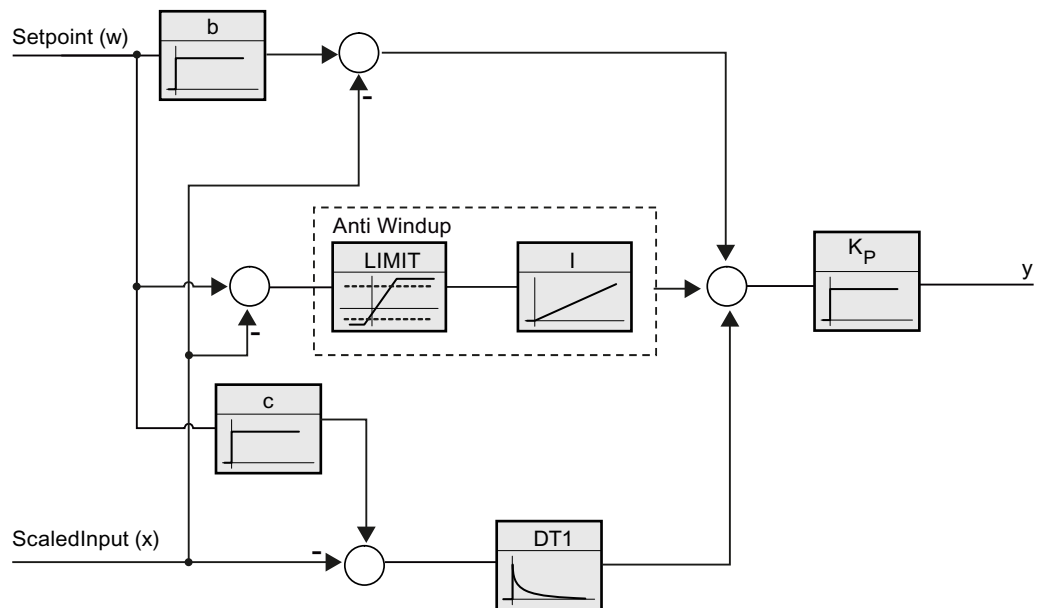

**Call**

PID\_Compact is called in the constant time scale of a cycle interrupt OB.

If you call PID\_Compact as a multi-instance DB, no technology object is created. No parameter assignment interface or commissioning interface is available. You must assign parameters for PID\_Compact directly in the multi-instance DB and commission it via a watch table.

**Download to device**

The actual values of retentive variables are only updated when you download PID\_Compact completely.

Downloading technology objects to device (Page 5937)

**Startup**

When the CPU starts up, PID\_Compact starts in the operating mode that is saved in the Mode in/out parameter. To switch to "Inactive" operating mode during startup, set RunModeByStartup = FALSE.

**Reaction to error**

In automatic mode and during commissioning, the reaction to error depends on the SetSubstituteOutput and ActivateRecoverMode variables. In manual mode, the reaction is independent of SetSubstituteOutput and ActivateRecoverMode. If ActivateRecoverMode = TRUE, the reaction additionally depends on the error that occurred.

SetSubstituteOutput	ActivateRecoverMode	Configuration editor > output value > Set Output to	Reaction
Not relevant	FALSE	Zero (inactive)	Switch to "Inactive" mode (State = 0) The value 0.0 0 is transferred to the actuator.
FALSE	TRUE	Current output value while error is pending	Switch to "Substitute output value with error monitoring" mode (State = 5) The current output value is transferred to the actuator while the error is pending.
TRUE	TRUE	Substitute output value while error is pending	Switch to "Substitute output value with error monitoring" mode (State = 5) The value at SubstituteOutput is transferred to the actuator while the error is pending.

In manual mode, PID\_Compact uses ManualValue as output value, unless ManualValue is invalid. If ManualValue is invalid, SubstituteOutput is used. If ManualValue and SubstituteOutput are invalid, Config.OutputLowerLimit is used.

The Error parameter indicates if an error is pending. When the error is no longer pending, Error = FALSE. The ErrorBits parameter shows which errors have occurred. ErrorBits is reset by a rising edge at Reset or ErrorAck.

## PID\_Compact V2 mode of operation

### Monitoring process value limits

You specify the high limit and low limit of the process value in the Config.InputUpperLimit and Config.InputLowerLimit tags. If the process value is outside these limits, an error occurs (ErrorBits = 0001h).

You specify a high and low warning limit of the process value in the Config.InputUpperWarning and Config.InputLowerWarning tags. If the process value is outside these warning limits, a warning occurs (Warning = 0040h), and the InputWarning\_H or InputWarning\_L output parameter changes to TRUE.

### Limiting the setpoint

You specify a high limit and low limit of the setpoint in the Config.SetpointUpperLimit and Config.SetpointLowerLimit tags. PID\_Compact automatically limits the setpoint to the process value limits. You can limit the setpoint to a smaller range. PID\_Compact checks whether this range falls within the process value limits. If the setpoint is outside these limits, the high or low limit is used as the setpoint, and output parameter SetpointLimit\_H or SetpointLimit\_L is set to TRUE.

The setpoint is limited in all operating modes.

### Limiting the output value

You specify a high limit and low limit of the output value in the Config.OutputUpperLimit and Config.OutputLowerLimit tags. Output, ManualValue, and SubstituteOutput are limited to these values. The output value limits must match the control logic.

The valid output value limit values depend on the Output used.

Output	-100.0 to 100.0%
Output_PER	-100.0 to 100.0%
Output_PWM	0.0 to 100.0%

Rule:

OutputUpperLimit > OutputLowerLimit

### Substitute output value

In the event of an error, PID\_Compact can output a substitute output value that you define at the tag SubstituteOutput. The substitute output value must be within the output value limits.

### Monitoring signal validity

The values of the following parameters are monitored for validity when used:

- Setpoint
- Input

## 9.7 References

- Input\_PER
- Disturbance
- ManualValue
- SubstituteOutput
- Output
- Output\_PER
- Output\_PWM

### Monitoring of the sampling time PID\_Compact

Ideally, the sampling time is equivalent to the cycle time of the calling OB. The PID\_Compact instruction measures the time interval between two calls. This is the current sampling time. On every switchover of operating mode and during the initial startup, the mean value is formed from the first 10 sampling times. Too great a difference between the current sampling time and this mean value triggers an error (Error = 0800h).

The error occurs during tuning if:

- New mean value  $\geq 1.1 \times$  old mean value
- New mean value  $\leq 0.9 \times$  old mean value

The error occurs in automatic mode if:

- New mean value  $\geq 1.5 \times$  old mean value
- New mean value  $\leq 0.5 \times$  old mean value

If you deactivate the sampling time monitoring (CycleTime.EnMonitoring = FALSE), you can also call PID\_Compact in OB1. You must then accept a lower control quality due to the deviating sampling time.

### Sampling time of the PID algorithm

The controlled system needs a certain amount of time to respond to changes in the output value. It is therefore not advisable to calculate the output value in every cycle. The sampling time of the PID algorithm represents the time between two calculations of the output value. It is calculated during tuning and rounded to a multiple of the cycle time. All other functions of PID\_Compact are executed at every call.

If you use Output\_PWM, the accuracy of the output signal is determined by the ratio of the PID algorithm sampling time to the cycle time of the OB. The cycle time should be at least 10 times the PID algorithm sampling time.

### Control logic

An increase of the output value is generally intended to cause an increase in the process value. This is referred to as a normal control logic. For cooling and discharge control systems, it may be necessary to invert the control logic. PID\_Compact does not work with negative proportional gain. If InvertControl = TRUE, an increasing control deviation causes a reduction in the output value. The control logic is also taken into account during pretuning and fine tuning.

## Input parameters of PID\_Compact V2

Table 9-77

Parameter	Data type	Default	Description
Setpoint	REAL	0.0	Setpoint of the PID controller in automatic mode
Input	REAL	0.0	A tag of the user program is used as the source of the process value. If you are using the Input parameter, then Config.InputPerOn = FALSE must be set.
Input_PER	INT	0	An analog input is used as the source of the process value. If you are using the Input_PER parameter, then Config.InputPerOn = TRUE must be set.
Disturbance	REAL	0.0	Disturbance variable or precontrol value
ManualEnable	BOOL	FALSE	<ul style="list-style-type: none"> <li>A FALSE -&gt; TRUE edge activates "manual mode", while State = 4, Mode remain unchanged. As long as ManualEnable = TRUE, you cannot change the operating mode via a rising edge at ModeActivate or use the commissioning dialog.</li> <li>A TRUE -&gt; FALSE edge activates the operating mode that is specified by Mode.</li> </ul> We recommend that you change the operating mode using ModeActivate only.
ManualValue	REAL	0.0	Manual value This value is used as the output value in manual mode. Values from Config.OutputLowerLimit to Config.OutputUpperLimit are permitted.
ErrorAck	BOOL	FALSE	<ul style="list-style-type: none"> <li>FALSE -&gt; TRUE edge ErrorBits and Warning are reset.</li> </ul>
Reset	BOOL	FALSE	Restarts the controller. <ul style="list-style-type: none"> <li>FALSE -&gt; TRUE edge               <ul style="list-style-type: none"> <li>Switch to "Inactive" mode</li> <li>ErrorBits and Warnings are reset.</li> <li>Integral action is cleared (PID parameters are retained)</li> </ul> </li> <li>As long as Reset = TRUE, PID_Compact remains in "Inactive" mode (State = 0).</li> <li>TRUE -&gt; FALSE edge PID_Compact switches to the operating mode that is saved in the Mode parameter.</li> </ul>
ModeActivate	BOOL	FALSE	<ul style="list-style-type: none"> <li>FALSE -&gt; TRUE edge PID_Compact switches to the operating mode that is saved in the Mode parameter.</li> </ul>

Output parameters of PID\_Compact V2

Table 9-78

Parameter	Data type	Default	Description
ScaledInput	REAL	0.0	Scaled process value
The "Output", "Output_PER", and "Output_PWM" outputs can be used concurrently.			
Output	REAL	0.0	Output value in REAL format
Output_PER	INT	0	Analog output value
Output_PWM	BOOL	FALSE	Pulse-width-modulated output value The output value is formed by by variable On and Off times.
SetpointLimit_H	BOOL	FALSE	If SetpointLimit_H = TRUE, the absolute setpoint high limit is reached (Setpoint ≥ Config.SetpointUpperLimit). The setpoint is limited to Config.SetpointUpperLimit .
SetpointLimit_L	BOOL	FALSE	If SetpointLimit_L = TRUE, the absolute setpoint low limit has been reached (Setpoint ≤ Config.SetpointLowerLimit). The setpoint is limited to Config.SetpointLowerLimit .
InputWarning_H	BOOL	FALSE	If InputWarning_H = TRUE, the process value has reached or exceeded the warning high limit.
InputWarning_L	BOOL	FALSE	If InputWarning_L = TRUE, the process value has reached or fallen below the warning low limit.
State	INT	0	The State parameter (Page 2610) shows the current operating mode of the PID controller. You can change the operating mode using the input parameter Mode and a rising edge at ModeActivate. <ul style="list-style-type: none"> <li>• State = 0: Inactive</li> <li>• State = 1: Pretuning</li> <li>• State = 2: Fine tuning</li> <li>• State = 3: Automatic mode</li> <li>• State = 4: Manual mode</li> <li>• State = 5: Substitute output value with error monitoring</li> </ul>
Error	BOOL	FALSE	If Error = TRUE, at least one error message is pending in this cycle.
ErrorBits	DWORD	DW#16#0	The ErrorBits parameter (Page 2614) shows which error messages are pending. ErrorBits is retentive and is reset upon a rising edge at Reset or ErrorAck.



## In/out parameters of PID\_Compact V2

Table 9-79

Parameter	Data type	Default	Description
Mode	INT	4	<p>At Mode, specify the operating mode to which PID_Compact is to switch. Options are:</p> <ul style="list-style-type: none"> <li>• Mode = 0: Inactive</li> <li>• Mode = 1: Pretuning</li> <li>• Mode = 2: Fine tuning</li> <li>• Mode = 3: Automatic mode</li> <li>• Mode = 4: Manual mode</li> </ul> <p>The operating mode is activated by:</p> <ul style="list-style-type: none"> <li>• Rising edge at ModeActivate</li> <li>• Falling edge at Reset</li> <li>• Falling edge at ManualEnable</li> <li>• Cold restart of CPU if RunModeByStartup = TRUE</li> </ul> <p>Mode is retentive.</p> <p>A detailed description of the operating modes can be found in Parameters State and Mode V2 (Page 2610).</p>

**See also**

Parameters State and Mode V2 (Page 2610)

**Static tags of PID\_Compact V2**

You must not change variables that are not listed. These are used for internal purposes only.

Table 9-80

Tag	Data type	Default	Description
IntegralResetMode	INT	1	<p>The tag IntegralResetMode determines how PIDCtrl.IntegralSum is pre-assigned when switching from "Inactive" operating mode to "Automatic mode". This setting only works for one cycle.</p> <p>Options are:</p> <ul style="list-style-type: none"> <li>• IntegralResetMode = 0: Smoothing The value of IntegralSum is pre-assigned so that the switchover is bumpless.</li> <li>• IntegralResetMode = 1: Deleting The value of IntegralSum is deleted. Any control deviation will cause a jump change of the output value.</li> <li>• IntegralResetMode = 2: Holding The value of IntegralSum is not changed. You can define a new value using the user program.</li> <li>• IntegralResetMode = 3: Pre-assigning The value of IntegralSum is automatically pre-assigned so that Output is calculated with reference to the value OverwriteInitialOutputValue. This setting is useful, for example, for an override controller.</li> </ul>
OverwriteInitialOutputValue	REAL	0.0	<p>If IntegralResetMode = 3, the value of IntegralSum is automatically pre-assigned so that Output = OverwriteInitialOutputValue in the next cycle.</p>
RunModeByStartup	BOOL	TRUE	<p>Activate operating mode at Mode parameter after CPU restart</p> <p>If RunModeByStartup = TRUE, PID_Compact starts in the operating mode saved in the Mode parameter after CPU startup.</p> <p>If RunModeByStartup = FALSE, PID_Compact remains in "Inactive" mode after CPU startup.</p>
LoadBackUp	BOOL	FALSE	<p>If LoadBackUp = TRUE, the last set of PID parameters is reloaded. The set was saved prior to the last tuning. LoadBackUp is automatically set back to FALSE.</p>
PhysicalUnit	INT	0	<p>Unit of measurement of the process value and setpoint, e.g., °C, or °F.</p>
PhysicalQuantity	INT	0	<p>Physical quantity of the process value and setpoint, e.g., temperature.</p>
ActivateRecoverMode	BOOL	TRUE	<p>The Tag ActivateRecoverMode V2 (Page 2616) determines the reaction to error.</p>
Warning	DWORD	0	<p>Tag Warning V2 (Page 2618) shows the warnings since Reset = TRUE or ErrorAck =TRUE. Warning is retentive.</p>
Progress	REAL	0.0	<p>Progress of tuning as a percentage (0.0 - 100.0)</p>

Tag	Data type	Default	Description
CurrentSetpoint	REAL	0.0	CurrentSetpoint always displays the current setpoint. This value is frozen during tuning.
CancelTuningLevel	REAL	10.0	Permissible fluctuation of setpoint during tuning. Tuning is not canceled until: <ul style="list-style-type: none"> <li>• Setpoint &gt; CurrentSetpoint + CancelTuningLevel or</li> <li>• Setpoint &lt; CurrentSetpoint - CancelTuningLevel</li> </ul>
SubstituteOutput	REAL	0.0	Substitute output value When the following conditions are met, the substitute output value is used: <ul style="list-style-type: none"> <li>• An error has occurred in automatic mode.</li> <li>• SetSubstituteOutput = TRUE</li> <li>• ActivateRecoverMode = TRUE</li> </ul>
SetSubstituteOutput	BOOL	TRUE	If SetSubstituteOutput = TRUE and ActivateRecoverMode = TRUE, the substitute output value configured is output as long as an error is pending. If SetSubstituteOutput = FALSE and ActivateRecoverMode = TRUE, the actuator remains at the current output value as long as an error is pending. If ActivateRecoverMode = FALSE, SetSubstituteOutput is not effective. If SubstituteOutput is invalid (ErrorBits = 20000h), the substitute output value cannot be output.
Config.InputPerOn	BOOL	TRUE	If InputPerOn = TRUE, the Input_PER parameter is used. If InputPerOn = FALSE, the Input parameter is used.
Config.InvertControl	BOOL	FALSE	Invert control logic If InvertControl = TRUE, an increasing control deviation causes a reduction in the output value.
Config.InputUpperLimit	REAL	120.0	High limit of the process value Input and Input_PER are monitored to ensure adherence to this limit. At the I/O input, the process value can be a maximum of 18% higher than the standard range (overrange). This pre-assignment ensures that an error is no longer signaled due to a violation of the "Process value high limit". Only a wire-break and a short-circuit are recognized and PID_Compact reacts according to the configured reaction to error. InputUpperLimit > InputLowerLimit
Config.InputLowerLimit	REAL	0.0	Low limit of the process value Input and Input_PER are monitored to ensure adherence to this limit. InputLowerLimit < InputUpperLimit

9.7 References

Tag	Data type	Default	Description
Config.InputUpperWarning	REAL	3.402822e+38	Warning high limit of the process value If you set InputUpperWarning outside the process value limits, the configured absolute process value high limit is used as the warning high limit. If you configure InputUpperWarning within the process value limits, this value is used as the warning high limit. InputUpperWarning > InputLowerWarning InputUpperWarning ≤ InputUpperLimit
Config.InputLowerWarning	REAL	-3.402822e+38	Warning low limit of the process value If you set InputLowerWarning outside the process value limits, the configured absolute process value low limit is used as the warning low limit. If you configure InputLowerWarning within the process value limits, this value is used as the warning low limit. InputLowerWarning < InputUpperWarning InputLowerWarning ≥ InputLowerLimit
Config.OutputUpperLimit	REAL	100.0	High limit of output value For details, see OutputLowerLimit OutputUpperLimit > OutputLowerLimit
Config.OutputLowerLimit	REAL	0.0	Low limit of output value For Output and Output_PER, the range of values from -100.0 to +100.0, including zero, is valid. At -100.0, Output_PER = -27648; at +100.0, Output_PER = 27648. For Output_PWM, the value range 0.0 to +100.0 applies. The output value limits must match the control logic. OutputLowerLimit < OutputUpperLimit
Config.SetpointUpperLimit	REAL	3.402822e+38	High limit of setpoint If you configure SetpointUpperLimit outside the process value limits, the configured absolute process value high limit is used as the setpoint high limit. If you configure SetpointUpperLimit within the process value limits, this value is used as the setpoint high limit.
Config.SetpointLowerLimit	REAL	-3.402822e+38	Low limit of the setpoint If you set SetpointLowerLimit outside the process value limits, the configured process value absolute low limit is used as the setpoint low limit. If you set SetpointLowerLimit within the process value limits, this value is used as the setpoint low limit.
Config.MinimumOnTime	REAL	0.0	The minimum ON time of the pulse width modulation in seconds is rounded to MinimumOnTime = n×CycleTime.Value
Config.MinimumOffTime	REAL	0.0	The minimum OFF time of the pulse width modulation in seconds is rounded to MinimumOffTime = n×CycleTime.Value

Tag	Data type	Default	Description
Config.InputScaling.UpperPointIn	REAL	27648.0	Scaling Input_PER high Input_PER is converted to percent based on the two value pairs UpperPointOut, UpperPointIn and LowerPointOut, LowerPointIn.
Config.InputScaling.LowerPointIn	REAL	0.0	Scaling Input_PER low Input_PER is converted to percent based on the two value pairs UpperPointOut, UpperPointIn and LowerPointOut, LowerPointIn.
Config.InputScaling.UpperPointOut	REAL	100.0	Scaled high process value Input_PER is converted to percent based on the two value pairs UpperPointOut, UpperPointIn and LowerPointOut, LowerPointIn.
Config.InputScaling.LowerPointOut	REAL	0.0	Scaled low process value Input_PER is converted to percent based on the two value pairs UpperPointOut, UpperPointIn and LowerPointOut, LowerPointIn.
CycleTime.StartEstimation	BOOL	TRUE	If CycleTime.StartEstimation = TRUE, the automatic determination of the cycle time is started. CycleTime.StartEstimation = FALSE once measurement is complete.
CycleTime.EnEstimation	BOOL	TRUE	If CycleTime.EnEstimation = TRUE, the PID_Compact sampling time is calculated. If CycleTime.EnEstimation = FALSE, the PID_Compact sampling time is not calculated and you need to correct the configuration of CycleTime.Value manually.
CycleTime.EnMonitoring	BOOL	TRUE	If CycleTime.EnMonitoring = FALSE, the PID_Compact sampling time is not monitored. If it is not possible to execute PID_Compact within the sampling time, no error (ErrorBits=0800h) is output and PID_Compact does not switch to "Inactive" mode.
CycleTime.Value	REAL	0.1	PID_Compact sampling time in seconds CycleTime.Value is determined automatically and is usually equivalent to the cycle time of the calling OB.
CtrlParamsBackUp.Gain	REAL	1.0	Saved proportional gain You can reload values from the CtrlParamsBackUp structure with LoadBackUp = TRUE.
CtrlParamsBackUp.Ti	REAL	20.0	Saved integral action time [s]
CtrlParamsBackUp.Td	REAL	0.0	Saved derivative action time [s]
CtrlParamsBackUp.TdFiltRatio	REAL	0.0	Saved derivative delay coefficient
CtrlParamsBackUp.PWeighting	REAL	0.0	Saved proportional action weighting factor
CtrlParamsBackUp.DWeighting	REAL	0.0	Saved derivative action weighting factor
CtrlParamsBackUp.Cycle	REAL	1.0	Saved sampling time of PID algorithm

9.7 References

Tag	Data type	Default	Description
PIDSelfTune.SUT.CalculateParams	BOOL	FALSE	The properties of the controlled system are saved during tuning. If SUT.CalculateParams = TRUE, the parameters for pretuning are recalculated according to these properties. This enables you to change the parameter calculation method without having to repeat controller tuning. SUT.CalculateParams is set to FALSE after the calculation.
PIDSelfTune.SUT.TuneRule	INT	0	Methods used to calculate parameters during pretuning: <ul style="list-style-type: none"> <li>• SUT.TuneRule = 0: PID according to Chien, Hrones and Reswick</li> <li>• SUT.TuneRule = 1: PI according to Chien, Hrones and Reswick</li> </ul>
PIDSelfTune.SUT.State	INT	0	The SUT.State tag indicates the current phase of pretuning: <ul style="list-style-type: none"> <li>• State = 0: Initialize pretuning</li> <li>• State = 100: Calculate standard deviation</li> <li>• State = 200: Determine point of inflection</li> <li>• State = 9900: Pretuning successful</li> <li>• State = 1: Pretuning not successful</li> </ul>
PIDSelfTune.TIR.RunIn	BOOL	FALSE	With the RunIn tag, you can specify that fine tuning can also be performed without pretuning. <ul style="list-style-type: none"> <li>• RunIn = FALSE Pretuning is started when fine tuning is started from inactive or manual mode. If the requirements for pretuning are not met, PID_Compact reacts as when RunIn = TRUE. If fine tuning is started from automatic mode, the system uses the existing PID parameters to control to the setpoint. Only then will fine tuning start. If pretuning is not possible, PID_Compact switches to the mode from which tuning was started.</li> <li>• RunIn = TRUE The pretuning is skipped. PID_Compact tries to reach the setpoint with minimum or maximum output value. This can produce increased overshoot. Fine tuning then starts automatically. RunIn is set to FALSE after fine tuning.</li> </ul>
PIDSelfTune.TIR.CalculateParams	BOOL	FALSE	The properties of the controlled system are saved during tuning. If TIR.CalculateParams = TRUE, the parameters for fine tuning are recalculated according to these properties. This enables you to change the parameter calculation method without having to repeat controller tuning. TIR.CalculateParams is set to FALSE after the calculation.

Tag	Data type	Default	Description
PIDSelfTune.TIR.TuneRule	INT	0	<p>Methods used to calculate parameters during fine tuning:</p> <ul style="list-style-type: none"> <li>• TIR.TuneRule = 0: PID automatic</li> <li>• TIR.TuneRule = 1: PID rapid</li> <li>• TIR.TuneRule = 2: PID slow</li> <li>• TIR.TuneRule = 3: Ziegler-Nichols PID</li> <li>• TIR.TuneRule = 4: Ziegler-Nichols PI</li> <li>• TIR.TuneRule = 5: Ziegler-Nichols P</li> </ul>
PIDSelfTune.TIR.State	INT	0	<p>The TIR.State tag indicates the current phase of fine tuning:</p> <ul style="list-style-type: none"> <li>• State = -100 Fine tuning is not possible. Pretuning will be performed first.</li> <li>• State = 0: Initialize fine tuning</li> <li>• State = 200: Calculate standard deviation</li> <li>• State = 300: Attempt to reach the setpoint</li> <li>• State = 400: Attempt to reach the setpoint with existing PID parameters (if pretuning was successful)</li> <li>• State = 500: Determine oscillation and calculate parameters</li> <li>• State = 9900: Fine tuning successful</li> <li>• State = 1: Fine tuning not successful</li> </ul>
PIDCtrl.IntegralSum	REAL	0.0	Current integral action
Retain.CtrlParams.Gain	REAL	1.0	<p>Active proportional gain</p> <p>To invert the control logic, use the Config.InvertControl tag. Negative values at Gain also invert the control logic. We recommend you use only InvertControl to set the control logic. The control logic is also inverted if InvertControl = TRUE and Gain &lt; 0.0.</p> <p>Gain is retentive.</p>
Retain.CtrlParams.Ti	REAL	20.0	<ul style="list-style-type: none"> <li>• CtrlParams.Ti &gt; 0.0: Active integral action time</li> <li>• CtrlParams.Ti = 0.0: Integral action is deactivated</li> </ul> <p>Ti is retentive.</p>
Retain.CtrlParams.Td	REAL	0.0	<ul style="list-style-type: none"> <li>• CtrlParams.Td &gt; 0.0: Active derivative action time</li> <li>• CtrlParams.Td = 0.0: Derivative action is deactivated</li> </ul> <p>Td is retentive.</p>

9.7 References

Tag	Data type	Default	Description
Retain.CtrlParams.TdFiltRatio	REAL	0.2	<p>Active derivative delay coefficient</p> <p>The derivative delay coefficient delays the effect of the derivative action.</p> <p>Derivative delay = derivative action time × derivative delay coefficient</p> <ul style="list-style-type: none"> <li>• 0.0: Derivative action is effective for one cycle only and therefore almost not effective.</li> <li>• 0.5: This value has proved useful in practice for controlled systems with <b>one</b> dominant time constant.</li> <li>• &gt; 1.0: The greater the coefficient, the longer the effect of the derivative action is delayed.</li> </ul> <p>TdFiltRatio is retentive.</p>
Retain.CtrlParams.PWeighting	REAL	1.0	<p>Active proportional action weighting</p> <p>The proportional action may weaken with changes to the setpoint.</p> <p>Values from 0.0 to 1.0 are applicable.</p> <ul style="list-style-type: none"> <li>• 1.0: Proportional action for setpoint change is fully effective</li> <li>• 0.0: Proportional action for setpoint change is not effective</li> </ul> <p>The proportional action is always fully effective when the process value is changed.</p> <p>PWeighting is retentive.</p>
Retain.CtrlParams.DWeighting	REAL	1.0	<p>Active derivative action weighting</p> <p>The derivative action may weaken with changes to the setpoint.</p> <p>Values from 0.0 to 1.0 are applicable.</p> <ul style="list-style-type: none"> <li>• 1.0: Derivative action is fully effective upon setpoint change</li> <li>• 0.0: Derivative action is not effective upon setpoint change</li> </ul> <p>The derivative action is always fully effective when the process value is changed.</p> <p>DWeighting is retentive.</p>
Retain.CtrlParams.Cycle	REAL	1.0	<p>Active sampling time of the PID algorithm</p> <p>CtrlParams.Cycle is calculated during tuning and rounded to an integer multiple of CycleTime.Value.</p> <p>Cycle is retentive.</p>

**Note**

Change the tags listed in this table in "Inactive" mode to prevent malfunction of the PID controller.



**See also**

Tag ActivateRecoverMode V2 (Page 2616)

Tag Warning V2 (Page 2618)

Downloading technology objects to device (Page 5937)

**Changing the PID\_Compact V2 interface**

The following table shows what has changed in the PID\_Compact instruction interface.

PID_Compact V1	PID_Compact V2	Change
Input_PER	Input_PER	Data type from Word to Int
	Disturbance	New
	ErrorAck	New
	ModeActivate	New
Output_PER	Output_PER	Data type from Word to Int
Error	ErrorBits	Renamed
	Error	New
	Mode	New
sb_RunModeByStartup	RunModeByStartup	Function
	IntegralResetMode	
	OverwriteInitialOutputValue	New
	SetSubstituteOutput	New
	CancelTuningLevel	New
	SubstituteOutput	New

The following table shows which variables have been renamed.

PID_Compact V1.x	PID_Compact V2
sb_GetCycleTime	CycleTime.StartEstimation
sb_EnCyclEstimation	CycleTime.EnEstimation
sb_EnCyclMonitoring	CycleTime.EnMonitoring
sb_RunModeByStartup	RunModeByStartup
si_Unit	PhysicalUnit
si_Type	PhysicalQuantity
sd_Warning	Warning
sBackUp.r_Gain	CtrlParamsBackUp.Gain
sBackUp.r_Ti	CtrlParamsBackUp.Ti
sBackUp.r_Td	CtrlParamsBackUp.Td
sBackUp.r_A	CtrlParamsBackUp.TdFiltRatio
sBackUp.r_B	CtrlParamsBackUp.PWeighting
sBackUp.r_C	CtrlParamsBackUp.DWeighting
sBackUp.r_Cycle	CtrlParamsBackUp.Cycle

PID_Compact V1.x	PID_Compact V2
sPid_Calc.r_Cycle	CycleTime.Value
sPid_Calc.b_RunIn	PIDSelfTune.TIR.RunIn
sPid_Calc.b_CalcParamSUT	PIDSelfTune.SUT.CalculateParams
sPid_Calc.b_CalcParamTIR	PIDSelfTune.TIR.CalculateParams
sPid_Calc.i_CtrlTypeSUT	PIDSelfTune.SUT.TuneRule
sPid_Calc.i_CtrlTypeTIR	PIDSelfTune.TIR.TuneRule
sPid_Calc.r_Progress	Progress
sPid_Cmpt.r_Sp_Hlm	Config.SetpointUpperLimit
sPid_Cmpt.r_Sp_Llm	Config.SetpointLowerLimit
sPid_Cmpt.r_Pv_Norm_IN_1	Config.InputScaling.LowerPointIn
sPid_Cmpt.r_Pv_Norm_IN_2	Config.InputScaling.UpperPointIn
sPid_Cmpt.r_Pv_Norm_OUT_1	Config.InputScaling.LowerPointOut
sPid_Cmpt.r_Pv_Norm_OUT_2	Config.InputScaling.UpperPointOut
sPid_Cmpt.r_Lmn_Hlm	Config.OutputUpperLimit
sPid_Cmpt.r_Lmn_Llm	Config.OutputLowerLimit
sPid_Cmpt.b_Input_PER_On	Config.InputPerOn
sPid_Cmpt.b_LoadBackUp	LoadBackUp
sPid_Cmpt.b_InvCtrl	Config.InvertControl
sPid_Cmpt.r_Lmn_Pwm_PPTm	Config.MinimumOnTime
sPid_Cmpt.r_Lmn_Pwm_PBTm	Config.MinimumOffTime
sPid_Cmpt.r_Pv_Hlm	Config.InputUpperLimit
sPid_Cmpt.r_Pv_Llm	Config.InputLowerLimit
sPid_Cmpt.r_Pv_HWrn	Config.InputUpperWarning
sPid_Cmpt.r_Pv_LWrn	Config.InputLowerWarning
sParamCalc.i_Event_SUT	PIDSelfTune.SUT.State
sParamCalc.i_Event_TIR	PIDSelfTune.TIR.State
sRet.i_Mode	sRet.i_Mode has been omitted. The operating mode is changed using Mode and ModeActivate.
sRet.r_Ctrl_Gain	Retain.CtrlParams.Gain
sRet.r_Ctrl_Ti	Retain.CtrlParams.Ti
sRet.r_Ctrl_Td	Retain.CtrlParams.Td
sRet.r_Ctrl_A	Retain.CtrlParams.TdFiltRatio
sRet.r_Ctrl_B	Retain.CtrlParams.PWeighting
sRet.r_Ctrl_C	Retain.CtrlParams.DWeighting
sRet.r_Ctrl_Cycle	Retain.CtrlParams.Cycle

## Parameters State and Mode V2

### Correlation of the parameters

The State parameter shows the current operating mode of the PID controller. You cannot change the State parameter.

With a rising edge at ModeActivate, PID\_Compact switches to the operating mode saved in the Mode in-out parameter.

When the CPU is switched on or switches from Stop to RUN mode, PID\_Compact starts in the operating mode that is saved in the Mode parameter. To leave PID\_Compact in "Inactive" mode, set RunModeByStartup = FALSE.

## Meaning of values

State / Mode	Description of operating mode
0	<p>Inactive</p> <p>In "Inactive" operating mode, the output value 0.0 is always output, regardless of Config.OutputUpperLimit and Config.OutputLowerLimit. Pulse width modulation is off.</p>
1	<p>Pretuning</p> <p>The pretuning determines the process response to a jump change of the output value and searches for the point of inflection. The PID parameters are calculated from the maximum rate of rise and dead time of the controlled system. You obtain the best PID parameters when you perform pretuning and fine tuning.</p> <p>Pretuning requirements:</p> <ul style="list-style-type: none"> <li>• Inactive (State = 0), manual mode (State = 4), or automatic mode (State = 3)</li> <li>• ManualEnable = FALSE</li> <li>• Reset = FALSE</li> <li>• The process value must not be too close to the setpoint.  <math> \text{Setpoint} - \text{Input}  &gt; 0.3 *  \text{Config.InputUpperLimit} - \text{Config.InputLowerLimit} </math> and  <math> \text{Setpoint} - \text{Input}  &gt; 0.5 *  \text{Setpoint} </math></li> <li>• The setpoint and the process value lie within the configured limits.</li> </ul> <p>The more stable the process value is, the easier it is to calculate the PID parameters and the more precise the result will be. Noise on the process value can be tolerated as long as the rate of rise of the process value is significantly higher compared to the noise.</p> <p>The setpoint is frozen in the CurrentSetpoint tag. Tuning is canceled when:</p> <ul style="list-style-type: none"> <li>• <math>\text{Setpoint} &gt; \text{CurrentSetpoint} + \text{CancelTuningLevel}</math> or</li> <li>• <math>\text{Setpoint} &lt; \text{CurrentSetpoint} - \text{CancelTuningLevel}</math></li> </ul> <p>Before the PID parameters are recalculated, they are backed up and can be reactivated with LoadBackUp.</p> <p>The controller switches to automatic mode following successful pretuning. If pretuning is unsuccessful, the switchover of the operating mode is dependent on ActivateRecoverMode.</p> <p>The phase of pretuning is indicated with PIDSelfTune.SUT.State.</p>

State / Mode	Description of operating mode
2	<p>Fine tuning</p> <p>Fine tuning generates a constant, limited oscillation of the process value. The PID parameters are recalculated based on the amplitude and frequency of this oscillation. PID parameters from fine tuning usually have better master control and disturbance characteristics than PID parameters from pretuning. You obtain the best PID parameters when you perform pretuning and fine tuning.</p> <p>PID_Compact automatically attempts to generate an oscillation greater than the noise of the process value. Fine tuning is only minimally influenced by the stability of the process value.</p> <p>The setpoint is frozen in the CurrentSetpoint tag. Tuning is canceled when:</p> <ul style="list-style-type: none"> <li>• Setpoint &gt; CurrentSetpoint + CancelTuningLevel</li> <li>or</li> <li>• Setpoint &lt; CurrentSetpoint - CancelTuningLevel</li> </ul> <p>Before the PID parameters are recalculated, they are backed up and can be reactivated with LoadBackUp.</p> <p>Requirements for fine tuning:</p> <ul style="list-style-type: none"> <li>• No disturbances are expected.</li> <li>• The setpoint and the process value lie within the configured limits.</li> <li>• ManualEnable = FALSE</li> <li>• Reset = FALSE</li> <li>• Automatic (State = 3), inactive (State = 0) or manual (State = 4) mode</li> </ul> <p>Fine tuning proceeds as follows when started from:</p> <ul style="list-style-type: none"> <li>• Automatic mode (State = 3) Start fine tuning from automatic mode if you wish to improve the existing PID parameters through tuning. PID_Compact controls the system using the existing PID parameters until the control loop has stabilized and the requirements for fine tuning have been met. Only then will fine tuning start.</li> <li>• Inactive (State = 0) or manual mode (State = 4) If the requirements for pretuning are met, pretuning is started. The determined PID parameters will be used for control until the control loop has stabilized and the requirements for fine tuning have been met. If the process value for pretuning is already too near the setpoint or PIDSelfTune.TIR.RunIn = TRUE, an attempt is made to reach the setpoint with the minimum or maximum output value. This can produce increased overshoot. Only then will fine tuning start.</li> </ul> <p>The controller switches to automatic mode following successful fine tuning. If fine tuning is unsuccessful, the switchover of the operating mode is dependent on ActivateRecoverMode.</p> <p>The "Fine tuning" phase is indicated with PIDSelfTune.TIR.State.</p>
3	<p>Automatic mode</p> <p>In automatic mode, PID_Compact corrects the controlled system in accordance with the parameters specified. The controller switches to automatic mode if one the following requirements is fulfilled:</p> <ul style="list-style-type: none"> <li>• Pretuning successfully completed</li> <li>• Fine tuning successfully completed</li> <li>• Changing of the Mode in-out parameter to the value 3 and a rising edge at ModeActivate.</li> </ul> <p>The switchover from automatic mode to manual mode is only bumpless if carried out in the commissioning editor.</p> <p>The ActivateRecoverMode tag is taken into consideration in automatic mode.</p>

State / Mode	Description of operating mode
4	<p>Manual mode</p> <p>In manual mode, you specify a manual output value in the ManualValue parameter.</p> <p>You can also activate this operating mode using ManualEnable = TRUE. We recommend that you change the operating mode using Mode and ModeActivate only.</p> <p>The switchover from manual mode to automatic mode is bumpless. Manual mode is also possible when an error is pending.</p>
5	<p>Substitute output value with error monitoring</p> <p>The control algorithm is deactivated. The SetSubstituteOutput tag determines which output value is output in this operating mode.</p> <ul style="list-style-type: none"> <li>• SetSubstituteOutput = FALSE: Last valid output value</li> <li>• SetSubstituteOutput = TRUE: Substitute output value</li> </ul> <p>You cannot activate this operating mode using Mode = 5.</p> <p>In the event of an error, it is activated instead of "Inactive" operating mode if all the following conditions are met:</p> <ul style="list-style-type: none"> <li>• Automatic mode (Mode = 3)</li> <li>• ActivateRecoverMode = TRUE</li> <li>• One or more errors have occurred in which ActivateRecoverMode is effective.</li> </ul> <p>As soon as the errors are no longer pending, PID_Compact switches back to automatic mode.</p>

### ENO characteristics

If State = 0, then ENO = FALSE.

If State ≠ 0, then ENO = TRUE.

### Automatic switchover of operating mode during commissioning

Automatic mode is activated following successful pretuning or fine tuning. The following table shows how Mode and State change during successful pretuning.

Cycle no.	Mode	State	Action
0	4	4	Set Mode = 1
1	1	4	Set ModeActivate = TRUE
1	4	1	Value of State is saved in Mode parameter Pretuning is started
n	4	1	Pretuning successfully completed
n	3	3	Automatic mode is started

PID\_Compact automatically switches the operating mode in the event of an error. The following table shows how Mode and State change during pretuning with errors.

Cycle no.	Mode	State	Action
0	4	4	Set Mode = 1
1	1	4	Set ModeActivate = TRUE

Cycle no.	Mode	State	Action
1	4	1	Value of State is saved in Mode parameter Pretuning is started
n	4	1	Pretuning canceled
n	4	4	Manual mode is started

If ActivateRecoverMode = TRUE, the operating mode that is saved in the Mode parameter is activated. At the start of pretuning or fine tuning, PID\_Compact has saved the value of State in the Mode in/out parameter. PID\_Compact therefore switches to the operating mode from which tuning was started.

If ActivateRecoverMode = FALSE, the system switches to "Inactive" operating mode.

**See also**

Output parameters of PID\_Compact V2 (Page 2600)

**Parameter ErrorBits V2**

If several errors are pending simultaneously, the values of the ErrorBits are displayed with binary addition. The display of ErrorBits = 0003h, for example, indicates that the errors 0001h and 0002h are pending simultaneously.

In manual mode, PID\_Compact uses ManualValue as output value. The exception is Errorbits = 10000h.

ErrorBits (DW#16#...)	Description
0000	There is no error.
0001	The "Input" parameter is outside the process value limits. <ul style="list-style-type: none"> <li>• Input &gt; Config.InputUpperLimit or</li> <li>• Input &lt; Config.InputLowerLimit</li> </ul> If automatic mode was active before the error occurred and ActivateRecoverMode = TRUE, PID_Compact remains in automatic mode. If pretuning or fine tuning mode was active before the error occurred and ActivateRecoverMode = TRUE, PID_Compact switches to the operating mode that is saved in the Mode parameter.
0002	Invalid value at "Input_PER" parameter. Check whether an error is pending at the analog input. If automatic mode was active before the error occurred and ActivateRecoverMode = TRUE, PID_Compact outputs the configured substitute output value. As soon as the error is no longer pending, PID_Compact switches back to automatic mode. If pretuning or fine tuning mode was active before the error occurred and ActivateRecoverMode = TRUE, PID_Compact switches to the operating mode that is saved in the Mode parameter.
0004	Error during fine tuning. Oscillation of the process value could not be maintained. If ActivateRecoverMode = TRUE before the error occurred, PID_Compact cancels the tuning and switches to the operating mode that is saved in the Mode parameter.
0008	Error at start of pretuning. The process value is too close to the setpoint. Start fine tuning. If ActivateRecoverMode = TRUE before the error occurred, PID_Compact cancels the tuning and switches to the operating mode that is saved in the Mode parameter.

ErrorBits (DW#16#...)	Description
0010	<p>The setpoint was changed during tuning.</p> <p>You can set the permitted fluctuation of the setpoint at the CancelTuningLevel tag.</p> <p>If ActivateRecoverMode = TRUE before the error occurred, PID_Compact cancels the tuning and switches to the operating mode that is saved in the Mode parameter.</p>
0020	<p>Pretuning is not permitted during fine tuning.</p> <p>If ActivateRecoverMode = TRUE before the error occurred, PID_Compact remains in fine tuning mode.</p>
0080	<p>Error during pretuning. Incorrect configuration of output value limits.</p> <p>Check whether the limits of the output value are configured correctly and match the control logic.</p> <p>If ActivateRecoverMode = TRUE before the error occurred, PID_Compact cancels the tuning and switches to the operating mode that is saved in the Mode parameter.</p>
0100	<p>Error during fine tuning resulted in invalid parameters.</p> <p>If ActivateRecoverMode = TRUE before the error occurred, PID_Compact cancels the tuning and switches to the operating mode that is saved in the Mode parameter.</p>
0200	<p>Invalid value at "Input" parameter: Value has an invalid number format.</p> <p>If automatic mode was active before the error occurred and ActivateRecoverMode = TRUE, PID_Compact outputs the configured substitute output value. As soon as the error is no longer pending, PID_Compact switches back to automatic mode.</p> <p>If pretuning or fine tuning mode was active before the error occurred and ActivateRecoverMode = TRUE, PID_Compact switches to the operating mode that is saved in the Mode parameter.</p>
0400	<p>Calculation of output value failed. Check the PID parameters.</p> <p>If automatic mode was active before the error occurred and ActivateRecoverMode = TRUE, PID_Compact outputs the configured substitute output value. As soon as the error is no longer pending, PID_Compact switches back to automatic mode.</p> <p>If pretuning or fine tuning mode was active before the error occurred and ActivateRecoverMode = TRUE, PID_Compact switches to the operating mode that is saved in the Mode parameter.</p>
0800	<p>Sampling time error: PID_Compact is not called within the sampling time of the cyclic interrupt OB.</p> <p>If automatic mode was active before the error occurred and ActivateRecoverMode = TRUE, PID_Compact remains in automatic mode.</p> <p>If pretuning or fine tuning mode was active before the error occurred and ActivateRecoverMode = TRUE, PID_Compact switches to the operating mode that is saved in the Mode parameter.</p>
1000	<p>Invalid value at "Setpoint" parameter: Value has an invalid number format.</p> <p>If automatic mode was active before the error occurred and ActivateRecoverMode = TRUE, PID_Compact outputs the configured substitute output value. As soon as the error is no longer pending, PID_Compact switches back to automatic mode.</p> <p>If pretuning or fine tuning mode was active before the error occurred and ActivateRecoverMode = TRUE, PID_Compact switches to the operating mode that is saved in the Mode parameter.</p>
10000	<p>Invalid value at ManualValue parameter. Value has an invalid number format.</p> <p>If ActivateRecoverMode = TRUE before an error occurred, PID_Compact uses SubstituteOutput as the output value. As soon as you specify a valid value in ManualValue, PID_Compact uses it as the output value.</p>

ErrorBits (DW#16#...)	Description
20000	Invalid value at SubstituteOutput tag. Value has an invalid number format. PID_Compact uses the output value low limit as the output value. If automatic mode was active before the error occurred, ActivateRecoverMode = TRUE, and the error is no longer pending, PID_Compact switches back to automatic mode.
40000	Invalid value at Disturbance parameter. Value has an invalid number format. If automatic mode was active and ActivateRecoverMode = TRUE before the error occurred, Disturbance is set to zero. PID_Compact remains in automatic mode. If pretuning or fine tuning mode was active and ActivateRecoverMode = TRUE before the error occurred, PID_Compact switches to the operating mode saved in the Mode parameter. If Disturbance in the current phase has no effect on the output value, tuning is not be canceled.

### Tag ActivateRecoverMode V2

The ActivateRecoverMode tag determines the reaction to error. The Error parameter indicates if an error is pending. When the error is no longer pending, Error = FALSE. The ErrorBits parameter shows which errors have occurred.

### Automatic mode

**NOTICE**

**Your system may be damaged.**

If ActivateRecoverMode = TRUE, PID\_Compact remains in automatic mode even if there is an error and the process limit values are exceeded. This may damage your system.

It is essential to configure how your controlled system reacts in the event of an error to protect your system from damage.



ActivateRecover Mode	Description
FALSE	PID_Compact automatically switches to "Inactive" mode in the event of an error. The controller is only activated by a falling edge at Reset or a rising edge at ModeActivate.
TRUE	<p>If errors occur frequently in automatic mode, this setting has a negative effect on the control response, because PID_Compact switches between the calculated output value and the substitute output value at each error. In this case, check the ErrorBits parameter and eliminate the cause of the error.</p> <p>If one or more of the following errors occur, PID_Compact stays in automatic mode:</p> <ul style="list-style-type: none"> <li>• 0001h: The "Input" parameter is outside the process value limits.</li> <li>• 0800h: Sampling time error</li> <li>• 40000h: Invalid value at parameter Disturbance.</li> </ul> <p>If one or more of the following errors occur, PID_Compact switches to "Substitute output value with error monitoring" mode:</p> <ul style="list-style-type: none"> <li>• 0002h: Invalid value at Input_PER parameter.</li> <li>• 0200h: Invalid value at Input parameter.</li> <li>• 0400h: Calculation of output value failed.</li> <li>• 1000h: Invalid value at Setpoint parameter.</li> </ul> <p>If the following error occurs, PID_Compact switches to "Substitute output value with error monitoring" mode and moves the actuator to Config.OutputLowerLimit:</p> <ul style="list-style-type: none"> <li>• 20000h: Invalid value at SubstituteOutput tag. Value has an invalid number format.</li> </ul> <p>This characteristics are independent of SetSubstituteOutput.</p> <p>As soon as the errors are no longer pending, PID_Compact switches back to automatic mode.</p>

### Pretuning and fine tuning

ActivateRecover Mode	Description
FALSE	PID_Compact automatically switches to "Inactive" mode in the event of an error. The controller is only activated by a falling edge at Reset or a rising edge at ModeActivate.
TRUE	<p>If the following error occurs, PID_Compact remains in the active mode:</p> <ul style="list-style-type: none"> <li>• 0020h: Pretuning is not permitted during fine tuning.</li> </ul> <p>The following errors are ignored:</p> <ul style="list-style-type: none"> <li>• 10000h: Invalid value at ManualValue parameter.</li> <li>• 20000h: Invalid value at SubstituteOutput tag.</li> </ul> <p>When any other error occurs, PID_Compact cancels the tuning and switches to the mode from which tuning was started.</p>

### Manual mode

ActivateRecoverMode is not effective in manual mode.

### Tag Warning V2

If several warnings are pending simultaneously, the values of the Warning tag are displayed with binary addition. The display of warning 0003h, for example, indicates that the warnings 0001h and 0002h are pending simultaneously.

Warning (DW#16#...)	Description
0000	No warning pending.
0001	The point of inflection was not found during pretuning.
0004	The setpoint was limited to the configured limits.
0008	Not all the necessary controlled system properties were defined for the selected method of calculation. Instead, the PID parameters were calculated using the TIR.TuneRule = 3 method.
0010	The operating mode could not be changed because Reset = TRUE or ManualEnable = TRUE.
0020	The cycle time of the calling OB limits the sampling time of the PID algorithm. Improve results by using shorter OB cycle times.
0040	The process value exceeded one of its warning limits.
0080	Invalid value at Mode. The operating mode is not switched.
0100	The manual value was limited to the limits of the controller output.
0200	The specified rule for tuning is not supported. No PID parameters are calculated.
1000	The substitute output value cannot be reached because it is outside the output value limits.

The following warnings are deleted as soon as the cause is eliminated:

- 0001h
- 0004h
- 0008h
- 0040h
- 0100h

All other warnings are cleared with a rising edge at Reset or ErrorAck.

### PID\_Compact V1

#### Description of PID\_Compact V1

##### Description

The PID\_Compact instruction provides a PID controller with integrated tuning for automatic and manual mode.

##### Call

PID\_Compact is called in the constant interval of the cycle time of the calling OB (preferably in a cyclic interrupt OB).

## Download to device

The actual values of retentive tags are only updated when you download PID\_Compact completely.

Downloading technology objects to device (Page 5937)

## Startup

At the startup of the CPU, PID\_Compact starts in the operating mode that was last active. To retain PID\_Compact in "Inactive" mode, set `sb_RunModeByStartup = FALSE`.

## Monitoring of the sampling time PID\_Compact

Ideally, the sampling time is equivalent to the cycle time of the calling OB. The PID\_Compact instruction measures the time interval between two calls. This is the current sampling time. On every switchover of operating mode and during the initial startup, the mean value is formed from the first 10 sampling times. If the current sampling time deviates too much from this mean value, Error = 0800 hex occurs and PID\_Compact switches to "Inactive" mode.

PID\_Compact, Version 1.1 or higher is set to "Inactive" mode during controller tuning under the following conditions:

- New mean value  $\geq 1.1 \times$  old mean value
- New mean value  $\leq 0.9 \times$  old mean value

In automatic mode, PID\_Compact, Version 1.1 or higher, is set to "Inactive" mode under the following conditions:

- New mean value  $\geq 1.5 \times$  old mean value
- New mean value  $\leq 0.5 \times$  old mean value

During controller tuning and in automatic mode, PID\_Compact 1.0 is set to "Inactive" operating mode under the following conditions:

- New mean value  $\geq 1.1 \times$  old mean value
- New mean value  $\leq 0.9 \times$  old mean value
- Current sampling time  $\geq 1.5 \times$  current mean value
- Current sampling time  $\leq 0.5 \times$  current mean value

## Sampling time of the PID algorithm

The controlled system needs a certain amount of time to respond to changes in the output value. It is therefore not advisable to calculate the output value in every cycle. The sampling time of the PID algorithm represents the time between two calculations of the output value. It is calculated during tuning and rounded to a multiple of the cycle time. All other functions of PID\_Compact are executed at every call.

**PID algorithm**

PID\_Compact is a PIDT1 controller with anti-windup and weighting of the proportional and derivative actions. The following equation is used to calculate the output value.

$$y = K_p \left[ (b \cdot w - x) + \frac{1}{T_i \cdot s} (w - x) + \frac{T_d \cdot s}{a \cdot T_d \cdot s + 1} (c \cdot w - x) \right]$$

Symbol	Description
y	Output value
K <sub>p</sub>	Proportional gain
s	Laplace operator
b	Proportional action weighting
w	Setpoint
x	Process value
T <sub>i</sub>	Integral action time
a	Derivative delay coefficient (T1 = a × T <sub>D</sub> )
	Derivative action time
c	Derivative action weighting

**Block diagram of PID\_Compact**

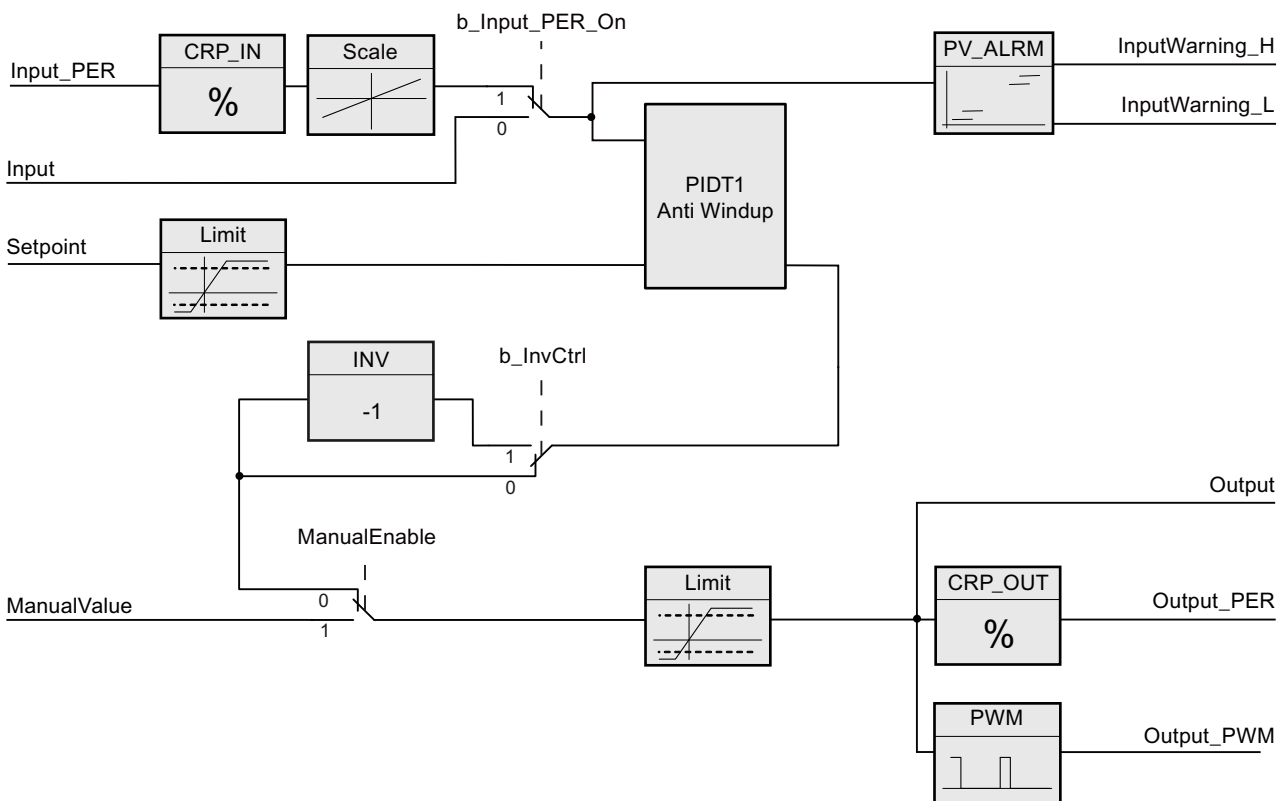

### Block diagram of PIDT1 with anti-windup

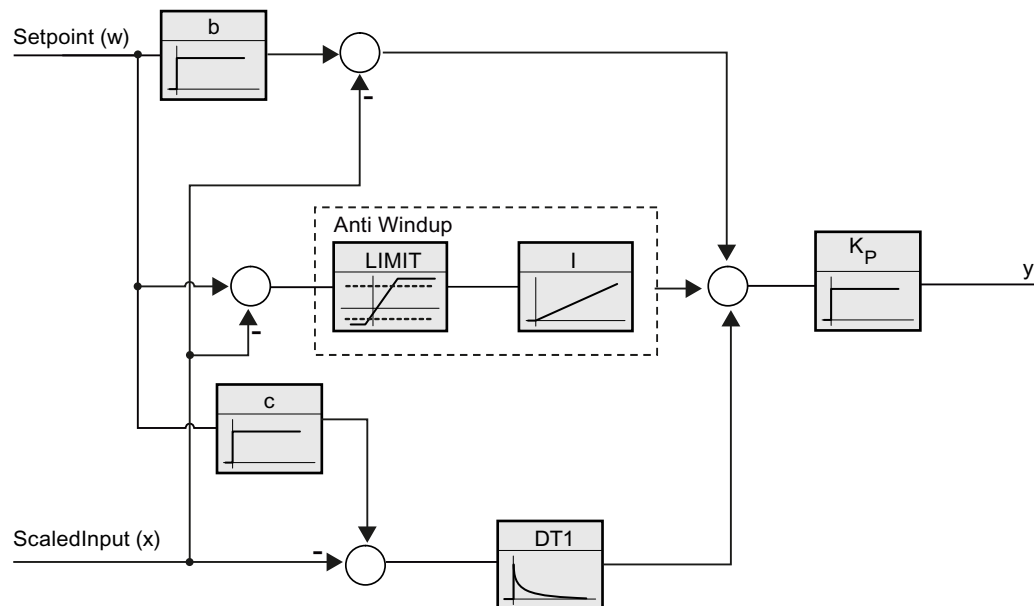

### Reaction to error

If errors occur, they are output in parameter Error, and PID\_Compact changes to "Inactive" mode. Reset the errors using the Reset parameter.

### Control logic

An increase of the output value is generally intended to cause an increase in the process value. This is referred to as a normal control logic. For cooling and discharge control systems, it may be necessary to invert the control logic. PID\_Compact does not work with negative proportional gain. If InvertControl = TRUE, an increasing control deviation causes a reduction in the output value. The control logic is also taken into account during pretuning and fine tuning.

### See also

Controller type (Page 5959)

### Input parameters of PID\_Compact V1

Table 9-81

Parameter	Data type	Default	Description
Setpoint	REAL	0.0	Setpoint of the PID controller in automatic mode
Input	REAL	0.0	A variable of the user program is used as source for the process value. If you are using parameter Input, then sPid_Cmpt.b_Input_PER_On = FALSE must be set.

9.7 References

Parameter	Data type	Default	Description
Input_PER	WORD	W#16#0	Analog input as the source of the process value If you are using parameter Input_PER, then sPid_Cmpt.b_Input_PER_On = TRUE must be set.
ManualEnable	BOOL	FALSE	<ul style="list-style-type: none"> <li>A FALSE -&gt; TRUE edge selects "Manual mode", while State = 4, sRet.i_Mode remains unchanged.</li> <li>A TRUE -&gt; FALSE edge selects the most recently active operating mode, State =sRet.i_Mode</li> </ul> <p>A change of sRet.i_Mode will not take effect during ManualEnable = TRUE. The change of sRet.i_Mode will only be considered upon a TRUE -&gt; FALSE edge at ManualEnable .</p> <p><b>PID_Compact V1.2 und PID_Compact V1.0</b> If at start of the CPU ManualEnable = TRUE, PID_Compact starts in manual mode. A rising edge (FALSE &gt; TRUE) at ManualEnable is not necessary.</p> <p><b>PID_Compact V1.1</b> At the start of the CPU, PID_Compact only switches to manual mode with a rising edge (FALSE-&gt;TRUE) at ManualEnable . Without rising edge, PID_Compact starts in the last operating mode in which ManualEnable was FALSE.</p>
ManualValue	REAL	0.0	Manual value This value is used as the output value in manual mode.
Reset	BOOL	FALSE	The Reset parameter (Page 2631) restarts the controller.

Output parameters of PID\_Compact V1

Parameter	Data type	Default	Description
ScaledInput	REAL	0.0	Output of the scaled process value
Outputs "Output", "Output_PER", and "Output_PWM" can be used concurrently.			
Output	REAL	0.0	Output value in REAL format
Output_PER	WORD	W#16#0	Analog output value
Output_PWM	BOOL	FALSE	Pulse-width-modulated output value The output value is formed by minimum On and Off times.
SetpointLimit_H	BOOL	FALSE	If SetpointLimit_H = TRUE, the setpoint absolute high limit is reached. The setpoint in the CPU is limited to the configured setpoint absolute high limit. The configured process value absolute high limit is the default for the setpoint high limit. If you set sPid_Cmpt.r_Sp_HLm to a value within the process value limits, this value is used as the setpoint high limit.
SetpointLimit_L	BOOL	FALSE	If SetpointLimit_L = TRUE, the setpoint absolute low limit has been reached. In the CPU, the setpoint is limited to the configured setpoint absolute low limit. The configured process value absolute low limit is the default setting for the setpoint low limit. If you set sPid_Cmpt.r_Sp_Llm to a value within the process value limits, this value is used as the setpoint low limit.
InputWarning_H	BOOL	FALSE	If InputWarning_H = TRUE, the process value has reached or exceeded the warning high limit.

Parameter	Data type	Default	Description
InputWarning_L	BOOL	FALSE	If InputWarning_L = TRUE, the process value has reached or fallen below the warning low limit.
State	INT	0	The State parameter (Page 2628) shows the current operating mode of the PID controller. To change the operating mode, use variable sRet.i_Mode. <ul style="list-style-type: none"> <li>• State = 0: Inactive</li> <li>• State = 1: pretuning</li> <li>• State = 2: fine tuning</li> <li>• State = 3: Automatic mode</li> <li>• State = 4: Manual mode</li> </ul>
Error	DWORD	W#16#0	The Error parameter (Page 2631) indicates the error messages. Error = 0000: No error pending.

### Static tags of PID\_Compact V1

You must not change tags that are not listed. These are used for internal purposes only.

Table 9-82

Tag	Data type	Default	Description
sb_GetCycleTime	BOOL	TRUE	If sb_GetCycleTime = TRUE, the automatic determination of the cycle time is started. CycleTime.StartEstimation = FALSE once measurement is complete.
sb_EnCyclEstimation	BOOL	TRUE	If sb_EnCyclEstimation = TRUE, the sampling time PID_Compact is calculated.
sb_EnCyclMonitoring	BOOL	TRUE	If sb_EnCyclMonitoring = FALSE, the sampling time PID_Compact is not monitored. If it is not possible to execute PID_Compact within the sampling time, an 0800 error is not output and PID_Compact does not change to "Inactive" mode.
sb_RunModeByStartup	BOOL	TRUE	Activate Mode after CPU restart If sb_RunModeByStartup = FALSE, the controller will remain inactive after a CPU startup. After a CPU startup and if sb_RunModeByStartup = TRUE, the controller will return to the most recently active operating mode.
si_Unit	INT	0	Unit of measurement of the process value and setpoint, e.g., °C, or °F.
si_Type	INT	0	Physical quantity of the process value and setpoint, e.g., temperature.
sd_Warning	DWORD	DW#16#0	Variable sd_warning (Page 2633) displays the warnings generated since the reset, or since the last change of the operating mode.
sBackUp.r_Gain	REAL	1.0	Saved proportional gain You can reload values from the sBackUp structure with sPid_Cmpt.b_LoadBackUp = TRUE.
sBackUp.r_Ti	REAL	20.0	Saved integral action time [s]

9.7 References

Tag	Data type	Default	Description
sBackUp.r_Td	REAL	0.0	Saved derivative action time [s]
sBackUp.r_A	REAL	0.0	Saved derivative delay coefficient
sBackUp.r_B	REAL	0.0	Saved proportional action weighting factor
sBackUp.r_C	REAL	0.0	Saved derivative action weighting factor
sBackUp.r_Cycle	REAL	1.0	Saved sampling time of PID algorithm
sPid_Calc.r_Cycle	REAL	0.1	Sampling time of the PID_Compact instruction r_Cycle is determined automatically and usually equivalent to the cycle time of the calling OB.
sPid_Calc.b_RunIn	BOOL	FALSE	<ul style="list-style-type: none"> <li>• b_RunIn = FALSE Pretuning is started when fine tuning is started from inactive or manual mode. If the requirements for pretuning are not met, PID_Compact reacts like b_RunIn = TRUE. If fine tuning is started from automatic mode, the system uses the existing PID parameters to control to the setpoint. Only then will fine tuning start. If pretuning is not possible, PID_Compact will change to "Inactive" mode.</li> <li>• b_RunIn = TRUE The pretuning is skipped. PID_3Compact tries to reach the setpoint with minimum or maximum output value. This can produce increased overshoot. Fine tuning then starts automatically. b_RunIn is set to FALSE after fine tuning.</li> </ul>
sPid_Calc.b_CalcParamSUT	BOOL	FALSE	The parameters for pretuning will be recalculated if b_CalcParamSUT = TRUE. This enables you to change the parameter calculation method without having to repeat controller tuning. b_CalcParamSUT will be set to FALSE after calculation.
sPid_Calc.b_CalcParamTIR	BOOL	FALSE	The parameters for fine tuning will be recalculated if b_CalcParamTIR = TRUE. This enables you to change the parameter calculation method without having to repeat controller tuning. b_CalcParamTIR will be set to FALSE after calculation.
sPid_Calc.i_CtrlTypeSUT	INT	0	Methods used to calculate parameters during pretuning: <ul style="list-style-type: none"> <li>• i_CtrlTypeSUT = 0: PID according to Chien, Hrones and Reswick</li> <li>• i_CtrlTypeSUT = 1: PI according to Chien, Hrones and Reswick</li> </ul>



Tag	Data type	Default	Description
sPid_Calc.i_CtrlTypeTIR	INT	0	Methods used to calculate parameters during fine tuning: <ul style="list-style-type: none"> <li>• i_CtrlTypeTIR = 0: PID automatic</li> <li>• i_CtrlTypeTIR = 1: PID rapid</li> <li>• i_CtrlTypeTIR = 2: PID slow</li> <li>• i_CtrlTypeTIR = 3: Ziegler-Nichols PID</li> <li>• i_CtrlTypeTIR = 4: Ziegler-Nichols PI</li> <li>• i_CtrlTypeTIR = 5: Ziegler-Nichols P</li> </ul>
sPid_Calc.r_Progress	REAL	0.0	Progress of tuning as a percentage (0.0 - 100.0)
sPid_Cmpt.r_Sp_Hlm	REAL	+3.402822e+38	High limit of setpoint If you set sPid_Cmpt.r_Sp_Hlm outside the process value limits, the configured process value absolute high limit is used as the setpoint high limit. If you set sPid_Cmpt.r_Sp_Hlm within the process value limits, this value is used as the setpoint high limit.
sPid_Cmpt.r_Sp_Llm	REAL	-3.402822e+38	Low limit of the setpoint If you set sPid_Cmpt.r_Sp_Llm outside the process value limits, the configured process value absolute low limit is used as the setpoint low limit. If you set sPid_Cmpt.r_Sp_Llm within the process value limits, this value is used as the setpoint low limit.
sPid_Cmpt.r_Pv_Norm_IN_1	REAL	0.0	Scaling Input_PER low Input_PER is converted to percent based on the two value pairs r_Pv_Norm_OUT_1, r_Pv_Norm_IN_1 and r_Pv_Norm_OUT_2, r_Pv_Norm_IN_2 from the sPid_Cmpt structure.
sPid_Cmpt.r_Pv_Norm_IN_2	REAL	27648.0	Scaling Input_PER high Input_PER is converted to percent based on the two value pairs r_Pv_Norm_OUT_1, r_Pv_Norm_IN_1 and r_Pv_Norm_OUT_2, r_Pv_Norm_IN_2 from the sPid_Cmpt structure.
sPid_Cmpt.r_Pv_Norm_OUT_1	REAL	0.0	Scaled low process value Input_PER is converted to percent based on the two value pairs r_Pv_Norm_OUT_1, r_Pv_Norm_IN_1 and r_Pv_Norm_OUT_2, r_Pv_Norm_IN_2 from the sPid_Cmpt structure.
sPid_Cmpt.r_Pv_Norm_OUT_2	REAL	100.0	Scaled high process value Input_PER is converted to percent based on the two value pairs r_Pv_Norm_OUT_1, r_Pv_Norm_IN_1 and r_Pv_Norm_OUT_2, r_Pv_Norm_IN_2 from the sPid_Cmpt structure.
sPid_Cmpt.r_Lmn_Hlm	REAL	100.0	Output value high limit for output parameter "Output"
sPid_Cmpt.r_Lmn_Llm	REAL	0.0	Low output value limit for output parameter "Output"
sPid_Cmpt.b_Input_PER_On	BOOL	TRUE	If b_Input_PER_On = TRUE, then parameter Input_PER is used. If b_Input_PER_On = FALSE, then parameter Input is used.

9.7 References

Tag	Data type	Default	Description
sPid_Cmpt.b_LoadBackUp	BOOL	FALSE	Activate the back-up parameter set. If an optimization has failed, you can reactivate the previous PID parameters by setting this bit.
sPid_Cmpt.b_InvCtrl	BOOL	FALSE	Invert control logic With b_InvCtrl = TRUE, a rising control deviation reduces the output value.
sPid_Cmpt.r_Lmn_Pwm_PPTm	REAL	0.0	The minimum ON time of the pulse width modulation in seconds is rounded to $r\_Lmn\_Pwm\_PPTm = r\_Cycle$ or $r\_Lmn\_Pwm\_PPTm = n * r\_Cycle$
sPid_Cmpt.r_Lmn_Pwm_PBTm	REAL	0.0	The minimum OFF time of the pulse width modulation in seconds is rounded to $r\_Lmn\_Pwm\_PBTm = r\_Cycle$ or $r\_Lmn\_Pwm\_PBTm = n * r\_Cycle$
sPid_Cmpt.r_Pv_Hlm	REAL	120.0	High limit of the process value At the I/O input, the process value can be a maximum of 18% higher than the standard range (overrange). An error is no longer reported for a violation of the "Process value high limit". Only a wire-break and a short-circuit are recognized and the PID_Compact switches to "Inactive" mode. $r\_Pv\_Hlm > r\_Pv\_Llm$
sPid_Cmpt.r_Pv_Llm	REAL	0.0	Low limit of the process value $r\_Pv\_Llm < r\_Pv\_Hlm$
sPid_Cmpt.r_Pv_HWrn	REAL	+3.402822e+38	Warning high limit of the process value If you set r_Pv_HWrn outside the process value limits, the configured process value absolute high limit is used as the warning high limit. If you set r_Pv_HWrn within the process value limits, this value is used as the warning high limit. $r\_Pv\_HWrn > r\_Pv\_LWrn$ $r\_Pv\_HWrn \leq r\_Pv\_Hlm$
sPid_Cmpt.r_Pv_LWrn	REAL	-3.402822e+38	Warning low limit of the process value If you set r_Pv_LWrn outside the process value limits, the configured process value absolute low limit is used as the warning low limit. If you set r_Pv_LWrn within the process value limits, this value is used as the warning low limit. $r\_Pv\_LWrn < r\_Pv\_HWrn$ $r\_Pv\_LWrn \geq r\_Pv\_Lwrn$
sParamCalc.i_Event_SUT	INT	0	Variable i_Event_SUT (Page 2634) indicates the current phase of "pretuning":
sParamCalc.i_Event_TIR	INT	0	Variable i_Event_TIR (Page 2634) indicates the current phase of "fine tuning":

Tag	Data type	Default	Description
sRet.i_Mode	INT	0	The operating mode is changed edge-triggered. The following operating mode is enabled on a change to <ul style="list-style-type: none"> <li>• i_Mode = 0: "Inactive" (controller stop)</li> <li>• i_Mode = 1: "Pretuning" mode</li> <li>• i_Mode = 2: "Fine tuning" mode</li> <li>• i_Mode = 3: "Automatic mode"</li> <li>• i_Mode = 4: "Manual mode"</li> </ul> i_Mode is retentive.
sRet.r_Ctrl_Gain	REAL	1.0	Active proportional gain Gain is retentive.
sRet.r_Ctrl_Ti	REAL	20.0	<ul style="list-style-type: none"> <li>• r_Ctrl_Ti &gt; 0.0: active integral action time</li> <li>• r_Ctrl_Ti = 0.0: Integral action is disabled</li> </ul> r_Ctrl_Ti is retentive.
sRet.r_Ctrl_Td	REAL	0.0	<ul style="list-style-type: none"> <li>• r_Ctrl_Td &gt; 0.0: Active derivative action time</li> <li>• r_Ctrl_Td = 0.0: Derivative action is disabled</li> </ul> r_Ctrl_Td is retentive.
sRet.r_Ctrl_A	REAL	0.0	Active derivative delay coefficient r_Ctrl_A is retentive.
sRet.r_Ctrl_B	REAL	0.0	Active proportional action weighting r_Ctrl_B is retentive.
sRet.r_Ctrl_C	REAL	0.0	Active derivative action weighting r_Ctrl_C is retentive.
sRet.r_Ctrl_Cycle	REAL	1.0	Active sampling time of the PID algorithm r_Ctrl_Cycle is calculated during controller tuning and rounded to an integer multiple of r_Cycle. r_Ctrl_Cycle is retentive.

**Note**

Change the tags listed in this table in "Inactive" mode to prevent malfunction of the PID controller. The "Inactive" mode is forced by setting variable "sRet.i\_Mode" to "0".

**See also**

Downloading technology objects to device (Page 5937)

## Parameters State and sRet.i\_Mode V1

### Correlation of the parameters

The State parameter indicates the current operating mode of the PID controller. You cannot modify the State parameter.

You need to modify the sRet.i\_Mode tag to change the operating mode. This also applies when the value for the new operating mode is already in sRet.i\_Mode. First set sRet.i\_Mode = 0 and then sRet.i\_Mode = 3. Provided the current operating mode of the controller supports this change, State is set to the value of sRet.i\_Mode.

When PID\_Compact automatically switches the operating mode, the following applies: State ! = sRet.i\_Mode.

Examples:

- Successful pretuning  
State = 3 and sRet.i\_Mode = 1
- Error  
State = 0 and sRet.i\_Mode remains at the same value, e.g sRet.i\_Mode = 3
- ManualEnalbe = TRUE  
State = 4 and sRet.i\_Mode remain at the previous value, for example, sRet.i\_Mode = 3

---

#### Note

You wish to repeat successful fine tuning without exiting automatic mode with i\_Mode = 0. Setting sRet.i\_Mode to an invalid value such as 9999 for one cycle has no effect on State. Set Mode = 2 in the next cycle. You can generate a change to sRet.i\_Mode without first switching to "inactive" mode.

---

## Meaning of values

State / sRet.i_Mode	Description of the operating mode
0	<p>Inactive</p> <p>The controller is switched off.</p> <p>The controller was in "inactive" mode before pretuning was performed.</p> <p>The PID controller will change to "inactive" mode when running if an error occurs or if the "Deactivate controller" icon is clicked in the commissioning window.</p>
1	<p>Pretuning</p> <p>The pretuning determines the process response to a jump of the output value and searches for the point of inflection. The optimized PID parameters are calculated as a function of the maximum rate of rise and dead time of the controlled system.</p> <p>Pretuning requirements:</p> <ul style="list-style-type: none"> <li>• The controller is in inactive mode or manual mode</li> <li>• ManualEnable = FALSE</li> <li>• The process value must not be too close to the setpoint.  <math> \text{Setpoint} - \text{Input}  &gt; 0.3 *  \text{sPid\_Cmpt.r\_Pv\_Hlm} - \text{sPid\_Cmpt.r\_Pv\_Llm} </math> and  <math> \text{Setpoint} - \text{Input}  &gt; 0.5 *  \text{Setpoint} </math></li> <li>• The setpoint may not be changed during pretuning.</li> </ul> <p>The higher the stability of the process value, the easier it is to calculate the PID parameters and increase precision of the result. Noise on the process value can be tolerated as long as the rate of rise of the process value is significantly higher compared to the noise.</p> <p>PID parameters are backed up before they are recalculated and can be reactivated with sPid_Cmpt.b_LoadBackUp.</p> <p>There is a change to automatic mode following successful pretuning and to "inactive" mode following unsuccessful pretuning.</p> <p>The phase of pretuning is indicated with Tag i_Event_SUT V1 (Page 2634).</p>

State / sRet.i_Mode	Description of the operating mode
2	<p>Fine tuning</p> <p>Fine tuning generates a constant, limited oscillation of the process value. The PID parameters are optimized based on the amplitude and frequency of this oscillation. The differences between the process response during pretuning and fine tuning are analyzed. All PID parameters are recalculated on the basis of the findings. PID parameters from fine tuning usually have better master control and disturbance behavior than PID parameters from pretuning.</p> <p>PID_Compact automatically attempts to generate an oscillation greater than the noise of the process value. Fine tuning is only minimally influenced by the stability of the process value.</p> <p>PID parameters are backed up before they are recalculated and can be reactivated with sPid_Cmpt.b_LoadBackUp.</p> <p>Requirements for fine tuning:</p> <ul style="list-style-type: none"> <li>• No disturbances are expected.</li> <li>• The setpoint and the process value lie within the configured limits.</li> <li>• The setpoint may not be changed during fine tuning.</li> <li>• ManualEnable = FALSE</li> <li>• Automatic (State = 3), inactive (State = 0) or manual (State = 4) mode</li> </ul> <p>Fine tuning proceeds as follows when started in:</p> <ul style="list-style-type: none"> <li>• Automatic mode (State = 3) Start fine tuning in automatic mode if you wish to improve the existing PID parameters using controller tuning. PID_Compact will regulate using the existing PID parameters until the control loop has stabilized and the requirements for fine tuning have been met. Only then will fine tuning start.</li> <li>• Inactive (State = 0) or manual (State = 4) mode If the requirements for pretuning are met, pretuning is started. The PID parameters established will be used for adjustment until the control loop has stabilized and the requirements for fine tuning have been met. Only then will fine tuning start. If pretuning is not possible, PID_Compact will change to "Inactive" mode. An attempt is made to reach the setpoint with a minimum or maximum output value if the process value for pretuning is already too near the setpoint or sPid_Calc.b_RunIn = TRUE. This can produce increased overshoot.</li> </ul> <p>The controller will change to "automatic mode" after successfully completed "fine tuning" and to "inactive" mode if "fine tuning" has not been successfully completed.</p> <p>The "Fine tuning" phase is indicated with Tag i_Event_TIR V1 (Page 2634).</p>
3	<p>Automatic mode</p> <p>In automatic mode, PID_Compact corrects the controlled system in accordance with the parameters specified. The controller changes to automatic mode if one of the following conditions is fulfilled:</p> <ul style="list-style-type: none"> <li>• Pretuning successfully completed</li> <li>• Fine tuning successfully completed</li> <li>• Change of variable sRet.i_Mode to the value 3.</li> </ul> <p>After CPU startup or change from Stop to RUN mode, PID_Compact will start in the most recently active operating mode. To retain PID_Compact in "Inactive" mode, set sb_RunModeByStartup = FALSE.</p>
4	<p>Manual mode</p> <p>In manual mode, you specify a manual output value in the ManualValue parameter.</p> <p>This operating mode is enabled if sRet.i_Mode = 4, or at the rising edge on ManualEnable. If ManualEnable changes to TRUE, only State will change. sRet.i_Mode will retain its current value. PID_Compact will return to the previous operating mode upon a falling edge at ManualEnable.</p> <p>The change to automatic mode is bumpless.</p>

**See also**

Output parameters of PID\_Compact V1 (Page 2622)

Pretuning (Page 5969)

Fine tuning (Page 5971)

"Manual" mode (Page 5973)

Tag i\_Event\_SUT V1 (Page 2634)

Tag i\_Event\_TIR V1 (Page 2634)

**Parameter Error V1**

If several errors are pending simultaneously, the values of the error codes are displayed with binary addition. The display of error code 0003, for example, indicates that the errors 0001 and 0002 are pending simultaneously.

Error (DW#16#...)	Description
0000	There is no error.
0001	The "Input" parameter is outside the process value limits. <ul style="list-style-type: none"> <li>• Input &gt; sPid_Cmpt.r_Pv_Hlm or</li> <li>• Input &lt; sPid_Cmpt.r_Pv_Llm</li> </ul> You cannot move the actuator again until you eliminate the error.
0002	Invalid value at "Input_PER" parameter. Check whether an error is pending at the analog input.
0004	Error during fine tuning. Oscillation of the process value could not be maintained.
0008	Error at start of pretuning. The process value is too close to the setpoint. Start fine tuning.
0010	The setpoint was changed during tuning.
0020	Pretuning is not permitted in automatic mode or during fine tuning.
0080	Incorrect configuration of output value limits. Check whether the limits of the output value are configured correctly and match the control logic.
0100	Error during tuning resulted in invalid parameters.
0200	Invalid value at "Input" parameter: Value has an invalid number format.
0400	Calculation of output value failed. Check the PID parameters.
0800	Sampling time error: PID_Compact is not called within the sampling time of the cyclic interrupt OB.
1000	Invalid value at "Setpoint" parameter: Value has an invalid number format.

**See also**

Output parameters of PID\_Compact V1 (Page 2622)

**Parameter Reset V1**

The response to Reset = TRUE depends on the version of the PID\_Compact instruction.

### Reset response PID\_Compact V.1.1 or higher

A rising edge at Reset resets the errors and warnings and clears the integral action. A falling edge at Reset triggers a change to the most recently active operating mode.

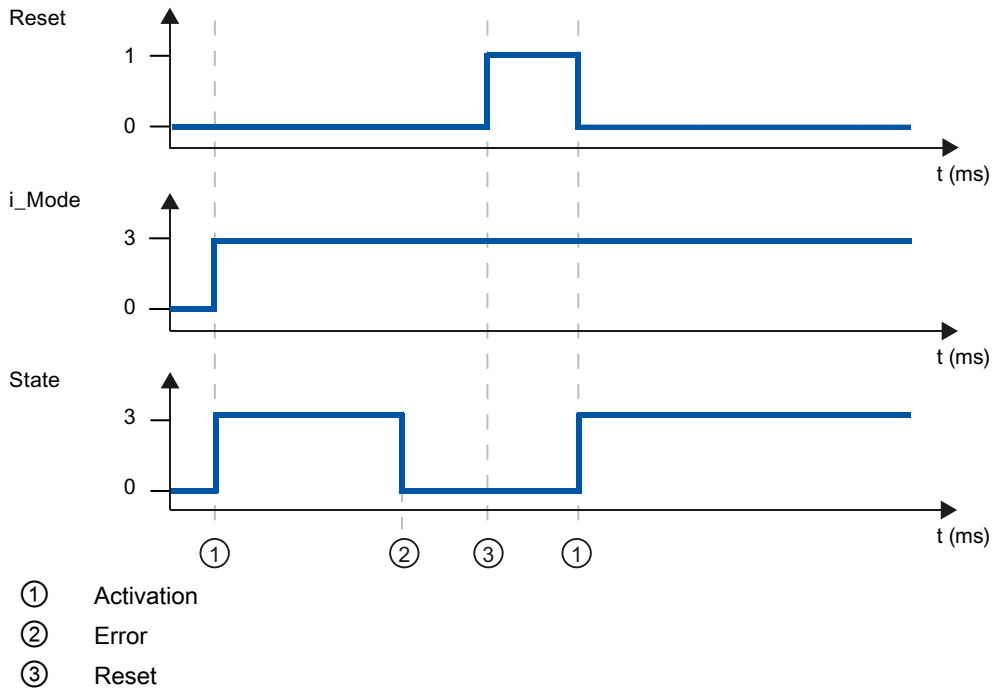



### Reset response PID\_Compact V.1.0

A rising edge at Reset resets the errors and warnings and clears the integral action. The controller is not reactivated until the next edge at i\_Mode.

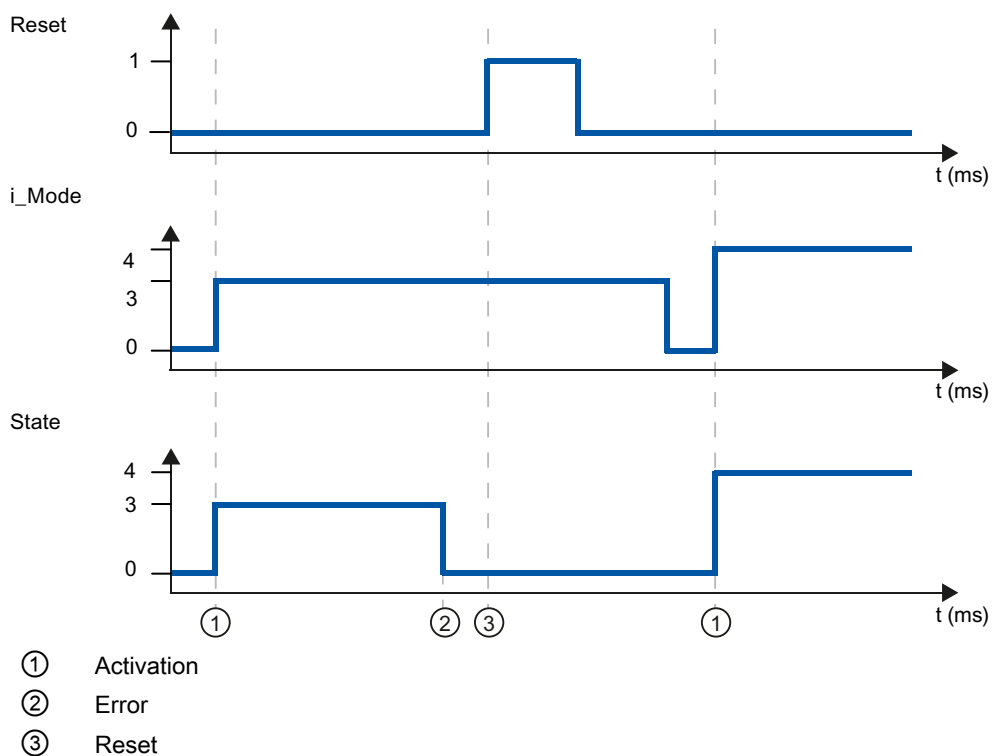

### Tag sd\_warning V1

If several warnings are pending, the values of variable sd\_warning are displayed by means of binary addition. The display of warning 0003, for example, indicates that the warnings 0001 and 0002 are also pending.

sd_warning (DW#16#...)	Description
0000	No warning pending.
0001	The point of inflection was not found during pretuning.
0002	Oscillation increased during fine tuning.
0004	The setpoint was outside the set limits.
0008	Not all the necessary controlled system properties were defined for the selected method of calculation. The PID parameters were instead calculated using the "i_CtrlTypeTIR = 3" method.
0010	The operating mode could not be changed because ManualEnable = TRUE.
0020	The cycle time of the calling OB limits the sampling time of the PID algorithm. Improve results by using shorter OB cycle times.
0040	The process value exceeded one of its warning limits.

9.7 References

The following warnings are deleted as soon as the cause is dealt with:

- 0004
- 0020
- 0040

All other warnings are cleared with a rising edge at Reset.

**Tag i\_Event\_SUT V1**

i_Event_SUT	Name	Description
0	SUT_INIT	Initialize pretuning
100	SUT_STDABW	Calculate the standard deviation
200	SUT_GET_POI	Find the point of inflection
9900	SUT_IO	Pretuning successful
1	SUT_NIO	Pretuning not successful

**See also**

Static tags of PID\_Compact V1 (Page 2623)

Parameters State and sRet.i\_Mode V1 (Page 2628)

**Tag i\_Event\_TIR V1**

i_Event_TIR	Name	Description
-100	TIR_FIRST_SUT	Fine tuning is not possible. Pretuning will be executed first.
0	TIR_INIT	Initialize fine tuning
200	TIR_STDABW	Calculate the standard deviation
300	TIR_RUN_IN	Attempt to reach the setpoint
400	TIR_CTRLN	Attempt to reach the setpoint with the existing PID parameters (if pretuning has been successful)
500	TIR_OSZIL	Determine oscillation and calculate parameters
9900	TIR_IO	Fine tuning successful
1	TIR_NIO	Fine tuning not successful

**See also**

Static tags of PID\_Compact V1 (Page 2623)

Parameters State and sRet.i\_Mode V1 (Page 2628)

## PID\_3Step

### New features of PID\_3Step

#### PID\_3Step V2.1

- **Use with S7-1200**  
As of PID\_3Step V2.1, the instruction with V2 functionality can also be used on S7-1200 with firmware version 4.0 or higher.

#### PID\_3Step V2.0

- **Reaction to error**  
The reaction to ActivateRecoverMode = TRUE has been completely overhauled. PID\_3Step reacts in a more fault tolerant manner in the default setting.

NOTICE
<p><b>Your system may be damaged.</b></p> <p>If you use the default setting, PID_3Step remains in automatic mode even if the process value limits are exceeded. This may damage your system.</p> <p>It is essential to configure how your controlled system reacts in the event of an error to protect your system from damage.</p>

You use the ErrorAck input parameter to acknowledge the errors and warnings without restarting the controller or clearing the integral action.

Switching operating modes does not acknowledge errors that are no longer pending.

- **Switching the operating mode**  
You specify the operating mode at the Mode in/out parameter and use a rising edge at ModeActivate to start the operating mode. The Retain.Mode tag has been omitted. The transition time measurement can no longer be started with GetTransitTime.Start, but only with Mode = 6 and a rising edge at ModeActivate.
- **Multi-instance capability**  
You can call up PID\_3Step as multi-instance DB. No technology object is created in this case and no parameter assignment interface or commissioning interface is available. You must assign parameters for PID\_3Step directly in the multi-instance DB and commission it via a watch table.
- **Startup characteristics**  
The operating mode specified at the Mode parameter is also started on a falling edge at Reset and during a CPU cold restart, if RunModeByStartup = TRUE.
- **ENO characteristics**  
ENO is set depending on the operating mode.  
If State = 0, then ENO = FALSE.  
If State ≠ 0, then ENO = TRUE.

- **Manual mode**  
The Manual\_UP and Manual\_DN input parameters no longer function as edge-triggered parameters. Edge-triggered manual mode continues to be possible using the ManualUpInternal and ManualDnInternal tags.  
In "Manual mode without endstop signals" (Mode = 10), the endstop signals Actuator\_H and Actuator\_L are ignored even though they are activated.
- **Default value of PID parameters**  
The following default settings have been changed:
  - Proportional action weighting (PWeighting) from 0.0 to 1.0
  - Derivative action weighting (DWeighting) from 0.0 to 1.0
  - Coefficient for derivative delay (TdFiltRatio) from 0.0 to 0.2
- **Limiting of motor transition time**  
You configure the maximum percentage of the motor transition time that the actuator will travel in one direction in the Config.VirtualActuatorLimit tag.
- **Setpoint value specification during tuning**  
You configure the permitted fluctuation of the setpoint during tuning at the CancelTuningLevel tag.
- **Switching a disturbance variable on**  
You can switch a disturbance variable on at the Disturbance parameter.
- **Troubleshooting**  
If the endstop signals are not activated (ActuatorEndStopOn = FALSE), ScaledFeedback is determined without Actuator\_H or Actuator\_L.

### PID\_3Step V1.1

- **Manual mode on CPU startup**  
If ManualEnable = TRUE when the CPU starts, PID\_3Step starts in manual mode. A rising edge at ManualEnable is not necessary.
- **Reaction to error**  
The ActivateRecoverMode tag is no longer effective in manual mode.
- **Troubleshooting**  
The Progress tag is reset following successful tuning or transition time measurement.

### Compatibility with CPU and FW

The following table shows which version of PID\_3Step can be used on which CPU.

CPU	FW	PID_3Step
S7-1200	V4.X	V2.1 V1.1
S7-1200	V3.X	V1.1 V1.0
S7-1200	V2.X	V1.1 V1.0

CPU	FW	PID_3Step
S7-1200	V1.X	-
S7-1500	V1.1	V2.1 V2.0
S7-1500	V1.0	V2.0

## PID\_3Step V2

### Description of PID\_3Step V2

#### Description

You use the PID\_3Step instruction to configure a PID controller with self tuning for valves or actuators with integrating behavior.

The following operating modes are possible:

- Inactive
- Pretuning
- Fine tuning
- Automatic mode
- Manual mode
- Approach substitute output value
- Transition time measurement
- Error monitoring
- Approach substitute output value with error monitoring
- Manual mode without endstop signals

For a more detailed description of the operating modes, see the State parameter.

**PID algorithm**

PID\_3Step is a PIDT1 controller with anti-windup and weighting of the proportional and derivative actions. The PID algorithm operates according to the following equation:

$$\Delta y = K_p \cdot s \cdot \left[ (b \cdot w - x) + \frac{1}{T_i \cdot s} (w - x) + \frac{T_D \cdot s}{a \cdot T_D \cdot s + 1} (c \cdot w - x) \right]$$

Symbol	Description
$\Delta y$	Output value of the PID algorithm
$K_p$	Proportional gain
$s$	Laplace operator
$b$	Proportional action weighting
$w$	Setpoint
$x$	Process value
$T_i$	Integral action time
$T_D$	Derivative action time
$a$	Derivative delay coefficient (derivative delay $T1 = a \times T_D$ )
$c$	Derivative action weighting

Block diagram without position feedback

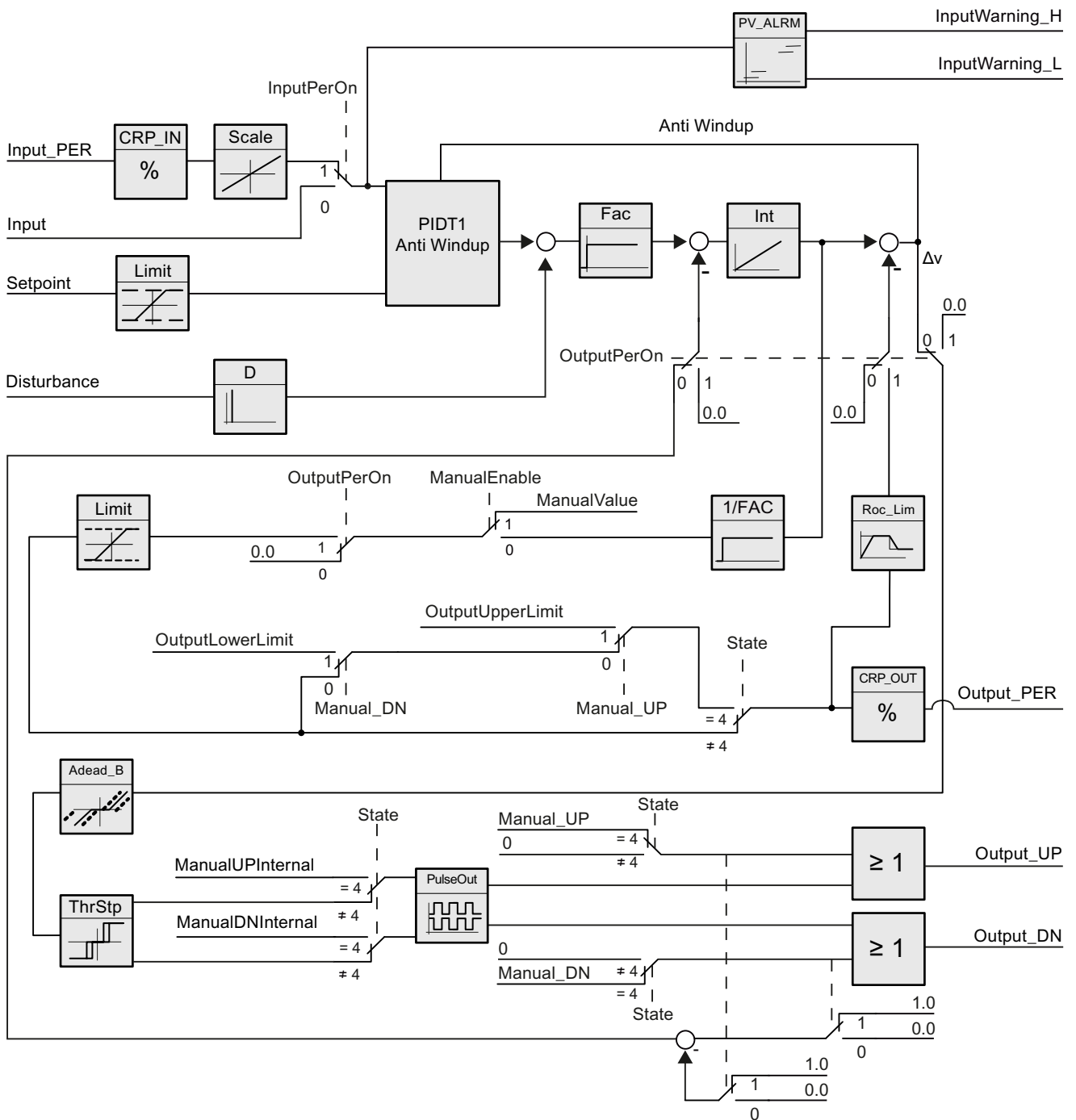

Block diagram with position feedback

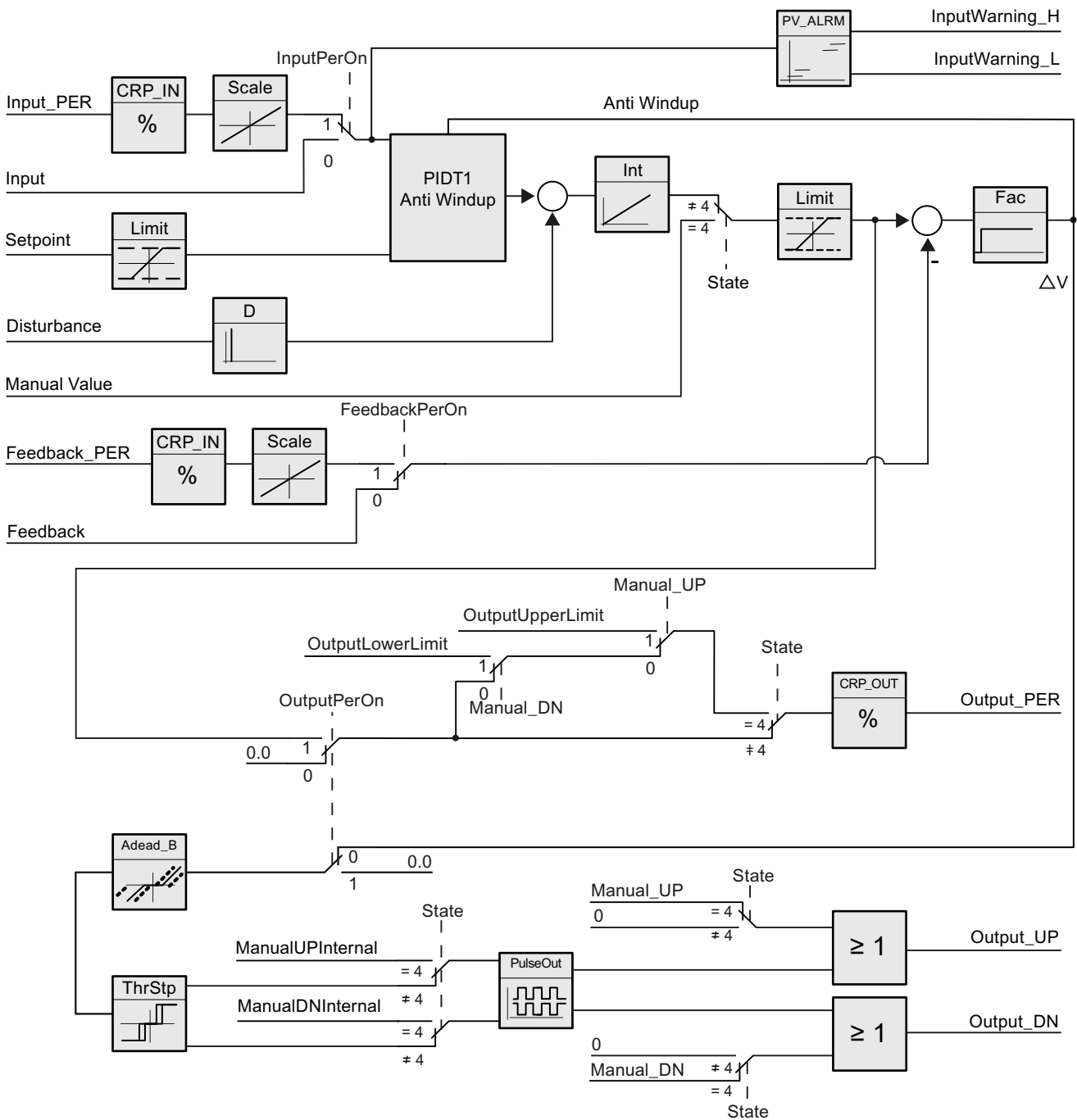



### Block diagram of PIDT1 with anti-windup

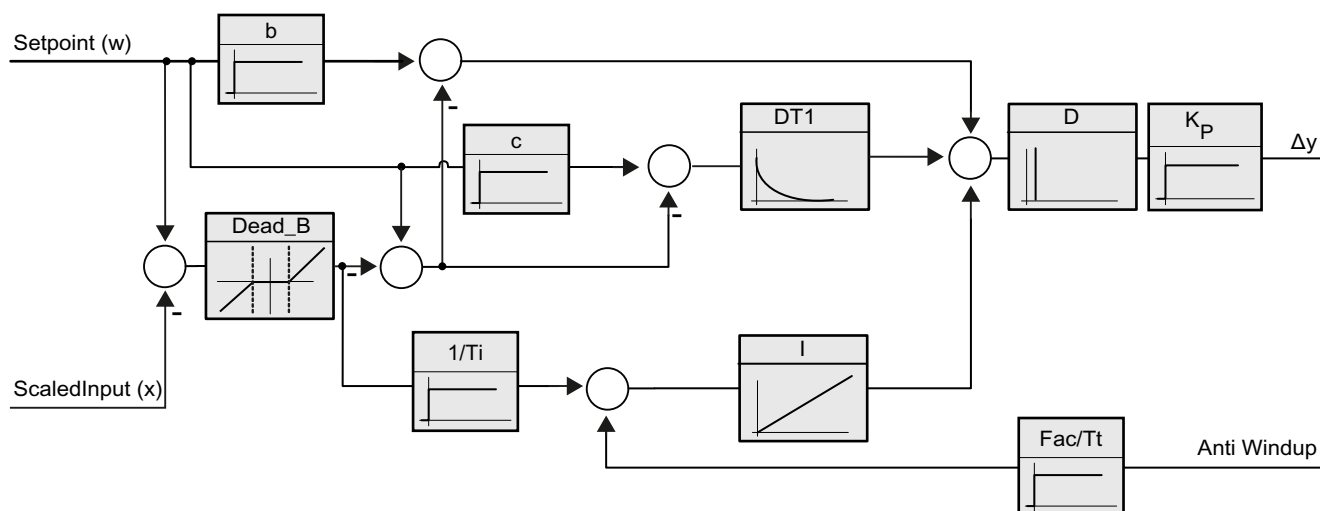

### Call

PID\_3Step is called in the constant time scale of a cycle interrupt OB.

If you call PID\_3Step as a multi-instance DB, no technology object is created. No parameter assignment interface or commissioning interface is available. You must assign parameters for PID\_3Step directly in the multi-instance DB and commission it via a watch table.

### Download to device

The actual values of retentive tags are only updated when you download PID\_3Step completely.

Downloading technology objects to device (Page 5937)

### Startup

When the CPU starts up, PID\_3Step starts in the operating mode that is saved in the Mode in/out parameter. To leave PID\_3Step in "Inactive" mode, set RunModeByStartup = FALSE.

### Reaction to error

In automatic mode and during commissioning, the reaction to error depends on the ErrorBehaviour and ActivateRecoverMode tags. In manual mode, the reaction is independent

of ErrorBehaviour and ActivateRecoverMode. If ActivateRecoverMode = TRUE, the reaction additionally depends on the error that occurred.

ErrorBehaviour	ActivateRecoverMode	Configuration editor > actuator setting > Set Output to	Reaction
FALSE	FALSE	Current output value	Switch to "Inactive" mode (State = 0) The actuator remains in the current position.
FALSE	TRUE	Current output value while error is pending	Switch to "Error monitoring" mode (State = 7) The actuator remains in the current position while the error is pending.
TRUE	FALSE	Substitute output value	Switch to "Approach substitute output value" mode (State = 5) The actuator moves to the configured substitute output value. Switch to "Inactive" mode (State = 0) The actuator remains in the current position.
TRUE	TRUE	Substitute output value while error is pending	Switch to "Approach substitute output value with error monitoring" mode (State = 8) The actuator moves to the configured substitute output value. Switch to "Error monitoring" mode (State = 7)

In manual mode, PID\_3Step uses ManualValue as output value, unless the following errors occur:

- 2000h: Invalid value at Feedback\_PER parameter.
- 4000h: Invalid value at Feedback parameter.
- 8000h: Error during digital position feedback.

You can only change the position of the actuator with Manual\_UP and Manual\_DN, not with ManualValue.

The Error parameter indicates whether an error has occurred in this cycle. The ErrorBits parameter shows which errors have occurred. ErrorBits is reset by a rising edge at Reset or ErrorAck.

**See also**

Parameters State and Mode V2 (Page 2658)

Parameter ErrorBits V2 (Page 2663)

Configuring PID\_3Step V2 (Page 5975)

## Mode of operation of PID\_3Step V2

### Monitoring process value limits

You specify the high limit and low limit of the process value in the Config.InputUpperLimit and Config.InputLowerLimit variables. If the process value is outside these limits, an error occurs (ErrorBits = 0001h).

You specify a high and low warning limit of the process value in the Config.InputUpperWarning and Config.InputLowerWarning variables. If the process value is outside these warning limits, a warning occurs (Warning = 0040h), and the InputWarning\_H or InputWarning\_L output parameter changes to TRUE.

### Limiting the setpoint

You specify a high limit and low limit of the setpoint in the Config.SetpointUpperLimit and Config.SetpointLowerLimit variables. PID\_3Step automatically limits the setpoint to the process value limits. You can limit the setpoint to a smaller range. PID\_3Step checks whether this range falls within the process value limits. If the setpoint is outside these limits, the high or low limit is used as the setpoint, and output parameter SetpointLimit\_H or SetpointLimit\_L is set to TRUE.

The setpoint is limited in all operating modes.

### Limiting the output value

You specify a high limit and low limit of the output value in the Config.OutputUpperLimit and Config.OutputLowerLimit variables. The output value limits must be within "Low endstop" and "High endstop".

- High endstop: Config.FeedbackScaling.UpperPointOut
- Low endstop: Config.FeedbackScaling.LowerPointOut

Rule:

$$\text{UpperPointOut} \geq \text{OutputUpperLimit} > \text{OutputLowerLimit} \geq \text{LowerPointOut}$$

The valid values for "High endstop" and "Low endstop" depend upon:

- FeedbackOn
- FeedbackPerOn
- OutputPerOn

OutputPerOn	FeedbackOn	FeedbackPerOn	LowerPointOut	UpperPointOut
FALSE	FALSE	FALSE	Cannot be set (0.0%)	Cannot be set (100.0%)
FALSE	TRUE	FALSE	-100.0% or 0.0%	0.0% or +100.0%
FALSE	TRUE	TRUE	-100.0% or 0.0%	0.0% or +100.0%
TRUE	FALSE	FALSE	Cannot be set (0.0%)	Cannot be set (100.0%)
TRUE	TRUE	FALSE	-100.0% or 0.0%	0.0% or +100.0%
TRUE	TRUE	TRUE	-100.0% or 0.0%	0.0% or +100.0%

If OutputPerOn = FALSE and FeedbackOn = FALSE, you cannot limit the output value. Output\_UP and Output\_DN are then reset at Actuator\_H = TRUE or Actuator\_L = TRUE. If endstop signals are also not present, Output\_UP and Output\_DN are reset after a travel time of  $\text{Config.VirtualActuatorLimit} \times \text{Retain.TransitTime}/100$ .

The output value is 27648 at 100% and -27648 at -100%. PID\_3Step must be able to close the valve completely.

### Substitute output value

If an error has occurred, PID\_3Step can output a substitute output value and move the actuator to a safe position that is specified in the SavePosition tag. The substitute output value must be within the output value limits.

### Monitoring signal validity

The values of the following parameters are monitored for validity when used:

- Setpoint
- Input
- Input\_PER
- Input\_PER
- Feedback
- Feedback\_PER
- Disturbance
- ManualValue
- SavePosition
- Output\_PER

### Monitoring the PID\_3Step sampling time

Ideally, the sampling time is equivalent to the cycle time of the calling OB. The PID\_3Step instruction measures the time interval between two calls. This is the current sampling time. On every switchover of operating mode and during the initial startup, the mean value is formed from the first 10 sampling times. Too great a difference between the current sampling time and this mean value triggers an error (ErrorBits = 0800h).

The error occurs during tuning if:

- New mean value  $\geq 1.1 \times$  old mean value
- New mean value  $\leq 0.9 \times$  old mean value

The error occurs in automatic mode if:

- New mean value  $\geq 1.5 \times$  old mean value
- New mean value  $\leq 0.5 \times$  old mean value

If you deactivate the sampling time monitoring (`CycleTime.EnMonitoring = FALSE`), you can also call `PID_3Step` in `OB1`. You must then accept a lower control quality due to the deviating sampling time.

### Sampling time of the PID algorithm

The controlled system needs a certain amount of time to respond to changes in the output value. It is therefore not advisable to calculate the output value in every cycle. The sampling time of the PID algorithm represents the time between two calculations of the output value. It is calculated during tuning and rounded to a multiple of the cycle time. All other functions of `PID_3Step` are executed at every call.

### Measuring the motor transition time

The motor transition time is the time in seconds the motor requires to move the actuator from the closed to the opened state. The actuator is moved in one direction for a maximum time of  $\text{Config.VirtualActuatorLimit} \times \text{Retain.TransitTime}/100$ . `PID_3Step` requires the motor transition time to be as accurate as possible for good controller results. The data in the actuator documentation contains average values for this type of actuator. The value for the specific actuator used may differ. You can measure the motor transition time during commissioning. The output value limits are not taken into consideration during the motor transition time measurement. The actuator can travel to the high or the low endstop.

### Control logic

An increase of the output value is generally intended to cause an increase in the process value. This is referred to as a normal control logic. For cooling and discharge control systems, it may be necessary to invert the control logic. `PID_3Step` does not work with negative proportional gain. If `InvertControl = TRUE`, an increasing control deviation causes a reduction in the output value. The control logic is also taken into account during pretuning and fine tuning.

### See also

Configuring `PID_3Step V1` (Page 5991)

### Changing the `PID_3Step V2` interface

The following table shows what has changed in the `PID_3Step` instruction interface.

<code>PID_3Step V1</code>	<code>PID_3Step V2</code>	Change
<code>Input_PER</code>	<code>Input_PER</code>	Data type from Word to Int
<code>Feedback_PER</code>	<code>Feedback_PER</code>	Data type from Word to Int
	<code>Disturbance</code>	New
<code>Manual_UP</code>	<code>Manual_UP</code>	Function
<code>Manual_DN</code>	<code>Manual_DN</code>	Function
	<code>ErrorAck</code>	New

9.7 References

PID_3Step V1	PID_3Step V2	Change
	ModeActivate	New
Output_PER	Output_PER	Data type from Word to Int
	ManualUPInternal	New
	ManualDNInternal	New
	CancelTuningLevel	New
	VirtualActuatorLimit	New
Config.Loadbackup	Loadbackup	Renamed
Config.TransitTime	Retain.TransitTime	Renamed and retentivity added
GetTransitTime.Start		Replaced by Mode and ModeActivate
SUT.CalculateSUTParams	SUT.CalculateParams	Renamed
SUT.TuneRuleSUT	SUT.TuneRule	Renamed
TIR.CalculateTIRParams	TIR.CalculateParams	Renamed
TIR.TuneRuleTIR	TIR.TuneRule	Renamed
Retain.Mode	Mode	Function Declaration of static for in-out parameters

Input parameters of PID\_3Step V2

Table 9-83

Parameter	Data type	Default	Description
Setpoint	REAL	0.0	Setpoint of the PID controller in automatic mode
Input	REAL	0.0	A tag of the user program is used as the source of the process value. If you are using the Input parameter, then Config.InputPerOn = FALSE must be set.
Input_PER	INT	0	An analog input is used as the source of the process value. If you are using the Input_PER parameter, then Config.InputPerOn = TRUE must be set.
Actuator_H	BOOL	FALSE	Digital position feedback of the valve for the high endstop If Actuator_H = TRUE, the valve is at the high endstop and is no longer moved towards this direction.
Actuator_L	BOOL	FALSE	Digital position feedback of the valve for the low endstop If Actuator_L = TRUE, the valve is at the low endstop and is no longer moved towards this direction.
Feedback	REAL	0.0	Position feedback of the valve If you are using the Feedback parameter, then Config.FeedbackPerOn = FALSE must be set.

Parameter	Data type	Default	Description
Feedback_PER	INT	0	<p>Analog position feedback of a valve</p> <p>If you are using the Feedback_PER parameter, then Config.FeedbackPerOn = TRUE must be set.</p> <p>Feedback_PER is scaled based on the tags:</p> <ul style="list-style-type: none"> <li>• Config.FeedbackScaling.LowerPointIn</li> <li>• Config.FeedbackScaling.UpperPointIn</li> <li>• Config.FeedbackScaling.LowerPointOut</li> <li>• Config.FeedbackScaling.UpperPointOut</li> </ul>
Disturbance	REAL	0.0	Disturbance tag or precontrol value
ManualEnable	BOOL	FALSE	<ul style="list-style-type: none"> <li>• A FALSE -&gt; TRUE edge activates "manual mode", while State = 4, Mode remain unchanged.</li> <li>• As long as ManualEnable = TRUE, you cannot change the operating mode via a rising edge at ModeActivate or use the commissioning dialog.</li> <li>• A TRUE -&gt; FALSE edge activates the operating mode that is specified by Mode.</li> </ul> <p>We recommend that you change the operating mode using ModeActivate only.</p>
ManualValue	REAL	0.0	In manual mode, the absolute position of the valve is specified. ManualValue is only evaluated if you are using Output_PER, or if position feedback is available.
Manual_UP	BOOL	FALSE	<ul style="list-style-type: none"> <li>• Manual_UP = TRUE The valve is opened even if you are using Output_PER or a position feedback. The valve is no longer moved if the high endstop has been reached. See also Config.VirtualActuatorLimit</li> <li>• Manual_UP = FALSE If you are using Output_PER or a position feedback, the valve is moved to ManualValue. Otherwise, the valve is no longer moved.</li> </ul> <p>If Manual_UP and Manual_DN are set to TRUE simultaneously, the valve is not moved.</p>
Manual_DN	BOOL	FALSE	<ul style="list-style-type: none"> <li>• Manual_DN = TRUE The valve is closed even if you are using Output_PER or a position feedback. The valve is no longer moved if the low endstop has been reached. See also Config.VirtualActuatorLimit</li> <li>• Manual_DN = FALSE If you are using Output_PER or a position feedback, the valve is moved to ManualValue. Otherwise, the valve is no longer moved.</li> </ul>
ErrorAck	BOOL	FALSE	<ul style="list-style-type: none"> <li>• FALSE -&gt; TRUE edge ErrorBits and Warning are reset.</li> </ul>

Parameter	Data type	Default	Description
Reset	BOOL	FALSE	<p>Restarts the controller.</p> <ul style="list-style-type: none"> <li>• FALSE -&gt; TRUE edge                             <ul style="list-style-type: none"> <li>- Switch to "Inactive" mode</li> <li>- ErrorBits and Warning are reset.</li> <li>- Integral action is cleared (PID parameters are retained)</li> </ul> </li> <li>• As long as Reset = TRUE, PID_3Step remains in "Inactive" mode (State = 0).</li> <li>• TRUE -&gt; FALSE edge PID_3Step switches to the operating mode that is saved in the Mode parameter.</li> </ul>
ModeActivate	BOOL	FALSE	<ul style="list-style-type: none"> <li>• FALSE -&gt; TRUE edge PID_3Step switches to the operating mode that is saved in the Mode parameter.</li> </ul>

### Output parameters of PID\_3Step V2

Table 9-84

Parameter	Data type	Default	Description
ScaledInput	REAL	0.0	Scaled process value
ScaledFeedback	REAL	0.0	<p>Scaled position feedback</p> <p>For an actuator without position feedback, the position of the actuator indicated by ScaledFeedback is very imprecise. ScaledFeedback may only be used for rough estimation of the current position in this case.</p>
Output_UP	BOOL	FALSE	<p>Digital output value for opening the valve</p> <p>If Config.OutputPerOn = FALSE, the Output_UP parameter is used.</p>
Output_DN	BOOL	FALSE	<p>Digital output value for closing the valve</p> <p>If Config.OutputPerOn = FALSE, the Output_DN parameter is used.</p>
Output_PER	INT	0	<p>Analog output value</p> <p>If Config.OutputPerOn = TRUE, Output_PER is used.</p>
SetpointLimit_H	BOOL	FALSE	<p>If SetpointLimit_H = TRUE, the absolute setpoint high limit is reached (Setpoint ≥ Config.SetpointUpperLimit). The setpoint is limited to Config.SetpointUpperLimit .</p>
SetpointLimit_L	BOOL	FALSE	<p>If SetpointLimit_L = TRUE, the absolute setpoint low limit has been reached (Setpoint ≤ Config.SetpointLowerLimit). The setpoint is limited to Config.SetpointLowerLimit .</p>
InputWarning_H	BOOL	FALSE	<p>If InputWarning_H = TRUE, the process value has reached or exceeded the warning high limit.</p>
InputWarning_L	BOOL	FALSE	<p>If InputWarning_L = TRUE, the process value has reached or fallen below the warning low limit.</p>



Parameter	Data type	Default	Description
State	INT	0	<p>The State parameter (Page 2658) shows the current operating mode of the PID controller. You can change the operating mode using the input parameter Mode and a rising edge at ModeActivate.</p> <ul style="list-style-type: none"> <li>• State = 0: Inactive</li> <li>• State = 1: Pretuning</li> <li>• State = 2: Fine tuning</li> <li>• State = 3: Automatic mode</li> <li>• State = 4: Manual mode</li> <li>• State = 5: Approach substitute output value</li> <li>• State = 6: Transition time measurement</li> <li>• State = 7: Error monitoring</li> <li>• State = 8: Approach substitute output value with error monitoring</li> <li>• State = 10: Manual mode without end stop signals</li> </ul>
Error	BOOL	FALSE	If Error = TRUE, at least one error message is pending in this cycle.
ErrorBits	DWORD	DW#16#0	The ErrorBits parameter (Page 2663) shows which error messages are pending. ErrorBits is retentive and is reset upon a rising edge at Reset or ErrorAck.

**See also**

Parameters State and Mode V2 (Page 2658)

Parameter ErrorBits V2 (Page 2663)

**In-out parameters of PID\_3Step V2**

Table 9-85

Parameter	Data type	Default	Description
Mode	INT	4	<p>At the Mode parameter, you specify the operating mode to which PID_3Step is to switch. Options are:</p> <ul style="list-style-type: none"> <li>• Mode = 0: Inactive</li> <li>• Mode = 1: Pretuning</li> <li>• Mode = 2: Fine tuning</li> <li>• Mode = 3: Automatic mode</li> <li>• Mode = 4: Manual mode</li> <li>• Mode = 6: Transition time measurement</li> <li>• Mode = 10: Manual mode without endstop signals</li> </ul> <p>The operating mode is activated by:</p> <ul style="list-style-type: none"> <li>• Rising edge at ModeActivate</li> <li>• Falling edge at Reset</li> <li>• Falling edge at ManualEnable</li> <li>• Cold restart of CPU if RunModeByStartup = TRUE</li> </ul> <p>Mode is retentive.</p> <p>A detailed description of the operating modes can be found in Parameters State and Mode V2 (Page 2658).</p>

**Static tags of PID\_3Step V2**

You must not change tags that are not listed. These are used for internal purposes only.

Tag	Data type	Default	Description
ManualUpInternal	BOOL	FALSE	In manual mode, each rising edge opens the valve by 5% of the total control range or for the duration of the minimum motor transition time. ManualUpInternal is only evaluated if you are not using Output_PER or position feedback. This tag is used in the commissioning dialog.
ManualDnInternal	BOOL	FALSE	In manual mode, every rising edge closes the valve by 5% of the total control range or for the duration of the minimum motor transition time. ManualDnInternal is only evaluated if you are not using Output_PER or position feedback. This tag is used in the commissioning dialog.
ActivateRecoverMode	BOOL	TRUE	The ActivateRecoverMode V2 (Page 2666) tag determines the reaction to error.
RunModeByStartup	BOOL	TRUE	<p>Activate operating mode at Mode parameter after CPU restart</p> <p>If RunModeByStartup = TRUE, PID_3Step starts in the operating mode saved in the Mode parameter after CPU startup.</p> <p>If RunModeByStartup = FALSE, PID_3Step remains in "Inactive" mode after CPU startup.</p>
LoadBackUp	BOOL	FALSE	If LoadBackUp = TRUE, the last set of PID parameters is reloaded. The set was saved prior to the last tuning. LoadBackUp is automatically set back to FALSE.

Tag	Data type	Default	Description
PhysicalUnit	INT	0	Unit of measurement of the process value and setpoint, e.g., °C, or °F.
PhysicalQuantity	INT	0	Physical quantity of the process value and setpoint, e.g., temperature.
ErrorBehaviour	BOOL	FALSE	<p>If ErrorBehaviour = FALSE and an error has occurred, the valve stays at its current position and the controller switches directly to "Inactive" or "Error monitoring" mode.</p> <p>If ErrorBehaviour = TRUE and an error occurs, the actuator moves to the substitute output value and only then switches to "Inactive" or "Error monitoring" mode.</p> <p>If the following errors occur, you can no longer move the valve to a configured substitute output value.</p> <ul style="list-style-type: none"> <li>• 2000h: Invalid value at Feedback_PER parameter.</li> <li>• 4000h: Invalid value at Feedback parameter.</li> <li>• 8000h: Error during digital position feedback.</li> <li>• 20000h: Invalid value at SavePosition tag.</li> </ul>
Warning	DWORD	DW#16#0	<p>The Warning tag (Page 2658) shows the warnings since Reset = TRUE or ErrorAck = TRUE. Warning is retentive.</p> <p>Cyclic warnings (for example, process value warning) are shown until the cause of the warning is removed. They are automatically deleted once their cause has gone. Non-cyclic warnings (for example, point of inflection not found) remain and are deleted like errors.</p>
SavePosition	REAL	0.0	<p>Substitute output value</p> <p>If ErrorBehaviour = TRUE, the actuator is moved to a position that is safe for the plant when an error occurs. As soon as the substitute output value has been reached, PID_3Step switches the operating mode according to ActivateRecoverMode.</p>
CurrentSetpoint	REAL	0.0	Currently active setpoint. This value is frozen at the start of tuning.
CancelTuningLevel	REAL	10.0	<p>Permissible fluctuation of setpoint during tuning. Tuning is not canceled until:</p> <ul style="list-style-type: none"> <li>• Setpoint &gt; CurrentSetpoint + CancelTuningLevel</li> <li>or</li> <li>• Setpoint &lt; CurrentSetpoint - CancelTuningLevel</li> </ul>
Progress	REAL	0.0	Progress of tuning as a percentage (0.0 - 100.0)
Config.InputPerOn	BOOL	TRUE	If InputPerOn = TRUE, the Input_PER parameter is used. If InputPerOn = FALSE, the Input parameter is used.
Config.OutputPerOn	BOOL	FALSE	If OutputPerOn = TRUE, the Output_PER parameter is used. If OutputPerOn = FALSE, the Ouput_UP and Output_DN parameters are used.
Config.InvertControl	BOOL	FALSE	<p>Invert control logic</p> <p>If InvertControl = TRUE, an increasing control deviation causes a reduction in the output value.</p>
Config.FeedbackOn	BOOL	FALSE	<p>If FeedbackOn = FALSE, a position feedback is simulated.</p> <p>Position feedback is generally activated when FeedbackOn = TRUE.</p>

9.7 References

Tag	Data type	Default	Description
Config.FeedbackPerOn	BOOL	FALSE	FeedbackPerOn is only effective when FeedbackOn = TRUE. If FeedbackPerOn = TRUE, the analog input is used for the position feedback (Feedback_PER parameter). If FeedbackPerOn = FALSE, the Feedback parameter is used for the position feedback.
Config.ActuatorEndStopOn	BOOL	FALSE	If ActuatorEndStopOn = TRUE, the digital position feedback Actuator_L and Actuator_H are taken into consideration.
Config.InputUpperLimit	REAL	120.0	High limit of the process value Input and Input_PER are monitored to ensure adherence to this limit. At the I/O input, the process value can be a maximum of 18% higher than the standard range (overrange). An error is no longer signaled due to a violation of the "Process value high limit". Only a wire-break and a short-circuit are recognized and PID_3Step reacts according to the configured reaction to error. InputUpperLimit > InputLowerLimit
Config.InputLowerLimit	REAL	0.0	Low limit of the process value InputLowerLimit < InputUpperLimit
Config.InputUpperWarning	REAL	+3.40282 2e+38	Warning high limit of the process value If you set InputUpperWarning outside the process value limits, the configured absolute process value high limit is used as the warning high limit. If you configure InputUpperWarning within the process value limits, this value is used as the warning high limit. InputUpperWarning > InputLowerWarning InputUpperWarning ≤ InputUpperLimit
Config.InputLowerWarning	REAL	-3.40282 2e+38	Warning low limit of the process value If you set InputLowerWarning outside the process value limits, the configured absolute process value low limit is used as the warning low limit. If you configure InputLowerWarning within the process value limits, this value is used as the warning low limit. InputLowerWarning < InputUpperWarning InputLowerWarning ≥ InputLowerLimit
Config.OutputUpperLimit	REAL	100.0	High limit of output value For details, see OutputLowerLimit
Config.OutputLowerLimit	REAL	0.0	Low limit of output value If OutputPerOn = TRUE or FeedbackOn = TRUE, the range of values from -100% to +100%, including zero, is valid. At -100%, Output = -27648; at +100%, Output = 27648 If OutputPerOn = FALSE, the range of values from 0% to 100% is valid. The valve is completely closed at 0% and completely opened at 100%.
Config.SetpointUpperLimit	REAL	+3.40282 2e+38	High limit of setpoint If you set SetpointUpperLimit outside the process value limits, the configured absolute process value high limit is preassigned as the setpoint high limit. If you configure SetpointUpperLimit within the process value limits, this value is used as the setpoint high limit.

Tag	Data type	Default	Description
Config.SetpointLowerLimit	REAL	- 3.402822 e+38	Low limit of the setpoint If you set SetpointLowerLimit outside the process value limits, the configured absolute process value low limit is preassigned as the setpoint low limit. If you set SetpointLowerLimit within the process value limits, this value is used as the setpoint low limit.
Config.MinimumOnTime	REAL	0.0	Minimum ON time Minimum time in seconds for which the servo drive must be switched on.
Config.MinimumOffTime	REAL	0.0	Minimum OFF time Minimum time in seconds for which the servo drive must be switched off.
Config.VirtualActuatorLimit	REAL	150.0	If all the following conditions have been satisfied, the actuator is moved in one direction for the maximum period of VirtualActuatorLimit × Retain.TransitTime/100 and the warning 2000h is output: <ul style="list-style-type: none"> <li>• Config.OutputPerOn = FALSE</li> <li>• Config.ActuatorEndStopOn = FALSE</li> <li>• Config.FeedbackOn = FALSE</li> </ul> If Config.OutputPerOn = FALSE and Config.ActuatorEndStopOn = TRUE or Config.FeedbackOn = TRUE, only the warning 2000h is output. If Config.OutputPerOn = TRUE, VirtualActuatorLimit is not taken into consideration.
Config.InputScaling.UpperPointIn	REAL	27648.0	Scaling Input_PER high Input_PER is converted to a percentage based on the two value pairs UpperPointOut, UpperPointIn and LowerPointOut, LowerPointIn of the InputScaling structure.
Config.InputScaling.LowerPointIn	REAL	0.0	Scaling Input_PER low Input_PER is converted to a percentage based on the two value pairs UpperPointOut, UpperPointIn and LowerPointOut, LowerPointIn of the InputScaling structure.
Config.InputScaling.UpperPointOut	REAL	100.0	Scaled high process value Input_PER is converted to a percentage based on the two value pairs UpperPointOut, UpperPointIn and LowerPointOut, LowerPointIn of the InputScaling structure.
Config.InputScaling.LowerPointOut	REAL	0.0	Scaled low process value Input_PER is converted to a percentage based on the two value pairs UpperPointOut, UpperPointIn and LowerPointOut, LowerPointIn of the InputScaling structure.
Config.FeedbackScaling.UpperPointIn	REAL	27648.0	Scaling Feedback_PER high Feedback_PER is converted to a percentage based on the two value pairs UpperPointOut, UpperPointIn and LowerPointOut, LowerPointIn of the FeedbackScaling structure.
Config.FeedbackScaling.LowerPointIn	REAL	0.0	Scaling Feedback_PER low Feedback_PER is converted to a percentage based on the two value pairs UpperPointOut, UpperPointIn and LowerPointOut, LowerPointIn of the FeedbackScaling structure.

9.7 References

Tag	Data type	Default	Description
Config.FeedbackScaling.UpperPointOut	REAL	100.0	High endstop Feedback_PER is converted to a percentage based on the two value pairs UpperPointOut, UpperPointIn and LowerPointOut, LowerPointIn of the FeedbackScaling structure.
Config.FeedbackScaling.LowerPointOut	REAL	0.0	Low endstop Feedback_PER is converted to a percentage based on the two value pairs UpperPointOut, UpperPointIn and LowerPointOut, LowerPointIn of the FeedbackScaling structure.
GetTransitTime.InvertDirection	BOOL	FALSE	If InvertDirection = FALSE, the valve is fully opened, closed, and then reopened in order to determine the valve transition time. If InvertDirection = TRUE, the valve is fully closed, opened, and then closed again.
GetTransitTime.SelectFeedback	BOOL	FALSE	If SelectFeedback = TRUE, then Feedback_PER, or Feedback is taken into consideration in the transition time measurement. If SelectFeedback = FALSE, then Actuator_H and Actuator_L are taken into consideration in the transition time measurement.
GetTransitTime.State	INT	0	Current phase of the transition time measurement <ul style="list-style-type: none"> <li>• State = 0: Inactive</li> <li>• State = 1: Open valve completely</li> <li>• State = 2: Close valve completely</li> <li>• State = 3: Move valve to target position (NewOutput)</li> <li>• State = 4: Transition time measurement successfully completed</li> <li>• State = 5: Transition time measurement canceled</li> </ul>
GetTransitTime.NewOutput	REAL	0.0	Target position for transition time measurement with position feedback The target position must be between "High endstop" and "Low endstop". The difference between NewOutput and ScaledFeedback must be at least 50% of the permissible control range.
CycleTime.StartEstimation	BOOL	TRUE	If StartEstimation = TRUE, the measurement of the PID_3Step sampling time is started. CycleTime.StartEstimation = FALSE once measurement is complete.
CycleTime.EnEstimation	BOOL	TRUE	If EnEstimation = TRUE, the PID_3Step sampling time is calculated. If CycleTime.EnEstimation = FALSE, the PID_3Step sampling time is not calculated and you need to correct the configuration of CycleTime.Value manually.
CycleTime.EnMonitoring	BOOL	TRUE	If EnMonitoring = TRUE, the PID_3Step sampling time is monitored. If it is not possible to execute PID_3Step within the sampling time, the error 0800h is output and the operating mode is switched. ActivateRecoverMode and ErrorBehaviour determine which operating mode is switched to. If EnMonitoring = FALSE, the PID_3Step sampling time is not monitored, the error 0800h is not output, and the operating mode is not switched.
CycleTime.Value	REAL	0.1	PID_3Step sampling time in seconds CycleTime.Value is determined automatically and is usually equivalent to the cycle time of the calling OB.

Tag	Data type	Default	Description
CtrlParamsBackUp.SetByUser	BOOL	FALSE	Saved value of Retain.CtrlParams.SetByUser. You can reload values from the CtrlParamsBackUp structure with LoadBackUp = TRUE.
CtrlParamsBackUp.Gain	REAL	1.0	Saved proportional gain
CtrlParamsBackUp.Ti	REAL	20.0	Saved integral action time in seconds
CtrlParamsBackUp.Td	REAL	0.0	Saved derivative action time in seconds
CtrlParamsBackUp.TdFiltRatio	REAL	0.0	Saved derivative delay coefficient
CtrlParamsBackUp.PWeighting	REAL	0.0	Saved proportional action weighting
CtrlParamsBackUp.DWeighting	REAL	0.0	Saved derivative action weighting
CtrlParamsBackUp.Cycle	REAL	1.0	Saved sampling time of PID algorithm in seconds
CtrlParamsBackUp.InputDeadBand	REAL	0.0	Saved deadband width of the control deviation
PIDSelfTune.SUT.CalculateParams	BOOL	FALSE	The properties of the controlled system are saved during tuning. If CalculateParams = TRUE, the PID parameters are recalculated on the basis of these properties. The PID parameters are calculated using the method set in TuneRule. CalculateParams is set to FALSE following calculation.
PIDSelfTune.SUT.TuneRule	INT	1	Methods used to calculate parameters during pretuning: <ul style="list-style-type: none"> <li>• SUT.TuneRule = 0: PID rapid I</li> <li>• SUT.TuneRule = 1: PID slow I</li> <li>• SUT.TuneRule = 2: Chien, Hrones and Reswick PID</li> <li>• SUT.TuneRule = 3: Chien, Hrones, Reswick PI</li> <li>• SUT.TuneRule = 4: PID rapid II</li> <li>• SUT.TuneRule = 5: PID slow II</li> </ul>
PIDSelfTune.SUT.State	INT	0	The SUT.State tag indicates the current phase of pretuning: <ul style="list-style-type: none"> <li>• State = 0: Initialize pretuning</li> <li>• State = 50: Determine start position without position feedback</li> <li>• State = 100: Calculate standard deviation</li> <li>• State = 200: Determine point of inflection</li> <li>• State = 300: Determine rise time</li> <li>• State = 9900: Pretuning successful</li> <li>• State = 1: Pretuning not successful</li> </ul>

Tag	Data type	Default	Description
PIDSelfTune.TIR.RunIn	BOOL	FALSE	<p>With the RunIn tag, you can specify that fine tuning can also be performed without pretuning.</p> <ul style="list-style-type: none"> <li>RunIn = FALSE Pretuning is started when fine tuning is started from inactive or manual mode. If fine tuning is started from automatic mode, the system uses the existing PID parameters to control to the setpoint. Only then will fine tuning start. If pretuning is not possible, PID_3Step switches to the mode from which tuning was started.</li> <li>RunIn = TRUE The pretuning is skipped. PID_3Step attempts to reach the setpoint with the minimum or maximum output value. This can produce increased overshoot. Only then will fine tuning start. RunIn is set to FALSE after fine tuning.</li> </ul>
PIDSelfTune.TIR.CalculateParams	BOOL	FALSE	<p>The properties of the controlled system are saved during tuning. If CalculateParams = TRUE, the PID parameters are recalculated on the basis of these properties. The PID parameters are calculated using the method set in TuneRule. CalculateParams is set to FALSE following calculation.</p>
PIDSelfTune.TIR.TuneRule	INT	0	<p>Methods used to calculate parameters during fine tuning:</p> <ul style="list-style-type: none"> <li>TIR.TuneRule = 0: PID automatic</li> <li>TIR.TuneRule = 1: PID rapid</li> <li>TIR.TuneRule = 2: PID slow</li> <li>TIR.TuneRule = 3: Ziegler-Nichols PID</li> <li>TIR.TuneRule = 4: Ziegler-Nichols PI</li> <li>TIR.TuneRule = 5: Ziegler-Nichols P</li> </ul>
PIDSelfTune.TIR.State	INT	0	<p>The TIR.State tag indicates the current phase of fine tuning:</p> <ul style="list-style-type: none"> <li>State = -100 Fine tuning is not possible. Pretuning will be performed first.</li> <li>State = 0: Initialize fine tuning</li> <li>State = 200: Calculate standard deviation</li> <li>State = 300: Attempt to reach the setpoint with the maximum or minimum output value</li> <li>State = 400: Attempt to reach the setpoint with existing PID parameters (if pretuning was successful)</li> <li>State = 500: Determine oscillation and calculate parameters</li> <li>State = 9900: Fine tuning successful</li> <li>State = 1: Fine tuning not successful</li> </ul>
Retain.TransitTime	REAL	30.0	<p>Motor transition time in seconds</p> <p>Time in seconds the actuating drive requires to move the valve from the closed to the opened state.</p> <p>TransitTime is retentive.</p>



Tag	Data type	Default	Description
Retain.CtrlParams.SetByUser	BOOL	FALSE	<p>If SetByUser = FALSE, the PID parameters are determined automatically and PID_3Step operates with a deadband at the output value. The deadband width is calculated during tuning on the basis of the standard deviation of the output value and saved in Retain.CtrlParams.OutputDeadBand.</p> <p>If SetByUser = TRUE, the PID parameters are entered manually and PID_3 Step operates without a deadband at the output value. Retain.CtrlParams.OutputDeadBand = 0.0</p> <p>SetByUser is retentive.</p>
Retain.CtrlParams.Gain	REAL	1.0	<p>Active proportional gain</p> <p>To invert the control logic, use the Config.InvertControl tag. Negative values at Gain also invert the control logic. We recommend you use only InvertControl to set the control logic. The control logic is also inverted if InvertControl = TRUE and Gain &lt; 0.0.</p> <p>Gain is retentive.</p>
Retain.CtrlParams.Ti	REAL	20.0	<ul style="list-style-type: none"> <li>• Ti &gt; 0.0: Active integral action time in seconds</li> <li>• Ti = 0.0: Integral action is deactivated</li> </ul> <p>Ti is retentive.</p>
Retain.CtrlParams.Td	REAL	0.0	<ul style="list-style-type: none"> <li>• Td &gt; 0.0: Active derivative action time in seconds</li> <li>• Td = 0.0: Derivative action is deactivated</li> </ul> <p>Td is retentive.</p>
Retain.CtrlParams.TdFiltRatio	REAL	0.2	<p>Active derivative delay coefficient</p> <p>The derivative delay coefficient delays the effect of the derivative action.</p> <p>Derivative delay = derivative action time × derivative delay coefficient</p> <ul style="list-style-type: none"> <li>• 0.0: Derivative action is effective for one cycle only and therefore almost not effective.</li> <li>• 0.5: This value has proved useful in practice for controlled systems with <b>one</b> dominant time constant.</li> <li>• &gt; 1.0: The greater the coefficient, the longer the effect of the derivative action is delayed.</li> </ul> <p>TdFiltRatio is retentive.</p>
Retain.CtrlParams.PWeighting	REAL	1.0	<p>Active proportional action weighting</p> <p>The proportional action may weaken with changes to the setpoint. Values from 0.0 to 1.0 are applicable.</p> <ul style="list-style-type: none"> <li>• 1.0: Proportional action for setpoint change is fully effective</li> <li>• 0.0: Proportional action for setpoint change is not effective</li> </ul> <p>The proportional action is always fully effective when the process value is changed.</p> <p>PWeighting is retentive.</p>

Tag	Data type	Default	Description
Retain.CtrlParams.DWeighting	REAL	1.0	Active derivative action weighting The derivative action may weaken with changes to the setpoint. Values from 0.0 to 1.0 are applicable. <ul style="list-style-type: none"> <li>• 1.0: Derivative action is fully effective upon setpoint change</li> <li>• 0.0: Derivative action is not effective upon setpoint change</li> </ul> The derivative action is always fully effective when the process value is changed. DWeighting is retentive.
Retain.CtrlParams.Cycle	REAL	1.0	Active sampling time of PID algorithm in seconds, rounded to an integer multiple of the cycle time of the calling OB. Cycle is retentive.
Retain.CtrlParams.InputDeadBand	REAL	0.0	Deadband width of the control deviation InputDeadBand is retentive.

**Note**

Change the tags listed in this table in "Inactive" mode to prevent malfunction of the PID controller.

**See also**

Parameters State and Mode V2 (Page 2658)

Tag ActivateRecoverMode V2 (Page 2666)

Downloading technology objects to device (Page 5937)

**Parameters State and Mode V2**

**Correlation of the parameters**

The State parameter shows the current operating mode of the PID controller. You cannot change the State parameter.

With a rising edge at ModeActivate, PID\_3Step switches to the operating mode saved in the Mode in-out parameter.

When the CPU is switched on or switches from Stop to RUN mode, PID\_3Step starts in the operating mode that is saved in the Mode parameter. To leave PID\_3Step in "Inactive" mode, set RunModeByStartup = FALSE.

## Meaning of values

State	Description of operating mode
0	<p>Inactive</p> <p>The controller is switched off and no longer changes the valve position.</p>
1	<p>Pretuning</p> <p>The pretuning determines the process response to a pulse of the output value and searches for the point of inflection. The PID parameters are calculated from the maximum rate of rise and dead time of the controlled system. You obtain the best PID parameters when you perform pretuning and fine tuning.</p> <p>Pretuning requirements:</p> <ul style="list-style-type: none"> <li>• The motor transition time has been configured or measured.</li> <li>• Inactive (State = 0), manual mode (State = 4), or automatic mode (State = 3)</li> <li>• ManualEnable = FALSE</li> <li>• Reset = FALSE</li> <li>• The setpoint and the process value lie within the configured limits.</li> </ul> <p>The more stable the process value is, the easier it is to calculate the PID parameters and the more precise the result will be. Noise on the process value can be tolerated as long as the rate of rise of the process value is significantly higher as compared to the noise. This is most likely the case in operating modes "Inactive" and "manual mode".</p> <p>The setpoint is frozen in the CurrentSetpoint tag. Tuning is canceled when:</p> <ul style="list-style-type: none"> <li>• <math>\text{Setpoint} &gt; \text{CurrentSetpoint} + \text{CancelTuningLevel}</math></li> <li>or</li> <li>• <math>\text{Setpoint} &lt; \text{CurrentSetpoint} - \text{CancelTuningLevel}</math></li> </ul> <p>Before the PID parameters are recalculated, they are backed up and can be reactivated with LoadBackUp.</p> <p>The controller switches to automatic mode following successful pretuning. If pretuning is unsuccessful, the switchover of operating mode is dependent on ActivateRecoverMode and ErrorBehaviour.</p> <p>The pretuning phase is indicated with the SUT.State tag.</p>

State	Description of operating mode
2	<p>Fine tuning</p> <p>Fine tuning generates a constant, limited oscillation of the process value. The PID parameters are recalculated based on the amplitude and frequency of this oscillation. PID parameters from fine tuning usually have better master control and disturbance characteristics than PID parameters from pretuning. You obtain the best PID parameters when you perform pretuning and fine tuning.</p> <p>PID_3Step automatically attempts to generate an oscillation greater than the noise of the process value. Fine tuning is only minimally influenced by the stability of the process value.</p> <p>The setpoint is frozen in the CurrentSetpoint tag. Tuning is canceled when:</p> <ul style="list-style-type: none"> <li>• Setpoint &gt; CurrentSetpoint + CancelTuningLevel or</li> <li>• Setpoint &lt; CurrentSetpoint - CancelTuningLevel</li> </ul> <p>The PID parameters are backed up before fine tuning. They can be reactivated with LoadBackUp.</p> <p>Requirements for fine tuning:</p> <ul style="list-style-type: none"> <li>• The motor transition time has been configured or measured.</li> <li>• The setpoint and the process value lie within the configured limits.</li> <li>• ManualEnable = FALSE</li> <li>• Reset = FALSE</li> <li>• Automatic (State = 3), inactive (State = 0) or manual (State = 4) mode</li> </ul> <p>Fine tuning proceeds as follows when started from:</p> <ul style="list-style-type: none"> <li>• Automatic mode (State = 3) Start fine tuning from automatic mode if you wish to improve the existing PID parameters through tuning. PID_3Step controls the system using the existing PID parameters until the control loop has stabilized and the requirements for fine tuning have been met. Only then will fine tuning start.</li> <li>• Inactive (State = 0) or manual mode (State = 4) If the requirements for pretuning are met, pretuning is started. The determined PID parameters will be used for control until the control loop has stabilized and the requirements for fine tuning have been met. If PIDSelfTune.TIR.RunIn = TRUE, pretuning is skipped and an attempt is made to reach the setpoint with the minimum or maximum output value. This can produce increased overshoot. Fine tuning then starts automatically.</li> </ul> <p>The controller switches to automatic mode following successful fine tuning. If fine tuning is unsuccessful, the switchover of operating mode is dependent on ActivateRecoverMode and ErrorBehaviour.</p> <p>The fine tuning phase is indicated with the TIR.State tag.</p>
3	<p>Automatic mode</p> <p>In automatic mode, PID_3Step controls the controlled system in accordance with the parameters specified. The controller switches to automatic mode if one the following requirements is fulfilled:</p> <ul style="list-style-type: none"> <li>• Pretuning successfully completed</li> <li>• Fine tuning successfully completed</li> <li>• Changing of the Mode in-out parameter to the value 3 and a rising edge at ModeActivate.</li> </ul> <p>The switchover from automatic mode to manual mode is only bumpless if carried out in the commissioning editor.</p> <p>The ActivateRecoverMode tag is taken into consideration in automatic mode.</p>

State	Description of operating mode
4	<p>Manual mode</p> <p>In manual mode, you specify manual output values in the Manual_UP and Manual_DN parameters or ManualValue parameter. Whether or not the actuator can be moved to the output value in the event of an error is described in the ErrorBits parameter.</p> <p>You can also activate this operating mode using ManualEnable = TRUE. We recommend that you change the operating mode using Mode and ModeActivate only.</p> <p>The switchover from manual mode to automatic mode is bumpless. Manual mode is also possible when an error is pending.</p>
5	<p>Approach substitute output value</p> <p>This operating mode is activated in the event of an error, if Errorbehaviour = TRUE and ActivateRecoverMode = FALSE..</p> <p>PID_3Step moves the actuator to the substitute output value and then switches to "Inactive" mode.</p>
6	<p>Transition time measurement</p> <p>The time that the motor needs to completely open the valve from the closed condition is determined.</p> <p>This operating mode is activated when Mode = 6 and ModeActivate = TRUE is set.</p> <p>If endstop signals are used to measure the transition time, the valve will be opened completely from its current position, closed completely, and opened completely again. If GetTransitTime.InvertDirection = TRUE, this behavior is inverted.</p> <p>If position feedback is used to measure the transition time, the actuator will be moved from its current position to a target position.</p> <p>The output value limits are not taken into consideration during the transition time measurement. The actuator can travel to the high or the low endstop.</p>
7	<p>Error monitoring</p> <p>The control algorithm is switched off and no longer changes the valve position.</p> <p>This operating mode is activated instead of "Inactive" mode in the event of an error.</p> <p>All the following conditions must be met:</p> <ul style="list-style-type: none"> <li>• Automatic mode (Mode = 3)</li> <li>• Errorbehaviour = FALSE</li> <li>• ActivateRecoverMode = TRUE</li> <li>• One or more errors have occurred in which ActivateRecoverMode (Page 2666) is effective.</li> </ul> <p>As soon as the errors are no longer pending, PID_3Step switches back to automatic mode.</p>
8	<p>Approach substitute output value with error monitoring</p> <p>This operating mode is activated instead of "approach substitute output value" mode when an error occurs. PID_3Step moves the actuator to the substitute output value and then switches to "error monitoring" mode.</p> <p>All the following conditions must be met:</p> <ul style="list-style-type: none"> <li>• Automatic mode (Mode = 3)</li> <li>• Errorbehaviour = TRUE</li> <li>• ActivateRecoverMode = TRUE</li> <li>• One or more errors have occurred in which ActivateRecoverMode (Page 2666) is effective.</li> </ul> <p>As soon as the errors are no longer pending, PID_3Step switches back to automatic mode.</p>
10	<p>Manual mode without endstop signals</p> <p>The endstop signals are <b>not</b> taken into consideration, even though Config.ActuatorEndStopOn = TRUE. The output value limits are not taken into consideration. Otherwise, PID_3Step behaves the same as in manual mode.</p>

**ENO characteristics**

If State = 0, then ENO = FALSE.

If State ≠ 0, then ENO = TRUE.

**Automatic switchover of operating mode during commissioning**

Automatic mode is activated following successful pretuning or fine tuning. The following table shows how Mode and State change during successful pretuning.

Cycle no.	Mode	State	Action
0	4	4	Set Mode = 1
1	1	4	Set ModeActivate = TRUE
1	4	1	Value of State is saved in Mode parameter Pretuning is started
n	4	1	Pretuning successfully completed
n	3	3	Automatic mode is started

PID\_3Step automatically switches the operating mode in the event of an error. The following table shows how Mode and State change during pretuning with errors.

Cycle no.	Mode	State	Action
0	4	4	Set Mode = 1
1	1	4	Set ModeActivate = TRUE
1	4	1	Value of State is saved in Mode parameter Pretuning is started
n	4	1	Pretuning canceled
n	4	4	Manual mode is started

If ActivateRecoverMode = TRUE, the operating mode that is saved in the Mode parameter is activated. At the start of transition time measurement, pretuning, or fine tuning, PID\_3Step saved the value of State in the Mode in/out parameter. PID\_3Step therefore switches to the operating mode from which transition time measurement or tuning was started.

If ActivateRecoverMode = FALSE, "Inactive" or "Approach substitute output value" mode is activated.

**Automatic switchover of operating mode after transition time measurement**

If ActivateRecoverMode = TRUE, the operating mode that is saved in the Mode parameter is activated after successful transition time measurement.

If ActivateRecoverMode = FALSE, the system switches to "Inactive" operating mode after successful transition time measurement.

### Automatic switchover of operating mode in automatic mode

PID\_3Step automatically switches the operating mode in the event of an error. The following diagram illustrates the influence of ErrorBehaviour and ActivateRecoverMode on this switchover of operating mode.

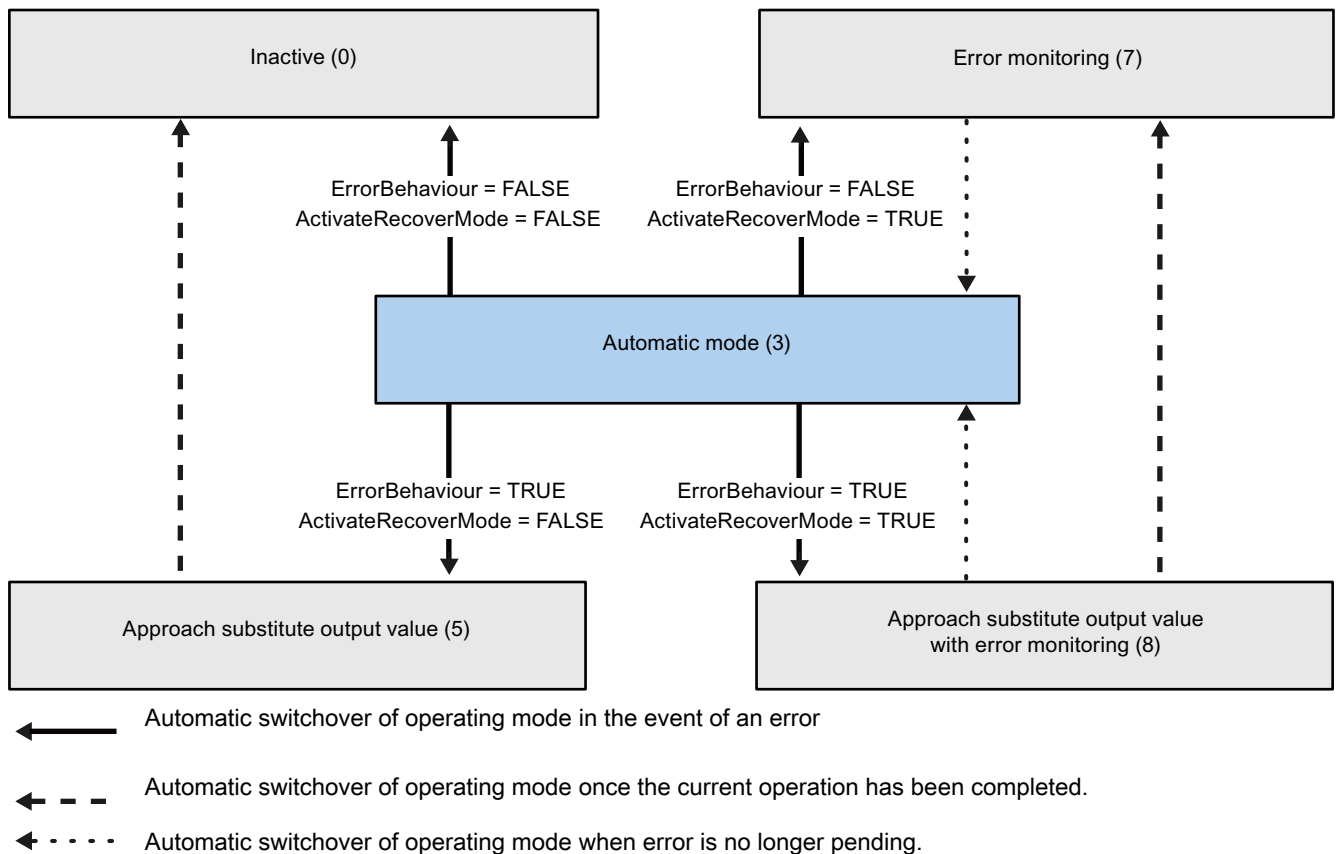

### See also

Tag ActivateRecoverMode V2 (Page 2666)

Parameter ErrorBits V2 (Page 2663)

### Parameter ErrorBits V2

If several errors are pending simultaneously, the values of the ErrorBits are displayed with binary addition. The display of ErrorBits = 0003h, for example, indicates that the errors 0001h and 0002h are pending simultaneously.

If there is a position feedback, PID\_3Step uses ManualValue as output value in manual mode. The exception is Errorbits = 10000h.

ErrorBits (DW#16#...)	Description
0000	There is no error.
0001	<p>The "Input" parameter is outside the process value limits.</p> <ul style="list-style-type: none"> <li>• Input &gt; Config.InputUpperLimit or</li> <li>• Input &lt; Config.InputLowerLimit</li> </ul> <p>If automatic mode was active before the error occurred and ActivateRecoverMode = TRUE, PID_3Step remains in automatic mode.</p> <p>If pretuning, fine tuning, or transition time measurement mode and ActivateRecoverMode = TRUE were active before the error occurred, PID_3Step switches to the operating mode that is saved in the Mode parameter.</p>
0002	<p>Invalid value at "Input_PER" parameter. Check whether an error is pending at the analog input.</p> <p>If automatic mode was active before the error occurred and ActivateRecoverMode = TRUE, PID_3Step switches to "Approach substitute output value with error monitoring" or "Error monitoring" mode. As soon as the error is no longer pending, PID_3Step switches back to automatic mode.</p> <p>If pretuning, fine tuning, or transition time measurement mode and ActivateRecoverMode = TRUE were active before the error occurred, PID_3Step switches to the operating mode that is saved in the Mode parameter.</p>
0004	<p>Error during fine tuning. Oscillation of the process value could not be maintained.</p> <p>If ActivateRecoverMode = TRUE before the error occurred, PID_3Step cancels the tuning and switches to the operating mode that is saved in the Mode parameter.</p>
0010	<p>The setpoint was changed during tuning.</p> <p>You can set the permitted fluctuation of the setpoint at the CancelTuningLevel tag.</p> <p>If ActivateRecoverMode = TRUE before the error occurred, PID_3Step cancels the tuning and switches to the operating mode that is saved in the Mode parameter.</p>
0020	<p>Pretuning is not permitted during fine tuning.</p> <p>If ActivateRecoverMode = TRUE before the error occurred, PID_3Step remains in fine tuning mode.</p>
0080	<p>Error during pretuning. Incorrect configuration of output value limits.</p> <p>Check whether the limits of the output value are configured correctly and match the control logic.</p> <p>If ActivateRecoverMode = TRUE before the error occurred, PID_3Step cancels the tuning and switches to the operating mode that is saved in the Mode parameter.</p>
0100	<p>Error during fine tuning resulted in invalid parameters.</p> <p>If ActivateRecoverMode = TRUE before the error occurred, PID_3Step cancels the tuning and switches to the operating mode that is saved in the Mode parameter.</p>
0200	<p>Invalid value at "Input" parameter: Value has an invalid number format.</p> <p>If automatic mode was active before the error occurred and ActivateRecoverMode = TRUE, PID_3Step switches to "Approach substitute output value with error monitoring" or "Error monitoring" mode. As soon as the error is no longer pending, PID_3Step switches back to automatic mode.</p> <p>If pretuning, fine tuning, or transition time measurement mode and ActivateRecoverMode = TRUE were active before the error occurred, PID_3Step switches to the operating mode that is saved in the Mode parameter.</p>
0400	<p>Calculation of output value failed. Check the PID parameters.</p> <p>If automatic mode was active before the error occurred and ActivateRecoverMode = TRUE, PID_3Step switches to "Approach substitute output value with error monitoring" or "Error monitoring" mode. As soon as the error is no longer pending, PID_3Step switches back to automatic mode.</p> <p>If pretuning, fine tuning, or transition time measurement mode and ActivateRecoverMode = TRUE were active before the error occurred, PID_3Step switches to the operating mode that is saved in the Mode parameter.</p>



ErrorBits (DW#16#...)	Description
0800	<p>Sampling time error: PID_3Step is not called within the sampling time of the cyclic interrupt OB.</p> <p>If automatic mode was active before the error occurred and ActivateRecoverMode = TRUE, PID_3Step remains in automatic mode.</p> <p>If pretuning, fine tuning, or transition time measurement mode and ActivateRecoverMode = TRUE were active before the error occurred, PID_3Step switches to the operating mode that is saved in the Mode parameter.</p>
1000	<p>Invalid value at "Setpoint" parameter: Value has an invalid number format.</p> <p>If automatic mode was active before the error occurred and ActivateRecoverMode = TRUE, PID_3Step switches to "Approach substitute output value with error monitoring" or "Error monitoring" mode. As soon as the error is no longer pending, PID_3Step switches back to automatic mode.</p> <p>If pretuning, fine tuning, or transition time measurement mode and ActivateRecoverMode = TRUE were active before the error occurred, PID_3Step switches to the operating mode that is saved in the Mode parameter.</p>
2000	<p>Invalid value at Feedback_PER parameter.</p> <p>Check whether an error is pending at the analog input.</p> <p>The actuator cannot be moved to the substitute output value and remains in its current position. In manual mode, you can change the position of the actuator only with Manual_UP and Manual_DN, and not with ManualValue.</p> <p>If automatic mode was active before the error occurred, ActivateRecoverMode = TRUE, and the error is no longer pending, PID_3Step switches back to automatic mode.</p> <p>If pretuning, fine tuning, or transition time measurement mode and ActivateRecoverMode = TRUE were active before the error occurred, PID_3Step switches to the operating mode that is saved in the Mode parameter.</p>
4000	<p>Invalid value at Feedback parameter. Value has an invalid number format.</p> <p>The actuator cannot be moved to the substitute output value and remains in its current position. In manual mode, you can change the position of the actuator only with Manual_UP and Manual_DN, and not with ManualValue.</p> <p>If automatic mode was active before the error occurred, ActivateRecoverMode = TRUE, and the error is no longer pending, PID_3Step switches back to automatic mode.</p> <p>If pretuning, fine tuning, or transition time measurement mode and ActivateRecoverMode = TRUE were active before the error occurred, PID_3Step switches to the operating mode that is saved in the Mode parameter.</p>
8000	<p>Error during digital position feedback. Actuator_H = TRUE and Actuator_L = TRUE.</p> <p>The actuator cannot be moved to the substitute output value and remains in its current position. Manual mode is not possible in this state.</p> <p>In order to move the actuator from this state, you must deactivate the "Actuator endstop" (Config.ActuatorEndStopOn = FALSE) or switch to manual mode without endstop signals (Mode = 10).</p> <p>If automatic mode was active before the error occurred, ActivateRecoverMode = TRUE, and the error is no longer pending, PID_3Step switches back to automatic mode.</p> <p>If pretuning, fine tuning, or transition time measurement mode and ActivateRecoverMode = TRUE were active before the error occurred, PID_3Step switches to the operating mode that is saved in the Mode parameter.</p>
10000	<p>Invalid value at ManualValue parameter. Value has an invalid number format.</p> <p>The actuator cannot be moved to the manual value and remains in its current position.</p> <p>Specify a valid value in ManualValue or move the actuator in manual mode with Manual_UP and Manual_DN.</p>

ErrorBits (DW#16#...)	Description
20000	Invalid value at SavePosition tag. Value has an invalid number format. The actuator cannot be moved to the substitute output value and remains in its current position.
40000	Invalid value at Disturbance parameter. Value has an invalid number format. If automatic mode was active and ActivateRecoverMode = TRUE before the error occurred, Disturbance is set to zero. PID_3Step remains in automatic mode. If pretuning or fine tuning mode was active and ActivateRecoverMode = TRUE before the error occurred, PID_3Step switches to the operating mode saved in the Mode parameter. If Disturbance in the current phase has no effect on the output value, tuning is not be canceled. The error has no effect during transition time measurement.

### Tag ActivateRecoverMode V2

The ActivateRecoverMode tag determines the reaction to error. The Error parameter indicates if an error is pending. When the error is no longer pending, Error = FALSE. The ErrorBits parameter shows which errors have occurred.

<p><b>NOTICE</b></p>
<p><b>Your system may be damaged.</b></p> <p>If ActivateRecoverMode = TRUE, PID_3Step remains in automatic mode even if the process limit values are exceeded. This may damage your system.</p> <p>It is essential to configure how your controlled system reacts in the event of an error to protect your system from damage.</p>

## Automatic mode

ActivateRecover Mode	Description
FALSE	In the event of an error, PID_3Step switches to "Inactive" or "Approach substitute output value" mode. The controller is only activated by a falling edge at Reset or a rising edge at ModeActivate.
TRUE	<p>If errors occur frequently in automatic mode, this setting has a negative effect on the control response, because PID_3Step switches between the calculated output value and the substitute output value at each error. In this case, check the ErrorBits parameter and eliminate the cause of the error.</p> <p>If one or more of the following errors occur, PID_3Step stays in automatic mode:</p> <ul style="list-style-type: none"> <li>• 0001h: The "Input" parameter is outside the process value limits.</li> <li>• 0800h: Sampling time error</li> <li>• 40000h: Invalid value at Disturbance parameter.</li> </ul> <p>If one or more of the following errors occur, PID_3Step switches to "Approach substitute output value with error monitoring" or "Error monitoring" mode:</p> <ul style="list-style-type: none"> <li>• 0002h: Invalid value at Input_PER parameter.</li> <li>• 0200h: Invalid value at Input parameter.</li> <li>• 0400h: Calculation of output value failed.</li> <li>• 1000h: Invalid value at Setpoint parameter.</li> </ul> <p>If one or more of the following errors occur, PID_3Step can no longer move the actuator:</p> <ul style="list-style-type: none"> <li>• 2000h: Invalid value at Feedback_PER parameter.</li> <li>• 4000h: Invalid value at Feedback parameter.</li> <li>• 8000h: Error during digital position feedback.</li> <li>• 20000h: Invalid value at SavePosition tag. Value has an invalid number format.</li> </ul> <p>The characteristics are independent of ErrorBehaviour.</p> <p>As soon as the errors are no longer pending, PID_3Step switches back to automatic mode.</p>

## Pretuning, fine tuning, and transition time measurement

ActivateRecover Mode	Description
FALSE	In the event of an error, PID_3Step switches to "Inactive" or "Approach substitute output value" mode. The controller is only activated by a falling edge at Reset or a rising edge at ModeActivate. The controller changes to "Inactive" mode after successful transition time measurement.
TRUE	<p>If the following error occurs, PID_3Step remains in the active mode:</p> <ul style="list-style-type: none"> <li>• 0020h: Pretuning is not permitted during fine tuning.</li> </ul> <p>The following errors are ignored:</p> <ul style="list-style-type: none"> <li>• 10000h: Invalid value at ManualValue parameter.</li> <li>• 20000h: Invalid value at SavePosition tag.</li> </ul> <p>When any other error occurs, PID_3Step cancels the tuning and switches to the mode from which tuning was started.</p>

## Manual mode

ActivateRecoverMode is not effective in manual mode.

**See also**

- Static tags of PID\_3Step V2 (Page 2650)
- Parameters State and Mode V2 (Page 2658)

**Tag Warning V2**

If several warnings are pending simultaneously, their values are displayed with binary addition. The display of warning 0005h, for example, indicates that the warnings 0001h and 0004h are pending simultaneously.

Warning (DW#16#...)	Description
0000	No warning pending.
0001	The point of inflection was not found during pretuning.
0004	The setpoint was limited to the configured limits.
0008	Not all the necessary controlled system properties were defined for the selected method of calculation. Instead, the PID parameters were calculated using the TIR.TuneRule = 3 method.
0010	The operating mode could not be changed because Reset = TRUE or ManualEnable = TRUE.
0020	The cycle time of the calling OB limits the sampling time of the PID algorithm. Improve results by using shorter OB cycle times.
0040	The process value exceeded one of its warning limits.
0080	Invalid value at Mode. The operating mode is not switched.
0100	The manual value was limited to the limits of the controller output.
0200	The specified rule for tuning is not supported. No PID parameters are calculated.
0400	The transition time cannot be measured because the actuator settings do not match the selected measuring method.
0800	The difference between the current position and the new output value is too small for transition time measurement. This can produce incorrect results. The difference between the current output value and new output value must be at least 50% of the entire control range.
1000	The substitute output value cannot be reached because it is outside the output value limits.
2000	The actuator was moved in one direction for longer than Config.VirtualActuatorLimit × Retain.TransitTime. Check whether the actuator has reached an endstop signal.

The following warnings are deleted as soon as the cause is eliminated:

- 0001h
- 0004h
- 0008h
- 0040h
- 0100h

All other warnings are cleared with a rising edge at Reset or ErrorAck.

## PID\_3Step V1

### Description of PID\_3Step

#### Description

You use the PID\_3Step instruction to configure a PID controller with self tuning for valves or actuators with integrating behavior.

The following operating modes are possible:

- Inactive
- Pretuning
- Fine tuning
- Automatic mode
- Manual mode
- Approach substitute output value
- Transition time measurement
- Approach substitute output value with error monitoring
- Error monitoring

For a more detailed description of the operating modes, see the State parameter.

**PID algorithm**

PID\_3Step is a PIDT1 controller with anti-windup and weighting of the proportional and derivative actions. The following equation is used to calculate the output value.

$$\Delta y = K_p \cdot s \cdot \left[ (b \cdot w - x) + \frac{1}{T_i \cdot s} (w - x) + \frac{T_D \cdot s}{a \cdot T_D \cdot s + 1} (c \cdot w - x) \right]$$

Symbol	Description
y	Output value
K <sub>p</sub>	Proportional gain
s	Laplace operator
b	Proportional action weighting
w	Setpoint
x	Process value
T <sub>i</sub>	Integral action time
a	Derivative delay coefficient (T1 = a × T <sub>D</sub> )
T <sub>D</sub>	Derivative action time
c	Derivative action weighting

Block diagram without position feedback

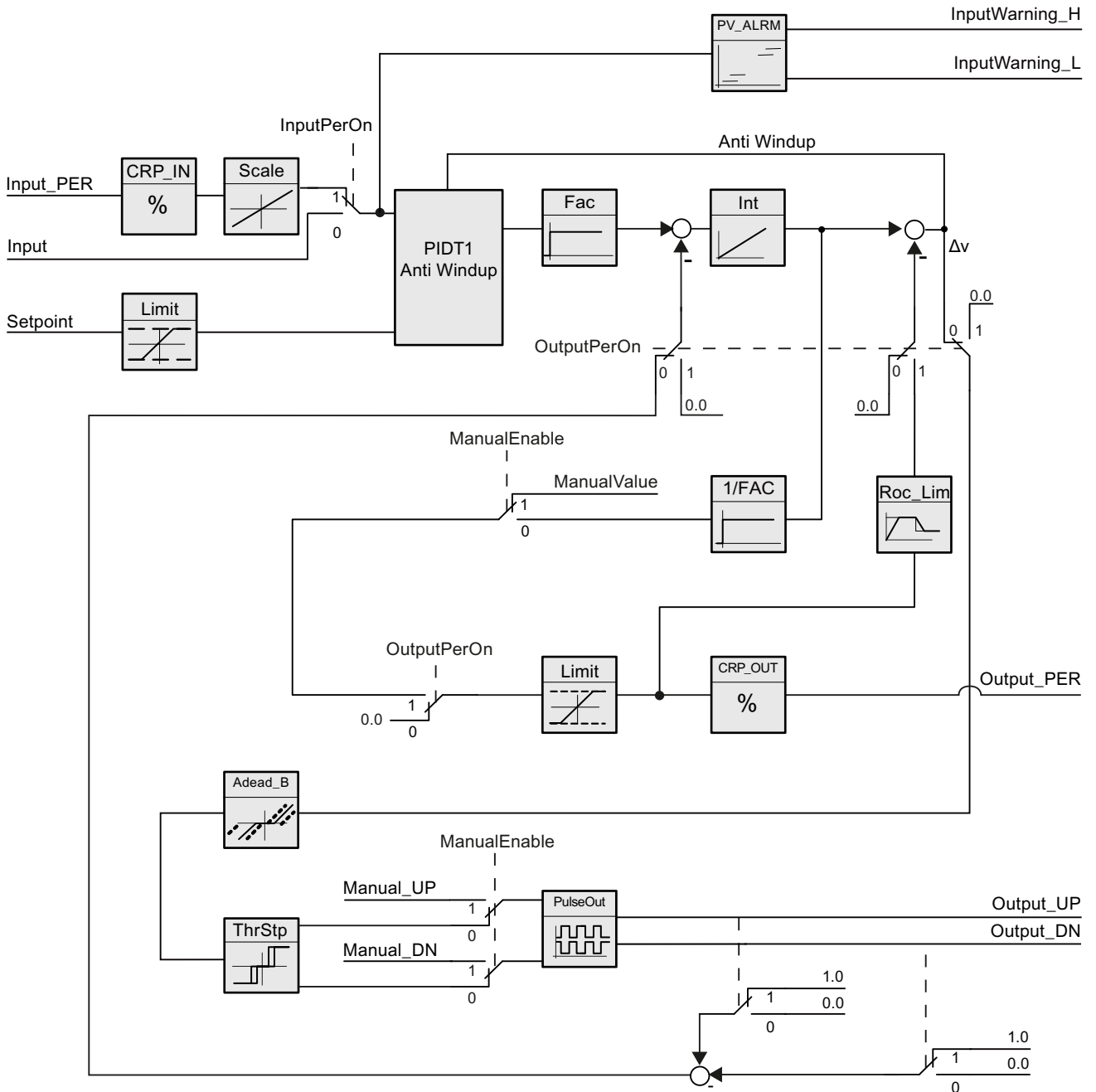

Block diagram with position feedback

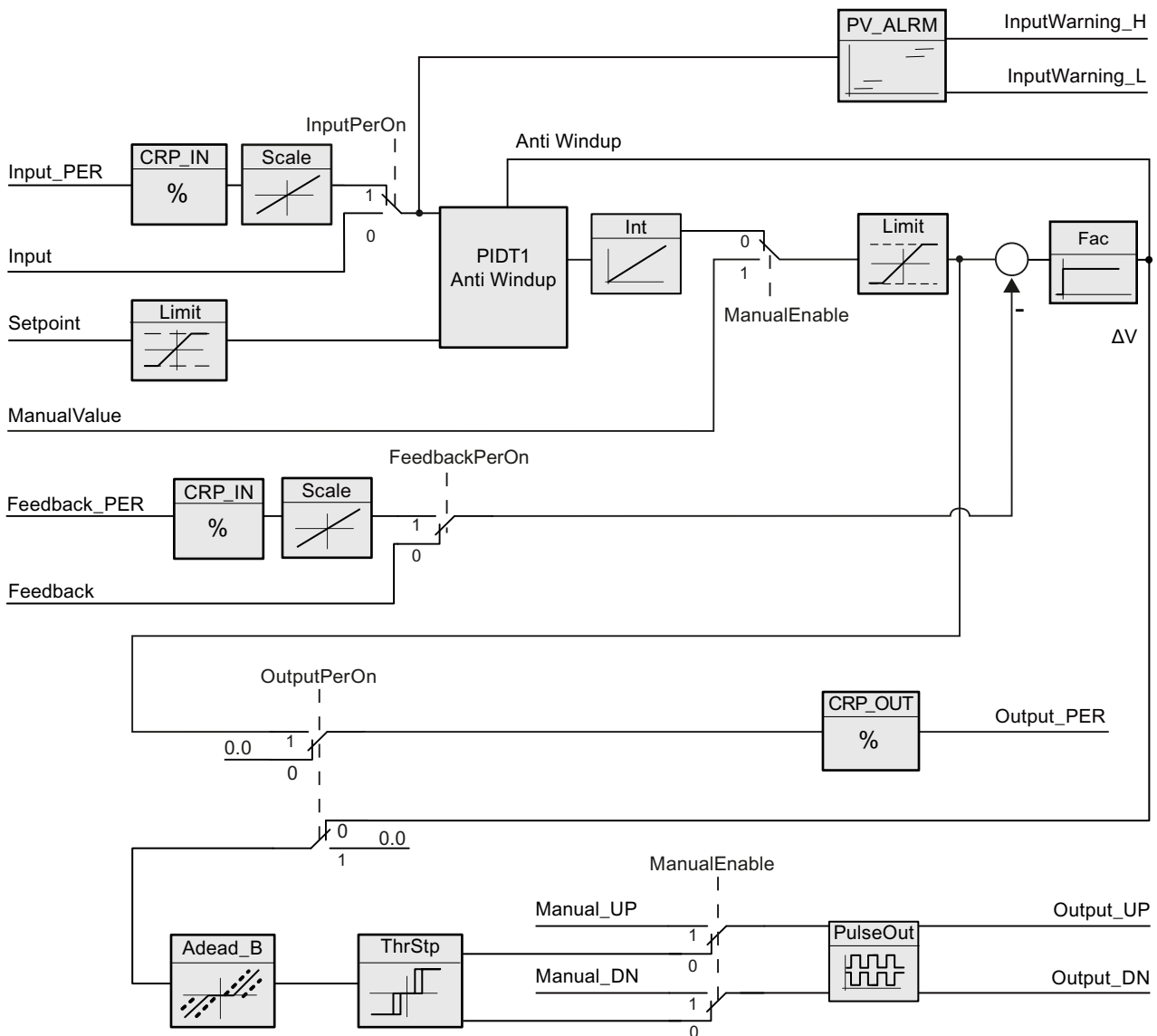



### Block diagram of PIDT1 with anti-windup

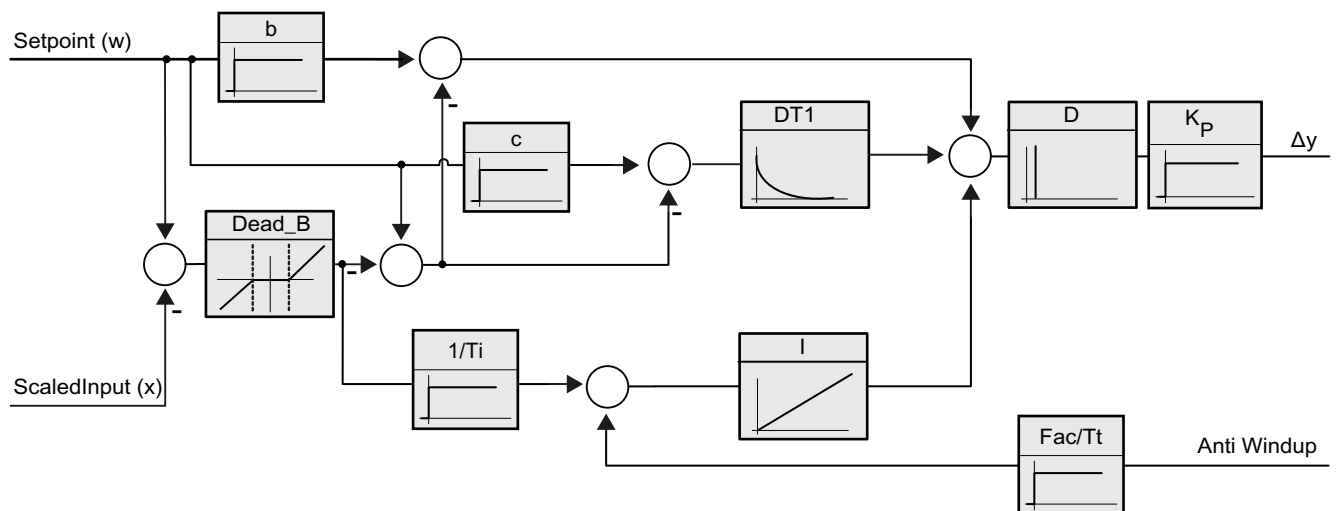

### Call

PID\_3Step is called in a constant time interval of the cycle time of the calling OB (preferably in a cyclic interrupt OB).

### Download to device

The actual values of retentive tags are only updated when you download PID\_3Step completely.

Downloading technology objects to device (Page 5937)

### Startup

At the startup of the CPU, PID\_3Step starts in the operating mode that was last active. To leave PID\_3Step in "Inactive" mode, set RunModeByStartup = FALSE.

### Reaction to error

If errors occur, these are output in the Error parameter. You configure the reaction of PID\_3Step using the ErrorBehaviour and ActivateRecoverMode tags.

ErrorBehaviour	ActivateRecoverMode	Actuator setting configuration Set Output to	Reaction
0	FALSE	Current output value	Switch to "Inactive" mode (Mode = 0)
0	TRUE	Current output value while error is pending	Switch to "Error monitoring" mode (Mode = 7)

ErrorBehaviour	ActivateRecoverMode	Actuator setting configuration Set Output to	Reaction
1	FALSE	Substitute output value	Switch to "Approach substitute output value" mode (Mode = 5) Switch to "Inactive" mode (Mode = 0)
1	TRUE	Substitute output value while error is pending	Switch to "Approach substitute output value with error monitoring" mode (Mode = 8) Switch to "Error monitoring" mode (Mode = 7)

The ErrorBits parameter shows which errors have occurred.

**See also**

State and Retain.Mode parameters (Page 2686)

ErrorBits parameter (Page 2693)

Configuring PID\_3Step V1 (Page 5991)

**Operating principle of PID\_3Step**

**Monitoring process value limits**

You specify the high limit and low limit of the process value in the Config.InputUpperLimit and Config.InputLowerLimit tags. If the process value is outside these limits, an error occurs (ErrorBits = 0001hex).

You specify a high and low warning limit of the process value in the Config.InputUpperWarning and Config.InputLowerWarning tags. If the process value is outside these warning limits, a warning occurs (Warnings = 0040hex), and the InputWarning\_H or InputWarning\_L output parameter changes to TRUE.

**Limiting the setpoint**

You specify a high limit and low limit of the setpoint in the Config.SetpointUpperLimit and Config.SetpointLowerLimit tags. PID\_3Step automatically limits the setpoint to the process value limits. You can limit the setpoint to a smaller range. PID\_3Step checks whether this range falls within the process value limits. If the setpoint is outside these limits, the high or low limit is used as the setpoint, and output parameter SetpointLimit\_H or SetpointLimit\_L is set to TRUE.

The setpoint is limited in all operating modes.

## Limiting the output value

You specify a high limit and low limit of the output value in the Config.OutputUpperLimit and Config.OutputLowerLimit tags. The output value limits must be within "Low endstop" and "High endstop".

- High endstop: Config.FeedbackScaling.UpperPointOut
- Low endstop: Config.FeedbackScaling.LowerPointOut

Rule:

$$\text{UpperPointOut} \geq \text{OutputUpperLimit} > \text{OutputLowerLimit} \geq \text{LowerPointOut}$$

The valid values for "High endstop" and "Low endstop" depend upon:

- FeedbackOn
- FeedbackPerOn
- OutputPerOn

OutputPerOn	FeedbackOn	FeedbackPerOn	LowerPointOut	UpperPointOut
FALSE	FALSE	FALSE	Cannot be set (0.0%)	Cannot be set (100.0%)
FALSE	TRUE	FALSE	-100.0% or 0.0%	0.0% or +100.0%
FALSE	TRUE	TRUE	-100.0% or 0.0%	0.0% or +100.0%
TRUE	FALSE	FALSE	Cannot be set (100.0%)	Cannot be set (100.0%)
TRUE	TRUE	FALSE	-100.0% or 0.0%	0.0% or +100.0%
TRUE	TRUE	TRUE	-100.0% or 0.0%	0.0% or +100.0%

If OutputPerOn = FALSE and FeedbackOn = FALSE, you cannot limit the output value. The digital outputs are reset with Actuator\_H = TRUE or Actuator\_L = TRUE, or after a travel time amounting to 110% of the motor transition time.

The output value is 27648 at 100% and -27648 at -100%. PID\_3Step must be able to close the valve completely. Therefore, zero must be included in the output value limits.

## Substitute output value

If an error has occurred, PID\_3Step can output a substitute output value and move the actuator to a safe position that is specified in the SavePosition tag. The substitute output value must be within the output value limits.

## Monitoring signal validity

The values of the following parameters are monitored for validity:

- Setpoint
- Input
- Input\_PER
- Feedback
- Feedback\_PER
- Output

### Monitoring the PID\_3Step sampling time

Ideally, the sampling time is equivalent to the cycle time of the calling OB. The PID\_3Step instruction measures the time interval between two calls. This is the current sampling time. On every switchover of operating mode and during the initial startup, the mean value is formed from the first 10 sampling times. Too great a difference between the current sampling time and this mean value triggers an error (ErrorBits = 0800 hex).

PID\_3Step is set to "Inactive" mode during tuning under the following conditions:

- New mean value  $\geq 1.1 \times$  old mean value
- New mean value  $\leq 0.9 \times$  old mean value

In automatic mode, PID\_3Step is set to "Inactive" mode under the following conditions:

- New mean value  $\geq 1.5 \times$  old mean value
- New mean value  $\leq 0.5 \times$  old mean value

### Sampling time of the PID algorithm

The controlled system needs a certain amount of time to respond to changes in the output value. It is therefore not advisable to calculate the output value in every cycle. The sampling time of the PID algorithm represents the time between two calculations of the output value. It is calculated during tuning and rounded to a multiple of the cycle time. All other functions of PID\_3Step are executed at every call.

### Measuring the motor transition time

The motor transition time is the time in seconds the motor requires to move the actuator from the closed to the opened state. The maximum time that the actuator is moved in one direction is 110% of the motor transition time. PID\_3Step requires the motor transition time to be as accurate as possible for good controller results. The data in the actuator documentation contains average values for this type of actuator. The value for the specific actuator used may differ. You can measure the motor transition time during commissioning. The output value limits are not taken into consideration during the motor transition time measurement. The actuator can travel to the high or the low endstop.

### Control logic

An increase of the output value is generally intended to cause an increase in the process value. This is referred to as a normal control logic. For cooling and discharge control systems, it may be necessary to invert the control logic. PID\_3Step does not work with negative proportional gain. If InvertControl = TRUE, an increasing control deviation causes a reduction in the output value. The control logic is also taken into account during pretuning and fine tuning.

### See also

Configuring PID\_3Step V1 (Page 5991)

## Input parameters of PID\_3Step

Table 9-86

Parameters	Data type	Default	Description
Setpoint	REAL	0.0	Setpoint of the PID controller in automatic mode
Input	REAL	0.0	A variable of the user program is used as source for the process value. If you are using parameter Input, then Config.InputPerOn = FALSE must be set.
Input_PER	WORD	W#16#0	An analog input is used as source for the process value. If you are using parameter Input_PER, then Config.InputPerOn = TRUE must be set.
Actuator_H	BOOL	FALSE	Digital position feedback of the valve for the high endstop If Actuator_H = TRUE, the valve is at the high endstop and is no longer moved towards this direction.
Actuator_L	BOOL	FALSE	Digital position feedback of the valve for the low endstop If Actuator_L = TRUE, the valve is at the low endstop and is no longer moved towards this direction.
Feedback	REAL	0.0	Position feedback of the valve If you are using parameter Feedback, then Config.FeedbackPerOn = FALSE must be set.
Feedback_PER	WORD	W#16#0	Analog feedback of the valve position If you are using parameter Feedback_PER, then Config.FeedbackPerOn = TRUE must be set. Feedback_PER is scaled based on the variables: <ul style="list-style-type: none"> <li>• Config.FeedbackScaling.LowerPointIn</li> <li>• Config.FeedbackScaling.UpperPointIn</li> <li>• Config.FeedbackScaling.LowerPointOut</li> <li>• Config.FeedbackScaling.UpperPointOut</li> </ul>
ManualEnable	BOOL	FALSE	<ul style="list-style-type: none"> <li>• A FALSE -&gt; TRUE edge selects "Manual mode", while State = 4, Retain.Mode remains unchanged.</li> <li>• A TRUE -&gt; FALSE edge selects the most recently active operating mode</li> </ul> <p>A change of Retain.Mode will not take effect during ManualEnable = TRUE. The change of Retain.Mode will only be considered upon a TRUE -&gt; FALSE edge at ManualEnable .</p> <p><b>PID_3Step V1.1</b> If at start of the CPU ManualEnable = TRUE, PID_3Step starts in manual mode. A rising edge (FALSE &gt; TRUE) at ManualEnable is not necessary.</p> <p><b>PID_3Step V1.0</b> At the start of the CPU, PID_3Step only switches to manual mode with a rising edge (FALSE-&gt;TRUE) at ManualEnable . Without rising edge, PID_3Step starts in the last operating mode in which ManualEnable was FALSE.</p>
ManualValue	REAL	0.0	In manual mode, you specify the absolute position of the valve. ManualValue will only be evaluated if you are using OutputPer, or if position feedback is available.

9.7 References

Parameters	Data type	Default	Description
Manual_UP	BOOL	FALSE	In manual mode, every rising edge opens the valve by 5% of the total control range, or for the duration of the minimum motor transition time. Manual_UP is evaluated only if you are not using Output_PER and there is no position feedback available.
Manual_DN	BOOL	FALSE	In manual mode, every rising edge closes the valve by 5% of the total control range, or for the duration of the minimum motor transition time. Manual_DN is evaluated only if you are not using Output_PER and there is no position feedback available.
Reset	BOOL	FALSE	Restarts the controller. <ul style="list-style-type: none"> <li>• FALSE -&gt; TRUE edge                             <ul style="list-style-type: none"> <li>- Change to "Inactive" mode</li> <li>- Intermediate controller values are reset (PID parameters are retained)</li> </ul> </li> <li>• TRUE -&gt; FALSE edge                             <ul style="list-style-type: none"> <li>- Change in most recent active mode</li> </ul> </li> </ul>

Output parameters of PID\_3Step

Table 9-87

Parameter	Data type	Default	Description
ScaledInput	REAL	0.0	Scaled process value
ScaledFeedback	REAL	0.0	Scaled position feedback For an actuator without position feedback, the position of the actuator indicated by ScaledFeedback is very imprecise. ScaledFeedback may only be used for rough estimation of the current position in this case.
Output_UP	BOOL	FALSE	Digital output value for opening the valve If Config.OutputPerOn = FALSE, the Output_UP parameter is used.
Output_DN	BOOL	FALSE	Digital output value for closing the valve If Config.OutputPerOn = FALSE, the Output_DN parameter is used.
Output_PER	WORD	W#16#0	Analog output value If Config.OutputPerOn = TRUE, Output_PER is used.
SetpointLimit_H	BOOL	FALSE	If SetpointLimit_H = TRUE, the absolute setpoint high limit is reached. In the CPU, the setpoint is limited to the configured absolute setpoint high limit. The configured absolute process value high limit is the default for the setpoint high limit. If you configure Config.SetpointUpperLimit to a value within the process value limits, this value is used as the setpoint high limit.
SetpointLimit_L	BOOL	FALSE	If SetpointLimit_L = TRUE, the absolute setpoint low limit has been reached. In the CPU, the setpoint is limited to the configured absolute setpoint low limit. The configured absolute process value low limit is the default setting for the setpoint low limit. If you configure Config.SetpointLowerLimit to a value within the process value limits, this value is used as the setpoint low limit.

Parameter	Data type	Default	Description
InputWarning_H	BOOL	FALSE	If InputWarning_H = TRUE, the process value has reached or exceeded the warning high limit.
InputWarning_L	BOOL	FALSE	If InputWarning_L = TRUE, the process value has reached or fallen below the warning low limit.
State	INT	0	The State parameter (Page 2686) shows the current operating mode of the PID controller. You change the operating mode with the Retain.Mode tag. <ul style="list-style-type: none"> <li>• State = 0: Inactive</li> <li>• State = 1: Pretuning</li> <li>• State = 2: Fine tuning</li> <li>• State = 3: Automatic mode</li> <li>• State = 4: Manual mode</li> <li>• State = 5: Approach substitute output value</li> <li>• State = 6: Transition time measurement</li> <li>• State = 7: Error monitoring</li> <li>• State = 8: Approach substitute output value with error monitoring</li> </ul>
Error	BOOL	FALSE	If Error = TRUE, at least one error message is pending.
ErrorBits	DWORD	DW#16#0	The ErrorBits parameter (Page 2693) indicates the error messages.

### See also

State and Retain.Mode parameters (Page 2686)

ErrorBits parameter (Page 2693)

### PID\_3Step static variables

You must not change tags that are not listed. These are used for internal purposes only.

Table 9-88

Tag	Data type	Default	Description
ActivateRecoverMode	BOOL	TRUE	The ActivateRecoverMode tag (Page 2694) determines the reaction to error.
RunModeByStartup	BOOL	TRUE	Activate Mode after CPU restart If RunModeByStartup = TRUE, the controller returns to the last active operating mode after a CPU restart. If RunModeByStartup = FALSE, the controller remains inactive after a CPU restart.
PhysicalUnit	INT	0	Unit of measurement of the process value and setpoint, e.g., °C, or °F.
PhysicalQuantity	INT	0	Physical quantity of the process value and setpoint, e.g., temperature.

Tag	Data type	Default	Description
ErrorBehaviour	INT	0	<p>If ErrorBehaviour = 0 and an error has occurred, the valve stays at its current position and the controller switches directly to "Inactive" or "Error monitoring" mode.</p> <p>If ErrorBehaviour = 1 and an error occurs, the actuator moves to the substitute output value and only then switches to "Inactive" or "Error monitoring" mode.</p> <p>If the following errors occur, you can no longer move the valve to a configured substitute output value.</p> <ul style="list-style-type: none"> <li>• 2000h: Invalid value at Feedback_PER parameter.</li> <li>• 4000h: Invalid value at Feedback parameter.</li> <li>• 8000h: Error during digital position feedback.</li> </ul>
Warning	DWORD	DW#16#0	<p>The Warning tag (Page 2686) displays the warnings generated since a Reset or since the last switchover of operating mode.</p> <p>Cyclic warnings (for example, process value warning) are shown until the cause of the warning is removed. They are automatically deleted once their cause has gone. Non-cyclic warnings (for example, point of inflection not found) remain and are deleted like errors.</p>
SavePosition	REAL	0.0	<p>Substitute output value</p> <p>If ErrorBehaviour = 1 and an error occurs, the actuator moves to a safe position for the plant and only then switches to "Inactive" mode.</p>
CurrentSetpoint	REAL	0.0	Currently active setpoint. This value is frozen at the start of tuning.
Progress	REAL	0.0	Progress of tuning as a percentage (0.0 - 100.0)
Config.InputPerOn	BOOL	TRUE	If InputPerOn = TRUE, the Input_PER parameter is used. If InputPerOn = FALSE, the Input parameter is used.
Config.OutputPerOn	BOOL	FALSE	If OutputPerOn = TRUE, the Output_PER parameter is used. If OutputPerOn = FALSE, the Ouput_UP and Output_DN parameters are used.
Config.LoadBackUp	BOOL	FALSE	If LoadBackUp = TRUE, the last set of PID parameters is reloaded. This set was saved prior to the last tuning operation. LoadBackUp is automatically reset to FALSE.
Config.InvertControl	BOOL	FALSE	<p>Invert control logic</p> <p>If InvertControl = TRUE, an increasing control deviation causes a reduction in the output value.</p>
Config.FeedbackOn	BOOL	FALSE	<p>If FeedbackOn = FALSE, a position feedback is simulated.</p> <p>Position feedback is generally activated when FeedbackOn = TRUE.</p>
Config.FeedbackPerOn	BOOL	FALSE	<p>FeedbackPerOn is only effective when FeedbackOn = TRUE.</p> <p>If FeedbackPerOn = TRUE, the analog input is used for the position feedback (Feedback_PER parameter).</p> <p>If FeedbackPerOn = FALSE, the Feedback parameter is used for the position feedback.</p>
Config.ActuatorEndStopOn	BOOL	FALSE	If ActuatorEndStopOn = TRUE, the digital position feedback Actuator_L and Actuator_H are taken into consideration.



Tag	Data type	Default	Description
Config.InputUpperLimit	REAL	120.0	High limit of the process value At the I/O input, the process value can be a maximum of 18% higher than the standard range (overrange). An error is no longer signaled due to a violation of the "Process value high limit". Only a wire-break and a short-circuit are recognized and PID_3Step reacts according to the configured reaction to error. InputUpperLimit > InputLowerLimit
Config.InputLowerLimit	REAL	0.0	Low limit of the process value InputLowerLimit < InputUpperLimit
Config.InputUpperWarning	REAL	+3.40282 2e+38	Warning high limit of the process value If you set InputUpperWarning outside the process value limits, the configured absolute process value high limit is used as the warning high limit. If you configure InputUpperWarning within the process value limits, this value is used as the warning high limit. InputUpperWarning > InputLowerWarning InputUpperWarning ≤ InputUpperLimit
Config.InputLowerWarning	REAL	-3.40282 2e+38	Warning low limit of the process value If you set InputLowerWarning outside the process value limits, the configured absolute process value low limit is used as the warning low limit. If you configure InputLowerWarning within the process value limits, this value is used as the warning low limit. InputLowerWarning < InputUpperWarning InputLowerWarning ≥ InputLowerLimit
Config.OutputUpperLimit	REAL	100.0	High limit of output value For details, see OutputLowerLimit
Config.OutputLowerLimit	REAL	0.0	Low limit of output value If OutputPerOn = TRUE or FeedbackOn = TRUE, the range of values from -100% to +100%, including zero, is valid. At -100%, Output = -27648; at +100%, Output = 27648 If OutputPerOn = FALSE, the range of values from 0% to 100% is valid. The valve is completely closed at 0% and completely opened at 100%.
Config.SetpointUpperLimit	REAL	+3.40282 2e+38	High limit of setpoint If you set SetpointUpperLimit outside the process value limits, the configured absolute process value high limit is preassigned as the setpoint high limit. If you configure SetpointUpperLimit within the process value limits, this value is used as the setpoint high limit.
Config.SetpointLowerLimit	REAL	- 3.40282 e+38	Low limit of the setpoint If you set SetpointLowerLimit outside the process value limits, the configured absolute process value low limit is preassigned as the setpoint low limit. If you set SetpointLowerLimit within the process value limits, this value is used as the setpoint low limit.

9.7 References

Tag	Data type	Default	Description
Config.MinimumOnTime	REAL	0.0	Minimum ON time Minimum time in seconds for which the servo drive must be switched on.
Config.MinimumOffTime	REAL	0.0	Minimum OFF time Minimum time in seconds for which the servo drive must be switched off.
Config.TransitTime	REAL	30.0	Motor transition time Time in seconds the actuating drive requires to move the valve from the closed to the opened state.
Config.InputScaling.UpperPointIn	REAL	27648.0	Scaling Input_PER high Input_PER is converted to a percentage based on the two value pairs UpperPointOut, UpperPointIn and LowerPointOut, LowerPointIn of the InputScaling structure.
Config.InputScaling.LowerPointIn	REAL	0.0	Scaling Input_PER low Input_PER is converted to a percentage based on the two value pairs UpperPointOut, UpperPointIn and LowerPointOut, LowerPointIn of the InputScaling structure.
Config.InputScaling.UpperPointOut	REAL	100.0	Scaled high process value Input_PER is converted to a percentage based on the two value pairs UpperPointOut, UpperPointIn and LowerPointOut, LowerPointIn of the InputScaling structure.
Config.InputScaling.LowerPointOut	REAL	0.0	Scaled low process value Input_PER is converted to a percentage based on the two value pairs UpperPointOut, UpperPointIn and LowerPointOut, LowerPointIn of the InputScaling structure.
Config.FeedbackScaling.UpperPointIn	REAL	27648.0	Scaling Feedback_PER high Feedback_PER is converted to a percentage based on the two value pairs UpperPointOut, UpperPointIn and LowerPointOut, LowerPointIn of the FeedbackScaling structure.
Config.FeedbackScaling.LowerPointIn	REAL	0.0	Scaling Feedback_PER low Feedback_PER is converted to a percentage based on the two value pairs UpperPointOut, UpperPointIn and LowerPointOut, LowerPointIn of the FeedbackScaling structure.
Config.FeedbackScaling.UpperPointOut	REAL	100.0	High endstop Feedback_PER is converted to a percentage based on the two value pairs UpperPointOut, UpperPointIn and LowerPointOut, LowerPointIn of the FeedbackScaling structure.
Config.FeedbackScaling.LowerPointOut	REAL	0.0	Low endstop Feedback_PER is converted to a percentage based on the two value pairs UpperPointOut, UpperPointIn and LowerPointOut, LowerPointIn of the FeedbackScaling structure.
GetTransitTime.InvertDirection	BOOL	FALSE	If InvertDirection = FALSE, the valve is fully opened, closed, and then reopened in order to determine the valve transition time. If InvertDirection = TRUE, the valve is fully closed, opened, and then closed again.

Tag	Data type	Default	Description
GetTransitTime.SelectFeedback	BOOL	FALSE	If SelectFeedback = TRUE, then Feedback_PER, or Feedback is taken into consideration in the transition time measurement. If SelectFeedback = FALSE, then Actuator_H and Actuator_L are taken into consideration in the transition time measurement.
GetTransitTime.Start	BOOL	FALSE	If Start = TRUE, the transition time measurement is started.
GetTransitTime.State	INT	0	Current phase of the transition time measurement <ul style="list-style-type: none"> <li>• State = 0: Inactive</li> <li>• State = 1: Open valve completely</li> <li>• State = 2: Close valve completely</li> <li>• State = 3: Move valve to target position (NewOutput)</li> <li>• State = 4: Transition time measurement successfully completed</li> <li>• State = 5: Transition time measurement canceled</li> </ul>
GetTransitTime.NewOutput	REAL	0.0	Target position for transition time measurement with position feedback The target position must be between "High endstop" and "Low endstop". The difference between NewOutput and ScaledFeedback must be at least 50% of the permissible control range.
CycleTime.StartEstimation	BOOL	TRUE	If StartEstimation = TRUE, the measurement of the PID_3Step sampling time is started. CycleTime.StartEstimation = FALSE once measurement is complete.
CycleTime.EnEstimation	BOOL	TRUE	If EnEstimation = TRUE, the PID_3Step sampling time is calculated.
CycleTime.EnMonitoring	BOOL	TRUE	If EnMonitoring = TRUE, the PID_3Step sampling time is monitored. If it is not possible to execute PID_3Step within the sampling time, the error 0800h is output and the operating mode is switched. ActivateRecoverMode and ErrorBehaviour determine which operating mode is switched to. If EnMonitoring = FALSE, the PID_3Step sampling time is not monitored, the error 0800h is not output, and the operating mode is not switched.
CycleTime.Value	REAL	0.1	PID_3Step sampling time in seconds CycleTime.Value is determined automatically and is usually equivalent to the cycle time of the calling OB.
CtrlParamsBackUp.SetByUser	BOOL	FALSE	Saved value of Retain.CtrlParams.SetByUser. You can reload values from the CtrlParamsBackUp structure with Config.LoadBackUp = TRUE.
CtrlParamsBackUp.Gain	REAL	1.0	Saved proportional gain
CtrlParamsBackUp.Ti	REAL	20.0	Saved integral action time
CtrlParamsBackUp.Td	REAL	0.0	Saved derivative action time
CtrlParamsBackUp.TdFiltRatio	REAL	0.0	Saved derivative delay coefficient
CtrlParamsBackUp.PWeighting	REAL	0.0	Saved proportional action weighting
CtrlParamsBackUp.DWeighting	REAL	0.0	Saved derivative action weighting
CtrlParamsBackUp.Cycle	REAL	1.0	Saved sampling time of PID algorithm
CtrlParamsBackUp.InputDeadBand	REAL	0.0	Saved dead band width of the control deviation

9.7 References

Tag	Data type	Default	Description
PIDSelfTune.SUT.CalculateSUTParams	BOOL	FALSE	The properties of the controlled system are saved during tuning. If CalculateSUTParams = TRUE, the PID parameters are recalculated on the basis of these properties. The PID parameters are calculated using the method set in TuneRuleSUT. CalculateSUTParams is set to FALSE following calculation.
PIDSelfTune.SUT.TuneRuleSUT	INT	1	Methods used to calculate parameters during pretuning: <ul style="list-style-type: none"> <li>• TuneRuleSUT = 0: PID rapid I</li> <li>• TuneRuleSUT = 1: PID slow I</li> <li>• TuneRuleSUT = 2: Chien, Hrones and Reswick PID</li> <li>• TuneRuleSUT = 3: Chien, Hrones, Reswick PI</li> <li>• TuneRuleSUT = 4: PID rapid II</li> <li>• TuneRuleSUT = 5: PID slow II</li> </ul>
PIDSelfTune.SUT.State	INT	0	The SUT.State tag indicates the current phase of pretuning:
PIDSelfTune.TIR.RunIn	BOOL	FALSE	<ul style="list-style-type: none"> <li>• RunIn = FALSE Pretuning is started when fine tuning is started from inactive or manual mode. If fine tuning is started from automatic mode, the system uses the existing PID parameters to control to the setpoint. Only then will fine tuning start. If pretuning is not possible, PID_3Step switches to "Inactive" mode.</li> <li>• RunIn = TRUE The pretuning is skipped. PID_3Step attempts to reach the setpoint with the minimum or maximum output value. This can produce increased overshoot. Only then will fine tuning start. RunIn is set to FALSE after fine tuning.</li> </ul>
PIDSelfTune.TIR.CalculateTIRParams	BOOL	FALSE	The properties of the controlled system are saved during tuning. If CalculateTIRParams = TRUE, the PID parameters are recalculated on the basis of these properties. The PID parameters are calculated using the method set in TuneRuleTIR. CalculateTIRParams is set to FALSE following calculation.
PIDSelfTune.TIR.TuneRuleTIR	INT	0	Methods used to calculate parameters during fine tuning: <ul style="list-style-type: none"> <li>• TuneRuleTIR = 0: PID automatic</li> <li>• TuneRuleTIR = 1: PID rapid</li> <li>• TuneRuleTIR = 2: PID slow</li> <li>• TuneRuleTIR = 3: Ziegler-Nichols PID</li> <li>• TuneRuleTIR = 4: Ziegler-Nichols PI</li> <li>• TuneRuleTIR = 5: Ziegler-Nichols P</li> </ul>
PIDSelfTune.TIR.State	INT	0	The TIR.State tag indicates the current phase of "fine tuning":

Tag	Data type	Default	Description
Retain.Mode	INT	0	<p>A change to the value of Retain.Mode initiates a switch to another operating mode.</p> <p>The following operating mode is enabled upon a change of Mode to:</p> <ul style="list-style-type: none"> <li>• Mode = 0: Inactive</li> <li>• Mode = 1: Pretuning</li> <li>• Mode = 2: Fine tuning</li> <li>• Mode = 3: Automatic mode</li> <li>• Mode = 4: Manual mode</li> <li>• Mode = 5: Approach substitute output value</li> <li>• Mode = 6: Transition time measurement</li> <li>• Mode = 7: Error monitoring</li> <li>• Mode = 8: Approach substitute output value with error monitoring</li> </ul> <p>Mode is retentive.</p>
Retain.CtrlParams.SetByUser	BOOL	FALSE	<p>If SetByUser = FALSE, the PID parameters are determined automatically and PID_3Step operates with a dead band at the output value. The dead band width is calculated during tuning on the basis of the standard deviation of the output value and saved in Retain.CtrlParams.OutputDeadBand.</p> <p>If SetByUser = TRUE, the PID parameters are entered manually and PID_3 Step operates without a dead band at the output value. Retain.CtrlParams.OutputDeadBand = 0.0</p> <p>SetByUser is retentive.</p>
Retain.CtrlParams.Gain	REAL	1.0	<p>Active proportional gain</p> <p>Gain is retentive.</p>
Retain.CtrlParams.Ti	REAL	20.0	<ul style="list-style-type: none"> <li>• Ti &gt; 0.0: Active integral action time</li> <li>• Ti = 0.0: Integral action is deactivated</li> </ul> <p>Ti is retentive.</p>
Retain.CtrlParams.Td	REAL	0.0	<ul style="list-style-type: none"> <li>• Td &gt; 0.0: Active derivative action time</li> <li>• Td = 0.0: Derivative action is deactivated</li> </ul> <p>Td is retentive.</p>
Retain.CtrlParams.TdFiltRatio	REAL	0.0	<p>Active derivative delay coefficient</p> <p>TdFiltRatio is retentive.</p>
Retain.CtrlParams.PWeighting	REAL	0.0	<p>Active proportional action weighting</p> <p>PWeighting is retentive.</p>
Retain.CtrlParams.DWeighting	REAL	0.0	<p>Active derivative action weighting</p> <p>DWeighting is retentive.</p>
Retain.CtrlParams.Cycle	REAL	1.0	<p>Active sampling time of PID algorithm in seconds, rounded to an integer multiple of the cycle time of the calling OB.</p> <p>Cycle is retentive.</p>
Retain.CtrlParams.InputDeadBand	REAL	0.0	<p>Dead band width of the control deviation</p> <p>InputDeadBand is retentive.</p>

---

**Note**

Change the tags listed in this table in "Inactive" mode to prevent malfunction of the PID controller. "Inactive" mode is forced by setting the "Retain.Mode" tag to "0".

---

**See also**

State and Retain.Mode parameters (Page 2686)

ActivateRecoverMode variable (Page 2694)

Downloading technology objects to device (Page 5937)

**State and Retain.Mode parameters**

**Correlation of the parameters**

The State parameter shows the current operating mode of the PID controller. You cannot change the State parameter.

To switch from one operating mode to another, you must change the Retain.Mode tag. This also applies when the value for the new operating mode is already in Retain.Mode. For example, set Retain.Mode = 0 first and then Retain.Mode = 3. Provided the current operating mode of the controller permits this switchover, State will be set to the value of Retain.Mode.

When PID\_3Step automatically switches from one operating mode to another, the following applies: State != Retain.Mode.

Examples:

- After successful pretuning  
State = 3 and Retain.Mode = 1
- In the event of an error  
State = 0 and Retain.Mode remain at the previous value, for example, Retain.Mode = 3
- ManualEnalbe = TRUE  
State = 4 and Retain.Mode remain at the previous value, e.g., Retain.Mode = 3

---

**Note**

You want, for example, to repeat successful fine tuning without exiting automatic mode with Mode = 0.

Setting Retain.Mode to an invalid value such as 9999 for one cycle has no effect on State. Set Mode = 2 in the next cycle. In this way, you can generate a change to Retain.Mode without first switching to "Inactive" mode.

---

## Meaning of values

State / Retain.Mode	Description
0	<p>Inactive</p> <p>The controller is switched off and no longer changes the valve position.</p>
1	<p>Pretuning</p> <p>The pretuning determines the process response to a pulse of the output value and searches for the point of inflection. The optimized PID parameters are calculated as a function of the maximum rate of rise and dead time of the controlled system.</p> <p>Pretuning requirements:</p> <ul style="list-style-type: none"> <li>• State = 0 or State = 4</li> <li>• ManualEnable = FALSE</li> <li>• The motor transition time has been configured or measured.</li> <li>• The setpoint and the process value lie within the configured limits.</li> </ul> <p>The more stable the process value is, the easier it is to calculate the PID parameters and the more precise the result will be. Noise on the process value can be tolerated as long as the rate of rise of the process value is significantly higher as compared to the noise.</p> <p>Before the PID parameters are recalculated, they are backed up and can be reactivated with Config.LoadBackUp. The setpoint is frozen in the CurrentSetpoint tag.</p> <p>The controller switches to automatic mode following successful pretuning and to "Inactive" mode following unsuccessful pretuning.</p> <p>The pretuning phase is indicated with the SUT.State tag.</p>

State / Retain.Mode	Description
2	<p>Fine tuning</p> <p>Fine tuning generates a constant, limited oscillation of the process value. The PID parameters are tuned based on the amplitude and frequency of this oscillation. The differences between the process response during pretuning and fine tuning are analyzed. All PID parameters are recalculated from the results. PID parameters from fine tuning usually have better master control and disturbance characteristics than PID parameters from pretuning.</p> <p>PID_3Step automatically attempts to generate an oscillation greater than the noise of the process value. Fine tuning is only minimally influenced by the stability of the process value.</p> <p>The PID parameters are backed up before fine tuning. They can be reactivated with Config.LoadBackUp. The setpoint is frozen in the CurrentSetpoint tag.</p> <p>Requirements for fine tuning:</p> <ul style="list-style-type: none"> <li>• The motor transition time has been configured or measured.</li> <li>• The setpoint and the process value lie within the configured limits.</li> <li>• ManualEnable = FALSE</li> <li>• Automatic (State = 3), inactive (State = 0) or manual (State = 4) mode</li> </ul> <p>Fine tuning proceeds as follows when started from:</p> <ul style="list-style-type: none"> <li>• Automatic mode (State = 3) Start fine tuning from automatic mode if you wish to improve the existing PID parameters through tuning. PID_3Step controls the system using the existing PID parameters until the control loop has stabilized and the requirements for fine tuning have been met. Only then will fine tuning start.</li> <li>• Inactive (State = 0) or manual mode (State = 4) Pretuning is always started first. The determined PID parameters will be used for control until the control loop has stabilized and the requirements for fine tuning have been met. If PIDSelfTune.TIR.RunIn = TRUE, pretuning is skipped and an attempt is made to reach the setpoint with the minimum or maximum output value. This can produce increased overshoot. Fine tuning then starts automatically.</li> </ul> <p>The controller switches to automatic mode following successful fine tuning. If fine tuning was not successful, the controller switches to "Inactive" mode.</p> <p>The fine tuning phase is indicated with the TIR.State tag.</p>
3	<p>Automatic mode</p> <p>In automatic mode, PID_3Step controls the controlled system in accordance with the parameters specified. The controller switches to automatic mode if one the following requirements is fulfilled:</p> <ul style="list-style-type: none"> <li>• Pretuning successfully completed</li> <li>• Fine tuning successfully completed</li> <li>• Changing the Retain.Mode tag to the value 3.</li> </ul> <p>When the CPU is switched on or switches from Stop to RUN mode, PID_3Step starts in the most recently active operating mode. To leave PID_3Step in "Inactive" mode, set RunModeByStartup = FALSE.</p> <p>The ActivateRecoverMode tag is taken into consideration in automatic mode.</p>



State / Retain.Mode	Description
4	<p>Manual mode</p> <p>In manual mode, you specify manual output values in the Manual_UP and Manual_DN parameters or ManualValue parameter. Whether or not the actuator can be moved to the output value in the event of an error is described in the ErrorBits parameter.</p> <p>This operating mode is enabled if Retain.Mode = 4, or on a rising edge at ManualEnable.</p> <p>If ManualEnable changes to TRUE, only State changes. Retain.Mode retains its current value. On a falling edge at ManualEnable, PID_3Step returns to the previous operating mode.</p> <p>The switchover to automatic mode is bumpless.</p> <p><b>PID_3Step V1.1</b></p> <p>Manual mode is always possible in the event of an error.</p> <p><b>PID_3Step V1.0</b></p> <p>Manual mode is dependent on the ActivateRecoverMode tag in the event of an error.</p>
5	<p>Approach substitute output value</p> <p>This operating mode is activated in the event of an error or when Reset = TRUE if Errorbehaviour = 1 and ActivateRecoverMode = FALSE..</p> <p>PID_3Step moves the actuator to the substitute output value and then switches to "Inactive" mode.</p>
6	<p>Transition time measurement</p> <p>The time that the motor needs to completely open the valve from the closed condition is determined.</p> <p>This operating mode is activated when GetTransitTime.Start = TRUE is set.</p> <p>If endstop signals are used to measure the transition time, the valve will be opened completely from its current position, closed completely, and opened completely again. If GetTransitTime.InvertDirection = TRUE, this behavior is inverted.</p> <p>If position feedback is used to measure the transition time, the actuator will be moved from its current position to a target position.</p> <p>The output value limits are not taken into consideration during the transition time measurement. The actuator can travel to the high or the low endstop.</p>
7	<p>Error monitoring</p> <p>The control algorithm is switched off and no longer changes the valve position.</p> <p>This operating mode is activated instead of "Inactive" mode in the event of an error.</p> <p>All the following conditions must be met:</p> <ul style="list-style-type: none"> <li>• Mode = 3 (automatic mode)</li> <li>• Errorbehaviour = 0</li> <li>• ActivateRecoverMode = TRUE</li> <li>• One or more errors have occurred in which ActivateRecoverMode (Page 2694) is effective.</li> </ul> <p>As soon as the errors are no longer pending, PID_3Step switches back to automatic mode.</p>
8	<p>Approach substitute output value with error monitoring</p> <p>This operating mode is activated instead of "Approach substitute output value" mode in the event of an error. PID_3Step moves the actuator to the substitute output value and then switches to "Error monitoring" mode.</p> <p>All the following conditions must be met:</p> <ul style="list-style-type: none"> <li>• Mode = 3 (automatic mode)</li> <li>• Errorbehaviour = 1</li> <li>• ActivateRecoverMode = TRUE</li> <li>• One or more errors have occurred in which ActivateRecoverMode (Page 2694) is effective.</li> </ul> <p>As soon as the errors are no longer pending, PID_3Step switches back to automatic mode.</p>

**Automatic switchover of operating mode during commissioning**

PID\_3Step automatically switches the operating mode in the event of an error. The following diagram illustrates the influence of ErrorBehaviour on the switchover of operating mode from transition time measurement, pretuning, and fine tuning modes.

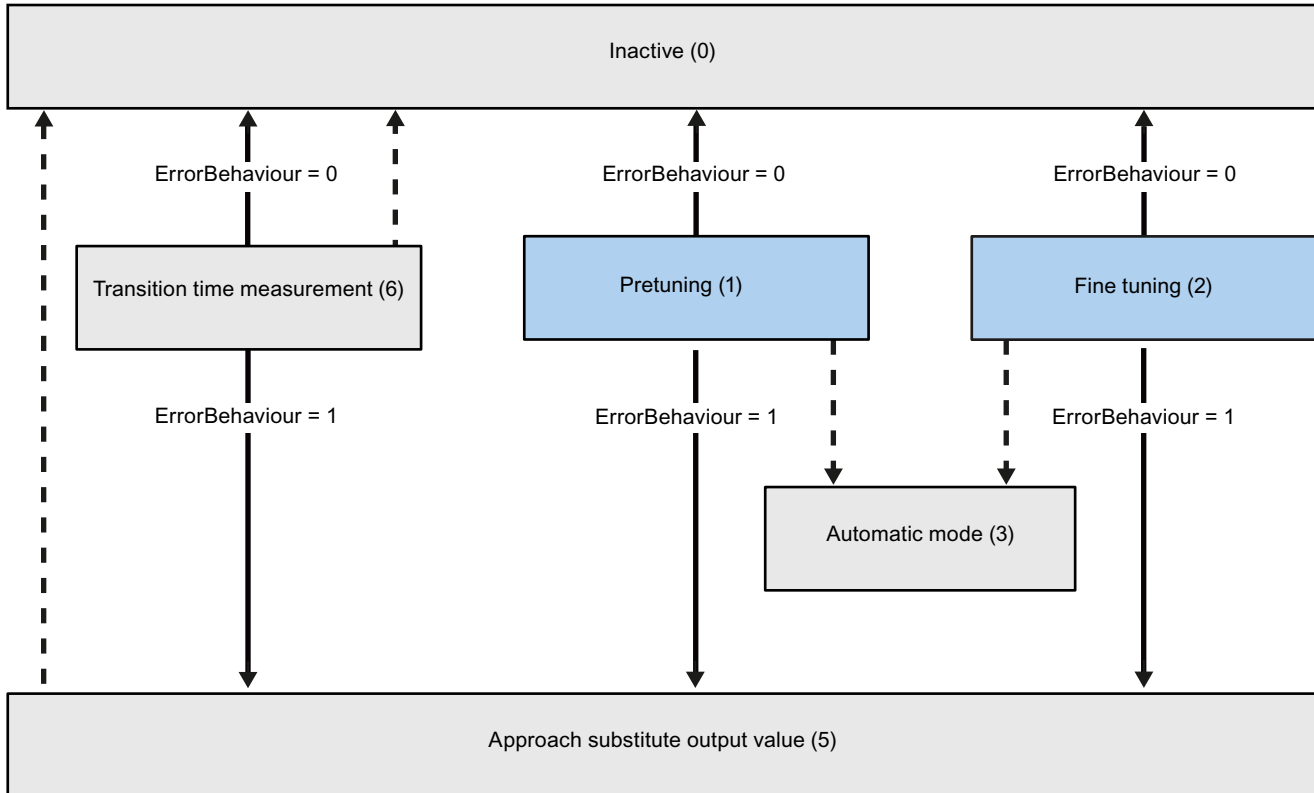

- ← Automatic switchover of operating mode in the event of an error
- ← - - - Automatic switchover of operating mode once the current operation has been completed.

### Automatic switchover of operating mode in automatic mode (PID\_3Step V1.1)

PID\_3Step automatically switches the operating mode in the event of an error. The following diagram illustrates the influence of ErrorBehaviour and ActivateRecoverMode on this switchover of operating mode.

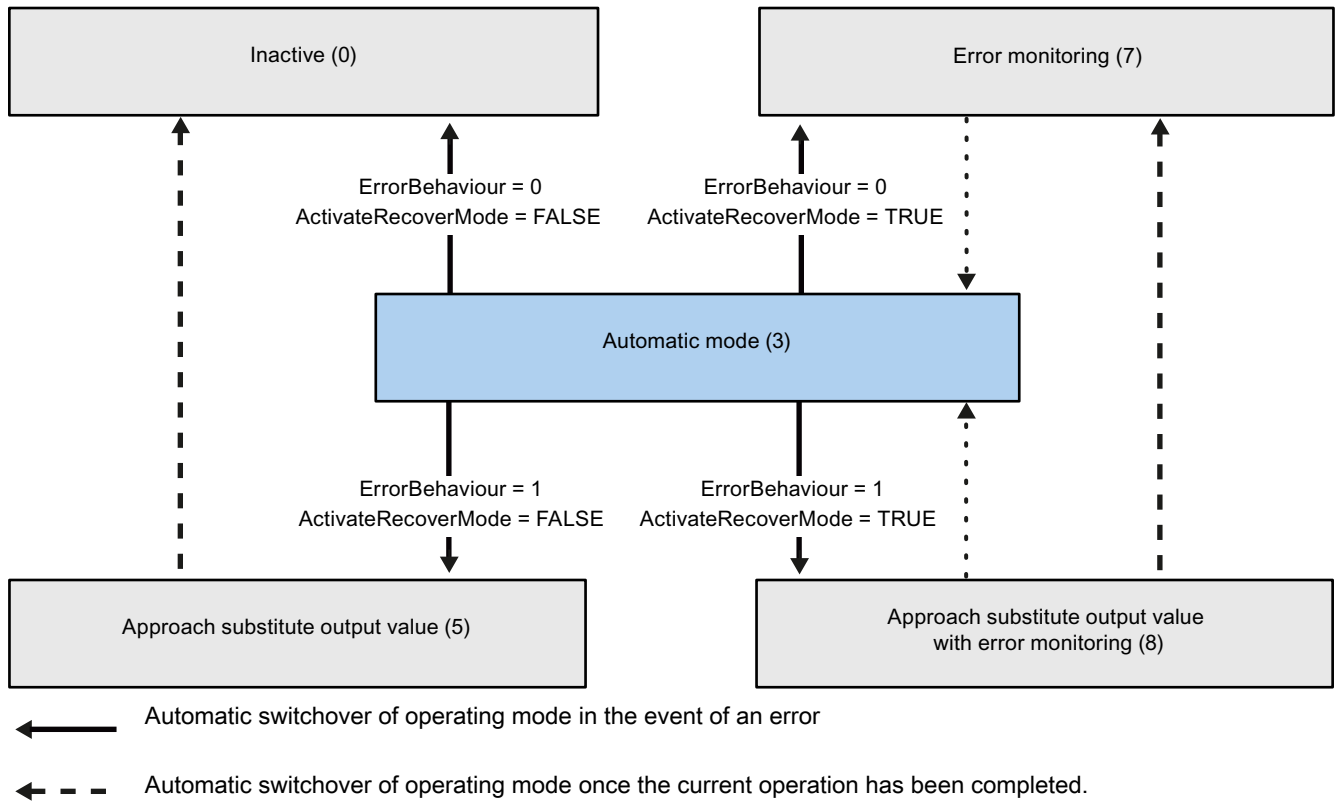

### Automatic switchover of operating mode in automatic and manual modes (PID\_3Step V1.0)

PID\_3Step automatically switches the operating mode in the event of an error. The following diagram illustrates the influence of ErrorBehaviour and ActivateRecoverMode on this switchover of operating mode.

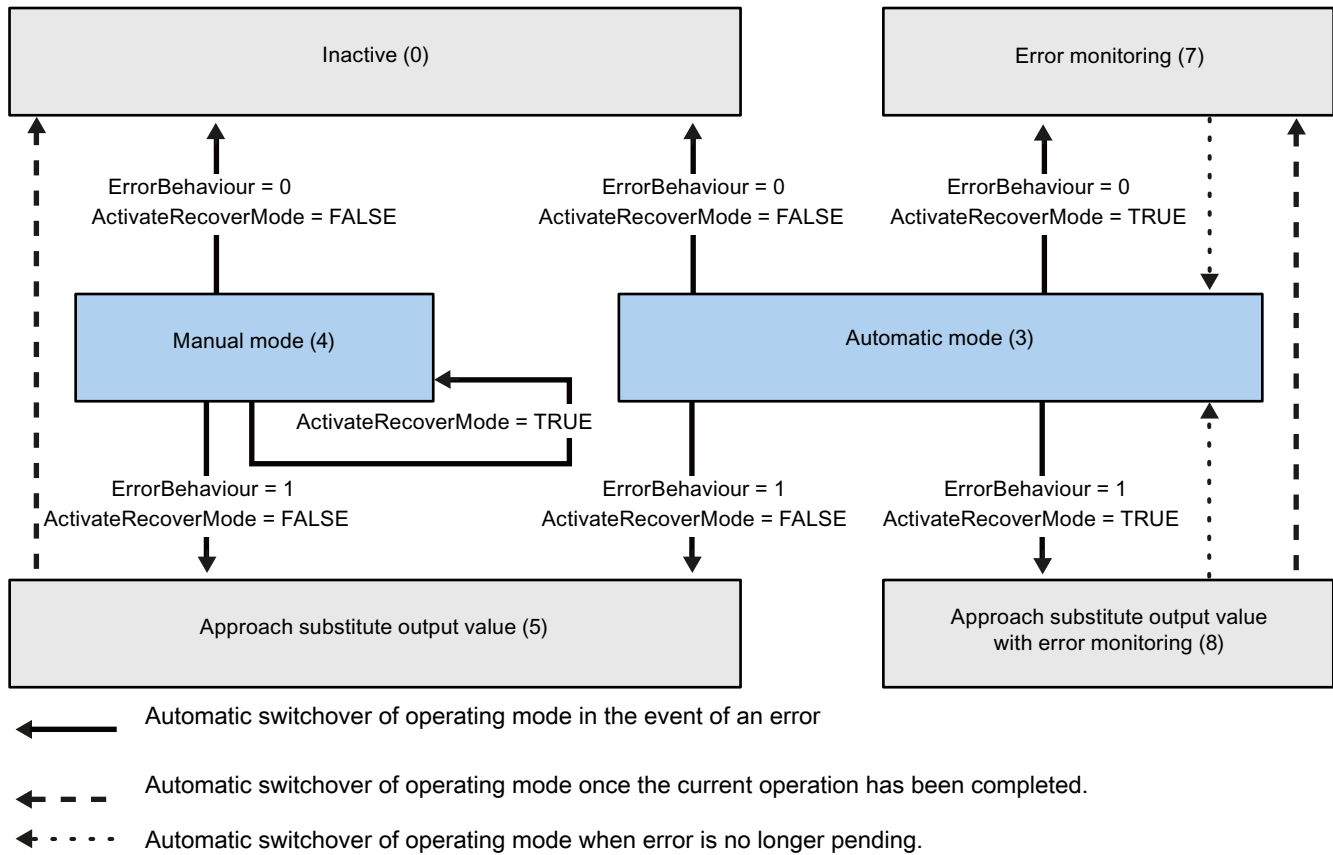

### See also

ActivateRecoverMode variable (Page 2694)

ErrorBits parameter (Page 2693)

## ErrorBits parameter

If several errors are pending simultaneously, the values of the error codes are displayed with binary addition. The display of error code 0003, for example, indicates that the errors 0001 and 0002 are pending simultaneously.

ErrorBits (DW#16#...)	Description
0000	There is no error.
0001	<p>The "Input" parameter is outside the process value limits.</p> <ul style="list-style-type: none"> <li>• Input &gt; Config.InputUpperLimit or</li> <li>• Input &lt; Config.InputLowerLimit</li> </ul> <p>If ActivateRecoverMode = TRUE and ErrorBehaviour = 1, the actuator moves to the substitute output value. If ActivateRecoverMode = TRUE and ErrorBehaviour = 0, the actuator stops in its current position. If ActivateRecoverMode = FALSE, the actuator stops in its current position.</p> <p>PID_3Step V1.1 You can move the actuator in manual mode. PID_3Step V1.0 Manual mode is not possible in this state. You cannot move the actuator again until you eliminate the error.</p>
0002	<p>Invalid value at "Input_PER" parameter. Check whether an error is pending at the analog input.</p> <p>If automatic mode was active before the error occurred, ActivateRecoverMode = TRUE, and the error is no longer pending, PID_3Step switches back to automatic mode.</p>
0004	Error during fine tuning. Oscillation of the process value could not be maintained.
0020	Pretuning is not permitted in automatic mode or during fine tuning.
0080	<p>Error during pretuning. Incorrect configuration of output value limits.</p> <p>Check whether the limits of the output value are configured correctly and match the control logic.</p>
0100	Error during fine tuning resulted in invalid parameters.
0200	<p>Invalid value at "Input" parameter: Value has an invalid number format.</p> <p>If automatic mode was active before the error occurred, ActivateRecoverMode = TRUE, and the error is no longer pending, PID_3Step switches back to automatic mode.</p>
0400	Calculation of output value failed. Check the PID parameters.
0800	<p>Sampling time error: PID_3Step is not called within the sampling time of the cyclic interrupt OB.</p> <p>If automatic mode was active before the error occurred, ActivateRecoverMode = TRUE, and the error is no longer pending, PID_3Step switches back to automatic mode.</p>
1000	<p>Invalid value at "Setpoint" parameter: Value has an invalid number format.</p> <p>If automatic mode was active before the error occurred, ActivateRecoverMode = TRUE, and the error is no longer pending, PID_3Step switches back to automatic mode.</p>
2000	<p>Invalid value at Feedback_PER parameter.</p> <p>Check whether an error is pending at the analog input.</p> <p>The actuator cannot be moved to the substitute output value and remains in its current position. Manual mode is not possible in this state. You must deactivate position feedback (Config. FeedbackOn = FALSE) to move the actuator from this state.</p> <p>If automatic mode was active before the error occurred, ActivateRecoverMode = TRUE, and the error is no longer pending, PID_3Step switches back to automatic mode.</p>

ErrorBits (DW#16#...)	Description
4000	<p>Invalid value at Feedback parameter. Value has an invalid number format.</p> <p>The actuator cannot be moved to the substitute output value and remains in its current position. Manual mode is not possible in this state. You must deactivate position feedback (Config.FeedbackOn = FALSE) to move the actuator from this state.</p> <p>If automatic mode was active before the error occurred, ActivateRecoverMode = TRUE, and the error is no longer pending, PID_3Step switches back to automatic mode.</p>
8000	<p>Error during digital position feedback. Actuator_H = TRUE and Actuator_L = TRUE.</p> <p>The actuator cannot be moved to the substitute output value and remains in its current position. Manual mode is not possible in this state.</p> <p>In order to move the actuator from this state, you must deactivate the "Actuator endstop" (Config.ActuatorEndStopOn = FALSE).</p> <p>If automatic mode was active before the error occurred, ActivateRecoverMode = TRUE, and the error is no longer pending, PID_3Step switches back to automatic mode.</p>

### Reset parameter

A rising edge at Reset resets the errors and warnings and clears the integral action. A falling edge at Reset triggers a change to the most recently active operating mode.

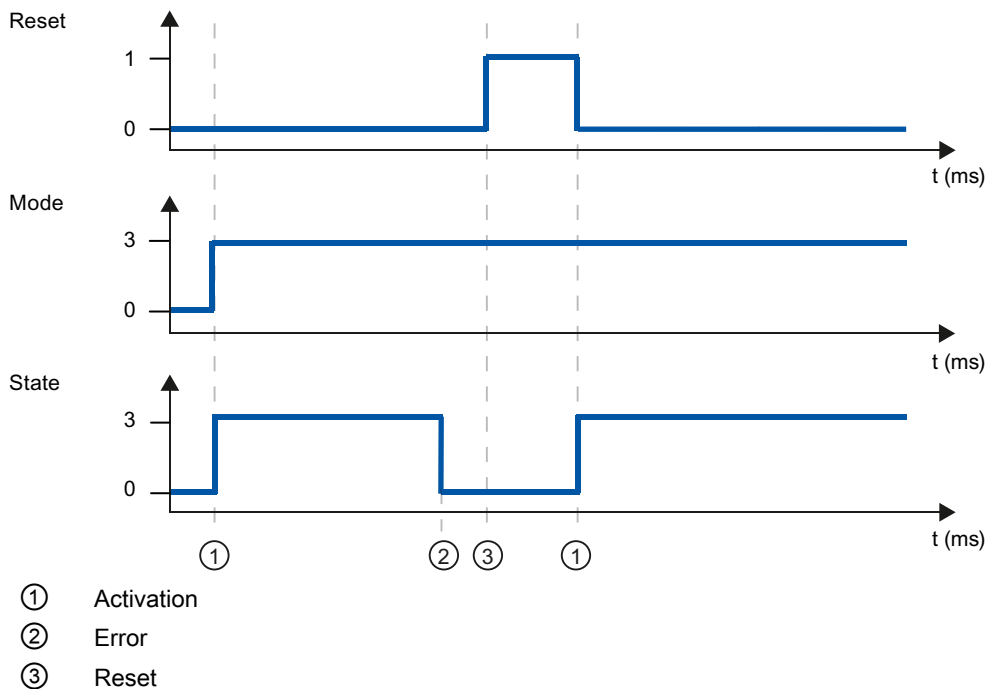

### ActivateRecoverMode variable

The effect of the ActivateRecoverMode variable depends on the version of the PID\_3Step.

### Behavior in version 1.1

The ActivateRecoverMode variable determines the behavior in the event of an error in automatic mode. ActivateRecoverMode is not effective during pretuning, fine tuning and transition time measurement.

ActivateRecover Mode	Description
FALSE	In the event of an error, PID_3Step switches to "Inactive" or "Approach substitute output value" operating mode. The controller is activated by a reset or a change in Retain.Mode.
TRUE	<p>If errors occur frequently in automatic mode, this setting has a negative effect on the control response. In this case, check the ErrorBits parameter and eliminate the cause of the error.</p> <p>If one or more errors occur, PID_3Step switches to "Approach substitute output value with error monitoring" or "Error monitoring" mode:</p> <ul style="list-style-type: none"> <li>• 0002h: Invalid value at parameter Input_PER.</li> <li>• 0200h: Invalid value at parameter Input.</li> <li>• 0800h: Sampling time error</li> <li>• 1000h: Invalid value at parameter Setpoint.</li> <li>• 2000h: Invalid value at parameter Feedback_PER.</li> <li>• 4000h: Invalid value at parameter Feedback.</li> <li>• 8000h: Error in digital position feedback.</li> </ul> <p>With errors 2000h, 4000h and 8000h, PID_3Step <b>cannot</b> approach the configured substitute output value. As soon as the errors are no longer pending, PID_3Step switches back to automatic mode.</p>

**Behavior in version 1.0**

The ActivateRecoverMode variable determines the behavior in the event of an error in automatic and manual mode. ActivateRecoverMode is not effective during pretuning, fine tuning and transition time measurement.

ActivateRecover Mode	Description
FALSE	In the event of an error, PID_3Step switches to "Inactive" or "Approach substitute output value" operating mode. The controller is activated by a reset or a change in Retain.Mode.
TRUE	<p><b>Errors in automatic mode</b></p> <p>If errors occur frequently in automatic mode, this setting has a negative effect on the control response. In this case, check the ErrorBits parameter and eliminate the cause of the error.</p> <p>If one or more errors occur, PID_3Step switches to "Approach substitute output value with error monitoring" or "Error monitoring" mode:</p> <ul style="list-style-type: none"> <li>• 0002h: Invalid value at parameter Input_PER.</li> <li>• 0200h: Invalid value at parameter Input.</li> <li>• 0800h: Sampling time error</li> <li>• 1000h: Invalid value at parameter Setpoint.</li> <li>• 2000h: Invalid value at parameter Feedback_PER.</li> <li>• 4000h: Invalid value at parameter Feedback.</li> <li>• 8000h: Error in digital position feedback.</li> </ul> <p>With errors 2000h, 4000h and 8000h, PID_3Step <b>cannot</b> approach the configured substitute output value. As soon as the errors are no longer pending, PID_3Step switches back to automatic mode.</p> <p><b>Errors in manual mode</b></p> <p>If one or more of the following errors occur, PID_3Step stays in manual mode:</p> <ul style="list-style-type: none"> <li>• 0002h: Invalid value at parameter Input_PER.</li> <li>• 0200h: Invalid value at parameter Input.</li> <li>• 0800h: Sampling time error</li> <li>• 1000h: Invalid value at parameter Setpoint.</li> <li>• 2000h: Invalid value at parameter Feedback_PER.</li> <li>• 4000h: Invalid value at parameter Feedback.</li> <li>• 8000h: Error in digital position feedback.</li> </ul> <p>With errors 2000h, 4000h and 8000h, you <b>cannot</b> move the valve to a suitable position.</p>

**See also**

PID\_3Step static variables (Page 2679)

State and Retain.Mode parameters (Page 2686)



## Tag Warning

If several warnings are pending simultaneously, their values are displayed with binary addition. The display of warning 0003, for example, indicates that the warnings 0001 and 0002 are pending simultaneously.

Warning (DW#16#...)	Description
0000	No warning pending.
0001	The point of inflection was not found during pretuning.
0002	Oscillation increased during fine tuning.
0004	The setpoint was limited to the configured limits.
0008	Not all the necessary controlled system properties were defined for the selected method of calculation. The PID parameters were instead calculated using the TuneRuleTIR = 3 method.
0010	The operating mode could not be changed because ManualEnable = TRUE.
0020	The cycle time of the calling OB limits the sampling time of the PID algorithm. Improve results by using shorter OB cycle times.
0040	The process value exceeded one of its warning limits.
0080	Invalid value at Retain.Mode. The operating mode is not switched.
0100	The manual value was limited to the limits of the controller output.
0200	The rule used for tuning produces an incorrect result, or is not supported.
0400	Method selected for transition time measurement not suitable for actuator. The transition time cannot be measured because the actuator settings do not match the selected measuring method.
0800	The difference between the current position and the new output value is too small for transition time measurement. This can produce incorrect results. The difference between the current output value and new output value must be at least 50% of the entire control range.
1000	The substitute output value cannot be reached because it is outside the output value limits.

The following warnings are deleted as soon as the cause is eliminated:

- 0004
- 0020
- 0040
- 0100

All other warnings are cleared with a rising edge at Reset.

## SUT.State variable

SUT.State	Name	Description
0	SUT_INIT	Initialize pretuning
50	SUT_TPDN	Determine start position without position feedback
100	SUT_STDABW	Calculate the standard deviation
200	SUT_GET_POI	Find the point of inflection

SUT.State	Name	Description
300	SUT_GET_RISETM	Determine the rise time
9900	SUT_IO	Pretuning successful
1	SUT_NIO	Pretuning not successful

**TIR.State variable**

TIR.State	Name	Description
-100	TIR_FIRST_SUT	Fine tuning is not possible. Pretuning will be executed first.
0	TIR_INIT	Initialize fine tuning
200	TIR_STDABW	Calculate the standard deviation
300	TIR_RUN_IN	Attempt to reach the setpoint with the maximum or minimum output value
400	TIR_CTRLN	Attempt to reach the setpoint with the existing PID parameters (if pretuning has been successful)
500	TIR_OSZIL	Determine oscillation and calculate parameters
9900	TIR_IO	Fine tuning successful
1	TIR_NIO	Fine tuning not successful

## 9.7.5 Communication

### 9.7.5.1 Communications processor

#### SIMATIC NET CM/CP

#### S7-1500 CM/CP

#### Industrial Ethernet

#### Instructions for FTP services

#### FTP\_CMD for FTP services

#### Overview of FTP\_CMD

#### Meaning

Using the FTP\_CMD instruction, you can establish FTP connections and transfer files from and to an FTP server.

Data transfer is possible using FTP or FTPS (secure SSL connections).

---

#### Note

##### **FTPS: Comparing certificates**

FTPS requires a comparison of the certificates between FTP server and FTP client. If the FTP server is configured outside the STEP 7 project of the FTP client, the certificate needs to be imported from the FTP server. Import the certificate of the FTP server as a trusted certificate in the certificate manager.

---

#### How it works

The FTP\_CMD instruction references a job block (ARG) in which the FTP command is specified. Depending on the type of FTP command (CMD), this job block uses different data structures for parameter assignment. Suitable data types (UDTs) are available for these various structures.

The following diagram shows the call structure:

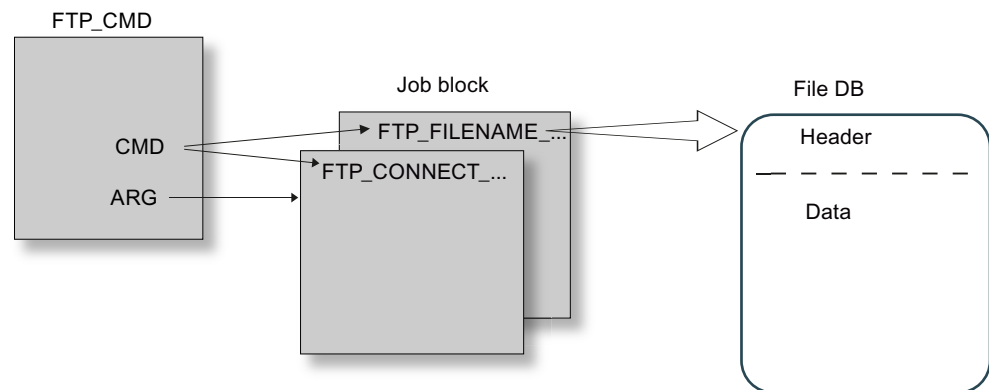

### Job blocks

The following data structures are used for the job blocks:

- Connection establishment
 

Various data structures are available for the connection establishment using the following types of access:

  - UDT FTP\_CONNECT\_IPV4: Connection establishment with IP addresses according to IPv4
  - UDT FTP\_CONNECT\_IPV6: Connection establishment with IP addresses according to IPv6
  - UDT FTP\_CONNECT\_NAME: Connection establishment with server name (DNS)
- Data transfer
 

For the data transfer, two different data structures are available:

  - UDT FTP\_FILENAME: Data structure for access to a complete file
  - UDT FTP\_FILENAME\_PART: Data structure for read access to a data area

### Data transfer in the File\_DB

The data transfer is achieved using data blocks containing a header for job data and the area for the user data. The data block is specified in the job buffer.

### Requirements in the CPU configuration

Use the following settings to allow FTP access:

- In the configuration data of the CPU in "Properties > General > Protection": Disable the "Disable PUT/GET communication" option.
- For all data blocks being used as file DBs, disable the "Optimized block access" attribute

## Validity

The FTP\_CMD instruction can be used with the following module types:

- CP 1543-1

## Call interface

Call interface in FBD representation

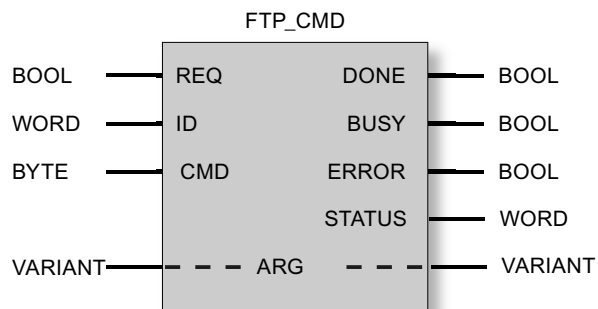

## See also

Output parameters and status information FTP\_CMD (Page 2708)

Input parameter - FTP\_CMD (Page 2701)

Structure of the data blocks (file DBs) for FTP services - FTP client mode (Page 2712)

## Input parameter - FTP\_CMD

### Explanation of the input parameters

You supply the FTP\_CMD instruction with the following input parameters:

Table 9-89 Formal parameters of the FTP\_CMD instruction - input parameters

Parameter	Declaration	Data type	Memory area	Meaning / remarks
REQ	Input	BOOL	I, Q, M, D, L	Starts the send job on a rising edge.
ID	INPUT	INT		The FTP jobs are handled on FTP connections. The parameter identifies the connection being used.

Parameter	Declaration	Data type	Memory area	Meaning / remarks
CMD	INPUT	BYTE		FTP command to be executed when the instruction is called. You will find value ranges for the FTP command types after the table. Note: The FTP command specified here must be specified identically in the job block (ARG parameter). If a command is not supported by the CP firmware, an error message with STATUS = 8F6B <sub>H</sub> is output.
ARG	INPUT	VARIANT		Job block References the data area with the execution parameters suitable for the FTP command. Specific data types (UDT) are used depending on the FTP command. The UDTs are shown below. Note: Do not use the data type ANY The ANY data type is <b>not</b> permitted for the pointer to be specified here!

**FTP commands in the "CMD" parameter**

The following table shows you the significance of the commands of the "CMD" parameter and which UDTs you use to supply the job blocks.

Table 9-90 Command types

CMD (command type)	Relevant job blocks / UDT	Meaning / handling
0 (NOOP)	-	The called FC does not execute any action. The status codes are set as follows when these parameters are supplied: • DONE=1; ERROR=0; STATUS=0
1 (CONNECT)	FTP_CONNECT_IPV4 FTP_CONNECT_IPV6 FTP_CONNECT_NAME	FTP connection establishment With this command, the FTP client establishes an FTP connection to an FTP server (port 21). The connection is available under the connection ID specified here for all further FTP commands. Data is then exchanged with the FTP server specified for this user.
2 (STORE)	FTP_FILENAME	This function call transfers a data block (file DB) from the FTP client (S7-CPU) to the FTP server. Caution: If the file (file DB) already exists on the FTP server, it will be overwritten.
3 (RETRIEVE)	FTP_FILENAME	This function call transfers a file from the FTP server to the FTP client (S7-CPU). Caution: If the data block (file DB) on the FTP client already contains a file, it will be overwritten.
4 (DELETE)	FTP_FILENAME	With this function call, you delete a file on the FTP server.

CMD (command type)	Relevant job blocks / UDT	Meaning / handling
5 (QUIT)	None	With this function call, you establish the FTP connections selected with the ID.
6 (APPEND)	FTP_FILENAME	Similar to "STORE", the "APPEND" command saves a file on the FTP server. With "APPEND", the file on the FTP server is, however, not overwritten. The new content is appended to the existing file. If the file (file DB) does not exist on the FTP server, it will be created.
7 (RETR_PART)	FTP_FILENAME_PART	Using the "RETR_PART" command (retrieve part) , you can request a section of a file from the FTP server. If very large files are involved, this allows you to restrict the read to the part you currently require. To do this, you need to know the structure of the file. Enter the required part of the file using the two parameters "OFFSET" and "LEN" in FB40.

**See also**

Overview of FTP\_CMD (Page 2699)

**Job blocks for FTP\_CMD****Meaning**

You supply the FTP\_CMD instruction with a job block using the ARG parameter. The structure depends on the FTP command type. By using the default data types (UDT), the instruction recognizes the type of the job block. Below, you will find the relevant data types (UDTs) for the following job blocks:

- FTP connection establishment with IP address according to IPv4
- FTP connection establishment with IP address according to IPv6
- FTP connection establishment with server name
- Write and read access and other FTP commands
- FTP command RETR\_PART

**Job block for FTP connection establishment with IP address according to IPv4**

For FTP connection establishment with IP address according to IPv4, the following data structure is used.

Table 9-91 UDT FTP\_CONNECT\_IPV4

Parameter	Type	Range of values	Meaning / remarks
LADDR	WORD		Module start address When you call an instruction, you transfer the module start address of the CP in the LADDR parameter. You will find the module start address of the CP in the configuration of the CP under: "Properties>Addresses>Inputs"
ID	INT	1, 2...64	The FTP jobs are handled on FTP connections. The parameter identifies the connection being used.
ConnectionType	BYTE	0	Connection type "FTP"
ActiveEstablished	BOOL	TRUE	
FTPcmd	BYTE	1	FTP command "CONNECT" FTP command that executes when the instruction is called. You will find the ranges of values in Table 9-90 Command types (Page 2702) Note: The FTP command specified here must be specified identically in the CMD input parameter.
CertIndex	BYTE	0 = FTP 1 = FTPS	Here, choose between the protocol types FTP or FTPS. Note on FTPS: If the FTP server is configured outside the STEP 7 project of the FTP client, the certificate needs to be imported from the FTP server.
UserName	STRING[32]	'user'	User name for the login on the FTP server
Password	STRING[32]	'password'	Password for the login on the FTP server
FTPserverIP_addr	IPv4	'142.11.25.135'	IP address of the FTP server



**Job block for FTP connection establishment with IP address according to IPv6**

For FTP connection establishment with IP address according to IPv6, the following data structure is used.

Table 9-92 UDT FTP\_CONNECT\_IPV6

Parameter	Type	Range of values	Meaning / remarks
LADDR	WORD		Module start address When you call an instruction, you transfer the module start address of the CP in the LADDR parameter. You will find the module start address of the CP in the configuration of the CP under: "Properties>Addresses>Inputs"
ID	INT	1, 2...64	The FTP jobs are handled on FTP connections. The parameter identifies the connection being used.
ConnectionType	BYTE	0	Connection type "FTP"
ActiveEstablished	BOOL	TRUE	
FTPcmd	BYTE	1	FTP command "CONNECT" FTP command that executes when the instruction is called. You will find the ranges of values in Table 9-90 Command types (Page 2702) Note: The FTP command specified here must be specified identically in the CMD input parameter.
CertIndex	BYTE	0 = FTP 1 = FTPS	Here, choose between the protocol types FTP or FTPS. Note on FTPS: If the FTP server is configured outside the STEP 7 project of the FTP client, the certificate needs to be imported from the FTP server.
UserName	STRING[32]	'user'	User name for the login on the FTP server
Password	STRING[32]	'password'	Password for the login on the FTP server
FTPserverIP_addr	IPv6 array [1..16] of Byte		IP address of the FTP server

**Job block for FTP connection establishment with server name**

For FTP connection establishment specifying the server name, the following data structure is used. The server name is assigned to an IP address using DNS.

Table 9-93 UDT FTP\_CONNECT\_NAME

Parameter	Type	Range of values	Meaning / remarks
LADDR	WORD		Module start address When you call an instruction, you transfer the module start address of the CP in the LADDR parameter. You will find the module start address of the CP in the configuration of the CP under: "Properties>Addresses>Inputs"
ID	INT	1, 2...64	The FTP jobs are handled on FTP connections. The parameter identifies the connection being used.
ConnectionType	BYTE	0	Connection type "FTP"
ActiveEstablished	BOOL	TRUE	
FTPcmd	BYTE	1	FTP command "CONNECT" FTP command that executes when the instruction is called. You will find the ranges of values in Table 9-90 Command types (Page 2702) Note: The FTP command specified here must be specified identically in the CMD input parameter.
CertIndex	BYTE	0 = FTP 1 = FTPS	Here, choose between the protocol types FTP or FTPS. Note on FTPS: If the FTP server is configured outside the STEP 7 project of the FTP client, the certificate needs to be imported from the FTP server.
UserName	STRING[32]	'user'	User name for the login on the FTP server
Password	STRING[32]	'password'	Password for the login on the FTP server
FTPserverName	STRING[254]		IP address of the FTP server

**Job block for write and read access and other FTP commands**

The following data structure is used for the FTP commands store, retrieve, delete and append.

Table 9-94 UDT FTP\_FILENAME

Parameter	Type	Range of values	Meaning / remarks
LADDR	WORD		Module start address When you call an instruction, you transfer the module start address of the CP in the LADDR parameter. You will find the module start address of the CP in the configuration of the CP under: "Properties>Addresses>Inputs"
ID	INT	1, 2...64	The FTP jobs are handled on FTP connections. The parameter identifies the connection being used.

Parameter	Type	Range of values	Meaning / remarks
ConnectionType	BYTE	0	Connection type "FTP"
ActiveEstablished	BOOL	TRUE	
FTPcmd	BYTE	2, 3, 4, 6	FTP command "STORE / RETRIEVE / DELETE / APPEND" FTP command that executes when the instruction is called. You will find the ranges of values in table Table 9-90 Command types (Page 2702) Note: The FTP command specified here must be specified identically in the CMD input parameter.
CertIndex	BYTE	0 = FTP 1 = FTPS	Here, choose between the protocol types FTP or FTPS. Note on FTPS: If the FTP server is configured outside the STEP 7 project of the FTP client, the certificate needs to be imported from the FTP server.
DataBlockNumber	UINT		The data block specified here contains the file DB to be read / written.
LenFilename	UINT	0...1000	Total length of the file name.
Filename	ARRAY[0..3] OF STRING[ 220]		File name of the source or destination file.

### Job block for the RETR\_PART FTP command

The following data structure is used for the RETR\_PART FTP command.

Table 9-95 UDT FTP\_FILENAME\_PART

Parameter	Type	Range of values	Meaning / remarks
LADDR	WORD		Module start address When you call an instruction, you transfer the module start address of the CP in the LADDR parameter. You will find the module start address of the CP in the configuration of the CP under: "Properties>Addresses>Inputs"
ID	INT	1, 2...64	The FTP jobs are handled on FTP connections. The parameter identifies the connection being used.
ConnectionType	BYTE	0	Connection type "FTP"
ActiveEstablished	BOOL	TRUE	
FTPcmd	BYTE	7	FTP command "RETR_PART" FTP command that is executed when the instruction is called. You will find value ranges in table Table 9-90 Command types (Page 2702) Note: The FTP command specified here must be specified identically in the CMD input parameter.

Parameter	Type	Range of values	Meaning / remarks
CertIndex	BYTE	0 = FTP 1 = FTPS	Here, choose between the protocol types FTP or FTPS. Note on FTPS: If the FTP server is configured outside the STEP 7 project of the FTP client, the certificate needs to be imported from the FTP server.
Offset	DWORD		Offset in bytes starting at which the file will be read.
Length	DWORD		Sublength in bytes that is read starting at the value specified in "OFFSET". Special features: <ul style="list-style-type: none"> <li>• If "DW#16#FFFFFFFF" is specified, the available rest of the file will be read. Result OK (DONE = 1, STATUS = 0) if no other error occurred.</li> <li>• When OFFSET &gt; length of the original file: Length of the destination file (ACT_LENGTH in file DB): 0 bytes on the CPU. Result OK (DONE = 1, STATUS = 0) if no other error occurred.</li> <li>• When OFFSET + LEN &gt; length of the original file (and LEN ≠ 0xFFFFFFFF): Length of the destination file (ACT_LENGTH in file DB): Available bytes starting at "OFFSET". Result OK (DONE = 1, STATUS = 0) if no other error occurred.</li> </ul>
DataBlockNumber	UINT		The data block specified here contains the file DB to be read / written.
LenFilename	UINT	0...1000	Total length of the file name.
Filename	ARRAY[0..3] OF STRING[ 220]		File name of the source or destination file.

**See also**

Overview of FTP\_CMD (Page 2699)

Input parameter - FTP\_CMD (Page 2701)

**Output parameters and status information FTP\_CMD**

**Parameters BUSY, DONE and ERROR**

You control the execution status with the parameters BUSY, DONE, ERROR and STATUS. The BUSY parameter indicates the processing status. With the DONE parameter, you check whether or not a job was correctly executed. The ERROR parameter is set if errors occur during execution of "FTP\_CMD". Error information is output in the STATUS parameter.

The following table shows the relationship between the parameters BUSY, DONE and ERROR:

BUSY	DONE	ERROR	Description
1	-	-	The job is being processed.
0	1	0	The job was completed successfully.
0	0	1	The job was terminated with an error. The cause of the error is specified in the STATUS parameter.
0	0	0	No new job was assigned.

## Evaluating status codes

### Note

For entries coded with 8FxxH in STATUS, refer to the information in the STEP 7 Standard and System Functions reference manual. The chapter describing error evaluation with the RET\_VAL output parameter contains detailed information.

Table 9-96 FTP\_CMD: Meaning of the STATUS parameter in conjunction with DONE and ERROR

DONE	ERROR	STATUS	Meaning
0	0	0000 <sub>H</sub>	No job is being executed.
1	0	0000 <sub>H</sub>	the job was completed without error.
0	0	7001 <sub>H</sub>	The job was triggered the first time (BUSY=1)
0	0	7002 <sub>H</sub>	The job is still being executed (BUSY=1)
0	0	80C4 <sub>H</sub>	Communication error (occurs temporarily, it is usually best to repeat the job in the user program).
0	0	8183 <sub>H</sub>	The configuration does not match the job parameters.
0	1	8401 <sub>H</sub>	Unknown error Possible causes: <ul style="list-style-type: none"> <li>• A timeout was detected on the connection.</li> <li>• The FTP server has aborted the connection.</li> </ul> Remedy: <ul style="list-style-type: none"> <li>• Send the QUIT and CONNECT commands again to re-establish the connection.</li> </ul>
0	1	8402 <sub>H</sub>	The connection has an error status. The timeout of the connection may have been exceeded or the FTP server may have terminated the connection. Remedy: Send the QUIT and CONNECT commands to re-establish the connection.
0	1	8403 <sub>H</sub>	Login has failed.
0	1	8404 <sub>H</sub>	FTP server is not obtainable.
0	1	8405 <sub>H</sub>	Transfer has failed.
0	1	8406 <sub>H</sub>	Timeout for current action
0	1	8407 <sub>H</sub>	File was not found on the FTP server.
0	1	8408 <sub>H</sub>	Transfer not possible.

DONE	ERROR	STATUS	Meaning
0	1	8409 <sub>H</sub>	File could not be fetched.
0	1	8410 <sub>H</sub>	Setting the TCP port for the data connection has failed.
0	1	8411 <sub>H</sub>	Offset information does not match.
0	1	8412 <sub>H</sub>	Error changing the specified directory
0	1	8413 <sub>H</sub>	Error receiving data
0	1	8414 <sub>H</sub>	Error sending data
0	1	8415 <sub>H</sub>	Specified CMD (command type) was rejected by the client.
0	1	8416 <sub>H</sub>	Connection was closed by the FTP server.
0	1	8418 <sub>H</sub>	Error in the user data. Possible causes: <ul style="list-style-type: none"> <li>• File name is empty.</li> <li>• Data length is "0"</li> <li>• etc.</li> </ul>
0	1	8419 <sub>H</sub>	There is no socket resource for opening a data connection.
0	1	8420 <sub>H</sub>	There is no socket resource for opening a control connection.
0	1	8421 <sub>H</sub>	Error opening the file DB to be read.
0	1	8422 <sub>H</sub>	Error opening the file DB to be written.
0	1	8423 <sub>H</sub>	Connection establishment to the FTP server has failed.
0	1	8424 <sub>H</sub>	Internal error
0	1	8425 <sub>H</sub>	Format error in the domain name
0	1	8426 <sub>H</sub>	There are too many DNS queries pending.
0	1	8427 <sub>H</sub>	The specified DNS server could not assign the specified domain name.
0	1	8428 <sub>H</sub>	There is no connection resource available.
0	1	8429 <sub>H</sub>	Unknown channel ID
0	1	8430 <sub>H</sub>	The file DB is too short.
0	1	8431 <sub>H</sub>	Error when writing to the file DB.
0	1	8432 <sub>H</sub>	Error when reading from the file DB.
0	1	8433 <sub>H</sub>	Error when accessing the file DB.
0	1	8434 <sub>H</sub>	Action was aborted.
0	1	8435 <sub>H</sub>	Channel will be reset.
0	1	8436 <sub>H</sub>	Unexpected server reply
0	1	8437 <sub>H</sub>	Certificate could not be verified.
0	1	8438 <sub>H</sub>	Unknown error occurred
0	1	8439 <sub>H</sub>	The FTP command causes an error. The cause must be looked for on the FTP server (REST command).
0	1	8440 <sub>H</sub>	The FTP server does not support the requested SSL protocol.
0	1	8446 <sub>H</sub>	After the FTP password was sent to the FTP server, an unexpected code was returned by the FTP server.
0	1	8451 <sub>H</sub>	An error was signaled when attempting to change the transmission mode from binary to ASCII.
0	1	8455 <sub>H</sub>	A memory request has failed on the CM/CP.
0	1	8460 <sub>H</sub>	A problem has occurred handling SSL/TLS.

DONE	ERROR	STATUS	Meaning
0	1	8469 <sub>H</sub>	Interface error The specified output interface could not be used. Remedy: Set the interface to be used for outgoing connections.
0	1	8475 <sub>H</sub>	The SSL certificate or the SSH md5 fingerprint was not considered trusted.
0	1	8476 <sub>H</sub>	Nothing was received from the FTP server. In the current status, an incorrect response must be assumed.
0	1	8477 <sub>H</sub>	The specified "Crypto engine" (cryptographic module) was not found.
0	1	8478 <sub>H</sub>	The attempt to set the selected SSL "Crypto engine" as the default failed.
0	1	8480 <sub>H</sub>	A problem has occurred with the certificate of the FTP client.
0	1	8481 <sub>H</sub>	The specified number could not be used.
0	1	8482 <sub>H</sub>	The FTP server uses a coding that is not supported.
0	1	8484 <sub>H</sub>	The maximum file size was exceeded.
0	1	8485 <sub>H</sub>	The file DB was modified while being processed to be sent or the file DB is incorrectly structured.
0	1	8489 <sub>H</sub>	Data could not be sent. There is not enough memory available for the action on the FTP server.
0	1	8492 <sub>H</sub>	The file already exists. The file will not be overwritten.
0	1	8496 <sub>H</sub>	A problem occurred reading the SSL CA certificate.
0	1	8497 <sub>H</sub>	An unexpected error occurred in the SSH session.
0	1	8498 <sub>H</sub>	It was not possible to terminate the SSL connection.
0	1	8499 <sub>H</sub>	The socket is not ready for sending/receiving. Wait until it is ready and try again.
0	1	8501 <sub>H</sub>	The SSL certificate check by the FTP server has failed.
0	1	8507 <sub>H</sub>	A timeout has occurred establishing the connection during the active FTP session while waiting for the FTP server.
0	1	8F55 <sub>H</sub>	Header status bit: Locked
0	1	8F56 <sub>H</sub>	The NEW bit in the file DB header was not reset
0	1	8F6B <sub>H</sub>	Possible causes: <ul style="list-style-type: none"> <li>Bad value for the CMD parameter Values from 0 to 15 are permitted.</li> <li>An FB40 command is not supported. Possible cause: Wrong firmware on the CP Remedy: Firmware update (with older CPs, use the functions FC 40...FC 44 instead of FB 40.)</li> </ul>
0	1	8F7F <sub>H</sub>	Internal error, for example illegal ANY reference

**See also**

Overview of FTP\_CMD (Page 2699)

## Structure and use of the file DB - FTP client mode

### Structure of the data blocks (file DBs) for FTP services - FTP client mode

#### How it works

To transfer data with FTP, create data blocks (file DBs) on the CPU of your S7 station. These data blocks must have certain structure to allow them to be handled as transferable files by the FTP services. They consist of the following sections:

- Section 1: File DB header (has a fixed length of 20 bytes)
- Section 2: User data (has a variable length and structure)

#### Requirements in the CPU configuration

Use the following settings to allow FTP access:

- In the configuration data of the CPU in "Properties > General > Protection": Disable the "Disable PUT/GET communication" option.
- For all data blocks being used as file DBs, disable the "Optimized block access" attribute

#### File DB header for FTP client mode

Note: The file DB header described here is largely identical to the file DB header for server mode. The differences relate to the following parameters:

- WRITE\_ACCESS
- FTP\_REPLY\_CODE



Parameter	Type	Value / meaning	Supply
EXIST	BOOL	<p>The EXIST bit indicates whether the user data area contains valid data.</p> <p>The retrieve FTP command executes the job only when EXIST=1.</p> <ul style="list-style-type: none"> <li>• 0: The file DB does not contain valid user data ("file does not exist").</li> <li>• 1: The file DB contains valid user data ("file exists").</li> </ul>	<p>The dele FTP command sets EXIST=0; The store FTP command sets EXIST=1;</p>
LOCKED	BOOL	<p>The LOCKED bit is used to restrict access to the file DB.</p> <ul style="list-style-type: none"> <li>• 0: The file DB can be accessed.</li> <li>• 1: The file DB is locked.</li> </ul>	<p>The stor and retr FTP commands set LOCKED=1 when they are executed.</p> <p>The following function is also possible when writing from the user program: The user program on the S7 CPU can set or reset LOCKED during write access to achieve data consistency.</p> <p>Recommended sequence in the user program:</p> <ol style="list-style-type: none"> <li>1. Check LOCKED bit; if = 0</li> <li>2. Set WRITEACCESS bit = 0</li> <li>3. Check LOCKED bit; if = 0</li> <li>4. Set LOCKED bit = 1</li> <li>5. Write data</li> <li>6. Set LOCKED bit = 0</li> </ol>
NEW	BOOL	<p>The NEW bit indicates whether data has been modified since the last read access.</p> <ul style="list-style-type: none"> <li>• 0: The content of the file DB is unchanged since the last write access. The user program of the S7 CPU has registered the last modification.</li> <li>• 1: The user program of the S7 CPU has not yet registered the last write access.</li> </ul>	<p>After execution, the stor FTP command sets NEW=1</p> <p>After reading the data, the user program in the S7-CPU must set NEW=0 to allow a new retr command.</p>

Parameter	Type	Value / meaning	Supply
WRITE_ACCESS	BOOL	0: The user program (FTP client blocks) has write access rights for the file DBs on the S7 CPU. 1: The user program (FTP client blocks) has no write access rights for the file DBs on the S7 CPU.	During the configuration of the DB, the bit is set to an initialization value. Recommendation: Whenever possible, the bit should remain unchanged! In special situations, adaptation during operation is possible.
ACT_LENGTH	DINT	Current length of the user data area. The content of this field is only valid when EXIST = 1.	The current length is updated following write access.
MAX_LENGTH	DINT	Maximum length of the user data area (length of the entire DB less 20 bytes header).	The maximum length should be specified during configuration of the DB. The value can also be modified by the user program during operation.
FTP_REPLY_CODE	INT	Unsigned integer (16-bit) containing the last reply code from FTP as a binary value. The content of this field is only valid when EXIST = 1.	This is updated by the FTP client when the FTP command is executed.
DATE_TIME	DATE_AND_TIME	Date and time of the last modification to the file. The content of this field is only valid when EXIST = 1.	The current date is updated following a write access. If the function for forwarding the time of day is used, the entry corresponds to the time that was passed on. If the function for forwarding the time of day is not used, a relative time is entered. This time relates to the startup of the CP (the initialization value is 1.1.1994 0.0 (midnight)).

**See also**

FILE\_DB\_HEADER data block as template - FTP client mode (Page 2714)

**FILE\_DB\_HEADER data block as template - FTP client mode**

**Meaning**

The data type FILE\_DB\_HEADER is predefined for creating a file DB header.

## How it works

To transfer data with FTP, create data blocks (file DBs) on the CPU of your S7 station. These data blocks must have certain structure to allow them to be handled as transferable files by the FTP services. They consist of the following sections:

- Section 1: File DB header (has a fixed length of 20 bytes)
- Section 2: User data (has a variable length and structure)

## Follow the steps outlined below:

1. For the PLC CPU on which you create the user program with the FTP instructions, create a data block of the type "Global DB".
2. Select the line you want to use as the start line for the file DB.
3. From the drop-down list in the "Data type" column, select a structure element of the type FILE\_DB\_HEADER.  
Result: A data structure with the header structure required for the file DB is created.
4. Select the properties of the newly created data block and disable the "Optimized block access" attribute.

---

### Note

#### "Add new block" function - type selection

When you create new data blocks, the "FILE\_DB\_HEADER" block type is also available under the "Type" entry in the drop-down list. Do not use this option! The data block created in this way only contains the header structure and cannot be expanded by the area required for storing user data.

---

## FILE\_DB\_HEADER data block - example and template for the file DB header

In the declaration view, you will see the following structure:

Address	Name	Type	Initial value	Comment
0.0		STRUCT		
+0.0	bit08	BOOL	FALSE	reserved
+0.1	bit09	BOOL	FALSE	reserved
+0.2	bit10	BOOL	FALSE	reserved
+0.3	bit11	BOOL	FALSE	reserved
+0.4	bit12	BOOL	FALSE	reserved
+0.5	bit13	BOOL	FALSE	reserved
+0.6	bit14	BOOL	FALSE	reserved
+0.7	bit15	BOOL	FALSE	reserved
+1.0	EXIST	BOOL	FALSE	if TRUE: File DB does not contain valid data

9.7 References

Address	Name	Type	Initial value	Comment
+1.1	LOCKED	BOOL	FALSE	if TRUE: The file DB is blocked due to a change to the content.
+1.2	NEW	BOOL	FALSE	if TRUE: The content of the File DB is new and must not be overwritten.
+1.3	WRITE_ACCESS	BOOL	FALSE	if TRUE: The FTP server has write access.
+1.4	bit04	BOOL	FALSE	reserved
+1.5	bit05	BOOL	FALSE	reserved
+1.6	bit06	BOOL	FALSE	reserved
+1.7	bit07	BOOL	FALSE	reserved
+2.0	ACT_LENGTH	DINT	L#0	Current length of the content in bytes (not including 20 bytes for the header)
+6.0	MAX_LENGTH	DINT	L#0	Current length of the content in bytes (not including 20 bytes for the header)
+10.0	FTP_REPLY_CODE	INT	0	Last replay information from the remote FTP server.
+12.0	DATE_TIME	DATE_AND_TIME	DT#00-1-1-0:0:0.000	Date and time of the last change to the content of the file DB.
=20.0		END_STRUCT		

Differences in the modes

File DB header for FTP client mode

The file DB header described here is largely identical for the FTP client mode and FTP server mode. The differences relate to the following parameters:

- WRITE\_ACCESS
- FTP\_REPLY\_CODE

## S7-1200 CM/CP

### Telecontrol

#### Telecontrol instructions

#### TC\_CON: Establish connection via the GSM network

#### Meaning

The TC\_CON instruction allows an S7-1200 with a CP 1242-7 to establish a connection of the following types:

- ISO-ON-TCP  
Connection partner is a CP 1242-7.  
ISO-ON-TCP connections are used only in "GPRS direct" mode.
- UDP  
Any connection partner is possible.
- SMS  
The connection partner is an SMS client.
- Telecontrol connection  
The connection partner is either a telecontrol server or another station that can be reached via the telecontrol server.

A TC\_CON establishes exactly one connection. Depending on the mode of the CP 1242-7 and the protocol you are using, a maximum of 3 to 5 simultaneous connections with unique IDs (see below) are supported per CP. You will find the maximum number of simultaneous connections in the performance data of the CP.

The CONNECT parameter uses a data block (DB) with the structure of a system data type (SDT) for the connection description.

The required connection type is defined using a connection-specific SDT "TCON\_..." (see below). For each of the connection types listed above, one of the following SDTs must be assigned:

- TCON\_IP\_RFC for ISO-ON-TCP connections
- TCON\_IP\_V4 for UDP connections
- TCON\_PHONE for SMS connections
- TCON\_WDC for telecontrol connections

The "ActiveEstablished" parameter of these SDTs also specifies whether or not connection establishment is active or passive.

For parameter settings for these SDTs, see TCON\_...: SDTs for the telecontrol connection establishment (Page 2732).

The ID parameter references the GPRS connection. The ID is assigned and must be unique within the CPU.

The INTERFACE parameter references the GPRS interface of the required local CP. This must be taken from STEP 7.

**Call interface in FBD representation**

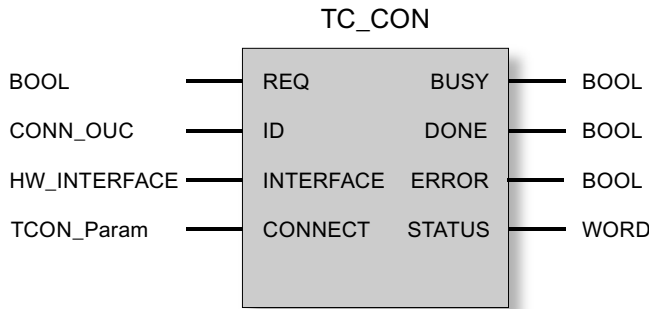

**Explanation of the formal parameters**

The following table explains all the formal parameters for the TC\_CON instruction.

Parameter	Declaration	Data type	Range of values	Description
REQ	INPUT	BOOL	0, 1	The instruction is started and the status codes initialized on a rising edge. Updating of the DONE, ERROR and STATUS status codes when there is a positive edge.
ID	INPUT	CONN_OUC (WORD)	1...07FF <sub>h</sub>	Reference to the relevant connection. The ID is assigned. The value of ID is also required by the system data type (SDT) of the CONNECT parameter.
INTERFACE	INPUT	HW_INTERFACE		Reference to the interface of the local CP 1242-7 (see STEP 7 > CP configuration > Telecontrol interface > "Hardware identifier")
CONNECT	INOUT	TCON_Param	See also "TCON_...: SDTs for telecontrol connection establishment"	Reference to a data block for connection establishment. The SDTs of the type TCON_IP RFC, TCON_IP_V4, TCON_PHONE or TCON_WDC specify the structure of the data block suitable for the relevant connection. In the SDTs, note the parameter "ActiveEstablished" (active / passive connection establishment).
ENO	OUTPUT	BOOL	0: Error 1: Error-free	Enable output If there is a runtime error with the instruction, ENO = 0 is set.

Parameter	Declaration	Data type	Range of values	Description
BUSY	OUTPUT	BOOL	0: Execution of the instruction not started, completed or aborted 1: The instruction is executing	Display of the processing status of the instruction
DONE	OUTPUT	BOOL	0: - 1: The instruction executed successfully	This parameter indicates whether or not the job was completed without errors. For the meaning in conjunction with the parameters ERROR and STATUS, refer to Codes of the instruction.
ERROR	OUTPUT	BOOL	0: - 1: Error	Error code For the meaning in conjunction with the parameters DONE and STATUS, refer to Codes of the instruction.
STATUS	OUTPUT	WORD		Status code For the meaning in conjunction with the parameters DONE and ERROR, refer to Codes of the instruction.

### The codes BUSY, DONE and ERROR

The codes of DONE and ERROR are relevant only when BUSY = 0.

BUSY	DONE	ERROR	Meaning
0	0	0	No job being executed

You will find all other code combinations of DONE and ERROR in the following table.

When called, the instruction remains in the BUSY = 1 state for several seconds. In the following situations, the BUSY state = 1 can last for a longer time:

- On active ISO-on-TCP connections if the partner cannot be reached.
- On passive connections when no frame is received.

### The codes DONE, ERROR and STATUS

The following table shows the condition codes formed based on DONE, ERROR and STATUS that must be evaluated by the user program.

DONE	ERROR	STATUS	Meaning
1	0	0000 <sub>H</sub>	Job executed without errors
0	0	7000 <sub>H</sub>	No job processing active (first instruction call)
0	0	7001 <sub>H</sub>	Job processing started (first instruction call)
0	0	7002 <sub>H</sub>	Job processing already active (renewed instruction call when BUSY = 1)
0	1	8086 <sub>H</sub>	Illegal value for ID
0	1	8087 <sub>H</sub>	Maximum number of connections reached, no further connection possible
0	1	80E3 <sub>H</sub>	The ID is already being used by another connection.
0	1	80E6 <sub>H</sub>	No query in progress (instruction call not started)

DONE	ERROR	STATUS	Meaning
0	1	80E8 <sub>H</sub>	Remote partner cannot be reached. Check the connection parameters. In the "GPRS direct" mode, the message is output if the partner can be reached but is not accepting a connection request.
0	1	80EB <sub>H</sub>	Request temporarily denied (TC_CON has already been called with the same destination address.)
0	1	80EC <sub>H</sub>	Opening the Listener Port failed: Check the connection parameters.
0	1	80F2 <sub>H</sub>	The CP is in the wrong mode: <ul style="list-style-type: none"> <li>• Telecontrol connections are permitted only in "Telecontrol" mode.</li> <li>• ISO-ON-TCP connections are permitted only in "GPRS direct" mode.</li> </ul>
0	1	80F3 <sub>H</sub>	No free connection endpoint for sending data: <ul style="list-style-type: none"> <li>• Use less connections or</li> <li>• Use less passive connections or</li> <li>• Turn off NTP.</li> </ul> Remember the maximum number of simultaneous connections of the CP 1242-7.
0	1	80F4 <sub>H</sub>	Connection endpoint cannot be generated: Repeat the call. If necessary, check the connection parameters.
0	1	80F6 <sub>H</sub>	Format error of a parameter in the called data block (wrong length, wrong format or invalid value) Check the configuration of the "TC_CON..." SDT.

### TC\_DISCON: Terminate connection via the GSM network

#### Meaning

The TC\_DISCON instruction on an S7-1200 with CP 1242-7 terminates an ISO-ON-TCP, UDP, SMS or telecontrol connection that was established with the TC\_CON instruction.

You will find detailed information on the connection types in the description of the TC\_CON instruction.

TC\_DISCON terminates the connection to the telecontrol server only logically. If you want the connection to the telecontrol server to be terminated physically, configure the connection as a "Temporary connection" in the "telecontrol server" parameter group in STEP 7.

At the TCP/IP level, the connection is retained. Temporary stations terminate the connection automatically after sending the data.

The ID parameter references the GPRS connection. The ID must be unique within the CPU and the same as the ID used with TC\_CON.

The INTERFACE parameter references the GPRS interface of the required local CP. The value must be the same as that used by TC\_CON for INTERFACE.



## Call interface in FBD representation

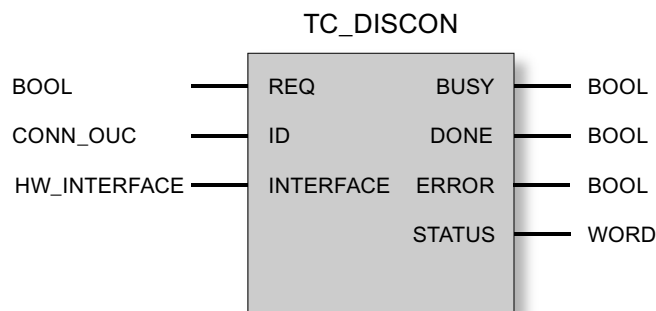

## Explanation of the formal parameters

The following table explains all the formal parameters for the TC\_DISCON instruction

Parameter	Declaration	Data type	Range of values	Description
REQ	INPUT	BOOL	0, 1	The instruction is started and the status codes initialized on a rising edge. Updating of the DONE, ERROR and STATUS status codes when there is a positive edge.
ID	INPUT	CONN_OUC (WORD)	1...07FF <sub>n</sub>	Reference to the relevant connection
INTERFACE	INPUT	HW_INTERFA CE		Reference to the interface of the local CP 1242-7 (see STEP 7 > CP configuration > Telecontrol interface > "Hardware identifier")
ENO	OUTPUT	BOOL	0: Error 1: Error-free	Enable output If there is a runtime error with the instruction, ENO = 0 is set.
BUSY	OUTPUT	BOOL	0: Execution of the instruction not started, completed or aborted 1: The instruction is executing	Display of the processing status of the instruction
DONE	OUTPUT	BOOL	0: - 1: The instruction executed successfully	This parameter indicates whether or not the job was completed without errors. For the meaning in conjunction with the parameters ERROR and STATUS, refer to Codes of the instruction.
ERROR	OUTPUT	BOOL	0: - 1: Error	Error code For the meaning in conjunction with the parameters DONE and STATUS, refer to Codes of the instruction.
STATUS	OUTPUT	WORD		Status code For the meaning in conjunction with the parameters DONE and ERROR, refer to Codes of the instruction.

### The codes BUSY, DONE and ERROR

The codes of DONE and ERROR are relevant only when BUSY = 0.

BUSY	DONE	ERROR	Meaning
0	0	0	The instruction has not yet been called.

You will find all other code combinations of DONE and ERROR in the following table.

#### Note

When called, the instruction remains in the BUSY = 1 state for several seconds.

### The codes DONE, ERROR and STATUS

The following table shows the condition codes formed based on DONE, ERROR and STATUS that must be evaluated by the user program.

DONE	ERROR	STATUS	Meaning
1	0	0000 <sub>H</sub>	Job executed without errors
0	0	7000 <sub>H</sub>	No job processing active (first instruction call)
0	0	7001 <sub>H</sub>	Job processing started (first instruction call)
0	0	7002 <sub>H</sub>	Job processing already active (renewed instruction call when BUSY = 1)
0	1	8086 <sub>H</sub>	Illegal value for ID
0	1	80E4 <sub>H</sub>	Unknown ID: No connection with this ID has been established by TC_CON.
0	1	80E6 <sub>H</sub>	No query in progress (instruction call not started)
0	1	80F5 <sub>H</sub>	Invalid connection endpoint: <ul style="list-style-type: none"> <li>• Connection establishment by TC_CON failed or</li> <li>• Connection terminated by remote partner.</li> </ul>
0	1	80F6 <sub>H</sub>	Format error of a parameter in the called data block (wrong length, wrong format or invalid value) Check the configuration of the "TC_CON..." SDT.

### TC\_SEND: Send data via the GSM network

#### Meaning

The TC\_SEND instruction allows the sending of data via programmed connections of the following types:

- ISO-ON-TCP connections
- UDP connections

- SMS connections  
The sending of SMS messages is supported only if this was set up in the STEP 7 configuration of the CP.
- Telecontrol connections

**Note****Sending SMS messages to multiple recipients**

If you want to send an identical SMS message to several recipients, you need to establish a connection to each recipient.

You will find more detailed information on the connection types in the description of the TC\_CON instruction.

The ID parameter references the GPRS connection. The value of ID must correspond to the value used for ID by TC\_CON.

The INTERFACE parameter references the GPRS interface of the required local CP. The value must be the same as that used by TC\_CON for INTERFACE.

The amount of data to be sent is specified with the LEN parameter.

The size of the data area specified in DATA must be at least as large as the number of bytes configured for LEN. Permitted data types in the data area specified in DATA are all except BOOL and ARRAY of BOOL.

The destination address (connection partner) for the data to be sent is configured in the TC\_CON instruction.

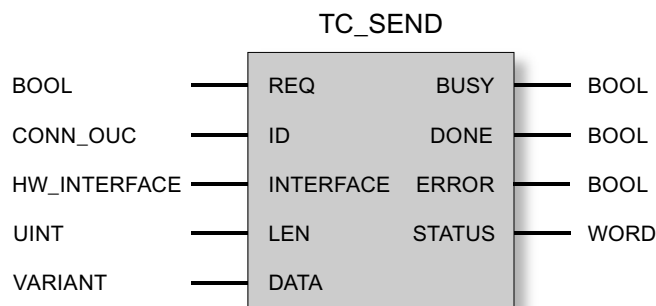
**Call interface in FBD representation**

**Explanation of the formal parameters**

The following table explains all the formal parameters for the TC\_SEND instruction.

Parameter	Declaration	Data type	Range of values	Description
REQ	INPUT	BOOL	0, 1	The instruction is started and the status codes initialized on a rising edge. Updating of the DONE, ERROR and STATUS status codes when there is a positive edge.
ID	INPUT	CONN_OUC (WORD)	1...07FF <sub>h</sub>	Reference to the relevant connection
INTERFACE	INPUT	HW_INTERFA CE		Reference to the interface of the local CP 1242-7 (see STEP 7 > CP configuration > Telecontrol interface > "Hardware identifier")
LEN	INPUT	UINT	1...2048	Number of bytes of data to be sent, maximum 2048. The value should match the size of the range of DATA.
DATA	INOUT	VARIANT		Address reference to the send data area of the CPU *
ENO	OUTPUT	BOOL	0: Error 1: Error-free	Enable output If there is a runtime error with the instruction, ENO = 0 is set.
BUSY	OUTPUT	BOOL	0: Execution of the instruction not started, completed or aborted 1: The instruction is executing	Display of the processing status of the instruction
DONE	OUTPUT	BOOL	0: - 1: The instruction executed successfully	This parameter indicates whether or not the job was completed without errors. ** For the meaning in conjunction with the parameters ERROR and STATUS, refer to Codes of the instruction.
ERROR	OUTPUT	BOOL	0: - 1: Error	Error code For the meaning in conjunction with the parameters DONE and STATUS, refer to Codes of the instruction.
STATUS	OUTPUT	WORD		Status code For the meaning in conjunction with the parameters DONE and ERROR, refer to Codes of the instruction.

\* For special features of the DATA parameter for SMS texts, refer to the next section.

\*\* After sending a frame, TC\_SEND sets DONE = 1. Note the following response:

The loss of an ISO-on-TCP connection is only recognized by the sender after 1 to 2 minutes. The transferred data may be lost although TC\_SEND has set DONE = 1 at the sender.

If an ISO-on-TCP connection is aborted after receiving a frame before TC\_RECV was started, the transferred data may be lost even if TC\_SEND sets DONE = 1 at the sender.

## Configuring SMS texts with the DATA parameter

The instruction sends the data referenced by the pointer of the type VARIANT of the DATA parameter as an SMS text.

If an operand of the data type STRING is referenced by DATA for SMS texts, the first two bytes are transferred with length information of the string.

One option for the correct text representation of SMS messages to be sent is to convert the text string into an Array of BYTE or Array of CHAR using the conversion function Strg\_TO\_Chars. Strg\_TO\_Chars at the EN parameter is linked to the output parameter ENO by TC\_SEND.

For SMS texts, the CP does not support all special characters, for example umlauts (ü, ä etc.). The specification GSM 03.38 applies. There may be additional restrictions imposed by the GSM network provider.

## The codes BUSY, DONE and ERROR

The codes of DONE and ERROR are relevant only when BUSY = 0.

BUSY	DONE	ERROR	Meaning
0	0	0	No job being executed

You will find all other code combinations of DONE and ERROR in the following table.

## The codes DONE, ERROR and STATUS

The following table shows the condition codes formed based on DONE, ERROR and STATUS that must be evaluated by the user program.

DONE	ERROR	STATUS *	Meaning
1	0	0000 <sub>H</sub>	Job executed without errors
0	0	7000 <sub>H</sub>	No job processing active (first instruction call)
0	0	7001 <sub>H</sub>	Job processing started (first instruction call)
0	0	7002 <sub>H</sub>	Job processing already active (renewed instruction call when BUSY = 1)
0	1	8086 <sub>H</sub>	Illegal value for ID
0	1	80E0 <sub>H</sub>	<ul style="list-style-type: none"> <li>The length information under LEN is greater than the range of data to be transferred under DATA.</li> <li>or</li> <li>Internal error</li> </ul> If you send the frames directly to the telecontrol server (mode "Telecontrol"), make sure that the send cycle time is ≥ 1 second.
0	1	80E1 <sub>H</sub>	Timeout: <ul style="list-style-type: none"> <li>Increase the value of the "Connection monitoring time" in the configuration of the CP 1242-7 or</li> <li>Check the connection partner.</li> </ul>
0	1	80E4 <sub>H</sub>	Unknown ID: First call TC_CON.
0	1	80E6 <sub>H</sub>	No query in progress (instruction call not started)

9.7 References

DONE	ERROR	STATUS *	Meaning
0	1	80E7 <sub>H</sub>	Data to be sent not completely transferred: Repeat the job.
0	1	80E8 <sub>H</sub>	Remote partner cannot be reached. Check the connection parameters. In the "GPRS direct" mode, the message is output if the partner can be reached but is not accepting a connection request.
0	1	80E9 <sub>H</sub>	Connection establishment by remote partner: Check the connection partner. If necessary, terminate the connection with TC_DISCON and establish it again with TC_CON.
0	1	80EA <sub>H</sub>	Error message from remote partner: <ul style="list-style-type: none"> <li>• Check the connection partner. Enable the "TC_RECV" instruction on the communications partner.</li> <li>• If necessary, terminate the connection with TC_DISCON and establish it again with TC_CON.</li> </ul>
0	1	80EF <sub>H</sub>	SMS could not be sent: <ul style="list-style-type: none"> <li>• Check whether the destination address (telephone number of the destination subscriber) exists.</li> <li>• Check whether the inserted SIM card allows sending of SMS.</li> <li>• Make sure that when the data block TCON_PHONE was created, the "Standard" option was selected for block access.</li> </ul>
0	1	80F1 <sub>H</sub>	Sending of SMS messages is not enabled in the STEP 7 configuration of the CP: Enable the "Allow SMS" option in the configuration of the CP.
0	1	80F4 <sub>H</sub>	Connection endpoint cannot be generated: Check the connection partner.
0	1	80F5 <sub>H</sub>	Invalid connection endpoint: <ul style="list-style-type: none"> <li>• Connection establishment by TC_CON failed. or</li> <li>• Connection terminated by remote partner: First call TC_DISCON.</li> </ul>
0	1	80F6 <sub>H</sub>	Format error of a parameter in the called data block (wrong length, wrong format or invalid value): Check the configuration of the "TC_CON..." SDT.

\* Further statuses that are not listed here can be found in the status display is of the "RDREC" or "WRREC" instructions in the two middle status bytes (STATUS[2], STATUS[3]).

## TC\_RECV: Receive data via the GSM network

### Meaning

The TC\_RECV instruction allows the reception of data via programmed connections of the following types:

- ISO-ON-TCP connections
- SMS connections  
To receive SMS messages, the phone number of the sender must be configured in the STEP 7 configuration of the receiving CP (authorized phone numbers). The sender must support the CLIP function.  
The phone number of the connection partner must be entered in the "TCON\_PHONE" SDT. Wake-up SMS messages are filtered out.
- Telecontrol connections

---

#### Note

##### Receiving SMS messages from different senders

If you want to receive SMS messages from different senders, you have two alternatives:

- You configure several connections (TC\_CON, TC\_RECV, TC\_DISCON).  
or
  - You may only enter no telephone number for only one configured connection in the required data block "TCON\_PHONE" in the "PhoneNumber" parameter. When receiving messages, this is then interpreted as a placeholder for all authorized connection partners.
- 

You will find more detailed information on the connection types in the description of the TC\_CON instruction.

The ID parameter references the GPRS connection. The value of ID must correspond to the value used for ID by TC\_CON.

The INTERFACE parameter references the GPRS interface of the required local CP. The value must be the same as that used by TC\_CON for INTERFACE.

The maximum amount of data to be received is specified with the LEN parameter.

The size of the data area specified in DATA must be at least as large as the number of bytes configured for LEN. Permitted data types in the data area specified in DATA are all except BOOL and ARRAY of BOOL. The received data is interpreted as if the sending partner had used the same data types.

The DB (system data type) used for the connection description of TC\_RECV must differ from a DB used for TC\_SEND.

Call interface in FBD representation

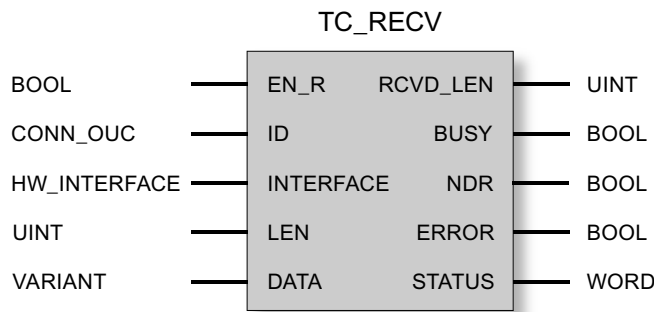

Explanation of the formal parameters

The following table explains all the formal parameters for the TC\_RECV instruction

Parameter	Declaration	Data type	Range of values	Description
EN_R	INPUT	BOOL	0: Data reception locked 1: Data reception enabled	Enables / locks the reception of data. After setting 1 to 0, the program block receives data again.
ID	INPUT	CONN_OUC (WORD)	1...07FF <sub>h</sub>	Reference to the relevant connection
INTERFACE	INPUT	HW_INTERFACE		Reference to the interface of the local CP 1242-7 (see STEP 7 > CP configuration > Telecontrol interface > "Hardware identifier")
LEN	INPUT	UINT	1...2048	(minimum) number of bytes of data to be received, maximum 2048
DATA	INOUT	VARIANT		Address reference to the receive data area of the CPU *
ENO	OUTPUT	BOOL	0: Error 1: Error-free	Enable output If there is a runtime error with the instruction, ENO = 0 is set.
RCVD_LEN	OUTPUT	UINT		Number of bytes of received data
BUSY	OUTPUT	BOOL	0: Execution of the instruction not started, completed or aborted 1: The instruction is executing	Display of the processing status of the instruction
DONE	OUTPUT	BOOL	0: - 1: The instruction executed successfully	This parameter indicates whether or not the job was completed without errors. For the meaning in conjunction with the parameters ERROR and STATUS, refer to Codes of the instruction.



Parameter	Declaration	Data type	Range of values	Description
ERROR	OUTPUT	BOOL	0: - 1: Error	Error code For the meaning in conjunction with the parameters DONE and STATUS, refer to Codes of the instruction.
STATUS	OUTPUT	WORD		Status code For the meaning in conjunction with the parameters DONE and ERROR, refer to Codes of the instruction.

\* For special features of the DATA parameter for SMS texts, refer to the next section.

### Configuring SMS texts with the DATA parameter

The instruction references the received SMS text with the pointer of the type VARIANT of the DATA parameter to the data area of the CPU.

If DATA references an operand of the data type STRING for the SMS text, the first two bytes of the SMS text will be interpreted as length information of the data type STRING and not as SMS text.

One option for the correct text representation of SMS messages to be received is to convert an Array of BYTE or Array of CHAR to a text string using the conversion function Chars\_TO\_Strg. Chars\_TO\_Strg at the EN parameter is linked to the output parameter ENO of TC\_RECVC.

For SMS texts, the CP does not support all special characters, for example umlauts (ü, ä etc.). The specification GSM 03.38 applies. There may be additional restrictions imposed by the GSM network provider.

### The codes BUSY, DONE and ERROR

The codes of DONE and ERROR are relevant only when BUSY = 0.

BUSY	DONE	ERROR	Meaning
0	0	0	No job being executed

You will find all other code combinations of DONE and ERROR in the following table.

### The codes DONE, ERROR and STATUS

The following table shows the condition codes formed based on DONE, ERROR and STATUS that must be evaluated by the user program.

DONE	ERROR	STATUS *	Meaning
1	0	0000 <sub>H</sub>	Job executed without errors
0	0	7000 <sub>H</sub>	No job processing active (first instruction call)
0	0	7001 <sub>H</sub>	Job processing started (first instruction call)
0	0	7002 <sub>H</sub>	Job processing already active (renewed instruction call when BUSY = 1)

DONE	ERROR	STATUS *	Meaning
0	1	80A3 <sub>H</sub>	<ul style="list-style-type: none"> <li>• An attempt is made to re-establish an existing connection.</li> <li>• An attempt is made to terminate a non-existent connection.</li> </ul>
0	1	80E0 <sub>H</sub>	<ul style="list-style-type: none"> <li>• The size of the data received for the range specified by DATA is greater than the length information in LEN. or</li> <li>• Internal error</li> </ul>
0	1	8086 <sub>H</sub>	Illegal value for ID
0	1	80E4 <sub>H</sub>	Unknown ID: First call TC_CON.
0	1	80E6 <sub>H</sub>	No query in progress (instruction call not started)
0	1	80F5 <sub>H</sub>	Invalid connection endpoint: <ul style="list-style-type: none"> <li>• Connection establishment by TC_CON failed. or</li> <li>• Connection terminated by remote partner: First call TC_DISCON.</li> </ul>
0	1	80F6 <sub>H</sub>	Format error of a parameter in the called data block (wrong length, wrong format or invalid value) Check the configuration of the "TC_CON..." SDT.

\* Further statuses that are not listed here can be found in the status display of the "RDREC" or "WRREC" instructions in the two middle status bytes (STATUS[2], STATUS[3]).

### TC\_CONFIG: Transferring configuration data to a CP

#### Meaning

With the TC\_CONFIG instruction, parameters of a the CP 1242-7 configured in STEP 7 can be modified. The configured values are not overwritten retentively. The overwritten values remain valid until TC\_CONFIG is called again or until the station starts up again (cold restart after cycling power).

If the STEP 7 configuration data of the CP needs to be changed permanently, the instruction needs to be called again each time the station restarts (cold restart) or a modified project must be downloaded to the station.

The CONFIG parameter points to the memory area with the configuration data. The configuration data is stored in a data block (DB). The structure of the DB is specified by the system data type (SDT) IF\_CONF.

The configuration data to be modified on the CP is put together as necessary in blocks in IF\_CONF "IF\_CONF\_..." for the individual parameters.

Parameters that are not intended to change as a result of the instruction are not entered in IF\_CONF. They retain the value configured in STEP 7.

For detail information on assigning value to IF\_CONF, refer to the section IF\_CONF: SDT for telecontrol configuration data (Page 2737).

The INTERFACE parameter references the GPRS interface of the required local CP.

## Call interface in FBD representation

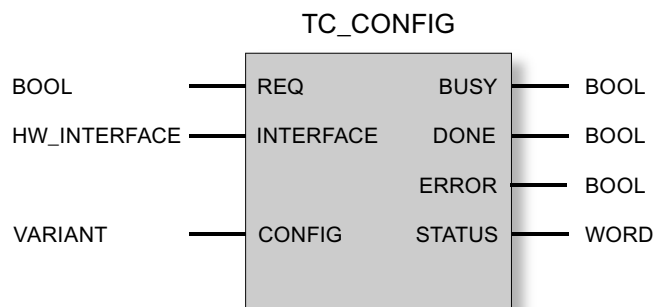

## Explanation of the formal parameters

The following table explains all the formal parameters for the TC\_CONFIG instruction

Parameter	Declaration	Data type	Range of values	Description
REQ	INPUT	BOOL	0, 1	The instruction is started and the status codes initialized on a rising edge. Updating of the DONE, ERROR and STATUS status codes when there is a positive edge.
INTERFACE	INPUT	HW_INTERFACE (WORD)		Reference to the interface of the local CP 1242-7
CONFIG	INOUT	VARIANT	See also "IF_CONF: SDT for telecontrol configuration data	Reference to the memory area with the collected configuration data to be modified
ENO	OUTPUT	BOOL	0: Error 1: Error-free	Enable output If there is a runtime error with the instruction, ENO = 0 is set.
BUSY	OUTPUT	BOOL	0: Execution of the instruction not started, completed or aborted 1: The instruction is executing	Display of the processing status of the instruction
DONE	OUTPUT	BOOL	0: - 1: The instruction executed successfully	This parameter indicates whether or not the job was completed without errors. For the meaning in conjunction with the parameters ERROR and STATUS, refer to Codes of the instruction.
ERROR	OUTPUT	BOOL	0: - 1: Error	Error code For the meaning in conjunction with the parameters DONE and STATUS, refer to Codes of the instruction.
STATUS	OUTPUT	WORD		Status code For the meaning in conjunction with the parameters DONE and ERROR, refer to Codes of the instruction.

**The codes BUSY, DONE and ERROR**

The codes of DONE and ERROR are relevant only when BUSY = 0.

BUSY	DONE	ERROR	Meaning
0	0	0	No job being executed

You will find all other code combinations of DONE and ERROR in the following table.

**The codes DONE, ERROR and STATUS**

The following table shows the condition codes formed based on DONE, ERROR and STATUS that must be evaluated by the user program.

DONE	ERROR	STATUS	Meaning
1	0	0000 <sub>H</sub>	Job executed without errors
0	0	7000 <sub>H</sub>	No job processing active (first instruction call)
0	0	7001 <sub>H</sub>	Job processing started (first instruction call)
0	0	7002 <sub>H</sub>	Job processing already active (renewed instruction call when BUSY = 1)
0	1	80E6 <sub>H</sub>	No query in progress (instruction call not started)
0	1	80EB <sub>H</sub>	Query temporarily rejected (the CP is currently being configured by STEP 7).
0	1	80F6 <sub>H</sub>	Format error of a parameter in the called data block (wrong length, wrong format or invalid value) Check the "IF_CONF" SDT.
0	1	80F7 <sub>H</sub>	Wrong ID in the parameter fields of the configuration data: Check the "IF_CONF" SDT.

**Other error messages**

**Other error messages**

The following error messages are used for diagnostics purposes. You can obtain more information from the Siemens hotline.

DONE	ERROR	STATUS	Meaning
0	1	80E0 <sub>H</sub>	Internal error You should also note the possible meaning with the TC_SEND and TC_RECV instructions.

**TCON\_...: SDTs for the telecontrol connection establishment**

**System data types TCON\_... for the TC\_CON instruction**

To configure a telecontrol connection using the TC\_CON instruction, the CONNECT parameter of the instruction is used for the connection description.

The connection description is specified by the structure of the system data type (SDT). The structure of the relevant SDT contains the parameters necessary to establish the connection with the remote communications partner.

For different connection types that depend on the remote communications partner, the following SDTs are used:

- TCON\_IP\_RFC for ISO-on-TCP connections to IPv4 stations with CP 1242-7
- TCON\_IP\_V4 for UDP connections to IPv4 stations (sending only)
- TCON\_PHONE for connections to SMS clients
- TCON\_WDC for connections to telecontrol servers or stations that can be reached via the telecontrol server.

The parameter assignment of the connection description is made in a data block of the same type as the SDT.

### Creating a DB of the type TCON\_...

You will need to type in the data types of the relevant DBs with the keyboard. They are not displayed in the selection list. The data types are not case-sensitive.

To create a TCON\_... DB, follow the steps outlined below:

1. Create a data block of the type "global DB" with block access "Standard".
2. Create an SDT in the table of the parameter configuration of the DB by assigning the name and typing in the required type (for example "TCON\_IP\_RFC") in the cell of the data type. The SDT and its parameters are created (see below).
3. Configure the parameters that are described below for each SDT type.

Reserved bits are not displayed.

### System data type TCON\_IP\_RFC for connections to IPv4 stations

This connection type is supported only on ISO-on-TCP connections to communications partners with a fixed IP address. The CP must be configured for the "GPRS direct" mode.

Table 9-97 Parameters of TCON\_IP\_RFC

Byte	Parameter	Data type	Initial value	Description
0 ... 1	InterfaceID	HW_ANY		Reference to the interface of the local CP 1242-7 (see STEP 7 > CP configuration > Telecontrol interface > "Hardware identifier")
2 ... 3	ID	CONN_OUC	1...07FF <sub>h</sub>	Reference to the GPRS connection. The ID is assigned and must be unique within the CPU. Here, the same value as that of the ID parameter of the TC_CON instruction must be used.
4	ConnectionType	BYTE	W#16#0C	Protocol variant 12 (C <sub>h</sub> ): ISO-on-TCP connection
5	ActiveEstablished	BOOL		Identifier for the type of connection establishment: <ul style="list-style-type: none"> <li>• 0: Passive connection establishment</li> <li>• 1: Active connection establishment</li> </ul>

Byte	Parameter	Data type	Initial value	Description
6 ... 7	-	-	-	- reserved -
8 ... 11	RemoteAddress	IP_V4		IP address of the connection partner
	ADDR	Array [1...4] of Byte		IP address of the relevant connection partner
12 ... 13	RemoteTSelector	TSelector		Remote T selector
	TSelLen	UINT		Length of the remote T selector "RemoteTSelector"
14 ... 45	TSel	Array [1...32] of Byte	any	Remote transport selector of the connection <ul style="list-style-type: none"> <li>When "ActiveEstablished" = 1: With active connection establishment, the T selector of the local partner must be the same as the T selector of the connection partner (passive connection establishment on the remote partner).</li> <li>When "ActiveEstablished" = 0 correspondingly (passive connection establishment local, active connection establishment remote)</li> </ul>
46 ... 47	LocalTSelector	TSelector		Local T selector
	TSelLen	UINT		Length of the local T selector "LOCAL_TSel"
48 ... 79	TSel	Array [1...32] of Byte	any	Local transport selector of the connection <ul style="list-style-type: none"> <li>When "ActiveEstablished" = 1: With active connection establishment, the T selector of the local partner must be the same as the T selector of the connection partner (passive connection establishment on the remote partner).</li> <li>When "ActiveEstablished" = 0 correspondingly (passive connection establishment local, active connection establishment remote)</li> </ul>

**System data type TCON\_IP\_V4 for connections to IPv4 stations**

This connection type is supported only for sending on UDP connections to communications partners with a fixed IP address.

To receive, ActiveEstablished = 0 must be set.

Table 9-98 Parameters of TCON\_IP\_V4

Byte	Parameter	Data type	Initial value	Description
0 ... 1	InterfaceID	HW_ANY		Reference to the interface of the local CP 1242-7 (see STEP 7 > CP configuration > Telecontrol interface > "Hardware identifier")
2 ... 3	ID	CONN_OUC	1...07FF <sub>h</sub>	Reference to the GPRS connection. The ID is assigned and must be unique within the CPU. Here, the same value as that of the ID parameter of the TC_CON instruction must be used.
4	ConnectionType	BYTE	W#16#0B	Protocol variant 11 (B <sub>n</sub> ): UDP connection

Byte	Parameter	Data type	Initial value	Description
5	ActiveEstablished	BOOL		Identifier for the type of connection establishment: <ul style="list-style-type: none"> <li>• 0: Passive connection establishment Setting for sending and receiving data.</li> <li>• 1: Active connection establishment Setting for sending data only.</li> </ul>
6 ... 7	-	-	-	- reserved -
8 ... 11	RemoteAddress	IP_V4		IP address of the connection partner
	ADDR	Array [1...4] of Byte		IP address of the relevant connection partner
12 ... 13	RemotePort	UINT	1...65535	IP port of the connection partner Not relevant if ActiveEstablished = 0
14 ... 15	LocalPort	UINT	1...65535	Local IP port ("0" is not permitted) Not relevant if ActiveEstablished = 1

### System data type TCON\_PHONE for SMS connections

#### Note

#### Authorized phone numbers

The CP only accepts an SMS if the sending communication partner is authorized based on its phone number. These numbers are in configured for the CP in STEP 7 in the "authorized phone numbers" list.

#### SMS text

- Programmed SMS texts for SMS messages to be sent are accessed using the DATA parameter of the TC\_SEND instruction.
- The text of a received SMS message is assigned to the address area of the CPU by the DATA parameter of the TC\_RECV instruction.

Table 9-99 Parameters of TCON\_PHONE

Byte	Parameter	Data type	Initial value	Description
0 ... 1	InterfaceID	HW_ANY		Reference to the interface of the local CP 1242-7 (see STEP 7 > CP configuration > Telecontrol interface > "Hardware identifier")
2 ... 3	ID	CONN_OUC	1...07FF <sub>h</sub>	Reference to the GPRS connection. The ID is assigned and must be unique within the CPU. Here, the same value as that of the ID parameter of the TC_CON instruction must be used.
4	ConnectionType	BYTE	W#16#0E	Protocol variant 14 (E <sub>n</sub> ): SMS connection
5	ActiveEstablished	BOOL		Identifier for the type of connection establishment (not relevant for the CP 1242-7): <ul style="list-style-type: none"> <li>• 0: Passive connection establishment (not relevant here)</li> <li>• 1: Active connection establishment</li> </ul>

Byte	Parameter	Data type	Initial value	Description
6...7	-	-	-	- reserviert -
8 ... 31	PhoneNumber	STRING[22]		<p>Call number of the connection partner</p> <p>Permitted values: Plus character (+) and numbers</p> <p>Note the exact notation of the international dialing code of the relevant phone number assigned by the network provider ("+" character or zeros).</p> <p>Without an entry for the PhoneNumber parameter, no connection partner is specified and SMS messages can be received reception from all authorized connection partners.</p> <p>Note the following during startup: Without an entry, TC_RECV first delivers the oldest received SMS message.</p>

**System data type TCON\_WDC for connections to telecontrol servers or remote stations**

You can configure the connection to the telecontrol server assigned to the S7-1200 or to a remote station that can be reached via the telecontrol server with TCON\_WDC. The address data of the telecontrol server assigned to the CP can be found in STEP 7 in the "Telecontrol interface > Mode" tab of the CP. The telecontrol server or a remote station is addressed using the host name or the IP address.

The "RemoteWdcAddress" parameter of TCON\_WDC specifies the Access ID of the connection partner.

Table 9-100 Parameters of TCON\_WDC

Byte	Parameter	Data type	Initial value	Description
0 ... 1	InterfaceID	HW_ANY		Reference to the interface of the local CP 1242-7 (see STEP 7 > CP configuration > Telecontrol interface > "Hardware identifier")
2 ... 3	ID	CONN_OUC	1...07FF <sub>h</sub>	Reference to the GPRS connection. The ID is assigned and must be unique within the CPU. Here, the same value as that of the ID parameter of the TC_CON instruction must be used.
4	ConnectionType	BYTE	W#16#0F	Protocol variant 15 (F <sub>h</sub> ): Telecontrol connection using an IP address
5	ActiveEstablished	BOOL		<p>Identifier for the type of connection establishment:</p> <ul style="list-style-type: none"> <li>• 0: Passive connection establishment</li> <li>• 1: Active connection establishment</li> </ul>



Byte	Parameter	Data type	Initial value	Description
6 ... 7	-	-	-	- reserved -
8 ... 11	RemoteWdcAddress	DWORD		<p>Specifies the Access ID (hex). The access ID depends on the connection partner.</p> <ul style="list-style-type: none"> <li>• Connection to a remote CP: The access ID is made up of the following: <ul style="list-style-type: none"> <li>- STEP 7 project number</li> <li>- Station number</li> <li>- Slot</li> </ul> If the remote station has more than one GPRS-CP and you do not want to specify the path, the last byte for the slot must be set to 0. You will find the access ID in the STEP 7 project in the "CP authentication of the CP" parameter group.</li> <li>• Connection to the telecontrol server: Access ID = 0</li> <li>• To only write to the process image of the CP: Access ID = DW#16#FEEDDADA</li> </ul>

## IF\_CONF: SDT for telecontrol configuration data

### Structure of the system data type IF\_CONF for the TC\_CONFIG instruction

The CONFIG parameter of the TC\_CONFIG instruction references the memory area with the configuration data of the CP 1242-7 to be modified. The configuration data stored in a data block is described as a structure of the system data type (SDT) IF\_CONF.

IF\_CONF is made up of a header followed by fields that correspond to the parameters or parameter areas of the CP in the device properties of the STEP 7 project.

The CP configuration data to be modified is collected together as IF\_CONF fields. Parameters that will not be modified are ignored in the IF\_CONF structure and remain as they were configured in the STEP 7 project.

### Creating the DB and the IF\_CONF structures

You can create the parameters of the CP within the IF\_CONF DB in one or more structures each with one or more fields.

You will need to type in the data types of the fields using the keyboard. They are not displayed in the selection list. The data types are not case-sensitive.

Follow the steps below to create IF\_CONF:

1. Create a data block of the type "global DB" with block access "Standard".
2. Create a structure (data type "Struct") in the table of the parameter configuration of the DB. You can specify any name.
3. Under this structure add a header by assigning the name of the header and typing it in in the cell of the data type "IF\_CONF\_Header".  
The header of the structure and its three parameters (see below) is created.

9.7 References

4. Create a field for the first parameter to be changed by typing in the required data type (for example "IF\_CONF\_APN") in the cell of the data type.
5. Repeat the last step for all parameters you want to change on the CP using the TC\_CONFIG instruction.
6. Finally, update the number of fields in the header in the "subfieldCnt" parameter.

Header of IF\_CONF

Table 9-101 IF\_CONF\_Header

Byte	Parameter	Data type	Initial value	Description
0 ... 1	fieldType	UINT		Field type: Must always be 0.
2 ... 3	fieldId	UINT		Field ID: Must always be 0.
4 ... 5	subfieldCnt	UINT		Total number of fields contained in the structure

General parameters of the parameter fields

Each field has the following general parameters:

- Id  
This parameter identifies the field and must not be modified.
- Length  
This parameter indicates the length of the field. The value serves as information. Fields with strings and / or arrays have a variable length. Due to hidden bytes, the actual length of fields can be greater than the sum of the displayed parameters.
- Mode  
The following values are permitted to these parameters:

Table 9-102 Values of "Mode"

Value	Meaning
1	Permanent validity of the configuration data Not relevant for the CP 1242-7
2	Temporary validity of the configuration data, including deleting of existing permanent configuration data The permanent configuration data is replaced by the parameter fields of IF_CONF.

Field for the parameter area "GPRS access"

Table 9-103 IF\_CONF\_APN

Parameter	Data type	Initial value	Description
Id	UINT	4	ID of the parameter field
Length	UINT		Length of the parameter field in bytes: 174
Mode	UINT		Validity (1: permanent, 2: temporary)

Parameter	Data type	Initial value	Description
AccesspointGPRS	STRING [98]		APN: Name of the access point of the GSM network provider to the Internet
AccesspointUser	STRING [42]		APN user name
AccesspointPassword	STRING [22]		APN password

### Field for the parameter area "CP identification"

Table 9-104 IF\_CONF\_Login

Parameter	Data type	Initial value	Description
Id	UINT	5	ID of the parameter field
Length	UINT		Length of the parameter field in bytes: 54
Mode	UINT		Validity (1: permanent, 2: temporary)
ModemName	STRING [22]		Access ID The value cannot be set.
ModemPassword	STRING [22]		Telecontrol password (max. 20 characters)

### Field for the parameter area "Telecontrol server access"

This field is only used when the telecontrol server is addressed with a name that can be resolved by DNS. If the telecontrol server is addressed with its IP address, the "IF\_CONF\_TCS\_IP\_V4" field is used.

In STEP 7, the corresponding data is located in the "Mode" parameter area.

If there is more than one telecontrol server, use the field once per server.

Table 9-105 IF\_CONF\_TCS\_Name

Parameter	Data type	Initial value	Description
Id	UINT	6	ID of the parameter field
Length	UINT		Length of the parameter field in bytes: 266
Mode	UINT		Validity (1: permanent, 2: temporary)
TcsName	-	-	- reserved -
	STRING [254]		Name of the telecontrol server that can be resolved by DNS
RemotePort	UINT		Port of the telecontrol server
Rank	UINT		Priority of the server [1, 2] 1 = main telecontrol server, 2 = substitute telecontrol server

### Field for the parameter area "Telecontrol server access"

This field is only used when the telecontrol server is addressed by its IP address. If the telecontrol server is addressed by its DNS name, the "IF\_CONF\_TCS\_Name" field is used.

In STEP 7, the corresponding data is located in the "Mode" parameter area.

If there is more than one telecontrol server, use the field once per server.

Table 9-106 IF\_CONF\_TCS\_IP\_v4

Parameter	Data type	Initial value	Description
Id	UINT	7	ID of the parameter field
Length	UINT		Length of the parameter field in bytes: 14
Mode	UINT		Validity (1: permanent, 2: temporary)
RemoteAddress	IP_V4		IP address of the telecontrol server
RemotePort	UINT		Port of the telecontrol server
Rank	UINT		Priority of the server [1, 2] 1 = main telecontrol server, 2 = substitute telecontrol server

**Field for the "Mode" parameter area**

In STEP 7, the corresponding data is located in the parameter areas "Mode" and Modem settings".

Table 9-107 IF\_CONF\_GPRS\_Mode

Parameter	Data type	Initial value	Description
Id	UINT	8	ID of the parameter field
Length	UINT		Length of the parameter field in bytes: 10
Mode	UINT		Validity (1: permanent, 2: temporary)
GPRSmode	UINT		Mode of the CP: <ul style="list-style-type: none"> <li>• 0 = Telecontrol</li> <li>• 1 = GPRS direct</li> </ul>
TemporaryStation	BOOL		Bit 0: Temporary connection If this option is selected, the CP only establishes a temporary connection to send data. Once the frames have been transferred, the CP terminates the connection again. <ul style="list-style-type: none"> <li>• 1: activated (temporary connection)</li> <li>• 0: deactivated (permanent connection)</li> </ul>
SMS_Enabled	BOOL		Bit 1: Allow SMS Selecting the option allows the S7 station to send SMS messages. <ul style="list-style-type: none"> <li>• 1: activated (SMS allowed)</li> <li>• 0: deactivated (no SMS)</li> </ul>

**Field for the "SMSC" parameter**

In STEP 7, the corresponding data is located in the parameter area "Modem settings".

Table 9-108 IF\_CONF\_SMS\_Provider

Parameter	Data type	Initial value	Description
Id	UINT	10	ID of the parameter field
Length	UINT		Length of the parameter field in bytes: 28

Parameter	Data type	Initial value	Description
Mode	UINT		Validity (1: permanent, 2: temporary)
SMSProvider	STRING [20]		Node number of the SMS center (SMSC) of the GSM network provider with which the contract was signed for this station.

### Field for the "PIN" parameter

In STEP 7, the corresponding data is located in the parameter area "Modem settings".

Table 9-109 IF\_CONF\_PIN

Parameter	Data type	Initial value	Description
Id	UINT	11	ID of the parameter field
Length	UINT		Length of the parameter field in bytes: 16
Mode	UINT		Validity (1: permanent, 2: temporary)
Pin	STRING [8]		PIN of the SIM card inserted in the SIM card The parameter is not relevant if the PIN was correctly configured. If the PIN was incorrectly configured, the correct PIN can be entered.

### Field for monitoring times

In STEP 7, the corresponding data is located in the parameter areas "Keepalive timeout" and "Operating mode".

Table 9-110 IF\_CONF\_TC\_Timeouts

Parameter	Data type	Initial value	Description
Id	UINT	12	ID of the parameter field
Length	UINT		Length of the parameter field in bytes: 12
Mode	UINT		Validity (1: permanent, 2: temporary)
KeepAliveTimeout	-	-	- Reserved - (cannot be set)
SendTimeout	UINT		Connection monitoring time: Monitoring time of the connection to the communications partner (seconds) Relevant in the modes "Telecontrol" and "GPRS direct"
RedialTimeout	UINT		Dialing repetition delay: Basic value for the wait time until the next attempt to establish a connection following an unsuccessful connection establishment. After every 3 attempts, the basic value is doubled up to a maximum of 900 s. Range of values: 10 to 600 s. If a substitute telecontrol server is configured, the CP attempts to connect to it at the 4th dialin attempt. Example: Basic value 20 results in the following dialing intervals: three times 20 s, three times 40 s, three times 80 s etc. up to a maximum of 900 s. Not relevant for SMS connections

**Field for the "Wake up right" parameter area**

Table 9-111 IF\_CONF\_WakeupList

Parameter	Data type	Initial value	Description
Id	UINT	13	ID of the parameter field
Length	UINT		Length of the parameter field in bytes: 246
Mode	UINT		Validity (1: permanent, 2: temporary)
WakeupPhone [1...10]	ARRAY [1...10] of STRING [22]		Phone number subscriber authorized to wake up The asterisk (*) at the end of a call number is used a placeholder for direct dialing numbers.

**Field for the "Preferred GSM networks" parameter area**

Table 9-112 IF\_CONF\_PrefProvider

Parameter	Data type	Initial value	Description
Id	UINT	14	ID of the parameter field
Length	UINT		Length of the parameter field in bytes: 46
Mode	UINT		Validity (1: permanent, 2: temporary)
Provider [1...5]	ARRAY [1...5] of STRING [6]		Alternative GSM networks with priority 1 to 5 into which the CP dials. Up to 5 networks can be configured. No. 1 with highest priority, no. 5 with lowest priority. Entry of the Public Land Mobile Network (PLMN) of the network provider consisting of Mobile Country Code (MCC) and Mobile Network Code (MNC). Example (test network of Siemens AG): 26276

**Field for the "DNS configuration" parameter area**

Table 9-113 IF\_CONF\_DNS

Parameter	Data type	Initial value	Description
Id	UINT	16	ID of the parameter field
Length	UINT		Length of the parameter field in bytes: 14
Mode	UINT		Validity (1: permanent, 2: temporary)
DNS_IP [1]	IP_V4		IP address of the 1st domain name system server
DNS_IP [2]	IP_V4		IP address of the 2nd domain name system server

### Field for the "Time-of-day synchronization" parameter area

Table 9-114 IF\_CONF\_NTP

Parameter	Data type	Initial value	Description
Id	UINT	17	ID of the parameter field
Length	UINT		Length of the parameter field in bytes: 24
Mode	UINT		Validity (1: permanent, 2: temporary)
NTP_IP [1]	ARRAY [1...4] of IP_V4		IP address of NTP server 1
...	...		(IP address of NTP server 2...3)
NTP_IP [4]	ARRAY [1...4] of IP_V4		IP address of NTP server 4

### Block for activating / deactivating TeleService users

SDT for activating or deactivating TeleService users already configured in the STEP 7 project of the CP. In STEP 7, the corresponding data can be found in the parameter area "TeleService settings" > "TeleService user management".

Table 9-115 IF\_CONF\_GPRS\_UserList

Parameter	Data type	Initial value	Description
Id	UINT	19	ID of the parameter field
Length	UINT		Length of the parameter field in bytes: 506
Mode	UINT		Validity (1: permanent, 2: temporary)
GPRS_User [1...10]	ARRAY [1...10] of GPRS_User		TeleService user no. 1 to max. no. 10

The array is formed from the parameter records for the TeleService users ("GPRS\_User" [1...n]).

Table 9-116 GPRS\_User [n] (parameter for TeleService user)

Parameter	Data type	Initial value	Description
UserName [n]	STRING [22]		TeleService user name
Password [n]	STRING [22]		- The string must be empty! -
Diag_Allowed [n]	BOOL		- Reserved - (cannot be set)
Teleserv_Allowed [n]	BOOL		Activation of the TeleService user <ul style="list-style-type: none"> <li>• 0 = user is deactivated</li> <li>• 1 = user is activated</li> </ul>
FW_Load_Allowed [n]	BOOL		- Reserved - (cannot be set)

### Field for setting the parameters for TeleService access (DNS name of the server)

Access data of the TeleService server (switching station).

In STEP 7, the corresponding data is located in the parameter area "TeleService settings".

If there is more than one TeleService server, use the field once per server.

Table 9-117 IF\_CONF\_TS\_Name

Parameter	Data type	Initial value	Description
Id	UINT	20	ID of the parameter field
Length	UINT		Length of the parameter field in bytes: 266
Mode	UINT		Validity (1: permanent, 2: temporary)
ts_name	String [254]		Name of the TeleService server that can be resolved by DNS
RemotePort	UINT		Port of the engineering station
Rank	UINT		Priority of the server [1] or [2] 1 = server 1, 2 = server 2

**Field for setting the parameters for TeleService access (IP address of the server)**

Access data of the TeleService server (switching station).

In STEP 7, the corresponding data is located in the parameter area "TeleService settings".

If there is more than one TeleService server, use the field once per server.

Table 9-118 IF\_CONF\_TS\_IF\_V4

Parameter	Data type	Initial value	Description
Id	UINT	21	ID of the parameter field
Length	UINT		Length of the parameter field in bytes: 14
Mode	UINT		Validity (1: permanent, 2: temporary)
RemoteAddress	IP_V4		IP address of the TeleService server
RemotePort	UINT		Port of the TeleService server
Rank	UINT		Priority of the server [1] or [2] 1 = server 1, 2 = server 2

**Point-to-point**

**PORT\_CFG: Configure communication parameters dynamically**

**Description**

The instruction "PORT\_CFG" allows dynamic configuration of communications parameters for a point-to-point communications port.

You set up the original static configuration of the port in the hardware configuration. You can change this configuration by executing the "PORT\_CFG" instruction. You can also use this function to save created blocks in libraries and to avoid configuration in the hardware configuration when you reuse it.

With "PORT\_CFG" you can influence the following communications parameter settings:



- Parity
- Baud rate
- Number of bits per character
- Number of stop bits
- Type and properties of flow control

The changes made by the "PORT\_CFG" instruction are not stored permanently on the target system.

You can transfer serial data via the electrical connections RS-232 (half and full duplex) and RS-485 (half duplex).

## Parameters

The following table shows the parameters of the "PORT\_CFG" instruction:

Parameter	Declaration	Data type	Memory area	Description
REQ	Input	BOOL	I, Q, M, D, L	Activates the configuration change on a rising edge
PORT	Input	PORT (UINT)	D, L or constant	Identification of the communication port (HW-ID)
PROTOCOL	Input	UINT	I, Q, M, D, L or constant	Transmission protocol: <ul style="list-style-type: none"> <li>• 0: Point-to-point communication protocol</li> <li>• 1..n: Future definition for specific transmission protocols</li> </ul>
BAUD	Input	UINT	I, Q, M, D, L or constant	Baud rate of the port: <ul style="list-style-type: none"> <li>• 1: 300 baud</li> <li>• 2: 600 baud</li> <li>• 3: 1200 baud</li> <li>• 4: 2400 baud</li> <li>• 5: 4800 baud</li> <li>• 6: 9600 baud (default)</li> <li>• 7: 19200 baud</li> <li>• 8: 38400 baud</li> <li>• 9: 57600 baud</li> <li>• 10: 76800 baud</li> <li>• 11: 115200 baud</li> </ul>
PARITY	Input	UINT	I, Q, M, D, L or constant	Parity of the port: <ul style="list-style-type: none"> <li>• 1: No parity (default)</li> <li>• 2: Even parity</li> <li>• 3: Odd parity</li> <li>• 4: Mark parity</li> <li>• 5: Space parity</li> </ul>
DATABITS	Input	UINT	I, Q, M, D, L or constant	Bits per character: <ul style="list-style-type: none"> <li>• 1: 8 bits per character (default)</li> <li>• 2: 7 bits per character</li> </ul>

9.7 References

Parameter	Declaration	Data type	Memory area	Description
STOPBITS	Input	UINT	I, Q, M, D, L or constant	Number of stop bits: <ul style="list-style-type: none"> <li>• 1: 1 stop bit (default)</li> <li>• 2: 2 stop bits</li> </ul>
FLOWCTRL	Input	UINT	I, Q, M, D, L or constant	Data flow control: <ul style="list-style-type: none"> <li>• 1: None (default)</li> <li>• 2: XON/XOFF</li> <li>• 3: Hardware flow control (RTS always activated)</li> <li>• 4: Hardware flow control (RTS can be deactivated during transmission)</li> </ul>
XONCHAR	Input	CHAR	D	Indicates the character used as XON character. The character DC1 (11H) is set as default.
XOFFCHAR	Input	CHAR	D	Indicates the character used as XOFF character. The character DC3 (13H) is set as default.
WAITIME	Input	UINT	I, Q, M, D, L or constant	Specifies the wait time for XON or CTS after the start of the transmission. The specified value must be greater than 0. 2000 milliseconds are set as default.
DONE	Output	BOOL	I, Q, M, D, L	Status parameter with the following values: <ul style="list-style-type: none"> <li>• 0: Job not yet started or is still executing</li> <li>• 1: Job executed without errors</li> </ul>
ERROR	Output	BOOL	I, Q, M, D, L	Status parameter with the following values: <ul style="list-style-type: none"> <li>• 0: No error</li> <li>• 1: Error occurred</li> </ul>
STATUS	Output	WORD	I, Q, M, D, L	Status of the instruction

You will find more detailed information on valid data types in "Overview of the valid data types (Page 1077)".

**STATUS parameter**

Error code* (W#16#...)	Description
80A0	The specified protocol is invalid.
80A1	The specified baud rate is invalid.
80A2	The specified parity rate is invalid.
80A3	The specified number of bits per character is invalid.
80A4	The specified number of stop bits is invalid.
80A5	The specified type of flow control is invalid.
80A6	Incorrect value at the WAITTIME parameter When the data flow control is enabled, the value at the WAITTIME parameter must be greater than zero.

Error code* (W#16#...)	Description
80A7	Invalid values at XONCHAR and XOFFCHAR parameters.
* The error codes can be displayed as integer or hexadecimal values in the program editor. For additional information on toggling display formats, refer to "See also".	

You will find more detailed information on general error codes of the communication instructions in: "General status information of the communications blocks (Page 2762)".

## SEND\_CFG: Configure serial transmission parameters dynamically

### Description

The instruction "SEND\_CFG" allows dynamic configuration of serial transmission parameters for a point-to-point communications port. All the messages waiting for transfer are discarded after execution of SEND\_CFG.

You set up the original static configuration of the port in the hardware configuration. You can change this configuration by executing the "SEND\_CFG" instruction. You can also use this function to save created blocks in libraries and to avoid configuration in the hardware configuration when you reuse it. With "SEND\_CFG" you can influence the following transmission parameter settings:

- Time between the activation of RTS (Request to Send) and the start of the transmission
- Time between the end of transmission and the deactivation of RTS
- Define bit times for breaks

The changes made by the "SEND\_CFG" instruction are not stored permanently on the target system.

You can transfer serial data via the electrical connections RS-232 (half and full duplex) and RS-485 (half duplex).

### Parameters

The following table shows the parameters of the "SEND\_CFG" instruction:

Parameter	Declaration	Data type	Memory area	Description
REQ	Input	BOOL	I, Q, M, D, L	Activates the configuration change on a rising edge
PORT	Input	PORT (UINT)	D, L or constant	Identification of the communication port (HW-ID)
RTSONDLY	Input	UINT	I, Q, M, D, L or constant	The time that should elapse after activating RTS until the start of transmission. Valid values for this parameter are as follows: <ul style="list-style-type: none"> <li>• 0 (default)</li> <li>• 0 to 65535 ms in steps of 1 ms</li> </ul> This parameter does not apply to RS-485 modules.

Parameter	Declaration	Data type	Memory area	Description
RTSOFFDLY	Input	UINT	I, Q, M, D, L or constant	Time that should elapse after the end of transmission until deactivation of RTS. Valid values for this parameter are as follows: <ul style="list-style-type: none"> <li>• 0 (default)</li> <li>• 0 to 65535 ms in steps of 1 ms</li> </ul> This parameter does not apply to RS-485 modules.
BREAK	Input	UINT	I, Q, M, D, L or constant	Specifies the bit times for a break, which are sent at the start of the message. 12 bit times are set as default. A maximum of 25000 bit times can be specified.
IDLELINE	Input	UINT	I, Q, M, D, L or constant	Specifies the bit times for idle line after the break at the start of the message. 12 bit times are set as default. A maximum of 25000 bit times can be specified.
DONE	Output	BOOL	I, Q, M, D, L	Status parameter with the following values: <ul style="list-style-type: none"> <li>• 0: Job not yet started or is still executing</li> <li>• 1: Job executed without errors</li> </ul>
ERROR	Output	BOOL	I, Q, M, D, L	Status parameter with the following values: <ul style="list-style-type: none"> <li>• 0: No error</li> <li>• 1: Error occurred</li> </ul>
STATUS	Output	WORD	I, Q, M, D, L	Status of the instruction

You will find more detailed information on valid data types in "Overview of the valid data types (Page 1077)".

### STATUS parameter

Error code* (W#16#...)	Description
80B0	The configuration of a transmission interruption is not permitted.
80B1	The specified break time exceeds the permitted maximum of 25000 bit times.
80B2	The specified time for idle line exceeds the permitted maximum of 25000 bit times.
* The error codes can be displayed as integer or hexadecimal values in the program editor. For additional information on toggling display formats, refer to "See also".	

You will find more detailed information on general error codes of the communication instructions in: "General status information of the communications blocks (Page 2762)".

## RCV\_CFG: Configure serial receive parameters dynamically

### Description

The instruction "RCV\_CFG" allows dynamic configuration of serial receive parameters for a point-to-point communications port. You can use this instruction to configure the conditions that specify the start and end of the message to be transmitted. The receipt of messages that correspond to these conditions can be enabled by the "RCV\_PTP (Page 2757)" instruction.

You set up the original static configuration of the port in the properties of the hardware configuration. Execute the "RCV\_CFG" instruction in your program to change the configuration. You can also use this function to save created blocks in libraries and to avoid configuration in the hardware configuration when you reuse it. The changes made by the "RCV\_CFG" instruction are not stored permanently on the target system.

All the messages waiting for transfer are discarded after execution of the "RCV\_CFG" instruction.

### Parameters

The following table shows the parameters of the "RCV\_CFG" instruction:

Parameter	Declaration	Data type	Memory area	Description
REQ	Input	BOOL	I, Q, M, D, L	Activates the configuration change on a rising edge.
PORT	Input	PORT (UINT)	D, L or constant	Identification of the communication port (HW-ID)
CONDITIONS	Input	CONDITIONS	D, L	Data structure defining the conditions for start and end of data transmission.
DONE	Output	BOOL	I, Q, M, D, L	Status parameter with the following values: <ul style="list-style-type: none"> <li>• 0: Job not yet started or is still executing</li> <li>• 1: Job executed without errors</li> </ul>
ERROR	Output	BOOL	I, Q, M, D, L	Status parameter with the following values: <ul style="list-style-type: none"> <li>• 0: No error</li> <li>• 1: Error occurred.</li> </ul>
STATUS	Output	WORD	I, Q, M, D, L	Status of the instruction

You will find more detailed information on valid data types in "Overview of the valid data types (Page 1077)".

### Data type CONDITIONS

You can use the CONDITIONS structure to define the start and end conditions for the message transmission. The structure CONDITIONS is included in the instance DB of the "RCV\_CFG"

9.7 References

instruction. Use the structure CONDITIONS to define the start and end conditions when the transmission of a message is complete and when the next message transfer is to start:

- You define the start conditions for the data transfer in the START structure.
- You define the end conditions for the data transfer in the END structure.

You can define one or more start and end conditions for this. If you specify multiple start or end conditions these are linked by an OR logic instruction.

The following table shows the "CONDITIONS" structure:

Parameters	Data type	Description
START	STRUCT	Start conditions
STARTCOND	UINT	<p>Specifies the start condition (details, see below). The start condition can be specified as a 16-bit hexadecimal value. Possible values for the start condition are:</p> <ul style="list-style-type: none"> <li>• 1: Start character</li> <li>• 2: Any character (default)</li> <li>• 4: Line break</li> <li>• 8: Idle line</li> <li>• 16: Character string 1</li> <li>• 32: Character string 2</li> <li>• 64: Character string 3</li> <li>• 128: Character string 4</li> </ul> <p>Multiple start conditions can also be defined at the STARTCOND parameter. The total from the values of the individual conditions is specified for this. If, for example, you want to define "Idle line" OR "Character string 1" OR "Character string 4" as start condition, the value "152" must be specified.</p>
IDLETIME	UINT	<p>Specifies the maximum idle time of the line before receipt is started. Valid values for this parameter are as follows:</p> <ul style="list-style-type: none"> <li>• 40 bit times (default)</li> <li>• 0 to 2500 bit times</li> </ul>
STARTCHAR	BYTE	<p>Specifies the start character. This setting is only enabled when the configured start condition is "Start character". Valid values for this parameter are as follows:</p> <ul style="list-style-type: none"> <li>• 02 (STX): Default setting</li> <li>• B#16#00 to B#16#FF</li> </ul>
SEQ[1].CTL	BYTE	<p>Character string 1: Control sequence for each character You can use the bit position of the character to define which characters of the character string will be considered or ignored. To evaluate the characters, the corresponding bits have to be set.</p> <ul style="list-style-type: none"> <li>• Bit 0: 1 character</li> <li>• Bit 1: 2 characters</li> <li>• Bit 2: 3 characters</li> <li>• Bit 3: 4 characters</li> <li>• Bit 4: 5 characters</li> </ul> <p>A character is ignored when the corresponding bit is reset.</p>
SEQ[1].STR	CHAR[5]	Character string 1: Start character (5 characters)

Parameters	Data type	Description
SEQ[2].CTL	BYTE	Character string 2: Ignore/compare control sequence for each character
SEQ[2].STR	CHAR[5]	Character string 2: Start character (5 characters)
SEQ[3].CTL	BYTE	Character string 3: Ignore/compare control sequence for each character
SEQ[3].STR	CHAR[5]	Character string 3: Start character (5 characters)
SEQ[4].CTL	BYTE	Character string 4: Ignore/compare control sequence for each character
SEQ[4].STR	CHAR[5]	Character string 4: Start character (5 characters)
END	STRUCT	End conditions
ENDCOND	UINT	<p>Specifies the end condition (details, see below).</p> <p>The end condition can be specified as a 16-bit hexadecimal value. Possible values for the end condition are:</p> <ul style="list-style-type: none"> <li>• 1: Reply timeout</li> <li>• 2: Message timeout</li> <li>• 4: Timeout within the character string</li> <li>• 8: Maximum length</li> <li>• 16: N+LEN+M; the information on the message length is integrated in the message and will be evaluated.</li> <li>• 32: Character string 1</li> </ul> <p>Multiple end conditions can also be defined at the ENDCOND parameter. The total from the values of the individual end conditions is specified for this. If, for example, you want to define the end condition "Maximum length" OR "Sequence 1", the value "40" must be specified.</p>
MAXLEN	UINT	<p>Specifies the maximum number of characters in a message.</p> <p>Valid values* for this parameter are as follows:</p> <ul style="list-style-type: none"> <li>• 1 character (default)</li> <li>• 0 to 1024 characters</li> </ul> <p>This setting is only enabled if the "Maximum length" end condition is set at the ENDCOND parameter.</p>
N	UINT	<p>Offset of the length field in the message</p> <p>Valid values for this parameter are as follows:</p> <ul style="list-style-type: none"> <li>• 0 characters (default)</li> <li>• 0 to 1024 characters</li> </ul> <p>This setting is only enabled if the "N+LEN+M" end condition is set at the ENDCOND parameter.</p>
LENGTHSIZE	UINT	<p>Size of the length field in bytes</p> <p>Valid values* for this parameter are as follows:</p> <ul style="list-style-type: none"> <li>• 0 bytes (default)</li> <li>• 1 byte</li> <li>• 2 bytes</li> <li>• 4 bytes</li> </ul> <p>This setting is only enabled if the "N+LEN+M" end condition is set at the ENDCOND parameter.</p>

9.7 References

Parameters	Data type	Description
LENGTHM	UINT	<p>Specifies the number of end characters that follow the length field but are not contained in the length of the message.</p> <p>Valid values for this parameter are as follows:</p> <ul style="list-style-type: none"> <li>• 0 characters (default)</li> <li>• 0 to 255 characters</li> </ul> <p>This setting is only enabled if the "N+LEN+M" end condition is set at the ENDCOND parameter.</p>
RCVTIME	UINT	<p>Specifies the maximum duration for the receipt of the first character of a message.</p> <p>Valid values for this parameter are as follows:</p> <ul style="list-style-type: none"> <li>• 200 ms (default)</li> <li>• 0 to 65535 ms in steps of 1 ms</li> </ul> <p>This setting is only enabled if the "Reply timeout" end condition is set at the ENDCOND parameter.</p>
MSGTIME	UINT	<p>Specifies the maximum duration of the receipt of a message.</p> <p>Valid values for this parameter are as follows:</p> <ul style="list-style-type: none"> <li>• 200 ms (default)</li> <li>• 0 to 65535 ms in steps of 1 ms</li> </ul> <p>This setting is only enabled if the "Message timeout" end condition is set at the ENDCOND parameter.</p>
CHARGAP	UINT	<p>Specifies the time interval between received consecutive characters.</p> <p>Valid values for this parameter are as follows:</p> <ul style="list-style-type: none"> <li>• 12 bit times (default)</li> <li>• 0 to 2500 bit times</li> </ul> <p>This setting is only enabled if the "Timeout within the character string" end condition is set at the ENDCOND parameter.</p>
SEQ.CTL	BYTE	<p>Character string: Control sequence for each character</p> <p>You can use the bit position of the character to define which characters of the character string will be considered or ignored. To evaluate the characters, the corresponding bits have to be set.</p> <ul style="list-style-type: none"> <li>• Bit 0: 1 character</li> <li>• Bit 1: 2 characters</li> <li>• Bit 2: 3 characters</li> <li>• Bit 3: 4 characters</li> <li>• Bit 4: 5 characters</li> </ul> <p>A character is ignored when the corresponding bit is reset.</p>
SEQ.STR	CHAR[5]	Character string: Start character (5 characters)
* These value ranges also apply to the corresponding hardware settings for specifying the end of message.		



### Start conditions for the message receipt (STARTCOND parameter)

The start of the message is recognized by the receiver if a configured start condition applies. The following conditions can be defined as start conditions for message receipt:

- **Start character:** The start of a message is recognized when a certain character occurs. This character is stored as first character of the message. All characters received before the start character are rejected.
- **Any character:** Any character can define the start of a message. This character is stored as first character of the message.
- **Line break:** The start of a message is recognized if the received data stream is interrupted for longer than one character length.
- **Idle line:** The start of a message is recognized when the send transmission line is in the idle state for a certain time (specified in bit times) followed by renewed transmission of characters.

- **Character string (sequence):** The start of a message is recognized when a specified character sequence occurs in the data stream. You can specify up to four character sequences with up to five characters each.

Example: A received hexadecimal message includes the following characters: "68 10 aa 68 bb 10 aa 16". The configured start character sequences are listed in the following table. Start character sequences will be evaluated once the first character 68H has been received successfully. After the fourth character has been received successfully (the second 68H), the start condition "1" has been met. Once the start conditions have been met, evaluation of the end conditions will start. Processing of the start character sequence can end due to different errors in parity, framing or time intervals between characters. These errors will prevent reception of the message, because the start condition has not been met.

Start condition	First character	First character +1	First character +2	First character +3	First character +4
1	68H	xx	xx	68H	xx
2	10H	aaH	xx	xx	xx
3	dcH	aaH	xx	xx	xx
4	e5H	xx	xx	xx	xx

### End conditions for the message receipt (ENDCOND parameter)

The start of a message is recognized by the receiver if a configured end condition applies. The following conditions can be defined as end conditions for message receipt:

- Reply timeout: The receipt of messages will end when the specified maximum duration for the receipt of a character is exceeded. The maximum duration is defined at the RCVTIME parameter. The defined time starts to run down as soon as the last transmission is completed and the RCV\_PTP instruction enables the receipt of the message. If no character was received within the defined time (RCVTIME), the RCV\_PTP instruction reports an error.
- Message timeout: The receipt of messages will end when the specified maximum duration for the receipt of a message is exceeded. The maximum duration is defined at the MSGTIME parameter. The defined time starts to run down as soon as the first character of the message is received.
- Timeout within the character string: The receipt of messages will end when the time interval between the receipt of two consecutive characters is longer than the value at the CHARGAP parameter.
- Maximum length: The receipt of messages will end when the length of the message defined at the MAXLEN parameter is exceeded.
- Reading message length (N+LEN+M): The receipt of messages will end when a certain message length is reached. This length is calculated by the values of the following parameters:
  - N: Position of the character in the message from which the length field begins.
  - LENGTHSIZE: Size of the length field in bytes
  - LENGTHM: Number of end characters that follow the length field. These characters are not taken into account in the evaluation of the message length.
- Character string: The receipt of messages will end when a defined character sequence is received. The character string can contain a maximum of five characters. For each character of the character string, you can use the bit position to define if this will be considered or ignored in the evaluation.

### STATUS parameter

Error code* (W#16#...)	Description
80C0	Error in start condition
80C1	<ul style="list-style-type: none"> <li>• Error in end condition</li> <li>• No end condition defined</li> </ul>
80C2	Receive interrupt enabled
80C3	A value that is equal to 0 or greater than 4132 was entered at the MAXLEN parameter while the "Maximum length" end condition was set.
80C4	A value that is greater than 4131 was entered at the N parameter while the "N+LEN+M" end condition was set.
80C5	A value that is equal to 0 or invalid was entered at the LENGTHSIZE parameter while the "N+LEN+M" end condition was set.

Error code* (W#16#...)	Description
80C6	A value that is greater than 255 was entered at the LENGTHM parameter while the "N+LEN+M" end condition was set.
80C7	A message length greater than 4132 was calculated while the "N+LEN+M" end condition was set.
80C8	A value that is equal to 0 was entered at the RCVTIME parameter while the "Reply timeout" end condition was set.
80C9	A value that is equal to 0 or greater than 2500 was entered at the CHARGAP parameter while the "Timeout within a character string" end condition was set.
80CA	A value that is equal to 0 or greater than 2500 was entered at the IDLETIME parameter while the "Idle line" start condition was set.
80CB	All characters of the character string are marked as "Don't care" even though "Character string" is set as the end condition.
80CC	All characters of the character string are marked as "Don't care" even though "Character string" is set as the start condition.
* The error codes can be displayed as integer or hexadecimal values in the program editor. For additional information on toggling display formats, refer to "See also".	

You will find more detailed information on general error codes of the communication instructions in: "General status information of the communications blocks (Page 2762)".

## SEND\_PTP: Transmit send buffer data

### Description

You use the "SEND\_PTP" instruction to start the transmission of data. The "SEND\_PTP" instruction does not execute the actual transmission of the data. The data of the send buffer is transmitted to the relevant point-to-point communication module (CM). The CM executes the actual transmission.

### Parameters

The following table shows the parameters of the "SEND\_PTP" instruction:

Parameter	Declaration	Data type	Memory area	Description
REQ	Input	BOOL	I, Q, M, D, L	Enables the requested transmission on a rising edge of this enable input. The content of buffer is transmitted to the point-to-point communication module (CM).
PORT	Input	PORT (UINT)	D, L or constant	Identification of the communication port (HW-ID)
BUFFER	Input	VARIANT	I, Q, M, D, L or constant	Pointer to the start address of the send buffer. Boolean values or Array of BOOL are not supported.
LENGTH	Input	UINT	I, Q, M, D, L or constant	Length of the send buffer

Parameter	Declaration	Data type	Memory area	Description
PTRCL	Input	BOOL	I, Q, M, D, L or constant	This parameter selects the buffer for normal point-to-point communication or for specific Siemens protocols implemented in the connected CM. FALSE = point-to-point operations controlled by the user program (only valid option)
DONE	Output	BOOL	I, Q, M, D, L	Status parameter with the following values: <ul style="list-style-type: none"> <li>• 0: Job not yet started or is still executing</li> <li>• 1: Job executed without errors</li> </ul>
ERROR	Output	BOOL	I, Q, M, D, L	Status parameter with the following values: <ul style="list-style-type: none"> <li>• 0: No error</li> <li>• 1: Error occurred</li> </ul>
STATUS	Output	WORD	I, Q, M, D, L	Status of the instruction

You will find more detailed information on valid data types in "Overview of the valid data types (Page 1077)".

### STATUS parameter

Error code* (W#16#...)	Description
7000	The send operation is not active.
7001	The send operation is processing the first call.
7002	The send operation is processing subsequent calls (queries following the first call).
8080	The identifier entered for the communications port number is invalid.
8088	The length of the LENGHT parameter does not correspond to the length of data to be sent. See also: Parameters LENGHT and BUFFER.
80D0	A new send request was received while a transmission was taking place.
80D1	The transmission was interrupted because the CTS signal was not confirmed within the specified wait time.
80D2	The send request was interrupted because the communications partner (DCE) signaled that it was not willing to receive (DSR).
80D3	The send request was interrupted because the maximum size of the waiting loop was exceeded (more than 1024 Byte).
* The error codes can be displayed as integer or hexadecimal values in the program editor. For additional information on toggling display formats, refer to "See also".	

You will find more detailed information on general error codes of the communication instructions in: "General status information of the communications blocks (Page 2762)".

## Parameters LENGTH and BUFFER

The minimum data size that can be sent by the "PTP\_SEND" instruction is one byte. The parameter BUFFER defines the size of the data to be sent. You can use neither the BOOL nor the Array of BOOL data type for the BUFFER parameter.

LENGTH parameter	BUFFER parameter	Description
LENGTH = 0	Not used	The complete data is sent as defined by the BUFFER parameter. If LENGTH = 0, you do not need to specify the number of bytes transferred.
LENGTH > 0	Elementary data type	The LENGTH value must contain the byte count of this data type. Otherwise, data is not transferred and error 8088 is output.
	STRUCT	The LENGTH value can contain a byte count that is smaller than the complete byte length of the structure. In this case, only the first LENGTH bytes are transferred.
	ARRAY	The LENGTH value can contain a byte count that is smaller than the complete byte length of the field. In this case, only the field elements that fit completely in the LENGTH bytes are transferred. The LENGTH value must be a multiple of the byte count of the data elements. Otherwise, STATUS = 8088, ERROR = 1, and no data is transferred.
	STRING	The complete memory arrangement of the character sequence format will be transmitted as well as the information about maximum length of the character string and the actual length of the character string. The LENGTH value must contain bytes for maximum length, actual length, and the characters of the character string. With the data type STRING, all lengths and characters have the size of one byte. If a character string is used for the BUFFER parameter, the LENGTH value must also contain two bytes for the two length fields.

## RCV\_PTP: Enable receive messages

### Description

With the RCV\_PTP instruction you enable receipt of a sent message. Each message must be enabled individually. The sent data is only available in the receive area when the message has been acknowledged by the relevant communications partner.

### Parameters

The following table shows the parameters of the "RCV\_PTP" instruction:

Parameter	Declaration	Data type	Memory area	Description
EN_R	Input	BOOL	I, Q, M, D, L	Enables receipt on a rising edge
PORT	Input	PORT (UINT)	D, L or constant	Identification of the communication port (HW-ID)

Parameter	Declaration	Data type	Memory area	Description
BUFFER	Input	VARIANT	I, Q, M, D, L or constant	Points to the start address of the receive buffer. Do not use a tag of the type STRING in the receive buffer.
NDR	Output	BOOL	I, Q, M, D, L	Status parameter with the following values: <ul style="list-style-type: none"> <li>• 0: Job not yet started or is still executing</li> <li>• 1: Job executed without errors</li> </ul>
ERROR	Output	BOOL	I, Q, M, D, L	Status parameter with the following values: <ul style="list-style-type: none"> <li>• 0: No error</li> <li>• 1: Error occurred</li> </ul>
STATUS	Output	WORD	I, Q, M, D, L	Status of the instruction
LENGTH	Output	UINT	I, Q, M, D, L	Length of the message in the receive buffer

You will find more detailed information on valid data types in "Overview of the valid data types (Page 1077)".

### STATUS parameter

Error code* (W#16#....)	Description
80E0	Receipt of messages was terminated because the receive buffer is full.
80E1	Receipt of messages was terminated as a result of a parity error.
80E2	Receipt of messages was terminated as a result of a framing error.
80E3	Receipt of messages was terminated as a result of an overflow error.
80E4	Receipt of messages was terminated because the calculated message length (N+LEN+M) exceeds the size of the receive buffer.
8080	The identifier entered for the communications port number is invalid.
8088	A data type STRING is referenced via the BUFFER parameter.
0094	Receipt of messages was terminated because the maximum character length was received.
0095	Receipt of messages was terminated as a result of a timeout.
0096	Receipt of messages was terminated because of a timeout within the character string.
0097	Receipt of messages was terminated as a result of a reply timeout.
0098	Receipt of messages was terminated because the "N+LEN+M" length condition has been satisfied.
0099	Receipt of messages was terminated because the character string defined as the end condition was received.

\* The error codes can be displayed as integer or hexadecimal values in the program editor. For additional information on toggling display formats, refer to "See also".

You will find more detailed information on general error codes of the communication instructions in: "General status information of the communications blocks (Page 2762)".

**RCV\_RST: Delete receive buffer****Description**

With the "RCV\_RST" instruction, you delete the receive buffer of a communications partner.

**Parameters**

The following table shows the parameters of the "RCV\_RST" instruction:

Parameter	Declaration	Data type	Memory area	Description
REQ	Input	BOOL	I, Q, M, D, L	Enables deleting of the receive buffer on a rising edge
PORT	Input	PORT (UINT)	D, L or constant	Identification of the communication port (HW-ID)
DONE	Output	BOOL	I, Q, M, D, L	Status parameter with the following values: <ul style="list-style-type: none"> <li>• 0: Job not yet started or is still executing</li> <li>• 1: Job executed without errors</li> </ul>
ERROR	Output	BOOL	I, Q, M, D, L	Status parameter with the following values: <ul style="list-style-type: none"> <li>• 0: No error</li> <li>• 1: Error occurred</li> </ul>
STATUS	Output	WORD	I, Q, M, D, L	Status of the instruction You will find more detailed information on general error codes of the communication instructions in: "General status information of the communications blocks (Page 2762)".

You will find more detailed information on valid data types in "Overview of the valid data types (Page 1077)".

**SGN\_GET: Query RS-232 signals****Description**

With the "SGN\_GET" instruction, you query the current state of several signals of an RS-232 communications module.

**Parameters**

The following table shows the parameters of the "SGN\_GET" instruction:

Parameter	Declaration	Data type	Memory area	Description
REQ	Input	BOOL	I, Q, M, D, L or constant	Enables the query on a rising edge
PORT	Input	PORT (UINT)	D, L or constant	Identification of the communication port (HW-ID)

9.7 References

Parameter	Declaration	Data type	Memory area	Description
NDR	Output	BOOL	I, Q, M, D, L	Is set for one cycle if new data are ready for sending and the instruction was executed error-free.
DTR	Output	BOOL	I, Q, M, D, L	Data terminal ready, module ready
DSR	Output	BOOL	I, Q, M, D, L	Data set ready, communications partner ready
RTS	Output	BOOL	I, Q, M, D, L	Send request, module ready to send
CTS	Output	BOOL	I, Q, M, D, L	Clear to send, communications partner can receive data (reaction to RTS = ON of the module).
DCD	Output	BOOL	I, Q, M, D, L	Data carrier detect, received signal level
RING	Output	BOOL	I, Q, M, D, L	Ring display, display of an incoming call
ERROR	Output	BOOL	I, Q, M, D, L	Status parameter with the following values: <ul style="list-style-type: none"> <li>• 0: No error</li> <li>• 1: Error occurred</li> </ul>
STATUS	Output	WORD	I, Q, M, D, L	Status of the instruction

You will find more detailed information on valid data types in "Overview of the valid data types (Page 1077)".

**STATUS parameter**

Error code* (W#16#...)	Description
80F0	The communication module is an RS-485 module and no signals are available.

\* The error codes can be displayed as integer or hexadecimal values in the program editor. For additional information on toggling display formats, refer to "See also".

You will find more detailed information on general error codes of the communication instructions in: "General status information of the communications blocks (Page 2762)".

**SGN\_SET: Set RS-232 signals**

**Description**

With the "SGN\_SET" instruction, you set the status of the output signals of an RS-232 communications module.



## Parameters

The following table shows the parameters of the "SGN\_SET" instruction:

Parameter	Declaration	Data type	Memory area	Description
REQ	Input	BOOL	I, Q, M, D, L or constant	Activates the action on a rising edge Initial value: FALSE
PORT	Input	PORT (UINT)	D, L or constant	Identification of the communication port (HW-ID) Initial value: 0
SIGNAL	Input	BYTE	I, Q, M, D, L or constant	Specifies the signals to be set: <ul style="list-style-type: none"> <li>Set 01H = RTS</li> <li>Set 02H = DTR</li> <li>Set 04H = DSR</li> </ul> Initial value: FALSE
RTS	Input	BOOL	I, Q, M, D, L or constant	Send request, module ready to send Initial value: FALSE
DTR	Input	BOOL	I, Q, M, D, L or constant	Data terminal ready, module ready Initial value: FALSE
DSR	Input	BOOL	I, Q, M, D, L or constant	Data set ready (applies only to interfaces of the DCE type) Initial value: FALSE
DONE	Output	BOOL	I, Q, M, D, L	Status parameter with the following values: <ul style="list-style-type: none"> <li>0: Job not yet started or is still executing</li> <li>1: Job executed without errors</li> </ul> Initial value: FALSE
ERROR	Output	BOOL	I, Q, M, D, L	Status parameter with the following values: <ul style="list-style-type: none"> <li>0: No error</li> <li>1: Error occurred</li> </ul> Initial value: FALSE
STATUS	Output	WORD	I, Q, M, D, L	Status of the instruction Initial value: 0

You will find more detailed information on valid data types in "Overview of the valid data types (Page 1077)".

## STATUS parameter

Error code* (W#16#...)	Description
80F0	The communication module is an RS-485 module and no signals are available.
80F1	No signals are settable because H/W flow control is enabled.
80F2	The DSR signal cannot be set because the module is a DTE device.
80F3	The DTR signal cannot be set because the module is a DCE device.
* The error codes can be displayed as integer or hexadecimal values in the program editor. For additional information on toggling display formats, refer to "See also".	

You will find more detailed information on general error codes of the communication instructions in: "General status information of the communications blocks (Page 2762)".

## General status information of the communications blocks

### General information on execution status of the communications blocks

The following table shows which general information can be output at the STATUS parameter of the communications blocks:

Error code* (W#16#...)	Description
8070	All internal instance memory is in use
8080	The identifier entered for the communications port is invalid
8081	Timeout, module error, internal error
8085	Error specifying the length at the LENGHT parameter. The specified length is "0" or greater than the maximum permitted value.
8090	Message length invalid, module invalid, message invalid
8091	Incorrect version in parameterization message
8092	Invalid record length in parameterization message

\* The error codes can be displayed as integer or hexadecimal values in the program editor. For additional information on toggling display formats, refer to "See also".

## USS

### Overview of USS instructions

#### Introduction

The USS instructions control the operation of drives that support the universal serial interface (USS). With the USS instructions, you can communicate with more than one drive via an RS-485 connection.

To do this, you require a CM 1241 RS-485 communications module or a CB 1241 RS-485 communications board. Up to three CM 1241 RS-485 modules and one CB 1241 RS-485 board can be installed in an S7-1200 CPU.

Each RS-485 port can operate up to sixteen drives.

The USS protocol uses a master/slave network for communication via a serial bus. The master uses an address parameter to send a message to a selected slave. A slave itself can never send without previously receiving a request. Direct exchange of messages between slaves is not possible. USS communication works in half duplex mode.

The following figure shows an example of a USS network diagram:

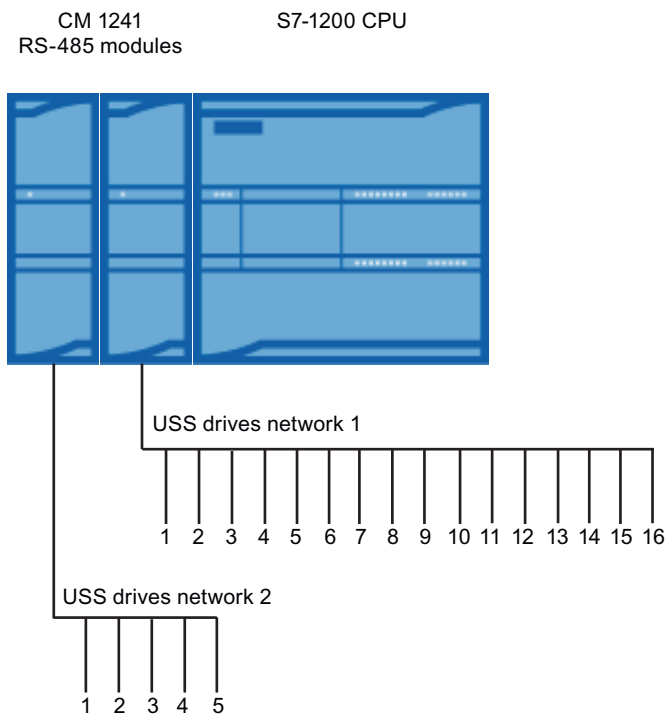

## Requirements for using the USS protocol

### General requirements for setting up a drive

- The use of 4 PKW words must be set up for the drives.
- The drives can be configured for 2, 4, 6 or 8 PZD words.
- The number of PZD words in the drive must correspond to the PZD\_LEN input of the "USS\_DRIVE (Page 2767)" instruction of the drive.
- The baud rate of all drives must match the baud rate of the BAUD input parameter of the "USS\_PORT (Page 2766)" instruction.
- The drive must be set up for remote control.
- USS must be specified for the desired frequency value on the COM connection of the drive.
- 1 to 16 must be set as the drive address. This address must correspond to the address of the DRIVE input parameter of the "USS\_DRIVE (Page 2767)" instruction.
- To control the direction of the drive, the polarity of the drive desired value must be set up.
- The RS-485 network must be connected correctly.

**Definition: PKW / PZD area**

- The PKW area relates to the handling of the parameter-identifier-value interface. The PKW interface is not a physical interface but describes a mechanism that controls the exchange of parameters between two communications partners, in other words, reading and writing parameter values, parameter descriptions and corresponding texts and the handling of parameter changes due to spontaneous messages. All the tasks handled via the PKW interface are essentially tasks for operator control and monitoring, service and diagnostics.
- The PZD area includes the signals required for automation:
  - Control word(s), and setpoint(s) from the master to the slave
  - Status word(s), and actual value(s) from the slave to the master.

Both areas together result in the user data field. This is transferred by the master to the slave as a job frame or by the slave to the master as a reply frame.

**Description**

Each communication module CM 1241 RS485 supports a maximum of 16 drives. A single instance data block contains temporary memory and buffer functions for all drives in the USS network that are connected to a PtP communications module you installed. The USS instructions for these drives have shared access to the information in this data block.

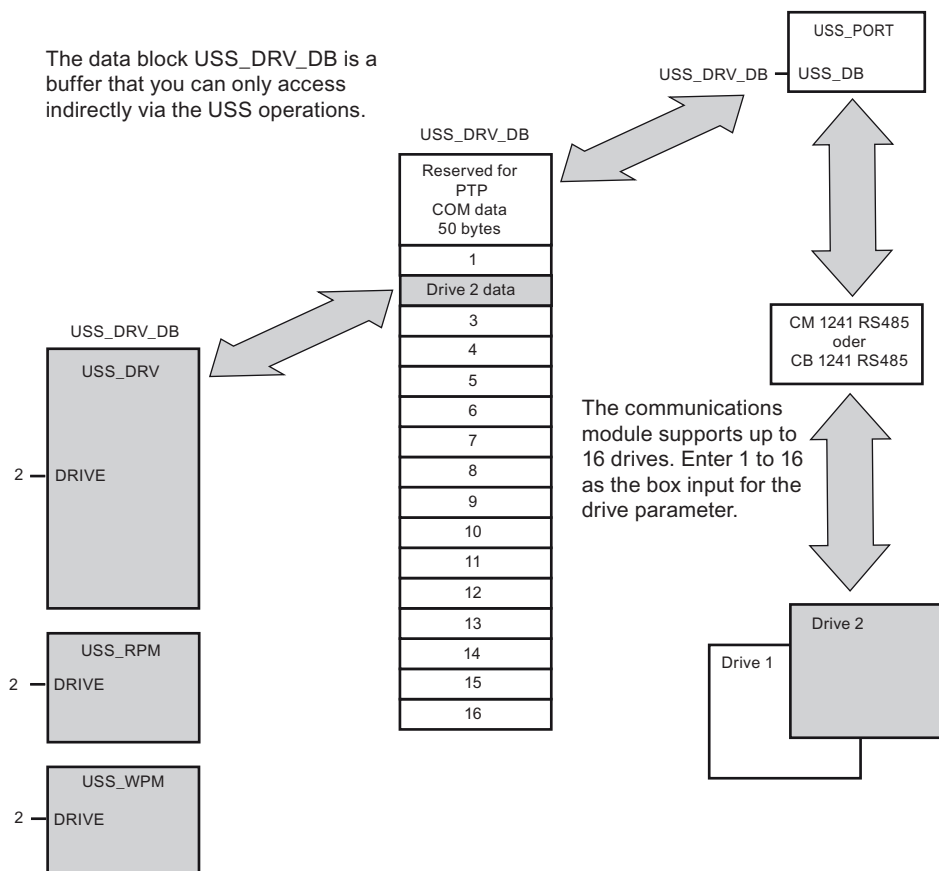

- All drives (max. 16) that are connected to an RS485 port are part of the same USS network. All drives that are connected to a different RS485 port are part of a different USS network. As the S7-1200 supports up to three CM 1241 RS485 modules, you can set up up to three USS networks, each having a maximum of 16 drives, thus a total of 48 USS drives are supported.
- Each USS network is managed via a unique data block (three data blocks are required for three USS networks with three CM 1241 RS485 modules). All instructions that belong to a USS network must share this data block. This includes all "USS\_DRIVE (Page 2767)", "USS\_PORT (Page 2766)", "USS\_RPM (Page 2770)", and "USS\_WPM (Page 2771)" instructions for controlling all drives in a USS network.
- The instruction "USS\_DRIVE (Page 2767)" is a function block (FB). When you insert the instruction "USS\_DRIVE" in the editor, the "Call options" dialog will ask you to assign a DB to the instruction.
  - If this is the first "USS\_DRIVE" instruction in this program for this USS network, you can accept the default DB assignment (or, if necessary, change the name) and the new DB will be created.
  - If, however, this is not the first "USS\_DRIVE" instruction for this network, you must select the DB that was previously assigned to this USS network in the drop-down list in the "Call options" dialog.
- All "USS\_PORT (Page 2766)", "USS\_RPM (Page 2770)", and "USS\_WPM (Page 2771)" instructions are functions (FCs). When you insert these FCs in the editor, no DB is assigned. Instead, you have to assign the DB in question to the USS\_DB input of these instructions (double-click on the parameter field and then on the icon to display the available DBs).
- The instruction "USS\_PORT (Page 2766)" controls communication between the CPU and the drives via the PtP communications module. Whenever this instruction is called, communication with a drive is processed. Your program must call this function quickly enough so that the drives do not report a timeout. The instruction can be called from the main program or any interrupt OB.
- The function block "USS\_DRIVE (Page 2767)" gives your program access to a specified drive in the USS network. Its inputs and outputs correspond to the states and operating functions of the drive. If there are 16 drives in the network, "USS\_DRIVE" must be called at least 16 times in your program, i.e., once for each drive. How quickly these blocks are called depends on the required speed for controlling drive functions. You can only call the instruction "USS\_DRIVE" from the main program OB.

** CAUTION**

Call "USS\_DRIVE", "USS\_RPM", "USS\_WPM" only from the main program OB. The instruction "USS\_PORT" can be called from any OB, it is usually called from a time-delay interrupt OB. If the instruction "USS\_PORT" is interrupted during execution, this may result in unexpected errors.

The "USS\_RPM" and "USS\_WPM" instructions are used to read and write the operating parameters of the drive. These parameters control the internal mode of operation of the drive. A definition of these parameters can be found in the drive manual.

Your program may also contain any number of these instructions; however only one read or write request can be active for a drive. You may only call the instructions "USS\_RPM" and "USS\_WPM" from the main program OB.

### Calculating the time for communication with the drive

Communication with the drive is runs asynchronous to the cycle of the S7-1200. The S7-1200 runs through several cycles before communication with a drive is completed.

The interval of "USS\_PORT" is the time required for a drive transaction. The following table shows the minimum intervals for "USS\_PORT" for each baud rate. Calling the "USS\_PORT" more frequently than the "USS\_PORT" interval will not increase the number of transactions. The timeout interval of the drive is the period of time available to a transaction if 3 attempts are required to complete the transaction due to communications errors. By default, up to 2 further attempts are made for each transaction with the USS protocol.

Baud rate	Calculated minimum interval for calling USS_PORT (ms)	Drive message interval timeout per drive (ms)
1200	790	2370
2400	405	1215
4800	212.5	638
9600	116.3	349
19200	68.2	205
38400	44.1	133
57600	36.1	109
115200	28.1	85

### USS\_PORT: Edit communication via USS network

#### Description

The "USS\_PORT" instruction handles communication over the USS network. In the program, use one "USS\_PORT" instruction per PtP communications port to control the transmission to or from one drive.

All USS instructions that are assigned to one USS network and one PtP communications port must use the same instance data block.

#### Call

Your program must execute the "USS\_PORT" instruction often enough to prevent timeouts in the drive. You should therefore call the "USS\_PORT" instruction from a cyclic interrupt OB to prevent drive timeouts and keep the most recent USS data updates available for "USS\_DRIVE (Page 2767)" calls.

## Parameters

The following table shows the parameters of the "USS\_PORT" instruction:

Parameter	Declaration	Data type	Memory area	Description
PORT	Input	PORT	D, L or constant	PtP communications port identifier Constant that can be referenced within the "Constants" tab of the default tag table.
BAUD	Input	DINT	I, Q, M, D, L or constant	Baud rate for USS communication.
USS_DB	InOut	USS_BASE	D	Reference to the instance DB of the "USS_DRIVE (Page 2767)" instruction.
ERROR	Output	BOOL	I, Q, M, D, L	ERROR is set to TRUE if an error occurs. A corresponding error code will be output at the STATUS output.
STATUS (Page 2772)	Output	WORD	I, Q, M, D, L	Status value of the request. It indicates the result of the cycle or initialization. Additional information is available in the "USS_Extended_Error (Page 2772)" tag for some status codes.

You will find more detailed information on valid data types in "Overview of the valid data types (Page 1077)".

## USS\_DRIVE: Swap data with drive

### Description

The "USS\_DRIVE" instruction exchanges data with the drive by creating request messages and interpreting the drive response messages. A separate instruction must be used for each drive, but all USS instructions assigned to one USS network and one PtP communications module must use the same instance data block. You must create the DB name when you place the first "USS\_DRIVE" instruction. Then reuse this DB that was created when the initial instruction was inserted.

When the "USS\_DRIVE" instruction is executed the first time, the drive indicated by the USS address (parameter DRIVE) is initialized in the instance DB. After this initialization, subsequent "USS\_PORT (Page 2766)" instructions can start communication with the drive at this drive number.

Changing the drive number requires a PLC STOP to RUN mode transition that initializes the instance DB. Input parameters are configured in the USS send buffer, and outputs are read from a "previous" valid response buffer if any exists. There is no data transmission during execution of the "USS\_DRIVE" instruction. Communication with the drives takes place when "USS\_PORT (Page 2766)" is executed. "USS\_DRIVE" only configures the messages to be sent and interprets data received in a previous request.

You can control the drive direction of rotation using either the DIR (BOOL) input or using the sign (positive or negative) at the SPEED\_SP (REAL) input. The following table explains how these inputs work together to determine the drive direction, assuming the motor is wired for forward rotation.

SPEED_SP	DIR	Direction of rotation of drive
Value > 0	0	Reverse
Value > 0	1	Forward
Value < 0	0	Forward
Value < 0	1	Reverse

### Parameters

Expand the box to display all the parameters by clicking the bottom of the box. The parameter connections that are grayed are optional and do not need to be assigned.

The following table shows the parameters of the "USS\_DRIVE" instruction:

Parameter	Declaration	Data type	Memory area	Description
RUN	Input	BOOL	I, Q, M, D, L or constant	Drive start bit: If this parameter has the value TRUE, this input enables the drive to run at the preset speed.
OFF2	Input	BOOL	I, Q, M, D, L or constant	"Electrical stop" bit: If this parameter has the value FALSE, this bit cause the drive to coast to a stop without braking.
OFF3	Input	BOOL	I, Q, M, D, L or constant	Fast stop bit - If this parameter has the value FALSE, this bit causes a fast stop by braking the drive.
F_ACK	Input	BOOL	I, Q, M, D, L or constant	Fault acknowledge bit - This bit resets the fault bit on a drive. This bit is set after the fault is cleared to indicate to the drive that it no longer needs to indicate the previous fault.
DIR	Input	BOOL	I, Q, M, D, L or constant	Drive direction control - This bit is set to indicate that the direction is forward (when SPEED_SP is positive).
DRIVE	Input	USINT	I, Q, M, D, L or constant	Drive address: This input is the address of the USS drive. The valid range is drive 1 to drive 16.
PZD_LEN	Input	USINT	I, Q, M, D, L or constant	Word length - This is the number of words of PZD data. Valid values are 2, 4, 6, or 8 words. The default is 2.
SPEED_SP	Input	REAL	I, Q, M, D, L or constant	Speed setpoint - This is the speed of the drive as a percentage of configured frequency. A positive value specifies forward direction (when DIR has the value TRUE).
CTRL3	Input	WORD	I, Q, M, D, L or constant	Control word 3 - A value written to a user-configurable parameter on the drive. The user must configure this on the drive. Optional parameter
CTRL4	Input	WORD	I, Q, M, D, L or constant	Control word 4 - A value written to a user-configurable parameter on the drive. The user must configure this on the drive. Optional parameter
CTRL5	Input	WORD	I, Q, M, D, L or constant	Control word 5 - A value written to a user-configurable parameter on the drive. The user must configure this on the drive. Optional parameter
CTRL6	Input	WORD	I, Q, M, D, L or constant	Control word 6 - A value written to a user-configurable parameter on the drive. The user must configure this on the drive.



Parameter	Declaration	Data type	Memory area	Description
CTRL7	Input	WORD	I, Q, M, D, L or constant	Control word 7 - A value written to a user-configurable parameter on the drive. The user must configure this on the drive. Optional parameter
CTRL8	Input	WORD	I, Q, M, D, L or constant	Control word 8 - A value written to a user-configurable parameter on the drive. The user must configure this on the drive. Optional parameter
NDR	Output	BOOL	I, Q, M, D, L	New data ready - If this parameter has the value TRUE, the bit indicates that the output contains data from a new communication request.
ERROR	Output	BOOL	I, Q, M, D, L	Error occurred - If this parameter has the value TRUE, this indicates that an error has occurred and the STATUS output is valid. All other outputs are set to zero on an error. Communication errors are only reported at the ERROR and STATUS outputs of the "USS_PORT" instruction.
STATUS (Page 2772)	Output	WORD	I, Q, M, D, L	Status value of the request. It indicates the result of the cycle. This is not a status word returned from the drive.
RUN_EN	Output	BOOL	I, Q, M, D, L	Run enabled - This bit indicates whether the drive is running.
D_DIR	Output	BOOL	I, Q, M, D, L	Drive direction - This bit indicates whether the drive is running forward.
INHIBIT	Output	BOOL	I, Q, M, D, L	Drive inhibited - This bit indicates the state of the inhibit bit on the drive.
FAULT	Output	BOOL	I, Q, M, D, L	Drive fault - This bit indicates that the drive has registered a fault. The user must eliminate the fault and then set the F_ACK bit to clear this bit.
SPEED	Output	REAL	I, Q, M, D, L	Drive current speed (scaled value of drive status word 2) - The value of the speed of the drive as a percentage of configured speed.
STATUS1	Output	WORD	I, Q, M, D, L	Drive status word 1 - This value contains fixed status bits of a drive.
STATUS3	Output	WORD	I, Q, M, D, L	Drive status word 3 - This value contains a user-configurable status word on the drive.
STATUS4	Output	WORD	I, Q, M, D, L	Drive status word 4 - This value contains a user-configurable status word on the drive.
STATUS5	Output	WORD	I, Q, M, D, L	Drive status word 5 - This value contains a user-configurable status word on the drive.
STATUS6	Output	WORD	I, Q, M, D, L	Drive status word 6 - This value contains a user-configurable status word on the drive.
STATUS7	Output	WORD	I, Q, M, D, L	Drive status word 7 - This value contains a user-configurable status word on the drive.
STATUS8	Output	WORD	I, Q, M, D, L	Drive status word 8 - This value contains a user-configurable status word on the drive.

You will find more detailed information on valid data types in "Overview of the valid data types (Page 1077)".

**USS\_RPM: Readout parameters from the drive**

**Description**

The "USS\_RPM" instruction reads a parameter from the drive. All USS functions that are assigned to one USS network and one PtP communications module must use the same instance data block. "USS\_RPM" must be called from the main program OB.

**Parameter**

The following table shows the parameters of the "USS\_RPM" instruction:

Parameter	Declaration	Data type	Memory area	Description
REQ	Input	BOOL	I, Q, M, D, L	Send request: If this parameter has the value TRUE, it indicates that a new read request is desired. This is ignored if the request for this parameter is already pending.
DRIVE	Input	USINT	I, Q, M, D, L or constant	Drive address: This input is the address of the USS drive. The valid range is drive 1 to drive 16.
PARAM	Input	UINT	I, Q, M, D, L or constant	Parameter number: This input specifies which drive parameter is written. The range of this parameter is 0 to 2047. See your drive manual for details on how to access any parameters above this range.
INDEX	Input	UINT	I, Q, M, D, L or constant	Parameter index: This input specifies which drive parameter index is to be written. This is a 16-bit value where the least significant byte is the actual index value with a range of (0 to 255). The most significant byte may also be used by the drive and is drive-specific. See your drive manual for additional information.
USS_DB	InOut	USS_BASE	D	Reference to the instance DB that is created and initialized when a "USS_DRIVE" instruction is inserted in your program.
DONE	Output	BOOL	I, Q, M, D, L	If this parameter has the value TRUE, it indicates that the VALUE output holds the previously requested read parameter value. This bit is set when the "USS_DRIVE" instruction recognizes the read response from the drive. This bit is reset when either: <ul style="list-style-type: none"> <li>• you request the response data via another "USS_RPM" poll</li> <li>or</li> <li>• the second of the next two calls of "USS_DRIVE (Page 2767)" is executed</li> </ul>
ERROR	Output	BOOL	I, Q, M, D, L	Error occurred - If this parameter has the value TRUE, this indicates that an error has occurred and the STATUS output is valid. All other outputs are set to zero on an error. Communication errors are only reported at the ERROR and STATUS outputs of the "USS_PORT (Page 2766)" instruction.

Parameter	Declaration	Data type	Memory area	Description
STATUS (Page 2772)	Output	WORD	I, Q, M, D, L	This is the status value of the request. It indicates the result of the read request. Additional information is available in the "USS_Extended_Error (Page 2772)" tag for some status codes.
VALUE	Output	VARIANT	I, Q, M, D, L	This is the value of the parameter that was read and is valid only when the DONE bit has the value TRUE.

You will find more detailed information on valid data types in "Overview of the valid data types (Page 1077)".

## USS\_WPM: Change parameters in the drive

### Description

The "USS\_WPM" instruction modifies a parameter in the drive. All USS functions that are assigned to one USS network and one PtP communications module must use the same instance data block. "USS\_WPM" must be called from the main program OB.

#### Note

##### EEPROM write operations

Beware of overusing the EEPROM write operation. Minimize the number of EEPROM write operations to extend the EEPROM life.

### Parameter

The following table shows the parameters of the "USS\_WPM" instruction:

Parameter	Declaration	Data type	Memory area	Description
REQ	Input	BOOL	I, Q, M, D, L	Send request: If this parameter has the value TRUE, it indicates that a new write request is desired. This is ignored if the request for this parameter is already pending.
DRIVE	Input	USINT	I, Q, M, D, L or constant	Drive address: This input is the address of the USS drive. The valid range is drive 1 to drive 16.
PARAM	Input	UINT	I, Q, M, D, L or constant	Parameter number: This input specifies which drive parameter is written. The range of this parameter is 0 to 2047. See your drive manual for details on how to access any parameters above this range.
INDEX	Input	UINT	I, Q, M, D, L or constant	Parameter index: This input specifies which drive parameter index is to be written. This is a 16-bit value where the least significant byte is the actual index value with a range of (0 to 255). The most significant byte may also be used by the drive and is drive-specific. See your drive manual for additional information.

9.7 References

Parameter	Declaration	Data type	Memory area	Description
EEPROM	Input	BOOL	I, Q, M, D, L or constant	Store to drive EEPROM: If this parameter has the value TRUE, values written to the drive parameter will be stored in the drive EEPROM. If this parameter has the value FALSE, the value written is only temporarily saved and will be lost the next time the drive is switched on.
VALUE	Input	VARIANT	I, Q, M, D, L or constant	The value of the parameter that is to be written. It must be valid on the transition of REQ.
USS_DB	InOut	USS_BASE	D	This is a reference to the instance DB that is created and initialized when a "USS_DRIVE (Page 2767)" instruction is inserted in your program.
DONE	Output	BOOL	I, Q, M, D, L	If this parameter has the value TRUE, the VALUE input was written to the drive. This bit is set when the "USS_DRIVE (Page 2767)" instruction recognizes the write response from the drive. This bit is reset when either: You request the drive's confirmation that the write operation has been completed via another "USS_WPM" query or when the second of the next two calls of "USS_DRIVE (Page 2767)" is executed.
ERROR	Output	BOOL	I, Q, M, D, L	Error occurred: If this parameter has the value TRUE, this indicates that an error has occurred and the STATUS output is valid. All other outputs are set to zero on an error. Communication errors are only reported at the ERROR and STATUS outputs of the "USS_PORT (Page 2766)" instruction.
STATUS (Page 2772)	Output	WORD	I, Q, M, D, L	This is the status value of the request. It indicates the result of the write request. Additional information is available in the "USS_Extended_Error (Page 2772)" tag for some status codes.

You will find more detailed information on valid data types in "Overview of the valid data types (Page 1077)".

Parameter STATUS of USS instructions

STATUS parameter

The following table contains the status codes of the USS operation that are output at the STATUS output of the USS instructions:

STATUS* (W#16#...)	Description
0000	No error
8180	The length of the drive response did not match the characters received from the drive. The drive number where the error occurred is returned in the "USS_Extended_Error" tag. See the extended error description below this table.
8181	The parameter VALUE is not of the data type WORD, REAL, or DWORD
8182	User supplied a parameter value of the type word and received a DWORD or REAL from the drive in the response

STATUS* (W#16#...)	Description
8183	User supplied a parameter value of the type DWORD or REAL and received a word from the drive in the response
8184	Response telegram from drive had a bad checksum. The drive number where the error occurred is returned in the "USS_Extended_Error" tag. See the extended error description below this table.
8185	Illegal drive address (valid drive address range: 1-16)
8186	Speed set point out of valid range (valid speed SP range: -200% to 200%)
8187	Wrong drive number responded to the request sent. The drive number where the error occurred is returned in the "USS_Extended_Error" tag. See the extended error description below this table.
8188	Illegal PZD word length specified (valid range = 2, 4, 6 or 8 words)
8189	Illegal baud rate was specified
818A	Parameter request channel is in use by another request for this drive
818B	Drive has not responded to requests and retries. The drive number where the error occurred is returned in the "USS_Extended_Error" tag. See the extended error description below this table.
818C	Drive returned an extended error on a parameter request operation. See the extended error description below this table.
818D	Drive returned an invalid access error on a parameter request operation. See your drive manual for information of why parameter access may be limited
818E	Drive has not been initialized: This error code is output at "USS_RPM (Page 2770)" or "USS_WPM (Page 2771)" if the "USS_DRIVE (Page 2767)" instruction has not been called at least once for this drive. This prevents the initialization of the first cycle of "USS_DRIVE (Page 2767)" from overwriting a pending parameter read or write request since it initializes the drive as a new entry. To eliminate this error, call the "USS_DRIVE (Page 2767)" instruction for this drive.
80Ax-80Fx	Specific errors returned from PtP (Point-to-Point) communication instructions called by the USS library: These error code values are not modified by the USS library and are defined in the PtP instruction descriptions.
* The error codes can be displayed as integer or hexadecimal values in the program editor. For additional information on toggling display formats, refer to "See also".	

### USS\_Extended\_Error - USS drive extended error codes

USS drives support read and write access to a drive's internal parameters. This feature allows distributed control and configuration of the drive. Drive parameter access operations can fail due to errors such as values out of range or invalid requests in a drive's current mode. The drive generates an error code that is output in the "USS\_Extended\_Error" variable in the instance DB of the "USS\_DRIVE (Page 2767)" instruction. This error code value is only valid for the last execution of the "USS\_RPM (Page 2770)" or "USS\_WPM (Page 2771)" instruction. The drive error code is put into the "USS\_Extended\_Error" tag when the value of STATUS is hexadecimal 818C. The error code of "USS\_Extended\_Error" depends on the drive variant. See the drive's manual for a description of the extended error codes for read and write parameter operations.

## MODBUS (RTU)

### MB\_COMM\_LOAD: Configure port on the PtP module for Modbus RTU

#### Description

The "MB\_COMM\_LOAD" instruction configures a port for communication using the Modbus RTU protocol. The following hardware can be used for this:

- Up to three point-to-point modules (PtP) CM 1241 RS485 or CM 1241 RS232
- A communications board CB 1241 RS485 in addition to this

After configuration of the port, you communicate over Modbus by executing the "MB\_SLAVE" or "MB\_MASTER" instruction.

#### Call

"MB\_COMM\_LOAD" must be called once to configure the port for the Modbus RTU protocol. On completion of the configuration, the port can be used by the "MB\_MASTER (Page 2777)" and "MB\_SLAVE (Page 2785)" instructions.

"MB\_COMM\_LOAD" only needs to be called again if one of the communication parameters has to be modified. Each "MB\_COMM\_LOAD" call deletes the communications buffer. To avoid data loss during communication, you should not call the instruction unnecessarily.

One instance of "MB\_COMM\_LOAD" must be used to configure the port of each communication module that is used for Modbus communication. You assign a unique "MB\_COMM\_LOAD" instance data block for each port that you use. The S7-1200 CPU is limited to three communication modules.

An instance data block is assigned when you insert the "MB\_MASTER (Page 2777)" or "MB\_SLAVE (Page 2785)" instruction. This instance data block is referenced when you specify the MB\_DB parameter on the "MB\_COMM\_LOAD" instruction.

#### Parameters

The following table shows the parameters of the instruction "MB\_COMM\_LOAD":

Parameter	Declaration	Data type	Memory area	Description
REQ	Input	BOOL	I, Q, M, D, L	Execution of the instruction upon a rising edge.
PORT	Input	PORT	I, Q, M, D, L or constant	ID of the communications port: After you have inserted the communications module in the device configuration, the port ID appears in the drop-down list at the PORT box connection. This constant can also be referenced within the "Constants" tab of the tag table.
BAUD	Input	UDINT	I, Q, M, D, L or constant	Baud rate selection: 300, 600, 1200, 2400, 4800, 9600, 19200, 38400, 57600, 76800, 115200 All other values are invalid.

Parameter	Declaration	Data type	Memory area	Description
PARITY	Input	UINT	I, Q, M, D, L or constant	Parity selection: <ul style="list-style-type: none"> <li>• 0 – None</li> <li>• 1 – Odd</li> <li>• 2 – Even</li> </ul>
FLOW_CTRL	Input	UINT	I, Q, M, D, L or constant	Flow control selection: <ul style="list-style-type: none"> <li>• 0 – (default) No flow control</li> <li>• 1 – Hardware flow control with RTS always ON (does not apply to RS485 ports)</li> <li>• 2 - Hardware flow control with RTS switched</li> </ul>
RTS_ON_DLY	Input	UINT	I, Q, M, D, L or constant	RTS on-delay selection: <ul style="list-style-type: none"> <li>• 0 – (default) No delay of RTS active until the first character of the message is transmitted.</li> <li>• 1 to 65535 – Delay in milliseconds of "RTS active" until the first character of the message is transmitted (does not apply to RS-485 ports). RTS delays must be applied independent of the FLOW_CTRL selection.</li> </ul>
RTS_OFF_DLY	Input	UINT	I, Q, M, D, L or constant	RTS off-delay selection: <ul style="list-style-type: none"> <li>• 0 – (default) No delay after the last character transmitted until "RTS inactive"</li> <li>• 1 to 65535 – Delay in milliseconds after the last character transmitted until "RTS inactive" (does not apply to RS-485 ports). RTS delays must be applied independent of the FLOW_CTRL selection.</li> </ul>
RESP_TO	Input	UINT	I, Q, M, D, L or constant	Response timeout: Time in milliseconds allowed by "MB_MASTER (Page 2777)" for the slave to respond. If the slave does not respond in this time, "MB_MASTER (Page 2777)" repeats the request or terminates the request with an error if the specified number of retries has been sent. 5 ms to 65535 ms (default = 1000 ms).
MB_DB	Input	MB_BASE	D	A reference to the instance data block of the "MB_MASTER (Page 2777)" or "MB_SLAVE (Page 2785)" instructions. After you insert "MB_SLAVE (Page 2785)" or "MB_MASTER (Page 2777)" in your program, the DB identifier appears in the drop-down list at the MB_DB box connection.
DONE	Output	BOOL	I, Q, M, D, L	Execution of instruction completed without error.
ERROR	Output	BOOL	I, Q, M, D, L	Error: <ul style="list-style-type: none"> <li>• 0 – No error detected</li> <li>• 1 – Indicates that an error was detected. An error code is output in the STATUS parameter.</li> </ul>
STATUS	Output	WORD	I, Q, M, D, L	Port configuration error code

For additional information on valid data types, refer to "Overview of the valid data types (Page 1077)".

**Parameter STATUS**

Error code* (W#16#...)	Description
0000	No error
8180	Invalid value for the port ID (wrong address for the communications module).
8181	Invalid baud rate value.
8182	Invalid parity value.
8183	Invalid flow control value.
8184	Invalid value for the timeout of the response (the time before which a timeout is reported must be at least 25 ms).
8185	Incorrect pointer in the MB_DB parameter to the instance DB of the "MB_MASTER (Page 2777)" or "MB_SLAVE (Page 2785)" instruction.
* The error codes can be displayed as integer or hexadecimal values in the program editor. For additional information on toggling display formats, refer to "See also".	

**MB\_COMM\_LOAD data block tags**

The table below shows the public static tags in the instance DB of MB\_COMM\_LOAD that you can use in your program.

Table 9-119 Static tags in the instance DB

Tag	Data type	Default	Description
ICHAR_GAP	WORD	0	Delay for the character spacing between characters. This parameter is specified in milliseconds and is used to increase the anticipated period between the received characters. The corresponding number of bit times for this parameter is added to the Modbus standard value of 35 bit times (3.5 character times).
RETRIES	WORD	2	The number of repeated attempts by the master before the error code 0x80C8 is returned for "No response".
MODE	USINT	0	Mode Permitted modes are: <ul style="list-style-type: none"> <li>• 0 = Full duplex (RS232)</li> <li>• 1 = Full duplex (RS422) four-wire mode (point-to-point)</li> <li>• 2 = Full duplex (RS422) four-wire mode (multipoint master)</li> <li>• 3 = Full duplex (RS422) four-wire mode (multipoint slave)</li> <li>• 4 = Half duplex (RS485) two-wire mode</li> </ul>



Tag	Data type	Default	Description
LINE_PRE	USINT	0	Receive line initial state Permitted defaults are: <ul style="list-style-type: none"> <li>• 0 = "No" default</li> <li>• 1 = Signal R(A)=5V, signal R(B)=0 V (break detection): No break detection is possible with this default. Can only be selected with: "Full duplex (RS422) four-wire mode (point-to-point connection)" and "Full duplex (RS422) four-wire mode (multipoint slave)".</li> <li>• 2 = Signal R(A)=0 V, signal R(B)=5 V: This default corresponds to the at-rest state (no send process is active). No break detection is possible with this default.</li> </ul>
CABLE-BREAK	USINT	0	Activate cable break detection: <ul style="list-style-type: none"> <li>• 0 - not activated</li> <li>• 1 - activated</li> </ul>

## MB\_MASTER: Communicate via the PtP port as Modbus master

### Description of MB\_MASTER

#### Description

The "MB\_MASTER" instruction allows your program to communicate as a Modbus master using a port on a point-to-point module (CM) or a communications board (CB). You can access data in one or more Modbus slave devices.

Before the "MB\_MASTER" instruction can communicate with a port, "MB\_COMM\_LOAD (Page 2774)" must first execute.

An instance DB is created when you insert the "MB\_MASTER" instruction in your program. You specify this instance DB in the MB\_DB input parameter of the "MB\_COMM\_LOAD (Page 2774)" instruction.

#### Rules for Modbus master communication

- A port used for Modbus master requests cannot be used for "MB\_SLAVE".
- A port can be used for one or more "MB\_MASTER" calls if the same instance DB is used.
- The Modbus instructions do not use communication interrupt events to control the communication process. Your program must poll the "MB\_MASTER" instruction for completed send and receive operations.

9.7 References

- Calling the instruction:
  - Call the "MB\_MASTER" instruction if possible in a cyclic program OB. The instruction can only be called in a time delay or cyclic interrupt OB.
  - Do not call more than one "MB\_MASTER" instruction in organization blocks with different priority classes. If a "MB\_MASTER" instruction executes "preemptively" from a higher priority class, the instruction may execute incorrectly.
  - Do not call the "MB\_MASTER" instruction in a startup, diagnostics or time error OB.
- After a transfer has started, the EN parameter (LAD/FBD) must remain set to the value "1" until the DONE or ERROR output parameter is set to "1" by the instruction. A renewed call by the REQ parameter while the instruction is executing causes an error. After the instruction executes, the bit in the REQ parameter remains set for the time specified by the BLOCKED\_PROC\_TIMEOUT parameter in the instance DB.
- If "MB\_MASTER" sends a request to a slave, make sure that "MB\_MASTER" continues to execute until the response from the slave arrives.

Parameters

The following table shows the parameters of the "MB\_MASTER" instruction:

Parameters	Declaration	Data type	Memory area	Description
REQ (Page 2780)	Input	BOOL	I, Q, M, D, L	Request input: <ul style="list-style-type: none"> <li>• 0 – No request</li> <li>• 1 – Request to transmit data to Modbus slave(s)</li> </ul>
MB_ADDR	Input	UINT	I, Q, M, D, L or constant	Modbus RTU station address: <ul style="list-style-type: none"> <li>• Default address range: 0 to 247</li> <li>• Extended address range: 0 to 65535</li> </ul> The value "0" is reserved for broadcasting a message to all Modbus slaves. Modbus function codes 05, 06, 15, and 16 are the only function codes supported for broadcast.
MODE (Page 2780)	Input	USINT	I, Q, M, D, L or constant	Mode selection: Specifies the type of request: Read, write, or diagnostics: Refer to the Modbus functions table for details.
DATA_ADDR (Page 2780)	Input	UDINT	I, Q, M, D, L or constant	Starting address in the slave: Specifies the starting address of the data to be accessed in the Modbus slave. You will find the valid addresses in the Modbus functions table.
DATA_LEN	Input	UINT	I, Q, M, D, L or constant	Data length: Specifies the number of bits or words to be accessed in this request. You will find the valid lengths in the Modbus functions table.
DATA_PTR (Page 2782)	Input	VARIANT	M, D	Points to the DB or bit memory address of the CPU for the data to be written or read. For a DB, this must be created with the "Standard - compatible with S7-300/400" access type.
DONE	Output	BOOL	I, Q, M, D, L	<ul style="list-style-type: none"> <li>• 0: Transaction not completed</li> <li>• 1: Transaction completed without error</li> </ul>

Parameters	Declaration	Data type	Memory area	Description
BUSY	Output	BOOL	I, Q, M, D, L	<ul style="list-style-type: none"> <li>0: No "MB_MASTER" transaction in progress</li> <li>1: "MB_MASTER" transaction in progress</li> </ul>
ERROR	Output	BOOL	I, Q, M, D, L	<ul style="list-style-type: none"> <li>0: No error</li> <li>1: Error, the error code is indicated by the STATUS parameter</li> </ul>
STATUS	Output	WORD	I, Q, M, D, L	Execution condition code

You will find more detailed information on valid data types in "Overview of the valid data types (Page 1077)".

## STATUS parameter

Table 9-120 Communications and configuration error messages of the instruction

Error code* (W#16#...)	Description
0000	No error
80C8	Slave timeout. Check the baud rate, parity and the connectors on the slave.
80D1	The receiver issued a flow control request to suspend an active transmission and never re-enabled the transmission within the wait time. This error is also generated during hardware flow control if the recipient does not detect CTS within the wait time.
80D2	The send request was aborted because no DSR signal is received from the DCE.
80E0	The message was terminated because the receive buffer is full.
80E1	The message was terminated as a result of a parity error.
80E2	The message was terminated as a result of a framing error.
80E3	The message was terminated as a result of an overrun error.
80E4	The message was terminated as a result of the specified length exceeding the total buffer size.
8180	Invalid value for the port ID.
8186	Invalid Modbus station address
8188	The MODE parameter has an invalid value for a broadcast call.
8189	Invalid data address value.
818A	Invalid data length value.
818B	Invalid pointer to the local data source/destination: Size not correct
818C	The DATA_PTR parameter has an invalid pointer. Use a pointer to a bit memory area or a DB with the "Standard - compatible with S7-300/400" access type.
8200	Port is busy processing a send request

\* The error codes can be displayed as integer or hexadecimal values in the program editor. For additional information on toggling display formats, refer to "See also".

Table 9-121 Error messages of the Modbus protocol

Error code* (W#16#...)	Response code of slave	Description
8380	-	CRC error
8381	01	Function code not supported
8382	03	Data length error
8383	02	Error in the data address or address outside the valid range of DATA_PTR
8384	> 03	Data value error
8385	03	Data diagnostic code value not supported (function code 08)
8386	-	Function code of the response does not match the function code of the query.
8387	-	Response from wrong slave
8388	-	The response of the slave to a write call is not correct. The data sent by the slave does not match the query from the master.

\* The error codes can be displayed as integer or hexadecimal values in the program editor. For additional information on toggling display formats, refer to "See also".

### Parameter REQ

#### Description

- REQ = FALSE: No request
- REQ = TRUE: Request to transmit data to Modbus slave(s)

You must supply this input through a positive edge-triggered contact on the first call of "MB\_MASTER" execution. The edge-triggered pulse will invoke the transmission request once. All inputs are captured and kept unchanged for the duration of a request and response triggered by this input.

While an instance of the "MB\_MASTER" executes, no further instance of the instruction can be called. If there is a further instance call by the REQ parameter while "MB\_MASTER" is executing, no automatic follow-on call will be started. To be able to call the instance again, the instruction must first be completed before it can be called again by the REQ parameter.

### DATA\_ADDR and MODE parameters

#### Description

You specify the start address for data access to the Modbus slave using the DATA\_ADDR parameter.

With the MODE parameter and the Modbus address, you specify the function code to be transferred to the Modbus slave. The following table shows the relationship between the MODE parameter, the function code and Modbus address range.

MODE	Modbus function	Data length	Operation and data	Modbus address
0	01	1 to 2000 1 to 1992 <sup>(1)</sup>	Read output bits: 1 to (1992 or 2000) bits per query	1 to 9999
0	02	1 to 2000 1 to 1992 <sup>(1)</sup>	Read input bits: 1 to (1992 or 2000) bits per query	10001 to 19999
0	03	1 to 125 1 to 124 <sup>(1)</sup>	Read holding register: 1 to (124 or 125) WORD per query	40001 to 49999 or 400001 to 465535
0	04	1 to 125 1 to 124 <sup>(1)</sup>	Read input WORD: 1 to (124 or 125) WORD per query	30001 to 39999
1	05	1	Writing an output bit: One bit per query	1 to 9999
1	06	1	Writing a holding register: 1 WORD per query	40001 to 49999 or 400001 to 465535
1	15	2 to 1968 2 to 1960 <sup>(1)</sup>	Writing multiple output bits: 2 to (1960 or 1968) bits per query	1 to 9999
1	16	2 to 123 2 to 122 <sup>(1)</sup>	Writing multiple holding registers: 2 to (122 or 123) WORD per query	40001 to 49999 or 400001 to 465535
2	15	1 to 1968 2 to 1960 <sup>(1)</sup>	Writing one or more output bits: 1 to (1960 or 1968) bits per query	1 to 9999
2	16	1 to 123 2 to 122 <sup>(1)</sup>	Writing one or more holding registers: 1 to (122 or 123) WORD per query	40001 to 49999 or 400001 to 465535
11	11	0	Reading out the communications status word of the slaves and the event counter:  The status word indicates execution of the instruction (0: is not executing; 0xFFFF: is executing). The event counter is incremented each time a message is transferred successfully.  The DATA_ADDR and DATA_LEN parameters of the "MB_MASTER" instruction are ignored with this function.	-
80	08	1	Checking the slave status by reading the error code (0x0000): 1 WORD per query	-
81	08	1	Resetting the event counter of the slave with the diagnostics code 0x000A: 1 WORD per query	-
3 to 10, 12 to 79, 82 to 2555			Reserved	-

<sup>(1)</sup>For the "Extended address range", the maximum data length is reduced by one byte or one WORD depending on which data type is used for the function.

## Parameter DATA\_PTR

### Description

The DATA\_PTR parameter is a pointer to a data block or bit memory from which the data should be written or read. If you use a data block, create a global data block with the "Standard - compatible with S7-300/400" access type.

### Data block structures for the DATA\_PTR parameter

- These data types are valid for **reading of words** of Modbus addresses 30001 to 39999, 40001 to 49999, and 400001 to 465536 and also for **writing of words** to Modbus addresses 40001 to 49999 and 400001 to 465536.
  - Standard array of WORD, UINT, or INT data types (see below).
  - Named WORD, UINT, or INT structure where each element has a unique name and 16 bit data type.
  - Named complex structure where each element has a unique name and 16 bit or 32 bit data type.
- For reading and writing of bits of Modbus addresses 00001 to 09999 and 10001 to 19999.
  - Standard array of Boolean data types.
  - Named Boolean structure of uniquely named Boolean variables.
- Although not required, it is recommended that each "MB\_MASTER" instruction has its own separate memory area in a global data block. The reason for this recommendation is that there is a greater possibility of data corruption if multiple "MB\_MASTER" instructions are reading and writing the same area of a global data block.
- The memory areas for DATA\_PTR do not need to be in the same global data block. You can create one data block with multiple areas for Modbus read operations, one data block for Modbus write operations, or one data block for each slave station.

## Instance DB of the "MB\_MASTER" instruction

### Static variables of the instance DB

The following table describes the static variables of the instance DB of the instruction that you can use in the user program.

Variable	Data type	Description
MB_STATE	UINT	Internal status of the Modbus instruction
BLOCKED_ PROC_TIMEOUT	REAL	Time between completion of the instruction call and resetting the ACTIVE bit in the instance DB. The time buffer is used to avoid execution of the instruction being terminated before a job has been sent completely. The default time is 500 ms.
EXTENDED_ ADDRESSING	BOOL	Configuring addressing: <ul style="list-style-type: none"> <li>• 0: Default address area (1 byte)</li> <li>• 1: Extended address area (2 bytes)</li> </ul> For additional information, refer to the section EXTENDED_ADDRESSING: Instance DB of the "MB_SLAVE" instruction (Page 2788)

### Sample program for a Modbus master

#### Networks (LAD)

**Network 1:** Initialize parameters of the RS-485 module only once during the first cycle.

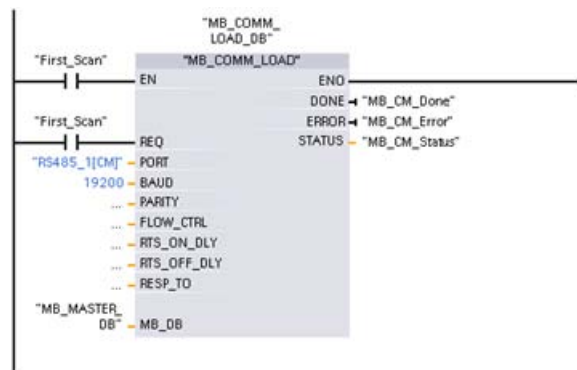

**Network 2:** Read 100 words from the holding register of the slave.

9.7 References

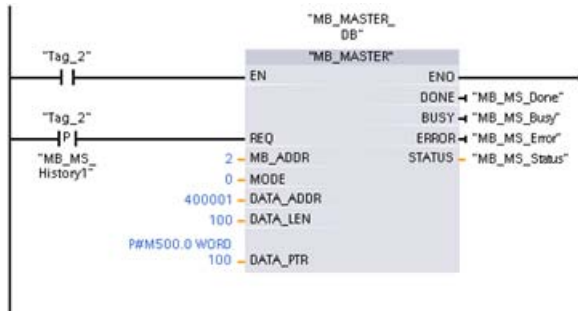

**Network 3:** This is an optional network that displays the values of the first 3 words as soon as the read operation has executed.

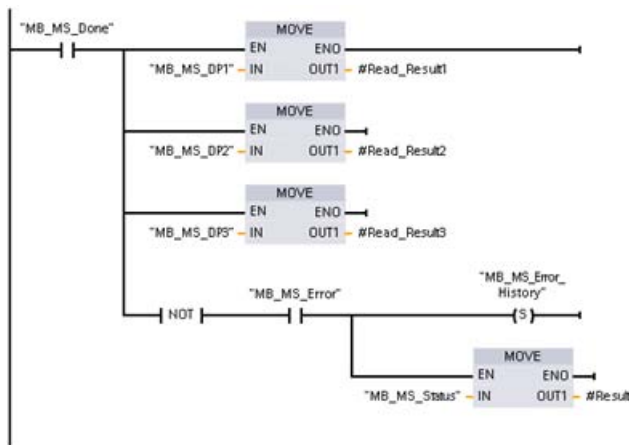

**Network 4:** Write 64 bits to the process image output, starting at slave address Q2.0.

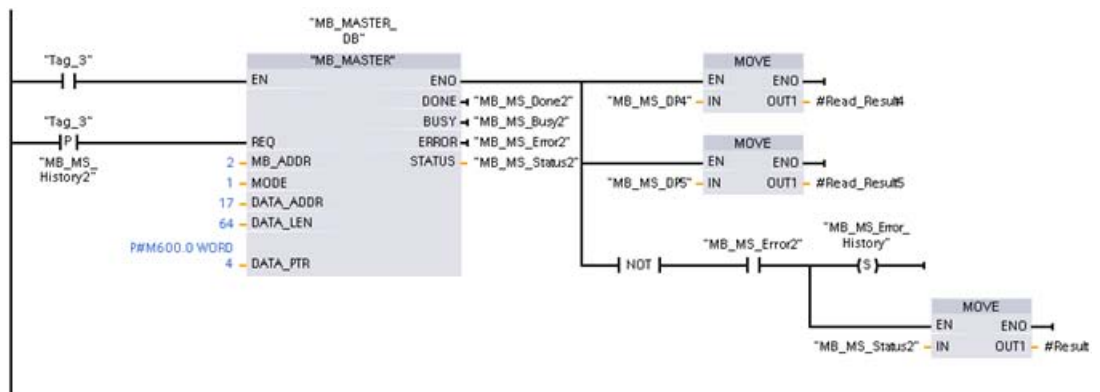



**MB\_SLAVE: Communicate via the PtP port as Modbus slave****Description of MB\_SLAVE****Description**

The "MB\_SLAVE" instruction allows your program to communicate as a Modbus slave using a port on a point-to-point module (PtP) or a communications board (CB). A Modbus RTU master can issue a request and then your program responds via "MB\_SLAVE" execution.

You must assign a unique instance data block when you insert the "MB\_SLAVE" instruction in your program. This instance data block is used when you specify it at the MB\_DB parameter of the "MB\_COMM\_LOAD (Page 2774)" instruction.

Modbus communication function codes (1, 2, 4, 5, and 15) can read and write bits and words directly in the process image input and process image output in the target system. The following table shows the mapping of Modbus addresses to the process image in the CPU.

Modbus functions of "MB_SLAVE"					S7-1200	
Codes	Function	Data area	Address range		Data area	CPU address
01	Read bits	Output	1	to	8192	Process image output Q0.0 to Q1023.7
02	Read bits	Input	10001	to	18192	Process image input I0.0 to I1023.7
04	Read words	Input	30001	to	30512	Process image input IW0 to IW1022
05	Write bit	Output	1	to	8192	Process image output Q0.0 to Q1023.7
15	Write bits	Output	1	to	8192	Process image output Q0.0 to Q1023.7

Modbus communication function codes (function codes 3, 6, 16) use a separate holding register. To do this, you can use bit memory or a data block with the "Standard - compatible with S7-300/400" access type.

You specify the type of the holding register using the MB\_HOLD\_REG parameter of the MB\_SLAVE instruction. The following table shows the mapping of the Modbus holding register to the DB address of MB\_HOLD\_REG in the target system.

Modbus functions of "MB_SLAVE"				S7-1200	
Codes	Function	Data area	Address range (WORD number)	Address in the DB (BYTE number)	Bit memory address (BYTE number)
03	Read words	Holding register	40001 to 49999 or	DW0 to DW19998 or	MW0 to CPU limit
			400001 to 465535	DW0 to DW131068	
06	Write word	Holding register	40001 to 49999 or	DW0 to DW19998 or	
			400001 to 465535	DW0 to DW131068	
16	Write words	Holding register	40001 to 49999 or	DW0 to DW19998 or	
			400001 to 465535	DW0 to DW131068	

The table below shows the supported Modbus diagnostic functions.

S7-1200 "MB_SLAVE" Modbus diagnostic functions		
Codes	Subfunction	Description
08	0000H	Return query data echo test: The "MB_SLAVE" instruction returns the echo of a received data word to a Modbus master.
08	000AH	Clear communication event counter: The "MB_SLAVE" instruction clears the communication event counter that is used for Modbus function 11.
11	-	Get communication event counter: The "MB_SLAVE" instruction uses an internal communication event counter for recording the number of successful Modbus read and write requests that are sent to the Modbus slave. The counter is not incremented on any Function 8, Function 11, or broadcast requests. It is also not incremented on any requests that result in a communication error (for example, parity or CRC errors).

The "MB\_SLAVE" instruction supports broadcast write requests from Modbus masters as long as the requests include access to valid addresses.

Regardless of the validity of a request, "MB\_SLAVE" gives no response to a Modbus master as the result of a broadcast request.

### Rules of Modbus slave communication

- "MB\_COMM\_LOAD" must be executed to configure a port, before the "MB\_SLAVE" instruction can communicate with this port.
- If a port is to respond as a slave to a Modbus master, then that port cannot be used by "MB\_MASTER (Page 2777)". Only one instance of "MB\_SLAVE" can be used with a given port.
- The Modbus instructions do not use communication interrupt events to control the communication process. Your program must control the communication process by polling the "MB\_SLAVE" instruction for completed send and receive operations.
- The "MB\_SLAVE" instruction must be executed periodically at a rate that allows it to make a timely response to incoming requests from a Modbus master. It is therefore advisable to call the instruction in a cyclic program OB. Calling the "MB\_SLAVE" instruction in an interrupt OB is possible but not advisable since it can lead to long delays in execution.

### Frequency of execution of "MB\_SLAVE"

The "MB\_SLAVE" instruction must be executed periodically to receive each request from the Modbus master and to respond as required. The frequency of execution of "MB\_SLAVE" is dependent upon the specified response timeout period of the Modbus master. This is illustrated in the following diagram.

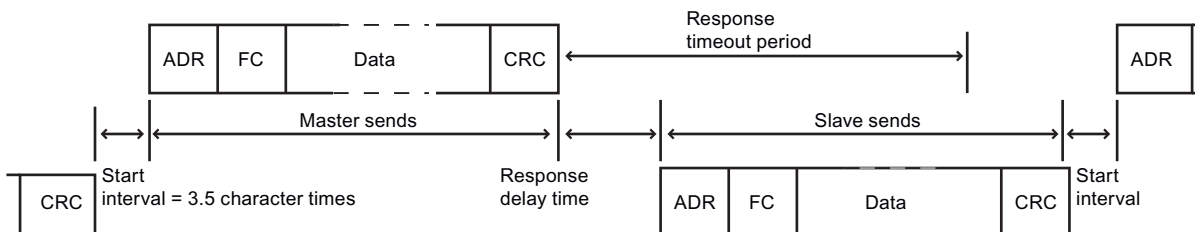

The response timeout period is the amount of time a Modbus master waits for the start of a response from a Modbus slave. This time period is not defined by the Modbus protocol, but rather by a parameter of each Modbus master. The frequency of execution (time between one execution and the next execution) of "MB\_SLAVE" must be based on the particular parameters of your Modbus master. As a minimum, you should execute "MB\_SLAVE" twice within the response timeout period of the Modbus master.

## Parameters

The following table shows the parameters of the "MB\_SLAVE" instruction:

Parameter	Declaration	Data type	Memory area	Description
MB_ADDR	Input	UINT	I, Q, M, D, L or constant	Station address of the Modbus slave <ul style="list-style-type: none"> <li>• Default address range: 0 to 247</li> <li>• Extended address range: 0 to 65535</li> </ul>
MB_HOLD_REG	Input	VARIANT	D	Pointer to the Modbus holding register DB. The DB must be created with the "Standard - compatible with S7-300/400" access type.
NDR	Output	BOOL	I, Q, M, D, L	New data ready: <ul style="list-style-type: none"> <li>• 0: No new data</li> <li>• 1: Indicates that new data has been written by the Modbus master</li> </ul>
DR	Output	BOOL	I, Q, M, D, L	Read data: <ul style="list-style-type: none"> <li>• 0: No data read</li> <li>• 1: Indicates that data has been read by the Modbus master</li> </ul>
ERROR	Output	BOOL	I, Q, M, D, L	<ul style="list-style-type: none"> <li>• 0: No error detected</li> <li>• 1: Error, a corresponding error code is output in the STATUS</li> </ul>
STATUS	Output	WORD	I, Q, M, D, L	Error code

You will find more detailed information on valid data types in "Overview of the valid data types (Page 1077)".

## STATUS parameter

STATUS* (W#16#...)	Description
80C8	The specified response timeout (refer to RCVTIME or MSGTIME) is "0".
80D1	The receiver issued a flow control request to suspend an active transmission and never re-enabled the transmission within the wait time. This error is also generated during hardware flow control if the recipient does not detect CTS within the wait time.
80D2	The send request was aborted because no DSR signal is received from the DCE.

9.7 References

STATUS* (W#16#....)	Description	
80E0	The message was terminated because the receive buffer is full	
80E1	The message was terminated as a result of a parity error	
80E2	The message was terminated as a result of a message frame error	
80E3	The message was terminated as a result of an overrun error	
80E4	The message was terminated as a result of the specified length exceeding the total buffer size	
8180	Invalid value for the port ID.	
8186	Invalid Modbus station address	
8187	Invalid pointer to MB_HOLD_REG-DB	
818C	Pointer to a type safe DB type MB_HOLD_REG (must be a Classic DB type)	
Response code sent to Modbus master (B#16#...)		
8380	No response	CRC error
8381	01	Function code not supported or not supported in a broadcast
8382	03	Data length error
8383	02	Error in the data address or address outside the valid range of MB_HOLD_REG
8384	03	Data value error
8385	03	Data diagnostic code value not supported (function code 08)
* The error codes can be displayed as integer or hexadecimal values in the program editor. For additional information on toggling display formats, refer to "See also".		

Instance DB of the "MB\_SLAVE" instruction

Static variables of the instance DB

The following table describes the static variables of the instance DB of the instruction that you can use in the user program. Your program can write values to the HR\_Start\_Offset and Extended\_Addressing variables and control the Modbus slave operations.

The other variables can be read to monitor the Modbus status.

Variable	Data type	Description
HR_Start_Offset	WORD	Start address of the Modbus holding register (default = " 0")
Extended_Addressing	BOOL	Configuring addressing: <ul style="list-style-type: none"> <li>• 0: Default address area (1 byte)</li> <li>• 1: Extended address area (2 bytes)</li> </ul>
Request_Count	WORD	Total number of queries received by the slave
Slave_Message_Count	WORD	Number of queries sent to this specific slave
Bad_CRC_Count	WORD	Number of received queries with CRC errors
Broadcast_Count	WORD	Number of received broadcast queries

Variable	Data type	Description
Exception_Count	WORD	Number of Modbus-specific errors that require the return of an exception
Success_Count	WORD	The number of requests received for this specific slave without protocol errors

## HR\_Start\_Offset

The addresses of the Modbus holding register start at 40001 or 400001. These addresses correspond to the start address of the holding register in the target system memory. Using the HR\_Start\_Offset variable, you can set the offset to a different start address.

Example: A holding register starts at MW 100 and has a length of 100 WORD. With an offset of 20 in the HR\_Start\_Offset parameter, the holding register begins at address 40021 instead of 40001. Each address below 40021 and above 400119 causes an addressing error.

	HR_Start_Offset = 0		HR_Start_Offset = 20	
	Modbus word address	S7-1200 byte address	Modbus word address	S7-1200 byte address
Minimum	40001	MW100	40021	MW100
Maximum	40099	MW198	40119	MW198

## Extended Addressing

To address the Modbus slave, a single byte (default address range) or a double byte (extended address range) can be configured. Extended addressing is used to address more than 247 devices in a single network. If you decide on extended addressing, you can address a maximum of 64,000 addresses. Below, you will see a frame of Modbus function 1 as an example.

Table 9-122 Slave address with one byte (byte 0)

Function 1	Byte 0	Byte 1	Byte 2	Byte 3	Byte 4	Byte 5	
Request	Slave address	F code	Start address		Length of the coils		
Valid response	Slave address	F code	Length	Coil data			
Error response	Slave address	0x81	E code				

Table 9-123 Slave address with two bytes (byte 0 and byte 1)

Function 1	Byte 0	Byte 1	Byte 2	Byte 3	Byte 4	Byte 5	Byte 6
Request	Slave address		F code	Start address		Length of the coils	
Valid response	Slave address		F code	Length	Coil data		
Error response	Slave address		0x81	F code			

Sample program for a Modbus slave

Networks (LAD)

**Network 1:** Initialize parameters of the RS-485 module only once during the first cycle.

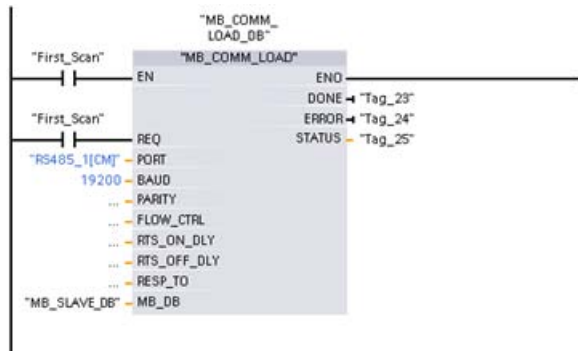

**Network 2:** Check the requests of the Modbus master in every cycle. 100 words starting at MW1000 are configured for the Modbus holding register.

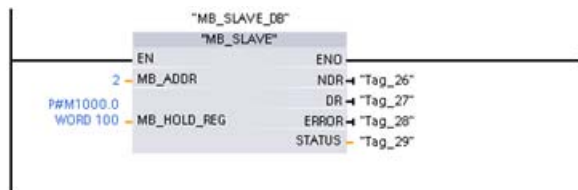

MODBUS (TCP)

MODBUS (TCP)

MB\_CLIENT: Communicating via PROFINET as a Modbus TCP client

Description of MB\_CLIENT

Description

The "MB\_CLIENT" instruction communicates as a Modbus TCP client via the PROFINET connection of the S7-1200 CPU. To use the instruction, you do not require any additional hardware module. With the "MB\_CLIENT" instruction, you establish a connection between the client and the server, send requests and receive responses and control connection termination of the Modbus TCP server.

## Parameters

The following table shows the parameters of the "MB\_CLIENT" instruction:

Parameter	Declaration	Data type	Description
REQ (Page 2793)	Input	BOOL	Communications request to the Modbus TCP server on a rising edge. The instance DB for other clients is blocked with the communications request. Changes to the input parameters will not become effective until the server has responded or an error message has been output. If the parameter REQ is set again during an ongoing request, no additional transmission takes place afterwards.
DISCONNECT (Page 2793)	Input	BOOL	With this parameter, you control the establishment and termination of the connection to the Modbus server: <ul style="list-style-type: none"> <li>• 0: Establish a communications connection to the specified IP address and port number.</li> <li>• 1: Disconnect the communications connection. No other function is executed during connection termination. The value 7003 is output at the STATUS parameter after successful connection termination.</li> </ul> The request is sent immediately if the REQ parameter is set during connection establishment.
CONNECT_ID	Input	UINT	Unique ID to identify the connection. Each instance of the instructions "MB_CLIENT" and "MB_SERVER (Page 2798)" must be assigned a unique connection ID.
IP_OCTET_1	Input	USINT	1. Octet of the IP address* of the Modbus TCP server.
IP_OCTET_2	Input	USINT	2. Octet of the IP address* of the Modbus TCP server.
IP_OCTET_3	Input	USINT	3. Octet of the IP address* of the Modbus TCP server.
IP_OCTET_4	Input	USINT	4. Octet of the IP address* of the Modbus TCP server.
IP_PORT	Input	UINT	IP port number of the server to which the client establishes the connection and communicates using the TCP/IP protocol (default value: 502).
MB_MODE (Page 2794)	Input	USINT	Selects the mode of the request (read, write or diagnostics).
MB_DATA_ADDR (Page 2794)	Input	UDINT	Start address of the data accessed by the "MB_CLIENT" instruction.
DATA_LEN	Input	UINT	Data length: Number of bits or words for the data access (see "MB_MODE and MB_DATA_ADDR parameters" - data length).
MB_DATA_PTR (Page 2795)	InOut	VARIANT	Pointer to the Modbus data register: The register is a buffer for the data received from the Modbus server or to be sent to the Modbus server. The pointer must reference a global data block with standard access. The number of bits addressed must be divisible by 8.
DONE	Out	BOOL	The bit at output parameter DONE is set to "1" as soon as the last job is completed without errors.
BUSY	Out	BOOL	<ul style="list-style-type: none"> <li>• 0: No "MB_CLIENT " job in progress</li> <li>• 1: "MB_CLIENT " job in progress</li> </ul>

Parameter	Declaration	Data type	Description
ERROR	Out	BOOL	<ul style="list-style-type: none"> <li>• 0: No error</li> <li>• 1: Error occurred. The cause of error is indicated by the STATUS parameter.</li> </ul>
STATUS (Page 2796)	Out	WORD	Error code of the instruction.
* 8-bit long component of the 32-bit IPv4 IP address of the Modbus TCP server.			

For additional information on valid data types, refer to "Overview of the valid data types (Page 1077)".

**Note**

**Consistent input data during an "MB\_CLIENT" call**

When a Modbus client calls a Modbus instruction, the status of the input parameters is stored internally and then compared at the next call. The comparison is used to determine whether this particular call initialized the current request. Several "MB\_CLIENT" calls can be executed if you use a common instance DB. The values of the input parameters must not be changed while an "MB\_CLIENT" instance is being executed. If the input parameters are changed during execution, "MB\_CLIENT" cannot be used to check whether or not the instance is currently being executed.

**Multiple client connections**

A Modbus TCP client can support several TCP connections and the maximum number of connections depends on the CPU being used. The total number of connections of one CPU, including those of the Modbus TCP clients and server must not exceed the maximum number of supported connections. Modbus TCP connections can also be shared by client and/or server connections.

With individual client connections, remember the following rules:

- Each "MB\_CLIENT" connection must use a unique instance DB.
- For each "MB\_CLIENT" connection, a unique server IP address must be specified.
- Each "MB\_CLIENT" connection requires a unique connection ID.  
The relevant individual connection ID must be used for each individual instance DB of the instruction. The connection ID and instance DB belong together in pairs and must be unique for each connection.
- Unique numbers for the IP port may or may not be required depending on the server configuration.



## Static tags of the instruction

The following table describes the editable static tags of the instance data block of the "MB\_CLIENT" instruction.

Tag	Data type	Start value	Description
Blocked_Proc_Timeout	REAL	3.0	Wait time in seconds before the static tag ACTIVE is reset if there is a blocked Modbus instance. This can, for example, occur if a client request is output and the execution of the client function aborts before the request was fully executed. The maximum wait time is 55 seconds.
MB_Transaction_ID	WORD	1	Transaction ID of the Modbus TCP protocol. The start value of "1" should only be changed if the Modbus TCP server requires a different value.
MB_Unit_ID	WORD	65535	Unit ID of the Modbus protocol. The tag corresponds to the slave address of the Modbus RTU protocol. Change this value only if the Modbus TCP server can be used as a gateway and is controlled by the application program within the Modbus server.
RCV_TIMEOUT	REAL	2.0	Time interval in seconds in which the "MB_CLIENT" instruction waits for a response from the server.
Connected	BOOL	0	Indicates whether the connection to the assigned client has been established or not: 1 = connected, 0 = not connected.

## See also

MB\_CLIENT example 1: Send several requests via a TCP connection (Page 2804)

MB\_CLIENT example 2: Send multiple requests via several TCP connections (Page 2805)

MB\_CLIENT example 3: Coordinate several requests (Page 2806)

## REQ and DISCONNECT parameters

### Description

If no instance of the "MB\_CLIENT" instruction is executing and if the value of the DISCONNECT parameter is "0", a new job executes on a rising edge of the REQ parameter. If there is not yet a connection, this is established during execution.

If the same instance of the "MB\_CLIENT" instruction executes again (DISCONNECT = 0 and REQ = 1), before the active job was executed, this is not executed on completion of the active job. A new job can only be started on completion of the active job (REQ = 1).

You can monitor the status of execution with the DONE parameter. You can use this to monitor the status of execution if the "MB\_CLIENT" instruction is executed sequentially.

## See also

Description of MB\_CLIENT (Page 2790)

### MB\_MODE and MB\_DATA\_ADDR parameters

#### Description

Instead of a function code, the "MB\_CLIENT" instruction uses the MB\_MODE parameter. The MB\_DATA\_ADDR parameter is used to specify the Modbus start address of the data you want to access. The combination of the parameters MB\_MODE and MB\_DATA\_ADDR defines the function code used in the current Modbus message.

The following table shows the relationship between the MB\_MODE parameter, the Modbus function and the address space.

MB_MODE	Modbus function	Data length	Function and data type	MB_DATA_ADDR
0	01	1 to 2000	Read output bits: 1 to 2000 bits per call	1 to 9999
0	02	1 to 2000	Read input bits: 1 to 2000 bits per call	10001 to 19999
0	03	1 to 125	Read holding register: 1 to 125 WORD per call	40001 to 49999
0	04	1 to 125	Read input words: 1 to 125 WORD per call	30001 to 39999
1	05	1	Write an output bit: One bit per call	1 to 9999
1	06	1	Write a holding register: 1 WORD per call	40001 to 49999
1	15	2 to 1968	Write multiple output bits: 2 to 1968 bits per call	1 to 9999
1	16	2 to 123	Write several holding registers: 2 to 123 WORD per call	40001 to 49999
2	15	1 to 1968	Write one or more output bits: 1 to 1968 bits per call	1 to 9999
2	16	1 to 123	Write one or more holding registers: 1 to 123 WORD per call	40001 to 49999
11	11	0	Read status word and event counter of server communication: <ul style="list-style-type: none"> <li>The status word reflects the the processing status (0 - not processing, 0xFFFF - processing).</li> <li>The event counter is incremented each time a message is sent successfully.</li> </ul> The MB_DATA_ADDR and MB_DATA_LEN parameters of the "MB_CLIENT" instruction are not evaluated when this function executes.	-
80	08	1	Check the server status with the error code 0x0000 (return loop test - the server sends the request back): 1 WORD per call	-

MB_MODE	Modbus function	Data length	Function and data type	MB_DATA_ADDR
81	08	1	Reset the event counter of the server with the error code 0x000A: 1 WORD per call	
3 to 10, 12 to 79, 82 to 255			Reserved	

## See also

Description of MB\_CLIENT (Page 2790)

## MB\_DATA\_PTR parameter

### Description

The MB\_DATA\_PTR parameter is a pointer to a data buffer for storing the data read from or written to the Modbus server. As the data buffer, you can use a global data block or a memory area (M).

For a buffer in the memory area (M), use a pointer in the ANY format as follows: "P#bit address" "data type" "length" (example: P#M1000.0 WORD 500).

The MB\_DATA\_PTR parameter uses a communications buffer:

- For the communication functions of the "MB\_CLIENT" instruction:
  - Reading and writing of 1 bit of data of the Modbus server addresses 00001 to 09999 and 10001 to 19999.
  - Reading of 16-bit WORD data of the Modbus server addresses 30001 to 39999 and 40001 to 49999.
  - Writing 16-bit WORD data of the Modbus server addresses 40001 to 49999.
- During data transmission (length: bit or WORD) from or to the global DB or the memory area (M) that you assigned with the MB\_DATA\_PTR parameter.

If you use a data block for the buffer in the MB\_DATA\_PTR parameter, you will need to assign data types to the DB elements.

- Use the 1-bit data type BOOL for a Modbus bit address
- Use a 16-bit data type such as WORD, UINT, INT or REAL for a Modbus WORD address.
- Use a 32-bit data type (double word) such as DWORD, DINT or REAL for two Modbus WORD addresses.

9.7 References

- With MB\_DATA\_PTR, you can also access complex DB elements such as:
  - Standard arrays
  - Structures with unique element names
  - Complex structures with unique naming of the elements and data type lengths of 16 or 32 bits.
- The data areas for the MB\_DATA\_PTR parameter can also be in different global data blocks (or in different memory areas). You can, for example, use a data block for the the read jobs and another one for the write jobs or a separate data block for each "MB\_CLIENT" station.

See also

Description of MB\_CLIENT (Page 2790)

Parameter STATUS

Parameter STATUS (general status information)

STATUS* (W#16#)	Description
0000	Instruction executed without errors.
0001	Connection established.
0003	Connection terminated.
7000	No call active (REQ=0).
7001	First call with REQ=1: Processing started; BUSY has the value 1.
7002	Intermediate call (REQ irrelevant). Processing already active; BUSY has the value 1.
7003	Connection is being terminated.
7004	Connection established and monitored. No job processing active.
7005	Data was sent.
7006	Data was received.
80BB	Invalid value at ACTIVE_EST parameter (identifier for the type of connection establishment, see T_CON_PARAM): <ul style="list-style-type: none"> <li>• Only passive connection establishment permitted for server (ACTIVE_EST = FALSE).</li> <li>• Only active connection establishment permitted for client (ACTIVE_EST = TRUE).</li> </ul>
8380	Received Modbus frame has incorrect format or too few bytes were received.
* The error codes can be displayed as integer or hexadecimal values in the program editor. For additional information on toggling display formats, refer to "See also".	

**Parameter STATUS (protocol error)**

STATUS* (W#16#)	Code of the response to the Modbus client (B#16#)	Description
8381	01	Function code is not supported.
8382	03	Error in data length.
8383	02	Error in the data address or access outside the address area of MB_DATA_PTR (Page 2795).
8384	03	Error in data value.
8385	03	Error codes of diagnostics not supported (function code 08).

\* The error codes can be displayed as integer or hexadecimal values in the program editor. For additional information on toggling display formats, refer to "See also".

**Parameter STATUS (parameter error)**

In addition to the errors listed in the following table, errors are also possible with the "MB\_CLIENT" instruction caused by the communications instructions ("TCON", "TDISCON", "TSEND" and "TRCV").

STATUS* (W#16#)	Description
80C8	No response of the server in the defined period. Check the connection to the Modbus server. This error is only reported on completion of the configured repeated attempts. If the "MB_CLIENT" instruction does not receive an answer with the originally transferred transaction ID (MB_TRANSACTION_ID tag) within the defined period, this error code is output.
8188	The MB_MODE parameter has an invalid value.
8189	Invalid addressing of data at the MB_DATA_ADDR parameter.
818A	Invalid data length at the MB_DATA_LEN parameter.
818B	The MB_DATA_PTR parameter has an invalid pointer. You should also check the values of the MB_DATA_ADDR (Page 2794) and MB_DATA_LEN parameters.
818C	<ul style="list-style-type: none"> <li>The MB_DATA_PTR (Page 2795) pointer references an optimized data block. Either use a data block with standard access or a memory area</li> <li>Timeout at parameter BLOCKED_PROC_TIMEOUT (see static tags of instruction). The limit of 55 seconds has been exceeded.</li> </ul>
818D	The transaction ID (MB_TRANSACTION_ID tag) does not correspond to the one sent originally (see static tags of instruction).
8200	<ul style="list-style-type: none"> <li>A further Modbus request is currently being processed via the port.</li> <li>Another instance of MB_CLIENT with the same connection parameters is processing an existing Modbus request.</li> </ul>
8380	Received block of transferred Modbus data is not well-formed or too few bytes were received.
8386	Received function code does not match the one sent originally.
8387	<ul style="list-style-type: none"> <li>The assigned connection ID is different from that used for previous requests. Only one connection ID can be used for each instance DB of the "MB_CLIENT" instruction.</li> <li>The error code is also output when the ID of the Modbus TCP protocol received by the server is not "0".</li> </ul>

STATUS* (W#16#)	Description
8388	The Modbus server sent a different data length than was requested. This error occurs only when using the Modbus functions 15 or 16.
* The error codes can be displayed as integer or hexadecimal values in the program editor. For additional information on toggling display formats, refer to "See also".	

---

**Note**

**Error codes of internally used communications instructions.**

With the "MB\_CLIENT" instruction, in addition to the errors listed in the tables, errors caused by the communication instructions ("TCON", "TDISCON", "TSEND" and "TRCV") used by the instruction can occur.

The error codes are assigned via the instance data block of the "MB\_CLIENT" instruction. The error codes are displayed for the respective instruction under STATUS in the Static section.

The meaning of the error codes is available in the documentation of the corresponding communications instruction.

---

**See also**

Description of MB\_CLIENT (Page 2790)

MB\_HOLD\_REG parameter (Page 2802)

**MB\_SERVER: Communicating via PROFINET as a Modbus TCP server**

**Description of MB\_SERVER**

**Description**

The "MB\_SERVER" instruction communicates as a Modbus TCP server via the PROFINET connection of the S7-1200 CPU. To use the instruction, you do not require any additional hardware module. The "MB\_SERVER" instruction processes connection requests of a Modbus TCP client, receives requests from Modbus functions and sends responses.

## Parameters

The following table shows the parameters of the "MB\_SERVER" instruction:

Parameter	Declaration	Data type	Description
DISCONNECT	Input	BOOL	The instruction "MB_SERVER" enters into a passive connection with a partner module, which means the server responds to a TCP connection request from each requesting IP address. You can use this parameter to control when a connection request is accepted: <ul style="list-style-type: none"> <li>• 0: A passive connection is established when there is no communications connection.</li> <li>• 1: Initialization of the connection termination. If the input is set, no other operations are executed. The value 7003 is output at the STATUS parameter after successful connection termination.</li> </ul>
CONNECT_ID	Input	UINT	The parameter uniquely identifies a connection within the CPU. Each individual instance of the instructions "MB_CLIENT (Page 2790)" and "MB_SERVER" must have a unique CONNECT_ID parameter.
IP_PORT	Input	UINT	Start value = 502. The number of IP ports defines which IP port is monitored for connection requests of the Modbus client. The following TCP port numbers must not be used for the passive connection of the "MB_SERVER" instruction: 20, 21, 25, 80, 102, 123, 5001, 34962, 34963 and 34964.
MB_HOLD_REG (Page 2802)	InOut	VARIANT	Pointer to the Modbus holding register of the "MB_SERVER" instruction: Use a global data block with standard access as holding register. The holding register contains the values that may be accessed by a Modbus client using the Modbus functions 3 (read), 6 (write) and 16 (read).
NDR	Output	BOOL	"New Data Ready": <ul style="list-style-type: none"> <li>• 0: No new data</li> <li>• 1: New data written by the Modbus client written</li> </ul>
DR	Output	BOOL	"Data Read": <ul style="list-style-type: none"> <li>• 0: No data read</li> <li>• 1: Data read by the Modbus client</li> </ul>
ERROR	Output	BOOL	If an error occurs during the call of the "MB_SERVER" instruction, the output of the ERROR parameter is set to TRUE. Detailed information about the cause of the problem is indicated by the STATUS parameter.
STATUS (Page 2803)	Output	WORD	Error code of the instruction.

For additional information on valid data types, refer to "Overview of the valid data types (Page 1077)".

## Mapping of Modbus addresses to the process image

The "MB\_SERVER" instruction allows incoming Modbus functions (1, 2, 4, 5 and 15) direct read and write access to the process image input and output of the S7-1200 CPU (use of the data types BOOL and WORD).

For the data transfer of the function codes 3, 6 and 16, the holding register (MB\_HOLD\_REG parameter) must be defined longer than one byte. The following table shows the mapping of the Modbus addresses to the process image of the CPU.

Modbus function						S7-1200	
Code	Function	Data area	Address space			Data area	CPU address
01	Read: Bits	Output	1	to	8192	Process image output	Q0.0 to Q1023.7
02	Read: Bits	Input	10001	to	18192	Process image input	I0.0 to I1023.7
04	Read: WORD	Input	30001	to	30512	Process image input	IW0 to IW1022
05	Write: Bits	Output	1	to	8192	Process image output	Q0.0 to Q1023.7
15	Write: Bits	Output	1	to	8192	Process image output	Q0.0 to Q1023.7

Incoming Modbus messages with the function codes 3, 6 and 16 write to or read from the Modbus holding registers (you specify the holding registers with the MB\_HOLD\_REG parameter).

### Multiple server connections

You can create multiple Server connections. This allows a single CPU to establish connections to more than one Modbus TCP client at the same time.

A Modbus TCP server can support several TCP connections and the maximum number of connections depends on the CPU being used.

The total number of connections of one CPU, including those of the Modbus TCP clients and server must not exceed the maximum number of supported connections.

Modbus TCP connections can also be shared by client and/or server connections.

In the case of Server connections, remember the following rules:

- Each "MB\_SERVER" connection must use a unique instance DB.
- Each "MB\_SERVER" connection must be created with a unique IP port number. Only one connection is supported for each port.
- Each "MB\_SERVER" connection must use a unique connection ID.  
The relevant individual connection ID must be used for each individual instance DB of the instruction. The connection ID and instance DB belong together in pairs and must be unique for each connection.
- For each connection, the "MB\_SERVER" instruction must be called individually.



## Modbus diagnostics functions

The table below contains a description of the Modbus diagnostics functions.

Code	Subfunction	Description
08	0x0000	Echo test: The "MB_SERVER" instruction receives a data word and returns this unchanged to the Modbus master.
08	0x000A	Reset event counter: The "MB_SERVER" instruction resets the event counter for communication that is used for Modbus function 11.
11	-	Fetch event counter of the communication: The "MB_SERVER" instruction uses an internal event counter for communication to record the number of successfully executed read and write requests sent to the Modbus server.  The event counter is not incremented by the functions 8, 11 or broadcast requests. The same applies to requests that result in a communications error (for example parity errors or CRC errors). The broadcast function is not available for Modbus TCP because only one client/server connection can exist at any one time.

## Static tags of the instruction

The following table describes the static tags of the instance data block of the "MB\_SERVER" instruction used in the program. You can write the HR\_Start\_Offset tag. You can read the other tags to monitor the Modbus status.

Tag	Data type	Start value	Description
HR_Start_Offset	WORD	0	Assign the start address of the Modbus holding register.
Request_Count	WORD	0	Total number of requests received by the server.
Server_Message_Count	WORD	0	Total number of received messages for the relevant Server.
Xmt_Rcv_Count	WORD	0	Counter for detecting the number of transfers during which an error occurred. The counter is also incremented if an invalid Modbus message is received.
Exception_Count	WORD	0	Counter for detecting the number of errors specifically for Modbus cause an exception.
Success_Count	WORD	0	Counter for detecting the number of requests that contain no error in the transferred protocol.
Connected	BOOL	0	Indicates whether the connection to the assigned client has been established or not: 1 = connected, 0 = not connected.

## Example: Addressing via static tag HR\_Start\_Offset

The addresses of the Modbus holding register start at 40001. These addresses correspond to the address space of the CPU memory area for the holding register. You can also define the HR\_Start\_Offset tag so that the Modbus holding register has a start address other than 40001.

Example: The holding register begins at MW100, and has a length of 100 WORD. An offset value in the HR\_Start\_Offset parameter means that the start address of the holding register is moved from 40001 to 40021. Whenever the holding register is addressed below the address 40021 and above the address 40119, this causes an error.

HR_Start_Offset	Address	Minimum	Maximum
0	Modbus address (WORD)	40001	40099
	S7-1200 address	MW100	MW298
20	Modbus address (WORD)	40021	40119
	S7-1200 address	MW100	MW298

**See also**

MB\_SERVER example: Multiple TCP connections (Page 2807)

**MB\_HOLD\_REG parameter**

**Description**

The MB\_HOLD\_REG parameter is a pointer to a data buffer for storing the data read from or written to the Modbus server. As the data buffer, you can use a global data block or a memory area (M).

As pointer to a buffer in the memory area (M), use the ANY format as follows: "P#bit address" "data type" "length" (example: P#M1000.0 WORD 500).

The following table shows examples of mapping Modbus addresses to the holding register for the Modbus functions 3 (read WORD), 6 (write WORD) and 16 (write several WORD). The upper limit for the number of addresses in the data block is decided by the maximum work memory of the CPU. If you use a memory area, the upper limit for the addresses is decided by the size of the memory area of the CPU.

Modbus addresses	MB_HOLD_REG parameter - examples		
P#M100.0 WORD 5	P#DB10.DBx0.0 WORD 5	"Recipe".ingredient	
40001	MW100	DB10.DBW0	"Recipe".ingredient[1]
40002	MW102	DB10.DBW2	"Recipe".ingredient[2]
40003	MW104	DB10.DBW4	"Recipe".ingredient[3]
40004	MW106	DB10.DBW6	"Recipe".ingredient[4]
40005	MW108	DB10.DBW8	"Recipe".ingredient[5]

**See also**

Description of MB\_SERVER (Page 2798)

## Parameter STATUS

### Parameter STATUS (general status information)

STATUS* (W#16#)	Description
0000	Instruction executed without errors.
0001	Connection established.
0003	Connection terminated.
7000	No call active (REQ=0).
7001	First call with REQ=1: Processing started; BUSY has the value 1.
7002	Intermediate call (REQ irrelevant). Processing already active; BUSY has the value 1.
7003	Connection is being terminated.
7004	Connection established and monitored. No job processing active.
7005	Data was sent.
7006	Data was received.
80BB	Invalid value at ACTIVE_EST parameter (identifier for the type of connection establishment, see T_CON_PARAM): <ul style="list-style-type: none"> <li>• Only passive connection establishment permitted for server (ACTIVE_EST = FALSE).</li> <li>• Only active connection establishment permitted for client (ACTIVE_EST = TRUE).</li> </ul>
8380	Received Modbus frame has incorrect format or too few bytes were received.
* The error codes can be displayed as integer or hexadecimal values in the program editor. For additional information on toggling display formats, refer to "See also".	

### Parameter STATUS (parameter error)

STATUS* (W#16#)	Code of the response to the Modbus server (B#16#)	Description
8187	No response	The MB_HOLD_REG parameter has an invalid pointer. Data area is too small.
818C	No response	<ul style="list-style-type: none"> <li>• The MB_HOLD_REG parameter references an an optimized data block. Either use a data block with standard access or a memory area</li> <li>• Error due to timeout of execution (more than 55 seconds).</li> </ul>
8381	01	Function code is not supported.
8382	03	Error in data length
8383	02	Error in data address or access outside the address area of the holding register (MB_HOLD_REG (Page 2802) parameter).
8384	03	Error in data value
8385	03	Value of the diagnostic code is not supported (only with function code 08).
* The error codes can be displayed as integer or hexadecimal values in the program editor. For additional information on toggling display formats, refer to "See also".		

---

**Note**

**Error codes of internally used communications instructions.**

With the "MB\_SERVER" instruction, in addition to the errors listed in the tables, errors caused by the communication instructions ("TCON", "TDISCON", "TSEND" and "TRCV") used by the instruction can occur.

The error codes are assigned via the instance data block of the "MB\_SERVER" instruction. The error codes are displayed for the respective instruction under STATUS in the Static section.

The meaning of the error codes is available in the documentation of the corresponding communications instruction.

---

**See also**

Description of MB\_SERVER (Page 2798)

**Examples**

**MB\_CLIENT example 1: Send several requests via a TCP connection**

**Description**

Several requests of the Modbus Client can be sent via a TCP connection. To do this, use the same instance DB, the same connection ID and the same port number.

Only one client can be active at any one time. After processing of a client has been completed, the next client is processed. The order of execution must be defined in the program.

In the following sample program, the value of the STATUS output parameter is also copied.

Network 1: Modbus function 1 - 16 read output bits

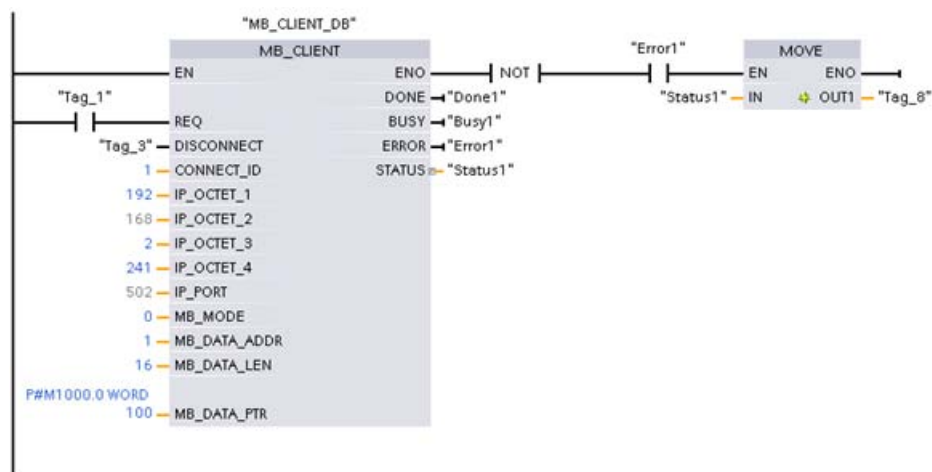

Network 2: Modbus function 2 - 32 read input bits

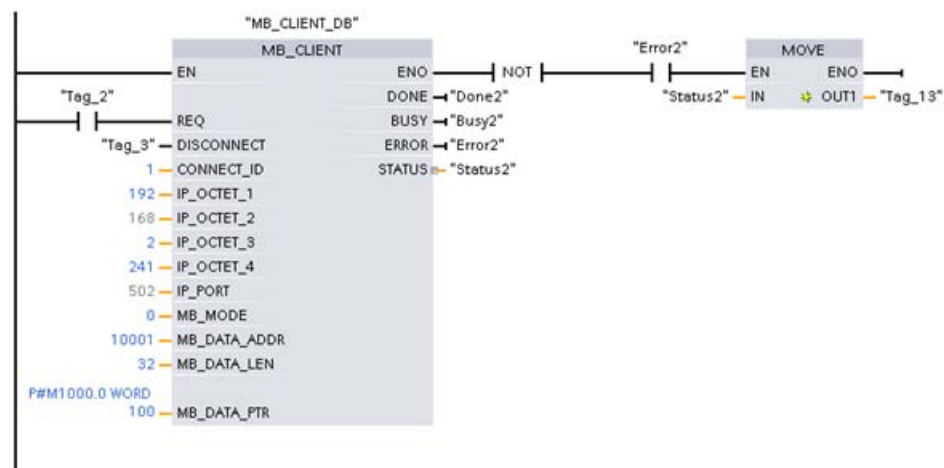

MB\_CLIENT example 2: Send multiple requests via several TCP connections

Description

Requests from the Modbus client can be sent via different TCP connections. If you require this, use a different instance DB and a different connection ID.

Use a different port number, if the connections are to the same Modbus server. If the connections are to different Modbus servers, you can freely assign the port number.

**Network 1: Modbus function 4 - read input (WORD)**

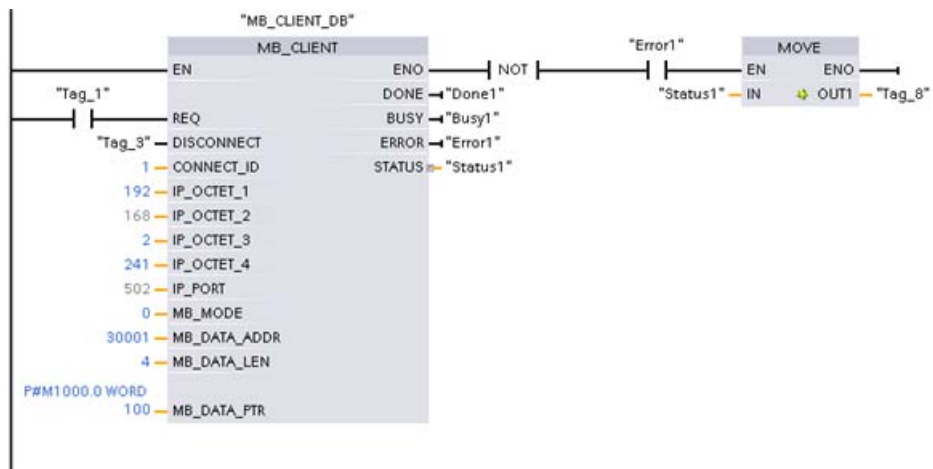

**Network 2: Modbus function 3 - read holding register (WORD)**

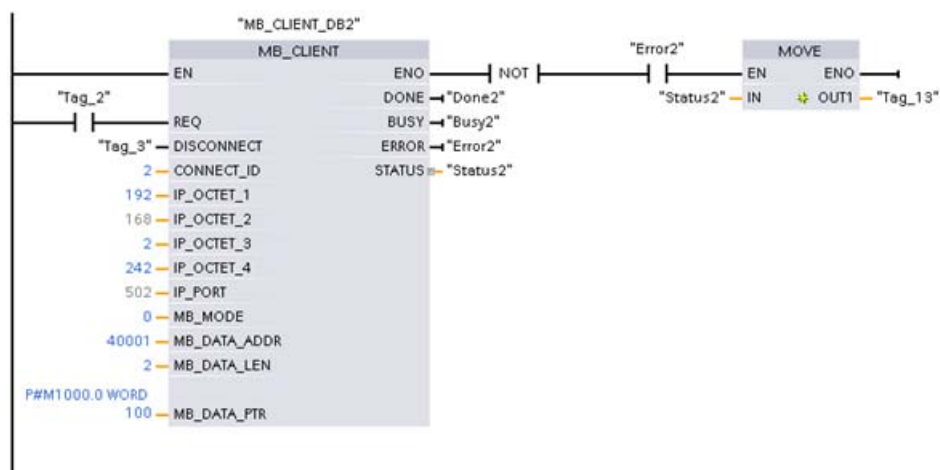

**MB\_CLIENT example 3: Coordinate several requests**

**Description**

Make sure that the individual Modbus requests are executed. You control coordination of requests with the program. The following example demonstrates how the output parameters of the first and second client request can be used to coordinate execution of the instructions.

## Network 1: Modbus function 3 - read holding register (WORD)

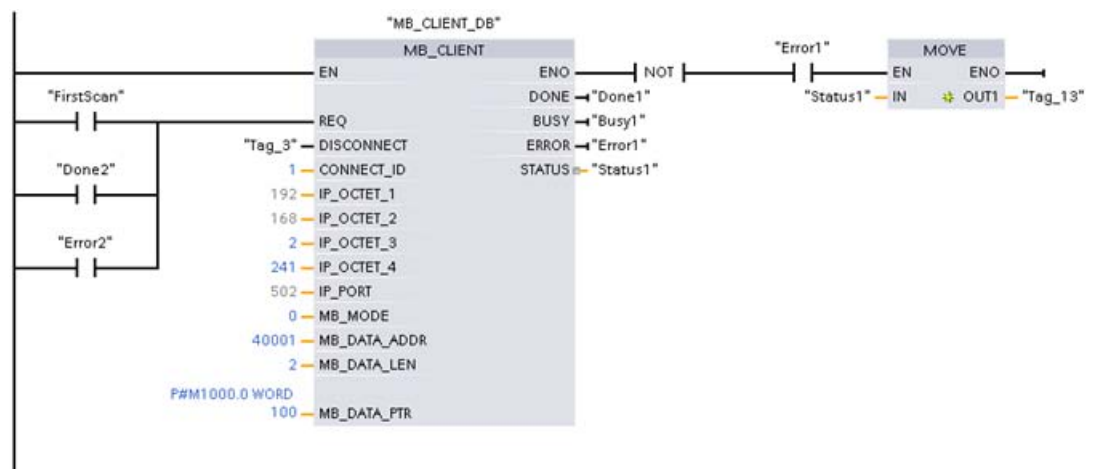

## Network 2: Modbus function 3 - read holding register (WORD)

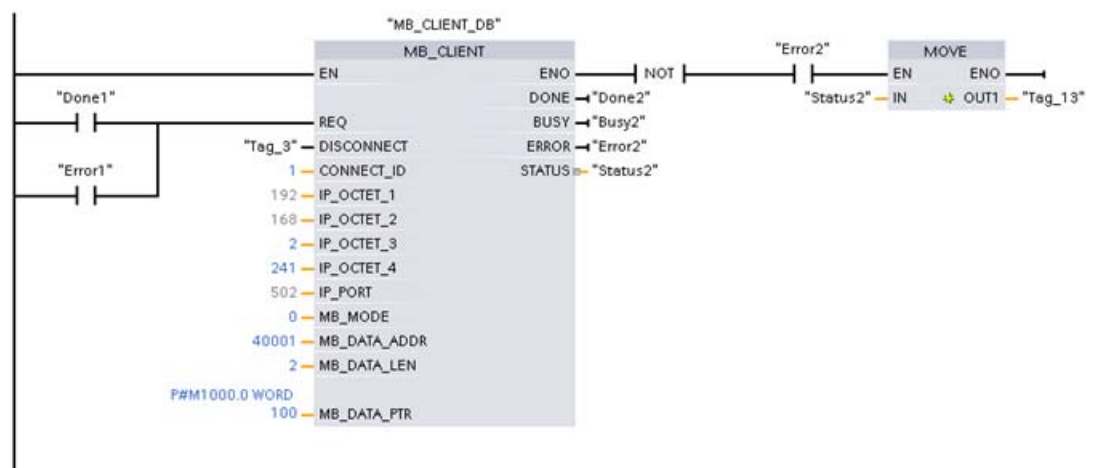

## MB\_SERVER example: Multiple TCP connections

## Description

You can use several Modbus TCP server connections. To do this, the "MB\_SERVER" instruction must be called independently for each connection.

Every connection requires the following:

- An independent instance data block of the instruction
- A unique connection ID
- A separate IP port (on the S7-1200, only one connection is permitted per IP port)

To optimize the performance "MB\_SERVER" should be executed once per program cycle for each connection.

**Network 1: Connection #1 with associated IP port connection ID and instance DB**

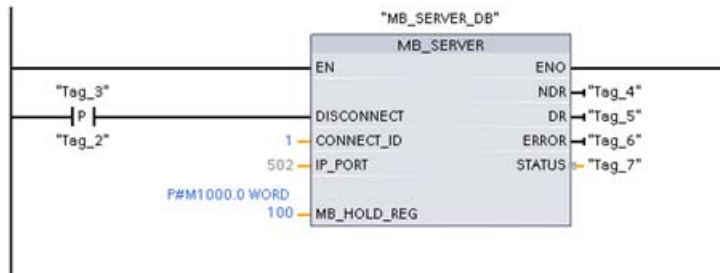

**Network 2: Connection #1 with associated IP port connection ID and instance DB**

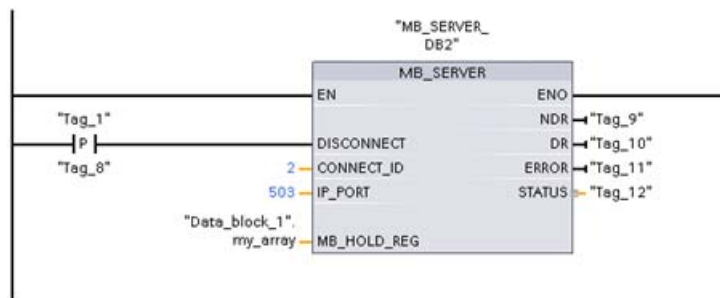

**MODBUS (TCP)**

**MB\_CLIENT: Communicating via PROFINET as a Modbus TCP client**

**Description of MB\_CLIENT**

**Description**

The "MB\_CLIENT" instruction communicates as a Modbus TCP client via the PROFINET connection. With the "MB\_CLIENT" instruction, you establish a connection between the client and the server, send Modbus requests and receive responses and control connection termination of the Modbus TCP client.

The "MB\_CLIENT" instruction V3.0 can be used for the S7-1500 as well as for the S7-1200 version 4.0 or higher. The connection can take place via the local interface of the CPU or CM/CP.

To use the instruction, you do not require an additional hardware module.



## Multiple client connections

A Modbus TCP client can support several TCP connections and the maximum number of connections depends on the CPU being used. The total number of connections of one CPU, including those of the Modbus TCP clients and server must not exceed the maximum number of supported connections. Modbus TCP connections can also be shared by "MB\_CLIENT" and/or "MB\_SERVER" instances.

With individual client connections, remember the following rules:

- Each "MB\_CLIENT" connection must use a unique instance DB.
- For each "MB\_CLIENT" connection, a unique server IP address must be specified.
- Each "MB\_CLIENT" connection requires a unique connection ID.  
The relevant individual connection ID must be used for each individual instance DB of the instruction. The connection ID and instance DB belong together in pairs and must be unique for each connection.
- Unique numbers for the IP port may or may not be required depending on the server configuration.

## Parameters

The following table shows the parameters of the "MB\_CLIENT" instruction:

Parameter	Declaration	Data type	Description
REQ (Page 2811)	Input	BOOL	Communications request to the Modbus TCP server on a rising edge. The instance DB for other clients is blocked with the communications request. Changes to the input parameters will not become effective until the server has responded or an error message has been output. If the parameter REQ is set again during an ongoing Modbus request, no additional transmission takes place afterwards.
DISCONNECT (Page 2811)	Input	BOOL	With this parameter, you control the establishment and termination of the connection to the Modbus server: <ul style="list-style-type: none"> <li>• 0: Establish communications connection to the connection partner configured at the CONNECT parameter (see CONNECT parameter).</li> <li>• 1: Disconnect the communications connection. No other function is executed during connection termination. The value 0003 is output at the STATUS parameter after successful connection termination.</li> </ul> The Modbus request is sent immediately if the REQ parameter is set during connection establishment.
MB_MODE (Page 2811)	Input	USINT	Selects the mode of the Modbus request (read, write or diagnostics).
MB_DATA_ADDR (Page 2811)	Input	UDINT	Start address of the data accessed by the "MB_CLIENT" instruction.
MB_DATA_LEN	Input	UINT	Data length: Number of bits or words for the data access (see "MB_MODE and MB_DATA_ADDR parameters" - data length).

Parameter	Declaration	Data type	Description
MB_DATA_PTR (Page 2813)	InOut	VARIANT	Pointer to the Modbus data register: The register is a buffer for the data received from the Modbus server or to be sent to the Modbus server. The pointer must reference a global data block with optimized access.  The number of bits addressed must be divisible by 8.
CONNECT (Page 2814)	InOut	VARIANT	Pointer to the structure of the connection description The following structures (SDTs) can be used: <ul style="list-style-type: none"> <li>• TCON_IP_v4: Includes all address parameters required for establishing a programmed connection. When using TCON_IP_v4, the connection is established when calling the instruction "MB_SERVER".</li> <li>• TCON_Configured: Includes the address parameters of a configured connection. When using TCON_Configured, an existing connection is used that was created by the CPU after download of the hardware configuration.</li> </ul>
DONE	Out	BOOL	The bit at output parameter DONE is set to "1" as soon as the last job is completed without errors.
BUSY	Out	BOOL	<ul style="list-style-type: none"> <li>• 0: No Modbus request in progress</li> <li>• 1: Modbus request being processed</li> </ul> The output parameter BUSY is not set during connection establishment and termination.
ERROR	Out	BOOL	<ul style="list-style-type: none"> <li>• 0: No error</li> <li>• 1: Error occurred. The cause of error is indicated by the STATUS parameter.</li> </ul>
STATUS (Page 2816)	Out	WORD	Detailed status information of the instruction.

For additional information on valid data types, refer to "Overview of the valid data types (Page 1077)".

**Note**

**Consistent input data during an "MB\_CLIENT" call**

When a Modbus client instruction is called, the status of the input parameters is stored internally and then compared at the next call. The comparison is used to determine whether this particular call initialized the current request. Several "MB\_CLIENT" calls can be executed if you use a common instance DB. The values of the input parameters must not be changed while an "MB\_CLIENT" instance is being executed. If the input parameters are changed during execution, "MB\_CLIENT" cannot be used to check whether or not the instance is currently being executed.

## Static tags of the instruction

The following table describes the editable static tags of the instance data block of the "MB\_CLIENT" instruction.

Tag	Data type	Start value	Description
Blocked_Proc_Timeout	REAL	3.0	Wait time in seconds before the static tag ACTIVE is reset if there is a blocked Modbus instance. This can, for example, occur if a client request is output and the execution of the client function aborts before the request was fully executed. The maximum wait time is 55 seconds.
MB_Transaction_ID	WORD	1	Transaction ID of the Modbus TCP protocol. The start value of "1" should only be changed if the Modbus TCP server requires a different value.
MB_Unit_ID	WORD	65535	Unit ID of the Modbus protocol. The tag corresponds to the slave address of the Modbus RTU protocol. Change this value only if the Modbus TCP server can be used as a gateway and is controlled by the application program within the Modbus server.
RCV_TIMEOUT	REAL	2.0	Time interval in seconds in which the "MB_CLIENT" instruction waits for a response from the server.
Connected	BOOL	0	Indicates whether the connection to the assigned server has been established or not: 1 = connected, 0 = not connected.

## REQ and DISCONNECT parameters

### Description

If no instance of the "MB\_CLIENT" instruction is executing and if the value of the DISCONNECT parameter is "0", a new job executes on a rising edge of the REQ parameter. If there is not yet a connection, this is established during execution.

If the same instance of the "MB\_CLIENT" instruction executes again (DISCONNECT = 0 and REQ = 1), before the active job was executed, this is not executed on completion of the active job. A new job can only be started on completion of the active job (REQ = 1).

The status of the execution is output by the output parameters. You can use it to monitor the execution status when the "MB\_CLIENT" instruction is executed sequentially.

## MB\_MODE and MB\_DATA\_ADDR parameters

### Description

Instead of a function code, the "MB\_CLIENT" instruction uses the MB\_MODE parameter. The MB\_DATA\_ADDR parameter is used to specify the Modbus start address of the data you want to access.

The combination of the parameters MB\_MODE, MB\_DATA\_ADDR and MB\_DATA\_LEN defines the function code used in the current Modbus message. For example:

9.7 References

- Function code 5
  - MB\_MODE=1
  - MB\_DATA\_ADDR=1
  - MB\_DATA\_LEN=1
- Function code 15
  - MB\_MODE=1
  - MB\_DATA\_ADDR=1
  - MB\_DATA\_LEN=2

The following table shows the relationship between the input parameters of the "MB\_CLIENT" instruction and the Modbus function.

MB_MODE	MB_DATA_ADDR	MB_DATA_LEN	Modbus function	Function and data type
0	Start address: • 1 to 9999	Data length (bits) per call: • 1 to 2000	01	Read input bits: • 1 to 2000
0	Start address: • 10001 to 19999	Data length (bits) per call: • 1 to 2000	02	Read input bits: • 1 to 2000
0	Start address: • 40001 to 49999 • 400001 to 465535	Data length (WORD) per call: • 1 to 125 • 1 to 125	03	Read holding register: • 0 to 9998 • 0 to 65534
0	Start address: • 30001 to 39999	Data length (WORD) per call: • 1 to 125	04	Read input words: • 0 to 9998
1	Start address: • 1 to 9999	Data length (bits) per call: • 1	05	Writing an output bit: • 0 to 9998
1	Start address: • 40001 to 49999 • 400001 to 465535	Data length (WORD) per call: • 1 • 1	06	Write a holding register: • 0 to 9998 • 0 to 65524
1	Start address: • 1 to 9999	Data length (bits) per call: • 2 to 1968	15	Write multiple output bits: • 0 to 9998
1	Start address: • 40001 to 49999 • 400001 to 465534	Data length (WORD) per call: • 2 to 123 • 2 to 123	16	Write multiple holding registers: • 0 to 9998 • 0 to 65534

MB_MODE	MB_DATA_A DDR	MB_DATA_L EN	Modbus function	Function and data type
2	Start address: • 1 to 9999	Data length (bits) per call: • 1 to 1968	15	Write one or more output bits: • 0 to 9998
2	Start address: • 40001 to 49999 • 400001 to 465535	Data length (WORD) per call: • 1 to 123 • 1 to 123	16	Write one or more holding registers: • 0 to 9998 • 0 to 65534
11	The MB_DATA_ADDR and MB_DATA_LEN parameters are not evaluated when this function is executed.		11	Read status word and event counter of the server: • The status word reflects the the processing status (0 - not processing, 0xFFFF - processing). • The event counter is incremented when the Modbus request was executed successfully. If an error occurred during execution of a Modbus function, a message is sent by the server but the event counter is not incremented.
80	-	Data length (WORD) per call: • 1	08	Check the server status with the diagnostic code 0x0000 (return loop test - the server sends the request back): • 1 WORD per call
81	-	Data length (WORD) per call: • 1	08	Reset the event counter of the server with the diagnostic code 0x000A: • 1 WORD per call
3 to 10, 12 to 79, 82 to 255				Reserved

## MB\_DATA\_PTR parameter

### Description

The MB\_DATA\_PTR parameter is a pointer to a data buffer for storing the data read from or written to the Modbus server. As the data buffer, you can use a global data block or a memory area (M).

For a buffer in the memory area (M), use a pointer in the ANY format as follows: "P#bit address" "data type" "length" (example: P#M1000.0 WORD 500).

The MB\_DATA\_PTR parameter uses a communications buffer:

The communications buffer is used:

- For the communication functions of the "MB\_CLIENT" instruction:
  - Reading and writing of 1 bit of data of the Modbus server addresses 00001 to 09999 and 10001 to 19999.
  - Reading of 16-bit WORD data of the Modbus server addresses 30001 to 39999 and 40001 to 49999.
  - Writing of 16-bit WORD data of the Modbus server addresses 40001 to 49999.
- During data transmission (length: bit or WORD) from or to the global DB or the memory area (M) that you assigned with the MB\_DATA\_PTR parameter.

If you use a data block for the buffer in the MB\_DATA\_PTR parameter, you will need to assign data types to the DB elements.

- Use the 1-bit data type BOOL for a Modbus bit address
- Use a 16-bit data type such as WORD, UINT, INT or REAL for a Modbus WORD address.
- Use a 32-bit data type (double word) such as DWORD, DINT or REAL for two Modbus WORD addresses.
- With MB\_DATA\_PTR, you can also access complex DB elements such as:
  - Standard arrays
  - Structures with unique element names
  - Complex structures with unique naming of the elements and data type lengths of 16 or 32 bits.
- The data areas for the MB\_DATA\_PTR parameter can also be in different global data blocks (or in different memory areas). You can, for example, use a data block for the the read jobs and another one for the write jobs or a separate data block for each "MB\_CLIENT" station.

## CONNECT parameter

### Connection descriptions at CONNECT parameter

Two different connection descriptions can be used for the "MB\_CLIENT" instruction:

- Programmed connections with the structure TCON\_IP\_v4  
The connection parameters are stored in the TCON\_IP\_v4 structure and the connection is set up with the call of the instruction "MB\_CLIENT".
- Configured connections with the structure TCON\_Configured  
The configured connection has already been established by the CPU. Use the structure TCON\_Configured to specify which existing connection is to be used for the instruction.

Each instance of the instruction "MB\_CLIENT" requires a unique connection. Create a separate structure TCON\_IP\_v4 or TCON\_Configured for each instance of the instruction to describe the connection.

### Connection description for programmed connections

Use the following structure for connection description to TCON\_IP\_v4 for programmed connections at the CONNECT parameter:

- Make sure that only connections of the type TCP are specified in the TCON\_IP\_v4 structure.
- The connection may not use the following TCP port numbers: 20, 21, 25, 80, 102, 123, 5001, 34962, 34963 and 34964.

Byte	Parameter	Data type	Start value	Description
0 ... 1	InterfaceID	HW_ANY	-	Hardware identifier of the local interface (value range: 0 to 65535).
2 ... 3	ID	CONN_OUC	-	Reference to this connection (value range: 1 to 4095). The parameter uniquely identifies a connection within the CPU. Each individual instance of the instruction "MB_CLIENT" must use a unique ID.
4	ConnectionType	BYTE	11	Connection type Select 11 (decimal) for TCP. Other connection types are not permitted. If another connection type (e.g. UDP) is used, a corresponding error message is output at the STATUS parameter of the instruction.
5	ActiveEstablished	BOOL	TRUE	ID for the manner in which the connection is established Select TRUE for active connection establishment.
6 ... 9	RemoteAddress	ARRAY [1..4] of BYTE	-	IP address of the connection partner (Modbus server), for example, for 192.168.0.1: <ul style="list-style-type: none"> <li>• addr[1] = 192</li> <li>• addr[2] = 168</li> <li>• addr[3] = 0</li> <li>• addr[4] = 1</li> </ul>
10 ... 11	RemotePort	UINT	502	Port number of the remote connection partner (value range: 1 to 49151). Use the IP port number of the server to which the client establishes the connection and communicates using the TCP/IP protocol (default value: 502).
12 ... 13	LocalPort	UINT	0	Port number of the local connection partner: <ul style="list-style-type: none"> <li>• Port numbers: 1 to 49151</li> <li>• Any port: "0"</li> </ul>

**Note**

**Migration of the instruction "MB\_CLIENT" version 2.1**

The parameters CONNECT\_ID, IP\_PORT and IP\_OCTET\_x are mapped in version 3.0 of the "MB\_CLIENT" instruction in the TCON\_IP\_v4 structure:

- The parameter CONNECT\_ID of the "MB\_CLIENT" V2.1 instruction corresponds to the ID parameter of TCON\_IP\_v4.
- The parameter IP\_PORT of the "MB\_CLIENT" V2.1 instruction corresponds to the RemotePort parameter of TCON\_IP\_v4.
- The four parameters IP\_OCTET\_x of the "MB\_CLIENT" V2.1 instruction correspond to the array of the RemoteAddress parameter of TCON\_IP\_v4.

**Connection description for configured connections**

For programmed connections at the CONNECT parameter, use the following structure for connection description to TCON\_Configured.

- Make sure that only connections of the type TCP are specified in the TCON\_Configured structure.
- The connection may not use the following TCP port numbers: 20, 21, 25, 80, 102, 123, 5001, 34962, 34963 and 34964.

Byte	Parameter	Data type	Start value	Description
0 ... 1	Interfaceld	HW_ANY	-	Hardware identifier of the local interface (value range: 0 to 65535).
2 ... 3	ID	CONN_OUC	-	Reference to this connection (value range: 1 to 4095). Enter the connection ID of the existing connection.
4	ConnectionType	BYTE	0	Connection type Select 254 (decimal) for a configured connection.

**Parameter STATUS**

**Parameter STATUS (general status information)**

STATUS* (W#16#)	Description
0000	Instruction executed without errors.
0001	Connection established.
0003	Connection terminated.
7000	No call active and no connection established (REQ=0).
7001	Connection establishment triggered.
7002	Intermediate call. Connection is being established.
7003	Connection is being terminated.



STATUS* (W#16#)	Description
7004	Connection established and monitored. No job processing active.
7005	Data is being sent.
7006	Data is being received.
80BB	Invalid value at ActiveEstablished parameter (identifier for the type of connection establishment, see CONNECT parameter (Page 2814)): <ul style="list-style-type: none"> <li>• Only passive connection establishment permitted for server (ActiveEstablished = FALSE).</li> <li>• Only active connection establishment permitted for client (ActiveEstablished = TRUE).</li> </ul>
8380	Received Modbus frame has incorrect format or too few bytes were received.

\* The status codes can be displayed as integer or hexadecimal values in the program editor. For additional information on toggling display formats, refer to "See also".

### Parameter STATUS (protocol error)

STATUS* (W#16#)	Error code in the error message from MB_SERVER (B#16#)	Description
8381	01	Function code is not supported.
8382	03	Error in data length: <ul style="list-style-type: none"> <li>• Invalid length specification in received Modbus frame.</li> <li>• The length of the Modbus frame in the frame header does not match the number of received bytes.</li> <li>• The number of bytes does not match the number of actually transmitted bytes (only functions 1-4).</li> <li>• The received start address does not match the one sent originally (functions 5, 6, 15, 16).</li> <li>• The number of words does not match the number of actually transmitted words (only functions 15 and 16).</li> </ul>
8383	02	Error reading or writing data or access outside the address area of MB_DATA_PTR (Page 2813). The error can occur locally as well as with the instruction "MB_SERVER".
8384	03	Error in data value: <ul style="list-style-type: none"> <li>• Error in data value for function 5 (error on server).</li> <li>• A different data value was received than was originally sent by the client (functions 5 and 6) (local error).</li> <li>• Invalid exception code received.</li> </ul>
8385	03	Diagnostic code is not supported (function code 08). The error can occur locally as well as on the server.
8386	-	Received function code does not match the one sent originally.
8387	-	<ul style="list-style-type: none"> <li>• The assigned connection ID is different from that used for previous requests. Only one connection ID can be used for each instance DB of the "MB_CLIENT" instruction.</li> <li>• The error code is also output when the protocol ID of the Modbus TCP frame received by the server is not "0".</li> </ul>

STATUS* (W#16#)	Error code in the error message from MB_SERVER (B#16#)	Description
8388	15 or 16	The Modbus server sent a different data length than was requested. This error occurs only when using the Modbus functions 15 or 16.

\* The status codes can be displayed as integer or hexadecimal values in the program editor. For additional information on toggling display formats, refer to "See also".

**Parameter STATUS (parameter error)**

STATUS* (W#16#)	Description
80B6	Invalid connection type, only TCP connections are supported.
80C8	No response of the server in the defined period. Check the connection to the Modbus server. This error is only reported on completion of the configured repeated attempts. If the "MB_CLIENT" instruction does not receive an answer with the originally transferred transaction ID (see static MB_TRANSACTION_ID tag) within the defined period, this error code is output.
8188	The MB_MODE parameter has an invalid value.
8189	Invalid addressing of data at the MB_DATA_ADDR parameter.
818A	Invalid data length at the MB_DATA_LEN parameter.
818B	The MB_DATA_PTR parameter has an invalid pointer. You should also check the values of the MB_DATA_ADDR (Page 2813) and MB_DATA_LEN parameters.
818C	Timeout at parameter BLOCKED_PROC_TIMEOUT or RCV_TIMEOUT (see static tags of instruction). The limit of 55 seconds has been exceeded.
818D	The transaction ID (MB_TRANSACTION_ID tag) does not correspond to the one sent originally (see static tags of instruction).
8200	<ul style="list-style-type: none"> <li>• A different Modbus request is currently being processed via the port.</li> <li>• Another instance of MB_CLIENT with the same connection parameters is processing an existing Modbus request.</li> </ul>

\* The status codes can be displayed as integer or hexadecimal values in the program editor. For additional information on toggling display formats, refer to "See also".

**Note**

**Error codes of internally used communications instructions**

With the "MB\_CLIENT" instruction, in addition to the errors listed in the tables, errors caused by the communication instructions ("TCON", "TDISCON", "TSEND", "TRCV", "T\_DIAG" and "TRESET") used by the instruction can occur.

The error codes are assigned via the instance data block of the "MB\_CLIENT" instruction. The error codes are displayed for the respective instruction under STATUS in the "Static" section.

The meaning of the error codes is available in the documentation of the corresponding communications instruction.

**See also**

GET\_ERR\_ID: Get error ID locally (Page 1787)

**MB\_SERVER: Communicating via PROFINET as a Modbus TCP server****Description of MB\_SERVER****Description**

The "MB\_SERVER" instruction communicates as Modbus TCP server via a PROFINET connection. The "MB\_SERVER" instruction processes connection requests of a Modbus TCP client, receives and processes Modbus requests and sends responses.

The "MB\_SERVER" instruction V3.0 can be used for the S7-1500 as well as for the S7-1200 version 4.0 or higher. The connection can take place via the local interface of the CPU or CM/CP.

To use the instruction, you do not require an additional hardware module.

**Multiple server connections**

You can create multiple Server connections. This allows a single CPU to accept connections from multiple Modbus TCP clients at the same time.

A Modbus TCP server can support several TCP connections and the maximum number of connections depends on the CPU being used.

The total number of connections of one CPU, including those of the Modbus TCP clients and server must not exceed the maximum number of supported connections.

Modbus TCP connections can also be shared by "MB\_CLIENT" and/or "MB\_SERVER" instances.

In the case of Server connections, remember the following rules:

- Each "MB\_SERVER" connection must use a unique instance DB.
- Each "MB\_SERVER" connection must use a unique connection ID.  
The relevant individual connection ID must be used for each individual instance DB of the instruction. The connection ID and instance DB belong together in pairs and must be unique for each connection.
- For each connection, the "MB\_SERVER" instruction must be called individually.

**Parameters**

The following table shows the parameters of the "MB\_SERVER" instruction:

Parameter	Declaration	Data type	Description
DISCONNECT	Input	BOOL	<p>The "MB_SERVER" instruction is used to enter into a passive connection with a partner module. The server responds to a connection request from the IP address which is entered in the SDT "TCON_IP_v4" in the CONNECT parameter.</p> <p>You can use this parameter to control when a connection request is accepted:</p> <ul style="list-style-type: none"> <li>• 0: A passive connection is established when there is no communications connection.</li> <li>• 1: Initialization of the connection termination. If the input is set, no other operations are executed. The value 0003 is output at the STATUS parameter after successful connection termination.</li> </ul>
MB_HOLD_REG (Page 2822)	InOut	VARIANT	<p>Pointer to the Modbus holding register of the "MB_SERVER" instruction</p> <p>The holding register contains the values that may be accessed by a Modbus client using the Modbus functions 3 (read), 6 (write) and 16 (read).</p> <p>As the holding register, use either a global data block with optimized access or the memory area of the bit memories.</p>
CONNECT (Page 2823)	InOut	VARIANT	<p>Pointer to the structure of the connection description</p> <p>The following structures (SDTs) can be used:</p> <ul style="list-style-type: none"> <li>• TCON_IP_v4: Includes all address parameters required for establishing a programmed connection. The default address is 0.0.0.0 (any IP address), but you can enter a specific IP address so that the server only responds to requests from this address. When using TCON_IP_v4, the connection is established when calling the instruction "MB_SERVER".</li> <li>• TCON_Configured: Includes the address parameters of a configured connection. When using TCON_Configured, the connection is established by the CPU after download of the hardware configuration.</li> </ul>
NDR	Output	BOOL	<p>"New Data Ready":</p> <ul style="list-style-type: none"> <li>• 0: No new data</li> <li>• 1: New data written by the Modbus client written</li> </ul>
DR	Output	BOOL	<p>"Data Read":</p> <ul style="list-style-type: none"> <li>• 0: No data read</li> <li>• 1: Data read by the Modbus client</li> </ul>
ERROR	Output	BOOL	<p>If an error occurs during the call of the "MB_SERVER" instruction, the output of the ERROR parameter is set to "1". Detailed information about the cause of the problem is indicated by the STATUS parameter.</p>
STATUS (Page 2825)	Output	WORD	<p>Detailed status information of the instruction.</p>

For additional information on valid data types, refer to "Overview of the valid data types (Page 1077)".

### Static tags of the instruction

The following table describes the static tags of the instance data block of the "MB\_SERVER" instruction used in the program. You can write the HR\_Start\_Offset tag. You can read the other tags to monitor the Modbus status.

Tag	Data type	Start value	Description
HR_Start_Offset	WORD	0	Assign the start address of the Modbus holding register.
Request_Count	WORD	0	Total number of requests received by the server.
Server_Message_Count	WORD	0	Total number of received messages for the relevant Server.
Xmt_Rcv_Count	WORD	0	Counter for detecting the number of transfers during which an error occurred. The counter is only incremented when an invalid Modbus request is received.
Exception_Count	WORD	0	Counters for detecting the number of errors specifically for Modbus which cause an error message to "MB_CLIENT".
Success_Count	WORD	0	Event counter for detecting the number of requests that were successfully executed by the server.
Connected	BOOL	0	Indicates whether the connection to the assigned client has been established or not: 1 = connected, 0 = not connected.

### Mapping of Modbus addresses to the process image

The "MB\_SERVER" instruction allows incoming Modbus functions (1, 2, 4, 5 and 15) direct read and write access to the process image inputs and outputs of the CPU (use of the data types BOOL and WORD).

For the data transfer of the function codes 3, 6 and 16, the holding register (MB\_HOLD\_REG parameter) must be defined longer than one byte. The following table shows the mapping of the Modbus addresses to the process image of the CPU.

Modbus function						S7-1500, S7-1200 V4.0	
Function code	Function	Data area	Address space			Data area	CPU address
01	Read: Bits	Output	1	to	9999	Process image output	Q0.0 to Q1248.6
02	Read: Bits	Input	10001	to	19999	Process image input	I0.0 to I1248.6
04	Read: WORD	Input	30001	to	39999	Process image input	IW0 to IW19996
05	Write: Bits	Output	1	to	9999	Process image output	Q0.0 to Q1248.6
15	Write: Bits	Output	1	to	9999	Process image output	Q0.0 to Q1248.6

Incoming Modbus requests with the function codes 3, 6, 16 and 23 write to or read from the Modbus holding register (you specify the holding register with the MB\_HOLD\_REG parameter).

### Example: Addressing via static tag HR\_Start\_Offset

The addresses of the Modbus holding register start at 40001. These addresses correspond to the address space of the CPU memory area for the holding register. You can also define the HR\_Start\_Offset tag so that the Modbus holding register has a start address other than 40001.

Example: The holding register begins at MW100, and has a length of 100 WORD. An offset value in the HR\_Start\_Offset parameter means that the start address of the holding register is moved from 40001 to 40021. Whenever the holding register is addressed below the address 40021 and above the address 40120, this causes an error.

HR_Start_Offset	Address	Minimum	Maximum
0	Modbus address (WORD)	40001	40100
	CPU address	MW100	MW298
20	Modbus address (WORD)	40021	40120
	CPU address	MW100	MW298

### Modbus diagnostics functions

The table below contains a description of the Modbus diagnostics functions.

Function code	Diagnostic code	Description
08	0x0000	Echo test: The "MB_SERVER" instruction receives a data word and returns this unchanged to the Modbus client.
08	0x000A	Reset event counter: The "MB_SERVER" instruction resets the following event counters: "Success_Count", "Xmt_Rcv_Count", "Exception_Count", "Server_Message_Co" and "Request_Count".
11	-	Fetch event counter of the communication: The "MB_SERVER" instruction uses an internal event counter for communication to record the number of successfully executed read and write requests sent to the Modbus server.  The event counter is not incremented with the functions 8 or 11. The same holds true for requests that cause a communications error, for example, if a protocol error has occurred (e.g., the function code in the received Modbus request is not supported).

### MB\_HOLD\_REG parameter

#### Description

The MB\_HOLD\_REG parameter is a pointer to a data buffer for storing the data read from or written to the Modbus server. You can use a global data block or a bit memory (M) as memory area.

- The high limit for the number of addresses in the data block (D) is determined by the maximum work memory of the CPU.
- The high limit for the number of bit memories (M) is determined by the size of the CPU memory area.

The following table shows examples of mapping Modbus addresses to the holding register for the Modbus functions 3 (read WORD), 6 (write WORD), 16 (write several WORD) and 23 (write and read several words).

Modbus addresses	MB_HOLD_REG parameter - examples		
40001	MW100	DB10.DBW0	"Recipe".ingredient[1]
40002	MW102	DB10.DBW2	"Recipe".ingredient[2]
40003	MW104	DB10.DBW4	"Recipe".ingredient[3]
40004	MW106	DB10.DBW6	"Recipe".ingredient[4]
40005	MW108	DB10.DBW8	"Recipe".ingredient[5]

## CONNECT parameter

### Connection descriptions at CONNECT parameter

Two different connection descriptions can be used for the "MB\_SERVER" instruction:

- Programmed connections with the structure TCON\_IP\_v4  
The connection parameters are stored in the TCON\_IP\_v4 structure and the connection is set up with the call of the instruction "MB\_SERVER".
- Configured connections with the structure TCON\_Configured  
The configured connection has already been established by the CPU. Use the structure TCON\_Configured to specify which existing connection is to be used for the instruction.

Each instance of the instruction "MB\_SERVER" requires a unique connection. Create a separate structure TCON\_IP\_v4 or TCON\_Configured for each instance of the instruction to describe the connection.

### Connection description for programmed connections

For programmed connections at the CONNECT parameter, use the following structure for connection description to TCON\_IP\_v4.

- Make sure that only connections of the type TCP are specified in the TCON\_IP\_v4 structure.
- The connection may not use the following TCP port numbers: 20, 21, 25, 80, 102, 123, 5001, 34962, 34963 and 34964.

Byte	Parameter	Data type	Start value	Description
0 ... 1	InterfaceID	HW_ANY	-	Hardware identifier of the local interface (value range: 0 to 65535).
2 ... 3	ID	CONN_OUC	-	Reference to this connection (value range: 1 to 4095). The parameter uniquely identifies a connection within the CPU. Each individual instance of the instruction "MB_SERVER" must use a unique ID.
4	ConnectionType	BYTE	11	Connection type Select 11 (decimal) for TCP. Other connection types are not permitted. If another connection type (e.g. UDP) is used, a corresponding error message is output at the STATUS parameter of the instruction.
5	ActiveEstablished	BOOL	FALSE	ID for the manner in which the connection is established Select FALSE for passive connection establishment.

Byte	Parameter	Data type	Start value	Description
6 ... 9	RemoteAddress	ARRAY [1..4] of BYTE	0.0.0.0	IP address of the connection partner, for example, for 192.168.0.1: <ul style="list-style-type: none"> <li>• addr[1] = 192</li> <li>• addr[2] = 168</li> <li>• addr[3] = 0</li> <li>• addr[4] = 1</li> </ul> If the instruction "MB_SERVER" is to accept connection requests from any connection partner, use "0.0.0.0" as IP address.
10 ... 11	RemotePort	UINT	0	Port number of the remote connection partner (value range: 1 to 49151). If the instruction "MB_SERVER" is to accept connection requests from any remote partner, use "0" as port number.
12 ... 13	LocalPort	UINT	502	Port number of the local connection partner (value range: 1 to 49151). The number of the IP port defines which IP port is monitored for connection requests of the Modbus client. The following TCP port numbers must not be used for the passive connection of the "MB_SERVER" instruction: 20, 21, 25, 80, 102, 123, 5001, 34962, 34963 and 34964.

**Note**

**Migration of the instruction "MB\_SERVER" version 2.1**

The parameters CONNECT\_ID and IP\_PORT are mapped in version 3.0 of the "MB\_SERVER" instruction in the TCON\_IP\_v4 structure:

- The parameter CONNECT\_ID of the "MB\_SERVER" V2.1 instruction corresponds to the ID parameter of TCON\_IP\_v4.
- The parameter IP\_PORT of the "MB\_SERVER" V2.1 instruction corresponds to the LocalPort parameter of TCON\_IP\_v4.

**Connection description for configured connections**

For configured connections at the CONNECT parameter, use the following structure for connection description to TCON\_Configured.

- Make sure that only connections of the type TCP are specified in the TCON\_Configured structure.
- The connection may not use the following TCP port numbers: 20, 21, 25, 80, 102, 123, 5001, 34962, 34963 and 34964.



Byte	Parameter	Data type	Start value	Description
0 ... 1	InterfaceID	HW_ANY	-	Hardware identifier of the local interface (value range: 0 to 65535).
2 ... 3	ID	CONN_OUC	-	Reference to this connection (value range: 1 to 4095). Enter the connection ID of the existing connection.
4	ConnectionType	BYTE	-	Connection type Select 254 (decimal) for a configured connection.

## Parameter STATUS

### Parameter STATUS (general status information)

STATUS* (W#16#)	Description
0000	Instruction executed without errors.
0001	Connection established.
0003	Connection terminated.
7000	No call active (REQ=0).
7001	First call. Connection establishment triggered.
7002	Intermediate call. Connection is being established.
7003	Connection is being terminated.
7005	Data is being sent.
7006	Data is being received.
80BB	Invalid value at ActiveEstablished parameter (identifier for the type of connection establishment, see CONNECT parameter (Page 2823)): <ul style="list-style-type: none"> <li>• Only passive connection establishment permitted for server (active_established = FALSE).</li> <li>• Only active connection establishment permitted for client (active_established = TRUE).</li> </ul>
8380	Received Modbus frame has incorrect format or too few bytes were received.
* The status codes can be displayed as integer or hexadecimal values in the program editor. For additional information on toggling display formats, refer to "See also".	

### Parameter STATUS (parameter error)

STATUS* (W#16#)	Error code in the error message from "MB_SERVER" (B#16#)	Description
8187	No response	The MB_HOLD_REG parameter has an invalid pointer. Data area is too small.
8381	01	Function code is not supported.

STATUS* (W#16#)	Error code in the error message from "MB_SERVER" (B#16#)	Description
8382	03	Error in data length: <ul style="list-style-type: none"> <li>• Invalid length specification in received Modbus frame</li> <li>• The frame length entered in the header of the Modbus frame does not match the number of actually received bytes.</li> <li>• The number of bytes entered in the header of the Modbus frame does not match the number of actually received bytes (functions 15 and 16).</li> </ul>
8383	02	Error in data address or access outside the address area of the holding register (MB_HOLD_REG (Page 2822) parameter).
8384	03	Invalid data value (function 5).
8385	03	Diagnostic code is not supported (only with function code 08).
* The status codes can be displayed as integer or hexadecimal values in the program editor. For additional information on toggling display formats, refer to "See also".		

**Note**

**Error codes of internally used communications instructions**

With the "MB\_SERVER" instruction, in addition to the errors listed in the tables, errors caused by the communication instructions ("TCON", "TDISCON", "TSEND", "TRCV", "T\_DIAG" and "T\_RESET") used by the instruction can occur.

The error codes are assigned via the instance data block of the "MB\_SERVER" instruction. The error codes are displayed for the respective instruction under STATUS in the "Static" section.

The meaning of the error codes is available in the documentation of the corresponding communications instruction.

**See also**

GET\_ERR\_ID: Get error ID locally (Page 1787)

**9.7.5.2 S7 communication**

**Data consistency**

**Definition**

The size of the data area which can be modified simultaneously by concurrent processes is called the consistent data area. Data areas which are larger than the consistent data area can thus be falsified as a whole.

This means that a data area which belongs together and which is larger than consistent data area can consist in part of new and of old consistent data blocks at the same time.

## Example

An inconsistency can arise if a communication block is interrupted, for example, by a hardware interrupt OB with a higher priority. If the user program in this OB now changes the data which have already been processed in part by the communication block, the transferred data originate:

- In part from the time before the hardware interrupt was processed
- And in part from the time after the hardware interrupt was processed

This means that these data are inconsistent (not coherent).

## Effect

If larger packages of data are to be transferred in a consistent form, the transfer should not be interrupted. This can, for example, increase the interrupt reaction time of the CPU.

In other words: The greater the quantity of data which must be transferred with absolute consistency, the longer the interrupt reaction time of a system.

## Data consistency with SIMATIC

- If the user program contains a communication function that accesses common data, access to this data area can be coordinated, e.g., by means of the DONE parameter itself. The data consistency of the communication areas which are transferred locally with a communication block can therefore be ensured in the user program.
- In the case of S7 communication instructions "PUT (Page 2833)"/"GET (Page 2831)", the size of the consistent data areas must already be taken into consideration during programming or configuration, because a communication block is not available in the user program of the target device (server) to synchronize communication data to the user program.
- For the S7-300 and C7-300 (exception: CPU 318-2 DP) the communication data are copied consistently into the user memory in blocks of 32 bytes in the cycle control point of the operating system. Data consistency is not guaranteed for larger data areas. If a defined data consistency is required, the communication data in the user program may not exceed 32 bytes (maximum of 8 bytes, depending on the version).
- In the S7-400 and S7-1500, on the other hand, the communication data in 462-byte blocks are not processed in the cycle control point, but in fixed time slices during the program cycle. The consistency of a tag is ensured by the system. These communication areas can then be accessed consistently using the "PUT (Page 2833)" / "GET (Page 2831)" instructions or when reading/writing tags, for example by an OP or an OS.

---

### Note

Additional information on data consistency is provided in the description of the specific instructions.

---

## Common parameters of instructions for S7 communication

### Classification

The parameters of the instructions for S7 communication can be divided into the following five categories according to their functions:

1. Control parameters are used to activate an instruction.
2. Addressing parameters are used to address the remote communication partner.
3. Send parameters point to the data areas that are to be sent to the remote partner.
4. Receive parameters point to the data areas where the data received from remote partners will be entered.
5. Status parameters are used to monitor whether the instruction has completed its task without error or for the analysis of any errors that have occurred.

### Control parameter

Data exchange will only be activated if the appropriate control parameters have a defined value (for example, are set) when the instruction is called or when the value has undergone a specific change since the previous call (for example, a positive edge).

### Addressing parameters

Parameter	Description
ID	Reference to the local connection description (specified by the configuration of the connection). Note: The ID W#16#EEEE is not permitted for S7 communication instructions.
R_ID	With the R_ID parameter, you specify that a send and a receive instruction belong together: The R_ID parameter must match in the instruction at the sending end and the instruction at the receiving end. This allows the communication of several instruction pairs via the same logic connection. <ul style="list-style-type: none"><li>• R_ID must be specified in the form DW#16#wxyzWXYZ.</li><li>• The instruction pairs of a logical connection specified in R_ID must be unique for this connection.</li></ul>

**Note****Addressing parameters ID and R\_ID**

You can reassign the addressing parameters ID and R\_ID during runtime. The new parameters are validated with each new job after the previous job has been closed.

You can use the following options to reduce the number of instance DBs and therefore the work memory required:

1. With tag IDs, you can use several connections via one data instance block.
2. With tag R\_IDs, you can define several pairs of sending and receiving instructions for one job with a single instance.
3. You can combine cases 1 and 2.

Please note that the new parameters are valid after the last job is executed. When you activate the sending operation, the R\_ID parameter in the instruction at the sending end must match its counterpart at the receiving end.

---

**Status parameter**

With the status parameters, you monitor whether the instruction has completed its task correctly or whether it is still active. The status parameters also indicate errors.

---

**Note**

The status parameters are valid for one cycle only, namely from the first command following the call until the next call. As a result, you must evaluate these parameters after each instruction cycle.

---

**Send and receive parameters**

For communication instructions configured at both ends

- The number of the SD\_i and RD\_i parameters used must match at the send and receive end.
- The data types of the SD\_i and RD\_i parameters that belong together must match at the send and receive end.
- The amount of data to be sent according to the SD\_i parameter must not exceed the range made available by the corresponding RD\_i (does not apply to "BSEND (Page 2839)" / "BRCV (Page 2841)"). The RD\_i parameters must (with exception of "BSEND"/"BRCV") have the identical data size.

If you do not keep to the rules above, this is indicated by ERROR = 1 and STATUS = 4.

**Note**

**Supplying the send and receive parameters**

With the VARIANT data type, send and receive parameters must always be supplied any time a communication instruction is called. It is not possible, for example, to supply the send buffer of the communication instruction at startup and to only trigger the send job in cyclic operation.

**User data size**

With the "USEND (Page 2836)", "URCV (Page 2837)", "GET (Page 2831)" and "PUT (Page 2833)" instructions, the amount of data to be transferred must not exceed a defined user data size. The maximum user data size depends on:

- The instruction used
- The communication partner.

The guaranteed minimum size of the user data for an instruction with 1-4 tags is listed in the following table:

Instruction	Partner: S7-300	Partner: S7-400	Partner: S7-1200	Partner: S7-1500
PUT / GET	160 bytes	400 bytes	160 bytes	880 bytes
USEND / URCV	160 bytes	440 bytes	-	920 bytes
BSEND / BRCV	32768/65534 bytes	65534 bytes	-	65534 bytes

Further information on the user data size can be found in the technical data of the respective CPU.

**Exact user data size**

If the user data size specified above is insufficient you can determine the maximum byte length of the user data as follows:

First read the data block size valid for communication from the following table:

Local CPU	Remote CPU	Data block size in bytes
S7-1200	Any	240
S7-1500	S7-300	240
	S7-400	480
	S7-1200	240
	S7-1500	960

Use this value in the following table to read the maximum possible user data length in bytes as total of the parameters used. It applies for even lengths of the areas SD\_i, RD\_i, and ADDR\_i.

For each range of uneven length the maximum possible user data length is reduced by one byte.

Data block size	Instruction	Number of SD_i, RD_i, ADDR_i parameters used			
		1	2	3	4
240 (S7-300)	PUT/GET/ USEND	160	-	-	-
240 (S7-300 via integrated interface)	PUT	212	-	-	-
	GET	222	-	-	-
	USEND	212	-	-	-
240 (S7-400)	PUT	212	196	180	164
	GET	222	218	214	210
	USEND	212	-	-	-
480 (S7-400)	PUT	452	436	420	404
	GET	462	458	454	450
	USEND	452	448	444	440
240 (S7-1200)	PUT	212	196	180	164
	GET	222	218	214	210
960 (S7-1500)	PUT	932	916	900	884
	GET	942	938	934	930
	USEND	932	928	924	920

## GET: Read data from a remote CPU

### Description

With the instruction "GET", you can read data from a remote CPU. This is only possible if the "Allow remote partner access via PUT/GET communication" function was activated for the partner CPU in the properties of the CPU in "Protection". You cannot use the "GET" instruction to access blocks that were created with "optimized" access type.

The instruction is started on a rising edge at control input REQ. The relevant pointers to the areas to be read out (ADDR\_i) are then sent to the partner CPU. The remote CPU can be in RUN or STOP mode. The remote partner returns the data.

- A zero at any of the ADDR\_i parameters will be ignored. The received data is copied to the configured receive areas (RD\_i) at the next call.
- Make sure that the areas defined with the parameters ADDR\_i and RD\_i match in terms of number, length and data type.  
The area to be read (ADDR\_i parameter) may not be smaller than the area for data storage (RD\_i parameter). Both areas must match in terms of number, length and data type.  
If the response exceeds the maximum user data length, this is indicated with the error code "2" at the STATUS parameter.

Changes in the data areas addressed on the partner CPU are not registered by the "GET" instruction.

Completion of this action is indicated by the status parameter NDR having the value "1". Reading can only be activated again after the previous reading process has been completed.

Errors and warnings are output via ERROR and STATUS if access problems occurred while the data was being read or if the data type check results in an error.

### Parameters

The following table shows the parameters of the "GET" instruction:

Parameter	Declaration	Data type	Memory area	Description
REQ	Input	BOOL	I, Q, M, D, L or constant	Control parameter request, activates the data exchange on a rising edge.
ID	Input	CONN_PRG (WORD)	I, Q, M, D, L or constant	Addressing parameters for specifying the connection to the partner CPU.
NDR	Output	BOOL	I, Q, M, D, L	Status parameter NDR: <ul style="list-style-type: none"> <li>• 0: Job not yet started or still running.</li> <li>• 1: Job successfully completed.</li> </ul>
ERROR	Output	BOOL	I, Q, M, D, L	Status parameters ERROR and STATUS, error code: <ul style="list-style-type: none"> <li>• ERROR=0 STATUS has the value:                             <ul style="list-style-type: none"> <li>- 0000H: Neither warning nor error</li> <li>- &lt;&gt; 0000H: Warning, STATUS supplies detailed information.</li> </ul> </li> <li>• ERROR=1 An error has occurred. STATUS supplies detailed information on the type of error.</li> </ul>
STATUS	Output	WORD	I, Q, M, D, L	
ADDR_1	InOut	REMOTE	I, Q, M, D	Pointers to the areas on the partner CPU that are to be read. When the REMOTE pointer accesses a DB, the DB must always be specified. Example: P#DB10.DBX5.0 Byte 10. When transferring data structures (e.g., Struct, Array), the data type CHAR, BYTE, WORD or DWORD must be used at the ADDR parameter.
ADDR_2	InOut	REMOTE		
ADDR_3	InOut	REMOTE		
ADDR_4	InOut	REMOTE		
RD_1	InOut	VARIANT	I, Q, M, D, L	Pointers to the areas on the local CPU in which the read data is entered.
RD_2	InOut	VARIANT		
RD_3	InOut	VARIANT		
RD_4	InOut	VARIANT		

You will find more detailed information on valid data types in "Overview of the valid data types (Page 1077)".



## Parameters ERROR and STATUS

The following table contains all specific error information for the "GET" instruction that can be output via the ERROR and STATUS parameters.

ERROR	STATUS (decimal)	Explanation
0	11	Warning: New job not active because the previous job is still busy.
0	25	Communication has started. The job is being processed.
1	1	Communications problems, for example <ul style="list-style-type: none"> <li>• Connection description not loaded (local or remote)</li> <li>• Connection interrupted (for example: cable, CPU off, CP in STOP mode)</li> <li>• Connection to partner not yet established</li> </ul>
1	2	<ul style="list-style-type: none"> <li>• Negative acknowledgement from the partner device. The function cannot be executed.</li> <li>• Response from the remote station exceeds the maximum user data length.</li> <li>• For S7-1500: Access protection for remote station activated.</li> </ul>
1	4	Error in the pointers to the data storage RD_i: <ul style="list-style-type: none"> <li>• Data types of the parameters RD_i and ADDR_i are not compatible with each other.</li> <li>• The length of the area RD_i is smaller than the length of the data of the ADDR_i parameter that is to be read.</li> </ul>
1	8	Access error on the partner CPU.
1	10	Access to the local user memory not possible (for example, access to a deleted DB).
1	20	<ul style="list-style-type: none"> <li>• Maximum number of parallel jobs exceeded.</li> <li>• The job is currently being processed in a priority class with low priority (first call).</li> </ul>

### Note

#### Data consistency

Data is received consistently if you read the part of the receive area RD\_i currently being used completely before initiating another job.

### See also

Common parameters of instructions for S7 communication (Page 2828)

## PUT: Write data to a remote CPU

### Description

You can write data to a remote CPU with the instruction "PUT". This is only possible if the "Permit access via PUT/GET communication from remote partner" function was activated for the partner CPU in the properties of the CPU under "Protection". You cannot use the "PUT" instruction to access blocks that were created with "optimized" access type. The remote CPU can be in RUN or STOP mode.

9.7 References

The instruction is started on a rising edge at control input REQ. The pointers to the areas to be written (ADDR\_i) and the data (SD\_i) are then sent to the partner CPU. Make sure that the areas defined with the parameters ADDR\_i and SD\_i match in terms of number, length and data type.

- The data to be sent is copied from the configured send areas (SD\_i) with a positive edge at the REQ parameter.
- Make sure that the areas defined with the parameters ADDR\_i and SD\_i match in terms of number, length and data type.  
The area to be written (ADDR\_i parameter) may not be larger than the send area (SD\_i parameter). Both areas must match in terms of number, length and data type.

The remote partner saves the required data under the addresses supplied with the data and returns an execution acknowledgement. If no errors occur, this is indicated at the next instruction call with status parameter DONE = "1". The writing process can only be activated again after the last job is complete.

Errors and warnings are output via ERROR and STATUS if access problems occurred while the data was being written or if the execution check results in an error.

Parameters

The following table shows the parameters of the "PUT" instruction:

Parameter	Declaration	Data type	Memory area	Description
REQ	Input	BOOL	I, Q, M, D, L or constant	Control parameter request, activates the data exchange on a rising edge.
ID	Input	CONN_PRG (WORD)	I, Q, M, D, L or constant	Addressing parameters for specifying the connection to the partner CPU.
DONE	Output	BOOL	I, Q, M, D, L	Status parameter DONE: <ul style="list-style-type: none"> <li>• 0: Job not yet started or still executing</li> <li>• 1: Job executed without errors.</li> </ul>
ERROR	Output	BOOL	I, Q, M, D, L	Status parameters ERROR and STATUS, error code:
STATUS	Output	WORD	I, Q, M, D, L	<ul style="list-style-type: none"> <li>• ERROR=0 STATUS has the value:                             <ul style="list-style-type: none"> <li>- 0000H: Neither warning nor error</li> <li>- &lt;&gt; 0000H: Warning, STATUS supplies detailed information.</li> </ul> </li> <li>• ERROR=1 An error has occurred. STATUS supplies detailed information on the type of error.</li> </ul>
ADDR_1	InOut	REMOTE	I, Q, M, D	Pointers to the areas on the partner CPU to which the data will be written. When the REMOTE pointer accesses a DB, the DB must always be specified. Example: P#DB10.DBX5.0 Byte 10. When transferring data structures (e.g., Struct, Array) the data type CHAR must be used at the ADDR_i parameters.
ADDR_2	InOut	REMOTE		
ADDR_3	InOut	REMOTE		
ADDR_4	InOut	REMOTE		

Parameter	Declaration	Data type	Memory area	Description
SD_1	InOut	VARIANT	I, Q, M, D, L	Pointers to the areas on the local CPU which contain the data to be sent. Only the data types BOOL, BYTE, CHAR, WORD, INT, DWORD, DINT, REAL are permitted. When transferring data structures (e.g., Struct, Array) the data type CHAR must be used at the SD_i parameters.
SD_2	InOut	VARIANT		
SD_3	InOut	VARIANT		
SD_4	InOut	VARIANT		

For additional information on valid data types, refer to "Overview of the valid data types (Page 1077)".

### Parameters ERROR and STATUS

The following table contains all specific error information for the "PUT" instruction that can be output via the ERROR and STATUS parameters.

ERROR	STATUS (decimal)	Explanation
0	11	Warning: New job not active because the previous job is still busy.
0	25	Communication has started. The job is being processed.
1	1	Communications problems, for example <ul style="list-style-type: none"> <li>• Connection description not loaded (local or remote)</li> <li>• Connection interrupted (for example: cable, CPU off, CP in STOP mode)</li> <li>• Connection to partner not yet established</li> </ul>
1	2	<ul style="list-style-type: none"> <li>• Negative acknowledgement from the partner device. The function cannot be executed.</li> <li>• For S7-1500: Access protection for remote station activated.</li> </ul>
1	4	Error in the pointers to the data storage: <ul style="list-style-type: none"> <li>• Data types of the parameters SD_i and ADDR_i are not compatible with each other.</li> <li>• The length of the area SD_i is greater than the length of the data of the ADDR_i parameter that is to be written.</li> <li>• Not possible to access SD_i.</li> <li>• Maximum user data size exceeded.</li> <li>• Number of the parameters SD_i and ADDR_i does not match.</li> </ul>
1	8	Access error with the partner CPU (e.g. DB not loaded or write-protected).
1	10	Access to the local user memory not possible (for example, access to a deleted DB).
1	20	<ul style="list-style-type: none"> <li>• Maximum number of parallel jobs exceeded.</li> <li>• The job is currently being processed in a priority class with low priority (first call).</li> </ul>

**Data consistency**

When a send operation is activated (rising edge at REQ), the data to be sent from the send area SD\_i is copied from the user program. After the block call, you can write to these areas without corrupting the current send data.

**Note**

The send operation is only complete when the DONE status parameter has the value "1".

**Other**

**USEND: Send data uncoordinated**

**Description**

The "USEND" instruction sends data to a remote partner instruction of type "URCV (Page 2837)". The sending process is carried out without coordination with the partner instruction. This means that the data transfer is carried out without acknowledgement by the partner instruction.

When a send operation is activated (rising edge at REQ), the data to be sent from the send areas SD\_i are copied from the user program. After the instruction call, you can write to these send areas again without corrupting the current send data.

Successful completion of the send operation is indicated by the value of the DONE status parameter being set to "1".

**Parameters**

The following table shows the parameters of the "USEND" instruction:

Parameter	Declaration	Data type	Memory area	Description
REQ	Input	BOOL	I, Q, M, D, L or constant	Control parameter request, activates the data exchange on a rising edge.
ID	Input	CONN_PRG	M, D or constant	Addressing parameters for specifying the connection to the partner CPU.
R_ID	Input	CONN_R_ID	I, Q, M, D, L or constant	Addressing parameter R_ID for defining the instruction pairs "USEND" and "URCV". See also: Common parameters of instructions for S7 communication (Page 2828)
DONE	Output	BOOL	I, Q, M, D, L	Status parameter <ul style="list-style-type: none"> <li>0: Job not yet started or still executing.</li> <li>1: Job executed without errors.</li> </ul>
ERROR	Output	BOOL	I, Q, M, D, L	Status parameter <ul style="list-style-type: none"> <li>0: Neither warning nor error.</li> <li>1: An error has occurred. STATUS supplies detailed information on the type of error.</li> </ul>

Parameter	Declaration	Data type	Memory area	Description
STATUS	Output	WORD	I, Q, M, D, L	Status parameter See "ERROR and STATUS parameters" table.
SD_i (1 ≤ i ≤ 4)	InOut	VARIANT	M, D	Pointer to the i-th send area. The only valid data types are BOOL (not valid: bit array), BYTE, CHAR, WORD, INT, DWORD, DINT, REAL. The maximum user data size for SD_i parameters depends on the partner CPU ("URCV" instruction) and on the number of parameters used. Additional information is available in: Common parameters of instructions for S7 communication (Page 2828)

You will find more detailed information on valid data types in "Overview of the valid data types (Page 1077)".

## Parameters ERROR and STATUS

ERROR	STATUS (decimal)	Explanation
0	11	Warning: New job not active because the previous job is still busy.
0	25	Communication has started. The job is being processed.
1	1	Communication problem has occurred. Possible causes: <ul style="list-style-type: none"> <li>• Connection description not loaded (local or remote)</li> <li>• Connection interrupted (for example: cable, CPU off, CP in STOP mode)</li> <li>• Connection to partner not yet established</li> </ul>
1	4	<ul style="list-style-type: none"> <li>• Errors in the send area pointers SD_i relating to the data length or the data type.</li> <li>• Maximum user data length was exceeded.</li> </ul>
1	10	Access to the local user memory not possible (for example, access to a deleted DB).
1	18	Value at R_ID parameter already exists in the connection specified at the ID parameter (R_ID value must be unique for the connection).
1	20	<ul style="list-style-type: none"> <li>• Maximum number of parallel jobs exceeded.</li> <li>• The job is currently being processed in a priority class with lower priority (first call).</li> </ul>

## URCV: Receive data uncoordinated

### Description

The "URCV" instruction receives data asynchronously from a remote partner instruction of type "USEND (Page 2836)" and copies this data into the configured receive areas.

The instruction is ready to receive if there is a logical 1 at the EN\_R input. An active job can be canceled with EN\_R=0.

The receive data areas are referenced by the parameters RD\_1 to RD\_4. Make sure that the areas defined by the parameters RD\_i / RD\_1 and SD\_i / SD\_1 (with the associated partner instruction "USEND (Page 2836)") match in terms of number and length.

Successful completion of the copy operation is indicated when the value of the NDR status parameter is set to logical "1". Once the status parameter NDR has changed to "1", there will be new receive data in your receive areas (RD\_i). A new block call may cause these data to be overwritten with new receive data. If you want to prevent this, call "URCV" (for example, during cyclic block processing) with the value 0 at EN\_R until you have finished processing the received data.

### Parameters

The following table shows the parameters of the "URCV" instruction:

Parameter	Declaration	Data type	Memory area	Description
EN_R	Input	BOOL	I, Q, M, D, L or constant	Control parameter enabled to receive, signals ready to receive if the input is set.
ID	Input	CONN_PR G	M, D or constant	Addressing parameters for specifying the connection to the partner CPU.
R_ID	Input	CONN_R_I D	I, Q, M, D, L or constant	Addressing parameter for defining the instruction pairs "USEND" and "URCV". See also: Common parameters of instructions for S7 communication (Page 2828)
NDR	Output	BOOL	I, Q, M, D, L	Status parameter <ul style="list-style-type: none"> <li>• 0: Job not yet started or still running.</li> <li>• 1: Job successfully completed.</li> </ul>
ERROR	Output	BOOL	I, Q, M, D, L	Status parameter <ul style="list-style-type: none"> <li>• 0: Neither warning nor error</li> <li>• 1: An error has occurred. STATUS supplies detailed information on the type of error.</li> </ul>
STATUS	Output	WORD	I, Q, M, D, L	Status parameter See "ERROR and STATUS parameters" table.
RD_i (1 ≤ i ≤ 4)	InOut	VARIANT	I, Q, M, D	Pointer to the i-th receive area: The only valid data types are BOOL (not valid: bit array), BYTE, CHAR, WORD, INT, DWORD, DINT, REAL. Additional information is available in: Common parameters of instructions for S7 communication (Page 2828)

For additional information on valid data types, refer to "Overview of the valid data types (Page 1077)".

## Parameters ERROR and STATUS

ERROR	STATUS (decimal)	Explanation
0	9	Warning: older received data is overwritten by newer received data.
0	11	Warning: The received data is already being processed in a priority class with lower priority (error can occur when copying data to the receive area).
0	25	Communication has started. The job is being processed.
1	1	Communication problem has occurred. Possible causes: <ul style="list-style-type: none"> <li>• Connection description not loaded (local or remote)</li> <li>• Connection interrupted (for example: cable, CPU off, CP in STOP mode)</li> <li>• Connection to partner not yet established</li> </ul>
1	4	Errors in the receive area pointers RD_i relating to the data length or the data type.
1	10	Access to the local user memory not possible (for example, access to a deleted DB).
1	18	Value at R_ID parameter already exists in the connection specified at the ID parameter (R_ID value must be unique for the connection).
1	19	The associated "USEND (Page 2836)" instruction sends data faster than it can be copied to the receive areas by "URCV".
1	20	<ul style="list-style-type: none"> <li>• Maximum number of parallel jobs exceeded.</li> <li>• The job is currently being processed in a priority class with lower priority (first call).</li> </ul>

## BSEND: Send data in segments

### Description

The "BSEND" instruction sends data to a remote partner instruction of type "BRCV (Page 2841)". With this type of data transfer, more data can be transported between the communication partners than is possible with all other communication instructions for configured S7 connections. In each case, the maximum data volume amounts to 65534 bytes for the integrated interface and for SIMATIC Net CP.

### Functional description

You specify the instruction pair "BSEND" and "BRCV" with the input parameter R\_ID. The R\_ID parameter must be identical in the related instructions.

The send job is activated after the instruction is called and a rising edge is detected at control input REQ. After the call, "BSEND" is not processed in the background, which means the data can only be read within the user program.

The data area to be transmitted is segmented. Each segment is sent individually to the partner. The last segment is acknowledged by the partner after the application of this segment by "BRCV (Page 2841)". If the data is segmented, "BSEND" must be called multiple times until all segments have been transferred.

The data area of the data to be sent is specified by SD\_1. To ensure data consistency, you may only write to the part of the currently used sending area SD\_1 after the current send operation is complete. This is the case when the value of the status parameter DONE changes to "1".

The length of the send data is specified by LEN based on the job. With LEN = "0", all data addressed with the SD\_1 parameter is sent.

If there is a rising edge at control input R, the current sending process is canceled.

Due to the asynchronous data transfer, a new data transfer can only be initiated if the previous data has been fetched by a partner instruction call. When the data has been collected, the status parameter "NDR" is set in the partner instruction "BRCV".

**Note**

**Migration of S7-400 user programs**

An S7-400 CPU interprets the parameter SD\_1 as pointer and not as data area.

With S7-1500, LEN may not exceed the area of SD1. This was permitted with S7-400. Recommendation: Use the maximum size for the LEN parameter (65534 bytes for the integrated interface) as size of the data area at the SD\_1 parameter.

**Parameters**

The following table shows the parameters of the "BSEND" instruction:

Parameter	Declaration	Data type	Memory area	Description
REQ	Input	BOOL	I, Q, M, D, L or constant	Control parameter request, activates the data exchange at a rising edge.
R	Input	BOOL	I, Q, M, D, L or constant	Control parameter reset, activates an abort of the current data exchange at a rising edge
ID	Input	CONN_PR G	M, D or constant	Addressing parameters for specifying the connection to the partner CPU.
R_ID	Input	CONN_R_I D	I, Q, M, D, L or constant	Addressing parameter for defining the instruction pairs "BSEND" and "BRCV (Page 2841)". See also: Common parameters of instructions for S7 communication (Page 2828)
SD_1	InOut	VARIANT	I, Q, M, D	Pointer to send area
LEN	InOut	WORD	I, Q, M, D, L	Length of the block of data to be sent in bytes. With LEN = "0", all data is sent by SD_1.
DONE	Output	BOOL	I, Q, M, D, L	Status parameter <ul style="list-style-type: none"> <li>• 0: Job not yet started or still executing.</li> <li>• 1: Job executed without errors.</li> </ul>
ERROR	Output	BOOL	I, Q, M, D, L	Status parameter <ul style="list-style-type: none"> <li>• 0: Neither warning nor error.</li> <li>• 1: An error has occurred. STATUS supplies detailed information on the type of error.</li> </ul>
STATUS	Output	WORD	I, Q, M, D, L	Status parameter See "ERROR and STATUS parameters" table.

For additional information on valid data types, refer to "Overview of the valid data types (Page 1077)".



## Parameters ERROR and STATUS

The following table contains all specific error information for "BSEND" that can be output via the ERROR and STATUS parameters.

ERROR	STATUS (decimal)	Explanation
0	11	Warning: New job not active because the previous job is still busy.
0	25	Communication has started. The job is being processed.
1	1	Communication problem has occurred. Possible causes: <ul style="list-style-type: none"> <li>• Connection description not loaded (local or remote)</li> <li>• Connection interrupted (for example: cable, CPU off, CP in STOP mode)</li> <li>• Connection to partner not yet established</li> </ul>
1	2	Negative acknowledgement of partner instruction. The instruction cannot be executed.
1	3	R_ID is unknown on the connection specified by the ID or the receive block has not yet been called.
1	4	<ul style="list-style-type: none"> <li>• Error in the data length or data type in the send area pointer SD_1.</li> <li>• Value for LEN is greater than area SD_1.</li> <li>• A memory area with optimized access is used and the value for LEN is not "0".</li> <li>• A memory area with standard access is used and the value for LEN is "0".</li> </ul>
1	5	Reset request was executed.
1	6	Partner instruction is in DISABLED status (EN_R has the value "0"). Also check the input parameters of "BRCV (Page 2841)" for consistency with "BSEND".
1	7	"BRCV (Page 2841)" partner instruction not called since the last data transfer.
1	8	Access to remote object in the user memory was rejected: The destination area for the associated "BRCV (Page 2841)" is too small. ERROR = 1, STATUS = 4 or ERROR = 1, STATUS = 10 reported at the output parameters of "BRCV (Page 2841)".
1	10	Access to the local user memory not possible (for example, access to a deleted DB).
1	18	R_ID already exists in the connection.
1	20	<ul style="list-style-type: none"> <li>• Maximum number of parallel jobs exceeded.</li> <li>• The job is currently being processed in a priority class with lower priority (first call).</li> </ul>

## BRCV: Receive data in segments

### Description

The "BRCV" instruction receives data from a remote partner instruction of type "BSEND (Page 2839)". The R\_ID parameter must be identical in the related instructions.

The instruction is ready to receive data (STATUS = 25) after it is called with the value "1" at control input EN\_R. An active job can be canceled with EN\_R=0.

The maximum receive area is specified by RD\_1. Data will be received consistently if you fully evaluate the part of the RD\_1 receive area currently in use before calling the block again with value 1 at control input EN\_R.

After each received data segment, an acknowledgement is sent to the partner instruction. In the case of multiple segments it is necessary to call "BRCV" several times until all segments

have been received. Asynchronous data receipt is indicated by STATUS = 17. The number of the currently received data is displayed at the LEN parameter. The RD\_1 parameter must remain constant during the operation.

Value "1" at the NDR status parameter indicates that all data segments have been received without error. The received data remains unchanged until the next call with EN\_R=1.

### Parameters

The following table shows the parameters of the "BRCV" instruction:

Parameter	Declaration	Data type	Memory area	Description
EN_R	Input	BOOL	I, Q, M, D, L or constant	Control parameter enabled to receive, signals ready to receive if the input is set.
ID	Input	CONN_PRG	M, D or constant	Addressing parameters for specifying the connection to the partner CPU.
R_ID	Input	CONN_R_ID	I, Q, M, D, L or constant	Addressing parameter for defining the instruction pairs "BSEND (Page 2839)" and "BRCV". See also: Common parameters of instructions for S7 communication (Page 2828)
RD_1	InOut	VARIANT	I, Q, M, D	Pointer to the receive area. The length information specifies the maximum length of the block to be received.
LEN	InOut	WORD	I, Q, M, D, L	Length of the data already received in bytes.
NDR	Output	BOOL	I, Q, M, D, L	Status parameter <ul style="list-style-type: none"> <li>• 0: Job not yet started or still running.</li> <li>• 1: Job successfully completed.</li> </ul>
ERROR	Output	BOOL	I, Q, M, D, L	Status parameter <ul style="list-style-type: none"> <li>• 0: Neither warning nor error</li> <li>• 1: An error has occurred. STATUS supplies detailed information on the type of error.</li> </ul>
STATUS	Output	WORD	I, Q, M, D, L	Status parameter See "ERROR and STATUS parameters" table.

For additional information on valid data types, refer to "Overview of the valid data types (Page 1077)".

### Parameters ERROR and STATUS

The following table contains all specific error information for "BRCV" that can be output via the ERROR and STATUS parameters.

ERROR	STATUS (decimal)	Explanation
0	11	Warning: The received data is already being processed in a priority class with lower priority.
0	17	Warning: Instruction receives data asynchronously. The LEN parameter shows the amount of data already received in bytes.
0	25	Communication has started. The job is being processed.

ERROR	STATUS (decimal)	Explanation
1	1	Communication problem has occurred. Possible causes: <ul style="list-style-type: none"> <li>• Connection description not loaded (local or remote)</li> <li>• Connection interrupted (for example: cable, CPU off, CP in STOP mode)</li> <li>• Connection to partner not yet established</li> </ul>
1	2	Function cannot be executed (protocol error).
1	4	Error in the receive area pointer RD_1 relating to the data length or data type. The block of data sent is longer than the receive area.
1	5	Reset request received, incomplete transfer.
1	8	Access error in associated "BSEND (Page 2839)": After the last valid data segment has been sent, ERROR = 1 and STATUS = 4 or ERROR = 1 and STATUS = 10 is reported.
1	10	Access to the local user memory not possible (for example, access to a deleted DB).
1	18	Value at R_ID parameter already exists in the connection specified at the ID parameter (R_ID value must be unique for the connection).
1	20	<ul style="list-style-type: none"> <li>• Maximum number of parallel jobs exceeded.</li> <li>• The job is currently being processed in a priority class with lower priority (first call).</li> </ul>

### 9.7.5.3 Open User Communication

#### TSEND\_C: Send data via Ethernet

#### TSEND\_C: Send data via Ethernet

#### Description

The following description of the "TSEND\_C" instruction is valid for the CPU S7-1200 to version 3.0.

The "TSEND\_C" instruction sets up and establishes a TCP or ISO-on-TCP communication connection. Once the connection has been set up and established, it is automatically maintained and monitored by the CPU. The connection description specified at the CONNECT parameter is used to set up the communication connection.

The instruction is executed asynchronously and has the following functions:

- A communication connection is set up and established:  
The communication connection is set up and established with CONT=1. Once the connection is successfully established, the DONE parameter is set to "1" for one cycle. An existing connection is terminated and the connection which has been set up is removed when the CPU goes into STOP mode. To set up and establish the connection again, you must execute "TSEND\_C" again. For information on the number of possible communication connections, refer to the technical specifications for your CPU.
- Sending data via an existing communication connection:  
You specify the send area with the DATA parameter. This includes the address and the length of the data to be sent. Do not use a data area with the data type BOOL or Array of BOOL at the DATA parameter. If you use purely symbolic values at the DATA parameter, the LEN parameter must have the value "0".
- The send job is executed when a rising edge is detected at the REQ parameter. With the LEN parameter, you specify the maximum number of bytes sent with a send job. When sending data (rising edge at the REQ parameter), the CONT parameter must have the value "1" in order to establish or maintain a connection. The data to be sent must not be edited until the send job is completed. If the send job executes successfully, the DONE parameter is set to "1". Signal state "1" at the DONE parameter is not confirmation that the data sent has already been read by the communication partner.
- Terminating the communication connection:  
The communication connection is terminated when the CONT parameter is set to "0" even if an ongoing data transmission is not complete yet. This does not apply if you are using an already configured connection for "TSEND\_C".

When setting the COM\_RST parameter to "1", the currently established connection or a current data transmission can be reset at any time. This terminates the existing communication connection and a new connection is established. If data is being transferred when it executes again, this can lead to a loss of data.

To enable "TSEND\_C" again after the execution (DONE = 1), call the instruction once with REQ = 0.

## Parameters

The following table shows the parameters of the "TSEND\_C" instruction:

Parameter	Declaration	Data type	Memory area	Description
REQ	Input	BOOL	I, Q, M, D, L	Starts the send job on a rising edge.
CONT	Input	BOOL	I, Q, M, D, L	Controls the communication connection: <ul style="list-style-type: none"> <li>• 0: Disconnect the communication connection</li> <li>• 1: Establish and maintain the communication connection</li> </ul> When sending data (rising edge at the REQ parameter), the CONT parameter must have the value TRUE in order to establish or maintain a connection.
LEN	Input	UINT	I, Q, M, D, L or constant	Maximum number of bytes to be sent with the job. If you use purely symbolic values at the DATA parameter, the LEN parameter must have the value "0".

Parameter	Declaration	Data type	Memory area	Description
CONNECT	InOut	TCON_Param	D	Pointer to the connection description See also: Auto-Hotspot
DATA	InOut	VARIANT	I, Q, M, D, L	Pointer to the send area containing the address and the length of the data to be sent.
COM_RST	InOut	BOOL	I, Q, M, D, L	Restarts the instruction: <ul style="list-style-type: none"> <li>• 0: Irrelevant</li> <li>• 1: Complete restart of the instruction causing an existing connection to be terminated and a new connection to be established.</li> </ul>
DONE	Output	BOOL	I, Q, M, D, L	Status parameter with the following values: <ul style="list-style-type: none"> <li>• 0: Job not yet started or still in progress</li> <li>• 1: Job completed without error</li> </ul>
BUSY	Output	BOOL	I, Q, M, D, L	Status parameter with the following values: <ul style="list-style-type: none"> <li>• 0: Job not yet started or already completed</li> <li>• 1: Job not yet completed. A new job cannot be started.</li> </ul>
ERROR	Output	BOOL	I, Q, M, D, L	Status parameter with the following values: <ul style="list-style-type: none"> <li>• 0: No error</li> <li>• 1: Error occurred</li> </ul>
STATUS	Output	WORD	I, Q, M, D, L	Status of the instruction

For additional information on valid data types, refer to "Overview of the valid data types (Page 1077)".

### Parameters BUSY, DONE and ERROR

You can check the status of the job with the BUSY, DONE, ERROR and STATUS parameters. The BUSY parameter indicates the processing status. With the DONE parameter, you can check whether or not a job executed successfully. The ERROR parameter is set when errors occurred during execution of "TSEND\_C". The error information is output at the STATUS parameter.

The following table shows the relationship between the BUSY, DONE and ERROR parameters:

BUSY	DONE	ERROR	Description
1	-	-	The job is being processed.
0	1	0	The job was completed successfully.
0	0	1	The job ended with an error. The cause of the error is specified in the STATUS parameter.
0	0	0	No new job was assigned.

**Parameters ERROR and STATUS**

ERROR	STATUS* (W#16#...)	Description
0	0000	Job completed without error.
0	0001	The connection establishment is complete.
0	0003	The connection termination is complete.
0	7000	No job processing active.
0	7001	<ul style="list-style-type: none"> <li>• Start execution of the job</li> <li>• Establish connection</li> <li>• Wait for connection partner</li> </ul>
0	7002	Data was sent.
0	7003	Connection is being terminated.
0	7004	Connection established and monitored, no job processing active.
0	7005	Data is currently being sent.
1	80A0	Group error for error codes 80A1 and 80A2.
1	80A1	<ul style="list-style-type: none"> <li>• Connection or port already being used by user.</li> <li>• Communication error:                             <ul style="list-style-type: none"> <li>– The specified connection has not yet been established.</li> <li>– The specified connection is being terminated. Transfer via this connection is not possible.</li> <li>– The interface is being re-initialized.</li> </ul> </li> </ul>
1	80A2	Local or remote port is being used by the system.
1	80A3	Attempt being made to terminate a non-existent connection.
1	80A4	IP address of the remote endpoint of the connection is invalid, in other words, it matches the IP address of the local partner.
1	80A7	Communication error: You called the instruction with COM_RST = 1 before the send job was complete.
1	80B2	The CONNECT parameter points to a data block that was generated with the attribute "Only store in load memory".
1	80B3	Inconsistent parameter assignment: Group error for error codes 80A0 to 80A2, 80A4, 80B4 to 80B9.
1	80B4	You have violated one or both of the following conditions for passive connection establishment (active_est = FALSE) when using the ISO-on-TCP protocol variant (connection_type = B#16#12): "local_tsap_id_len >= B#16#02", and/or "local_tsap_id[1] = B#16#E0".
1	80B5	Only passive connection establishment is permitted for connection type 13 = UDP.
1	80B6	Parameter assignment error in the connection_type parameter of the data block for connection description.
1	80B7	Error in one of the following parameters of the data block for connection description: block_length, local_tsap_id_len, rem_subnet_id_len, rem_staddr_len, rem_tsap_id_len, next_staddr_len.
1	8085	The LEN parameter is larger than the highest permitted value.
1	8086	The ID parameter within the CONNECT parameter is outside the permitted range.
1	8087	Maximum number of connections reached; no additional connection possible.
1	8088	The value at the LEN parameter does not correspond to the receive area set at the DATA parameter.
1	8089	The CONNECT parameter does not point to a data block.

ERROR	STATUS* (W#16#...)	Description
1	8091	Maximum nesting depth exceeded.
1	809A	The CONNECT parameter points to a field that does not correspond to the length of the connection description.
1	809B	The ID of the local device in the connection description does not correspond to the CPU.
1	80C3	<ul style="list-style-type: none"> <li>All connection resources are in use.</li> <li>A block with this ID is already being processed in a different priority group.</li> </ul>
1	80C4	Temporary communication error: <ul style="list-style-type: none"> <li>The connection cannot be established at this time.</li> <li>The interface is receiving new parameters or the connection is being established.</li> <li>The configured connection is currently being removed by a "TDISCON" instruction.</li> <li>The connection used is being terminated by a call with COM_RST= 1.</li> </ul>
1	80C6	Remote network error. Remote partner cannot be reached.
1	8722	Parameter CONNECT: The source area is invalid. The area does not exist in the DB.
1	873A	Parameter CONNECT: Access to the connection description is not possible (for example, DB does not exist).
1	877F	Parameter CONNECT: Internal error.
1	8822	Parameter DATA: Invalid source area, the area does not exist in the DB.
1	8824	Parameter DATA: Area error in the VARIANT pointer.
1	8832	Parameter DATA: The DB number is too high.
1	883A	Parameter CONNECT: Access to specified connection data not possible (e.g. because the DB does not exist).
1	887F	Parameter DATA: Internal error, e.g. invalid VARIANT reference.
1	893A	Parameter DATA: Access to send area not possible (e.g. because the DB does not exist).
* The error codes can be displayed as integer or hexadecimal values in the program editor. For additional information on toggling display formats, refer to "See also".		

### Note

#### Error messages of the instructions "TCON", "TSEND", "T\_DIAG" and "TDISCON"

Internally, the "TSEND\_C" instruction uses the instructions "TCON (Page 2877)", "TSEND (Page 2889)", "T\_DIAG (Page 2909)", "T\_RESET (Page 2907)" and "TDISCON (Page 2884)". The error messages of these instructions can also be output at the STATUS parameter. The meaning of the error codes is described in the corresponding instructions. In the event of identical error codes for internally used instructions with different meanings, the instance data block of "TSEND\_C" can be used to determine which instruction output the error.

## TSEND\_C: Send data via Ethernet

### Description

The following description of the "TSEND\_C" instruction is valid for the CPU S7-1500 and S7-1200 V4.0.

The "TSEND\_C" instruction sets up and establishes a communications connection. Once the connection has been set up and established, it is automatically maintained and monitored by the CPU.

The instruction is executed asynchronously and has the following functions:

- Setting up and establishing a communication connection
- Sending data via an existing communication connection
- Terminating or resetting the communication connection

Internally, the instruction "TSEND\_C" uses the communication instructions TCON", "TSEND", "T\_DIAG", "T\_RESET" and "TDISCON".

### Setting up and establishing a communication connection

The communication connection is set up and established with CONT=1. For information on the number of possible communication connections, refer to the technical specifications for your CPU. The connection description specified at the CONNECT parameter is used to set up the communication connection. The following connection types can be used:

- Programmed connections (structure of connection via "TCON"):
  - TCP / UDP: Connection description via the TCON\_IP\_v4 system data type
  - ISO-on-TCP: Connection description via the TCON\_IP\_RFC system data type
  - ISO: Connection description via the TCON\_ISOnative system data type (for CP1543-1 only)
- Configured connections
  - Specify an existing connection in the TCON\_Configured system data type.

An existing connection is terminated and the connection which has been set up is removed when the CPU goes into STOP mode. To set up and establish the connection again, you must execute "TSEND\_C" again.

### Sending data via an existing communication connection

The send job is executed when a rising edge is detected at the REQ parameter. As described above, the communication connection is established first.

You specify the send area with the DATA parameter. This includes the address and the length of the data to be sent. Do not use a data area with the data type BOOL or Array of BOOL at the DATA parameter. With the LEN parameter, you specify the maximum number of bytes sent with a send job. If you use a send area with optimized access at the DATA parameter, the LEN parameter must have the value "0".

The data to be sent must not be edited until the send job is completed.

### Terminating and resetting the communication connection

The communication connection is terminated when the CONT parameter is set to "0" even if an ongoing data transmission is not complete yet. This does not apply if you are using a configured connection for "TSEND\_C".



The connection can be reset at any time by setting the parameter COM\_RST to "1". This terminates the existing communication connection and a new connection is established. If data is being transferred at this time, this can lead to data loss.

## Parameters

The following table shows the parameters of the "TSEND\_C" instruction:

Parameter	Declaration	Data type	Memory area	Description
REQ	Input	BOOL	I, Q, M, D, L, T, C or constant	Starts the send job on a rising edge.
CONT	Input	BOOL	I, Q, M, D, L	Controls the communication connection: <ul style="list-style-type: none"> <li>0: Disconnect the communications connection.</li> <li>1: Establish and maintain the communication connection.</li> </ul>
LEN	Input	UDINT	I, Q, M, D, L or constant	Optional parameter (hidden) Maximum number of bytes to be sent with the job. If you use a send area with optimized access at the DATA parameter, the value "0" must be used at the LEN parameter.
CONNECT	InOut	VARIANT	D	Pointer to the structure of the connection description: <ul style="list-style-type: none"> <li>Programmed connection: <ul style="list-style-type: none"> <li>For TCP, use the TCON_IP_v4 system data type For description, refer to:Auto-Hotspot</li> <li>For ISO-on-TCP, use the TCON_IP_RFC system data type For description, refer to: Auto-Hotspot</li> <li>For ISO, use the TCON_ISOnative system data type (only for CP1543-1) For description, refer to instruction "TCON (Page 2880)".</li> </ul> </li> <li>Configured connection: <ul style="list-style-type: none"> <li>For existing connections, use the TCON_Configured system data type For a description see "System data type for configured connections" below</li> </ul> </li> </ul>
DATA	InOut	VARIANT	I, Q, M, D, L	Pointer to the send area containing the address and the length of the data to be sent.
ADDR	InOut	VARIANT	D	Optional parameter (hidden) Pointer to the address of the recipient.
COM_RST	InOut	BOOL	I, Q, M, D, L	Optional parameter (hidden) Resets the connection: <ul style="list-style-type: none"> <li>0: Irrelevant</li> <li>1: The existing connection is reset.</li> </ul> The COM_RST parameter is reset after evaluation by the "TSEND_C" instruction and should not, therefore, be interconnected statically.

Parameter	Declaration	Data type	Memory area	Description
DONE	Output	BOOL	I, Q, M, D, L	Status parameter with the following values: <ul style="list-style-type: none"> <li>• 0: Send job not yet started or still in progress.</li> <li>• 1: Send job executed without error. This state is only displayed for one cycle.</li> </ul> The output parameter DONE is set if an intermediate step was completed successfully during processing (connection establishment, sending, connection termination) and if the execution of "TSEND_C" was completed successfully.
BUSY	Output	BOOL	I, Q, M, D, L	Status parameter with the following values: <ul style="list-style-type: none"> <li>• 0: Send job not yet started or already completed.</li> <li>• 1: Send job not yet completed. A new send job cannot be started.</li> </ul>
ERROR	Output	BOOL	I, Q, M, D, L	Status parameter with the following values: <ul style="list-style-type: none"> <li>• 0: No error</li> <li>• 1: Error occurred during connection establishment, data transmission or connection termination.</li> </ul> The output parameter ERROR can be set due to an error in the "TSEND_C" instruction or the communication instructions used internally.
STATUS	Output	WORD	I, Q, M, D, L	Status of instruction (see the "ERROR and STATUS" parameters" description).

For additional information on valid data types, refer to "Overview of the valid data types (Page 1077)".

### Parameters REQ, CONT and COM\_RST

The parameter CONT controls the connection establishment of the "TSEND\_C" instruction regardless of the REQ parameter. The behavior of the CONT parameter partially depends on whether a programmed or a configured connection is used:

- With CONT = "0": No data is sent (regardless of whether a programmed or a configured connection is used).
- When changing CONT = "0" to "1":
  - With a programmed connection, it is established with "TCON".
  - With a configured connection, it is checked with "T\_DIAG".
- With CONT = "1":
  - As long as no data is sent (REQ="0"), the connection is checked with "T\_DIAG".
  - If the internally used communication instructions signal that no connection end point exists, the connection is automatically reestablished with "TCON".
- When changing CONT = "1" to "0":
  - With a programmed connection, it is terminated with "TDISCON".
  - With a configured connection, it is reset with "T\_RESET".

The parameter COM\_RST resets the connection when changing from "0" to "1":

- If a connection is established, it is reset with "T\_RESET" (regardless of whether a programmed or configured connection is used).
- If no connection is established, the setting of the parameter has no effect.

The parameters REQ and COM\_RST are only active if CONT was set to "1". The following table shows the relationship between the REQ, CONT and COM\_RST parameters:

REQ	CONT	COM_RST	Status of the instruction	Description
irrelevant	0	irrelevant	Not yet executed	No job active (STATUS = 7000).
irrelevant	0	irrelevant	Initialization	Connection is being terminated. The instruction is being reset.
irrelevant	0 > 1	irrelevant	Connection establishment	Connection is being established. Data is not being transferred yet.
0	1	0	Connection established	The connection is established and is monitored with the instruction "T_DIAG".
irrelevant	1	0 > 1	Connection established	The connection is interrupted by "T_RESET" briefly and reset.
0 > 1	1	0	Connection established	Instruction starts sending.
irrelevant	1	0 > 1	Data is being sent	Data transmission is interrupted. The connection is being reset.

### System data type for configured connections

For configured connections at the CONNECT parameter, use the following structure for connection description to TCON\_Configured:

Byte	Parameter	Data type	Start value	Description
0 ... 1	InterfaceID	HW_ANY	-	Hardware identifier of the local interface (value range: 0 to 65535).
2 ... 3	ID	CONN_OUC	-	Reference to the connection (value range: 1 to 4095). Enter the connection ID of the existing connection.
4	ConnectionType	BYTE	-	Connection type Select 254 (decimal) for a configured connection.

### Parameters BUSY, DONE and ERROR

You can check the status of the job with the BUSY, DONE, ERROR and STATUS parameters. The BUSY parameter indicates the processing status. With the DONE parameter, you can check whether or not a send job executed successfully. The ERROR parameter is set when errors occurred during execution of "TSEND\_C". The error information is output at the STATUS parameter.

The following table shows the relationship between the BUSY, DONE and ERROR parameters:

DONE	BUSY	ERROR	Description
0	0	0	The instruction has not been executed yet (no positive edge at REQ parameter).
0	1	0	The instruction is being executed and calls the internally used communication instructions.
1	0	0	The send job was completed successfully. "0000" is output at the STATUS parameter. DONE = "1" is only displayed for one cycle.
0	0	1	The execution of the instruction or an intermediate step during processing was terminated with an error. If there is a subsequent error due to an internally used communication instruction, the error that occurred first during processing is displayed. This state is only displayed for one cycle.

### Parameters ERROR and STATUS

ERROR	STATUS* (W#16#...)	Description
0	0000	Send job was executed without error.
0	0001	The connection establishment is complete.
0	0003	The connection termination is complete.
0	7000	No active send job execution; no communication connection established.
0	7001	<ul style="list-style-type: none"> <li>• Start send job execution.</li> <li>• Establish connection.</li> <li>• Wait for connection partner.</li> </ul>
0	7002	Data is being sent.
0	7003	Communication connection is being terminated.
0	7004	Communication connection established and monitored; no send job execution active.
0	7005	Communication connection is being reset.
1	80A1	<ul style="list-style-type: none"> <li>• Connection or port already being used by user.</li> <li>• Communication error:                             <ul style="list-style-type: none"> <li>– The specified connection has not yet been established.</li> <li>– The specified connection is being terminated. Transfer via this connection is not possible.</li> <li>– The interface is being re-initialized.</li> </ul> </li> </ul>
1	80A3	Attempt being made to terminate a non-existent connection.
1	80A4	IP address of the remote endpoint of the connection is invalid or it matches the IP address of the local partner.
1	80A7	Communication error: You called the instruction with COM_RST = 1 before the send job was complete.
1	80B4	You have violated one or both of the following conditions for passive connection establishment (active_est = FALSE) when using the ISO-on-TCP protocol variant (connection_type = B#16#12): <ul style="list-style-type: none"> <li>• local_tsap_id_len &gt;= B#16#02</li> <li>• local_tsap_id[1] = B#16#E0</li> </ul>
1	80B5	Only passive connection establishment is permitted for connection type 13 = UDP.
1	80B6	Parameter assignment error in the connection_type parameter of the data block for connection description.

ERROR	STATUS* (W#16#...)	Description
1	80B7	Error in one of the following parameters of the data block for connection description: block_length, local_tsap_id_len, rem_subnet_id_len, rem_staddr_len, rem_tsap_id_len, next_staddr_len.
1	8085	The LEN parameter is larger than the highest permitted value.
1	8086	The ID parameter within the CONNECT parameter is outside the permitted range.
1	8087	Maximum number of connections reached; no additional connection possible.
1	8088	The value at the LEN parameter does not correspond to the receive area set at the DATA parameter.
1	8089	The CONNECT parameter does not point to a data block.
1	8091	Maximum nesting depth exceeded.
1	809A	The CONNECT parameter points to a field that does not correspond to the length of the connection description.
1	809B	InterfaceID is invalid. It is either zero or it does not point to a local CPU interface or a CP.
1	80C3	<ul style="list-style-type: none"> <li>• All connection resources are in use.</li> <li>• A block with this ID is already being processed in a different priority group.</li> </ul>
1	80C4	Temporary communication error: <ul style="list-style-type: none"> <li>• The connection cannot be established at this time.</li> <li>• The interface is receiving new parameters or the connection is being established.</li> <li>• The configured connection is currently being removed by a "TDISCON (Page 2884)" instruction.</li> <li>• The connection used is being terminated by a call with COM_RST = 1.</li> </ul>
1	80C6	Remote network error. Remote partner cannot be reached.
1	8722	Parameter CONNECT: The source area is invalid. The area does not exist in the DB.
1	873A	Parameter CONNECT: Access to the connection description is not possible (for example, because the DB is not available).
1	877F	Parameter CONNECT: Internal error.
1	8822	Parameter DATA: Invalid source area, the area does not exist in the DB.
1	8824	Parameter DATA: Area error in the VARIANT pointer.
1	8832	Parameter DATA: The DB number is too high.
1	883A	Parameter CONNECT: Access to specified connection data not possible (e.g. because the DB does not exist).
1	887F	Parameter DATA: Internal error, e.g. invalid VARIANT reference.
1	893A	Parameter DATA: Access to send area not possible (e.g. because the DB does not exist).
* The error codes can be displayed as integer or hexadecimal values in the program editor. For additional information on toggling display formats, refer to "See also".		

---

**Note**

**Error messages of the instructions "TCON", "TSEND", "T\_DIAG", "T\_RESET" and "TDISCON"**

Internally, the "TSEND\_C" instruction uses the instructions "TCON (Page 2880)", "TSEND (Page 2889)", "T\_DIAG (Page 2909)", "T\_RESET (Page 2907)" and "TDISCON (Page 2884)". The error messages of these instructions can also be output at the STATUS parameter. The meaning of the error codes is described in the corresponding instructions. In the event of identical error codes for internally used instructions with different meanings, the instance data block of "TSEND\_C" can be used to determine which instruction output the error.

---

## TRCV\_C: Receive data via Ethernet

## TRCV\_C: Receive data via Ethernet

### Description

The "TRCV\_C" instruction is executed asynchronously and has the following functions:

**1. Setting up and establishing a communication connection:**

"TRCV\_C" sets up and establishes a TCP or ISO-on-TCP communication connection. Once the connection has been set up and established, it is automatically maintained and monitored by the CPU.

The connection description specified at the CONNECT parameter is used to set up the communication connection. To establish a connection, the CONT parameter must be set to the value "1". Once the connection is successfully established, the DONE parameter is set to "1".

An existing connection is terminated and the connection which has been set up is removed when the CPU goes into STOP mode. To set up and establish the connection again, you must execute "TRCV\_C" again.

For information on the number of possible communication connections, refer to the technical specifications for your CPU.

**2. Receiving data via an existing communication connection:**

If the EN\_R parameter is set to the value "1", receipt of data is enabled. When receiving data (rising edge at the EN\_R parameter), the CONT parameter must have the value TRUE in order to establish or maintain a connection.

The received data is entered in a receive area. You specify the length of the receive area either with the LEN parameter (if LEN <> 0) or with the length information of the DATA parameter (if LEN = 0) in accordance with the protocol variant used. If you use purely symbolic values at the DATA parameter, the LEN parameter must have the value "0".

After data has been received successfully, the signal state at the DONE parameter is "1". If errors occur in the data transfer, the DONE parameter is set to "0".

**3. Terminating the communication connection:**

The communication connection is terminated when the CONT parameter is set to "0".

TRCV\_C is executed again when the COM\_RST parameter is set. This terminates the existing communication connection and a new connection is established. If data is being received when it executes again, this can lead to a loss of data.

## Receive modes of TRCV\_C

The following table shows how the received data is entered in the receive area.

Protocol variant	Availability of data in the receive area	connection_type parameter of the connection description	Parameter LEN
TCP (Ad-hoc mode)	The data is immediately available.	Hexadecimal value: B#16#11 Integer value: 17	0
TCP (Receipt of data with specified length)	The data is available as soon as the data length specified at the LEN parameter has been fully received.	Hexadecimal value: B#16#11 Integer value: 17	1 to 8192
ISO on TCP (Message-oriented data transfer)	The data is available as soon as the data length specified at the LEN parameter has been fully received.	Hexadecimal value: B#16#12 Integer value: 18	<ul style="list-style-type: none"> <li>• 1 to 1452, if a CP is used.</li> <li>• 1 to 8192, if no CP is used.</li> </ul>

### TCP (Ad-hoc mode)

The ad-hoc mode is only available with the TCP protocol variant. You use the ad-hoc mode to receive data with dynamic length with the "TRCV" instruction.

You set ad-hoc mode by assigning the value "0" to the LEN parameter. All data types can be used for data blocks with standard access when you use ad-hoc mode. Only ARRAY of BYTE or data types with a length of 8 bits can be used for data blocks with optimized access (e.g., CHAR, USINT, SINT, etc.). The data length actually received is output at the RCVD\_LEN parameter.

### TCP (Receipt of data with specified length)

You use the value of the LEN parameter to specify the length for the data receipt. The data receipt is not complete until the length of data specified at the LEN parameter has been completely received. Only then is the data available in the receive area (DATA parameter). The actually received data length in bytes at the RCVD\_LEN parameter corresponds to the data length at the LEN parameter after receipt.

### ISO on TCP (Message-oriented data transfer)

Complete message blocks are sent via a connection with the protocol variant ISO on TCP; these are recognized as such by the recipient. When using ISO on TCP, "TRCV\_C" signals data receipt as soon as the message block has been completely received. The receive area is defined by the LEN and DATA parameters. If the receive buffer (DATA parameter) is too small for the sent data, "TRCV\_C" signals an error. The actually received data length in bytes at the RCVD\_LEN parameter corresponds to the data length at the LEN parameter after receipt.

**Parameters**

The following table shows the parameters of the "TRCV\_C" instruction:

Parameter	Declaration	Data type	Memory area	Description
EN_R	Input	BOOL	I, Q, M, D, L	Receive enable
CONT	Input	BOOL	I, Q, M, D, L	Controls the communication connection: <ul style="list-style-type: none"> <li>• 0: Automatically disconnect communication connection after data have been sent</li> <li>• 1: Establish and maintain the communication connection</li> </ul> When receiving data (rising edge at the EN_R parameter), the CONT parameter must have the value TRUE in order to establish or maintain a connection.
LEN	Input	UINT	I, Q, M, D, L or constant	Maximum length of the data to be received. If you use purely symbolic values at the DATA parameter, the LEN parameter must have the value "0".
CONNECT	InOut	TCON_Param	D	Pointer to the connection description See also: Auto-Hotspot
DATA	InOut	VARIANT	I, Q, M, D, L	Pointer to the receive area
COM_RST	InOut	BOOL	I, Q, M, D, L	Restarts the instruction: <ul style="list-style-type: none"> <li>• 0: Irrelevant</li> <li>• 1: Complete restart of the instruction causing an existing connection to be terminated</li> </ul>
DONE	Output	BOOL	I, Q, M, D, L	Status parameter with the following values: <ul style="list-style-type: none"> <li>• 0: Job not yet started or still in progress</li> <li>• 1: Job completed without error</li> </ul>
BUSY	Output	BOOL	I, Q, M, D, L	Status parameter with the following values: <ul style="list-style-type: none"> <li>• 0: Job not yet started or already completed</li> <li>• 1: Job not yet completed. A new job cannot be started</li> </ul>
ERROR	Output	BOOL	I, Q, M, D, L	Status parameter ERROR: <ul style="list-style-type: none"> <li>• 0: No error</li> <li>• 1: Error occurred</li> </ul>
STATUS	Output	WORD	I, Q, M, D, L	Status of the instruction
RCVD_LEN	Output	UDINT	I, Q, M, D, L	Amount of data actually received in bytes

For additional information on valid data types, refer to "Overview of the valid data types (Page 1077)".

**Parameters BUSY, DONE and ERROR**

You can check the status of the job with the BUSY, DONE, ERROR and STATUS parameters. The BUSY parameter indicates the processing status. With the DONE parameter, you can check whether or not a job executed successfully. The ERROR parameter is set when errors



occurred during execution of "TRCV\_C". The error information is output at the STATUS parameter.

The following table shows the relationship between the BUSY, DONE and ERROR parameters:

BUSY	DONE	ERROR	Description
1	-	-	The job is being processed.
0	1	0	The job was completed successfully.
0	0	1	The job ended with an error. The cause of the error is output at the STATUS parameter.
0	0	0	No new job was assigned.

### Parameters ERROR and STATUS

ERROR	STATUS* (W#16#...)	Description
0	0000	Job completed without error.
0	0001	The connection establishment is complete.
0	0003	The connection termination is complete.
0	7000	No job processing active.
0	7001	<ul style="list-style-type: none"> <li>Start execution of the job</li> <li>Establish connection</li> <li>Wait for connection partner</li> </ul>
0	7002	Data is being received.
0	7003	Connection is being terminated.
0	7004	<ul style="list-style-type: none"> <li>Connection established and monitored</li> <li>No job processing active</li> </ul>
0	7006	Data is currently being received.
1	8085	<ul style="list-style-type: none"> <li>The LEN parameter is larger than the highest permitted value.</li> <li>The value at the LEN or DATA parameter was changed after the first call.</li> </ul>
1	8086	The ID parameter is outside the permitted range.
1	8087	Maximum number of connections reached; no additional connection possible
1	8088	The value at the LEN parameter does not correspond to the receive area set at the DATA parameter.
1	8089	The CONNECT parameter does not point to a data block.
1	8091	Maximum nesting depth exceeded.
1	809A	The CONNECT parameter points to a field that does not correspond to the length of the connection description.
1	809B	The ID of the local device (local_device_id) in the connection description does not correspond to the CPU.
1	80A0	Group error for error codes W#16#80A1 and W#16#80A2.

9.7 References

ERROR	STATUS* (W#16#...)	Description
1	80A1	<ul style="list-style-type: none"> <li>• Connection or port already being used by user.</li> <li>• Communication error:                             <ul style="list-style-type: none"> <li>– The specified connection has not yet been established.</li> <li>– The specified connection is being terminated. Transfer via this connection is not possible.</li> <li>– The interface is being re-initialized.</li> </ul> </li> </ul>
1	80A2	Local or remote port is being used by the system.
1	80A3	<ul style="list-style-type: none"> <li>• Attempt being made to re-establish an existing connection.</li> <li>• Attempt being made to terminate a non-existent connection.</li> </ul>
1	80A4	IP address of the remote endpoint of the connection is invalid, in other words, it matches the IP address of the local partner.
1	80A7	Communication error: You called the instruction with COM_RST = 1 before the send job was complete.
1	80B2	The CONNECT parameter points to a data block that was generated with the attribute "Only store in load memory".
1	80B3	Inconsistent parameter assignment: Group error for error codes W#16#80A0 to W#16#80A2, W#16#80A4, W#16#80B4 to W#16#80B9.
1	80B4	You have violated one or both of the following conditions for passive connection establishment (active_est = FALSE) when using the ISO-on-TCP protocol variant (connection_type = B#16#12): "local_tsap_id_len >= B#16#02", and/or "local_tsap_id[1] = B#16#E0".
1	80B5	Only passive connection establishment is permitted for connection type 13 = UDP.
1	80B6	Parameter assignment error in the connection_type parameter of the data block for connection description.
1	80B7	Error in one of the following parameters of the data block for connection description: block_length, local_tsap_id_len, rem_subnet_id_len, rem_staddr_len, rem_tsap_id_len, next_staddr_len.
1	80C3	<ul style="list-style-type: none"> <li>• All connection resources are in use.</li> <li>• A block with this ID is already being processed in a different priority group.</li> </ul>
1	80C4	Temporary communication error: <ul style="list-style-type: none"> <li>• The connection cannot be established at this time.</li> <li>• The interface is receiving new parameters or the connection is being established.</li> <li>• The configured connection is currently being removed by a "TDISCON" instruction.</li> <li>• The connection used is being terminated by a call with COM_RST= 1.</li> </ul>
1	8722	Error in the CONNECT parameter: Invalid source area (area not declared in data block).
1	873A	Error in the CONNECT parameter: Access to connection description is not possible (no access to data block).
1	877F	Error in the CONNECT parameter: Internal error
1	8922	Parameter DATA: Invalid target area; the area does not exist in the DB.
1	8924	Parameter DATA: Area error in the VARIANT pointer.
1	8932	Parameter DATA: The DB number is too high.
1	893A	Parameter CONNECT: Access to specified connection data not possible (e.g. because the DB does not exist).
1	897F	Parameter DATA: Internal error, e.g. invalid VARIANT reference.

ERROR	STATUS* (W#16#...)	Description
1	8A3A	Parameter DATA: No access to the data area, for example because the data block does not exist.
* The error codes can be displayed as integer or hexadecimal values in the program editor. For additional information on toggling display formats, refer to "See also".		

**Note****Error messages of the instructions "TCON", "TRCV" and "TDISCON"**

Internally, the TRV\_C instruction uses the "TCON (Page 2877)", "TRCV (Page 2892)" and "TDISCON (Page 2884)" instructions. The error messages of these instructions are contained in the respective descriptions.

**TRCV\_C: Receive data via Ethernet****Description**

The following description of the "TRCV\_C" instruction is valid for the CPU S7-1500 and S7-1200 V4.0.

The "TRCV\_C" instruction is executed asynchronously and implements the following functions in sequence:

- Setting up and establishing a communication connection
- Receiving data via an existing communication connection
- Terminating or resetting the communication connection

Internally, the instruction "TRCV\_C" uses the communication instructions "TCON", "TRCV", "T\_DIAG", "T\_RESET" and "TDISCON".

**Setting up and establishing a communication connection**

The communication connection is set up and established with CONT=1. For information on the number of possible communication connections, refer to the technical specifications for your CPU. The connection description specified at the CONNECT parameter is used to set up the communication connection. The following connection types can be used:

- Programmed connections (structure of connection via "TCON"):
  - TCP / UDP: Connection description via the TCON\_IP\_v4 system data type
  - ISO-on-TCP: Connection description via the TCON\_IP\_RFC system data type
  - ISO: Connection description via the TCON\_ISOnative system data type (for CP1543-1 only)
- Configured connections
  - Specify an existing connection in the TCON\_Configured system data type.

An existing connection is terminated and the connection which has been set up is removed when the CPU goes into STOP mode. To set up and establish the connection again, you must execute "TRCV\_C" again.

### Receiving data via an existing communication connection

Receipt of data is enabled when the EN\_R parameter is set to the value "1". The received data is entered in a receive area. You specify the length of the receive area either with the LEN parameter (if LEN <> 0) or with the length information of the DATA parameter (if LEN = 0), depending on the protocol variant being used. If you use purely symbolic values at the DATA parameter, the LEN parameter must have the value "0".

Receive modes of TRCV\_C:

- **TCP (Ad-hoc mode)**  
 The ad-hoc mode is only available with the TCP protocol variant. You use the ad-hoc mode to receive data with dynamic length with the "TRCV\_C" instruction. You set ad-hoc mode by assigning the value "1" to the ADHOC parameter. All data types can be used for data blocks with standard access when you use ad-hoc mode. Only ARRAY of BYTE or data types with a length of 8 bits can be used for data blocks with optimized access (e.g., CHAR, USINT, SINT, etc.). The data length actually received is output at the RCVD\_LEN parameter.
- **TCP (Receipt of data with specified length)**  
 Assign the value "0" to the ADHOC parameter for receipt of data with specified length. If ad-hoc mode is disabled, the data receipt is not complete until the length of data specified at the LEN parameter has been completely received. Only then is the data available in the receive area (DATA parameter). The actually received data length in bytes at the RCVD\_LEN parameter corresponds to the data length at the LEN parameter after receipt.
- **ISO on TCP (Message-oriented data transfer)**  
 Complete message blocks are sent via a connection with the protocol variant ISO on TCP; these are recognized as such by the recipient. The receive area is defined by the LEN and DATA parameters. If the receive buffer (DATA parameter) is too small for the sent data, "TRCV\_C" signals an error. The actually received data length in bytes at the RCVD\_LEN parameter corresponds to the data length at the LEN parameter after receipt.

The following table shows how the received data is entered in the receive area.

Protocol variant	Availability of data in the receive area	connection_type parameter of the connection description	Parameter LEN
TCP (Ad-hoc mode)	The data is immediately available.	Hexadecimal value: B#16#11 Integer value: 17	1 up to maximum length (depending on the CPU)
TCP (Receipt of data with specified length)	The data is available as soon as the data length specified at the LEN parameter has been fully received.	Hexadecimal value: B#16#11 Integer value: 17	1 to 8192
ISO on TCP (Message-oriented data transfer)	The data is available as soon as the data length specified at the LEN parameter has been fully received.	Hexadecimal value: B#16#12 Integer value: 18	1 to 8192

## Terminating the communication connection

The communication connection is terminated when the CONT parameter is set to "0" even if an ongoing data transmission is not complete yet. This does not apply if you are using a configured connection, however.

The connection can be reset at any time by setting the parameter COM\_RST to "1". This terminates the existing communication connection and a new connection is established. If data is being transferred at this time, this can lead to data loss.

## Parameters

The following table shows the parameters of the "TRCV\_C" instruction:

Parameter	Declaration	Data type	Memory area	Description
EN_R	Input	BOOL	I, Q, M, D, L, T, C or constant	Receive enable
CONT	Input	BOOL	I, Q, M, D, L	Controls the communication connection: <ul style="list-style-type: none"> <li>• 0: Automatically disconnect communication connection after data has been received.</li> <li>• 1: Establish communication connection and maintain after receipt of data.</li> </ul>
LEN	Input	UDINT	I, Q, M, D, L or constant	Maximum length of the data to be received. If you use a receive area with optimized access at the DATA parameter, the value "0" must be used at the LEN parameter.
ADHOC	Input	BOOL	I, Q, M, D, L or constant	Optional parameter (hidden) Use ad-hoc mode for the TCP protocol variant.
CONNECT	InOut	VARIANT	D	Pointer to the connection description <ul style="list-style-type: none"> <li>• Programmed connection: <ul style="list-style-type: none"> <li>– For TCP or UDP, use the structure TCON_IP_v4 For description, refer to:Auto-Hotspot</li> <li>– For ISO-on-TCP, use the structure TCON_IP_RFC For description, refer to: Auto-Hotspot</li> <li>– For ISO, use the structure TCON_ISOnative (only for CP1543-1) For description, refer to instruction "TCON (Page 2880)": "Structure of the connection description according to TCON_ISOnative"</li> </ul> </li> <li>• Configured connection: <ul style="list-style-type: none"> <li>– For existing connections, use the TCON_Configured system data type. For a description, see "System data type for configured connections" below.</li> </ul> </li> </ul>
DATA	InOut	VARIANT	I, Q, M, D, L	Pointer to the receive area.
ADDR	InOut	VARIANT	D	Optional parameter (hidden) Pointer to the address of the sender with connection type UDP.

Parameter	Declaration	Data type	Memory area	Description
COM_RST	InOut	BOOL	I, Q, M, D, L	Optional parameter (hidden) Resets the connection: <ul style="list-style-type: none"> <li>• 0: Irrelevant</li> <li>• 1: The existing connection is reset.</li> </ul> The COM_RST parameter is reset after evaluation by the "TRCV_C" instruction and should not, therefore, be interconnected statically.
DONE	Output	BOOL	I, Q, M, D, L	Status parameter with the following values: <ul style="list-style-type: none"> <li>• 0: Receipt not yet started or still in progress.</li> <li>• 1: Receipt executed without error. This state is only displayed for one cycle.</li> </ul> The output parameter DONE is set if an intermediate step was completed successfully during processing (connection establishment, receipt, connection termination) and if the execution of "TRCV_C" was completed successfully.
BUSY	Output	BOOL	I, Q, M, D, L	Status parameter with the following values: <ul style="list-style-type: none"> <li>• 0: Receipt not yet started or already completed.</li> <li>• 1: Receipt not yet completed. A new send job cannot be started.</li> </ul>
ERROR	Output	BOOL	I, Q, M, D, L	Status parameter with the following values: <ul style="list-style-type: none"> <li>• 0: No error</li> <li>• 1: Error occurred during connection establishment, data receipt or connection termination.</li> </ul> The output parameter ERROR can be set due to an error in the "TRCV_C" instruction or the communication instructions used internally.
STATUS	Output	WORD	I, Q, M, D, L	Status of the instruction
RCVD_LEN	Output	UDINT	I, Q, M, D, L	Amount of data actually received in bytes

For additional information on valid data types, refer to "Overview of the valid data types (Page 1077)".

### Parameters EN\_R, CONT and COM\_RST

The parameter CONT controls the connection establishment of the "TRCV\_C" instruction regardless of the EN\_R parameter. The behavior of the CONT parameter partially depends on whether a programmed or a configured connection is used:

- With CONT = "0": No data is received (regardless of whether a programmed or a configured connection is used).
- When changing CONT = "0" to "1":
  - With a programmed connection, it is established with "TCON".
  - With a configured connection, it is checked with "T\_DIAG".

- With CONT = "1":
  - As long as no data is received (EN\_R="0"), the connection is checked with "T\_DIAG".
  - If the internally used communication instructions signal that no connection end point exists, the connection is automatically reestablished with "TCON".
- When changing CONT = "1" to "0":
  - With a programmed connection, it is terminated with "TDISCON".
  - With a configured connection, it is reset with "T\_RESET".

The parameter COM\_RST resets the connection when changing from "0" to "1":

- If a connection is established, it is reset with "T\_RESET" (regardless of whether a programmed or configured connection is used).
- If no connection is established, the setting of the parameter has no effect.

The parameters EN\_R and COM\_RST are only active if CONT was set to "1". The following table shows the relationship between the EN\_R, CONT and COM\_RST parameters:

EN_R	CONT	COM_RST	Status of the instruction	Description
irrelevant	0	irrelevant	Not yet executed	No job active (STATUS = 7000).
irrelevant	0	irrelevant	Initialization	Connection is being terminated. The instruction is being reset.
irrelevant	0 > 1	irrelevant	Connection establishment	Connection is being established. Data is not being transferred yet.
0	1	0	Connection established	The connection is established and is monitored with the instruction "T_DIAG".
irrelevant	1	0 > 1	Connection established	The connection is interrupted by "T_RESET" briefly and reset.
0 > 1	1	0	Connection established	Instruction starts receiving.
irrelevant	1	0 > 1	Data is being received	Data transmission is interrupted. The connection is being reset.

### System data type for configured connections

For configured connections at the CONNECT parameter, use the following structure for connection description to TCON\_Configured:

Byte	Parameter	Data type	Start value	Description
0 ... 1	InterfaceID	HW_ANY	-	Hardware identifier of the local interface (value range: 0 to 65535).
2 ... 3	ID	CONN_OUC	-	Reference to the connection (value range: 1 to 4095). Enter the connection ID of the existing connection.
4	ConnectionType	BYTE	-	Connection type Select 254 (decimal) for a configured connection.

### Parameters BUSY, DONE and ERROR

You can check the status of the job with the BUSY, DONE, ERROR and STATUS parameters. The BUSY parameter indicates the processing status. With the DONE parameter, you can check whether or not a job executed successfully. The ERROR parameter is set when errors occurred during execution of "TRCV\_C". The error information is output at the STATUS parameter.

The following table shows the relationship between the BUSY, DONE and ERROR parameters:

DONE	BUSY	ERROR	Description
0	0	0	The instruction has not been executed yet (no positive edge at EN_R parameter).
0	1	0	The instruction is being executed and calls the internally used communication instructions.
1	0	0	The receipt has been completed successfully. "0000" is output at the STATUS parameter. DONE = "1" is only displayed for one cycle.
0	0	1	The execution of the instruction or an intermediate step during processing was terminated with an error. If there is a subsequent error due to an internally used communication instruction, the error that occurred first during processing is displayed. This state is only displayed for one cycle.

### Parameters ERROR and STATUS

ERROR	STATUS (W#16#...)	Description
0	0000	Receive job executed without error.
0	0001	The connection establishment is complete.
0	0003	The connection termination is complete.
0	7000	No job processing active.
0	7001	<ul style="list-style-type: none"> <li>Start receive job execution</li> <li>Establish communication connection</li> <li>Wait for connection partner</li> </ul>
0	7002	Data is being received.
0	7003	Communication connection is being terminated.
0	7004	<ul style="list-style-type: none"> <li>Communication connection established and monitored.</li> <li>No receive job processing active.</li> </ul>
0	7005	Communication connection is being reset.
0	7006	Data is currently being received.
1	8085	<ul style="list-style-type: none"> <li>The LEN parameter is larger than the highest permitted value.</li> <li>The value at the LEN or DATA parameter was changed after the first call.</li> </ul>
1	8086	The ID parameter is outside the permitted range.
1	8087	Maximum number of connections reached; no additional connection possible
1	8088	The value at the LEN parameter does not correspond to the receive area set at the DATA parameter.
1	8089	The CONNECT parameter does not point to a data block.
1	8091	Maximum nesting depth exceeded.
1	809A	The CONNECT parameter points to a field that does not correspond to the length of the connection description.



ERROR	STATUS (W#16#...)	Description
1	809B	InterfaceID is invalid. It is either zero or it does not point to a local CPU interface or a CP.
1	80A1	<ul style="list-style-type: none"> <li>• Connection or port already being used by user.</li> <li>• Communication error: <ul style="list-style-type: none"> <li>– The specified connection has not yet been established.</li> <li>– The specified connection is being terminated. Transfer via this connection is not possible.</li> <li>– The interface is being re-initialized.</li> </ul> </li> </ul>
1	80A3	<ul style="list-style-type: none"> <li>• Attempt being made to re-establish an existing connection.</li> <li>• Attempt being made to terminate a non-existent connection.</li> </ul>
1	80A4	IP address of the remote endpoint of the connection is invalid or it matches the IP address of the local partner.
1	80A7	Communication error: You called the instruction with COM_RST = 1 before the send job was complete.
1	80B4	You have violated one or both of the following conditions for passive connection establishment (active_est = FALSE) when using the ISO-on-TCP protocol variant (connection_type = B#16#12): "local_tsap_id_len >= B#16#02", and/or "local_tsap_id[1] = B#16#E0".
1	80B5	Only passive connection establishment is permitted for connection type 13 = UDP.
1	80B6	Parameter assignment error in the connection_type parameter of the data block for connection description.
1	80B7	Error in one of the following parameters of the data block for connection description: block_length, local_tsap_id_len, rem_subnet_id_len, rem_staddr_len, rem_tsap_id_len, next_staddr_len.
1	80C3	<ul style="list-style-type: none"> <li>• All connection resources are in use.</li> <li>• A block with this ID is already being processed in a different priority group.</li> </ul>
1	80C4	Temporary communication error: <ul style="list-style-type: none"> <li>• The connection cannot be established at this time.</li> <li>• The interface is receiving new parameters or the connection is being established.</li> <li>• The configured connection is currently being removed by a "TDISCON" instruction.</li> <li>• The connection used is being terminated by a call with COM_RST = 1.</li> </ul>
1	8722	Error in the CONNECT parameter: Invalid source area (area not declared in data block).
1	873A	Error in the CONNECT parameter: Access to connection description is not possible (no access to data block).
1	877F	Error in the CONNECT parameter: Internal error
1	8922	Parameter DATA: Invalid target area; the area does not exist in the DB.
1	8924	Parameter DATA: Area error in the VARIANT pointer.
1	8932	Parameter DATA: The DB number is too high.
1	893A	Parameter CONNECT: Access to specified connection data not possible (e.g. because the DB does not exist).
1	897F	Parameter DATA: Internal error, e.g. invalid VARIANT reference.
1	8A3A	Parameter DATA: No access to the data area, for example because the data block does not exist.

---

**Note**

**Error messages of the instructions "TCON", "TRCV" and "TDISCON"**

Internally, the TRV\_C instruction uses the "TCON (Page 2880)", "TRCV (Page 2892)" and "TDISCON (Page 2884)" instructions. The error messages of these instructions are contained in the respective descriptions.

---

**See also**

TSEND\_C: Send data via Ethernet (Page 2847)

**TMAIL\_C: Transfer email**

**Description of TMAIL\_C**

**Description**

You use the instruction "TMAIL\_C" to send an e-mail via the Ethernet interface of the S7-1500 CPU or S7-1200 V4.0, a communication module (CM), or of a communication processor (CP).

The instruction can only be used once the hardware has been configured and if the network infrastructure allows for a communication connection to the mail server.

You define the content of the e-mail, and the connection data, using the following parameters:

- You define the recipient addresses with the parameters TO\_S and CC.
- You define the content of the e-mail with the parameters SUBJECT and TEXT.
- You can define an attachment using VARIANT pointers at the ATTACHMENT and ATTACHMENT\_NAME parameters.
- The connection data is defined, and addressing and authentication for the mail server executed, using the system data type Tmail\_v4, Tmail\_v6 or Tmail\_FQDN at the MAIL\_ADDR\_PARAM parameter.
  - If you are using the interface of the S7-1500 CPU, the system data type Tmail\_v4 must be used. In this case, the e-mail can only be sent via SMTP.
  - Any of the system data types can be used if you are using the interface of a CM/CP. The e-mail can then also be sent via SMTPS.
- You start the sending of an e-mail with an edge change from "0" to "1" for the REQ parameter.
- The job status is indicated by the output parameters "BUSY", "DONE", "ERROR" and "STATUS".

You cannot send an SMS directly with the "TMAIL\_C" instruction. Whether or not the e-mail can be forwarded by the mail server as an SMS depends on your telecommunications provider.

## Operation of the instruction

The "TMAIL\_C" instruction works asynchronously, which means its execution extends over multiple calls. You must specify an instance when you call the instruction "TMAIL\_C".

In the following cases, the connection to the mail server will be lost:

- If the CPU switches to STOP while "TMAIL\_C" is active.
- If communication problems occur at the Industrial Ethernet bus.

In this case, the transfer of the e-mail will be interrupted and it will not reach its recipient. The connection is also canceled once the instruction has been successfully executed and the e-mail sent.

### NOTICE

#### Changing user programs

You can change the parts of your user program that directly affect calls of "TMAIL\_C" only:

- The CPU is in "STOP" mode.
- No e-mail is being sent (REQ = 0 and BUSY = 0).

This relates, in particular, to deleting and replacing program blocks that contain "TMAIL\_C" calls or calls for the instance of "TMAIL\_C".

Ignoring this restriction can tie up connection resources. The automation system can change to an undefined status with the TCP/IP communication functions via Industrial Ethernet.

A warm or cold restart of the CPU is required after the changes are transferred.

## Data consistency

The TO\_S, CC, SUBJECT, TEXT, ATTACHMENT and MAIL\_ADDR\_PARAM parameters are applied by the "TMAIL\_C" instruction while it is running, which means that they may only be changed after the job has been completed (BUSY = 0).

## SMTP authentication

Authentication refers here to a procedure for verifying identity, for example, with a password query.

If you are using the S7-1500 CPU interface, the instruction "TMAIL\_C" supports the SMTP authentication procedure AUTH-LOGIN which is required by most mail servers. For information about the authentication procedure of your mail server, please refer to your mail server manual or the website of your Internet service provider.

- Before you can use the AUTH-LOGIN authentication procedure, the "TMAIL\_C" instruction requires the user name with which it is to log on to the mail server. This user name corresponds to the user name with which you set up a mail account on your mail server. It is transferred via the UserName parameter to the structure at parameter MAIL\_ADDR\_PARAM.  
If no user name is specified at the MAIL\_ADDR\_PARAM parameter, the AUTH-LOGIN authentication procedure is not used. The e-mail is then sent without authentication.
- To log on, the "TMAIL\_C" instruction also requires the associated password. This password corresponds to the password you specified when you set up your mail account. It is transferred via the PassWord parameter to the structure at parameter MAIL\_ADDR\_PARAM.

### Parameters

The following table shows the parameters of the "TMAIL\_C" instruction:

Parameter	Declaration	Data type	Memory area	Description
REQ	Input	BOOL	I, Q, M, D, L, T, C or constant	Control parameter REQUEST: Activates the sending of an e-mail upon a rising edge.
TO_S (Page 2870)	Input	STRING	D	Recipient addresses STRING with a maximum length of 180 characters (bytes). For the e-mail address format, please see the example in the parameter description.
CC (Page 2870)	Input	STRING	D	CC recipient addresses (optional) STRING with a maximum length of 180 characters (bytes). Same e-mail address format as for the TO_S parameter. If an empty string is assigned here, the e-mail is not sent to a CC recipient.
SUBJECT	Input	STRING	D	Subject of the e-mail STRING with a maximum length of 180 characters (bytes).
TEXT	Input	STRING	D	Text of the e-mail (optional) STRING with a maximum length of 180 characters (bytes). If an empty string is assigned at this parameter, the e-mail is sent without text.
ATTACHMENT	Input	VARIANT	D	E-mail attachment (optional) Reference to a byte/word/double word field (ArrayOfByte, ArrayOfWord or ArrayOfDWord) with a maximum length of 64 bytes. If no value is assigned, the e-mail is sent without an attachment.

Parameter	Declaration	Data type	Memory area	Description
ATTACHMENT_NAME	Input	VARIANT	D	E-mail attachment name (optional) Reference to a character string with a maximum length of 50 characters (bytes) to define the file name of the attachment. If an empty string is assigned at this parameter, the e-mail attachment will be sent with the file name "attachment.bin".
MAIL_ADDR_PARAM (Page 2870)	Input	VARIANT	D	Connection parameter and address of the e-mail server To define the connection parameters, use the structure Tmail_v4, Tmail_v6 or Tmail_FQDN (see parameter description).
DONE (Page 2873)	Output	BOOL	I, Q, M, D, L	Status parameter <ul style="list-style-type: none"> <li>• DONE = 0: Job not yet started or still executing.</li> <li>• DONE = 1: Job was executed without errors.</li> </ul>
BUSY (Page 2873)	Output	BOOL	I, Q, M, D, L	Status parameter <ul style="list-style-type: none"> <li>• BUSY=0: The processing of "TMAIL_C" was stopped.</li> <li>• BUSY = 1: E-mail transmission is not yet complete.</li> </ul>
ERROR (Page 2873)	Output	BOOL	I, Q, M, D, L	Status parameter <ul style="list-style-type: none"> <li>• ERROR = 0: No error has occurred.</li> <li>• ERROR = 1: An error occurred during processing. STATUS supplies detailed information on the type of error.</li> </ul>
STATUS (Page 2874)	Output	WORD	I, Q, M, D, L	Status parameter Return value or error information of the "TMAIL_C" instruction (see parameter description).

You will find more detailed information on valid data types in "Overview of the valid data types (Page 1077)".

#### Note

##### Optional parameters

The optional parameters CC, TEXT, and ATTACHMENT are only sent with the e-mail if the corresponding parameters contain a string of length > 0.

## TO\_S and CC parameters

### Description

The TO\_S and CC parameters are strings, for example, with the following content:

- <wenna@mydomain.com>, <ruby@mydomain.com>
- <admin@mydomain.com>, <judy@mydomain.com>

Note the following rules when entering the parameters:

- A space and an opening pointed bracket "<" must be entered before each address.
- A closing pointed bracket ">" must be entered after each address.
- A comma must be entered between the addresses in TO and CC.

For runtime and memory space reasons, the "TMAIL\_C" instruction does not perform a syntax check of parameter TO\_S or CC.

## MAIL\_ADDR\_PARAM parameter

### Description

At the MAIL\_ADDR\_PARAM parameter, you define the connection for sending the e-mail in the structure Tmail\_v4, Tmail\_v6 or Tmail\_FQDN, and save the e-mail server address and login details.

The structure you use at the MAIL\_ADDR\_PARAM parameter depends on the format in which the e-mail server is to be addressed:

- Tmail\_v4: Addressing by IP address (IPv4).
- Tmail\_v6: Addressing by IP address (IPv6).
- Tmail\_FQDN: Addressing by fully qualified domain name (FQDN).

Which structure you can use depends on the interface addressed at the Interfaceld parameter:

- If you want to use the "TMAIL\_C" instruction with the internal interface, the structure Tmail\_v4 must be used at the MAIL\_ADDR\_PARAM parameter.
- If you are using a communication processor (CP) or communication module (CM), you can use all three addressing options (IPv4, IPv6 and FQDN).

Table 9-124 Tmail\_v4: Addressing the mail server by IP address (IPv4)

Parameter	Data type	Description
Tmail_v4	Struct	
Interfaceld	LADDR	Hardware identifier of the interface
ID	CONN_OUC	Connection ID
ConnectionType	BYTE	Connection type. Select 16#20 as the connection type for IPv4.
ActiveEstablished	BOOL	Status bit. Set to "1" once the connection is established.

Parameter	Data type	Description
CertIndex	BYTE	<ul style="list-style-type: none"> <li>=0: SMTP used (<b>S</b>imple <b>M</b>ail <b>T</b>ransfer <b>P</b>rotocol). SMTP must be used if the e-mail is being sent via the interface of an S7-1500 CPU.</li> <li>≠0: SMTPS used to secure the connection before it is established (with CPs/CMs). You use the CertIndex parameter to specify the certificate to be used (see "Project navigation" &gt; "Global security settings" &gt; "Certificate manager").</li> </ul>
WatchDogTime	TIME	<p>Execution watchdog. Use this parameter to define the maximum execution time for the send operation.</p> <p>Note: Connection establishment can take longer (approx. one minute) if the connection is slow. When you specify the WATCH_DOG_TIME parameter, remember to allow for the time required to establish the connection.</p> <p>The connection is terminated once the specified time has elapsed.</p>
MailServerAddress	IP_v4	<p>IP address of the mail server. IPv4 in the following format: XXX.XXX.XXX.XXX (decimal).</p> <p>Example: 192.142.131.237.</p>
UserName	STRING[254]	Mail server login name
PassWord	STRING[254]	Mail server password
From	EMAIL_ADDR	E-mail sender address, which is defined using the following two STRING parameters. For example: "myname@mymailserver.com".
LocalPartPlusAtSign	STRING[64]	Local part of sender address, including @ sign. Example: "myname@".
FullQualifiedDomainName	STRING[254]	Fully Qualified Domain Name ( FQDN for short) of the mail server. Example: "mymailserver.com".

Table 9-125 Tmail\_v6: Addressing the mail server by IP address (IPv6)

Parameter	Data type	Description
Tmail_v6	Struct	
Interfaceld	LADDR	Hardware identifier of the interface
ID	CONN_OUC	Connection ID
ConnectionType	BYTE	Connection type. Select 16#21 as the connection type for IPv6.
ActiveEstablished	BOOL	Status bit. Set to "1" once the connection is established.
CertIndex	BYTE	<ul style="list-style-type: none"> <li>=0: SMTP used (<b>S</b>imple <b>M</b>ail <b>T</b>ransfer <b>P</b>rotocol). SMTP must be used if the e-mail is being sent via the interface of an S7-1500 CPU.</li> <li>≠0: SMTPS used to secure the connection before it is established (with CPs/CMs). You use the CertIndex parameter to specify the certificate to be used (see "Project navigation" &gt; "Global security settings" &gt; "Certificate manager").</li> </ul>

Parameter	Data type	Description
WatchDogTime	TIME	Execution watchdog. Use this parameter to define the maximum execution time for the send operation. Note: Connection establishment can take longer (approx. one minute) if the connection is slow. When you specify the WATCH_DOG_TIME parameter, remember to allow for the time required to establish the connection. The connection is terminated once the specified time has elapsed.
MailServerAddress	IP_v6	IP address of the mail server (IPv6) in the following format: XXXX.XXXX.XXXX.XXXX.XXXX.XXXX.XXXX.XXXX (hexadecimal). The address is divided into 8 blocks of 2 bytes each (16 bytes in total). Example: 2001:db8:1f11:08d3:290:27ff:0370:2093
UserName	STRING[254]	Mail server login name
PassWord	STRING[254]	Mail server password
From	EMAIL_ADDR	E-mail sender address, which is defined using the following two STRING parameters. For example: "myname@mymailserver.com".
LocalPartPlusAtSign	STRING[64]	Local part of sender address, including @ sign. Example: "myname@".
FullQualifiedDomainName	STRING[254]	Fully Qualified Domain Name ( FQDN for short) of the mail server. Example: "mymailserver.com".

Table 9-126 Tmail\_FQDN: Addressing the mail server by FQDN

Parameter	Data type	Description
Tmail_v6	Struct	
Tmail_FQDN	LADDR	Hardware identifier of the interface
ID	CONN_OUC	Connection ID
ConnectionType	BYTE	Connection type. Select 16#22 as the connection type for FQDN.
ActiveEstablished	BOOL	Status bit. Set to "1" once the connection is established.
CertIndex	BYTE	<ul style="list-style-type: none"> <li>=0: SMTP used (Simple Mail Transfer Protocol). SMTP must be used if the e-mail is being sent via the interface of an S7-1500 CPU.</li> <li>≠0: SMTPS used to secure the connection before it is established (with CPs/CMs). You use the CertIndex parameter to specify the certificate to be used (see "Project navigation" &gt; "Global security settings" &gt; "Certificate manager").</li> </ul>
WatchDogTime	TIME	Execution watchdog. Use this parameter to define the maximum execution time for the send operation. Note: Connection establishment can take longer (approx. one minute) if the connection is slow. When you specify the WATCH_DOG_TIME parameter, remember to allow for the time required to establish the connection. The connection is terminated once the specified time has elapsed.



Parameter	Data type	Description
MailServerAddress	STRING[254]	FQDN (Fully Qualified Domain Name) of the mail server. The mail server is addressed using the fully qualified domain name. Example: "www.mymailserver.com".
UserName	STRING[254]	Mail server login name
PassWord	STRING[254]	Mail server password
From	Struct	E-mail sender address, which is defined using the following two STRING parameters. For example: "myname@mymailserver.com".
LocalPartPlusAtSign	STRING[64]	Local part of sender address, including @ sign. Example: "myname@".
FullQualifiedDomainName	STRING[254]	Fully Qualified Domain Name ( FQDN for short) of the mail server. Example: "mymailserver.com".

## DONE, BUSY and ERROR parameters

### Description

The output parameters DONE, BUSY and ERROR are each displayed for only one cycle if the status of the BUSY output parameter changes from "1" to "0".

The following table shows the relationship between DONE, BUSY, and ERROR. Using this table, you can determine the current status of the instruction "TMAIL\_C and when the sending of the e-mail is complete.

DONE	BUSY	ERROR	Description
0	1	0	The job is being processed.
1	0	0	Job successfully completed.
0	0	1	The job ended with an error. The cause of the error can be found in the STATUS (Page 2874) parameter.
0	0	0	The "TMAIL_C" instruction was not assigned a (new) job.

**STATUS parameter**

**Description**

The following table shows the return values of "TMAIL\_C" at the STATUS parameter:

Return value STATUS* (W#16#...):	Explanation	Notes
0000	The processing of "TMAIL_C" was completed without errors.	Error-free completion of "TMAIL_C" does not mean that the e-mail sent will necessarily arrive.  Incorrectly entering the recipient addresses does not generate a status error of the "TMAIL_C" instruction. In this case, there is no guarantee that the e-mail will be sent to other recipients, even if these were entered correctly.
7001	"TMAIL_C" is active (BUSY = 1).	First call: Job triggered.
7002	"TMAIL_C" is active (BUSY = 1).	Intermediate call: Job already active.
8xxx	The processing of "TMAIL_C" was completed with an error code of the communication instructions called internally.	For detailed information, please refer to the STATUS parameter descriptions for the "TCON (Page 2880)", "TDISCON (Page 2884)", "TSEND (Page 2889)" and "TRCV (Page 2892)" communication instructions.
8010	Error during connection establishment	You will find further information on evaluation in the SFB_STATUS parameter of the instance data block. The error code displayed at the SFB_STATUS parameter is explained in the STATUS parameter description for the "TCON (Page 2880)" instruction.
8011	Error sending the data	You will find further information on evaluation in the SFB_STATUS parameter of the instance data block. The error code displayed at the SFB_STATUS parameter is explained in the STATUS parameter description for the "TSEND (Page 2889)" instruction.
8012	Error receiving the data	You will find further information on evaluation in the SFB_STATUS parameter of the instance data block. The error code displayed at the SFB_STATUS parameter is explained in the STATUS parameter description for the "TRCV (Page 2892)" instruction.
8013	Error during connection establishment	You will find further information on evaluation in the SFB_STATUS parameter of the instance data block. The error code displayed at the SFB_STATUS parameter is explained in the STATUS parameter description for the TCON (Page 2880)" and "TDISCON (Page 2884)" instructions.

Return value STATUS* (W#16#...):	Explanation	Notes
8014	Establishment of a connection is not possible.	You may have entered an incorrect mail server IP address (MailServerAddress (Page 2870)) or too short a time span (WatchDogTime (Page 2870)) for connection establishment. It is also possible that the CPU has no connection to the network or that the CPU configuration is incorrect.
8015	Incorrect data type for MAIL_ADDR_PARAM	The only valid data types are the system data types (structures) Tmail_v4, Tmail_v6 and TMail_FQDN.
8016	Incorrect data type for the ATTACHMENT parameter	The only valid data types are ArrayOfByte, ArrayOfWord and ArrayOfDWord.
8017	Incorrect data length for the ATTACHMENT parameter	Data length must be <= 65534 bytes.
8401	No channels available. Possible cause: There is already an e-mail connection via the CP. A second connection cannot be established in parallel.	Specific error for CP 1543
8403	A TCP/IP connection to the mail server was not possible.	Specific error for CP 1543
8405	Server has denied login request.	Specific error for CP 1543
8406	SMTP client has detected an internal SSL error or a problem with the certificate structure.	Specific error for CP 1543
8407	Request to use SSL denied.	Specific error for CP 1543
8408	Client unable to identify socket for establishing a TCP/IP connection to the mail server.	Specific error for CP 1543
8409	Writing via the connection not possible. Possible cause: The communication partner has reset the connection or the connection has been lost.	Specific error for CP 1543
8410	Reading via the connection not possible. Possible cause: The communication partner has reset the connection or the connection has been lost.	Specific error for CP 1543
8411	E-mail could not be sent. Cause: Insufficient memory space to execute the send operation.	Specific error for CP 1543
8412	DNS server configured was unable to resolve the specified domain name.	Specific error for CP 1543
8413	An internal error in the DNS subsystem prevented domain name resolution.	Specific error for CP 1543

Return value STATUS* (W#16#...):	Explanation	Notes
8414	Empty character string entered as domain name.	Specific error for CP 1543
8415	An internal error has occurred in the cURL module. Execution was stopped.	Specific error for CP 1543
8416	An internal error has occurred in the SMTP module. Execution was stopped.	Specific error for CP 1543
8417	Request to SMTP on a channel already in use or invalid channel ID. Execution was stopped.	Specific error for CP 1543
8418	E-mail send job aborted. Possible causes: Execution time exceeded (WatchDogTime parameter) or CP transition from start to stop.	Specific error for CP 1543
8419	Channel interrupted and cannot be used before the connection is closed.	Specific error for CP 1543
8420	Server certificate string could not be verified with CP root certificate.	Specific error for CP 1543
8421	Internal error occurred. Execution was stopped.	Specific error for CP 1543
82xx, 84xx, or 85xx	The error message originates from the mail server and corresponds, except for the "8", to the error number of the SMTP protocol.  The following lines list several error codes that can occur.	You will find more detailed information on the SMTP error code and other error codes in the SMTP protocol on the Internet or in the error documentation of the mail server. You can also view the most recent error message from the mail server in your instance DB in the BUFFER1 parameter. You will find the last data sent by the "TMAIL_C" instruction under DATEN in the instance DB.
8450	Action not executed: Mailbox not available/cannot be reached	Try again later.
8451	Action aborted: Local processing error	Try again later.
8500	Syntax error: Error not recognized. This also includes the error when a command string is too long. This can also occur when the e-mail server does not support the LOGIN authentication procedure.	Check the parameters of "TMAIL_C". Try to send an e-mail without authentication. To do this, replace the content of the UserName parameter with an empty string. If no user name is specified, the LOGIN authentication procedure is not used.
8501	Syntax error: Incorrect input at a parameter	Possible cause: Incorrect address at the TO_S or CC parameter (see also: TO_S and CC parameters (Page 2870)).
8502	Command unknown or not implemented	Check your entries, in particular the FROM parameter. It may be incomplete and you may have forgotten the "@" or "." (see also: TO_S and CC parameters (Page 2870)).
8535	SMTP authentication incomplete	You have possibly entered an incorrect user name or incorrect password.

Return value STATUS* (W#16#...):	Explanation	Notes
8550	Mail server cannot be reached. You have no access rights.	You may have entered an incorrect user name or password, or the mail server may not support your login. Another cause of error could be a mistake in the domain name after the "@" at the TO_S or CC parameter (see also: TO_S and CC parameters (Page 2870)).
8552	Action aborted: Assigned memory size has been exceeded	Try again later.
8554	Transfer failed	Try again later.
* The error codes can be displayed as integer or hexadecimal values in the program editor. For additional information on toggling display formats, refer to "See also".		

## Other

### TCON: Establishing a communication connection

### TCON: Establish communication connection

## Description

You use the "TCON" instruction to set up and establish a communication connection. Once the connection has been set up and established, it is automatically maintained and monitored by the CPU. "TCON" is executed asynchronously.

The connection data specified for the CONNECT and ID parameters are used to set up the communication connection. To establish the connection, a rising edge must be detected at the REQ parameter. Once the connection is successfully established, the DONE parameter is set to "1".

## Number of possible connections

For information on the number of possible communication connections, refer to the technical specifications for your CPU.

## Connection with TCP and ISO-on-TCP

Both communication partners call the "TCON" instruction to set up and establish the communication connection. During parameter assignment, you specify which partner is the active communication end point and which is the passive one.

If the connection aborts, for example due to a line break or due to the remote communication partner, the active partner attempts to reestablish the configured connection. You do not have to call "TCON" again. This applies only if "TCON" has been executed successfully once (DONE = 1).

An existing connection is terminated and the connection set up is removed when the "TDISCON (Page 2884)" instruction is executed or when the CPU changes to STOP mode. To set up and establish the connection again, you will need to execute "TCON" again.

**Parameters**

The following table shows the parameters of the "TCON" instruction:

Parameter	Declaration	Data type	Memory area	Description
REQ	Input	BOOL	I, Q, M, D, L or constant	Starts the job to establish the connection specified in the ID upon a rising edge.
ID	Input	CONN_OUC (WORD)	I, Q, M, D, L or constant	Reference to the assigned connection. Range of values: W#16#0001 to W#16#0FFF
CONNECT	InOut	TCON_Param	D	Pointer to the connection description See also: Auto-Hotspot
DONE	Output	BOOL	I, Q, M, D, L	Status parameter with the following values: <ul style="list-style-type: none"> <li>0: Job not yet started or still in progress</li> <li>1: Job completed without error</li> </ul>
BUSY	Output	BOOL	I, Q, M, D, L	Status parameter with the following values: <ul style="list-style-type: none"> <li>0: Job not yet started or already completed</li> <li>1: Job not yet completed. A new job cannot be started</li> </ul>
ERROR	Output	BOOL	I, Q, M, D, L	Status parameter ERROR: <ul style="list-style-type: none"> <li>0: No error</li> <li>1: Error occurred</li> </ul>
STATUS	Output	WORD	I, Q, M, D, L	Status of the instruction

For additional information on valid data types, refer to "Overview of the valid data types (Page 1077)".

**Parameters BUSY, DONE and ERROR**

You can check the status of the job with the BUSY, DONE, ERROR and STATUS parameters. The BUSY parameter indicates the processing status. You use the DONE parameter to check whether or not a job has been executed successfully. The ERROR parameter is set when errors occurred during execution of "TCON". The error information is output at the STATUS parameter.

The following table shows the relationship between the BUSY, DONE and ERROR parameters:

BUSY	DONE	ERROR	Description
1	0	0	The job is being processed.
0	1	0	The job was completed successfully.
0	0	1	The job ended with an error. The cause of the error is output at the STATUS parameter.
0	0	0	No new job was assigned.

## Parameters ERROR and STATUS

ERROR	STATUS* (W#16#...)	Explanation
0	0000	Connection successfully established.
0	7000	No job processing active
0	7001	Start job execution, establish connection.
0	7002	Connection is being established (REQ irrelevant).
1	8085	ID is used by a configured connection
1	8086	The ID parameter is outside the valid range.
1	8087	Maximum number of connections reached; no additional connection possible
1	8089	The CONNECT parameter does not point to a data block.
1	809A	The CONNECT parameter points to a field that does not correspond to the length of the connection description.
1	809B	The element Interfaceld within the TCON_xxx structure does not reference a hardware identifier of a CPU or CM/CP interface or has the value "0".
1	80A0	Group error for error codes W#16#80A1 and W#16#80A2.
1	80A2	Local or remote port is being used by the system.
1	80A3	Attempt being made to re-establish an existing connection.
1	80A4	IP address of the remote endpoint of the connection is invalid, in other words, it matches the IP address of the local partner.
1	80A5	Connection ID is already in use.
1	80A7	Communication error: You executed "TDISCON (Page 2884)" before "TCON" had completed.
1	80B2	The CONNECT parameter points to a data block that was generated with the attribute "Only store in load memory".
1	80B4	You have violated one or more of the following conditions for passive connection establishment with the ISO-on-TCP protocol variant (connection_type = B#16#12): <ul style="list-style-type: none"> <li>• local_tsap_id_len &gt;= B#16#02</li> <li>• local_tsap_id[1] = B#16#E0</li> <li>• With local_tsap_id_len &gt;= B#16#03, local_tsap_id[1] is an ASCII character.</li> <li>• local_tsap_id[1] is an ASCII character and local_tsap_id_len &gt;= B#16#03.</li> </ul>
1	80B5	Only passive connection establishment is permitted for connection type 13 = UDP.
1	80B6	Parameter assignment error at the connection_type parameter of the SDT TCON_Param.
1	80B7	Error in one of the following parameters of the data block for connection description: block_length, local_tsap_id_len, rem_subnet_id_len, rem_staddr_len, rem_tsap_id_len, next_staddr_len.
1	80B8	Connection description of the structure element ID and the block parameter ID are not identical.
1	80C3	All connection resources are in use.
1	80C4	Temporary communication error: <ul style="list-style-type: none"> <li>• The connection cannot be established at this time.</li> <li>• The interface is currently receiving new parameters.</li> <li>• The configured connection is currently being removed by a "TDISCON (Page 2884)" instruction.</li> </ul>

\* The error codes can be displayed as integer or hexadecimal values in the program editor. For additional information on toggling display formats, refer to "See also".

## TCON: Establish communication connection

### Description

You use the "TCON" instruction to set up and establish a communication connection. Once the connection has been set up and established, it is automatically maintained and monitored by the CPU. "TCON" is executed asynchronously.

The connection data specified for the CONNECT and ID parameters are used to set up the communication connection.

- At the CONNECT parameter, if possible, only use the predefined structures as created by the connection parameter assignment in the Inspector window of the program editor.
- If the CONNECT parameter is not interconnected with a structure listed in the parameter table or if the structure includes an error, the error code 8089 is output at the STATUS parameter.

To establish the connection, a rising edge must be detected at the REQ parameter. Once the connection is successfully established, the DONE parameter is set to "1".

The instruction "TCON" V3.0 can also be used with CPU S7-1200, Version 4.0 or later.

### Number of possible connections

For information on the number of possible communication connections, refer to the technical specifications for your CPU.

### Connection with TCP and ISO-on-TCP

Both communication partners call the "TCON" instruction to set up and establish the communication connection. During parameter assignment, you specify which partner is the active communication end point and which is the passive one.

If the connection aborts, for example due to a line break or due to the remote communication partner, the active partner attempts to reestablish the configured connection. You do not have to call "TCON" again. This applies only if "TCON" has been executed successfully once (DONE = 1).

An existing connection is terminated and the connection set up is removed when the "TDISCON (Page 2884)" instruction is executed or when the CPU changes to STOP mode. To set up and establish the connection again, you will need to execute "TCON" again.



## Parameters

The following table shows the parameters of the "TCON" instruction:

Parameter	Declaration	Data type	Memory area	Description
REQ	Input	BOOL	I, Q, M, D, L or constant	Starts the job to establish the connection specified on a rising edge.
ID	Input	CONN_OUC (WORD)	I, Q, M, D, L or constant	Reference to the assigned connection. Range of values: W#16#0001 to W#16#0FFF
CONNECT	InOut	VARIANT	D	Pointer to the connection description <ul style="list-style-type: none"> <li>For TCP or UDP, use the structure TCON_IP_v4 For description, refer to: Auto-Hotspot</li> <li>For ISO-on-TCP, use the structure TCON_IP_RFC For description, refer to: Auto-Hotspot</li> <li>For ISO, use the structure TCON_ISOnative (only for CP1543-1) For description, refer to: "Structure of the connection description according to TCON_ISOnative"</li> </ul>
DONE	Output	BOOL	I, Q, M, D, L	Status parameter with the following values: <ul style="list-style-type: none"> <li>0: Job not yet started or still in progress</li> <li>1: Job completed without error</li> </ul>
BUSY	Output	BOOL	I, Q, M, D, L	Status parameter with the following values: <ul style="list-style-type: none"> <li>0: Job not yet started or already completed</li> <li>1: Job not yet completed. A new job cannot be started</li> </ul>
ERROR	Output	BOOL	I, Q, M, D, L	Status parameter ERROR: <ul style="list-style-type: none"> <li>0: No error</li> <li>1: Error occurred</li> </ul>
STATUS	Output	WORD	I, Q, M, D, L	Status of the instruction

For additional information on valid data types, refer to "Overview of the valid data types (Page 1077)".

## Parameters BUSY, DONE and ERROR

You can check the status of the job with the BUSY, DONE, ERROR and STATUS parameters. The BUSY parameter indicates the processing status. You use the DONE parameter to check whether or not a job has been executed successfully. The ERROR parameter is set when errors occurred during execution of "TCON". The error information is output at the STATUS parameter.

The instruction "TCON" generates an error message in version 3.0 if an active connection establishment to a remote partner fails. Create a rising edge at the REQ parameter to establish a connection once again.

The following table shows the relationship between the BUSY, DONE and ERROR parameters:

BUSY	DONE	ERROR	Description
1	0	0	The job is being processed.
0	1	0	The job was completed successfully.
0	0	1	The job ended with an error. The cause of the error is output at the STATUS parameter.
0	0	0	No new job was assigned.

### Structure of the connection description according to TCON\_ISOnative

A connection description DB with a structure according to TCON\_ISOnative is used to assign the communication connection parameters for ISO. The fixed data structure of the TCON\_ISOnative contains all parameters that are required to establish the connection.

Byte	Parameter	Data type	Start value	Description
0 ... 1	Interfaceld	HW_ANY	64	Hardware identifier of the local interface (value range: 0 to 65535).
2 ... 3	ID	CONN_OUC	1	Reference to this connection (unique ID in the value range: 1 to 4095).
4	ConnectionType	BYTE	16#16	Connection type: ISO
5	ActiveEstablished	BOOL	TRUE	ID for the manner in which the connection is established: <ul style="list-style-type: none"> <li>• FALSE: Passive connection establishment</li> <li>• TRUE: Active connection establishment</li> </ul>
8 ... 13	RemoteMacAddress	ARRAY [1..6] of BYTE	-	MAC address of the partner end point, for example, for 00-74-41-FD-AE-84: <ul style="list-style-type: none"> <li>• MacAddr[1] = 00</li> <li>• MacAddr[2] = 74</li> <li>• MacAddr[3] = 41</li> <li>• MacAddr[4] = FD</li> <li>• MacAddr[5] = AE</li> <li>• MacAddr[6] = 84</li> </ul>
14 .. . 19	LocalMacAddress	ARRAY [1..6] of BYTE	-	MAC address of the local end point, for example, for 00-74-41-FD-AE-84: <ul style="list-style-type: none"> <li>• MacAddr[1] = 00</li> <li>• MacAddr[2] = 74</li> <li>• MacAddr[3] = 41</li> <li>• MacAddr[4] = FD</li> <li>• MacAddr[5] = AE</li> <li>• MacAddr[6] = 84</li> </ul>
20 .. . 53	RemoteTSelector	Struct	-	TSelector of the remote connection partner: <ul style="list-style-type: none"> <li>• Bytes 20 to 21 = TSelLength</li> <li>• Bytes 22 to 53: = TSel[1-32]</li> </ul>
	TSelLength	UINT	-	Value range from 0 to 32
	TSel	ARRAY [1..32] of BYTE	-	Value range in each case 0 to 255 in bytes

Byte	Parameter	Data type	Start value	Description
54 .. . 87	LocalTSelector	Struct	-	TSelector of the remote connection partner: <ul style="list-style-type: none"> <li>Bytes 20 to 21 = TSelLength</li> <li>Bytes 22 to 53: = TSel[1-32]</li> </ul>
	TSelLength	UINT		Value range from 0 to 32
	TSel	ARRAY [1..32] of BYTE	-	Value range in each case 0 to 255 in bytes
88 ... 89	CrRetransmissionTime	UINT	-	Duration until connection attempt is repeated in seconds.
90 .. . 91	DataRetransmissionTime	UINT	100 ms	Duration until data transfer is repeated in milliseconds.
92 .. . 93	MaxRetransmissionCount	UINT	-	Maximum number of repetitions.
94 .. . 95	InactivityTime	UINT	-	in seconds
96 .. . 97	WindowTime	UINT		in seconds

## Parameters ERROR and STATUS

ERROR	STATUS* (W#16#...)	Explanation
0	0000	Connection successfully established.
0	7000	No job processing active
0	7001	Start job execution, establish connection.
0	7002	Connection is being established (REQ irrelevant).
1	8085	ID is used by a configured connection.
1	8086	The ID parameter is outside the valid range.
1	8087	Maximum number of connections reached; no additional connection possible
1	8089	The CONNECT parameter does not point to a connection description or the connection description was created manually.
1	809A	The structure at the CONNECT parameter is not supported or the length is invalid.
1	809B	The element InterfacelD within the TCON_xxx structure does not reference a hardware identifier of a CPU or CM/CP interface or has the value "0".
1	80A2	Local or remote port is being used by the system. The following ports are reserved locally: 20, 21, 80, 102, 135, 161, 162, 443, 34962, 34963, 34964 as well as the area 49152 to 65535.
1	80A3	ID is used by a connection created by the user program, which uses the same connection description at the CONNECT parameter.
1	80A4	IP address of the remote endpoint of the connection is invalid or it corresponds to the IP address of the local partner.
1	80A7	Communication error: You executed "TDISCON (Page 2884)" before "TCON" had completed.
1	80B4	Only with TCON_IP_RFC: The local T selector was not specified or the first byte does not contain the value 0x0E (only with a length of T selector = 2) or the local T selector starts with "SIMATIC-".
1	80B5	Only passive connection establishment is permitted for connection type 13 = UDP (parameter ActiveEstablished of the structure TCON_IP_v4 / TCON_PARAM has the value TRUE).

ERROR	STATUS* (W#16#...)	Explanation
1	80B6	Parameter assignment error in the ConnectionType parameter of the data block for connection description. <ul style="list-style-type: none"> <li>• Only valid with TCON_IP_v4: 0x11, 0x0B and 0x13.</li> <li>• Only valid with TCON_IP_RFC: 0x0C and 0x12</li> </ul>
1	80B7	With TCON_IP_v4: <ul style="list-style-type: none"> <li>• TCP (active connection establishment): Remote port is "0".</li> <li>• TCP (passive connection establishment): Local port is "0".</li> <li>• UDP: Local port is "0".</li> </ul> With TCON_IP_RFC: <ul style="list-style-type: none"> <li>• Local (LocalTSelector) or remote (RemoteTSelector) T selector was specified with a length of more than 32 bytes.</li> <li>• For TSelLength of the T selector (local or remote), a length greater than 32 was entered.</li> <li>• Error in the length of the IP address of the specific connection partner.</li> </ul>
1	80B8	Parameter ID in the local connection description (structure at CONNECT parameter) and parameter ID of the instruction are different.
1	80C3	All connection resources are in use.
1	80C4	Temporary communication error: <ul style="list-style-type: none"> <li>• The connection cannot be established at this time.</li> <li>• The interface is currently receiving new parameters.</li> <li>• The configured connection is currently being removed by a "TDISCON (Page 2884)" instruction.</li> </ul>
1	80C5	The connection partner refuses to establish the connection, has terminated the connection or actively ended it.
1	80C6	The connection partner cannot be reached (network error).
1	80C7	Execution timeout.
1	80C8	Value at the ID parameter is already being used by a connection that was created using the user program. The connection uses the identical ID, but different connection settings at the parameter CONNECT.
1	80C9	Validation of the connection partner failed. The connection partner that wants to establish the connection does not match the defined partner of the structure at the CONNECT parameter.
1	80CE	The IP address of the local interface is 0.0.0.0.
* The error codes can be displayed as integer or hexadecimal values in the program editor. For additional information on toggling display formats, refer to "See also".		

## TDISCON: Terminate communication connection

### Description

The "TDISCON" instruction terminates a communications connection from the CPU to a connection partner.

## Functional description

"The TDISCON" instruction works asynchronously, which means its job processing extends over multiple calls. You start the job for terminating a connection by calling the "TDISCON" instruction with REQ = 1.

After "TDISCON" has been successfully executed, the ID specified for "TCON" is no longer valid and cannot be used for sending or receiving.

The job status is indicated by the output parameters BUSY and STATUS. Here, STATUS corresponds to the output parameter RET\_VAL of the asynchronous instructions (see also: Meaning of the parameters REQ, RET\_VAL and BUSY with asynchronous instructions (Page 1582)).

The following table shows the relationship between BUSY, DONE and ERROR. Using this table, you can recognize the current status of "TDISCON" or when the establishment of the connection is completed.

BUSY	DONE	ERROR	Description
1	0	0	The job is being processed.
0	1	0	Job successfully completed.
0	0	1	The job ended with an error. The cause of the error can be found in the STATUS parameter.
0	0	0	The instruction was not assigned a (new) job.

## Parameters

The following table shows the parameters of the instruction "TDISCON":

Parameter	Declaration	Data type	Memory area		Description
			S7-1200	S7-1500	
REQ	Input	BOOL	I, Q, M, D, L or constant	I, Q, M, D, L or constant	Control parameter REQUEST starts the job for terminating the connection specified by ID. The job starts on a rising edge.
ID	Input	CONN_OUT C (WORD)	D, L or constant	I, Q, M, D, L or constant	Reference to the connection to be terminated (connection ID) Range of values: W#16#0001 to W#16#0FFF
DONE	Output	BOOL	I, Q, M, D, L	I, Q, M, D, L	Status parameter: <ul style="list-style-type: none"> <li>0: Job not yet started or still executing.</li> <li>1: Job executed without errors</li> </ul>
BUSY	Output	BOOL	I, Q, M, D, L	I, Q, M, D, L	Status parameter: <ul style="list-style-type: none"> <li>BUSY = 1: The job is not yet completed.</li> <li>BUSY = 0: The job is completed or has not started yet.</li> </ul>

Parameter	Declaration	Data type	Memory area		Description
			S7-1200	S7-1500	
ERROR	Output	BOOL	I, Q, M, D, L	I, Q, M, D, L	Status parameter: <ul style="list-style-type: none"> <li>ERROR=0: No error.</li> <li>ERROR=1: Error occurred during processing. STATUS supplies detailed information on the type of error</li> </ul>
STATUS	Output	WORD	I, Q, M, D, L	I, Q, M, D, L	Status parameter: Error information (see "Parameters ERROR and STATUS")

You will find more detailed information on valid data types in "Overview of the valid data types (Page 1077)".

### Parameters ERROR and STATUS

ERROR	STATUS* (W#16#...)	Explanation
0	0000	Connection terminated successfully.
0	7000	No job processing active.
0	7001	Start of job processing, connection being terminated.
0	7002	Intermediate call (REQ irrelevant), connection being terminated.
1	8086	The ID parameter is not in the permitted value range.
1	80A3	Attempt is being made to terminate a non-existent connection or the connection is already terminated.
1	80C4	Temporary communication error: New parameters are being assigned to the interface or the connection is currently being established.

\* The error codes can be displayed as integer or hexadecimal values in the program editor. For additional information on toggling display formats, refer to "See also".

### TSEND: Send data via communication connection

### TSEND: Send data via communication connection

#### Description

The following description of the "TSEND" instruction is valid for the CPU S7-1200 to version 3.0.

You use the "TSEND" instruction to send data over an existing communication connection. "TSEND" is executed asynchronously.

You specify the send area with the DATA parameter. This includes the address and the length of the data to be sent. All data types except BOOL and Array of BOOL can be used for the data to be sent.

The send job is executed when a rising edge is detected at the REQ parameter.

With the LEN parameter, you specify the maximum number of bytes sent with a send job.

- When data is transferred with TCP (streaming protocol), the "TSEND" instruction provides no information about the length of the data sent to "TRCV (Page 2892)".
- When data is transferred with ISO-on-TCP (message-oriented protocol), the length of the data sent is communicated to "TRCV (Page 2892)". The amount of data sent with "TSEND" as packet must also be received again at the receiving end ("TRCV (Page 2892)"):
  - If the receive buffer is too small for the sent data, an error occurs at the receiving end.
  - If the receive buffer is sufficiently large, "TRCV" returns with DONE=1 as soon as the data packet is received.

The data to be sent must not be edited until the send job is completed. If the send job executes successfully, the DONE parameter is set to "1". Signal state "1" at the DONE parameter is not confirmation that the data sent has already been read out by the communication partner.

## Parameters

The following table shows the parameters of the "TSEND" instruction:

Parameter	Declaration	Data type	Memory area	Description
REQ	Input	BOOL	I, Q, M, D, L or constant	Starts the send job on a rising edge.
ID	Input	CONN_OUC (WORD)	D, L or constant	Reference to the connection established with "TCON". Range of values: W#16#0001 to W#16#0FFF
LEN	Input	UINT	I, Q, M, D, L	Maximum number of bytes to be sent with the job.
DATA	InOut	VARIANT	I, Q, M, D	Pointer to the send area containing the address and the length of the data to be sent. The address references: <ul style="list-style-type: none"> <li>• The process image of the inputs</li> <li>• The process image of the outputs</li> <li>• A bit memory</li> <li>• A data block</li> </ul>
DONE	Output	BOOL	I, Q, M, D, L	Status parameter with the following values: <ul style="list-style-type: none"> <li>• 0: Job not yet started or still in progress</li> <li>• 1: Job completed without error</li> </ul>
BUSY	Output	BOOL	I, Q, M, D, L	Status parameter with the following values: <ul style="list-style-type: none"> <li>• 0: Job not yet started or already completed</li> <li>• 1: Job not yet completed. A new job cannot be started.</li> </ul>
ERROR	Output	BOOL	I, Q, M, D, L	Status parameter with the following values: <ul style="list-style-type: none"> <li>• 0: No error</li> <li>• 1: Error occurred</li> </ul>
STATUS	Output	WORD	I, Q, M, D, L	Status of the instruction

For additional information on valid data types, refer to "Overview of the valid data types (Page 1077)".

**Parameters LEN and DATA**

- With LEN = 0 , all the data specified with the DATA parameter is sent.
- If the number of bytes at the LEN parameter is larger than the length of the data to be sent that was defined with the DATA parameter, the error code 8088 is output at the STATUS parameter (see description of the STATUS parameter below).
- If a structure (Struct) is referenced via the DATA parameter, LEN can be shorter than the structure. In this case, only the data up to the length of the LEN parameter is transferred.
- With data types STRING and WSTRING, all data is transferred if the parameter LEN = 0. When LEN > 0, the length must be at least the maximum number of bytes plus two additional bytes which contain the length information. You can find more detailed information on the structure of the data types in: "Overview of the valid data types (Page 1077)".
- The maximum number of bytes that can be transmitted is 65534.
- When you use structured tags from optimized DBs, the address of the structured tag should be interconnected at the DATA parameter and the parameter LEN = 0. This guarantees type-safe transmission of the entire structure if the same structure is used at the receiving end.

**Parameters BUSY, DONE and ERROR**

You can check the status of the job with the BUSY, DONE, ERROR and STATUS parameters. The BUSY parameter indicates the processing status. With the DONE parameter, you can check whether or not a job executed successfully. The ERROR parameter is set when errors occurred during execution of "TSEND". The error information is output at the STATUS parameter.

The following table shows the relationship between the BUSY, DONE and ERROR parameters:

BUSY	DONE	ERROR	Description
1	0	0	The job is being processed.
0	1	0	The job was completed successfully.
0	0	1	The job ended with an error. The cause of the error is specified in the STATUS parameter.
0	0	0	No new job was assigned.

**Note**

Because "TSEND" is executed asynchronously, you must keep the data in the send area consistent until the DONE parameter or the ERROR parameter changes to the value "1".

**Parameters ERROR and STATUS**

ERROR	STATUS* (W#16#...)	Description
0	0000	Send job completed without error.
0	7000	No job processing active.



ERROR	STATUS* (W#16#...)	Description
0	7001	Start of job execution, data is being sent. When processing this job, the operating system accesses the data in the DATA send area.
0	7002	Job executing (REQ irrelevant). When processing this job, the operating system accesses the data in the DATA send area.
1	8085	<ul style="list-style-type: none"> <li>The LEN parameter is greater than the highest permitted value (65536).</li> <li>DATA and LEN parameters both have the value "0".</li> </ul>
1	8086	The ID parameter is outside the permitted address range (1..0xFFFF).
1	8088	The LEN parameter is greater than the area specified in DATA.
1	80A1	Communication error: <ul style="list-style-type: none"> <li>The specified connection has not yet been established.</li> <li>The specified connection is being terminated. Transfer via this connection is not possible.</li> <li>The interface is being re-initialized.</li> </ul>
1	80B3	The protocol variant (ConnectionType parameter in the connection description) is set to UDP. Use the instruction "TUSEND" with a UDP connection.
1	80C3	<ul style="list-style-type: none"> <li>A block with this ID is already being processed in a different priority group.</li> <li>Internal lack of resources.</li> </ul>
1	80C4	Temporary communication error: <ul style="list-style-type: none"> <li>The connection cannot be established to the partner at this time.</li> <li>The interface is receiving new parameter settings or the connection is being established.</li> </ul>
1	80C5	Connection terminated by the communication partner.
1	80C6	Network error. Communication partner cannot be reached.
1	80C7	Execution timeout.
* The error codes can be displayed as integer or hexadecimal values in the program editor. For additional information on toggling display formats, refer to "See also".		

## TSEND: Send data via communication connection

### Description

The following description of the "TSEND" instruction is valid for the CPU S7-1500 and S7-1200 V4.0.

You use the "TSEND" instruction to send data over an existing communication connection. "TSEND" is executed asynchronously.

You specify the send area with the DATA parameter. This includes the address and the length of the data to be sent. All data types except BOOL and Array of BOOL can be used for the data to be sent.

The send job is executed when a rising edge is detected at the REQ parameter.

With the LEN parameter, you specify the maximum number of bytes sent with a send job.

9.7 References

- When data is transferred with TCP (streaming protocol), the "TSEND" instruction provides no information about the length of the data sent to "TRCV (Page 2892)".
- When data is transferred with ISO-on-TCP (message-oriented protocol), the length of the data sent is communicated to "TRCV (Page 2892)". The amount of data sent with "TSEND" as packet must also be received again at the receiving end ("TRCV (Page 2892)"):
  - If the receive buffer is too small for the sent data, an error occurs at the receiving end.
  - If the receive buffer is sufficiently large, "TRCV" returns with DONE=1 as soon as the data packet is received.

The data to be sent must not be edited until the send job is completed. If the send job executes successfully, the DONE parameter is set to "1". Signal state "1" at the DONE parameter is not confirmation that the data sent has already been read out by the communication partner.

Parameters

The following table shows the parameters of the "TSEND" instruction:

Parameter	Declaration	Data type	Memory area	Description
REQ	Input	BOOL	I, Q, M, D, L or constant	Starts the send job on a rising edge.
ID	Input	CONN_OUC (WORD)	D, L or constant	Reference to the connection established with "TCON". Range of values: W#16#0001 to W#16#0FFF
LEN	Input	UDINT	I, Q, M, D, L	Maximum number of bytes to be sent with the job.
DATA	InOut	VARIANT	I, Q, M, D	Pointer to the send area containing the address and the length of the data to be sent. The address references: <ul style="list-style-type: none"> <li>• The process image of the inputs</li> <li>• The process image of the outputs</li> <li>• A bit memory</li> <li>• A data block</li> </ul>
DONE	Output	BOOL	I, Q, M, D, L	Status parameter with the following values: <ul style="list-style-type: none"> <li>• 0: Job not yet started or still in progress</li> <li>• 1: Job completed without error</li> </ul>
BUSY	Output	BOOL	I, Q, M, D, L	Status parameter with the following values: <ul style="list-style-type: none"> <li>• 0: Job not yet started or already completed</li> <li>• 1: Job not yet completed. A new job cannot be started.</li> </ul>
ERROR	Output	BOOL	I, Q, M, D, L	Status parameter with the following values: <ul style="list-style-type: none"> <li>• 0: No error</li> <li>• 1: Error occurred</li> </ul>
STATUS	Output	WORD	I, Q, M, D, L	Status of the instruction

For additional information on valid data types, refer to "Overview of the valid data types (Page 1077)".

## Parameters LEN and DATA

- With LEN = 0 , all the data specified with the DATA parameter is sent.
- If the number of bytes at the LEN parameter is larger than the length of the data to be sent that was defined with the DATA parameter, the error code 8088 is output at the STATUS parameter (see description of the STATUS parameter below).
- If a structure (Struct) is referenced via the DATA parameter, LEN can be shorter than the structure. In this case, only the data up to the length of the LEN parameter is transferred.
- With data types STRING and WSTRING, all data is transferred if the parameter LEN = 0. When LEN > 0, the length must be at least the maximum number of bytes plus two additional bytes which contain the length information. You can find more detailed information on the structure of the data types in: "Overview of the valid data types (Page 1077)".
- The maximum number of bytes that can be transmitted depends on the device.
- When you use structured tags from optimized DBs, the address of the structured tag should be interconnected at the DATA parameter and the parameter LEN = 0. This guarantees type-safe transmission of the entire structure if the same structure is used at the receiving end.

## Parameters BUSY, DONE and ERROR

You can check the status of the job with the BUSY, DONE, ERROR and STATUS parameters. The BUSY parameter indicates the processing status. With the DONE parameter, you can check whether or not a job executed successfully. The ERROR parameter is set when errors occurred during execution of "TSEND". The error information is output at the STATUS parameter.

The following table shows the relationship between the BUSY, DONE and ERROR parameters:

BUSY	DONE	ERROR	Description
1	0	0	The job is being processed.
0	1	0	The job was completed successfully.
0	0	1	The job ended with an error. The cause of the error is specified in the STATUS parameter.
0	0	0	No new job was assigned.

### Note

Because "TSEND" is executed asynchronously, you must keep the data in the send area consistent until the DONE parameter or the ERROR parameter changes to the value "1".

## Parameters ERROR and STATUS

ERROR	STATUS* (W#16#...)	Description
0	0000	Send job completed without error.
0	7000	No job processing active.

ERROR	STATUS* (W#16#...)	Description
0	7001	Start of job execution, data is being sent. When processing this job, the operating system accesses the data in the DATA send area.
0	7002	Job executing (REQ irrelevant). When processing this job, the operating system accesses the data in the DATA send area.
1	8085	<ul style="list-style-type: none"> <li>The LEN parameter is greater than the highest permitted value (65536).</li> <li>DATA and LEN parameters both have the value "0".</li> </ul>
1	8086	The ID parameter is outside the permitted address range (1..0xFFF).
1	8088	The LEN parameter is greater than the area specified in DATA.
1	80A1	Communication error: <ul style="list-style-type: none"> <li>The specified connection has not yet been established.</li> <li>The specified connection is being terminated. Transfer via this connection is not possible.</li> <li>The interface is being re-initialized.</li> </ul>
1	80B3	The protocol variant (ConnectionType parameter in the connection description) is set to UDP. Use the instruction "TUSEND" with a UDP connection.
1	80C3	<ul style="list-style-type: none"> <li>A block with this ID is already being processed in a different priority group.</li> <li>Internal lack of resources.</li> </ul>
1	80C4	Temporary communication error: <ul style="list-style-type: none"> <li>The connection cannot be established to the partner at this time.</li> <li>The interface is receiving new parameter settings or the connection is being established.</li> </ul>
1	80C5	Connection terminated by the communication partner.
1	80C6	Network error. Communication partner cannot be reached.
1	80C7	Execution timeout.
* The error codes can be displayed as integer or hexadecimal values in the program editor. For additional information on toggling display formats, refer to "See also".		

**TRCV: Receive data via communication connection**

**TRCV: Receive data via communication connection**

**Description**

The following description of the "TRCV" instruction is valid for the CPU S7-1200 up to version 3.0.

You use the "TRCV" instruction to receive data over an existing communication connection. "TRCV" is executed asynchronously.

Receipt of data is enabled when the EN\_R parameter is set to the value "1". The received data is entered in a receive area. You specify the length of the receive area either with the LEN parameter (if LEN <> 0) or with the length information of the DATA parameter (if LEN = 0), depending on the protocol variant being used.

While data is being received, you cannot make changes to the DATA parameter or the defined receive area to ensure consistency of the received data.

After successful receipt of data, the NDR parameter is set to the value "1". You can query the amount of data actually received at the RCVD\_LEN parameter.

## Receive modes of "TRCV"

The following table shows how the received data is entered in the receive area.

Protocol variant	Availability of data in the receive area	connection_type* parameter of the connection description	Parameter LEN
TCP (Ad-hoc mode)	The data is immediately available.	Hexadecimal value: B#16#11 Integer value: 17	0
TCP (Receipt of data with specified length)	The data is available as soon as the data length specified at the LEN parameter has been fully received.	Hexadecimal value: B#16#11 Integer value: 17	1 to 8192
ISO on TCP (Message-oriented data transfer)	The data is available as soon as the data length specified at the LEN parameter has been fully received.	Hexadecimal value: B#16#12 Integer value: 18	<ul style="list-style-type: none"> <li>• 1 to 1452, if a CP is used.</li> <li>• 1 to 8192, if no CP is used.</li> </ul>
* See "Auto-Hotspot".			

### TCP (Ad-hoc mode)

The ad-hoc mode is only available with the TCP protocol variant. You use the ad-hoc mode to receive data with dynamic length with the "TRCV" instruction.

You set ad-hoc mode by assigning the value "0" to the LEN parameter. All data types can be used for data blocks with standard access when you use ad-hoc mode. Only ARRAY of BYTE or data types with a length of 8 bits can be used for data blocks with optimized access (e.g., CHAR, USINT, SINT, etc.). When ad-hoc mode is active, receipt of data is already signaled after a received byte at the NDR parameter.

### TCP (Receipt of data with specified length)

For receipt of data with a specified length, enter the length of the data at the LEN parameter. The data receipt is not complete until the length of data specified at the LEN parameter has been completely received. Only then is the data available in the receive area (DATA parameter). The receipt of data is signaled by the NDR output parameter. The actually received data length in bytes at the RCVD\_LEN parameter corresponds to the data length at the LEN parameter after receipt.

### ISO on TCP (Message-oriented data transfer)

Complete message blocks are sent via a connection with the protocol variant ISO on TCP; these are recognized as such by the recipient. When using ISO on TCP, "TRCV" signals data receipt as soon as the message block has been completely received. The receive area is defined by the LEN and DATA parameters. If the receive buffer (DATA parameter) is too small for the sent data, "TRCV" signals an error. The successful receipt of data is signaled by the

NDR output parameter. The actually received data length in bytes at the RCVD\_LEN parameter corresponds to the data length at the LEN parameter after receipt.

### Parameters

The following table shows the parameters of the "TRCV" instruction:

Parameter	Declaration	Data type	Memory area	Description
EN_R	Input	BOOL	I, Q, M, D, L or constant	Receive enable
ID	Input	CONN_OUC (WORD)	D, L or constant	Reference to the connection established with "TCON (Page 2877)". Range of values: W#16#0001 (1) to W#16#0FFF (4095)
LEN	Input	UDINT	I, Q, M, D, L or constant	Length of the receive area in bytes (hidden). If you use a memory area with optimized access at the DATA parameter, the LEN parameter must have the value "0".
DATA	InOut	VARIANT	I, Q, M, D	Pointer to the receive area
NDR	Output	BOOL	I, Q, M, D, L	Status parameter (New Data Received): <ul style="list-style-type: none"> <li>0: Job not yet started or still in progress</li> <li>1: Job completed without error</li> </ul>
BUSY	Output	BOOL	I, Q, M, D, L	Status parameter: <ul style="list-style-type: none"> <li>0: Job not yet started or already completed</li> <li>1: Job not yet completed. A new job cannot be started</li> </ul>
ERROR	Output	BOOL	I, Q, M, D, L	Status parameter: <ul style="list-style-type: none"> <li>0: No error.</li> <li>1: An error occurred during execution of the instruction.</li> </ul> Detailed information is output via the STATUS parameter.
STATUS	Output	WORD	I, Q, M, D, L	Status parameter: Output of status and error information.
RCVD_LEN	Output	UDINT	I, Q, M, D, L	Amount of data actually received in bytes

For additional information on valid data types, refer to "Overview of the valid data types (Page 1077)".

### Parameters LEN, DATA and RCVD\_LEN

- If LEN = 0, the received data is saved in the receive area specified at the DATA parameter. The number of bytes received is indicated at the RCVD\_LEN parameter.
- If the length specified at the LEN parameter is greater than the length of the data received at the DATA parameter, the error code 8088 is output at the STATUS parameter (see description of the STATUS) parameter in the following.

- If a structure (Struct) is referenced via the DATA parameter, LEN can be shorter than the structure. In this case, only the data up to the length of the LEN parameter is transferred.
- If the DATA parameter references a data block with optimized access, the LEN parameter must be set to "0".
- If a STRING data type is referenced via the DATA parameter, the length specified at the LEN parameter must be 0 or >=2 (LEN = 1 is not permitted).
- If a WSTRING data type is referenced via the DATA parameter, the length specified at the LEN parameter must be 0 or >=5.

### Parameters BUSY, NDR and ERROR

You can check the status of the job with the BUSY, NDR, ERROR and STATUS parameters. The BUSY parameter indicates the processing status. With the NDR parameter, you can check whether or not a job executed successfully. The ERROR parameter is set when errors occurred during execution of TRCV. The error information is output at the STATUS parameter.

The following table shows the relationship between the BUSY, NDR and ERROR parameters:

BUSY	NDR	ERROR	Description
1	-	-	The job is being processed.
0	1	0	The job was completed successfully.
0	0	1	The job ended with an error. The cause of the error is output at the STATUS parameter.
0	0	0	No new job was assigned.

#### Note

Because "TRCV" is executed asynchronously, the data in the receive area is only consistent when the NDR parameter is set to the value "1".

### Parameters ERROR and STATUS

ERROR	STATUS* (W#16#...)	Explanation
0	0000	Job completed successfully. The current length of the received data is output at the RCVD_LEN parameter.
0	7000	Block not ready to receive.
0	7001	Block is ready to receive, receive job was activated.
0	7002	Interim call, the receive job is executing. Note: While the job is being processed, data is written to the receive area. Access to the receive area during this time may provide inconsistent data.
1	8085	<ul style="list-style-type: none"> <li>• The LEN parameter is larger than the highest permitted value.</li> <li>• The value of the LEN or DATA parameter was changed after the first call.</li> <li>• Both LEN parameters and the DATA parameter have the value "0" or LEN is longer than the maximum permitted value (65536).</li> </ul>
1	8086	The ID parameter is outside the permitted address range (1 .. 0x0FFF).

ERROR	STATUS* (W#16#...)	Explanation
1	8088	<ul style="list-style-type: none"> <li>Receive area is too small.</li> <li>The value at the LEN parameter is larger than the receive area set at the DATA parameter.</li> </ul>
1	80A1	Communication error: <ul style="list-style-type: none"> <li>The specified connection has not yet been established.</li> <li>The specified connection is being terminated. Receive job over this connection is not possible.</li> <li>The connection is being re-initialized.</li> </ul>
1	80B3	The protocol variant (connection_type parameter in the connection description) is set to UDP. Use the instruction "TRCV" with a UDP connection.
1	80C3	<ul style="list-style-type: none"> <li>A block with this ID is already being processed in a different priority group.</li> <li>Internal lack of resources.</li> </ul>
1	80C4	Temporary communication error: <ul style="list-style-type: none"> <li>The connection cannot be established to the partner at this time.</li> <li>The interface is receiving new parameter settings or the connection is being established.</li> </ul>
1	80C5	The remote partner has terminated the connection.
1	80C6	The remote partner cannot be reached (network error).
1	80C7	Execution timeout.
1	80C9	The length of the receive area is smaller than the length of the sent data.

\* The error codes can be displayed as integer or hexadecimal values in the program editor. For additional information on toggling display formats, refer to "See also".

### TRCV: Receive data via communication connection

#### Description

The following description of the "TRCV" instruction is valid for the CPU S7-1500 and S7-1200 V4.0.

You use the "TRCV" instruction to receive data over an existing communication connection. "TRCV" is executed asynchronously.

Receipt of data is enabled when the EN\_R parameter is set to the value "1". The received data is entered in a receive area. You specify the length of the receive area either with the LEN parameter (if LEN <> 0) or with the length information of the DATA parameter (if LEN = 0), depending on the protocol variant being used.

While data is being received, you cannot make changes to the DATA parameter or the defined receive area to ensure consistency of the received data.

After successful receipt of data, the NDR parameter is set to the value "1". You can query the amount of data actually received at the RCVD\_LEN parameter.



## Receive modes of "TRCV"

The following table shows how the received data is entered in the receive area.

Protocol variant	Parameter ADHOC	Availability of data in the receive area	connection_type parameter of the connection description	Parameter LEN
TCP (Ad-hoc mode)	1 (ad-hoc activated)	The data is immediately available.	Hexadecimal value: B#16#11 Integer value: 17	1 up to maximum length (depending on the CPU)
TCP (Receipt of data with specified length)	0 (ad-hoc deactivated)	The data is available as soon as the data length specified at the LEN parameter has been fully received.	Hexadecimal value: B#16#11 Integer value: 17	1 to 8192
ISO on TCP (Message-oriented data transfer)	-	The data is available as soon as the data length specified at the LEN parameter has been fully received.	Hexadecimal value: B#16#12 Integer value: 18	<ul style="list-style-type: none"> <li>• 1 to 1452, if a CP is used.</li> <li>• 1 to 8192, if no CP is used.</li> </ul>

### TCP (Ad-hoc mode)

The ad-hoc mode is only available with the TCP protocol variant. You use the ad-hoc mode to receive data with dynamic length with the "TRCV" instruction.

You set ad-hoc mode by assigning the value "1" to the ADHOC parameter. All data types can be used for data blocks with standard access when you use ad-hoc mode. Only ARRAY of BYTE or data types with a length of 8 bits can be used for data blocks with optimized access (e.g., CHAR, USINT, SINT, etc.). When ad-hoc mode is active, receipt of data is already signaled after a received byte at the NDR parameter.

### TCP (Receipt of data with specified length)

Assign the value "0" to the ADHOC parameter for receipt of data with specified length. If ad-hoc mode is disabled, the data receipt is not complete until the length of data specified at the LEN parameter has been completely received. Only then is the data available in the receive area (DATA parameter). The successful receipt of data is signaled by the NDR output parameter. The actually received data length in bytes at the RCVD\_LEN parameter corresponds to the data length at the LEN parameter after receipt.

### ISO on TCP (Message-oriented data transfer)

Complete message blocks are sent via a connection with the protocol variant ISO on TCP; these are recognized as such by the recipient. When using ISO on TCP, "TRCV" signals data receipt as soon as the message block has been completely received. The receive area is defined by the LEN and DATA parameters. If the receive buffer (DATA parameter) is too small for the sent data, "TRCV" signals an error. The successful receipt of data is signaled by the NDR output parameter. The actually received data length in bytes at the RCVD\_LEN parameter corresponds to the data length at the LEN parameter after receipt.

**Parameters**

The following table shows the parameters of the "TRCV" instruction:

Parameter	Declaration	Data type	Memory area	Description
EN_R	Input	BOOL	I, Q, M, D, L or constant	Receive enable
ID	Input	CONN_OUC (WORD)	D, L or constant	Reference to the connection established with "TCON". Range of values: W#16#0001 to W#16#0FFF
LEN	Input	UDINT	I, Q, M, D, L or constant	Length of the receive area in bytes (hidden). If you use a receive area with optimized access at the DATA parameter, the LEN parameter must have the value "0".
ADHOC	Input	BOOL	I, Q, M, D, L or constant	Use ad-hoc mode for the TCP protocol variant (hidden).
DATA	InOut	VARIANT	I, Q, M, D	Pointer to the receive area
NDR	Output	BOOL	I, Q, M, D, L	Status parameter (New Data Received): <ul style="list-style-type: none"> <li>0: Job not yet started or still in progress</li> <li>1: New data received</li> </ul>
BUSY	Output	BOOL	I, Q, M, D, L	Status parameter with the following values: <ul style="list-style-type: none"> <li>0: Job not yet started or already completed</li> <li>1: Job not yet completed. A new job cannot be started</li> </ul>
ERROR	Output	BOOL	I, Q, M, D, L	Status parameter ERROR: <ul style="list-style-type: none"> <li>0: No error</li> <li>1: Error occurred</li> </ul>
STATUS	Output	WORD	I, Q, M, D, L	Status of the instruction
RCVD_LEN	Output	UDINT	I, Q, M, D, L	Amount of data actually received in bytes

For additional information on valid data types, refer to "Overview of the valid data types (Page 1077)".

**Parameters LEN, DATA and RCVD\_LEN**

- If LEN = 0, the received data is saved in the receive area specified at the DATA parameter. The number of bytes received is indicated at the RCVD\_LEN parameter.
- If the length specified at the LEN parameter is greater than the length of the data received at the DATA parameter, the error code 8088 is output at the STATUS parameter (see description of the STATUS) parameter in the following.
- If a structure (Struct) is referenced via the DATA parameter, LEN can be shorter than the structure. In this case, only the data up to the length of the LEN parameter is transferred.
- If the DATA parameter references a data block with optimized access, the LEN parameter must be set to "0". If the length of the data does not match for elementary data types, the data will not be received and the error code 8088 is output at the STATUS parameter.

- If a STRING data type is referenced via the DATA parameter, the length specified at the LEN parameter must be 0 or >=2 (LEN = 1 is not permitted).
- If a WSTRING data type is referenced via the DATA parameter, the length specified at the LEN parameter must be 0 or >=5.

### Parameters BUSY, NDR and ERROR

You can check the status of the job with the BUSY, NDR, ERROR and STATUS parameters. The BUSY parameter indicates the processing status. With the NDR parameter, you can check whether or not a job executed successfully. The ERROR parameter is set when errors occurred during execution of TRCV. The error information is output at the STATUS parameter.

The following table shows the relationship between the BUSY, NDR and ERROR parameters:

BUSY	NDR	ERROR	Description
1	-	-	The job is being processed.
0	1	0	The job was completed successfully.
0	0	1	The job ended with an error. The cause of the error is output at the STATUS parameter.
0	0	0	No new job was assigned.

#### Note

Because "TRCV" is executed asynchronously, the data in the receive area is only consistent when the NDR parameter is set to the value "1".

### Parameters ERROR and STATUS

ERROR	STATUS* (W#16#...)	Explanation
0	0000	Job completed successfully. The current length of the received data is output at the RCVD_LEN parameter.
0	7000	Block not ready to receive.
0	7001	Block is ready to receive, receive job was activated.
0	7002	Interim call, the receive job is executing. Note: While the job is being processed, data is written to the receive area. Access to the receive area during this time may provide inconsistent data.
1	8085	<ul style="list-style-type: none"> <li>• The LEN parameter is larger than the highest permitted value.</li> <li>• The value of the LEN or DATA parameter was changed after the first call.</li> <li>• Both LEN parameters and the DATA parameter have the value "0" or LEN is longer than the maximum permitted value (65536).</li> </ul>
1	8086	The ID parameter is outside the permitted value range (1 .. 0x0FFF).
1	8088	<ul style="list-style-type: none"> <li>• Receive area is too small.</li> <li>• The value at the LEN parameter is larger than the receive area set at the DATA parameter.</li> </ul>

ERROR	STATUS* (W#16#...)	Explanation
1	80A1	Communication error: <ul style="list-style-type: none"> <li>• The specified connection has not yet been established.</li> <li>• The specified connection is being terminated. Receive job over this connection is not possible.</li> <li>• The connection is being re-initialized.</li> </ul>
1	80B3	The protocol variant (connection_type parameter in the connection description) is set to UDP. Use the instruction "TURCV" with a UDP connection.
1	80C3	<ul style="list-style-type: none"> <li>• A block with this ID is already being processed in a different priority group.</li> <li>• Internal lack of resources.</li> </ul>
1	80C4	Temporary communication error: <ul style="list-style-type: none"> <li>• The connection cannot be established to the partner at this time.</li> <li>• The interface is receiving new parameter settings or the connection is being established.</li> </ul>
1	80C5	The remote partner has terminated the connection.
1	80C6	The remote partner cannot be reached (network error).
1	80C7	Execution timeout.
1	80C9	The length of the receive area is smaller than the length of the sent data.
* The error codes can be displayed as integer or hexadecimal values in the program editor. For additional information on toggling display formats, refer to "See also".		

**See also**

TRCV: Receive data via communication connection (Page 2892)

TCON: Establish communication connection (Page 2880)

**Structure of the address information for the remote partner with UDP**

**Overview**

- With "TUSEND (Page 2901)", you transfer the address information of the receiver at the ADDR parameter. This address information must have the structure specified below.
- With "TURCV (Page 2904)", you receive the address of the sender of the received data at the ADDRparameter. This address information must have the structure specified below.

**Data block for the address information of the remote partner**

You must create a DB that contains one or more data structures as per PLC data type "TADDR\_PARAM".

In the ADDR parameter of "TUSEND (Page 2901)", you transfer a pointer of type VARIANT to the address of the corresponding remote partner (e.g. P#DB100.DBX0.0 USINT 8). This pointer is received in the ADDR parameter of "TURCV (Page 2904)".

### Configuration of the address information for the remote partner for "TADDR\_PARAM"

Byte	Parameter	Data type	Start value	Description
0 to 3	rem_ip_addr	ARRAY [1..4] of USINT	B#16#00 ...	IP address of the remote partner, e.g. 192.168.002.003: <ul style="list-style-type: none"> <li>rem_ip_addr[1] = B#16#C0 (192)</li> <li>rem_ip_addr[2] = B#16#A8 (168)</li> <li>rem_ip_addr[3] = B#16#02 (002)</li> <li>rem_ip_addr[4] = B#16#03 (003)</li> </ul>
4 to 5	rem_port_nr	UINT	B#16#00 ...	remote port no. (possible values see: Auto-Hotspot): <ul style="list-style-type: none"> <li>rem_port_nr[1] = high byte of the port no. in hexadecimal notation</li> <li>rem_port_nr[2] = low byte of port no. in hexadecimal notation</li> </ul>
6 to 7	reserved	WORD	B#16#00 ...	Not used. Assign "0" to this parameter.

### TUSEND: Send data via Ethernet (UDP)

#### Description

The "TUSEND" instruction sends data to the remote partner addressed by the ADDR parameter using UDP.



#### WARNING

##### Data transfer via UDP

Data transferred via UDP to RFC 768 to the remote partner are sent without acknowledgement and are therefore unsecured. This means the data can be lost without any indication at the block.

#### Note

For sequential send operations to different partners, you only need to adjust the ADDR parameter when calling "TUSEND". You do not need to call the "TCON (Page 2877)" and "TDISCON (Page 2884)" instructions again.

#### Functional description

"The TUSEND" instruction works asynchronously, which means its job processing extends over multiple calls. You start the send operation by calling "TUSEND" with REQ = 1.

The job status is indicated by the output parameters BUSY and STATUS. Here, STATUS corresponds to the output parameter RET\_VAL of the asynchronous instructions.

See also: Meaning of the parameters REQ, RET\_VAL and BUSY with asynchronous instructions (Page 1582).

The following table shows the relationship between BUSY, DONE and ERROR. Using this table, you can determine the current status of "TUSEND" or when the send process is concluded.

BUSY	DONE	ERROR	Description
TRUE	irrelevant	irrelevant	The job is being processed.
FALSE	TRUE	FALSE	Job successfully completed.
FALSE	FALSE	TRUE	The job ended with an error. The cause of the error can be found in the STATUS parameter.
FALSE	FALSE	FALSE	The instruction was not assigned a (new) job.

**Note**

Due to the asynchronous operation of "TUSEND", make sure the data in the send area remains consistent until the DONE parameter or the ERROR parameter has the value TRUE.

**Parameters**

The following table shows the parameters of the "TUSEND" instruction:

Parameter	Declaration	Data type	Memory area		Description
			S7-1200	S7-1500	
REQ	Input	BOOL	I, Q, M, D, L or constant	I, Q, M, D, L or constant	Control parameter REQUEST starts the send job on a rising edge. The data is transferred from the area specified by DATA and LEN.
ID	Input	WORD	M, D or constant	M, D or constant	Reference to the associated connection between the user program and the communication layer of the operating system. ID must be identical to the associated parameter ID in the local connection description. Range of values: W#16#0001 to W#16#0FFF
LEN	Input	UINT	I, Q, M, D, L	I, Q, M, D, L	Number of bytes to be sent with the job Range of values: 1 to 1472
DONE	Output	BOOL	I, Q, M, D, L	I, Q, M, D, L	Status parameter DONE: <ul style="list-style-type: none"> <li>0: Job not yet started or still executing.</li> <li>1: Job executed without errors</li> </ul>
BUSY	Output	BOOL	I, Q, M, D, L	I, Q, M, D, L	<ul style="list-style-type: none"> <li>BUSY = 1: The job is not yet completed. A new job cannot be triggered.</li> <li>BUSY = 0: The job is completed.</li> </ul>
ERROR	Output	BOOL	I, Q, M, D, L	I, Q, M, D, L	Status parameter ERROR: <ul style="list-style-type: none"> <li>ERROR=1: An error has occurred during processing, STATUS supplies detailed information on the type of error.</li> </ul>

Parameter	Declaration	Data type	Memory area		Description
			S7-1200	S7-1500	
STATUS	Output	WORD	M, D	M, D	Status parameter STATUS: Error information
DATA	InOut	VARIANT	I, Q, M, D	I, Q, M, D	Send area, contains address and length  The address refers to: <ul style="list-style-type: none"> <li>• The process image of the inputs</li> <li>• The process image of the outputs</li> <li>• A bit memory</li> <li>• A data block</li> </ul>
ADDR	InOut	TADDR_P aram	D	D	Pointers to the address of the recipient (e.g. P#DB100.DBX0.0 USINT 8) See also: Structure of the address information for the remote partner with UDP (Page 2900)

**Note**

Create the data block for the ADDR parameter using the "Add new block" dialog, by selecting the type "TADDR\_Param".

For additional information on valid data types, refer to "Overview of the valid data types (Page 1077)".

**Parameters ERROR and STATUS**

ERROR	STATUS* (W#16#...)	Explanation
0	0000	Send job completed without error
0	7000	No job processing active
0	7001	Start of job processing, data being sent Note: During this processing phase, the operating system accesses the data in the DATA send area.
0	7002	Intermediate call (REQ irrelevant), job is being processed Note: During this processing phase, the operating system accesses the data in the DATA send area.
1	8085	The LEN parameter has the value "0" or is greater than the highest permitted value.
1	8086	The ID parameter is not in the permitted value range.
0	8088	The LEN parameter is greater than the memory area specified in DATA.
1	8089	The ADDR parameter does not point to a data block with the TADDR_Param structure.

ERROR	STATUS* (W#16#...)	Explanation
1	80A1	Communication error: <ul style="list-style-type: none"> <li>• The specified connection between user program and communication layer of the operating system has not yet been established.</li> <li>• The specified connection between the user program and the communication layer of the operating system is currently being terminated. Transmission over this connection is not possible.</li> <li>• The interface is being reinitialized.</li> </ul>
1	80A4	IP address (at the ADDR parameter) of the remote connection end point is invalid; it may correspond to the local partner's own IP address.
1	80B3	<ul style="list-style-type: none"> <li>• The protocol variant (connection_type parameter in the connection description) is not set to UDP. Please use "TSEND (Page 2889)".</li> <li>• ADDR parameter: Invalid information for port no.</li> </ul>
1	80C3	<ul style="list-style-type: none"> <li>• A block with this ID is already being processed in a different priority class.</li> <li>• Internal lack of resources.</li> </ul>
1	80C4	Temporary communication error: <ul style="list-style-type: none"> <li>• The connection between the user program and the communication layer of the operating system cannot be established at this time.</li> <li>• New parameter settings are being assigned to the interface.</li> </ul>
1	80C5	The remote partner has terminated the connection.
1	80C6	The remote partner cannot be reached (network error).
1	80C7	Execution timeout.
-	General error information	See also: GET_ERR_ID: Get error ID locally (Page 1787)

\* The error codes can be displayed as integer or hexadecimal values in the program editor. For additional information on toggling display formats, refer to "See also".

### TURCV: Receive data via Ethernet (UDP)

#### Description

The "TURCV" instruction receives data via UDP. After successful completion of "TURCV", the ADDR parameter will show you the address of the remote partner (the sender).

 <b>WARNING</b>
<p><b>Unsecured data transfer</b></p> <p>Data transferred via UDP to RFC 768 to the remote partner are sent without acknowledgement and are therefore unsecured. This means the data can be lost without any indication at the block.</p>



## Functional description

"The TURCV" instruction works asynchronously, which means its job processing extends over multiple calls. You start the receive job by calling "TURCV" with EN\_R = 1.

The job status is indicated by the output parameters BUSY and STATUS. Here, STATUS corresponds to the output parameter RET\_VAL of the asynchronous instructions

See also: Meaning of the parameters REQ, RET\_VAL and BUSY with asynchronous instructions (Page 1582).

The following table shows the relationship between BUSY, NDR and ERROR. Using this table, you can determine the current status of TURCV or when the receive process is concluded.

BUSY	NDR	ERROR	Description
TRUE	irrelevant	irrelevant	The job is being processed.
FALSE	TRUE	FALSE	Job successfully completed.
FALSE	FALSE	TRUE	The job ended with an error. The cause of the error can be found in the STATUS parameter.
FALSE	FALSE	FALSE	The instruction was not assigned a (new) job.

### Note

Due to the asynchronous operation of "TURCV", the data in the receive area is only consistent when the NDR parameter has the value TRUE.

## Parameters

The following table shows the parameters of the "TURCV" instruction:

Parameter	Declaration	Data type	Memory area		Description
			S7-1200	S7-1500	
EN_R	Input	BOOL	I, Q, M, D, L or constant	I, Q, M, D, L or constant	Control parameter enabled to receive: When EN_R = 1, "TURCV" is ready to receive. The receive job is being processed.
ID	Input	WORD	M, D or constant	M, D or constant	Reference to the associated connection between the user program and the communication layer of the operating system. ID must be identical to the corresponding parameter ID in the local connection description. Value range: W#16#0001 to W#16#0FFF
LEN	Input	UINT	I, Q, M, D, L	I, Q, M, D, L	Length of the receive area in bytes: 0 (recommended) or 1 to 1472
NDR	Output	BOOL	I, Q, M, D, L	I, Q, M, D, L	Status parameter NDR: <ul style="list-style-type: none"> <li>NDR = 0: Job not yet started or still running</li> <li>NDR = 1: Job successfully completed</li> </ul>
ERROR	Output	BOOL	I, Q, M, D, L	I, Q, M, D, L	Status parameter ERROR: <ul style="list-style-type: none"> <li>ERROR=1: Error occurred during processing. STATUS supplies detailed information on the type of error</li> </ul>

9.7 References

Parameter	Declaration	Data type	Memory area		Description
			S7-1200	S7-1500	
BUSY	Output	BOOL	I, Q, M, D, L	I, Q, M, D, L	<ul style="list-style-type: none"> <li>• BUSY = 1: The job is not yet completed. A new job cannot be triggered.</li> <li>• BUSY = 0: The job is completed.</li> </ul>
STATUS	Output	WORD	M, D	M, D	Status parameter STATUS: Error information
RCVD_LEN	Output	UINT	I, Q, M, D, L	I, Q, M, D, L	Amount of data actually received in bytes
DATA	InOut	VARIANT	I, Q, M, D	I, Q, M, D	Receive area The address references: <ul style="list-style-type: none"> <li>• The process image of the inputs</li> <li>• The process image of the outputs</li> <li>• A bit memory</li> <li>• A data block</li> </ul>
ADDR	InOut	TADDR_Param	D	D	Pointers to the address of the receiver (for example, P#DB100.DBX0.0 byte 8), see also: Structure of the address information for the remote partner with UDP (Page 2900)

You will find more detailed information on valid data types in "Overview of the valid data types (Page 1077)".

Parameters ERROR and STATUS

ERROR	STATUS* (W#16#...)	Explanation
0	0000	New data was accepted. The current length of the received data is shown in RCVD_LEN.
0	7000	Block not ready to receive
0	7001	Block is ready to receive, receive job was activated
0	7002	Intermediate call, receive job being processed Note: During this processing phase, "TURCV" writes data to the receive area. For this reason, an error could result in inconsistent data in the receive area.
1	8085	The LEN parameter is greater than the largest permitted value, or you changed the value of the LEN or DATA parameter since the first call
1	8086	The ID parameter is not in the permitted range
1	8088	<ul style="list-style-type: none"> <li>• Receive area is too small</li> <li>• Value in LEN is higher than the receive area specified by DATA</li> </ul>
1	8089	The ADDR parameter does not point to a data block with the TADDR_Param structure.
1	80A1	Communication error: <ul style="list-style-type: none"> <li>• The specified connection between user program and communication layer of the operating system has not yet been established.</li> <li>• The specified connection between the user program and the communication layer of the operating system is currently being terminated. A receive job over this connection is not possible.</li> <li>• New parameter settings are being assigned to the interface.</li> </ul>
1	80A4	IP address (at the ADDR parameter) of the remote connection end point is invalid; it may correspond to the local partner's own IP address.

ERROR	STATUS* (W#16#...)	Explanation
1	80B3	The protocol variant (connection_type parameter in the connection description) is not set to UDP. Please use "TRCV (Page 2892)".
1	80B7	The length at ADDR parameter does not correspond to 8 bytes.
1	80C3	<ul style="list-style-type: none"> <li>• A block with this ID is already being processed in a different priority class.</li> <li>• Internal lack of resources.</li> </ul>
1	80C4	Temporary communication error: New parameter settings are being assigned to the interface.
1	80C5	The remote partner has terminated the connection.
1	80C6	The remote partner cannot be reached (network error).
1	80C7	Execution timeout.
1	80C9	With RFC1006 / UDP: The received data is longer than expected (size of receive buffer exceeded).
-	General error information	See also: GET_ERR_ID: Get error ID locally (Page 1787)

\* The error codes can be displayed as integer or hexadecimal values in the program editor. For additional information on toggling display formats, refer to "See also".

## See also

TCON: Establish communication connection (Page 2877)

TDISCON: Terminate communication connection (Page 2884)

## T\_RESET: Resetting the connection

### Description

The "T\_RESET" instruction terminates and then reestablishes an existing connection.

The local end points of the connection are retained. They are generated automatically:

- If a connection has been configured and loaded to the CPU.
- If a connection has been generated by the user program, for example, by calling the instruction "TCON (Page 2877)".

The instruction "T\_RESET" can be executed for all connection types (TCP, UDP, ISO-on-TCP, etc.). It does not matter whether the local interface of the CPU or the interface of a CM/CP was used for the connection.

Once the instruction "T\_RESET" has been called using the REQ parameter, the connection specified with the ID parameter is terminated and, if necessary, the data send and receive buffer cleared. Canceling the connection also cancels any data transfer in progress. There is therefore a risk of losing data if data transfer is in progress. The CPU defined as the active connection partner will then automatically attempt to restore the interrupted communication connection. You therefore do not need to call the "TCON (Page 2877)" instruction to reestablish the communication connection.

The output parameters DONE, BUSY and STATUS indicate the status of the job.

**Parameters**

The following table shows the parameters of the "T\_RESET" instruction:

Parameter	Declaration	Data type	Memory area	Description
REQ	Input	BOOL	I, Q, M, D, L or constant	Control parameter REQUEST starts the job for terminating the connection specified by ID. The job starts on a rising edge.
ID	Input	CONN_OUC (WORD)	L, D or constant	Reference to the connection to the passive partner which is to be terminated. ID must be identical to the corresponding parameter ID in the local connection description. Range of values: W#16#0001 to W#16#0FFF
DONE	Output	BOOL	I, Q, M, D, L	Status parameter DONE <ul style="list-style-type: none"> <li>• 0: Job not yet started or still executing.</li> <li>• 1: Job executed without errors</li> </ul>
BUSY	Output	BOOL	I, Q, M, D, L	Status parameter BUSY <ul style="list-style-type: none"> <li>• 0: Job is complete.</li> <li>• 1: The job is not yet completed.</li> </ul>
ERROR	Output	BOOL	I, Q, M, D, L	Status parameter ERROR <ul style="list-style-type: none"> <li>• 0: No error occurred.</li> <li>• 1: Error occurred during processing. The STATUS parameter supplies detailed information on the type of error</li> </ul>
STATUS	Output	WORD	I, Q, M, D, L	Status parameter STATUS Error information (see "STATUS parameter" table).

You will find more detailed information on valid data types in "Overview of the valid data types (Page 1077)".

**Parameter STATUS**

STATUS* (W#16#...)	Explanation
0000	No error.
0001	Connection has not been established.
7001	Connection termination launched.
7002	Connection being terminated.
8081	Unknown connection specified at the ID parameter.
* The error codes can be displayed as integer or hexadecimal values in the program editor. For additional information on toggling display formats, refer to "See also".	

## T\_DIAG: Checking the connection

### Description

You use the "T\_DIAG" instruction to check the status of a connection and read further information on the local end point of this connection.

- The connection is referenced by the ID parameter. You can read both connection end points configured in the connection editor and programmed connection end points (e.g. with the "TCON" instruction).  
Temporary connection end points (for example end points created when you connect to an engineering station) cannot be diagnosed, as no connection ID is generated in this process.
- The connection information read is stored in a structure referenced by the RESULT parameter.
- The output parameter STATUS indicates whether it was possible to read the connection information. The connection information in the structure at the RESULT parameter is only valid if the "T\_DIAG" instruction has been completed with STATUS = W#16#0000 and ERROR = FALSE.  
Connection information cannot be evaluated if an error occurs.

### Possible connection information

Two different structures can be used to read the connection information at the RESULT parameter:

- The "TDiag\_Status" structure only contains the most important information about a connection end point, for example the protocol used, the connection status and the number of data bytes sent or received.
- The structure "TDiag\_StatusExt" supplies not just the most important information, but also the number of connection attempts, the reason for a connection abort, etc.

The structure and parameters of the two structures are described below (see the "TDIAG\_Status and TDIAG\_StatusExt structures" table).

### Parameters

The following table shows the parameters of the "T\_DIAG" instruction:

Parameter	Declaration	Data type	Memory area	Description
REQ	Input	BOOL	I, Q, M, D, L or constant	Starts the instruction to check the connection specified in the ID parameter when there is a positive edge.
ID	Input	CONN_OUC (WORD)	L, D or constant	Reference to the assigned connection. Range of values: W#16#0001 to W#16#0FFF
RESULT	InOut	VARIANT	D	Pointer to the structure in which the connection information is stored. The structure TDiag_Status or TDiag_StatusExt can be used at the RESULT parameter (for a description, see the "TDIAG_Status and TDIAG_StatusExt structures" table).

Parameter	Declaration	Data type	Memory area	Description
DONE	Output	BOOL	I, Q, M, D, L	Status parameter: <ul style="list-style-type: none"> <li>0: Instruction not yet started or still in progress.</li> <li>1: Instruction executed without errors.</li> </ul>
BUSY	Output	BOOL	I, Q, M, D, L	Status parameter: <ul style="list-style-type: none"> <li>0: Instruction not yet started or already completed.</li> <li>1: Instruction not yet completed. A new job cannot be started.</li> </ul>
ERROR	Output	BOOL	I, Q, M, D, L	Status parameter: <ul style="list-style-type: none"> <li>0: No error.</li> <li>1: Error occurred.</li> </ul>
STATUS	Output	WORD	I, Q, M, D, L	Status of the instruction

You will find more detailed information on valid data types in "Overview of the valid data types (Page 1077)".

### Parameters BUSY, DONE and ERROR

You can check the status of "T\_DIAG" instruction execution with the BUSY, DONE, ERROR and STATUS parameters. The BUSY parameter indicates the processing status. You use the DONE parameter to check whether or not an instruction has been executed successfully. The ERROR parameter is set if errors occur during execution of "T\_DIAG".

The following table shows the relationship between the BUSY, DONE and ERROR parameters:

BUSY	DONE	ERROR	Description
1	-	-	The instruction is being processed.
0	1	0	The instruction has been executed successfully. The data in the structure referenced by RESULT are only valid if this is the case.
0	0	1	Instruction completed with an error. The cause of the error is output at the STATUS parameter.
0	0	0	No new instruction has been assigned.

### Parameter STATUS

The following table shows the meaning of the values at the STATUS parameter:

STATUS* (W#16#..)	Explanation
0000	The instruction "T_DIAG" has been executed successfully. The data in the structure referenced at the RESULT parameter can be evaluated.
7000	No instruction processing active.
7001	Instruction processing launched.
7002	Connection information is being read (REQ parameter irrelevant).

STATU S* (W#16#. ..)	Explanation
8086	The value at the ID parameter is outside the valid range (W#16#0001 ... W#16#0FFF).
8089	The RESULT parameter points to an invalid data type (structures TDIAG_Status and TDIAG_StatusExt only).
80A3	The ID parameter references a connection end point which does not exist. With programmed connections, this error can also occur after the "TDISCON" instruction is called.
80C4	Internal error. Access to the connection end point is temporarily unavailable.
* The error codes can be displayed as integer or hexadecimal values in the program editor. For additional information on toggling display formats, refer to "See also".	

### Structures TDIAG\_Status and TDIAG\_StatusExt

The table below details the form of the TDIAG\_Status and TDIAG\_StatusExt structures:

- From the InterfaceID to the ReceivedBytes parameter, the "TDIAG\_StatusExt" and "TDIAG\_Status" structures are identical.
- The structure TDIAG\_StatusExt also includes the parameters ConnTrials to LastDisconnTimeStamp.

The value of each element is only valid if the instruction has been executed without errors. If an error occurs, the content of the parameters will not change.

Name	Data type	Description
The following parameters are in both the TDIAG_Status and the TDIAG_StatusExt structure:		
InterfaceID	HW_ANY	Interface ID (LADDR) of the CPU or the CM/CP.
ID	CONN_OUT C	ID of the connection diagnosed. Following a successful call, the value of this element is identical to the parameter ID of the "T_DIAG" instruction.

9.7 References

Name	Data type	Description
ConnectionType	BYTE	Protocol type used for connection: <ul style="list-style-type: none"> <li>• 0x01: Not used.</li> <li>• ...</li> <li>• 0x0B: TCP protocol (IP_v4)</li> <li>• 0x0C: ISO-on-TCP protocol (RFC1006)</li> <li>• 0x0D: TCP protocol (DNS)</li> <li>• 0x0E: Dial-in protocol</li> <li>• 0x0F: WDC protocol</li> <li>• 0x10: SMTP protocol</li> <li>• 0x11: TCP protocol</li> <li>• 0x12: TCP and ISO-on-TCP protocol (RFC1006)</li> <li>• 0x13: UDP protocol</li> <li>• 0x14: Reserved</li> <li>• 0x15: PROFIBUS bus access protocol (FDL)</li> <li>• 0x16: ISO 8073 transport protocol (ISO native)</li> <li>• ...</li> <li>• 0x20: SMTP or SMTPS protocol - based on IPv4</li> <li>• 0x21: SMTP or SMTPS protocol - based on IPv6</li> <li>• 0x22: SMTP or SMTPS protocol - based on FQDN (<b>Fully Qualified Domain Name</b>)</li> <li>• ...</li> <li>• 0x70: S7 connection</li> <li>• Other: Reserved</li> </ul>
ActiveEstablished	BOOL	<ul style="list-style-type: none"> <li>• FALSE: Locally, the passive connection end point</li> <li>• TRUE: Locally, the active connection end point</li> </ul>
State	BYTE	Current status of the connection end point <ul style="list-style-type: none"> <li>• 0x00: Not used.</li> <li>• 0x01: Connection terminated. Temporary status, for example, after the "T_RESET" instruction is called. The system then automatically attempts to reestablish the connection.</li> <li>• 0x02: The active connection end point is attempting to establish a connection to the remote communication partner.</li> <li>• 0x03: The passive connection end point is waiting for establishment of the connection to the remote communication partner.</li> <li>• 0x04: Connection established.</li> <li>• 0x05: The connection is being terminated. This may be because the "T_RESET" or "T_DISCON" instruction has been called. Other possible reasons are protocol errors and line breaks.</li> <li>• 0x06..0xFF: Not used.</li> </ul>



Name	Data type	Description
Kind	BYTE	Mode of the connection end point: <ul style="list-style-type: none"> <li>• 0x00: Not used.</li> <li>• 0x01: Configured, static connection which has been configured and loaded to the CPU.</li> <li>• 0x02: Configured, dynamic connection which has been configured and loaded to the CPU (not currently supported).</li> <li>• 0x03: Programmed connection generated in the user program with the instruction "TCON". A call of the instruction "TDISCON" or a transition to CPU STOP status has destroyed the connection end point.</li> <li>• 0x04: Temporary, dynamic connection established by the engineering station (ES) or operator station (OS), for example. (this connection type cannot currently be diagnosed as there is no ID).</li> <li>• 0x05..0xFF: Not used.</li> </ul>
SentBytes	UDINT	Number of data bytes sent.
ReceivedBytes	UDINT	Number of data bytes received.
The following parameters only occur in the TDiag_StatusExt structure:		
ConnTrials	UDINT	Number of connection attempts. Once a connection has been established, ConnTrials has the value 0. If this element is not equal to 0, there are connection problems. Note: With a passive connection end point, this value is never greater than 1.
ConnTrialsSuccesses	UDINT	Number of successful connection attempts. This element is never reset during the life cycle of a connection end point, and returns to 0 after reaching 0xFFFF FFFF. Note: This parameter is 1 if there has never been a problem in this connection.
LastConnErrReason	UDINT	Error ID output during the last connection attempt with errors (the error messages are identical to those at the LastDisconnReason parameter): <ul style="list-style-type: none"> <li>• 0x4F01: Remote connection end point cannot be reached (this error usually occurs during connection establishment).</li> <li>• 0x4F02: Connection terminated locally.</li> <li>• 0x4F03: Connection terminated by remote communication partner.</li> <li>• 0x4F04: Connection terminated by a protocol error.</li> <li>• 0x4F05: Connection terminated by a network problem detected locally.</li> <li>• 0x4F06: Connection terminated by a network problem detected remotely.</li> <li>• 0x4F07: Connected terminated due to timeout in protocol.</li> <li>• 0x4F08: Incorrect parameter assignment: Connection to be established to local partner's own address.</li> <li>• 0x4F09: Connection temporarily reset by a call of the instruction "T_RESET".</li> <li>• 0x4F0A: Insufficient connection resources available (quantity exceeded)</li> <li>• 0x4F0B: Internal error: Incorrect addressing parameters</li> <li>• 0x4F0C: Internal CPU communication error</li> <li>• 0x4F0D: Internal AS communication error between CPU and CM/CP</li> <li>• 0x4F0E: The local TCP/UDP port (or RFC1006-T selector) specified is already in use.</li> </ul>
LastConnErrTimeStamp	LDT	Time of the last connection attempt with errors.

Name	Data type	Description
LastDisconnReason	UDINT	<p>Error ID which led to the last connection termination (the error messages are identical to those at the LastConnErrReason parameter):</p> <ul style="list-style-type: none"> <li>• 0x4F01: Remote connection end point cannot be reached (this error usually occurs during connection establishment).</li> <li>• 0x4F02: Connection terminated locally.</li> <li>• 0x4F03: Connection terminated by remote communication partner.</li> <li>• 0x4F04: Connection terminated by a protocol error.</li> <li>• 0x4F05: Connection terminated by a network problem detected locally.</li> <li>• 0x4F06: Connection terminated by a network problem detected remotely.</li> <li>• 0x4F07: Connected terminated due to timeout in protocol.</li> <li>• 0x4F08: Incorrect parameter assignment: Connection to be established to local partner's own address.</li> <li>• 0x4F09: Connection temporarily reset by a call of the instruction "T_RESET".</li> <li>• 0x4F0A: Insufficient connection resources available (quantity exceeded)</li> <li>• 0x4F0B: Internal error: Incorrect addressing parameters</li> <li>• 0x4F0C: Internal CPU communication error</li> <li>• 0x4F0D: Internal AS communication error between CPU and CM/CP</li> <li>• 0x4F0E: The local TCP/UDP port (or RFC1006-T selector) specified is already in use.</li> </ul>
LastDisconnTimeStamp	LDT	Time of the last connection termination.

### T\_CONFIG: Configure interface

#### Description T\_CONFIG

#### Description

The "T\_CONFIG" instruction is used for the program-controlled configuration of the integrated PROFINET interfaces of the CPU or the interface of a CP/CM. The existing configuration data is overwritten.

You can make the following interface configuration settings:

- IP parameters: IP address, subnet mask, router address
- PROFINET IO device name (if the CPU is operated as a PROFINET IO device)

You store the configuration data in a data block (CONF\_DB parameter).

You can make the program-controlled setting of the IP configuration with the "T\_CONFIG" instruction as an alternative to configuration in the device configuration. It only takes effect, however, if you explicitly specified in the hardware configuration that IP address parameters are assigned differently.

## Functional description

The "T\_CONFIG" instruction works asynchronously, which means its execution extends over multiple calls. You start the transfer operation by calling "T\_CONFIG" with REQ = 1. Only one job can be active at any time.

The block is edge-triggered, which means the block must be activated again following BUSY=FALSE using REQ=FALSE to enable the instance.

The job status is indicated by the output parameters BUSY and STATUS.

The following table shows the relationship between BUSY, DONE and ERROR. Using this table, you can determine the current status of the instruction and when the transfer of configuration data is concluded.

BUSY	DONE	ERROR	Description
TRUE	irrelevant	irrelevant	The job is being processed.
FALSE	TRUE	FALSE	Job successfully completed.
FALSE	FALSE	TRUE	The job ended with an error. The cause of the error can be found in the STATUS parameter.
FALSE	FALSE	FALSE	The instruction was not assigned a (new) job.

## Parameters

The following table shows the parameters of the "T\_CONFIG" instruction:

Parameter	Declaration	Data type	Memory area		Description
			S7-1200	S7-1500	
REQ	Input	BOOL	I, Q, M, D, L or constant	I, Q, M, D, L, T, C or constant	Calling the instruction with REQ = 1 starts processing of the instruction.
INTERFAC E	Input	HW_INTERFA CE	I, Q, M, D, L or constant	I, Q, M, D, L or constant	Hardware identification of the interface (see "Properties" in the Inspector window of the device configuration). The hardware identifier is stored in the system constants of the PLC tags.
CONF_DA TA (Page 2917)	Input	VARIANT	D	D	Pointer to a data block in which you store the connection data. Use the pointer to reference a higher-level Struct element containing the Header, Addr and NOS fields as subelements (refer to the description of the CONF_DATA parameter).
DONE	Output	BOOL	I, Q, M, D, L	I, Q, M, D, L	The status parameter indicates if the job was executed without errors: <ul style="list-style-type: none"> <li>• 0: Processing not yet complete.</li> <li>• 1: Processing of instruction finished successfully.</li> </ul>
BUSY	Output	BOOL	I, Q, M, D, L	I, Q, M, D, L	Status of the instruction: <ul style="list-style-type: none"> <li>• 0: Processing of the instruction has not started, completed or canceled yet.</li> <li>• 1: Processing of instruction in progress</li> </ul>

Parameter	Declaration	Data type	Memory area		Description
			S7-1200	S7-1500	
ERROR	Output	BOOL	I, Q, M, D, L	I, Q, M, D, L	Error display <ul style="list-style-type: none"> <li>• 0: No error</li> <li>• 1: Error</li> </ul>
STATUS	Output	DWORD	I, Q, M, D, L	I, Q, M, D, L	Status display For meaning in connection with the parameters DONE and ERROR see under displays of the instruction.
ERR_LOC	Output	DWORD	I, Q, M, D, L	I, Q, M, D, L	Error location (fieldId and id of the subfield in which an error has occurred at a parameter)

You will find more detailed information on valid data types in "Overview of the valid data types (Page 1077)".

### Parameters ERROR and STATUS

ERROR	STATUS (DW#16#..)	ERR_LOC*	Explanation
0	00000000	0	Job execution terminated without error
0	00700000	0	No job processing active
0	00700100	0	Start of job execution
0	00700200	0	Intermediate call (REQ irrelevant)
1	C08xyy00	0	General error information See also: Evaluating errors with output parameter RET_VAL (Page 1584)
1	C0808000	0	Hardware identification at parameter INTERFACE invalid.
1	C0808100	0	Hardware identification at parameter INTERFACE is not assigned to the supported PROFINET interface.
1	C0808700	0	Incorrect length of the data block at the CONF_DATA parameter.
1	C0808800	f, 0	Field_type has an invalid value.
1	C0808900	f, 0	The parameter fieldid has an invalid value or was used several times.
1	C0808A00	f, 0	Incorrect number for subfield_cnt parameter or incorrect length at Length parameter.
1	C0808B00	f, s	The parameter Id of a subfield contains an invalid value.
1	C0808C00	f, s	Error when placing subfield (incorrect subfield, incorrect sequence or multiple use of subfield).
1	C0808D00	f, s	The parameter Length of a subfield contains an incorrect or invalid value.
1	C0808E00	f, s	The parameter Mode of a subfield contains an incorrect or invalid value.
1	C0809000	f, s	The parameters of the subfield are write-protected. E.g. parameters are specified via configuration or PNIO mode is enabled.
1	C0809100	f, s	Reserved
1	C0809400	f, s	The parameter value in the subfield is not defined or invalid.
1	C0809500	f, s	The value of a subfield parameter is inconsistent with another parameter value.
1	C080C200	0	Transfer cannot be carried out (e.g. because the interface is not reachable).

ERROR	STATUS (DW#16#..)	ERR_LOC*	Explanation
1	C080C300	0	Insufficient resources (for example, multiple calling of "T_CONFIG" with different parameters)
1	C080C400	0	Temporary communication error
1	C080D200	0	Call not possible / not supported by the PROFINET interface

\* In the table above, f is the field\_id and s the id of the subfield in which the error occurred.

## Parameter CONF\_DATA

### Structure of the DBs of the configuration data

The CONF\_DATA parameter of the "T\_CONFIG" instruction points to a global data block (DB), in which you store the configuration data.

The DB consists of a IF\_CONF\_Header structure and the IF\_CONF\_V4 and / or IF\_CONF\_NOS structures:

- The structure IF\_CONF\_Header has to be at the start of the DB. Use the structure to determine the number of subfields you want to use.
- The structures IF\_CONF\_V4 and IF\_CONF\_NOS are the subfields used in the DB which contain the actual configuration data. The respective parameters of the two subfields correspond largely to the structure in the device properties.
- All three structures must be defined below a higher-level structure (in the following example the Struct Element "Conf\_Data"). The following figure shows the data block structure.

1	Static				
2	Conf_data	Struct	0.0	false	
3	header	IF_CONF_Header	0.0	false	
4	FieldType	UInt	0.0	0	
5	Fieldid	UInt	2.0	0	
6	SubfieldCount	UInt	4.0	0	
7	addr	IF_CONF_v4	6.0	false	
8	Id	UInt	0.0	30	
9	Length	UInt	2.0	18	
10	Mode	UInt	4.0	0	
11	InterfaceAddress	IP_V4	6.0		
12	ADDR	array [1..4] of Byte	0.0		
13	SubnetMask	IP_V4	10.0		
14	ADDR	array [1..4] of Byte	0.0		
15	DefaultRouter	IP_V4	14.0		
16	ADDR	array [1..4] of Byte	0.0		
17	nos	IF_CONF_NOS	24.0	false	
18	Id	UInt	0.0	40	
19	Length	UInt	2.0	246	
20	Mode	UInt	4.0	0	
21	NOS	array [1..240] of Byte	6.0		

### Interconnection of the data block in the CONF\_DATA parameter

In the CONF\_DATA parameter, call the higher-level Struct element of the data block (in the example above the Struct element "Conf\_Data"; the call in the parameter is achieved by specifying the data block followed by the name of the Struct element: "Name\_of\_DB".Conf\_data).

### Field IF\_CONF\_Header

Use the field IF\_CONF\_Header to select how many subfields you want to use during execution of "T\_CONFIG".

Byte	Parameter	Data type	Start value	Description
0 ... 1	FieldType	UINT		Field type: Must always be 0.
2 ... 3	FieldId	UINT		Error ID: Must always be 0.
4 ... 5	SubfieldCount	UINT		Total number of subfields in the structure

### General parameters of the subfields

The subfields "Addr" and "Nos" contain the following general parameters:

- Id  
This parameter identifies the respective field and may not be altered.
- Length  
This parameter specifies the actual length of the subfield. If a field contains a parameter of the data type String or Array, it may be that the maximum length of the parameter is not exhausted. In this case the actual length of the subfield is less than the maximum length.
- Mode  
The following values are permitted for this parameter:
  - 1: Permanent validity of the configuration data
  - 2: Temporary validity of the configuration data including the deletion of existing permanent configuration data

### Subfield IF\_CONF\_V4

Use the subfield IF\_CONF\_V4 to specify the Ethernet addresses that you want to assign to the interface of the CPU.

Byte	Parameter	Data type	Start value	Description
0 ... 1	Id	UINT	30	Subfield identifier
2 ... 3	Length	UINT	18	Length of the subfield in bytes
4 ... 5	Mode	UINT		Validity of addressing: <ul style="list-style-type: none"> <li>• 1: permanent</li> <li>• 2: temporary</li> </ul>
6 ... 9	InterfaceAddress	IP_V4 *		IP address
10 ... 12	SubnetMask	IP_V4 *		Subnet mask

Byte	Parameter	Data type	Start value	Description
14 ... 16	DefaultRouter	IP_V4 *		Router address

\* The data type IP\_V4 is a structure of 4 BYTE, which includes the respective address of the respective parameter (e.g. at parameter SubnetMask the four-digit address of the subnet mask of the IP protocol).

### Subfield IF\_CONF\_NOS

Use the subfield IF\_CONF\_NOS to specify the station name to be assigned during execution of the instruction "T\_CONFIG".

Byte	Parameter	Data type	Start value	Description
0 ... 1	Id	UINT	40	Subfield identifier
2 ... 3	Length	UINT	246	Length of the subfield in bytes
4 ... 5	Mode	UINT		Validity of the station name change: <ul style="list-style-type: none"> <li>• 1: permanent</li> <li>• 2: temporary</li> </ul>
6 ... 244	NoS	ARRAY [1...240] of Byte		Station name: You must occupy the ARRAY from the first byte. If the ARRAY is longer than the station name to be assigned, you must enter a zero byte after the actual station name (in conformity with IEC 61185-6-10). Otherwise, NoS is rejected and the "T_CONFIG" instruction enters the error code DW#16#C0809400 in STATUS. If you occupy the first byte with zero, the station name is deleted.

The station name is subject to the following limitations:

- The name must be specified in ASCII code.
- Restricted to a total of 240 characters (lower case letters, numbers, dash, or dot)
- No name component within the station name, which means a character string between two dots may not exceed 63 characters.
- No special characters such as umlauts, brackets, underscore, slash, blank space, etc. The only special character permitted is the dash.
- The station name must not begin or end with the "-" character.
- The station name must not begin with a number.
- The station name form n.n.n.n (n = 0, ... 999) is not permitted.
- The station name must not begin with the string "port-xyz" or "port-xyz-abcde" (a, b, c, d, e, x, y, z = 0, ... 9).

#### Note

You can also create an ARRAY NoS that is shorter than 240 bytes, but not less than 2 bytes. In this case, you must adjust the "Length" (length of subfield) tag accordingly.

#### 9.7.5.4 Web server

### WWW: Synchronizing user-defined web pages

#### Description

The instruction WWW initializes the web server of the CPU or synchronizes user-defined web pages with the user program in the CPU.

User-defined web pages together with the web server make it possible for the CPU to access freely designed web pages of the CPU with a web browser.

Use script instructions (such as Javascript) and HTML code in user-defined web pages to transfer data via a web browser for further processing to the CPU and to display data from the operand area of the CPU in the web browser. Call the WWW instruction in the user program for synchronization of the user program and the web server as well as initialization.

#### Initialization

User-defined web pages are "packaged" in data blocks for processing by the CPU. You will have to generate appropriate data blocks from the source files (HTML files, screens, Javascript files, ...) during configuration. The Web Control DB has a special role (default: DB 333). It contains status and control information as well as links to additional data blocks with coded web pages. The data blocks with coded web pages are called fragment DBs.

When the data block is downloaded into the CPU, the CPU does not "know" that user-defined web pages are coded inside it. The instruction "WWW" in the startup OB, for example, will inform the CPU which DB is the Web Control DB. The user-defined web pages can be accessed via a web browser after this initialization.

#### Synchronization

If you want the user program to interact with the user-defined web pages, then the instruction WWW must be used in the cyclical program part.

Examples of interaction between user program and web page:

- Check received data
- Assemble and send back data to the web browser making the request

In this case it must be possible to evaluate the current status information and the web server must receive control information, such as release of a web page requested by a web browser.



## Parameter

The following table shows the parameters of the instruction "WWW":

Parameter	Declaration	Data type	Description
CTRL_DB	Input	DB_WWW	Data block that describes the user-defined web pages (Web Control DB)
RET_VAL	Output	INT	Error information

For additional information on valid data types, refer to Overview of the valid data types (Page 1077).

## Parameter RET\_VAL

Error code (W#16#...)	Explanation
0000	No error occurred. There are no web page requests that have to be released by the user program.
00xy	x: indicates whether an error has occurred during initialization of the Web Control DB (CTRL_DB): x=0: No errors occurred. x=1: Error occurred. The error is coded in the byte "CTRL_DB.last_error" of the Web Control DB, see description of Web Control DB. y: Number of the pending request. Several requests are possible (e. g. requests "0" and "1" are pending: y="3". y="1": Request "0" y="2": Request "1" y="4": Request "2" y="8": Request "3"
803A	The specified Web Control DB does not exist on the CPU.
8081	Incorrect version or incorrect format of the Web Control DB
80C1	There are no resources to initialize the web application.

## See also

Overview of the valid data types (Page 1077)

### 9.7.5.5 TeleService

#### TM\_MAIL: Transfer email

#### Description of TM\_MAIL

##### Description

The "TM\_MAIL" instruction works asynchronously, in other words, its execution extends over multiple calls. You must specify an instance when you call the instruction "TM\_MAIL". The attribute "retentive" may not be set in the instance. This attribute ensures that the instance is initialized when the CPU switches from STOP to RUN and that a new e-mail send job can be triggered afterwards.

You start the sending of an e-mail with an edge change from "0" to "1" for the REQ parameter. The job status is indicated by the output parameters BUSY , "DONE", "ERROR", "STATUS" and "SFC\_STATUS". "SFC\_STATUS" corresponds in this case to the "STATUS" output parameter of the called communication blocks.

The output parameters DONE, ERROR, STATUS, and SFC\_STATUS are each displayed for only one cycle if the status of the BUSY output parameter changes from "1" to "0". The following table shows the relationship between BUSY, DONE, and ERROR. Using this table, you can determine the current status of the instruction "TM\_MAIL" and when the sending of the e-mail is complete.

DONE	BUSY	ERROR	Description
0	1	0	The job is being processed.
1	0	0	Job successfully completed.
0	0	1	The job ended with an error. The cause of the error can be found in the STATUS and SFC_STATUS parameters.
0	0	0	The "TM_MAIL" instruction was not assigned a (new) job.

If the CPU changes to STOP mode while "TM\_MAIL" is active, the communication connection to the mail server aborts. The communication connection to the mail server will also be lost if

communication problems occur on the Industrial Ethernet bus. In this case, the transfer of the e-mail will be interrupted and it will not reach its recipient.

#### NOTICE

##### Changing user programs

You can change the parts of your user program that directly affect calls of "TM\_MAIL" only:

- when the CPU is in "STOP" mode or
- when no mail is being sent (REQ = 0 and BUSY = 0).

This relates, in particular, to deleting and replacing program blocks that contain "TM\_MAIL" calls or calls for the instance of "TM\_MAIL".

Ignoring this restriction can tie up connection resources. The automation system can change to an undefined status for the TPC/IP communication functions via Industrial Ethernet.

A warm or cold restart of the CPU is required after the changes are transferred.

### Data consistency

The ADDR\_MAIL\_SERVER input parameter of the instruction is taken from the "TM\_MAIL" instruction again each time the sending of an e-mail is triggered. If a change is made during operation, the "new" value only becomes effective once an e-mail is triggered again.

In contrast, the WATCH\_DOG\_TIME, TO\_S, CC, FROM, SUBJECT, TEXT, ATTACHMENT, and, if applicable, USERNAME and PASSWORD parameters are taken from the "TM\_MAIL" instruction while it is running, which means that they may only be changed after the job is complete (BUSY = 0)

### Setting the parameters of the TS Adapter IE

On the TS Adapter IE, you need to specify parameters for outgoing calls in such a way as to enable the TS Adapter IE to establish a connection to the dial-up server of your service provider.

If you set "When required" for connection establishment, the connection will only be established when an e-mail needs to be sent.

Connection establishment can take longer (approx. one minute) for an analog modem connection. When you specify the WATCH\_DOG\_TIME parameter, remember to allow for the time required to establish the connection.

**Parameters**

The following table shows the parameters of the "TM\_MAIL" instruction:

Parameter	Declaration	Data type	Memory area	Description
REQ	Input	BOOL	I, Q, M, D, L or constant	Control parameter REQUEST: Activates the sending of an e-mail on a rising edge.
ID	Input	CONN_OUT C (Word)	D, L or constant	Reference to the connection to be established. See ID parameter of the TCON (Page 2877), TDISCON (Page 2884), TSEND (Page 2889), and TRCV (Page 2892) instructions. A number that is not used for any additional instances of this instruction in the user program must be entered here.
TO_S (Page 2926)	Input	STRING	D	Input parameter for receiver addresses: STRING with a maximum length of 240 characters (see example call).
CC (Page 2926)	Input	STRING	D	Input parameter for CC recipient addresses (optional): STRING with a maximum length of 240 characters (see example call). If an empty string is assigned here, the e-mail is not sent to a CC recipient.
SUBJECT	Input	STRING	D	Input parameter for subject of the e-mail: STRING with a maximum length of 240 characters.
TEXT	Input	STRING	D	Input parameter for text of the e-mail (optional): Reference to a data string with a maximum length of 240 characters. If an empty string is assigned at this parameter, the e-mail is sent without text.
ATTACHMENT	Input	VARIANT	I, Q, M, D, L	Input parameter for e-mail attachment (optional): Reference to a byte/word/double word field with a maximum length of 65534 bytes. If no value is assigned, the e-mail is sent without an attachment.
DONE	Output	BOOL	I, Q, M, D, L	<ul style="list-style-type: none"> <li>• DONE = 0: Job not yet started or still executing.</li> <li>• DONE = 1: Job was executed without errors.</li> </ul>
BUSY	Output	BOOL	I, Q, M, D, L	<ul style="list-style-type: none"> <li>• BUSY = 1: E-mail transmission is not yet complete.</li> <li>• BUSY=0: The processing of "TM_MAIL" was stopped.</li> </ul>
ERROR	Output	BOOL	I, Q, M, D, L	ERROR=1: An error occurred during processing. STATUS and SFC_STATUS supply detailed information about the type of error.
STATUS (Page 2927)	Output	WORD	I, Q, M, D, L	Output/status parameter STATUS: Return value or error information of the "TM_MAIL" instruction.

Parameter	Declaration	Data type	Memory area	Description
ADDR_MAIL_SERVER	Static*	DWORD	I, Q, M, D, L	IP address input parameter of the mail server: Specify as a data word in HEX format, for example: IP address = 192.168.0.200. ADDR_MAIL_SERVER = DW#16#C0A800C8, where: <ul style="list-style-type: none"> <li>• 192 = 16#C0,</li> <li>• 168 =16#A8</li> <li>• 0 = 16#00 and</li> <li>• 200 = 16#C8.</li> </ul>
WATCH_DOG_TIME	Static*	TIME	I, Q, M, D, L	Input parameter for max. period of time: The "TM_MAIL" instruction should establish a connection within the period specified by WATCH_DOG_TIME. The block is exited with an error if this period is exceeded. The time before the block is exited and the error is output can exceed the WATCH_DOG_TIME because connection termination also takes a certain amount of time. To begin with, you should set a period of 2 minutes. If you have an ISDN telephone connection, a significantly shorter period can be selected.
USERNAME	Static*	STRING	D	Input parameter for user name: STRING with a maximum length of 180 characters. A user name is an absolute requirement for authentication.
PASSWORD	Static*	STRING	D	Input parameter for password: STRING with a maximum length of 180 characters. A password is an absolute requirement for authentication.
FROM (Page 2926)	Static*	STRING	D	Input parameter for sender address: STRING with a maximum length of 240 characters (see example call).
SFC_STATUS (Page 2927)	Static*	WORD	I, Q, M, D, L	Output/status parameter "SFC_STATUS": Error information of the called communication blocks.
*The values of the parameter are not modified at every call of the instruction "TM_MAIL". The values are in the static parameters of the instance and are only written once at the first call of the instruction.				

You will find more detailed information on valid data types in "Overview of the valid data types (Page 1077)".

#### Note

##### Optional parameters

The optional parameters CC, TEXT, and ATTACHMENT are only sent with the e-mail if the corresponding parameters contain a string of length > 0.

## SMTP authentication

Authentication refers here to a procedure for ensuring an identity, for example, by a password query.

The "TM\_MAIL" instruction supports the SMTP authentication procedure AUTH-LOGIN that is requested by most mail servers. For information about the authentication procedure of your mail server, please refer to your mail server manual or the website of your Internet service provider.

To use the AUTH-LOGIN authentication procedure, the "TM\_MAIL" instruction requires the user name with which it can log onto the mail server. This user name corresponds to the user name with which you set up a mail account on your mail server. It is made available to the "TM\_MAIL" instruction in the USERNAME parameter.

To log on, the "TM\_MAIL" instruction also requires the associated password. This password corresponds to the password you specified when you set up your mail account. It is made available to the "TM\_MAIL" instruction in the PASSWORD parameter.

The user name and the password are each transferred to the mail server unencrypted (BASE64-coded).

If no user name is specified in the DB, the AUTH-LOGIN authentication procedure is not used. The e-mail is then sent without authentication.

## Parameters TO\_S, CC, and FROM

### Description

The TO\_S, CC, and FROM parameters are strings with, for example, the following content:

- TO: <wenna@mydomain.com>, <ruby@mydomain.com>,
- CC: <admin@mydomain.com>, <judy@mydomain.com>,
- FROM: <admin@mydomain.com>

Note the following rules when entering the parameters:

- The "TO:", "CC:", and "FROM:" characters must be entered.
- A space and an opening pointed bracket "<" must be entered before each address.
- A closing pointed bracket ">" must be entered after each address.
- A comma must be entered after each address in TO and CC.
- Only one e-mail may be entered in FROM, and there must not be a comma at the end of this address

Because of runtime and memory space, the "TM\_MAIL" instruction does not perform any syntax check of the parameters TO\_S, CC and FROM.

## STATUS and SFB\_STATUS parameters

### Description

The return values of the "TM\_MAIL" instruction can be classified as follows:

- W#16#0000: "TM\_MAIL" was completed successfully
- W#16#7xxx: Status of "TM\_MAIL"
- W#16#8xxx: An error was reported during the internal call of a communication block or from the mail server.

The following table shows the return values of "TM\_MAIL" except for error codes of the internally called communication blocks.

Return value STATUS* (W#16#...):	Return value SFB_STATUS (W#16#...):	Explanation	Notes
0000	-	The processing of "TM_MAIL" was completed without error.	A without error completion of "TM_MAIL" does not mean that the sent e-mail will necessarily arrive (see below - note on point 1)
7001		"TM_MAIL" is active (BUSY = 1).	Initial call; job has started
7002	7002	"TM_MAIL" is active (BUSY = 1).	Intermediate call; job already active
8xxx	xxxx	The processing of "TM_MAIL" was completed with an error code of the internally called communication instructions.	For detailed information on the evaluation of the SFB_STATUS parameter, refer to the descriptions of the STATUS parameter of the communication instructions.
8010	xxxx	Error during connection establishment.	For further information on the evaluation of the SFB_STATUS parameter, refer to the descriptions of the STATUS parameter of the "TCON (Page 2877)" instruction.
8011	xxxx	Error sending the data.	For further information on the evaluation of SFB_STATUS, refer to the descriptions of the STATUS parameter of the "TSEND (Page 2889)" instruction.
8012	xxxx	Error receiving the data.	For further information on the evaluation of SFB_STATUS, refer to the descriptions of the STATUS parameter of the "TRCV (Page 2892)" instruction.
8013	xxxx	Error during connection establishment.	For further information on the evaluation of SFB_STATUS, refer to the descriptions of the STATUS parameter of the "TCON (Page 2877)" and "TDISCON (Page 2884)" instructions.

9.7 References

Return value STATUS* (W#16#...):	Return value SFB_STATUS (W#16#...):	Explanation	Notes
8014	-	Establishment of a connection is not possible.	You have possibly entered an incorrect mail server IP address (ADDR_MAIL_SERVER) or a time span that is too short (WATCH_DOG_TIME) to establish the connection. It is also possible that the CPU has no connection to the network or that the CPU configuration is incorrect.
8016	-	Error copying the attachment	-
82xx, 84xx, or 85xx	-	The error message originates from the mail server and corresponds, except for the "8", to the error number of the SMTP protocol.  The following columns list several error codes that can occur:	See point 2 in the note.
8450	-	Action not executed: Mailbox not available/ not reachable.	Try again later.
8451	-	Action aborted: Local processing error	Try again later.
8500	-	Syntax error: Error not recognized. This also includes the error when a command string is too long. This can also be occur when the e-mail server does not support the LOGIN authentication procedure.	Check the parameters of "TM_MAIL". Try to send an e-mail without authentication. To do this, replace the USERNAME parameter with an empty string.
8501	-	Syntax error: Parameter or argument incorrect	You have possibly entered an incorrect address in TO_S or CC.
8502	-	Command unknown or not implemented.	Check your entries, in particular the FROM parameter. This is possibly incomplete and you have forgotten "@" or ".".
8535	-	SMTP authentication incomplete.	You have possibly entered an incorrect user name or incorrect password.
8550	-	Mail server cannot be reached, you have no access rights.	You have possibly entered an incorrect user name or password, or the mail server does not support your LOGIN. Another cause of error could be an incorrect entry of the domain name after the "@" in TO_S or CC.
8552	-	Action aborted: Assigned memory size has been exceeded	Try again later.
8554	-	Transmission failed.	Try again later.
* The error codes can be displayed as integer or hexadecimal values in the program editor. For additional information on toggling display formats, refer to "See also".			



---

**Note**

**Status error**

1. An incorrect entry of the recipient addresses does not generate a status error of the "TM\_MAIL" instruction. In this case, there is no guarantee that the e-mail will be sent to other recipients, even if these were entered correctly.
  2. You can find more detailed information on the SMTP error code and other error codes in SMTP protocol on the Internet or in the error documentation of the mail server. You can also view the most recent message from the mail server in your instance DB in the BUFFER1 parameter. If you look under "Data", you will find the data most recently sent by the "TM\_MAIL" instruction.
-



## Visualizing processes (Comfort/Advanced)

### 10.1 Creating screens

#### 10.1.1 Basics

##### 10.1.1.1 Screen basics

#### Introduction

In WinCC you create screens that an operator can use to control and monitor machines and plants. When you create your screens, the object templates included support you in visualizing processes, creating images of your plant, and defining process values.

#### Application example

The figure shows a screen that was created in WinCC. With the help of this screen, the operator can operate and monitor the mixing station of a fruit juice manufacturing system. Fruit juice base is supplied from various tanks to a mixing unit. The screen indicates the fill level of the tanks.

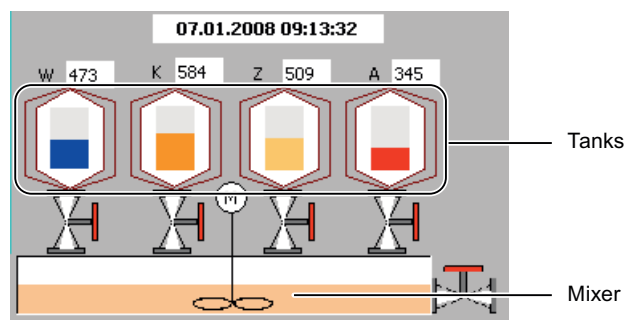

#### Screen design

Insert an object you need to represent a process into your screen. Configure the object to correspond to the requirements of your process.

A screen may consist of static and dynamic elements.

## 10.1 Creating screens

- Static elements such as text or graphic objects do not change their status in runtime. The tank labels (W, K, Z, A) shown in this example of a mixing unit are static elements.
- Dynamic elements change their status based on the process. Visual current process values as follows:
  - From the memory of the PLC
  - From the memory of the HMI device in the form of alphanumeric displays, trends and bars.

Input fields on the HMI device are also considered dynamic objects. The fill level values of the tanks in our example of a mixing plant are dynamic objects.

Process values and operator inputs are exchanged between the controller and the HMI device via tags.

### Screen properties

The screen layout is determined by the features of the HMI device you are configuring. It corresponds with the layout of the user interface of this device. If the set HMI device has function keys, the screen shows these function keys. Other properties such as the screen resolution, fonts and colors are also determined by the characteristics of the selected HMI.

### Function keys

A function key is a key on the HMI device to which you can assign one or several functions in WinCC. The functions are triggered as soon as the operator presses the key on the HMI device.

A function key can be assigned global or local functions:

Global function keys always trigger the same action, regardless of the currently displayed screen.

Local function keys trigger different actions depending on the currently displayed screen on the HMI device. This assignment applies only to the screen in which you have defined the function key.

## Navigation

You configure a screen navigation to enable the operator to call a screen on the HMI device in Runtime.

- The "Screen" editor is used to configure buttons for calling other screens.
- You use the "Global Screen" editor to configure globally assigned function keys.

## See also

Overview of objects (Page 2950)

Basics on dynamizing screens (Page 3007)

Basics on working with layers (Page 3042)

Basics on libraries (Page 5488)

Basics on faceplates (Page 3049)

Bar (Page 3086)

Basics on screen navigation (Page 3162)

Basics on text lists (Page 2991)

Basic principles of graphics lists (Page 2999)

### 10.1.1.2 Device-specific functional scope of screens

#### Introduction

The functions of an HMI device determine the display of the device in WinCC and the scope of functions of the editors.

The following screen properties are determined by the functions of the selected HMI device:

- Device layout
- Screen resolution
- Number of colors
- Fonts
- Objects available

#### Device layout

The device layout of a screen forms the image of the HMI device in your configuration. The device layout of the screen shows all the function keys available on the HMI device, for example.

## Screen resolution

The screen resolution is determined by the different display dimensions of the various operator panels. You can only change the screen resolution if you configure the "WinCC Runtime Advanced" or "WinCC Runtime Professional" HMI device.

## Number of colors

You can assign colors to the screen objects. The number of possible colors is determined by the color depth and specific colors supported on the selected HMI device.

## Fonts

You can customize the appearance of the texts in all the screen objects that contain static or dynamic text. How to highlight individual texts in a screen. Select the font, font style and size, and set additional effects such as underscoring, for example.

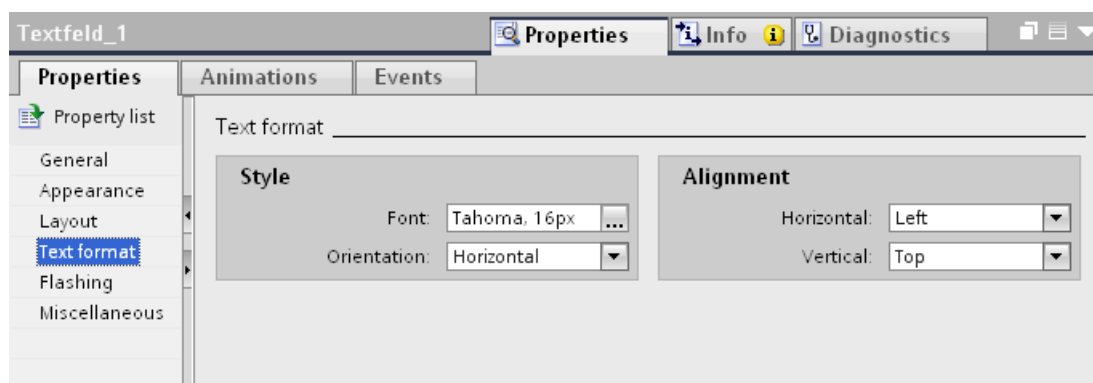

The settings for the text markups such as font style and effects always refer to the entire text of a screen object. That is, you can display the complete title in bold format, but not its individual characters or words, for example.

## Objects available

Some of the screen objects can not be configured globally for all HMI devices. These screen objects are not displayed in the "Tools" task card. For a KTP 1000 touch panel unit you can not configure a slider, for example.

### 10.1.1.3 Elements and basic settings

#### Task cards

##### Introduction

The following task cards are available in the "Screens" editor:

- Tools: Display and operating objects
- Animations: Templates for dynamic configuration
- Layout: Aid for customizing the display
- Libraries: Administration of the project library and of the global libraries

---

##### Note

##### WinCC Basic

The "Animations" task card is not available in WinCC Basic.



---

#### Tools

The "Tools" task card contains objects in different panes:

- Basic objects
- Elements
- Controls
- User controls (optional)
- Graphics

You paste objects from the palettes into your screens by drag&drop or a double click. The objects available for selection are determined by the features of the HMI device you are configuring. The following icons are used to change the display mode:

Icon	Meaning
	Displays the objects as a list.
	Displays the objects as a graphic.

#### Animations

The "Animations" task card contains the possible dynamizations of a screen object in the palettes. You paste the animations to a screen object by drag&drop or a double click from the "Movements", "Display" and "Tag Binding" palettes.

#### Layout

The "Layout" task card contains the following panes for displaying objects and elements:

## 10.1 Creating screens

- Layers: Serves to manage screen object layers. The layers are displayed in a tree view and contain information about the active layer and the visibility of all layers.
- Grid: You specify whether you want to align the objects to a grid or to other objects and set the grid size for a grid.
- Objects out of range: Objects that lie outside the visible area are displayed with name, position and type.

### Libraries

The "Libraries" task card shows the following libraries in separate panes:

- Project library: The project library is stored together with the project.
- Global library: The global library is stored in a separate file in the specified path on your configuration PC.

### Move view

### Introduction

To display only a section of the entire screen in the work area, use the  icon of the "Screens" editor:

### Requirement

- A screen is open.
- The view shows only a screen section.

### Procedure

To move the view:

1. Click the  icon at the bottom right corner of the work area and press the left mouse button. A miniature view of the full screen is shown. An orange frame shows the currently selected area.
2. Hold down the mouse button and drag the frame to the desired area.

---

#### Note

The screen is scrolled when you drag a screen object from the visible to a currently hidden section.

---



## Zooming the view

### Introduction

To view a small screen section in closer detail, use the zoom tool to magnify the screen in the working area. The maximum zoom amounts to 800%.

You can zoom with the toolbar in the work area or with the "Layout > Zoom" task card.

There are different ways to increase the screen, for example, with the zoom factor or by adapting the work area to the height of the screen.

### Requirement

The screen is opened.

### Procedure

Proceed as follows to zoom a view with the selection frame:

1. Click the  toolbar button.
2. Use the mouse to draw a selection frame in the screen.

After you have released the mouse button, the section enclosed by the selection frame is zoomed to fit the complete work area.

Alternatively, use the slider in the lower right-hand corner of the screen.

### Result

The selected screen section is magnified.

#### 10.1.1.4 Working with screens

### Steps

### Steps

To create screens, you need to take the following initial steps:

- Plan the structure of the process visualization: Number of screens and their layout  
Example: Subprocesses are visualized in separate screens, and merged in a master screen.
- Define your screen navigation control strategies.

## 10.1 Creating screens

- Adapt the templates and the global screen.  
You define objects centrally and assign function keys for example.
- Create the screens. Use the following options of efficient screen creation:
  - Working with libraries
  - Working with layers
  - Working with faceplates

### Creating a new screen

#### Introduction

Create screens to display processes in your system.

#### Requirement

- The project has been created.
- The Inspector window is open.

#### Procedure

1. Double-click "Screens > Add New Screen" in the project navigation.  
The screen is generated in the project and appears in your view. The screen properties are shown in the Inspector window.
2. Enter a meaningful name for the screen.
3. Configure the screen properties in the Inspector window:
  - Specify whether and on which template the screen is based.
  - Set the "Background Color" and the "Screen Number."
  - Specify a documenting text under "Tooltip".
  - Specify the layers to be displayed under "Layers" in the engineering system.
  - Select dynamic screen update under "Animations."
  - Select "Events" to define which functions you want to execute in Runtime when you call and exit the screen or at other events.

---

**Note**

Not all HMI devices support the "Visibility" animation.

---

#### Result

You created the screen in your project. You can now paste objects and control elements from the "Tools" task card and assign function keys in further work steps.

## Managing Screens

### Introduction

You can move screens within a project to other groups, or copy, rename, and delete them.

### Moving screens in a group

1. Select the "Screens" folder in the project tree.
2. Select the "Add group" command from the shortcut menu.  
A folder called "Group\_x" is inserted.
3. Select the screen in the project tree.
4. Drag-and-drop the screen to the required group.  
The screen is moved into this group.

### Copy screen

1. Select the screen in the project tree.
2. Select the "Copy" command in the shortcut menu to copy the screen to the clipboard.
3. In the project tree, select the screen insert position.
4. Select "Paste" from the shortcut menu to insert the screen.  
A copy of the screen is inserted. A consecutive number is appended to the name of the original in the copy.

Alternatively, press <Ctrl> while you drag the screen to the required position.

---

#### Note

If you copy a screen with interconnected template for several devices and projects, the template will also be copied. Any existing matching template is not used. This holds particularly true when you copy the screens with drag-and-drop.

---

### Rename screen

1. Select the screen in the project tree.
2. Select "Rename" from the shortcut menu.
3. Type in a new name.
4. Press <Enter>.

As an option, use the <F2> function key to rename the screen.

## Delete screen

1. Select the screen in the project tree.
2. Select "Delete" from the shortcut menu.  
The screen and all its objects are deleted from the current project.

## Defining the start screen of the project

### Introduction

The start screen is the initial screen opened at the start of project in Runtime. You can define a different start screen for each one of the HMI devices. Beginning at this start screen, the operator calls the other screens.

### Requirement

The project contains the screen you want to use as the start screen.

### Procedure

1. Double-click "Runtime settings > General" in the project tree.

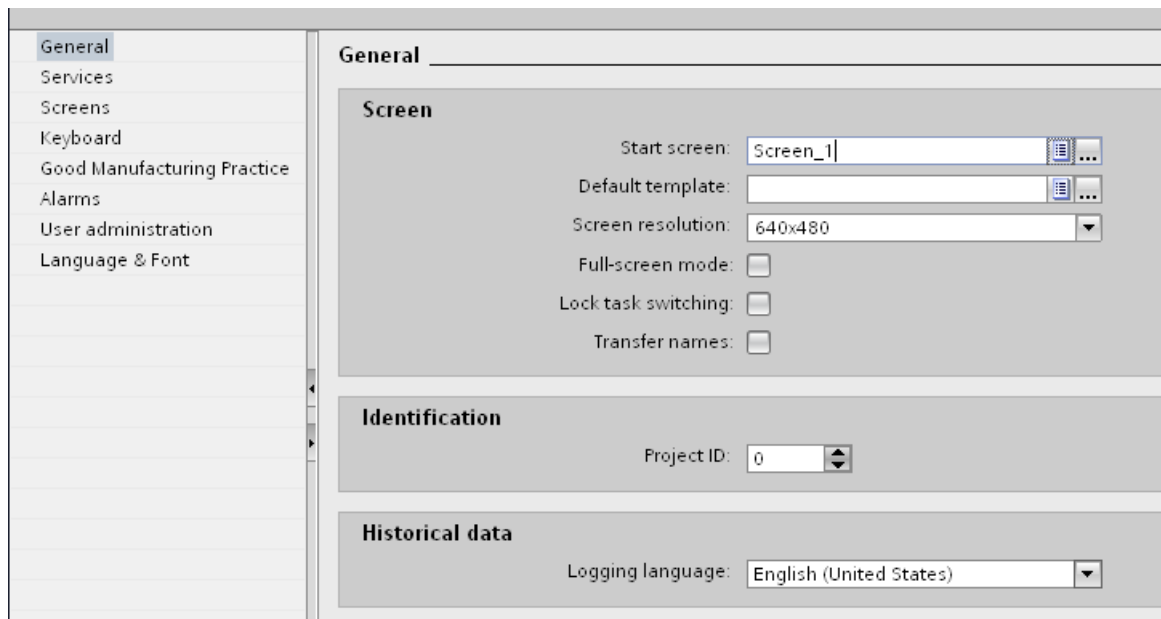

2. Select the desired screen as "Start screen".

Alternatively select a screen in the project tree and select "Use as start screen" in the shortcut menu.

### Result

The start screen opens on the HMI at the start of Runtime.

### 10.1.1.5 Working with templates

#### Basics on working with templates

##### Introduction

Configure the objects in a template which are to be displayed in all screens based on this template.

Note the following rules:

- A screen must not be based on a template.
- A screen is only based on one template.
- You can create several templates for one device.
- A template cannot be based on another template.

##### Objects for a template

You determine functions and objects in the template which are to apply for all screens based on this template:

- Assignment of function keys: You also assign the function keys in the template for HMI devices with function keys. This assignment overwrites a possible global assignment.
- Permanent window: Some devices support a permanent window for all screens in the top area of the screen. In contrast to the template, the permanent window occupies an area of the screen for itself alone.
- Operator controls: You can paste all screen objects which you also use for a screen into a template.

##### Application examples

- You want to assign the "ActivateScreen" function to a function key in the template. The operator uses this key to switch to another screen in runtime. This configuration applies to all screens that are based on this template.
- A graphic with your company logo can be added to the template. The logo appears on all screens that are based on this template.

---

##### Note

If an object from the template has the same position as an object in the screen, the template object is covered.

---

## See also

Screen basics (Page 2931)

Using a template in the screen (Page 2946)

Configuring a permanent window in the template (Page 2945)

## Global screen

### Introduction

You define global elements for all screens of an HMI device independently of the used template.

### Function keys

For HMI devices with function keys you assign the function keys globally in the "Global Screen" editor. This global assignment applies for all screens of the HMI device.

Proceed as follows to assign function keys locally in screens or templates:

1. Click the function key in your screens or templates.
2. Deactivate "Properties > Properties > General > Use Global Assignment" in the inspection window.

### Indicator and control objects for alarms

The "Alarm window" and "Alarm indicator" objects that are available as global objects are configured within the "Global screen" editor.

The "Alarm window" and "Alarm indicator" are always shown in the foreground.

For Comfort Panels you also have the possibility of configuring a "System diagnostic view" in the global screen.

---

#### Note

If you have configured a permanent window in a template, do not position the alarm window and alarm indicator in the area of the permanent window. Otherwise, the alarm window and the alarm indicator will not be displayed in Runtime.

The permanent window is not visible in the "Global screen" editor.

---

## Order of configuration of screens

The following order applies for the configuration:

- The global screen comes before screens and templates
- Screens come before templates

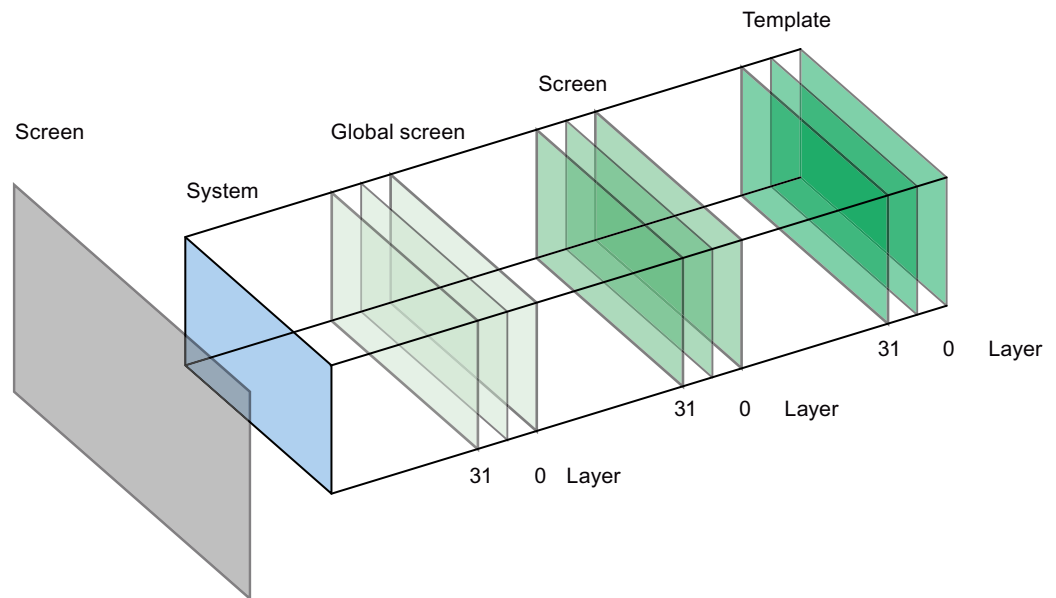

The system layer is not configurable. This contains

- input dialog boxes
- alarms from the operating system
- the direct keys for touch panels

## Managing templates

### Introduction

You can move, copy, rename, and delete templates within a project in the Project window.

### Moving a template into a group

1. Select the templates in the project navigation "Screen management > Templates".
2. Select "Add group" in the shortcut menu.  
A folder called "Group\_x" is inserted.
3. Select the template in the project navigation.
4. Drag-and-drop the template to the required group.  
The template is moved to this group.

### Copying templates

1. Select the template in the project navigation.
2. Select "Copy" in the shortcut menu.
3. Select the position in the project navigation where you want to paste the template.
4. Select "Paste" from the shortcut menu to insert the template.  
A unique name is assigned automatically to the copy.

Alternatively, you can hold down the <Ctrl> key, and drag the template into position.

### Deleting a template

1. In the project navigation, select the template to be deleted.
2. Select "Delete" in the shortcut menu.  
The template, and all its objects are deleted from the current project.

### Assigning a template to a screen

1. In the project navigation, select the screen to which you want to assign the template.
2. In the Inspector window, select "Properties > Properties > General".
3. Select the desired template under "Template."  
The selected template and all the objects contained in it are assigned to the screen.

### Creating a new template

#### Introduction

In a template, you can centrally modify objects and function keys. Changes to an object or of a function key assignment in the template are applied to the object in all the screens which are based on this template.

---

#### Note

##### HMI device dependency

Function keys are not available on all HMI devices.

---

#### Requirement

- The project has been created.
- The Inspector window is open.



## Procedure

1. Select "Screen management > Templates" in the project tree and then double-click "Add new template".  
The template is created in the project, and appears in your view.  
The properties of the template are displayed in the Inspector window.
2. Define the name of the template under "Properties > Properties > General" in the Inspector window.
3. Specify the layers in the engineering system that are displayed under "Properties > Properties > Layers" in the Inspector window.
4. Add the necessary objects from the "Tools" task card.
5. Configure the function keys.

## Result

The template is created in your project.

## Configuring a permanent window in the template

### Introduction

In the permanent window you configure objects which are visible in all screens. In contrast to the template, the permanent window occupies an area of the screen for itself alone.

### Configuring permanent windows

Proceed as follows to configure a permanent window:

1. Open a template for a HMI device with a permanent window.
2. Use the mouse (cursor shape: ) to drag the top edge of the editable screen area down.

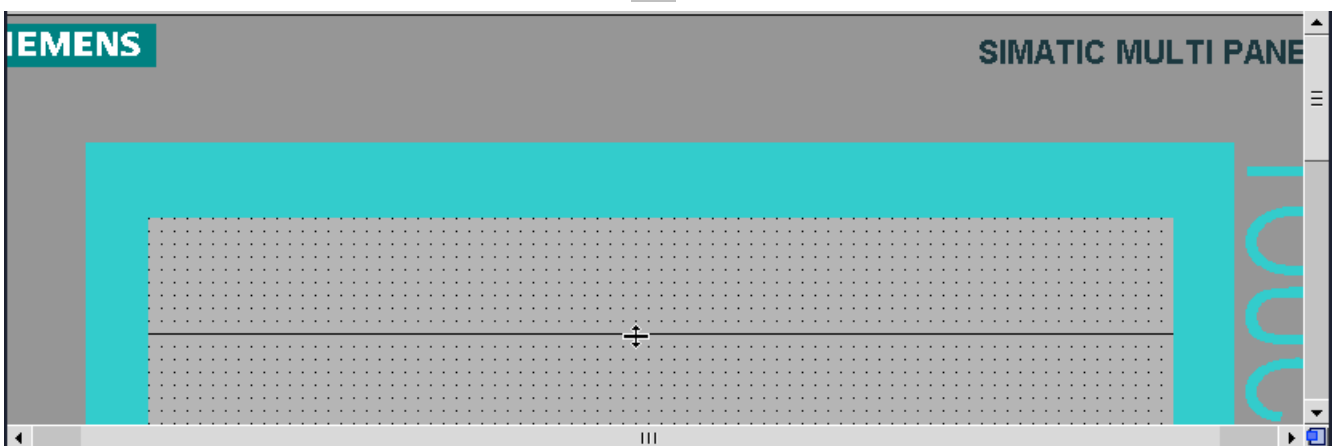

3. Configure the desired objects in the area of the permanent window.

The default height of the permanent window is "0". The maximum height is the maximum height of the screen minus 10 pixels.

## Result

The content of the permanent window appears on every screen, and in the template. The area above this line is now used as a permanent window in all the screens of the HMI device. Already configured objects in the screens are moved down by the height of the permanent window.

## See also

Basics on working with templates (Page 2941)

## Using a template in the screen

### Introduction

You use a template in the screen. All the objects configured in the template are also available in the screen.

### Requirement

A template has been created.

A screen has been created.

### Procedure

Proceed as follows to use a template in a screen:

1. Double click a screen in the project tree. The screen opens in the work area.
2. Open "Properties > Properties > General" in the inspector window.
3. Select a template that is to be applied to the screen under "Template".

### Show template in screen

When you edit a screen, you can show an existing template in the screen.

Proceed as follows to show a template in the screen:

1. Activate "Extras > Settings > Visualization > Show template in screens" in the menu.

## Result

The screen is based on the selected template. All objects which you have configured in the template are available in the screen. The template is displayed in the screen.

## See also

Basics on working with templates (Page 2941)

## 10.1.2 Working with objects

### 10.1.2.1 Overview of objects

#### Introduction

Objects are graphics elements which you use to design the screens of your project.

The "Tools" task card contains all objects that can be used for the HMI device. Display the Task Card with menu command "View" by activating the "Task Card" option.

The toolbox contains various palettes, depending on the currently active editor. If the "Screens" editor is open, the toolbox contains the following palettes:

- "Basic objects"  
The basic objects include basic graphic objects such as "Line", "Circle", "Text field" or "Graphic view".
- "Elements"  
The elements include basic control elements, e.g. "I/O field", "Button" or "Gauge".
- "Controls"  
The controls provide advanced functions. They also represent process operations dynamically, for example Trend view and Recipe view.

10.1 Creating screens

- "Graphics"  
 Graphics are broken down into subjects in the form of a directory tree structure. The various folders contain the following graphic illustrations:
  - Machine and plant areas
  - Measuring equipment
  - Control elements
  - Flags
  - Buildings







You can create links to your own graphic folders. The external graphics are located in these folders and subfolders. They are displayed in the toolbox and incorporated into the project using links.
- "Libraries" task card  
 In addition to the display and operating elements, the library objects are available. They are located within the palettes of the "Libraries" task card. A library contains preconfigured objects such as graphics of pipes, pumps, or preconfigured buttons. You can also integrate multiple instances of library objects into your project without having to reconfigure them. The WinCC software package includes libraries, e.g. "HMI Buttons & Switches". You can also store customized objects, and faceplates in user libraries. Faceplates are objects that you create from existing screen objects, and for which you define the configurable properties.

**Note**







**HMI device dependency**

Some of the toolbox objects are either available with restricted functionality, or not at all. This depends on the HMI device you are configuring. Unavailable properties of an object are displayed as deactivated, and cannot be selected.





**Basic objects**

Icon	Object	Instructions
	"Line"	-
	"Ellipsis"	-
	"Circle"	-
	"Rectangle"	-
	"Text field"	One or more lines of text. The font and layout are adjustable.
	"Graphic view"	Displays graphics from external graphic programs, and inserts OLE objects. The following graphic formats can be used: ".emf", ".wmf", ".dib", ".bmp", ".jpg", ".jpeg", ".gif" and ".tif".

## Elements

Icon	Object	Instructions
	"I/O field"	Outputs the values of a tag, and/or writes values to a tag. You can define limits for the tag values shown in the I/O field. To hide the operator input in runtime, configure "Hidden input".
	"Button"	Executes a list of functions, or a script as configured.
	"Symbolic I/O field"	Outputs the values of a tag, and/or writes values to a tag. A text from a text list is displayed in relation to the tag value.
	"Graphic I/O field"	Outputs the values of a tag, and/or writes values to a tag. A graphic from a graphics list is displayed in relation to the tag value.
	"Date/time field"	Outputs the system date and time, or the time and date from a tag. This allows the operator to enter new values. The display format is adjustable.
	"Bar"	The bar represents a value from the PLC in the form of a scaled bar graph.
	"Switch"	Toggles between two defined states. You can label a switch with text, or a graphic.

## Controls

Icon	Object	Description
	"Alarm view"	Shows currently pending alarms or alarm events from the alarm buffer or alarm log.
	"Trend view"	Represents multiple curves with values from the PLC, or from a log.
	"User view"	Allows an administrator to administer users on the HMI device. It also allows an operator without administrator rights to change his password.
	"Recipe view"	Displays data records, and allows them to be edited.
	"System diagnostics view"	Provides an overview of all devices capable of diagnostics. Displays errors in the plant.

## See also

Overview of objects (Page 2950)

Designing an object (Page 2966)

## 10.1.2.2 Overview of objects

### Introduction

Objects are graphics elements which you use to design the screens of your project.

The "Tools" task card contains all objects that can be used for the HMI device. Display the Task Card with menu command "View" by activating the "Task Card" option.

The toolbox contains various palettes, depending on the currently active editor. If the "Screens" editor is open, the toolbox contains the following palettes:

- "Basic objects"  
The basic objects include basic graphic objects such as "Line", "Circle", "Text field" or "Graphic view".
- "Elements"  
The elements include basic control elements, e.g. "I/O field", "Button" or "Gauge".
- "Controls"  
The controls provide advanced functions. They also represent process operations dynamically, for example Trend view and Recipe view.
- "Graphics"  
Graphics are broken down into subjects in the form of a directory tree structure. The various folders contain the following graphic illustrations:
  - Machine and plant areas
  - Measuring equipment
  - Control elements
  - Flags
  - Buildings

You can create links to your own graphic folders. The external graphics are located in these folders and subfolders. They are displayed in the toolbox and incorporated into the project using links.

- "Libraries" task card  
In addition to the display and operating elements, the library objects are available. They are located within the palettes of the "Libraries" task card. A library contains preconfigured objects such as graphics of pipes, pumps, or preconfigured buttons. You can also integrate multiple instances of library objects into your project without having to reconfigure them. The WinCC software package includes libraries, e.g. "HMI Buttons & Switches". You can also store customized objects, and faceplates in user libraries. Faceplates are objects that you create from existing screen objects, and for which you define the configurable properties.

---









#### Note

##### HMI device dependency











Some of the toolbox objects are either available with restricted functionality, or not at all. This depends on the HMI device you are configuring. Unavailable properties of an object are displayed as deactivated, and cannot be selected.

---







## Basic objects

Icon	Object	Instructions
	"Line"	-
	"Polyline"	The polyline is an open object. Even if the start and end points have the same coordinates, the area they enclose cannot be filled in. If you want to fill a polygon, select the "Polygon" object.
	"Polygon"	-
	"Ellipsis"	-
	"Circle"	-
	"Rectangle"	-
	"Text field"	One or more lines of text. The font and layout are adjustable.
	"Graphic view"	Displays graphics from external graphic programs, and inserts OLE objects. The following graphic formats can be used: "*.emf", "*.wmf", "*.dib", "*.bmp", "*.jpg", "*.jpeg", "*.gif" and "*.tif".











## Elements

Icon	Object	Instructions
	"I/O field"	Outputs the values of a tag, and/or writes values to a tag. You can define limits for the tag values shown in the I/O field. To hide the operator input in runtime, configure "Hidden input".
	"Button"	Executes a list of functions, or a script as configured.
	"Symbolic I/O field"	Outputs the values of a tag, and/or writes values to a tag. A text from a text list is displayed in relation to the tag value.
	"Graphic I/O field"	Outputs the values of a tag, and/or writes values to a tag. A graphic from a graphics list is displayed in relation to the tag value.
	"Date/time field"	Outputs the system date and time, or the time and date from a tag. This allows the operator to enter new values. The display format is adjustable.
	"Bar"	The bar represents a value from the PLC in the form of a scaled bar graph.
	"Charge condition"	Shows the charge condition of the battery for Mobile Wireless
	"Switch"	Toggles between two defined states. You can label a switch with text, or a graphic.
	"Slider"	Displays a current value from the PLC, or sends a numeric value to the PLC.
	"Symbol library"	Used to add screen objects based on controls of the same name.
	"Effective range name"	Shows the name of the effective range.

10.1 Creating screens

Icon	Object	Instructions
	"Effective range name (RFID)"	Displays the name of the effective range (RFID).
	"Effective range signal"	Indicates how accurately the Mobile Panel Wireless is positioned within an effective range.
	"WLAN reception"	Indicates how good the WLAN radio connection is.
	"Gauge"	Displays numeric values. The appearance of the gauge is adjustable.
	"Zone name"	Displays the name of the zone.
	"Zone signal"	Indicates how accurately the Mobile Panel Wireless is positioned within a zone.
	"Clock"	Displays the system time in analog or digital format.

Controls

Icon	Object	Description
	"Alarm view"	Shows currently pending alarms or alarm events from the alarm buffer or alarm log.
	"Trend view"	Represents multiple curves with values from the PLC, or from a log.
	"User view"	Allows an administrator to administer users on the HMI device. It also allows an operator without administrator rights to change his password.
	"HTML browser"	Displays HTML pages.
	"Status/Force"	This function gives the operator direct read / write access from the HMI device to individual address areas in the connected SIMATIC S7.
	"Sm@rtClient view"	Allows an operator to monitor and maintain a connected device remotely.
	"Recipe view"	Displays data records, and allows them to be edited.
	"f(x) trend view"	Represents the values of a tag as a function of another tag.
	"System diagnostics view"	Provides an overview of all diagnostics capable devices. Displays errors in the plant.
	"Media Player"	Media files are shown in the media player.



## See also

Screen basics (Page 2931)  
Example: Configuring a rectangle (Page 2988)  
Storing an external image in the graphics library. (Page 2977)  
Managing external graphics (Page 2975)  
External graphics (Page 2974)  
Repositioning and resizing multiple objects (Page 2971)  
Selecting multiple objects (Page 2969)  
Inserting multiple objects of the same type (stamping tool) (Page 2967)  
Flashing (Page 2966)  
Flipping objects (Page 2965)  
Rotating objects (Page 2963)  
Show objects outside the screen area (Page 2963)  
Moving an object forward or backward (Page 2962)  
Aligning objects (Page 2960)  
Resizing an object (Page 2958)  
Positioning an object (Page 2957)  
Deleting an Object (Page 2956)  
Inserting an object (Page 2954)  
Overview of objects (Page 2947)

### 10.1.2.3 Options for Editing Objects

#### Introduction

Objects are graphics elements which you use to design the screens of your project.

You have the following options for editing objects:

- Copying, pasting or deleting objects using the shortcut menu. If you copy an object in a screen and the screen already includes an object of the same name, the name of the object is changed.
- Maintaining the standard size of the objects you are inserting or customizing their size on insertion.
- Moving an object in front of or behind other objects
- Rotating objects
- Mirroring objects
- Defining the tab sequence for objects
- Stamping: Inserting several objects of the same type

## 10.1 Creating screens

- Selecting several objects simultaneously
- Repositioning and resizing multiple objects
- You can assign external graphics to objects, e.g. in the Graphic View.  
You can view only the images you have previously stored in the graphic browser of your WinCC project.  
You can save graphics in the graphic browser:
  - Via drag & drop from the "Graphics" object group to the working area
  - As graphic files in the following formats: \*.bmp, \*.dib, \*.ico, \*.emf, \*.wmf, \*.gif, \*.tif, \*.jpeg or \*.jpg
  - As an OLE object  
You either create a new OLE object or save an existing graphic file as an OLE object.  
To save an OLE object, an OLE-compatible graphics program must be installed on the configuration computer.

### 10.1.2.4 Inserting an object

#### Introduction

In the "Screens" or "Reports" editor, insert the objects to the "Toolbox" task card. Use the mouse to drag the objects into the work area. You either keep the objects in their original size, or scale them up or down when you paste them.

In addition, you can copy or move objects via the clipboard from one editor to another, for example to transfer a screen object to a report. Alternatively, you can also use the mouse instead of the clipboard for copying and moving:

- Copying: <Ctrl + Drag&Drop>
- Moving: Drag&drop

---

#### Note

##### Basic Panels

The "Reports" editor is not available for Basic Panels.

---

#### Requirement

The "Tools" task card is open.

#### Inserting objects in their standard size

1. In the "Toolbox" task card, select the desired graphic object or the desired graphic in the WinCC graphics folder.  
When you move the cursor across the work area, it turns into a crosshair with an appended object icon.
2. Click the location in the work area where you want to insert the object or graphic.  
The object is inserted with its standard size at the desired position in the work area.

Alternatively, double-click the object in the "Toolbox" task card.

### Copying an object

1. Select the desired object.
2. Select "Copy" in the shortcut menu.
3. Click the desired location and select "Paste" in the shortcut menu.

WinCC inserts a copy of the object at the desired location. You can only change the properties that are appropriate for the relevant context.

Example: In the "Screens" editor, you can set for I/O fields and the mode for input and output. In the "Reports" editor, the mode is set to "Output".

Original and copy are not interconnected and are configured independently from one another.

### Inserting lines

1. Select the desired graphic object in the "Tools" task card.
2. Click on a location in the work area. A line in the standard size is inserted.

### Inserting a polygon or polyline

1. Select the desired object "Polyline" or "Polygon" in the "Tools" task card.
2. Click on a location in the work area. This fixes the starting point of the object.
3. Click another location in the work area. A corner point is set.
4. For every additional corner point, click on the corresponding location in the work area.
5. Double-click on a location in the work area. The last corner point is set. This fixes all the points of the polygon or polyline.

---

#### Note

##### Basic Panels

The "Polyline" and "Polygon" objects are not available for Basic Panels.

---

---

#### Note

If you want to insert several objects of the same type, use the "Stamp" function. This avoids having to reselect the object in the "Tools" task card every time before inserting it. To do so, select the  icon in the toolbar of the "Tools" task card.

---

## See also

Overview of objects (Page 2950)

Example: Configuring a rectangle (Page 2988)

Designing an object (Page 2966)

### 10.1.2.5 Deleting an Object

#### Introduction

You can delete objects individually or with a multiple selection.

#### Requirement

You have opened the work area containing at least one object.

#### Procedure

1. Select the object that you want to delete.  
To delete multiple objects, keep the <Shift> key pressed and select the objects to be deleted one after the other. Alternatively, drag and maximize an area around the desired objects with the mouse.
2. Select "Delete" from the shortcut menu.

#### Result

The selected objects are deleted.

## See also

Overview of objects (Page 2950)

Example: Configuring a rectangle (Page 2988)

Designing an object (Page 2966)

### 10.1.2.6 Positioning an object

#### Introduction

When you select an object, it is enclosed by a rectangle with resizing handles. This rectangle is the rectangle which surrounds the object. The position of an object is defined by the coordinates of the top left corner of the rectangle surrounding the object.

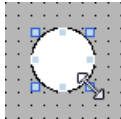

---

#### Note

If the position is outside the work area the object is not displayed in Runtime.

---

#### Position and align

You have the possibility of having a grid displayed in the work area. You have three options for easier positioning of objects:

- "Snap to grid" When you reposition objects, they are automatically snapped and pasted to the grid. If you hold down the <Alt> key, the object is no longer snapped to the grid.
- "Snap to objects" When you reposition objects, they are displayed with help lines. You can use other objects for orientation during positioning.
- "None": You position the objects in any position.

You activate and deactivate the grid and options as follows:

- In the "Options > Settings > Visualization > Screens" menu
- In the "Layout > Grid" task card

#### Requirement

You have opened the work area containing at least one object.

#### Procedure

1. Select the object you want to move.  
The selected object is framed by a rectangle with resizing handles.

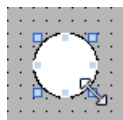

2. Left-click the object and keep the mouse button pressed.

## 10.1 Creating screens

3. Move the mouse pointer onto the new position.  
The contour of the object moves with the mouse and displays the new position for the object.



The object initially remains at its original position.

4. Now release the mouse button.  
The object is moved into the position indicated by the contour of the selection rectangle.

### Alternative procedure

1. In the Inspector window, select "Properties > Properties > Layout".
2. Enter the X and Y values for the position under "Position & Size".

### Result

The object appears at its new position.

### See also

- Overview of objects (Page 2950)
- Example: Configuring a rectangle (Page 2988)
- Designing an object (Page 2966)

## 10.1.2.7 Resizing an object

### Introduction

When you select an object, it is enclosed by a rectangle with handles. You have the following options of resizing an object:

- Drag the handles using the mouse.
- Modify the "Size" property in the Inspector window.

### Requirement

You have opened the work area containing at least one object.

## Procedure

1. Select the object you want to resize.  
The selection rectangle appears. The following figure shows a selected object:

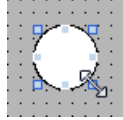



2. Drag a resizing contact of the rectangle to a new position.  
The size of the object changes.
  - The size of the object is aligned to the grid pattern, provided the "Snap to grid" function is set.
  - Press <ALT> to disable this function while you drag the object.  
In order to scale the object proportionally, keep the <Shift> key pressed while changing the size with the mouse.

## Alternative procedure

1. In the Inspector window, select "Properties > Properties > Layout".
2. Enter the size of the object under "Position & Size".



## Harmonizing the object size

1. Select the objects.
2. Now, click one of the following buttons:  or  or   
The size of the selected objects is matched to each other.

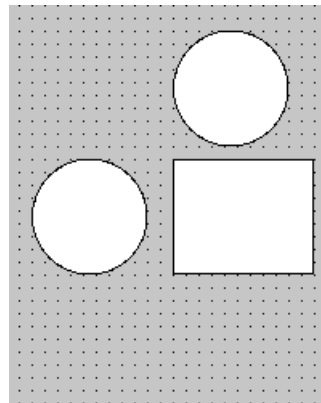
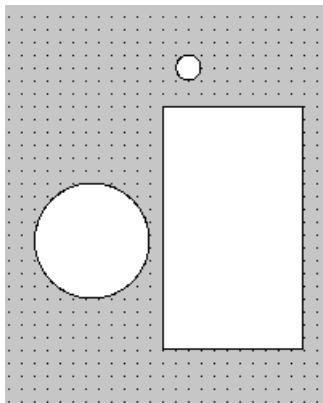
The following screen shows how the selected objects are adapted to the height of the reference object:



10.1 Creating screens

Icon	Description
	Aligns the selected objects to the width of the reference object.
	Aligns the selected objects to the height of the reference object.
	Aligns the selected objects to the width and height of the reference object.

**Result**

The object now appears with its new size.

**See also**

Overview of objects (Page 2950)

Designing an object (Page 2966)









**10.1.2.8 Aligning objects**

**Procedure**

1. Select the objects via multiple selection.
2. Specify an object as the reference object.
3. Select the desired command in the toolbar or the shortcut menu - see table below.  
The selected objects will be aligned.

**Aligning objects flush**

The selected objects will be aligned flush to the reference object.

Icon	Description
	Aligns the selected objects to the left edge of the reference object.
	Aligns the selected objects to the vertical center axis of the reference object.
	Aligns the selected objects to the right edge of the reference object.
	Aligns the selected objects to the upper edge of the reference object.
	Aligns the selected objects to the horizontal center axis of the reference object.
	Aligns the selected objects to the lower edge of the reference object.
	Centers the selected objects to the center points of the reference object.
	Centers the selected objects vertically in the screen.



## Snap to object

When you reposition objects, they are displayed with help lines. You can use other objects for orientation during positioning.

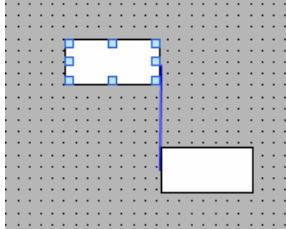

If you are working with the keyboard, press the Alt key. When you move the selected object with the arrow keys, the next anchor point is displayed.

## Distributing objects evenly

You need at least three selected objects. A reference object is not required.

1. Select the objects.
2. Click one of the buttons "Distribute horizontally equal" or "Distribute vertically equal".  
The selected objects are distributed at equal distances.

The following screen shows how you align the vertical spacing of the selected objects:

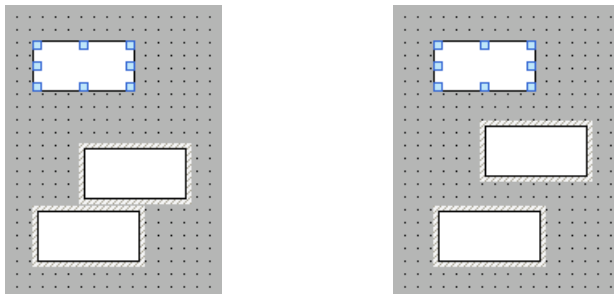

Icon	Description
	Aligns the horizontal distance between the objects. The position of the objects on the extreme left and right side remains unchanged. All other objects are distributed evenly between them.
	Aligns the vertical distance between the objects. The position of the objects at the extreme top and bottom (right and left) remains unchanged. All other objects are distributed evenly between them.

## See also

Overview of objects (Page 2950)

Designing an object (Page 2966)

### 10.1.2.9 Moving an object forward or backward

#### Introduction

You can use the "Order" functions in the shortcut menu of a selected object or in the toolbar to move a selected object in front of or behind other objects within an object layer.

---

**Note**

ActiveX controls are always positioned in front of an object layer (.NET property).





---

#### Requirement

You have opened a screen which contains a layer with multiple objects.

#### Procedure

1. Select the object you want to move forward or backward.
2. Select the "Sort" command and one of the following commands from the shortcut menu:

Icon	Description
	Moves the selected object before all the other objects of the same layer
	Moves the selected object to the lowest position in the same layer
	Moves the selected object up by one position
	Moves the selected object down by one position

#### Alternative procedure

1. Open the "Layers" palette of the "Layout" task card.
2. Navigate to the required object.
3. Hold down the mouse button, and drag the object in the tree topology to the required position in the layer.
4. Now release the mouse button.

#### Result

The object is moved up or down.

#### See also

Overview of objects (Page 2950)

Example: Configuring a rectangle (Page 2988)

Designing an object (Page 2966)

### 10.1.2.10 Show objects outside the screen area

#### Introduction

If you assign objects to positions that are outside the configurable area, these objects will be hidden. The functions of the "Objects outside the visible area" palette in the "Layout" task card are used to move these objects back into the screen.

#### Requirement

- You have opened a screen which contains objects that are outside the configurable area.
- The "Layout" task card is open.

#### Procedure

1. Open the "Layout > Objects outside the area" task card.  
This displays a list of objects that are outside the configurable area.
2. Select the the object which you want to move back into the screen from the list.
3. Select "Move to screen" in the object shortcut menu.

Alternatively open the "Layout > Layer" task card. Objects outside the area are indicated by the  icon. If you click this icon, the object is moved back into the screen.

#### Result

The objects are moved to the configurable area.

#### See also

Overview of objects (Page 2950)

Example: Configuring a rectangle (Page 2988)

Designing an object (Page 2966)

### 10.1.2.11 Rotating objects

#### Introduction

You can rotate a suitable object clockwise or counterclockwise around its center axis in steps of 90°.

---

#### Note

Not all the objects can be rotated. Some objects that can be rotated in screens cannot be rotated in reports.

---

You can also rotate multiple objects using the multiple selection function. Certain WinCC objects such as buttons cannot be rotated.

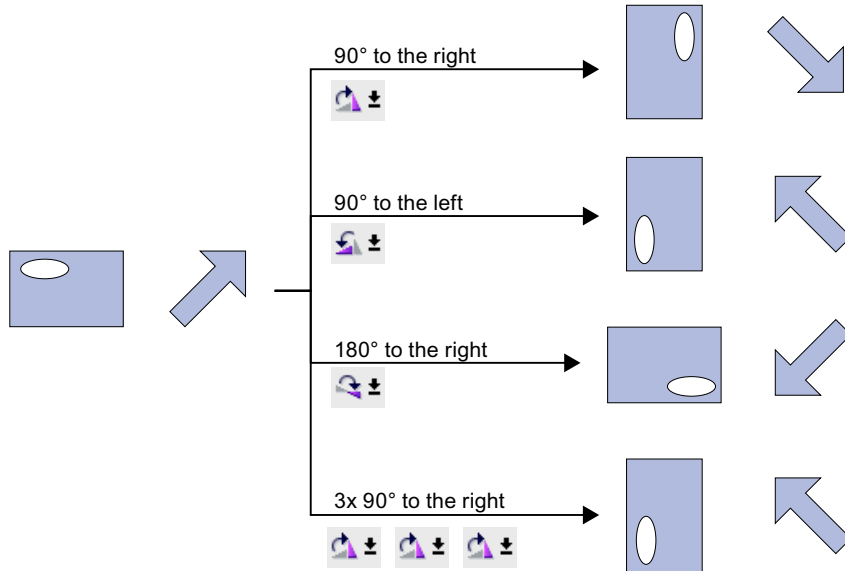

The alignment of elements in an object will change in a rotated object. The following figure shows how a rectangle and an ellipse behave under the different commands for rotating an object:



## Requirement

You have opened the work area containing at least one object.

## Procedure

1. Select the object that you want to rotate.
2. Click one of the following toolbar icons:
  - , to rotate the object clockwise around its center point. The angle of rotation is 90°.
  - , to rotate the object counterclockwise around its center point. The angle of rotation is 90°.
  - , to rotate the object clockwise by 180°.

## Result

The object is shown at its new angle.

## See also

- Overview of objects (Page 2950)
- Example: Configuring a rectangle (Page 2988)
- Designing an object (Page 2966)

### 10.1.2.12 Flipping objects

#### Introduction

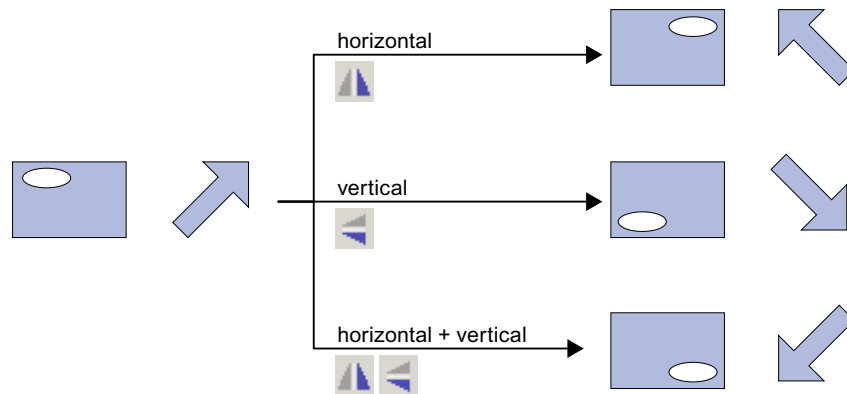

You can flip an object along its vertical or horizontal center axis. The alignment of elements in an object will change when you flip an object. The following figure shows how a rectangle and an ellipse behave under the different commands for flipping an object.



#### Requirement

You have opened a screen which contains at least one object.

#### Procedure

1. Select the object that you want to flip.
2. Click the "Flip" command in the shortcut menu and select one of the options displayed:
  - , to flip the selected object along its vertical center axis.
  - , to flip the selected object along its horizontal center axis.

#### Result

The object is shown at its flipped position.

#### See also

- Overview of objects (Page 2950)
- Example: Configuring a rectangle (Page 2988)
- Designing an object (Page 2966)

### 10.1.2.13 Flashing

#### Introduction

You want an object to flash in Runtime.

#### Requirement

You have opened the work area containing at least one object.

#### Procedure

1. Select the object that you want to flash.
2. In the Inspector window, select the type "Default" under ""Properties > Properties > Flashing".

#### Result

The object flashes in runtime.

#### See also

Example: Configuring a rectangle (Page 2988)

Designing an object (Page 2966)

### 10.1.2.14 Designing an object

#### Introduction

You design the border and background of an object.

#### Requirement

A line has been created in a screen.

#### Procedure

1. Select the line on your screen.
2. In the Inspector window, select "Properties > Properties > Appearance":
3. Select "Dash" as the style.
4. To display the dashed line in two colors, select the line width "1".
5. Select the setting "Arrow" in the "Line ends" area.

## Result

The line is displayed in two colors as a dashed line. The end of the line is an arrow.

## See also

Overview of objects (Page 2947)

Inserting an object (Page 2954)

Deleting an Object (Page 2956)

Positioning an object (Page 2957)

Resizing an object (Page 2958)

Aligning objects (Page 2960)

Moving an object forward or backward (Page 2962)

Show objects outside the screen area (Page 2963)

Rotating objects (Page 2963)

Flipping objects (Page 2965)

Flashing (Page 2966)

Inserting multiple objects of the same type (stamping tool) (Page 2967)

Selecting multiple objects (Page 2969)

Repositioning and resizing multiple objects (Page 2971)

Managing My Controls (Page 2972)

External graphics (Page 2974)

Managing external graphics (Page 2975)

Storing an external image in the graphics library. (Page 2977)

### 10.1.2.15 Inserting multiple objects of the same type (stamping tool)



#### Introduction

WinCC offers the possibility to "stamp" several objects of the same type directly one after the other, i.e. paste without having to reselect the object every time. In addition you have the possibility of multiplying an object that has already been inserted.

#### Requirement

The "Tools" task card is open.

### Inserting several objects of one type

1. Select the object that you want to insert in the "Tools" task card.
2. Click the  icon in the toolbar of the "Tools" task card.  
The "Stamp" function is activated.
3. To insert the object with its standard size, click the relevant insertion position in the work area.  
To insert the object with another size, position the mouse pointer at the desired location in the work area. Press the left mouse button and drag the object to the required size.  
The object is inserted in the work area as soon as you release the mouse button.
4. Repeat step 3 to insert further objects of the same type.
5. Click the  icon again.  
The "Stamp" function is deactivated.

---

#### Note

You can copy existing objects using the drag-and-drop +<CTRL> function. The existing object is not moved in this case. You paste a copy of this object into the new position instead.

---

### Inserting and multiplying an object

1. Insert the desired object from the "Tools" task card.
2. Press the <Ctrl> key and position the cursor on one of the handles displayed in the figure shown below.

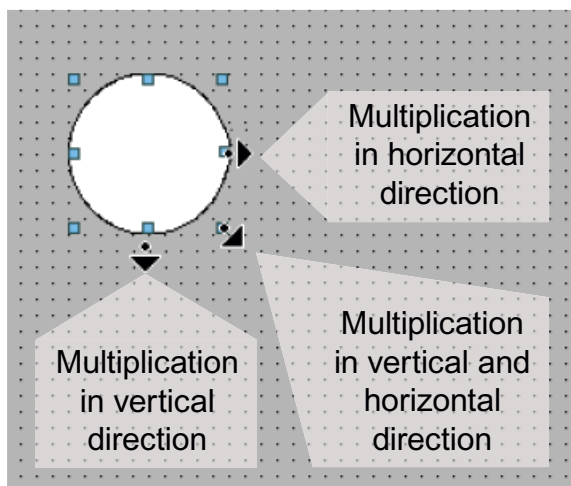



3. Drag the handles to the right and/or down while keeping the left mouse button pressed.
4. The object is multiplied depending on available space if you keep moving the cursor.

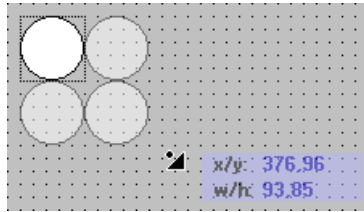

## Result

You have pasted and stamped an object in a screen.

## See also

Overview of objects (Page 2950)

Example: Configuring a rectangle (Page 2988)

Designing an object (Page 2966)

### 10.1.2.16 Selecting multiple objects

#### Introduction

Select all objects you want to align with each other or to change global properties. This procedure is called "multiple selection."

The Inspector window shows all the properties of the selected objects.

You now have several options of selecting multiple objects:

- Draw a selection frame around the objects.
- Hold down the <Shift> key, and click the required objects.

#### Selection frame of a multiple selection

The selection frame surrounds all objects of a multiple selection. The selection frame is comparable with the rectangle that surrounds an individual object.

The selection frame is not visible. When you have made your multiple selection, the following frame is displayed:

- The reference object is indicated by the rectangle around it.
- The other selected objects are indicated by a dashed-line frame.

### Specifying a reference object

The reference object is the object upon which the other objects are oriented. The reference object is framed by a rectangle with handles. The following figure shows a reference object with two other selected objects:

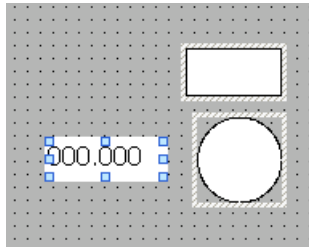

You have the following options to specify the reference object:

- Select the objects via multiple selection. The object selected first is then the reference object.
- Draw a selection frame around the objects. The reference object compiled automatically. If you wish to specify a different object within the selection as the reference object, click on the desired object. This action does not cancel your multiple selection.

### Requirement

You have opened the work area containing at least two objects.

### Selecting multiple objects with a selection frame

1. Position the mouse pointer in the work area close to one of the objects to be selected.
2. Hold down the mouse button, and draw a selection frame around the objects to be selected.

Or:

1. Hold down the <Shift> key.
2. Click the relevant objects, working in succession.  
All the selected objects are identified by frames.  
The object selected first is identified as reference object.

---

#### Note

To remove an object from the multiple selection, press <SHIFT>, hold it down and then click the relevant object once again.

---

### Result

Multiple objects are selected. One of those is identified as the reference object. You can now perform the following steps:

- Changing the object properties of all the objects
- Resizing all the objects by the same ratio, by dragging the selection frame to increase or reduce the size

- Moving all the objects in one group
- Aligning the objects to the reference object

### See also

Overview of objects (Page 2950)

Example: Configuring a rectangle (Page 2988)

Designing an object (Page 2966)

### 10.1.2.17 Repositioning and resizing multiple objects

#### Possible modifications

After you have selected multiple objects, you edit them:

- Shift using the mouse
  - To change the absolute position of the marked objects, position the mouse pointer over an object, and shift the multiple selection with the mouse button pressed.
  - To resize all the objects by the same ratio, grab the resizing handles of the reference object.
- Move over the work area with the icons of the toolbar
  - Change the position of the marked objects with respect to each other
  - Align the height and width of the marked objects
- Moving with the shortcut menu commands of the work area
  - Change the position of the marked objects with respect to each other
  - Align the height and width of the marked objects

### See also

Overview of objects (Page 2950)

Designing an object (Page 2966)

### 10.1.2.18 Managing My Controls

#### Introduction

Add standardized or user-defined controls in the "Tools > My Controls" task card. All the ActiveX controls registered in the operating system and the .Net controls on your system are available for use in WinCC.

- **ActiveX controls**  
ActiveX controls are control elements from any providers, which can be used by other programs over a defined OLE-based interface.
- **.Net controls**  
.Net controls are control elements from any providers based on the Microsoft .Net Framework.
- **Specific .Net controls**  
.Net controls are control elements from any providers based on the Microsoft .Net Framework.

When you intend to run external controls in your WinCC project, you need to verify that these run on the HMI device you are configuring. If you are using controls from third parties, you must first of all add these to the "My controls" palette before you copy the project to different PCs.

---

#### Note

The use of any control elements that are not included in the delivery scope (for example of third parties) may cause errors such as performance loss, or system hangs. The user of such control software is alone responsible for any problems caused by its use. We therefore advise you to closely examine such elements prior to their use.

---

#### Requirement

- The required ActiveX control is installed in the PC's operating system.
- The required or specific .Net control is available on the PC in an assembly.
- A screen is open.
- The "Tools" task card is open.

### Adding a new control to the "My controls" group

1. Open "Tools > My controls" in the "Tools" task card.
2. Select "Select objects" from the shortcut menu.  
A dialog opens. This contains all the controls available on the system. Controls that already exist in the "Tools" task card are identified by a check mark.

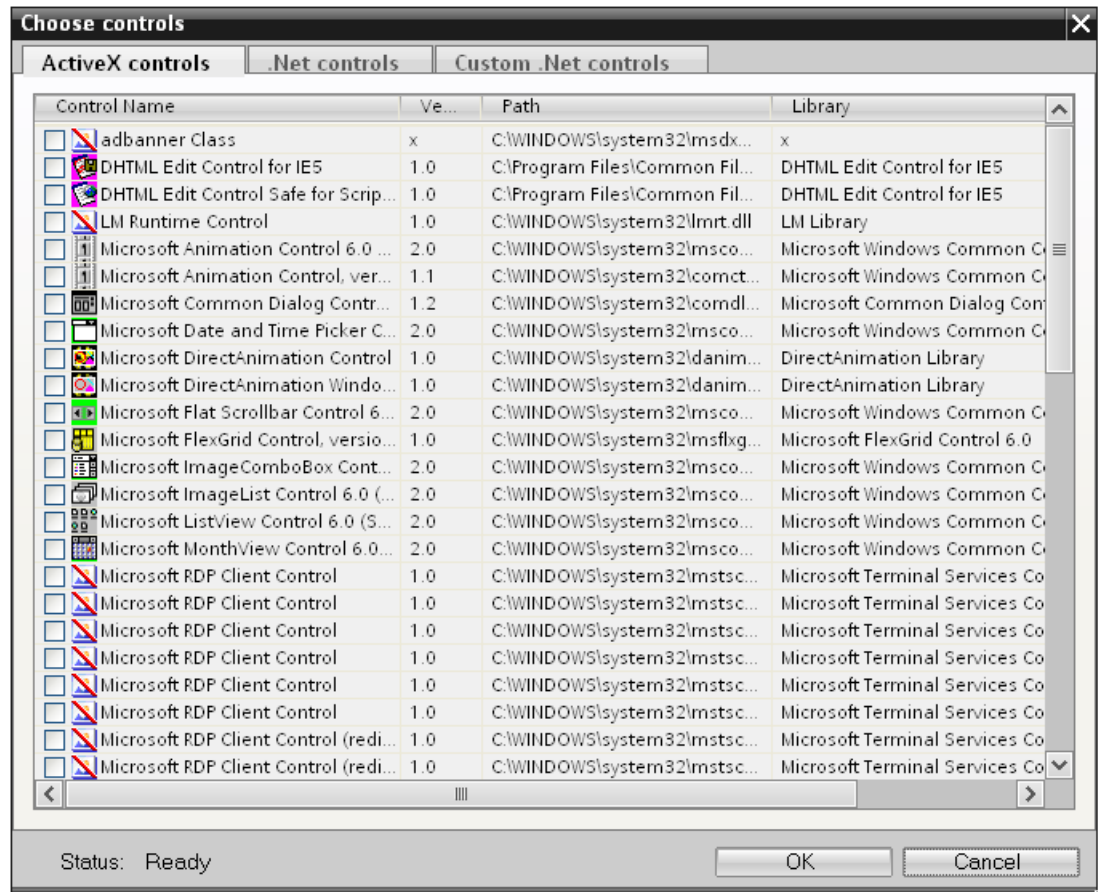

3. Select the desired tab, e.g. ActiveX controls.
4. Activate the required control.
5. Confirm your selection with "OK".

### Inserting a specific .Net control in the "My controls" group

1. Select the "Specific .Net controls" tab. The list is empty the first time you select the tab.
2. Click the "... " button.
3. Select the folder in which the assembly is contained.
4. Select a file.
5. Click "Open." All the available controls are displayed in the "Specific .Net controls" tab.
6. Activate the required .Net control.
7. Confirm your selection with "OK".

## Result

The control now appears in the "Tools > My controls" task card and can be configured in a screen.

## Removing a control from the "My controls" group

1. Select "Delete" from the shortcut menu for the control concerned.  
The control is removed from the "My controls" group.

## See also

Designing an object (Page 2966)

### 10.1.2.19 External graphics

#### Introduction

You can use graphics created with an external graphic program in WinCC. To use these graphics you store them in the graphic browser of the WinCC project.

You can save graphics in the graphic browser:

- When you drag-and-drop graphics objects from the "Graphics" pane into the work area, these are stored automatically in the graphic browser. The graphic names are numbered in the order of their creation, for example, "Graphic\_1." Use the <F2> function key to rename the graphic.
- As a graphic file with the following formats:  
.bmp, \*.ico, \*.emf, \*.wmf, \*.gif, \*.tif, \*.png, \*.jpeg or \*.jpg
- As an OLE object that is embedded in WinCC and is linked to an external graphic editor. In the case of an OLE link, you open the external graphic editor from WinCC. The linked object is edited using the graphic editor. An OLE link only works if the external graphic editor is installed on your PC, and supports OLE.

#### Use of graphics from the graphic browser

Graphics from the graphic browser are used in your screens:

- In a Graphic view
- In a graphics list
- As labeling for a button/function key

#### Transparent graphics

In WinCC you also use graphics with a transparent background. When a graphic with a transparent background is inserted into a graphic object of WinCC, the transparency is replaced by the background color specified for the graphic object. The selected background color is linked firmly with the graphic. If you use the graphic in another graphic object of WinCC, this object is displayed with the same background color as the graphic object that was

configured first. If you want to use the graphic with different background colors, include this graphic in the graphic browser again under a different name. The additional background color is configured when the graphic is used at the corresponding graphic object of WinCC.

## Managing graphics

An extensive collection of graphics, icons and symbols is installed with WinCC, for example:

In the Toolbox window of the "Graphic" pane the graphic objects are structured by topic in the "WinCC graphics folder." The link to the WinCC graphics folder cannot be removed, edited or renamed.

The "Graphics" pane is also used to manage the external graphics. The following possibilities are available:

- Creating links to graphics folders  
The external graphic objects in this folder, and in the subfolders, are displayed in the toolbox and are thus integrated in the project.
- Editing folder links
- You open the program required for editing of the external graphic in WinCC.

## See also

Overview of objects (Page 2950)

Example: Configuring a rectangle (Page 2988)

Designing an object (Page 2966)

### 10.1.2.20 Managing external graphics

#### Introduction

External graphics that you want to use in WinCC are managed in the "Screens" editor by using the "Tools" task card in the "Graphics" pane.

#### Requirement

- The "Screens" editor is open.
- The "Tools" task card is open.
- The graphics are available.
- The graphics have the following formats:  
\*.bmp, \*.ico, \*.emf, \*.wmf, \*.gif, \*.tif, \*.jpeg or \*.jpg

## 10.1 Creating screens

### Creating a folder link

1. Click "My graphics folder."
2. Select "Link" in the shortcut menu.  
The "Create link to folder" dialog is opened. The dialog suggests a name for the folder link.
3. Edit the name as required. Select the path containing the graphic objects.
4. Click "OK" to confirm your input.  
The new folder link is added to the "Graphics" object group. The external graphics that are located in the target folder and in sub-folders are displayed in the toolbox.

### Editing folder links

1. Select the folder link to edit.
2. Select the "Edit link..." command from the shortcut menu.  
The "Create link to folder" dialog is opened.
3. Edit the name and path of the folder link as required.
4. Click "OK" to confirm your input.

### Renaming the folder link

1. Select the folder link to rename.
2. Select "Rename" from the shortcut menu.
3. Assign a name to the new folder link.

### Removing a folder link

1. Select the folder link you want to delete.
2. Select "Remove" in the shortcut menu.

### Edit external graphics

1. Select the graphic you want to edit.
2. Select the "Edit graphic" command from the shortcut menu.  
This opens the screen editor associated with the graphic object file.

### Editing graphics folders from WinCC

1. Select the graphic you want to edit.
2. Select the "Open parent folder" command from the shortcut menu.  
The Windows Explorer opens.



## See also

- Overview of objects (Page 2950)
- Example: Configuring a rectangle (Page 2988)
- Designing an object (Page 2966)

### 10.1.2.21 Storing an external image in the graphics library.

#### Introduction

To display graphics that have been created in an external graphics program in your screens, you will first have to store these graphics in the graphics browser of the WinCC project.

#### Requirement

- A screen has been created.
- A Graphic View is inserted in the screen.
- The Inspector window of the Graphic view is open.

To store an external graphic in the image browser:

- A graphic is available.

To store an OLE object in the browser:

- An OLE-compatible graphics program is installed on your configuration computer.

#### Save graphics file

1. Open the Windows Explorer.
2. Select the graphic that you want to store.
3. Drag-and-drop the graphic into the graphic browser.

#### Creating and saving a new graphic as an OLE object

1. Select the Graphic view on your screen.
2. In the Inspector window, select "Properties > Properties > General":
3. Open the graphic selection list.
4. Click .
5. The "Insert object" dialog box opens.

---

#### Note

In addition, the dialog "External application running..." will open. The dialog will not close until you exit the external application.

---

## 10.1 Creating screens

6. From the "Insert object" dialog box, select "New" and an object type. The settings in "Settings > "OLE settings" determine which object types are shown.
7. Click "OK." The associated graphic program is opened.  
When you are finished creating graphics, end the graphic programming software with "File > Close" or "File > Close & return to WinCC."  
The graphic will be stored in the graphic programming software standard format and added to the graphic browser.

### Inserting created graphics in WinCC

---

#### Note

A new graphic object created as OLE object may not be directly accepted in WinCC when you save it to an external graphics program.

---

1. Reopen the dialog for inserting a graphic.
2. From the "Insert object" dialog box, select "Create from file."
3. Click the "Browse" button.
4. Navigate to the created graphic and select it.

### Saving an existing graphic object as an OLE object

1. In the Inspector window, select "Properties > Properties > General":
2. Open the graphic selection list.
3. Click .
4. The "Insert object" dialog box opens.

---

#### Note

In addition, the dialog "External application running..." will open. The dialog will not close until you exit the external application.

---

5. From the "Insert object" dialog box, select "Create from file."
6. Click the "Browse" button.
7. Use the dialog to help you navigate to the folder in which the graphic file is saved.

---

#### Note

To import graphics files, note the following size restrictions:

\*.bmp, \*.tif, \*.emf, \*.wmf ≤4 MB

\*.jpg, \*.jpeg, \*.ico, \*.gif ""≤1 MB

---

## Result

The image file is now stored in your image browser. It is shown in a screen with a Graphic view , or is added as a list element in an image list.

You can double-click OLE objects in your library to open them for editing in the corresponding graphic editor. When you have finished editing graphics, end the graphic programming software with "File > Close" or "File > Close & return to WinCC." The changes are applied to WinCC.

## See also

Overview of objects (Page 2950)

Example: Configuring a rectangle (Page 2988)

Designing an object (Page 2966)

### 10.1.2.22 Working with object groups

#### Basics on groups

##### Introduction

Groups are several objects that are grouped together with the "Group" function. You edit a group in the same way as any other object.

##### Overview

WinCC offers the following methods for editing multiple objects:

- Multiple selection
- Creating object groups

##### Editing mode

To edit an individual object in a group, select the object in the "Layout > Layers" task card. Alternatively select "Group > Edit group" in the object group's shortcut menu.

##### Hierarchical groups

You add further objects or groups to extend a group. The group is enlarged by the new objects and is structured hierarchically in main and sub-groups. Such hierarchical groups must be broken up in stages. You also break up the group in the same order in which you grouped the objects or groups. It takes exactly the same number of steps to break up these hierarchical groups as it did to create them.

## Rectangle surrounding the object

Only one surrounding rectangle is now displayed for the whole group. The surrounding rectangles of all objects are displayed for a multiple selection on the other hand.

## Layers

All objects of a group are located in the same layer.

## See also

Example: Configuring a rectangle (Page 2988)

## Creating object groups

### Introduction

The "Group" command combines multiple objects to form a group.

You can change the size and position of the group. The following rules apply:

- The system automatically adapts the position coordinates of the grouped objects when you reposition the group. The relative position of the grouped objects to the group is not affected.
- The system automatically adapts the height and width of the grouped objects in proportion to a change of the group size.
- To change the size of the group proportionately, hold down the <Shift> key and drag the rectangle around the object until has the required size.

---

#### Note

To create a hierarchical group, organize the individual groups like objects.

---

## Requirement

- You have opened a screen which contains at least two objects.

## Creating object groups

1. Select all the objects you want to organize in a group.
2. Select the command "Group > Group" from the shortcut menu.

The objects of the group are displayed with a rectangle around the objects.

## Grouping objects within a group

1. Select the group you want to edit.
2. Select the command "Group > Edit group" from the shortcut menu.  
The group that you are editing is highlighted by a red frame.

3. Select the objects of a group that you want to combine into a subgroup.
4. Select the command "Group > Group" from the shortcut menu.

A subgroup with the objects is created.

### Adding objects into an existing group

1. Select the group to which you want to add objects.
2. Press the <Shift> key and select the object you want to add to the group.
3. Select the "Group > Add to group" command from the shortcut menu.

The object is added to this group.

### Alternative procedure

You can also edit groups in the "Layout" task card. Using drag-and-drop you can also easily edit nested groups in the "Layers" pane.

### Result

The selected objects are combined in a group. The multiple selection rectangle becomes the rectangle surrounding the objects in the group. The handles are shown only for the group. The group is in the active layer.

### See also

Example: Configuring a rectangle (Page 2988)

### Ungroup

#### Introduction

Select the "Ungroup" command to split a group into the original object fractions.

#### Requirement

- You have opened a screen that contains a group.

### Ungroup

1. Select the group.
2. Select the "Group > Ungroup" command from the shortcut menu.

### Ungrouping a group within a group

1. Select the higher-level group.
2. Select the command "Group > Edit group" from the shortcut menu.  
The group that you are editing is highlighted by a red frame.
3. Select the lower-level group.
4. Select the "Group > Ungroup" command from the shortcut menu.

### Result

The lower-level group is ungrouped. The objects are assigned to the next higher group.

### Alternative procedure

You can also edit groups in the "Layout" task card. Using drag-and-drop you can also easily edit nested groups in the "Layers" pane.

### See also

Example: Configuring a rectangle (Page 2988)

### Adding objects to a group

#### Introduction

The "Add objects to group" command is used to add objects to a group, without ungrouping it first.

#### Requirements

A screen with one group and at least one other object is opened.

#### Procedure

1. Select the group.
2. Press the <Shift> key and select the object you want to add to the group.
3. Select the "Group > Add to group" command from the shortcut menu.

### Result

The group consists of the original objects, and the newly-added objects. The added objects are arranged at the front of the group.

### Alternative procedure

You can also edit groups in the "Layout" task card. Using drag&drop you can also easily edit hierarchical groups in the "Layers" palette.

### See also

Example: Configuring a rectangle (Page 2988)

## Removing Objects from the Group

### Introduction

You use the "Remove objects from group" command to remove individual objects from a group, without ungrouping it first.

You do not have to remove the object from the group to edit an object in a group. You can edit the objects of a group individually.

### Requirement

- You have opened a screen that contains a group.

### Removing objects from a group

To remove an object from a group:

1. Select the group.
2. Select the command "Group > Edit group" from the shortcut menu.  
The group you want to edit is highlighted by a red frame.
3. Select all objects in the group that you want to remove from the group.
4. Select the "Group > Remove from group" command from the shortcut menu.

The objects are removed from the group.

---

#### Note

If there are only two objects in the group, the menu command "Remove from group" is not available.

---

### Deleting objects from a group

To remove an object from the group, and from the screen:

1. Select the group.
2. Select the command "Group > Edit group" from the shortcut menu.  
The group you want to edit is highlighted by a red frame.

## 10.1 Creating screens

3. Select the objects in the group that you want to delete.
4. Select "Delete" from the shortcut menu.

---

### Note

If there are only two objects in the group, the menu command "Delete" is not available.

---

### Alternative procedure

You can also edit groups in the "Layout" task card. Using drag-and-drop you can also easily edit nested groups in the "Layers" pane.

### See also

Example: Configuring a rectangle (Page 2988)

## Editing an Object in a Group

### Introduction

You can edit the objects of a group individually.

### Requirement

You have opened a screen that contains a group.

### Editing grouped objects

1. Select the group.

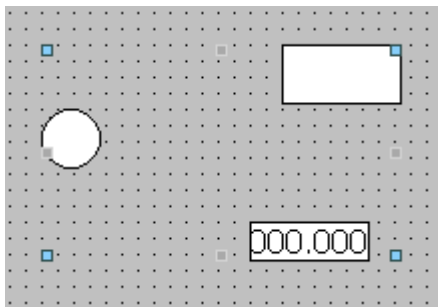

The properties of the group are displayed in the Inspector window.

2. Change the position and size of the grouped objects in "Properties > Properties > Layout."
3. Change the name of the group in "Properties > Properties > Miscellaneous."



## Modifying the properties of an object within a group

1. Select the group.
2. Select the object whose properties you want to change in the Inspector window.

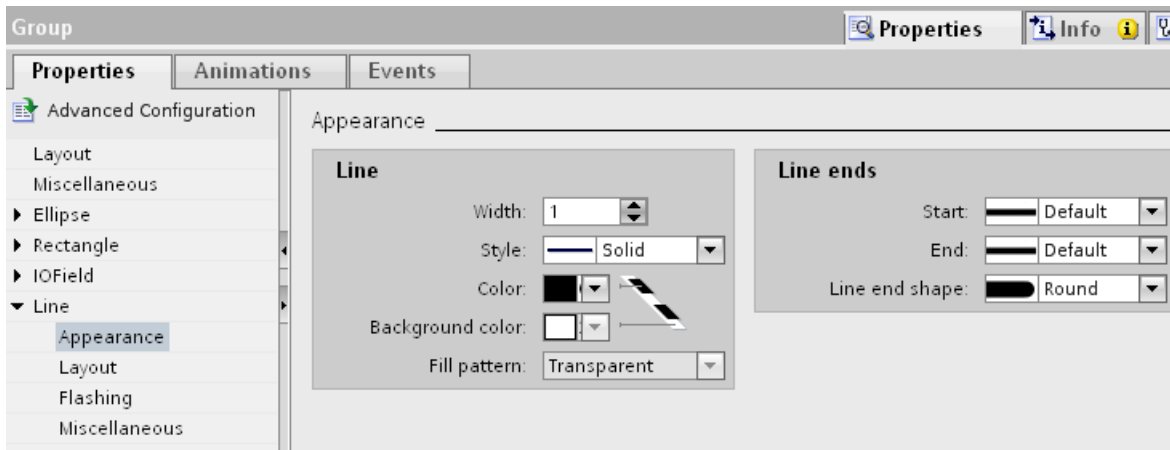

The properties of the object are displayed.

3. Change the object properties.

## Result

Although you have edited the object, it is still an element of the group. These changes do not affect the other objects of the group.

## See also

Example: Configuring a rectangle (Page 2988)

### 10.1.2.23 Configuring the keyboard access

## Overview of keyboard access

### Introduction

For keyboard units without a mouse, the operator activates control objects using the <Tab> key. You can set up keyboard input to make the process easier to run, and to make sure that the operator enters all the necessary values. If you are using the keyboard, use the <Tab> key to activate the objects in a certain order, and to enter the necessary values.

For HMI devices without key, you can simulate the <Tab> key by configuring the "SimulateSystemKey" system function to a function key.

## Operator authorizations and operator control enables

If you configure an object for operator input with the <Tab> key, the object must have both an operator authorization, and an operator control enable.

## Editing the tab sequence

The tab sequence is determined automatically when the control objects are created. The numbers of the tab sequence are assigned in the sequence in which the libraries are created.

It makes sense to change the tab sequence in the following cases:

- The operator changes directly to a specific control object.
- The screen requires a specific sequence

Change to the tab sequence mode to change the tab sequence. In this mode, the tab sequence number is displayed at the top left of the control objects. The tab sequence numbers of hidden objects are also shown. The distribution of these numbers is edited using the mouse.

---

### Note

Other functions are not available in the tab sequence mode.

---

## See also

Example: Configuring a rectangle (Page 2988)

## Defining the Operator Authorization and Operator Control Enable for an Object

### Introduction

If you configure an object for operator input with the <Tab> key, the object must have both an operator authorization, and an operator control enable.

### Requirement

You have opened a screen which contains at least one object.

### Procedure

1. Select the object.
2. Select "Properties > Properties > Security" in the Inspector window.
3. Select the operator authorization under "Authorization."
4. Activate the authorization to operate.

## Result

The operator can use the <Tab> key in Runtime to select the object.

## See also

Example: Configuring a rectangle (Page 2988)

## Setting the tab sequence order

### Introduction

All operable objects can be reached in runtime with the <Tab> key. You use the "Tab sequence" command to define the order in which the operator can activate objects in runtime.

---

#### Note

You cannot reach objects with the "Output" or "Two states" mode in runtime with the <Tab> key.

---

You can operate the screen in runtime:

- Using the <Tab> key
- Using the mouse
- Using a configured hotkey

## Requirement

- The active screen contains operable objects.
- No object is selected.
- The objects have been enabled for use in runtime, and have operator authorization.

## Procedure

1. Select "Edit tab sequence" in the "Edit" menu.  
Tab sequence mode is activated. The tab sequence number is displayed for all objects that can be used. The tab sequence number is also displayed for hidden objects.
2. Use edit the tab sequence mode, click the accessible objects in the order in which you want them to be activated using <Tab> in runtime.  
The following figure shows how the tab sequence is defined in the screen. In runtime, the <Tab> key first activates the alarm view (number 1), then the I/O field (number 2), and then the button (number 3):

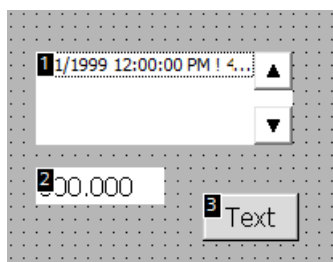

3. To exclude a screen object from the tab sequence, press the key combination <Shift+Ctrl> and click on the desired object.  
The tab sequence number is no longer displayed in the screen object. The screen object is now excluded from the tab sequence. The remaining tab sequence numbers are automatically decreased by 1.
4. To reenter an excluded screen object in the tab sequence, repeat step 3.  
The screen object entered as the first object in the tab sequence.

## Result

The operator selects the objects in the specified order in Runtime with the <Tab> key.

## See also

Example: Configuring a rectangle (Page 2988)

### 10.1.2.24 Examples

#### Example: Configuring a rectangle

## Task

In this example you configure a rectangle:

- Color = red
- Black frame 2 pixels wide
- Position = (20, 20)
- Size = (100,100)

## Changing the color of the rectangle

To change the color of the rectangle:

1. Select the rectangle.
2. Define the background color in "Properties > Properties > Appearance > Background > Color" in the Inspector window.
3. Select "Solid" as the fill pattern.
4. Define the color for the border in "Properties > Properties > Appearance > Border > Color" in the Inspector window.
5. Enter the value "2" for "width".
6. Select "Solid" as the "Style".

## Interim result

The rectangle is red and has a black frame with a width of two pixels.

## Repositioning and resizing the rectangle

To change the position and size of the rectangle:

1. Select the rectangle.
2. In the Inspector window, select "Properties > Properties > Layout".

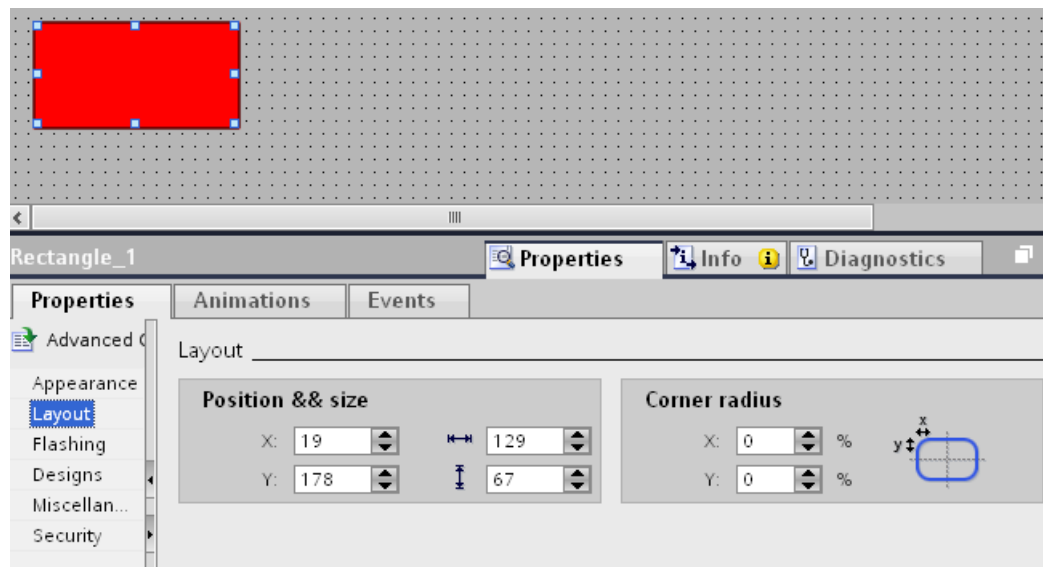

3. Set "20" for the both the X and Y coordinates under "Position & Size".
4. Set "100" for the height and for the width.

## Result

The rectangle is positioned at the coordinates (20, 20), and has a width and height of 100 pixels.

## See also

Overview of objects (Page 2950)

## Example: Inserting a rectangle

### Task

In this example, you insert and rename a rectangle. Do not use the special characters ?, ", /, \, \*, <, > for the name.

### Requirement

- A screen is open.
- The Inspector window is open.
- The "Tools" task card is open.

### Procedure

1. Click the "Basic objects" palette in the "Tools" task card.
2. Drag the "Rectangle" object into the screen.
3. In the Inspector window, select "Properties > Properties > Miscellaneous".
4. Type in the new name "MyRectangle".

### Result

The rectangle is now inserted and named "MyRectangle". The rectangle has the default properties of the "rectangle" object.

## Example: Inserting and configuring a rectangle

### Task

In this example, you insert a rectangle in a screen. You can configure the following properties:

- Name = "MyRectangle"
- Position = (20, 20)
- Size = (100,100)
- Color = red
- Black frame 2 pixels wide

## Principle

The rectangle is a closed object which can be filled with a color or pattern. The height and width of a rectangle can be adjusted to allow its horizontal and vertical alignment.

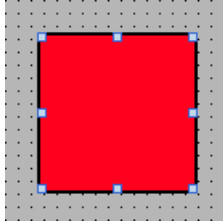

## Overview

Carry out the following steps in order to create a rectangle:

- Inserting a rectangle
- Configuring a rectangle

### 10.1.3 Working with text lists and graphics lists

#### 10.1.3.1 Working with text lists

##### Basics on text lists

##### Introduction

Texts are assigned to the values of a tag in a text list. Assign the text list to a symbolic I/O field for example in the configuration. This supplies the text to be displayed to the object. The text lists are created in the ""Text List" editor. You configure the interface between the text list and a tag at the object that uses the text list.

The selection of objects that can have a text list assigned depends on the Runtime.

##### Application

The text list is used, for example, to display a drop-down list in a symbolic I/O field.

## 10.1 Creating screens

If the symbolic I/O field is a display field, the associated texts will differ according to the value of the configured tags. If the symbolic I/O field is an input field, the configured tag assumes the associated value when the operator selects the corresponding text in Runtime.

---

### Note

#### Display of tag values without text

The display of tag values to which no text has been assigned depends on the Runtime:

- The display and operating object remains empty.
  - Three asterisks \*\*\* are displayed.
- 

## Multilingual texts

You can configure multiple languages for the texts in a text list. The texts will then be displayed in the set language in Runtime. To this purpose you set the languages in the Project window under "Language support > Project languages."

## Configuration steps

The following steps are necessary to display texts in a symbolic I/O field for example:

1. Creating the text list
2. Assignment of the texts to values or value ranges of a text list
3. Assignment of a text list in the display object, e.g. the symbolic I/O field

## See also

Screen basics (Page 2931)

## Creating a text list

### Introduction

The text list allows you to assign specific texts to values and to output these in Runtime, for example in a symbolic I/O field. The type of symbolic I/O field can be specified, for example as a pure input field.

The following types of list are available:

- Value/Range
- Bit
- Bit Number



## Procedure

1. Double-click "Text and graphics lists" in the project window.
2. Open the "Text lists" tab.

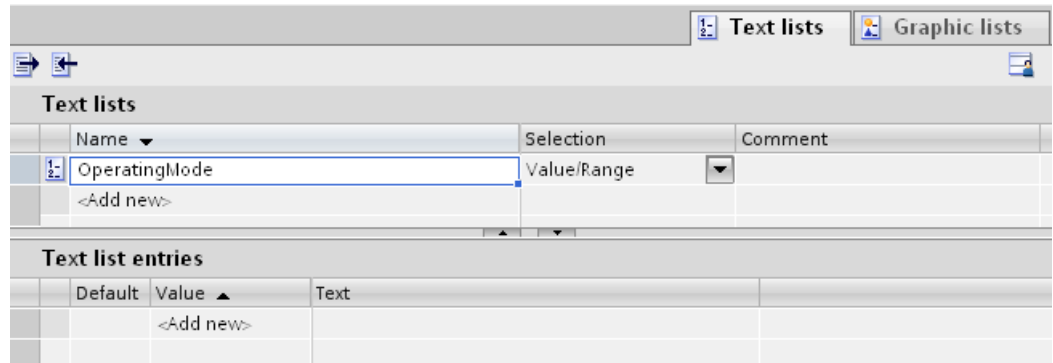

3. Click "Add" in the "Text lists" table.  
The Inspector window of the text list is open.
4. Assign a name to the text list that indicates its function.
5. Select the text list type under "Selection":
  - Value/Range: Text from the text list is displayed when the tag has a value that lies within the specified range.
  - Bit (0,1): A text from the text list is displayed when the tag has the value 0. A different text from the text list is displayed when the tag has the value 1.
  - Bit number (0-31): Text from the text list is displayed when the tag has the value of the assigned bit number.
6. Enter a comment for the text list.

---

### Note

You must not use semicolons in the texts in a text list. The semicolon is a control character and is automatically deleted from a text.

---

## Result

A text list is created.

## Assigning texts and values to a range text list

### Introduction

For each area text list you specify which texts are displayed at which value range.

## Requirement

- The "Text and graphics list" editor is open.
- The "Text lists" tab is open.
- An area text list has been created and selected.

## Procedure

1. Click "Add" in the "Text list entries" table.  
The Inspector window for this list entry opens.

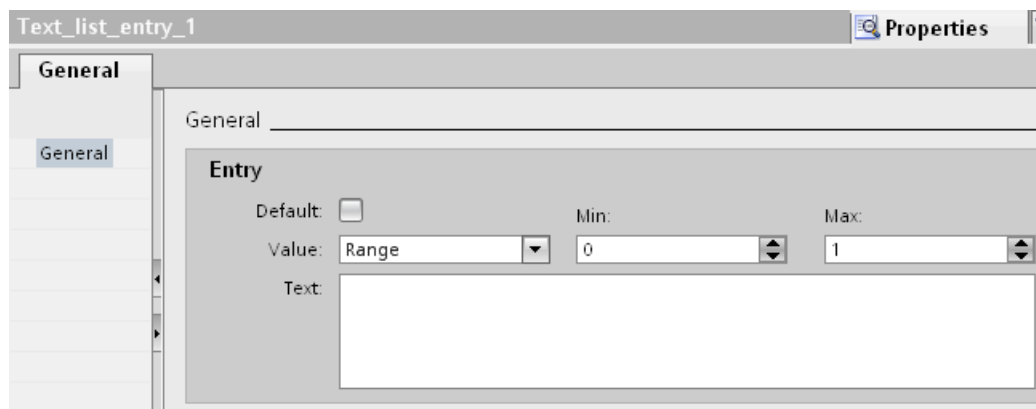

2. Select the setting "Range" in "Properties > Properties > General > Value" in the Inspector window.

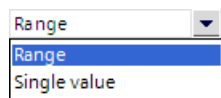

- Enter the value "1" for "Min" for example.
- Enter the value "20" for "Max" for example.
- For "Text", enter the text that is displayed in Runtime if the tag is within the specified value range.

---

### Note

Use a maximum of 255 characters and no semicolons for the text.

---

3. Click "Add" in the "Text list entries" table. A second list entry is created.

4. Select the setting "Range" in "Properties > Properties > General > Value" in the Inspector window.
  - Enter the value "21" for "Min" for example.
  - Enter the value "40" for "Max" for example.
  - For "Text", enter the text that is displayed in Runtime when the tag is within the specified value range.
5. If required, activate the "default entry".

The entered text is always displayed when the tag has an undefined value. Only one default entry is possible per list.

## Result

An area text list is created. Texts have been assigned to the possible value ranges.

## Assigning texts and values to a bit text list

### Introduction

For each text list, you specify which text is displayed at which bit value.

### Requirement

- The "Text and graphics list" editor is open.
- The "Text lists" tab is open.
- A bit text list has been created and selected.

## Procedure

1. Click "Add" in the "Text list entries" table.  
The Inspector window for this list entry opens.

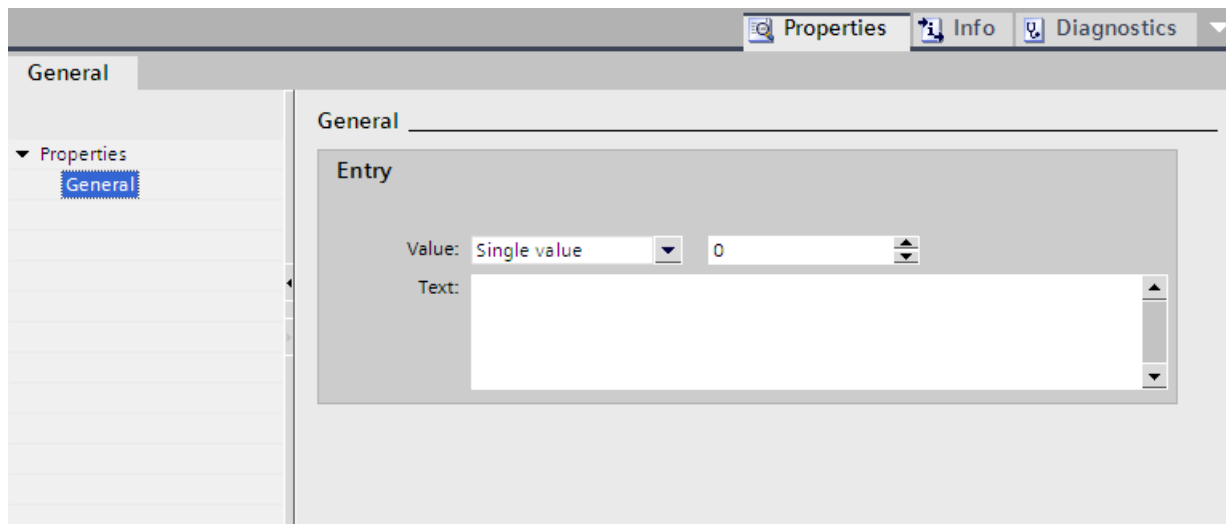

2. Select the setting "Single value" in "Properties > Properties > General > Value" in the Inspector window.
  - Enter "0" for "Value."
  - Enter the text which is displayed in Runtime under "Text" if the bit tag is set to "0".

---

### Note

Use a maximum of 255 characters and no semicolons for the text.

---

3. Click "Add" in the "Text list entries" table. A second list entry is created.
4. Select the setting "Single value" in "Properties > Properties > General > Value" in the Inspector window.
  - Enter "1" under "Value."
  - Enter the text which is to be displayed in Runtime under "Text" if the bit tag is set to "1".

## Result

A bit text list is created. Texts that appear in Runtime are assigned to the possible values "0" and "1".

## Assigning texts and values to a bit number text list

### Introduction

For each bit number text list you specify which texts are displayed at which bit number.

## Requirement

- The "Text and graphics list" editor is open.
- The "Text lists" tab is open.
- A bit number text list has been created and selected.

## Procedure

1. Click "Add" in the "Text list entries" table.  
The Inspector window for this list entry opens.

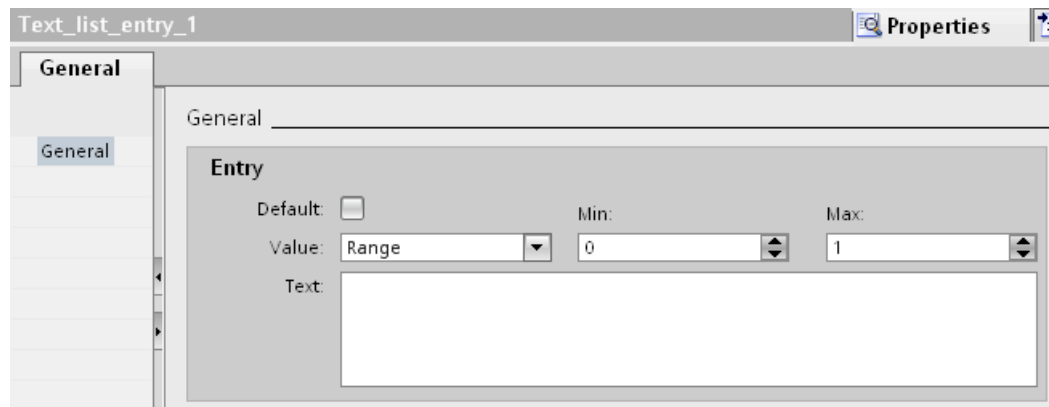

2. Select the setting "Single value" in "Properties > Properties > General > Value" in the Inspector window.
  - Enter "10", for example, for "Value".
  - Under "Text", enter the text that is displayed in Runtime when the tag has the value "10".

---

### Note

Use a maximum of 255 characters and no semicolons for the text.

---

3. If required, activate the "default entry".  
The entered text is always displayed when the tag has an undefined value. Only one default entry is possible per list.
4. Create further list entries for additional bit numbers of the same text list.

## Result

A bit number text list is created. Texts that appear in Runtime are assigned to the specified bit numbers.

## Configuring objects with a text list

### Introduction

The output value and value application for text lists are specified in the display and operating object that displays the texts of the text list in Runtime. The properties of these objects are configured as required.

### Requirement

- A text list is created.
- You have created a tag.
- The "Screens" editor is open.
- A screen with a symbolic I/O field is open. The object is edited.

### Procedure

1. Select the text list which you want to have displayed in Runtime in "Properties > Properties > General > Text list" in the Inspection window.
2. Select the setting "Output" as the "Mode".

#### Note

##### Runtime dependency

Different field types are available for a symbolic I/O field depending on the Runtime.

3. Select the tag the value of which determines the display in the symbolic I/O field as "Tag".

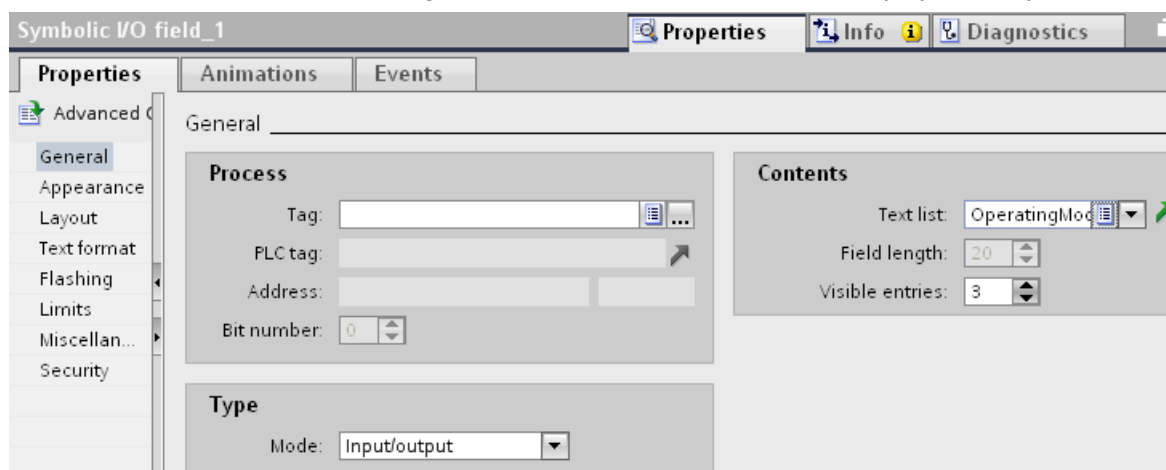

### Result

The defined texts of the text list are displayed in the symbolic I/O field in Runtime when the tag has the specified value.

### 10.1.3.2 Working with graphics lists

#### Basic principles of graphics lists

##### Introduction

The possible values of a tag are assigned to specific graphics in a graphics list. During configuration, you can create a graphics list for a button or a graphic I/O field. This supplies the graphics to be displayed to the object.

The graphics lists are created with the "Text and graphics list" editor. You configure the interface between the graphics list and a tag at the object that uses the graphics list. The availability of the graphics list is determined by the HMI device used.

##### Application

You can configure the graphics list for the following situations:

- Drop-down list with a graphic I/O field
- State-specific graphic for a button

The graphics in a graphics list can be configured as multilingual. The graphics will then be displayed in the set language in runtime.

##### Graphic sources

Graphics can be added to the graphics list from the following sources:

- By selecting from a graphic browser
- By selecting an existing file  
You can use the following file types:  
\*.bmp, \*.ico, \*.emf, \*.wmf, \*.gif, \*.tiff, \*.png, \*.jpeg and \*.jpg.
- By creating a new file

##### Function

If the graphic I/O field is a display field, the associated graphics will differ according to the value of the configured tags. If the graphic I/O field is an input field, the configured tag assumes the associated value when the operator selects a graphic in runtime.

##### Configuration steps

The following tasks are required to display graphics, for example, in a graphic I/O field:

1. Creating the graphics list
2. Assignment of the graphics to values or value ranges of a graphics list
3. Assigning a graphics list in the display object, for example the graphic I/O field

## See also

Screen basics (Page 2931)

## Creating a graphics list

### Introduction

The graphics list allows you to assign specific graphics to variable values and to output these in a graphic IO field in Runtime. You can specify the type of graphic I/O field, for example as a pure output field.

### Procedure

1. Double-click "Text and graphics lists" in the project window.
2. Open the "Graphics lists" tab.

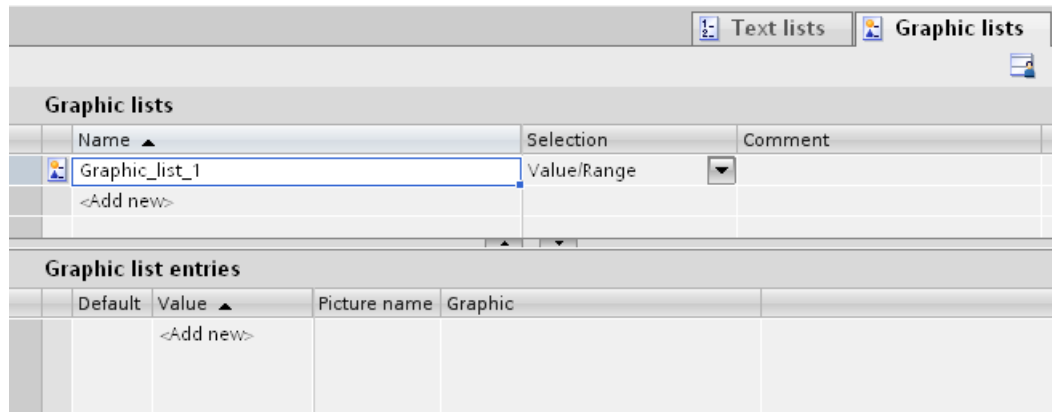

3. Click "Add" in the "Graphics lists" table. The Inspector window of the graphics list will open up.

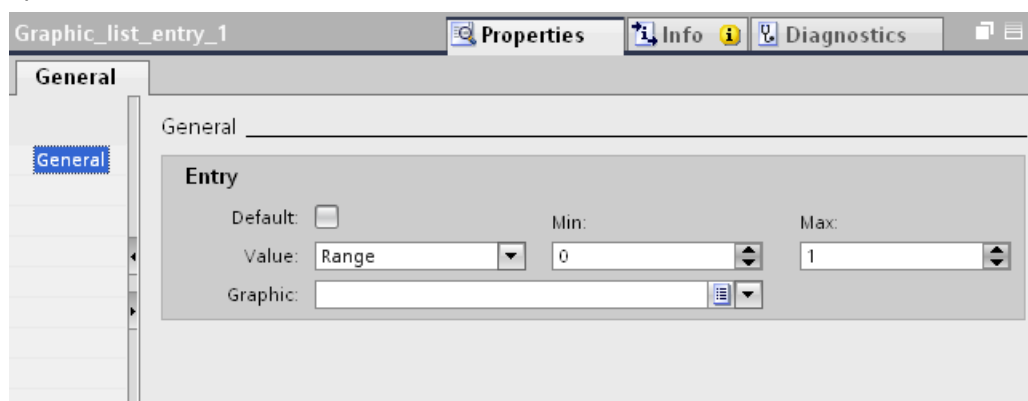

4. Assign a name to the graphics list that indicates its function.
5. Select the graphics list type "Bit number (0 - 31)" for example under "Select".
6. Enter a comment for the graphics list.



## Result

A graphics list of the type "Range (0 - 31)" is created.

## Assigning a graphic and values to a range graphics list

### Introduction

For each area graphics list you specify which graphics are displayed at which value range.

### Requirement

- The "Text and graphics list" editor is open.
- The "Graphics list" tab is open.
- An area graphics list has been created and selected.

## Procedure

1. Click "Add" in the "Graphics list entries" table.  
The Inspector window for this list entry opens.

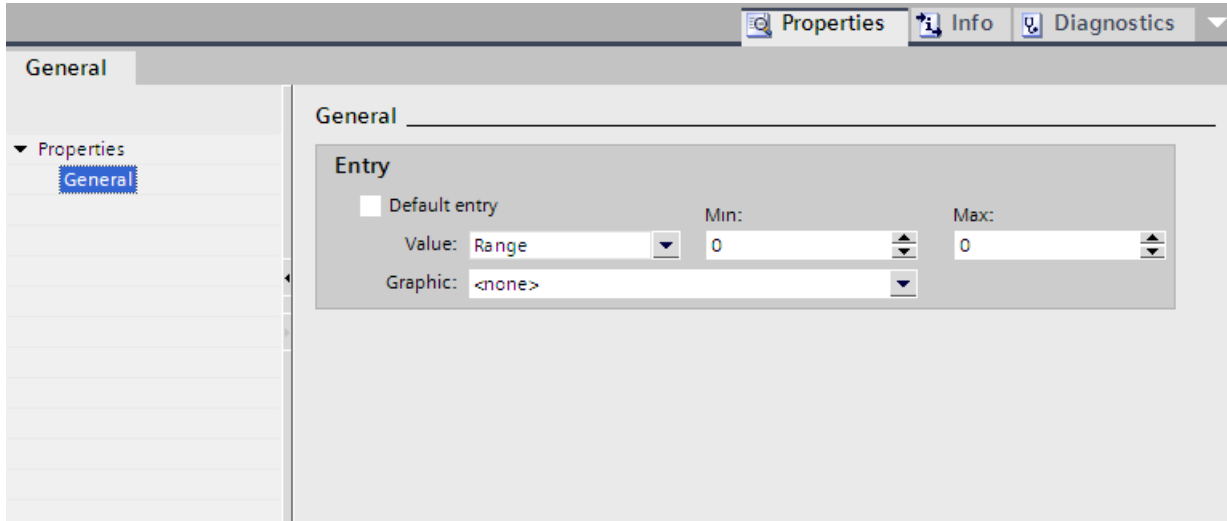

2. Select the settings "Range" in "Properties > Properties > General > Value" in the Inspector window:
  - Enter the value "1" for "Min" for example.
  - Enter the value "20" for "Max" for example.
  - Select a graphic that is displayed in Runtime when the tag is within the specified value range.



---

### Note

As an alternative to the drop-down menu, you can insert graphics from libraries or from your file system:

1. Select a graphic in the library or in your file system.
  2. Drag-and-drop the graphic into the "Graphics list entries > Graphic" table.
- 

3. Click "Add" in the "Graphics list entries" table. A further list entry is created.

4. Select the settings "Single value" in "Properties > Properties > General > Value" in the Inspector window:
  - Enter the value "21" for example.
  - Select a graphic which is displayed in Runtime if the bit "21" is set in the tag.



The screenshot shows a configuration window titled "Entry". It contains a checkbox labeled "Default entry" which is currently unchecked. Below the checkbox, there are two fields: "Value:" and "Graphic:". The "Value:" field has a dropdown menu set to "Single value" and a text input field containing the number "21". The "Graphic:" field has a dropdown menu set to "<none>".

5. If required, activate the "default entry".  
The graphic is always displayed when the tag has an undefined value. Only one default entry is possible per list.

## Result

An area graphics list is created. Graphics that appear in Runtime are assigned to the possible values.

## Assigning graphics and values to a bit graphics list

### Introduction

For each graphics list you specify which graphic is displayed at which bit value.

### Requirement

- The "Text and graphics list" editor is open.
- The "Graphics list" tab is opened.
- A bit graphics list has been created and selected.

## Procedure

1. Click "Add" in the "Graphics list entries" table.  
The Inspector window for this list entry opens.

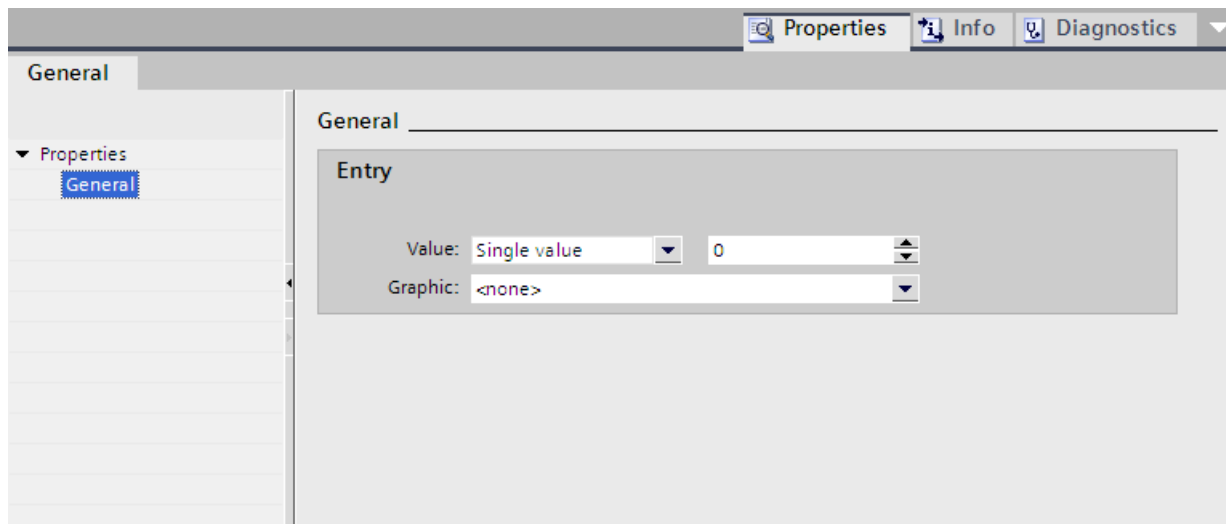

2. Select the settings "Single value" in the inspector window "Properties > Properties > General > Value":
  - Enter "0" as the value.
  - Select a graphic which is displayed in Runtime if the bit "0" is set in the tag.

---

### Note

As an alternative to the drop-down menu, you can insert graphics from libraries or from your file system:

1. Select a graphic in the library or in your file system.
  2. Drag-and-drop the graphic into the "Graphics list entries > Graphic" table.
- 

3. Click "Add" in the "Graphics list entries" table. A new list entry is created.
4. Select "Properties > Properties > General > Value > Single value": in the Inspector window.
  - Enter "1" as the value.
  - Select a graphic which is displayed in Runtime if the bit "1" is set in the tag.

## Result

A bit graphics list is created. Graphics that appear in Runtime are assigned to the values "0" and "1".

## Assigning graphics and values to a bit number graphics list

### Introduction

For each bit number graphics list you specify which graphics are displayed at which bit number.

## Requirement

- The "Text and graphics list" editor is open.
- The "Graphics list" tab is open.
- A bit number graphics list has been created and selected.

## Procedure

1. Click "Add" in the "Graphics list entries" table.  
The Inspector window for this list entry opens.

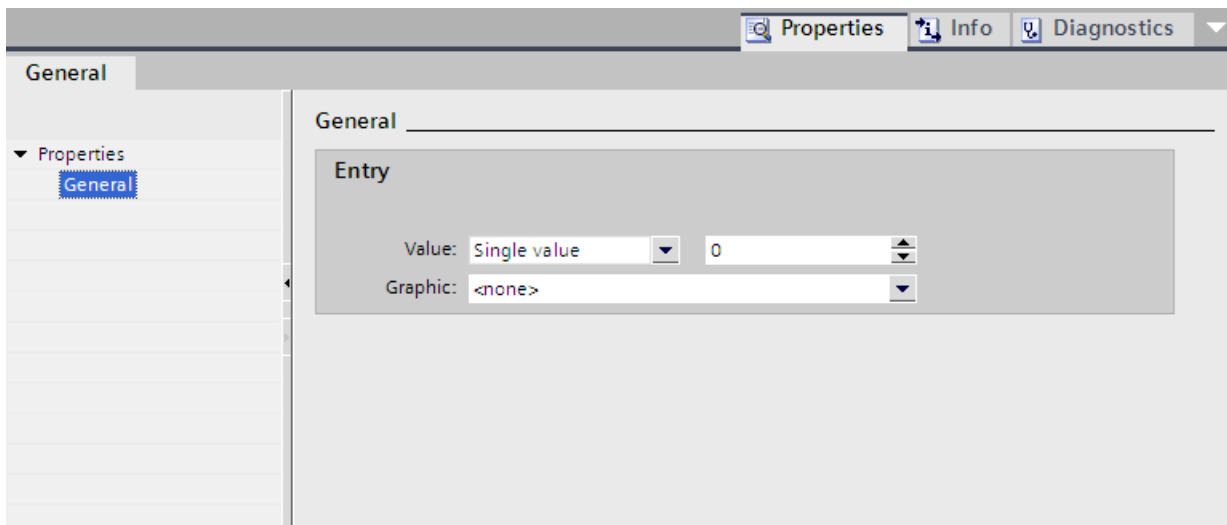

2. Select the settings "Single value" in "Properties > Properties > General > Value" in the Inspector window:
  - Enter the value "0" for example.
  - Select a graphic which is displayed in Runtime if the bit "0" is set in the tag.



### Note

As an alternative to the drop-down menu, you can insert graphics from libraries or from your file system:

1. Select a graphic in the library or in your file system.
2. Drag-and-drop the graphic into the "Graphics list entries > Graphic" table.

3. If required, activate the "default entry".  
The graphic is always displayed when the tag has an undefined value. Only one default entry is possible per list.
4. Create further list entries for additional bit numbers of the same graphics list.

## Result

A bit number graphics list is created. Graphics that appear in Runtime are assigned to the specified bit numbers.

## Configuring objects with a graphics list

### Introduction

The output value and value application for graphics list are specified in the display and operating object that displays the graphics of the graphics list in Runtime. The properties of these objects are configured as required.

### Requirement

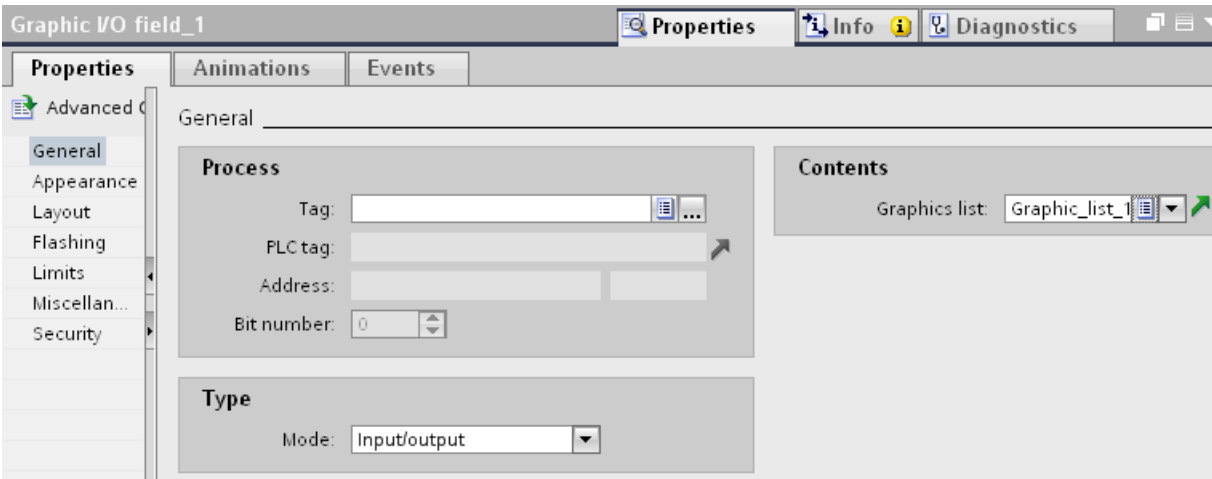

### Procedure

- 1.
- 2.

as the "Mode".

### Note

#### Runtime dependency

Different field types are available for a graphic I/O field depending on the Runtime.

3. As "Tag", select the tag whose values are defined by the display in the graphic I/O field.

## Result

The defined graphics of the graphics list are displayed in the graphic I/O field in Runtime when the tag has the specified value.

## 10.1.4 Dynamizing screens

### 10.1.4.1 Basics on dynamizing screens

#### Dynamizing objects

In WinCC you dynamize objects to map your system and show processes on HMI devices.

You implement dynamizations by

- Animations
- Tags
- System functions

One example is the mapping of a tank, the liquid level of which rises or falls in relation to a process value.

The options for dynamization depend on the object involved. When you copy an object, its dynamization functions are included.

#### See also

Basics on dynamizing screens (Page 3007)

Screen basics (Page 2931)

Basics on dynamization in the property list (Page 3024)

Basic on events (Page 3028)

Dynamization in the inspector window (Page 3010)

Dynamization in the inspector window (Page 3008)

### 10.1.4.2 Basics on dynamizing screens

#### Dynamizing objects

In WinCC you dynamize objects to map your system and show processes on HMI devices.

You implement dynamizations by

- Animations
- System functions
- Tags
- Local scripts

One example is the mapping of a tank, the liquid level of which rises or falls in relation to a process value.

## 10.1 Creating screens

The options for dynamization depend on the object involved. When you copy an object, its dynamization functions are included.

### See also

Basics on dynamizing screens (Page 3007)

### 10.1.4.3 Dynamization in the inspector window

#### Introduction

Basically, you can dynamize all the screen objects which you have configured in a screen. Which dynamization possibilities and which events are available depends on the device and the selected object.

#### Animations

WinCC helps you to implement dynamization using predefined animations. If you want to animate an object, first configure the desired animation in the object's inspector window. Then adapt the animation to the requirements of your project.

The selection of the supported animations depends on the HMI device and the selected object. You choose between the following types of animation:

- Layout: Appearance, visibility
- Movements: direct, diagonal, horizontal and vertical movement
- Variable binding

You can configure the "Variable binding" type of animation several times for one object.

You configure animations in the "Properties > Animations" inspector window.



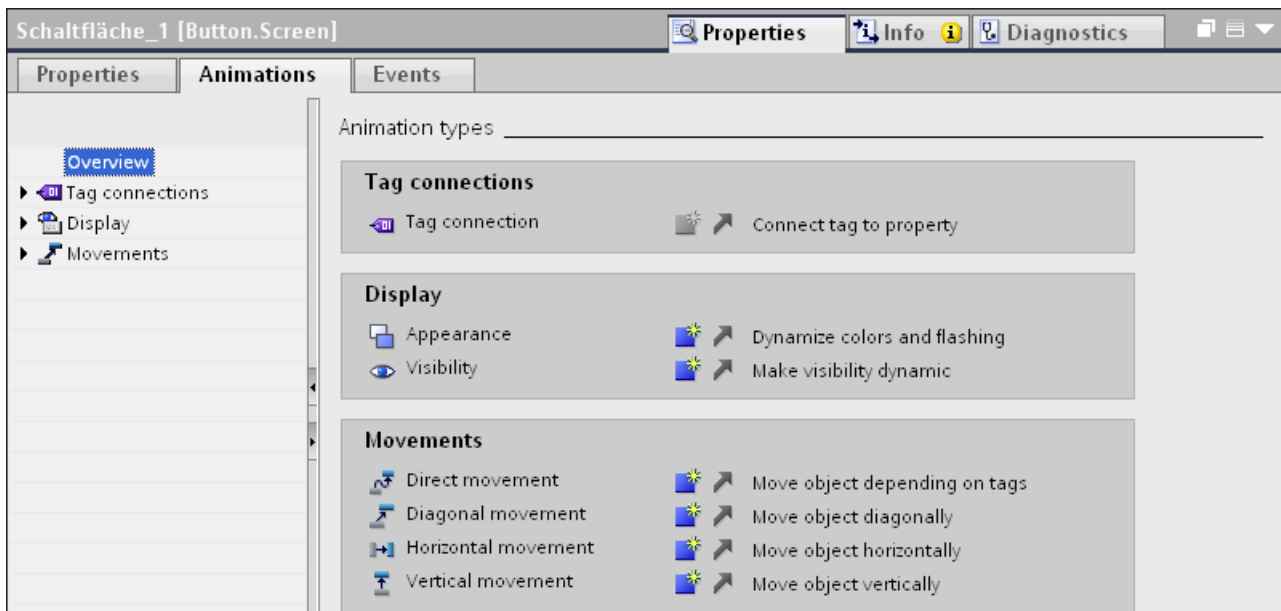

## Events

Operable objects also react to events, such as a mouse click.

You configure a function list with system functions on an event. The system functions are processed as a reaction to the triggered event.

You configure events in the "Properties > Events" inspector window.

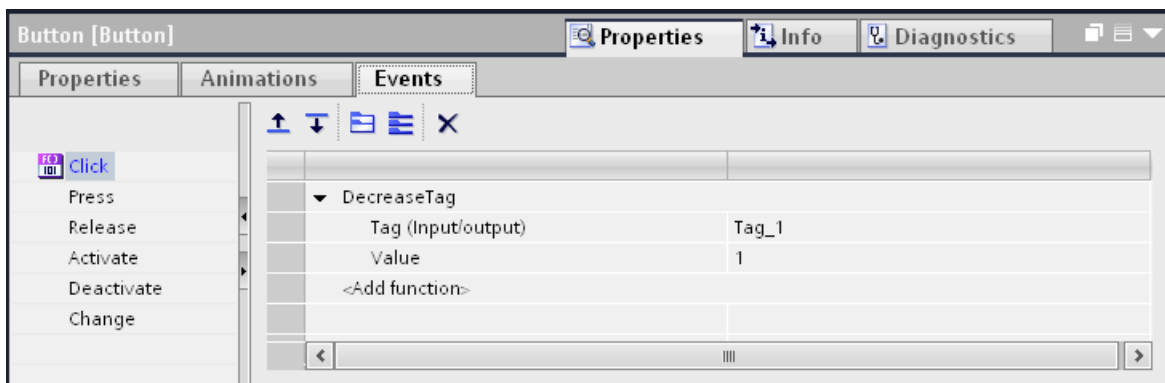

You will find further information in "Working with function lists".

## See also

Basics on dynamizing screens (Page 3007)

### 10.1.4.4 Dynamization in the inspector window

#### Introduction

Basically, you can dynamize all the screen objects which you have configured in a screen. Which dynamization possibilities and which events are available depends on the device and the selected object.

The inspector window offers you the possibilities for dynamization of screen objects in three tabs.

#### Property list

With the  button you go to the properties list in the "Properties > Properties" inspector window.

In the property list, you set any dynamization for the individual object properties using tags or local C and VB scripts. You can, for example, dynamically change the background color of an object.



In the "Dynamic Value" column you can dynamize the object property of a tag, a C-script or a VB-script.

Whether an object property can be dynamized is indicated in the Property list by means of the background color:

- Light gray: Can be dynamized
- Dark gray: Cannot be dynamized

Any animations you have already configured will also appear in the object property list, where you can edit the animations.

The following table shows you how to sort the property list:

	Sort by alphabet
	Sort by category

With the  button you return to the property pages in the inspector window.

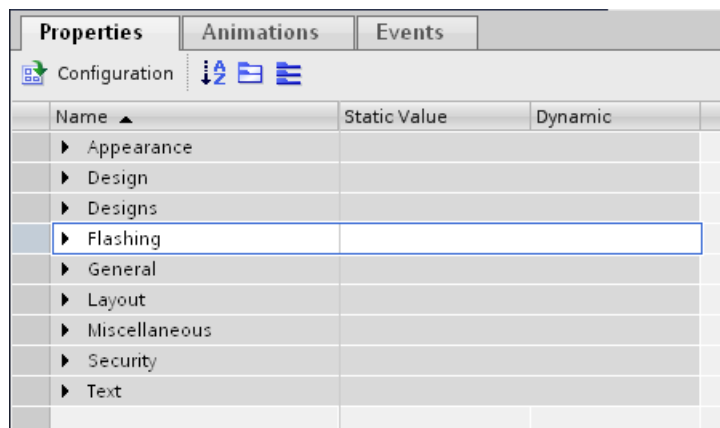

## Animations

You have two different options for animating objects.

You configure animations

- in the inspector window under "Properties > Animations",
- in the "Animations" task card.

WinCC helps you to implement dynamization using predefined animations. If you want to animate an object, first configure the desired animation with the tools of the toolbox or in the object's inspector window. Then customize the animation in the Inspector window to suit the requirements of your project.

The selection of the supported animations depends on the device and the selected object. You choose between the following types of animation:

- Tag binding
- Layout: Appearance, control enable, visibility
- Movements: direct, diagonal, horizontal and vertical movement
- Property animation

---

### Note

#### HMI device dependency

The "Control enable" animation is not available for every HMI device.

---

You can configure the "Tag binding" and "Property animation" types of animation several times for one object.

You configure animations in the "Properties > Animations" inspector window.

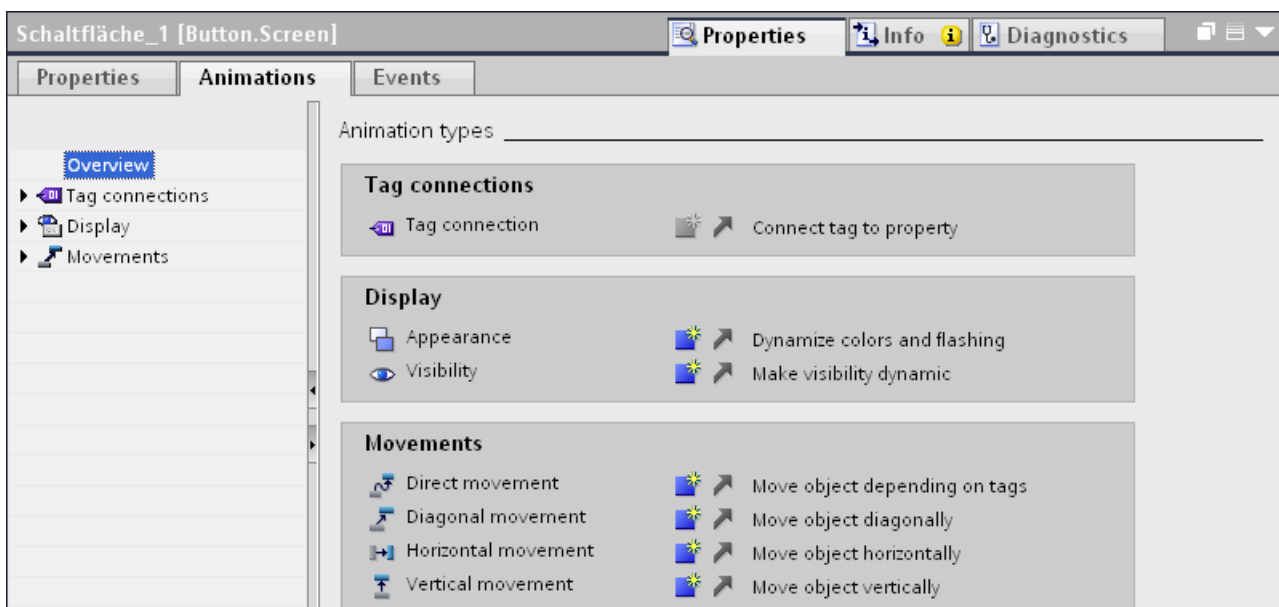

## Events

Operator control enabled objects also react to events, such as a mouse click.

You configure a function list with system functions or local scripts on an event. The system functions or the local script are processed as a reaction to the triggered event.

You configure events in the "Properties > Events" inspector window.

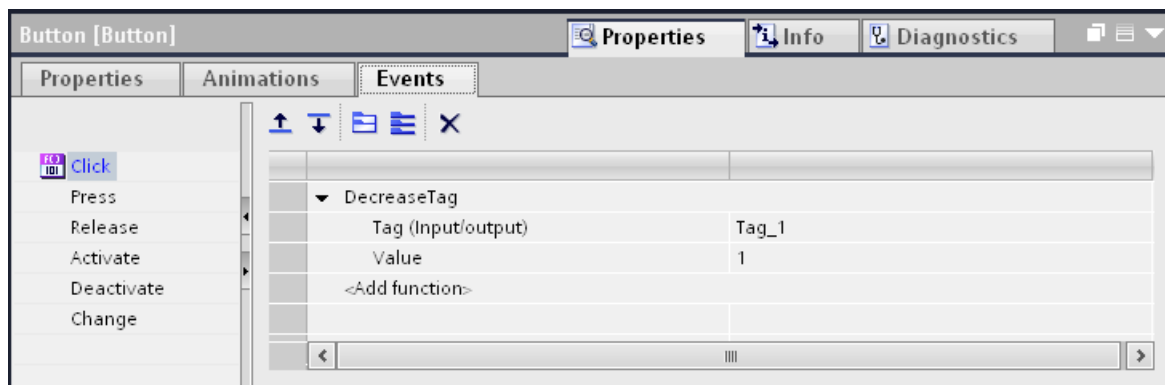

You will find further information in "Working with function lists".

## See also

Basics on dynamizing screens (Page 3007)

### 10.1.4.5 Dynamization with animations

#### Configuring a new animation

##### Introduction

Use predefined animations to dynamize screen objects.

##### Requirement

- You have opened a screen which contains at least one dynamic object.
- The Inspector window is open.
- The toolbox window is displayed.

##### Procedure in the inspector window

1. In the Inspector window, select "Properties > Animations".
2. Select the animation you want to use.
3. Click the  button.

## Procedure in the "Animations" task card.

1. Open the object group containing the required animation in the "Animations" task card.
2. Drag the animation onto the object that you want to make dynamic.

Alternatively you select the object in the screen and double click the desired animation in the "Animation" task card.

## Result

The animation appears in the Inspector window of the object. You configure the animation in the following steps.

In the animations overview the green arrow indicates which animation is already configured. The configured animation opens in the inspector window when you click the green arrow.

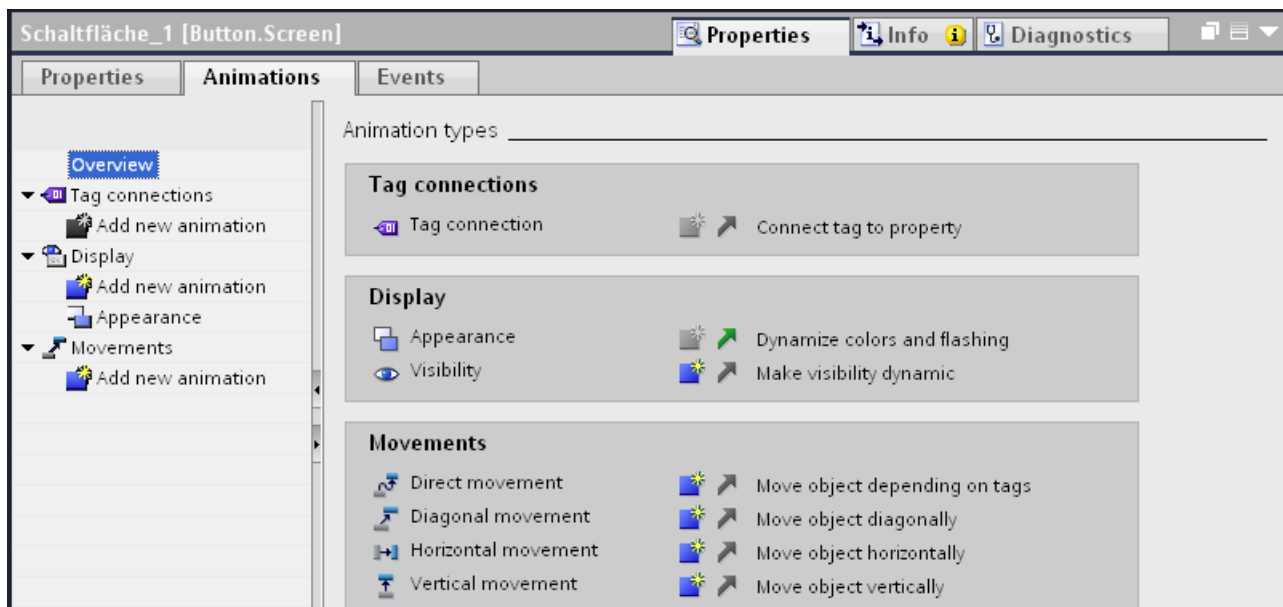

## See also

- Animations in multiple selection (Page 3023)
- Animations of object groups (Page 3023)
- Animations of object groups (Page 3022)
- Configuring animation with tag binding (Page 3020)
- Dynamizing the visibility of an object (Page 3019)
- Dynamization of the control enable state of an operating element (Page 3018)
- Configuring direct movement (Page 3017)
- Configuring movement (Page 3015)
- Dynamizing the appearance of an object (Page 3014)

## Dynamizing the appearance of an object

### Introduction

The appearance of a screen object is controlled by changing the value of a tag in runtime. When the tag adopts a certain value, the screen object changes its color or flashing characteristics according to the configuration.

### Type

Areas or single values of the tag are observed in Runtime depending on the selection. The appearance of the object changes according to the configuration.

### Requirement

- A screen is open.
- A dynamic object is contained and selected in the screen.
- The Inspector window is open.
- The toolbox window is displayed.

### Procedure

1. In the Inspector window, select "Properties > Animations".  
The animations available for the selected object are displayed.
2. Select the animation "Appearance" and click the  button.  
The parameters of the animation are displayed.
3. Select a tag in "Tag > Name".
4. Select "Type > Range" for example.
5. Click "Add" in the table.
6. Enter the tag interval "0 - 20" in the "Range" column for example.
7. For "Foreground color" and "Background color", select the color the object is to acquire in Runtime when the tag reaches the interval.

8. Select a flashing mode for the object from the "Flashing" list.
9. Repeat steps 5 to 8 to create another tag interval, e.g. "21 - 60".

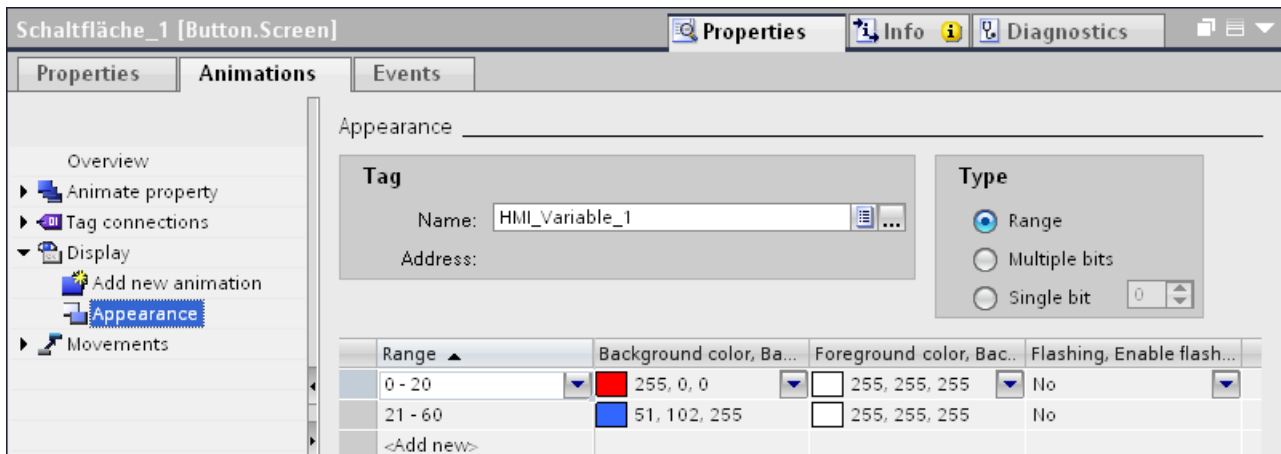

## Result

In Runtime, the flashing response, and color of the object change dynamically according to the process value returned in the tag.

## See also

Configuring a new animation (Page 3012)

## Configuring movement

### Introduction

You can configure dynamic objects in such a way that they move on a certain track. The movement is controlled via tags. The object moves every time the tag is updated.

You can only program one type of movement for each object.

### Requirement

- You have created a tag.
- You have opened a screen which contains at least one dynamic object.
- The Inspector window is open.
- The toolbox window is displayed.

## Procedure

1. Select the screen object you want to control dynamically.  
The object properties are displayed in the Inspector window.
2. In the Inspector window, select "Properties > Animations".  
The animations available for the selected object are displayed.
3. Select "Horizontal movement" and click the  button.  
The parameters of the animation are displayed.  
A transparent copy of the object is shown in the work area, which is connected to the source object by means of an arrow.
4. Select a tag for control of movement.
5. Move the object copy to the relevant destination. The system automatically enters the pixel values of the final position in the Inspector window.
6. Customize the range of values for the tag as required.

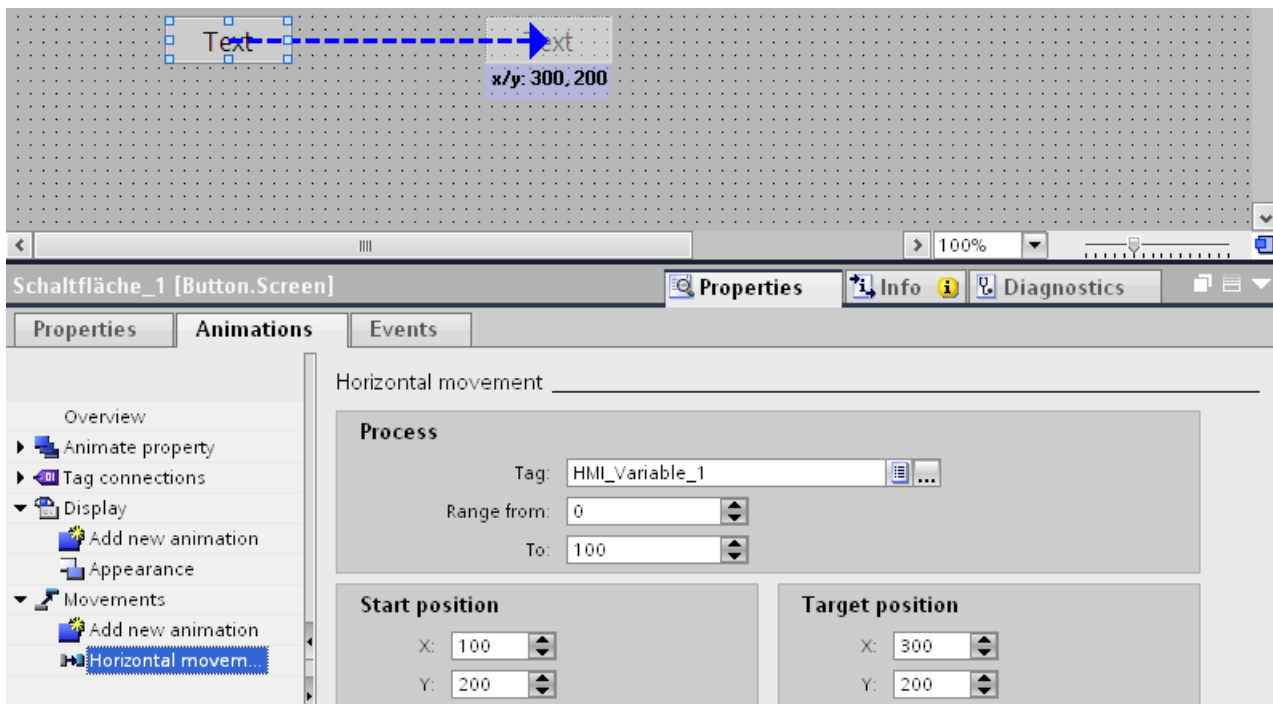

## Result

In Runtime, the object moves in response to every change in value of the tag that is used to control the movement. The direction of movement corresponds to the configured type of movement "horizontal".

---

### Note

You configure vertical and diagonal movements similar to horizontal movements

---



## See also

Configuring a new animation (Page 3012)

## Configuring direct movement

### Introduction

The object is moved respectively in x direction and y direction with "Direct movement". Two tags define the number of pixels by which the object moves from its original static start position.

### Requirement

- Two tags are set up.
- You have opened a screen which contains at least one dynamic object.
- The Inspector window is open.
- The toolbox window is displayed.

### Configuring "Direct movement"

1. Select the screen object you want to control dynamically.  
The object properties are displayed in the Inspector window.
2. In the Inspector window, select "Properties > Animations".
3. Select "Direct movement" and click the  button.  
The parameters of the animation are displayed.
4. Select a tag for the X position with which the movement in x direction is controlled.
5. Select a tag for the Y position with which the movement in y direction is controlled.

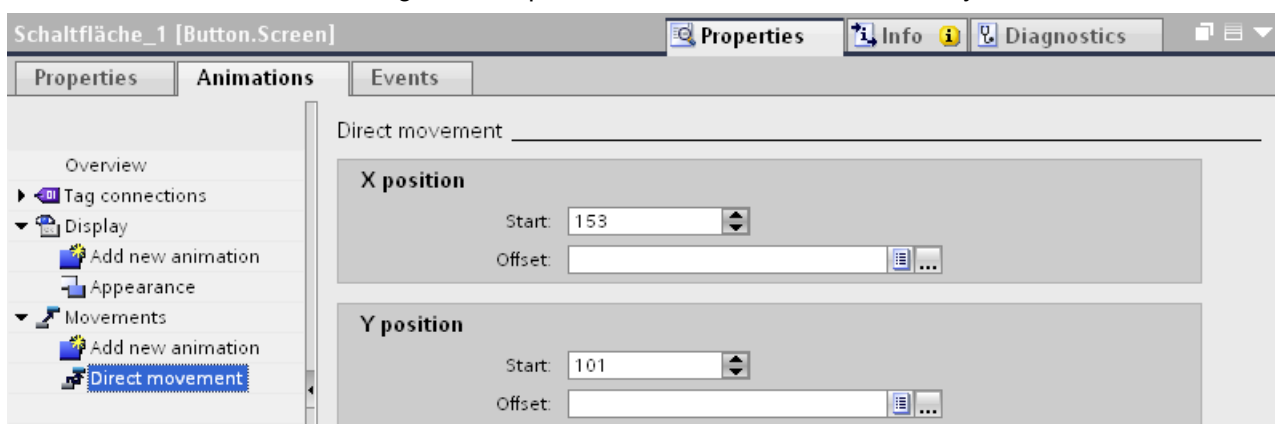

### Result

In Runtime, the object moves in response to every change in value of the tag that is used to control the movement.

## See also

Configuring a new animation (Page 3012)

## Dynamization of the control enable state of an operating element

### Introduction

You can dynamically change the usability of an operating element. The object either can, or cannot be used in Runtime, depending on the value of a tag.

You can use this dynamic control to restrict operator access to an operating element to specific situations, such as for maintenance.

### Requirement

- You have created a tag.
- A screen with an operating element is open.
- The Inspector window is open.
- The toolbox window is displayed.

### Procedure

1. Select the operating element in the screen that you want to control dynamically.  
The object properties are displayed in the Inspector window.
2. In the Inspector window, select "Properties > Animations".  
The animations available for the selected object are displayed.
3. Select "Control enable" and click the  button.  
The parameters of the animation are displayed.

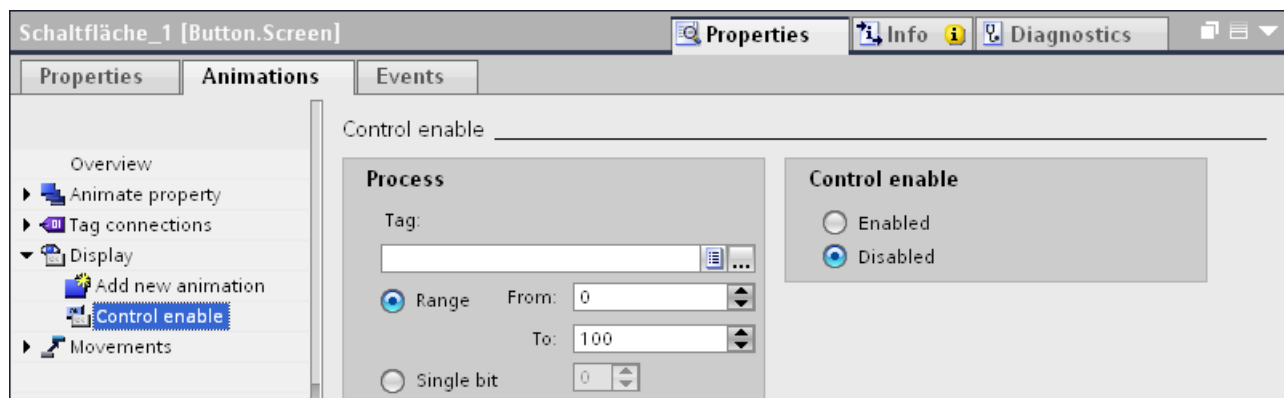

4. Select a tag.

5. Activate "Range".
  - For "From:" enter e.g. the value "0"
  - For "To:" enter e.g. the value "100"
6. Activate "Control enable > Activated".

## Result

The screen object is operator control enabled in Runtime depending on the tag value:

- The object becomes operator control enabled when the tag value is between 0 and 100.
- The object is not operator control enabled if the tag value is outside the range.

## See also

Configuring a new animation (Page 3012)

## Dynamizing the visibility of an object

### Introduction

Dynamization of the "Visibility" property allows you to output an alarm to your screen, which is triggered when the tag value exceeds a critical range, for example. The alarm is cleared when the tag value returns to the non-critical range.

The "Simple recipe view" and "Simple alarm view" objects are always visible.

### Requirement

- You have created a tag.
- You have opened a screen containing an object that you want to show or hide in Runtime.
- The Inspector window is open.

### Procedure

1. Select the screen object you want to control dynamically.  
The object properties are displayed in the Inspector window.
2. In the Inspector window, select "Properties > Animations".  
The animations available for the selected object are displayed.
3. Select "Visibility" and click the  button.  
The parameters of the animation are displayed.
4. Select a tag.
5. Activate "Range".

6. Select, for example, "from 20" and "to 40"
7. Activate "Visible".

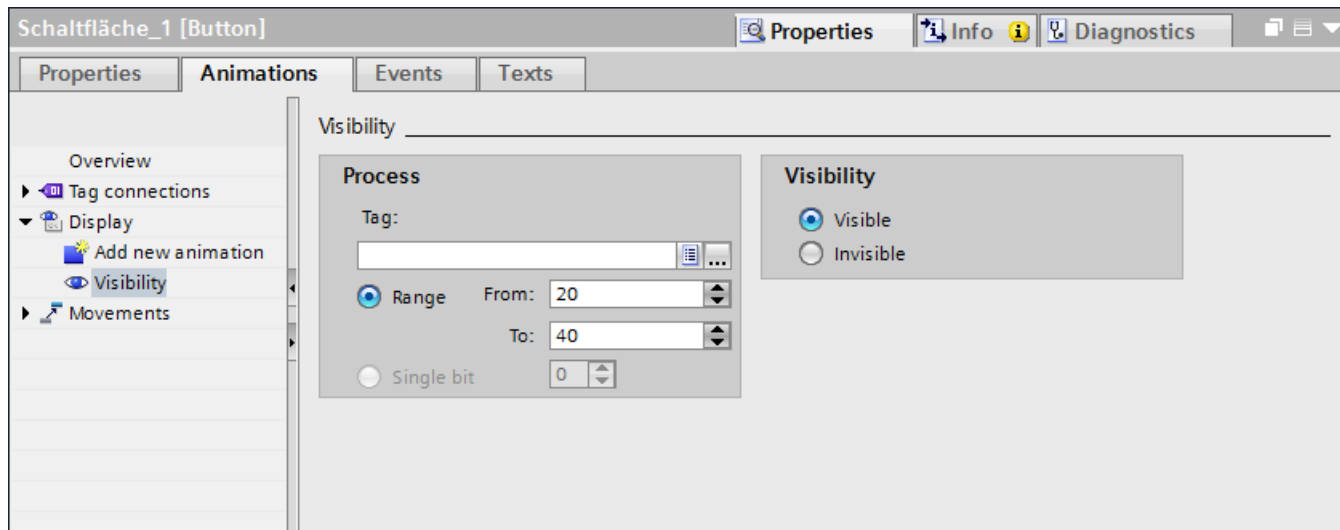

## Result

The screen object is shown or hidden in Runtime depending on the tag value.

- If the tag value matches the configured range between 20 and 40, the screen object is shown.
- If the tag value is outside the configured range, the screen object is hidden.

## See also

Configuring a new animation (Page 3012)

## Configuring animation with tag binding

### Introduction

When you object property an object property with a tag, the object property is changed in Runtime depending on the tag value.

The following example shows the tag binding in the "Properties > Animations" inspector window. If you have configured tag binding it is also visible in the property list or in the property pages in the inspector window.

### Requirement

- An object with the property to be dynamized is selected.
- You have created a tag.
- The Inspector window is open.

## Procedure

1. Select the screen object whose properties you want to control dynamically.  
The object properties are displayed in the Inspector window.
2. In the Inspector window, select "Properties > Animation".  
The animations available for the selected object are displayed.
3. Select "Tag connection" and click the  button.  
The parameters of the animation are displayed.
4. Select the object property that you want to dynamize in "Properties > Animation > Tag binding > Property > Name", e.g. "Background color".
5. Select a tag.

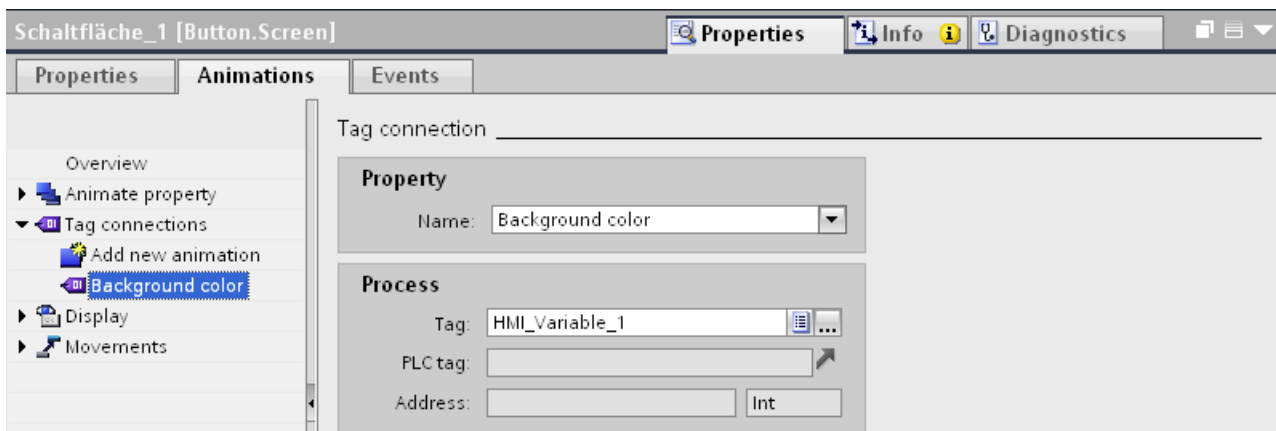

## Result

You have dynamized the "Background color" property with a tag. The background color of the screen object changes in Runtime depending on which value the tag adopts.

## See also

Configuring a new animation (Page 3012)

## Animations of object groups

### Applying animations to object groups

The inspector window shows all objects of a group and their possible animations. The animation types which are supported by all objects in the group are also listed separately.

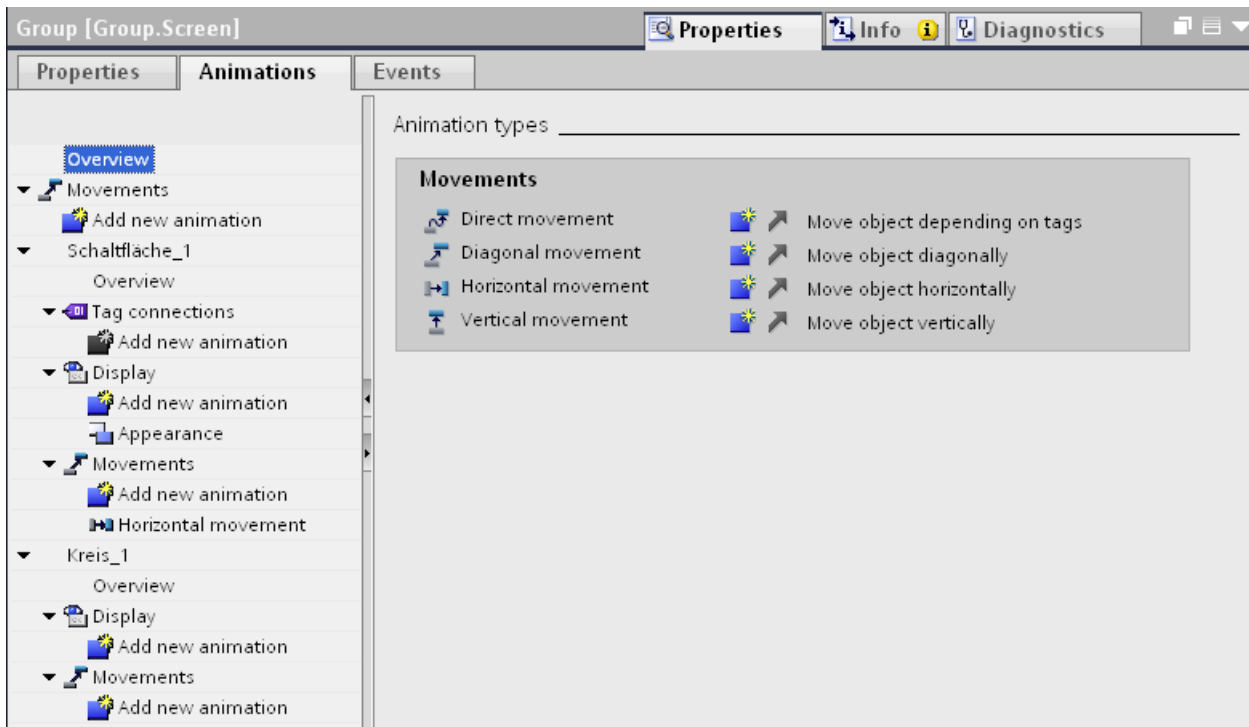

If you configure an animation for an object group, this animation will apply to all individual objects that support this animation.

### Application example

The "horizontal movement" animation is configured for the object of an object group. The "direct movement" animation is configured for the whole object group. Only the animation of the object group i.e. "direct movement" is executed in Runtime. This also applies for object groups within object groups. Only the animation of the group on the top layer is listed.

### See also

Configuring a new animation (Page 3012)

## Animations of object groups

### Changing animations of object groups

The inspector window shows all objects of a group and their possible animations. The animation types which are supported by all objects in the group are also listed separately.

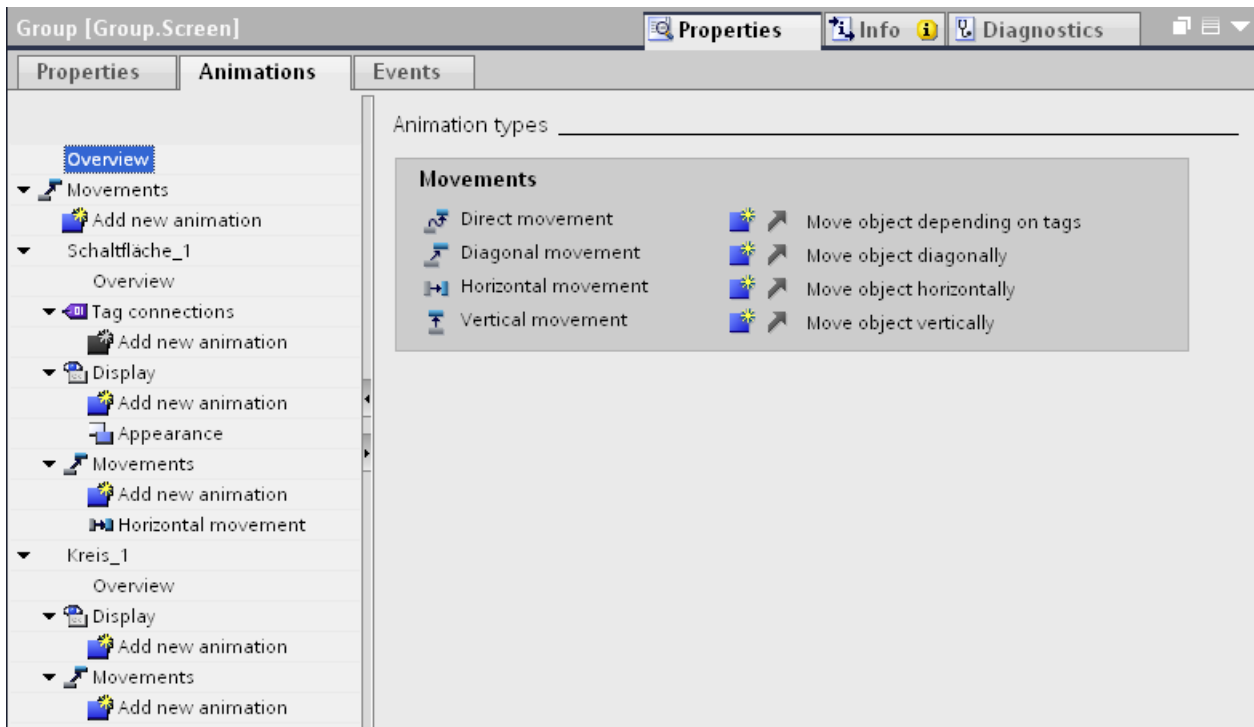

If you configure an animation for an object group, this animation will apply to all individual objects that support this animation.

### Application example

The "horizontal movement" animation is configured for the object of an object group. The "direct movement" animation is configured for the whole object group. Both animation types are executed in runtime. This also applies for object groups within object groups.

### See also

Configuring a new animation (Page 3012)

### Animations in multiple selection

### Changing animations for multiple objects

For a multiple selection, the animations that are configured for the reference object appear in the Inspector window. You can change the animations as usual. The changes will apply to all

## 10.1 Creating screens

the objects in the multiple selection that support the configured animation. This means that even objects for which you have not yet configured an animation will have the reference object's animation.

### Application example

Select a button, and a circle at the same time. The button is the reference object. The "Appearance" animation is already configured for the button, so it appears in the Inspector window of the multiple selection. When you activate "Properties > Animations > Appearance > Flashing" in the inspector window, the settings of the "Appearance" animation apply for the button and for the circle.

### Configuring new animations for multiple objects

If you configure a new animation for the objects of a multiple selection, this animation will apply to all selected objects that support the configured animation. If the new animation replaces an existing animation, a security prompt appears.

### Application example

You select a circle, and a rectangle. The "Diagonal movement" animation is already configured for the circle. You configure the "Horizontal movement" animation for the multiple selection. This animation applies to the rectangle since no animation of the Movement type is yet configured for it. For the circle, you are asked to confirm that you want to replace the existing "Diagonal movement" animation with the new "Horizontal movement" animation.

### See also

Configuring a new animation (Page 3012)

## 10.1.4.6 Dynamization in the property list

### Basics on dynamization in the property list

#### Basic principle of dynamization

Select a tag from the object list for a dynamizable object property in the property list. The object is dynamized if the tag value changes in Runtime.

#### Dynamization with tags

You dynamize an object property with a tag and configure a function list. The tags are updated in the update cycle set for the screen.

The figure below shows the "Radius" object property dynamized with a tag. When the value of the tag changes, a function list is executed additionally:



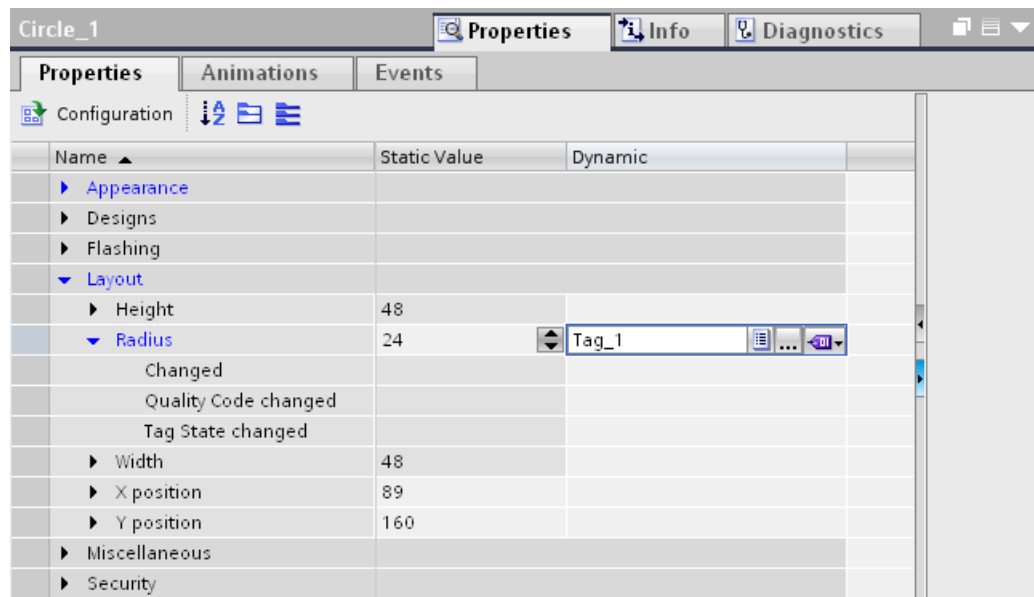

You can also convert the function list into a local script.

You can find additional information under "Basics on the function list (Page 3545)".

## See also

Basics on dynamizing screens (Page 3007)

Programming a dynamization method for a tag change (Page 3027)

Dynamizing an object property with a tag (Page 3025)

## Dynamizing an object property with a tag

### Introduction

When you dynamize an object property with a tag, the object property is changed in Runtime depending on the tag value. When you indirectly dynamize the object property, you connect the property to a tag that sets the property value in Runtime.

### Requirement

- An object with the property to be dynamized is selected.
- You have created a tag.
- The Inspector window is open.

**Procedure**

1. Select the screen object whose properties you want to control dynamically. The object properties are displayed in the Inspector window.
2. Click the  button in the Inspector window. The property list is displayed with the properties of the selected object.
3. Select the property to be dynamized.
4. In the "Dynamization" column, select the entry "HMI\_Tag". A dialog opens.
5. Select a tag.
6. Activate "Use indirect addressing" to dynamize the object property.

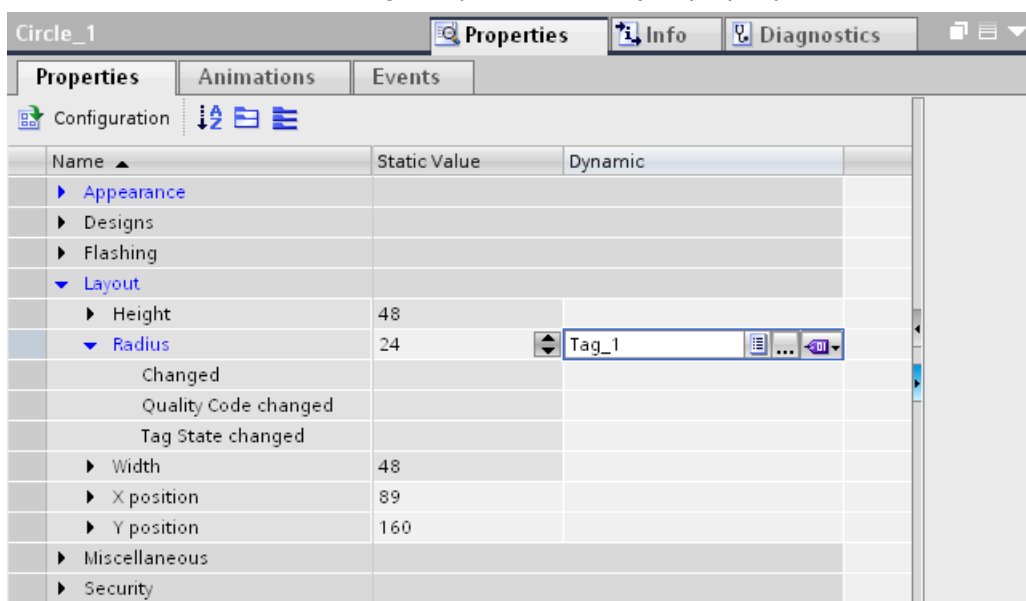

**Result**

The object property changes in Runtime according to how the property list is configured.

**Representation of a multiple selection in the property list**

If you selected multiple objects at the same time, the "Object type" column is added to the property list. The objects that support the property displayed in the row are displayed in this column. Changes to, or dynamization applied to a property affect all the objects displayed in the "Object type" column.

**See also**

Basics on dynamization in the property list (Page 3024)

## Programming a dynamization method for a tag change

### Introduction

If you have entered a tag in the "Dynamization" column, you can configure a function list additionally on different events.

### Requirement

- An object with the property to be dynamized is selected.
- You have created a tag.
- The property list is open in the inspector window.
- An object property is connected with the tag.

### Procedure

1. Extend the property list by clicking next to the property which you have dynamized with a tag.
2. Three other lines with the following events are displayed below the property.
  - Changed
  - Tag status changed
  - Quality code changed
3. Configure a function list for the required event.  
Alternatively you can convert the function list into a local script.

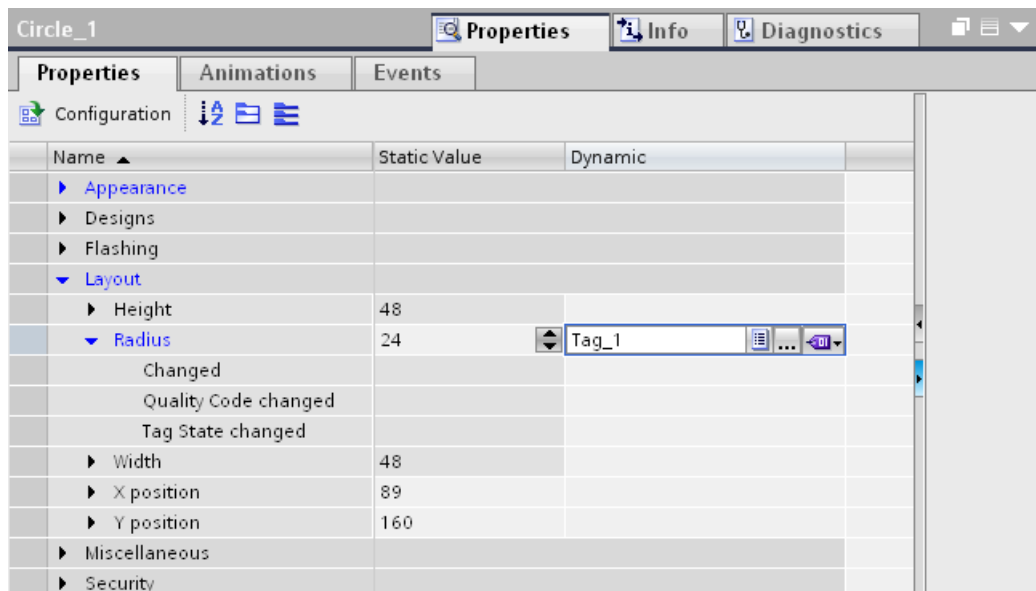

## Result

The object property changes in Runtime according to how the property list is configured.

## See also

Basics on dynamization in the property list (Page 3024)

### 10.1.4.7 Dynamize with system functions

## Basic on events

### Introduction

Screen objects react to events. You configure a function list with system functions on the events of an object.

### Events

Which events and system functions are available depends on the object used.

If the operator activates a screen object for example, the configured system function is executed.

You can find additional information under "Basics on the function list (Page 3545)".

## See also

Basics on dynamizing screens (Page 3007)

Example: Configuring a button for language switching (Page 3029)

Configure system function on the "Click" event (Page 3028)

### Configure system function on the "Click" event

#### Introduction

You configure a function list on an object event. The linked system function is executed when the event occurs in runtime.

#### Requirements

A screen is open.

A button has been created in the screen.

The inspector window is open.

## Procedure

1. Select the button.
2. Click "Properties> Events" in the Inspector window.
3. Select the "Click" event.
4. Click "Add function" in the table.
5. Select the "ShowAlarmWindow" system function.

## Result

The alarm window opens in the screen if the operator clicks the button in runtime.

## See also

Basic on events (Page 3028)

## Example: Configuring a button for language switching

### Introduction

In this example, you configure a button that can be used to toggle between multiple runtime languages during runtime.

### Requirements

- You have completed the "Configuring a button in multiple languages" example.
- The "Screen\_1" screen is open.
- The button on the screen has been selected.

### Procedure

1. In the Inspector window, select "Properties > Events > Press".
2. Click on "Add function" in the table.
3. Select the "SetLanguage" system function and the "Switch" setting.

### Result

You have assigned the button the function "SetLanguage". Pressing the button during runtime will switch the runtime language. The runtime languages are switched in the order specified by the number sequence in the "Languages and fonts" editor.

## See also

Basic on events (Page 3028)

Button (Page 3130)

## 10.1.5 Working with function keys

### 10.1.5.1 Working with function keys

#### Introduction

The function key is a physical key on your HMI device and its functions can be configured. A function list can be configured for the events "Key pressed" and "Release key".

A function key can be assigned global or local functions.

---

#### Note

##### Availability for specific HMI devices

Function keys are not available on all HMI devices.

---

#### Global function keys

Global function keys always trigger the same action, regardless of the displayed screen.

Global function keys are configured in the "Global Screen" editor. The global assignment applies for all the screens of the set HMI device.

Global function keys reduce programming considerably, because there is no need to assign these global keys to each individual screen.

#### Local function keys in screens

Local function keys in screens can trigger a different action in each screen. This assignment applies only to the screen in which you have defined the function key.

Within a screen, a function key has only one function assignment, either a global or local one. The project planner specifies which assignment has priority.

---

#### Note

If a screen with local function keys is overlapped by an alarm view or an alarm window, then the function keys are still active in runtime. This may happen in particular on HMI devices with a small display.

---

## Local function keys in templates

Local functions keys that are assigned in templates are valid for all the screens based on this template. They can trigger a different action in every screen. Function keys for templates are assigned in the template of the "Screens" editor. Within a template, a function key has only one function assignment, either a global or local one. The project planner specifies which assignment has priority.

## Hotkey assignment

You can assign hotkeys, such as buttons, to control objects. The available hotkeys depend on the HMI device.

### Note





The function key has a local or global action assigned to it. If the function key also has a hotkey assigned to it, then the hotkey function will be executed in Runtime.





## Graphics

When a function key is placed directly next to the display, you can assign a graphic to it to make the function of the function key more clear.

## Display of assignment

Table 10-1 The following table shows which symbols display the assignment of the function keys:

Function key	Description
	Not assigned
	Global assignment
	Assigned locally in the template
	Local assignment
	Local assignment (local assignment of the template overwrites global assignment)

Function key	Description
	Local assignment (local assignment overwrites global assignment)
	Local assignment (local assignment overwrites local assignment of the template)
	Local assignment (local assignment overwrites local assignment of the template, which already overwrites global assignment)
	Assigning buttons with screen navigation

**Note**

**Basic Panels**

The "Screen Navigation" editor is not available for Basic Panels.

### 10.1.5.2 Assigning function keys globally

#### Introduction

You define the global assignment of a function key in the "Global Screen" editor. The global assignment applies to all screens of the set HMI device.

**Note**

**Availability for specific HMI devices**

Function keys are not available on all HMI devices.

#### Requirement

- You have opened the project.
- The Inspector window is open.



## Procedure

Proceed as follows to assign a screen-based function to a function key:

1. To open the "Global Screen" editor, double-click "Global Screen" in the "Screen management" group of the Project window.
2. Select the desired function key.  
The properties of the function key are shown in the Inspector window.

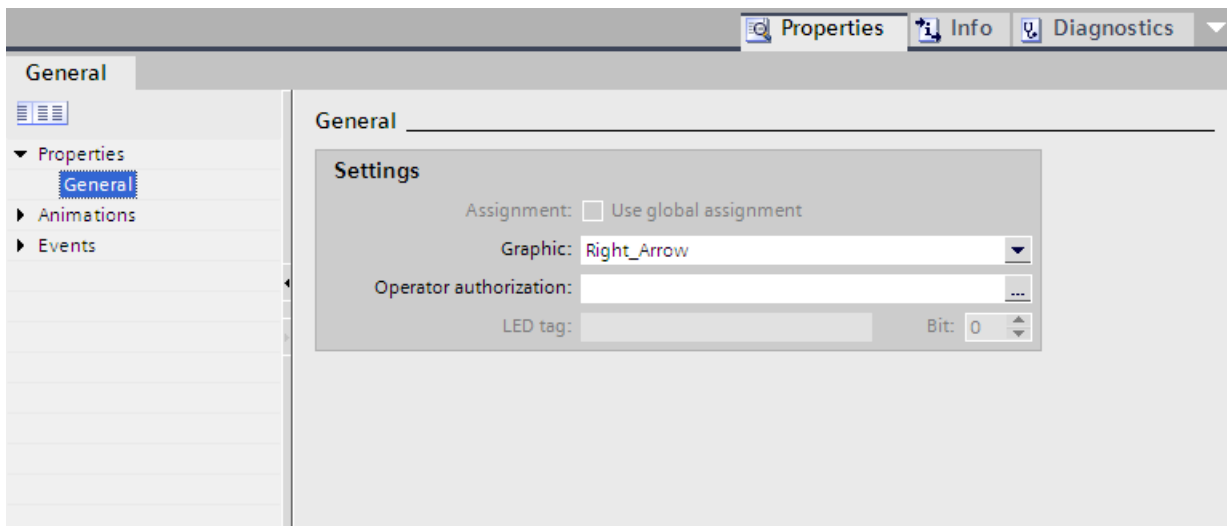

3. Under "General", configure a graphic and an operator authorization for the function key.
4. Configure a function list for the required event under "Events".

## Result

If a local assignment does not overwrite the global assignment, the assignment of the function key changes in all the screens of the set HMI device in accordance with your entry.

### 10.1.5.3 Local assignment of function keys

#### Introduction

Function keys are assigned globally and locally. A local assignment of the function keys is only valid for the screen or the template in which it was defined. The following local function keys are available:

- Local function keys of a screen  
Different functions are assigned to the function key for each screen. This assignment applies only to the screen in which you have defined the function key.
- Local function keys of a template  
You assign the function keys in a template. The assignment applies to all the screens that are based on this template and are not overwritten by a local assignment in a screen.

A local assignment overwrites the global assignment of a function key.

**Note**

**Availability for specific HMI devices**

Function keys are not available on all HMI devices.

**Using existing assignments**

The option for using existing assignments is referred to as follows in the Inspector window:

- In a template: "Use global assignment"
- In a screen:
  - Screen based on a template: "Use local template"
  - Screen not based on a template: "Use global assignment"

The "Use local template" option includes the use of the local assignment in the template and the global assignment.

**Requirement**

- You have opened the screen or the template in which you want to assign a function key locally.
- The Inspector window is open.

**Procedure**

Proceed as follows:

1. Select the desired function key in the screen or in the template.  
The properties of the function key are shown in the Inspector window.
2. Click "General" in the Inspector window.

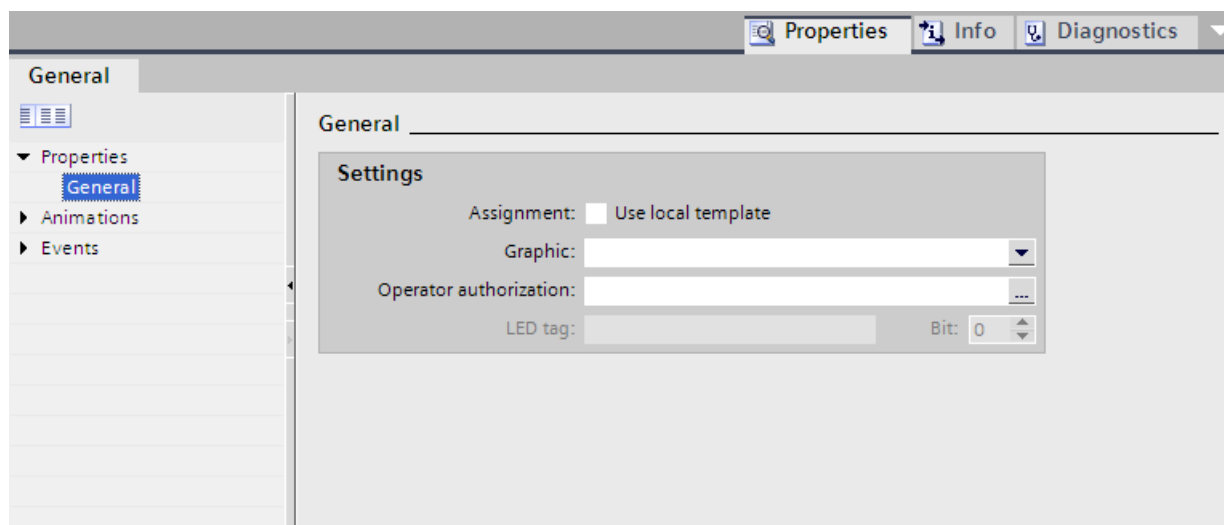

3. Disable the "Use local template" or "Use global assignment" option.
4. Under "General", configure a graphic and an operator authorization for the function key.
5. Configure a function list for the required event under "Events".

## Result

The function key is assigned the configured function in the screen or in the template.

### 10.1.5.4 Assigning a function key to a function

#### Introduction

A function key can have two states:

- Pressed: Defined by the "Key pressed" event.
- Released: Defined by the "Release key" event.

Both of these events are configured in the Inspector window of the function key. You can assign any event a function list which contains system functions or scripts. Execution of this function list is event-driven in runtime.

---

#### Note

##### Availability for specific HMI devices

Function keys are not available on all HMI devices.

---

#### Note

##### Basic Panels

Scripts are not available for Basic Panels.

---

#### Requirement

To assign the function key a global function:

- The "Global Screen" editor is open.

To assign the function key a local function:

- The screen in which you want to assign a function key is open.

If you want to assign a function key locally in a template:

- The template in which you want to assign a function key is open.
- The Inspector window is open.

## Procedure

Proceed as follows:

1. Select the function key you want to define.  
The properties of the function key are shown in the Inspector window.
2. Configure the function list for the desired result in the Inspector window under "Properties" in the "General" group.

## Result

The function list is executed in runtime when the operator presses or releases the function key.

### 10.1.5.5 Assigning operator authorization for a function key

#### Introduction

In WinCC you can assign an operator authorization for a function key in runtime. This allows you to restrict access to the function keys to specific persons or operator groups when you configure your project. Only authorized personnel can then change important parameters and settings in runtime.

You configure access protection in order to avoid operator errors and increase plant or machine security.

---

#### Note

##### Availability for specific HMI devices

Function keys are not available on all HMI devices.

---

#### Requirement

- The user groups have been defined.

To protect a global function key:

- The "Global Screen" editor is open.

If you want to protect a local function key of a screen or of a template:

- The screen or the template which contains the function key is open.
- The Inspector window is open.

## Procedure

Proceed as follows:

1. Select the relevant function key.  
The properties of the function key are shown in the Inspector window.
2. Click "General" in the Inspector window.

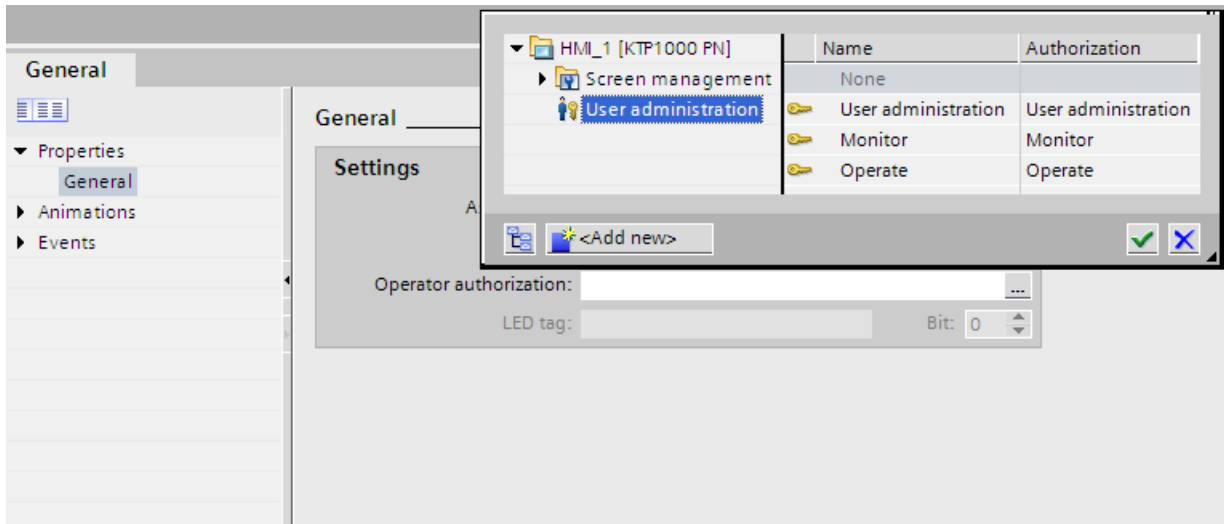

3. In the "Authorization" list, select the user group you want to allow runtime access to the function key.

## Result

The operator authorization is configured.

### 10.1.5.6 Assigning a function key to a graphic

#### Introduction

In order to make the function of a key more clear, you can insert a graphic in the screen alongside the function key. Graphics can only be assigned to function keys that border the screen margin of the HMI device.

#### Note

##### Availability for specific HMI devices

Function keys are not available on all HMI devices.

## Requirement

To assign a graphic to a global function key:

- The "Global Screen" editor is open.

If you want to assign a graphic to a local function key in a screen or template:

- The screen or the template that contains the corresponding function key is open.
- The Inspector window is open.
- You have created the graphic for the function key.

## Procedure

Proceed as follows:

1. Select the relevant function key.  
The properties of the function key are shown in the Inspector window.
2. Click "General" in the Inspector window.

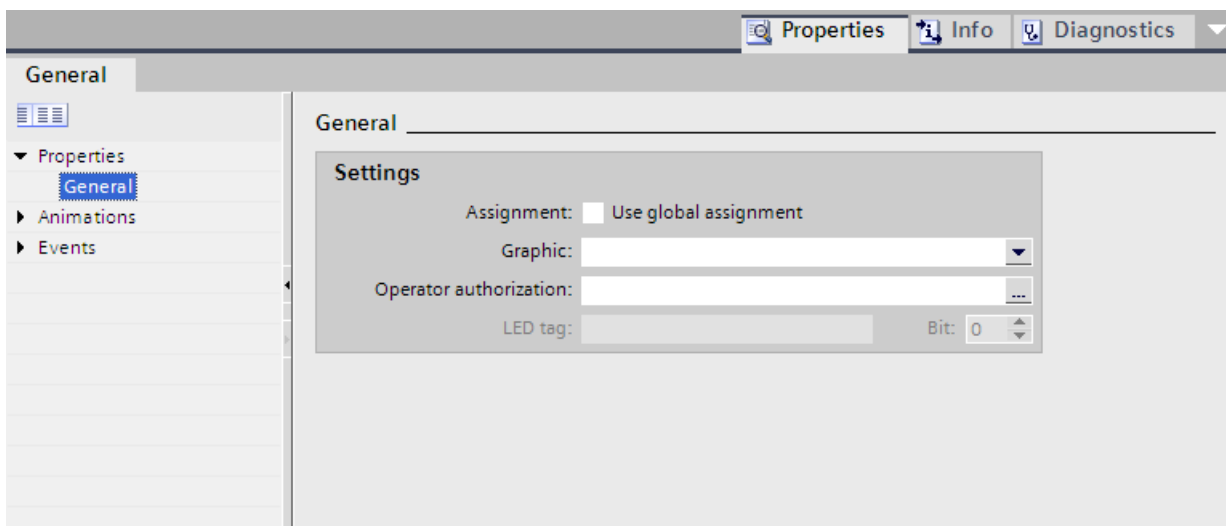

- Click in the "Graphic" area of the list.  
The graphic browser of your WinCC project appears. The pane on the left side shows the external graphics which are stored in the browser. The pane on the right side shows you a preview of the graphic you have selected in the browser.

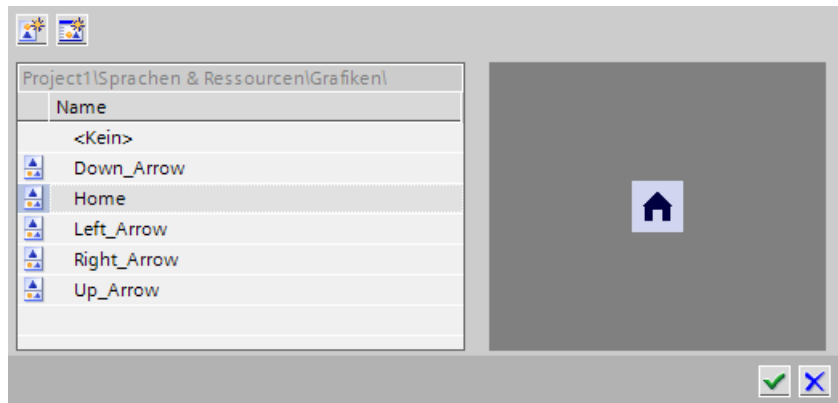

Using the  and  icons, you can display the collection either in form of thumbnails or as a list.

In order to open and edit OLE objects with the associated graphics program, double-click on the object.

- In the browser click the desired graphic or store the relevant graphic in the graphic browser. The graphic preview is shown in the right pane.
- Click "Select" to add the graphic to the screen.  
Click "Clear" to remove the graphic from the screen.

## Result

The graphic is displayed next to the function key.

### 10.1.5.7 Configuring LED tags

#### Requirements

- An HMI device with key operation has been created.
- You have created an LED tag.

#### Procedure

- Create a new screen.
- Click an F-key of the HMI device.

3. In the Inspector window, click "Properties > Properties > General".

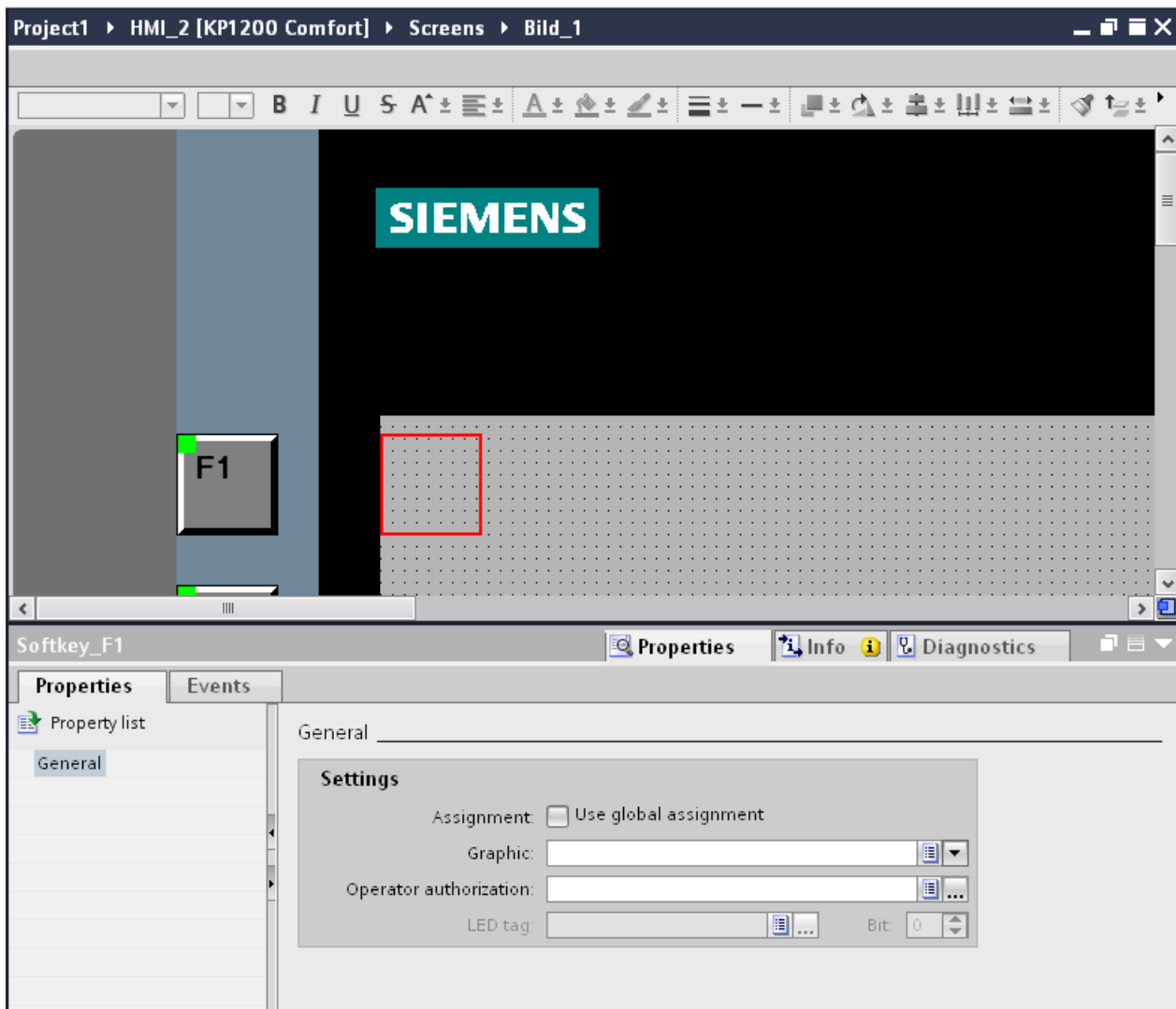

4. Select a tag under "LED tag" in the "General > Settings" area.

5. Under "Bit" enter the correct bit number.

The correct bit number depends on the HMI device and the input and output assignments on the HMI device.

### Assignment of inputs and outputs

The exact assignment of inputs and outputs can be found under:

- PROFINET IO direct keys: Auto-Hotspot
- PROFIBUS DP direct keys: Auto-Hotspot



### 10.1.5.8 Example: Using function keys for screen navigation

#### Task

In this example you create a local function key in a screen. When the operator presses this function key, a screen change to a predefined screen is triggered, for example "Boiler 2".

#### Note

##### Availability for specific HMI devices

Function keys are not available on all HMI devices.

#### Requirement

- The screen in which you want to assign the function key is open.
- You have created the "Boiler 2" screen.
- The Inspector window is open.

#### Procedure

Proceed as follows to use the "ActivateScreen" function:

1. Select the desired function key.  
The properties of the function key are shown in the Inspector window.
2. Click "General."
3. To overwrite a global assignment, disable the "Use local template" option.
4. Click "Key pressed" under "Events".

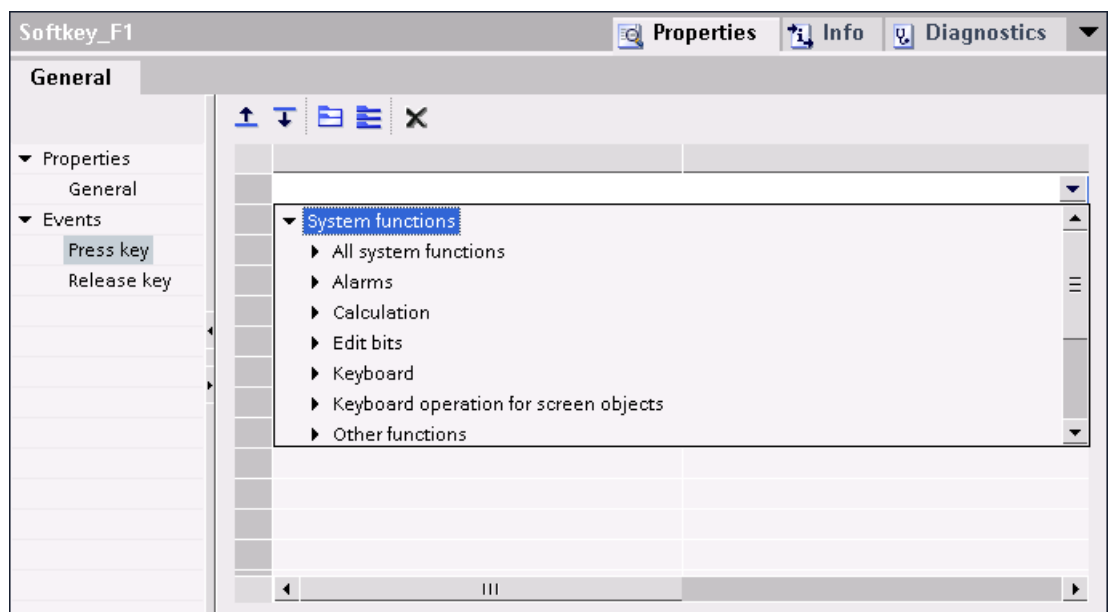

10.1 Creating screens

5. Select the "ActivateScreen" system function from the list.  
The "ActivateScreen" function appears in the "Function list" dialog box, including the "Screen name" and "Object number" parameters.

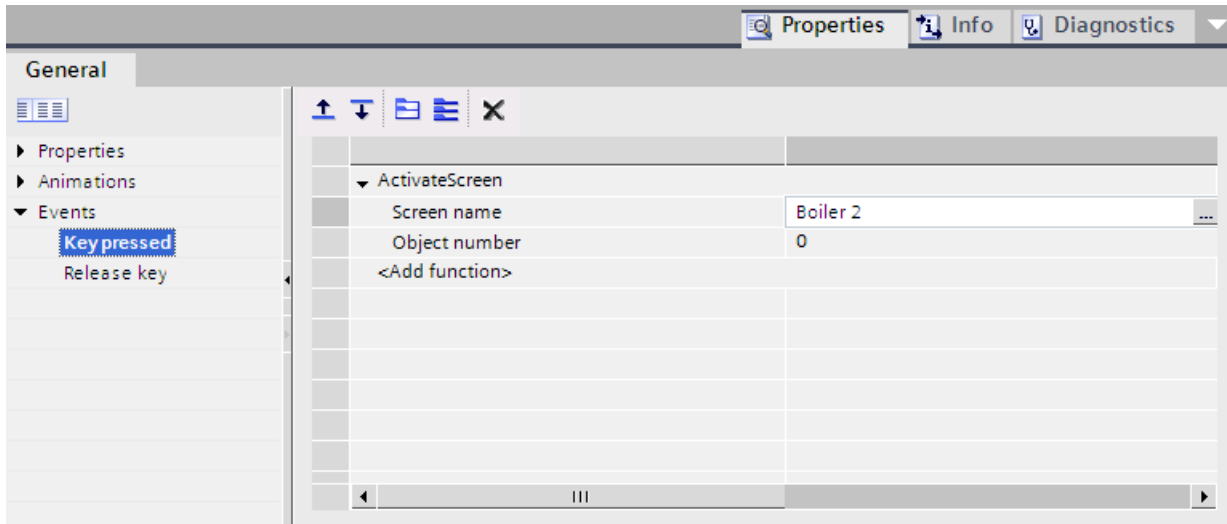

6. Select the "Boiler 2" screen from the "Screen name" list.

**Result**

The operator changes to the "Boiler 2" screen in runtime by pressing the selected function key.

**10.1.6 Working with layers**

**10.1.6.1 Basics on working with layers**

**Layers**

Use layers in order to achieve differentiated editing of the objects in a screen. A screen consists of 32 layers that you can give any names. If you assign objects to the layers, you thereby define

the screen depth. Objects of layer 0 are located at the screen background, while objects of layer 31 are located in the foreground.

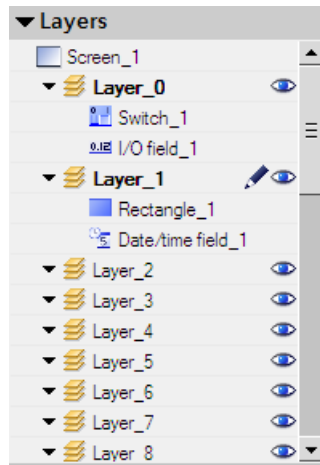

The objects of a single layer are also arranged hierarchically. When you create a screen, the object inserted first is located at the rear within the layer. Each further object is placed one position towards the front. You can shift objects forwards and backwards within a layer.

### Principle of the layer technique

Always one layer of the 32 layers is active. New objects you add to the screen are always assigned to the active layer. The number of the active level is displayed in the inspector window of the screen and in the "Layout > Layers" task card.

When you open a screen, all 32 layers of the screen are displayed. You can hide all the layers except for the active layer in the inspector window of the screen and in the "Layout > Layers" task card. You then explicitly edit objects of the active layer.

In the tree view of the "Layers" palette in the "Layout" task card, you administer layers and objects with drag-and-drop and the context menu.

### Application examples

Use layers, for example, in the following cases:

- To hide the labeling of objects when editing,
- To hide objects, e.g. alarm windows, while configuring other objects

### See also

Screen basics (Page 2931)

Renaming layers (Page 3047)

Show and hide layers (Page 3046)

Setting the active layer (Page 3044)

Moving objects between layers (Page 3044)

### 10.1.6.2 Moving objects between layers

#### Introduction

By default, a new object is inserted on the active layer. You can, however, assign an object to another layer at a later time.

#### Requirement



- A screen with an object is open.
- The Inspector window is open.

#### Procedure

1. Select the object in the screen.  
The object properties are displayed in the Inspector window.
2. Enter the layer to which you want to move the object in "Properties > Properties > Miscellaneous > Layer" in the Inspector window.

Alternatively, select the object from the "Layout" task card and drag it to the required layer.

#### Changing the order of objects

1. Select the object in the screen.  
The object properties are displayed in the Inspector window.
2. To move the object to the front or back, select the "Order" > "Move backward" or "Move forward" command from the shortcut menu.  
Alternatively, use the  or  button in the toolbar.

#### Result

The object is assigned to the selected layer, and positioned at the top of the layer.

#### See also

Basics on working with layers (Page 3042)

### 10.1.6.3 Setting the active layer

#### Introduction

The screen objects are always assigned to one of the 32 layers. There is always an active layer in the screen. New objects you add to the screen are always assigned to the active layer.

The number of the active layer is indicated in the "Layer" toolbar. The active layer is indicated by the  icon in the "Layout > Layers" task card.

Layer 0 is the active layer when you start programming. You can activate a different layer during configuration, if necessary.

### Requirement

- You have opened a screen which contains at least one object.
- The Inspector window of the active screen is open.

### Procedure

1. Click "Properties > Properties > Layers" in the Inspector window of the current screen.
2. Enter the layer number in "Settings > Active layer".

### Alternative procedure

1. Select "Layout > Layers" in the "Layout" task card.
2. Select the "Set to active" command from the shortcut menu of a layer.

### Result

The layer with the specified number is now active.

### See also

Basics on working with layers (Page 3042)

### 10.1.6.4 Show and hide layers

#### Introduction

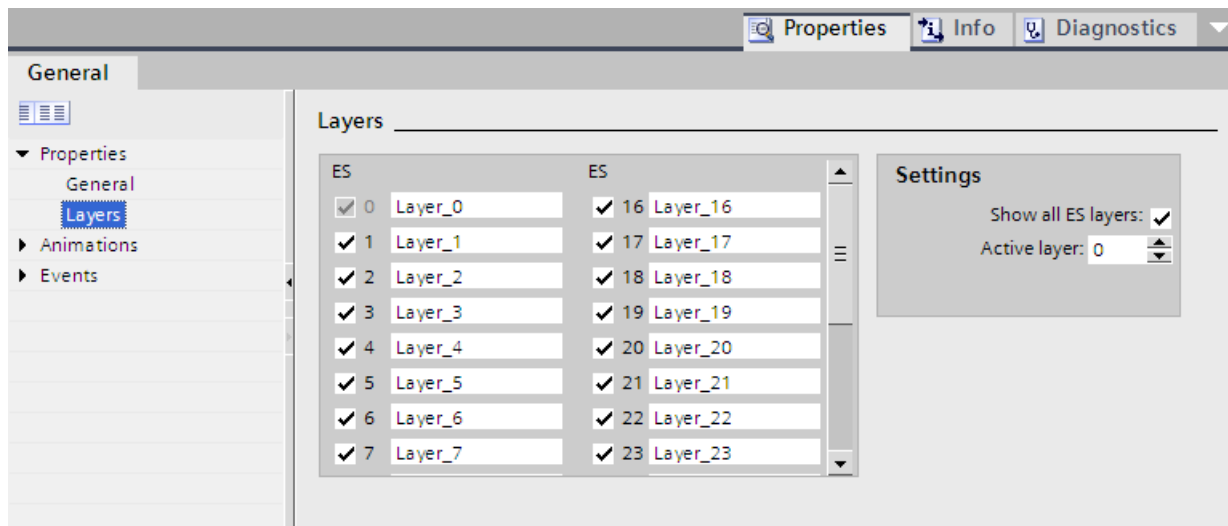

You can show or hide the layers of a screen as required. You specify the layers that are shown in the Engineering System. When you open a screen, all the layers are always shown.



#### Requirement

- The screen is opened.
- The "Layout" task card is open.

#### Procedure

1. Select the layer that you want to hide or show in the "Layout > Layers" task card.
2. Click one of the icons next to the corresponding layer:
  -  A shown layer is hidden
  -  A hidden layer is shown

---

#### Note

The active layer cannot be hidden.

---

### Alternative procedure

1. Click in an area of the screen that does not contain an object.  
The screen properties are shown in the Inspector window.
2. In the Inspector window, select "Properties > Properties > Layers":

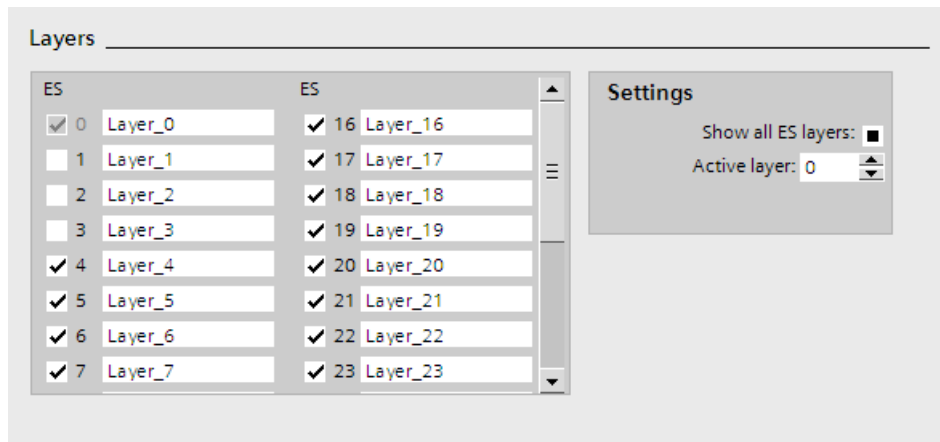

3. In the list, disable the levels you wish to hide.  
If you activate "All ES layers" for a layer, the objects in this layer will be shown in the Engineering System.

### Result

The layers are shown according to your settings.

### See also

Basics on working with layers (Page 3042)

#### 10.1.6.5 Renaming layers

### Introduction

When you create a screen, the 32 layers are numbered consecutively by default. To improve clarity, you can rename the layers to suit your requirements.

## Requirement

- The screen is opened.

## Procedure

1. Click in an area of the screen that does not contain an object.  
The screen properties are shown in the Inspector window.
2. In the Inspector window, select "Properties > Properties > Layers".

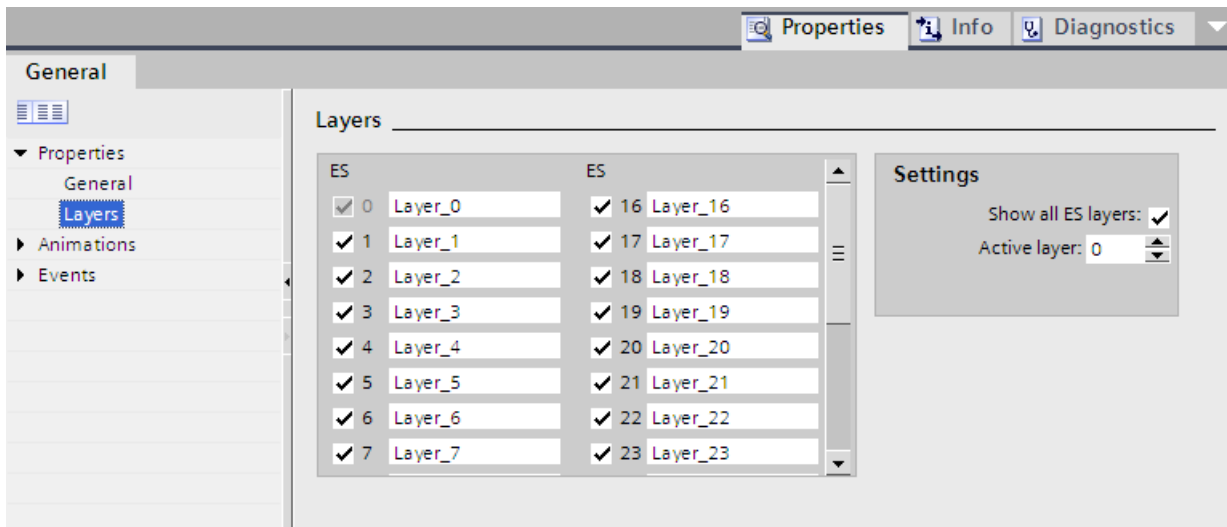

3. Enter the new layer name.

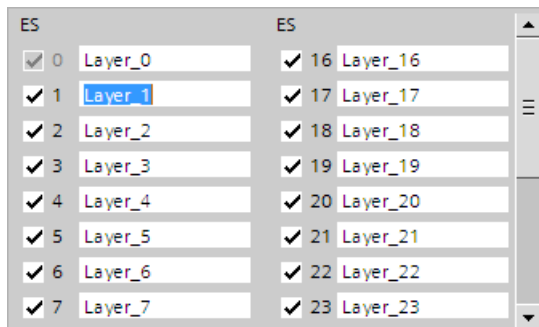

## Result

The layer is displayed with the new name.

## See also

Basics on working with layers (Page 3042)



## 10.1.7 Working with faceplates

### 10.1.7.1 Basics on faceplates

#### Introduction

Faceplates are a configured group of display and control objects which you manage and change centrally in a library. You can use a faceplate in several projects as required. The faceplates are stored in the project library.

#### Use

You use faceplates to create individually configured display and control objects. You can use faceplates several times in the project or in different projects. All instances of a faceplate in the project are changed centrally. This reduces the configuration effort.

#### Types and instances

Faceplates are based on a type-instance model to support the central changeability. You create central properties for an object in types. The instances represent local application points of the types.

- **Faceplate type**  
You create a display and control object according to your requirements and store it in the project library. The instances are bound to the respective faceplate type. If you change a property of a faceplate type, the property is saved centrally and also changed in all instances. In the faceplate type, you define the properties that can be changed on the faceplate. You edit a faceplate type in the "Faceplates" editor.
- **Faceplate**  
The faceplate is an instance of the faceplate type. You use a faceplate in screens as a display and control object. You configure the variable properties of the faceplate type on the instance. You assign the tags of your project to the faceplate for example. If you configure properties on the faceplate, you overwrite the properties of the faceplate type. The changes on the faceplate are saved at the application point and have no effects on the faceplate type.

The figure below shows the relations between the faceplate type and the faceplate. The background color of the I/O field is configured in the faceplate type in such a way that every instance can change the property. Blue is used as a background color for the faceplate type. Use yellow as a background color for the faceplate.

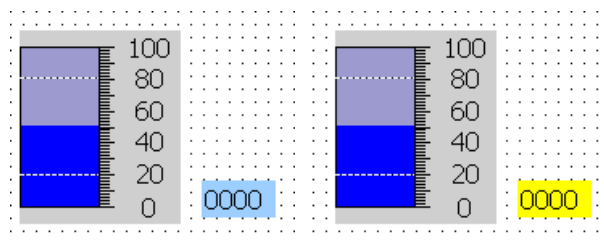

## 10.1 Creating screens

When you change the background color in the faceplate type, this has no effect on the faceplate because the "Background color" property is assigned instance-specifically.

### Device dependence of faceplates

Not all HMI devices support every display and screen object. The screen objects which are not available in the respective HMI device are not displayed when using the faceplate.

The following devices support faceplates:

### Runtimes

- WinCC Runtime Advanced
- WinCC Runtime Professional

### Comfort Panels

- KTP 400
- KP 400
- TP 700
- KP 700
- TP 900
- KP 900
- TP 1200
- KP 1200
- TP 1500
- KP 1500
- TP 1900
- TP 2200

### Panels

- TP 277
- OP 277

### Mobile Panels

- Mobile Panels
- Mobile Panel 277
- Mobile Panel 277 IWLAN V2
- Mobile Panel 277F IWLAN V2
- Mobile Panel 277F IWLAN (RFID Tag)

## **Multi Panels**

- [MP 277](#)
- [MP 377](#)

## **See also**

[Faceplate editor \(Page 3051\)](#)

[Creating a faceplate type \(Page 3054\)](#)

[Screen basics \(Page 2931\)](#)

[Basics of dynamizing faceplates \(Page 3069\)](#)

[Example: Configuring a faceplate \(Page 3070\)](#)

### **10.1.7.2 Faceplate editor**

#### **Open**

Create faceplate types and edit them in the library view.

## Layout

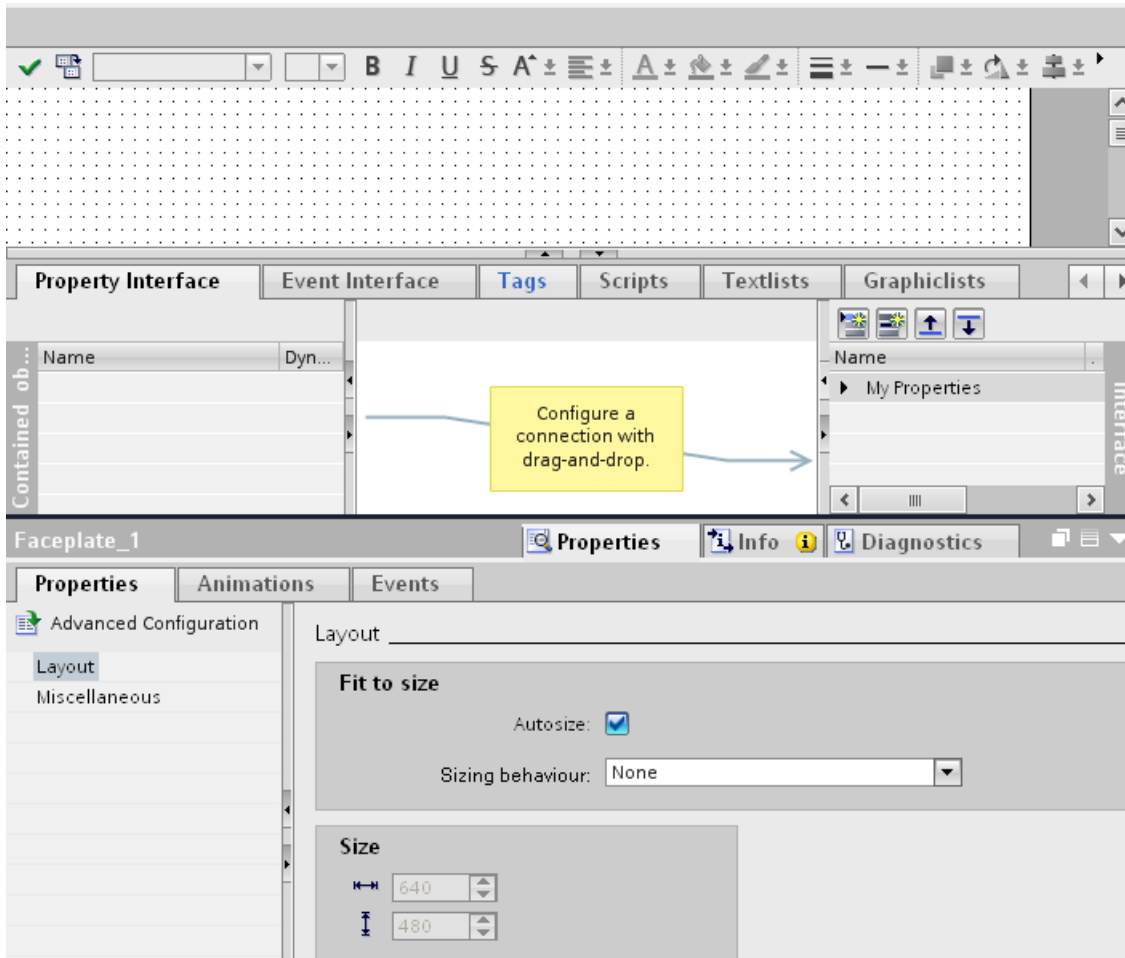

The library view for faceplate types consists of several editors, e.g. "Screens" and "Tags" which are arranged in the work area and the configuration area.



## Work area

In the work area, place the objects contained in the faceplate type as you usually do in the "Screens" editor. You can remove objects, or use the "Toolbox" task card to add new objects.

## Configuration section

- Properties  
The static and dynamic properties are identified as follows:
  - The  symbol identifies a dynamic property. Dynamic implementation of this property, using tags or text and graphic lists.
  - The  symbol identifies a static property. You change only the values of a static property.

---

### Note

#### Device dependency of static properties

Static properties are only available for panels and RT Advanced.

---

You define the faceplate type properties in the "Properties" tab.

You use the following two lists for this:

- The "Contained objects" list  
This list includes the properties of the objects contained in the faceplate type. These properties can only be configured in the faceplate type in the "Faceplate" editor.
  - The "Interface" list contains the properties and tags of the faceplate type. The "Interface" list consists of the pre-defined category "Dynamic properties" and user-defined categories.
- Events  
You define the faceplate type events in the "Events" tab. You use the following two lists for this:
    - The "Contained objects" list contains the events of the objects embedded in the faceplate type.
    - The "Interface" list contains the events of the faceplate.  
You create links between the two lists using a drag and drop operation.
  - Tags  
You can also create faceplate tags on the "Tags" tab. The tags are only available within the faceplate type. You can interconnect the faceplate type tags directly with an object contained in the faceplate type.
  - Scripts  
In the "Scripts" tab, you can configure scripts for the faceplate type. In the script, you can call up system functions or program new functions, for example to convert values. The scripts are only available within the faceplate type. They work with VB Script code.

---

### Note

The "Scripts" tab is not available for Runtime Professional.

---

- Text lists  
You can also create and edit text lists for the faceplate type in the "Text lists" tab. These text lists are only available within the faceplate type. You can interconnect the text lists of the faceplate type directly with an object contained in the faceplate type, such as a symbolic I/O field.

## 10.1 Creating screens

- **Graphics lists**  
If necessary, you can also create graphics lists for the faceplate type in the "Graphics lists" tab. These graphic lists are only available within the faceplate type. You can interconnect the graphic lists of the faceplate type directly with an object contained in the faceplate type, e.g. a graphic I/O field.
- **User texts**  
The "User text" tab shows the contained user text of the opened faceplate type, for example entries from text lists. You can enter the compilations for the individual project languages directly in the "User text" tab.

### See also

Basics on faceplates (Page 3049)

Example: Configuring a faceplate (Page 3070)

### 10.1.7.3 Creating and managing faceplates

#### Creating a faceplate type

##### Introduction

Faceplate types are display and control objects which are made up of several objects, e.g. controller modules.

##### Requirement

You have opened a screen which contains multiple objects.

##### Procedure in the project view

1. Select all the objects that you need for the faceplate type.
2. Select the "Create faceplate type" command in the shortcut menu of the multiple selection. A dialog opens.
3. Enter a name for the faceplate.
4. If necessary, add a comment or change the version number.

##### Result

The library view opens. Two versions of the type are displayed in the "types" folder. Version 0.0.1 has been released and contains the currently selected objects.

The 0.0.2 version has the status "in progress". Edit the faceplate type in version 0.0.2 as required.

## Procedure in the library view

1. The library view is open.
2. Select the "Create new type" command in the shortcut menu of the project library. A dialog opens.
3. Select the runtime for which the faceplate type is to be available. An empty faceplate type is created.
4. Drag-and-drop the objects from the "Toolbox" task card to the work area of the faceplate type.

## Result

The new faceplate type is created and displayed under the selected name in the project library. The faceplate type is assigned the status "in progress" and the version 0.0.1.

## See also

- Configuring a faceplate type (Page 3055)
- Configuring a tag in the faceplate type (Page 3059)
- Configuring an event in the faceplate type (Page 3060)
- Configuring scripts in the faceplate type (Page 3061)
- Creating an instance of the faceplate type (Page 3067)
- Editing the faceplate type (Page 3065)
- Basics on faceplates (Page 3049)
- Example: Configuring a faceplate (Page 3070)
- Editing the category and property of a faceplate type (Page 3058)
- Configuring a graphics list in the faceplate type (Page 3063)
- Configuring text lists in the faceplate type (Page 3062)
- Removing faceplate object from faceplate (Page 3068)
- Resizing a faceplate (Page 3066)

## Configuring a faceplate type



### Introduction

In the configuration area of the "Faceplates" editor you define which properties and process values of the objects contained in the faceplate can be configured in the "Properties" tab.

## Requirement

- The faceplate is generated and is displayed in the "Faceplate" editor.
- The "Properties" tab is open in the configuration area.

## Procedure

1. To create a new property, click the "Add property"  button in the interface list. A new property is displayed in the "Interface" list.
2. To create a new category, click the "Add category"  button in the interface list. A new category including a new property is displayed in the "Interface" list.
3. Click the name of the property and assign a name, for example, "Color".
4. Select the data type.

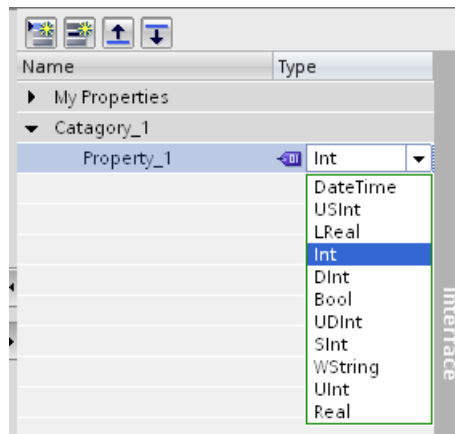

## Interim result

You have created a new property.

1. Click an object in the "Contained objects" list.
2. Select a property, e.g. "Appearance > Background color".



3. Move the property from the "Contained objects" list to the desired property in the "Interface" list by drag&drop.  
The connection is displayed as a colored line.  
The system assigns the same data type to the property in the "Interface" list as that of the property in the "Contained objects" list.  
To change the data type, select the data type from the data types of the connected property.
4. Repeat step 3 to connect other properties of the contained properties with the interface.

---

#### Note

The property from the "Contained objects" list must be in concordance with the data type of the already connected property of the "Interface" list.

---

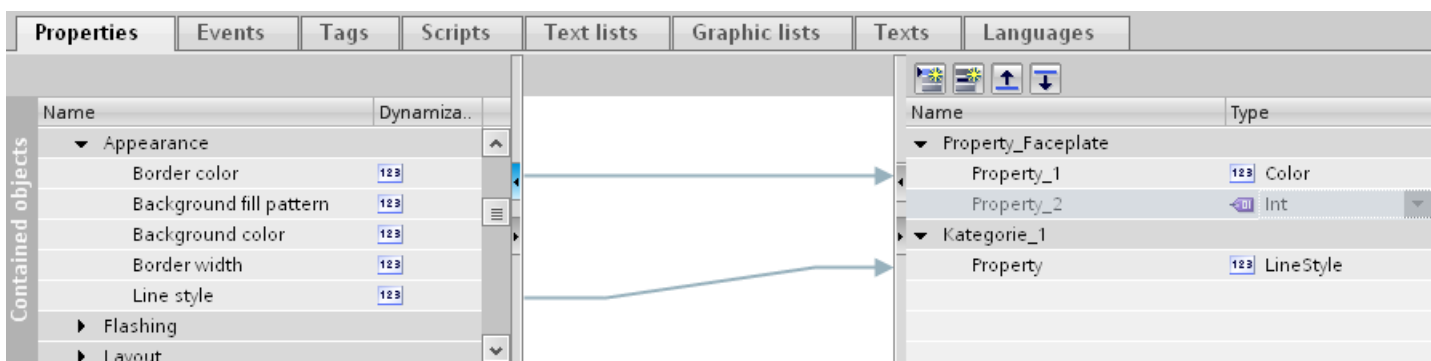

#### Deleting a connection

1. Click the connection that you wish to delete.
2. In the shortcut menu select the "Delete" command or use the <DEL> key.  
The connection is deleted.

#### Result

You have created a new property or a new category with a property. You have connected the property of the interface with a property of the contained objects. If you use an instance of the faceplate type in a screen, you configure the properties of the faceplate which you have created in the "Interface" list.

---

#### Note

##### Device dependency of static properties

Static properties are only available for panels and RT Advanced. You work with dynamic properties in RT Professional.

---

## See also

Creating a faceplate type (Page 3054)

Example: Configuring a faceplate (Page 3070)

## Editing the category and property of a faceplate type

### Deleting a property in the "Interface" list

1. Select "Edit faceplate" in the shortcut menu. The "Faceplates" editor is open.
2. Select the property which you want to delete in the "Interface" list.
3. Select "Delete" in the shortcut menu.

The property is deleted from the "Interface" list. Existing connections to the contained objects are deleted. All linked faceplates lose their instance-specific property.

### Deleting a category in the "Interface" list

1. Select "Edit faceplate" in the shortcut menu. The "Faceplates" editor is open.
2. Select the category which you want to delete in the "Interface" list.
3. Select "Delete" in the shortcut menu.

The category including the properties is deleted from the "Interface" list. Existing connections to the contained objects are deleted. All linked faceplates lose their instance-specific properties.

### Moving a property to another category

1. Select a property in the "Interface" list.
2. Move the property to a new category by "drag&drop".

You have moved the property to a new category.

### Changing the data type of a property

1. Select a property in the "Interface" list.
2. Click the second column of the drop-down list.
3. Select a data type.

You have changed the data type of the property in the "Interface" list.

## See also

Creating a faceplate type (Page 3054)

## Configuring a tag in the faceplate type

### Introduction

You connect a tag in the faceplate type directly with the properties of the objects contained in the faceplate type. The tags in the faceplate type are a central means of defining dynamic properties in the faceplate type.

The tags of a faceplate type have limited functionality. The "Tags" tab of the configuration area has the same structure as the "Tags" editor.

### Array elements for faceplates

In the following situations you may not assign an array element or a multiplex tag that is interconnected with a faceplate to the property of a screen object.

- The property is configured in a faceplate as parameter of a system function.
- System functions or scripts are assigned in the faceplate to events of the property.

### Requirements

- The library view is open.
- The faceplate type is created and has the "in progress" status.
- The "Tags" tab is open in the configuration area.

### Procedure

1. Click "Add" in the "HMI tags" table. A new tag is created in the faceplate type.
2. Open "Properties > Events" in the inspector window if necessary. You configure the "Value change" event on the tag for example.
3. In the work area, select the object to which you want to assign this tag, e.g. an I/O field.
4. Select the tag in the inspector window of the I/O field "Properties > Properties > General > Process > Tag".

---

**Note**

Only tags of the faceplate type are displayed in the object list in the "Faceplates" editor.

---

### Result

You have created a tag in the faceplate type. You are using the tag in the faceplate for scripting, for example.

### See also

Creating a faceplate type (Page 3054)

Example: Configuring a faceplate (Page 3070)

## Configuring an event in the faceplate type

### Introduction

In the configuration area of the "Faceplates" editor you define which events of the objects contained in the faceplate can be configured in the "Events" tab. You configure a function list on the events of the faceplate in the "Screens" editor.

### Requirement

- The library view is open.
- The faceplate type is created and has the "in progress" status.
- The "Events" tab of the configuration area is open.

### Procedure

1. Click an object in the "Contained objects" list.
2. Select an event, e.g. "Activate".
3. Move the event from the "Contained objects" list to a new category in the "Interface" list. The new event is displayed in the "Interface" list. The connection appears as a colored line.

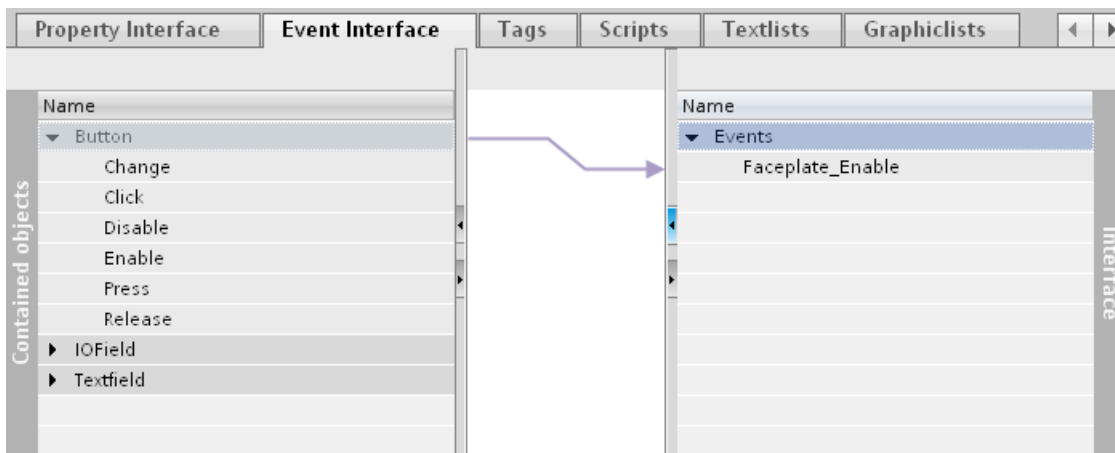

4. Double-click the event and, if required, change the name of the event.

## Result

You have created an event in the faceplate type. If you use an instance of the faceplate type, you will only be offered the configured events in the inspector window. You configure a function list on the event in the faceplate.

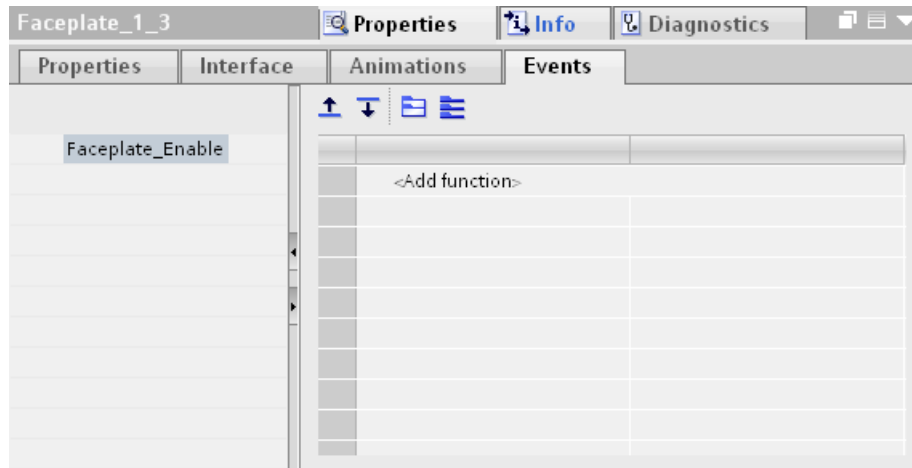

## See also

Creating a faceplate type (Page 3054)

Example: Configuring a faceplate (Page 3070)

## Configuring scripts in the faceplate type

### Introduction

In the configuration area of the "Faceplates" editor you create scripts which you only use within a faceplate type. You can only refer to tags of the faceplate type or properties of the contained objects within the script. The script is used as a copy in the instance of the faceplate type.

### Requirement

- The library view is open.
- The faceplate type is created and has the "in progress" status.
- Faceplate tags or dynamic properties have been created.

### Procedure

1. Click the "Scripts" tab in the configuration area of the faceplate.
2. Double click "Faceplate scripts > Add VB script".
3. Write the program code.

## 10.1 Creating screens

4. Press the shortcut keys <CTRL+J> to Include tags of the faceplate type in the script. The object list opens.
5. Click "HMI tags".  
All tags of the faceplate type are displayed in the object list.
6. Select a tag and confirm the selection.
7. Press the shortcut keys <CTRL+J> to use properties of the faceplate type in the script. The object list opens.
8. Click "Properties".  
All dynamic properties of the "Interface" list for the faceplate type are displayed in the object list.

### Result

You have created a script in the faceplate type. The instance of the faceplate type uses a copy of the script. The script is executed in runtime depending on the configuration.

### See also

Creating a faceplate type (Page 3054)

Example: Configuring a faceplate (Page 3070)

## Configuring text lists in the faceplate type

### Introduction

In a faceplate type, you connect a text list with an object included in the faceplate type. Text is assigned to the values of a tag in a text list. The text list is used, for example, to display a selection list in a symbolic I/O field contained in the faceplate type. The interface between the text list and a tag of the faceplate type is configured at the object that uses the text list.

### Requirements

- The library view is open.
- The faceplate type is created and has the "in progress" status.
- The "Text list" tab is open in the configuration range.
- A tag has been created in the faceplate type.

### Procedure

1. Click "Add" in the "Text lists" table. A new text list is created in the faceplate type.
2. Assign a name to the text list that indicates its function.
3. Select the text list type, e.g. "Value/Range" under "Select".
4. Click "Add" in the "Text list entries" table.

5. Define the values or range of values for the text list.
6. Enter a text for every value range which is displayed in Runtime when the tag is within the specified value range.
7. Select an object, for example a button in the work area of the faceplate type.
8. In the Inspector window of the object, enable "Properties > Properties > General > Label > Text list".
9. Select the "Text list" from the selection list.
10. Select a tag of the faceplate type under "Process > Tag".

## Result

You have created a text list in the faceplate type. This text list is linked to an object contained in the faceplate type. You have configured a faceplate type tag at the object.

## See also

Creating a faceplate type (Page 3054)

## Configuring a graphics list in the faceplate type

### Introduction

In a graphics list, specific graphics are assigned to possible values of a tag. In a faceplate type, you connect a graphics list with an object included in the faceplate type. Graphics are assigned to the values of a tag in a graphics list. For example, the graphics list is used to display a selection list in a graphic I/O field contained in the faceplate type. The interface between the graphics list and a tag of the faceplate type is configured at the object that uses the graphics list.

### Requirements

- The library view is open.
- The faceplate type is created and has the "in progress" status.
- The "Graphics list" tab is open in the configuration range.
- A tag has been created in the faceplate type.

### Procedure

1. Click "Add" in the "Graphics lists" table. A new graphics list is created in the faceplate type.
2. Assign a functional name to the graphics list.
3. Select a graphics list type, e.g. "Range (... - ...)", under "Selection".
4. Click "Add" in the "Graphics list entries" table. A new entry is created in the list.
5. Define the values or range of values for the graphics list.

## 10.1 Creating screens

6. Select a graphic for every value or value range which is displayed in runtime when the tag is within the specified value range.
7. Select an object, e.g. a graphic I/O field, in the work area of the faceplate type.
8. Activate "Properties > Properties > General > Contents > Graphics list" in the object's Inspector window.
9. Select the "Graphics list" from the selection list.
10. Select a tag of the faceplate type in "Process > Tag".

### Result

You have created a graphics list in the faceplate type. This graphics list is linked to an object contained in the faceplate type. You have configured a faceplate type tag at the object.

### See also

Creating a faceplate type (Page 3054)

## Translating texts directly in the faceplate type

### Translating texts

If you use several languages in your project, you can translate individual texts directly. As soon as you change the language of the software user interface, the translated texts are available in the selected language.

### Requirements

- A project is open.
- You have opened the "Faceplates" editor.
- You have created a faceplate type.
- The faceplate type contains at least one object with text, e.g. a text field.

### Procedure



Proceed as follows to translate individual texts:

1. Open the "Tasks" task card.
2. Click the  button under "Languages & Resources > Editing language". The "Project languages" editor opens.
3. Activate at least two project languages.



- Open the "Texts" tab in the "Faceplates" editor.  
A list with the texts in the project is displayed in the work area. There is a separate column for each project language.

Properties	Events	Tags	Scripts	Text lists	Graphic lists	Texts	Languages
Device filter: (Alle Objekte ausgewählt)							
English (United Sta..		Category	Reference				
		Alarm text	V 0.0.2\ModuleDevice [ModuleDevice]\HMI alarms\Warnings\AlarmClassData_IDIS..				
		Other text category	V 0.0.2\Comment				
	!	Alarm text	V 0.0.2\ModuleDevice [ModuleDevice]\HMI alarms\Errors\AlarmClassData_IDISpla..				
	\$	Alarm text	V 0.0.2\ModuleDevice [ModuleDevice]\HMI alarms\System\AlarmClassData_IDISpl..				
	0	HMI screen	V 0.0.2\ModuleDevice [ModuleDevice]\Screens\Version\Symbolisches EA-Feld_1\T..				
	1	HMI screen	V 0.0.2\ModuleDevice [ModuleDevice]\Screens\Version\Symbolisches EA-Feld_1\T..				
	AG/CPU-Nummer	Alarm text	V 0.0.2\ModuleDevice [ModuleDevice]\HMI alarms\PLC\CPU number\Display name				
	Archivieren	Alarm text	V 0.0.2\ModuleDevice [ModuleDevice]\HMI alarms\Archiving ID\Display name				
	Benutzername	Alarm text	V 0.0.2\ModuleDevice [ModuleDevice]\HMI alarms\User name\Display name				
	CPU number	Alarm text	V 0.0.2\ModuleDevice [ModuleDevice]\HMI alarms\CPU number\Display name				
	Datum	Alarm text	V 0.0.2\ModuleDevice [ModuleDevice]\HMI alarms\Date\Display name				
	Dauer	Alarm text	V 0.0.2\ModuleDevice [ModuleDevice]\HMI alarms\Duration\Display name				
	G	Alarm text	V 0.0.2\ModuleDevice [ModuleDevice]\HMI alarms\Diagnosis events\Text for "Out...				

- Click on the  button in the toolbar to group identical texts together.
- To hide texts that do not have a translation, click on the  button in the toolbar.
- Click on an empty column and enter the translation.

## Result

You have translated individual texts in the "Texts" tab of the faceplate type. The texts will then be displayed in the runtime language.

## Editing the faceplate type

### Introduction

All faceplate types in the project library have a status. You create a faceplate type in the "in progress" status. You can edit the faceplate types as required in this status. When editing is complete, release the faceplate type.

### Requirement

- A faceplate type has been created.
- The faceplate type has the version 0.0.1. and the status "in progress".
- The "Library" task card or the library view is open.

### Enable faceplate type

1. Select version 0.01 of the faceplate type in the project library.
2. Select "Enable faceplate type" in the shortcut menu.

You have enabled version 0.0.1 of the faceplate type.

### Edit faceplate type

1. In the project library select, for example, the enabled version 0.0.1 of a faceplate type.
2. Select "Edit faceplate type" in the shortcut menu.

The library view opens. The new version 0.0.2 of the faceplate type has been created.

The faceplate type has the "In progress" status.

### Restoring the last version of the faceplate type

The last enabled version of the faceplate type is version 0.0.2.

Edit the faceplate type. A new version 0.0.3 is created and the "in progress" status is assigned to it.

1. Select the faceplate type from the project library.
2. Select "Discard changes and restore type" in the shortcut menu.

All changes to the faceplate type since the last enabling operation are rejected. The faceplate type is enabled again and has the version 0.0.2.

### See also

Creating a faceplate type (Page 3054)

Example: Configuring a faceplate (Page 3070)

### Resizing a faceplate

#### Introduction

In the faceplate type, specify the response of the faceplate when it is resized.

#### Requirements

- A faceplate type has been created.
- You have opened the "Faceplates" editor.
- The Inspector window is open.

## Specifying the response to resizing

1. Activate "Properties > Properties > Layout > Fit to size > Auto-size."
2. Select the "Fixed aspect ratio" setting, for example.  
This setting retains the aspect ratio when you resize the faceplate.
3. Click the faceplate in the "Libraries" task card.
4. Select "Enable faceplate type" in the shortcut menu.

## Result

You have specified how the faceplate responds when its size in a screen is changed. You can change the response for a particular faceplate.

Select a faceplate in the screen. Select the required setting in "Properties > Properties > Layout > Characteristics" in the Inspector window.

## See also

Creating a faceplate type (Page 3054)

## Creating an instance of the faceplate type

### Introduction

The faceplate type is stored in the project library. If you use the faceplate type in a screen, you create an instance of the faceplate type.

---

#### Note

Note that a faceplate is always configured for a particular class of HMI devices. For example, you cannot use a faceplate type that is configured for "RT Professional" in a screen on an "RT Advanced" HMI device.

---

## Requirement

- A screen is open.
- The "Libraries" task card is opened.
- The project library is open and it contains at least one faceplate type.

---

#### Note

Faceplate types are also stored in global libraries. When you add a faceplate type from the global library to the screen, the system automatically saves a copy of it to the project library.

---

- The Inspector window is open.

## Procedure

1. Move the desired faceplate type from a library to the screen by drag&drop.

## Result

You have created an instance of the faceplate type. The instance is given the version number of the most recently released type.

Configure the properties of the faceplate in the Inspector window as required. To dynamize the faceplate, open the interface in the Inspector window.

## See also

Creating a faceplate type (Page 3054)

Example: Configuring a faceplate (Page 3070)

## Removing faceplate object from faceplate

### Introduction

Cancel application, to remove specified instances from the update of the faceplate type.

### Requirement

- A faceplate type has been created.
- The faceplate must be used in a minimum of one screen.

### Disconnect the faceplate object from faceplate type.

1. Select a faceplate on the screen.
2. In the shortcut menu, select "Disconnect faceplate object from faceplate type".

## Result

The faceplate is independent of the associated faceplate type. Changes to the faceplate type are not updated in the faceplate.

## See also

Creating a faceplate type (Page 3054)

#### 10.1.7.4 Dynamizing faceplates

### Basics of dynamizing faceplates

#### Application

You can dynamically control events and properties of faceplates in two ways:

- Dynamically controlling faceplates  
You configure the events or dynamic properties individually for the application point on the faceplate. To do this, define in the "Faceplates" editor that these properties and events are configurable in the faceplate. To dynamize the faceplates in the "Screens" editor, use the scripts and tags that are created in the project.
- Dynamizing the faceplate type  
You dynamize the objects which are contained in the faceplate type in the "Faceplates" editor. You configure the individual objects as in the "Screens" editor. Tags and scripts are available in the "Faceplates" editor to dynamize properties and events. You do not have access to the tags and scripts of the project within the faceplate.  
Every faceplate created with the faceplate type has the same preconfigured dynamization. You can edit this dynamic control only in the "Faceplates" editor.

#### Animation

WinCC provides preconfigured dynamic control in the "Animations" task card. You use animations to dynamize faceplates and faceplate types.

#### See also

Basics on faceplates (Page 3049)

Example: Configuring a faceplate (Page 3070)

### Dynamizing faceplates

#### Introduction

You dynamize a faceplate in exactly the same way as you dynamize an object from the "Tools" task card.

You connect the dynamic properties of the faceplate in the "Screens" editor with a tag or a script which supplies values to the property in runtime.

You include tags and scripts which you have created in the project for the faceplate.

## 10.1 Creating screens

### Requirement

- A faceplate is inserted in the screen.

### Procedure

1. Select the faceplate.
2. In the Inspector window, open "Properties > Animation".  
The animations available for the selected object are displayed.
3. Select "Horizontal movement" and click the  button.  
The parameters of the animation are displayed.  
A transparent copy of the object is shown in the work area, which is connected to the source object by means of an arrow.
4. Select a tag for control of movement.
5. Move the object copy to the relevant destination. The system automatically enters the pixel values of the final position in the Inspector window.
6. Customize the range of values for the tag as required.

### Result

In Runtime, the object moves in response to every change in value of the tag that is used to control the movement. The direction of movement corresponds to the configured type of movement "horizontal".

### 10.1.7.5 Examples of faceplates

#### Example: Configuring a faceplate

##### Introduction

In this example you create a faceplate in which you can convert the value of a length measuring system from kilometers into meters. The length in meters is displayed in an output field.

##### Procedures overview

The example is divided into the following steps:

1. Creating a faceplate type
2. Configuring a faceplate type
3. Creating a script in the faceplate type
4. Connecting a script with the contained objects of the faceplate type
5. Creating a faceplate and connecting with a tag

**See also**

Basics on faceplates (Page 3049)

Example: Creating an instance of the faceplate type (Page 3075)

Example: Configuring included objects (Page 3075)

Example: Creating a script in the faceplate type (Page 3073)

Example: Configuring a faceplate type (Page 3072)

Example: Creating a faceplate type (Page 3071)

**Example: Creating a faceplate type****Task**

You create a faceplate type.

**Requirement**

- A screen is open.
- The toolbox window is displayed.

**Settings**

For the example you require objects with the following settings:

Object	Object name	Properties
Text field	Label_Meter	Text: Meter
I/O field	Output_Meter	Mode: Output
Button	KM_to_Meter	Text OFF: Convert

**Procedure**

1. In the toolbox, click the individual objects and drag&drop the objects into the screen.
2. Set the properties as shown above.
3. Select all objects.
4. Select the "Create faceplate type" command in the shortcut menu of the multiple selection.  
The library view opens.
5. In the Inspector window, click "Properties > Properties > Miscellaneous".
6. Enter "KMtoMeter" as the name.

## Result

The faceplate types appears in the project library under the name "KMtoMeter". The faceplate type is assigned the "in progress" status.

## See also

Example: Configuring a faceplate (Page 3070)

## Example: Configuring a faceplate type

### Job

You create the dynamic property and tag of the faceplate type.

### Creating a new property

1. Click "Properties" in the configuration area of the faceplate.
2. In the "Interface" list, click the  icon "Add property". A new property is added to the "Interface" list.
3. Double click the name of the property and enter "KMToMeter".
4. Click the selection list and select the data type "Int".

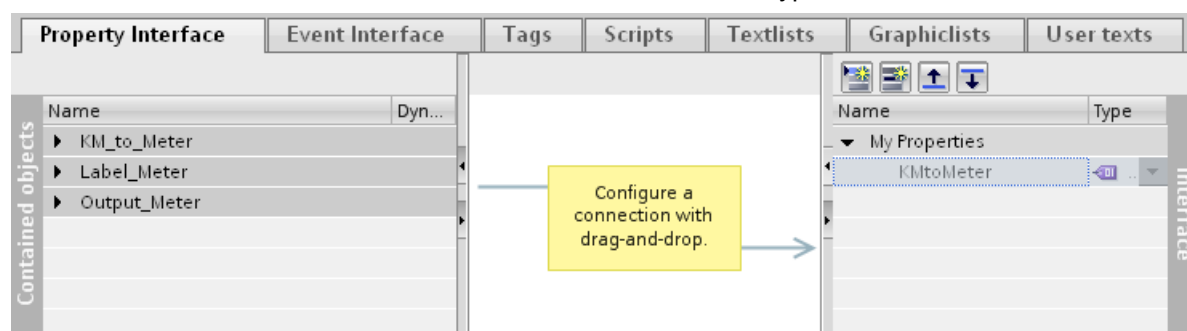

### Interim result

The "KMToMeter" property is displayed in the "Interface" list. The symbol identifies the dynamic property. The property will be linked to a tag in the next step.

### Creating a tag in the faceplate type

1. Click "Tags" in the configuration area.
2. Click "Add" in the "HMI tags" table. A new tag is added to the table. The inspector window of the tag is opened.
3. In the Inspector window, select "Properties > Properties > General":
4. Enter "BB\_Tag" as the name. Select the "Int" data type.



## Result

The "KMTtoMeter" property and the "BB\_Tag" of the faceplate type are created in the configuration area of the "Faceplates" editor.

## See also

Example: Configuring a faceplate (Page 3070)

## Example: Creating a script in the faceplate type

## Task

You create a script that converts the value of a length measuring system from kilometers to meters.

## Procedure

1. Click "Scripts > Faceplate scripts" in the configuration area.
2. Double click "Add VB script".
3. Press the shortcut keys <CTRL+J>. The object list opens.
4. Click "HMI tags". The faceplate tag "BB\_Tag" is displayed in the object list.

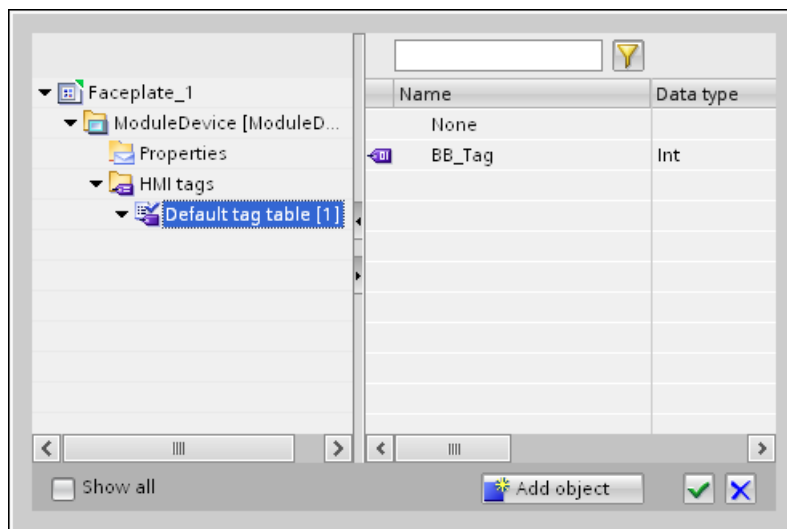

5. Select the faceplate type tag "BB\_Tag". Confirm the selection.
6. Insert an "=" sign.
7. Press the shortcut keys <CTRL+J>. The object list is opened.

8. Click "Properties."  
The dynamic property "KMtoMeter" is displayed in the object list.

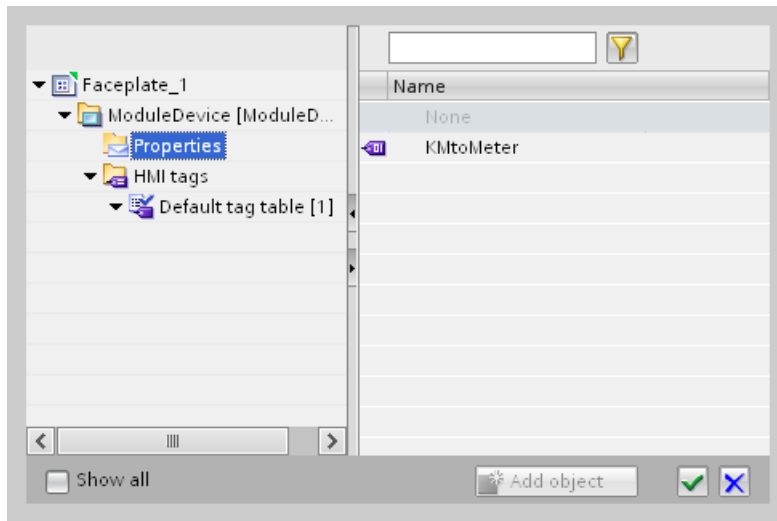

9. Select the "KMtoMeter" dynamic property. Confirm the selection.
10. Enter "\*1000" at the end of the code. This corresponds to the conversion factor from kilometers to meters.
11. Enter the name "Script\_1" under "Properties > Properties > General >Setting > Name" in the Inspector window.

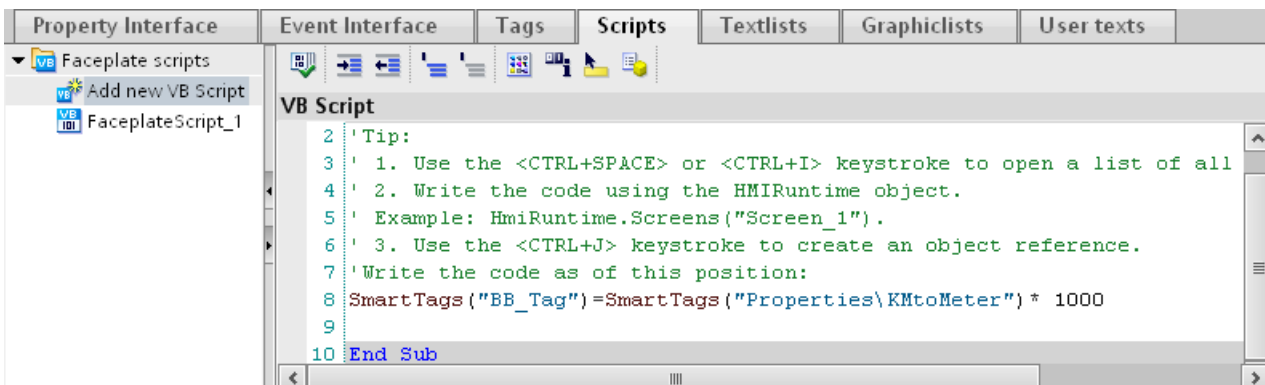

## Result

The script has been created in the faceplate type. If you use the "KMtoMeter" faceplate type in a screen, you assign a tag to the "KMtoMeter" property. The value of this tag is multiplied by factor 1000 and assigned to the tag of the faceplate type "BB\_Tag" as a new value. In this way you supply values to the tags of the faceplate type.

## See also

Example: Configuring a faceplate (Page 3070)

## Example: Configuring included objects

### Task

You connect the included objects in the faceplate "KMtoMeter" to a faceplate tag and a faceplate script.

You connect the I/O field with the "BB\_Var" tag of the faceplate type. You connect the "Click" event for a button to the script "Script\_1".

### Requirement

The faceplate is displayed in the "Faceplates" editor.

### Interconnecting I/O field with a tag

1. Select the "Output\_Meter" I/O field in the faceplate.
2. Connect the I/O field with the faceplate tag "BB\_Tag" in the "General > Process > Tag" inspector window.

### Connecting an event to a faceplate script

1. Select the "KM\_to\_Meter" button in the faceplate.
2. Select "Script\_1" in the inspector window under "Events > Click".

### Result

The I/O field is connected with the tag of the faceplate type. The button is connected with the script of the faceplate type.

If you click the button of the faceplate during runtime, the script is executed. The value of the tag of the faceplate is output in the I/O field.

### See also

Example: Configuring a faceplate (Page 3070)

## Example: Creating an instance of the faceplate type

### Task

You insert the faceplate type "KMtoMeter" in a screen and assign a tag to the dynamic property "KMtoMeter".

## Requirement

- The "Screens" editor is open.
- A new screen has been created.

## Settings

For the example you require a tag with the following settings:

Name	PLC connection	Type
Kilometer	No	ULong

## Procedure

1. Create the HMI tag "Kilometer" with the settings named above.
2. Open the "project library" in the "Libraries" task card.
3. Move the "KMtoMeter" faceplate type into the screen by drag&drop.
4. Click "Properties > Properties > Interface" in the Inspector window.  
The table shows all the properties which you can dynamize in the faceplate.

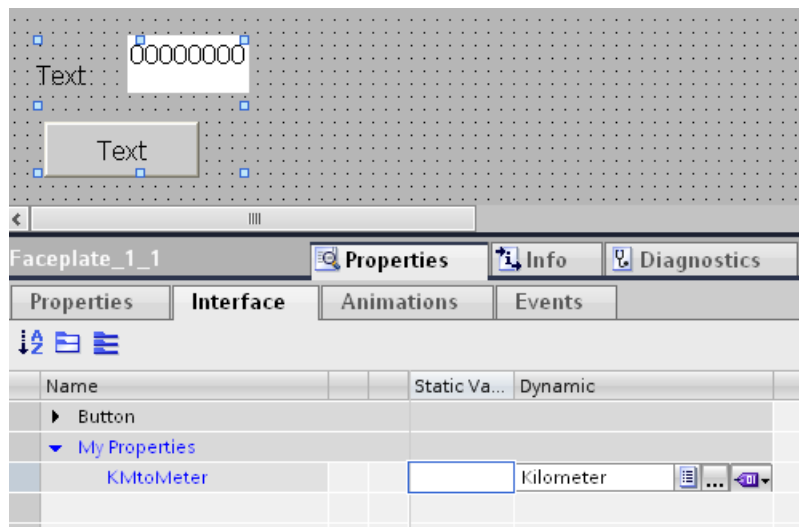

5. Click the "Dynamization" column in the "KMtoMeter" line.
6. Select "HMI tag".
7. Click the "..." button.
8. Select the tag "Kilometer" from the object list.
9. Confirm the selection.

## Result

The dynamic property "KMtoMeter" is linked with the "Kilometer" tag. During runtime the dynamic property is supplied with values of the "Kilometer" tag. The values are multiplied by

factor 1000 in the script of the faceplate type and assigned to the tag in the faceplate as a new value.

## See also

Example: Configuring a faceplate (Page 3070)

## 10.1.8 Indicator and control objects

### 10.1.8.1 Device-Specific Nature of the Objects

#### Objects for Basic Panels

#### Availability of display and operating elements for Basic Panels

Only the objects which can be used for the device you are configuring will be shown in the object window. The following table shows the availability of indicator and control objects for the Basic Panels.

#### Overview

	KP300 Basic KP400 Basic	KTP400 Basic KTP600 Basic KTP1000 Basic TP1500 Basic
Bar	Yes	Yes
User view	Yes	Yes
Date/time field	Yes	Yes
I/O field	Yes	Yes
Ellipse	Yes	Yes
Graphic view	Yes	Yes
Graphic I/O field	Yes	Yes
Help indicator	Yes	No
Circle	Yes	Yes
Trend view	Yes	Yes
Line	Yes	Yes
Alarm view	Yes	Yes
Alarm window		
Alarm indicator	Yes	Yes
Rectangle	Yes	Yes
Recipe view	Yes	Yes

10.1 Creating screens

	KP300 Basic KP400 Basic	KTP400 Basic KTP600 Basic KTP1000 Basic TP1500 Basic
Button	Yes	Yes
Switch	Yes	Yes
Symbolic I/O field	Yes	Yes
System diagnostics view	Yes	Yes
Text field	Yes	Yes

**See also**

- Objects for Panels (Page 3078)
- Objects for Comfort Panels (Page 3080)
- Objects for Multi Panels (Page 3081)
- Objects for Mobile Panels (Page 3083)
- Objects for WinCC Runtime Advanced (Page 3084)

**Objects for Panels**

**Availability of display and operating elements for Panels**

Only the objects which can be used for the device you are configuring will be shown in the object window. The following table shows the availability of indicator and control objects for the Panels.

**Overview**

	OP 73	OP 77A OP 77B	TP 177A	TP 177B OP 177B	TP 277 OP 277
Bar	Yes	Yes	Yes	Yes	Yes
User view	Simple	Simple	Simple	Yes	Yes
Date/time field	Yes	Yes	Yes	Yes	Yes
I/O field	Yes	Yes	Yes	Yes	Yes
Ellipse	No	No	Yes	Yes	Yes
f(x) trend view	No	No	No	No	No
Function key	only on keyboard units				
Graphic view	Yes	Yes	Yes	Yes	Yes
Graphic I/O field	Yes <sup>1)</sup>	Yes <sup>1)</sup>	Yes <sup>1)</sup>	Yes	Yes
Handwheel	No	No	No	No	No
Help indicator	Yes	No	No	No	No
HTML Browser	No	No	No	No	No

	OP 73	OP 77A OP 77B	TP 177A	TP 177B OP 177B	TP 277 OP 277
Circle	No	No	Yes	Yes	Yes
Trend view	No	No	Yes	Yes	Yes
Charging condition	No	No	No	No	No
Illuminated pushbutton	No	No	No	No	No
Line	No	No	Yes	Yes	Yes
Media Player	No	No	No	No	No
Alarm view Alarm window	Simple	Simple	Simple	Yes	Yes
Alarm indicator	Simple	No	Simple	Yes	Yes
Polygon	No	No	No	Yes	Yes
Polyline	No	No	No	Yes	Yes
Rectangle	No	No	Yes	Yes	Yes
Recipe view	No	Simple	Simple	Yes	Yes
Button	Yes	Yes	Yes	Yes	Yes
Switch	Yes <sup>2)</sup>	Yes <sup>2)</sup>	Yes <sup>2)</sup>	Yes	Yes
Slider	No	No	No	Yes	Yes
Key switch	No	No	No	No	No
Sm@rtClient view	No	No	No	Yes	Yes
Status/Force	No	No	No	Yes	Yes
Symbol library	No	No	No	Yes	Yes
Symbolic I/O field	Yes	Yes	Yes	Yes	Yes
System diagnostics view	No	No	No	No	No
System diagnostics window	No	No	No	No	No
Text field	Yes	Yes	Yes	Yes	Yes
Clock	No	No	No	No	No
Effective range signal	No	No	No	No	No
Effective range name	No	No	No	No	No
Effective range name (RFID)	No	No	No	No	No
WLAN reception	No	No	No	No	Yes
Gauge	No	No	Yes	Yes	Yes
Zone name	No	No	No	No	No
Zone signal	No	No	No	No	No

- 1) Only two different graphics can be used.
- 2) Only the "Switch with text" and "Switch with graphic" types can be used.

## See also

Objects for Basic Panels (Page 3077)

## Objects for Comfort Panels

### Availability of display and operating elements for Comfort Panels

Only the objects which can be used for the device you are configuring will be shown in the object window. The following table shows the availability of indicator and control objects on Comfort Panels.

#### Overview

	KP400 Comfort KTP400 Comfort	KP700 Comfort TP700 Comfort	KP900 Comfort TP900 Comfort	KP1200 Comfort TP1200 Comfort	TP1900 Comfort TP2200 Comfort
Bar	Yes	Yes	Yes	Yes	Yes
User view	Yes	Yes	Yes	Yes	Yes
Date/time field	Yes	Yes	Yes	Yes	Yes
I/O field	Yes	Yes	Yes	Yes	Yes
Ellipse	Yes	Yes	Yes	Yes	Yes
f(x) trend view	Yes	Yes	Yes	Yes	Yes
Function key	only on keyboard units				
Graphic view	Yes	Yes	Yes	Yes	Yes
Graphic I/O field	Yes	Yes	Yes	Yes	Yes
Handwheel	No	No	No	No	No
Help indicator	No	No	No	No	No
HTML browser	No	No	No	No	No
Circle	Yes	Yes	Yes	Yes	Yes
Trend view	Yes	Yes	Yes	Yes	Yes
Charging condition	No	No	No	No	No
Illuminated pushbutton	No	No	No	No	No
Line	Yes	Yes	Yes	Yes	Yes
Media Player	Yes	Yes	Yes	Yes	Yes
Alarm view alarm window	Yes	Yes	Yes	Yes	Yes
Alarm indicator	Yes	Yes	Yes	Yes	Yes
Polygon	Yes	Yes	Yes	Yes	Yes
Polyline	Yes	Yes	Yes	Yes	Yes
Rectangle	Yes	Yes	Yes	Yes	Yes
Recipe view	Yes	Yes	Yes	Yes	Yes
Button	Yes	Yes	Yes	Yes	Yes
Switch	Yes	Yes	Yes	Yes	Yes
Slider	Yes	Yes	Yes	Yes	Yes
KeySwitch	No	No	No	No	No



	KP400 Comfort KTP400 Comfort	KP700 Comfort TP700 Comfort	KP900 Comfort TP900 Comfort	KP1200 Comfort TP1200 Comfort	TP1900 Comfort TP2200 Comfort
Sm@rtClient view	Yes	Yes	Yes	Yes	Yes
Status/Force	Yes	Yes	Yes	Yes	Yes
Symbol library	Yes	Yes	Yes	Yes	Yes
Symbolic I/O field	Yes	Yes	Yes	Yes	Yes
System diagnostics view	Yes	Yes	Yes	Yes	Yes
System diagnostics window	Yes	Yes	Yes	Yes	Yes
Text field	Yes	Yes	Yes	Yes	Yes
Clock	Yes	Yes	Yes	Yes	Yes
Effective range signal	No	No	No	No	No
Effective range name	No	No	No	No	No
Effective range name (RFID)	No	No	No	No	No
WLAN reception	No	No	No	Yes	Yes
Gauge	Yes	Yes	Yes	Yes	Yes
Zone name	No	No	No	No	No
Zone signal	No	No	No	No	No

**See also**

Objects for Basic Panels (Page 3077)

**Objects for Multi Panels****Availability of display and operating elements for Multi Panels**

Only the objects which can be used for the device you are configuring will be shown in the object window. The following table shows the availability of indicator and control objects for the Multi Panels.

**Overview**

	MP 177	MP 277	MP 377
Bar	Yes	Yes	Yes
User view	Yes	Yes	Yes
Date/time field	Yes	Yes	Yes
I/O field	Yes	Yes	Yes

Visualizing processes (Comfort/Advanced)

10.1 Creating screens

	MP 177	MP 277	MP 377
Ellipse	Yes	Yes	Yes
f(x) trend view	No	No	No
Function key	only on keyboard units		
Graphic view	Yes	Yes	Yes
Graphic I/O field	Yes	Yes	Yes
Handwheel	No	No	No
Help indicator	No	No	No
HTML browser	No	No	No
Circle	Yes	Yes	Yes
Trend view	Yes	Yes	Yes
Charging condition	No	No	No
Illuminated pushbutton	No	No	No
Line	Yes	Yes	Yes
Media Player	No	No	Yes
Alarm view, Alarm window	Yes	Yes	Yes
Alarm indicator	Yes	Yes	Yes
Polygon	Yes	Yes	Yes
Polyline	Yes	Yes	Yes
Rectangle	Yes	Yes	Yes
Recipe view	Yes	Yes	Yes
Button	Yes	Yes	Yes
Switch	Yes	Yes	Yes
Slider	Yes	Yes	Yes
Key switch	No	No	No
Sm@rtClient view	Yes	Yes	Yes
Status/Force	Yes	Yes	Yes
Symbol library	Yes	Yes	Yes
Symbolic I/O field	Yes	Yes	Yes
System diagnostics display	No	No	No
System diagnostics window	No	No	No
Text field	Yes	Yes	Yes
Clock	Yes	Yes	Yes
Effective range signal	No	No	No
Effective range name	No	No	No
Effective range name (RFID)	No	No	No
WLAN reception	No	No	No
Gauge	Yes	Yes	Yes
Zone name	No	No	No
Zone signal	No	No	No

**See also**

Objects for Basic Panels (Page 3077)

**Objects for Mobile Panels****Availability of display and operating elements for Mobile Panels**

Only the objects which can be used for the device you are configuring will be shown in the object window. The following table shows the availability of indicator and control objects for the Mobile Panels.

**Overview**

	Mobile Panel 177 DP	Mobile Panel 177 PN	Mobile Panel 277	Mobile Panel 277 IWLAN V2	Mobile Panel 277F IWLAN V2	Mobile Panel 277F IWLAN (RFID Tag)
Bar	Yes	Yes	Yes	Yes	Yes	Yes
User view	Yes	Yes	Yes	Yes	Yes	Yes
Date/time field	Yes	Yes	Yes	Yes	Yes	Yes
I/O field	Yes	Yes	Yes	Yes	Yes	Yes
Ellipse	Yes	Yes	Yes	Yes	Yes	Yes
f(x) trend view	No	No	No	No	No	No
Function key	Yes	Yes	Yes	Yes	Yes	Yes
Graphic view	Yes	Yes	Yes	Yes	Yes	Yes
Graphic I/O field	Yes	Yes	Yes	Yes	Yes	Yes
Handwheel	Yes <sup>1)</sup>	Yes <sup>1)</sup>	Yes <sup>1)</sup>	Yes <sup>1)</sup>	Yes <sup>1)</sup>	Yes <sup>1)</sup>
Help indicator	No	No	No	No	No	No
HTML browser	No	No	No	No	No	No
Circle	Yes	Yes	Yes	Yes	Yes	Yes
Trend view	Yes	Yes	Yes	Yes	Yes	Yes
Charging condition	No	No	No	Yes	Yes	Yes
Illuminated pushbutton	Yes <sup>1)</sup>	Yes <sup>1)</sup>	Yes <sup>1)</sup>	Yes <sup>1)</sup>	Yes <sup>1)</sup>	Yes <sup>1)</sup>
Line	Yes	Yes	Yes	Yes	Yes	Yes
Media Player	No	No	No	No	No	No
Alarm view, Alarm window	Yes	Yes	Yes	Yes	Yes	Yes
Alarm indicator	Yes	Yes	Yes	Yes	Yes	Yes
Polygon	Yes	Yes	Yes	Yes	Yes	Yes
Polyline	Yes	Yes	Yes	Yes	Yes	Yes
Rectangle	Yes	Yes	Yes	Yes	Yes	Yes
Recipe view	Yes	Yes	Yes	Yes	Yes	Yes
Button	Yes	Yes	Yes	Yes	Yes	Yes
Switch	Yes	Yes	Yes	Yes	Yes	Yes

10.1 Creating screens

	Mobile Panel 177 DP	Mobile Panel 177 PN	Mobile Panel 277	Mobile Panel 277 IWLAN V2	Mobile Panel 277F IWLAN V2	Mobile Panel 277F IWLAN (RFID Tag)
Slider	Yes	Yes	Yes	Yes	Yes	Yes
Key switch	Yes <sup>1)</sup>	Yes <sup>1)</sup>	Yes <sup>1)</sup>	Yes <sup>1)</sup>	Yes <sup>1)</sup>	Yes <sup>1)</sup>
Sm@rtClient view	No	Yes	Yes	Yes	Yes	Yes
Status/Force	Yes	Yes	Yes	Yes	Yes	Yes
Symbol library	Yes	Yes	Yes	Yes	Yes	Yes
Symbolic I/O field	Yes	Yes	Yes	Yes	Yes	Yes
System diagnostics display	No	No	No	No	No	No
System diagnostics window	No	No	No	No	No	No
Text field	Yes	Yes	Yes	Yes	Yes	Yes
Clock	No	No	Yes	Yes	Yes	Yes
Effective range signal	No	No	No	No	Yes	Yes
Effective range name	No	No	No	No	Yes	No
Effective range name (RFID)	No	No	No	No	No	Yes
WLAN reception	No	No	No	Yes	Yes	Yes
Gauge	Yes	Yes	Yes	Yes	Yes	Yes
Zone name	No	No	No	Yes	Yes	No
Zone signal	No	No	No	Yes	Yes	No

1) optional operator control

**See also**

Objects for Basic Panels (Page 3077)

**Objects for WinCC Runtime Advanced**

**Availability of display and operating elements for WinCC Runtime Advanced**

Only the objects which can be used for the device you are configuring will be shown in the object window. The following table shows the availability of indicator and control objects for WinCC Runtime Advanced.

**Overview**

WinCC Runtime Advanced	
Bar	Yes
User view	Yes
Date/time field	Yes
I/O field	Yes
Ellipse	Yes
f(x) trend view	Yes
Function key	No
Graphic view	Yes
Graphic I/O field	Yes
Handwheel	No
Help indicator	No
HTML browser	Yes
Circle	Yes
Trend view	Yes
Charging condition	No
Illuminated pushbutton	No
Line	Yes
Media Player	No
Alarm view, Alarm window	Yes
Alarm indicator	Yes
Polygon	Yes
Polyline	Yes
Rectangle	Yes
Recipe view	Yes
Switch	Yes
Button	Yes
Slider	Yes
Key switch	No
Sm@rtClient view	Yes
Status/Force	Yes
Symbol library	Yes
Symbolic I/O field	Yes
System diagnostics display	Yes
System diagnostics window	Yes
Text field	Yes
Clock	Yes
Effective range signal	No
Effective range name	No

WinCC Runtime Advanced	
Effective range name (RFID)	No
WLAN reception	No
Gauge	Yes
Zone name	No
Zone signal	No

**See also**

Objects for Basic Panels (Page 3077)

**10.1.8.2 Objects**

**Bar**

**Application**

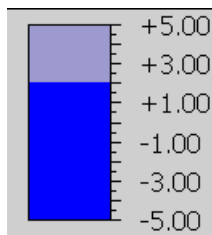

isplayed graphically using the "Bar" object. The bar graph can be labeled with

**Layout**

In the Inspector window, you customize the settings for the position, shape, style, color, and font types of the object. You can adapt the following properties in particular:

- Color transition: Specifies the change in color display when limit values are exceeded.
- Displaying the limit lines / limit markers: Shows the configured limit as a line or marker.
- Define bar segments: Defines the gradations on the bar scale.
- Define scale gradation: Defines the subdivisions, scale markings and intervals of a bar scale.

**Color transition**

You define how the color change is represented in "Properties > Properties > Appearance" in the Inspector window.

Color transition	Description
"Segmented"	If a particular limit was reached, the bar changes color segment by segment. With segment by segment representation, you visualize, for example, which limits are exceeded by the displayed value.
"Entire bar"	If a particular limit was reached, the entire bar changes color.

## Displaying limit lines and limit markers

You display the configured limit in the bar as a line or marking in Runtime using the "Lines" and "Markings" property:

1. In the Inspector window, select "Properties > Properties > Appearance":
2. Activate "Lines" and "Markings".

## Define bar segments

Use the "Subdivisions" property to define the number of segments into which the bar is divided by the main gradations on the scale.

Use the "Interval" property to divide the distance between the main gradations. The value appears as the difference in value between two adjacent main gradations:

1. In the Inspector window, select "Properties > Properties > Scales":
2. Activate "Show scale."
3. Select the corresponding value for "Settings > Subdivisions".
4. Select the corresponding value for "Settings > Marks label".
5. Select the corresponding value for "Large interval > Interval".

## See also

Device-Specific Nature of the Objects (Page 3077)

## User view

## Application

The "User view" object is used to set up and administer users and authorizations. The user view is used, for example, to create new users in runtime and assign them to a user group.

---

### Note

Configure only one user view at a time in one screen on the HMI devices TP 177A 6", TP 177A 6" (Portrait), OP 73 and OP 77A. Otherwise, a corresponding error message appears during generation.

---

### Complex user view

The complex or simple user view is available for administration of users and authorizations depending on the HMI devices.

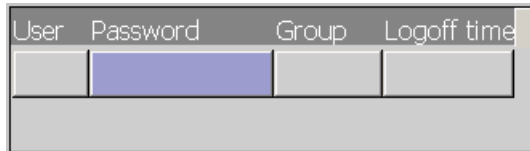

User	Password	Group	Logoff time

### Simple user view

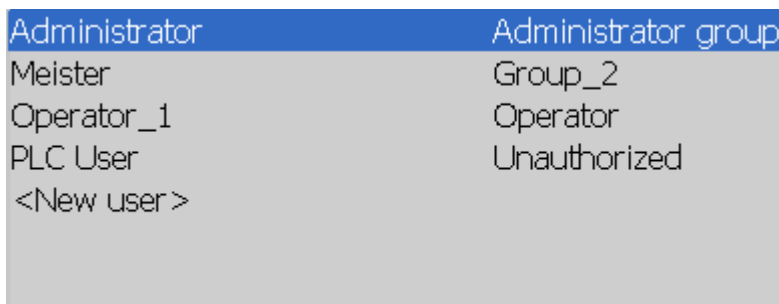

Administrator	Administrator group
Meister	Group_2
Operator_1	Operator
PLC User	Unauthorized
<New user >	

Proceed as follows to configure the appropriate user view:

1. Click "Properties > Properties > Layout > Mode" in the inspector window.
2. Select "Simple" or "Complex".

### Layout

In the Inspector window, you customize the position, shape, style, color and font types of the object. You can adapt the following properties in particular:

- Number of lines: Specifies the maximum number of visible entries.
- Columns moveable: Specifies whether the operator can change the sequence of columns in Runtime.

### Number of lines

The number of lines in the user view displayed in Runtime is specified in the Inspector window. The setting for the number of lines is only effective if "Fit object to contents" is active.

1. Click "Properties > Properties > View" in the Inspector window.
2. Enter an integer value under "Number of lines".
3. In the Inspector window, select "Properties > Properties > Layout".
4. Activate "Fit object to contents."



## Columns moveable

The operator can change the sequence of columns in Runtime with the "Columns movable" property.

1. In the Inspector window, select "Properties > Properties > Layout".
2. Activate "Columns moveable".

This option is only available at the complex user view.

## See also

Device-Specific Nature of the Objects (Page 3077)

Configuring a user view (Page 3519)

Complex user view (Page 3518)

Creating users (Page 3519)

Basic user view (Page 3516)

## Date/time field

### Application

The "Date/time field" object shows the system time and the system date. The appearance of the "Date/time field" depends on the language set on the HMI device.

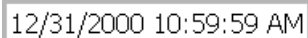

12/31/2000 10:59:59 AM

### Layout

In the Inspector window, you customize the position, style, colors and font types of the object. You can adapt the following properties in particular:

- Display system time: Specifies that the system time is displayed.
- Include tag: Specifies that the time of the connected tag is displayed.
- Long date/time format: This setting defines the format displayed for the data and time.

### Display system time

The time displayed in the "Date/time field" on the HMI device is specified in the inspector window.

1. In the Inspector window, select "Properties > Properties > General".
2. Activate "Format > System time".

### Using tags

The time of the interconnected tag is displayed in the date/time field.

1. In the Inspector window, select "Properties > Properties > General".
2. In the "Format" area, select a tag with the "DateTime" data type, e.g. an internal tag.

### Long date/time format

Visualization of the date and time is specified in the "Format" area under "General" in the inspector window.

Option	Description
"Enabled"	Date and time are displayed in full, e.g. "Sunday, December 31, 2000 10:59:59 AM"
"Disabled"	Date and time are displayed in short form, e.g. "12/31/2000 10:59:59 AM"

### See also

Device-Specific Nature of the Objects (Page 3077)

Example: 2. Configuring a Date/time field (Page 4908)

### I/O field

### Application

The "I/O field" object is used to enter and display process values.

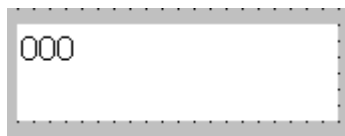

## Layout

In the Inspector window, you customize the position, shape, style, color and font types of the object. You can adapt the following properties in particular:

- **Mode:** Specifies the response of the object in Runtime.
- **Display format:** Specifies the display format in the I/O field for input and output of values.
- **Hidden input:** Specifies whether the input value is displayed normally or encrypted during input.

---

### Note

#### Reports

In reports, I/O fields only output data. "Output" mode is preset. Properties for configuring input are not available, e.g. "hidden input".

---

## Mode

The response of the I/O field is specified in the Inspector window in "Properties > Properties > General > Type".

Mode	Description
"Input"	Values can only be input into the I/O field in runtime.
"Input/output"	Values can be input and output in the I/O field in runtime.
"Output"	The I/O field is used for the output of values only.

## Layout

The "display format" for the input and output of values is specified in "Properties > Properties > General > Format" in the Inspector window.

Layout	
"Binary"	Input and output of values in binary form
"Date"	Input and output of date information. The format depends on the language setting on the HMI device.
"Date/time"	Input and output of date and time information. The format depends on the language setting on the HMI device.
"Decimal"	Input and output of values in decimal form
"Hexadecimal"	Input and output of values in hexadecimal form
"Time"	Input and output of times. The format depends on the language setting on the HMI device.
"Character string"	Input and output of character strings.

---

**Note**

**Data formats**

Not all data formats are available for selection for Runtime Professional.

---

## Hidden input

In Runtime the input can be displayed normally or encrypted, for example for hidden input of a password. A "\*" is displayed for every character during hidden input. The data format of the value entered cannot be recognized.

1. In the Inspector window, select "Properties > Properties > Response":
2. Activate "Hidden input".

## Avoid overlaps in output fields

If several I/O fields are configured as output fields with a transparent background in a screen, these I/O fields may overlap. The transparent part of the one field covers the digits of the other field. This may cause display problems in Runtime. In order to avoid such overlaps, set the margins of the I/O fields to zero in the object properties under "Properties > Properties > Appearance". Activate "Properties > Properties > Layout > Fit object to contents."

## See also

Using multiple tags simultaneously in a screen (Page 3180)

Device-Specific Nature of the Objects (Page 3077)

## Ellipse

### Application

The "Ellipse" is an enclosed object that can be filled with a color or pattern.



### Layout

In the Inspector window you can customize the settings for the object position, geometry, style, frame and color. You can adapt the following properties in particular:

- Horizontal radius: Specifies the horizontal radius of the elliptical object.
- Vertical radius: Specifies the vertical radius of the elliptical object.

## Horizontal radius

The horizontal radius of the "Ellipse" object is specified in the Inspector window. The value is entered in pixels.

1. In the Inspector window, select "Properties > Properties > Layout".
2. Enter a value between 0 and 2500 under "Horizontal."

## Vertical radius

The vertical radius of the "Ellipse" object is specified in the Inspector window. The value is entered in pixels.

1. In the Inspector window, select "Properties > Properties > Layout".
2. Enter a value between 0 and 2500 at "Vertical."

## See also

Device-Specific Nature of the Objects (Page 3077)

Rotating objects (Page 2963)

Flipping objects (Page 2965)

## f(x) trend view

### Application

You use the "f(x) trend view" object to represent the values of a tag as a function of another tag. This means that you can present temperature trends as a function of the pressure, for example. You can also compare the trend to a setpoint trend.

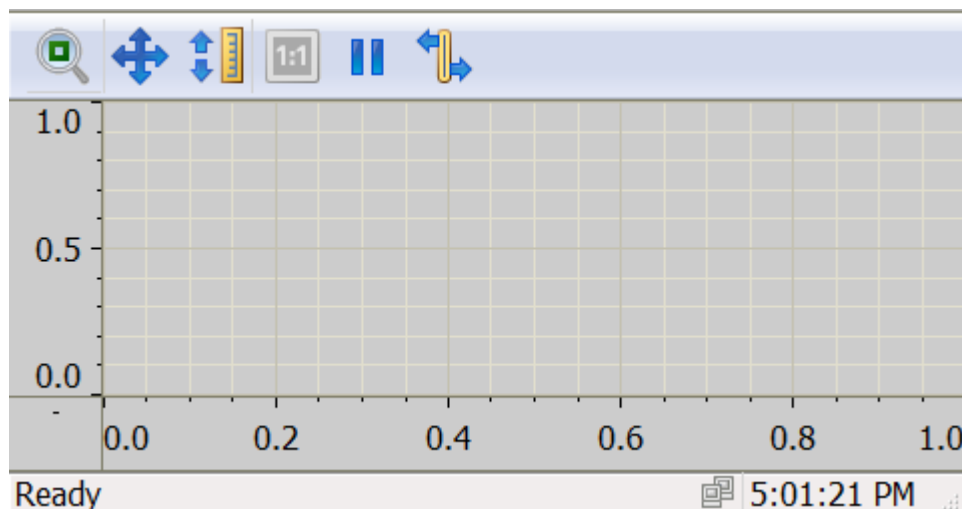

## Layout

In the Inspector window, you customize the position, shape, style, colors and font types of the object. You can adapt the following properties in particular:

- Adding and configuring trends
- Configuring a diagram
- Window settings
- Persistence
- Toolbar

## Configuring trends

You create and configure trends in the Inspector window "Properties > Properties > Properties > Trend".

1. Select the data supply for the trend in the "Data source" column.
  - "Log tag": The trend window is supplied with values from a data log.
  - "Tags": The trend view is supplied with current values from the PLC. The values are constantly updated.
2. Configure the area of the trend display under "Data area".
  - "Time span": You define the time range using a starting time and a following time span.
  - "End time": You define the time range using a starting time and an end time.
  - "Measuring points": You define the time range using a starting time and a number of measuring points.
3. Configure the value range of the trend display under "X axis" and "Y axis".
4. Under "Limits", configure the colored marking of specific values, .e.g.. high and low limit, uncertain status.









## Configuring a diagram

Configure the display of several trends under "Properties > Properties > Appearance":

- Common diagram or separate diagrams
- Common or separate axes
- Writing direction of all trends

## Toolbar

The control elements of the  $f(x)$  trend display are defined in the "Properties > Properties > Toolbar" inspector window. The following control elements are available for the  $f(x)$  trend view:

Button	Name	Function
	Zoom +/-	Increases or decreases the size of the trends in the trend window. Increase the size of the trends by left-clicking with the mouse. Hold down <Shift> and left-click to decrease the size of the trends.
	Zoom area	Increases the size of any section of the trend window. Specify an area in the trend window by using the mouse. This area of the trend window is enlarged.
	Zoom X axis	Increases or decreases the size of the X axis in the trend window. Enlarge the X axis by left-clicking with the mouse. Hold down <Shift> and left-click to decrease the size of the X axis.
	Zoom Y axis	Increases or decreases the size of the Y axis in the trend window. Enlarge the Y axis by left-clicking with the mouse. Hold down <Shift> and left-click to decrease the size of the Y axis.
	Trend area	Shift the trends in the trend window along the X axis and Y axis by using this button.
	Axis area	Shift the trends in the trend window along the value axis by using this button.
	Original view	Switches from the magnified trend view back to the normal view
	Start/stop	Stops and starts the trend update. The values are buffered and updated as soon as you start trend update again.
	Ruler	Determines the coordination of a point of the trend.

The order of the buttons is fixed. The operator can set up individual key assignments, and shortcuts for every button on the toolbar.

## See also

Bar (Page 3086)

Device-Specific Nature of the Objects (Page 3077)

Trend view (Page 3104)

## Graphic view

### Application

The "Graphic view" object is used to display graphics.



### Layout

In the Inspector window, you customize the position, shape, style, color and font types of the object. You can adapt the following properties in particular:

- Graphic: Specifies the graphic file that is displayed in the object.
- Stretch graphic: Specifies the automatic size stretching for objects with graphics.
- Transparent color: Specify whether or not the transparent color is used for the graphic.

### Inserting graphics

The following graphic format is used in the "Graphic view" object: \*.bmp, \*.tif, \*.png, \*.ico, \*.emf, \*.wmf, \*.gif, \*.jpg or \*.jpeg. You may also use graphics as OLE objects in the Graphic view .

1. In the Inspector window, select "Properties > Properties > General":
2. Select the graphic that you wish to insert.  
The graphic preview is shown in the right pane.
3. Click "Apply" to insert the graphic in the Graphic view .

### Stretch graphic

Whether a graphic displayed in a Graphic view is stretched to the size of the Graphic view in runtime is specified in the Inspector window.

1. Click "Properties > Properties > Layout" in the inspector window.
2. Select the required size adjustment for the graphic.



## Transparent color

This property defines whether the transparent color is used for the graphic to be displayed.

1. Click "Properties > Properties > Appearance" in the inspector window:
2. Activate "Background > Transparent".
3. Select a transparent color.

---

### Note

When using bitmaps in WinCC screens the "Transparent color" setting demands a high character performance in the layout on the panel. Visualization performance is enhanced by disabling the "Transparent" setting in the properties of the relevant display object. This restriction applies in particular when bitmaps are used as background image.

---

### Note

#### Basic Panels

The "Transparent" property is not available for Basic Panels.

---

## See also

Device-Specific Nature of the Objects (Page 3077)

Options for Editing Objects (Page 2953)

Storing an external image in the graphics library. (Page 2977)

## Graphic I/O field

### Application

The "Graphic I/O field" object can be used to configure a list for display and selection of graphic files.



## Layout

In the Inspector window, you customize the position, shape, style, color and font types of the object. You can adapt the following properties in particular:

- Mode: Specifies the response of the object in Runtime.
- Scroll bar type: Specifies the graphic layout of the scroll bar.

**Note**

**Basic Panels**

The scroll bar is not available for Basic Panels.

**Note**

**Reports**

Graphic I/O fields output exclusively graphics in reports. "Output" mode is preset. Properties for configuring the selection of graphics are not available, e.g. "scroll bar".

**Mode**

The response of the "Graphic I/O field" object is specified under "Properties > Properties > General > Type > Mode" in the Inspector window.

Mode	Description
"Input"	The "Graphic I/O field" object is only used to select graphics.
"Input/output"	The "Graphic I/O field" object is used to select and display graphics.
"Output"	The "Graphic I/O field" object is used to display graphics only.
"Two states"	The "Graphic I/O field" object is only used to display graphics and can have a maximum of two states. You use no graphics list but insert one graphic each for the "ON" and "OFF" state.

**Stretch graphic**

Whether a graphic displayed in a graphic I/O field is stretched to the size of the view in runtime is specified in the Inspector window.

1. In the Inspector window, select "Properties > Properties > Layout".
2. Select the required size adjustment for the graphic.

**Scroll bar type**

The response for the graphic representation of the scroll bar is specified under "Properties > Properties > Appearance > Scroll Bar > Type" in the Inspector window.

Type	Description
"Permanent"	The scroll bar is always visible.
"No scrollbar"	The scroll bar is not visible.
"Visible after clicking"	The scroll bar is made visible by a mouse click.

## See also

Device-Specific Nature of the Objects (Page 3077)

Symbolic I/O field (Page 3142)

## Handwheel

### Application

The object "Handwheel" is a control element for some SIMATIC Mobile Panels. You can enter incremental values in Runtime using the "HandWheel" object.



### Layout

You can set the following property in the Inspector window:

- Tag: Specifies the tags to which the "HandWheel" object is linked.

### Tag

#### Global assignment

The "Tag" property is specified in the template for the global assignment of the "HandWheel" object. There is only one template for each HMI device.

1. In the Inspector window, select "Properties > Properties > General".
2. Select a tag from the selection list under "Settings > Tag".

#### Local assignment

The "HandWheel" object is assigned to another tag. To do so you configure a function that assigns the tag to the handwheel in Runtime.

Example for configuration to a button:

1. Open the screen in which the "HandWheel" object is assigned to another tag.
2. Drag the "Button" object from the toolbox to the screen. Select the button on your screen.
3. Click "Properties > Events > Click" in the Inspector window.

## 10.1 Creating screens

4. The "Function list" dialog box opens. Click the first line of the function list. The list of system functions and scripts available in the project appears.
5. Select the system function "SetTagToHandWheel" from the "Other functions" group. Select a tag from the combo box at "Value".

---

### Note

The Mobile Panel may ignore the change of the value in the PLC made at another location while the handwheel is being operated. The value in the PLC is overwritten again.

---

### See also

Device-Specific Nature of the Objects (Page 3077)

Illuminated pushbutton (Page 3106)

### Help indicator

#### Application

The object "help indicator" is available for the HMI devices OP 73 and KP300 Basic. If a tooltip exists for the selected object, the help indicator is displayed during runtime. If a tooltip was configured for the opened screen, the help indicator always remains visible.



You configure the object "help indicator" exclusively in the global screen.

#### Layout

You can adapt the following properties in the Inspector window:

- Position: Determines the position of the object "Help indicator."

#### Position

You can use this property to set the position of the object "Help indicator."

1. Select the object "Help indicator" in the template.
2. In the Inspector window, select "Properties > Properties > Layout".
3. Enter a value for X and Y. You can also use the cursor keys to position the selected object.

If you have configured a screen object at this position, the visible help indicator covers the screen object. The help indicator is covered only by incoming system alarms and dialogs.

### See also

Device-Specific Nature of the Objects (Page 3077)

## HTML browser

### Application

The "HTML Browser" object is designed for the visualization of simple HTML pages. This function allows you to draw up machine-specific descriptions which are stored centrally and which can then be displayed from different HMI devices.



---

### Note

Changing the functionality of the HTML Browser to that of a file explorer by one of the following methods, for example, is not authorized in the context of WinCC:

- Entering a folder or drive, for example "\" or "C:" or
- Connecting to an FTP server, for example "ftp://"

One reason this function is not implemented is to prevent inadvertent changes to files, their deletion or execution.

When configuring, ensure that the operator can only enter valid Internet addresses, for example, by using symbolic I/O fields. Configure a password-protected input for service purposes.

---

### Layout

Customize the object position and size in the Inspector window. In particular, you can customize the following property:

- URL: Specifies which Internet address is opened in the HTML Browser.

### Address

The internet address is specified in "Properties > Properties > General >URL" in the Inspector window.

## Basic procedure

1. Create an internal tag of the "String" data type, for example InternetAddress, in the "Tag" editor.
2. Insert the "HTML Browser" object in the screen in the "Screens" editor.
3. In the Inspector window, select "Properties > Properties > General".
4. At "Tag for the URL", select the "InternetAddress" tag from the selection list.
5. Insert an I/O field in the screen in the "Screens" editor.
6. Select "Properties > Properties > General > Tag for URL" in the Inspector window and then select the "InternetAddress" tag at "URL tag" from the selection list.

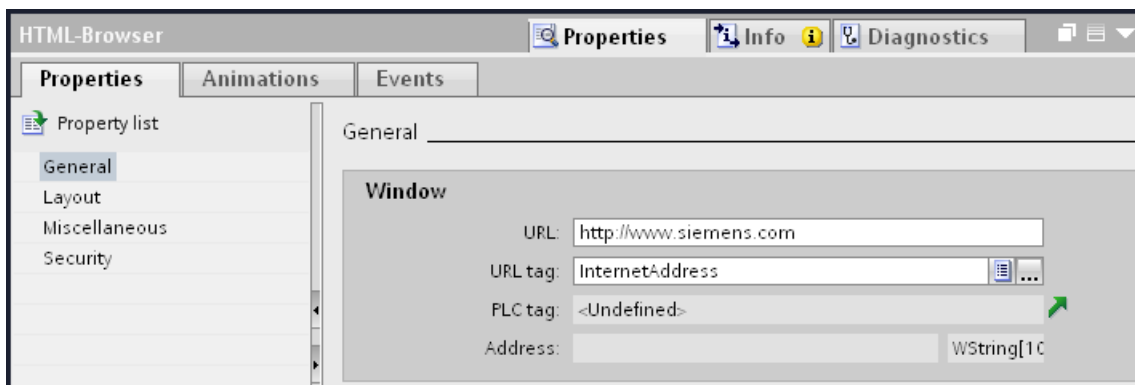

The HTML Browser opens the relevant page after the operator has entered an address.

## Control elements

Control elements are configured buttons in the process screen or softkeys on the HMI device.

The "HTML Browser" object does not have its own operator control components. Assign the system functions used to control the "HTML Browser" object to your configured control elements, such as buttons.

1. For example, drag the "Button" object to the screen from the toolbox.
2. Input a text of any length or select a graphic, for example Update.
3. In the Inspector window, select "Properties > Events > Click".  
The "Function list" dialog box is opened.
4. The system functions for controlling the "HTML Browser" object can be found in the list of system functions in the "Keyboard online operation for screen objects".  
Select a function from the list, for example, HTMLBrowserRefreshName.
5. Select the object name of the HTML Browser in which the command will be executed from the "Screen object" list.

## Comments

The functional scope of the HTML Browser is limited in comparison to the Internet Explorer:

- The HTML Browser will only show pure HTML pages. VBScript, Java, JavaScript, Flash and ActiveX controls are not supported. Set up the HTML pages for display in the HTML Browser by using a text editor or using a simple HTML editor.
- Links to embedded files, for example \*.pdf or \*.xls, are not supported.
- Queries and dialogs that are conducted during the access of, for example protected pages are not supported. When accessing protected pages enter your user name and password in the URL: <http://User\_Name:Password@Server\_Name> (for example, "http://Administrator:Admin123@192.168.0.199").

## Circle

### Application

The "Circle" object is a closed object which can be filled with a color or pattern.

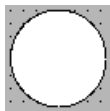

### Layout

In the Inspector window you can customize the settings for the object position, geometry, style, frame and color. You can adapt the following properties in particular:

- Radius: Specifies the size of the circle.

### Radius

The radius of the "Circle" object is specified in the Inspector window. The value is entered in pixels.

1. In the Inspector window, select "Properties > Properties > Layout".
2. Enter a value between 0 and 2500 in the "Radius" area.

### See also

Device-Specific Nature of the Objects (Page 3077)

## Trend view

### Application

The trend view is meant for the graphical representation of tag values from the current process or from a log in form of trends.

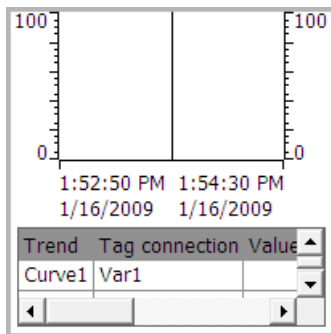

### Layout

In the Inspector window, you customize the position, geometry, style, color, and font types of the object. You can adapt the following properties in particular:

- Display value table, ruler and grid: Specifies whether a value table, a ruler or a grid is displayed in addition to the coordinate system to improve legibility.
- Toolbars: Defines the display of the control elements.

### Display value table, ruler and grid

For improved legibility a value table, a ruler and a grid can be displayed in Runtime.

1. Activate "Properties > Properties > Appearance > Show ruler".
2. Activate "Properties > Properties > Table > Show table".
3. Activate "Properties > Properties > Table > Show grid".

### Toolbars

The layout of the control elements is defined in the "Properties > Properties > Toolbar" inspector window.

---









#### Note

##### Basic Panels

As archiving is not possible for Basic Panels, the control elements are not available.

---



Toolbar button	Brief description	Description
	"Go to start"	Scrolls back to the beginning of the trend recording. The start values with which the trend recording started are displayed.
	"Zoom in"	Zooms out of the displayed time section
	"Zoom out"	Zooms into the displayed time section.
	"Ruler backward"	Moves the ruler back.
	"Ruler forward"	Moves the ruler forward.
	"Backward"	Scrolls back one display width.
	"Forward"	Scrolls forward one display width.
	"Ruler"	Shows or hides the ruler. The ruler displays the X-value associated with a Y-value.
	"Start/stop"	Stops trend recording or continues trend recording.

## Configuration behavior

### Displaying column headers

The layout of the table in the trend view depends on the view settings in the Control Panel. Depending on the setting, the column headers may be truncated. This setting is found under "Display > Appearance" in the control panel. To display column headers correctly, set the display in "Windows and buttons" to "Windows Classic" style.

This behavior only occurs during configuration. The column headers are displayed correctly in Runtime.

### Consistency test

If warnings or errors are displayed in the output window during a consistency check in connection with trend views, clicking "Go to Error/Tag" on the shortcut menu will not always take you to the exact error position. In some cases only the trend view is shown as cause of error.

### Adding, configuring, and removing trends

The trends of the trend view are managed in the Inspector window under "Properties > Properties > Trend". You can copy trends between different trend views.

### See also

Device-Specific Nature of the Objects (Page 3077)

Configuring trend displays for values from the PLC (Page 3240)

Trends (Page 3237)

Outputting tag values in screens (Page 3239)



Configuring trend display for values from the PLC (Basic) (Page 3236)

## Charging status

### Application

The object "Charging condition" is a control element for some SIMATIC Mobile Panels. The "Charging condition" object indicates the charging status of the battery. Charge the battery in good time. Alternatively, you can replace the battery with a spare battery.

### Layout

Symbol	Description	Charging condition
	Battery is charged	>20 %
	Battery must be charged	<20 % and >6 %
	Battery is weak	< 6 %

### Operation

The object is for display only and cannot be controlled by the operator.

### See also

- Device-Specific Nature of the Objects (Page 3077)
- Effective range name (Page 3152)
- Effective range name (RFID) (Page 3154)
- Effective range signal (Page 3156)
- WLAN reception (Page 3157)
- Zone name (Page 3160)
- Zone signal (Page 3161)

## Illuminated pushbutton

### Application

The object "Illuminated pushbutton" is a control element for some SIMATIC Mobile Panels. The LEDs can be activated by the PLC. The illuminated LED signals the operator in Runtime

that the illuminated pushbutton has to be pressed. The illuminated pushbutton is configured in the global screen.



## Layout

You can adapt the following properties in the Inspector window:

- Tag: Specifies the tag in which the status of the illuminated pushbutton is written.
- LED assignment: Specifies the assignment of the LED to the bit in the LED tag.

## Tag

The "Tag" property is used to specify the global assignment of the "Illuminated pushbutton" object in the global screen.

---

### Note

#### Information for configuring

The current status of the illuminated pushbutton is written to the tag when Runtime is started and whenever the button is pressed. This may cause inconsistencies between the status of the illuminated pushbutton and the illuminated pushbutton tags.

1. If the tag has a connection to the PLC, the current value is transferred from the PLC to the tag after establishment of communication. The tag that contains the current status of the key is overwritten by this process. The illuminated pushbutton tag may therefore no longer reflect the current value of the illuminated pushbutton, for example if the Mobile Panel is switched off while the illuminated pushbutton is pressed.
2. If the illuminated pushbutton is pushed before communication to the PLC could be established (for example after a device start-up), it may not be possible to send the value of the illuminated pushbutton tag to the PLC. In this case the value of the tag in the PLC is different from the current status of the key.

Carry out the following configuration steps so that the illuminated pushbutton always reflects the actual state.

---

**Basic procedure**

1. Specify the connection to the PLC in the "Connections" editor. Activate the "Coordination" area pointer to ensure that the life bit is available to the PLC side.

Parameter		Area pointer					
Active	Display name	PLC tag	Access mode	Address	Length	Acquisition mode	Acquisition cycle
<input checked="" type="checkbox"/>	Coordination	<undefined>	<absolute access>	%DB1.DBW0	1	Cyclic continuous	<Undefined>
<input type="checkbox"/>	Date/time	<undefined>	<symbolic access>		6	Cyclic continuous	<Undefined>
<input type="checkbox"/>	Job mailbox	<undefined>	<symbolic access>		4	Cyclic continuous	<Undefined>
<input type="checkbox"/>	Data record	<undefined>	<symbolic access>		5	Cyclic continuous	<Undefined>

Global area pointer of HMI device							
Connection	Display name	PLC tag	Access mode	Address	Length	Acquisition mode	Acquisition cycle
<Undefined>	Project ID	<undefined>	<symbolic access>		1	Cyclic continuous	<Undefined>
<Undefined>	Screen number	<undefined>	<symbolic access>		5	Cyclic continuous	<Undefined>
<Undefined>	Date/time PLC	<undefined>	<symbolic access>		6	Cyclic continuous	<Undefined>

2. Open the "HMI tags" editor and create three tags.
  - Internal tag: Pushbutton\_State
  - External tag: BufferTag
  - External tag: Pushbutton\_PLC
3. Open the Inspector window of the "Pushbutton\_State" tag.
4. In the Inspector window, select "Properties > Events > Value change". Click the first line of the function list. The list opens, showing the system functions available in the project.
5. Select the "SetTag" system function.
  - Select the "Pushbutton\_PLC" tag at "Tag (output)".
  - Select the "Pushbutton\_State" tag at "Value".

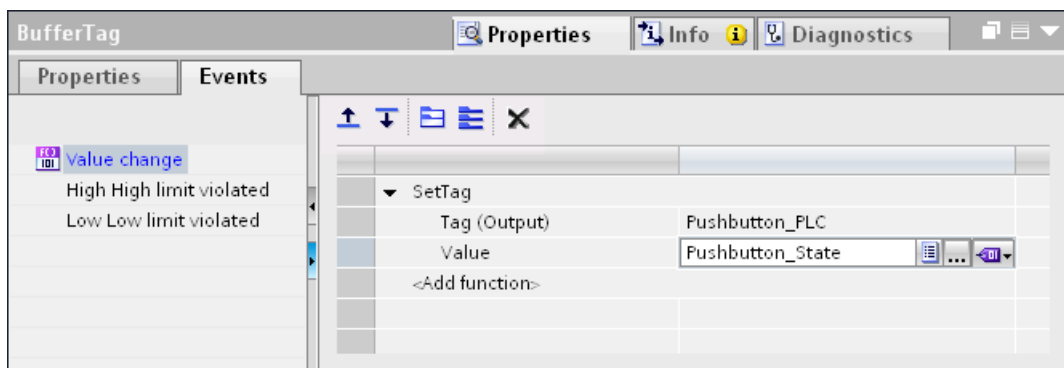

The value of the "Pushbutton\_PLC" tag is written to the PLC with the "Pushbutton\_PLC" tag. A program in the PLC evaluates the life bit. If communication is established, the current value is written to the "Pushbutton\_PLC" tag from the PLC. The "BufferTag" is required to transfer the current position of the pushbutton to the PLC.

6. Open the Inspector window of the "BufferTag" tag.
7. In the Inspector window, select "Properties > Events > Value change".
8. Click the first line of the function list. The list opens, showing the system functions available in the project.
9. Select the "SetTag" system function.
  - Select the "Pushbutton\_PLC" tag at "Tag (output)".
  - Select the "Pushbutton\_State" tag at "Value".

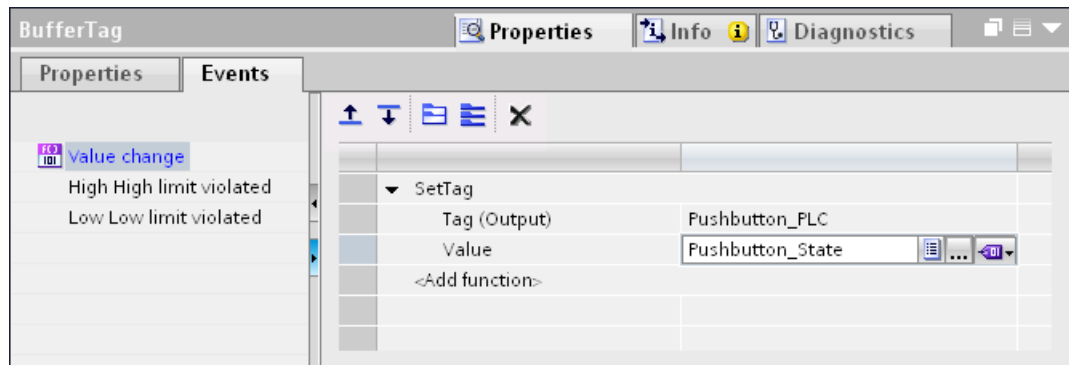

After establishing communication the current value is written to the "BufferTag" from the PLC. The "SetTag" system function is executed by the value change in the auxiliary tag. The system function re-allocates the value of the "Pushbutton\_State" tag to the "Pushbutton\_PLC" tag.

10. Open the global screen in the "Screen navigation" editor.
11. Select the illuminated key on the global screen.
12. Select the tag "Pushbutton\_State" in "Properties > Properties > General > Settings > Tag" in the Inspector window.
  - If you press the illuminated pushbutton, the value is written to the "Pushbutton\_PLC" tag.

## LED assignment

To actuate the LED an LED tag or an array tag must be set up in the PLC and specified as an LED tag during configuration. The LED tag is specified at "LED tag" in the "Settings" area in the "General" group. With "LED bit" the allocated bit is given. When the bit is set the following states of the LED can be realized in runtime.

Bit n+1	Bit n	LED function
0	0	Off
0	1	Fast flash
1	0	Slow flash
1	1	On permanently

## See also

Device-Specific Nature of the Objects (Page 3077)

Handwheel (Page 3099)

## Line

### Application

The "Line" object is an open object. The line length and gradient slope are defined by the height and width of the rectangle enclosing the object.



### Layout

In the Inspector window, you customize the settings for the object position, shape, style, and color. You can adapt the following properties in particular:

- Line style
- Line start and end

### Line style

The representation of the line is specified under "Properties > Properties > Appearance" in the Inspector window. The line is shown without interruption if you select "Solid", for example.

---

#### Note

The line styles available depend on the selected HMI device.

---

### Line start and end

The start and end points of the line are specified under "Properties > Properties > Appearance > Line ends" in the Inspector window.

Use arrow point, for example, as start and end point. The available start and end points depend on the device.

## See also

Device-Specific Nature of the Objects (Page 3077)

## Media Player

### Application

The Media Player is used in Runtime to play back video or audio files.

The Media Player is only available for the following devices:

- MP 377
- Comfort Panels

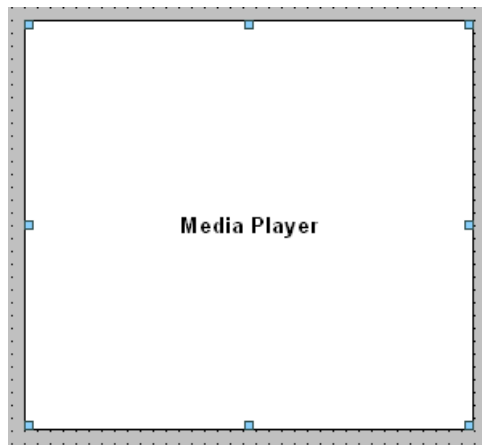

### Layout

You can set the following properties in the Inspector window:

- Display status bar: Determines whether to display the status bar.
- Display control elements: specifies the control elements during runtime.
- Show seek: establishes, whether a slider is available for the operation.

### Control elements

The control elements that can be used to control the Media Player in Runtime are specified in the Inspector window under "Properties > Properties > Appearance > Elements".

### Supported file formats

The following audio formats are supported by Media Player:

- Moving Picture Experts Group standard 1, Layer 1,2, 3 (.mpa, .mp2, .mp3)
- Windows Media Audio (.wma)
- Waveform Audio (.wav)

The following video formats are supported by Media Player:

- Moving Picture Experts Group standard 1 (.mpg, .mpeg, .mpv, .mpe)
- Advanced Streaming Format (.asf)

10.1 Creating screens

- Windows Media Video Format (.wmv)
- Audio-Video Interleaved (.avi)

---

**Note**

Media Player does not support the creation and management of favorites. If you create favorites before closing the Media Player, they will not reappear when you open it again.

---

**See also**

Device-Specific Nature of the Objects (Page 3077)

**Alarm view**

**Application**

Alarms are indicated in the Alarm view or in the Alarm window of the HMI device. The following screen contains an alarm view with no content:



**Complex alarm view**

The complex or simple alarm view is available for editing alarms depending on the HMI devices. The figure below shows a complex alarm view:

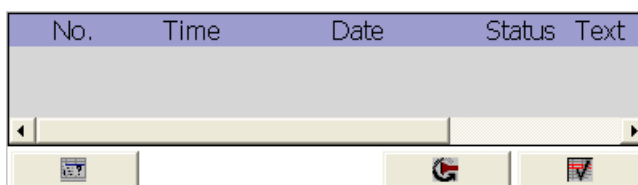



## Simple alarm view

The following screen contains a simple alarm view:



Proceed as follows to configure the appropriate alarm view:

1. Click "Properties > Properties > Layout > Mode" in the Inspector window.
2. Select "Simple" or "Complex".

### Note

In the Engineering System you can dynamically control the visibility of an object, for example, in the "Animations" tab of the Inspector window. In Runtime, the "Simple alarm view" does not support animations. If you have configured an animation and, for example, wish to perform a consistency check of the project, then an error alarm is issued in the Output window.

## Alarm line

The alarm line allows display of the most current pending alarm in Runtime. The following figure shows an alarm line:

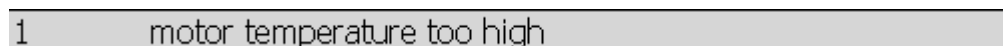

How to configure the alarm line:

1. In the Inspector window, select "Properties > Properties > Layout".
2. Select "Mode > Alarm line".

## Layout

In the Inspector window, you customize the position, geometry, style, color and font types of the object.

---

### Note

The fonts available for selection depend on the "Language and fonts" you have configured in the device settings and the fonts your HMI device supports.

---

You can adapt the following properties in particular:

- Control elements: Defines the operator controls of the alarm view.
- Alarm classes: This setting defines which alarm classes are displayed in the alarm view.
- Columns: Specifies the displayed columns in Runtime.
- Sequence of columns: Specifies whether the sequence of columns can be changed in Runtime.
- Identification of alarm classes: To be able to distinguish various alarm classes, they are identified in the first column of the alarm view.
- Filter: Defines that only alarms that contain a specific character string will be displayed in the alarm text.
- Enable sorting: Specifies whether the messages can be sorted in runtime by date and time.
- Defining display area This setting specifies from which date on alarms are displayed in the alarm view.

---



### Note

If you have different alarm classes output, these will be initially sorted into alarm classes in runtime, and then by when the alarm occurred.

---

## Control elements

The control elements that can be used to control the alarm view in Runtime are specified in the Inspector window under "Properties > Properties > Display > Settings". The following table shows the control elements in the alarm view, and what they do:

Button		Function
"Tooltip"		Displays a tooltip for an alarm.
"Acknowledge"		Acknowledges an alarm.
"Loop-In-Alarm"		If a screen change is configured, the display switches to a screen containing information about the alarm.

### Select alarm classes

1. Click "Properties > Properties > General" in the Inspector window.
2. Under "Alarm classes" activate the alarm classes to be displayed in the alarm view in Runtime .

### Access protection in Runtime

Configure access protection in the "Properties > Security" group in the properties of the alarm view. If a logged-on user has the required authorization, he can acknowledge and edit alarms using the operator controls in the alarm view. If the logged-in user does not have the required authorization, or if no user is logged in, using the "Acknowledge" or "Edit" buttons or double-clicking an alarm line opens the login dialog.

### Define columns

Define the columns to be displayed in the alarm view in Runtime in the Inspector window.

1. In the Inspector window, select "Properties > Properties > Columns".
2. Activate the columns that are to be displayed in Runtime under "Columns".

### Sequence of columns

If this property is enabled, the column sequence in the alarm view can be changed in Runtime.

1. In the Inspector window, select "Properties > Properties > Columns".
2. Activate "Column properties > Column order".

### Enable sorting

If this property is enabled, the alarms displayed in the alarm view in Runtime can be sorted by date and time.

1. In the Inspector window, select "Properties > Properties > Columns".
2. Activate "Column properties > Sorting by date/time possible".

### Filtering alarms

This property is used to define that only alarms that contain a configured string will be displayed in the alarm text in runtime for the extended alarm view.

1. In the Inspector window, select "Properties > Properties > Filter".
2. Enter the required term for filtering in the field "Filter string".  
Alternatively, you configure a filter tag using the field "Filter tag". The contents of the filter tag serve as the filter criterion in runtime.

### Identify alarm classes

An icon is displayed in the first column of the alarm view. This symbol allows the alarm to be allocated to an alarm class.

1. In the Inspector window, select "Properties > Properties > Columns".
2. Activate "Columns > Alarm class".
3. Open the "Alarms" editor, and click the "Alarm Classes" tab.
4. Specify an icon for use to identify the alarms of this alarm class for an alarm class in the "Display name" column.

#### Note

The "alarm view" object cannot be grouped.

### Defining display area

You select a tag which defines the time from which alarms should be displayed. The following data types are permitted:

- External tags: Date, Date\_and\_Time, Time\_of\_Day
- Internal Tags: DateTime

To define the display area, proceed as follows:

1. Click "Properties > Properties > Display" in the Inspector window.
2. Define the tag in which the time is specified under "Control tag for the display area".

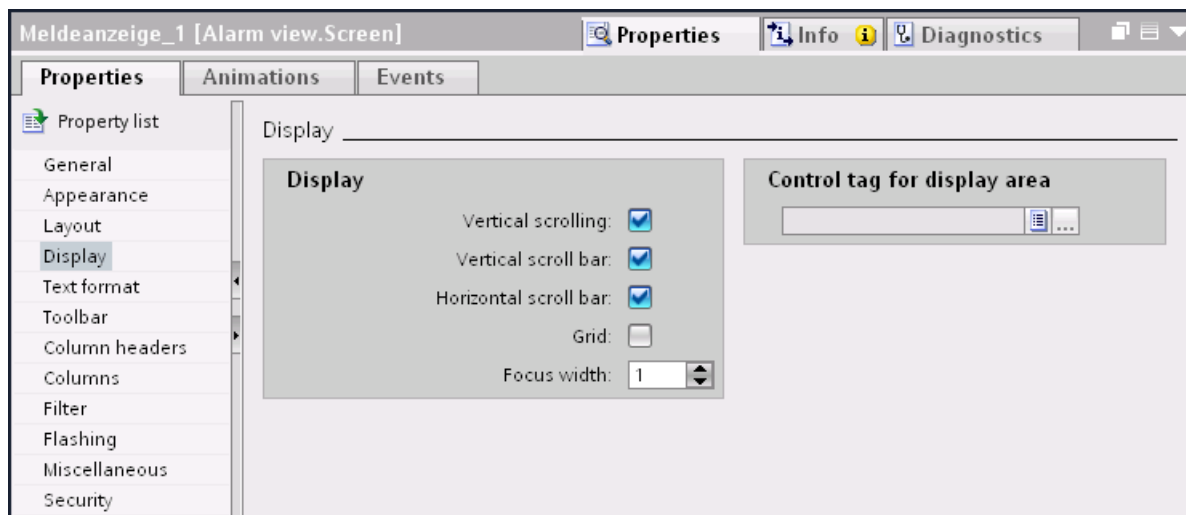

### Configuration behavior

#### Displaying column headers

The layout of the alarm view is dependent on the view settings in the control panel. Depending on the setting, the column headers may be truncated. This setting is found under "Display >

Appearance tab" in the control panel. To display column headers correctly, set the display in "Windows and buttons" to "Windows Classic" style.

This behavior only occurs during configuration. The column headers are displayed correctly in Runtime.

### Displaying the buttons for operation

The simple alarm view in the HMI devices OP 73, OP 77A and TP 177A has a button which displays the alarm text in its own window. This button is not shown during configuration.

The display of the buttons for using the simple alarm view depends on the configured size. You should check on the HMI device whether all necessary buttons are available.

### See also

Device-Specific Nature of the Objects (Page 3077)

Alarm window (Page 3117)

Alarm indicator (Page 3120)

Configuring an alarm view for active alarms (Page 3286)

### Alarm window

#### Application

Alarms are indicated in the Alarm view or in the Alarm window of the HMI device. The layout and operation of the Alarm window are similar to that of the Alarm view. The Alarm window has the following characteristics that are the same as in the Alarm view:

- Simple alarm window
- Advanced alarm window
- Alarm line

---

#### Note

##### Basic Panels

Only the simple alarm window is available for Basic Panels.

---

The Alarm window is configured in the "Global screen" editor.

The alarm window is not assigned to any screen. Depending on the configuration the alarm window is opened when an alarm that belongs to a specific alarm class is active. Depending on the configuration, it is not closed until the alarm is acknowledged.

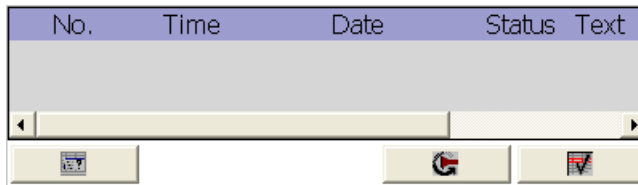

**Note**

In the engineering system you dynamize, for example, the visibility of an object in "Properties > Animations" in the Inspector window. In runtime, the "Simple alarm window" object does not support animations. If you have configured an animation and, for example, wish to perform a consistency check of the project, then an error alarm is issued in the Output window.

**Layout**

In the Inspector window, you customize the position, geometry, style, color and font types of the object. You configure the Alarm window in the same way as the Alarm view. In addition you adapt the following properties:



- Fixed alarm windows: Specifies that the Alarm window retains the focus after a screen change.
- Window: You define the operator input and response of the Alarm window in runtime.

**Note**

If you have different alarm classes output, these will be initially sorted into alarm classes in runtime, and then by when the alarm occurred.

**Control elements**

The control elements that can be used to control the alarm view in runtime are specified in the Inspector window under "Properties > Display > Settings". The following table shows the control elements in the Alarm window, and what they do:

Button		Function
"Tooltip"		Displays a tooltip for an alarm.
"Acknowledge"		Acknowledges an alarm.
"Loop-In-Alarm"		If a screen change is configured, the display switches to a screen containing information about the alarm.

## Access protection in Runtime

Configure access protection under "Properties > Properties > Security" in the Inspector window of the alarm view. If a logged-on user has the required authorization, he can acknowledge and edit alarms using the operator controls in the alarm view. If the logged-in user does not have the required authorization, or if no user is logged in, clicking the "Acknowledge" or "Edit" buttons or double-clicking an alarm line opens the login dialog box.

---

### Note

#### Basic Panels

Access protection is not available for Basic Panels.

---

## Activating the focus of the Alarm window

Select the following option so that the Alarm window does not lose the focus after a screen change:

1. In the Inspector window, select "Properties > Properties > Mode".
2. Enable "Label".

## Window

Define the response of the Alarm window under "Properties > Properties > Mode > Window" in the Inspector window. The following table shows the possible properties:

Option	Function
Automatic display	The Alarm window is automatically displayed when a system alarm occurs, for example.
Closable	The window closes again after a set time has elapsed. You define the display duration in the alarm settings.
Modal	The Alarm window is linked to a confirmation, such as: Alarm must be acknowledged. If the modal alarm window has the focus, the buttons in the screen behind it cannot be used. The functions configured on a function key are carried out.
Sizeable	You can change the size of the Alarm window in runtime.

## See also

Device-Specific Nature of the Objects (Page 3077)

Alarm view (Page 3112)

Alarm indicator (Page 3120)

Configuring an alarm window (Page 3291)

## Alarm indicator

### Application

The alarm indicator is a graphic symbol that shows current errors or errors that need to be acknowledged, depending on the configuration. The alarm indicator is configured in the "Global screen" editor. The following figure shows an alarm indicator:



### Alarm indicator OP 73

A "simple" alarm indicator is available for the HMI OP 73. The following diagram shows the alarm indicator for the OP 73 HMI devices:



The "simple" alarm indicator shows alarms to be acknowledged or alarms which have already been acknowledged and have not yet gone. Only the position can be defined for the "simple" alarm indicator. The alarm indicator is displayed on the device at the selected position. If you have configured a screen object at this position, the visible alarm indicator covers the screen object. The alarm indicator is covered by system dialogs, such as the login dialog, Help dialog, and alarm windows.

### Layout

In the Inspector window, you customize the position, shape, style, color and font types of the object. You can adapt the following properties in particular:

- Alarm classes: Establishes the alarm classes where the alarm indicator is displayed.
- Operator control in Runtime: Defines the operator actions in Runtime that cause the Alarm window to open.

### Alarm classes

You define which alarm classes are shown with an alarm indicator in "General > Alarm classes" in the Inspector window. Alarm classes, such as "Warnings" or "Errors".

### Define operator control in Runtime

1. Select the alarm indicator in the screen.
2. Click "Events > Click" or "Click when flashing" in the Inspector window.
3. The "function list" opens. Click the first line of the function list. The list of system functions, and scripts available in the project opens.



4. Select the "ShowAlarmWindow". system function under "Alarms."
5. Under "object name" select the name of the Alarm window from the selection list. Under "Layout", define whether the Alarm window should be visible, hidden, or should toggle between the two states.

## See also

Device-Specific Nature of the Objects (Page 3077)

Alarm view (Page 3112)

Alarm window (Page 3117)

Configuring an alarm indicator (Page 3292)

## Polygon

### Application

The "Polygon" is a closed object which you can fill with a background color.

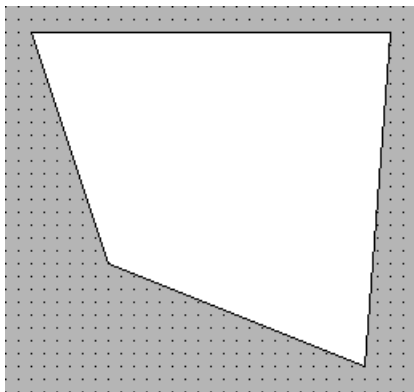

### Layout

In the Inspector window, you customize the settings for the object position, shape, style, and color. In particular, you can customize the following property:



Geometry: Modifies, deletes or adds corners.

### Geometry

The corner points are numbered in the order of their creation. You can change, delete, or add more corner points:

1. In the Inspector window, select "Properties > Properties > Layout".
2. Select the required corner point in the "Geometry" area. Input a value at "X position " and "Y position ".

## 10.1 Creating screens

3. To add a corner point, click the  button.
4. To delete a corner point, click the  button.

### Alternative procedure

You can also change, delete, or add new corner points using the mouse:

1. Select the object. Position the mouse cursor on the desired corner. The mouse cursor changes to a crosshair.
2. Drag the corner to the desired position while holding down the mouse button.
3. Right-click the position at which you want to insert the corner point. Select "Add point" from the shortcut menu.

### Configuring Rotation in runtime

You configure the "Polygon" object so that it rotates about a reference point in runtime. The rotation in runtime is only possible for devices with Runtime Professional.

Enter the values for the angle of rotation using Degrees as the unit.

1. In the Inspector window, select "Properties > Properties > Layout".
2. Enter values for the following attributes in the "Rotation" area.
  - X
  - Y
  - Angle

### See also

Device-Specific Nature of the Objects (Page 3077)

Polyline (Page 3123)

## Polyline

### Application

The "Polyline" is an open object. Use the "Polygon" object if you want to fill the object with color.

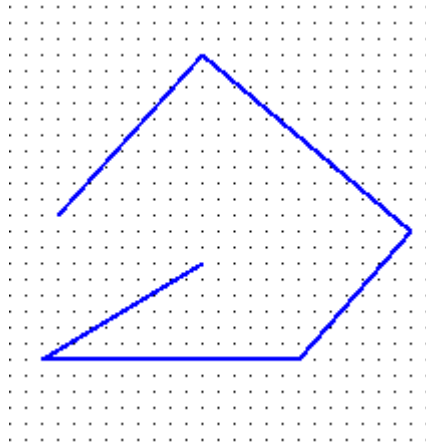

### Layout

In the Inspector window, you customize the settings for the object position, shape, style, and color. You can adapt the following properties in particular:



- Line start and end: Specifies the type of line start and line end.
- Geometry: Modifies, deletes or adds corners.

### Line start and end

You define the start point and the end point of the line under "Properties > Properties > Appearance" in the Inspector window. Use arrow point, for example, as start and end point. The available start and end points depend on the device.

### Geometry

The corner points are numbered in the order of their creation. You can change, delete, or add more corner points:

1. In the Inspector window, select "Properties > Properties > Layout".
2. Select the required corner point in the "Geometry" area. Input a value at "X position" and "Y position".
3. To add a corner point, click the  button.
4. To delete a corner point, click the  button.

### Alternative procedure

You can also change, delete, or add new corner points using the mouse:

1. Select the object. Position the mouse cursor on the desired corner. The mouse cursor changes to a crosshair.
2. Drag the corner to the desired position while holding down the mouse button.

### Configuring rotation in Runtime

You configure the "Polyline" object so that it rotates about a reference point in Runtime. The rotation in Runtime is only possible for devices with Runtime Professional.

Enter the values for the angle of rotation using Degrees as the unit.

1. Click "Layout" in the Inspector window.
2. Enter values for the following attributes in the "Rotation" area.
  - X
  - Y
  - Angle

Further information can be found in "Device-Specific Nature of the Objects (Page 3077)".

### See also

Polygon (Page 3121)

### Rectangle

### Application

The "Rectangle" is a closed object which you can fill with a color.

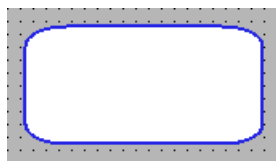

## Layout

In the Inspector window, you customize the position, shape, style, color and font types of the object. You can adapt the following properties in particular:

- **Corner radius:** Specifies the horizontal and vertical distance between the corner of the rectangle and the start point of a rounded corner.

## Corner radius

The corners of the "Rectangle" object can be rounded to suit your requirements. When the properties "X" and "Y" are set to the 100 % value, the rectangle is displayed as an ellipse. As soon as one of the properties has the value 0%, a normal rectangle without a rounded corner is shown.

1. Click "Properties > Properties > Layout" in the inspector window.
2. Enter a value for "X" in the "Corner radius" area.  
The input value is the percentage proportion of half the width of the rectangle.
3. Enter a value for "Y" in the "Corner radius" area.  
The input value is the percentage proportion of half the height of the rectangle.

## See also

Device-Specific Nature of the Objects (Page 3077)

Rotating objects (Page 2963)

Flipping objects (Page 2965)

## Recipe view

## Application

The "Recipe view" object is used to display and modify recipes.

The screenshot shows a software window titled "Recipe view". It contains the following elements:

- Two rows of input fields. The first row has "Recipe Name:" followed by a dropdown menu and "No.:" followed by a text box containing "----".
- The second row has "Data Record Name:" followed by a dropdown menu and "No.:" followed by a text box containing "----".
- A table with two columns: "Entry Name" and "Value". The table is currently empty.
- A toolbar with five icons: a document, a save icon, a close icon, a bar chart, and a pie chart.
- A "Status bar" at the bottom of the window.

### Advanced recipe view

Both the advanced and the "Simple recipe view" can be used to administer and process recipes on HMI devices with a display larger than 6".

Configuring the advanced recipe view:

1. Click "Properties > Properties > General" in the Inspector window.
2. Activate "Format > Advanced view" in the "Display type" area.

### Simple recipe view

The "Simple recipe view" is used for display and processing of recipes on HMI devices with a display size less than 6".

---

#### Note

Do not use the simple recipe view in a group.

---

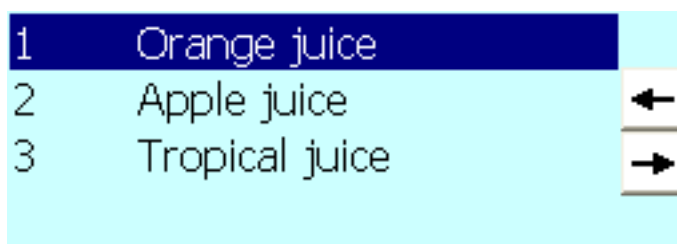

Configuring the simple recipe view:

1. In the Inspector window, select "Properties > Properties > General".
2. Activate ""Display type" > Basic view".

---

#### Note

##### Behavior for Runtime Professional, Runtime Advanced and Panels

In the Engineering System you can dynamically control the visibility of an object, for example, in the "Animations" tab of the Inspector window. In Runtime, the "Simple recipe view" does not support animations. If you have configured an animation and, for example, want to check the consistency of the project, an error alarm is displayed in the Output window.

---









### Layout

In the Inspector window, you customize the position, geometry, style, color and font types of the object. You can adapt the following properties in particular:

- Control elements: Defines the control elements of the recipe view.
- Display number: establishes if the number of the recipe and the number of the recipe data record is displayed.

## Control elements

The control elements with which the recipe view is operated in runtime are configured under "Properties > Buttons" in the inspector window. In the simple recipe view the operating elements are based on the functions of the menu.

Control element		Description
	"Tooltip"	Calls up the configured tooltip for the selected recipe.
	"New record"	Creates a new recipe data record in the recipe.
	"Delete record"	Deletes the selected record.
	"Saving"	Saves the modified record with its current name.
	"Save as"	Saves the modified record with a new name.
	"Write to PLC"	Sends the current value to the PLC.
	"Read from PLC"	Reads the current value from the PLC.
	"Synchronizing recipe tags"	Compares the values of the selected record with the values on the PLC.

## Display number

Specifies whether the number of the recipe and the number of the recipe data record are displayed during runtime. The number of the recipe uniquely identifies the recipe in the project.

1. Click "Properties > Properties > View" in the Inspector window.
2. Activate "Display > Display numbers".

## Configuration behavior

### Displaying column headers

The layout of the recipe view is dependent on the view settings in the control panel. Depending on the setting, the column headers may be truncated. This setting is found under "Display > Appearance" in the control panel. To display column headers correctly, set the display in "Windows and buttons" to "Windows Classic" style.

This behavior only occurs during configuration. The column headers are displayed correctly in Runtime.

## See also

Device-Specific Nature of the Objects (Page 3077)

Simple recipe view (Page 3407)

Advanced recipe view (Page 3412)

Display of recipes (Page 3395)

Configuring the Advanced Recipe View (Page 3430)

## Recipe view

### Application

The "Recipe view" object is used to display and modify recipes.

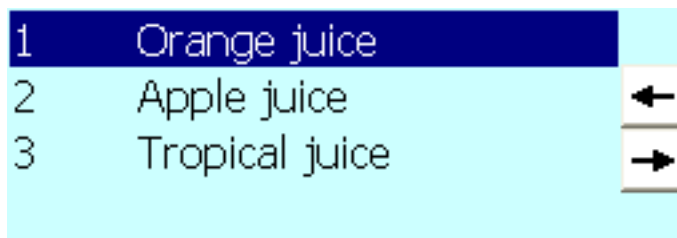

### Layout

In the Inspector window, you customize the position, geometry, style, color and font types of the object. You can adapt the following properties in particular:

- **Toolbar:** Specifies the menu commands of the recipe view.

### Toolbar

The menu items with which the recipe view is operated in Runtime are configured under "Properties > Properties > Toolbar" in the Inspector window.

Menu command	Description
"Tooltip"	Calls up the configured tooltip for the selected recipe.
"New record"	Creates a new recipe record in the recipe.
"Delete record"	Deletes the selected record.
"Saving"	Saves the modified record with its current name.
"Save as"	Saves the modified record with a new name.
"Write to PLC"	Sends the current value to the PLC.
"Read from PLC"	Reads the current value from the PLC.
"Rename"	Specifies that the "Rename" button is shown.
"Forward"	Specifies that the menu buttons are visible.
"Back"	Specifies that the "Back" button is shown.

### See also

Objects for Basic Panels (Page 3077)



## Switch

### Application

The "Switch" object is used to configure a switch that is used to switch between two predefined states in runtime. The current state of the "Switch" object can be visualized with either a label or a graphic.

The following figure shows a "Switch" type switch.

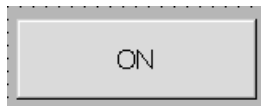

### Layout

In the Inspector window, you customize the position, shape, style, color and font types of the object. In particular, you can customize the following property:

- Type: Defines the graphic representation of the object.

### Type

Button visualization is specified at "Properties > Properties > General >Type" in the Inspector window.

Type	Description
"Switch"	The two states of the "Switch" are displayed in the form of a switch. The position of the switch indicates the current state. The state is changed in runtime by sliding the switch. You specify the direction of movement of the switch in "Switch orientation" with this type.
"Switch with text"	The switch is shown as a button. The current state is visualized with a label. In runtime click on the button to actuate the switch.
"Switch with graphic"	The switch is shown as a button. The current state is visualized with a graphic. In runtime click on the button to actuate the switch.

#### Note

##### Basic Panels

The "Switch" type is not available for Basic Panels.

### See also

Device-Specific Nature of the Objects (Page 3077)

Overview of objects (Page 2950)

## Button

### Application

The "Button" object allows you to configure an object that the operator can use in runtime to execute any configurable function.



### Layout

In the Inspector window, you customize the position, geometry, style, color and font types of the object. You can adapt the following properties in particular:

- Mode: Defines the graphic representation of the object.
- Text / Graphic: Defines whether the Graphic view is static or dynamic.
- Define hotkey: Defines a key, or shortcut that the operator can use to actuate the button.

---

#### Note

You can only define a hotkey for HMI devices with keys.

---

### Mode

The button display is defined in "Properties > Properties > General >Mode" in the Inspector window.

Mode	Description
"Invisible"	The button is not visible in runtime.
"Text"	The button is displayed with text. This text explains the function of the button.
"Graphic"	The button is displayed with a graphic. This graphics represents the function of the button.

Depending on the device, further options are available:

### Text / Graphic

The "Mode" property settings are used to define whether the display is static or dynamic. The display is defined in "Properties > Properties > General >Text" or "Graphic" in the Inspector window.

Your options for the type "Graphic" include the following.

Type	Option	Description
"Graphic"	"Graphic"	"Graphic OFF" is used to specify a graphic that is displayed in the button when the state is "OFF". If you enable "Graphic ON", you can enter a graphic for the "ON" state.
	"Graphics list"	The graphic in the button depends on the state. The entry from the graphics list corresponding to the state is displayed.

## Define hotkey

In the Inspector window, a key or key combination is defined that the operator can use to control the button in runtime.

1. In the Inspector window, select "Properties > Properties > General":
2. Select a key or key combination from the selection list in the "Hotkey" area.

## See also

Device-Specific Nature of the Objects (Page 3077)

Example: Configuring a button for language switching (Page 3029)

Example: Configuring a button with logon dialog box (Page 3531)

Example: Configuring a button with access protection (Page 3535)

## Slider

### Application

Process values are monitored and adapted within a defined range with the "Slider" object. The monitored range is visualized in the form of a slider. By adjusting the slider, you intervene in the process and correct the displayed process value.

---

#### Note

Do not configure a system function at the "Change" event for a regulated project if it is used to execute a GMP-relevant action.

Instead configure the system functions at the "Value change" event of the tags in order to reduce the number of user actions.

---

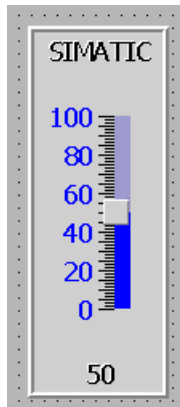

## Layout

In the Inspector window, you customize the position, shape, style, color and font types of the object. You can, in particular, adapt the following properties as required:

- Maximum Value and Minimum Value: Specifies the top and bottom values of the scale.
- Display current value: Specifies whether the current position of the controller appears below the slider.
- Display of bars: The sliders above and below the bar can be hidden.

### Maximum Value and Minimum Value

The top and bottom end values of the scale are specified in the Inspector window.

1. In the Inspector window, activate "Properties > Properties > General".
2. Enter a number at "Maximum value" and "Minimum value". If you select a tag as the end value of the scale, the number will be no longer available.

### Display current value

Specify that the value of the current position is displayed below the slider in the Inspector window.

1. In the Inspector window, activate "Properties > Properties > Layout".
2. Activate "Show current value."

### Display bar

The bar can be hidden.

1. In the Inspector window, activate "Properties > Properties > Layout".
2. Deactivate "Display bar".

**See also**

Device-Specific Nature of the Objects (Page 3077)

**KeySwitch****Application**

The object "KeySwitch" is an optional control element for the SIMATIC Mobile Panel. The key switch is used to lock functions that can be triggered from the Mobile Panel.

You configure the object "key switch" object in the "global screen" or in a template.

**Layout**

You can set the following properties in the Properties view:

- Tag: Specifies the tag in which the position of the key switch is written.

**Tag**

The "Tag" property is used to specify the "Key switch" object assignment in the global screen or template.

---

**Note****Notes on configuring**

When starting runtime and every time the key is pressed the current position of the key switch is written to the tag. In doing so it can cause inconsistencies between the position of the key switch and the key switch tags.

1. If the tag has a process connection, the current value is transferred from the PLC to the tag after establishment of communication. The tag that contains the current position of the key is overwritten by this process. It can be that the key switch tag no longer reflects the current value of the key switch, e.g. if the Mobile Panel is switched off while the key is being turned.
2. If the key switch is pressed before communication with the PLC has been established (e.g. after a device start-up), it may not be possible to send the value of the key switch tag to the PLC. In this case the value of the tag in the PLC is different from the current position of the key.

A specific configuration is required to make sure that the key switch tag reflects the actual position of the key switch at all times. See the instructions below for the basic procedure.

---

**Basic procedure**

1. Specify the connection to the PLC in the "Connections" editor. Activate the "Coordination" area pointer to ensure that the life bit is available to the PLC side.

Connections					
Parameter	Area pointer				
Active	Display name	PLC tag	Access mode	Address	Length
<input checked="" type="checkbox"/>	Coordination	<Undefined->	<absolute access>	%DB1.DBW0	1
<input type="checkbox"/>	Date/time	<Undefined->	<symbolic access>		6
<input type="checkbox"/>	Job mailbox	<Undefined->	<symbolic access>		4
<input type="checkbox"/>	Data record	<Undefined->	<symbolic access>		5

Global area pointer of HMI device					
Connection	Display name	PLC tag	Access mode	Address	Length
<Undefined->	Project ID	<Undefined->	<symbolic access>		1
<Undefined->	Screen number	<Undefined->	<symbolic access>		5
<Undefined->	Date/time PLC	<Undefined->	<symbolic access>		6

2. Create three tags in the "Tag" editor.
  - Internal tag: Position\_Keyswitch
  - External tag: Auxiliary tag
  - External tag: Keyswitch\_PLC
3. Open the Inspector window of the "Position\_KeySwitch" tag.
4. In the Inspector window, select "Properties > Events > Value change".
5. Click the first line of the function list. The list of system functions available in the project appears.
6. Select the "SetTag" system function.
  - Select the "Keyswitch\_PLC" tag at "Tag (output)".
  - Select the "Position\_Keyswitch" tag at "Value".

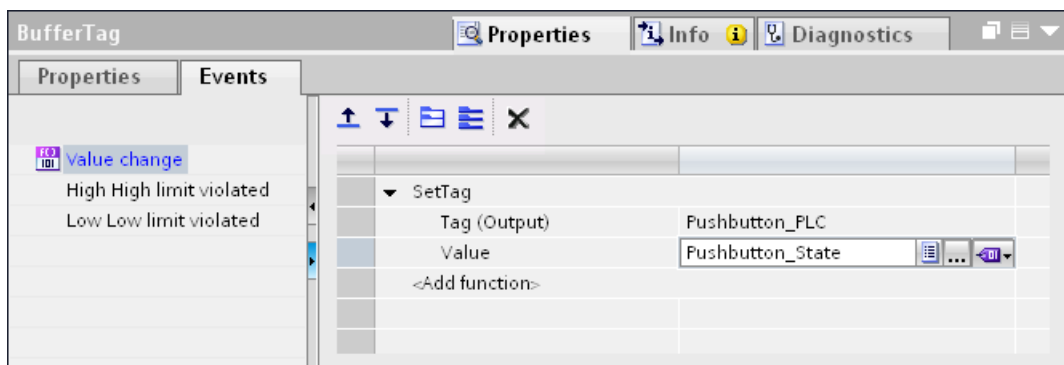

The value of the "Keyswitch\_PLC" tag is written to the PLC with the "Position\_Keyswitch" tag. A program in the PLC evaluates the life bit. If communication is established, the current value is written to the "Keyswitch\_PLC" tag from the PLC.

7. Open the Inspector window of the "Auxiliary tag" tags.
8. In the Inspector window, select "Properties > Events > Value change".
9. Click the first line of the function list. The list of system functions available in the project appears.
10. Select the "SetTag" system function.
  - Select the "Keyswitch\_PLC" tag at "Tag (output)".
  - Select the "Position\_Keyswitch" tag at "Value".

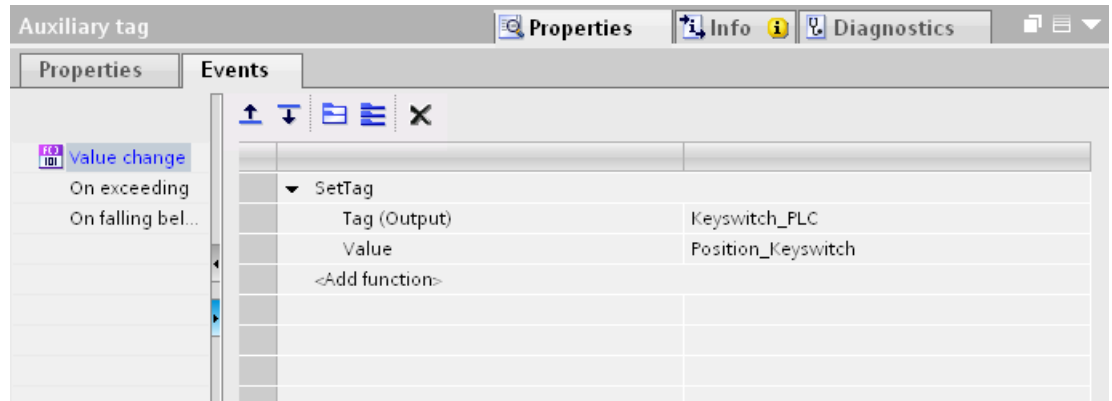

After establishing communication the current value is written to the "Auxiliary Tag" from the PLC. The "SetTag" system function is executed by the value change in the auxiliary tags. The system function re-allocates the value of the "Position\_Keyswitch" tag to the "Keyswitch\_PLC".

11. Open the global screen or a template in the "Screen navigation" editor.
12. Select the key switch in the screen.
13. Select the "Position\_KeySwitch" tag in the Inspector window under "Properties > Properties > General > Settings > Tag".  
If you press the illuminated pushbutton, the value is written to the "Position\_KeySwitch" tag.

## See also

Field of application of the Mobile Panel Wireless (Page 4864)

## Sm@rtClient view

### Application

The "Sm@rtClient View" object is used to configure a network connection to the remote monitoring and remote maintenance of a connected unit.



### Layout

In the Inspector window, you customize the position, shape, style, color and font types of the object. You can adapt the following properties in particular:

- **Connect on start:** Establishes whether when opening the Sm@rtClient view the connection to the HMI device is automatically created which should be remote-controlled.
- **Shared use\_** Specifies that an HMI device is shared by several Sm@rtClient Views.
- **Local cursor:** Specifies whether the cursor data is transferred separately in order to increase the performance.
- **Use cursor key scroll:** For keyboard devices places the control of the horizontal and vertical scroll with the cursor keys.
- **Show controls:** Establishes whether additional fields exist for entering the address and password.
- **Allow menu:** Specifies whether the shortcut menu is enabled to control the Sm@rtClient view.
- **Connection type:** Establishes the expected transfer speed for the remote monitoring.
- **Scaling:** Specifies whether the Sm@rtClient view can be zoomed in or out.

### Connect on start

Establishes whether when opening the Sm@rtClient view the connection to the HMI device is automatically created which is remote-controlled.

1. In the Inspector window, select "Properties > Properties > General".
2. Activate "View > Connect on start".



## Shared use

Define whether the HMI device can be used by several Sm@rtClient views under "Properties > Properties > General > View > Shared".

Shared use	
Enabled	HMI devices on which remote control is activated can access the remote HMI device and control the process. Only one HMI device can be active at a time in this case. A different HMI device can only assume control when there has been no activity on the active HMI device for a specified period of time.
Disabled	<p>Only one HMI device can use the remote control at any given time. The activities can be followed on the other HMI devices.</p> <p>Depending on the settings on the Sm@rtServer the following options are available if another HMI device logs on:</p> <ul style="list-style-type: none"> <li>• The HMI device is rejected.</li> <li>• The active HMI device is disconnected and the new HMI device is connected.</li> </ul>

## Local cursor

If this property is set, then the cursor data is transferred separately.

1. In the Inspector window, select "Properties > Properties > General".
2. Activate "View > Local cursor".

## Display extended objects

If this property is set then there are additional fields for inputting the address and password. For the fields to be shown the "Connect on start" option is not activated.

1. In the Inspector window, select "Properties > Properties > General".
2. Activate "View > Show enhanced objects".

## Allow menu

If this property is set, then a shortcut menu to control the Sm@rtClient view is opened in runtime.

When operating using the mouse, the left mouse key must remain depressed for a few seconds for the shortcut menu to open.

1. In the Inspector window, select "Properties > Properties > General".
2. Activate "View > Allow Menu".

## Connection type

The "Connection type" property establishes the expected transfer speed for the remote monitoring.

10.1 Creating screens

Set the connection type at "Connection type" under "Properties > Properties > General > Connection type" in the Inspector window.

Connection type	
LAN	Connection via network
Slow	Connection with a low transfer speed
Medium	Connection with a medium transfer speed
Modem	Connection via an analog modem
Very slow	Connection with a very low transfer speed

**Scaling**

If this property is set, then via "Client scale factor" and "Server scale" you can reduce or enlarge the Sm@rtClient view on the HMI device.

1. In the Inspector window, select "Properties > Properties > Scaling".
2. Activate "Scaling > Scaling".
3. Enter the values for the scaling under "Client scale factor" and "Server scale factor".

**Operation behavior**

If the program cannot resolve the dynamic address of a Sm@rtClient view after a screen change, the system connects to the configured server using the static address of the server. If a tag is now set using the dynamic address, you can make a second connection to this server. As a remedy preset the tags of the dynamic address for example by means of a script.

**See also**

Device-Specific Nature of the Objects (Page 3077)

**Status/Force**

**Application**

The "Status/Force" object is used to configure an editor that will allow you to process single address areas of a SIMATIC S7 in runtime.

Connection	Type	DB-Nr.	Offset	Bit	Data Type	Format	Status	Value	Control



## Layout

In the Inspector window, you customize the position, shape, style, color and font types of the object. You can adapt the following properties in particular:

- PLC type: Specifies the PLC type in the object for which the address area is output in runtime.
- Control elements: Specifies the controls of the object.
- Visible columns: Specifies the displayed columns in runtime.
- Columns moveable: Specifies whether the operator can change the sequence of columns in runtime.

## Control elements

Set the control elements that you can use to control the "Status/Force" object in runtime at "Properties > Properties > Display" in the "Settings" area of the Inspector window.

	Function
	This button refreshes the display in the status value column.
	Use this button to accept the new value in the control value column. The control value is then written to the PLC.

## Visible columns

The columns that are displayed in runtime are specified in the Inspector window in the "General" group in the "Visible columns" area.

Column	Description
"Connection"	The PLC of which the address areas are displayed.
"Type" "DB- number" "Offset" "Bit"	The address area of the operand.
"Data type" "Format"	The data type of the operand.
"Status value"	The value that was read from the specified address of the operand.
"Control value"	The value written to the specified address of the operand.

## Sequence of columns

The operator can use the "Column ordering" property to change the sequence of columns in runtime.

1. Select "Properties > Properties > Columns" in the Inspector window.
2. Activate "Properties of columns > Sequence of columns".

## Display of the column headers and buttons

The layout of the "Status/Force" object is dependent on the view settings in the control panel. Depending on the setting, the column headers may be truncated. This setting is found under "Display > Appearance" in the control panel. To display column headers correctly, set the display in "Windows and buttons" to "Windows Classic" style. This behavior only occurs during configuration. The column headers are displayed correctly in runtime.

If you change the layout, for example from "Windows Classic" to "Windows XP Style", the button in the "Status/Force" object may no longer be displayed. Change the size of the object to make the buttons in the engineering system visible again.

## See also

Device-Specific Nature of the Objects (Page 3077)

## Symbol library

## Application

The "Symbol library" object contains a large collection of ready-to-use icons. These icons are used to represent systems and plant areas in screens.



## Layout

In the Inspector window, you customize the position, shape, style, color and font types of the object. You can adapt the following properties in particular:

- Select icon: Specifies which library object will be used.
- Fill style: Specifies the graphic design of the object.
- Flip: Specifies the flip type of the library object.
- Rotate: Specifies the angle around which the library object is rotated.
- Fixed aspect ratio Defines whether the aspect ratio is maintained if the size is changed.

## Select symbol

Select the icon at "Properties > Properties > General" in the Inspector window.

## Fill style

Specify the design of the library object at "Properties > Properties > Appearance > Style" in the Inspector window.

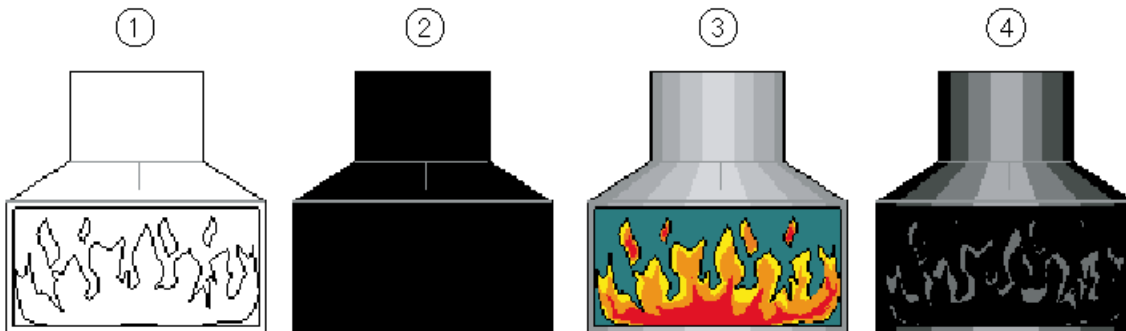

- |   |            |  |
|---|------------|--|
| 1 | "Hollow"   | The library object is displayed in outline.  |
| 2 | "Solid"    | Black lines remain as outlines. Elements of the icon with a different color are displayed as a main color.                 |
| 3 | "Original" | The screen object will not be changed.   |
| 4 | "Shaded"   | Black lines remain as outlines. Elements of the symbol in other colors are displayed as brightness levels of a main color. |

At the TP 177B mono and OP 177B mono HMI devices the library object is displayed as an outline. "Hollow" is set as the default value for the fill style.

If you change the setting from "hollow" to "original" or "shaded" then the color of the display on the configuration computer will deviate from that on the HMI device. This deviation is caused by the different color resolutions. You may also use a graphic object from the "Graphics" object group. The graphic objects are structured by topic and by depth of color in the "WinCC graphics folder."

## Flip and rotate

The content of the screen flips around the horizontal or vertical central axis of the icon. The icon can be flipped horizontally, vertically or simultaneously horizontally and vertically.

The screen content rotates around the central point of the icon. The symbol is rotated clockwise in increments of 90, 180, or 270 degrees.

1. In the Inspector window, select "Properties > Properties > Layout".
2. Select the mirroring mode at "Orientation > Mirror image".
3. Select the angle of rotation at "Orientation > Rotate".

## Fixed aspect ratio

The smaller page of the library object defines the maximum size of the symbol. If you change the size of the library object unproportionally, the symbol is still scaled proportionally. Proceed as follows to configure a fixed aspect ratio:

1. In the Inspector window, select "Properties > Properties > Layout".
2. Activate "Form > Fixed aspect ratio".

## See also

Device-Specific Nature of the Objects (Page 3077)

## Symbolic I/O field

### Application

The "Symbolic I/O field" object can be used to configure a selection list for input and output of texts in runtime.



### Layout

In the Inspector window, you customize the position, shape, style, color and font types of the object. You can adapt the following properties in particular:

- Mode: Specifies the response of the object in runtime.
- Text list: Specifies the text list that is linked to the object.
- Button for selection list: Specifies that the object has a button to open the selection list.

---

#### Note

#### Reports

In reports, symbolic I/O fields only output data. "Output" mode is preset. Properties for configuring the selection of graphics are not available, e.g. "button for selection list".

---

## Mode

The response of the symbolic I/O field is specified in the Inspector window in "Properties > Properties > General > Type".

Mode	Description
"Output"	The symbolic I/O field is used to output values.
"Input"	The symbolic I/O field is used to input values.
"Input/output"	The symbolic I/O field is used for the input and output of values.
"Two states"	The symbolic I/O field is used only to output values and has a maximum of two states. The field switches between two predefined texts. This is used, for example, to visualize the two states of a valve: closed or open.

---

#### Note

The behavior possible for the symbolic I/O field depends on the Runtime.

---

## Text list

In the Inspector window, you specify which text list is linked to the symbolic I/O field.

1. In the Inspector window, select "Properties > Properties > General".
2. Under "Contents" open the selection list for "Text list".
3. Select a text list.

## Button for selection list

The "Button for selection list" property is used to display a button for opening the selection list.

1. Select "Properties > Properties > Layout" in the Inspector window.
2. Activate "Response > Button for selection list".

---

### Note

#### Basic Panels

The "Button for selection list" option is not available for Basic Panels.

---

## See also

Device-Specific Nature of the Objects (Page 3077)

Graphic I/O field (Page 3097)

## System diagnostics view

### Introduction

The system diagnostics view offers you an overview of all the available devices in your plant. You navigate directly to the cause of the error and to the relevant device. You have access to all diagnostics-capable devices which you have configured in the "Devices & networks" editor.

### Application

The system diagnostics view enables you to achieve the maximum level of detail of the diagnostics data. A precise diagnosis is possible, as all the available data is displayed. You have the system status of the entire plant at one glance.

Basic Panels support only the "Basic system diagnostics view".

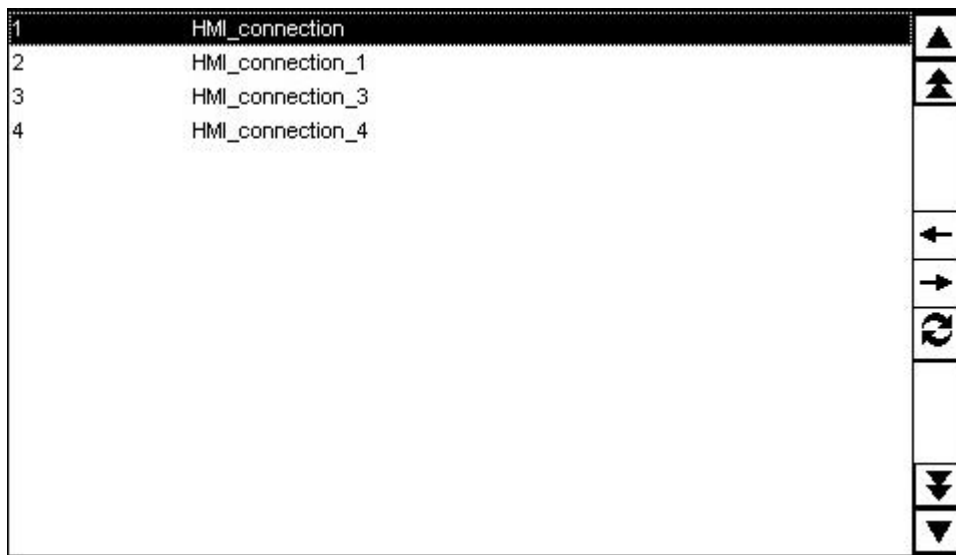

Three different views are available in the system diagnostics view.

- Device view
- Diagnostic buffer view
- Detail view

### Device view

The device view of the system diagnostics view shows all the available links in tabular form. Double-clicking a link opens the detail view. The device view is only displayed if more than one link has been created in the "Devices & Networks" editor.

### Diagnostic buffer view

In the diagnostic buffer view, the current data from the diagnostic buffer is displayed.

### Detail view

The detail view shows detailed information on the selected link. You cannot sort error texts in the detail view. The detail view is only available if there is an integrated link to an S7 1200 or S7 1500



## Layout

In the Inspector window, you customize the position, shape, style, color and font type of the object. You can adapt the following properties in particular:

- Lines per entry: Specifies the number of lines that are shown for an entry.

## Configuring the system diagnostics view

1. Drag-and-drop the system diagnostics view from the toolbox.
2. In the Inspector window, select "Properties > Layout".
3. Enter a number under "Lines per entry", i.e. 5.
4. Select an authorization for operation in "Properties > Properties > Security".

## See also

System diagnostics display (Page 3145)

## System diagnostics display

### Introduction

The system diagnostic view offers you an overview of all the available devices in your plant. You navigate directly to the cause of the error and to the relevant device. You have access to all diagnostics-capable devices which you have configured in the "Devices & networks" editor.

## Use

The system diagnostic view enables you to achieve the maximum level of detail of the diagnostics data. A precise diagnosis is possible, as all the available data is displayed. You have the system status of the entire plant at one glance.

Status	Name	Ope...	Slot	Type
	Rack_1			
	PLC_1			
	CP 443-1			
	DI_1			
	DI_2			
	PS_1			

Three different views are available in the system diagnostic view.

- Device view
- Detail view
- Diagnostic buffer view
- Matrix view (only for master systems, PROFIBUS)

## Layout

In the Inspector window, you can change the position, geometry, style, color and font of the object. You can adapt the following properties in particular:

- Columns: Defines the elements of the device view and detail view.
- Show split view: Specifies that the device view and the detail view are shown simultaneously.

## Configuring the system diagnostic view

1. Drag-and-drop the system diagnostic view from the toolbox.
2. In the Inspector window, select "Properties > Properties > Columns".
3. Enable the columns that you require in the device view for Runtime, for example: status, name, slot.
4. Activate the columns which you need in the detail view for runtime, e.g.: status, name, address.

5. Activate the columns that you require in the diagnostic buffer view, e.g. status, name, rack.
6. Customize the column headers, if necessary.
7. Enter "IP" for "Address", for example.  
The column header "IP" is displayed in the device view in runtime.
8. Rename other elements if necessary.
9. Select an authorization for operation in "Properties > Properties > Security".

### Showing device view and detail view in a single display











You can split the system diagnostic view and allow the device and detail view to be shown in the same window.

1. In the Inspector window, click "Properties > Properties > Layout".
2. Activate "Show split view".

### Single display

1. In the Inspector window, select "Properties > Properties > Layout".
2. Select "Mode > Display type > Single".

### Symbols in the system diagnostic view

Icon	Function
	Device in operation
	Device cannot be accessed
	Errors in device
	Device deactivated
	Maintenance required
	Maintenance recommended
	Superimposed symbol Shows the subordinate status
	Current configuration
	Stop e.g. Update, Boot, Own initialization
	Stop

## See also

Device-Specific Nature of the Objects (Page 3077)

System diagnostics window (Page 3148)

System diagnostics view (Page 3143)

## System diagnostics window

### Introduction

The system diagnostics window offers you an overview of all the available devices in your plant. You navigate directly to the cause of the error and to the relevant device. You have access to all diagnostics-capable devices which you have configured in the "Devices & networks" editor.

The system diagnostics window is only available in the global screen.

### Use

The system diagnostics window enables you to achieve the maximum level of detail of the diagnostics data. A precise diagnosis is possible, as all the available data is displayed. You have the system status of the entire plant at one glance.

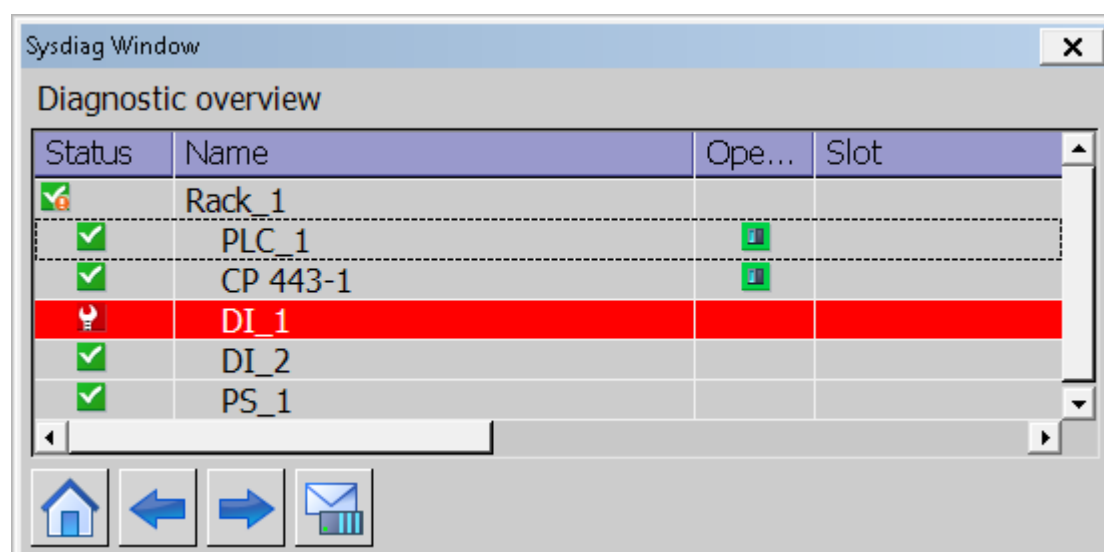

Three different views are available in the system diagnostics window.

- Device view
- Detail view
- Diagnostic buffer view
- Matrix view (only for master systems, PROFIBUS)

## Layout











In the Inspector window, you can change the position, geometry, style, color and font of the object. You can adapt the following properties in particular:

- Columns: Defines the elements of the device view and detail view.
- Table headers: Specifies the table headers of the view.
- Window: Specifies whether the system diagnostics window can be closed, for example.

## Configuring the system diagnostics window

1. Drag and drop the system diagnostics view from the toolbox into the global screen.
2. In the Inspector window, select "Properties > Properties > Columns".
3. Activate the columns that you require in the device view for Runtime, e.g. status, name, slot.
4. Activate the columns that you require in the device view for Runtime, e.g. Status, Name, Plant designation.
5. To change a column heading, click in the field and (for example) enter "IP" for "Address". The column header "IP" is displayed in the device view in runtime.
6. Rename other elements if necessary.
7. To be able to close the system diagnostics window in runtime, select "Properties > Properties > Window > Closable" in the Inspector window.

## Icons in the system diagnostics window

Button	Function
	Device in operation
	Device cannot be accessed
	Errors in device
	Device deactivated
	Maintenance required
	Maintenance recommended
	Superimposed symbol Shows the subordinate status
	Current configuration
	Stop e.g. Update, Boot, Own initialization
	Stop

## See also

System diagnostics display (Page 3145)

Device-Specific Nature of the Objects (Page 3077)

## Text field

### Application

The "Text field" is a closed object which you can fill with a color.

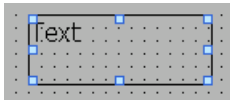

## Layout

In the Inspector window, you customize the position, shape, style, color and font types of the object. You can adapt the following properties in particular:

- Text: Specifies the text for the text field.
- Size of text field: Defines whether the size of the object is adapted to the space required by the largest list entry.

## Text

Specify the text for the text field in the Inspector window.

1. In the Inspector window, select "Properties > Properties > General".
2. Enter a text.  
For texts over several lines you can set a line break by pressing the key combination <Shift + Enter>.

## Size of text field

In the Inspector window, you can define whether the size of the object is adapted to the space required by the largest list entry.

1. In the Inspector window, select "Properties > Properties > Layout".
2. Activate "Resize > Fit to contents".

## See also

Device-Specific Nature of the Objects (Page 3077)

## Clock

### Application

The "Clock" object displays the date and time.

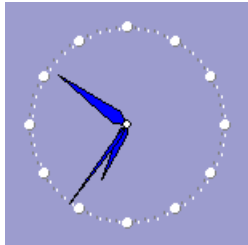

### Layout

In the Inspector window, you customize the position, shape, style, color and font types of the object. You can adapt the following properties in particular:

- Analog display: Specifies whether the clock is shown as an analog clock or digital clock.
- Display clock dial: Specifies whether hour marks of the analog clock will be displayed.
- Width and length of hands: Specifies the width and length of the hands.

### Analog display

In the Inspector window you can specify whether the clock is displayed as an analog or digital clock. The digital clock shows both the time and the date. The display format depends on the language set on the HMI device.

1. In the Inspector window, select "Properties > Properties > General":
2. Activate "Analog".

### Display dial

In the Inspector window you can specify whether hour marks will be displayed.

1. In the Inspector window, select "Properties > Properties > General":
2. Activate "Analog".
3. Activate "Show dial".

### Width and length of hands

The width of the second hand, minute hand and hour hand is set for the analog display.

1. In the Inspector window, select "Properties > Properties > Layout".
2. Enter values for "width" and "length".  
The values for the length are interpreted as a percentage of the size of the clock. The value for the length of the second hand influences the radius of the dial at the same time.

**See also**





Device-Specific Nature of the Objects (Page 3077)

**Effective range name**

**Application**

The "Effective range name" object is a control element for some SIMATIC Mobile Panels. The "Effective range name" object shows the names of the effective range in which the HMI device is located and also the logon status.

**Layout**

Symbol	Meaning	Description	Logon status
	Acknowledgement button has no effect	Within the "MixingAxisControl" effective range	It is not possible to log on to the effective range
	Acknowledgement button functions	Within the "MixingAxisControl" effective range	Logged on to effective range
	Acknowledgement button has no effect	Within the "MixingAxisControl" effective range	Logon to the effective range is rejected because a different HMI device is already logged on. Note: When using the "Override" mode: Although no other HMI device is still logged on to the effective range, logon is rejected because the override switch is still set.
	Acknowledgement button has no effect	Outside of each effective range	Note: You can only log on within the effective range

In the Inspector window "Properties > Properties > Security", assign an authorization to log on to a machine in runtime.

**Logon requirements**

- The HMI device is located within the effective range.
- No HMI device is logged on to this effective range.



### Logon procedure

1. Click on the "Effective range name" object.  
The "Effective range logon" dialog box opens.
2. Read the ID from the machine or plant to be operated.
3. Enter the ID you read.
4. Confirm your entries by clicking "OK".

### Result

If the ID and effective range match, the HMI device is logged on to the effective range. Successful logon is signaled by an icon on green background. No other HMI device can log on to this effective range.

### Requirement for logging off

The HMI device is logged on to this effective range.

### Logoff procedure

Before you leave the effective range or runtime, you must log off from the effective range first. If you leave the effective range without logging off, a warning appears.

1. Click on the "Effective range name" object. The "Effective range logoff" dialog box opens.
2. Confirm logoff with "Yes".

### Result

The HMI device is no longer logged into the effective range. Other HMI devices can now log on to this effective range.

---

#### Note

Do not deactivate the "Override" mode again unless you logon a different HMI device.

---

**See also**

- Device-Specific Nature of the Objects (Page 3077)
- Charging status (Page 3106)
- Effective range signal (Page 3156)
- WLAN reception (Page 3157)
- Zone name (Page 3160)
- Zone signal (Page 3161)
- Configuring the effective range name (Page 4887)

**Effective range name (RFID)**

**Application**



The "Effective range name (RFID)" object is a control element for some SIMATIC Mobile Panels. The "Effective range name (RFID)" object shows the name of the effective range (RFID) in which the HMI device is located and also the logon status.

**Note**

**RFID tags in the plant area**

RFID tags may only be attached in demarcated areas which are secured by additional protective measures, e.g. protective fencing.

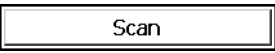
**Layout**

Symbol	Description	Description	Logon status
	Acknowledgement button has no effect	Within the effective range (RFID) "MixingAxisControl"	It is not possible to log on to the effective range (RFID)
	Acknowledgement button functions	Within the effective range (RFID) "MixingAxisControl"	Logon to effective range (RFID) running
	Acknowledgement button functions	Within the effective range (RFID) "MixingAxisControl"	Logged on to the effective range (RFID)

In the "Properties > Properties > Security" category of the Inspector window, you can assign an authorization for the user group that logs on to the effective range (RFID) during runtime.

### Logon requirements

- The HMI device is located within the effective range (RFID).
- The machine is demarcated by additional protective measures.
- No HMI device is logged on to this effective range (RFID).

### Logon procedure

1. Click on the "Effective range name (RFID)" object.  
The "Effective range logon" dialog box opens.
2. Read the ID from the machine or plant to be operated.
3. Enter the ID you read.
4. Confirm your entries by clicking "OK".

### Result

If the ID and effective range (RFID) match, the HMI device is logged on to the machine. Successful logon is signaled by an icon on green background. No other HMI device can log on to this effective range (RFID) or the machine.

### Logoff requirements

The HMI device is logged on to this effective range (RFID).

### Logoff procedure

Before you exit the effective range (RFID) or runtime, you must first log off from the effective range (RFID). If you exit the effective range (RFID) without logging off, a local rampdown is executed.

1. Click on the "Effective range name (RFID)" object. The "Effective range (RFID) - logoff" dialog box opens.
2. Confirm logoff with "Yes".

### Result

The HMI device is no longer logged into the effective range (RFID) or machine. Other HMI devices can now log on to this effective range (RFID).

### See also

Device-Specific Nature of the Objects (Page 3077)

Charging status (Page 3106)

WLAN reception (Page 3157)





Configuring the effective range name (RFID) (Page 4890)

## Effective range signal

### Application

The "Effective range signal" object is a control element for some SIMATIC Mobile Panels. The "Effective range signal" object indicates how accurately the Mobile Panel Wireless is positioned within an effective range.

### Layout

Symbol	Description
	Within an effective range
	When leaving an effective range When entering an effective range
	Outside of each effective range
	Override function is activated: Within a special security range of the effective range

The "Effective range name" object indicates which effective range this concerns.

### Override function

An effective range, e.g. "robots" is formed outwardly through transponders. However, within a special protection zone, e.g. "robot cells", the effective range is not formed by transponders, but by alternative restrictions e.g. by railings and a door.

The operator initially logs on to the effective range. An operator who enters the restricted and secure zone "robot cells" must press an additional switch to activate the override function:

- The effective range is allocated and can no longer be established by the transponder.
- Therefore, the quality does not play a role and is no longer displayed.
- The HMI device remains logged into the effective range.
- Other HMI devices can no longer logon to this effective range.

### Calculating the signal quality

The quality within an effective range depends, as follows, on the measured distance:

- In the center of the effective range the quality is 100%.
- On the transponder and on the border of the effective range, the quality is 0%.

### Operation

The object is for display only and cannot be controlled by the operator.







**See also**

Device-Specific Nature of the Objects (Page 3077)  
 Charging status (Page 3106)  
 Effective range name (Page 3152)  
 WLAN reception (Page 3157)  
 Zone name (Page 3160)  
 Zone signal (Page 3161)  
 Configuring additional Mobile Wireless objects (Page 4888)

**WLAN reception****Application**

The "WLAN reception" object is a control element for some SIMATIC Mobile Panels. The "WLAN reception" object displays the signal strength of the WLAN wireless connection. In addition, the signal strength is measured and displayed by means of 5 bars.

**Layout**

Symbol	Meaning	Signal strength
	No wireless connection	No signal
	Very poor wireless connection	=<20 %
	Poor wireless connection	>20 % =<40 %
	Wireless connection OK	>40 % =<60 %
	Good wireless connection	>60 % =<80 %
	Very good wireless connection	>80 %

**Operation**

The object is for display only and cannot be controlled by the operator.

## See also

- Device-Specific Nature of the Objects (Page 3077)
- Charging status (Page 3106)
- Effective range name (Page 3152)
- Effective range name (RFID) (Page 3154)
- Effective range signal (Page 3156)
- Zone name (Page 3160)
- Zone signal (Page 3161)
- Configuring additional Mobile Wireless objects (Page 4888)

## Gauge

### Use

The "Gauge" object shows numeric values in the form of an analog gauge. For example, a glance during Runtime is enough to note that the boiler pressure is in the normal range.

---

#### Note

The gauge is for display only and cannot be controlled by the operator.

Configure system functions that are performed at value changes in the tag properties at the "Value change" event and not at the "Change" event of the gauge. If your project is to comply with Good Manufacturing Practices, and the system function performs a GMP-relevant action. e.g. increasing a GMP-relevant tag, every value change of the tag used at the gauge is interpreted as a user action.

---

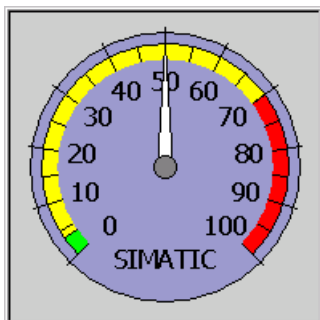

## Layout

In the Inspector window, you customize the position, geometry, style, color and font types of the object. You can adapt the following properties in particular:

- Display peak value pointer: Specifies whether the actual measurement range is indicated with a slave pointer.
- Maximum Value and Minimum Value: Specifies the top and bottom values of the scale.
- Start value of the danger range and start value of the warning range: Specifies the scale value from which the danger range and the warning range start.
- Display normal range: Specifies whether the normal range is shown in color on the scale.
- Color of individual ranges: Different operating modes, such as normal range, warning range and danger range, are shown in different colors so that the operator can distinguish them easily.

## Display peak value

The "Display peak value" property can be used to activate a marker function for the maximum and minimum pointer movement in Runtime. The actual measurement range is shown with a slave pointer.

1. In the Inspector window, activate "Properties > Properties > Appearance > Show peak values".

## Maximum Value and Minimum Value

You can set the top and bottom end values of the scale in the Inspector window.

1. In the Inspector window, select "Properties > Properties > General".
2. Enter a number under "Scale > Maximum value" and at "Minimum value".  
If you select a tag as the end value of the scale, the number will be no longer available.

---

### Note

Ensure that the minimum value is always less than the maximum value, especially if you make the minimum value or maximum value dynamic through a tag. If the minimum value is greater than the maximum value, no adjustment is made to the scale end values.

---

## Start value of the danger range and start value of the warning range

Define the scale value at which the danger range and the warning range start in the inspector window.

1. Click "Properties > Properties > Areas" in the inspector window.
2. Input the start value at "start value of danger range" and "start value of warning range".
3. Activate "start value of danger range" and "start value of warning range" to display the ranges on the scale.

### Normal range visible

In the inspector window, define whether to show the normal range in color.

1. Click "Properties > Properties > Areas" in the inspector window.
2. Activate "Normal".

### Color of individual ranges

You can display the normal range, the danger range and the warning range in different colors. Define the color in the inspector window.

1. In the Inspector window, select "Properties > Properties > Areas".
2. Select a color from the color palette for the three areas.

---

#### Note

The following restrictions apply for HMI devices with Windows CE:

- The three ranges (normal / warning / danger) are not visualized in different colors in Runtime.
- 

### See also



Device-Specific Nature of the Objects (Page 3077)

### Zone name

### Application

The "Zone name" object is a control element for some SIMATIC Mobile Panels. The "Zone name" object shows the names of the zone in which the HMI device is located.

### Layout

Symbol	Meaning	Description
	The "On entry" and "On exit" events of the zone and the zone ID can be used in the configuration.	Within the "MixingPlant" zone
	-	Outside of each zone



## Procedure for "On entry" event

1. In the "Zones" or "Zones and effective ranges" editor, configure the function "ActivateScreen" on the "On entry" event.

## Procedure with zone ID

1. Select an internal tag as the "Zone ID / Connection point ID" in the "Runtime settings > General" editor.
2. Animate the visibility of an object, e.g. "I/O field" via the internal tag.

## Operation

The object is for display only and cannot be operated.

## See also

Device-Specific Nature of the Objects (Page 3077)

Charging status (Page 3106)

Effective range name (Page 3152)

Effective range signal (Page 3156)

WLAN reception (Page 3157)



Zone signal (Page 3161)

## Zone signal

## Application

The "Zone signal" object is a control element for some SIMATIC Mobile Panels. The "Zone signal" object indicates how well the Mobile Panel is still in a zone. Compared to the "WLAN reception" object, it is not the signal strength that is measured, it is calculated from the distance.

## Layout

Symbol	Meaning	Quality
	Within one zone	$\geq 15\%$
	When leaving a zone When entering a zone	$< 15\%$ and $> 0\%$
	Outside of each zone	$= 0\%$

The "Zone name" object indicates which zone this concerns.

## Calculating the signal quality

The quality of the signal within a zone depends, as follows, on the measured distance:

- In the centre of the zone the quality is 100%.
- To the rear towards the transponder and to the front away from the transponder, the quality starts to diminish linearly.
- On the transponder and on the border of the zone, the quality is 0%.

## Operation

The object is for display only and cannot be operated.

## See also

Device-Specific Nature of the Objects (Page 3077)

Charging status (Page 3106)

Effective range name (Page 3152)

Effective range signal (Page 3156)

WLAN reception (Page 3157)

Zone name (Page 3160)

## 10.1.9 Configuring screen navigation

### 10.1.9.1 Basics on screen navigation

#### Types of navigation for the screen change

For a production process consisting of multiple subprocesses, you will configure multiple screens. You have the following options to enable the operator to switch from one screen to the next in Runtime:

- Assign buttons to screen changes
- Configuring screen changes at local function keys

#### Procedure

Before you create a screen change, define the plant structure and derive from it the screen changes that you want to configure.

Create the start screen under "Runtime Settings > General > Start screen".

**See also**

Screen basics (Page 2931)

Assigning screen change to function key (Page 3164)

Assigning button with screen change (Page 3163)

**10.1.9.2 Assigning button with screen change****Introduction**

Configure a button in the screen to switch between the screens on the HMI device during operation.

**Note**

If you have set the "Visibility" of animations to "Hidden" in the Inspector window of a screen, this screen cannot be called up in Runtime.

**Requirements**

- You have created the project.
- You have created the "Screen\_2" screen.
- "Screen\_1" is created.

**Procedure**

1. Double-click "Screen\_1" in the project navigation. The screen is displayed in the work area.
2. Move "Screen\_2" from the project tree to the open screen by drag&drop. A button with the name "Screen\_1" is inserted.
3. In the Inspector window, select "Properties > Events > Click". The "ActivateScreen" system function is displayed in the "Function list".

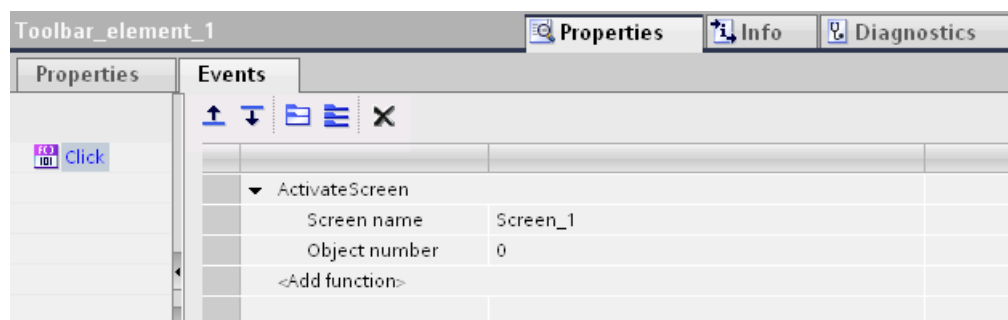

4. At the "Object number" attribute, define, if required, the tab sequence number of the object on which the focus is to be set after a screen change. You can also specify a tag that contains the object number.

### Alternative procedure

1. Move a button from the "Tools" task card to "Screen2" by drag&drop.
2. In the Inspector window, select "Properties > Events > Click".
3. Select the "ActivateScreen" system function.
4. Select "Screen\_2" for the "Screen number".

### Result

The operator goes to "Screen\_1" with the button in Runtime. If you have specified an object number, the object with this object number has the focus following a screen change.

### See also

Basics on screen navigation (Page 3162)

### 10.1.9.3 Assigning screen change to function key

#### Introduction

Configure a screen change function key in the screen to switch between the screens on the HMI device during operation.

---

#### Note

If you have set the "Visibility" of animations to "Hidden" in the inspector window of a screen, this screen cannot be called up in Runtime.

---

#### Requirements

- You have created a project.
- You have created the "Screen\_2" screen.
- You have created the "Screen\_1" screen.

#### Procedure

1. Double click "Screen\_1" in the project tree. The screen is displayed in the work area.
2. Move "Screen\_2" from the project tree to a function key, e.g. "F2".  
The configured function key displays a yellow triangle.
3. Click "Properties > Events > Press key" in the inspector window.  
The "ActivateScreen" system function is displayed.

**Result**

The operator goes to the specified "Screen\_2" with function key "F2" in Runtime.

**See also**

Basics on screen navigation (Page 3162)

## 10.2 Working with Tags

### 10.2.1 Basics

#### 10.2.1.1 Basics of tags

##### Introduction

Process values are forwarded in runtime using tags. Process values are data which is stored in the memory of one of the connected automation systems. They represent the status of a plant in the form of temperatures, fill levels or switching states, for example. Define external tags for processing the process values in WinCC.

WinCC works with two types of tag:

- External tags
- Internal tags

The external tags form the link between WinCC and the automation systems. The values of external tags correspond to the process values from the memory of an automation system. The value of an external tag is determined by reading the process value from the memory of the automation system. It is also possible to rewrite a process value in the memory of the automation system.

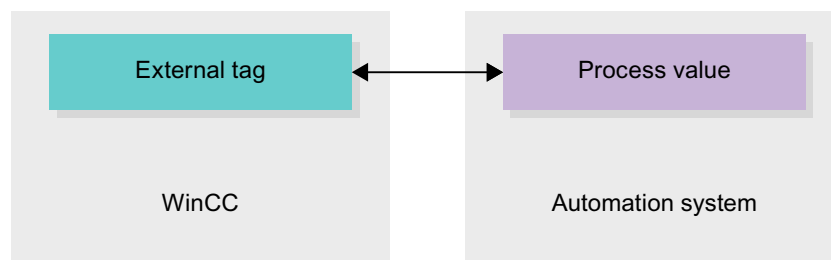

Internal tags do not have a process link and only convey values within the WinCC. The tag values are only available as long as runtime is running.

##### Tags in WinCC

For external tags, the properties of the tag are used to define the connection that the WinCC uses to communicate with the automation system and form of data exchange.

Tags that are not supplied with values by the process - the internal tags - are not connected to the automation system. In the tag's "Connection" property, this is identified by the "Internal tag" entry.

You can create tags in different tag tables for greater clarity. You then directly access the individual tag tables in the "HMI tags" node in the project tree. The tags from all tag tables can be displayed with the help of the table "Show all tags".

With structures you bundle a number of different tags that form one logical unit. Structures are project-associated data and are available for all HMI devices of the project. You use the "Types" editor in the project library to create and edit a structure.

## See also

Creating external tags (Page 3173)  
Editing a Tag (Page 3177)  
Tag Limits (Page 3183)  
Indirect addressing of tags (Page 3197)  
Internal Tags (Page 3172)  
Basics on arrays (Page 3201)  
Basics on user data types (Page 3204)  
Cycle basics (Page 3212)  
Trends (Page 3237)  
Overview of HMI tag tables (Page 3167)  
Addressing external tags (Page 3170)  
Basic principles for data logging (Page 3214)  
External tags (Page 3169)  
Outputting tag values in screens (Basic) (Page 3235)

### 10.2.1.2 Overview of HMI tag tables

#### Introduction

HMI tag tables contain the definitions of the HMI tags that apply across all devices. A tag table is created automatically for each HMI device created in the project.

In the project tree there is an "HMI tags" folder for each HMI device. The following tables can be contained in this folder:

- Default tag table
- User-defined tag tables
- Table of all tags

In the project tree you can create additional tag tables in the HMI tags folder and use these to sort and group tags and constants. You can move tags to a different tag table using a drag-and-drop operation or with the help of the "Tag table" field. Activate the "Tags table" field using the shortcut menu of the column headings.

#### Default tag table

There is one default tag table for each HMI device of the project. It cannot be deleted or moved. The default tag table contains HMI tags and, depending on the HMI device, also system tags.

You can declare all HMI tags in the standard tags table or, as necessary, additional user-defined tables of tags.

### User-defined tag tables

You can create multiple user-defined tag tables for each HMI device in order to group tags according to your requirements. You can rename, gather into groups, or delete user-defined tag tables. To group tag tables, create additional subfolders in the HMI tags folder.

### All tags

The "All tags" table shows an overview of all HMI tags and system tags of the HMI device in question. This table cannot be deleted, renamed or moved. This table also contains the "Tags table" column, which indicates the tag table of where a tag is included. Using the "Tags table" field, the assignment of a tag to a tags table can be changed.

With devices for Runtime Professional, the table "All tags" contain an additional tab "System tags". The system tags are created by the system and used for internal management of the project. The names of the system tags begin with the "@" character. System tags cannot be deleted or renamed. You can evaluate the value of a system tag, but cannot modify it.

### Additional tables

The following tables are also available in an HMI tag table:

- Discrete alarms
- Analog alarms
- Logging tags

With the help of these tables you configure alarms and logging tags for the currently selected HMI tag.

### Discrete alarms table

In the "Discrete alarms" table, you configure discrete alarms to the HMI tag selected in the HMI tag table. When you configure a discrete alarm, multiple selection in the HMI tag table is not possible. You configure the discrete alarms for each HMI tag separately.

### Analog alarms table

In the "Analog alarms" table, you configure analog alarms to the HMI tag selected in the HMI tag table. When you configure an analog alarm, multiple selection in the HMI tag table is not possible. You configure the analog alarms for each HMI tag separately.

### Logging tags table

In the "Logging tags" table, you configure logging tags to the HMI tag selected in the HMI tag table. When you configure a logging tag, multiple selection in the HMI tag table is not possible. You configure the logging tags for each HMI tag separately. The "Logging tags" table is only available if the HMI device used supports logging.



If WinCC Runtime Professional is used, you can also assign several log tags to a tag. With the other HMI devices, you can only assign one log tag to a tag.

## See also

Basics of tags (Page 3166)

### 10.2.1.3 External tags

#### Introduction

External tags allow communication (exchange of data) between the components of an automation system, such as between the HMI device and the PLC.

#### Principle

An external tag is the image of a defined memory location in the PLC. You have read and write access to this storage location from both the HMI device and from the PLC.

Since external tags are the image of a storage location in the PLC, the applicable data types depend on the PLC which is connected to the HMI device.

In STEP 7, if you write a PLC control program, the PLC tags created in the control program will be added to the PLC tag table. If you want to connect an external tag to a PLC tag, access the PLC tags directly via the PLC tag table and connect them to the external tag.

#### Data types

All the data types which are available at the connected PLC are available at an external tag in WinCC. Information about data types which are available for connection to other PLCs can be found in the documentation about the respective communication drivers.

See "Auto-Hotspot" for additional information.

---

#### Note

As well as external tags, area pointers are also available for communication between the HMI device and PLC. You can set up and enable the area indicators in the "Connections" editor.

---

#### Update of tag values

For external tags, the current tag values are transmitted in runtime via the communication connection between WinCC and the connected automation systems and then saved in the runtime memory. Next, the tag value will be updated to the set cycle time. For use in the runtime project, WinCC accesses tag values in the runtime memory that were read from the PLC at the previous cycle time. As a result, the value in the PLC can already change whilst the value from the runtime memory is being processed.

**See also**

Basics of tags (Page 3166)



**10.2.1.4 Addressing external tags**

**Introduction**

The options for addressing external tags depend on the type of connection between WinCC and the PLC in question. A distinction must be made between the following connection types:

- **Integrated connection**  
Connections of devices which are within a project and were created with the "Devices & Networks" editor are referred to as integrated connections.
- **Non-integrated connection**  
Connections of devices which were created with the "Connections" editor are referred to as non-integrated connections. It is not necessary that all of the devices be within a single project.

The connection type can also be recognized by its icon.

	Integrated connection
	Non-integrated connection

You can find additional information in the section "Basics of communication (Page 4911)".

**Addressing with integrated connections**

An integrated connection offers the advantage that you can address a tag both symbolically and absolutely.

For symbolic addressing, you select the PLC tag via its name and connect it to the HMI tag. The valid data type for the HMI tag is automatically selected by the system. You have to distinguish between the following cases when you address elements in data blocks:

**Symbolic addressing of data blocks with optimized access and standard access:**

During the symbolic addressing of a data block with optimized access and standard access, the address of an element in the data block is dynamically assigned and is automatically adopted in the HMI tag in the event of a change. You do not need to compile the connected data block or the WinCC project for this step.

For data blocks with optimized access, only symbolic addressing is available.

For symbolic addressing of elements in a data block, you only need to recompile and reload the WinCC project in case of the following changes:

- If the name or the data type of the linked data block element or global PLC tag has changed.
- If the name or the data type of the higher level structure node of a linked element in the data block element or global PLC tag has changed.
- If the name of the connected data block has changed.

Symbolic addressing is currently available with the following PLCs:

- SIMATIC S7 1200
- SIMATIC S7 1500

Symbolic addressing is also available if you have an integrated link.

---

#### Note

Symbolic addressing is not possible if you are using the "Date/Time" area pointer.

---

You can also use absolute addressing with an integrated connection. You have to use absolute addressing for PLC tags from a SIMATIC S7 300/400 PLC. If you have connected an HMI tag with a PLC tag and the address of the PLC tag changes, you only have to recompile the control program to update the new address in WinCC. Then you recompile the WinCC project and load it onto the HMI device.

In WinCC, symbolic addressing is the default method. To change the default setting, select the menu command "Options > Settings". Select "Visualization > Tags" in the "Settings" dialog. If required, disable the "Symbolic access" option.

The availability of an integrated connection depends on the PLC used. The following table shows the availability:

PLC	Integrated connection	Comments
S7 300/400	Yes	The linking of tags is not checked in Runtime. If the tag address changes in the PLC and the HMI device is not compiled again and loaded, the change is not registered in runtime.
S7 1200	Yes	A validity check of the tag connection is performed in runtime during symbolic addressing. If an address is changed in the PLC, the change is registered and an error message is issued. In the case of absolute addressing, the following behavior applies to the S7 300/400.
S7 1500	Yes	A validity check of the tag connection is performed in runtime during symbolic addressing. If an address is changed in the PLC, the change is registered and an error message is issued. In the case of absolute addressing, the following behavior applies to the S7 300/400.

Create an integrated connection in the "Devices & Networks" editor. If the PLC is contained in the project and integrated connections are supported, you can then also have the connection created automatically. To do this, when configuring the HMI tag, simply select an existing PLC tag to which you want to connect the HMI tag. The integrated connection is then automatically created by the system.

### Addressing with non-integrated connections

In the case of a project with a non-integrated connection, you always configure a tag connection with absolute addressing. Select the valid data type yourself. If the address of a PLC tag changes in a project with a non-integrated connection during the course of the project, you

## 10.2 Working with Tags

also have to make the change in WinCC. The tag connection cannot be checked for validity in Runtime, an error message is not issued.

A non-integrated connection is available for all supported PLCs.

Symbolic addressing is not available in a non-integrated connection.

With a non-integrated connection, the control program does not need to be part of the WinCC project. You can perform the configuration of the PLC and the WinCC project independently of each other. For configuration in WinCC, only the addresses used in the PLC and their function have to be known.

### See also

Basics of communication (Page 4911)

Basics of tags (Page 3166)

### 10.2.1.5 Internal Tags

#### Introduction

Internal tags do not have any connection to the PLC. Internal tags transport values within the HMI device. The tag values are only available as long as runtime is running.

#### Principle

Internal tags are stored in the memory of the HMI device. Therefore, only this HMI device has read and write access to the internal tags. You can create internal tags to perform local calculations, for example.

You can use the HMI data types for internal tags. Availability depends on the HMI device being used.

The following HMI data types are available:

HMI data type	Data format
ARRAY	One-dimensional array
BOOL	Binary tag
DATETIME	Date/time format
DINT	Signed 32-bit value
INT	Signed 16-bit value
LREAL	Floating-point number 64-bit IEEE 754
REAL	Floating-point number 32-bit IEEE 754
SINT	Signed 8-bit value
UDINT	Unsigned 32-bit value
UINT	Unsigned 16-bit value
USINT	Unsigned 8-bit value
WSTRING	Text tag, 16-bit character set

**See also**

Basics of tags (Page 3166)

**10.2.2 Working with Tags****10.2.2.1 Creating tags****Creating external tags****Introduction**

You can access an address in the PLC via a PLC tag using an external tag. The following options are available for addressing:

- Symbolic addressing
- Absolute Addressing

You can find further details on symbolic addressing in section "Addressing external tags (Page 3170)". If possible, use symbolic addressing when configuring a tag. You create tags either in the standard tag table or in a tag table you defined yourself.



**Requirement**

- You have opened the project.
- A connection to the PLC is configured.
- The Inspector window is open.

**Procedure**

To create an external tag, proceed as follows:

1. Open the "HMI tags" folder in the project tree and double-click the standard tag table. The tag table opens.  
Alternatively, create a new tag table and then open it.
2. In the "Name" column, double-click "Add" in the tag table. A new tag is created.
3. Select the "Properties > Properties >General" category in the Inspector window and, if required, enter a unique tag name in the "Name" field. The tag name must be unique throughout the device.
4. If required, select the "Display name" field to enter a name to be displayed in Runtime. The name to be displayed is language-specific and can be translated for the required Runtime languages. The display name is available for Basic Panels, Panels and Runtime Advanced.

5. Select the connection to the required PLC in the "Connection" box. If the connection you require is not displayed, you must first create the connection to the PLC. You create the connection to a SIMATIC S7 PLC in the "Devices & Networks" editor. You create the connection to external PLCs in the "Connections" editor.  
If the project contains the PLC and supports integrated connections, you can also have the connection created automatically. To do this, when configuring the HMI tag, simply select an existing PLC tag to which you want to connect the HMI tag. The integrated connection is then automatically created by the system.
6. If you are working with an integrated connection, click the  button in the "PLC tag" field and select an already created PLC tag in the object list. Click the  button to confirm the selection.

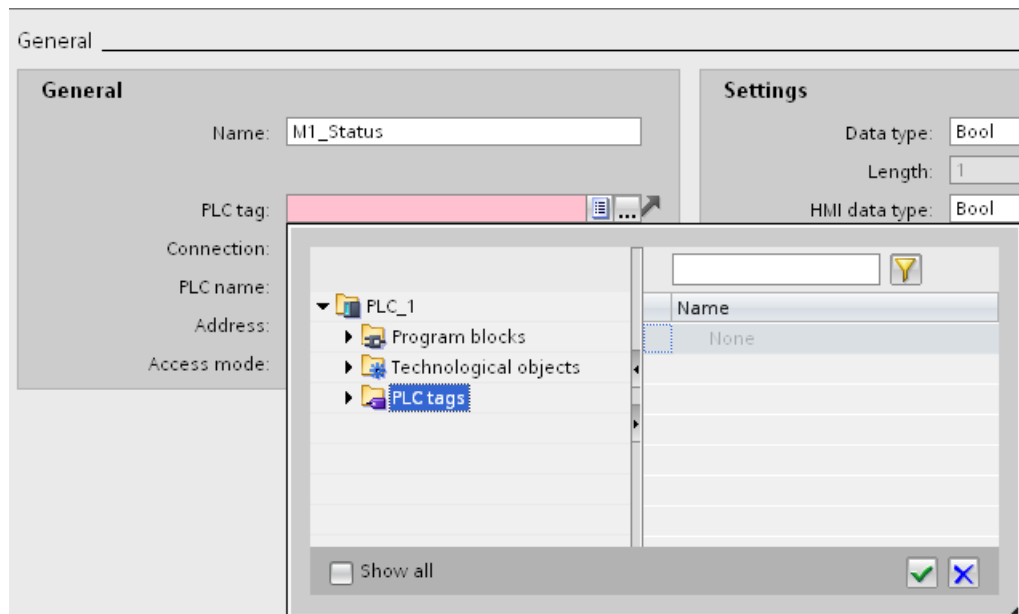

7. If you are working with a non-integrated connection, enter the address from the PLC in the "Address" field. The "PLC tag" field remains empty.
8. Configure the other properties of the tag in the inspector window.

You can also configure all tag properties directly in the tag table. To view hidden columns, activate the column titles using the shortcut menu.

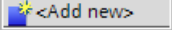
You can also create **new tags** alternatively directly at the application point, e.g. on an I/O field. To do this, click the  button in the object list. You then configure the new tag in the Inspector window.

## Result

An external tag has been created and linked to a PLC tag or an address in the PLC.

## Alternative procedure

You can also create external HMI tags by dragging and dropping data block elements or global PLC tags in an HMI tag table.

## See also

- Creating internal tags (Page 3175)
- Creating multiple tags (Page 3176)
- Basics of tags (Page 3166)
- Addressing external tags (Page 3170)
- Editing a Tag (Page 3177)
- Tag Limits (Page 3183)
- Indirect addressing of tags (Page 3197)

## Creating internal tags

### Introduction

You must at least set the name and data type for internal tags. Select the "Internal tag" item, rather than a connection to a PLC.

For documentation purposes, it is a good idea to enter a comment for every tag.

### Requirement

You have opened the project.

### Procedure

1. Open the "HMI tags" folder in the project tree and double-click the entry "Standard tag table". The tag table opens.  
Alternatively, create and then open a new tag table.
2. Double-click "Add" in the "Name" column of the tag table. A new tag is created.
3. If the Inspector window is not open, select the "Inspector window" option in the "View" menu.
4. Select the "Properties > Properties > General" category in the Inspector window and, if required, enter a unique tag name in the "Name" field. This tag name must be unique throughout the project.
5. If required, select the "Display name" field to enter a name to be displayed in Runtime. The name to be displayed is language-specific and can be translated for the required Runtime languages. The display name is available for Basic Panels, Panels and Runtime Advanced.
6. Select "Internal tag" as the connection in the "Connection" field.
7. Select the required data type in the "Data type" field.
8. In the "Length" field, you must specify the maximum number of characters to be stored in the tag according to the selected data type. The length is automatically defined by the data type for numerical tags.
9. As an option, you can enter a comment regarding the use of the tag. To do so, click "Properties > Properties > Comment" in the Inspector window and enter a text.

## 10.2 Working with Tags

You can also configure all tag properties directly in the tag table. To view hidden columns, activate the column titles using the shortcut menu.

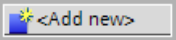
You can also create new tags alternatively directly at the application point, e.g. on an I/O field. Click the  button in the object list. You can then configure the new tag in the Properties window that opens.

### Result

An internal tag is created. You can now use this in your project.

In additional steps you can configure the tag, for example, by setting the start value and limits.

### See also

Creating external tags (Page 3173)

## Creating multiple tags

### Introduction

In a tag table, you create additional identical tags by automatically filling the rows of the table below a tag.

The tag names are incremented automatically when filling in automatically.

You can also use the auto fill function to fill table cells below a tag with a single tag property and thus modify the corresponding tags.

If you apply the automatic filling in to already filled cells of a tag table, you will be asked whether you want to overwrite the cells or insert new tags.

If you do not want to overwrite already configured tags, activate insert mode. Activate insert mode by keeping the <Ctrl> key pressed during insertion. Already existing entries in the tag table are moved down if insert mode is activated.

### Requirement

- You have opened the project.
- A tag table is open.
- The tag which is to serve as a template for other tags is configured.



## Procedure

1. If you want to create new tags, mark in the "Name" column the tag that should be used as a template for the new tags.

Tags		
	Name ▲	Connection
	<01 Motor	<Internal tag> ...
	<Add new>	

a tag to the tags below it, select the cell which contains

d in color and a small blue square will appear in its bottom  
e over this square, the cursor will change to a black cross.

2. 

Tags		
	Name ▲	Connection
	<01 Motor	<Internal tag> ...
	<01 Motor_1	<Internal tag>
	<01 Motor_2	<Internal tag>

 drag this square over the cells below that you wish to fill

over this area.

3. 

Tags		
	Name ▲	Connection
	<01 Motor	<Internal tag>
	<01 Motor_1	<Internal tag>
	<01 Motor_2	<Internal tag>
	<01 Motor_3	<Internal tag>
	<01 Motor_4	<Internal tag>
	<01 Motor_5	<Internal tag>

 All of the marked cells will be filled automatically.  
pty cells in the marked area.

## Result

Depending on which cells were selected, the function may automatically fill individual properties or create new tags.

## See also

Creating external tags (Page 3173)

### 10.2.2.2 Editing tags

#### Editing a Tag

#### Introduction

You can always rename, copy or delete tags.

When a tag is renamed, the new name must be unique for the whole device.

If you use the "Copy" command to copy a tag to the clipboard, the objects and references linked to the tag are copied as well.

If you use the "Insert" command to add a tag to another device, the tag will be added without the connected references. Only the object name of the reference will be inserted. If a reference of the same name and valid properties exists in the target system, the existing reference will then be connected to the copied tag.

If you copy a tag, some of the objects linked to the tag are copied as well. The following objects are copied:

- Logging tags
- Cycles
- Alarms

If you add the copied tag to another device, the tag is added together with the linked objects.

### Requirement

- The tag which you wish to rename, copy or delete must exist.
- The tag table containing the tag is open.

### Renaming tags

1. In the "Name" field, select the tag in the tag table.
2. Select "Rename" from the shortcut menu.
3. Type in a new name.  
The tag appears under its new name.

### Copying tags

1. Mark one or more tags in the tags table.
2. Select "Copy" from the shortcut menu.
3. Click on the point at which you want to insert the tag. For example, click another tag table in the same device or the tag table in a second device.
4. Select "Paste" from the shortcut menu. The tag is inserted as described above.

### Deleting a tag

1. Select one or more tags in the tag table.
2. Select the "Cross-reference" command from the "Tools" menu. In the "Cross-reference" editor, check to see where the tags are used. In this manner, you can see what impact the deletion of the tag will have on your project.
3. Select "Delete" in the pop-up menu of the tag.  
All marked tags will be deleted.

### Export and import of tags

WinCC gives you the option to export and import tags. With Export and Import, you have the option to export tags from one project and import them into another project. There is also the option to create larger numbers of tags outside of WinCC, edit them and subsequently import into any WinCC project. For further details, refer to Importing and exporting tags (Page 5519).

## See also

- Changing the tag configuration (Page 3179)
- Configuring multiple tags simultaneously (Page 3179)
- Using multiple tags simultaneously in a screen (Page 3180)
- Basics of tags (Page 3166)
- Reconnecting a tag (Page 3182)
- Creating external tags (Page 3173)
- Importing and exporting tags (Page 5519)

## Changing the tag configuration

### Introduction

You can modify tags at any time to adapt them to changed requirements in the project.

### Changing the tag configuration

if you want to change the configuration of a tag, open the tag table in which the tag is contained. Open the "Show all tags" tag table alternatively.

In the tag tables, you can perform such tasks as comparing and adjusting the properties of multiple tags or sorting the tags by their properties.

Change the properties either directly in the table or in the inspector window.

If you change a tag property and this change causes a conflict with another property, it will be highlighted in color to draw your attention to this fact. This could happen, for example, if you connect the tag to another PLC which does not support this data type.

## See also

- Editing a Tag (Page 3177)

## Configuring multiple tags simultaneously

### Introduction

In WinCC, you can assign the same properties to multiple tags in a single operation. This facilitates efficient programming.

### Requirement

- You created the tags you want to configure.
- The tag table is open.
- The Inspector window is open.

## Procedure

1. In the tag table, select all the tags that you want to configure at the same time.  
If the selected property is identical for all the tags, the setting for this property will appear in the Inspector window. The associated field will remain blank otherwise.
2. You can define the shared properties in the Inspector window or directly in the tag table.  
if you change a property commonly on several tags, only this one property is changed. The other properties of the tag remain unchanged.

## Result

All marked tags will be reconfigured.

To edit tag properties which differ from one tag to the other, simply clear the multiple selection.

## See also

Editing a Tag (Page 3177)

## Using multiple tags simultaneously in a screen

### Introduction

In WinCC, you can create multiple I/O fields that are linked with tags in one screen in a single operation. This facilitates efficient programming.

### Requirement

- Several tags are set up.
- A screen is open.

## Procedure

1. In the project tree, select the required tag table under "HMI tags".

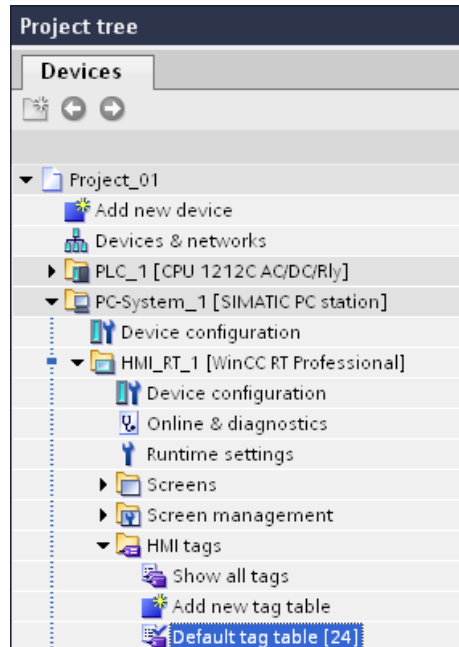

2. Select the detail view at the bottom of the project tree. The detail view shows the tags that exist in the selected tag group.

Details view		
	Name	Data type
	Tag_1	Bool
	Tag_2	Bool
	Tag_3	Bool
	Tag_4	Bool
	Tag_5	Bool
	Tag_6	Bool

3. Mark the tags in the detail window.
4. Drag the tags to the screen. For each tag, this creates an I/O field that is connected to the tag.

---

### Note

When you move a PLC tag from the detail window to the work area by drag&drop, a network and a connection are created additionally in the "Devices & Networks" editor.

---

## See also

Editing a Tag (Page 3177)

## Reconnecting a tag

### Introduction

WinCC enables you to automatically connect tags to addresses in the PLC. This procedure is suitable if, for example, changes were made to the connection between the HMI device and the PLC and the tag connections were lost. The function can also be used if you have configured the control program and HMI project separately.

The shortcut menu "Reconnect PLC tag" is available for this.

The menu command is available under the following conditions:

- An integrated connection to the PLC is present.
- The absolute address from the PLC is entered in the HMI tag.
- The HMI tag is configured with the correct data type.

The menu command is not available at a tag with symbolic addressing.

If you select multiple tags, the menu command is available if at least one of the selected tags meets the above-mentioned requirements. Only the tags that meet the requirements are connected.

### Requirement

- You have created an HMI tag.
- The tag table is open.
- A PLC tag with the absolute address from the PLC is present.

### Procedure

Proceed as follows to reconnect tags:

1. Select the row with the tag in the tag table.
2. Open the shortcut menu and select the menu command "Reconnect PLC tag".  
The system looks for a PLC tag whose absolute address and data type match the settings for the HMI tag. If a matching PLC tag is found, the tag connection is established immediately.

### Result

The PLC tag is connected to the HMI tag.

### See also

Editing a Tag (Page 3177)

### 10.2.2.3 Configuring Tags

#### Tag Configuration Basics

#### Tag Limits

##### Introduction

You can restrict the value range with limits for numerical tags.

##### Principle

You can specify a value range defined by a high limit and a low limit for numerical tags.

If the operator enters a value for the tag that is outside the configured value range, the input is rejected. The value is not accepted. You configure a function list when configuring for Runtime Advanced and Panels. When the tag value leaves the value range, the function list is processed.

---

**Note**

If you want to output an analog alarm when a limit is violated, configure the respective tag in the "Analog alarms" tab. You can also configure the analog alarm in the "HMI alarms" editor. The values for output of an analog alarm depend on the configured tag limits.

---

##### Application example

Use the limits to warn the operator when the value of a tag enters a critical range, for example.

## See also

- Defining Limits for a Tag (Page 3184)
- Start value of a tag (Page 3185)
- Defining the start value of a tag (Page 3186)
- Updating the Tag Value in Runtime (Page 3186)
- Linear scaling of a tag (Page 3187)
- Applying linear scaling to a tag (Page 3189)
- Connecting a tag to another PLC (Page 3189)
- Basics of tags (Page 3166)
- Address multiplexing (Page 3190)
- Configuring address multiplexing with absolute addressing (Page 3191)
- Configuring address multiplexing with symbolic addressing (Page 3194)
- Creating external tags (Page 3173)

## Defining Limits for a Tag

### Introduction

For numerical tags, you can specify a value range by defining a low and high limit.



For Runtime Advanced and Panels you can configure the system to process a function list whenever a tag value drops below or exceeds its configured value range.

### Requirement

- The tag for which you want to set the limits is created.
- The Inspector window with the properties for this tag is open.

### Procedure

To define limits for a tag, proceed as follows:

1. In the Inspector window select "Properties > Properties > Limits." If you want to define one of the limits as a constant value, select "Constant" using the  button. Enter a number in the relevant field.  
If you want to define one of the limits as a tag value, select "HMI tag" using the  button. Use the object list to define the tag for the limit.
2. To set additional limits for the tag, repeat step 1 with the appropriate settings.

### Alternative procedure

You can also configure the high and low limit directly in the tag table. To view hidden columns, activate the column titles using the shortcut menu.



## Configuring a function list for Runtime Advanced and Panels

When you configure Runtime Advanced and Panels, you can have a function list called up if a high or low limit is violated.

1. If you want to start a function list when the value drops below the value range, click "Properties > Events > Minimum violated" in the Inspector window. Create a function list in this dialog.
2. If you want to start a function list when the value exceeds the value range, click "Properties > Events > Maximum violated" in the Inspector window. Create a function list in this dialog.

## Result

You have set a value range defined by a high and low limit for the selected tag. If the value range is exceeded or undershot, a function list may be carried out.

## See also

Tag Limits (Page 3183)

## Start value of a tag

### Value of a tag at start of Runtime

You can configure a start value for numeric tags and tags for date/time values. The tag will be preset to this value when Runtime starts. In this way, you can ensure that the tag has a defined status when Runtime starts.

For external tags, the start value will be displayed on the HMI device until it is overwritten by the PLC or by input.

If no start value was configured, the tag contains the value "0" when starting Runtime.

In WinCC Runtime Professional you can enter a tag value in place of the start value on a tag with the "String" data type. The tag value is saved in the "Project texts" editor and is multilingual. After the text has been translated, it is displayed in Runtime as a language-dependent start value.

## Application example

You can assign a default value to an I/O field. Enter the desired default value as start value for the tag that is linked to the I/O field.

## See also

Tag Limits (Page 3183)

## Defining the start value of a tag

### Introduction

In WinCC you can configure a start value for a numeric tag and a tag for date/time values which this adopts at Runtime start.

### Requirement

- You have created the tag for which you want to define a start value.
- The Inspector window with the tag properties is open.

### Procedure

To configure a start value, proceed as follows:

1. In the Inspector window select "Properties > Properties > Values."
2. Enter the desired "Start value."

### Alternative procedure

You can also configure the start value directly in the tag table. To view hidden columns, activate the column titles using the shortcut menu.

### Result

The start value you selected for the tag is transferred to the project.

### See also

Tag Limits (Page 3183)

## Updating the Tag Value in Runtime

### Introduction

Tags contain process values which change while Runtime is running. Value changes are handled differently at internal and external tags.

### Principle

When Runtime starts, the value of a tag is equal to its start value. Tag values change in Runtime.

In Runtime, you have the following options for changing the value of a tag:

- A value change in an external tag in the PLC.
- By input, for example, in an I/O field.
- By running a system function, such as "SetValue."
- A value assignment in a script.

## Updating the Value of External Tags

The value of an external tag is updated as follows:

- **Cyclic in operation**  
If you select the "Cyclic in operation" acquisition mode, the tag is updated in Runtime while it is displayed in a screen or is logged. The acquisition cycle determines the update cycle for tag value updates on the HMI device. You can either choose a default acquisition cycle or define a user-specific cycle.
- **Cyclic continuous**  
If you select the "Cyclic continuous" acquisition mode, the tag will be updated continuously in Runtime, even if it is not in the currently-open screen. This setting is activated for tags that are configured to trigger a function list when their value changes, for example. Only use the "Cyclic continuous" setting for tags that must truly be updated. Frequent read operations increase communication load.
- **On demand**  
If you select the "On demand" acquisition mode, the tag is not updated cyclically. It will only be updated on demand using the "UpdateTag" system function, for example, or by a script.

## See also

Tag Limits (Page 3183)

## Linear scaling of a tag

### Introduction

Numeric data types can be processed with linear scaling. The process values in the PLC for an external tag can be mapped onto a specific value range in the project.

## Principle

To apply linear scaling to a tag, you must specify one value range on the HMI device and one on the PLC. The value ranges will be mapped to each other linearly.

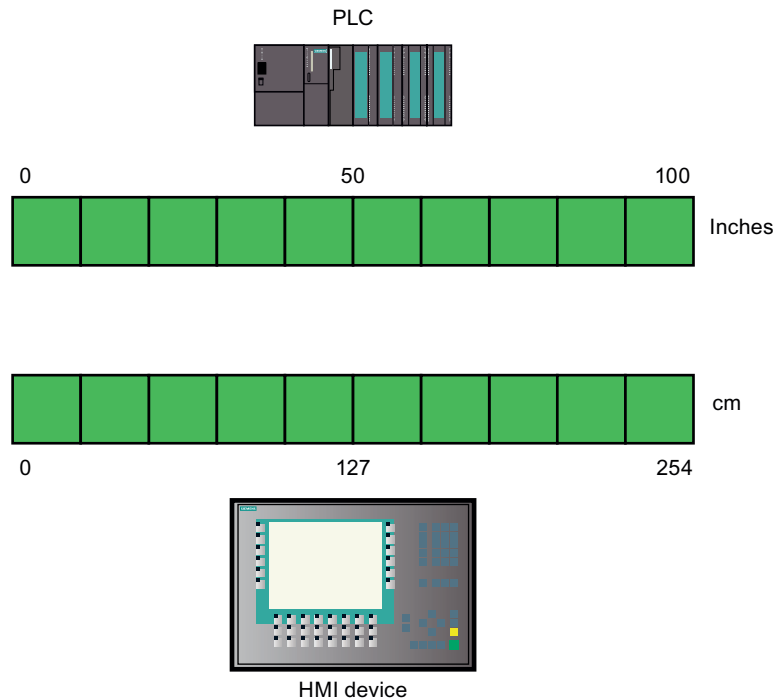

As soon as data from the HMI device is written to an external tag, it will be automatically mapped to the value range of the PLC. As soon as data from the HMI device is read from the external tag, a corresponding transformation will be performed in the other direction.

### Note

You can also use the system functions "LinearScaling" and "InvertLinearScaling" to automatically convert process values.

## Application example

The user enters length dimensions in centimeters but the PLC is expecting inches. The entered values are automatically converted before they are forwarded to the controller. Using linear scaling, the value range [0 to 100] on the PLC can be mapped onto the value range [0 to 254] on the HMI device.

## See also

Tag Limits (Page 3183)

## Applying linear scaling to a tag

### Introduction

To apply linear scaling to a tag, you must specify one value range on the HMI device and one on the PLC. The value ranges will be mapped to each other linearly.

### Requirement

- The external tag to which linear scaling is to be applied must exist.
- The Inspector window with the properties for this tag is open.

### Procedure

To apply linear scaling to a tag, follow these steps:

1. In the Inspector window select "Properties > Properties > Linear scaling."
2. Click on "Enable" to switch on linear scaling.  
Using this option, you can temporarily switch off linear scaling for testing purposes, for example. Settings which were made earlier for linear scaling remain unchanged.
3. In the "PLC" area, enter the start and end values of the value range to be applied to the process values on the PLC.
4. In the "HMI device" area, enter the end and start values of the value range to be applied to the process values on the HMI device.

### Result

In Runtime the data will be automatically mapped from one value range to the other.

---

#### Note

You can also use the "LinearScaling" and "InvertLinearScaling" system functions to automatically convert process values.

---

### See also

Tag Limits (Page 3183)

## Connecting a tag to another PLC

### Introduction

In WinCC, you can change the PLC connection of a tag at any time. This is needed when you change the configuration of your plant, for example.

## 10.2 Working with Tags

Depending on the PLC selected, you may need to modify the configuration of the tag. The tag properties which must be changed will be highlighted in color.

### Requirement

- The external tag, whose connection you wish to change, must already exist.
- The connection to the PLC must already exist.
- The Properties window for this tag is open.

### Procedure

To change the PLC connection of a tag, proceed as follows:

1. In the Inspector window select "Properties > Properties > General."
2. Select the new connection in the "Connection" field.  
The tag properties that you must change will be highlighted in color in the tag table and in the Inspector window.
3. Change all highlighted properties of the tag to suit the requirements of the new PLC.

### Result

The external tag is connected to the new PLC.

### See also

Tag Limits (Page 3183)

## Address multiplexing

### Introduction

Using address multiplexing, you can use a single tag to access a multitude of memory locations within the PLC's address range. You read and write to the addresses without defining a tag for each individual address.

### Multiplexing with absolute addressing

When using multiplexing with absolute addressing, you configure tags as placeholders for the address in the PLC to be addressed.

If you want to access, for example, an address of the format "%DBx.DBWy", the expression for multiplexing is as follows:

```
"%DB[HMITag1].DBW[HMITag2]"
```

In Runtime, you supply the tag "HMITag1" with the required value for the data block you want to address.

In Runtime, you supply the tag "HMITag2" with the required address from the data block.

Tags are supplied with values, for example, with the help of values from the PLC or via a script.

Multiplexing with absolute addresses is supported for the following PLCs and communication drivers.

- SIMATIC S7 300/400
- SIMATIC S7 1200

Multiplexing with absolute addresses is not available for data blocks with optimized access.

### Multiplexing with symbolic addressing

When multiplexing with symbolic addressing, you access an array element of an array tag in a data block of the connected PLC by means of a multiplex tag and an index tag. The multiplex tag contains the symbolic address of the data block which you want to access. The symbolic address also contains the index tag via which you access the index of the array tag.

If you want to access, for example, the array tag "Arraytag\_1" in the data block "Datablock\_1", the expression for symbolic addressing is as follows:

```
"Datablock_1.Arraytag_1["HMITag_1"]
```

You control the access to the index of the array elements with the HMI-Variable "HMITag\_1". In Runtime, you supply the tag with the index of the array element that you want to access.

Multiplexing with symbolic addressing is only available if the following components support symbolic addressing:

- the HMI device
- PLC
- Communication driver

Symbolic addressing is currently only supported by the SIMATIC S7 1200 communication driver.

### See also

Tag Limits (Page 3183)

### Configuring address multiplexing with absolute addressing

#### Introduction

When using address multiplexing, you can efficiently access different addresses in the PLC with the help of a small number of tags. Instead of the absolute address in the PLC, you use tags in order to be able to change the address in Runtime.

#### Requirement

- The tag for address multiplexing is created and connected to the PLC.
- The Properties window for this tag is open.

**Procedure**

1. Select the tag for address multiplexing in the tag table, and select "Properties > Properties > General" in the Inspector window. The general properties of the tag are displayed.

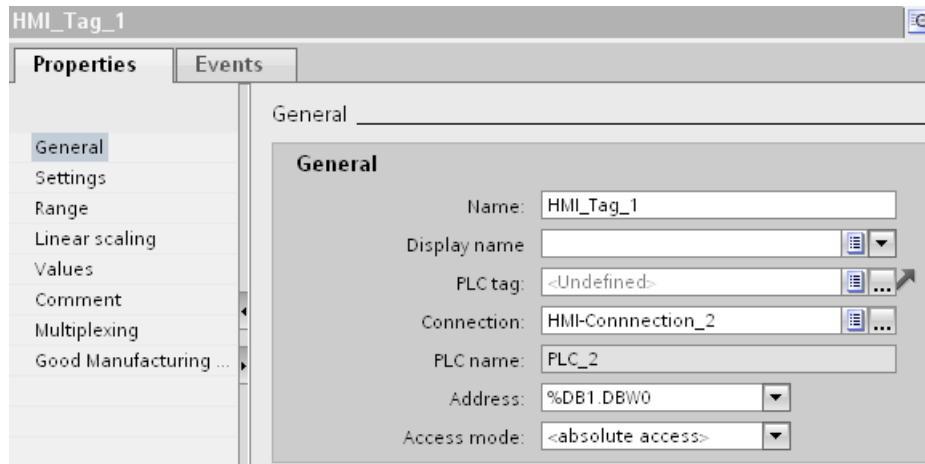

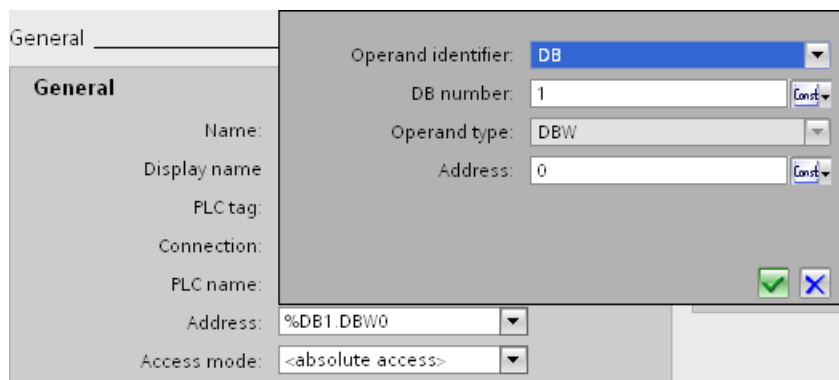

2. Select the "Int" data type for this example.
3. Select the access type "Absolute addressing".
4. Click the selection button in the "Address" field. The address dialog opens.

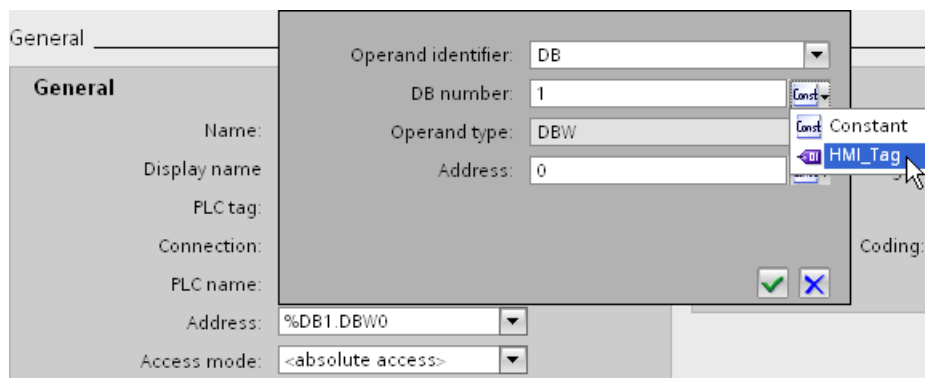

5. Click the selection button in the "DB number" field and select the entry "HMI tag".





6. In the "DB number" field, click the  button and select a tag for the DB number in the object list. Or create a new tag with the help of the object list. Accept the tag by clicking the  button.

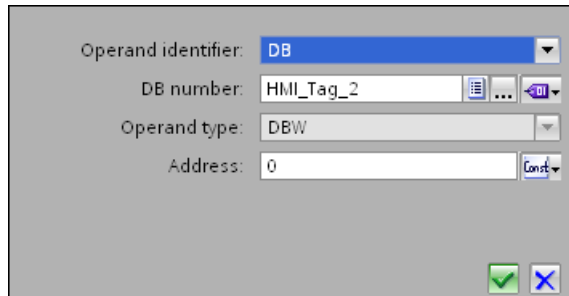

7. Repeat steps 3 and 4 for the "Address" field and configure a further tag for calling the address area in the data block.

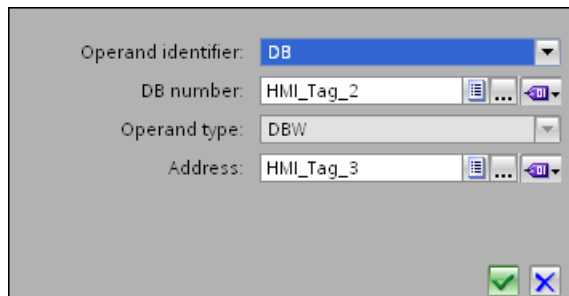

The selection options in the Address dialog depend on the selected data type of the multiplex tag. The Address dialog offers only address settings that can be configured with the selected data type.

## Result

In runtime, the multiplex tag is used to access the memory location corresponding to the address currently found in the tag. You control access to the data block with the tag in the DB number field. You control access to the address in the selected data block with the tag in the "Address" field.

### Note

The value in the memory location will only be read at the next update cycle for the addressed tag.

If, for example, you use a multiplex tag in a script, do not attempt to access contents of the memory location directly after changing it.

## See also

Tag Limits (Page 3183)

## **Configuring address multiplexing with symbolic addressing**

### **Introduction**

When using address multiplexing, you can efficiently access different addresses in the PLC with the help of a small number of tags. Instead of the symbolic address in the PLC, you use tags in order to be able to change the address in Runtime.

### **Requirement**

- The tag for address multiplexing is created.
- The Properties window for this tag is open.
- A data block with an array tag is created in the connected PLC.
- The data block was compiled.

## Procedure

1. Select the tag for address multiplexing in the tag table, and select "Properties > Properties > General" in the Inspector window. The general properties of the tag are displayed.

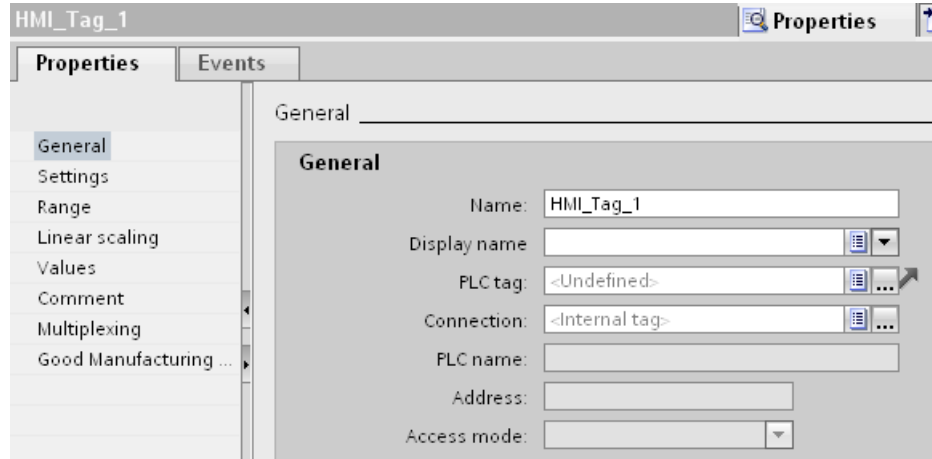

2. Select the connection to the PLC via the "Connection" field.

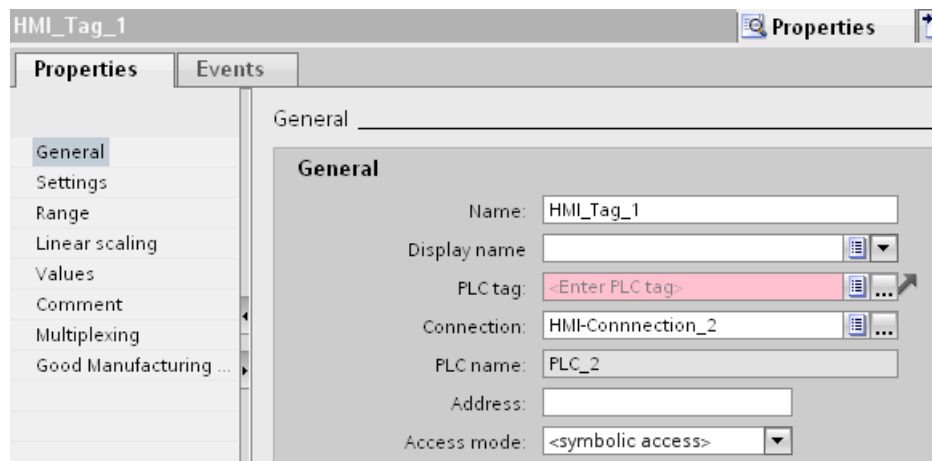

3. Select the access type "Symbolic addressing".

- Navigate to the data block of the PLC via the "PLC tag" field and select an array element of the array tag.

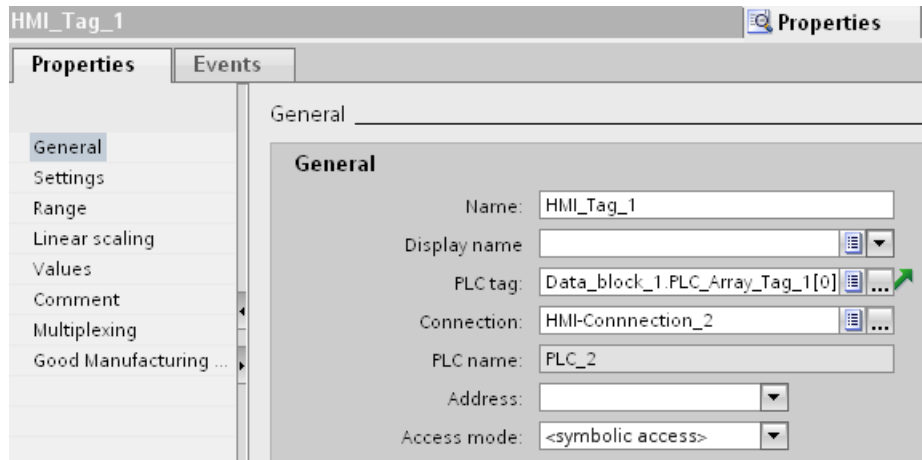

- Click the selection button in the "Address" field. The address dialog opens.
- Click the selection button in the "Index tag" field and select the entry "HMI tag".

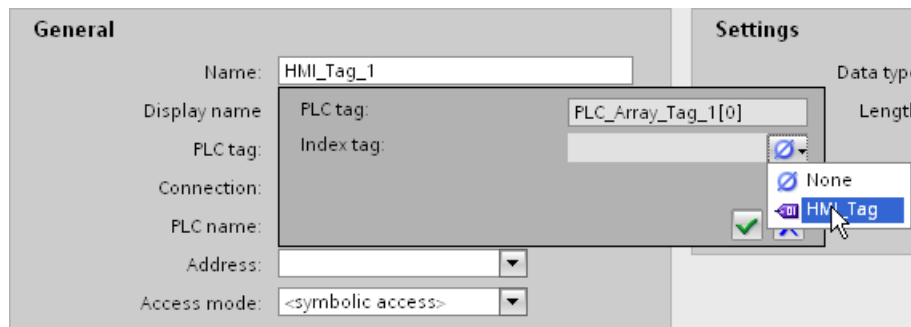

- In the "Index tag" field, click the ... button and select a tag for the array index in the object list. Or create a new tag with the help of the object list. Accept the tag by clicking the ✓ button.

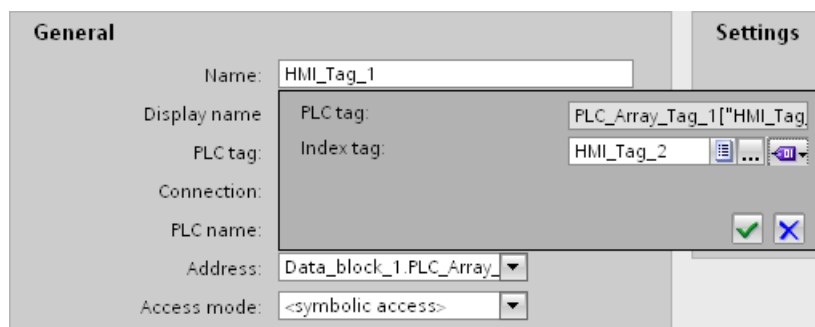

## Result

In Runtime, the array element whose index value is contained in the index tag is accessed.

## See also

Indirect addressing of tags (Page 3197)

Tag Limits (Page 3183)

## Special configuration options

### Indirect addressing of tags

#### Principle

In multiplexes, a type of indirect addressing, the tag used is first determined at runtime. A list of tags is defined for the multiplex tag. The relevant tag is selected from the list of tags in runtime. The selection of the tag depends on the value of the index tag.

In Runtime, the system first reads the value of the index tag. Then the tag which is specified in the corresponding place in the tag list is accessed.

#### Application example

Using indirect addressing, you could configure the following scenario:

The operator selects one of several machines from a selection list. Depending on the operator's selection, data from the selected machine will be displayed in an output field.

To configure such a scenario, configure the index tag for a symbolic I/O field. Configure the multiplex tag at an I/O field. Configure the tag list of the multiplex tag to reflect the structure of the selection list.

If the operator selects another machine, the value of the index tag will change. The selection field then displays the content of the tag that is pointed to in the tag list in the multiplex tag by the new index value.

## See also

Addressing tags indirectly (Page 3198)

Using tags to trigger functions (Page 3199)

Defining the acquisition cycle for a tag (Page 3200)

Basics of tags (Page 3166)

Configuring address multiplexing with symbolic addressing (Page 3194)

Creating external tags (Page 3173)

## Addressing tags indirectly

### Introduction

With indirect addressing, the tag used is first determined at runtime. Instead of a single tag, a list of tags is defined. The list entries consist of an index value and the name of the tag to be used. Using an index tag, you can control which entry in the tag list will be accessed.

### Requirement

- The tag which you wish to address indirectly must already exist.
- The index tag must exist.
- The tags which will be contained in the tag list must already exist.
- The Inspector window with the tag properties is open.

### Procedure

To address tags indirectly, proceed as follows:

1. In the Inspector window select "Properties > Properties > Multiplexing".
2. Select the "Multiplexing" option to activate indirect addressing.  
Using this option, you can temporarily switch off indirect addressing for testing purposes, for example. Settings which were made earlier for indirect addressing remain unchanged.
3. Select an "Index tag" or define a new tag using the object list.
4. Click the first entry in the "Tags" column in the tag list.
5. Select a tag as a list entry or define a new tag using the object list.  
The entry in the "Index" column will be generated automatically.
6. Repeat step 5 for all tags that you wish to add to the tag list.
7. If necessary, you can use drag-and-drop to change the order of the entries in the list.

### Result

In runtime, the system will dynamically access the tag in the tag list which has the same index value as the value currently in the index tag.

### See also

Indirect addressing of tags (Page 3197)

## Using tags to trigger functions

### Introduction

You can use the values of variables as the triggering event for an action in runtime. To start an action in Runtime, configure a function list for a tag. Include one or more system functions or VB scripts in the function list. The function list is processed when the configured event occurs.

The following events are available for a tag:

- Change in value of the tag  
Function list processing is triggered by each change in the value of the variable. When the tag is defined as an array tag, the function list is processed whenever an array element changes.
- Violation of the tag's high limit  
The function list is processed when the high limit is violated.
- Violation of the tag's low limit  
The function list is processed when the low limit is violated.

### Requirement

- The tag whose value you wish to use as an event already exists.
- The Inspector window with the properties for this tag is open.

### Procedure

To configure a tag with a function list, proceed as follows:

1. Under "Properties > Events >" in the Inspector window, select the event for which you want to create a function list.  
The function list associated with the selected event is shown.
2. Click "<Add function>". The second table column contains a selection button.
3. Click the selection button and select a system function.
4. Define the parameter values.

Alternatively, select a script to run in the function list, rather than a system function. The "VB scripts" entry is only displayed if there is a script available in the project.

### Result

If the configured event occurs in Runtime, the function list or the script is processed.

### See also

Indirect addressing of tags (Page 3197)

## Defining the acquisition cycle for a tag

### Introduction

The value of an external tag can be changed in Runtime by the PLC to which the tag is linked. To ensure that the HMI device is informed of any changes in tag values by the PLC, the values must be updated on the HMI. The value is updated at regular intervals while the tag is displayed in the process screen or is logged. The interval for regular updates is set with the acquisition cycle. The update can also be made continuous.

### Requirement

- You have created the tag for which you want to define an acquisition cycle.
- The Inspector window with the tag properties is open.

### Procedure

To configure an acquisition cycle for a tag, follow these steps:

1. In the Inspector window select "Properties > Properties > General."
2. If you want to update the tag at regular intervals as long as it is being displayed on the screen or logged, select "Cyclic in operation" as the acquisition mode.  
Or:  
If you want to update the tag at regular intervals even though it is not being displayed on the screen or logged, select "Cyclic continuous" as the acquisition mode.  
The "Cyclic continuous" setting is selected for a tag, for example, that has a function list configured for a change of its value and that is not directly visible in a screen.
3. Select the required cycle time in the "Acquisition cycle" field or define a new acquisition cycle using the object list.

Alternatively, you can configure the acquisition cycle directly in the work area of the tag table. To view hidden columns, activate the column titles using the shortcut menu.

---

#### Note

Only use the "Cyclic continuous" acquisition mode for tags that really have to be continuously updated. Frequent read operations generate a heavy communication load.

---

### Result

The configured tag is updated in Runtime with the selected acquisition cycle.

### See also

Indirect addressing of tags (Page 3197)



## 10.2.3 Working with arrays

### 10.2.3.1 Basics on arrays

#### Definition

Array data of a uniform data type is successively arranged and is addressed within the address space to allow access to these data by means of an index. The individual array elements are addressed by means of an integer index. Each array element is assigned the same properties which are configured at the array tag.

Default tag table			
Name ▲	Tag table	Data type	Connection
▼ HMI_Tag_1	Default tag table	Array [0..4] of Int	<Internal tag>
■ [0]	Default tag table	Int	<Internal tag>
■ [1]	Default tag table	Int	<Internal tag>
■ [2]	Default tag table	Int	<Internal tag>
■ [3]	Default tag table	Int	<Internal tag>
■ [4]	Default tag table	Int	<Internal tag>

#### Advantages

You can configure numerous array elements with the same properties all at once with a single array tag. You can then use each array element as any other tag in your configuration.

#### Restrictions

The following restrictions apply to the use of arrays:

- Arrays are only available in projects for Runtime Advanced and Panels; array tags are not available for Runtime Professional.
- An array may contain only one dimension.
- The lower index of an array must begin with "0".

#### Application examples

Array tags can be used in the following situations:

- To group process values in profile trends: You map process values to trends which are acquired at different points in time, for example.
- To access specific values which are grouped in trends: For example, display all recorded values of the profile trend by gradually increasing the index tag.
- To configure discrete alarms with successive bit number.
- To save the complete machine data records in a recipe.

### License rule for runtime

An array tag is counted in WinCC Runtime as one PowerTag, regardless of the number of array elements.

### Special features

 **WARNING**

**Increased system load and performance losses**

Read or write access to a single array element always includes read or write access to all array elements of the array tag. Transfer of the data of large arrays from and to the PLC usually takes longer compared to the transfer of a basic data type. This may cause communication overload and disruption as a result.

### Example:

- An array tag which consists of 100 array elements of data type "Real" was configured.
- If an array element with a length of four bytes changes, 100 x 4 bytes are written to the PLC.

### Use in scripts.

To maintain performance, always use internal arrays to change arrays in scripts.

1. Copy the PLC array to the internal array at the start of the script.
2. Load on data transfer to the PLC is avoided while the script processes the internal array.

 **CAUTION**

**Data inconsistency at array tags**

If the value of a single element must be changed in an array tag, the whole array is read, changed and rewritten as a complete array. Changes carried out in the meantime to other array elements in the PLC are overwritten during rewriting.

You should always prevent the HMI device and the PLC from concurrently writing values to the same array tag. Use synchronous transfer of recipe data records to synchronize an array tag with the PLC.

### See also

Basics of tags (Page 3166)

Creating array tags (Page 3203)

Examples of arrays (Page 3204)

### 10.2.3.2 Creating array tags

#### Introduction

Create an array tag to configure a large number of tags of the same data type. The array elements are saved to a consecutive address space.

You can create an array tag as an internal tag or as an external tag.



If you want to create an array tag as an external tag, first configure an array tag in a data block of the connected PLC. You then connect the array tag to an HMI tag.

#### Requirement

- The HMI tag table is open.

#### Procedure

To create an array tag, follow these steps:

1. Double click <Add> in the "Name" column of the HMI tag table.  
A new HMI tag is created.
2. Click  in the Data type column and select the "Array" data type.
3. Click  in the data type column. The dialog box for configuring the array is opened.

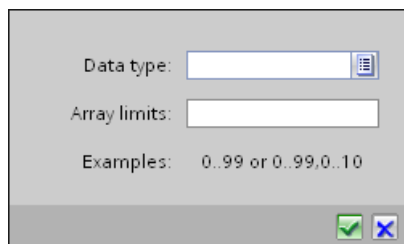

4. Select the desired data type for the array tag in the "Date type" field.

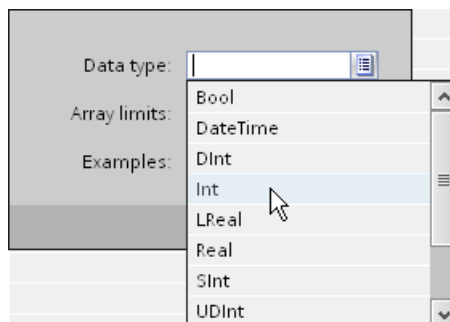

5. Define the number of array elements in the "Array limits" field. The lower limit must begin with "0".
6. Click . The settings for the array are saved.
7. Save the project.

## Result

An array tag is created. The properties of the array elements are inherited from the parent array tag.

## See also

Basics on arrays (Page 3201)

### 10.2.3.3 Examples of arrays

#### Introduction

Array tags combine a number of tags, e.g. 100 array elements. You use array tags as complete arrays in the following places:

- In the "Alarms" editor
- In the "Recipes" editor
- For address multiplexing
- In the trend view

You use individual array elements everywhere in the configuration like HMI tags.

#### Examples

You can configure an array tag with the corresponding number of array elements to handle multiple tags of the same data type.

- The individual array elements can be accessed indirectly by means of a multiplex index tag, for example.
- Use these index tags to operate and monitor the array elements.

## See also

Basics on arrays (Page 3201)

### 10.2.4 Working with user data types

#### 10.2.4.1 Basics on user data types

#### Introduction

With user data types you bundle a number of different tags that form one logical unit. You create a user data type as a type and use instances of this type in the project. User data types are project-associated data and are available for all HMI devices of the project.

User data types differ in their association to a family of devices. User data types are available for the following families of devices:

- WinCC Runtime Advanced and Panels
- WinCC Runtime Professional







User data types also differ in their applicability with a specific communication driver. User data types are available for the following communication drivers:

- SIMATIC S7 300/400
- SIMATIC S7 1200
- SIMATIC S7 1500

Create user data types and user data type elements in the project library.

## Principle

For example, the different conditions of a motor can be described using six unique Boolean tags.

Default tag table			
	Name	Data type	Connection
	Motor off	Bool	<Internal tag>
	slow forward	Bool	<Internal tag>
	fast forward	Bool	<Internal tag>
	slow backward	Bool	<Internal tag>
	fast backward	Bool	<Internal tag>
	error	Bool	<Internal tag>
	<Add new>		

If the overall condition should be described with a single tag, this tag can be created based on a user data type. For each of the individual Boolean tags you create a user data type element in the user data type.

This user data type can then be assigned complete to a faceplate for the motor. The created and released version of user data type is displayed at the tag in the "Data type" selection field.

The configured properties of a user data type are used in the instances of the user data type. If required, you change individual properties directly at the point of use, e.g. at a tag. Changing a property at the tag does not affect the user data type created.

### NOTICE

#### Availability of user data types

The connection of user data types to faceplates is only supported in WinCC Runtime Advanced and Panels.

## License regulation in Runtime

If you use external tags of the "User data type" data type in a faceplate instance, each user data type element is counted as a tag in Runtime.

### Example

You have created two screens in the "Screens" editor: Screen\_1 and Screen\_2

3 instances of a faceplate type are inserted in Screen\_1. 4 instances of a faceplate type are inserted in Screen\_2.

Each faceplate instance is connected to an external tag of the "User data type" data type. The user data type includes 10 user data type elements.

Screen 1: 3 faceplate instances \* 10 user data type elements corresponds to 30 external tags = 30 PowerTags.

Screen 2: 4 faceplate instances \* 10 user data type elements corresponds to 40 external tags = 40 PowerTags.

In Runtime, 70 PowerTags are counted together for both screens. This also applies to the user data type elements that are not required.

### See also

Basics of tags (Page 3166)

Creating tags with a user data type data type (Page 3210)

Managing versions of user data types (Page 3209)

Creating user data type elements (Page 3208)

Creating a user data type (Page 3206)

## 10.2.4.2 Creating a user data type

### Introduction

You create a user data type in the project library.

### Requirement

- A project is open.
- The "Libraries" task card is displayed or the library view is open.

### Procedure

To create a user data type, follow these steps:

1. Click the "Libraries" task card.
2. Double-click the "Project library" item. The folder structure of the project library is open.

- Click the "Create new type" button.  
A dialog opens.

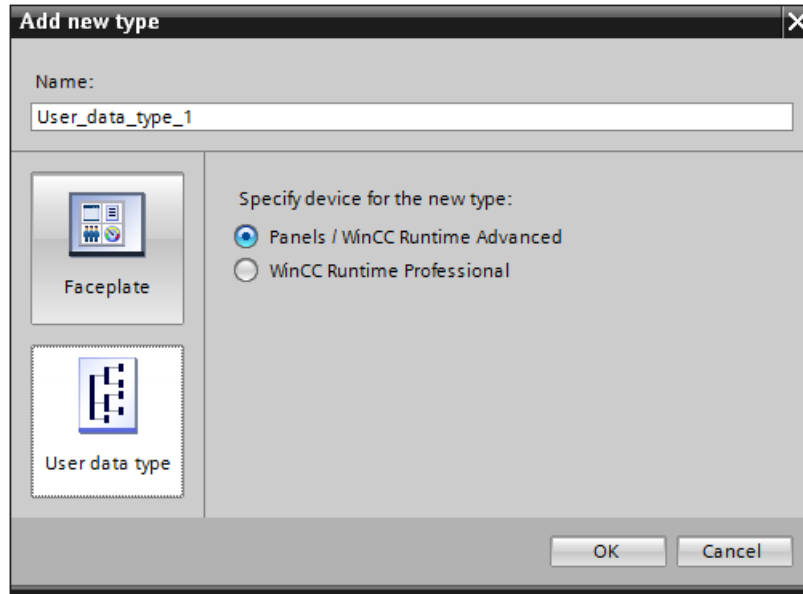

- Click the "HMI UDT" button in the dialog.
- In the "Specify device for the new type" area select the HMI device on which the user data type is used.
- Enter a descriptive name in the "Name" field.
- Click "OK" to apply your settings. The user data type is created. The library view opens.

## Result

A user data type with the configured properties is created. Version 0.0.1 of the user data type is created and receives the status "in progress".

Create the required user data type elements in the next step.

Before you use the version of user data types, for example at a tag, the version must be released.

## See also

Basics on user data types (Page 3204)

Managing versions of user data types (Page 3209)

### 10.2.4.3 Creating user data type elements

#### Introduction

You define user data type elements in the library view. You add or delete elements in the "HMI user data types" table in the work area.

#### Requirement

- The library view is open.
- A user data type is created and opened in the editor.

#### Procedure

1. Select a communication driver for the user data type.
  - If you select the <Internal communication> entry, you can only assign the user data type to the internal tags as the data type.
  - If a connection to a PLC is selected as the communication driver, the user data type can only be assigned to tags with a connection to this PLC as the data type.
  - The communication type set applies to all user data type elements of a user data type. In a user data type for the "WinCC Runtime Professional" family of devices, you can define for each user data type element whether the configured driver is used for control or internal communication.
1. Double-click "Add" in the "Name" column of the table. A new user data type element is added to the user data type.
2. Assign a name.
3. Select the required data type in the "Data Type" field.
4. Create as many user data type elements as you need.
5. You configure the user data type elements in the "Properties" group in the Inspector window. Alternatively, you can configure the properties of the user data type elements directly in the table. To view hidden columns, activate the column titles using the shortcut menu.

#### Result

You have added elements to version 0.0.1 of the user data type. The version 0.0.1 has the status "in progress".

To use the version in the project, release the version in the next step.

#### See also

Basics on user data types (Page 3204)



#### 10.2.4.4 Managing versions of user data types

##### Introduction

All user data types have at least one version. When a user data type is created, a version is created at the same time and this version has the status "in progress". You can edit the user data type in this status as required. When the editing is complete, you release the version of the user data type.

##### Requirement

- You have created a user data type.
- The user data type has the version 0.0.1. and the status "In progress".
- The "Libraries" task card or the library view is open.

##### Releasing a version

1. Select the version 0.0.1 of the user data type in the project library.
  2. Select "Release version" in the shortcut menu.  
A dialog opens.
  3. If necessary, change the properties of the version:
    - Enter a name for the type in the "Name" field.
    - In the "Version" field, define a main and an intermediate version number for the version to be released.
1. Select the options for the release:
    - Select the "Delete all unused versions of the affected type" to delete all versions of the same type from the library if these are not assigned any instance in the project and no other dependencies exist.

You have released version 0.0.1 of the user data type.

##### Editing a version

1. Select, for example, the released version 0.0.1 of a user data type in the project library.
2. Select "Edit type" in the shortcut menu.

The library view opens. The new version 0.0.2 of the user data type is created.

The version has the status "in progress".

##### Restoring the last version of a user data type

The last released version of the user data type is version 0.0.2.

You edit the user data type. A new version of the user data type, 0.0.3, is generated and receives the status "In progress".

## 10.2 Working with Tags

1. Select the version of the user data type in the project library.
2. Select "Discard changes and restore version" in the shortcut menu.

### Alternative

1. If you have opened a version for editing, click "Discard version" in the toolbar.  
The version is deleted.

All changes to the user data type since the last release operation are discarded. The user data type is released again and has version 0.0.2.

## Deleting user data type

To delete a user data type, follow these steps:

1. In the project library, under "Types", select the user data type you want to delete.
2. Select "Delete" from the shortcut menu. If the user data type is being used in a faceplate, a request will be made to confirm deletion of the user data type.

If you delete a user data type, you also delete all user data type elements contained therein. The entry remains in the allocated tag. In the "Tags" editor, a colored background appears to draw your attention to the fact that an invalid data type has occurred by the deletion.

If you delete a user data type, all instances and copy templates of this user data type are deleted as well. You are informed by a warning message that the deletion action will delete existing instances or copy templates. Deletion starts after confirmation of the warning message with "OK".

## See also

Basics on user data types (Page 3204)

Creating a user data type (Page 3206)

### 10.2.4.5 Creating tags with a user data type data type

#### Introduction

When a tag is created, you assign the version of user data type as a data type. In the "Tag" editor you can create internal tags or tags with a link to a PLC. A tag has access to all user data type versions that use the same communication driver as the tag itself. In connection with a PLC, a user data type can only be used if the absolute addressing is selected.

#### Requirement

- A user data type with a user data type element is created.
- The user data type is enabled.
- The tag table is open.
- The Inspector window with the tag properties is open.

## Procedure

To create a tag of the "User data type" data type, follow these steps:

1. In the "Name" column, double-click "Add" in the tag table. A new tag is created.
2. In the Inspector window select "Properties > Properties > General".
3. Enter a unique tag name in the "Name" field.
4. Select the connection to the required PLC in the "Connection" box.
5. Select the desired version of the user data type in the "Data type" field.  
The selected connection determines which user data types will be displayed. For internal tags, only user data type versions of the <Internal user data type> type are available.

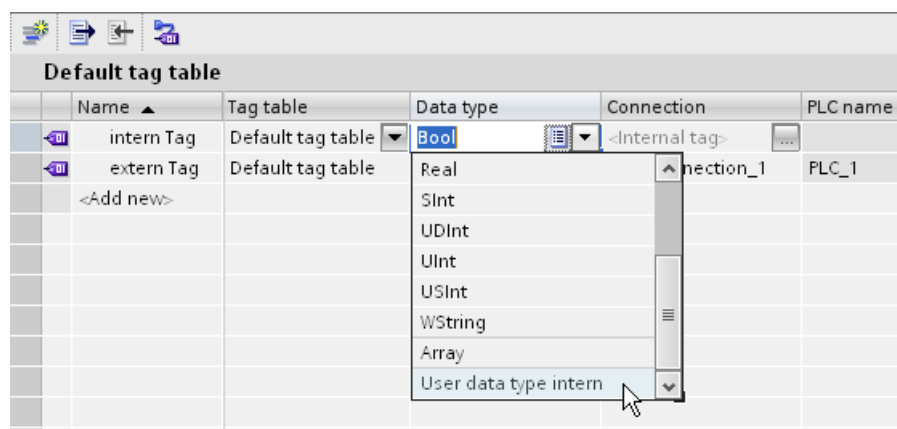

For tags with a connection to a PLC, only those user data types that have a link to a PLC can be accessed.

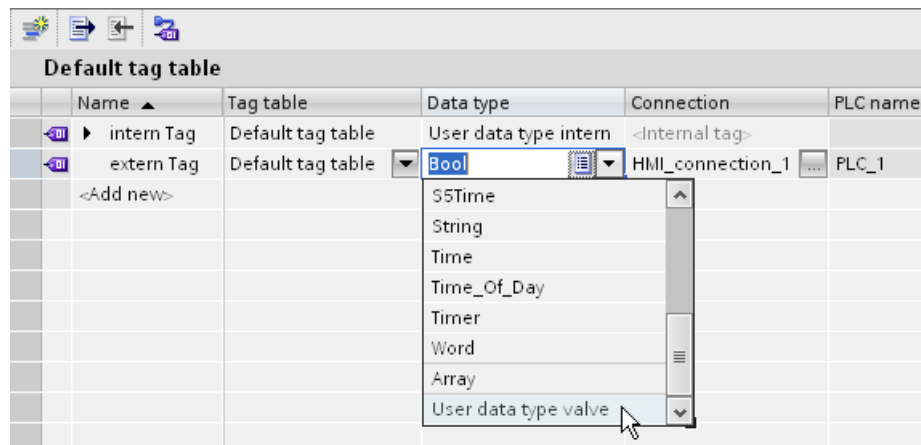

6. Enter the address of the PLC that you want to access with the external tags in the "Address" field of the "Settings" area. The specified address must always point to the start data bit, for example, <DB1.DBX0.0>.

## Result

You have created a tag of the "User data type" data type. In additional steps you can configure the tag, for example, by setting the start value and limits.

With tags of the "User data type" data type, you can connect the dynamic properties of a faceplate instance, which then supplies these properties with values in Runtime.

If you wish to change the properties of a user data type tag, you must change the properties of the user data type element.

Properties such as "Start value", "Use substitute value" or "Linear scaling" can be changed in the employed instances of the user data type.

## See also

Basics on user data types (Page 3204)

## 10.2.5 Working with cycles

### 10.2.5.1 Cycle basics

## Introduction

Cycles are used to control actions that regularly occur in runtime. Common applications are the acquisition cycle, the logging cycle and the update cycle. You can also define your own cycles in addition to those already provided in WinCC.

## Principle

In Runtime, actions that are performed regularly are controlled by cycles. Typical applications for cycles:

- Acquisition of external tags  
The acquisition cycle determines when the HMI device will read the process value of an external tag from the PLC. Set the acquisition cycle to suit the rate of change of the process values. The temperature of an oven, for example, changes much more slowly than the speed of an electrical drive.  
Do not set the acquisition cycle too low, since this will unnecessarily increase the communication load of the process.
- Logging process values  
The logging cycle determines when a process value is saved in the logging database. The logging cycle is always an integer multiple of the acquisition cycle.

The smallest possible value for the cycle depends on the HMI device that will be used in your project. For most HMIs, this value is 100 ms. The values of all other cycles are always an integer multiple of the smallest value.

If the cycles provided in WinCC do not meet the needs of your project, you can define your own cycles using the "Cycles" editor. User-defined cycles must always be an integer multiple of the smallest value.

---

**Note****Device dependency**

You cannot configure self-defined cycle times for Basic Panels.

---

**Application example**

You can use cycles for the following tasks:

- To regularly log a process.
- To draw attention to maintenance intervals.

**See also**

Basics of tags (Page 3166)

Defining cycles (Page 3213)

**10.2.5.2 Defining cycles****Introduction**

Use cycles to control actions that are run at regular intervals in Runtime. You can also define your own cycles in addition to those already provided in WinCC.

**Requirement**

You have opened the project.

**Procedure**

1. Double-click the "Cycles" entry in the project navigation.  
The "Cycles" editor opens.
2. In the "Name" column of the "Cycles" editor, double-click "Add".  
A new cycle time is created.
3. Enter a unique name in the "Name" field.
4. Select the desired cycle unit.

## 10.2 Working with Tags

5. Select the desired value for the cycle time.  
The available selection of values varies depending on the cycle unit selected. The smallest possible value for the cycle depends on the HMI device that will be used in your project. For most HMIs, this value is 100 ms. The available values are always an integer multiple of this value.
6. As an option, you can enter a comment regarding the use of the cycle.

### Result

The cycle you configured is created and beside the default cycles in WinCC for use during configuration.

### See also

Cycle basics (Page 3212)

## 10.2.6 Logging tags

### 10.2.6.1 Basic principles for data logging

#### Introduction

Data logging is used to collect, process and log process data from an industrial system.

When you analyze the logged process data, you can extract important business and technical information regarding the operational state of the system.

#### Application of the data logging

You can use data logging to analyze error statuses and to document the process. By analyzing data logs, you can extract the information necessary to allow you to optimize maintenance cycles, increase product quality and ensure that quality standards are met.

### See also

Data logging (Page 3215)

Logging Tags (Page 3218)

Basics of tags (Page 3166)

## 10.2.6.2 Data logging in Runtime Advanced and Panels

### Basics

### Data logging

#### Introduction

Data is information that is collected during the process and saved in the memory of one of the connected automation systems. They represent the status of a plant in the form of temperatures, fill levels or switching states, for example. You define tags for acquiring and editing the process values in WinCC.

External tags are used in WinCC to collect process values and to access a memory address in the connected automation system. Internal tags are not connected to any process and are only available to the associated HMI device.

#### Principle

The values of external and internal tags can be saved in data logs. Create a log tag for every tag and specify the log in which it is saved.

Data logging is controlled via cycles and events. Logging cycles are used to ensure continuous acquisition and storage of the tag values. You can also trigger tag logging in response to events, such as the change in value of a tag. Define these settings independently for each log tag.

In runtime, the tag values which are to be logged are captured, processed and stored in an ODBC database or a file.

#### Logging methods

In WinCC, you have access to the following logging methods:

- Circular log
- Segmented circular log
- Circular log which sends a system alarm message when it is full
- Circular log which executes system functions when it is full.

### Storage media and storage location

The logged data is stored in an ODBC database or in a file. An ODBC database is only available on a PC.

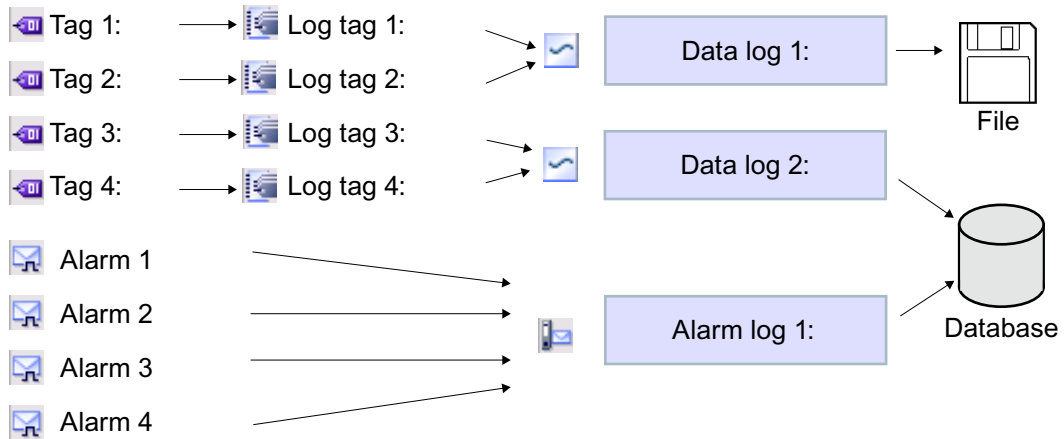

Depending on the hardware configuration of the HMI device, the data logs and alarm logs can be saved locally (on the hard disk of the PC or on the memory card on a panel) or, if available, on a network drive.

You can further process the saved data in other programs for analysis purposes, for example.

### Outputting logged data

In runtime, you can output the logged tag values as trends in the process screens.

### See also

Basic principles for data logging (Page 3214)

Storage locations of logs (Page 3216)

### Storage locations of logs

#### Storage location of a log

Depending on the HMI device used, you have several options of setting up the storage location for a data log you may be using in WinCC flexible.

#### File - CSV (ASCII)

Data is saved to a CSV file in standard ASCII format.



---

Use the "File - CSV (ASCII)" storage location if you are going to read or evaluate logged data without using WinCC Runtime.

---

**Note**

Double quotation marks or several characters are not permitted as list separators for the storage location "File - CSV (ASCII)." You can find the settings for list separators under "Start > Settings > Control Panel > Regional and Language Options".

---

### File - TXT (Unicode)

Data is stored in Unicode.

This file format supports all characters that can be used in WinCC and WinCC Runtime. For editing, you will need software that can save files in Unicode, such as Notepad.

---

**Note**

Use "File - TXT (Unicode)" as the storage location to log Asian languages.

---

### File - RDB

Data will be saved with quick access to a proprietary database.

Use the "File - RDB" storage location if you require maximum read performance in Runtime.

Data logs of this format can only be read or displayed using WinCC Runtime.

Convert the RDB file to CSV format using the "CopyLog" function to make the data available for applications outside WinCC Runtime.

### Logs with checksum

The following files are generated under special circumstances:

**\*.keep**

1. If a log is started without checksum and will be continued with a checksum.
2. If you update WinCC with a service pack or a new version and the Audit Trail or the log is continued with the checksum.

The content of the keep file will remain the same when compared with the original csv file or txt file.

**\*.bak**

If WinCC Runtime has determined a serious, irregular problem in the file.

### Database

Data is saved to a database which is set up for ODBC access by the PC administrator.

## See also

Data logging (Page 3215)

## Working with Data Logs

### Logging Tags

#### Introduction

In Runtime, you store tag values in logs. You can then analyze the logged data at a later date. You define the following conditions for logging a tag:

- The log tag, through which the values of the connected tag are logged.
- The data log in which the tag is stored.
- The cycle or the event with which the tag is stored.
- The value range within which the tag is stored.

---

#### Note

You use data logging mainly to log the values of external tags. You can also log the values of internal tags.

---

## Principle

Several steps come together during data logging:

- Creating and configuring the data log  
When you create a data log, you define the following settings:
  - General settings, such as name, size and storage location
  - Runtime start characteristics
  - Behavior when the log is full
- Configuring the logging of tags  
For every log tag, specify a data log in which the values of the connected tags and other information are logged, such as the time of logging.  
When and how often the values of a log tag are logged are also defined. You have the following options:
  - "On demand":  
The tag values are logged by calling the "LogTag" system function.
  - "On change":  
The tag values are logged as soon as the HMI device detects a change in the value of the tag.
  - "Cyclic":  
The tag values are logged at regular intervals. You can supplement the default cycles in WinCC with your own cycles based on the default cycles. The smallest value that can be set is 1 s. All other values are integer multiples of this value.  
You can also restrict the logging of values within or outside a tolerance band. In this way, the logging of values within a relevant range of values is restricted.

Note the following points if you want to log a tag on demand:

- Do not log this type of tag in a segmented circular log in which tags are logged in a continuous cycle or in response to changes.

Background:

- If logging takes place on demand only rarely, the log segment will be filled by cyclically-logged values, for example, and the next log segment will be created. If you then attempt to access the tag that was logged on demand, it will not be possible to display the tag since it is the current log segment that is accessed in Runtime. To remedy this, you should create a separate data log for tags that are logged only rarely.
- Further processing logged tag values  
You can analyze the logged tag values directly in your project, such as in a trend view, or in another user program, such as Excel.

## See also

- Creating a data log (Page 3220)
- Managing logging behavior when Runtime starts (Page 3222)
- Controlling the Logging in relation to the Fill Level (Page 3223)
- Logging process values (Page 3224)
- Triggering a system function when log is full (Page 3226)
- System functions for logs (Page 3227)
- Basic principles for data logging (Page 3214)
- Configuring logging tags (Page 3233)
- Configuring a checksum for a log (Page 3228)
- Evaluating the checksum of log data (Page 3229)

## Creating a data log

### Introduction

Data logs are used to store values from external and internal tags in runtime. When you create a log, you must give it a name and define its size and storage location. In addition you can enter comments for each log.

### Requirement

- A project is open.
- The Inspector window is open.

### Procedure

To create a data log, proceed as follows:

1. Double-click on the "Historical Data" entry in the project tree.  
The editor for data logs and alarm logs opens.
2. Open the "Data logs" tab and double-click "Add" in the "Name" column of the "Data logs" editor.  
A new data log is created.
3. In the Inspector window select "Properties > Properties > General."
4. Enter a unique name for the log in the "Name" field.
5. Define the number of data records to be logged in each log in the "Number of data records per log" field.  
The size of a log is calculated as follows: The number of items \* the length of each tag value to be logged.  
In the Inspector window, the maximum size that the log can reach if the currently selected number of data records is observed is displayed beneath the "Number of data records" input field.

6. In the "Storage location" field, select whether the logged data should be stored in a file or in a database. The log can only be stored in a database on a PC.
7. If you selected "File" as the storage location, select the storage location for the file in the "Path" field.  
On PC HMI devices, you save the log on the hard disk or on a network drive, if there is one. The syntax for path specification is as follows:
  - For hard disk: <C:\My\_File\_Folder\My\_Archives\Machine\_1>
  - For network drive: <\\My\_Fileservername\My\_File\_Folder\My\_Archives\Machine\_1>
 Select one the following storage location for Panel HMI devices:
  - Memory card  
Select the path <\Storage Card MMC>. Here, as required, a sub-folder can be specified, for example <\Storage Card MMC\My\_Archives\TagLogs>
  - USB memory  
Select the path <\Storage Card USB>. Here, as required, a sub-folder can be specified, for example <\Storage Card USB\My\_Archives\TagLogs>
  - Network drive  
The syntax to specify the path is as follows: <\\My\_Fileservername\My\_File\_Folder\My\_Archives\Machine\_1>
 The selection available depends on the HMI device in use.
8. If you selected "Database" as the storage location, specify whether the data source name from the system should be used or whether you want to enter one yourself. In the latter case, enter a name for the data source.
9. If necessary, enter a descriptive text under "Comment" to document your project.

Alternatively you can configure log properties directly in the "Data log" editor. To view hidden columns, activate the column titles using the shortcut menu.

---

### Note

The characters which can be used in the name of the data source depend on the storage location.

If the "File" storage location is used, the following characters must not be used: \ / \* ? : " < > |

If the "Database" storage location is used, the following characters may be used: a-z A-Z 0-9 \_ @ # \$

However, the characters \_ @ # \$ may not be used as the first character of the name.

The names of logs must be unique in a project. Log names must also be unique if different storage locations are selected for different logs. You must also assign different names for alarm logs and data logs.

---

## Result

The data log is created.

You can now configure tags so that their values are stored in this log.

To continue the log configuration, perform the following steps:

- Define the restart characteristics of the log when Runtime is started.
- Define how the log should behave when it is full.
- Configure a function list for the "Overflow" event.

## See also

Logging Tags (Page 3218)

## Managing logging behavior when Runtime starts

### Introduction

When you configure a data log, you define the restart characteristics of the log when Runtime is started. You define whether the logging should start when Runtime starts in the log properties. You can also define whether an existing log will be continued or overwritten.

You define the restart characteristics separately for each log.

### Requirement

- A data log has been created.
- The "Data log" editor is open.
- The Inspector window with the log properties is open.

### Procedure

To configure the restart characteristics of a data log, proceed as follows:

1. Select the log for which you want to define the restart characteristics in the "Data Log" editor.
2. In the Inspector window select "Properties > Properties > Restart behavior."
3. If you want logging to start when Runtime starts, enable the "Enable logging at runtime start" option in the "Logging" area.  
You can also start logging in Runtime using the "StartLogging" system function, for example.
4. Select the restart behavior of the log in the "Log handling at restart" area.
  - The logged values are deleted and logging is started again with the option "Reset log".
  - The option "Append data to existing log" is used to append the values to be logged to the existing log.

Alternatively you can configure the restart characteristics of a log directly in the "Data log" editor table. To view hidden columns, activate the column titles using the shortcut menu.

### Result

Logging will start in runtime according to your settings.

## See also

Logging Tags (Page 3218)





## Controlling the Logging in relation to the Fill Level

### Introduction

The size of a log is determined by the number of entries. You use the logging method to determine how the log responds when it is full.

### Logging methods

The following logging methods are available:

-  Circular log  
When the configured log size has been reached, the oldest entries are deleted. When the configured log size has been reached, approx. 20% of the oldest entries are deleted. It is therefore not possible to display all the configured entries. During configuration, select an appropriate size for the circulation log. Alternatively, configure a segmented circular log.
-  Segmented circular log  
In a segmented circular log, multiple log segments of the same size are filled in succession. When all logs are completely full, the oldest log is overwritten.
-  Log that sends a system alarm when it is full  
When a defined level is reached, such as 90 %, a system alarm is triggered. When the log is 100% full, new tag values are not logged.
-  Log with level-dependent triggering of an event.  
When the log is completely full, the "Overflow" event is triggered. Configure a function list for the event that will be carried out when the "Overflow" event occurs. When the configured size of the log is reached, new tag values are not logged.  
The following system functions are available for further processing of full logs: For further details, refer to System functions for logs (Page 3227).

### Requirement

- A data log has been created.
- The "Data log" editor is open.
- The Inspector window with the log properties is open.

## Procedure

1. Select the log for which you want to define the logging method in the "Data Log" editor.
2. Select "Properties > Properties > Logging method" in the Inspector window and select the required logging method.
3. If you have selected the "Segmented circular log" type, enter the number of log segments. If you selected a log with the "Display system alarm on" setting, specify the level as a percentage at which a system alarm is to be triggered. If you selected the "Trigger event" setting, configure the function list in the "Events" group.

Alternatively you can configure the logging method directly in the "Data log" editor table. To view hidden columns, activate the column titles using the shortcut menu.

The "Overflow" event is not available in the editor table. You must therefore configure the function list in the Inspector window.

## Result

The selected log responds according to the settings in Runtime.

## See also

Logging Tags (Page 3218)

System functions for logs (Page 3227)

## Logging process values

### Introduction

You can save the process values of a tag in a data log in Runtime. You define the following conditions for logging a tag:

- The log tag, through which the values of the connected tag are logged.
- In which log the values are stored
- The conditions under which the values are stored
- If only process values for a certain range of values are stored

To log the tag values, assign a logging tag to an HMI tag. The logging tag is stored in the data log and logs the values of the connected HMI tag. You can configure logging tags directly in the "HMI tags" editor. The "HMI tags" editor contains the "Logging tags" editing table.



HMI tags		
Name ▲	Data type	Connection
HMI_Tag_5	SInt	<Internal tag>
HMI_Tag_6	DInt	<Internal tag>
HMI_Tag_7	DInt	<Internal tag>

Discrete alarms		
Analog alarms		
Logging tags		
Name ▲	Assigned data log	Logging me
Archive_Tag_5	Tag_Archive_2	Cyclic

If the view of the "Logging tags" table is minimized, click the arrow button below the tag table.

HMI tags		
Name	Data type	Connection
HMI_Tag_1	Int	<Internal tag>
<Add new>		

Figure 10-1 The "Logging tags" table is displayed.

## Requirement

- The data log has been created.
- The tag for which you wish to configure the logging must already exist.
- The "Tags" editor is open.
- The "Logging tags" table is displayed.
- The Inspector window with the tag properties is open.

## Procedure

To log process values in a tag, proceed as follows:

1. Select a tag in the tag table.
2. Double-click "Add" in the "Name" field in the "Logging tags" table.  
A new logging tag is created; it is given the same name as the associated HMI tag.
3. Select the data log in which the values of the tags are to be logged under "Properties > Properties > General" in the Inspector window.
4. Select "Properties > Properties > Logging type" in the Inspector window and select the log type for logging.
  - "Cyclic": The tag values are logged in accordance with the set logging cycle.
  - "On change": The tag values are logged, as soon as the operator device detects a change in value.
  - "On demand": The tag values are logged by calling the "LogTag" system function.

## 10.2 Working with Tags

5. If you want to log tag values cyclically, select a cycle time in the "Logging cycle" area. Alternatively, you can define your own cycle using the object list. The smallest value that can be set is 1 s. All other values are integer multiples of this value.
6. If you only want to log tag values outside or inside a defined value range, select "Properties > Properties > Deadband for logging" in the Inspector window. Define the values for the high and low limits.  
If you want to configure a dynamic limit, select "HMI tag" using the selection button. In the second field, select the tag that contains the limit.  
If you want to configure a fixed limit, select "Constant." Enter the limit value in the second field.  
If you want to leave a limit undefined, select "None".
7. Under "Scope", specify whether tag values are to be logged only if they are within the defined limits or only if they are outside the defined limits.

Alternatively, you can configure the logging of a tag directly in the "Logging tags" editor table. To view hidden columns, activate the column titles using the shortcut menu.

You can also fully configure a logging tag in the "Historical Data" editor.

### Result

The process values of the configured tag are logged in Runtime according to the selected settings.

---

#### Note

To have the tag values actually logged in runtime, you must ensure that the data log is started. Logging can be started automatically at start up or by means of a system function. To automatically start the log, use the setting in the log Properties window.

---

### See also

Logging Tags (Page 3218)

### Triggering a system function when log is full

#### Introduction

You can select a logging method that executes a function list as soon as the log is full.

#### Application example

You can use system functions, for example, to swap the data from a full log file out to another log before the full log is overwritten. You can then continue to process the transferred data in another program. Assign the "CopyLog" system function to the "Overflow" event accordingly.

**Requirement**

- A log with the "Trigger event" logging method is created.
- The "Data log" editor is open.
- The Inspector window with the data log properties is open.

**Procedure**

To configure a system function for the "Overflow" event, proceed as follows:

1. Select the required log in the table in the "Data Log" editor.
2. In the Inspector window select "Properties > Events > Overflow."  
The function list will open.
3. Double-click "Add function" and select the desired system function.
4. Configure the required parameters of the selected system function.

**Result**

During runtime, the function list will be executed as soon as the log is full.

**See also**

Logging Tags (Page 3218)

**System functions for logs****System functions**

The following system functions are available for logging:

Function name	How it works
ArchiveLogFile	This function moves or copies a log to another storage location for long-term archiving. Use the system function if you want to move the Audit Trail, for example, from a local storage medium to the server.  With Audit Trails, always use the "Move log (hmiMove)" mode, otherwise you will be violating the FDA guideline by duplicating the data stored.
LogTag	Saves the value of the given tags in the given data log. Use the system function to log a process values at a specific time.
StartLogging	Starts the logging process in the specified log. You can interrupt logging in Runtime by calling the "StopLogging" system function.
StopLogging	Stops the logging process in the specified log. To resume logging in Runtime, select the "StartLogging" system function.
ClearLog	Deletes all entries in the specified log.
StartNextLog	Stops the logging process in the specified log. Logging is continued in the log segment that has been configured for the given log.

Function name	How it works
CloseAllLogs	Closes all logs. The connection between WinCC and the log files or log database is terminated. You can use this system function, for example, to enable hot-swapping of the storage medium on the HMI device without exiting the Runtime software.
OpenAllLogs	Opens all logs to resume logging. The connection between WinCC and the log files or log database is restored.
CopyLog	Copies the contents of the specified log to another log.

**See also**

Logging Tags (Page 3218)

**Configuring a checksum for a log**

**Introduction**

In a regulated project, you have the option of assigning a checksum to the log data of an data log or alarm log. This checksum can be used during plant operation to determine if the data of this log has subsequently changed.

**Requirement**

- GMP compliant configuration is enabled.
- A data log or alarm log has been created.

**Procedure**

Proceed as follows to configure a data log or alarm log for the use of a checksum:

1. Open the data log or alarm log in the corresponding log editor.
2. In the "Storage location" box, select "File - CSV (ASCII)" or "File - TXT (Unicode)".

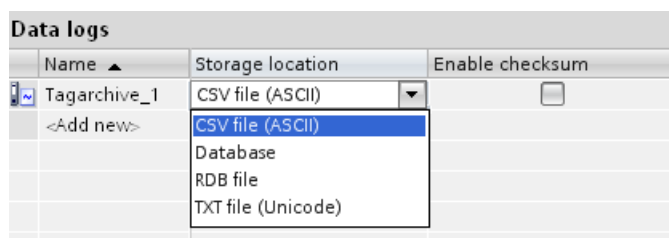

- Under "Properties > Properties > Logging method" in the Inspector window, select the option "Display system event at" or "Trigger event".

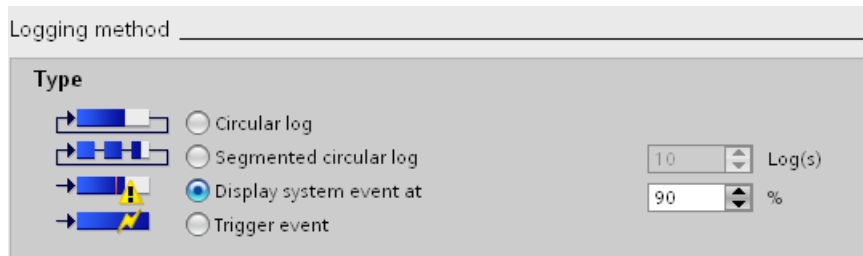

- In the editor table activate the option "Activate checksum". Columns that are not displayed are activated with the shortcut menu of the column title.

Data logs		
Name ▲	Storage location	Enable checksum
Tagarchive_1	CSV file (ASCII) ▼	<input checked="" type="checkbox"/>
<Add new>		

- Save the project.

## Result

The log data of the log is assigned a checksum in runtime.

## See also

Logging Tags (Page 3218)

Enabling GMP compliant configuration (Page 5761)

GMP-compliant configuration (Page 5757)

Evaluating the checksum of log data (Page 3229)

## Evaluating the checksum of log data

### Introduction

If you have configured a data log or alarm log with generation of a checksum, you can check if the log data has subsequently changed.

The DOS program "HmiCheckLogIntegrity" is available for checking the integrity of the log data.

The "HmiCheckLogIntegrity" program supports verification of the following files:

- Log files of alarm logs, data logs, and Audit in CSV format
- Log files of alarm logs, data logs, and Audit in TXT format
- Recipe data records in CSV format
- Recipe data records in TXT format

You can find the "HmiCheckLogIntegrity.exe" program in the installation directory of WinCC under the folder "WinCC Runtime Advanced", for example <C:\Program Files\Siemens\Automation WinCC Runtime Advanced>.

**Note**

**Audit Trail and Log with Checksum**

Before you update WinCC with a Service Pack or a new version, exit and save the Audit Trail or the logs using checksum. After WinCC is updated, the audit trail or logs will be continued with new files using checksum.

Make sure that the logs are started at a defined state with the new version.

**Procedure**

1. Copy the file to be checked from the HMI device to your configuration computer.
2. Open a command line prompt with "Start > Programs > Accessories > Command Prompt".
3. Enter the path to "HmiCheckLogIntegrity.exe" followed by a space in the command line prompt. After the space, enter the storage location of the file to be checked within quotation marks.
4. Press <Enter>.
5. The check is performed.  
When the checked data are consistent, the "Consistency check succeeded" message appears.

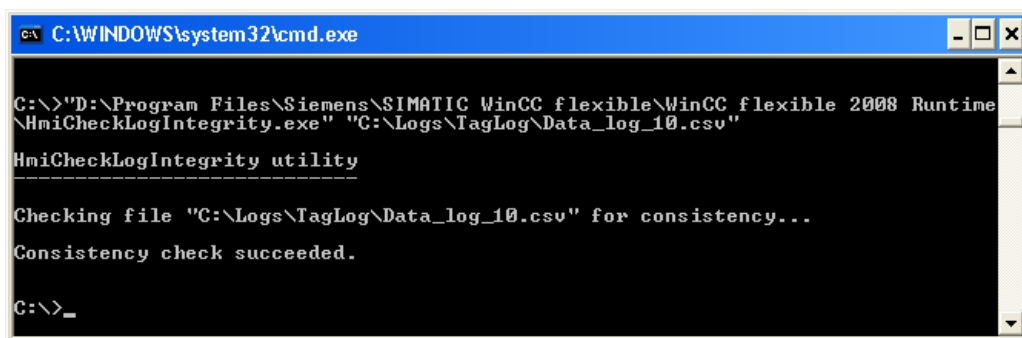

When the checked data are inconsistent, the "Consistency check failed" message appears. Information about the first inconsistent line in the file is also displayed.

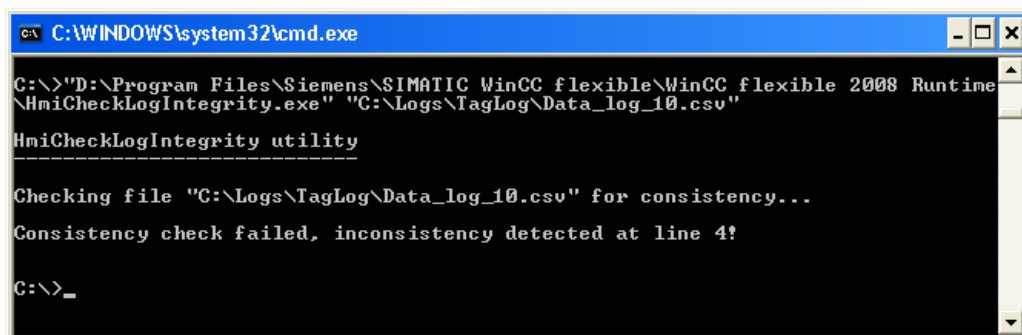

**Note**

If there are spaces in the path to the "HmiCheckLogIntegrity.exe" program, you need to specify the path in quotation marks.

---

You can also check the integrity of the log data with the AuditViewer.

**See also**

Logging Tags (Page 3218)

Enabling GMP compliant configuration (Page 5761)

Configuring a checksum for a log (Page 3228)

GMP-compliant configuration (Page 5757)

Evaluating Audit Trails in AuditViewer (Page 5779)

**Log response to language switching in runtime****Introduction**

In the "Device Settings" editor, select the language to be used for writing to logs in runtime.

**Requirements**

- The languages used in your project are activated in the "Project languages" editor, for example, "German (Germany)" and "English (USA)".

**Procedure**

1. Open the "Languages and fonts" editor.
2. Activate the runtime language, for example, "German (Germany)" and "English (USA)".
3. Set the "Language switch order":
  - German 0
  - English 1With "0", German is specified as the "Startup language".
4. Open the "Device settings" editor.
5. Select "Startup language" in the "Settings for Runtime" area.

**Result**

The project starts after it is transferred. German is specified as the "Startup language" with "Language switch order". The logs are now written in German. During runtime, the operator switches the runtime language to English. The logs will still to be written in German.

## 10.2 Working with Tags

The operator closes runtime. Due to the previously performed language switch, the next time the system starts the "startup language" is English. Since English is the startup language, the logs are now written in English.

The logging language remains English even when the language is switched again in runtime until runtime is closed once again.

If you use another option instead of "Startup language" to select the language, the logs are always written in the same language. This is true regardless of the language selected by the operator in runtime.

## Direct access to the ODBC log database (Advanced)

### Overview

The storage location of a log can be a database or a file.

The database is addressed by means of its "Data source name" (DSN). Select the database to be used in WinCC as follows:

Select the database from the Windows Start menu under "Settings > Control panel > ODBC Data Sources".

In your configuration, specify the "Data source name" (DSN) instead of a directory name as storage path for log data. With the DSN, you are referencing the database and the storage location.

The entire functional scope of the database is available for additional processing and evaluation of log data.

### Application

The data source sets up the connection to the database. Create the data source on the same PC on which the Runtime software is stored. Then enter the DSN configured on this PC when you create a log in WinCC.

The ODBC interface allows you to use other programs, such as MS Access or MS SQL Server, to access the database directly.

In addition, you can use the "StartProgram" system function to configure program calls, e.g. MS Access, on the HMI device. Runtime is not interrupted while you configure such calls.

## Setting up the ODBC data source

### Introduction

To store process values or alarms in the log database in Runtime, set up the ODBC data source.



## Requirement

- A log database has been created.  
You create the log database using the SQL Enterprise Manager. You can find more detailed information on how to do this from Microsoft.

## Procedure

To set up an ODBC data source, follow these steps:

1. In Control Panel, open "Administrative Tools" and select "Data Sources (ODBC)".  
The "ODBC Data Source Administrator" dialog is opened.
2. Click "User DSN > Add".
3. Select the "SQL-Server" and click on "Finish".
4. In the dialog that follows, enter a name for the User DSN and the SQL-Server and click on "Next".
5. In the dialog that follows, define the logon procedure for the SQL database and click on "Next".
6. Activate "Change the default database to".
7. Select the database you have created and click on "Next".
8. In the dialog that follows, click "Finish".

## Logging tags in the "Historical Data" editor

### Configuring logging tags

#### Introduction

You can also create and edit logging tags in the "Historical Data" editor in WinCC. You also directly edit the properties of logging tags in the "Historical Data" editor.

---

#### Note

If you delete, move or copy in the "Historical Data" editor, the changes also take effect in the tag table.

---

## Requirement

- The "Data logs" tab is open in the "Historical Data" editor.
- A data log has been created.

**Procedure**

Proceed as follows to configure a logging tag in the "Historical Data" editor:

1. Select an existing data log in the "Data logs" table of the editor.  
Alternatively, double-click on "Add..." in the "Name" column to create a new data log.

Data logs				
Name	Storage loc...	Number of data re...	Path	Logging method
Tag_Log_1	File - RDB	500	\Storage Card MMC\Logs	Circular log
<Add new>				

2. Double-click "Add ..." in the "Name" column of the editor "Logging tags" table.

Logging tags			
Name	Process tag	Acquisition mode	Logging cycle
Logging_Tag_1	<None>	Cyclic	5 s
<Add new>			

3. Enter a unique name for the logging tag in the "Name" field.
4. In the "Process tag" field, click on the selection button and select the process tag for logging in the object list.

Logging tags				
Name	Process tag	Acquisition mo..	Logging cycle	High limit
Logging_Tag_1	<None>	Cyclic	5 s	
<Add new>				

Name	Data type	Address
None		
Tag_1	Int	
Tag_2	Int	

5. Select the desired trigger mode in the "Log type" field:
  - "Cyclic": The tag values are logged in accordance with the set logging cycle.
  - "On change": The tag values are logged, as soon as the operator device detects a change in value.
  - "On demand": The tag values are logged by calling the "LogTag" system function.

6. If you want to log tag values cyclically, select the desired cycle time in the "Logging cycle" area. Alternatively, you can define your own cycle using the object list. The smallest value that can be set is 1 s. All other values are integer multiples of this value.
7. Configure additional parameters for logging in the table of the editor or in the Inspector window.

## Result

The configured logging tag is created in the "Historical Data" editor and is also displayed in the tag table.

## See also

Logging Tags (Page 3218)

## 10.2.7 Displaying Tags

### 10.2.7.1 Displaying tags with Basic Panels

#### Outputting tag values in screens (Basic)

##### Introduction

In runtime you can output tag values in the screens of the operator device in the form of a trend. A trend is a graphic representation of the values that a tag takes during runtime. Use the "Trend display" graphic object to represent it. Process values for the trend display are loaded by the PLC from the ongoing process.

The values to be displayed are determined individually within a fixed, configurable cycle. Cyclically-triggered trends are suitable for representing continuous curves, such as the changes in the operating temperature of a motor.

##### Displayed values

You will need to configure a trend view in a screen so that tag values are displayed on the HMI device. When configuring the trend view, specify which tag values are to be displayed.

You can control the updating of the trend display by defining the cycle time.

## See also

Configuring trend display for values from the PLC (Basic) (Page 3236)

Basics of tags (Page 3166)

## Configuring trend display for values from the PLC (Basic)

### Introduction

You use a trend view to graphically represent values that a tag assumes during the process.

### Requirement

- A screen is open.
- The Inspector window with the trend view properties is open.

### Procedure

To configure a trend view, follow these steps:

1. Add the "Trend view" object from the toolbox in the "Control" group to the screen.



2. Select the "Trend" category from the "Properties" group in the Inspector window and double-click "<Add>" in the "Name" column.

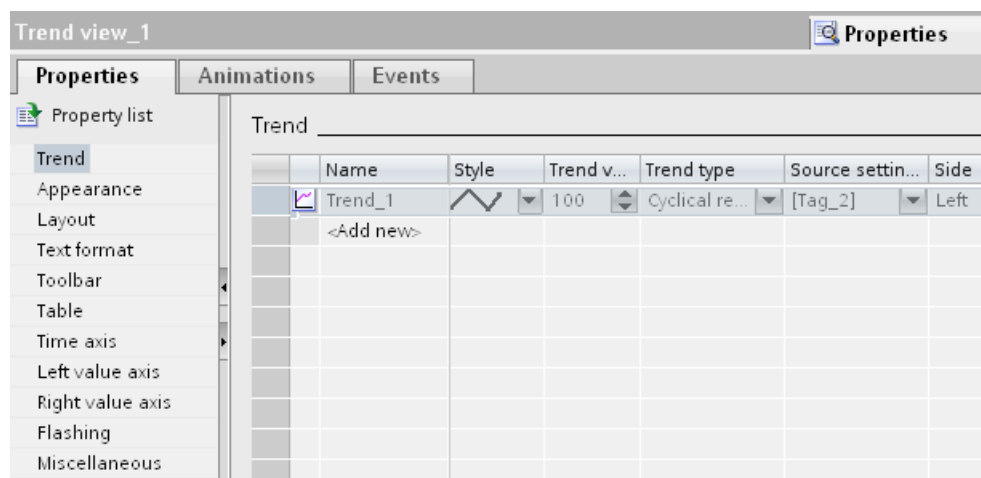

3. Assign a name to the trend in the "Name" column.
4. In the "Style" column, use the selection button to open the "Style" dialog and select the style of the line.
5. Select the number of trend values in the "Trend values" column.

6. In the "Settings" column, use the selection button to open the "Data source" dialog and select the tags to supply the trend with values. Specify the cycle for reading the tags from the PLC.

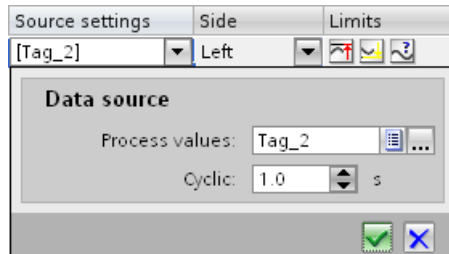

7. You can make other settings in the dialogs of the Inspector window. For example, you can select the "Display table" option in the "Table" category to display a value table beneath the trend view.

---

#### Note

If you hold down the <CTRL> key and double-click the trend view, the trend view is activated. You set the column width and the position of the columns in the table header of the values table in active mode. In order to activate the trend view the zoom factor has to be set to 100 %.

---

## Result

In runtime, the values of the selected tags are displayed in the configured trend view.

## See also

Outputting tag values in screens (Basic) (Page 3235)

### 10.2.7.2 Displaying tags with Runtime Advanced and Panels

## Trends

### Introduction

A trend is a graphic representation of the values that a tag takes during runtime. In order to display trends, configure a trend view in a screen of your project.

To configure the trend view, specify a trend type for the values to be displayed.

- Log: For displaying the logged values of a tag
- Cyclical real time: For time-triggered display of values
- Bit-triggered real time: For event-triggered display of values
- Bit-triggered buffer: For event-triggered display with buffered data acquisition

### Displaying logged values

In Runtime, the trend view displays the values of a tag from a data log. The trend shows the logged values in a particular window in time. The operator can move the time window in Runtime to view the desired information from the log.

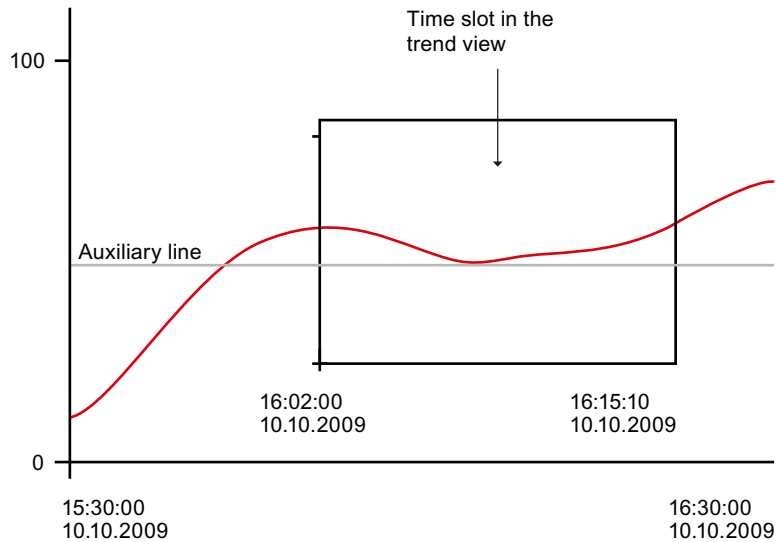

### Pulse-triggered trends

The values to be displayed are determined individually with a definable time pattern. Cyclically-triggered trends are suitable for representing continuous curves, such as the changes in the operating temperature of a motor.

### Bit-triggered trends

The values to be displayed are event-driven by setting a defined bit in "Trend transfer" tags. The bit is reset after reading has been completed. Bit-triggered trends are useful for displaying fast-changing values, such as the injection pressure for producing plastic parts.

### Bit-triggered trends with buffered data acquisition

When you set buffered data acquisition, the values to be displayed are buffered in the PLC and read in bit-triggered as a block. These trends are suitable for displaying rapid changes when the course of the trend as a whole is interesting and not so much the individual values.

You configure a switch buffer in the PLC so it can continue to write the new values while the trend buffer is being read. The switch buffer ensures that the PLC does not overwrite values while the operator devices reads the values for the trend.

The switch between the trend buffer and the switch buffer functions as follows:

Whenever the bit assigned to the trend is set in the "Trend transfer 1" tag, all the values are read simultaneously from the trend buffer and are displayed as a trend on the HMI device. The bit in "Trend Transfer 1" is reset after reading has been completed.

While the operator device is reading the tag values from the trend buffer, the PLC writes the new tag values into the switch buffer. When the bit which is assigned to the trend is set in the "Trend transfer 2" tag , all the trend values are read from the switch buffer and displayed at the operator device. While the operating device is reading the switch buffer, the PLC writes again to the trend buffer.

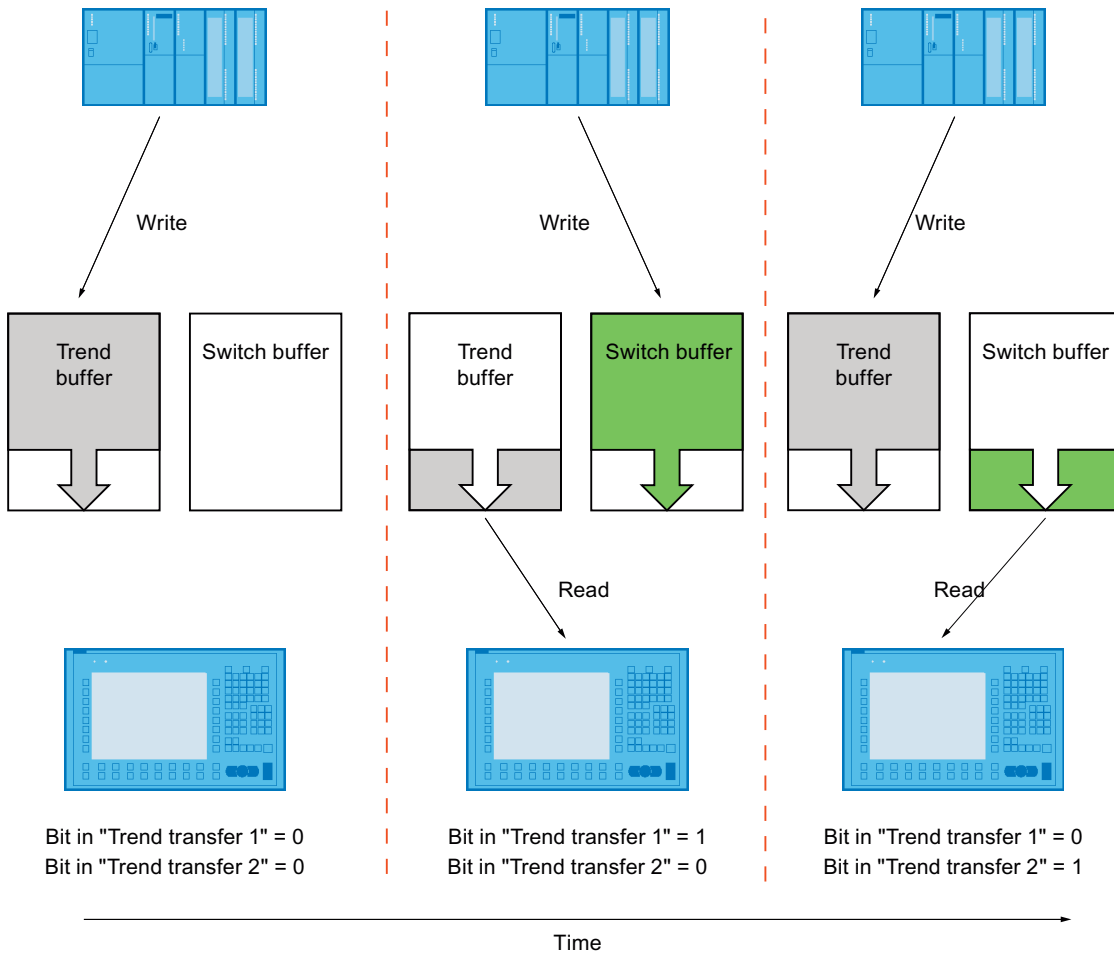

## Outputting tag values in screens

### Introduction

In runtime you can output tag values in the screens of the operator device in the form of a trend. The process values are loaded by the PLC from the current process or from a log database.

### Displayed values

You will need to configure a trend view in a screen so that tag values are displayed on the HMI device. When configuring the trend view, specify which tag values are to be displayed.

## 10.2 Working with Tags

The following options are available:

- **Current values from the PLC**  
Writing of the trend is continued with individual values from the PLC. The following trigger types are available for display in real time:
  - **Bit-triggered real time:** The time of the update can be controlled by setting a bit. Bit-triggered trends are normally used to visualize rapidly changing values. One example might be the injection pressure in the production of plastic parts.
  - **Cyclical real time:** You control the update time with a cycle. Cyclically-triggered trends are suitable for representing continuous curves, such as the changes in the operating temperature of a motor.
  - **Bit-triggered buffer:** The trend contains values that were stored in a buffer in the period between two reads from the PLC. Use this format pattern if the course of the trend as a whole is more interesting than the individual values.
- **Logged tag values**  
In runtime, the trend view displays the values of a tag from a data log. The following trigger type is available to display logged tag values:
  - **Data log:** The trend shows the logged values in a particular window in time. To obtain the requested information from the archive, the operator uses the corresponding operator controls in the screen or in the trend view.

## Configuring trend displays for values from the PLC

### Introduction

You use a trend view to graphically represent values that a tag assumes during the process.

### Requirement

- A screen is open.

### Procedure

To configure a trend view, follow these steps:

1. Add the "Trend view" object from the toolbox in the "Controls" group to the screen.
2. Select "Properties . Properties > Trend" in the Inspector window and double-click "Add" in the "Name" field. A new trend is created.
3. If required, enter a unique name for the trend in the "Name" field.
4. In the "Style" column, use the selection button to open the "Style" dialog and select the style of the line.
5. Select the number of trend values in the "Trend values" column.



6. In the "Trend type" column, select the required trend type. The following entries are available:
  - "Bit-triggered real time"
  - "Cyclical real time"
  - "Bit-triggered buffer"
  - "Data log"
7. In the "Settings source" column, use the selection button to open the "Data source" dialog and select the tags to supply the trend with values.  
If you selected the "Cyclical real time" trend type, specify a cycle for reading the tags from the PLC.  
Only for bit-triggered trends:
  - Under "Bit", specify which bit of the "Trend request" tag and of the "Trend transfer" tags are to be assigned to the trend. Select a different value for each trend.
  - Enter a tag under "Trend request" which contains at least as many bits as trends are to be displayed in the trend view. The status of the bits of these tags specifies which trend is currently being displayed at the operator device.Only for the trend type "Bit-triggered real time":
  - Enter a tag under "Trend transfer" which contains at least as many bits as trends are to be displayed in the trend view. The status of the bits of these tags specifies for which trend values are to be read from the PLC.Only for the trend type "Bit-triggered buffer":
  - Enter a buffer tag for the switch buffer. The tags have to be of the same type and of the same length as the trend tag.
  - Enter a tag each under "Trend transfer 1" and "Trend transfer 2" which contains at least as many bits as trends are to be displayed in the trend view. The status of these tag bits specifies the trend for which values will be read from the PLC. "Trend transfer 1" controls reading from the trend buffer; "Trend transfer 2" controls reading from the switch buffer.
8. You can make other settings in the dialogs of the Inspector window. For example, you can select the "Display table" option in the "Table" category to display a value table beneath the trend view.

---

**Note**

If you hold down the <CTRL> key and double-click the trend view, the trend view is activated. You can set the column width and the position of the columns in active mode in the values table. In order to activate the trend view the zoom factor has to be set to 100 %.

---

**Result**

In runtime, the values of the selected tags are displayed in the configured trend view.

## Configuring a trend view for a data log

### Introduction

You can use a trend view to display logged tag values in Runtime. The trend view shows the logged tag values in a particular window in time. To obtain the requested information from the archive, the operator uses the corresponding operator controls in the screen or in the trend view.

### Application example

At the end of a shift, for example, an operator wants information about the process carried out during the shift.

### Requirement

- A data log has been created.
- A screen is open.
- The Inspector window with the trend view properties is open.

### Procedure

To configure a trend view to display values from a data log, follow these steps:

1. Add the "Trend view" object from the toolbox in the "Controls" group to the screen.
2. Select "Properties . Properties > Trend" in the Inspector window and double-click "Add" in the "Name" field. A new trend is created.
3. If required, enter a unique name for the trend in the "Name" field.
4. In the "Style" column, use the selection button to open the "Style" dialog and select the style of the line.
5. In the "Trend type" column, select the trend type "Data log".
6. In the "Settings" column, use the selection button to open the "Data source" dialog; select the data log and the tags to supply the trend with values.
7. You can make other settings in the dialogs of the Inspector window. For example, you can select the "Display table" option in the "Table" category to display a value table beneath the trend view.

---

#### Note

If you hold down the <CTRL> key and double-click the trend view, the trend view is activated. You can set the column width and the position of the columns in active mode in the values table. In order to activate the trend view the zoom factor has to be set to 100 %.

---

## Result

In runtime, the logged values of the selected tags are displayed in the configured trend view.

## The structure of a \*.CSV file with tags

### Introduction

In the \*.csv (comma-separated value) file format, the "Name" and "Value" table columns of the entry are separated by semicolons. Each table row ends with a line break.

### Example of a \*.CSV file

The example shows a file with logged tag values:

```
"VarName";"TimeString";"VarValue";"Validity";"Time_ms"
```

```
"Var_107";"01.04.98 11:02:52";66,00;1;35886460322,81
```

```
"Var_108";"01.04.98 11:02:55 AM";60.00;1;35886460358.73
```

```
"Var_109";"01.04.98 11:02:57 AM";59.00;1;35886460381.22
```

### Structure of a log file in \*.csv format

The following values are entered in the individual columns of a log file:

Parameters	Description
VarName	Name of the tag from WinCC
Time string	Time stamp as a STRING, e.g. readable data format
VarValue	Value of the tag
Validity	Validity: 1 = value is valid 0 = an error occurred (e.g. interrupted connection)
Time_ms	Specify a time stamp as a decimal value (see below for conversion). Only needed to display the tag values in a trend.

## Conversion of the time stamp decimal value

If the value needs to be processed using a different program, proceed as follows:

1. Divide Time\_ms by 1,000,000.

Example: : 36343476928:1 000 000 = 36343,476928

2. The whole number portion (36344) is the date calculated from 31.12.1899.

Example: 36343 results in 02.07.1999

You can now convert the time stamp value to days in Excel by assigning a corresponding format from the "Date" group to the cells, which contain the time stamp.

Result: 37986 results in 31.12.2003

3. The value after the comma (0,476928) indicates the time:

- Multiply the value (0.476928) by 24 to obtain the hours (11.446272).
- Multiply the remainder (0.446272) by 60 results in the minutes (26.77632).
- Multiply the remainder (0.77632) by 60 results in the seconds (46.5792).

Result 11:26:46.579

This conversion is supported by Microsoft Excel, for example.

## Accessing the ODBC log database directly

### Introduction

The storage location of a log can be a database or a file.

The database is addressed by means of its "Data source name" (DSN). Select the database you want to use in WinCC from the Windows Start menu under "Settings > Control panel > ODBC Data Sources".

To store log data, specify the DSN, rather than a directory name during configuration. With the DSN, you are referencing the database and the storage location.

### Application

The entire functional scope of the database is available for additional processing and evaluation of log data.

### Principle

The data source establishes the connection to the database. You create the data source on the same computer that contains the Runtime software. Then enter the DSN configured here when you create a log in WinCC.

The ODBC interface allows you to use other programs, such as MS Access or MS SQL Server, to access the database directly.

With the "StartProgram" system function, you can also configure a program call (to MS Access, for example) on the HMI device. This does not interrupt Runtime.

## 10.3 Working with alarms

### 10.3.1 Basics

#### 10.3.1.1 Alarm Logging in WinCC

##### Introduction

The alarm system allows you to display and record operating states and faults on the HMI device that are present or occur in a plant.

An alarm may have the following content:

N o.	Time	Date	Alarm text	Status	Alarm class
5	12:50:24 :590	24.02. 2007	Boiler pressure above high limit.	Incoming Outgoing	Warning: Color Red

##### Alarm system in WinCC

The alarm system processes a variety of alarm types. The alarm procedures can be broken down into system-defined alarms and user-defined alarms:

- User-defined alarms are used to monitor the plant process.
- System-defined alarms monitor the HMI device.

The detected alarm events are displayed on the HMI device. Targeted access to the alarms combined with supplementary information about individual alarms ensures that faults are localized and cleared quickly. This reduces stoppages or even prevents them altogether.

The following figure shows the alarm system structure:

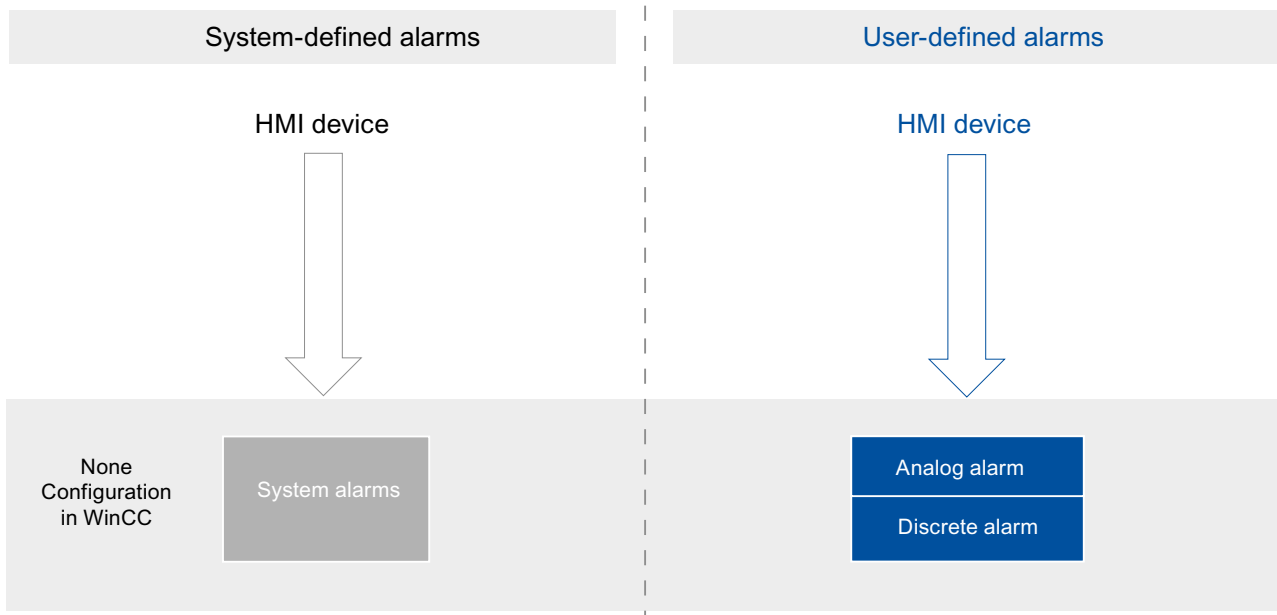

### 10.3.1.2 Alarm Logging in WinCC

#### Introduction

Alarm logging allows you to display and record operating states and faults on the HMI device that are present or occur in a plant.

An alarm may have the following content:

N o.	Time of day	Date	Alarm text	Status	Alarm class
5	12:50:24 :590	24.02. 2007	Boiler pressure above high limit.	Incoming Outgoing	Warning: Color Red

#### Alarm Logging in WinCC

Alarm logging processes various alarm procedures used by the PLC and the HMI device. The alarm procedures can be broken down into system-defined alarms and user-defined alarms:

- User-defined alarms serve to monitor the plant.
- System-defined alarms are used to monitor the HMI device or the PLC.

The detected alarm events are displayed on the HMI device. You can use the alarm logging system to log alarms from the ongoing process. Targeted access to the alarms combined with supplementary information about individual alarms ensures that faults are localized and cleared quickly. This reduces stoppages or even prevents them altogether.

The following figure shows the alarm logging structure:

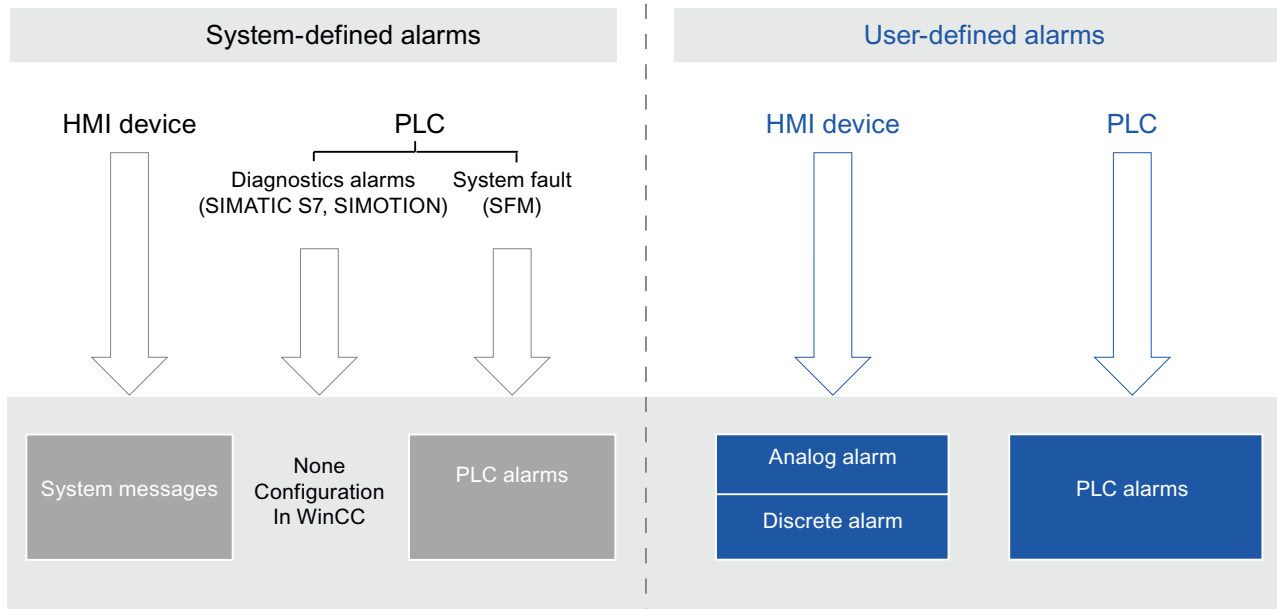

### 10.3.1.3 Alarm Procedures

#### Overview of the alarm types

##### Introduction

The alarm types serve various purposes for monitoring the plant. The alarms from the individual alarm types are configured and triggered in different ways.

Select the relevant tab in the "HMI alarms" editor to configure alarms based on the individual alarm types.

## Alarm types in WinCC

WinCC supports the following alarm types:

### User-defined alarms

- **Analog alarms**
  - Analog alarms are used to monitor limit violations.
- **Discrete alarms**
  - Discrete alarms are used to monitor states.

### System-defined alarms

- **System events**
  - System events belong to the HMI device and are imported into the project.
  - System events monitor the HMI device.

## Overview of the alarm types

### Introduction

The alarm types serve various purposes for monitoring the plant. The alarms from the individual alarm types are configured and triggered in different ways.

Select the relevant tab in the "HMI alarms" editor to configure alarms based on the individual alarm types.

## Alarm types in WinCC

WinCC supports the following alarm types:



## User-defined alarms

- **Analog alarms**
  - Analog alarms are used to monitor limit violations.
- **Discrete alarms**
  - Discrete alarms are used to monitor states.
- **Controller alarms**
  - You configure controller alarms in STEP 7.
  - You continue to process the controller alarms in WinCC.

---

**Note****Device dependency**

The controller alarm is not supported on all HMI devices.

---

## System-defined alarms

- **System-defined controller alarms**
  - System-defined controller alarms consist of diagnostic alarms (SIMATIC S7) and system errors (SFM)
  - System-defined controller alarms are used to monitor the PLC.

---

**Note****Device dependency**

System-defined controller alarms are not supported on all HMI devices.

---

- **System events**
  - System events belong to the HMI device and are imported into the project.
  - System events monitor the HMI device.

## User-defined alarms

### Analog alarms

#### Description

Analog alarms signal limit violations during the process.

#### Example

The speed of the mixer in a fruit juice mixing plant must not be too high or too low. You can configure analog alarms to monitor the speed of the mixer. If the high or low limit for the speed

### 10.3 Working with alarms

of the mixer is violated, an alarm is output on the HMI device containing the following alarm text, for example: "Mixer speed is too low".

#### Discrete alarms

##### Description

Discrete alarms indicate a status in the current process.

##### Example

A fruit juice mixing plant consists of several tanks containing the ingredients. To ensure the correct mixing ratio of water, fruit concentrate, sugar, and flavoring, the valves in the intakes open and close at the right moment. This operation should be monitored.

You configure a suitable discrete alarm for all the valve states. If a valve on one of the four tanks opens or closes, an alarm is displayed, such as "Water valve closed".

The operator can thus monitor whether the plant is producing correctly.

#### PLC alarms

##### Example of an alarm

CPU operating mode switch to Stop

##### Description

The custom controller alarms are created by the control system engineer in STEP 7. The status values, such as time stamp and process values, are mapped in the controller alarm. If controller alarms are configured in STEP 7, accept them into the integrated WinCC operation as soon as a connection is established to the PLC.

In STEP 7, the controller alarm is assigned to an alarm class. You can import this alarm class with the controller alarm as a common alarm class.

#### Types of controller alarms

SIMATIC S7 supports different types of controller alarms. WinCC supports different types of controller alarms according to which Runtime is used.

#### Controller alarms for multiple HMI devices

If a PLC is connected to multiple HMI devices, the project engineer assigns display classes to the controller alarms in STEP 7. The display classes determine the allocation to the HMI device. You can activate the display classes for your HMI device that are to be displayed on it. In this case, only the controller alarms from this display class will be displayed on the HMI device. Up to 17 display classes are possible.

## See also

Editing controller alarms (Page 3277)

## System-defined Alarms

## System events

## Examples for alarms

- "An online connection to the PLC is established."

## Description

A system alarm indicates the status of the system, plus communication errors between the HMI device and system.

Under "Runtime settings > Alarms" you specify how long a system alarm is shown on the HMI device.

## Support

The reference contains a list of the possible system events, along with the cause and possible remedies. If you contact online support because of a system alarm on the HMI device, you will need the alarm number and tags used in the system alarm.

## System events

## Examples of alarms

- "Overflow of the buffer for printing lines in text mode"
- "No printer is installed or a default printer has not been set up."

## Description

A system event indicates the system status, including errors in the communication between the HMI device and system.

The system events depend on the HMI device.

You can load system events in the "HMI alarms" editor from an \*.xml file.

## Support

The reference contains a list of the possible system events, along with the cause and possible remedies. When contacting Online Support because of a system event on the HMI device, you need the event number and tags used in the system event.

## System-defined controller alarms

### Example of an alarm

Valve open due to overpressure

### Description

System-defined controller alarms are installed with STEP 7 and are only available if WinCC is operated in the STEP 7 environment.

WinCC processes system-defined controller alarms of the type "SIMATIC S7 diagnostic alarm".

S7 diagnostic alarms show states and events in the SIMATIC S7 controllers. You only have read access to S7 diagnostic alarms. They are assigned to the "Diagnostics" alarm class by the system. S7 diagnostic alarms are not acknowledged or reported. They are for signaling purposes only.

### See also

Enabling system-defined controller alarms (Page 3278)

#### 10.3.1.4 Alarm states

### Introduction

An alarm assumes various alarm states in Runtime. The user analyzes and reports on the process execution with reference to the alarm states.

---

#### Note

Device dependency

Reporting and logging are not available for all HMI devices.

---

### Description

Every alarm has an alarm status. The alarm states are made up of the following events:

- **Incoming**  
The condition for triggering an alarm is satisfied. The alarm is displayed, such as "Boiler pressure too high".
- **Outgoing**  
The condition for triggering an alarm is no longer satisfied. The alarm is no longer displayed as the boiler was vented.
- **Acknowledge**  
The operator acknowledges the alarm.

### Alarms without acknowledgment

The following table shows the alarm states for alarms that do not have to be acknowledged:

Status	Description
Incoming	The condition for an alarm is satisfied.
Outgoing	The condition for an alarm is no longer satisfied.

### Alarms with acknowledgment

The following table shows the alarm states for alarms that have to be acknowledged:

Status	Description
Incoming	The condition for an alarm is satisfied
Outgoing, not acknowledged	The condition for an alarm is no longer satisfied. The operator has not acknowledged the alarm.
Outgoing, and subsequently acknowledged	The condition for an alarm is no longer satisfied. The operator has acknowledged the alarm after this time.
Incoming, acknowledged	The condition for an alarm is satisfied. The operator has acknowledged the alarm.
Outgoing, but acknowledged first	The condition for an alarm is no longer satisfied. The operator acknowledged the alarm while the condition was still satisfied.

Each occurrence of these states can be displayed and logged on the HMI device and a protocol printed.

#### Note

The display text for the states of an alarm is language-specific and configuration-specific.

## 10.3.1.5 Alarm classes

### Basics on alarm classes

#### Introduction

Many alarms occur in a plant. These are all of different importance. You can assign the alarms of your project to alarm classes to clearly show the user which of the alarms are most important.

#### Description

The alarm class defines how an alarm is displayed. The alarm class specifies if and how the user has to acknowledge alarms of this alarm class.

A new alarm class with mandatory acknowledgment is generated in WinCC.

---

**Note**

The choice of display modes for alarm classes depends on the options on your HMI device.

---

**Examples of how to use alarm classes**

- The alarm "Speed of fan 1 in upper tolerance range" has alarm class "Warnings". The alarm is displayed with a white background. The alarm does not have to be acknowledged.
- The alarm "Speed of fan 2 has exceeded upper warning range" is assigned to the "Errors" alarm class. The alarm is displayed with a red background and flashes at high frequency in runtime. The alarm is displayed until the user acknowledges it.

**Using alarm classes**

Use the following alarm classes to define the acknowledgment model and display of alarms for your project:

- **Predefined alarm classes**  
You cannot delete predefined alarm classes and edit them only to a limited extent. Predefined alarm classes have been created for each HMI device under "HMI alarms > Alarm classes".
- **Custom alarm classes**  
You can create new alarm classes under "HMI alarms > Alarm classes", configure how you want the alarms to be displayed, and define an acknowledgment model for alarms of this alarm class. The possible number of custom alarm classes depends on which runtime is used in your project.

**See also**

Predefined alarm classes (Page 3255)

Creating alarm classes (Page 3263)

Using project-wide alarm classes (Page 3264)

**Basics on alarm classes**

**Introduction**

Many alarms occur in a plant. These are all of different importance. You can assign the alarms of your project to alarm classes to clearly show the user which of the alarms are most important.

**Description**

The alarm class defines how an alarm is displayed. The alarm class specifies if and how the user has to acknowledge alarms of this alarm class.

---

A new alarm class with mandatory acknowledgment is generated in WinCC.

---

**Note**

The choice of display modes for alarm classes depends on the options on your HMI device.

---

**Examples of how to use alarm classes**

- The "Speed of fan 1 in upper tolerance range" alarm has "Warnings" alarm class. The alarm is displayed with a white background. The alarm does not have to be acknowledged.
- The "Speed of fan 2 has exceeded upper warning range" alarm is assigned to the "Errors" alarm class. The alarm is displayed with a red background and flashes at high frequency in runtime. The alarm is displayed until the user acknowledges it.

**Using alarm classes**

Use the following alarm classes to define the acknowledgment model and display of alarms for your project:

- **Predefined alarm classes**  
You cannot delete predefined alarm classes and edit them only to a limited extent. Predefined alarm classes have been created for each HMI device under "HMI alarms > Alarm classes".
- **Custom alarm classes**  
You can create new alarm classes under "HMI alarms > Alarm classes", configure how you want the alarms to be displayed, and define an acknowledgment model for alarms of this alarm class. The possible number of custom alarm classes depends on which runtime is used in your project.
- **Common alarm classes**  
Common alarm classes are displayed under "Shared data > Alarm classes" in the project tree and can be used for the alarms of an HMI device. Common alarm classes originate in the alarm configuration of STEP 7. If needed, you can create additional common alarm classes in WinCC.

**See also**

Predefined alarm classes (Page 3255)

Creating alarm classes (Page 3263)

Using project-wide alarm classes (Page 3264)

**Predefined alarm classes****Predefined alarm classes**

The following alarm classes already created in WinCC for every HMI device:

### Alarm classes for user-defined alarms

- "Warnings"  
The "Warnings" alarm class is designed to show irregular statuses and routines in the process. Users do not acknowledge alarms from this alarm class.
- "Errors"  
The "Errors" alarm class is intended to show critical or dangerous states or limit violations in the process. The user must acknowledge alarms from this alarm class.

### Alarm classes for system-defined alarms

- "System"  
The "System" alarm class contains alarms that display states of the HMI device and the PLCs.
- "Diagnosis Events"  
The "Diagnosis Events" alarm class contains alarms that display states and events in SIMATIC S7 controllers. Users do not acknowledge alarms from this alarm class.

---

#### Note

#### Device dependency

The "Diagnosis Events" alarm class is not available for all HMI devices.

---

### See also

Basics on alarm classes (Page 3254)

Creating alarm classes (Page 3263)

Using project-wide alarm classes (Page 3264)

### 10.3.1.6 Acknowledgement

#### Acknowledging alarms

##### Introduction

To make sure that an alarm was registered by the plant operator, configure this alarm so that it is displayed until acknowledged by the operator. Alarms that display critical or hazardous states in the process have to be acknowledged.

##### Description

The acknowledgment of an alarm is an event that is logged and reported. Acknowledging an alarm changes the alarm status from "Incoming" to "Acknowledged". When the operator



acknowledges an alarm, the operator confirms that he or she has processed the status that triggered the alarm.

---

**Note**

**HMI device dependency**

Reporting and logging are not available for all HMI devices.

---

### Triggering acknowledgment of an alarm

In Runtime, you trigger alarm acknowledgments in various ways:

- Acknowledgement by the authorized user at the HMI device
- Automatic acknowledgment by the system without operator action, e.g. by means of
  - Tags
  - PLC
  - System functions in function lists or scripts

---

**Note**

**HMI device dependency**

Scripts are not available for all HMI devices.

---

### Acknowledging alarms that belong together

To make the alarm system clearer and easier to use in Runtime, you can configure an alarm group. You can acknowledge all alarms belonging to this alarm group in a single pass.

### Acknowledgment by the PLC

Discrete alarms will be automatically acknowledged by the PLC, if necessary. The acknowledgment is triggered by a bit in the "Acknowledgment tag PLC". You define the bit and tag at the configuration stage.

### Acknowledgment of an alarm on the HMI device

In Runtime, the user acknowledges an alarm in one of the following ways, depending on the configuration:

- Using the acknowledgment button <ACK> on the HMI device
- Using the button in the alarm view
- Using configured function keys or buttons in screens

---

#### Note

##### Acknowledgment button <ACK> on the HMI device

To ensure that critical alarms are processed only by authorized users, protect the "ACK" button on the HMI devices, including the operating controls and display objects of the alarms. Use the appropriate operator authorization for this.

---

#### Note

##### HMI device dependency

The acknowledgement key <ACK> is not available on all HMI devices.

---

### Reaction to the acknowledgment of alarms of an alarm group

- Alarm acknowledgment by the operator  
You acknowledge the alarm of an alarm group, for example, using the <ACK> acknowledgment key or a function key. All alarms of the alarm group are acknowledged.
- Alarm acknowledgment by the controller  
The controller sets a tag bit to acknowledge the alarm of an alarm group. The respective alarm is acknowledged.

### Acknowledgement Model

#### Overview

You define the acknowledgment model for an alarm class. Alarms that are assigned to this alarm class will be acknowledged on the basis of this acknowledgment model. The following acknowledgment model is used in WinCC:

- Alarm without acknowledgment  
This alarm comes and goes without having to be acknowledged. There is no visible response from the system.
- Alarm with simple acknowledgment  
This alarm must be acknowledged as soon as the event that triggers the alarm occurs. The alarm remains pending until it is acknowledged.

### 10.3.1.7 Alarm groups

#### Introduction

Many alarms from different areas and processes occur in a plant. You can compile associated alarms into alarm groups.

#### Alarm groups

You can use the alarm groups to monitor the parts of the plant and to acknowledge the associated alarms together as required.

Alarm groups can contain alarms from different alarm classes. You only assign alarms that require acknowledgment to alarm groups.

#### Using alarm groups

It is a good idea to compile alarm groups for alarms such as the following:

- Alarms that are caused by the same fault.
- Alarms of the same type
- Alarms from a machine unit, such as "Fault in drive XY"
- Alarms from an associated part of the process, such as "Fault in cooling water supply"

#### Display in Runtime

In Runtime, the "Alarm group" column displays the number of the alarm group to which the alarm belongs.

#### See also

Configuring Alarm Groups (Page 3267)

### 10.3.1.8 Alarm number

#### Assigning alarm numbers

The system assigns unique alarm numbers within an alarm type.

---

**Note**

When adapting alarm numbers, observe the uniqueness of the alarm number within an alarm type.

---

## 10.3.2 Working with Alarms

### 10.3.2.1 Alarm components and properties

#### Overview

You configure the components of alarms in WinCC. The following table shows the basic components of alarms:

Alarm class	Alarm number	Time of day	Date	Alarm status	Alarm text	Alarm group	Tooltip	Trigger tag	Limit value
Warning	1	11:09:14	06.08.2007	IO	Maximum speed reached	2	This alarm is ...	speed_1	27
System	110001	11:25:58	06.08.2007	I	Switch to "Online" mode	0	This alarm is ...	PLC-Variable_1	-

#### Alarm class

Alarm classes, such as "Warnings" or "Errors". The alarm class defines the following for an alarm:

- Acknowledgment model
- Appearance in Runtime (e.g. color)
- Logging

---

#### Note

##### Device dependency

Logging is not available for all HMI devices.

---

#### Alarm number

An alarm is identified by a unique alarm number. The alarm number is assigned by the system. You can change the alarm number to a sequential alarm number, if necessary, to identify alarms associated in your project.

#### Time and date

Every alarm has a time stamp that shows the time and date at which the alarm was triggered.

#### Alarm status

An alarm has the events "Incoming," "Outgoing," "Acknowledge." For each event, a new alarm is output with the current status of the alarm.

### Alarm text

The alarm text describes the cause of the alarm.

The alarm text can contain output fields for current values. The values you can insert depend on the Runtime in use. The value is retained at the time at which the alarm status changes.

### Alarm group

The alarm group bundles individual alarms.

### Tooltip

You can configure a separate tooltip for each alarm; the user can display this tooltip in Runtime.

### Trigger tag

Each alarm is assigned a tag as trigger. The alarm is output when this trigger tag meets the defined condition, e.g. when its state changes or it exceeds a limit.

### Limit value

Analog alarms indicate limit violations. Depending on the configuration, WinCC outputs the analog alarm as soon as the trigger tag exceeds or undershoots the limit value.

### See also

Output of a tag value in the alarm text (Page 3274)

Alarm states (Page 3252)

Basics on alarm classes (Page 3254)

Alarm groups (Page 3259)

## 10.3.2.2 Configuring Alarms

### Overview of alarm configuration tasks

#### Steps to configure alarms

Configuring alarms in WinCC involves the following steps:

1. Edit and create alarm classes  
You use the alarm class to define how an alarm will be displayed in runtime and to define the acknowledgment model for it.
2. Creating tags in the "HMI tags" editor
  - Configure the tags for your project.
  - You create range values for the tags.

### 10.3 Working with alarms

3. Creating tags in the "HMI alarms " editor
  - Create custom alarms and assign these the tag to be monitored, alarm classes, alarm groups, and other properties.
  - You can also assign system functions or scripts to the alarm events.
4. Output of configured alarms  
To output configured alarms, configure an alarm view or an alarm window in the "Screens" editor.

#### Additional configuration tasks

Additional tasks may be necessary for configuring alarms, depending on the requirements of your project:

1. Creating alarm groups  
You assign the alarms of your project to alarm groups according to their association, such as by the cause of the problem (power failure) or source of the error (Motor 1).
2. Configuring Loop-In-Alarm  
A Loop-In-Alarm is configured in order to change to a screen containing relevant information on an alarm received.

#### Overview of alarm configuration tasks

#### Steps to configure alarms

Configuring alarms in WinCC involves the following steps:

1. Edit and create alarm classes  
You use the alarm class to define how an alarm will be displayed in runtime and to define the acknowledgment model for it.
2. Creating tags in the "HMI tags" editor
  - Configure the tags for your project.
  - You create range values for the tags.
1. Creating tags in the "HMI alarms " editor
  - Create custom alarms and assign these the tag to be monitored, alarm classes, alarm groups, and other properties.
  - You can also assign system functions or scripts to the alarm events.
2. Output of configured alarms  
To output configured alarms, configure an alarm view or an alarm window in the "Screens" editor.

## Additional configuration tasks

Additional tasks may be necessary for configuring alarms, depending on the requirements of your project:

- **Activating and editing system events**  
You can import system events when you initially open the "System events" tab in the "HMI alarms" editor. On completion of the import, you can edit the system events.
- **Activating and editing controller alarms**  
For integrated operation of a project in STEP 7, specify the controller alarms to be displayed on your HMI device in the alarm settings.
- **Creating alarm groups**  
Assign the alarms of your project to alarm groups based on their relation, e.g. by error cause (e.g. "power failure"), or by error source (e.g. "Motor 1").
- **Configuring Loop-In-Alarm**  
Configure a Loop-In-Alarm in order to change to a screen that contains information about an incoming alarm.

## Configuring Alarm Classes

### Creating alarm classes

#### Introduction

Create alarm classes in the "Alarm classes" tab of the "HMI alarms" editor. Some default alarm classes are already created for every project. You can create additional custom alarm classes. You can create up to 32 alarm classes.

#### Requirement

- The "HMI alarms" editor is open.
- The Inspector window is open.

10.3 Working with alarms Alarm classes

Procedure

	Display name	Name ▲	Acknowledgment model	Log	E-mail address
	S7	Diagnosis events	Alarm without acknowledgment	<No log>	
To	!	Errors	Alarm with single acknowledgment	<No log>	
	↓	System	Alarm without acknowledgment	<No log>	
1.		Warnings	Alarm without acknowledgment	<No log>	
	<Add new>				

1. Double-click "<Add>" in the table.  
A new alarm class is created. Each new alarm is automatically assigned a static ID. The properties of the new alarm class are shown in the Inspector window.
2. Configure the alarm class under "Properties > Properties > General" in the Inspector window.
  - Enter a "Name" and the "Display name".
  - Depending on the HMI device, you can also activate logging, or automatic sending of e-mails.
3. Define the acknowledgment model for the alarm class under "Properties > Properties > Acknowledgment" in the Inspector window.
4. Change the default text under "Properties > Properties > Status" in the Inspector window. This text indicates the status of an alarm in Runtime.
5. Change the default colors under "Properties > Properties > Colors" in the Inspector window. Depending on the HMI device, also change the flashing characteristics.

These settings define how alarms from this alarm class are displayed in Runtime.

**Note**

To display the alarm classes in color in Runtime, the "Use alarm class colors" option must be activated. In the project navigation, enable "Runtime settings > Alarms > General > Use alarm class colors" accordingly. This option is selected in a new project in WinCC.

**See also**

- Predefined alarm classes (Page 3255)
- Basics on alarm classes (Page 3254)

**Using project-wide alarm classes**

**Introduction**

Project-wide alarm classes are displayed under "Shared data > Alarm classes" in the project navigation. Create additional common alarm classes in WinCC.

Controller alarms are assigned to common alarm classes. If you work with controller alarms, common alarm classes are automatically loaded in WinCC.



## Requirements

- You have created a project.

## Creating project-wide alarm class

To create a project-wide alarm class, proceed as follows:

1. Double-click "Shared data > Alarm classes" in the project navigation.  
The "Project-wide message classes" editor opens in the work area.
2. To create a project-wide message class, double-click in the first empty line of the table editor.
3. Specify the name and display name of the alarm class.
4. Select "With acknowledgment" if the alarm class requires acknowledgment.

## Assign alarms to a common alarm class

Proceed as follows to assign an analog or discrete alarm to a common alarm class:

1. In the "HMI alarms" editor, select the alarm that you want to assign to the common alarm class.
2. Click "General" in the Inspector window.
3. Click "Shared data > Alarm classes" in the project navigation.
4. Select the common alarm class in the detail view.

5. Drag-and-drop the alarm class to the "Alarm class" selection box or "Alarm class" column in the work area of the Inspector window of the alarm.

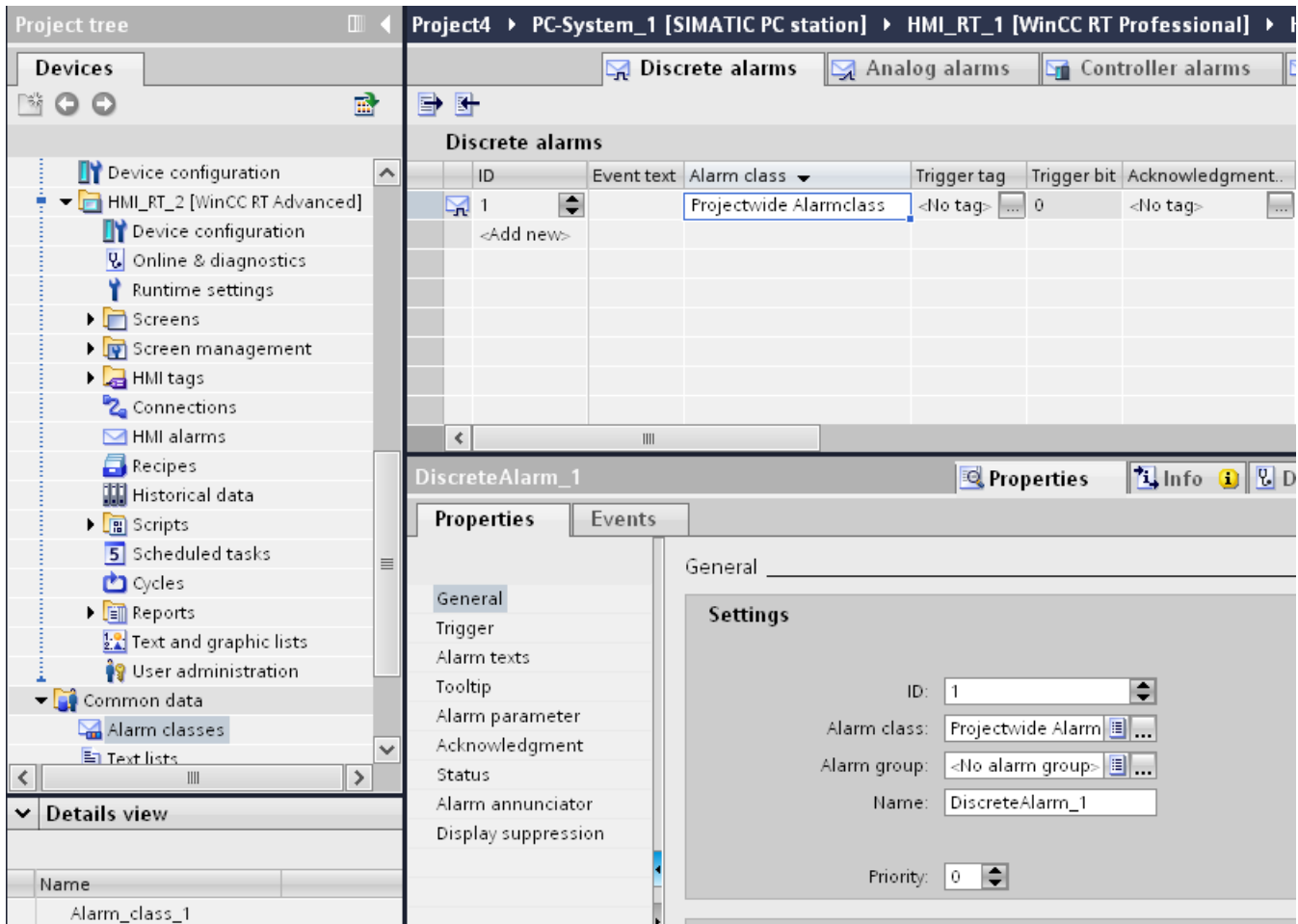

The system creates a new alarm class that is linked to the common alarm class. The new name of the common alarm class is displayed in the "Alarm class" area of the Inspector window of the alarm. The display name of the common alarm class is activated for the alarm class in your project.

6. Click the "Alarm Class" tab.
7. Check to see whether the display name of the common alarm class is displayed in WinCC.
8. You can change the object name of the alarm class.

## Alternative procedure

To assign an alarm to a common alarm class, proceed as follows:

1. Click the "Alarm Classes" tab.  
The alarm classes are displayed.
2. Click "Shared data > Alarm classes" in the project navigation. The following table shows the common alarm classes:

Project4 > Common data > Alarm classes			
Alarm classes			
	Name	Display name	With acknowledgment
1	Projectwide Alarmclass_1	Error	<input type="checkbox"/>
2	Projectwide Alarmclass_2	Status	<input checked="" type="checkbox"/>
3			<input type="checkbox"/>

3. Select the common alarm class in the detail view.
4. Drag-and-drop the alarm class to the "Alarm classes" tab of the "HMI alarms" editor  
The system creates a new alarm class that is linked to the common alarm class. The new name of the new alarm class in your project is displayed in the "Alarm class" tab.
5. Open the tab with the alarm procedure for the required alarm.
6. Under "General" in the Inspector window, select the alarm and the alarm class linked to the common alarm class.

---

### Note

#### Deleting a common alarm class

If you delete a common alarm class, the linked alarm class is maintained. If necessary, link the alarm class with another common alarm class or use it as WinCC alarm class.

---

## See also

Predefined alarm classes (Page 3255)

Basics on alarm classes (Page 3254)

## Configuring Alarm Groups

### Introduction

Create alarm groups on the "Alarm Groups" tab in the "HMI alarms" editor. An alarm group is a compilation of single alarms. You assign alarms in an alarm group by association, such as cause of the problem or source of the error. If you acknowledge an alarm from this alarm group in Runtime, all other alarms in the alarm group are acknowledged automatically.

## Requirement

- You have created a project.

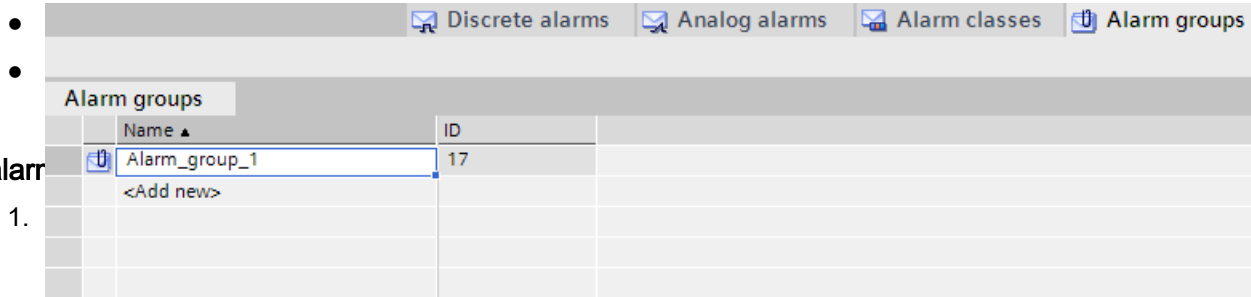

## Creating a new alarm

1. In the work area of the table, double-click "<Add>" in the first free row. A new alarm group is created.
2. You can overwrite the proposed "Name".

## Result

An alarm group is created. For the group acknowledgment of alarms in Runtime, assign the associated alarms that require acknowledgment to an alarm group.

## Configuring discrete alarms

### Introduction

Discrete alarms triggered by the PLC indicate status changes in a plant. They indicate the opened or closed state of a valve, for example.

The following sections describes the configuration procedures in the "HMI alarms" editor. You can also configure discrete alarms in the "HMI tags" editor.

### Requirements

- The "HMI alarms" editor is open.
- The Inspector window is open.
- You have created the required alarm classes and alarm groups.

### Procedure

To configure a discrete alarm, proceed as follows:

1. Open the "Discrete alarms" tab.
2. To create a new discrete alarm, double-click in the work area on "<Add>". A new discrete alarm is created.

3. To configure the alarm, select "Properties > Properties > General" in the Inspector window:
  - Enter an alarm text as event text.  
Use the functions of the shortcut menu to format the text on a character-by-character basis, or to insert output fields for HMI tags, or texts from the text lists.
  - You can renumber the alarm.
  - Select the alarm class and the alarm group, if necessary.
4. In the Inspector window, select the tag and the bit that triggers the alarm under "Properties > Properties > Trigger". Note the following information:
  - Use the data types "Int" or "UInt" to select an HMI tag.
  - Use the data types "Int" or "Word" to select a PLC tag.
  - Use trigger tag bits only for alarms.
  - Do not use trigger tags for anything else.
  - If you want to acknowledge the alarm via the PLC, use this tag also as PLC acknowledgment tag.

---

**Note**

Note the method used to count bits in the utilized PLC when specifying the bit. For more information, refer to the "Communication" section in the PLC Online Help.

---

**Note**

If the object does not yet exist in the selection list, create it directly in the object list and change its properties later.

---

**Status-dependent alarm texts**

To display a different text independent of the alarm status, link a text list to the alarm text. You control the text list with a tag.

## Additional settings for discrete alarms

### Creating a tooltip

To configure a tooltip for the alarm, follow these steps:

- Enter your text under "Properties > Properties > Tooltip".

### Configuring event-driven tasks

To configure event-driven tasks, such as a loop-in alarm, follow these steps:

1. Select the discrete alarm.
2. Select "Properties > Events" in the Inspector window and configure a new function list for the relevant event.

### See also

Configuring trigger for alarm acknowledgment (Page 3301)

Output of a tag value in the alarm text (Page 3274)

Formatting alarm text (Page 3273)

Configuring loop-in alarm (Page 3279)

## Configuring analog alarms

### Introduction

Analog alarms indicate limit violations. For example, if the speed of a motor drops below a certain value, an analog alarm is triggered.

### Requirements

- The "HMI alarms" editor is open.
- The Inspector window is open.
- You have created the required alarm classes and alarm groups.

### Procedure

To configure an analog alarm, proceed as follows:

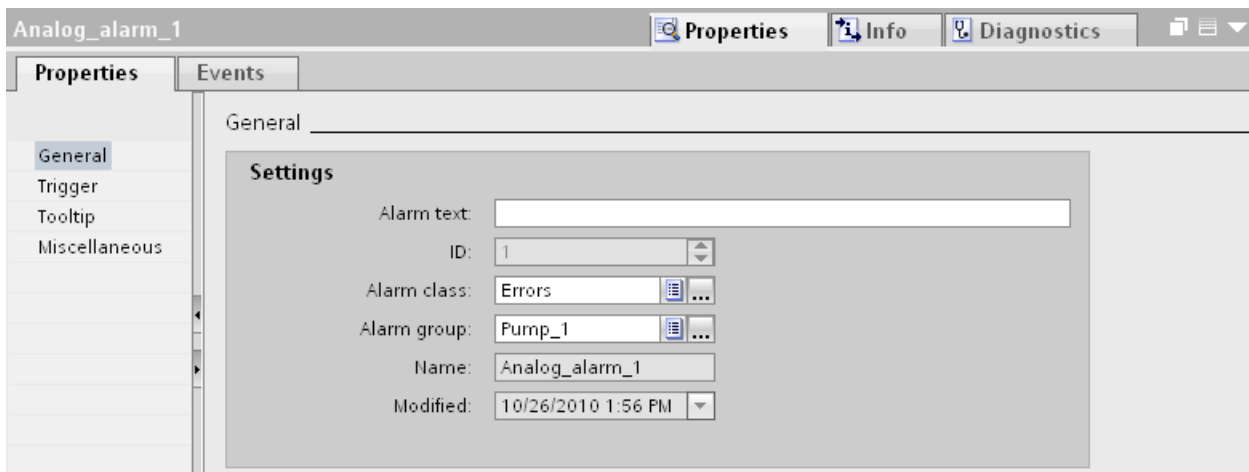

1. Click the "Analog alarms" tab.
2. To create a new analog alarm, double-click in the table on "<Add>".  
A new analog alarm is created.

3. To configure the alarm, select "Properties > Properties > General" in the Inspector window:
  - Enter an alarm text as event text.  
Format the text character-for-character using the shortcut menu.  
Using the shortcut menu, you can insert output fields for HMI tags, or text from text lists.
  - You can renumber the alarm.
  - Select the alarm class and the alarm group, if necessary.



4. Configure the tag that triggers the alarm under "Properties > Properties > Trigger > Settings".  
Do not use trigger tags for anything else.

### Configure limit values for an analog alarm

1. In the Inspector window, click the button  under "Properties > Properties > Trigger > Limit > Value".
  - To use a constant as limit value, select "Constant".  
Enter the required limit value.
  - To use a tag as limit value, select "HMI tag".  
The  button is shown. Use this button to select the tag you want to use.

---

#### Note

If the required tag does not exist in the selection list yet, create it in the object list and change its properties later.

---

2. Select the mode:
  - "High limit violation": The alarm is triggered when the limit is exceeded.
  - "Low limit violation": The alarm is triggered when the limit is undershot.

## Optional settings for analog alarms

### Setting the delay time

To set the delay time, proceed as follows:

- Enter a time period in the Inspector window under "Properties > Properties> Trigger > Settings > Delay".  
The alarm is only triggered when the trigger condition is still present after the delay time has elapsed.

### Setting the deadband

---

#### Note

If a process value fluctuates around the limit, the alarm associated with this fault may be triggered multiple times. To prevent this from happening, configure a deadband or delay time.

---

To enter the deadband, follow these steps:

1. Under "Properties > Properties> Trigger > Deadband > Mode", select the change in alarm status for which the deadband is to be taken into account.
2. Enter a constant value under "Value".
3. To define the deadband value as a percentage of the limit, set the "in %" check box.



## Automatic reporting

To print the alarms continuously:

- Select the "Activate" option under "Properties > Properties > Miscellaneous > Report."

---

### Note

Device dependency

Reporting is not available for all HMI devices.

---

## Creating a tooltip

To configure a tooltip for the alarm, follow these steps:

- Select "Properties > Properties > Tooltip" in the Inspector window and enter your text.

## Configuring event-driven tasks

To configure event-driven tasks, such as a loop-in alarm, follow these steps:

1. Select the analog alarm.
2. Select "Properties > Events" in the Inspector window and configure a new function list for the relevant event.

## See also

Configuring trigger for alarm acknowledgment (Page 3301)

Output of a tag value in the alarm text (Page 3274)

Formatting alarm text (Page 3273)

Configuring loop-in alarm (Page 3279)

## Formatting alarm text

### Requirements

- The "HMI alarms" editor is open.
- An alarm has been created.

### Procedure

To format an alarm text, proceed as follows:

1. Select the alarm to edit.
2. In the Inspector window, select the characters to format under "Properties > Properties > General > Alarm text".
3. Select the formatting from the shortcut menu, e.g. "Underscored" or "Uppercase".

## Result

The selected characters are displayed in Runtime with the selected formatting.

## Removing format settings

To remove all text formats, proceed as follows:

1. In the Inspector window, select the characters whose formatting you want to remove in the alarm text.
2. Select "Delete formatting characters" from the shortcut menu.

## Result

The selected characters are displayed in unformatted notation in Runtime.

## Output of a tag value in the alarm text

### Introduction

In WinCC, you can insert output fields into the alarm text which display the content of tags.

### Requirements

- The "HMI alarms" editor is open.
- The alarm is selected.

## Output of a tag value in the alarm text

To insert an output field for a tag value in the alarm text, proceed as follows:

1. Place the cursor onto the required position in the event text.
2. Select "Insert tag output field" in the shortcut menu.
3. Open the object list under "Tag" and select a tag.  
You can also create the tag in the object list.
4. Under "Format", specify the length of the output field and the format for tag value output in the alarm text.  
Configure an output field of sufficient size. Otherwise, the tag content is not output to the full extent in the alarm.
5. Click  to save your entries.

WinCC inserts a placeholder for the output field into the alarm text: "<tag: n, [tag name]>" whereby n = text string length.

### Editing output field properties

To edit the properties of an output field, proceed as follows:

- Double-click on the output field in the alarm text and edit the settings.

### Deleting an output field from the alarm text

To delete an output field from the alarm text, proceed as follows:

- Select the output field in the alarm text and then select the "Delete" command from the shortcut menu.

---

#### Note

The sequence of the tag output fields in the alarm text depends on the language. The sequence of the Runtime language is used for logging alarms to a CSV log file.

Changing the tag of an output field in one language causes the modified output field to appear at the end of the alarm text in all other languages. This changes the sequence of the output fields in the log.

Device dependency

Logging is not available for all HMI devices.

---

## Output of texts from a text list in an alarm

### Introduction

Text lists are used to create dynamic alarm texts. For example, you can configure the output of both states of a discrete alarm in an alarm text.

Insert a corresponding output field in the alarm text and specify the tag that returns the search key for the text list.

### Requirements

- A text list is created.
- The "HMI alarms" editor is open
- The alarm is selected

### Output of a text list value in an alarm text

To insert an output field for a value from a text list in the alarm text, proceed as follows:

1. Place the cursor at the required position in the alarm text.
2. Select "Insert text list output field" command from the shortcut menu.
3. Select the text list under "Text list".

### 10.3 Working with alarms

4. Open the object list under "Tag" and select the tag that returns the search key for the text list.  
You can also create the tag in the object list.
5. Define the length of the output field under "Format".  
Configure an output field of sufficient size so that the complete text from the text list is displayed in the alarm.
6. Click on the  icon to save your entries.  
WinCC inserts a placeholder for the output field into the alarm text:  
""<textlist: n, [textlist name]>" whereby n = text string length.

#### Editing output field properties

To edit the properties of an output field, proceed as follows:

- Double-click on the output field in the alarm text and edit the settings.

#### Deleting text list from the alarm text

To delete an output field from the alarm text, proceed as follows:

- Select the output field in the alarm text and then select the "Delete" command from the shortcut menu.

#### Editing System Events

##### Editing system events

When you open the "System events" tab in the "HMI alarms" editor, WinCC prompts you to import or update the system events. Import the system events and specify the display period. You cannot delete or create new system events. You can only edit the alarm text with system events.

##### Requirements

- You have imported the system events.

##### Specifying the display period

To determine the display period, proceed as follows:

1. Double-click "Runtime settings" in the project navigation.
2. Enter a value under "Alarms > System events > Display period".  
This value specifies a time in seconds during which the system events are displayed on the HMI device. If you want to display system events permanently, enter "0".

## Changing the alarm text

To change the alarm text of a system event, follow these steps:

1. Open the "HMI alarms" editor and then click the "System events" tab.
2. Select the system event that you want to edit.
  1. Change the alarm text under "Properties > Properties > Properties > General" in the Inspector window.

---

### Note

If you change an alarm text for a system event that contains a placeholder, leave the number of placeholders unchanged. A placeholder may be a "%1".

---

## Configuring event-driven tasks

The "Incoming" event is available for certain system events, depending on the HMI device. To configure event-driven tasks, proceed as follows:

1. Select the system event.
2. Select "Properties > Properties > Incoming" in the inspector window and configure a function list.

## Editing controller alarms

### Introduction

Controller alarms are configured in STEP 7. Controller alarms are available in WinCC running in a STEP 7 environment.

In WinCC you only edit the properties of controller alarms that are specific to an HMI device. Different properties of a controller alarm can be edited, depending on the HMI device and PLC.

You can filter the displayed controller alarms for your project using the display classes that were configured on the PLC for controller alarms.

### Requirements

- The connection was established to the PLC.
- Alarms were configured in STEP 7.

## Editing controller alarms

Proceed as follows to edit controller alarms:

1. Double-click "HMI alarms" in the project navigation.  
The "HMI alarms" editor is opened.
2. Open the "Controller alarms" tab.

### 10.3 Working with alarms

3. Select the alarm that you want to change in the work area.
4. Make your changes. Depending on the HMI device, it may not be possible to display or enable some of the controller alarm properties.

#### Editing SIMATIC S7 alarms

You can edit these controller alarms in the STEP 7 alarm configuration system. To do this, proceed as follows:

1. Select the alarm that you want to change in the work area.
2. Select "Open in alarm editor of the PLC" from the shortcut menu.  
The STEP 7 alarm configuration system is opened.
3. Make your changes.

#### Filtering the controller alarm using display classes

To filter controller alarms by display classes, proceed as follows:

1. Click "Runtime settings > Alarms" in the project navigation under your HMI device.  
One or several connections to a PLC are shown in "Controller alarms".
2. Select the display classes whose controller alarms you want to display for the connection.

#### Result

Only those controller alarms whose display class you have enabled for your HMI device will be displayed on the "Controller alarms" tab of the "HMI alarms" editor.

#### See also

PLC alarms (Page 3250)

#### Enabling system-defined controller alarms

#### Enabling system-defined controller alarms

To activate system-defined controller alarms for your HMI device, proceed as follows:

1. Select "Runtime settings > Alarms" in the project navigation.  
The alarm settings open.
2. Under "System events" activate the system-defined controller alarms.

3. To display the system events with alarm text, activate "With text".
4. To display these alarms in Runtime, configure an alarm view that displays alarms from the "Diagnosis Events" alarm class.

---

**Note**

For HMI devices with small display units, specify to display only the alarm number for system-defined controller alarms.

---

**See also**

System-defined controller alarms (Page 3252)

**Configuring loop-in alarm**

**Introduction**

A Loop-In-Alarm is configured in order to change to a screen containing relevant information on an alarm received.

**Requirement**

- The screen called by the Loop-In-Alarm has been created.
- The "HMI alarms" editor is open.

**Procedure**

To configure a Loop-In-Alarm for an alarm, proceed as follows:

1. Click the tab that contains the alarm for which you want to configure the Loop-In-Alarm.
2. Select the alarm.
3. In the Inspector window, select "Properties > Events > Loop-In-Alarm".

4. Select the "ActivateScreen" system function.
5. Select the screen called by the Loop-In-Alarm as parameter.

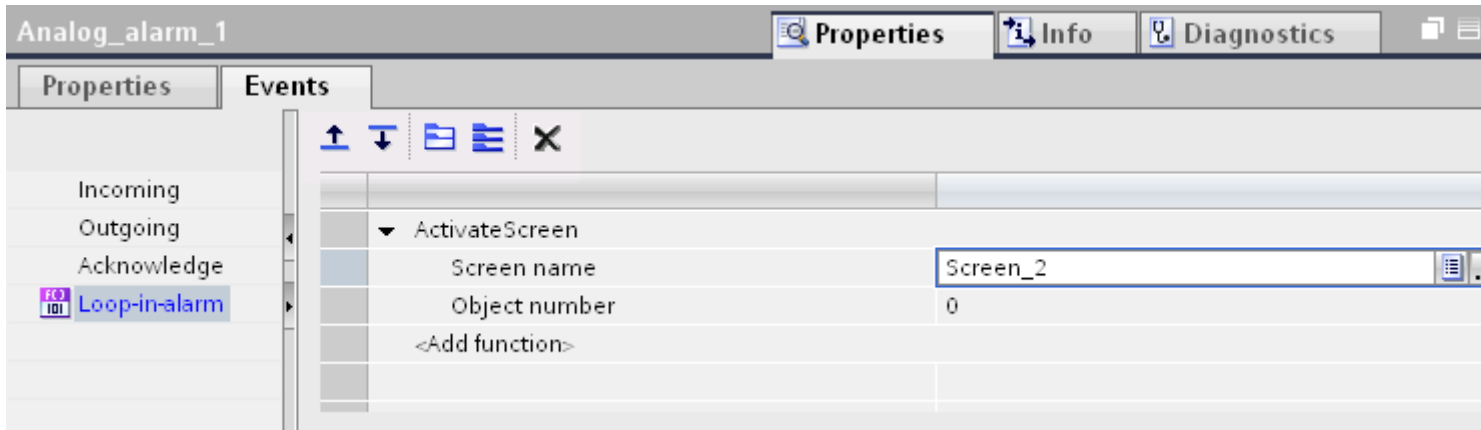

---

#### Note

To configure the Loop-In-Alarm for an alarm view with an "alarm line" format, use a button with the following system functions:

- "EditAlarm" for HMI devices with keys
- "AlarmViewEditAlarm" for HMI devices without keys

The system functions trigger the "Loop-In-Alarm" event. The alarm line has no buttons.

---

#### Result

If you click on the "Loop-In-Alarm" button of the alarm view in Runtime, a screen is opened with information on the selected alarm.

#### See also

Configuring discrete alarms (Page 3268)

Configuring analog alarms (Page 3270)



## Alarms in the "HMI tags" Editor

### Configuring discrete alarms

#### Introduction

In WinCC, you can create and edit discrete and analog alarms, including the trigger tags, in the "HMI tags" editor.

---

**Note**

If you delete, move or copy objects in the "HMI tags" editor, the changes also take effect in the "HMI alarms" editor.

---

#### Requirements

The "HMI tags" editor is open.

#### Procedure

To configure a discrete alarm, proceed as follows:

1. To create a tag, click on "<Add>" in the table at the top of the work area.  
A new tag is created.
2. Configure an internal or external tag as required.
  - Use the data types "Int" or "UInt" to select an HMI tag.
  - Use the data types "Int" or "Word" to select a PLC tag.
3. Select the tag at the top of the work area.
4. Click on "<Add>" in the table on the "Discrete alarms" tab at the bottom of the work area.  
A new discrete alarm is created for the tag. If you have selected the incorrect data type, the tag will be marked in the discrete alarm.
5. Configure the discrete alarm in the Inspector window:
  - Enter the alarm text under "Properties > Properties > General > Alarm text".  
You can also insert output fields into the alarm text.
  - Select an alarm class.
  - Select the trigger bit of the tag that triggers the discrete alarm under "Properties > Trigger".
6. You can create additional discrete alarms to monitor the tags.

---

**Note**

A tag is monitored using only one alarm type. You should therefore create either analog alarms **or** discrete alarms for a tag.

---

## Result

The configured discrete alarms are created in the "HMI tags" editor and displayed in the "HMI alarms" and "HMI tags" editors.

## Configuring analog alarms

### Introduction

In WinCC, create the discrete and analog alarms, including the trigger tags, in the "HMI tags" editor. You can also edit the alarms as in the "HMI alarms" editor. You can create up to two range values for a tag. You monitor these limits with analog alarms.

### Requirements

The "HMI tags" editor is open.

### Procedure

To configure an analog alarm in the "HMI tags" editor, proceed as follows:

1. To create a tag, click on "<Add>" in the table at the top of the work area.  
A new tag is created.
2. Configure an internal or external tag as required.
3. In the Inspector window, configure the range values of the tags under "Properties > Properties > Range":
  - Select whether to use a "Constant" or an "HMI tag" as limit value for your range values. The object list opens when you select "HMI tag". Select the tag you want to use.

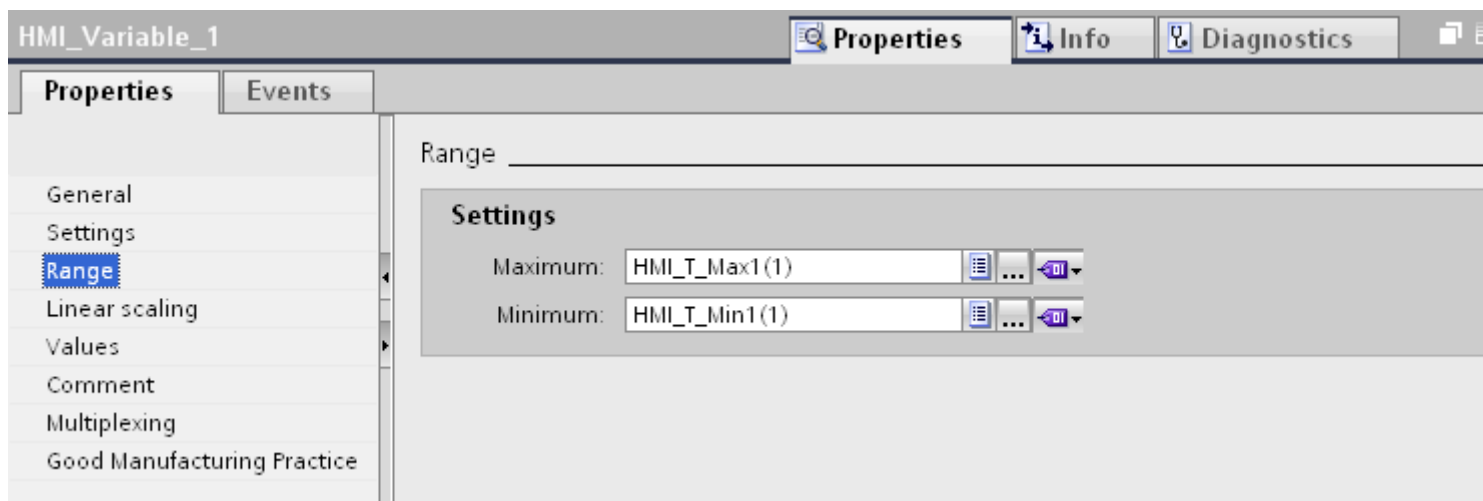

1. Click the "Analog Alarms" tab at the bottom of the work area.  
Create an analog alarm for both range values.
2. Select an analog alarm and configure it in the Inspector window:
  - Enter the alarm text under "Properties > Properties > General > Alarm text".
  - You can also insert output fields into the alarm text.
  - You can change the default alarm class.
3. Configure the analog alarms as in the "HMI alarms" editor.
4. Complete the configuration of all analog alarms.

---

**Note**

A tag is monitored using only one alarm type. You should therefore create either analog alarms **or** discrete alarms for a tag.

---

**Result**

The configured analog alarms are created in the "HMI tags" editor and displayed in the "HMI alarms" and "HMI tags" editors.

### 10.3.2.3 Configuring the Outputting of Alarms

#### Overview of configuring alarm output

#### Steps to complete when configuring alarm output

You configure the alarm output in WinCC in the following steps:

1. Create alarm view  
Use the display and control objects in the "Screens" editor to display alarms in Runtime. You can also configure an alarm view for logged alarms.
2. Configure acknowledgment  
In the "Screens" editor, you can set the operator action that will trigger the acknowledgment.
3. Configure reporting  
You can create reports in the "Reports" editor to print alarms in Runtime. In the "Scheduler", "Screens", "HMI alarms" or "HMI tags" editors, you define when and how the printing of a report is triggered.

---

**Note**

Device dependency

Reporting and logging are not available for all HMI devices.

---

### Additional configuration tasks

Additional tasks may be necessary for configuring alarm views, depending on the requirements of your project:

1. Setting up authorizations  
To make sure only authorized operators process the alarms, assign authorizations for the alarm view and the function keys of the HMI device.
2. Configuring the filtering of the alarm view  
You configure the filtering of the alarms in Runtime in the "Screens" editor. You can also configure alarm views that only display selected alarms.
3. Configure operator input alarms  
Configure the operator input alarms on the operator controls of the HMI device in the "Screens" editor. A preconfigured operator input alarm is output for an operator action. An operator input is, e.g. the acknowledgment of an alarm.

### Displaying alarms

#### Options for displaying alarms on the HMI device

WinCC offers the following options for displaying alarms on the HMI device:

- Alarm view  
The alarm view is configured in a screen. More than one alarm can be displayed simultaneously, depending on the configured size. You can configure multiple alarm views with different contents.
- Alarm window  
The Alarm window is configured in the "Global screen" editor. The alarm window can display multiple alarms at the same time, depending on the configured size. An event can trigger closing and reopening of the alarm window. To hide it during configuration, create an alarm window on its own level.

## Additional signals

- **Alarm indicator**  
The alarm indicator is a configurable, graphical icon. When an alarm comes in, the alarm indicator is displayed on the HMI device. You configure the alarm indicator in the "Global screen" editor.  
The alarm indicator has two states:
  - **Flashing:** At least one alarm that requires acknowledgment is pending.
  - **Static:** The alarms are acknowledged but at least one of them has not gone out yet. The alarm indicator also displays the number of pending alarms according to the HMI device.
- **E-mail notification**  
To inform someone other than the operator, such as an engineer, when an alarm with a specific alarm class arrives, assign the alarm class to an e-mail address.

---

### Note

#### Device dependency

E-mail notification is not available for all HMI devices.

---

- **System functions**  
You can configure a list of functions for the event associated with an alarm. These functions must be executed in Runtime when the event occurs.  
Use system functions for alarms in WinCC to control the alarm view or the alarm window other than via the toolbar.

## Displaying the predefined alarm classes in Runtime

The following table shows the symbols used to display the predefined alarm classes in the alarm view:

Alarm class	Displayed icon
"Diagnosis Events"	S7
"Errors"	!
"System"	\$
"Warnings"	<No symbol>

## See also

- Configuring an alarm view for active alarms (Page 3286)
- Configuring an alarm window (Page 3291)
- Configuring an alarm indicator (Page 3292)
- Configuring alarm filtering (Page 3294)
- Displaying Logged Alarms (Page 3297)
- System functions for alarms (Page 3334)

## **Configuring an alarm view**

### **Configuring an alarm view for active alarms**

#### **Introduction**

Current alarms are displayed in Runtime in an alarm view or alarm window.

#### **Requirement**

- A screen is open in the "Screen" editor.
- The "Tools" task card is open.

## Configuring alarms for the alarm view

To specify the alarms that will be shown in the alarm view, proceed as follows:

1. Insert an "Alarm view" object from the "Tools" task card into the screen.
2. Select the alarm view.
  - In the Inspector window, select "Properties > Properties > General > View > Current alarm states".  
Set whether to display alarms with and/or without mandatory acknowledgment.

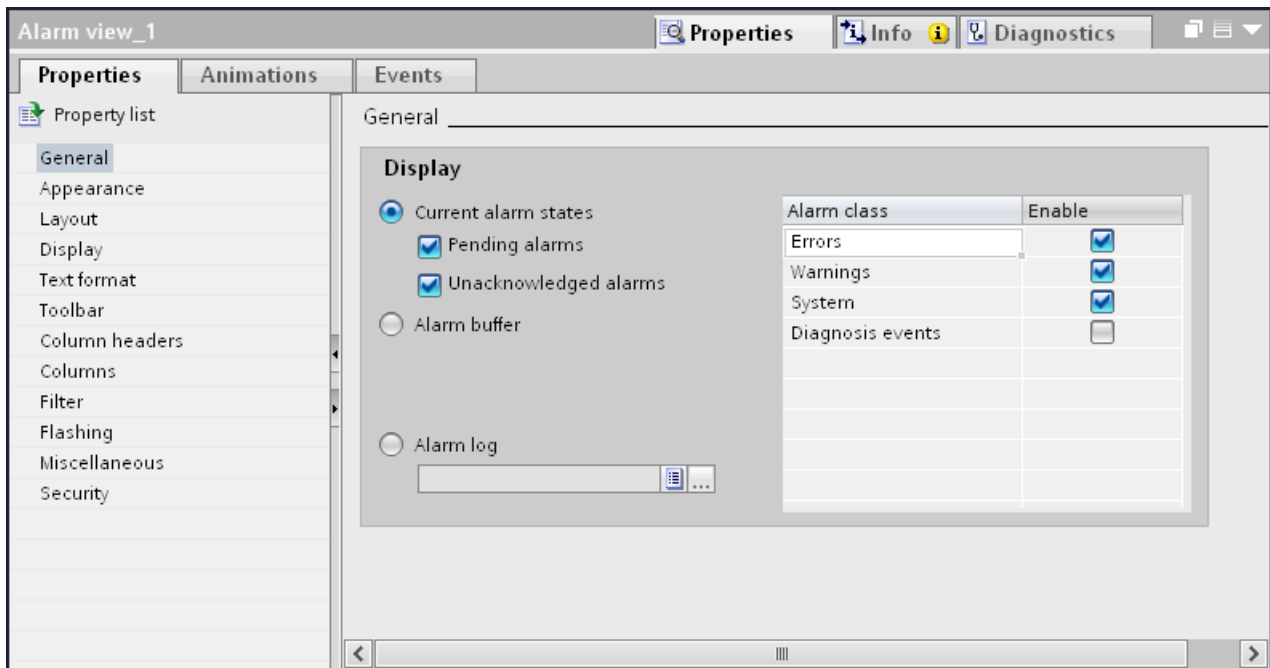

- To display all alarms in the alarm buffer, enable "Alarm buffer".

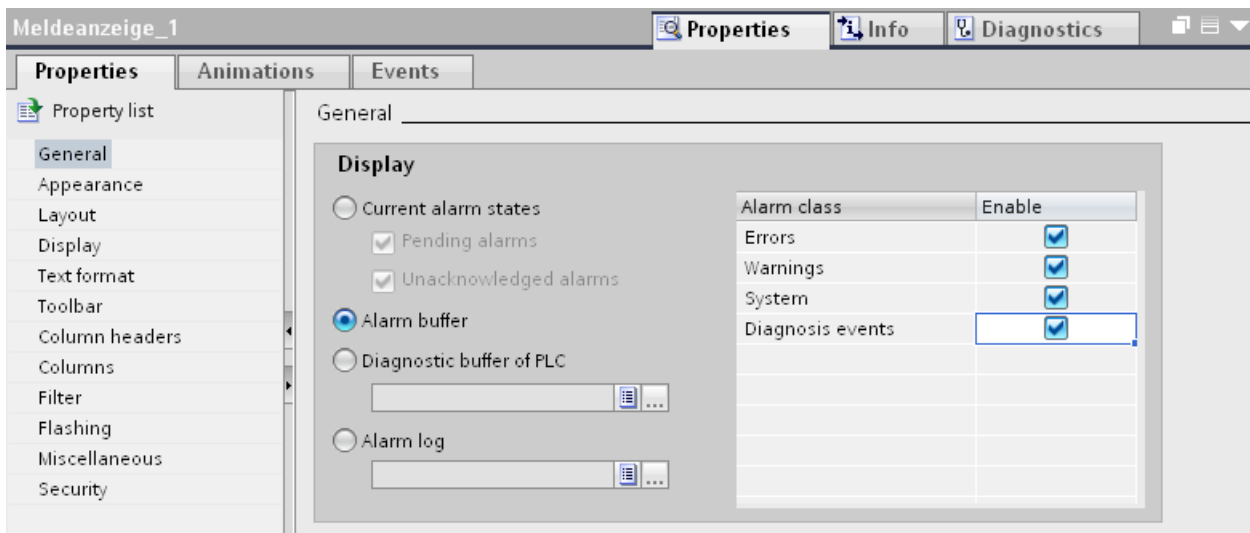

3. In the table, activate the alarm classes to be displayed in the alarm view.
4. Under ""Properties > Properties > View > Control tag for display area", define the tag that returns the date as of which the alarms will be displayed.

**Note**

**Device dependency**

The "Control tag for display area" property is not available for all HMI devices.

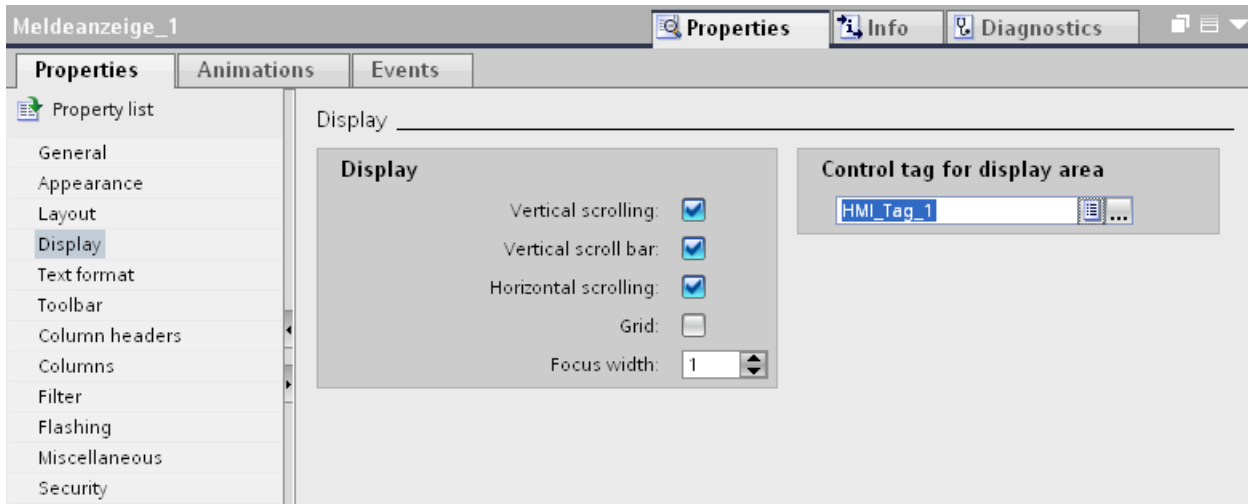



## Configuring the layout of the alarm view

To specify how the alarms are shown in the alarm view, proceed as follows.

1. Under "Properties > Properties > Layout > Settings > Lines per alarm" in the Inspection window, specify the number of lines to display for each alarm.
2. In "Properties > Properties > View", select the control elements that are available on the HMI device.
3. Configure the columns under "Properties > Properties > Columns":
  - Under "Visible columns" select the columns to be output in the alarm view.
  - Under "Properties Column", define the properties of the columns.
  - Under "Sort", select the sorting order of the alarms.

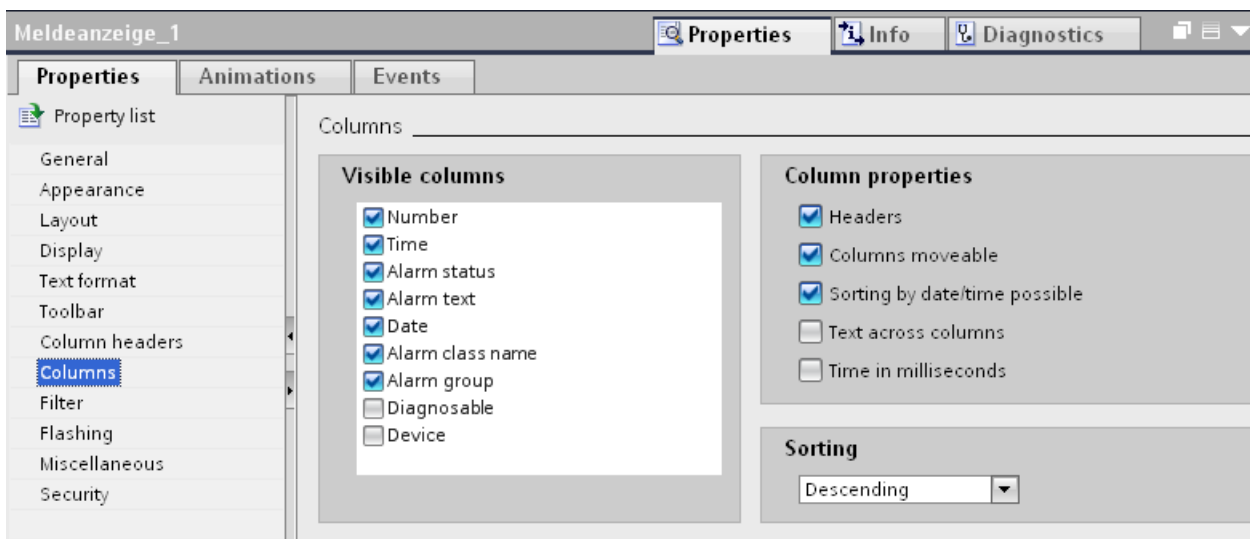

### Note

Select the "Edit" command in the shortcut menu for the alarm view to activate the alarm view. You can set the column width and position in active mode. To enable the alarm view, set the zoom factor to 100 %.

The alarm view is deactivated as soon as you deselect the object in the screen.

## Result

Alarms of various alarm classes are output in the alarm view during runtime.

## See also

Creating alarm classes (Page 3263)

Configuring an alarm window (Page 3291)

Alarm view (Page 3112)

## Configuring an alarm view for the S7 diagnostic alarms

### Introduction

To display S7 diagnostic alarms, configure an alarm view or alarm window for the predefined "Diagnosis Events alarm class. Activate the diagnostic alarms accordingly in the Runtime settings of your HMI device.

#### Note

##### HMI device dependency

The "Diagnosis Events" alarm class is not available for all HMI devices.

### Requirements

- An alarm view or alarm window is configured in the "Screens" editor
- A connection to the PLC is set up.

## Configuring the display of S7 diagnostic alarms

To configure the display of S7 diagnostic alarms, follow these steps:

1. Select "Runtime settings > Alarms > System events > S7 diagnostics alarms" in the project navigation.
2. To display the S7 diagnostics alarms with text, activate "With text".
3. Open the screen with the alarm view and select the alarm view.
4. In the Inspector window, select "Properties > Properties > General > Display > Alarm class "Diagnosis Events".

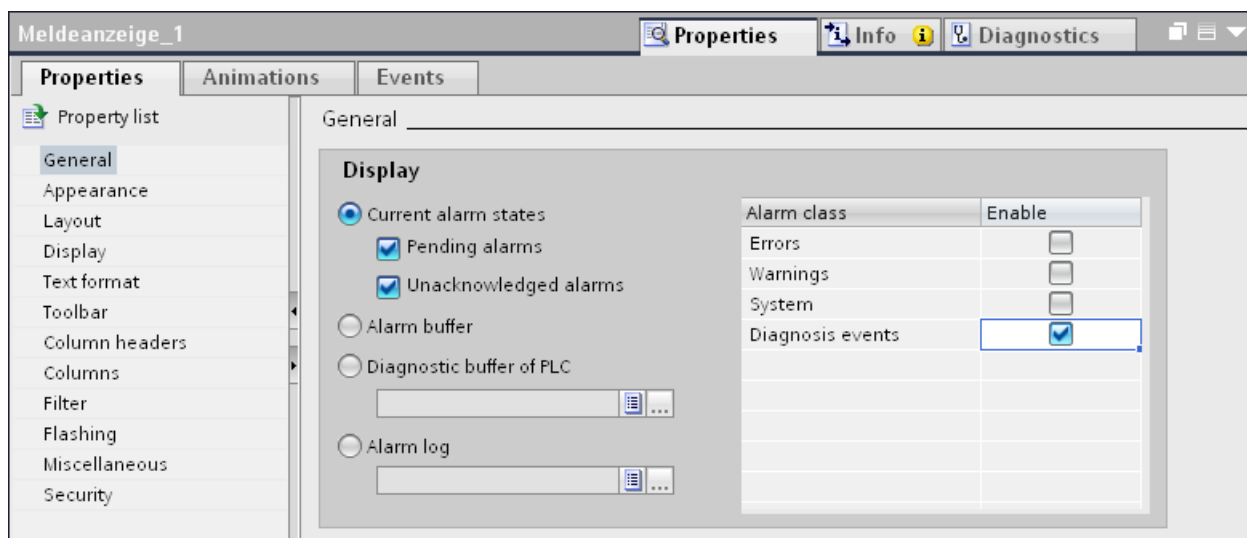

5. Continue to configure the alarm view as for the display of current alarms.

## Result

In Runtime the alarm view displays the S7 diagnostic alarms of the controller.

## Configuring an alarm view for logged alarms

### Introduction

In Runtime, logged alarms are displayed in an alarm view or alarm window.

### Requirements

- An alarm view or alarm window is configured in the "Screens" editor
- An alarm log was created in the "Log" editor.
- The alarms are assigned the "loggable" attribute in the "HMI alarms" editor.

## Configuring an alarm view for logged alarms

To configure an alarm view for logged alarms, proceed as follows:

1. Open the screen with the alarm view and select the alarm view.
2. In the Inspector window, select "Properties > Properties > General > Alarm log".
3. Click the "... " button and select the alarm log.
4. Continue to configure the alarm view as for the display of current alarms.

## Result

In Runtime, the logged alarms are output in the alarm view.

## Configuring an alarm window

### Introduction

The alarm window displays current alarms. The alarm window is configured in the "Global screen" editor. The alarm window is not assigned to any screen. Depending on the configuration the alarm window is opened when an alarm that belongs to a specific alarm class is active. Depending on the configuration, it is not closed until the alarm is acknowledged. The HMI device can still be used, even if alarms are pending and displayed. An alarm window is displayed and configured like an alarm view.

To hide an alarm window during configuration, create it on its own level.

## Requirement

- The "Global Screen" editor is open.
- The "Tools" task card is displayed.
- The Inspector window is open.

## Procedure

Proceed as follows to configure an alarm window:

1. Insert an "Alarm window" object from the "Tools" task card into the global screen.
2. Configure the alarm window like an alarm view.
3. Under "Properties > Properties > Mode > Window" in the Inspector window, select how the alarm window reacts and is operated in Runtime.
  - Activate "Modal" if the alarm window is to retain the focus in Runtime after a screen change.  
This option is important, as switching back and forth between the screen and different windows with <Ctrl+TAB> is not supported.

## Result

During runtime, the alarms of the selected alarm class are displayed in the alarm window.

## See also

Configuring an alarm view for active alarms (Page 3286)

Creating alarm classes (Page 3263)

Alarm window (Page 3117)

## Configuring an alarm indicator

### Introduction

The alarm indicator uses a warning triangle to indicate that alarms are pending or require acknowledgement. If an alarm of the configured alarm class occurs, the alarm indicator is displayed.

The alarm indicator has two states:

- Flashing: At least one alarm that requires acknowledgment is pending.
- Static: At least one of the acknowledged alarms has not gone out yet.

During configuration, specify whether Runtime has to open an alarm window when you operate the alarm indicator.

## Requirement

- The "Global Screen" editor is open.
- The "Tools" task card is open.
- The Inspector window is open.

## Procedure

Proceed as follows to configure the alarm indicator:

1. Insert the "Alarm indicator" object from the "Tools" task card into the work area.
2. Select the alarm indicator.
3. Under "Properties > Properties > General" in the Inspector window, select the alarm classes to be displayed by the alarm indicator.  
Specify whether to display pending and/or acknowledged alarms in the alarm indicator.

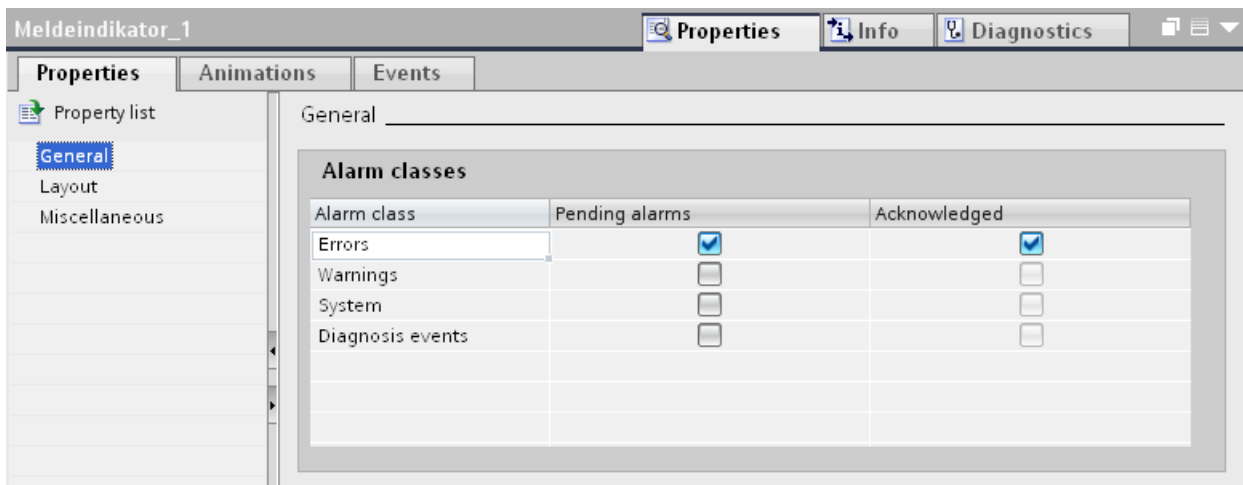

4. Under "Properties > Event", assign system function "ShowAlarmWindow" to an event of the alarm indicator.

### Note

If you have configured a permanent window in the screen or template, do not position the alarm window and alarm indicator in the vicinity of the permanent window. Otherwise the alarm window and the alarm indicator are not displayed in Runtime. However, the permanent window is not visible in the "Global screen" editor.

## Result

The alarm indicator is displayed if alarms from the selected alarm class are pending or need to be acknowledged in Runtime. The alarm window opens when the user operates the alarm indicator.

## See also

Alarm indicator (Page 3120)

## Configuring alarm filtering

### Introduction

You can filter the display of alarms in the enhanced alarm view. The criterion is always a character string. There are two ways to filter the alarm view:

- A fixed criterion is configured in WinCC.  
In Runtime, all alarms that contain the complete character string in the alarm text are displayed.
- You filter the alarm view in Runtime.  
In Runtime, a filter tag sets the relevant character string in the alarm view by means of an I/O field, e.g. as described below.  
The filter affects the display in the alarm view. All alarms in the alarm buffer are retained.

### Requirements

- An enhanced alarm view has been configured.
- The screen with the alarm view is open.
- The Inspector window is open.

### Configuring filters for a fixed character string

1. Select the alarm view.
2. In the Inspector window, select "Properties > Properties > Filter".
3. Enter a filter string in "Filter string".

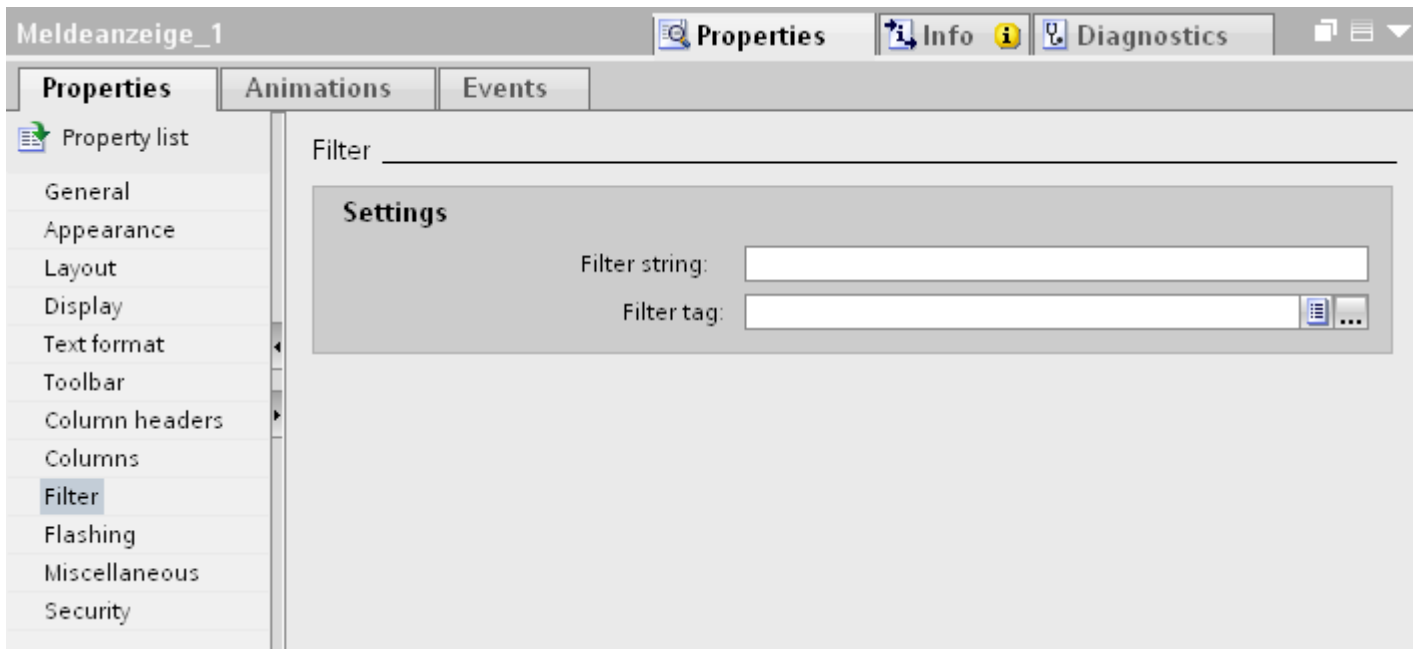

### Result

Only those alarms are displayed in Runtime that contain the complete character string from the filter in the alarm text.

### Configuring filters for a variable character string

1. Select the enhanced alarm view.
2. In the Inspector window, select "Properties > Properties > Filter".

3. Select a tag from "Filter tag". The tag must be of the "String" type.
4. In the screen, configure an I/O field for entering the filter string in Runtime.
  - In the Inspector window, select "Properties > Properties > General > Format > Display format > String".
  - To link the I/O field to the alarm view, select "Process" to set the filter tag you selected for the alarm view.

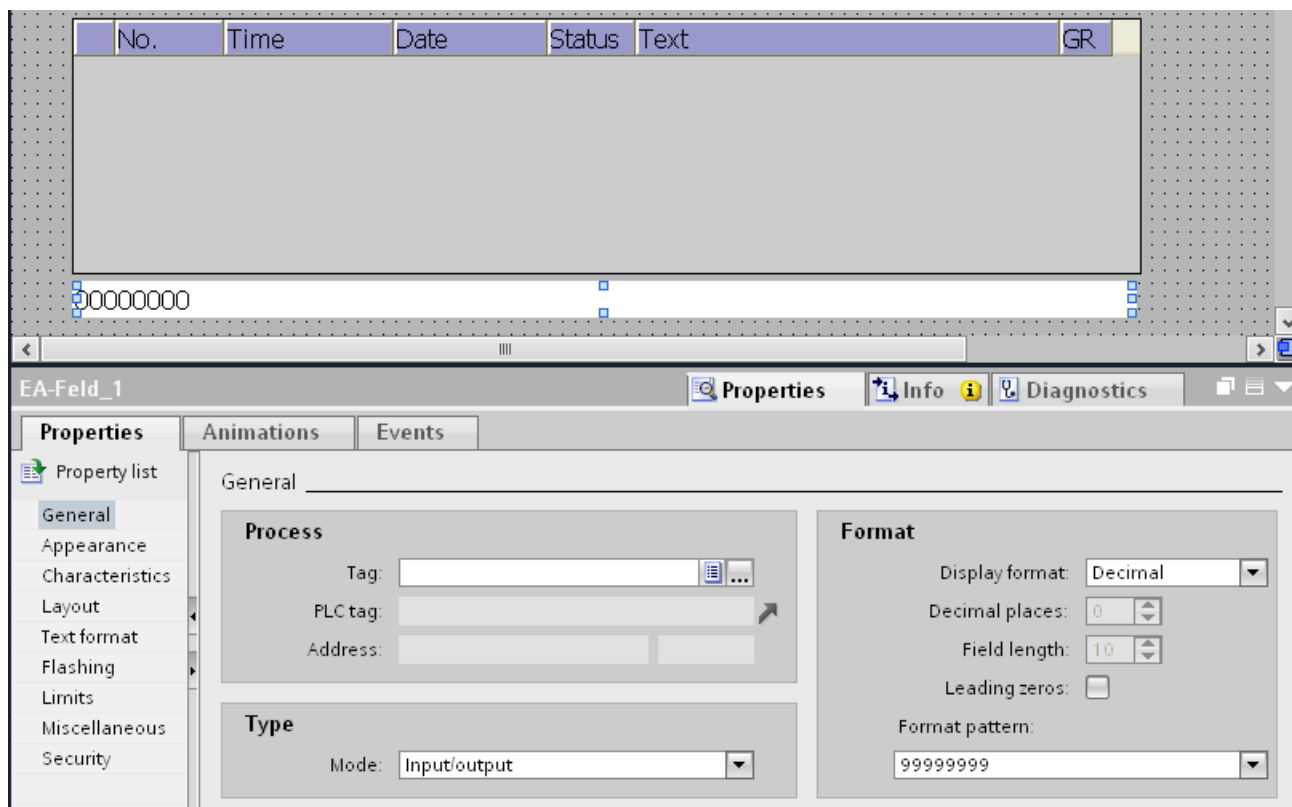

## Result

If you enter a string in the I/O field in Runtime, the alarm view only displays alarms that contain the complete string in their alarm text.

If a permanently configured character string and a filter tag were configured, the alarms will be filtered in Runtime according to the content of the filter tag. If the filter tag is blank, the permanently configured character string is used as the filter.

### Note

Filtering is not possible for the following alarm views:

- Simple alarm view
- Alarm line
- Alarm window
- Alarm view for logged alarms



## Displaying Logged Alarms

### Introduction

You display logged alarms in Runtime in an alarm view. The alarm view shows the content of an alarm log.

### Application

For example, you want to view information about the process at the end of a shift.

### Requirements

- An alarm log has been created.
- A screen is open.
- The Inspector window is open.

### Procedure

Proceed as follows to configure an alarm view to output an alarm log:

1. Configure an alarm view in a screen.
2. Under "Properties > Properties > General > Display > Alarm log" in the Inspector window, select the required alarm log.  
You can always create a new alarm log.

### Result

During runtime, the alarms logged in the selected alarm log appear in the Alarm view.

---

#### Note

In runtime, the alarm texts logged are not displayed but rather the alarm texts in the current project. The logged alarm texts are only intended for external evaluation of the log file.

If the alarm log displayed was configured differently, the alarm texts displayed may not correspond with those logged.

---

## Reporting Alarms

### Overview

WinCC can report on all alarms that occur in the system. The following options are available:

- Output an alarm sequence report  
In Runtime, the standard printer of the HMI device will continuously print each alarm and any changes in its status.
- Output of an alarm report  
You configure an alarm report in the "Reports" editor and specify when it is output in Runtime:
  - For event-driven output, configure an object that is assigned the "PrintReport" system function. The object can be a button or tag.
  - For time-driven output, create a "Print job" in the scheduler. Assign an alarm report to the job.

---

#### Note

In the alarm report, specify whether to output current or logged alarms.

---

## Requirements

- A printer was configured on the HMI device.

## Activating continuous alarm reporting

To activate continuous reporting of alarms, follow these steps:

1. Double-click "Runtime settings" in the project navigation.
2. Select "Alarms > General > Report".

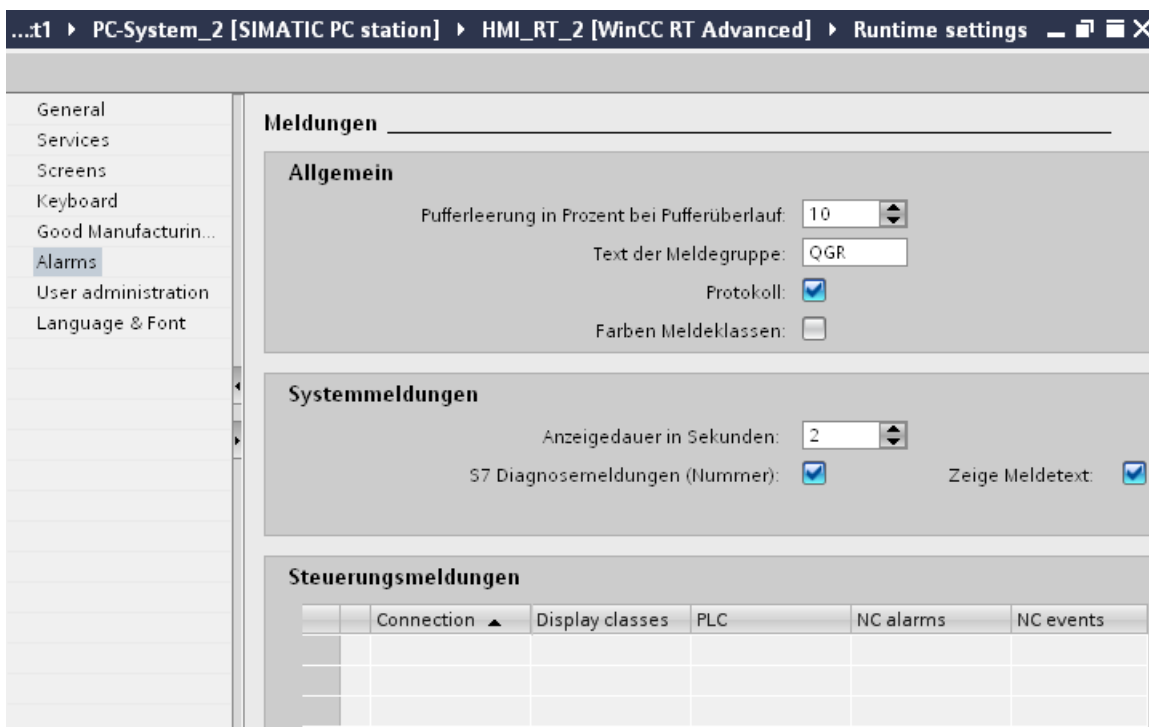

## Result

The latest alarms are output at the printer of the HMI device.

### Excluding an alarm from reporting

To exclude specific alarms from reporting, proceed as follows:

1. Open the "HMI alarms" editor.
2. Select the alarm to exclude from reporting on the tab of the selected alarm type.
3. In the Inspector window, disable "Properties > Properties > Miscellaneous > Report".

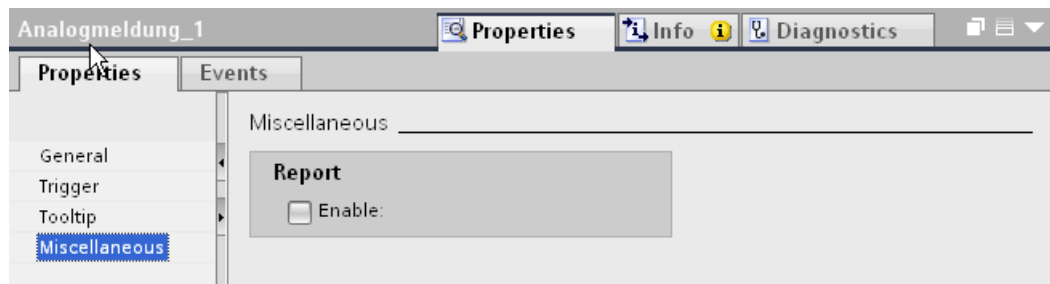

### Result

WinCC does not output these alarms currently on the connected printer.

### See also

Working with reports (Page 3463)

#### 10.3.2.4 Acknowledging alarms

### Configuring alarm acknowledgment by means of alarm class

#### Introduction

To configure an alarm with alarm acknowledgment, assign it to an alarm class with the "Alarm with single acknowledgment" acknowledgment model.

#### Requirement

- The "HMI alarms" editor is open.
- The required alarm class has been created.
- The required alarm has been created.

### Selecting the acknowledgment model for an alarm class

The acknowledgment model for a predefined alarm class has already been set. You can only set the acknowledgment model for user-defined alarm classes. Proceed as follows:

1. In the "HMI alarms" editor, click the "Alarm class" tab and select the alarm class.
2. Select the required acknowledgment model under "Properties > Properties > Acknowledgment" in the Inspector window.

### Assign alarms to an alarm class requiring acknowledgment

Proceed as follows to assign an alarm to an alarm class requiring acknowledgment.

1. In the "HMI alarms" editor, click the tab for the alarm type and select the alarm.
2. Under "Properties > Properties > General" in the Inspector window, select the alarm class of the alarm.

### Result

The alarm will not disappear in Runtime until it is acknowledged by the operator.

### Configuring trigger for alarm acknowledgment

#### Introduction

You always specify the acknowledgment requirement for an alarm using the alarm class. Then the operator acknowledges the alarm using the "ACK" function key of the HMI device or the "Acknowledgment" button of the alarm view.

The following options are also available to trigger acknowledgment:

- Configuring a button to acknowledge an alarm
- Acknowledgment of a Discrete Alarm by the PLC

#### Requirement

- The "HMI alarms" editor is open.
- The required alarm class has been created.
- The required alarm has been created.
- An alarm view and a button are created in the "Screens" editor.

### Configuring a button to acknowledge an alarm

To configure a button for acknowledging an alarm, proceed as follows:

1. Select the button in the "Screens" editor.
2. Under "Properties > Events" in the Inspector window, assign the "AlarmViewAcknowledgeAlarm" system function to the "Click" event.
3. Select the alarm view as parameter.

### Acknowledgment of a Discrete Alarm by the PLC

1. In the "HMI alarms" editor, click the "Discrete alarm" tab and select the discrete alarm.
2. In the Inspector window, select the tag and the bit that acknowledges the PLC alarm under "Properties > Properties > Acknowledgment > PLC".

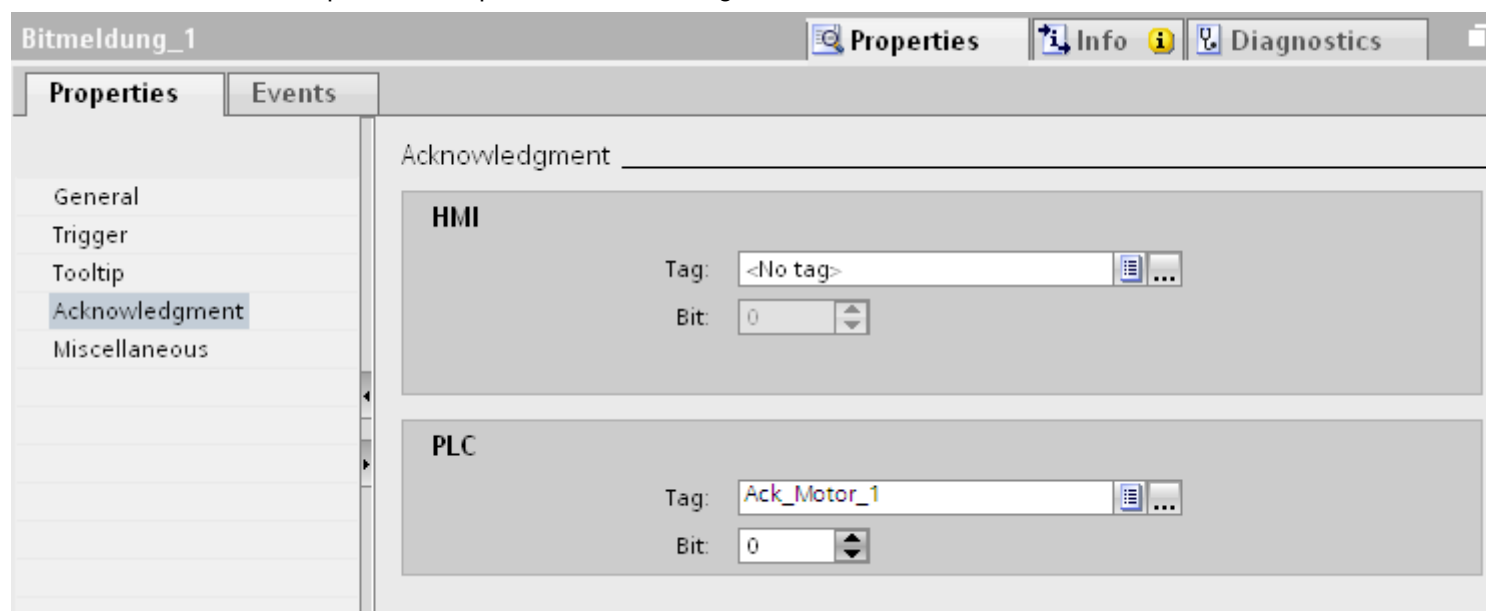

### Sending alarm acknowledgments to the PLC

#### Requirement

- The "HMI alarms" editor is open.
- The required alarm has been created and assigned to an alarm class requiring acknowledgment.

---

#### Note

You cannot send the acknowledgment of analog alarms to the PLC.

---

## Sending alarm acknowledgments to the PLC

To configure that acknowledgment of an alarm is sent to the PLC, follow these steps:

1. In the "HMI alarms" editor, click the "Discrete alarm" tab and select the discrete alarm.
2. In the Inspector window, select "Properties > Properties > Acknowledgment".
3. Under "HMI", select the tag and the bit set by the alarm acknowledgment function.

---

### Note

The HMI device and PLC only have read access to the acknowledgment tag memory area.

---

## Result

If the operator acknowledges the alarm in Runtime, the operating step is forwarded to the PLC.

### 10.3.2.5 Configuring alarm buffer overflow

#### Introduction

The size of the alarm buffer depends on the type of HMI device. In WinCC, specify the percentage of the alarm buffer to be deleted on alarm buffer overflow.

#### Requirements

- You have created a project.

#### Procedure

To configure the response to an alarm buffer overflow, follow these steps:

1. Double-click "Runtime settings" in the project navigation under your HMI device.
2. Under "Alarms > General > Buffer clearance in percent upon buffer overflow", enter a value between 1 and 100.  
This value specifies the percentage of the alarm buffer that is deleted on alarm buffer overflow.

## Result

If data in the alarm buffer exceeds the resources of alarm buffer memory, the configured percentage of data will be deleted from the oldest alarms in the alarm buffer.

---

### Note

You cannot check the alarm buffer overflow separately by alarm method. You can use the "ClearAlarmBuffer" system function to delete specific alarms of specific alarm classes from the alarm buffer.

---

## See also

Alarm Logging Basics (Page 3304)

### 10.3.3 Logging Alarms

#### 10.3.3.1 Alarm Logging Basics

##### Introduction

An alarm log is used to record project alarms.

---

##### Note

Alarm logging is not available for every HMI device.

---

##### Configuration steps

To log an alarm, follow these configuration steps:

1. Creating an alarm log  
You define the following properties for the alarm log:
  - Logging method  
Behavior of the log when reaching a specific fill level
  - Storage location and file format
  - Log size
  - Runtime start characteristics
  - Checksum
2. Assigning an alarm log to an alarm class  
You can log the alarms from multiple alarm classes in an alarm log.
3. Assigning an alarm to a loggable alarm class
4. Configure display of logged alarms in an alarm view

##### Content of the alarm log

All states are logged for configured alarms. The following three entries, for example, are stored in the log for an alarm that requires acknowledgment:

- 04.08.2007 10:00:25:520, analog alarm, ID5, **K**, error, fill level exceeded by 10 %
- 04.08.2007 10:01:20:442, analog alarm, ID5, **Q**, error, fill level exceeded by 10 %
- 04.08.2007 10:01:30:112, analog alarm, ID5, **G**, error, fill level exceeded by 10 %

In the example, the alarm states are identified by the following letters:



**K** = Incoming

**Q** = Acknowledged

**G** = Outgoing

All data belonging to an alarm is stored in the alarm log, including configuration data such as the alarm class, time stamp, and alarm text.

The potential number of logged alarms depends on the data medium used.

---

**Note**

Alarm text and error location are only logged if you have configured such a setting in the log properties.

---

**Note**

The time stamp of a logged alarm is always specified in standard UTC format (Universal Time Coordinated).

---

## Logging methods

The logging method determines how the alarm log responds when the configured size is reached. WinCC supports the following logging methods:

- **Circular log**  
When the configured log size has been reached, the oldest entries are deleted. When the configured log size has been reached, approximately 20% of the oldest entries are deleted. It is therefore not possible to display all the configured entries. During configuration, select an appropriate size for the circulation log. Alternatively, configure a segmented circular log.
- **Segmented circular log**  
In a segmented circular log, multiple single logs of the same size are filled in succession. When all logs are completely full, the oldest log is overwritten.
- **Log with level-dependent system alarm**  
When a defined level is reached, such as 90 %, a system alarm is triggered. When the configured size of the log has been reached, new alarm events are not logged.
- **Log with level-dependent execution of system functions**  
When the log is completely full, the "Overflow" event is triggered. You configure a function list for the event.  
When the configured size of the log has been reached, new alarm events are not logged.

## Checksums in regulated projects

With WinCC you configure regulated projects as required by FDA guidelines, if necessary. Use the "Audit" option to create regulated projects.

In regulated projects you supply a checksum for the logged data of an alarm log. The operator will use this checksum during operation of the plant to see if the data of an alarm log have been changed.

### 10.3 Working with alarms

For the checksum to be clear, it starts with the first line of an alarm log and integrates the previous lines when continuously generating the checksum. This means a checksum can only be generated for the following logs:

- Log that sends a system alarm when it is full
- Log with execution of system functions when log is full.

Generation of a checksum is also available for alarm logs that are saved as files of the "\*.csv" or "\*.txt" (Unicode) format.

If you want to continue an existing log without checksum as one with checksum, a backup copy of the existing log is created in the "\*.keep" file format. A new log with checksums is created.

To maintain the validity of checksums, the following limitations apply when using the system function "CopyLog":

- You cannot copy a log without checksums into a log with checksums.
- You cannot copy a log with checksums into a log without checksums.

#### Storage location and storage medium

You can save the log data to a file on a data carrier, e.g. MMC, SD, or CF cards. If you are using a PC as your HMI device, you may store your information in a database. You can further process the saved data in other programs for analysis purposes, for example.

#### Displaying logged data

On the HMI device, the logged data is displayed in an alarm view that is configured for this purpose.

#### See also

Configuring alarm buffer overflow (Page 3303)

#### 10.3.3.2 Storage locations for log files

##### Introduction

The alarm log is stored in an ODBC database or in a file. Select "Database" or "File" as the storage location.

---

##### Note

An "ODBC database" storage location is only available on a PC.

---

## Log file

Depending on the configuration of the HMI device, select one of the following storage locations for the log file:

- Local hard disk of the PC
- Storage card of the Panel
- Network drive

---

### Note

#### Logging on network drives

Do not log alarms, tags and Audit Trail directly on a network drive. Power supply can be interrupted at any time. This means there is no guarantee for a reliable operation of logs and audit trails.

Save the logs on your local hard drive or a local storage card. Use the system function "ArchiveLogFile" to save the logs long-term on a network drive. This step ensures reliable operation.

---

## File - CSV (ASCII)

Data is saved to a "\*.csv" file in standard ASCII format.

Use the "File - CSV (ASCII)" storage location if you are going to read logged data without using WinCC Runtime.

---

### Note

Double quotation marks or several characters are not permitted as list separator for the storage site "File - CSV (ASCII)." You can find the settings for list separators under "Start > Settings > Control Panel > Regional and Language Options."

---

## File - TXT (Unicode)

The log data are saved in Unicode.

This file format supports all characters that can be used in WinCC and WinCC Runtime. For editing, use software that can save files in Unicode, such as Notepad.

---

### Note

Use "File - TXT (Unicode)" as the storage location to log Asian languages.

---

## File - RDB

Data will be saved with quick access to a proprietary database.

Use the "File - RDB" storage location if you require maximum read performance in Runtime.

Data logs of this format can only be read and displayed using WinCC Runtime.

Convert the RDB file to CSV format using the "CopyLog" function to make the data available for applications outside WinCC Runtime.

### Files of logs with checksums

- \*.keep  
This file is created in the following cases:
  - A log is started without checksum and will be continued with a checksum.
  - You update WinCC with a Service Pack or a new version. Writing of the Audit Trail or the log with checksum is continued.The content of the "\*.keep" file remains the same when compared with the original "\*.csv" or \*.txt" file.
- \*.bak  
This file is created when WinCC Runtime has determined a serious, irregular problem in the file.

### Database

Data is saved to a database which is set up for ODBC access by the PC administrator.

If you have selected an ODBC database as storage location, select one of the following options for naming:

- "User-defined name of data source"  
You define the name of the data source.
- "System-defined name of data source",  
The system defines the name.  
You will need a special instance of Microsoft SQL Server on the target system in order to do this. Download the free SQL Server 2005 Express from the Internet for this purpose.

---

#### Note

##### Device dependency

This setting is not available on the Panel PC 477.

---

### 10.3.3.3 Creating an alarm log

#### Introduction

In Runtime, you save alarms to the alarm logs. Specify the alarm log in the alarm class. An alarm log contains the alarms of several alarm classes. Create the alarm log in the "Logs" editor. When creating an alarm log, define the following parameters:

- Name
- Size
- Storage location

- Runtime start characteristics
- Log type
- Advanced content
- Checksum

You can also enter comments for each log.

## Requirement

- The "Alarm log" tab is open in the "Log" editor.
- The Inspector window is open.

## Procedure

To create an alarm log, proceed as follows:

1. Double-click "<Add>" in the table.  
A new alarm log is created.
2. Under "Properties > Properties > General" in the Inspector window, enter a unique name for the alarm log.

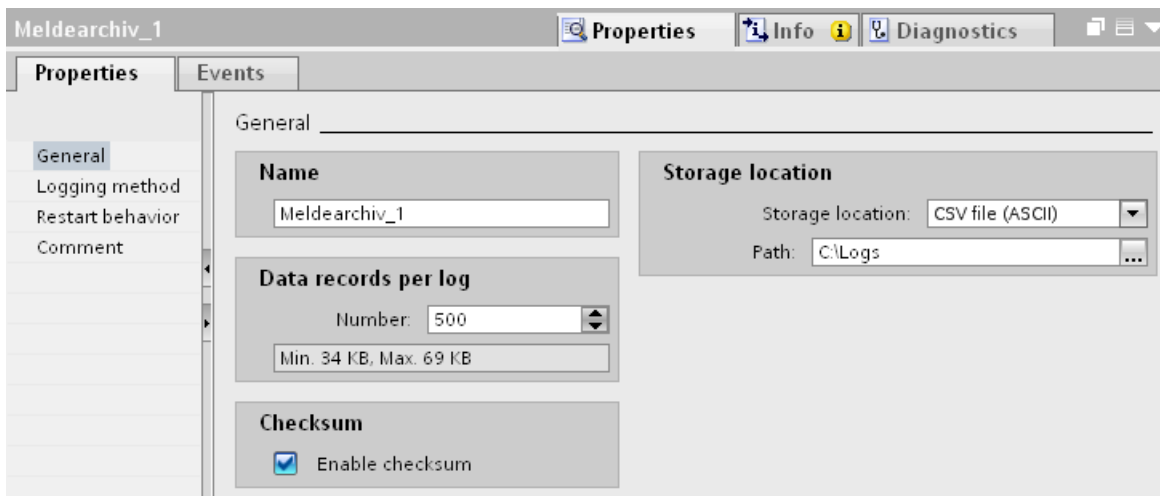

---

## Note

The log names must be unambiguous in a project. The name of a log must always be unique, regardless of whether different storage locations are selected for the log.

---

**Note**

The characters which can be used in the name of the data source depend on the storage location.

The characters \ / \* ? : " < > | are not permitted for the following storage locations:

- File - RDB
- File - CSV (ASCII)
- File - TXT (Unicode)

If the "Database" storage location is used, the following characters may be used: a-z A-Z 0-9 \_ @ # \$

The characters \_ @ # \$ cannot be used as the first character of a name.

---

1. Under "Number of data records per log", define the number of alarms to be saved to a log file.  
The approximate space required on the storage medium is displayed. Memory space requirements will increase accordingly if you log alarm texts with tag values.
2. Under "Storage location", select a file, or an ODBC database.
  - If you select a file, enter the corresponding path. Depending on the HMI device, save the log files to the hard disk of the PC, to the memory card of a panel, or to a network drive.  
Different file formats are supported, depending on the HMI device.
  - If you select a "Database" storage location, specify the following:  
Specify whether the name of the data source is accepted by the system.  
Specify whether to select the name of the data source yourself.  
Enter a name for the database.

1. To determine if audit trail data were changed at a later time, activate "Properties > Properties > General > Checksum".

---

#### Note

#### Device dependency

The "Checksum" option is only available for display and HMI devices which support logs.

---

### Configuring the behavior of the log when it reaches a specific fill level

1. Define how the log should behave when it is full under "Properties > Properties > Logging method".
  - Specify the number of logs for the "Segmented circular log" log type.
  - For the "Display system event on" log type, specify the fill level triggering the system event.

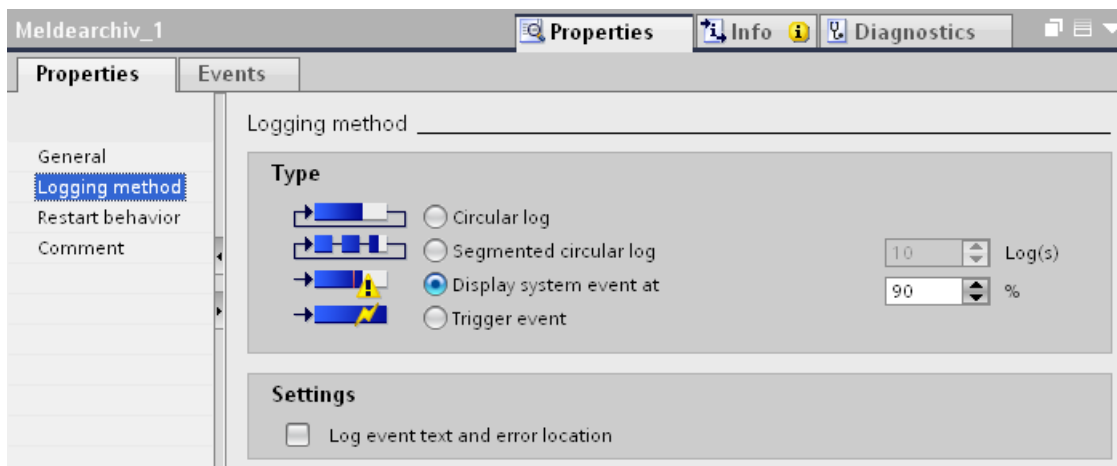

- If you selected the "Trigger event" log version, configure a function list under "Properties > Events > Overflow". The function list will be processed when the log is full.
2. Under "Properties > Properties > Archiving method > Settings", specify whether to log the alarm text and fault location.  
 Logged alarms that contain alarm text and the fault location exceed the estimated size of the configured alarms. Check to see whether the specified storage location still has sufficient space.

### Configuring the behavior of the log when Runtime starts

1. Select "Properties > Properties > Start behavior> Type".
  - Define whether to start the log automatically at the start of Runtime.
  - To overwrite logged data with new data, activate "Reset log".
  - To add the logged data to an existing log, activate "Continue log".

---

**Note**

Use system functions to control the restart of a log in Runtime.

---

### Configuring a comment

To record a text to document your configuration of a log, follow these steps:

1. Enter your text under "Properties > Properties > Comment".

### Result

The alarm log is created. You can assign one or several alarm classes to this alarm log.

### See also

Managing logging behavior when Runtime starts (Page 3319)

Controlling the Logging in relation to the Fill Level (Page 3320)

## 10.3.3.4 Logging Alarms

### Overview

To log alarms, follow these steps:

- Create an alarm log.
- Assign the created alarm log to an alarm class.
- Assign the alarm class with the created alarm log to an alarm.



- In the Runtime settings specify the language in which you want to write the logs.
- You evaluate logged alarms.  
You can analyze the logged alarms directly in your WinCC project, such as in an alarm view, or in another user program, such as Microsoft Excel.

---

**Note****Tag fields in the alarm text**

The sequence of tag fields in the alarm text is language dependent. The sequence of the Runtime language is used for logging alarms to a "\*.csv" log file.

Changing the tag of an output field in one language causes the modified output field to appear at the end of the alarm text in all other languages. This means the sequence of the output fields in the log file can change.

---

**Requirements**

- You have created an alarm log.
- The "HMI alarms" editor is open.

**Assigning an alarm log to an alarm class**

To assign the alarm log to an alarm class, proceed as follows:

1. Open the "Alarm classes" tab in the "HMI alarms" editor.
2. Select the required alarm class.
3. Under "Properties > Properties > General > Log" in the Inspector window, select the alarm log.

**Assign alarm to an alarm class**

To assign an alarm to the alarm class, proceed as follows:

1. In the "HMI alarms" editor, open the "Analog alarms" tab, or the "Discrete alarms" tab.
2. Select the required alarm.
3. Under "Properties > Properties > General > Alarm class" in the Inspection window, select the alarm class for which the alarm log was configured.

**Result**

The alarm is saved to the configured alarm log.

**10.3.3.5 Configuring an alarm view for logged alarms****Introduction**

In Runtime, logged alarms are displayed in an alarm view or alarm window.

## Requirements

- An alarm view or alarm window is configured in the "Screens" editor
- An alarm log was created in the "Log" editor.
- The alarms are assigned the "loggable" attribute in the "HMI alarms" editor.

## Configuring an alarm view for logged alarms

To configure an alarm view for logged alarms, proceed as follows:

1. Open the screen with the alarm view and select the alarm view.
2. In the Inspector window, select "Properties > Properties > General > Alarm log".
3. Click the "..." button and select the alarm log.
4. Continue to configure the alarm view as for the display of current alarms.

## Result

In Runtime, the logged alarms are output in the alarm view.

### 10.3.3.6 Direct access to the ODBC log database

#### Overview

The storage location of a log can be a database or a file.

The database is addressed by means of its "Data source name" (DSN). Select the database to be used in WinCC as follows:

Select the database from the Windows Start menu under "Settings > Control panel > ODBC Data Sources".

In your configuration, specify the "Data source name" (DSN) instead of a directory name as storage path for log data. With the DSN, you are referencing the database and the storage location.

The entire functional scope of the database is available for additional processing and evaluation of log data.

#### Application

The data source sets up the connection to the database. Create the data source on the same PC on which the Runtime software is stored. Then enter the DSN configured on this PC when you create a log in WinCC.

The ODBC interface allows you to use other programs, such as MS Access or MS SQL Server, to access the database directly.

In addition, you can use the "StartProgram" system function to configure program calls, e.g. MS Access, on the HMI device. Runtime is not interrupted while you configure such calls.

### 10.3.3.7 Setting up the ODBC data source

#### Introduction

To store process values or alarms in the log database in Runtime, set up the ODBC data source.

#### Requirement

- A log database has been created.  
You create the log database using the SQL Enterprise Manager. You can find more detailed information on how to do this from Microsoft.

#### Procedure

To set up an ODBC data source, follow these steps:

1. In Control Panel, open "Administrative Tools" and select "Data Sources (ODBC)".  
The "ODBC Data Source Administrator" dialog is opened.
2. Click "User DSN > Add".
3. Select the "SQL-Server" and click on "Finish".
4. In the dialog that follows, enter a name for the User DSN and the SQL-Server and click on "Next".
5. In the dialog that follows, define the logon procedure for the SQL database and click on "Next".
6. Activate "Change the default database to".
7. Select the database you have created and click on "Next".
8. In the dialog that follows, click "Finish".

### 10.3.3.8 Configuring a checksum for a log

#### Introduction

In a regulated project, you have the option of assigning a checksum to the log data of an data log or alarm log. This checksum can be used during plant operation to determine if the data of this log has subsequently changed.

#### Requirement

- GMP compliant configuration is enabled.
- A data log or alarm log has been created.

**Procedure**

Proceed as follows to configure a data log or alarm log for the use of a checksum:

1. Open the data log or alarm log in the corresponding log editor.
2. In the "Storage location" box, select "File - CSV (ASCII)" or "File - TXT (Unicode)".

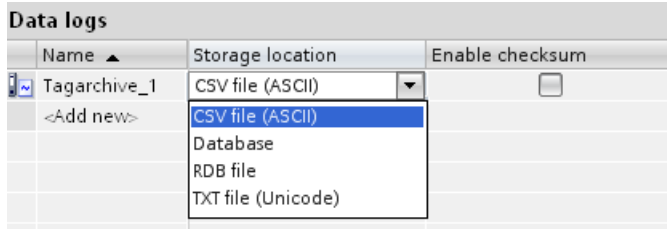

3. Under "Properties > Properties > Logging method" in the Inspector window , select the option "Display system event at" or "Trigger event".

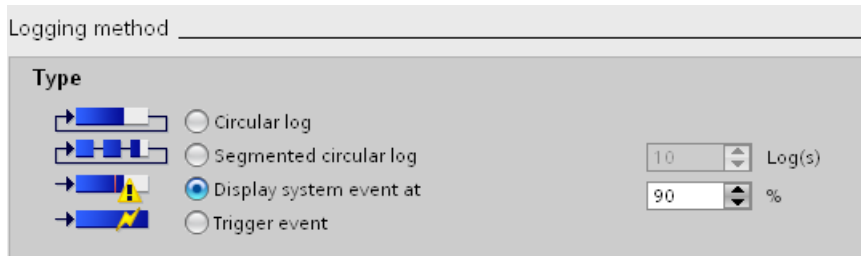

4. In the editor table activate the option "Activate checksum".  
Columns that are not displayed are activated with the shortcut menu of the column title.

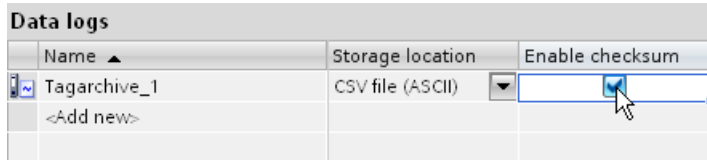

5. Save the project.

**Result**

The log data of the log is assigned a checksum in runtime.

**See also**

- GMP-compliant configuration (Page 5757)
- Enabling GMP compliant configuration (Page 5761)

### 10.3.3.9 Evaluating the checksum of log data

#### Introduction

If you have configured a data log or alarm log with generation of a checksum, you can check if the log data has subsequently changed.

The DOS program "HmiCheckLogIntegrity" is available for checking the integrity of the log data.

The "HmiCheckLogIntegrity" program supports verification of the following files:

- Log files of alarm logs, data logs, and Audit in CSV format
- Log files of alarm logs, data logs, and Audit in TXT format
- Recipe data records in CSV format
- Recipe data records in TXT format

You can find the "HmiCheckLogIntegrity.exe" program in the installation directory of WinCC under the folder "WinCC Runtime Advanced", for example <C:\Program Files\Siemens\Automation WinCC Runtime Advanced>.

---

#### Note

##### Audit Trail and Log with Checksum

Before you update WinCC with a Service Pack or a new version, exit and save the Audit Trail or the logs using checksum. After WinCC is updated, the audit trail or logs will be continued with new files using checksum.

Make sure that the logs are started at a defined state with the new version.

---

#### Procedure

1. Copy the file to be checked from the HMI device to your configuration computer.
2. Open a command line prompt with "Start > Programs > Accessories > Command Prompt".
3. Enter the path to "HmiCheckLogIntegrity.exe" followed by a space in the command line prompt. After the space, enter the storage location of the file to be checked within quotation marks.

4. Press <Enter>.
5. The check is performed.  
When the checked data are consistent, the "Consistency check succeeded" message appears.

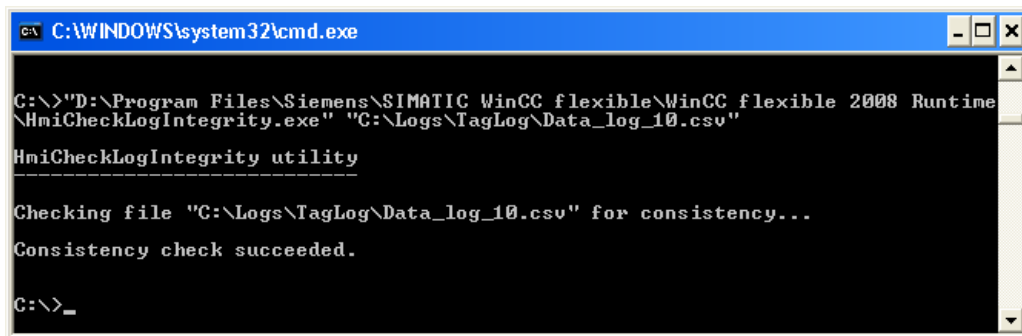

```
C:\WINDOWS\system32\cmd.exe

C:\>"D:\Program Files\Siemens\SIMATIC WinCC flexible\WinCC flexible 2008 Runtime
\HmiCheckLogIntegrity.exe" "C:\Logs\TagLog\Data_log_10.csv"

HmiCheckLogIntegrity utility
-----

Checking file "C:\Logs\TagLog\Data_log_10.csv" for consistency...

Consistency check succeeded.

C:\>_
```

When the checked data are inconsistent, the "Consistency check failed" message appears. Information about the first inconsistent line in the file is also displayed.

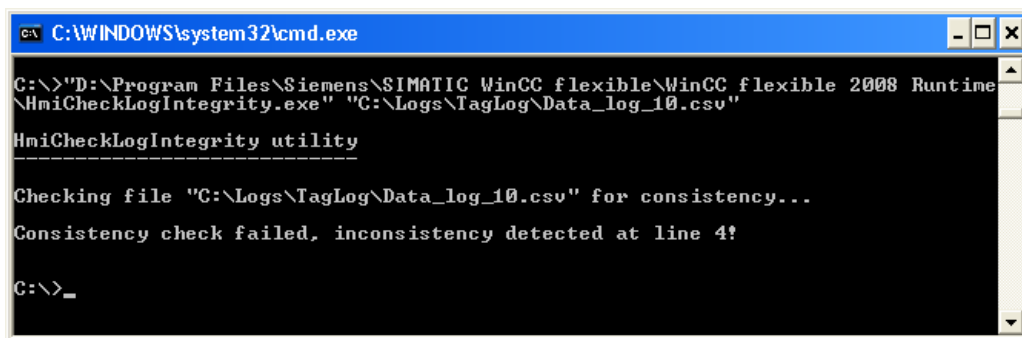

```
C:\WINDOWS\system32\cmd.exe

C:\>"D:\Program Files\Siemens\SIMATIC WinCC flexible\WinCC flexible 2008 Runtime
\HmiCheckLogIntegrity.exe" "C:\Logs\TagLog\Data_log_10.csv"

HmiCheckLogIntegrity utility
-----

Checking file "C:\Logs\TagLog\Data_log_10.csv" for consistency...

Consistency check failed, inconsistency detected at line 4!

C:\>_
```

---

**Note**

If there are spaces in the path to the "HmiCheckLogIntegrity.exe" program, you need to specify the path in quotation marks.

---

You can also check the integrity of the log data with the AuditViewer.

**See also**

- Enabling GMP compliant configuration (Page 5761)
- Evaluating Audit Trails in AuditViewer (Page 5779)

### 10.3.3.10 Log response to language switching in runtime

#### Introduction

In the Runtime settings of your HMI device, select the language to be used for writing to logs in runtime.

## Requirement

- The languages used in your project are activated in the "Project languages" editor, for example, "German (Germany)" and "English (USA)".

## Procedure

To determine the startup language, follow these steps:

1. Select "Runtime settings > Language and fonts" in the project navigation.
2. Activate the runtime language, for example, "German (Germany)" and "English (USA)".
3. Set the "Language switch order". Use 0 to determine the startup language, for example:
  - German 0.
  - English 1With "0", German is specified as the "Startup language".
4. Select "Runtime settings > General" in the project navigation.
5. Select the "Logs > Logging language > Startup language".

## Result

The project starts after it is transferred. German is specified as the "Startup language" with "Language switch order". The logs are now written in German. During runtime, the operator switches the runtime language to English. The logs will still to be written in German.

The operator closes runtime. Due to the previously performed language switch, the next time the system starts the "startup language" is English. Since English is the startup language, the logs are now written in English.

The logging language remains English even when the language is switched again in runtime until runtime is closed once again.

If you use another option instead of "Startup language" to select the language, the logs are always written in the same language. This is true regardless of the language selected by the operator in runtime.

### 10.3.3.11 Managing logging behavior when Runtime starts

#### Introduction

When you configure a data log, you define the restart characteristics of the log when Runtime is started. You define whether the logging should start when Runtime starts in the log properties. You can also define whether an existing log will be continued or overwritten.

You define the restart characteristics separately for each log.

## Requirement

- A data log has been created.
- The "Data log" editor is open.
- The Inspector window with the log properties is open.

## Procedure

To configure the restart characteristics of a data log, proceed as follows:

1. Select the log for which you want to define the restart characteristics in the "Data Log" editor.
2. In the Inspector window select "Properties > Properties > Restart behavior."
3. If you want logging to start when Runtime starts, enable the "Enable logging at runtime start" option in the "Logging" area.  
You can also start logging in Runtime using the "StartLogging" system function, for example.
4. Select the restart behavior of the log in the "Log handling at restart" area.
  - The logged values are deleted and logging is started again with the option "Reset log".
  - The option "Append data to existing log" is used to append the values to be logged to the existing log.

Alternatively you can configure the restart characteristics of a log directly in the "Data log" editor table. To view hidden columns, activate the column titles using the shortcut menu.

## Result

Logging will start in runtime according to your settings.



### 10.3.3.12 Controlling the Logging in relation to the Fill Level

#### Introduction



The size of a log is determined by the number of entries. You use the logging method to determine how the log responds when it is full.

#### Logging methods

The following logging methods are available:

-  Circular log  
When the configured log size has been reached, the oldest entries are deleted. When the configured log size has been reached, approx. 20% of the oldest entries are deleted. It is therefore not possible to display all the configured entries. During configuration, select an appropriate size for the circulation log. Alternatively, configure a segmented circular log.
-  Segmented circular log  
In a segmented circular log, multiple log segments of the same size are filled in succession. When all logs are completely full, the oldest log is overwritten.



-  Log that sends a system alarm when it is full  
 When a defined level is reached, such as 90 %, a system alarm is triggered. When the log is 100% full, new tag values are not logged.
-  Log with level-dependent triggering of an event.  
 When the log is completely full, the "Overflow" event is triggered. Configure a function list for the event that will be carried out when the "Overflow" event occurs. When the configured size of the log is reached, new tag values are not logged.  
 The following system functions are available for further processing of full logs: For further details, refer to Auto-Hotspot.

## Requirement

- A data log has been created.
- The "Data log" editor is open.
- The Inspector window with the log properties is open.

## Procedure

1. Select the log for which you want to define the logging method in the "Data Log" editor.
2. Select "Properties > Properties > Logging method" in the Inspector window and select the required logging method.
3. If you have selected the "Segmented circular log" type, enter the number of log segments. If you selected a log with the "Display system alarm on" setting, specify the level as a percentage at which a system alarm is to be triggered. If you selected the "Trigger event" setting, configure the function list in the "Events" group.

Alternatively you can configure the logging method directly in the "Data log" editor table. To view hidden columns, activate the column titles using the shortcut menu.

The "Overflow" event is not available in the editor table. You must therefore configure the function list in the Inspector window.

## Result

The selected log responds according to the settings in Runtime.

## 10.3.4 Using Alarms in Runtime

### 10.3.4.1 Alarms in Runtime

#### Alarms

Alarms indicate events and states on the HMI device which have occurred in the system, in the process or on the HMI device itself. A status is reported when it is received.

An alarm could trigger one of the following alarm events:

### 10.3 Working with alarms

- Incoming
- Outgoing
- Acknowledge
- Loop-in-alarm

The configuration engineer defines which alarms must be acknowledged by the user.

An alarm may contain the following information:

- Date
- Time
- Alarm text
- Location of fault
- Status
- Alarm class
- Alarm number
- Alarm group

#### Alarm classes

Alarms are assigned to various alarm classes.

- "Warnings"  
Alarms of this class usually indicate states of a plant such as "Motor switched on". Alarms in this class do not require acknowledgement.
- "Errors"  
Alarms in this class must always be acknowledged. Error alarms normally indicate critical errors within the plant such as "Motor temperature too high".
- "System"  
System alarms indicate states or events which occur on the HMI device. System alarms provide information on occurrences such as operator errors or communication faults.
- Custom alarm classes  
The properties of this alarm class must be defined in the configuration.

#### Alarm buffer

Alarm events are saved to an internal buffer. The size of this alarm buffer depends on the HMI device type.

#### Alarm view

The alarm view shows selected alarms or alarm events from the alarm buffer. Whether alarm events have to be acknowledged or not is specified in your configuration.

## Alarm window

The alarm window is not assigned to any screen. Depending on the configuration the alarm window is opened when an alarm that belongs to a specific alarm class is active.

You can configure the order in which the alarms are displayed. You can choose to display the alarms in ascending or descending order of their occurrence. The alarm window can also be set to indicate the exact location of the fault, including the date and time of the alarm event. By means of configuration, the display can be filtered in such a way that only alarms that contain a specific character string will be shown.

## Alarm indicator

The alarm indicator is a graphic symbol that is displayed on the screen when an alarm of the specified alarm class is activated.

The alarm indicator can have one of two states:

- Flashing: At least one unacknowledged alarm is pending.
- Static: The alarms are acknowledged but at least one of them is not yet deactivated. The number indicates the number of queued alarms.

### 10.3.4.2 Alarms in Runtime

## Alarms

Alarms indicate events and states on the HMI device which have occurred in the system, in the process or on the HMI device itself. A status is reported when it is received.

An alarm could trigger one of the following alarm events:

- Incoming
- Outgoing
- Acknowledge

The configuration engineer defines which alarms must be acknowledged by the user.

An alarm may contain the following information:

- Date
- Time
- Alarm text
- Location of fault
- Status
- Alarm class
- Alarm number
- Alarm group

## Alarm classes

Alarms are assigned to various alarm classes.

- "Warnings"  
Alarms of this class usually indicate states of a plant such as "Motor switched on". Alarms in this class do not require acknowledgement.
- "Errors"  
Alarms in this class must always be acknowledged. Error alarms normally indicate critical errors within the plant such as "Motor temperature too high".
- "System"  
System alarms indicate states or events which occur on the HMI device. System events provide information on occurrences such as operator errors or communication faults.
- "Diagnosis Events"  
SIMATIC diagnostic alarms show states and events in the SIMATIC S7 controller.
- STEP 7 alarm classes  
The alarm classes configured in STEP 7 are also available to the HMI device.
- Custom alarm classes  
The properties of this alarm class are defined in the configuration.

## Alarm buffer

Alarm events are saved to an internal buffer. The size of this alarm buffer depends on the HMI device type.

## Alarm report

When alarm logging is enabled in the project, alarms are output directly to the printer.

You can set the logging function separately for each alarm. Printing of such an alarm is initiated when the "incoming" and "outgoing" alarm events are generated.

The output of alarms of the "System" alarm class to a printer must be initiated by means of the corresponding alarm buffer. This outputs the content of the alarm buffer to the printer. To be able to initiate this print function, you need to configure a corresponding control object in the project.

## Alarm log

Alarm events are stored in an alarm log, provided this log file is configured. The capacity of the log file is limited by the storage medium and system limits.

## Alarm view

The alarm view shows selected alarms or events from the alarm buffer or alarm log. Whether alarm events have to be acknowledged or not is specified in your configuration. By means of configuration, the display can be filtered in such a way that only alarms that contain a specific character string will be shown.

## Alarm window

The alarm window is not assigned to any screen. Depending on the configuration the alarm window is opened when an alarm that belongs to a specific alarm class is active. Depending on the configuration, it is not closed until the alarm is acknowledged.

You can configure the order in which the alarms are displayed. At the first position, the current, or the oldest alarm will be displayed. The alarm window can also be set to indicate the exact location of the fault, including the date and time of the alarm event. By means of configuration, the display can be filtered in such a way that only alarms that contain a specific character string will be shown.

## Alarm indicator

The alarm indicator is a graphic symbol that is displayed on the screen when an alarm of the specified alarm class is activated.

The alarm indicator can have one of two states:

- Flashing: At least one unacknowledged alarm is pending.
- Static: The alarms are acknowledged but at least one of them is not yet deactivated. The number indicates the number of queued alarms.

### 10.3.4.3 Using the Alarm Window or Alarm View

#### Alarm window, alarm view in Runtime

#### Application

Alarms are indicated in the alarm view or in the alarm window on the HMI device. The layout and operation of the alarm window correspond to that of the alarm view.

The alarm window is not assigned to any screen. Depending on the configuration the alarm window is opened when an alarm that belongs to a specific alarm class is active. Depending on the configuration, it is not closed until the alarm is acknowledged.

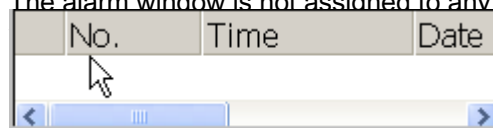

#### Layout

Depending on the configuration, in the alarm view different columns with information regarding an alarm or an alarm event are displayed. If a filter is configured, only alarms that contain a specific string in the alarm text will be displayed.

To differentiate between the different alarm classes, the first column in the alarm view contains an icon:

Symbol	Alarm class
!	"Errors"
Empty	"Warnings"
depends on the configuration	Custom alarm classes
\$	"System"
S7	"Diagnosis Event"



## Operation

You use the alarm view as follows, depending on how it is configured:

- Change the order of the columns.
- Change the order in which the alarms are displayed.
- Acknowledging alarms
- Editing alarms

## Control elements

The buttons have the following functions:

Button	Function
	Displaying a tooltip for an alarm
	Editing alarms
	Acknowledge alarm

## Operation behavior

### Linked alarm window for touch panels

When configuring the alarm window for keyboard units, enable the "Modal" property under "Properties > Mode". This ensures that the alarm window does not defocus during screen changes. Switching back and forth between the screen and different windows with <Ctrl+TAB> is not supported. If the linked alarm window has the focus, then the buttons in the screen behind it cannot be operated. The functions configured on a function key are carried out.

## Changing the order of the displayed alarms

When you click on the column, first of all alarms requiring acknowledgement are sorted according to date and time. Then those alarms that do not require acknowledgement are sorted according to date and time.

## Using the Alarm Window, Alarm View

### Introduction

As an alternative to using the mouse, you can operate the alarm view and the alarm window using the <TAB> key on your HMI device. This allows you to select the button and the most recently selected alarm in the alarm view. Depending on the configuration, you can also operate the alarm view via the function keys.

### Operation using the mouse

1. Select the alarm to be edited.
2. Click the button whose function you want to run.

### Operation using the keyboard

1. Press the <Tab> key until the list of displayed alarms is selected in the alarm view.
2. Click on the alarm to be edited. Use the <Up> and <Down> keys accordingly.
3. Press the <Tab> key until the button whose function you wish to use is selected.
4. Press <Enter>.

### Change the order of the columns

1. Select the column header, such as the "Date" column header.
2. While holding down the mouse button, drag the column header to the column header "Time".  
The "Date" column is in front of the "Time" column.

### Change the sorting

You can sort the list according to date or time.

1. Click on the corresponding column header.  
The list is sorted in descending or ascending order according to this criterion.
2. Click the same column header again to reverse the sort order.

### Acknowledge alarm

1. Click on the alarm to be edited.
2. Click the  button.

### Loop-In-Alarm trigger

1. Click on the alarm to be edited.
2. Click the  button.  
The screen containing information about the alarm is displayed.

---

#### Note

If you trigger a Loop-In-Alarm during an unacknowledged alarm, it is acknowledged automatically.

---

### Displaying configured tooltip

1. Click on the alarm concerned.
2. Click the  button.  
The tooltip configured for the alarm is displayed.

#### 10.3.4.4 Using the Simple Alarm Window, Alarm View

### Basic alarm view, alarm window in Runtime

#### Application

The simple alarm view shows selected alarms or alarm events from the alarm buffer. The layout and operation of the simple alarm window correspond to that of the simple alarm view.

---

#### Note

The "Single alarm view" object is not assigned dynamic functions by means of scripting.

In the Engineering System, for example, dynamize the visibility of an object in the "Animations" tab of the Inspector window. In Runtime, the "Simple alarm view" does not support animations. If you configured an animation and, for example, run a consistency check on the project, an error alarm is displayed in the output window.

---





## Layout

Depending on the configuration, in the alarm view different columns with information regarding an alarm or an alarm event are displayed.

To differentiate between the different alarm classes, the first column in the alarm view contains an icon:

Icon	Alarm class
!	"Errors"
empty	"Warnings"
depends on the configuration	Custom alarm classes
\$	"System"

## Operation







You use the alarm view as follows, depending on how it is configured:

- Acknowledging alarms
- Editing alarms

## Control elements

The buttons have the following functions:

Button	Function
	Acknowledge alarm
	Loop-In-Alarm Changes to the screen that contains information about the error event

Button	Function
	Displaying a tooltip for an alarm
	Displays the full text of the selected alarm in a separate window, namely the alarm text window In the alarm text window, you can view alarm texts that exceed the space available in the Alarm view. Close the alarm text window with the  button.
	Scrolls one alarm up.
	Scrolls one page up in the alarm view.
	Scrolls one page down in the alarm view.
	Scrolls one alarm down.

### Format of the control elements

The display of the buttons for using the simple alarm view depends on the configured size. You should therefore check on the HMI device whether all the required buttons are available.

### Basic alarm view, using the alarm window

#### Introduction

As an alternative to using the mouse, you can operate the simple alarm view using the <TAB> key on your HMI device. This allows you to select the button and the most recently selected alarm in the alarm view. Depending on the configuration, you can also operate the alarm view via the function keys.

#### Operation using the mouse

1. Select the alarm to be edited.
2. Click the button whose function you want to run.

#### Operation using the keyboard

1. Press the <Tab> key until the list of displayed alarms is selected in the alarm view.
2. Click on the alarm to be edited. Use the <Up> and <Down> keys accordingly.
3. Press the <Tab> key until the button whose function you wish to use is selected.
4. Press <Enter>.



#### Acknowledge alarm

1. Select the alarm to be acknowledged.
2. Click the  button.

### Loop-In-Alarm trigger

1. Select the alarm to be edited.
2. Click the  button.  
The screen containing information about the alarm is displayed.

### Calling the infotext

1. Select the alarm to be edited.
2. Click the  button.
3. To close the window for displaying the operator note, press the  button or use the key combination <Alt+F4>.

### 10.3.4.5 Using the Alarm Indicator

#### Alarm indicator in Runtime

#### Application

The alarm indicator is displayed if alarms of the specified alarm class are pending or require acknowledgment.



#### Layout

The alarm indicator can have one of two states:

- Flashing: At least one unacknowledged alarm is pending.
- Static: The alarms are acknowledged but at least one of them is not yet deactivated. The number indicates the number of queued alarms.

#### Operation

Depending on the configuration, when operating the alarm indicator an alarm window is opened. The icons from the symbol library can only be operated with a mouse or touch screen.

---

#### Note

##### Device dependency

Operation with mouse is not available for all HMI devices.

---

## Operating the alarm indicator using the mouse

### Operation using the mouse

1. Click on the alarm indicator with the mouse pointer. Depending on the configuration, the Alarm window is open.
2. Click  to close the alarm window. The Alarm window can be opened again by clicking on the alarm indicator.

### 10.3.4.6 Acknowledging alarms

#### Introduction

You can acknowledge alarms in Runtime according to your project configuration settings. You can acknowledge alarms as follows:

- Using the display and control object buttons
- Using the "ACK" key on your HMI device
- Using individually-configured function keys or buttons

If an operator authorization is configured for an individual control, the alarms can only be acknowledged by authorized users.

To automatically acknowledge alarms in Runtime, use the system functions and scripts, plus the "Acknowledgment by the PLC" option.

---

#### Note

##### Device dependency

Scripts are not available for all HMI devices.

---

#### Acknowledgment variants

You acknowledge individual alarms or multiple alarms together in Runtime. They are distinguished as follows:



- Single acknowledgment  
Acknowledgment of an alarm using a button or a function key.
- Acknowledge alarm groups  
Acknowledgment of all the alarms of an alarm group using a button or a function key.

## Requirement

- An alarm is displayed on the HMI device.

## Procedure

To acknowledge an alarm, proceed as follows:

1. Select the alarm.
2. If you are using an alarm view or an alarm window, click the  button.
3. If you are using a simple alarm view or a simple alarm window, click the  button.
4. Press the "ACK" button on your HMI device to acknowledge an alarm in an alarm line.

---

### Note

#### Device dependency

The extended alarm view or alarm window and the alarm line are not available for all HMI devices.

---

## Result

The alarm status changes to "Acknowledged". If the condition for triggering an alarm no longer applies, the alarm status also changes to "Outgoing", and it is no longer displayed on the HMI device.

### 10.3.4.7 Filtering Alarms

#### Introduction

The alarm view in Runtime does not contain a control element for entering filter criteria. To provide this functionality, configure an I/O field using the "Screens" editor.

#### Requirements

- A filter has been configured for the alarm view.
- An I/O field for entering the criterion is displayed.
- Alarms are displayed in Runtime.

#### Enable filter

1. Enter the filter string in the I/O field.
2. Confirm your input.  
The alarm view displays only those alarms that are contained in the specified character string. Thereby this distinguishes between upper and lower case letters.

### Disable filter

1. Delete the string from the I/O field that is used to filter the alarm view.
2. Confirm your input.  
All alarms are displayed in the alarm view once more.

## 10.3.5 Reference

### 10.3.5.1 System functions for alarms

#### System functions

System functions are predefined functions you can use to implement many tasks in runtime, even with no programming knowledge. You use system functions in a function list or in a script.

---

#### Note

##### Device dependency

Scripts are not available for all HMI devices.

---

The table shows all the system functions available for displaying and editing alarms.

System function	Effect
EditAlarm	Triggers the Loop-In-Alarm event for all selected alarms.
ClearAlarmBuffer	Deletes alarms from the alarm buffer on the HMI device.
ClearAlarmBufferProtoolLegacy	Function such as "ClearAlarmBuffer". This system function has been retained to ensure compatibility and uses the old ProTool numbering.
AlarmViewUpdate	Updates the advanced alarm view.
AlarmViewEditAlarm	Triggers the event Loop-In-Alarm for all alarms selected in the specified alarm view.
AlarmViewAcknowledgeAlarm	Acknowledges the alarms that are selected in the specified alarm view.
AlarmViewShowOperatorNotes	Displays the configured tooltip for the alarm selected in the specified alarm view.
AcknowledgeAlarm	Acknowledges all selected alarms.
SetAlarmReportMode	Switches the automatic reporting of alarms on the printer on or off.
ShowAlarmWindow	Hides or shows the alarm window on the HMI device.
ShowSystemEvent	Displays the value of the delivered parameter as a system event on the HMI device.

**Note****Device dependency**

The following system functions are not available for all HMI devices:

- SetAlarmReportMode
- AlarmViewUpdate
- ShowSystemEvent

### 10.3.5.2 Alarm events

#### Alarm events and their display and control objects

In Runtime, the following alarm events are triggered by their display and control objects. You can configure a function list for every event.

Object	Configurable events
Alarms	Incoming Outgoing Acknowledge Loop-In-Alarm
Alarm view	Enabling Disable Selection changed
Alarm indicator	Click Click when flashing

**Note****Device dependency**

The following events in the alarm view are not available for all HMI devices:

- Enabling
- Disable
- Selection changed
- Click
- Click when flashing

### 10.3.5.3 System functions for logs

#### System functions

The following system functions are available for logging:

Function name	Function method
ArchiveLogFile	This function moves or copies a log to another storage location for long-term archiving. Use the system function, for example, to move the audit trail from a local storage medium to the server. When handling audit trails, always use the "Move log (hmiMove)" mode in order to avoid noncompliance with FDA guidelines as a result of redundant data storage.
LogTag	Saves the value of the given tags in the given data log. Use the system function to log a process values at a specific time.
StartLogging	Starts the logging process in the specified log. You can interrupt logging in Runtime by calling the "StopLogging" system function.
StopLogging	Stops the logging process in the specified log. To resume logging in Runtime, select the "StartLogging" system function.
ClearLog	Deletes all entries in the specified log.
StartNextLog	Stops the logging process in the specified log. Logging is continued in the sequential log that has been configured for the specified log file.
CloseAllLogs	Closes all logs. The connection between WinCC and the log files or log database is terminated. You can use this system function, for example, to enable hot-swapping of the storage medium on the HMI device without exiting the Runtime software.
OpenAllLogs	Opens all logs to resume logging. The connection between WinCC and the log files or log database is recovered.
CopyLog	Copies the contents of the specified log to another log.

### 10.3.5.4 Structure of \*.csv files that contain alarms

#### Introduction

You can save an alarm log as a file in "\*.csv" format. CSV stands for **C**omma **S**eparated **V**alue. In this format, the table columns that contain the names and the value of the entry are separated by semicolons. Each table row terminates with a line break.

#### Example of a log file in \*.csv format

This example shows a file with logged alarms:

```
"Time_ms";"MsgProc";"StateAfter";"MsgClass";"MsgNumber";"Var1";...;"Var8";"TimeString";"MsgText";"PLC"37986550590,27;1;1;3;110001;"";...;"";"30.06.99 13:12:51";"Change to operating mode 'online'";37986550682,87;1;1;3;140010;"";...;"";"30.06.99 13:12:59";"Connection established: PLC_1, Station 2, Rack 0, Position 2";
```



### Structure of a log file in \*.csv format

The following values are entered in the log file columns:

Parameters	Description
Time_ms	Specify a time stamp as a decimal value ( see below for conversion)
Msg_Proc	Alarm procedures: 0 = Unknown alarm procedure 1 = System event 2 = Alarm bit procedure (operating alarms) 3 = Alarm number procedure ALARM_S 4 = Diagnostic event 7 = Analog alarm procedure 100 = Alarm bit procedure (fault alarms)
State after	Alarm event: 0 = Incoming/Outgoing 1 = Incoming 2 = Incoming/Acknowledged/Outgoing 3 = Incoming/Acknowledged 4 = All alarms in the PLC were deleted with SFC106 or after PLC STOP/RUN an alarm is pending 6 = Incoming/Outgoing/Acknowledged
Msg_Class	Alarm class: 0 = No alarm class 1 = "Errors" 2 = "Warnings" 3 = "System" 4 = "Diagnostic Events" 64 ... = user-configured alarm classes
Msg Number	Alarm number
Var1 to Var8	Value of the trigger tag as a STRING
Time string	Time stamp, as STRING in legible data format
Msg text	Alarm in a readable STRING
PLC	Alarm localization (relevant PLC)

### Conversion of the time stamp decimal value

To further process the time stamp value using a different program, proceed as follows:

1. Divide Time\_ms by 1,000,000.  
Example: 37986476928 : 1,000,000 = 37986.476928
2. The whole number portion (37986) is the date calculated from 12/31/1899.  
In Excel you can now convert the time stamp into days. To do this, assign to the cell that contains the time stamp, a respective format from the "Date" group.  
Result: 37986 results in 12/31/2003
3. The value after the point (0.476928) indicates the time:
  - Multiply the value (0.476928) by 24 to obtain the hours (11.446272).
  - Multiply the remainder (0.446272) by 60 results in the minutes (26.77632).
  - Multiply the remainder (0.77632) by 60 results in the seconds (46.5792).Result 11:26:46.579  
This conversion is supported by Microsoft Excel, for example.

#### 10.3.5.5 System events

### Basics on system events

#### System events

System events on the HMI device provide information about internal states of the HMI device and PLC.

The following overview illustrates when a system event occurs and how to eliminate the cause of error.

---

#### Note

##### HMI device dependency

Some of the system events described in this section apply to the individual HMI devices based on their scope of functions.

---

---

#### Note

System events are output in an alarm view. System events are output in the language currently set on your HMI device.

---

## System event parameters

System events may contain encrypted parameters. The parameters are of relevance when troubleshooting because they provide a reference to the source code of the Runtime software. These parameters are output after the "Error code:" text.

## 10000 - Printer alarms

### Meaning of the system alarms

All system alarms that can be displayed are listed below.

Table 10-2 10000 - Printer alarms

Number	Effect/cause	Remedy
10000	The print job could not be started or was canceled due to an unknown error. Faulty printer setup. Or: No authorization is available for accessing the network printer. Power supply failure during data transfer.	Check the printer settings, cable connections and the power supply. Set up the printer once again. Obtain a network printer authorization. If the error persists, contact the Hotline!
10001	No printer is installed or a default printer has not been set up.	Install a printer and/or select it as the default printer.
10002	Overflow of the graphics buffer for printing. Up to two graphics are buffered.	Allow sufficient intervals between successive print jobs.
10003	Graphics can now be buffered again.	--
10004	Overflow of the buffer for printing lines in text mode (e.g. alarms). Up to 1000 lines are buffered.	Allow sufficient intervals between successive print jobs.
10005	Text lines can now be buffered again.	--
10006	The Windows printing system reports an error. Refer to the output text and the error ID to determine the possible causes. Nothing is printed or the print is faulty.	Repeat the action if necessary.

## 20000 - Global script alarms

### Meaning of the system events

All system events that can be displayed are listed below. The system events are divided into different ranges.

10.3 Working with alarms

Table 10-3 20000 - Global script alarms

Number	Effect/causes	Remedy
20010	An error has occurred in the specified script line. Execution of the script was therefore aborted. Note the system event that may have occurred prior to this.	Select the specified script line in the configuration. Ensure that the tags used are of the allowed types. For system functions, verify the correct number of parameters and the parameter types.
20011	An error has occurred in a script that was called by the specified script. Execution of the script was therefore aborted in the called script. Note the system event that may have occurred prior to this.	In the configuration, select the script that has been called directly or indirectly by the specified script. Ensure that the tags used are of the allowed types. For system functions, verify the correct number of parameters and the parameter types.
20012	Inconsistent configuration data. The script could therefore not be generated.	Recompile the configuration data.
20013	Incorrect installation of the scripting component of WinCC Runtime. Therefore, no scripts can be executed.	Reinstall WinCC Runtime on your PC. Recompile your project using the "Compile > Software (compile all)" command from the context-sensitive menu and then download the project to the HMI device.
20014	The system function returns a value that is not written in any return tag.	Select the specified script in the configuration. Check whether the script name has been assigned a value.
20015	Too many successive scripts have been triggered in short intervals. When more than 20 scripts are queued for processing, any subsequent scripts are rejected. In this case, the script indicated in the alarm is not executed.	Check what is triggering the scripts. Extend the times, e.g. the acquisition cycle of the tag initiating the script.

30000 - Alarms errors when using system functions

Meaning of the system events

All system events that can be displayed are listed below. The system events are divided into different ranges.

Table 10-4 30000 - Alarms errors when using system functions

Number	Effect/causes	Remedy
30010	The tag could not accept the function result, e.g. when it has exceeded the value range.	Check the tag types of the system function parameters.
30011	A system function could not be executed because the function was assigned an invalid value or type in the parameter.	Check the parameter value and tag type of the invalid parameter. If a tag is used as a parameter, check its value.
30012	A system function could not be executed because the function was assigned an invalid value or type in the parameter.	Check the parameter value and tag type of the invalid parameter. If a tag is used as a parameter, check its value.

**40000 - Linear scaling alarms****Meaning of the system alarms**

All system alarms that can be displayed are listed below. The system alarms are divided into different ranges:

Table 10-5 40000 - Linear scaling alarms

Number	Effect/causes	Remedy
40010	The system function could not be executed since the parameters could not be converted to a common tag type.	Check the parameter types in the configuration.
40011	The system function could not be executed since the parameters could not be converted to a common tag type.	Check the parameter types in the configuration.

**50000 - Data server alarms****Meaning of the system alarms**

All system alarms that can be displayed are listed below. The system alarms are divided into different ranges:

Table 10-6 50000 - Data server alarms

Number	Effect/causes	Remedy
50000	The HMI device is receiving data faster than it is capable of processing. Therefore, no further data is accepted until all current data have been processed. Data exchange then resumes.	--
50001	Data exchange has been resumed.	--

**60000 - Win32 function alarms****Meaning of the system events**

All system events that can be displayed are listed below.

10.3 Working with alarms

Table 10-7 60000 - Win32 function alarms

Number	Effect/causes	Remedy
60000	This alarm is generated by the "ShowSystemEvent" system function. The text to be displayed is transferred to the function as a parameter.	--
60010	The file could not be copied in the direction defined because one of the two files is currently open or the source/target path is not available. It is possible that the Windows user has no access rights to one of the two files.	Restart the system function or check the paths of the source/target files. In Windows NT/XP: Users executing WinCC Runtime must be granted access to the files.
60011	An attempt was made to copy a file to itself. It is possible that the Windows user has no access rights to one of the two files.	Check the path of the source/target file. In Windows NT//XP and NTFS file system: Users executing WinCC Runtime must be granted access to the files.

70000 - Win32 function alarms

Meaning of the system events

All system events that can be displayed are listed below.

Table 10-8 70000 - Win32 function alarms

Number	Effect/causes	Remedy
70010	The application could not be started because it could not be found in the path specified or there is insufficient memory space.	Check whether the application exists in the specified path or close other applications.
70011	The system time could not be modified. The error alarm only appears in connection with area pointer "Date/time PLC". Possible causes: <ul style="list-style-type: none"> <li>An invalid time was transferred in the job mailbox.</li> <li>The Windows user has no right to modify the system time.</li> </ul> If the first parameter in the system event is displayed with the value 13, the second parameter indicates the byte containing the incorrect value.	Check the time which is to be set. Using Windows NT/XP: Users running WinCC Runtime must be granted the right to set the system time of the operating system.
70012	Error when executing the function "StopRuntime" with the "Runtime and operating system" option. Windows and WinCC Runtime are not closed. The error was possibly generated because other programs cannot be closed.	Close all programs currently running. Then close Windows.
70013	The system time could not be modified because an invalid value was entered. Incorrect separators may have been used.	Check the time which is to be set.

Number	Effect/causes	Remedy
70014	The system time could not be modified. Possible causes: <ul style="list-style-type: none"> <li>• An invalid time was transferred.</li> <li>• The Windows user has no right to modify the system time.</li> </ul> Windows rejects the setting request.	Check the time which is to be set. Using Windows NT/XP: Users running WinCC Runtime must be granted the right to set the system time of the operating system.
70015	The system time could not be read because Windows rejects the reading function.	--
70016	An attempt was made to select a screen by means of a system function or job. This is not possible because the screen number specified does not exist. Or: A screen could not be generated due to insufficient system memory. Or: The screen is blocked. Or: Screen call has not been executed correctly.	Check the screen number in the function or job with the screen numbers configured. Assign the number to a screen if necessary. Check the details for the screen call and whether the screen is blocked for specific users.
70017	Date/time is not read from the area pointer because the address set in the PLC is either not available or has not been set up.	Change the address or set up the address in the PLC.
70018	Acknowledgment that the password list has been successfully imported.	--
70019	Acknowledgment that the password list has been successfully exported.	--
70020	Acknowledgment for activation of alarm reporting.	--
70021	Acknowledgment for deactivation of alarm reporting.	--
70022	Acknowledgment to starting the Import Password List action.	--
70023	Acknowledgment to starting the Export Password List action.	--
70024	The range of values of the tag was exceeded in the system function. No calculation of the system function.	Check and correct the calculation.
70025	The range of values of the tag was exceeded in the system function. No calculation of the system function.	Check and correct the calculation.
70026	No other screens are stored in the internal screen memory. No other screens can be selected.	--
70027	The backup of the RAM file system has been started.	--
70028	The files from the RAM have been copied in the Flash memory. The files from the RAM have been copied in the Flash memory. Following a restart, these saved files are copied back to the RAM file system.	--
70029	Backup of the RAM file system has failed. No backup copy of the RAM file system has been made.	Check the settings in the "Control Panel > OP" dialog and save the RAM file system using the "Save Files" button in the "Persistent Storage" tab.
70030	The parameters configured for the system function are faulty. The connection to the new PLC was not established.	Compare the parameters configured for the system function with the parameters configured for the PLCs and correct them as necessary.

10.3 Working with alarms

Number	Effect/causes	Remedy
70031	The PLC configured in the system function is not an S7 PLC. The connection to the new PLC was not established.	Compare the S7 PLC name parameter configured for the system function with the parameters configured for the PLC and correct them as necessary.
70032	The object configured with this number in the tab sequence is not available in the selected screen. The screen changes but the focus is set to the first object.	Check the number of the tab sequence and correct it if necessary.
70033	An e-mail cannot be sent because a TCP/IP connection to the SMTP server no longer exists. This system event is generated only at the first attempt. All subsequent unsuccessful attempts to send an e-mail will no longer generate a system event. The event is regenerated when an e-mail has been successfully sent in the meantime. The central e-mail component in WinCC Runtime attempts to connect to the SMTP server at cyclic intervals (1 minute) in order to transmit the remaining e-mails.	Check the network connection to the SMTP server and re-establish it if necessary.
70034	Following a disruption, the TCP/IP connection to the SMTP server could be re-established. The queued e-mails are then sent.	--
70036	No SMTP server for sending e-mails is configured. An attempt to connect to an SMTP server has failed and it is not possible to send e-mails. WinCC Runtime generates the system event after the first attempt was made to send an e-mail.	Configure an SMTP server: In the WinCC Engineering System using "Device settings > Device settings" In the Windows CE operating system using "Control Panel > Internet Settings > E-mail > SMTP Server"
70037	An e-mail cannot be sent for unknown reasons. The contents of the e-mail are lost.	Check the e-mail parameters (recipient etc.).
70038	The SMTP server has rejected sending or forwarding an e-mail because the domain of the recipient is unknown to the server or because the SMTP server requires authentication. The contents of the e-mail are lost.	Check the domain of the recipient address or disable the authentication on the SMTP server if possible. SMTP authentication is currently not used in WinCC Runtime.
70039	The syntax of the e-mail address is incorrect or contains illegal characters. The contents of the e-mail are discarded.	Check the e-mail address of the recipient.
70040	The syntax of the e-mail address is incorrect or contains illegal characters.	--
70041	The import of the user management was aborted due to an error. Nothing was imported.	Check your user administration or download it again to the panel.
70042	The range of values of the tag was exceeded while executing the system function. The system function was not calculated.	Check and correct the calculation.
70043	The range of values of the tag was exceeded while executing the system function. The system function was not calculated.	Check and correct the calculation.
70044	An error occurred while sending the e-mails. The e-mails were not sent.	Check the SMTP settings and the error message in the system event.



Number	Effect/causes	Remedy
70045	Cannot load a file required for encrypting the e-mail.	Update the operating system and Runtime.
70046	The server does not support encryption.	Select an SMTP server that supports encryption.
70047	The SSL versions of the HMI device and SMTP server may not be compatible.	Contact your network administrator or the operator of the SMTP server.

## 80000 - Log alarms

### Meaning of the system events

All system events that can be displayed are listed below.

Table 10-9 80000 - Log alarms

Number	Effect/causes	Remedy
80001	The log specified is filled to the size defined (in percent) and must be stored elsewhere.	You swap out the file or table by executing a 'move' or 'copy' function.
80002	A line is missing in the specified log.	--
80003	The copying process for logging was not successful. In this case, it is advisable to check any subsequent system events, too.	--
80006	Since logging is not possible, this causes a permanent loss of the functionality.	In the case of databases, check whether the corresponding data source exists and start up the system again.
80009	A copying action has been completed successfully.	--
80010	An incorrect storage location was entered in WinCC and causes permanent loss of functionality.	Configure the storage location for the respective log again and restart the system when the full functionality is required.
80012	Log entries are stored in a buffer. If the values are read to the buffer faster than they can be physically written (using a hard disk, for example), overloading may occur and recording is then stopped.	Archive fewer values. Or: Increase the logging cycle.
80013	The overload status no longer exists. Archiving resumes the recording of all values.	--
80014	The same action was triggered twice in quick succession. Since the process is already in operation, the action is only carried out once.	--
80015	This system event is used to report DOS or database errors to the user.	--
80016	The logs are separated by system function "CloseAllLogs" and the incoming entries exceed the defined buffer size. All buffer entries are deleted.	Reconnect the logs.
80017	The number of incoming entries cause a buffer overflow. This can be caused, for example, by several copying actions being activated at the same time. All copy jobs in the buffer are deleted.	Stop the copy action.

10.3 Working with alarms

Number	Effect/causes	Remedy
80019	The connection between WinCC and all log files was shut down, for example, after execution of the "CloseAllLogs" system function. Entries are written to the buffer and written to the logs when the connection is recovered. There is no connection to the storage location and the storage medium can be changed.	--
80020	The maximum number of simultaneously copy operations has been exceeded. Copying is not executed.	Wait until the current copying actions have been completed, then restart the last copy action.
80021	An attempt was made to delete a log which is still busy with a copy action. Deletion has not been executed.	Wait until the current copying actions have been completed, then restart the last action.
80022	An attempt was made to use system function "StartSequenceLog" to start a sequence log for a log which is not configured as sequence log. No sequence log file is created.	In the project, check <ul style="list-style-type: none"> <li>• whether the "StartSequenceLog" system function was properly configured.</li> <li>• if the tag parameters are properly provided with data on the HMI device.</li> </ul>
80023	An attempt was made to copy a log to itself. The log is not copied.	In the project, check <ul style="list-style-type: none"> <li>• whether the "CopyLog" system function was properly configured.</li> <li>• if the tag parameters are properly provided with data on the HMI device.</li> </ul>
80024	In your configuration, you specified that the "CopyLog" system function should not allow copying if the destination log already contains data ("Mode" parameter). The log is not copied.	Edit the "CopyLog" system function in your configuration, if necessary. Before you initiate the system function, delete the destination log file.
80025	You have canceled the copy operation. Data written up to this point are retained. The target log file (if configured) was not deleted. The cancellation is reported by an error entry \$RT_ERR\$ at the end of the target log.	--
80026	This alarm is output after all logs are initialized. Values are written to the logs from then on. No entries are written to the logs before this time has expired, irrespective of the active state of WinCC Runtime.	--
80027	The internal Flash memory has been specified as the storage location for a log. This is not permissible. No values are written to this log and the log file is not created.	Configure "Storage Card" or network path as the storage location.
80028	The alarm serves as status report indicating that the logs are currently being initialized. No values are logged until the alarm 80026 is output.	--
80029	The number of logs specified in the alarm could not be initialized. Initialization of logs was finished. The faulty log files are not available for logging jobs.	Evaluate the additional system events related to this alarm. Check the configuration, the ODBC (Open Database Connectivity), and the specified drive.
80030	The structure of the existing log file does not match the expected structure. Logging is stopped for this log.	Delete the existing log data manually, in advance.

Number	Effect/causes	Remedy
80031	The log in CSV format is corrupted. The log cannot be used.	Delete the faulty file.
80032	Logs can be configured with events. These are triggered as soon as the log is full. Assuming WinCC Runtime is started and the log is already full, the event would never be triggered. The specified log is full and no longer accepts data.	Close WinCC Runtime, delete the log, and restart WinCC Runtime. Or: Configure a button which contains the same actions as the event and press it.
80033	"System Defined" is set in the data log file as the data source name. This causes an error. No data is written to the database logs, whereas the logging to the CSV logs works.	Reinstall SQL Sever 2005 Express.
80034	An error has occurred in the initialization of the logs. An attempt has been made to create the tables as a backup. This action was successful. A backup copy of the tables of the corrupted log file was generated and the cleared log restarted.	No action is necessary. However, it is recommended to save the backup files or delete them in order to make the space available again.
80035	An error has occurred in the initialization of the logs. An attempt has been made to create backups of the tables and this has failed. No logging or backup has been performed.	It is recommended to save the backups or to delete them in order to release memory.
80044	The export of a log was interrupted because Runtime was closed or due to a power failure. At the restart of Runtime, it was detected that the export must be resumed.	The export resumes automatically.
80045	The export of a log was interrupted due to an error in the connection to the server or at the server itself.	The export is repeated automatically. Check: <ul style="list-style-type: none"> <li>• The connection to the server.</li> <li>• If the server is running.</li> <li>• If there is enough free space on the server.</li> </ul>
80046	The destination file or the associated directory could not be created on the server.	Check whether there is enough space on the server and if you have permission to create the log file.
80047	The log could not be read while exporting it.	Check whether the storage medium is correctly inserted.
80049	The log could not be renamed while preparing to export it. The job can not be completed."	Check whether the storage medium is correctly inserted and if there is sufficient space on the medium.
80050	The log which shall be exported is not closed. The job can not be completed.	Make sure to call the "CloseAllLogs" system function before using the "ExportLog" system function. Change the configuration as required.
80051	The log to be copied contains an invalid checksum. The log was not copied.	Select a log with a valid checksum. The selected log may have been manipulated.
80052	The log cannot be read.	Check the log and the specified path.
80053	The closed log cannot be read.	Open the log.

## 90000 - FDA alarms

### Meaning of the system events

All system events that can be displayed are listed below.

10.3 Working with alarms

Table 10-10 90000 - FDA alarms

Number	Effect/causes	Remedy
90024	No operator actions can be logged due to lack of space on the storage medium for log. The operator action will therefore not be executed.	Provide more storage space by inserting a blank storage medium, or backup the log files to the server using the "ExportLog" function.
90025	No user actions can be logged because of error state of the archive. Therefore the user action will not be executed.	Check whether the storage medium is correctly inserted.
90026	No operator actions can be logged because the log is closed. The operator action will therefore not be executed.	Before further operator actions are carried out, the log must be reopened with the help of system function "OpenAllLogs". Change the configuration as required.
90028	The password you entered is incorrect.	Enter the correct password.
90029	Runtime was closed during ongoing operation (perhaps due to a power failure) or a storage medium in use is incompatible with Audit Trail. An Audit Trail is not suitable if it belongs to another project or has already been logged.  It could also be that archiving was not stopped before automatic execution of the "CloseAllArchives" function was started (e.g. by the task scheduler).	Ensure that you are using the correct storage medium.
90030	Runtime was closed during ongoing operation (perhaps due to a power failure).	--
90031	Runtime was closed during ongoing operation (perhaps due to a power failure).	--
90032	Running out of space on the storage medium for log.	Provide more storage space by inserting a blank storage medium, or backup the log files to the server using the "ExportLog" function.
90033	No more space on the storage medium for log. As of now, no more operator actions requiring logging will be executed.	Provide more storage space by inserting a blank storage medium, or backup the log files to the server using the "ExportLog" function.
90039	You do not have the necessary authorization to perform this action.	Adapt or upgrade your authorizations.
90040	Audit Trail is switched off because of a forced user action.	Reactivate the "Audit Trail" with the help of system function "StartLog".
90041	A user action which has to be logged has been executed without a logged on user.	A user action requiring logging should only be possible with permission. Change the configuration by setting a required authorization for the input object.
90044	A user action which has to be confirmed was blocked, because there is another user action pending.	Repeat the user action if necessary.
90048	The Audit Trail cannot be printed while data relevant to the audit is being logged.	Stop logging by calling system function "StopLogging".
90049	Access to required file is not possible.	Check the network connection or the storage medium.
90056	The recipe was not imported because the file contains no checksum.	Select a file with a checksum.  You can also disable checksum verification by calling system function "ImportDataRecords".
90057	The recipe was not imported because the file contains an invalid checksum. The selected file may have been manipulated.	Select a file with a valid checksum.

**110000 - Offline function alarms****Meaning of the system events**

All system events that can be displayed are listed below.

Table 10-11 110000 - Offline function alarms

Number	Effect/causes	Remedy
110000	The operating mode was changed. "Offline" mode is now set.	--
110001	The operating mode was changed. "Online" mode is now set.	--
110002	The operating mode was not changed.	Check the connection to the PLCs. Check whether the address range for the "Coordination" area pointer is present in the PLC.
110003	The operating mode of the specified PLC was changed by the "SetConnectionMode" system function. The "offline" operating mode is now set.	--
110004	The operating mode of the specified PLC was changed by the "SetConnectionMode" system function. The "online" operating mode is now set.	--
110005	An attempt was made to use the "SetConnectionMode" system function to set the specified PLC to "online" mode, although the entire system is in "offline" mode. This changeover is not allowed. The PLC remains in "offline" mode.	Switch the complete system to "online" mode and repeat execution of the system function.
110006	The content of the "project ID" area pointer does not match the project ID configured in WinCC. The WinCC Runtime is therefore terminated.	Check: <ul style="list-style-type: none"> <li>the project ID entered on the PLC.</li> <li>the project ID entered in WinCC.</li> </ul>

**120000 - Trend alarms****Meaning of the system alarms**

All system alarms that can be displayed are listed below.

Table 10-12 120000 - Trend alarms

Number	Effect/causes	Remedy
120000	The trend is not displayed because you configured an incorrect axis to the trend or an incorrect trend.	Change the configuration.
120001	The trend is not displayed because you configured an incorrect axis to the trend or an incorrect trend.	Change the configuration.
120002	The trend is not displayed because the tag assigned attempts to access an invalid PLC address.	Check whether the data area for the tag exists in the PLC, the configured address is correct and the value range for the tag is correct.

### 130000 - System information alarms

#### Meaning of the system events

All system events that can be displayed are listed below.

Table 10-13 130000 - System information alarms

Number	Effect/causes	Remedy
130000	The action was not executed.	Close all other programs. Delete files no longer required from the hard disk.
130001	The action was not executed.	Delete files no longer required from the hard disk.
130002	The action was not executed.	Close all other programs. Delete files no longer required from the hard disk.
130003	No data medium found. The operation is canceled.	Check the following conditions, for example: <ul style="list-style-type: none"> <li>• Access to the correct data carrier?</li> <li>• Is a data carrier inserted?</li> </ul>
130004	The data carrier is write-protected. The operation is canceled.	Check whether the correct data medium is being accessed. Remove the write-protection if necessary.
130005	The file is read only. The operation is canceled.	Check whether the correct file is being accessed. Change the file attributes.
130006	No access to the file. The operation is canceled.	Check the following conditions, for example: <ul style="list-style-type: none"> <li>• Is the correct file being accessed?</li> <li>• Does the file exist?</li> <li>• Is another action preventing concurrent access to the file?</li> </ul>
130007	The network connection is interrupted. Records cannot be saved or read via the network connection.	Check the network connection and eliminate the cause of error.
130008	No storage card available. The specified records cannot be saved to or read from Storage Card.	Insert the storage card.
130009	The specified folder does not exist on the storage card. The files stored in this directory are not backed up after switching off the HMI device.	Insert the storage card.
130010	The maximum nesting depth can be exhausted when, for example, value changes in a script initiate the call of an infinite number of further scripts. The configured functionality is not provided.	Check the configuration.
130013	No storage card available. The specified records cannot be saved to or read from Storage Card.	Insert the storage card.

**140000 - Connection alarms: Connection + device****Meaning of the system events**

All system events that can be displayed are listed below.

Table 10-14 140000 - Connection alarms: Connection + device

Number	Effect/causes	Remedy
140000	An online connection to the PLC is established.	--
140001	The online connection to the PLC was shut down.	--
140003	No tag update or write operations are executed.	Check whether the connection is up and the PLC is switched on. In the Control Panel, check the set parameters using the "Set PG/PC interface" function. Restart the system.
140004	No tag update or write operations are executed due to an incorrect access point, or incorrect module configuration.	Check the connection and whether the PLC is switched on. Check the access point or the module configuration (MPI, PPI, PROFIBUS) in the Control Panel with "Set PG/PC interface". Restart the system.
140005	No tag update or write operations are executed due to an incorrect HMI device address (possibly too high).	Use a different address for the HMI device. Check the connection and whether the PLC is switched on. Check the parameters set in the "Set PG/PC interface" dialog of the Control Panel. Restart the system.
140006	No tag update or write operations are executed due to an incorrect baud rate setting.	Select a different baud rate in WinCC (according to module, profile, communication peer, etc.).
140007	An incorrect bus profile prevents tag updates or write operations (see %1). The following parameters could not be written to the registry database: 1: Tslot 2: Tqui 3: Tset 4: MinTsdr 5: MaxTsdr 6: Trdy 7: Tid1 8: Tid2 9: Gap Factor 10: Retry Limit	Check the custom bus profile. Check the connection and whether the PLC is switched on. Check the parameters set in the "Set PG/PC interface" dialog of the Control Panel. Restart the system.

10.3 Working with alarms

Number	Effect/causes	Remedy
140008	An incorrect baud rate prevents tag updates or write operations. The following parameters could not be written to the registry database: 0: General error 1: Wrong version 2: Profile cannot be written to the registry database. 3: The subnet type cannot be written to the registry database. 4: The Target Rotation Time cannot be written to the registry database. 5: Incorrect Highest Station Address (HSA).	Check whether the connection is up and the PLC is switched on. In the Control Panel, check the set parameters using the "Set PG/PC interface" function. Restart the system.
140009	No tag updates or write operations because the S7 communication module was not found.	To reinstall the module, open the Control Panel and select "Set PG/PC interface".
140010	No S7 communication partner found because the PLC is shut down. DP/T: The option "PG/PC is the only master" is not set in the Control Panel under "Set PG/PC interface".	Switch on the PLC. DP/T: If only one master is connected to the network, disable "PG/PC is the only master" in "Set PG/PC interface". If several masters are connected to the network, enable these. Do not change any settings, for this will cause bus errors.
140011	No tag updates or write operations because communication is down.	Check the connection and whether the communication partner is switched on.
140012	Initialization error (e.g. if WinCC Runtime was closed in Task Manager). Or: Another application (e.g. STEP 7) with different bus parameters is active and the driver cannot be started with the new bus parameters (baud rate, for example).	Restart the HMI device. Or: Start WinCC Runtime and then start your other applications.
140013	The MPI cable is disconnected and, therefore, there is no power supply.	Check the connections.
140014	The configured bus address is in use by another application.	Change the HMI device address in the PLC configuration.
140015	Incorrect baud rate Or: Incorrect bus parameters (e.g. HSA) Or: OP address > HSA or: Incorrect interrupt vector (interrupt not registered by the driver)	Correct the parameters.
140016	The hardware does not support the configured interrupt.	Change the interrupt number.
140017	The set interrupt is in use by another driver.	Change the interrupt number.
140018	SIMOTION Scout disabled the consistency check. Only a corresponding note appears.	In SIMOTION Scout, reactivate the consistency check and once again download the project to the PLC.
140019	SIMOTION Scout is downloading a new project to the PLC. Connection to the PLC is canceled.	Wait until the end of the reconfiguration.
140020	Mismatch of the PLC and project (FWX file) versions. The connection to the PLC is canceled.	The following remedies are available: Download the current version to the PLC using SIMOTION Scout. Recompile the project using WinCC ES, close WinCC Runtime, and restart with the new configuration.



Number	Effect/causes	Remedy
140021	Setup of the connection to the PLC failed. Incorrect configuration of the "Access password" for the connection to the PLC.	Select the "Access password" area in the "Connections" editor to check the password entered for the connection to the PLC. Assign the correct password. The "Password" for the connection to the PLC is assigned in the "Security" area of the PLC properties.
140022	Setup of the connection to the PLC failed. Incorrect configuration of the access password for the connection to the PLC.	Select the "Access password" area in the "Connections" editor to check the password entered for the connection to the PLC. The "Password" for the connection to the PLC is assigned in the "Security" area of the PLC properties.
140025	Setup of the connection to the PLC failed. The access password of the PLC is disabled in the PLC display.	Enable the access password in the PLC display.

## 160000 - Connection alarms: OPC: Connection

### Meaning of the system events

All system events that can be displayed are listed below.

Table 10-15 160000 - Connection alarms: OPC: Connection

Number	Effect/causes	Remedy
160000	No more data is read or written. Possible causes: <ul style="list-style-type: none"> <li>• The cable connection is interrupted.</li> <li>• The PLC does not respond or has failed, etc.</li> <li>• The wrong port is used for the connection.</li> <li>• System overload</li> </ul>	Check whether the cable is plugged in and the PLC is OK, and whether the correct port is used. Restart the system if the system event persists.
160001	The connection is recovered because the cause of the interruption has been eliminated.	--
160010	No connection to the server because the server ID (CLS-ID) cannot be determined. Values cannot be read or written.	Check access rights.
160011	No connection to the server because the server ID (CLS-ID) cannot be determined. Values cannot be read or written.	Check the following conditions, for example: <ul style="list-style-type: none"> <li>• Correct server name?</li> <li>• Correct station name?</li> <li>• Is the server registered?</li> </ul>
160012	No connection to the server because the server ID (CLS-ID) cannot be determined. Values cannot be read or written.	Check the following conditions, for example: <ul style="list-style-type: none"> <li>• Correct server name?</li> <li>• Correct station name?</li> <li>• Is the server registered?</li> </ul> Note for advanced users: Interpret the value from HRESULT.

10.3 Working with alarms

Number	Effect/causes	Remedy
160013	The specified server was started as InProc server. This has not been released and may lead to undefined behavior because the server is running in the same process area as WinCC Runtime.	Configure the server as OutProc Server or Local Server.
160014	Only one OPC server project can be started on a PC/MP. An alarm is output after an attempt was made to start a second project.  The second project has no OPC server functionality and cannot be located as an OPC server by external sources.	Do not start a second project with OPC server functionality on the computer.

170000 - S7 dialog alarms

Meaning of the system alarms

All system alarms that can be displayed are listed below.

Table 10-16 170000 - S7 dialog alarms

Number	Effect/causes	Remedy
170000	S7 diagnostics events are not indicated because it is not possible to log on to the S7 diagnostics functions at this device. The service is not supported.	--
170001	The S7 diagnostics buffer cannot be viewed because communication with the PLC is shut down.	Set the PLC to online mode.
170002	The S7 diagnostics buffer cannot be viewed because reading of the diagnostics buffer (SSL) was canceled with error.	--
170003	An S7 diagnostics event cannot be visualized. The system returns internal error %2.	--
170004	An S7 diagnostics event cannot be visualized. The system returns an internal error of error class %2, error number %3.	--
170007	It is not possible to read the S7 diagnostics buffer (SSL) because this operation was canceled with an internal error of class %2 and error code %3.	--

180000 - General alarms

Meaning of the system events

All system events that can be displayed are listed below.

Table 10-17 180000 - General alarms

Number	Effect/causes	Remedy
180000	A component/OCX received configuration data with a version ID which is not supported.	Install a newer component.
180001	System overload because too many actions are running in parallel. Certain actions can be executed, while others are discarded.	Several remedies are available: <ul style="list-style-type: none"> <li>• Generate alarms at a slower rate (polling).</li> <li>• Initiate scripts and functions at greater intervals.</li> </ul> If the alarm appears more frequently: Restart the HMI device.
180002	The screen keyboard could not be activated. Possible causes: "TouchInputPC.exe" was not registered due to faulty Setup.	Reinstall WinCC Runtime.

## 190000 - Tag alarms

### Meaning of the system events

All system events that can be displayed are listed below.

Table 10-18 190000 - Tag alarms

Number	Effect/causes	Remedy
190000	It is possible that the tag is not updated.	--
190001	The tag is updated after the cause of the last error state has been eliminated (recovery of normal operation).	--
190002	The tag is not updated because communication with the PLC is down.	Select system function "SetOnline" to enable communication.
190004	The tag is not updated because the address configured for this tag does not exist.	Check the configuration.
190005	The tag is not updated because the configured PLC type does not exist for this tag.	Check the configuration.
190006	The tag is not updated because it is not possible to map the PLC type in the data type of the tag.	Check the configuration.
190007	The tag value is not modified because the connection to the PLC is interrupted or the tag is offline.	Set online mode or reconnect to the PLC.
190008	The configured tag limits were violated due to one of the following events: <ul style="list-style-type: none"> <li>• Value input</li> <li>• System function</li> <li>• Script</li> </ul>	Observe the configured or current tag limits.
190009	An attempt was made to assign this tag a value that is outside the valid range of values for this data type. For example, input of the value 260 for a byte tag, or input of the value -3 for an unsigned word tag.	Observe the range of values for the data type of the tags.

10.3 Working with alarms

Number	Effect/causes	Remedy
190010	<p>The rate at which values are written to the tag is too high (e.g. initiated in a script loop). Values will be lost because buffer capacity is limited to 100 operations.</p>	<p>The following remedies are available:</p> <ul style="list-style-type: none"> <li>• Extend the interval between multiple write actions.</li> <li>• Do not use an array tag longer than 6 words when configuring an acknowledgment on the HMI device using "HMI acknowledgment tag".</li> </ul>
190011	<p>Possible cause 1: The value entered could not be written to the configured PLC tag because the high or low limit was exceeded. The system discarded the entry and restored the original value.</p> <p>Possible cause 2: The connection to the PLC was interrupted.</p>	<p>Note that the value entered must be within the range of values of the control tag.</p> <p>Check the connection to the PLC.</p>
190012	<p>It is not possible to convert a value from a source format to a target format, for example: An attempt is being made to write a counter value that is outside the valid, PLC-specific range of values. A tag of the type Integer should be assigned a value of the type string.</p>	<p>Check the range of values, or the data type of the tag.</p>
190013	<p>You entered a string that exceeds the tag length. The string is truncated automatically to a valid length.</p>	<p>Always enter strings that do not exceed the valid tag length.</p>

**190100 - Area pointer alarms****190100 - Area pointer alarms**

Number	Effect/causes	Remedy
190100	The area pointer is not updated because the address configured for this pointer does not exist. Type 1 Warnings 2 Errors 3 PLC acknowledgment 4 HMI device acknowledgment 5 LED image 6 Trend request 7 Trend transfer 1 8 Trend transfer 2 No.: Consecutive number displayed in WinCC ES.	Check the configuration.
190101	The area pointer is not updated because it is not possible to map the PLC type to the area pointer type. Parameter type and no.: see alarm 190100	--
190102	The area pointer is updated after the cause of the last error state has been eliminated (recovery of normal operation). Parameter type and no.: See alarm 190100.	--

**200000 - PLC coordination alarms****200000 - PLC coordination alarms**

Number	Effect/causes	Remedy
200000	Coordination is not executed because the address configured in the PLC does not exist/is not set.	Change the address or set up the address in the PLC.
200001	Coordination is canceled because the write access to the address configured in the PLC is not possible.	Change the address or set the address in the PLC at an area which allows write access.
200002	Coordination is not carried out at the moment because the address format of the area pointer does not match the internal storage format.	Internal error
200003	Coordination can be executed again because the last error state is eliminated (return to normal operation).	--
200004	The coordination may not be executed.	--
200005	No more data is read or written. Possible causes: <ul style="list-style-type: none"> <li>• The cable is defective.</li> <li>• The PLC does not respond, is defective, etc.</li> <li>• System overload</li> </ul>	Ensure that the cable is plugged in and the PLC is operational. Restart the system if the system alarm persists.

10.3 Working with alarms

210000 - PLC job alarms

210000 - PLC job alarms

Number	Effect/causes	Remedy
210000	Jobs are not processed because the configured address does not exist/has not been set up in the PLC.	Change the address or set up the address in the PLC.
210001	Jobs are not processed because read/write access to the configured address is not possible in the PLC.	Change the address, or set up the address in a PLC area at which read/write access is possible.
210002	Jobs are not executed because the address format of the area pointer does not match the internal storage format.	Internal error
210003	The job buffer is processed again because the last error status has been eliminated (recovery of normal operation).	--
210004	The job buffer is possibly not going to be processed.	--
210005	A job mailbox with invalid number was initiated.	Check the PLC program.
210006	An error occurred while executing the job mailbox. As a result, the control job is not executed. Observe the next/previous system event.	Check the parameters of the control job. Recompile the configuration data.

220000 - WinCC communication driver alarms

220000 - WinCC communication driver alarms

Number	Effect/causes	Remedy
220001	The tag is not downloaded because write access to data type Bool/Bit is not supported by the sublevel communication driver/HMI device.	Change the configuration.
220002	The tag is not downloaded because write access to data type Byte is not supported by the sublevel communication driver/HMI device.	Change the configuration.
220003	The communication driver cannot be loaded as it is possibly not installed.	Install the driver by reinstalling WinCC Runtime.
220004	Communication is down and no update data is transferred because the cable is not connected or defective etc.	Check the connection.
220005	Communication is up.	--
220006	The connection between the specified PLC and the specified port is active.	--

Number	Effect/causes	Remedy
220007	The connection to the specified PLC is interrupted at the specified port.	Check the following: <ul style="list-style-type: none"> <li>• Is the cable plugged in?</li> <li>• Is the PLC OK?</li> <li>• Is the right port being used?</li> <li>• Is your configuration OK (port parameters, protocol settings, PLC address)?</li> </ul> Restart the system if the system event persists.
220008	The communication driver cannot access or open the specified port. This port might be in use by another application, or a port that does not exist on the target device is being used. No communication with the PLC.	Close all applications that access the port and restart the computer. Use another port that exists in the system.

## 230000 - Screen object alarms

## 230000 - Screen object alarms

Number	Effect/causes	Remedy
230000	The value entered could not be used. The system discards this entry and restores the previous value. Possible causes: <ul style="list-style-type: none"> <li>• The range of values is exceeded.</li> <li>• You entered invalid characters</li> <li>• The valid maximum number of users has been exceeded.</li> </ul>	Enter a practical value, or delete a user that is no longer required.
230002	The user currently logged on does not have the necessary authorization, so the system discards the entry and restores the previous value.	Log on as user with appropriate authorization.
230003	Change to the specified screen failed because this screen is not available/configured. The current screen remains selected.	Configure the screen and check the selection function.
230005	The range of values of the tag has been exceeded in the I/O field. The original tag value is retained.	Observe the range of values for the tag when entering a value.
230100	During navigation in the Web browser, the system returned a message which may be of interest to the user. The Web browser continues to run but may not (fully) show the new page.	Navigate to another page.
230200	The HTTP channel connection was interrupted due to an error. This error is explained in detail by another system event. Data is no longer exchanged.	Check the network connection. Check the server configuration.
230201	The HTTP channel connection is set up. Data is exchanged.	--

10.3 Working with alarms

Number	Effect/causes	Remedy
230202	<p>WININET.DLL has detected an error. Usually, this error occurs if it is not possible to connect to the server, or the server denies a connection because the client lacks proper authorization. An unknown server certificate may also be the cause if the connection is encrypted by means of SSL.</p> <p>The alarm text provides details. This text is always in the language of the Windows installation because it is returned by the Windows OS.</p> <p>Process values are no longer exchanged. The part of the alarm returned by the Windows OS might not be displayed, e.g. "An error has occurred". WININET.DLL returns the following error: Number: 12055 Text:HTTP: &lt;no error text available&gt;."</p>	<p>Depending on the cause:</p> <p>When an attempt to connect fails, or a timeout occurs:</p> <ul style="list-style-type: none"> <li>• Check the network connection and the network.</li> <li>• Check the server address.</li> <li>• Check whether the WebServer is actually running on the target station.</li> </ul> <p>Incorrect authorization:</p> <ul style="list-style-type: none"> <li>• The configured user name and/or password do not match the entries on the server. Set consistent data.</li> </ul> <p>If the server certificate is rejected: Certificate signed by an unknown CA ( ):</p> <ul style="list-style-type: none"> <li>• Ignore this point, or install a certificate that has been signed with one of the root certificates known to the client station.</li> </ul> <p>The date of the certificate is invalid:</p> <ul style="list-style-type: none"> <li>• Ignore this point, or install a certificate with valid date on the server.</li> </ul> <p>Invalid CN (Common Name or Computer Name):</p> <ul style="list-style-type: none"> <li>• Ignore this point, or install a certificate with a name that corresponds to the server address.</li> </ul>
230203	<p>Although a connection can be made to the server, the HTTP server refused to connect. Possible causes:</p> <ul style="list-style-type: none"> <li>• WinCC Runtime does not run on the server</li> <li>• The HTTP channel is not supported (503 Service unavailable).</li> </ul> <p>Other errors can only occur if the Webserver does not support the HTTP channel. The language of the alarm text depends on the Webserver.</p> <p>Data is not exchanged.</p>	<p>On 503 Service unavailable error:</p> <p>Check whether WinCC Runtime is running on the server and whether the HTTP channel is supported.</p>
230301	<p>Internal error. An English text explains the error in more detail. The error may be caused by insufficient memory. OCX does not work.</p>	--
230302	<p>The name of the remote server cannot be resolved. An attempt to connect has failed.</p>	<p>Check the configured server address. Check whether the DNS service is available on the network.</p>
230303	<p>The remote server is not running on the addressed computer. incorrect server address. An attempt to connect has failed.</p>	<p>Check the configured server address. Check whether the remote server is running on the target computer.</p>
230304	<p>The remote server on the addressed computer is incompatible with VNCOCX. An attempt to connect failed.</p>	Use a compatible remote server.
230305	<p>Authentication has failed due to incorrect password. An attempt to connect failed.</p>	Configure the correct password.



Number	Effect/causes	Remedy
230306	Error in the connection to the remote server. This may occur as a result of network problems. An attempt to connect failed.	Check whether the network cable is plugged in, or whether there are network problems.
230307	The connection to the remote server was shut down. Possible causes: <ul style="list-style-type: none"> <li>• The remote server was shut down</li> <li>• The user instructed the server to close all connections.</li> </ul> The connection is cancelled.	--
230308	This alarm provides information on the connection status. An attempt is made to connect.	--

## 240000 - Authorization alarms

### 240000 - Authorization alarms

Number	Effect/causes	Remedy
240000	WinCC Runtime is running in demo mode. You have no authorization, or your authorization is corrupted.	Install the authorization.
240001	WinCC Runtime is running in demo mode. You configured too many tags for the installed version.	Load an adequate authorization / powerpack.
240002	WinCC Runtime is running with time-limited emergency authorization.	Restore the full authorization.
240004	Error when reading the emergency authorization. WinCC Runtime is running in demo mode.	Restart WinCC Runtime. Install or repair the authorization (see Commissioning Instructions for Software Protection).
240005	Automation License Manager has detected an internal system error. Possible causes: <ul style="list-style-type: none"> <li>• Corrupted file</li> <li>• Faulty installation</li> <li>• No free memory space for Automation License Manager, or similar.</li> </ul>	Restart the HMI device/PC. If this procedure does not solve the problem, remove and then reinstall Automation License Manager.

**250000 - S7 Status/Force alarms**

**250000 - S7 Status/Force alarms**

Number	Effect/causes	Remedy
250000	The tag in the specified line in "Status Force" is not updated because the address configured for this tag is not available.	Check the set address and then verify that the address is set up in the PLC.
250001	The tag in the specified line in "Status Force" is not updated because the PLC type configured for this tag does not exist.	Check the set address.
250002	The tag in the specified line in "Status Force" is not updated because it is not possible to map the PLC type in the tag type.	Check the set address.
250003	An attempt to connect to the PLC failed. The tags are not updated.	Check the connection to the PLC. Check that the PLC is switched on and is online.

**260000 - Password system alarms**

**260000 - Password system alarms**

Number	Effect/causes	Remedy
260000	An unknown user or an unknown password has been entered in the system. The current user is logged off from the system.	Log on to the system as a user with a valid password.
260001	The logged in user does not have sufficient authorization to execute the protected functions on the system.	Log on to the system as a user with sufficient authorization.
260002	This alarm output when the "TrackUserChange" system function is triggered.	--
260003	The user has logged off from the system.	--
260004	The user name entered into the user view already exists in the user management.	Select another user name because user names have to be unique in the user management.
260005	The entry is discarded.	Enter a shorter user name.
260006	The entry is discarded.	Use a shorter or longer password.
260007	The logoff time entered is outside the valid range from 0 to 60 minutes. The new value entered is discarded and the original value is retained.	Enter a logon timeout value between 0 and 60 minutes.
260008	An attempt was made in WinCC to read a PTProRun.pwl file created with ProTool V 6.0. Reading of the file was canceled due to incompatibility of the format.	--
260009	You have attempted to delete the user "Administrator" or "PLC User". These users are fixed components of the user management and cannot be deleted.	If you need to delete a user, because perhaps you have exceeded the maximum number permitted, delete another user.

Number	Effect/causes	Remedy
260012	The password entries in the "Change Password" dialog and in the confirmation field do not match. The password is not changed. User will be logged off.	You have to log on to the system again. Then enter the identical password twice to be able to change the password.
260013	The password entered in the "Change Password" dialog is invalid because it is already in use. The password is not changed. User will be logged off.	You have to log on to the system again. Then enter a new password that has not been used before.
260014	You have tried to log on with an incorrect password three times in a row. You will be locked out and assigned to group no. 0.	You can log on to the system with your correct password. Only an administrator can change the assignment to a group.
260024	The password you entered does not meet the necessary security guidelines.	Enter a password that contains at least one number.
260025	The password you entered does not meet the necessary security guidelines.	Enter a password that comprises at least three characters.
260028	Upon system start-up, an attempt to log on, or when trying to change the password of a SIMATIC log-on user, the system attempts to access the SIMATIC Logon Server. If attempting to log on, the new user is not logged in. If a different user was logged on before, then this user is logged off.	Check the connection to the SIMATIC Logon Server and its configuration; for example: 1. Port number 2. IP address 3. Server name 4. Functional transfer cable Or use a local user.
260030	The SIMATIC Logon user could not change his password on the SIMATIC Logon Server. The new password is possibly noncompliant with password rules set on the server, or the user is not authorized to change his password. The old password remains and the user is logged off.	Log in again and choose a different password. Check the password rules on the SIMATIC Logon Server.
260033	The action change password or log on user could not be carried out.	Check the connection to the SIMATIC Logon Server and its configuration; for example: 1. Port number 2. IP address 3. Server name 4. Functional transfer cable Or use a local user.
260034	The last logon operation has not yet ended. A user action or a logon dialog can therefore not be called. The logon dialog is not opened. The user action is not executed.	Wait until the logon operation is complete.
260035	The last attempt to change the password was not completed. A user action or a logon dialog can therefore not be called. The logon dialog is not opened. The user action is not executed.	Wait until the procedure is complete.

10.3 Working with alarms

Number	Effect/causes	Remedy
260036	There are insufficient licenses on the SIMATIC Logon Sever. The logon is not authorized.	Check the licensing on the SIMATIC Logon Server.
260037	There is no license on the SIMATIC Logon Sever. A logon is not possible. It is not possible to log on via the SIMATIC Logon Server, only via a local user.	Check the licensing on the SIMATIC Logon Server.
260040	The system attempts to access the SIMATIC Logon Server upon system start-up or when trying to change the password. If attempting to log on, the new user is not logged in. If a different user was logged on before, then this user is logged off.	Check connection to the domain and its configuration in the Runtime security settings editor. Or use a local user.
260043	It was not possible to log the user on to the SIMATIC Logon Server. The user name or the password could be incorrect or the user does not have sufficient rights to log on. The new user is not logged in. If a different user was logged on before, then this user is logged off.	Try again. If necessary, check the password data on the SIMATIC Logon Server.
260044	It was not possible to log the user on to the SIMATIC Logon Server as his account is blocked. The new user is not logged in. If a different user was logged on before, then this user is logged off.	Check the user data on the SIMATIC Logon Server.
260045	The SIMATIC Logon user is not associated to any or several groups. The new user is not logged in. If a different user was logged on before, then this user is logged off.	Check user data on the SIMATIC Logon Server and the configuration in your WinCC project. A user may only be assigned to one group.

270000 - System alarms

270000 - System Alarms

Number	Effect/causes	Remedy
270000	The alarm does not indicate the tag because it is accessing an invalid address in the PLC.	Check whether the data area for the tag exists on the PLC, whether the configured address is correct, and whether the value range for the tag is correct.
270001	There is a device-specific limit as to how many alarms may be queued for viewing (see the operating instructions). This limit has been exceeded. The view no longer contains all the alarms. However, all alarms are written to the alarm buffer.	--

Number	Effect/causes	Remedy
270002	The view shows alarms of a log for which there is no data in the current project. Placeholders are output for the alarms.	Delete old log data, if necessary.
270003	The service cannot be set up because too many devices want to access this service. A maximum of four devices can execute this action.	Reduce the number of HMI devices which want to use the service.
270004	Access to the persistent alarm buffer is not possible. Alarms cannot be restored or backed up.	If the problems persist at the next restart, contact Customer Support (delete Flash).
270005	Persistent alarm buffer corrupted: Alarms cannot be restored.	If the problems persist at the next restart, contact Customer Support (delete Flash).
270006	Project modified: Alarms cannot be restored from the persistent alarm buffer.	The project was compiled and downloaded again to the HMI device. The error should no longer occur at the next restart of the HMI device.
270007	A configuration problem is preventing you from the restoring the data (e.g. a DLL was deleted, or unknown directory).	Update the operating system and download your project again to the HMI device.

## 290000 - Recipe system alarms

### 290000 - Recipe system alarms

Number	Effect/causes	Remedy
290000	The recipe tag could not be read or written. It is assigned the start value. The alarm can be entered in the alarm buffer for up to four more faulty tags. After that, alarm 290003 is output.	Check the configuration to see whether the address has been set up in the PLC.
290001	An attempt was made to assign the recipe tag a value that is outside the valid range of values for this type. The alarm can be entered in the alarm buffer for up to four more faulty tags if necessary. After that, alarm 290004 is output.	Observe the range of values for the tag type.
290002	It is not possible to convert a value from a source format to a target format. The alarm can be entered in the alarm buffer for up to four more faulty recipe tags if necessary. After that, alarm 290005 is output.	Check the range of values or type of the tag.
290003	This alarm is output after alarm 290000 was triggered more than five times. In this case, no further separate alarms are generated.	Check the configuration to see whether the tag addresses have been set up in the PLC.
290004	This alarm is output after alarm 290001 was triggered more than five times. In this case, no further separate alarms are generated.	Observe the range of values for the tag type.

10.3 Working with alarms

Number	Effect/causes	Remedy
290005	This alarm is output after alarm 290002 was triggered more than five times. In this case, no further separate alarms are generated.	Check the range of values or type of the tag.
290006	The limits configured for the tag have been exceeded by the values entered.	Observe the configured or current tag limits.
290007	There is a difference between the source and target structure in the recipe currently being processed. The target structure contains an additional recipe tag that is not available in the source structure. The recipe tag specified is assigned its start value.	Insert the specified recipe tag into the source structure.
290008	There is a difference between the source and target structure in the recipe currently being processed. The source structure contains an additional recipe tag that is not available in the target structure and cannot be assigned. The value is discarded.	Remove the specified recipe tag in the specified recipe from the project.
290010	The storage location configured for the recipe is invalid. Possible causes: Invalid characters, write protection, data carrier out of space or not available.	Check the configured storage location.
290011	A data record of the specified number does not exist.	Check the source for the number (constant or tag value).
290012	A recipe of the specified number does not exist.	Check the source for the number (constant or tag value).
290013	An attempt was made to save a data record under a data record number that already exists. The operation is not executed.	The following remedies are available: <ul style="list-style-type: none"> <li>• Check the source for the number (constant or tag value).</li> <li>• First, delete the data record.</li> <li>• Modify the "Overwrite" function parameter.</li> </ul>
290014	The specified import file was not found.	Check the following: <ul style="list-style-type: none"> <li>• The file name</li> <li>• Ensure that the file is in the specified directory.</li> </ul>
290020	Check back to verify that the download of data records from the HMI device to the PLC has started.	--
290021	Check back to verify that the download of records from the HMI device to the PLC was completed.	--
290022	Check back to indicate that the download of data records from the HMI device to the PLC was canceled due to an error.	Check the following conditions in the configuration: <ul style="list-style-type: none"> <li>• Are the tag addresses configured in the PLC?</li> <li>• Does the recipe number exist?</li> <li>• Does the data record number exist?</li> <li>• Is the "Overwrite" function parameter set?</li> </ul>

Number	Effect/causes	Remedy
290023	Check back to verify that the download of data records from the PLC to the HMI device has started.	--
290024	Check back to verify that the download of data records from the PLC to the HMI device was completed.	---
290025	Check back to indicate that the download of data records from the PLC to the HMI device was canceled due to an error.	Check the following conditions in the configuration: <ul style="list-style-type: none"> <li>• Are the tag addresses configured in the PLC?</li> <li>• Does the recipe number exist?</li> <li>• Does the data record number exist?</li> <li>• Is the "Overwrite" function parameter set?</li> </ul>
290026	An attempt was made to read/write a data record that is not free at present. This error can occur if recipes were configured for download with synchronization.	Set the mailbox status to zero.
290027	Unable to connect to the PLC at present. As a result, the data record cannot be read or written. Possible causes: No hardware connection to the PLC (no cable plugged in, cable is defect), or the PLC is switched off.	Check the connection to the PLC.
290030	This alarm is output after you selected screen which contains a recipe view in which a data record is already selected.	Reload the data record from the storage location, or retain the current values.
290031	While saving, it was detected that a data record with the specified number already exists.	Overwrite the data record, or cancel the action.
290032	During the export of data records, a file with the specified name was found.	Overwrite the file, or cancel the process.
290033	Confirmation prompt before deleting data records.	--
290040	A data record error with error code %1 that cannot be described in more detail occurred. The action is canceled. It is possible that the mailbox was not installed correctly on the PLC.	Check the storage location, the data record, the "Data record" area pointer, and the connection to the PLC. Restart the action after a short waiting time. If the error persists, contact Customer Support. Forward the relevant error code to Customer Support.
290041	A data record or file cannot be saved because the storage location is out of sufficient space.	Delete files no longer required.
290042	An attempt was made to execute several recipe actions simultaneously. The last action is not executed.	Retrigger the action after a short waiting time.
290043	Confirmation prompt before saving data records.	--
290044	The database for the recipe was corrupted and will be deleted.	--
290050	A check back indicates that the export of data records was started.	--
290051	A check back indicates successful completion of the export of data records.	--

10.3 Working with alarms

Number	Effect/causes	Remedy
290052	A check back indicates that the export of data records was canceled due to an error.	Ensure that the structure of the data records at the storage location and the current recipe structure on the HMI device are identical.
290053	A check back indicates that the import of records was started.	--
290054	A check back indicates successful completion of the import of data records.	--
290055	A check back indicates that the import of data records was canceled due to an error.	Ensure that the structure of the data records at the storage location and the current recipe structure on the HMI device are identical.
290056	Error when reading/writing the value in the specified row/column. The action was canceled.	Check the specified row/column.
290057	The tags of the recipe specified were toggled from "offline" to "online" mode. Each change of a tag in this recipe is now immediately transferred to the PLC.	--
290058	The tags of the specified recipe were toggled from "online" to "offline" mode. Modifications to tags in this recipe are no longer immediately transferred to the PLC but must be transferred there explicitly by downloading a data record.	--
290059	A check back indicates that the specified record was successfully saved.	--
290060	A check back indicates that the specified data record memory was cleared.	--
290061	A check back indicates that deletion of the data record memory was canceled due to an error.	--
290062	The data record number exceeds the maximum of 65536. This data record cannot be created.	Select another number.
290063	This occurs when you execute system function "ExportDataRecords" while the "Overwrite" parameter is set to "No". An attempt was made to save a recipe under a file name that already exists. The export is canceled.	Check the parameters of the "ExportDataRecords" system function.
290064	A check back indicates that the deletion of data records was started.	--
290065	A check back indicates successful completion of the deletion of data records.	--
290066	Confirmation prompt before deleting data records.	--
290068	Confirmation prompt for deletion of all recipe data records.	--
290069	Confirmation prompt for deletion of all recipe data records.	--
290070	The data record specified was not found in the import file.	Check the source of the data record number, or the data record name (constant, or tag value).



Number	Effect/causes	Remedy
290071	When the editing data record values, you entered a value that is below the low limit of the recipe tag. The entry is discarded.	Enter a value within the recipe tag limits.
290072	When editing data record values, you entered a value that exceeds the high limit of the recipe tag. The entry is discarded.	Enter a value within the recipe tag limits.
290073	An action (e.g. saving a record) failed for an unknown reason. The error corresponds to status alarm IDS_OUT_CMD_EXE_ERR in the large recipe view.	--
290074	While saving, a data record with the specified number but with different name was found.	Overwrite the record, change the record number or cancel the action.
290075	A data record of this name already exists. The data record is not saved.	Select a different data record name.
290110	The default values could not be set due to an error.	--
290111	The recipes subsystem cannot be used. Recipe views have no content and recipe-specific functions will not be executed. Possible causes: <ul style="list-style-type: none"> <li>• Error when loading the recipes.</li> <li>• The recipe structure was changed in the ES. The recipes were not included in the latest project download. This means that the new configuration data no longer matches the old recipes on the device.</li> </ul>	Download the project to the device again, including the recipes (the corresponding check box in the download dialog must be check marked).

### 300000 - Alarm\_S alarms

### 300000 - Alarm\_S alarms

Number	Effect/causes	Remedy
300000	Faulty configuration of process monitoring (e.g. using PDiag or S7 Graph): More alarms are queued than specified in the specifications of the CPU. No further ALARM_S alarms can be managed by the PLC and reported to the HMI devices.	Change the PLC configuration.
300001	ALARM_S is not registered on this PLC.	Select a controller that supports the ALARM_S service.

10.3 Working with alarms

**310000 - Reporting alarms**

**310000 - Reporting alarms**

Number	Effect/causes	Remedy
310000	An attempt is being made to print too many reports in parallel. Only one log file can be output to the printer at a given time; the print job is therefore rejected.	Wait until the previous active log was printed. Repeat the print job if necessary.
310001	An error occurred on triggering the printer. The report is either not printed or printed with errors.	Evaluate the additional system alarms related to this alarm. Repeat the print job if necessary.

**330000 - Interaction alarms**

**330000 - Interaction alarms**

Number	Effect/causes	Remedy
330022	Too many open dialogs on the HMI device.	Close all dialogs you do not require on the HMI device.

**350000 - PROFIsafe alarms**

**350000 - PROFIsafe alarms**

Number	Effect/causes	Remedy
350000	PROFIsafe packets were not received within the specified time. There is a communication problem with the F-CPU. RT is terminated.	Check the WLAN connection.
350001	PROFIsafe packets were not received within the specified time. There is a communication problem with the F-CPU. The PROFIsafe connection is set up again.	Check the WLAN connection.
350002	Internal error. Runtime is terminated.	Internal error
350003	Check back for indicating the connection setup to the F-CPU. The Emergency-Off buttons are active immediately.	--

Number	Effect/causes	Remedy
350004	PROFIsafe communication was set up and the connection was shut down. Runtime can be terminated. The Emergency-Off buttons are deactivated immediately.	--
350005	Incorrect address configured for the F-Device. A PROFIsafe connection cannot be set up.	Check and modify the address of the F-Device in WinCC ES.
350006	The project was started. At the start of the project, check the proper function of the ACK buttons.	Press the two ACK buttons successively in the "Acknowledge" and "Panic" positions.
350008	You configured an incorrect number of failsafe buttons. A PROFIsafe connection cannot be set up.	Modify the number of failsafe buttons in the project.
350009	The device is in Override mode. It may no longer be possible to detect the location because transponder detection fails.	Exit the override mode.
350010	Internal error: The device has no failsafe buttons.	Return the device to Siemens. Worldwide contact partners

## 10.3.6 Configuring system diagnostics

### 10.3.6.1 System diagnostics basics

#### Introduction

You use system diagnostics to detect problems and errors in any part of your plant. WinCC has two display and operating elements for quick error localization.

#### System diagnostics view

The alarm view shows the status of a PLC while the system diagnostics view gives you an overview of all devices available in your plant: You navigate directly to the cause of the error and to the relevant device. You have access to all diagnostics-capable devices which you have configured in the "Devices & networks" editor.

#### System diagnostics window

The system diagnostics window is an operating and display element that you can only use in the global screen.

### 10.3 Working with alarms

The functions of the system diagnostics window are no different than those of the system diagnostics view. Because the system diagnostics window is configured in the global screen, you can, for example, also specify if the object is closable in Runtime.

---

#### **Note**

##### **System diagnostics on Basic Panels**

The "System--Diagnostics window" object is not available for Basic Panels.

---

#### **See also**

System diagnostics views (Page 3372)

#### **10.3.6.2 System diagnostics views**

##### **Introduction**

There are four different views available in the system diagnostics view and the system diagnostics window.

- Device view
- Diagnostic buffer view
- Detail view
- Matrix view (for master systems, PROFIBUS, PROFINET only)

## Device view

The device view shows all the available devices of a layer in a table. Double-clicking on a device opens either the child devices or the detail view. Symbols in the first column provide information about the current status of the device.

Diagnostic overview

Status	Name	Ope...	Slot	Type
	Rack_1			
	PLC_1			
	CP 443-1			
	DI_1			
	DI_2			
	PS_1			

Navigation icons: Home, Previous, Next, Refresh

## Diagnostic buffer view

In the diagnostic buffer view, the current data from the diagnostic buffer of the device is displayed. The diagnostic buffer view can only be called up in the device view.

To update the diagnostic buffer view, you click

AS\_1/Rack\_1/PLC\_1/PLC log

Nr.	Datum	Uhrzeit	Ereignis
1	25.11.2010	14:58:35.163	Betriebszustandsübergang von ANLAUF nach RUN
2	25.11.2010	14:58:35.163	Manuelle Neustart (Warmstart)-Anforderung
3	25.11.2010	14:58:31.451	Betriebszustandsübergang von STOP nach ANLAUF
4	25.11.2010	14:58:31.451	Neue Anlaufinformation im Betriebszustand STOP
5	25.11.2010	14:58:19.635	Neue Anlaufinformation im Betriebszustand STOP
6	25.11.2010	14:58:19.615	Neue Anlaufinformation im Betriebszustand STOP
7	25.11.2010	14:57:03.693	Neue Anlaufinformation im Betriebszustand STOP
8	25.11.2010	14:57:03.300	Urlöschen durchgeführt
9	25.11.2010	14:57:03.300	Start Urlöschen automatisch (ungepuffertes NETZ-EIN)

Navigation icons: Home, Previous, Next, Refresh

### Detail view

The detail view gives detailed information about the selected device and the pending errors. Check whether the data is correct in the detail view. You cannot sort error texts in the detail view.

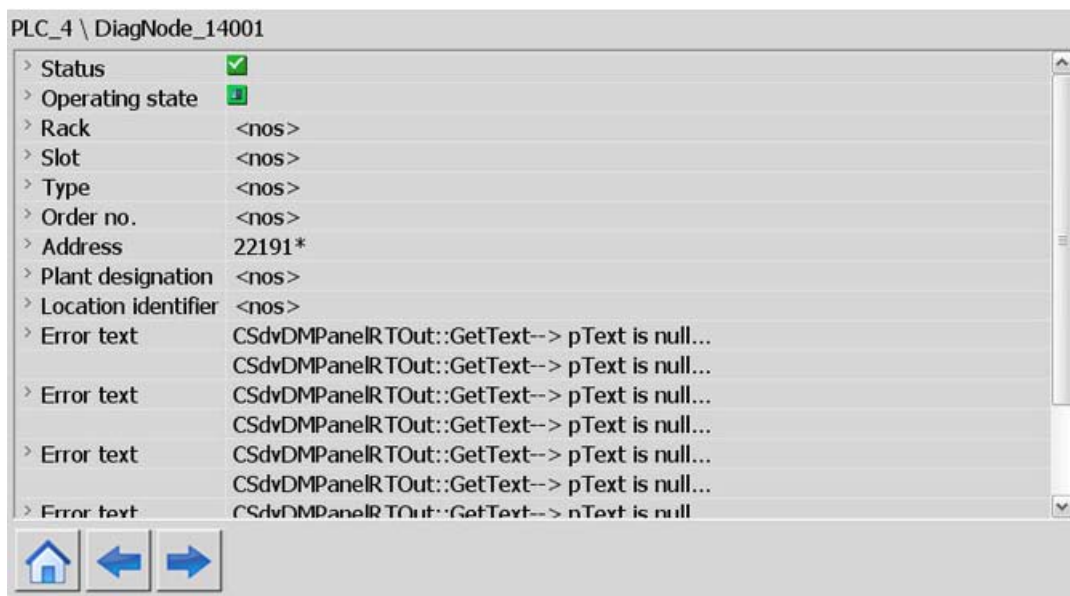

#### Note

##### Contents of the detail view

The contents of the detail view are only available for integrated connections with S7 1200 and S7 1500 PLCs.





## Matrix view

The matrix view is only available for master systems. In the matrix view you can see the status of the subdevices of the master system.

- In PROFIBUS, the numbers assigned by PROFIBUS are used as identification (DP station number).
- The IO devices are numbered consecutively beginning with 1 in PROFINET.



## Navigation buttons

Button	Key	Function
	Enter key	Opens the child devices or the detail view if there are no child devices.
	Esc key	Opens the parent device or the device view if there is no parent device.
	Home key	Opens the device view.
	Configured function key, e.g. F1.	Opens the diagnostic buffer view. Only visible in the device view.
	Configured function key, e.g. F2.	Updates the diagnostic buffer view.

---

**Note**

**Navigation in the matrix view of Comfort Panels with function keys**

The Shift key is additionally used to select PNIO or PROFIBUS slaves in the matrix view.

---

### Language switching in runtime

Switch over the language in runtime before you open the details view.

If you switch over the runtime language while the details view is opened, you change back to the diagnostic buffer view.

Open the details view again. The selected runtime language is now displayed correctly.

### See also

System diagnostics basics (Page 3371)

### 10.3.6.3 Basic Panel basics

### System diagnostics basics

#### Introduction

Using system diagnostics, you can display the messages from the diagnostic buffer of all integrated connections.

#### System diagnostics view

The system diagnostics display is an operating and display object that you use in a screen.

You navigate directly to the cause of the error and the associated connection. You have access to all integrated connections that you have configured in the "Devices & networks" editor.

#### System diagnostics views

##### Introduction

Three different views are available in the simple system diagnostic view.

- Device view
- Diagnostic buffer view
- Detail view



## Device view

The device view is only displayed if more than one integrated connection has been configured.

The device view shows all available connections in a table. Double-clicking a connection opens the diagnostic buffer view.

1	HMI_connection	▲
2	HMI_connection_1	▲▲
3	HMI_connection_3	
4	HMI_connection_4	←
		→
		↻
		▼▼
		▼

## Diagnostic buffer view

The diagnostic buffer view shows the current data from the diagnostic buffer.

To update the diagnostic buffer view, you click .

1	1/1/1994 2:18:49 AM Mode transition from STARTUP to RUN	▲
2	1/1/1994 2:18:48 AM Request for manual warm restart	▲▲
3	1/1/1994 2:18:48 AM Mode transition from STOP to STARTUP	
4	1/1/1994 2:18:48 AM New startup information in STOP mode	
5	1/1/1994 2:18:37 AM New startup information in STOP mode	
6	1/1/1994 2:18:37 AM STOP caused by stop switch being activated	
7	1/1/1994 12:09:09 AM Distributed I/Os: station return	←
8	1/1/1994 12:09:09 AM I/O access error when transferring the process image to the outpu...	→
9	1/1/1994 12:09:09 AM I/O access error when transferring the process image to the outpu...	↻
10	1/1/1994 12:09:09 AM I/O access error when transferring the process image to the outpu...	
11	1/1/1994 12:09:09 AM I/O access error when transferring the process image to the outpu...	
12	1/1/1994 12:09:09 AM I/O access error when transferring the process image to the outpu...	
13	1/1/1994 12:09:09 AM I/O access error when transferring the process image to the outpu...	
14	1/1/1994 12:09:09 AM I/O access error when transferring the process image to the outpu...	▼▼
15	1/1/1994 12:09:09 AM I/O access error when transferring the process image to the outpu...	▼

### Detail view

The detail view gives detailed information about the selected connection and any pending errors. Check whether the data is correct in the detail view.

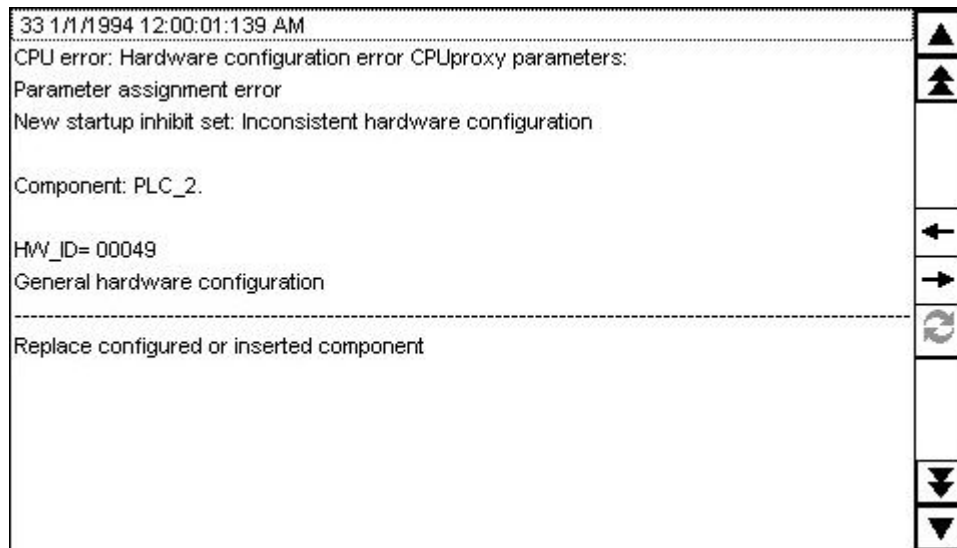



#### Note

##### Contents of the detail view

The contents of the detail view are only available for integrated connections with S7 1200 and S7 1500 PLCs.

### Navigation buttons

Button	Key	Function
	Enter key	In the device view: Opens the diagnostic buffer view of the selected device.  In the diagnostic buffer view: Opens the detail view.
	Esc key	In the diagnostic buffer view: Opens the device view.  In the detail view: Opens the diagnostic buffer view.
	Configured function key, e.g. F1.	Updates the diagnostic buffer view.

### 10.3.6.4 Configuring system diagnostics objects

#### Enabling system diagnostics in the PLC

##### Introduction

During communication with the SIMATIC S7 1500 and SIMATIC S7 1200 PLCs, system diagnostics is automatically activated.

For other PLCs, the following settings must be implemented in the PLC to enable the PLC to transfer error messages to the system diagnostics view.

##### Requirements

- A PLC such as SIMATIC S7 300/400 or ET 200 has been created.
- The "Devices & Networks" editor is open in the "Device view".

##### Procedure

1. Select the PLC in the selection list.
2. Click on the PLC and select "Properties" in the shortcut menu. The properties of the PLC are displayed in the Inspector window.
3. Select "Properties > General > System diagnostics" in the Inspector window.
4. Enable "Activate system diagnostics for this CPU".
5. Select the PLC and then "Compile > Hardware configuration" in the shortcut menu.

##### Result

The settings will be effective following compilation. The PLC can now transfer error messages to the system diagnostics display.

#### Adding a system diagnostics indicator

##### Introduction

The system diagnostics indicator is a predefined graphic symbol of the library which alerts you to errors in your system.

If an error occurs, the appearance of the object changes. The library object can display two states:

- No error
- Error

## **Requirement**

- The "Libraries" task card is opened.
- The global library "Buttons and Switches > Master copies > DiagnosticsButtons" is open.
- A screen is open.
- A system diagnostics window has been created in the global screen.

## Procedure

1. Select the "DiagnosticsIndicator" object in the library.

### Note

#### System diagnostics indicator for different device types

When selecting the object ensure that you use the correct object for the device type used in the project.

2. Drag-and-drop the library object to the position in the work area where you want to insert the object.  
The library object is inserted.

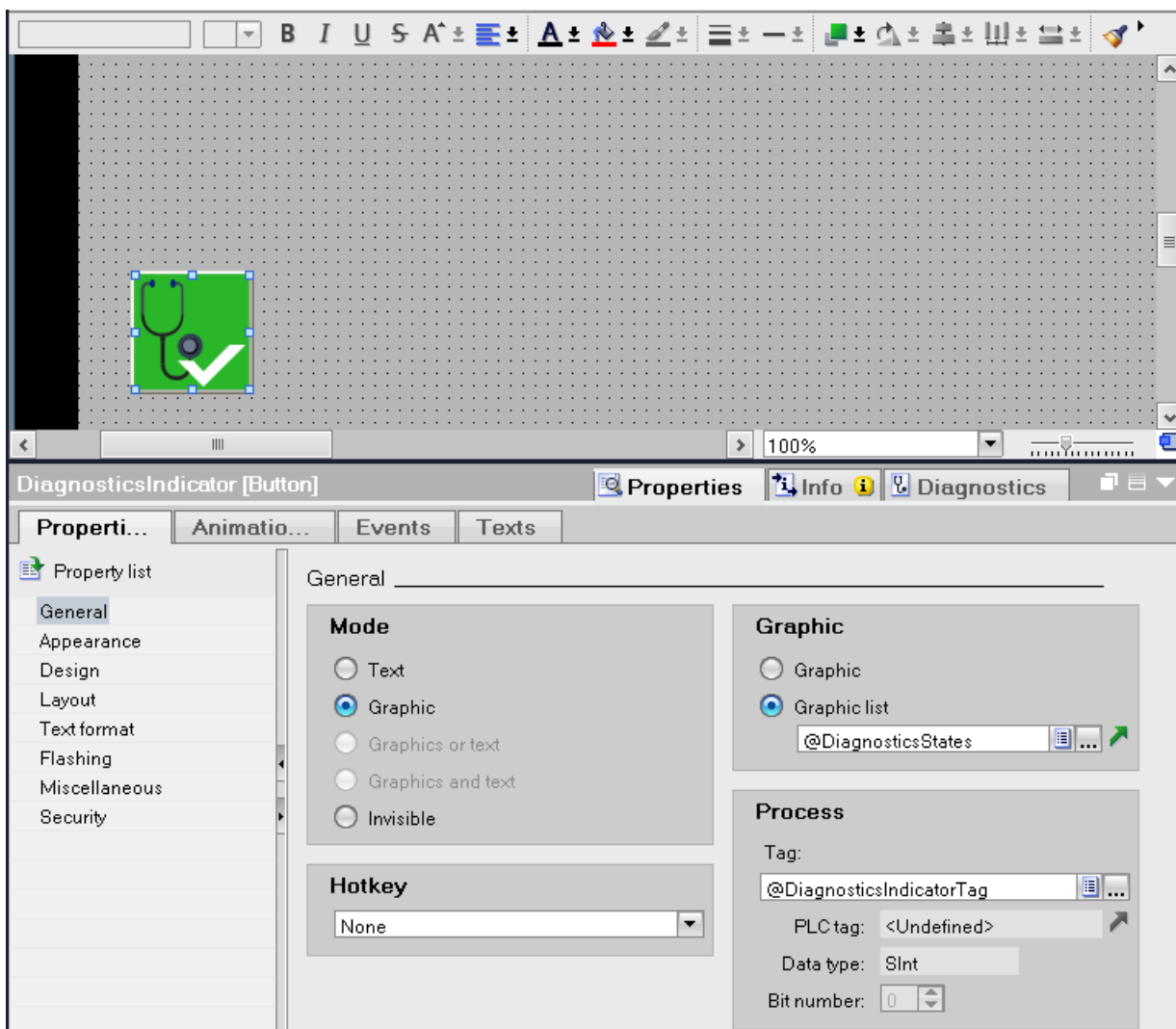

3. Select the library object.
4. Click "Properties > Events" in the Inspector window.  
The system function "ShowSystemDiagnosticsWindow" is preset for the event "Click".

## Result

The status diagnostics indicator has been added to the project and connected with the system diagnostics window.

The system diagnostics indicator changes its appearance if an error message is output in Runtime. The system diagnostics window opens when you click on the system diagnostics indicator. The system diagnostics window shows the detail view of the affected device.

## Configuring access protection for the system diagnostics window

Configure access protection for the system diagnostics indicator to prevent unauthorized access to the system diagnostics window.

1. Select the "DiagnosticsIndicator" object in the screen.
2. Select an authorization in "Properties > Properties > Security in Runtime" in the Inspector window.

A logon dialog opens when you click on the system diagnostics indicator in Runtime. The system diagnostics window does not open unless you have the required authorization.

## Configuring a system diagnostics window in the global screen

### Introduction

The system diagnostics window gives you an overview of all devices available in your plant. The system diagnostics window operates like the system diagnostics view, but it is only available in the global screen.

### Requirements

- At least one PLC has been created.
- The option "Activate system diagnostics for this CPU" is activated on each PLC.
- A Comfort Panel or WinCC RT Advanced has been created.
- The global screen is open.
- The Inspector window is open.

### Procedure

1. Double-click the "System diagnostics window" object in the "Tools" task card. The object is added to the global screen.
2. Select "Properties > Properties > Columns > Devices/Detail view" in the Inspector window.
3. Enable the columns that you require in the device view for Runtime, for example: status, name, address.
4. Enable the properties which you require in the detail view for Runtime, for example: status, name, plant designation.

5. Activate the columns that you require in the diagnostic buffer view, for example, status, name.
6. Customize the column headers, if necessary.
7. Enable "Properties > Properties > Layout > Column settings > Columns moveable" to move the columns in Runtime.
8. Enable "Properties > Properties > Window > Closable" to allow the system diagnostics window to be closed in Runtime.

## Result

The system diagnostics window has been added to the global screen. The system diagnostics window will respond to error messages in the plant and display the device affected.

Configure a system diagnostics indicator in a screen to open the system diagnostics window.

## Configuring button as system diagnostics indicator

### Introduction

Instead of using the object "DiagnosticsIndicator" from the library, you can configure a button, for example, to indicate errors in your plant.

### Requirements

- At least one PLC has been created.
- The option "Activate system diagnostics for this CPU" is activated on each PLC.
- The "Tools" task card is open.
- A bit graphics list has been created with two different graphics for the statuses.
- A screen is open.
- You have created a system diagnostics view.

### Procedure

1. Double-click the "Button" object in the "Tools" task card. A button will be added to the screen.
2. In the Inspector window, select "Properties > Properties > General > Mode > Graphic".
3. Select the bit graphics list under "Graphic > Graphics list".
4. Select the "@DiagnosticsIndicatorTag" tag under "Properties > Properties > General > Tag" in the Inspector window.

### Configuring system function to the button

1. Click "Properties > Events" in the Inspector window.
2. Select the "Click" event.

### 10.3 Working with alarms

3. Click on "Add function" in the table.
4. Select the "ActivateSystemDiagnosticsView" system function.
5. Select the system diagnostics view.

## Result

You have now configured a button which will respond to error messages from the PLC. The button changes its appearance if an error message is output in Runtime.

The button has two states:

- Error  
The system diagnostics view opens when you click the button. The system diagnostics view shows the detail view of the device concerned.
- No error  
The system diagnostics view opens when you click the button. The system diagnostics view shows the device view.

## Configuring the system diagnostic view

### Introduction

You add a system diagnostics view to your project to get an overview of all devices available in your plant.

### Requirements

- At least one PLC has been created.
- The option "Activate system diagnostics for this CPU" is activated on each PLC.
- A Comfort Panel or WinCC RT Advanced has been created.
- You have created a screen.
- The Inspector window is open.

### Procedure

1. Double-click the "System diagnostics view" object in the "Tools" task card. The object is added to the screen.
2. Select "Properties > Properties > Columns > Devices/Detail view" in the Inspector window.
3. Activate the columns that you require in the device view for Runtime, e.g. Status, Name, Slot.
4. Activate the columns that you require in the device view for Runtime, e.g. Status, Name, Plant designation.
5. Activate the columns that you require in the diagnostic buffer view, for example, Status, Name.



6. Enable "Properties > Properties > Layout > Column settings > Columns moveable" to move the columns in Runtime.
7. You can change the column headers under "Properties > Properties > Column headers", if necessary.

## Result

The system diagnostics view has been added to the screen. Error for the entire plant are now displayed in the system diagnostics view in Runtime.

## Configuring the system diagnostic view

### Introduction

For an overview of all integrated connections, you insert a system diagnostics view in your project.

### Requirements

- A PLC has been created.
- A Basic Panel has been created.
- An integrated connection has been created in the "Devices & Networks" editor.
- You have created a screen.
- The Inspector window is open.

### Procedure

1. Double-click the "System diagnostics view" object in the "Tools" task card. The object is added to the screen.
2. In the Inspector window, select "Properties > Layout".
3. Enter a number under "Lines per entry", i.e. 5.

## Result

The system diagnostics view has been added to the screen.

To obtain the latest alarms, update the diagnostic buffer.

## Splitting the view in system diagnostics view

### Introduction

The system diagnostics view also offers a split view of the display. You have the option to see the devices and the associated details at a glance.

## Requirements

- At least one PLC has been created.
- The option "Activate system diagnostics for this CPU" is activated on each PLC.
- An HMI device has been created, for example, a Comfort Panel.
- You have created a screen.
- The Inspector window is open.

## Procedure

1. Double-click the "System diagnostics view" object in the "Tools" task card. The object is added to the screen.
2. In the Inspector window, click "Properties > Properties > Layout".
3. Activate "Show split view".
4. Activate "Sizing > Auto-size"
5. You may also change the number of lines for the "Device view" and the "Detail view" if required.

## Result

The system diagnostics view has been added to the screen. The system diagnostics view is split into two areas.

The top area shows the device view. The bottom view shows the detail view.

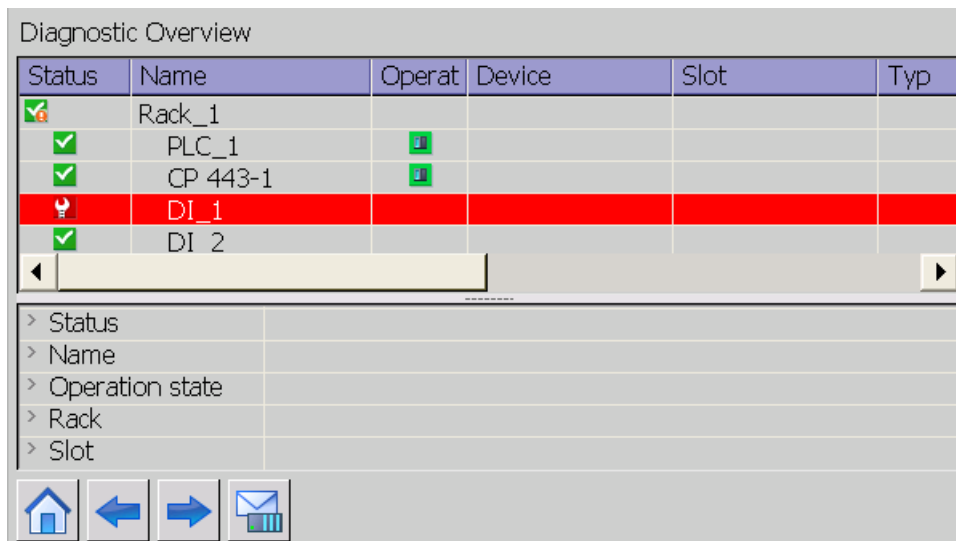

The screenshot shows a window titled "Diagnostic Overview" with a table of system components. The table has columns for Status, Name, Operat, Device, Slot, and Typ. The components listed are Rack\_1, PLC\_1, CP 443-1, DI\_1, and DI 2. The DI\_1 row is highlighted in red, indicating an alarm or error state. Below the table is a scrollable area with expandable sections for Status, Name, Operation state, Rack, and Slot. At the bottom of the window are navigation icons: a home icon, a left arrow, a right arrow, and a refresh icon.

Status	Name	Operat	Device	Slot	Typ
✓	Rack_1				
✓	PLC_1	!			
✓	CP 443-1	!			
!	DI_1				
✓	DI 2				

If you open the diagnostic buffer view, the top area displays an overview of the diagnostic buffer and the bottom area displays the details.

AS_1Rack_1PLC_1 PLC log			
Nr.	Datum und Uhrzeit	Ereignis	
1	25.11.2010 14:58:35.163	Betriebszustandsübergang von ANLAUF nach RUN	
2	25.11.2010 14:58:35.163	Manuelle Neustart (Warmstart)-Anforderung	
3	25.11.2010 14:58:31.451	Betriebszustandsübergang von STOP nach ANLAUF	
4	25.11.2010 14:58:31.451	Neue Anlaufinformation im Betriebszustand STOP	
5	25.11.2010 14:58:19.635	Neue Anlaufinformation im Betriebszustand STOP	
6	25.11.2010 14:58:19.615	Neue Anlaufinformation im Betriebszustand STOP	
7	25.11.2010 14:57:03.693	Neue Anlaufinformation im Betriebszustand STOP	
8	25.11.2010 14:57:03.300	Urlöschen durchgeführt	

Betriebszustandsübergang von ANLAUF nach RUN

Anlaufinformation:

- Uhr für Zeitstempel bei letztem NETZ-EIN nicht gepuffert
- Einprozessorbetrieb

Aktuelle/letzte durchgeführte Anlaufart:

- Neustart (Warmstart) über Betriebsartenschalter, letzter NETZ-EIN ungepuffert

Zulässigkeit bestimmter Anlaufarten:

---

**Note****Contents of the detail view**

The contents of the detail view are only available for integrated connections with S7 1200 and S7 1500 PLCs.

---

## 10.4 Working with logs

### 10.4.1 Working with logs for Runtime Advanced and Panels

#### 10.4.1.1 Log Basics

##### Introduction

WinCC provides the following types of log for logging process data for HMI Runtime:

- Data logs
- Alarm logs

A data log is used to log process data from an industrial plant.

An alarm log is used to log alarms that occur in the monitored process.

##### Principle

The two types of log both have roughly the same structure and largely work in the same way. They are very clear and easy to configure. With both types of log you define the same properties for the log. The same logging methods are also available for both types of log.

The following logging methods are available:

- Circular log  
If a circular log is totally full, the oldest entries are overwritten.
- Segmented circular log  
In a segmented circular log, multiple single logs of the same size are filled in succession. When all log segments are filled, the oldest log segment is overwritten.
- Log with level-dependent system alarm  
A system alarm is triggered when a defined level is reached.
- Log with level-dependent triggering of an event  
The "Overflow" event is triggered when the log is full. The "Overflow" event triggers a system function.

#### 10.4.1.2 Properties of Logs

##### Introduction

You define the properties of a data log in the "Data logs" editor.

You define the properties of an alarm log in the "Alarm log" editor.

The properties of the data log and alarm log are configured in the same way. You configure the properties either directly in the table of the respective editor or in the log properties of the Inspector window.

## General properties

- **Name**  
You can assign any name to the log. The name must contain at least one letter or one number.
- **Storage location**  
The log is stored in a file or a database. You can only save to a database on a PC. Select "File" or "Database" as the storage location.  
You can specify a folder on the local PC hard disk or a folder on a network drive as the storage location, depending on how the HMI device is configured. The following storage locations are available for an HMI device:
  - Memory card
  - USB storage medium
  - Network driveThe selection available depends on the HMI device in use.
- **Size**  
The size of a log depends on the type of log and the selected settings.
  - **Size of a data log**  
The size of a data log is calculated as follows:  
The number of items \* the length of each tag value to be logged.  
In the "Properties" window, the maximum size that the log accepts for retention of the currently selected number of data records is displayed in the input field "Number of data records". The maximum log size is limited by the volume of the storage medium.
  - **Size of an alarm log**  
The size of an alarm log is calculated from the number of data records and the approximate size of an entry. The size of an entry depends on whether the alarm text and the associated tag values are to be logged as well.
- **Restart characteristics**  
Under Restart characteristics you can specify that the logging starts when Runtime starts. Check the "Enable logging at runtime start" check box.  
You can also control the behavior when Runtime starts. Enable "Reset log" if you want to overwrite existing logged data with the new data. Select the "Append data to existing log" option if you want to retain the existing logged data. This setting adds the data to be logged to an existing log.

See "Auto-Hotspot" and "Auto-Hotspot" for more details.

---

### Note

You can use system functions to control the restarting of a log in Runtime.

---

### Automatic log entries

In Runtime, the following log entries are created as standard:

Entry	File format	Log type	Meaning
\$RT_DIS\$	Any	Data log	Indicates that the connection to the log was interrupted at this point in time. (A bold line is shown in the trend display for this time period.)
\$RT_OFF\$	Any	Data log	Indicates that Runtime was shut down at this point in time. (No line is shown in the trend display for this time period.)
\$RT_ERR\$	Any	Data log Alarm log AuditTrail	Indicates in the target log that a copy operation was not successful or was interrupted. (The log copy was not fully created.)
\$RT_COUNT	*.CSV *.TXT	Data log Alarm log AuditTrail	This entry was created at the end of the log and serves to increase the system performance when Runtime starts.

## 10.5 Working with recipes

### 10.5.1 Basics

#### 10.5.1.1 Definition and applications

##### Introduction

Recipes are collections of related data, for example, machine parameterizations or production data.

---

##### **Note**

##### **Restrictions for recipes**

Recipes are not available on the HMI device OP 73:

---

Examples:

- Machine parameter settings that are needed to convert production to a different product variant.
- Product components that result in different compositions for different end products.

A recipe has a fixed data structure. The structure of a recipe is defined during configuration. A recipe contains recipe data records. These differ in terms of their values, but not their structure.

Recipes are stored on the HMI device or on an external storage medium. Recipe data records are always transferred complete and in a single pass between the HMI device and the PLC. In addition, production data can be imported in runtime, in the form of a CSV file.

---

##### **Note**

##### **Restrictions for Import / Export**

It is not possible to export or import the recipes for the following HMI devices:

- Basic Panels
- OP 77A
- OP 177A
- TP 177A (Portrait)

Complete recipe data, but not single recipe data records, can be exported and imported using ProSave in CSV format and transferred to the HMI device. Thereby, Runtime is interrupted.

---

## Using recipes

Recipes can be used in the following situations:

- **Manual production**  
You select the required recipe data and display it on the HMI device. You modify the recipe data as required and save it on the HMI device. You transfer the recipe data to the PLC.
- **Automatic production**  
The control program starts transfer of the recipe data between the PLC and HMI device. You can also start the transfer from the HMI device. Production is then implemented automatically. It is not essential to display or modify the data.
- **Teach-in mode**  
You optimize production data that was optimized manually on the system, e.g. axis positions or filling volumes. The values thus determined are transferred to the HMI device and saved in a recipe data record. You can then transfer the saved recipe data back to the PLC at a later date.

## Entering and modifying the recipe data

You enter the data in the individual recipe data records and modify it as required. The following options are available:

- **Data entry during configuration**  
If the production data exists already, you enter the data in the "Recipes" editor during recipe configuration.
- **Entering the data in Runtime**  
If you have to frequently modify production data, you can do this directly in Runtime as follows:
  - Enter the data directly on the HMI device.
  - Set the parameters directly on the machine. You then transfer the data from the PLC to the HMI device and save it in the recipe.



### 10.5.1.2 Examples for using recipes

Recipes are used in the manufacturing industry and mechanical engineering, for example. The following recipes show typical applications which you can implement with the recipe function of WinCC:

- **Machine parameter assignment**  
One field of application for recipes is the assignment of machine parameters in the manufacturing industry: A machine cuts wooden boards to a certain size and drills holes. The guide rails and drill have to be moved to new positions according to the board size. The required position data are stored as data records in a recipe. You reassign the machine parameters using "Teach in" mode if, for example, a new board size is to be processed. You transfer the new position data directly from the PLC to the HMI device and save it as a new data record.
- **Batch production**  
Batch production in the food processing industry represents another field of application for recipes: A filling station in a fruit juice plant produces juice, nectar, and fruit drinks in a variety of flavors. The ingredients are always the same, differing only in their mixing ratios. Each flavor corresponds to a recipe. Each mixing ratio corresponds to a data record. All of the required data for a mixing ratio can be transferred to the machine control at the touch of a button.

### 10.5.1.3 Recipe structure

#### Introduction

The basic structure of a recipe is illustrated with reference to the filling station in a fruit juice plant.

There may be several different recipes in an HMI device. A recipe can be compared to an index card box that contains several index cards. The index card box contains several variants for manufacturing a product family. All the data for each manufacturing variant is contained on a single index card.

Example:

In a soft drinks production plant, a recipe is needed for different flavors. Drink variants include fruit juice drink, juice and nectar.

## Recipe

The recipe contains all the recipe data records for the different drink variants.

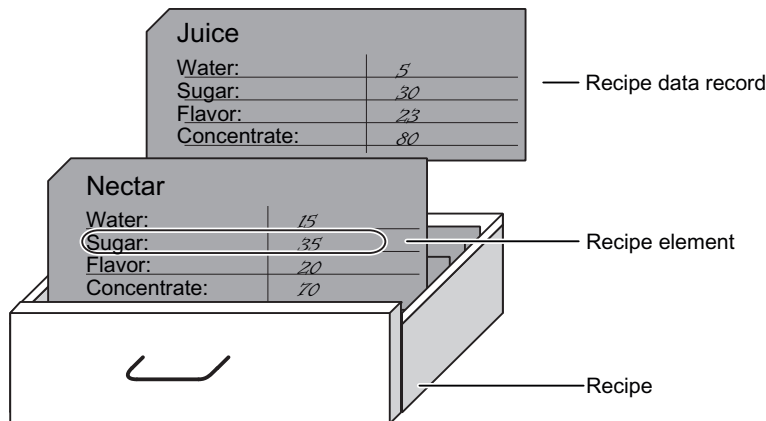

## Recipe data records

Each index card represents a recipe data record needed to manufacture a product variant.

## Recipe entries

Each index card in a drawer has the same structure. All the index cards contain fields for the different ingredients. Each field corresponds to a recipe entry. All the records of a recipe thus contain the same entries. The records differ, however, in the value of the individual entries.

Example:

All the drinks contain the following ingredients:

- Water
- Concentrate
- Sugar
- Flavoring

The records for juice drink, fruit juice or nectar differ, however, in the quantity of sugar used in production.

### 10.5.1.4 Display of recipes

#### Introduction

You can display recipes in the following ways:

- Recipe view
- Recipe screen

#### Input in the recipe view and recipe screen

You change the values of a recipe in the recipe screen or recipe view and thus modify the manufacturing process or a machine.

The recipe view and recipe screen can perform the same functions when using recipes. They differ in the following respects:

- Display options
- Operation
- Possibility of transferring data between the PLC and the HMI device

#### Recipe view

The recipe view is suitable for viewing simple recipes.

The recipe view is an off-the-shelf WinCC display and operator control object for managing recipe data records. The recipe view is always part of a screen. The recipe view shows recipe data records in tabular form. You adapt the appearance and the possible operations to suit your specific needs.

Recipe Name:	No.:
Recipe_1	1
Data Record Name:	No.:
Recipe data_1	1
Entry Name	Value
Recipe element_1	0

If you are editing recipes with a recipe view in your project, the values are saved in recipe data records. The values are not transferred between the HMI device and PLC until you use the relevant operator control object.

## Recipe screen

The recipe screen is an individual screen that contains:

- Input fields for recipe variables
- Operator control objects for using the recipes, e.g. "SaveDataRecord"

Water	40	l
Concentrate	70	l
Sugar	30	kg
Flavoring	30	l

Recipe name: Orange No.: 1

Data record name: Nectar No.: 2

Buttons: Save, Load, Data from the PLC, Data to PLC

The recipe screen is suitable in the following situations:

- Large recipes
- Allocation of recipe fields to the graphic display of the relevant plant area
- Breakdown of the recipe data into several screens

---

### Note

The values of recipe variables are transferred between the PLC and recipe screen at the following times depending on the configuration:

- Immediately after modification
  - When a relevant operator control object is used
- 

## Synchronizing recipe view and recipe screen

There may be differences in Runtime between the values displayed in the recipe view and the values saved in the associated tags when you edit recipes in both a recipe view and a recipe screen. To prevent this, you must synchronize the recipe data record values with the values of the recipe tags.

A complete recipe data record will always be saved or synchronized.

---

### Note

Recipe tags can only be synchronized in the advanced recipe view. Synchronization only takes place if the "Synchronize recipe view and recipe tags" setting is activated for the recipe.

---

### 10.5.1.5 Transferring recipe data records

#### Flow of data in recipes

The following picture illustrates the flow of data in recipes:

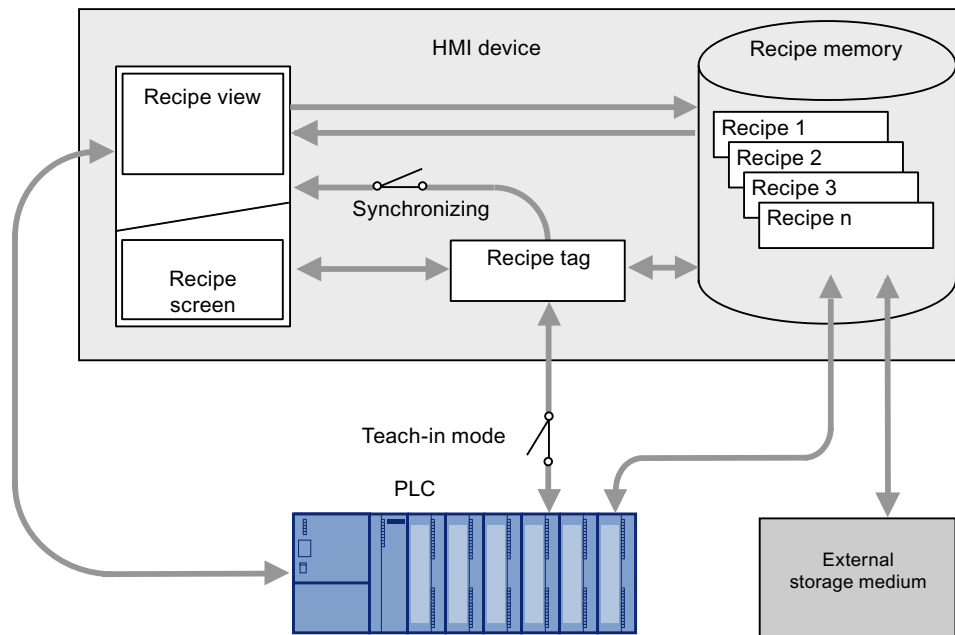

#### Interaction between the components

There is interaction between the following components at runtime:

- **Recipe view / recipe screen**  
On the HMI device, recipes are displayed and edited in the recipe view or in a recipe screen:
  - The recipe data records from the internal memory of the HMI device are displayed and edited in the recipe view.
  - The values of the recipe tags are displayed and edited in the recipe screen.
 You synchronize the values displayed in the recipe view with the values of recipe tags according to the configuration.
- **HMI device recipe memory**  
Recipes are saved in the form of recipe data records in the HMI device's recipe memory.
- **Recipe tags**  
The recipe tags contain recipe data. When you edit recipes in a recipe screen, the recipe values are stored in recipe tags. The point at which the values of the recipe tags are exchanged with the PLC depends on the configuration.

#### Note

You can synchronize the recipe tags with the recipe data records so that the same values are saved in both.

### Loading and saving recipe data

Complete recipe data records are loaded from or saved to the recipe memory on the HMI device in the recipe view.

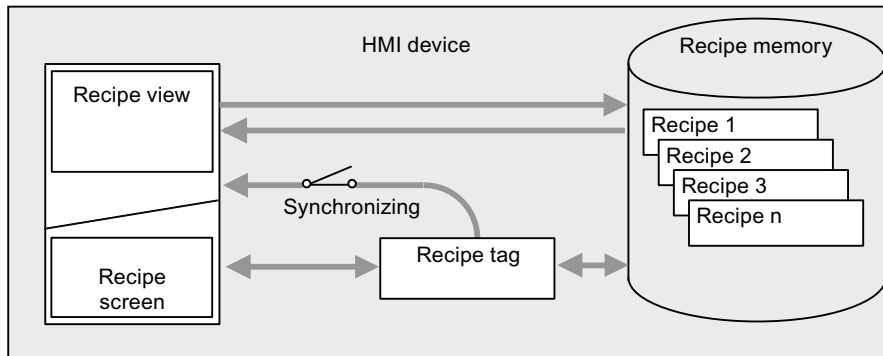

The values of the recipe data record are loaded from the recipe memory to the recipe tags in the recipe screen. When they are saved, the values of the recipe tags are saved to a recipe data record in the recipe memory.

### Transferring the recipe values between the HMI device and the PLC

Complete recipe data records are transferred between the recipe view and PLC.

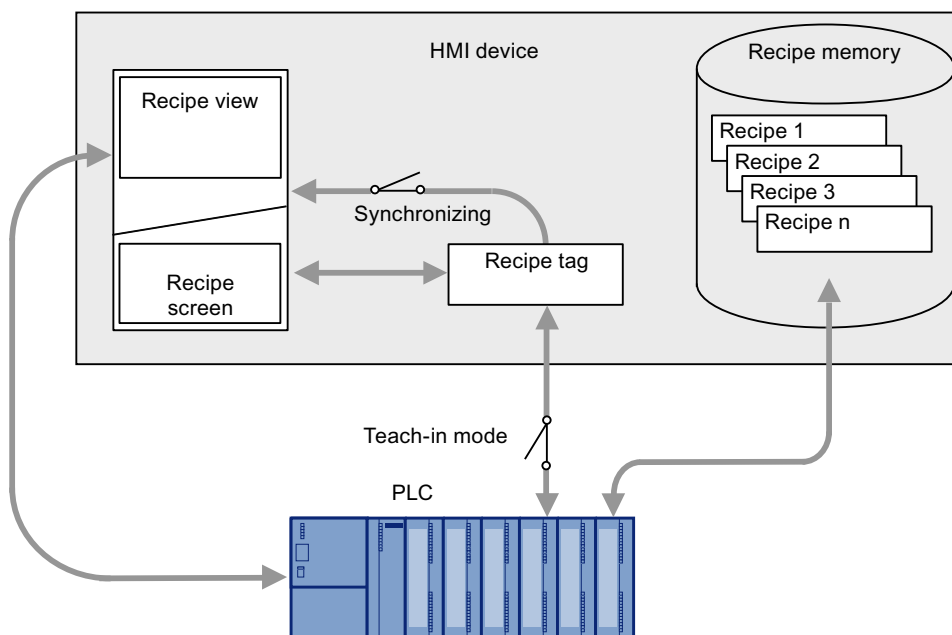

The following transfers are possible between the recipe screen and PLC, depending on the configuration:

- Transferring recipe data records between recipe view and recipe tags
- Immediate transfer of individual modified values between the recipe tags and PLC. The following settings are needed in the recipe in order to do this:
  - "Synchronizing recipe view and recipe tags" is activated.
  - "Manual transfer of individual modified values (teach-in mode)" is deactivated.

Recipe data records can be transferred directly between the HMI device and PLC. In these situations, the display on the HMI device is not essential.

### Exporting and importing recipe data records

Recipe data records are exported from the HMI device recipe memory and are saved to a CSV file on the external storage medium. The records can be reimported from the storage medium to the recipe memory.

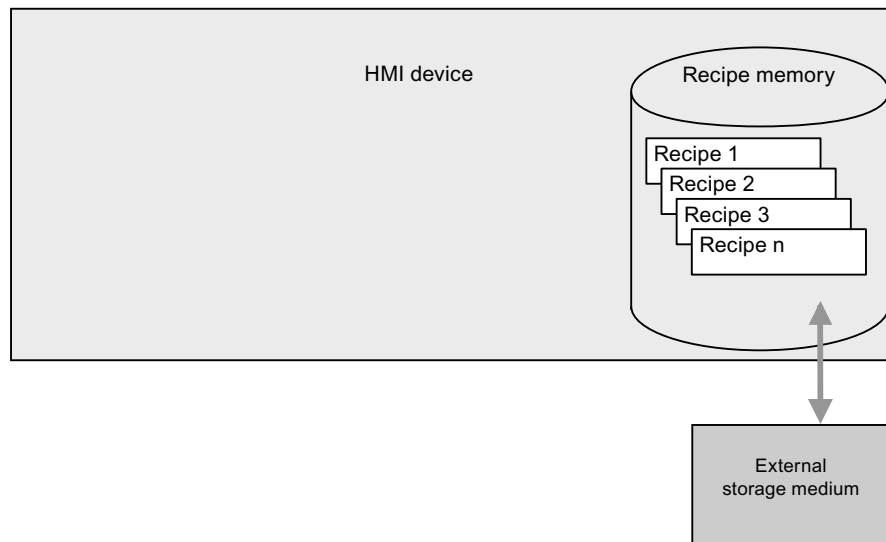

The following external storage media may be used, depending on the HMI device:

- No storage medium, for example, for basic panels
- Memory card
- USB stick
- Hard disk

### 10.5.1.6 Configuration of recipes

#### Introduction

Recipes are configured differently according to the intended use:

- If you are editing recipes with a recipe view in your project, the values are only saved in recipe data records.
- If you are editing recipes in a recipe screen in your project, the values are saved in recipe tags.

The following possible settings determine how the recipe data records, recipe tags and PLC all interact.

#### "Synchronizing recipe view and recipe tags" deactivated

The data in a data record is only displayed and can only be edited in the recipe view. If you use data outside the recipe view, they are not synchronized with the recipe view.

#### "Synchronizing recipe view and recipe tags" activated

There may be differences in Runtime between the values displayed in the recipe view and the values saved in the associated tags when you edit recipes in both a recipe view and a recipe screen. To prevent this, you must synchronize the recipe data record values with the values of the recipe tags.

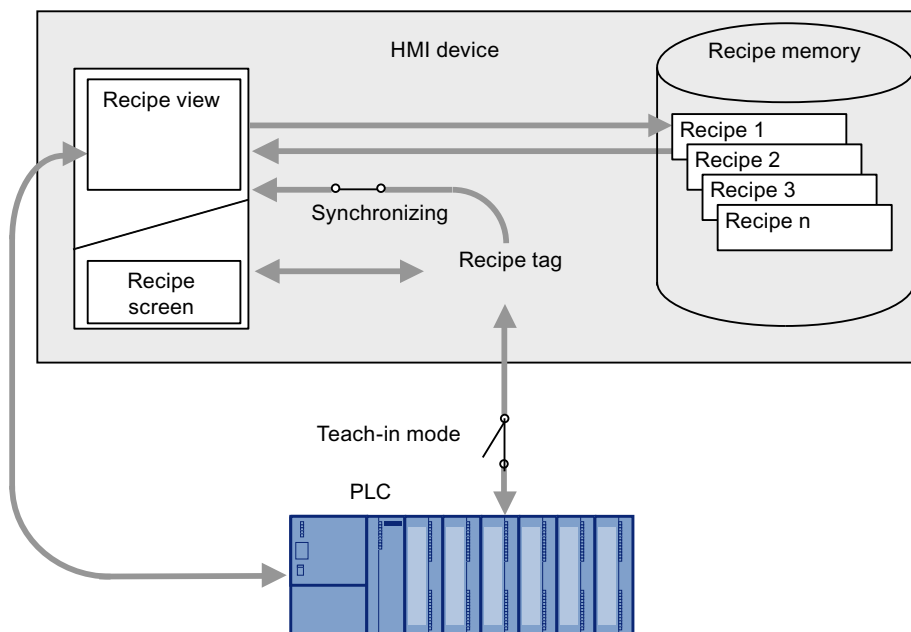

#### Note

Recipe tags can only be synchronized in the advanced recipe view.



The values of the recipe view and the associated recipe tags are not synchronized automatically. The recipe tags and the recipe view are not synchronized until you use the operating element with the "RecipeViewSynchronizeDataRecordWithTags" function.

### "Synchronize recipe view and recipe tags" activated and "Manual transfer of individual modified values (teach-in mode)" activated

With this setting, modified recipe values are not synchronized immediately between the recipe tags in the recipe screen of the HMI device, and PLC.

There must be an operating element with the "SetDataRecordToPLC" and "GetDataRecordFromPLC" functions present in order to synchronize the values.

If recipe values are changed in the controller, the modified values are displayed immediately in the recipe screen if you use the operating element with the "GetDataRecordFromPLC" function.

### "Synchronize recipe view and recipe tags" activated and "Manual transfer of individual modified values (teach-in mode)" deactivated

With this setting, modified recipe values are synchronized immediately between the recipe tags on the HMI device and PLC.

When you change recipe values in the recipe screen, these changes are applied immediately by the PLC and immediately influence the process.

If recipe values are changed in the PLC, the changed values are displayed immediately in the recipe screen.

#### 10.5.1.7 Special features of some devices

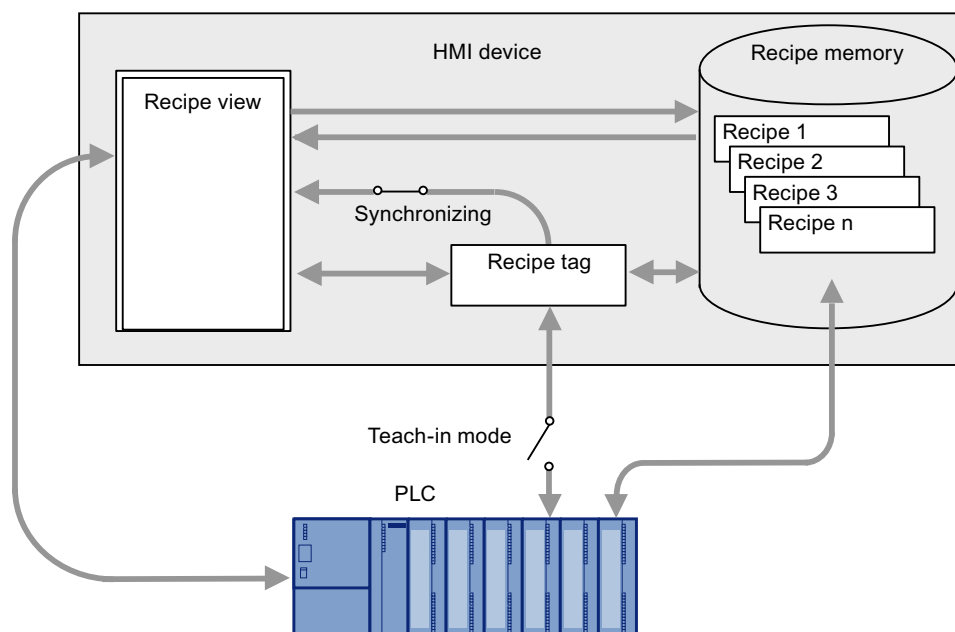

Basic panels, OP 77A, TP 177A and TP 177A (Portrait) respond differently to the other HMI devices in the following respects:

- Only the simple recipe view is supported.
- Recipe tags are always synchronized with the recipe view (see figure above): When the operator changes a value of the recipe element in recipe view, the value of the associated recipe tag will also change.
- Recipe tags are not automatically transferred between the PLC and HMI device when they are modified. Recipe tags are always transferred manually in teach-in mode. There must be an operator control object with the "SetDataRecordToPLC" and "GetDataRecordFromPLC" functions present in order to synchronize the values with the PLC.

---

**Note**

**Restrictions for recipe tags**

Generally, in Basic Panels and OP77A, TP177A (Portrait) recipe tags cannot be used, except in a recipe.

---

**Note**

**Restrictions for Import / Export**

It is not possible to export or import the recipes for the following HMI devices:

- Basic Panels
- OP 77A
- OP 177A
- TP 177A (Portrait)

Complete recipe data, but not single recipe data records, can be exported and imported using ProSave in CSV format and transferred to the HMI device. Thereby, Runtime is interrupted.

---

<b>NOTICE</b>
---------------

<b>Data loss with several recipe views in the screen</b>
--

Applies only to Basic Panels, OP73, OP77A, TP177A and TP177A (Portrait): If two or more recipe views show the same recipe in a screen, you have a conflict when accessing the data.
---

The result is data loss and unpredictable status of recipe data.
--

Make sure the operators do not select and edit the same recipe in different recipe views.
---

- |   |
|---|
| <ul style="list-style-type: none"><li>• Display only one recipe in a recipe view.</li><li>• Display a different recipe in each recipe view.</li></ul> |
|---|

## Interaction between the components

There is interaction between the following components at runtime:

- **Recipe view**  
Recipes are displayed and edited in the recipe view on the HMI device. The recipe data records from the internal memory of the HMI device are displayed and edited in the recipe view.
- **HMI device recipe memory**  
Recipes are saved in the form of recipe data records in the HMI device's recipe memory.
- **Recipe tags**  
The recipe tags contain the values of recipe elements.

### 10.5.1.8 Synchronization of recipe data records with the PLC

#### Overview

When recipe data records are transferred between the HMI device and PLC, both communication peers access common communication areas on the other peer.

Recipe data records are always transferred directly. The values of the tags are written directly to or read directly from the configured addresses without being placed on the clipboard.

#### Data transfer types

There are two ways to transfer recipe data records between the HMI device and PLC:

- Transfer without coordination
- Coordinated transfer via the "Data record" area pointer.

---

**Note****Coordinated transfer**

Transfer with coordinated transfer is used to prevent the uncontrolled overwriting of data in either direction in your control program.

---

#### Requirements for coordinated transfer

The following requirements apply to coordinated transfer:

- The "Data record" area pointer must be set up for the required connection in the "Communication > Connections" editor.
- In the properties of the recipe "Coordinated transfer of data records" is activated.
- The connection to the PLC is specified in the properties of the recipe with which the HMI device coordinates the transfer.

## Coordinated transfer

In the case of coordinated transfer, both the PLC and the HMI device set the status bits in the shared data compartment.

Coordinated transfer of recipe data records can be a useful solution in the following cases:

- The PLC is the "active partner" for the transfer of recipe data records.
- The PLC evaluates information about the recipe number and name, as well as the recipe data record number and name.
- The transfer of recipe data records is started by the following PLC jobs:
  - "Set\_data\_record\_in\_PLC"
  - "Get\_data\_record\_from\_PLC"

### 10.5.1.9 "Recipes" editor

#### Introduction

You can create, configure and edit recipes, recipe entries and recipe data records in the "Recipes" editor. The "Recipes" editor also allows you to enter values in recipe data records.

#### Structure of the "Recipes" editor

You create recipes in the top part of the table editor. You can also configure them there or in the Inspector window.

The bottom part of the table editor has the following tabs:

- Elements
 

Define the recipe elements of the selected recipe using the table cells provided here. You can move recipe elements within the table with the shortcut menu commands, "Up" and "Down".
- Data records
 

Define the values of the data records of the selected recipe using the table cells provided here.

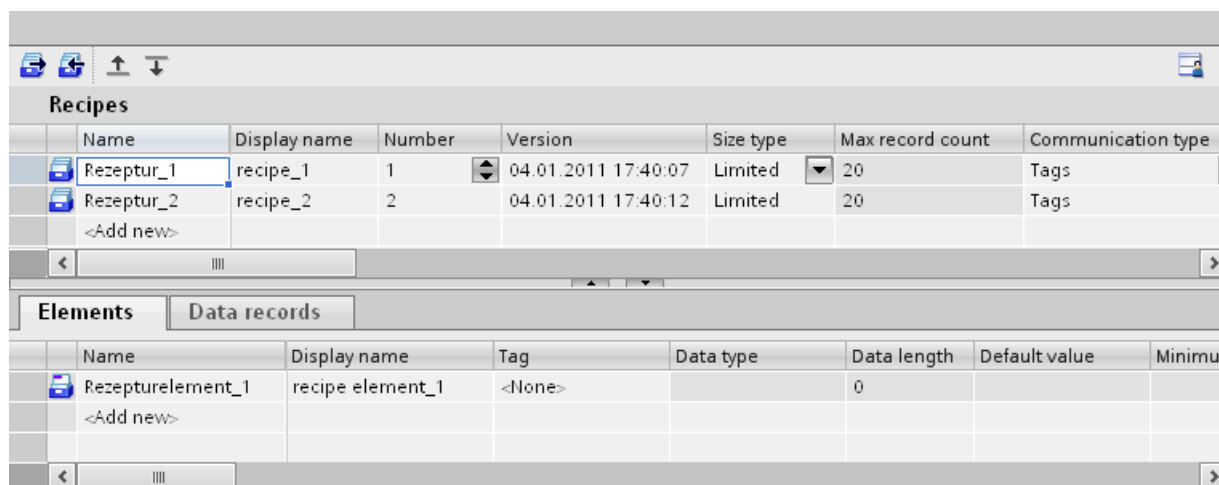

You can then configure the selected recipe, the recipe element or the recipe data record in the Inspector window. You will find further notes on configuring the components of a recipe under "Configuring Recipes".

## Recipe settings

The following settings are available for recipes:

Setting	Description
Name of the recipe	This is a unique identification for the recipe within the HMI device.
Display name	Appears in the recipe view, for example, in Runtime. You can configure display names in multiple languages. Assign descriptive names or designations which the operator can associate directly with a recipe, e.g. "fruit juice drink".
Recipe number	This is a unique identification for the recipe within the HMI device.
Version	Information about the recipe. The date and time of the last change to the recipe is set by default.
Path	Defines the storage location for recipes. The recipes are stored as a file.
Size type [fixed]	The recipe data records are limited to a predetermined number by default.
Number of data records [fixed]	Maximum number of data records in a recipe in Runtime. The number is limited by the recipe memory of the HMI device.
Communication type [fixed]	The recipe data records are written directly to the addresses of the recipe tags and read from there.
Tooltip	Tooltip for the recipe which is shown to the operator in Runtime.

### Note

#### Path

The storage location depends on the storage media available on the HMI device.

Basic Panels and OP77A, TP177A (Portrait)

These HMI devices have no external memory. Recipes are always saved in the internal Flash memory. The "Path" setting is therefore not available.

## Recipe element settings

You can make the following settings on the "Elements" tab:

Setting	Description
Name of the recipe element	Identifies a recipe element uniquely within the recipe. Enter meaningful names or labels that you can allocate uniquely, such as axis labels on a machine or ingredients such as "Flavoring".
Display name	Appears in the recipe view, for example, in Runtime. You can configure display names in multiple languages. Assign meaningful names or designations which the operator can associate directly, e.g. "fruit juice flavoring".

Setting	Description
Recipe tag	An assigned tag in Runtime stores the current value of the recipe element in the recipe data record.
Data type	Data type of the recipe tag.
Data length [fixed]	Data length of the recipe tag, depending on the data type.
Text list	Text is assigned to a value or range of values in a text list. You can display this text in an output field, for example. The assigned recipe tag must have the data type of a number. The tag value must be within the range of values of the text list.
Default value	This is used as the default entry when you create a new recipe data record.
Minimum value [fixed]	The smallest representable value of a number-based recipe tag, depending on the type of data.
Maximum value [fixed]	The largest representable value of a number-based recipe tag, depending on the type of data.
Decimal places	Determines how many places a decimal number is rounded to, e.g. 3 decimal places and vice versa by what power of ten an integer value is multiplied, e.g. 1,000.
Tooltip	Tooltip about the recipe element which is shown to the operator in Runtime.

### Recipe data record settings

You can make the following settings on the "Data records" tab:

Setting	Description
Name of the recipe data record	Identifies a recipe data record uniquely within the recipe.
Display name	Appears in the recipe view, for example, in Runtime. You can configure display names in multiple languages. Assign meaningful names or product numbers which the operator can associate directly with a product, e.g. "yellow fruit juice E231".
Recipe data record number	Identifies a recipe data record uniquely within the recipe.
Recipe elements 1 to n	You can store various values for each recipe element even during configuration. Together with the values of the other recipe elements, a value always forms a recipe data record. You can store multiple recipe data records.  If enabled in the transfer settings, the recipe data records are transferred to the HMI device when downloading the project and existing data records on the HMI device are overwritten.
Comment	Comment about the recipe data record

## 10.5.2 Displaying and Editing Recipes in Runtime

### 10.5.2.1 Recipe screen and recipe view

You can display and edit recipes on the HMI device with a recipe view or recipe screen.

#### Recipe view

The recipe view is an off-the-shelf WinCC display and operator control object.

The recipe view is available in the following views:

- As advanced recipe view
- As simple recipe view

---

**Note****Availability**

In basic panels and OP77A, TP177A, only the simple recipe view is available.

---

#### Recipe screen

The recipe screen contains an individual screen form for entering the recipes. The screen form contains I/O fields and other display and operator control objects. The recipe functionality is implemented with system functions, e.g. for saving recipe data records.

---

**Note****Availability**

In basic panels and OP73, OP77A, TP177A (Portrait), the recipe screens are not available.

---

### 10.5.2.2 Simple recipe view

#### Recipe view

The simple recipe view is a ready-made display element and operator control that is used to manage recipe data records. The recipe view shows recipe data records in tabular form.

The displayed buttons and information in the columns are adjustable.

The values displayed or entered in the recipe view are saved in recipe data records. The displayed recipe data record can be written into the PLC by buttons or values can be read in from the PLC.

## Layout of the display

The simple recipe view consists of three areas:

- Recipe list
- Data record list
- Element list

In the simple recipe view, each area is shown separately on the HMI device. Depending on the configuration, the simple recipe view starts with the recipe list.

The figure below shows an example of the data record list.

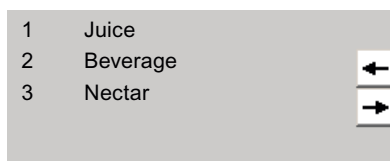

## Display of values

---

### Note

#### Processed recipe data record is changed in the background

Only applies for Basic Panels: if an operator has changed a recipe data record and a PLC job wants to read or write any recipe data record of this recipe, the PLC job is stopped and a system alarm is output. On the other hand, the changed value is displayed immediately if only the PLC job and no operator has changed recipe data.

Does not apply for Basic Panels: If an operator has changed a recipe data record and a PLC job has changed the values of the recipe data record concerned, the recipe view is not updated automatically. To update the recipe view, reselect the respective recipe data record.

---

## See also

Recipe view (Page 3125)



### 10.5.2.3 Configuration options of the simple recipe view

The response of the simple recipe view can be defined in the recipe view inspector window.

#### Note

##### Validity

Some devices, for example basic panels, only support the simple recipe view.

For all other devices, observe the following:

- In the Inspector window, under "Properties > Display > Mode", select "Simple view" as "View type".
- The "Properties > Simple view" area contains additional properties only applicable to the simple recipe view.
- All other properties are also applicable to the advanced recipe view.

### Displaying recipe data record values only

To display the recipe data in a recipe view for checking only, proceed as follows:

1. Deselect "Edit mode" in the "General" group.

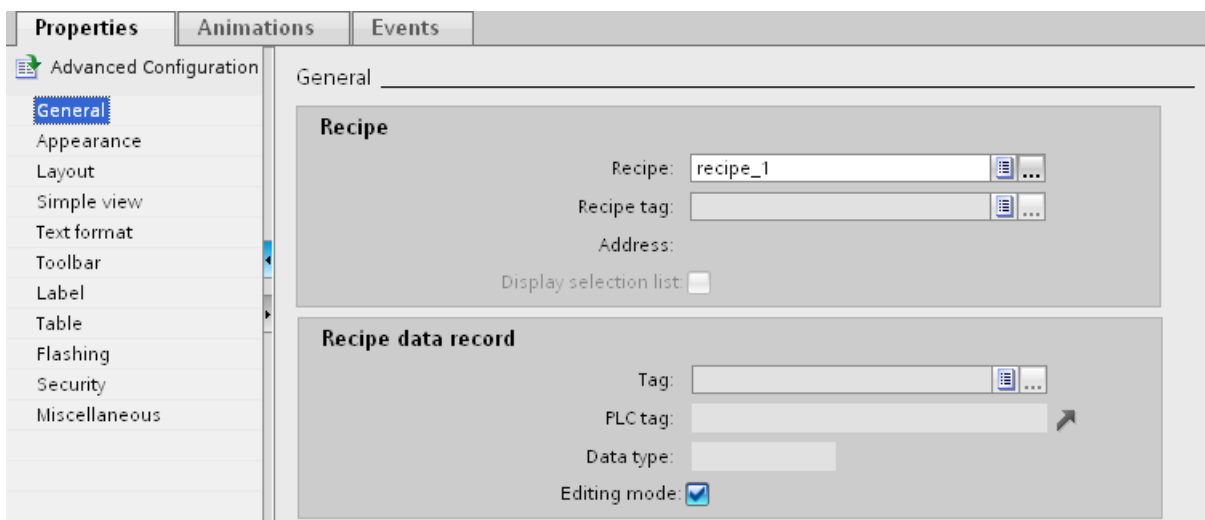

You cannot create, rename, edit or delete recipe data.

### Writing a recipe data record number or name to a tag

A tag to each recipe data record can be configured in the advanced recipe view. Depending on the "String" or "Int" data type of the tag, the name or number of the recipe data record is stored in the tag. Conversely, the tag can also be used to select a recipe data record by entering the corresponding value. For example, the tag can be transferred as a parameter for a system function.

Proceed as follows:

1. Enter a tag of the "Int" type in the field "Tag", under "Properties > General > Recipe data record".

The number of the recipe data record is stored in a tag.

## Configuring an event on the recipe view

---

### Note

#### Events and buttons

The "Events" register is faded out when a minimum of one button is enabled.

---

To configure an event for the recipe view, proceed as follows:

1. Select the recipe view that was added to the screen in the "Screens" editor.  
The properties of the recipe view are shown in the Inspector window.
2. Deactivate all buttons under "Properties > Toolbar" and "Properties > Simple view".
3. In the Inspector window, under "Properties > Events", click the event to be configured, e.g. "Enable".
4. Configure a function list for the event.

The function list is processed when the operator enables the recipe view.

## Animation properties of the recipe view

To configure an animation of a recipe view, proceed as follows:

1. Select the recipe view that was added to the screen in the "Screens" editor.  
The properties of the recipe view are shown in the Inspector window.
2. Click under "Properties > Animations" in the Inspector window.

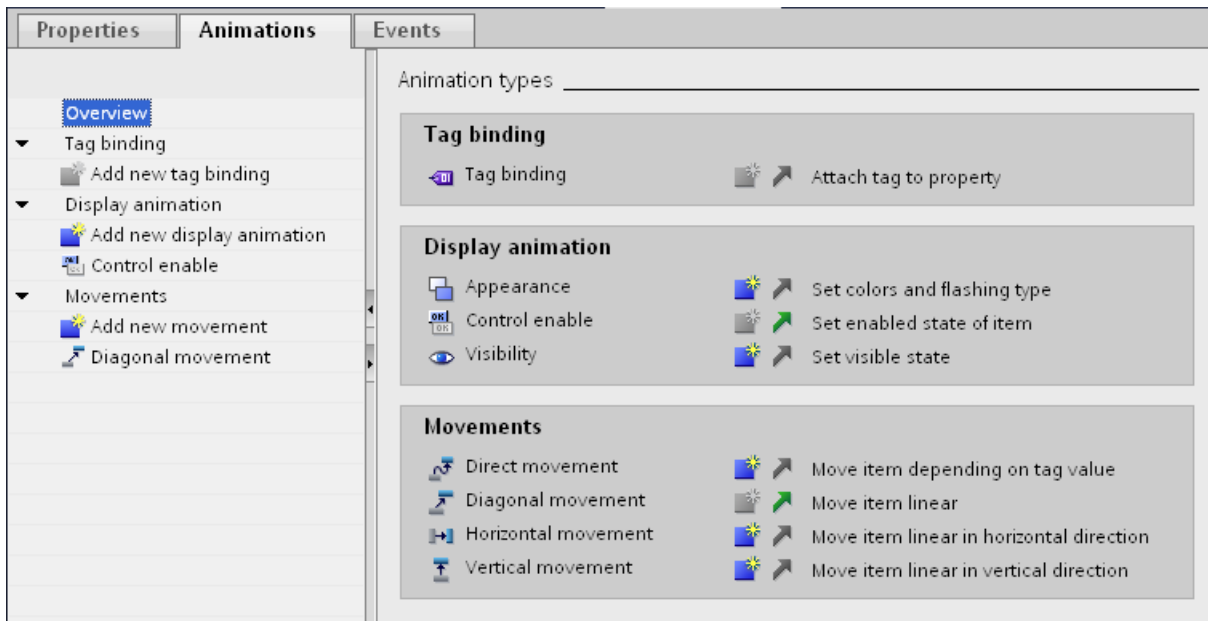

3. Link a tag to one or more of the following properties.

- X-Position and y-Position
- Design: Colors, flashing
- Operability
- Visibility

In the "Animations > Overview" area, all animations are summarized in tabular form. Under "Animations > Tag links > Tag linkage", as well as visibility and position a tag can also be linked to height and width.

### Note

#### Animations and buttons

If all buttons are not disabled, an error message appears whilst compiling the project for windows-CE HMI devices.

## Constraints on the simple recipe view

The following functions are not possible in the simple recipe view:

- Synchronizing recipe view and recipe tags
- Writing a recipe number / name to a tag
- Display status bar

- Display data record number
- Display label
- Display table

### 10.5.2.4 Advanced recipe view

#### Recipe view

The advanced recipe view is an off-the-shelf display and operator control object that is used to manage recipe data records. The recipe view shows recipe data records in tabular form.

The buttons, headers and information displayed in the columns are variable.

The values displayed or entered in the recipe view are saved in recipe data records.

#### Layout of the display

The picture below contains an example of the advanced recipe view:

Entry Name	Value
Recipe element_1	0

#### Display of values

##### Note

##### Changing the recipe data record in the background

Applies to the processing of a recipe data record:

If values of the corresponding recipe data record are changed by a control job, the recipe view is not updated automatically.

To update the recipe view, reselect the respective recipe data record.

**See also**

Recipe view (Page 3125)

**10.5.2.5 Configuration options of the advanced recipe view**

The response of the advanced recipe view in the recipe view inspector window can be determined.

**Note****Validity**

The following description also applies to the advanced recipe view. In the Inspector window, under "Properties > Display > Mode", select "Advanced view" as "View type".

All properties described for the simple recipe view are also applicable in the advanced recipe view, except "Properties > Simple view". The "Simple view" area contains additional properties only applicable to the simple recipe view.

Basic Panels, OP77A and TP177A (Portrait) do not support any advanced recipe view.

**Displaying a recipe**

To allow access to the recipe data records of a specific recipe only in a screen, proceed as follows:

1. Enter the recipe or select an existing recipe in the "Recipe" field, under "Properties > General".
2. When a recipe is entered in the "Recipe" field, you will have to enable the "Selection list" if you want to display the recipe name in Runtime.

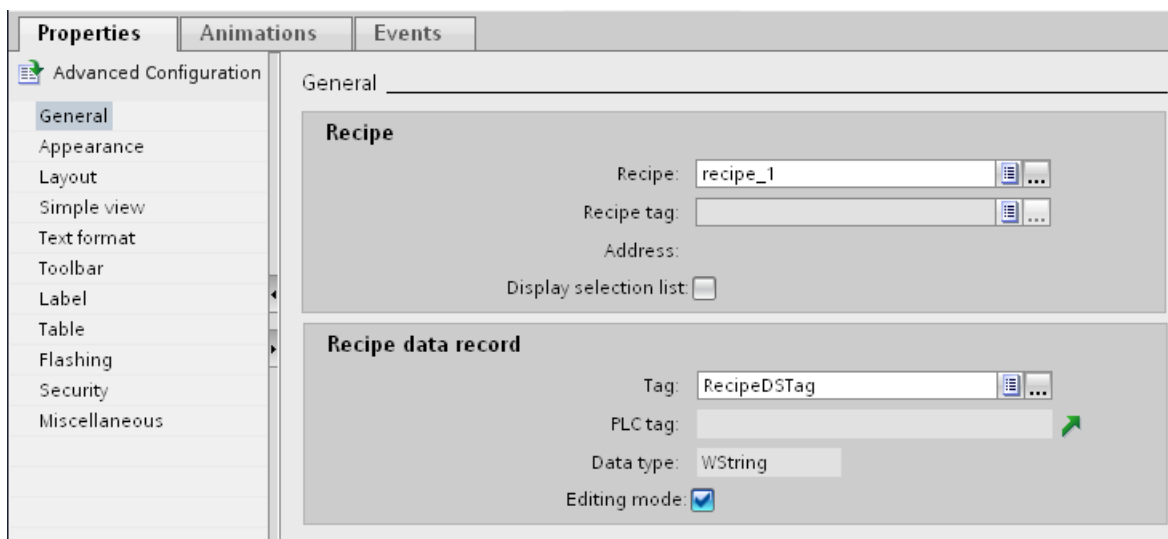

The selected recipe appears in the recipe view.

### Writing a recipe number or name and recipe data record number or name to a tag

Both the recipe and the recipe data record can each be configured to a tag in the recipe view. Depending on the "String" or "Int" data type of the tag, the name or number of the recipe or recipe data record is stored in the tag. Conversely, the tag can be used to select the recipe or recipe data record by entering the corresponding value. For example, the tag can be transferred as a parameter for a system function.

Proceed as follows:

1. Enter a tag of the "String" type in the field "Recipe tag", under "Properties > General > Recipe".
2. Enter a tag of the "Int" type in the field "Tag", under "Properties > General > Recipe data record".

The name of the recipe and the number of the recipe data record are each stored in a tag.

### Using the recipe view as a drop-down list

To use the recipe view as a selection field for recipes and recipe data records in a recipe screen, proceed as follows:

1. Select the tag for the recipe name under "General > Recipe > Recipe tag".
2. Select the tag for the recipe data record name under "General > Recipe data record > Tag".
3. Disable the "Edit mode". You cannot create, rename, edit or delete recipe data.
4. In order to select recipes, enable "Show selection list" and make sure that no recipe is selected under "Properties > General > Recipe".
5. Deactivate all buttons under "Properties > Toolbar".

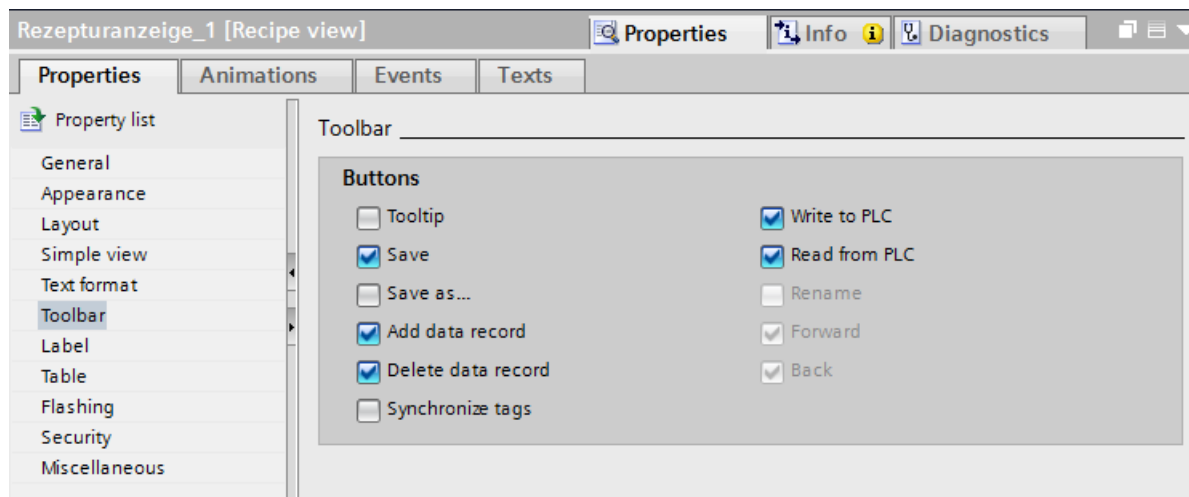

### Configuring an event on the recipe view

To configure an event on the recipe view, proceed as follows:

1. Select the recipe view that was added to the screen in the "Screens" editor.  
The properties of the recipe view are shown in the Inspector window.
2. In the Inspector window, click the event you want to configure under "Properties > Events".
3. Configure a function list for the selected event.

The function list is processed when the configured event occurs.

### 10.5.2.6 Response of the recipe view in Runtime

#### Screen change

If you change to another screen and have not yet saved changes to the recipe data in the recipe view, you will be prompted to save the recipe data. The recipe name and the name of the recipe data record are displayed to show which recipe data have not been saved yet.

#### Create, change, copy or delete recipe data records

If you attempt to create a new recipe data record and a recipe data record already exists, a system alarm will appear on screen.

#### Operating the recipe view with function keys

The Recipe view can be operated with function keys, e.g. if the HMI device does not have touch functionality. You can assign functions such as "SaveDataRecord" to the function keys on the HMI device.

#### Display after import of recipe data

---

**Note****Availability**

Import and export of recipe data is not available for Basic Panels and OP77A, TP177A (Portrait).

---

If you open the recipe view during the import of recipe data, only the recipe data that is already completely imported will be displayed. The recipe view is not automatically updated with a data import. In order to have a complete view of all the recipe data, do not open the recipe view until the system prompts you that the recipe data has been imported successfully. Alternatively, update the recipe view after successful completion of the import procedure.

## Updating tag for recipes and recipe data records

### Note

#### Availability

Tags for recipes and recipe data records are not available for Basic Panels and OP77A, TP177A (Portrait).

The current recipe data record or its number can be saved to a tag, depending on the configuration. The tag will be updated under the following conditions:

- The recipe data record has been loaded.
- The screen with the recipe view was not exited during loading.

This operation may take some time.

### 10.5.2.7 Basics on the recipe screen

#### Introduction

The recipe screen contains an individual screen form for entering the recipes. The screen form contains I/O fields and other display and operator control objects. The recipe functionality is implemented with system functions, e.g. for saving recipe data records.

The picture below contains an example of a recipe screen:

The screenshot shows a recipe configuration interface. On the left, there is a table of ingredients:

Water	40	l
Concentrate	70	l
Sugar	30	kg
Flavoring	30	l

On the right, there are two dropdown menus for recipe configuration:

- Recipe name: Orange, No.: 1
- Data record name: Nectar, No.: 2

At the bottom, there are four buttons: Save, Data from the PLC, Load, and Data to PLC.

### Note

#### Availability of recipe screens

Basic Panels and OP73A, OP77A, TP177A (Portrait) do not support any recipe screens.



## Principle

Configuring a recipe screen allows you to customize the display. You can spread large recipes over several screens according to topic and display them clearly using features such as graphical display and operator control objects.

- Spreading recipes over several screens according to topic
  - You can distribute recipe data records with multiple entries across several screens. For example, for each plant area you can configure a screen containing the associated screen forms for the recipe data records.

Spreading recipes over several screens is useful for HMI devices with small displays as they avoid having to scroll through tables in Runtime.

- Visual machine simulation
 

You can visually simulate your machine in a screen using graphical screen objects. This enables you to display parameter settings more clearly by positioning I/O fields immediately next to machine elements such as axes or guide rails, which produces a direct relationship between the values and the machine.

## Synchronizing recipe values

To enter recipe data record values outside the advanced recipe view in the configured I/O fields, activate "Synchronize recipe view and recipe tags" under "Properties > Synchronization" in the recipe properties.

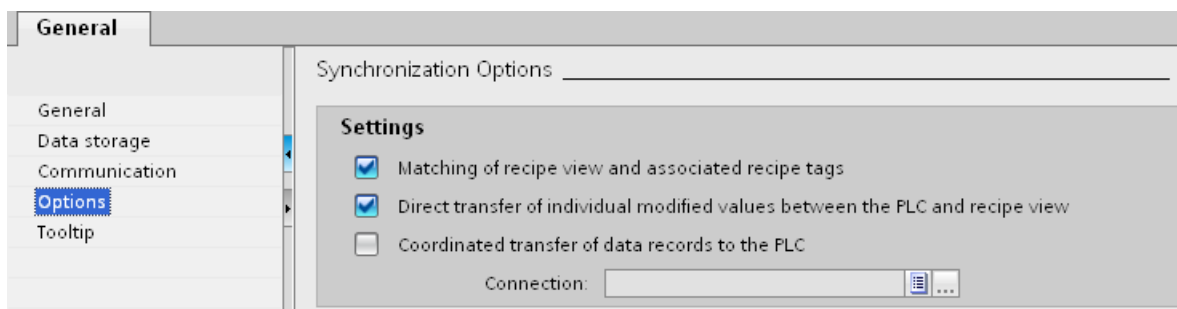

The "Synchronize recipe view and recipe tags" option is not available for the simple recipe view.

## Transferring recipe values automatically

If the entered recipe values must be immediately transferred to the connected PLC in Runtime, deactivate "Manual transfer of individual modified values (teach-in mode)" under "Properties > Options".

Configure the "SetRecipeTags" system function if you want to enable and disable the immediate transfer of entered recipe values in Runtime.

## System functions

The following system functions are available for operator control of a recipe screen:

- ImportDataRecords
- ExportDataRecords
- LoadDataRecord
- SaveDataRecord
- SetDataRecordTagsToPLC
- GetDataRecordTagsFromPLC

The following system functions are available for operator control of the recipe view when it is being used in the recipe screen:

- RecipeViewSaveDataRecord
- RecipeViewSaveAsDataRecord
- RecipeViewSynchronizeDataRecordWithTags
- RecipeViewDeleteDataRecord
- RecipeViewNewDataRecord
- RecipeViewGetDataRecordFromPLC
- RecipeViewRenameDataRecord (for simple recipe view only)
- RecipeViewShowOperatorNotes
- RecipeViewMenu (for simple recipe view only)
- RecipeViewOpen (for simple recipe view only)
- RecipeViewBack (for simple recipe view only)

The system functions for loading, saving and transferring recipe data records and recipes are located in the "Recipes" group.

## 10.5.3 Configuring Recipes

### 10.5.3.1 General configuration procedure

Carry out the following configuration steps when you create a new recipe:

Step	Description
1	Define the structure of the recipe.
2	Create tags according to the recipe structure. Assign process names to these tags.
3	Create the recipe.

Step	Description
4	Enter the required properties for the recipe: <ul style="list-style-type: none"> <li>• Language-dependent view name of the recipe</li> <li>• "Coordinated transfer of data records" option</li> </ul> Not for Basic Panels: <ul style="list-style-type: none"> <li>• Recipe storage location</li> <li>• "Synchronize recipe view and recipe tags" option</li> <li>• "Manual transfer of individual modified values (teach-in mode)" option</li> </ul>
5	Create the recipe elements and enter the required properties: <ul style="list-style-type: none"> <li>• Language-dependent view name of the recipe elements</li> <li>• Tag binding of the recipe elements</li> <li>• Standard values and decimal places (power of ten) for the recipe elements</li> </ul>
6	Create the recipe data records. Enter the language-specific display names for the recipe data records.
7	Configure a screen with recipe view or a recipe screen.

**Note****Basic Panels and OP77A, TP177A (Portrait)**

The selection of the storage location is not available for these devices. The recipes are always saved in the internal Flash memory.

Recipe tags cannot be used outside a recipe, e.g. not in I/O fields, not in alarms as trigger tags, not in systems functions as parameters, etc.

**Note****Restrictions recipe view and recipe image**

Only the simple recipe view is available in Basic Panels and OP77A, TP177A. Recipe images are not available in Basic Panels and OP73, OP77A, TP177A (Portrait).

### 10.5.3.2 Creating and Editing Recipes

#### Creating a new recipe

##### Introduction

To create a complete recipe, start by creating a new recipe, assign the corresponding recipe elements and then define the associated values in a recipe data record.

##### Requirement

- The tags for the recipe have been created.
- The "Recipes" editor is open.

## Create recipe

Create a recipe as follows:

1. Click "Add" in the first free row of the table in the "Recipes" editor.  
The new recipe is created and displayed on a line.

The screenshot shows the 'General' settings panel for a recipe. The panel is titled 'General' and contains two sections: 'Settings' and 'Size'. The 'Settings' section has four fields: 'Name' (text input with 'Rezeptur\_1'), 'Display name' (text input with 'recipe\_1'), 'Version' (text input with '04.01.2011 17:40:07'), and 'Number' (spin button with '1'). The 'Size' section has two fields: 'Size type' (dropdown menu with 'Limited') and 'Number of records' (spin button with '20'). A left sidebar shows a tree view with 'General' selected.

2. Enter a descriptive name for the recipe under "Name" in the "General" area.  
This name identifies the recipe unambiguously within the project.
3. Select "Display name" to enter the language-specific name to be displayed in runtime.
4. Select a recipe number in "Number".  
The number identifies the recipe unambiguously within the HMI device.  
The recipe is automatically assigned a version that indicates the date and time of the last change. As an alternative, you can enter specific information relating to the recipe.
5. Specify the storage location for recipe data records in "Data medium". The options offered depend on the specific HMI device used.

---

### Note

#### Basic Panels and OP77A, TP177A (Portrait)

The selection of the storage location is not available for these devices. The recipes are always saved in the internal Flash memory.

Recipe tags cannot be used outside a recipe, e.g. not in I/O fields, not in alarms as trigger tags, not in systems functions as parameters, etc.

---

6. Enter a tooltip that is shown to the operator in runtime.

- To compare recipe tags which are configured in I/O fields with the recipe view in Runtime, activate "Synchronize recipe view and recipe tags" in the Inspector window under "Properties > Synchronization".

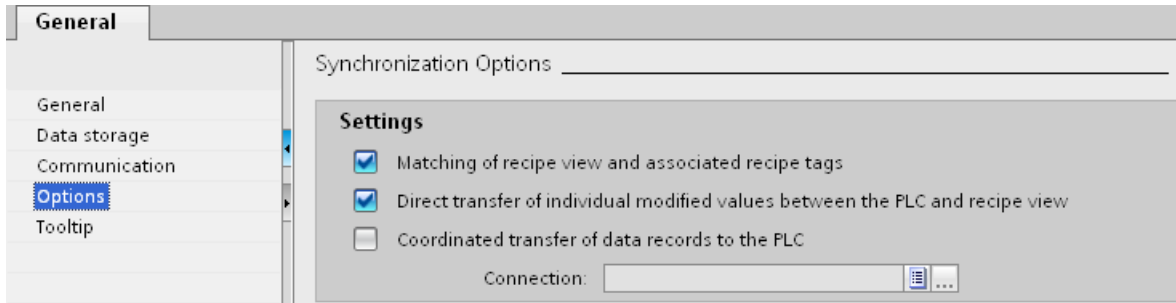

---

### Note

#### Basic Panels and OP77A, TP177A (Portrait)

Because the recipe tags cannot be additionally used in I/O fields in screens for Basic Panels, the "Synchronize recipe view and recipe tags" is not available; you will also not be able to use the "Manual transfer of individual modified values (teach-in mode)" option.

---

- Deactivate "Manual transfer of individual modified values (teach-in mode)" to specify that the recipe tags are automatically transferred to the PLC when editing the I/O fields.
- Activate "Coordinated transfer of data records" to monitor the transfer of recipe data in Runtime using area pointers.
- Select the appropriate connection to the PLC for coordinated transfer under "Synchronize with".

### Create recipe element

To create recipe elements, proceed as follows:





- Click the "Elements" tab.
- Click "Add" in the first free line of the table editor.  
A new recipe element is created.
- Enter a descriptive name for the element under "Name".  
The name identifies the element uniquely within the recipe.
- Enter a language-specific display name for the element under "Display name".  
The display name appears in the recipe view, for example, in runtime.

10.5 Working with recipes

- Select the tag you want to link to the recipe element under "Tag".  
The value of the recipe data element is saved in Runtime in this tag, which is stored in a recipe data record.

Elements		Data records				
	Name	Display name	Tag	Default value	Decimal places	Infotext
	Water	Water	LitreWater	0	0	
	<Add new>					

- Enter a tooltip.  
The tooltip is shown to the operator in Runtime.
- Under "Default value", enter the value that you want to use as the default entry when you create a new recipe data record.
- To assign text to a value or range of values, select the relevant text list here. The assigned recipe tag must have the data type of a number. The tag value must be within the range of values of the text list.  
The text stored in the text list is displayed in an output field, for example, in Runtime.
- Determine exactly how many places a decimal number is rounded to in the "Decimal places" column, e.g. 3 decimal places and vice versa by what power of ten an integer value is multiplied, e.g. 1,000.  
Examples for 3 decimal places: Entering "5" for a recipe element with the "Integer" data type gives the value "5000". Entering "5.6789" for a recipe element with the "Real" data type gives the value "5.679".
- Create as many recipe entries as needed for the recipe. The maximum number of recipe entries possible depends on the HMI device being used.

Elements		Data records				
	Name	Display name	Tag	Default value	Decimal places	Infotext
	Water	Water	LitreWater	0	0	
	Concentrat	Concentrat	LitreConcentrat	0	0	
	Sugar	Sugar	KiloSugar	0	0	
	Aroma	Aroma	GramAroma	0	0	
	<Add new>					

### Create recipe data record with known recipe values

To create recipe elements, proceed as follows:



1. Click the "Data records" tab.
2. Click "Add" in the first free line of the table editor.  
A new recipe data record is created. The recipe data record has a separate column for every recipe element created in the recipe.

Elements		Data records							
	Name	Display name	Number	Water	Concentrat	Sugar	Aroma	Comment	
	Recipe_data_record_1	Recipe_data_record_1	1	0	0	0	0		
	<Add new>								

3. Enter a descriptive name under "Name".  
The name identifies the data record uniquely within the recipe.
4. Enter a language-specific name under "Display name".  
The display name appears in the recipe view, for example, in runtime.
5. Enter a recipe data record number under "Number".  
The recipe data record number identifies the recipe data record uniquely within the recipe.
6. If you already know the recipe values at the configuration stage, you can enter the relevant value for each recipe element.

Elements		Data records							
	Name	Display name	Number	Water	Concentrat	Sugar	Aroma	Comment	
	Beverage	Beverage	1	30	70	45	600		
	<Add new>								

7. Create as many data records as you need for the recipe.

Elements		Data records							
	Name	Display name	Number	Water	Concentrat	Sugar	Aroma	Comment	
	Beverage	Beverage	1	30	70	45	600		
	Nectar	Nectar	2	50	50	10	300		
	Juice	Juice	3	5	95	3	100		
	<Add new>								

### Enter the values in runtime

The following options are available for entering values in the recipe data records at runtime:

- Transfer data directly from the PLC (Teach-in mode)
- Import of values from a CSV file
- Input values on the HMI device

---

#### Note

##### Basic Panels and OP77A, TP177A (Portrait)

The import of values is not available for these devices.

---

### Result

The complete recipe is configured.

### Recipe data records with date or time stamp

If you use date or time data, make sure that the system setting for time and date on the configuring computer match those on the target system. Example: You load a recipe data record on the target system at 13:55 in which 14 h is stored as the processing time. If it is already 14:05 on the target computer, the recipe will not be processed. If an operator processes the recipe, change information will not written back correctly into the database.

After loading to the target system, check the recipes with date or time stamps on the target system.

### Editing a recipe

#### Purpose

You want to modify, extend or delete parts of a recipe.

#### Requirement

- You have created at least one recipe.
- The "Recipes" editor is open.

### Changing recipe settings

To change the recipe settings, proceed as follows:

1. Select the recipe that you want to change in the "Recipes" editor.  
The Inspector window opens.
2. Change the recipe configuration in the Inspector window.

You change recipe elements and recipe data records in the same way.



### Change recipe values

To change recipe values, proceed as follows:

1. Select the recipe whose values you want to change.
2. Click the "Data records" tab.
3. Enter the new values in the value columns.

### Adding a recipe element

To add more recipe elements to a recipe, proceed as follows:

1. Select the recipe to which you want to add more elements in the "Recipes" editor.
2. Click the "Elements" tab.
3. Click "Add" in the first free line.  
The recipe element is created.
4. Configure the recipe element.

You add recipe data records in the same way.

### Managing recipes

#### Requirement

- You have created a recipe with recipe elements and recipe data record.
- The "Recipes" editor is open.

#### Renaming recipes

We distinguish between internal names and display names for recipes, recipe entries and recipe data records.

To rename recipe elements, proceed as follows:

1. Select the recipe that you want to rename.  
The Inspector window opens.
2. Select the "Rename" command from the shortcut menu.
3. Enter the new name.  
You rename recipe elements and recipe data records on the relevant tab in the same way.

---

#### Note

The view names in the "Recipes" editor can also be renamed under "Languages & Resources > Project Texts". This possibility is useful when you have already configured in several languages for example.

---

### Copying and pasting recipes

To copy and paste recipes, proceed as follows:

1. Select the recipe that you want to copy.
2. Select the "Copy" command from the shortcut menu.
3. Select the "Paste" command from the shortcut menu in the first free table row.

The copied recipe is pasted into the table. The recipe elements and recipe data records are also copied in the appropriate tab with the recipe.

You also copy the recipe elements and recipe data records on the appropriate tab in the same way.

If a recipe data record of the same name already exists, the name of the copied recipe data record is extended by one digit. This ensures that the name is unique. Recipe data records can only be copied or pasted within the same recipe.

### Deleting a recipe

To delete a recipe, proceed as follows:

1. Select the recipe that you want to delete.
2. Select the "Delete" command from the shortcut menu.  
The recipe is deleted.

You delete recipe elements and recipe data records on the relevant tab in the same way.

---

#### Note

When a recipe is deleted, the recipe data records contained in the recipe are also deleted.

---

#### Note

When you delete a recipe element, the associated values in the recipe data records are also deleted. The assigned tags are retained.

---

### 10.5.3.3 Configuring the display of recipes

#### Configuring the simple recipe view

##### Requirement

- The recipe has been created.
- The "Screens" editor is open.
- The screen has been created and opened.

**NOTICE****Data loss with several recipe views in the screen**

Applies only to Basic Panels, OP73, OP77A, TP177A and TP177A (Portrait): If two or more recipe views show the same recipe in a screen, you have a conflict when accessing the data.

The result is data loss and unpredictable status of recipe data.

Make sure the operators do not select and edit the same recipe in different recipe views.

- Display only one recipe in a recipe view.
- Display a different recipe in each recipe view.

##### Procedure

To configure a simple recipe view, proceed as follows:

1. Paste the recipe view into the screen. You will find the recipe view under "Controls" in the "Tools" task card.
2. Only in devices which also support the extended recipe view: Activate "Simple view" under "Properties > Display > Mode".

3. If you want to display only the recipe data records of a specific recipe in the recipe view, select the specific recipe under "Properties > General > Recipe".

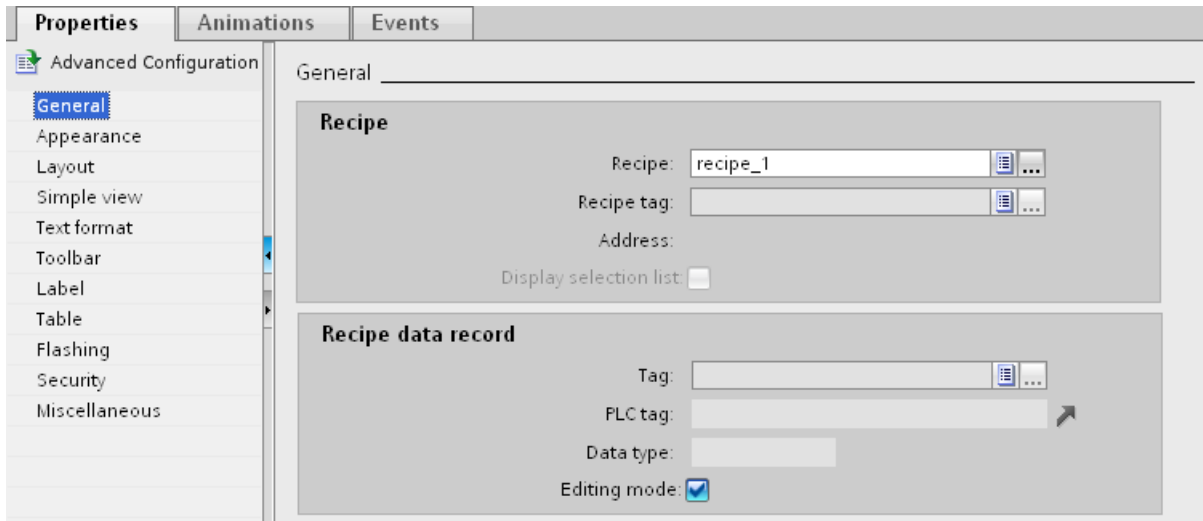

4. If you only want to display the recipe data in the recipe view, deactivate "Processing mode" in the "Recipe data record" area.
5. You can define additional options for the recipe view under "Properties > Appearance" and "Properties > Layout".

6. Select "Properties > Simple view" to select the position, the field length, and the number of lines required.  
 Select "Position > Top" to display the recipe value in the first line of the recipe entry.  
 Select "Position > Bottom" to display the recipe value in the last line of the recipe entry.

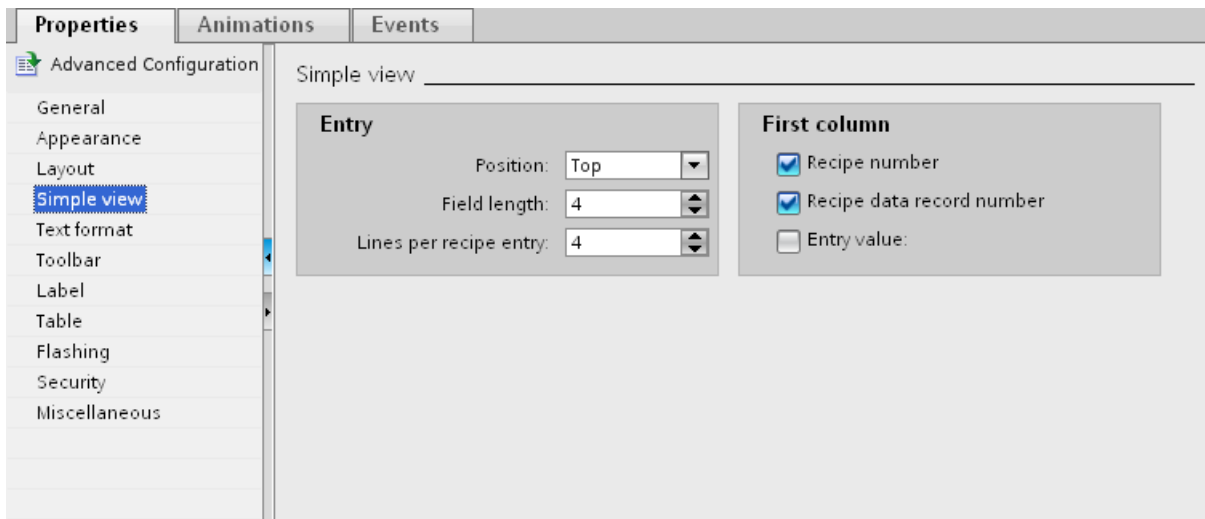

7. Under "Properties" > "Toolbar" specify which menu commands are available in the recipe view in Runtime.

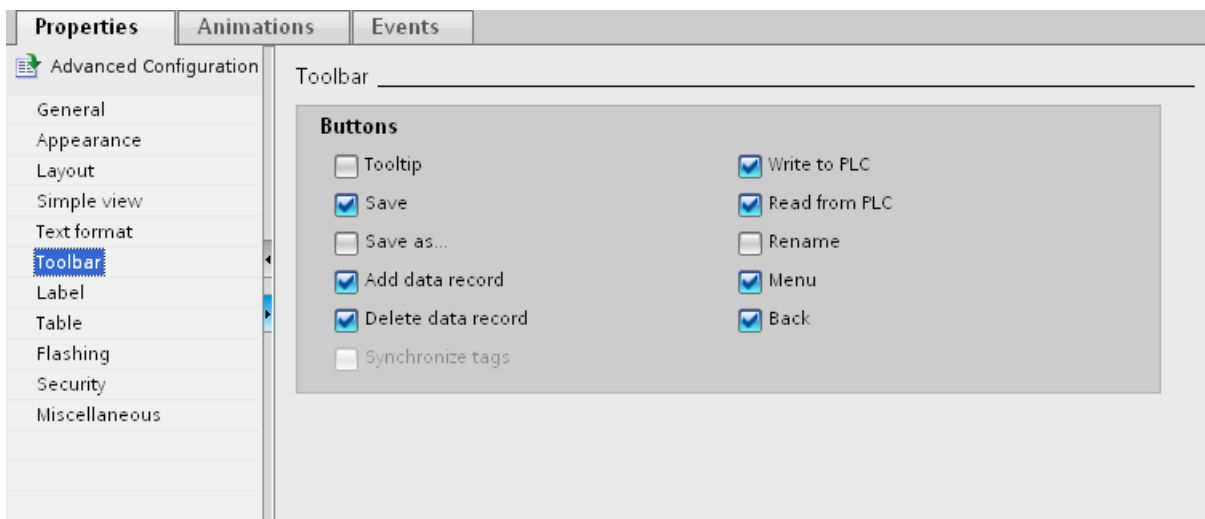

## Result

The simple recipe view is configured. You can use the recipe view to display and edit recipe data during runtime.

Deactivation of the editing mode in "Properties > Properties > General" has no impact on the toolbar icons. The buttons you activated in "Properties > Toolbar" can still be used even if editing mode is disabled.

## Configuring the Advanced Recipe View

### Requirement

- The recipe has been created.
- The "Screens" editor is open.
- The screen has been created and opened.

### Procedure

To configure an advanced recipe view, proceed as follows:

1. Paste the recipe view into the screen. The recipe view is found in the task card "Tools" > "Controls".
2. Select "Properties > Display > Mode > Advanced view" in the Inspector window.

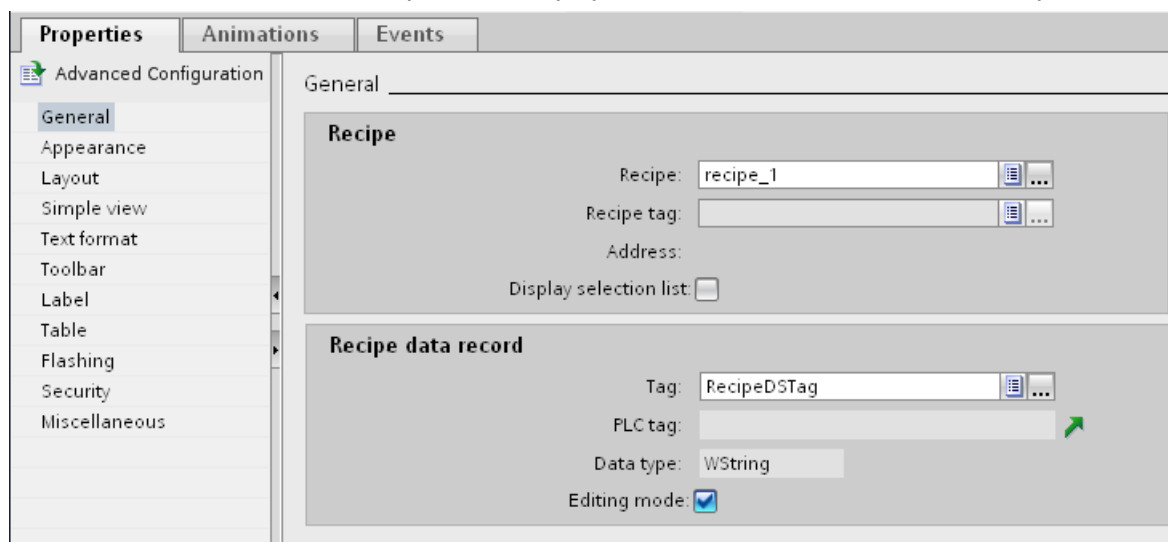

3. Select the required settings from the "General" group in the Inspector window.
  - If you want to display only the recipe data records for a particular recipe in the recipe view, select the recipe under "Recipe" in the "Recipes" area.
  - If you want to save the recipe name or the recipe number in a tag, select the tag under "Recipe tag" in the "Recipe" area.
  - If you want to save the recipe data record name or number in a tag, select the tag under "Tag" in the "Recipe data record" area.
  - If you only want to display the recipe data in the recipe view, deselect "Edit mode".
  - If you only want to use the recipe view to select recipes, disable "Display table" under "Properties > Table".
4. You can define additional options for the recipe view under "Properties > Appearance" and "Properties > Layout".

5. If you want to change the label in the recipe view, enter a suitable text under "Properties" > "Label".
6. Under "Properties" > "Toolbar" specify which buttons are available in the recipe view in Runtime.

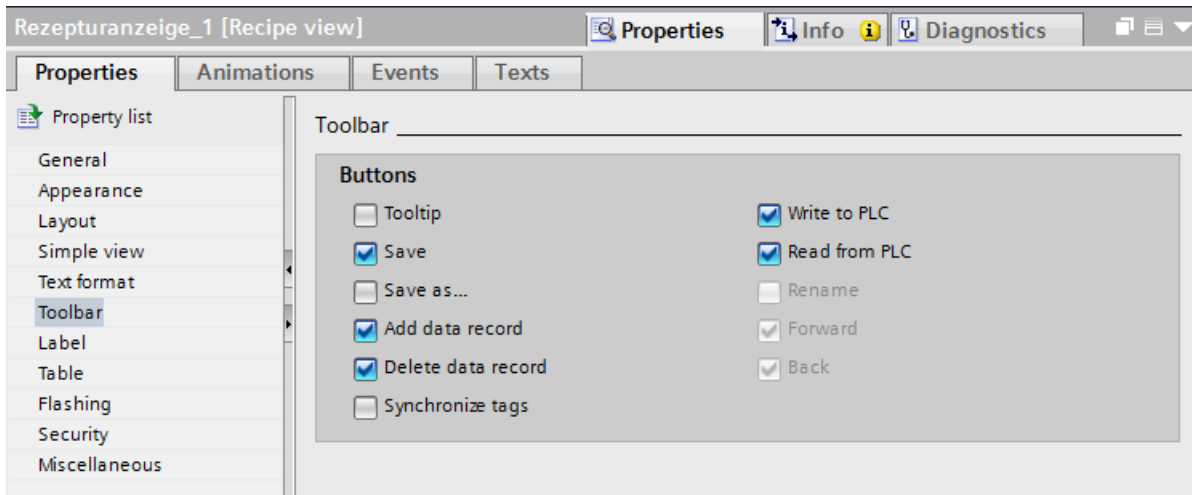

---

### Note

If you select the "Edit" command in the context menu of the recipe view, the recipe view becomes active. To activate the recipe view, the zoom factor must be set to 100%.

You can set the column width and the position of the "Entry name" and "Value" columns in active mode.

---

### Result

The recipe view is configured. You can use the recipe view to display and edit recipe data during runtime.

Deactivation of the editing mode in "Properties > Properties > General" has no impact on the toolbar icons. The buttons you activated in "Properties > Toolbar" can still be used even if editing mode is disabled.

### Configuring a recipe screen

#### Introduction

The recipe screen is a screen in which you configure a customized screen form in the "Screens" editor. You create the screen form from input/output fields and other display and operator

control objects. System functions are used to configure the recipe functionality, such as saving recipe data records.

---

**Note**

**Availability**

Recipe screens cannot be created for basic panels and OP73, OP77A and TP177A (Portrait).

---

## Application

You can spread recipe data records containing lots of entries across several screens. For example, for each plant you can configure a screen containing the associated screen forms for the recipe data records.

You can visually simulate your machine in a screen using graphical screen objects. This enables you to display parameter settings more clearly by positioning I/O fields immediately next to machine elements, such as axes or guide rails. You can use this to produce a direct reference between the values and the machine.

## Requirement

- You have created the recipe.
- The "Screens" editor is open.

## Procedure

To configure a recipe screen, proceed as follows:

1. Configure the screen and create the I/O fields for the input mask of the recipe.  
You can create multiple screens to suit the size and complexity of the recipe.
2. Configure the I/O fields with the tags you have linked to the recipe element.
3. Configure I/O fields for selecting recipes and recipe data records.

Alternatively:

1. Configure a recipe view as a selection list for recipe data records and recipes.
2. Hide the buttons that are not required in the recipe view.
3. Configure the system functions for editing recipe data records on the configured control elements.  
Control elements are configured buttons in the screen or function keys on the HMI device. You will find the system functions for editing recipe data records under "Recipes" and "Keyboard operation for screen objects".

## Result

The recipe screen is created.



### 10.5.3.4 Importing recipes into the configuration and exporting them

#### Introduction

You can export recipes as a CSV file and import them again into the configuration.

#### Application case

Recipe data is exported for long-term storage and backup on a computer.

In order to unify and distribute recipe data, export the recipe data to an HMI device. Change the CSV file in Microsoft Excel and import the CSV file to all HMI devices that require the same recipe data.

You want to exchange recipe data between different projects. You change the recipe data in Runtime. To transfer the modified recipe data to WinCC ES, export the recipe data records in Runtime and copy the CSV file to the configuring computer. There you import the CSV file containing the recipe data records into the recipe. And in the opposite direction, you transfer the modified recipe data records to the HMI device in WinCC ES in Runtime.

#### Requirement

- You have created the recipe.
- The structures of the exported CSV file and the recipe in WinCC ES match; name, number and data type of the recipe elements are identical.
- The "Recipes" editor is open.

## Importing CSV files

To import recipe data records into a recipe, proceed as follows:

1. Select the row which contains the desired recipe in the "Recipes" tab.
2. Select the "Import recipe data" command from the shortcut menu.  
The "Import" dialog box opens.

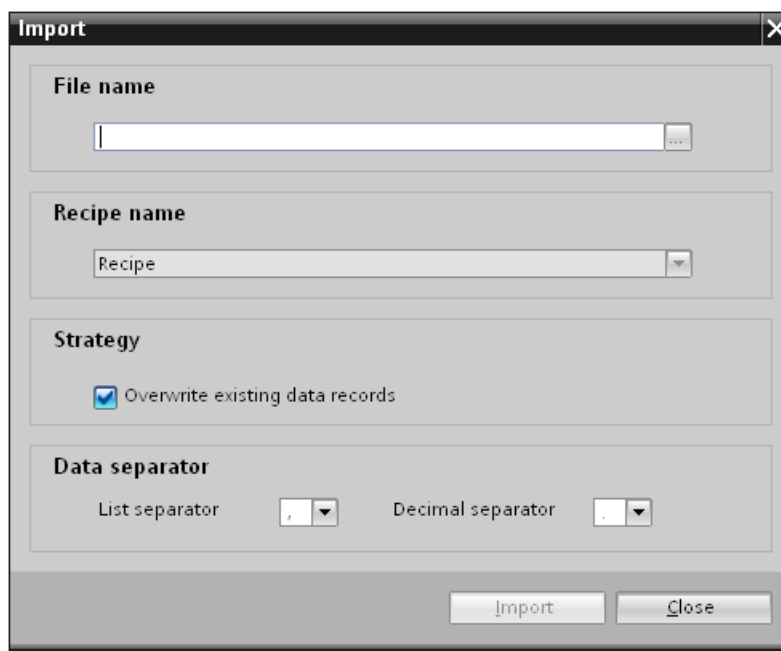

3. To select the desired CSV file, go to "File name".
4. Under "Strategy", specify whether a recipe data record with the same recipe number in WinCC ES should be overwritten.
5. Specify the list separator and decimal separator under "Data separation". The list separator separates individual recipe elements in the CSV file. The decimal separator separates integers and decimal places.

---

### Note

Use the same list separator for import as in the CSV file for export.

---

6. Click "Import" to start the operation.

## Result

The recipe will be amended by recipe data records from the CSV file that have not yet been entered. If the option is selected, existing recipe data records will be overwritten.

An error message is shown in the "Info" of the Inspector window if the structure of the recipe does not match the structure of the CSV file.

## Exporting CSV files

1. Select the row which contains the recipe to export in the "Recipes" tab.
2. Select the "Export recipe data" command from the shortcut menu.  
The "Export" dialog box opens.

The screenshot shows the 'Export' dialog box with the following fields and options:

- File name:** A text input field with a browse button (three dots).
- Recipe name:** A dropdown menu currently showing 'Recipe'.
- Content selection:** Two radio buttons. The first is 'All' and is selected. The second is 'Data record number', which is followed by 'from' and 'to' input fields, both containing the number '0'.
- Data separation:** Two dropdown menus. The first is 'List separator' with a comma (,) selected. The second is 'Decimal separator' with a period (.) selected.
- Buttons:** 'Export' and 'Cancel' buttons at the bottom right.

3. Under "File name", specify the path of the CSV file.
4. Select all recipe data records under "Selection content", or restrict the selection to specific record numbers of the recipe data.
5. Specify the list separator and decimal separator under "Data separation". The list separator separates individual recipe elements in the CSV file. The decimal separator separates integers and decimal places.
6. Click "Export" to start the operation.

## Result

The configuration is exported as a CSV file.

## 10.5.4 Using Recipes in Runtime

### 10.5.4.1 Simple recipe view

#### Description of the simple recipe view

##### Layout

The simple recipe view consists of the following display areas:

- Recipe list
- Data record list
- Element list

This application is illustrated below:

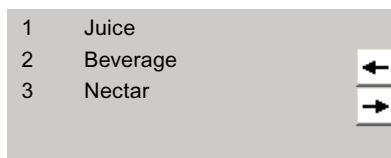

In the simple recipe view, each area is shown separately on the HMI device. You can use the shortcut menu to operate each of these display areas.

The simple recipe view always begins with the recipe list.

##### Operation

You have the following options for using the simple recipe view, according to the configuration:

- Create, change, copy or delete recipe data records
- Read recipe data records from the PLC or transfer to the PLC

#### Using the display area and shortcut menu



Toggle between the display areas and the shortcut menus to operate the simple recipe views.

The table below shows the operation of the display area.

Button	Key	Function
	<Enter>	The next lowest display area is opened, i.e. the data record list or the element list.
	<Esc>	The previous display area opens.

Button	Key	Function
	<INS>	Creates a new data record for the selected recipe if the list of recipes or recipe data records is displayed. Then changes to the list of recipe element. Requirement: "Properties >General > Processing mode" is activated. The button can be simulated with the "Key SimulateSystemKey" function even on devices without keys.
	<DEL>	Deletes the selected recipe data record in the list of recipe data records. Requirement: "Properties >General > Processing mode" is activated.
	<Up>/<Down>	Selects the previous/next entry.
	<Pg Up>/<Pg Down>	Moves the display up or down one page.
	<Home>/<End>	Selects the first/last entry. The first/last entry is selected.

The table below shows the operation of the shortcut menu:

Button	Key	Function
	<Right>	The shortcut menu of the display area opens.
	<Esc>	The menu is closed. The display area opens.
	Input of the number of the menu command	The menu command is executed.

### Shortcut menus of the simple recipe view

You can click the  button in each display area to call up a selection of commands. The command selection lists those commands that are available in the current display area. A number is assigned to each command. The command is executed when you enter this number. Alternatively select the command and press the <Return> key.

### Shortcut menus in the recipe list

Menu command	Function
New	A new recipe data record is created for the selected recipe. If a start value is configured, it is displayed in the input field.
Display tooltip	The tooltip configured for the recipe is displayed.
Open	The record list of the selected recipe opens.

### Shortcut menus of the recipe data record list

Menu command	Function
New	Creates a new recipe data record. If a start value is configured, it is displayed in the input field.
Deleting	The displayed record is deleted.
Save as	The selected data record is saved under a different name. A dialog box opens where you can enter the name.
Rename	Renames the selected data record. A dialog box opens where you can enter the name.
Open	The element list of the selected data record opens.
Previous	The recipe list opens.

### Shortcut menus of the recipe element list

Menu command	Function
Save	The selected data record with the recipe element is saved.
To PLC	The displayed values of the selected data record are transferred from the HMI device to the PLC.
From PLC	The recipe values from the PLC are displayed in the recipe view of the HMI device.
Save as	The data record is saved under a new name. A dialog box opens where you can enter the name.
Display tooltip	The tooltip configured for the recipe element is displayed.
Rename	The selected recipe element is renamed. A dialog box opens where you can enter the name.
Previous	The data record list opens.

### Shortcut menus in the data record list

#### Note

#### HMI device dependency

The following menu commands are configured in Basic Panels and in OP 77A, TP 177A, TP 177A (Portrait) and TB 177B.

Menu command	Function
To PLC	The displayed values of the selected data record are transferred from the HMI device to the PLC.
From PLC	The recipe values from the PLC are displayed in the recipe view of the HMI device.

## Using the simple recipe view

### Controlling the simple recipe view with mouse or touchpad

To control the simple recipe view with mouse or touchpad, proceed as follows:

1. Select the desired recipe from the recipe view.
2. Click the  button.  
The shortcut menu is opened.
3. Select the desired menu command.  
The menu command is executed.

### Controlling the simple recipe view with the keyboard

To control the simple recipe view with the keyboard, proceed as follows:

1. Press the <Tab> key until the simple recipe view is selected.
2. Select the desired recipe with the cursor keys.
3. Press <Right>.  
The shortcut menu is opened.
4. Press the <Down> key until the desired menu command is selected.
5. Press <Enter> to confirm the command.

### Key shortcuts for the simple recipe view

The following key shortcuts are activated for the simple recipe view in Runtime if "Activate keyboard operation" is enabled in the ES.

Key shortcut	Effect	Menu command
<Insert>	Generates a new recipe data record	New
<Del>	Deletes the recipe data record displayed.	Delete

## Managing recipe data records

### Recipe data record administration

You have the following options for managing the simple recipe view, according to the configuration:

- Creating new recipe data records
- Copy recipe data records
- Edit recipe data records
- Delete recipe data records

### Creating new recipe data records

To create a new recipe data record, proceed as follows:

1. Select the recipe on the HMI device in which you want to create a new recipe data record.
2. Select the "New" command from the shortcut menu for the recipe list.  
A new data record with the next available number will be created.  
The element list of the new recipe data record opens.
3. Enter values for the elements of the recipe data record.  
The configuration data may already contain default values for the recipe data record.
4. Select the "Save" command from the shortcut menu for the element list.  
The dialog "Save as" opens.
5. Enter the name and number of the recipe data record.
6. Click the "OK" button.

### Result

The new recipe data records will be saved to the selected recipe. If the recipe data records already exists, a system event will be output to the screen.

### Copying a recipe data record

To copy a recipe data record, proceed as follows:

1. Select the recipe on the HMI device in which you want to copy an existing recipe data record.
2. On the HMI device, select the recipe data record of which you want to save a copy.
3. Select the "Save As" command from the shortcut menu for the data record list.  
The dialog "Save as" opens. The recipe data record is automatically given the next free recipe data record number.
4. Under name, enter the name of the record.
5. Click the "OK" button.

### Result

The recipe data record is stored under the new name.

### Modify recipe data record

To change a recipe data record, proceed as follows:

1. Select the recipe on the HMI device in which you want to edit an existing recipe data record.
2. Select the recipe data record that you want to edit on the HMI device.
3. Select the recipe data record.  
The element list of the recipe data record is displayed.
4. Replace the old values with new ones.
5. Select the "Save" command from the shortcut menu for the element list.



## Result

The modified values are applied to the recipe data record.

## Deleting a recipe data record

To delete a recipe data record, proceed as follows:

1. Select the recipe on the HMI device from which you want to delete an existing recipe data record.
2. Select the recipe data record that you want to delete on the HMI device.
3. Select the "Delete" command from the shortcut menu for the data record list.
4. Confirm this security prompt to delete the data record.

## Result

The recipe data record is deleted.

## Read recipe data record from PLC

### Introduction

In Runtime, you can change values directly in the plant that are also stored in recipes in the HMI device. This applies if a valve was opened further directly in the plant than was specified in the recipe. The values of the recipe data records saved in the HMI device possibly no longer match the values in the PLC.

You can read the values of the recipe tags from the PLC and write them to a recipe data record.

The read values are written to the recipe data record that is currently displayed on the HMI device.

### Procedure

To read a recipe data record from the PLC, proceed as follows:

1. Open the recipe on the HMI device.  
The data record list opens.
2. Select the element list of the recipe data record to which you want to apply the values from the PLC.
3. Select the "From PLC" command from the shortcut menu for the element list.  
The values are read from the PLC and displayed in the current recipe data record.
4. If you want to save the values, select the "Save" or "Save As" command.

## Result

The values are read from the PLC, visualized on the HMI device and saved to the recipe data record.

## Transferring a recipe data record to the PLC

### Introduction

For the values of a data record that was changed in the recipe view to take effect, you must transfer the values to the PLC.

The values displayed in the recipe view are always transferred to the PLC.

### Procedure

To transfer a recipe data record to the PLC, proceed as follows:

1. Open the recipe you want to use.  
The data record list opens.
2. Select the element list of the recipe data record whose values you want to transfer to the PLC.
3. Select the "To PLC" command from the shortcut menu for the element list.

### Result

The values of the recipe data record are transferred to the PLC.

#### 10.5.4.2 Advanced recipe view

### Description of the advanced recipe view

### Application

The recipe view is used to display, edit and manage data records.

Recipe Name:	No.:
Orange	2
Data Record Name:	No.:
Nectar	2
Entry Name	Value
Water	50
Concentrat	50

Ready









## Operation

Depending on the configuration you can:

- Create, change, copy or delete recipe data records
- Synchronizing recipe data records with the associated recipe tags
- Read recipe data records from or transfer to the PLC

## Operating elements

The following operating elements can be configured in the recipe view:

Operating element	Key combination	Function
		The configured tooltip is displayed.
	<Ctrl+Space Bar>	Creates a new recipe data record. If a start value is configured, it is shown in the input field.
	<Ctrl+Enter>	Saves the displayed values of the recipe data record. The storage location is predefined by the project.
	<Ctrl+*>	The recipe data record is saved under a different name regardless of the recipe view. A dialog box opens where you can enter the name.
	<Ctrl+Del>	The displayed recipe data record is deleted.
	<Ctrl+=>	The system always updates the current value of the recipe view with the up-to-date recipe tag value.  When the value shown in the recipe view is more recent than the current recipe tag value, the system writes this value to the recipe tag.  "Synchronize recipe view and recipe tags" must be activated in the recipe properties before this function can be used.
	<Ctrl+Down>	The values of the set recipe data record displayed in the recipe view are transferred to the PLC.
	<Ctrl+Up>	The recipe values from the PLC are displayed in the recipe view.

## Using the advanced recipe view

### Introduction

You can control the recipe view using both mouse or touchpad or with the keyboard.

### Controlling the recipe view with mouse or touchpad

To control the recipe view with mouse or touchpad, proceed as follows:

1. Select the recipe you want to use.  
The records for the recipe are displayed.
2. Click on the data record you wish to edit.
3. Click the button whose function you want to run.

### Controlling the recipe view with the keyboard







To control the recipe view with the keyboard, proceed as follows:

1. Press the <Tab> key until the cursor reaches the field for selecting the recipe.
2. Press <Enter>.  
The drop-down list box for the recipes opens.
3. Select a recipe. You navigate between the next or previous entry in the list by using the cursor keys <Left>, <Right>, <Up> and <Down>.
4. Select a data record.
5. Press the <Tab> key until the operator control object you wish to use is selected.

Alternatively you can control the recipe view using certain key combinations.

### Key shortcuts for the advanced recipe view

The following key shortcuts are activated for the advanced recipe view in Runtime if "Activate keyboard operation" is enabled in the ES.

Keys shortcut	Effect	Menu command	Button
<Ctrl+Space>	Generates a new recipe data record. Any configured start value is displayed in the input field.	Add data record	
<Ctrl+Del>	Deletes the recipe data record displayed.	Delete data record"	
<Ctrl+Enter>	Saves the edited data record by its current name.	Save	
<Ctrl+*>	Saves the edited data record by a new name.	Save as	
<Ctrl+=>	Compares the values of the selected data record with the values on the PLC. Any value in the recipe view which is more recent compared to the current recipe tag value is written to the recipe tag. This function is only available if enabled in the ES.	Synchronizing recipe tags	
<Ctrl+Down>	Transfers the current value to the PLC.	Write to PLC	
<Ctrl+Up>	Reads the actual value from the PLC.	Read from PLC	

## Managing recipe data records



### Administration of recipe data records

You have the following options for managing recipe data records, according to the configuration:

- Create new recipe data records
- Copy recipe data records
- Edit recipe data records
- Delete recipe data records

### Creating new recipe data records

To create a new recipe data record, proceed as follows:

1. Select the recipe on the HMI device in which you want to create a new recipe data record.
2. Click the  button or press the <Ctrl + Spacebar> keys.  
A new recipe data record with the next available number is created.  
If you change the new data record number to an existing data record number, the existing data record is overwritten.
3. Enter values for the elements of the data record.  
The elements of the recipe data record can be assigned default values depending on the configuration.
4. Click the  button or press the <Ctrl + \*> keys.  
The dialog "Save as" opens.
5. Enter a name for the data record.
6. Click on "OK" to confirm your input.  
The data record is saved under the new name.  
If the recipe data record already exists, a dialog is opened. In this dialog, specify whether the existing data record is to be overwritten.

### Result

The new recipe data records will be saved to the selected recipe. If the recipe data records already exists, a system alarm will be output to the screen.

### Copying a recipe data record

To copy a recipe data record, proceed as follows:

1. Select the recipe on the HMI device in which you want to copy an existing recipe data record.
2. Select the recipe data record that you want to copy on the HMI device.
3. Click the  button in the recipe view or press the <Ctrl + \*> keys.  
The dialog "Save as" opens.

4. Enter a name for the data record.
5. Click on "OK" to confirm your input.

## Result

The recipe data record is stored under the new name.

## Modify recipe data record

To change a recipe data record, proceed as follows:

1. Select the recipe on the HMI device in which you want to edit an existing recipe data record.
2. Select the recipe data record that you want to edit on the HMI device.
3. Replace the old values with new ones.
4. Click the  button in the recipe view or press the <Ctrl + Enter> keys.

## Result

The modified values are applied to the recipe data record.

## Delete recipe data record

To delete a recipe data record, proceed as follows:

1. Select the recipe on the HMI device in which you want to delete an existing recipe data record.
2. Select the recipe data record that you want to delete on the HMI device.
3. Click the  button in the recipe view or press the <Ctrl + Del> keys.

## Result

The recipe data record is deleted.

## Synchronizing recipe data record

### Introduction

Differences between the following values may occur during runtime:

- The values displayed in the recipe view
- The actual values of the recipe tags

Depending on the configuration, the values displayed in the recipe view are synchronized with the recipe tags. Synchronization encompasses all tags of a recipe data record.

---

**Note****Changed tag name**

The tag and the value of the recipe data record cannot be associated if you have renamed the tag you want to synchronize. The tags in question are not synchronized.

---

**Note**

Recipe tags can only be synchronized in the advanced recipe view.

---

**Requirement**

- A recipe data record is displayed in the recipe view.
- The values of recipe tags were modified by teaching, for example.

**Procedure**

To synchronize a recipe data record, proceed as follows:

1. Click the  button in the recipe view or press the <Ctrl + => keys.

**Result**

The system always updates the current value of the recipe view with the up-to-date recipe tag value.

When the value shown in the recipe view is more recent than the current recipe tag value, the system writes this value to the recipe tag.

**Read recipe data record from PLC****Introduction**

In Runtime, you can change values directly in the plant which are also stored in recipes in the HMI device. This applies if a valve was opened further directly in the plant than was specified in the recipe. The values of the recipe data records saved in the HMI device possibly no longer match the values in the PLC.

You can read the values of the recipe tags from the PLC and write them to a recipe data record.

The read values are written to the recipe data record that is currently displayed on the HMI device.

## Procedure

To read a recipe data record from the PLC, proceed as follows:

1. Select the recipe on the HMI device.
2. On the HMI device, select the recipe data record of which you want to fetch the values from the PLC.
3. Click the  button in the recipe view or press the <Ctrl + Up> keys.

## Result

The values are read from the PLC and displayed on the HMI device.

## Transferring recipe data records to the PLC

### Introduction

For the values of a data record that was changed in the recipe view to take effect, you must transfer the values to the PLC.

The values displayed in the recipe view are always transferred to the PLC.

## Procedure

To transfer a recipe data record to the PLC, proceed as follows:

1. Select the recipe on the HMI device.
2. On the HMI device, select the recipe data record of which you want to transfer the values to PLC.
3. Click the  button in the recipe view, or press the <CTRL+DOWN> shortcut key.

## Result

The values of the recipe data record are transferred to the PLC.



### 10.5.4.3 Exporting and importing recipe data records

#### Introduction

Depending on configuration and the HMI device, either export recipe data records to a CSV file, e.g. for editing in MS Excel, or import these from a CSV file. The extent to which you can influence these processes is determined by the project configuration.

---

#### Note

##### Restrictions for Import / Export

It is not possible to export or import the recipes for the following HMI devices:

- Basic Panels
- OP 77A
- OP 177A
- TP 177A (Portrait)

Complete recipe data, but not single recipe data records, can be exported and imported using ProSave in CSV format and transferred to the HMI device. Thereby, Runtime is interrupted.

---

A list separator is used to separate the data records during importing and exporting.

---

#### Note

The list separator used as the default depends on the setting for formats and numbers in the operating system. Select "Start > Settings > Control Panel > Regional and Language Options". If you want to import or export recipe data records, do not use this list separator in the display name of the recipe data records.

---

The following fields can be configured on the user interface, for example, in order to use the export/import function:

- Selection field for the recipe
- Selection field for the recipe data record
- Operating element with the "ExportDataRecords" functionality
- Operating element with the "ImportDataRecords" functionality

#### Export recipe data record

To export a recipe data record, proceed as follows:

1. Select the relevant recipe and recipe data record from the selection boxes.
2. Click the control element with the "ExportDataRecords" functionality.

## Result

The recipe data record are exported to a CSV file.

---

### Note

New data records created in runtime can be exported to an external file.

---

## Importing recipe data records

To import a recipe data record, proceed as follows:

1. Select the relevant recipe and recipe data record from the selection boxes.
2. Click the control element with the "ImportDataRecords" functionality.

## Result

The recipe data record are imported.

### 10.5.4.4 Reactions to modifications of the recipe structure

#### Introduction

Different recipe structures can occur in the following situations:

- In the event of changes during commissioning
- When work is carried out on the machine by the machine manufacturer (retrofit)
- When CSV files are imported, the structure of the CSV file can differ from the recipe structure.

Nevertheless, you can still use any recipe data records already created.

<b>NOTICE</b>
---------------

When a tag is renamed, the assignment is lost.
--

## Effects

Handle any structural differences as follows:

- If the old recipe data record or the CSV file contains additional values, these values will be discarded.
- If the old recipe data record or the CSV file contains values of the wrong data type, the configured default value will be used in the recipe data record.  
Example: The recipe data record contains values that show the tank contents and were input as floating point numbers. However, the corresponding recipe tag expects an integer value. In this case, the system discards the transferred value and the configured default value is used.
- If the old recipe data record or the CSV file contains too few values, the configured default value will also be used in the recipe data record.

## 10.5.5 Examples

### 10.5.5.1 Example of creating a recipe

#### Task

In this example, you create three recipes for a fruit juice mixing machine. The fruit juice mixing machine produces drinks with "orange", "apple" and "tropical" flavors. You create a recipe for each flavor.

Each recipe contains a recipe data record for the following mixing ratios:

- Beverage
- Nectar
- Juice

#### Settings

The settings relate to an HMI device which is connected to a SIMATIC S7-300 or SIMATIC S7-400.

In this example, you will need the following tags, recipes, recipe entries and recipe data records:

#### Tags:

Name	PLC connection	Address	Type
Liter water	Yes	DB 120, DBW 0	Integer
Liter concentrate	Yes	DB 120, DBW 4	Integer
Kilo sugar	Yes	DB 120, DBW 8	Integer
Gram flavoring	Yes	DB 120, DBW 12	Integer

#### Recipes:

- Orange
- Apple
- Tropical

**Recipe entries:**

Recipe element	Associated tag
Liter water	Liter water
Liter concentrate	Liter concentrate
Kilo sugar	Kilo sugar
Gram flavoring	Gram flavoring





**Recipe data records for drink, nectar and juice:**

Data record name	Liter water	Liter concentrate	Kilo sugar	Gram flavoring
Beverage	30	70	45	600
Nectar	50	50	10	300
Juice	5	95	3	100



**Procedure**

To create a recipe, proceed as follows:

1. Create the following tags with the settings specified above: "LiterWater", "LiterConcentrate", "KiloSugar" and "GramFlavoring".
2. Create the "Orange", "Apple" and "Tropical" recipes with the settings indicated above. Create the recipe entries in each recipe.

Elements		Data records				
	Name	Display name	Tag	Default value	Decimal places	Infotext
	Water	Water	LitreWater	0	0	
	Concentrat	Concentrat	LitreConcentrat	0	0	
	Sugar	Sugar	KiloSugar	0	0	
	Aroma	Aroma	GramAroma	0	0	
	<Add new>					

3. Not for Basic Panels: Configure each recipe so that you can synchronize the recipe data records between the recipe screen and recipe view. The values of the recipe tags should not be transferred automatically to the PLC.  
You will have to make the following settings in the Properties dialog for the recipe concerned:  
Under "Properties > Options":
  - Activate the "Synchronize recipe view and recipe tags" option.
  - Activate the "Manual transfer of individual modified values (teach-in mode)" option.
4. Create the data records indicated above in each recipe. Enter the values indicated above in each of the data records.

Elements		Data records						
	Name	Display name	Number	Water	Concentrat	Sugar	Aroma	Comment
	Beverage	Beverage	1	30	70	45	600	
	Nectar	Nectar	2	50	50	10	300	
	Juice	Juice	3	5	95	3	100	
	<Add new>							

## Result

The "Orange", "Apple" and "Tropical" recipes have been created.

### 10.5.5.2 Example of configuring a recipe screen

## Task

In this example, you create a recipe screen for the visualization of values of the fruit juice mixing machine. You use a recipe view to select the recipes and their associated recipe data records.

You should be able to use the following functions with the buttons:

- "Load" Button  
The selected recipe data record is loaded from the recipe memory on the HMI device and displayed in the recipe screen.
- "Save" Button  
The displayed recipe tags are saved in the recipe memory of the HMI device.

10.5 Working with recipes

- "Data to PLC" button  
The displayed tags are transferred to the PLC.
- "Data from PLC" button  
The current recipe data record in the PLC is transferred to the recipe variables and displayed on the HMI device.

**Requirement**

- The "Creating a recipe" sample application has been carried out.
- You have created and opened the "Fruit juice mixing plant" screen.

**Settings**

In this example, you need the following tags and buttons with the indicated settings:

**Tags:**

Name	PLC connection	Type
RecipeNumber	No	Integer
Data record number	No	Integer

**Buttons:**

Labeling	Configured event	System function
Load	Click	LoadDataRecord
Save	Click	SaveDataRecord
Data to PLC	Click	SetDataRecordTagsToPLC
Data from PLC	Click	GetDataRecordTagsFromPLC

## Procedure

To configure a recipe screen, proceed as follows:

1. Drag-and-drop the "Liter water", "Liter concentrate", "Kilo sugar" and "Gram flavoring" tags from the object view to the "Fruit juice mixing machine" process screen. Four IO fields are created and linked by the specified tags.
2. Add a recipe view containing selection fields for the recipe name and data record name only.  
Make the following settings in the Inspector window for the recipe view:
  - Select the "Advanced view" display type under "General".
  - Deselect "Edit mode" under "Properties > General" and "Display table" under "Properties > Table".
  - Connect the "Recipe tag" field to the "RecipeNumber" tag.
  - Connect the "Tag" field to the "DataRecordNumber" tag.
  - Disable all the buttons under "Properties > Buttons".
3. Assign the above settings to four buttons. Transfer each "Recipe number" and "Data record number" tag as a parameter for the recipe number and recipe data record number.

## Result

You can select the recipe and the associated recipe data record from the recipe view and modify the recipe values at runtime. You can load, save and transfer the recipe data records using the buttons.

### 10.5.5.3 Scenario for Entering Recipe Data Records in Runtime

#### Objective

You want to enter production data on the HMI device without disturbing the process that is currently underway. Therefore, the production data should not be transferred to the PLC.

#### Requirement

- The recipe has been created.
- The recipe has the following settings:
  - "Synchronizing recipe view and recipe tags" is activated or deactivated.
  - If "Synchronize recipe view and recipe tags" is activated, "Manual transfer of individual modified values (teach-in mode)" has to be activated.  
This will prevent the recipe tags being transferred automatically between the HMI device and PLC.
- A recipe screen or a screen with recipe view is available.
- There is an operating element for saving the recipe data records.

## Sequence

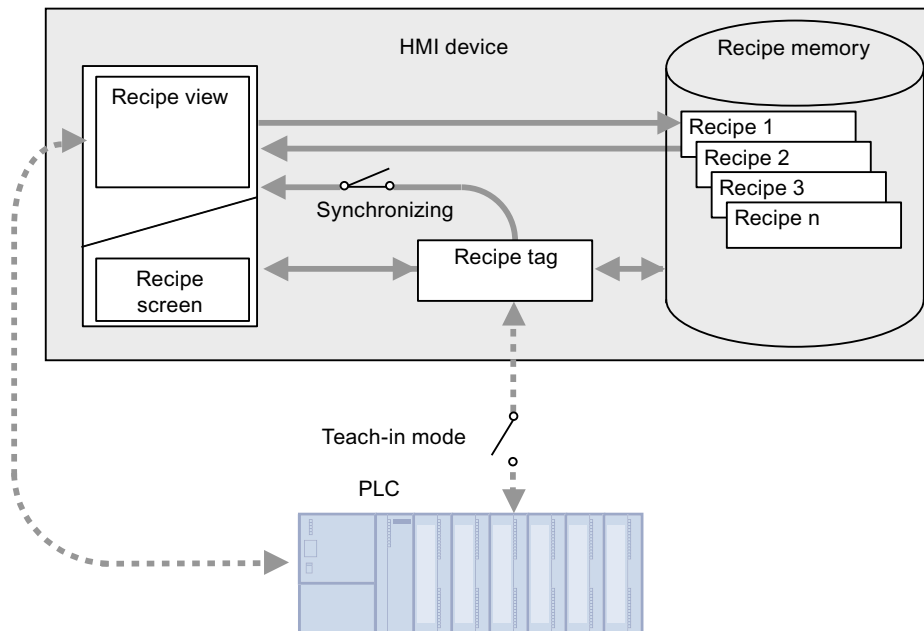

1. Enter the production data in the recipe view or recipe screen.
2. Save the modified recipe data record.

## Transfer the recipe data to the PLC

The configuration may provide operating elements for transferring recipe data to the PLC.

### 10.5.5.4 Scenario for a manual production sequence

#### Objective

A reading device connected to the PLC reads a bar code on the work piece to be processed. The recipe data record names correspond to the respective bar code names. This will enable the PLC to load the necessary recipe data record from the storage medium of the HMI device. The recipe data record is displayed for inspection on screen.

You want to be able to correct the transferred production data online, if necessary.



## Requirement

- You have created the recipe.
- The recipe has the following settings:
  - "Synchronizing recipe view and recipe tags" is activated.
  - "Manual transfer of individual modified values (teach-in mode)" is deactivated.

---

### Note

The changes are immediately transferred to the PLC

---

- There is a recipe screen available.  
There may also be an operating element for saving the recipe data records in the recipe screen.

## Sequence

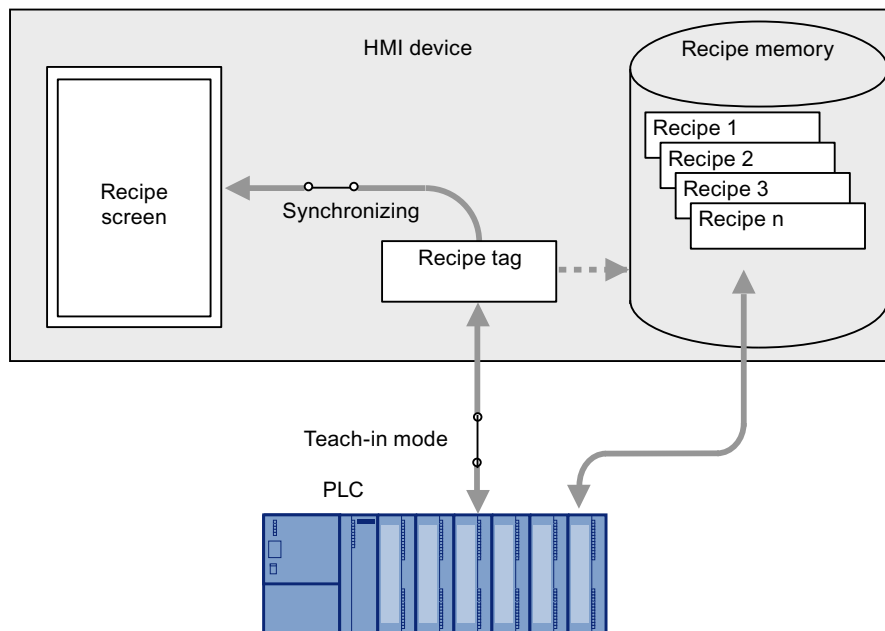

## Behavior when the recipe view is used

If the recipe view is used, it is not possible to transfer changes immediately. You must use the operating element to transfer the recipe data record to the PLC.

### 10.5.5.5 Scenario for an Automatic Production Sequence

#### Objective

You want production to be executed automatically. The production data is to be transferred directly to the PLC, either from the recipe memory in the HMI device or from an external storage medium. The screen display is not necessary.

#### Requirement

- You have created the recipe.
- The recipe has the following settings:
  - "Coordinated transfer of data records" is activated.  
The production data is transferred to the PLC, so a coordinated transfer with the PLC is necessary to prevent the data from being accidentally overwritten.

#### Sequence

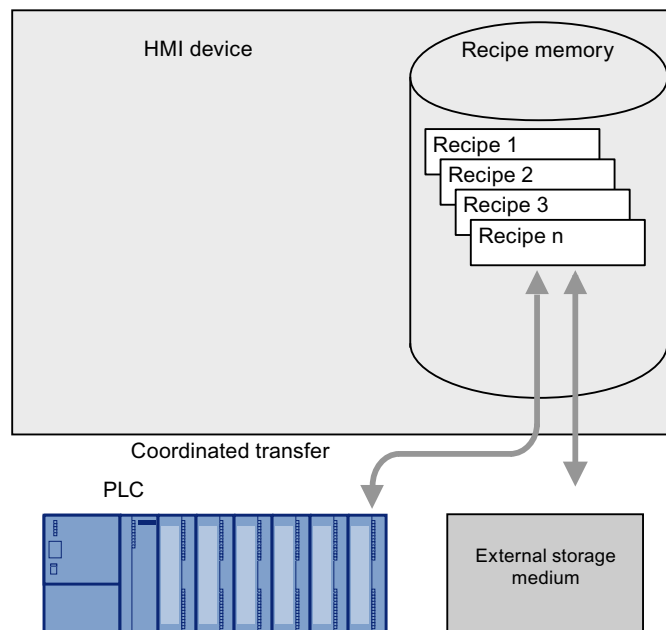

#### Implementation

You can control the flow of data in the following ways:

- The control program controls the automatic transfer via control jobs or via WinCC system functions, if necessary.  
The sequence is controlled via the status information in the mailbox and via return values from the functions used.
- One or more scripts control the automatic transfer via WinCC system functions.  
The sequence can be checked using the values returned by the functions used.

You can implement the automatic production sequence with available system functions:

- "ImportDataRecords"  
This function loads data records from a \*.CSV file into the recipe memory of the HMI device.
- "SetDataRecordToPLC"  
This function transfers a data record from the HMI device's recipe memory to the PLC.

## 10.6 Working with reports

### 10.6.1 Basics

#### 10.6.1.1 Reports

##### Introduction

Reports are used to record process data and processed production cycles. You have the opportunity, for example, to create regular shift reports, output batch data, or record the production process for quality control (QC).

##### Creating reports

A report is created and edited in the "Reports" editor. In this editor, you configure the following report items:

- **Formal appearance**  
Specify the formal layout of the report in the Inspector window. In this window, for example, you specify the page format, page margins, title page, back page, headers, or footers for the report.
- **Content**  
In the work area, specify the content of the report, for example, the alarms of a shift. To this purpose you insert the corresponding objects into the report.

The modular structure lets you configure reports that suit all of your applications.

---

##### Note

The "Reports" editor is not available at HMI devices that do not support reporting.

---

##### Report output

In runtime, the configured reports are printed on the default printer of the HMI device.

In runtime, report output is event or time-controlled.

- **Time-controlled:** Automatic print at specific dates, times or intervals.
- **Event-driven:** Printing is initiated by specific events, e.g. click on a button, or when a limit is exceeded.

## **See also**

Principles for preparation of reports (Page 3463)

Printing reports (Page 3468)

Structure of reports (Page 3461)

Inserting an object (Page 3469)

Printing reports (Page 3484)

Audit report (Page 3484)

### **10.6.1.2 Structure of reports**

#### **Introduction**

A report in WinCC consists of several sections that can be enabled or disabled, as required.

### Sections of a report

The following figure shows an example of the different sections of a report in the "Reports" editor.

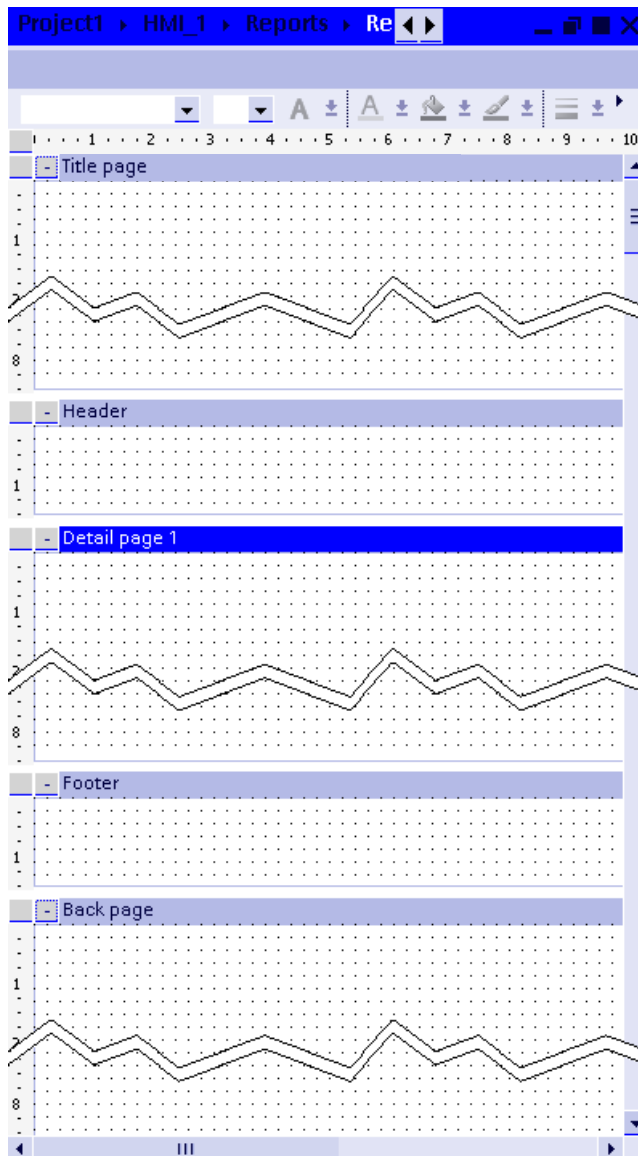

### Title page and back page

The title page contains important information about the report content. The back page is used, for example, as Impressum, on which you provide contact information of shift managers or service technicians. The title page and back page are output separately on a single page. Each of them consist of exactly one page and page breaks are not used.

## Detail page

Configure the output of runtime data such as recipe or alarm reports on the detail pages of the report.

Use the shortcut menu on the detail page to insert additional detail pages or change their order.

## Header and footer

The header and footer are output on each detail page of the report. You typically insert the page numbers or the date in the header or footer.

## See also

Reports (Page 3460)

Principles for preparation of reports (Page 3463)

## 10.6.2 Working with reports

### 10.6.2.1 Creating reports

#### Principles for preparation of reports

##### Introduction

A report in WinCC consists of several sections that can be enabled or disabled, as required.

- Title page
- Back page
- Detail pages
- Headers and footers for the detail pages

## Procedure

The following figure shows the general procedure for creating a report:

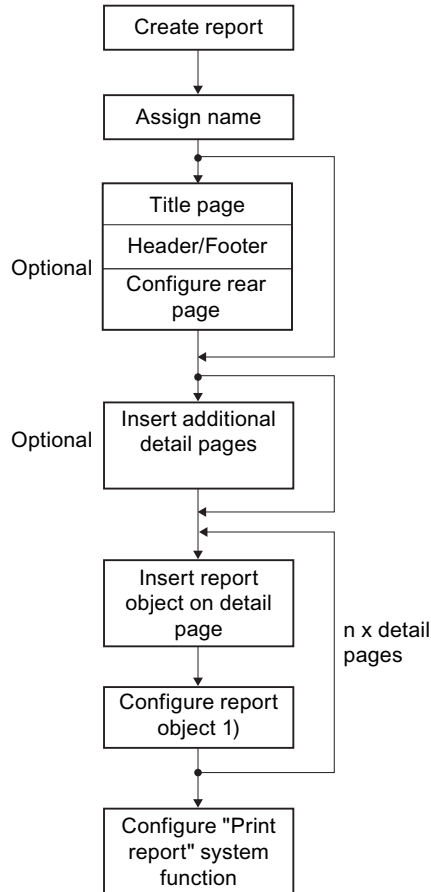

1) Settings depend on the report object used.

## Tools for the design of reports

The tools that you can use to design reports are available in the "Tools" task card.

- For *graphic design* insert "basic objects", "elements" and "graphics" in the different sections of the report. For example, for a Logo in the header, separation lines and a page number in the footer.
- Using the "Controls" in the detail pages, configure the *output of runtime data*.

---

### Note

The "Screens" editor provides many objects for designing a report – however, with restricted functionality. Data input properties are not available. The I/O fields in the reports, for example, serve only to output data.

---



## Position and size of objects

Insert the objects at the position where you want them to be output in the report. The objects are output in their configured size and with the following special features:

On the detail pages, configure "recipe reports" or "alarm reports" that serve to output runtime data in tabular format.

- The *width* of the table is set up automatically to fit the width of the detail page. You cannot modify the width.
- WinCC automatically wraps the *height* of the table to fit the data content for output in the report. The table can be continued on the next page.  
In the detail page, WinCC automatically extends tables of dynamic length to the bottom margin.

The following figure shows an example of a detail page in the report and its output in Runtime:

Detail page in the report



Report output in Runtime

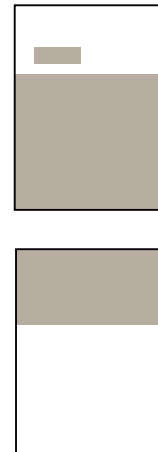

## Additional detail pages

Use the shortcut menu on the detail page to insert additional detail pages or change their order.

## See also

Objects in reports (Page 3484)

Structure of reports (Page 3461)

Administration of detail pages (Page 3467)

## Create a report

## Requirement

A project with an HMI device is open.

## Procedure

To create a report, proceed as follows:

1. Double-click "Add new report" under "Reports" in the project navigation.  
A new blank report is displayed in the "Reports" editor.
2. Select the "Report properties" command in the shortcut menu of the report.
3. In the "Properties > Properties > General" area of the Inspector window, specify whether you want to configure the "Title page", "Back page", "Header" and "Footer" in the report.  
The report sections are updated accordingly.

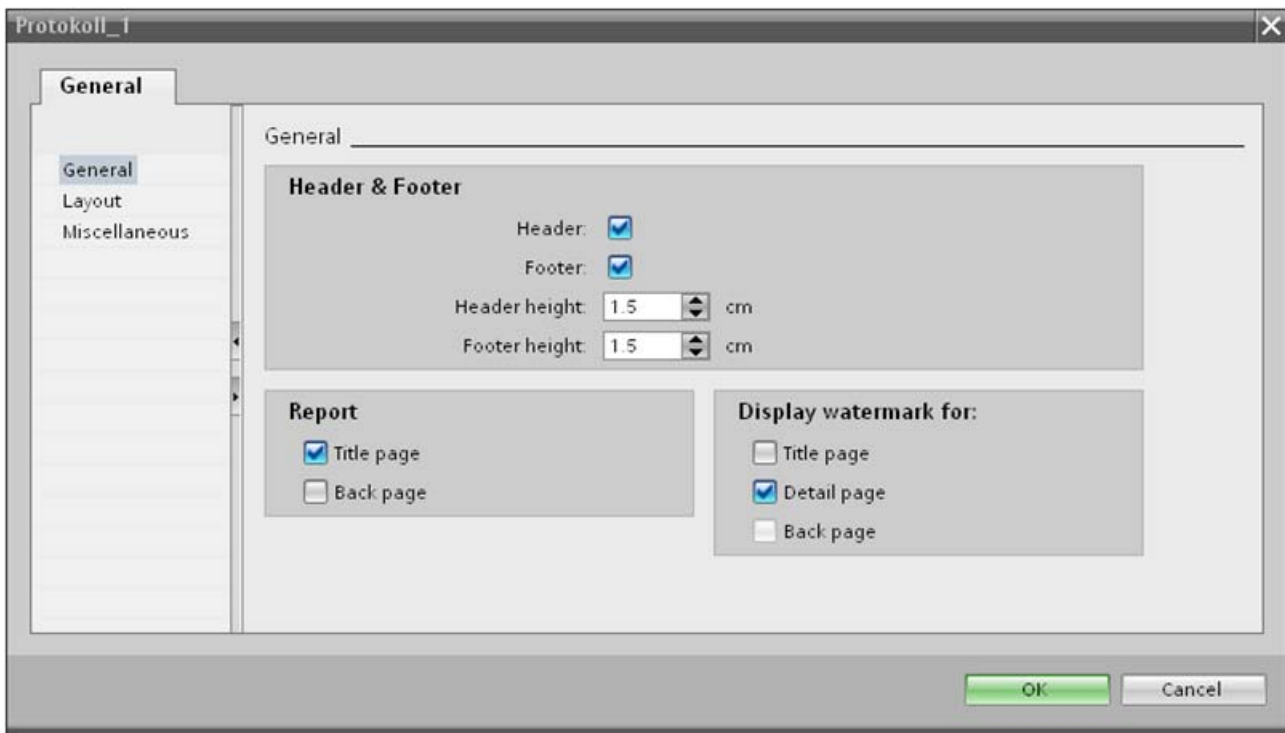

4. Configure the format, the page layout, and the page margins of the report under "Properties > Properties > Layout."

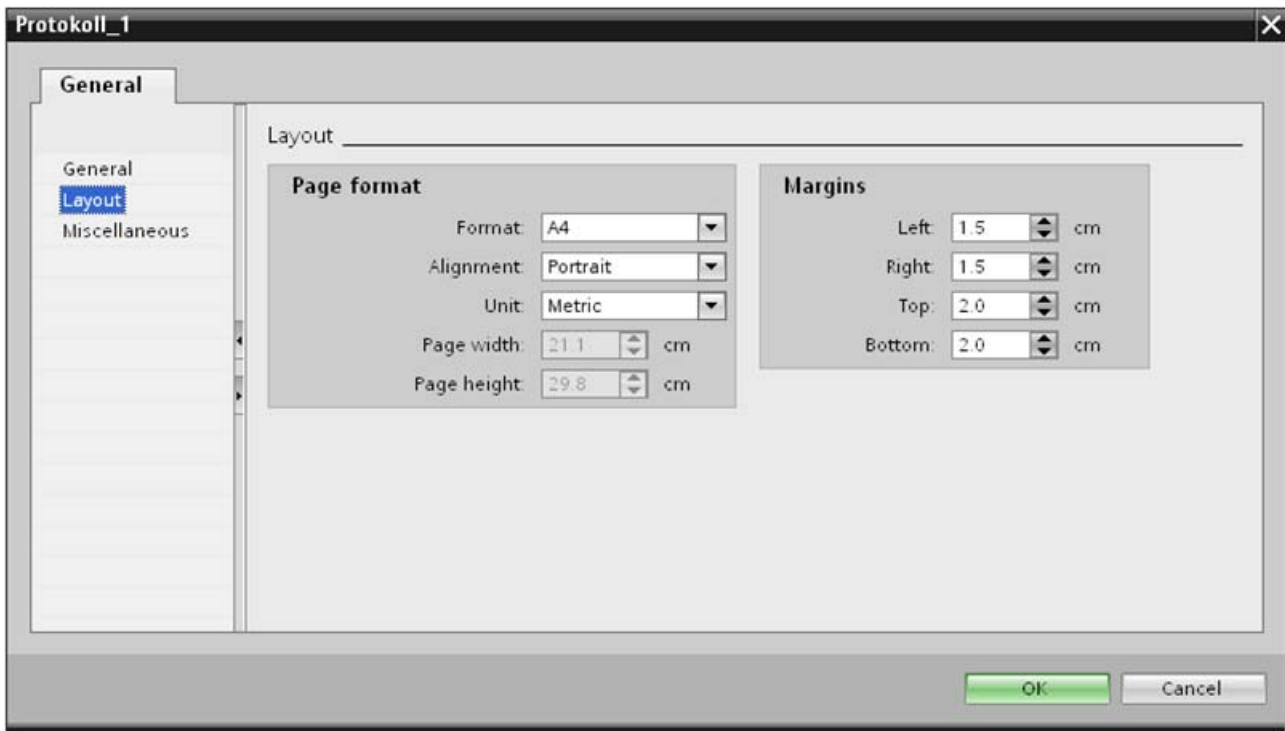

5. Enter a meaningful report name under "Properties > Properties > Miscellaneous."
6. Design the report sections as required.  
Drag and drop the necessary basic objects, elements, graphic images and controls from the "Tools" task card to the required position.  
Alternatively, you can also copy or move objects already configured from a screen to the report.
7. Configure the objects in the Inspector window:

## See also

Objects in reports (Page 3484)

## Administration of detail pages

### Adding a detail page

1. Open the shortcut menu of a detail page.
2. Select the command "Pages > Insert page before" or "Pages > Insert page after."  
Depending on the selected command, the new detail page is inserted either before or after the existing detail page.

### Deleting a detail page

1. Open the shortcut menu of the detail page that you want to remove.
2. Select the command "Pages > Delete detail page".  
The detail page is deleted.

### Sorting detail pages

1. Open the shortcut menu of the detail page that you want to move.
2. Select the "Pages > Move one page up" or "Pages > Move one page down" command.  
Depending on the selected command, the detail page is moved either upward or downward.

### Showing and hiding sections

1. To show or hide a specific section, click on the plus or minus sign in the title bar of the section in the working area.
2. If you want to show or hide all sections of a report, select the command "Show all pages" or "Hide all pages" in the report shortcut menu.

### See also

Structure of reports (Page 3461)

Principles for preparation of reports (Page 3463)

## 10.6.2.2 Printing reports

### Introduction

In Runtime, report output is event-driven or time-driven.

### Event-driven output

The report is output after an event was generated.

Examples:

- A tag value changes or exceeds a limit.
- Alarm is incoming, outgoing or acknowledged
- Action by the operator, for example, clicking a button

### Time-driven output

The report is output automatically.

Examples:

- Once at a specified date, e.g. on December 31, 2010
- At intervals, e.g. daily at 8 am, or on Mondays at 6 pm

### Configuration steps

Configuring event-driven output:

- An event is configured on a button or tag with the "PrintReport" system function.

Configuring time-driven output:

- In the scheduled tasks, configure a "Print job" task and assign it to the desired report. In the task properties, specify the time and frequency of report output.

### Output in Runtime

On the control panel of the HMI device, the report is output to the printer that is specified as the default printer.

The default printer enabled for a HMI device can be found in the "Printer list". For further information about the "Printer list", refer to the Internet page of Siemens Customer Support and the Article ID "11376409".

### See also

Planning jobs (Page 4900)

Printing reports (Page 3484)

## 10.6.2.3 Working with objects

### Inserting an object

#### Introduction

In the "Screens" or "Reports" editor, insert the objects to the "Toolbox" task card. Use the mouse to drag the objects into the work area. You either keep the objects in their original size, or scale them up or down when you paste them.

In addition, you can copy or move objects via the clipboard from one editor to another, for example to transfer a screen object to a report. Alternatively, you can also use the mouse instead of the clipboard for copying and moving:

- Copying: <Ctrl + Drag&Drop>
- Moving: Drag&drop

---

#### Note

##### Basic Panels

The "Reports" editor is not available for Basic Panels.

---

## Requirement

The "Tools" task card is open.

## Inserting objects in their standard size

1. In the "Toolbox" task card, select the desired graphic object or the desired graphic in the WinCC graphics folder.  
When you move the cursor across the work area, it turns into a crosshair with an appended object icon.
2. Click the location in the work area where you want to insert the object or graphic.  
The object is inserted with its standard size at the desired position in the work area.

Alternatively, double-click the object in the "Toolbox" task card.

## Copying an object

1. Select the desired object.
2. Select "Copy" in the shortcut menu.
3. Click the desired location and select "Paste" in the shortcut menu.

WinCC inserts a copy of the object at the desired location. You can only change the properties that are appropriate for the relevant context.

Example: In the "Screens" editor, you can set for I/O fields and the mode for input and output. In the "Reports" editor, the mode is set to "Output".

Original and copy are not interconnected and are configured independently from one another.

## Inserting lines

1. Select the desired graphic object in the "Tools" task card.
2. Click on a location in the work area. A line in the standard size is inserted.

## Inserting a polygon or polyline

1. Select the desired object "Polyline" or "Polygon" in the "Tools" task card.
2. Click on a location in the work area. This fixes the starting point of the object.
3. Click another location in the work area. A corner point is set.
4. For every additional corner point, click on the corresponding location in the work area.
5. Double-click on a location in the work area. The last corner point is set.  
This fixes all the points of the polygon or polyline.

---

### Note

#### Basic Panels

The "Polyline" and "Polygon" objects are not available for Basic Panels.

---

---

### Note

If you want to insert several objects of the same type, use the "Stamp" function. This avoids having to reselect the object in the "Tools" task card every time before inserting it. To do so, select the  icon in the toolbar of the "Tools" task card.

---

### See also

Deleting an object (Page 3471)

Inserting multiple objects of the same type (stamping tool) (Page 3472)

Positioning objects (Page 3473)

Resizing objects (Page 3476)

Storing an object in a library (Page 5502)

Inserting a library object (Page 5502)

Moving an object forwards or backwards (Page 3475)

Flipping objects (Page 3483)

Reports (Page 3460)

### Deleting an object

#### Introduction

You can delete objects individually or with a multiple selection.

#### Requirement

You have opened the work area containing at least one object.

#### Procedure

1. Select the object that you want to delete.  
To delete multiple objects, keep the <Shift> key pressed and select the objects to be deleted one after the other. Alternatively, drag and maximize an area around the desired objects with the mouse.
2. Select "Delete" from the shortcut menu.

#### Result

The selected objects are deleted.

## Inserting multiple objects of the same type (stamping tool)



### Introduction

WinCC offers the possibility to "stamp" several objects of the same type directly one after the other, i.e. paste without having to reselect the object every time. In addition you have the possibility of multiplying an object that has already been inserted.

### Requirement

The "Tools" task card is open.

### Inserting several objects of one type

1. Select the object that you want to insert in the "Tools" task card.
2. Click the  icon in the toolbar of the "Tools" task card.  
The "Stamp" function is activated.
3. To insert the object with its standard size, click the relevant insertion position in the work area.  
To insert the object with another size, position the mouse pointer at the desired location in the work area. Press the left mouse button and drag the object to the required size.  
The object is inserted in the work area as soon as you release the mouse button.
4. Repeat step 3 to insert further objects of the same type.
5. Click the  icon again.  
The "Stamp" function is deactivated.

---

#### Note

You can copy existing objects using the drag-and-drop +<CTRL> function. The existing object is not moved in this case. You paste a copy of this object into the new position instead.

---



## Inserting and multiplying an object

1. Insert the desired object from the "Tools" task card.
2. Press the <Ctrl> key and position the cursor on one of the handles displayed in the figure shown below.

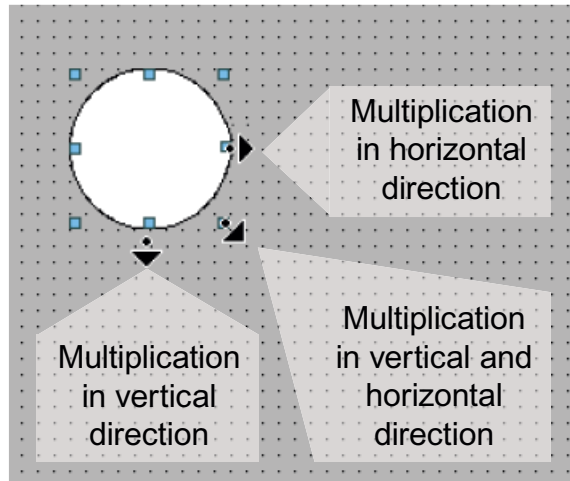

3. Drag the handles to the right and/or down while keeping the left mouse button pressed.
4. The object is multiplied depending on available space if you keep moving the cursor.

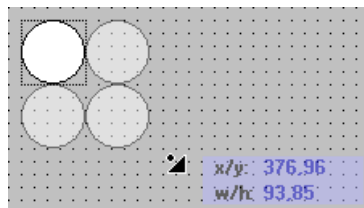

## Result

You have pasted and stamped an object in a screen.

## Positioning objects

### Introduction

When you select an object, it is enclosed by a rectangle with resizing handles. This rectangle is the rectangle which surrounds the object. The position of an object is defined by the coordinates of the top left corner of the rectangle surrounding the object.

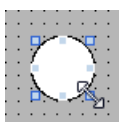

---

**Note**

If the position is outside the work area the object is not displayed in Runtime.

---

**Position and align**

You have the possibility of having a grid displayed in the work area. You have three options for easier positioning of objects:

- "Snap to grid" When you reposition objects, they are automatically snapped and pasted to the grid. If you hold down the <Alt> key, the object is no longer snapped to the grid.
- "Snap to objects" When you reposition objects, they are displayed with help lines. You can use other objects for orientation during positioning.
- "None": You position the objects in any position.

You activate and deactivate the grid and options as follows:

- In the "Options > Settings > Visualization > Screens" menu
- In the "Layout > Grid" task card

**Requirement**

You have opened the work area containing at least one object.

**Procedure**

1. Select the object you want to move.  
The selected object is framed by a rectangle with resizing handles.

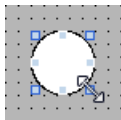

2. Left-click the object and keep the mouse button pressed.
3. Move the mouse pointer onto the new position.  
The contour of the object moves with the mouse and displays the new position for the object.



The object initially remains at its original position.

4. Now release the mouse button.  
The object is moved into the position indicated by the contour of the selection rectangle.

**Alternative procedure**

1. In the Inspector window, select "Properties > Properties > Layout".
2. Enter the X and Y values for the position under "Position & Size".

**Result**

The object appears at its new position.

**See also**

Rotating objects (Page 3481)

**Moving an object forwards or backwards****Introduction**

You can use the "Order" functions in the shortcut menu of a selected object or in the toolbar to move a selected object in front of or behind other objects within an object layer.

**Note**





ActiveX controls are always positioned in front of an object layer (.NET property).

**Requirement**

You have opened a screen which contains a layer with multiple objects.

**Procedure**

1. Select the object you want to move forward or backward.
2. Select the "Sort" command and one of the following commands from the shortcut menu:

Icon	Description
	Moves the selected object before all the other objects of the same layer
	Moves the selected object to the lowest position in the same layer
	Moves the selected object up by one position
	Moves the selected object down by one position

**Alternative procedure**

1. Open the "Layers" palette of the "Layout" task card.
2. Navigate to the required object.

3. Hold down the mouse button, and drag the object in the tree topology to the required position in the layer.
4. Now release the mouse button.

## Result

The object is moved up or down.

## See also

Inserting an object (Page 3469)

## Resizing objects

### Introduction

When you select an object, it is enclosed by a rectangle with handles. You have the following options of resizing an object:

- Drag the handles using the mouse.
- Modify the "Size" property in the Inspector window.

### Requirement

You have opened the work area containing at least one object.

### Procedure

1. Select the object you want to resize.  
The selection rectangle appears. The following figure shows a selected object:

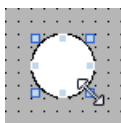



2. Drag a resizing contact of the rectangle to a new position.  
The size of the object changes.
  - The size of the object is aligned to the grid pattern, provided the "Snap to grid" function is set.
  - Press <ALT> to disable this function while you drag the object.  
In order to scale the object proportionally, keep the <Shift> key pressed while changing the size with the mouse.

### Alternative procedure



1. In the Inspector window, select "Properties > Properties > Layout".
2. Enter the size of the object under "Position & Size".

## Harmonizing the object size

1. Select the objects.
2. Now, click one of the following buttons:  or  or   
The size of the selected objects is matched to each other.

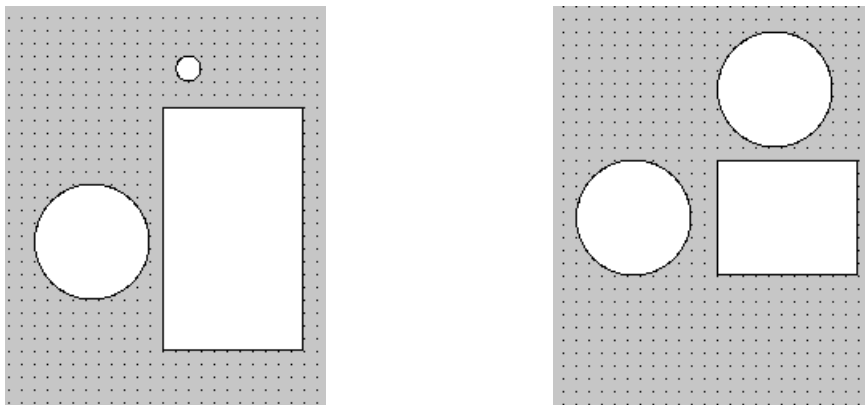
The following screen shows how the selected objects are adapted to the height of the reference object:



Icon	Description
	Aligns the selected objects to the width of the reference object.
	Aligns the selected objects to the height of the reference object.
	Aligns the selected objects to the width and height of the reference object.

## Result

The object now appears with its new size.

## Selecting multiple objects

### Introduction

Select all objects you want to align with each other or to change global properties. This procedure is called "multiple selection."

The Inspector window shows all the properties of the selected objects.

You now have several options of selecting multiple objects:

- Draw a selection frame around the objects.
- Hold down the <Shift> key, and click the required objects.

### Selection frame of a multiple selection

The selection frame surrounds all objects of a multiple selection. The selection frame is comparable with the rectangle that surrounds an individual object.

The selection frame is not visible. When you have made your multiple selection, the following frame is displayed:

- The reference object is indicated by the rectangle around it.
- The other selected objects are indicated by a dashed-line frame.

### Specifying a reference object

The reference object is the object upon which the other objects are oriented. The reference object is framed by a rectangle with handles. The following figure shows a reference object with two other selected objects:

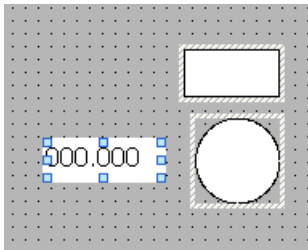

You have the following options to specify the reference object:

- Select the objects via multiple selection. The object selected first is then the reference object.
- Draw a selection frame around the objects. The reference object compiled automatically. If you wish to specify a different object within the selection as the reference object, click on the desired object. This action does not cancel your multiple selection.

### Requirement

You have opened the work area containing at least two objects.

### Selecting multiple objects with a selection frame

1. Position the mouse pointer in the work area close to one of the objects to be selected.
2. Hold down the mouse button, and draw a selection frame around the objects to be selected.

Or:

1. Hold down the <Shift> key.
2. Click the relevant objects, working in succession.  
All the selected objects are identified by frames.  
The object selected first is identified as reference object.

---

**Note**

To remove an object from the multiple selection, press <SHIFT>, hold it down and then click the relevant object once again.

---

**Result**

Multiple objects are selected. One of those is identified as the reference object. You can now perform the following steps:

- Changing the object properties of all the objects
- Resizing all the objects by the same ratio, by dragging the selection frame to increase or reduce the size
- Moving all the objects in one group
- Aligning the objects to the reference object

**Repositioning and resizing multiple objects****Possible modifications**

After you have selected multiple objects, you edit them:

- Shift using the mouse
  - To change the absolute position of the marked objects, position the mouse pointer over an object, and shift the multiple selection with the mouse button pressed.
  - To resize all the objects by the same ratio, grab the resizing handles of the reference object.
- Move over the work area with the icons of the toolbar
  - Change the position of the marked objects with respect to each other
  - Align the height and width of the marked objects
- Moving with the shortcut menu commands of the work area
  - Change the position of the marked objects with respect to each other
  - Align the height and width of the marked objects









## Aligning objects

### Procedure

1. Select the objects via multiple selection.
2. Specify an object as the reference object.
3. Select the desired command in the toolbar or the shortcut menu - see table below.  
The selected objects will be aligned.

### Aligning objects flush

The selected objects will be aligned flush to the reference object.

Icon	Description
	Aligns the selected objects to the left edge of the reference object.
	Aligns the selected objects to the vertical center axis of the reference object.
	Aligns the selected objects to the right edge of the reference object.
	Aligns the selected objects to the upper edge of the reference object.
	Aligns the selected objects to the horizontal center axis of the reference object.
	Aligns the selected objects to the lower edge of the reference object.
	Centers the selected objects to the center points of the reference object.
	Centers the selected objects vertically in the screen.

### Snap to object

When you reposition objects, they are displayed with help lines. You can use other objects for orientation during positioning.

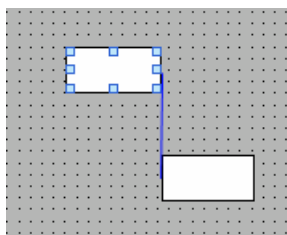

If you are working with the keyboard, press the Alt key. When you move the selected object with the arrow keys, the next anchor point is displayed.

### Distributing objects evenly

You need at least three selected objects. A reference object is not required.

1. Select the objects.
2. Click one of the buttons "Distribute horizontally equal" or "Distribute vertically equal".  
The selected objects are distributed at equal distances.



The following screen shows how you align the vertical spacing of the selected objects:

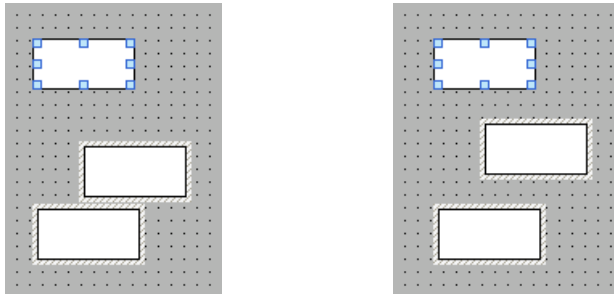

Icon	Description
	Aligns the horizontal distance between the objects. The position of the objects on the extreme left and right side remains unchanged. All other objects are distributed evenly between them.
	Aligns the vertical distance between the objects. The position of the objects at the extreme top and bottom (right and left) remains unchanged. All other objects are distributed evenly between them.

## Rotating objects

### Introduction

You can rotate a suitable object clockwise or counterclockwise around its center axis in steps of 90°.

#### Note

Not all the objects can be rotated. Some objects that can be rotated in screens cannot be rotated in reports.

You can also rotate multiple objects using the multiple selection function. Certain WinCC objects such as buttons cannot be rotated.

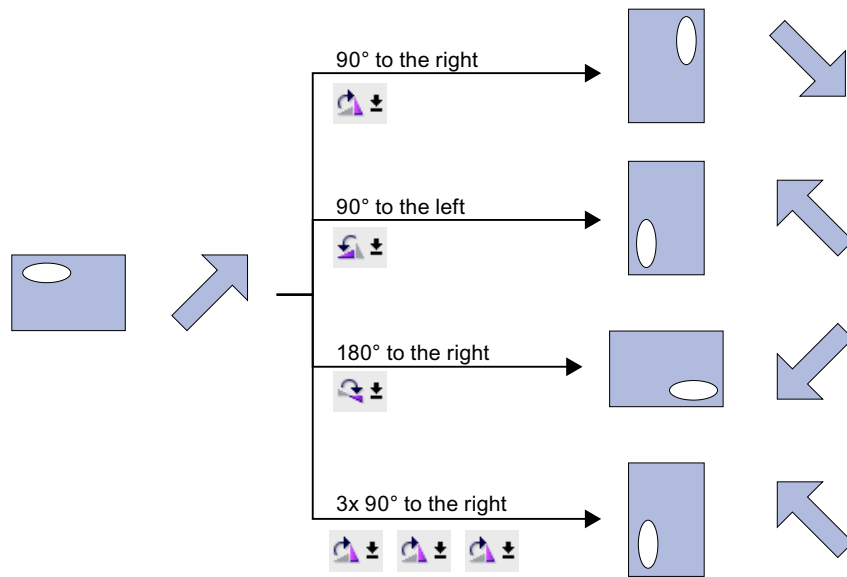

The alignment of elements in an object will change in a rotated object. The following figure shows how a rectangle and an ellipse behave under the different commands for rotating an object:



## Requirement

You have opened the work area containing at least one object.

## Procedure

1. Select the object that you want to rotate.
2. Click one of the following toolbar icons:
  - , to rotate the object clockwise around its center point. The angle of rotation is 90°.
  - , to rotate the object counterclockwise around its center point. The angle of rotation is 90°.
  - , to rotate the object clockwise by 180°.

## Result

The object is shown at its new angle.

## Flipping objects

### Introduction

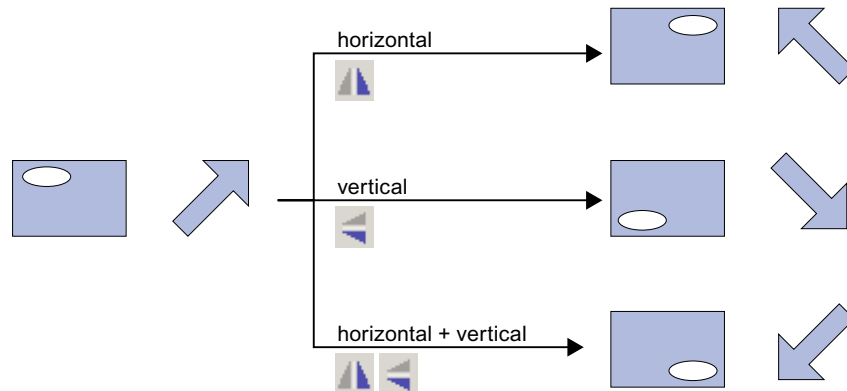

You can flip an object along its vertical or horizontal center axis. The alignment of elements in an object will change when you flip an object. The following figure shows how a rectangle and an ellipse behave under the different commands for flipping an object.



### Requirement

You have opened a screen which contains at least one object.

### Procedure

1. Select the object that you want to flip.
2. Click the "Flip" command in the shortcut menu and select one of the options displayed:
  - , to flip the selected object along its vertical center axis.
  - , to flip the selected object along its horizontal center axis.

### Result

The object is shown at its flipped position.

### See also

Inserting an object (Page 3469)

### 10.6.3 Operation in Runtime

#### 10.6.3.1 Printing reports

##### Printing a report in Runtime

If you have configured an object with the "PrintReport" system function, the operator can print out a report in Runtime. To do this, the operator uses the "Print report" button on a screen. The operator can set or change further settings for the report. The report is output to the default printer.

##### See also

Printing reports (Page 3468)

Principles for preparation of reports (Page 3463)

Reports (Page 3460)

### 10.6.4 Objects in reports

#### 10.6.4.1 Audit report

##### Application

With the audit report, the content of the audit trail of a HMI device is output as a report.

RecordID	Timestamp	DeltaToUTC	UserID
0	18.11.2007 23:00 ObjectID: Application Description: This is an example description. It may not be cut and will be printed out completely.	-1:00	System

##### Requirements

The "audit report" object is available only if the following requirements are met:

- The HMI device supports a GMP-compliant configuration.
- GMP-compliant configuration is active in the Runtime settings of the HMI device.

Note that operator actions and system operations are only recorded if a corresponding log is configured.

## Layout

In the Inspector window the position, shape, style, color and font types of the object are customized. In particular, the following can be adjusted:

- Visibility of the comment

## See also

Enabling GMP compliant configuration (Page 5761)

Audit Trail (Page 5763)

Creating an audit trail (Page 5764)

Principles for preparation of reports (Page 3463)

Reporting an audit trail (Page 5772)

Audit Trail reporting (Page 5773)

Parameters for the audit trail report (Page 5774)

Printing out an audit trail report (Page 5777)

Date/time field (Page 3485)

I/O field (Page 3486)

Graphic view (Page 3488)

Graphic I/O field (Page 3489)

Alarm report (Page 3489)

Recipe report (Page 3492)

Page number (Page 3493)

Symbolic I/O field (Page 3494)

Text field (Page 3494)

Reports (Page 3460)

### 10.6.4.2 Date/time field

## Application

The "Date/time field" object shows the system time of the HMI device or the date and / or time of a connected tag. The layout depends on the language setting on the HMI device.

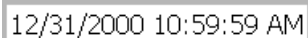

12/31/2000 10:59:59 AM

## Layout

In the Inspector window, you customize the position, shape, style, color, and font types of the object. In the "Properties > Properties > General" dialog, you can adapt the following properties in particular:

- Long date/time format: This setting defines the format displayed for the data and / or time.
- System time: Specifies whether to use the system time of the HMI device, or the data and / or time of a connected tag.

### Long date/time format

Option	Description
"Enabled"	Date and / or time is fully displayed, for example "Sunday, December 31, 2000 10:59:59 AM"
"Disabled"	Date and / or time is displayed in abbreviated form, e.g. "12/31/2000 10:59:59 AM"

### System time

Option	Description
"Enabled"	The system time of the HMI device is displayed
"Disabled"	The date and / or time of the connected tag is displayed Select a tag of the "DateTime" data type, e.g. an internal tag. Information about data types which are available for connection to other PLCs can be found in the documentation about the respective communication drivers.

### See also

Create a report (Page 3465)

Principles for preparation of reports (Page 3463)

Audit report (Page 3484)

#### 10.6.4.3 I/O field

### Application

The "I/O field" object is used to enter process values.



## Layout

In the Inspector window, you customize the position, shape, style, color and font types of the object. You can adapt the following properties in particular:

- Display format: Specifies the format in which the values in the I/O field are output.

---

### Note

The "I/O field" object is also available in "Screens" editor. In reports, the object only outputs data. Accordingly only configure the output of data for application in reports.

---

## Display format

The "display format" for the output of values is specified in "Properties > Properties > General > Format", in the Inspector window.

Layout	
"Binary"	Output of values in binary form
"Date" *	Output of date specifications. The format depends on the language setting on the HMI device.
"Date/time" *	Output of date and time specifications. The format depends on the language setting on the HMI device.
"Decimal" *	Output of values in decimal form.
"Hexadecimal"	Output of values in hexadecimal form.
"Time" *	Output of time specifications. The format depends on the language setting on the HMI device.
"Character string"	Output of strings.
*: not in Runtime Professional	

## Avoid overlaps with output fields

If several I/O fields are configured as output fields with a transparent background in a report, these I/O fields may overlap. The transparent part of the one field covers the digits of the other field. This may cause display problems in the report. In order to avoid such overlaps, set the margins of the I/O fields to zero in the object properties under "Properties > Properties > Appearance". Activate "Properties > Properties > Layout > Fit object to contents."

## See also

Create a report (Page 3465)

Principles for preparation of reports (Page 3463)

Audit report (Page 3484)

#### 10.6.4.4 Graphic view

##### application

The "Graphic view" object is used to display graphics.



##### Layout

In the Inspector window, you customize the position, shape, style, color and font types of the object. You can adapt the following properties in particular:

- Graphic: Specifies the graphic file that is displayed in the object.
- Stretch graphic: Specifies the automatic size stretching for objects with graphics.

##### Inserting graphics

The following graphic format is used in the "Graphic view" object: \*.bmp, \*.tif, \*.png, \*.ico, \*.emf, \*.wmf, \*.gif, \*.jpg or \*.jpeg. You may also use graphics as OLE objects in the Graphic view .

1. In the Inspector window, select "Properties > Properties > General":
2. Select the graphic you want to add in the drop-down list under "Graphic".  
The graphic preview is shown in the right pane.
3. Click "Assign" to insert the graphic in the Graphic view .

##### Stretch graphic

Whether a graphic displayed in a Graphic view is stretched to the size of the Graphic view in runtime is specified in the Inspector window.

1. In the Inspector window, select "Properties > Properties > Layout".
2. Select one of the following options from the "Fit to size" area:
  - Fit object size to content
  - Fit content to object size

##### See also

Audit report (Page 3484)



#### 10.6.4.5 Graphic I/O field

##### Application

With the "Graphic I/O field" object, the graphics of a graphics list are displayed, depending on the tag value. In the Inspector window, the tag and graphics list are configured, under "Properties > Properties > General":



---

##### Note

The "Graphic I/O field" object is also available in "Screens" editor. In reports, the object only outputs data. Accordingly only configure the output of data for application in reports.

---

##### Layout

Customize settings for color, frame, position and object size in the inspector window. In particular, the "Fit to size" is defined by specifying whether the object is adjusted to the graphics during output in the report or the graphic is adjusted in the object.

##### See also

Create a report (Page 3465)

Audit report (Page 3484)

Objects in reports (Page 3484)

#### 10.6.4.6 Alarm report

##### Application

Use the "Alarm report" object to output alarms of the selected alarm classes from the alarm buffer or alarm log to the report.

No.	Time	Status	Date	GR	PLC
0	12:00:00 PM	KGQ	1/1/1999	0	* Device
	normal <i>kursiv</i>	normal			
1	12:00:00 PM	KGQ	1/1/1999	1	* Device
	normal <b>blinken</b>	normal			
2	12:00:00 PM	KGQ	1/1/1999	2	* Device
	Message Text				
3	12:00:00 PM	KGQ	1/1/1999	3	* Device
	normal <b>bold</b>	normal			
4	12:00:00 PM	KGQ	1/1/1999	4	* Device
	normal <u>underline</u>	normal			

## Layout

In the Inspector window, you customize the position, shape, style, color, and font types of the object. You can adapt the following properties in particular:

- Source
- Alarm classes
- Time range
- Additional settings for the display
- Visible columns

### Specifying the source

Under "Properties > Properties > General > Settings > Source", specify whether to display alarms from the alarm buffer, or from the alarm log. Select the alarm log in the "Alarm log" dialog.

### Specifying alarm classes

Under "Properties > Properties > General > Alarm classes, enable the alarm classes for the alarms output to the report.

### Specifying the time range

If you want to restrict alarm output to a specific time range, select the start and end tags for the time range in the "Properties > Properties > General > Time range" dialog. The tag must be of the "DateTime" type.

### Additional settings for the display

Under "Properties > Properties > General > Settings, specify the following settings for the display in the alarm report:

- Under "Sorting", specify whether to start the display with the oldest or most recent alarm.
- Under "Lines per entry", specify the number of lines to be available for each alarm. The required number of lines depends on the following factors:
  - Number and width of the selected columns for the output
  - Font size used
  - Paper format of the printer
- Select "Visible heading" to enable the display of column headers.
- Select "Display milliseconds" to enable the display of milliseconds for time data.

### Visible columns

Under ""Properties > Properties > Layout > Visible columns", enable the columns to be displayed in the alarm report.

### See also

Create a report (Page 3465)

Principles for preparation of reports (Page 3463)

Audit report (Page 3484)

### 10.6.4.7 Recipe report

#### application

Use the "Recipe report" object to output the elements of recipe data records in the report.

Recipe Number:1 Name:STRUCT_1			
Data record Number:1 Name:DATA_1			
Tag:	Name:	Type:	Value:
Variable_Number_0	Entry_Number_01	ULONG	689874030
Variable_Number_0	Entry_Number_02	LONG	-99253259
Variable_Number_0	Entry_Number_01	INT	-9
Variable_Number_0	Entry_Number_03	UINT	8172
Variable_Flag_05	Entry_Flag_05	BOOL	False
Variable_String_06	Entry_String_06	STRING	WinCC flexible RT
Variable_Date_07	Entry_Date_07	DATETIME	12/30/1899 12:00:00 AM
Variable_Number_0	Entry_Number_08	LONG	6968192
Variable_Number_0	Entry_Number_09	ULONG	9903155
Variable_Flag_10	Entry_Flag_10	BOOL	True

#### Layout

In the Inspector window, you customize the position, shape, style, color, and font types of the object. You can adapt the following properties in particular:

- Recipe
- Data record
- Format
- Visible entries

#### Selecting a recipe

Specify the recipes to be output in the recipe report under "Properties > Properties > General > Recipe". You can define the recipes based on their recipe name, or on a range of recipe numbers. Under "First recipe" and "Last recipe", enter a value or select a tag.

You can also choose to display all recipes.

#### Selecting a data record

Under "Properties > Properties > General > Data record", specify which data records of the selected recipes are to be output in the recipe report. You can define the data records based on the data record name, or on a range of data record numbers. Under "First recipe" and "Last recipe", enter a value or select a tag.

You can also choose to display all data records of the selected recipes.

## Format

In the "Format" field of the "Properties > Properties > Layout > Settings" dialog, specify whether to output the data records as a table in column format or line report format.

WinCC updates the preview in the detail page accordingly.

## Visible entries

Under "Properties > Properties > Layout > Visible entries", enable the columns to be displayed in the recipe report. Select "Show headings" to enable the display of column headers.

## See also

Create a report (Page 3465)

Principles for preparation of reports (Page 3463)

Audit report (Page 3484)

### 10.6.4.8 Page number

#### application

Use the "Page number" object to output the current page number in the report.



#### Layout

In the inspector window, change the settings for color, font, position and object size. In particular, specify "Size adaptation":

#### Fit to size

Under "Properties > Properties > Layout > Fit to size", the "Fit object to content" option is used to specify whether WinCC adjusts to the object size of the field content:

- Enabled "Fit object to contents" option:  
WinCC automatically adjusts the size of the object to the configured format. The font size and field length are defined under "Properties > Properties > General > Text".  
The object can be moved in the working area, however, the size cannot be changed. During report output, the entire field content is output at the time of report output.
- Disabled "Fit object to contents" option:  
Customize the field size by yourself. WinCC does not resize the field for report output. It can be possible that not all content of the field is output in the report. Therefore, configure a field of sufficient size.

## See also

Create a report (Page 3465)

Principles for preparation of reports (Page 3463)

Audit report (Page 3484)

### 10.6.4.9 Symbolic I/O field

#### application

With the "Symbolic I/O field" object, the content of a text list in reports is displayed, depending on the tag value. In the inspector window, the tag and text list is configured under "Properties > Properties > General":



#### Layout

In the inspector window, change the settings for color, frame, font, position and object size. In particular, the "Fit to size" is defined, by specifying whether the object size is adjusted to the text during output in the report or not.

---

#### Note

The "Symbolic I/O field" object is also available in "Screens" editor. In reports, the object only outputs data. Accordingly only configure the output of data for application in reports.

---

## See also

Create a report (Page 3465)

Principles for preparation of reports (Page 3463)

Audit report (Page 3484)

### 10.6.4.10 Text field

#### Application

The "Text field" is a closed object which you can fill with a color.



## Layout

In the Inspector window, you customize the position, shape, style, color and font types of the object. You can adapt the following properties in particular:

- Text: Specifies the text for the text field.
- Size of text field: Defines whether the size of the object is adapted to the space required by the largest list entry.

## Text

Specify the text for the text field in the Inspector window.

1. In the Inspector window, select "Properties > Properties > General".
2. Enter a text.  
For texts over several lines you can set a line break by pressing the key combination <Shift + Enter>.

## Size of text field

In the Inspector window, you can define whether the size of the object is adapted to the space required by the largest list entry.

1. In the Inspector window, select "Properties > Properties > Layout".
2. Activate "Resize > Fit to contents".

## See also

Audit report (Page 3484)

## 10.7 Configuring user administration

### 10.7.1 Field of application of the user administration

#### Principle

The access protection controls access to data and functions in Runtime. This feature protects your applications against unauthorized operation. Safety-related operations are already limited to specific user groups when a project is being created. To this purpose you set up users and user groups that you equip with characteristic access rights, so-called authorizations. You then configure the authorizations required for operation of safety-related objects. Operators only have access, for example, to specific operator controls. Commissioners, for example, have unlimited access in Runtime.

#### Definition

You administer users, user groups and authorizations centrally in the user administration of WinCC. You transfer users and user groups together with the project to the HMI device. The users and passwords are managed on the HMI device in the User view.

#### Application example

You configure the "Service" authorization so that only service technicians have access to the configuration parameters. You assign the authorization to the "Service technician" user group. This allows all members of this group to set the protected configuration parameters.

NOTICE
Access protection does not protect against incorrect operations. It is your job to ensure that only authorized personnel with appropriate training will design, commission, operate and maintain plants and machines.
Access protection is not suitable for defining work routines and monitoring their observance.

### 10.7.2 Form of the user administration

#### Introduction

In case of a project in manufacturing engineering, the environment at the equipment manufacturer has to be differentiated from the environment at the end customer as plant operator.

The equipment manufacturer allows users, for example Mr. Foreman, a specific access within the application or HMI device. However, a user Foreman does not exist at the end customer. The machine manufacturer cannot know the end users and the tasks they have to perform for configuration. The final users are usually set after commissioning at the end customer.



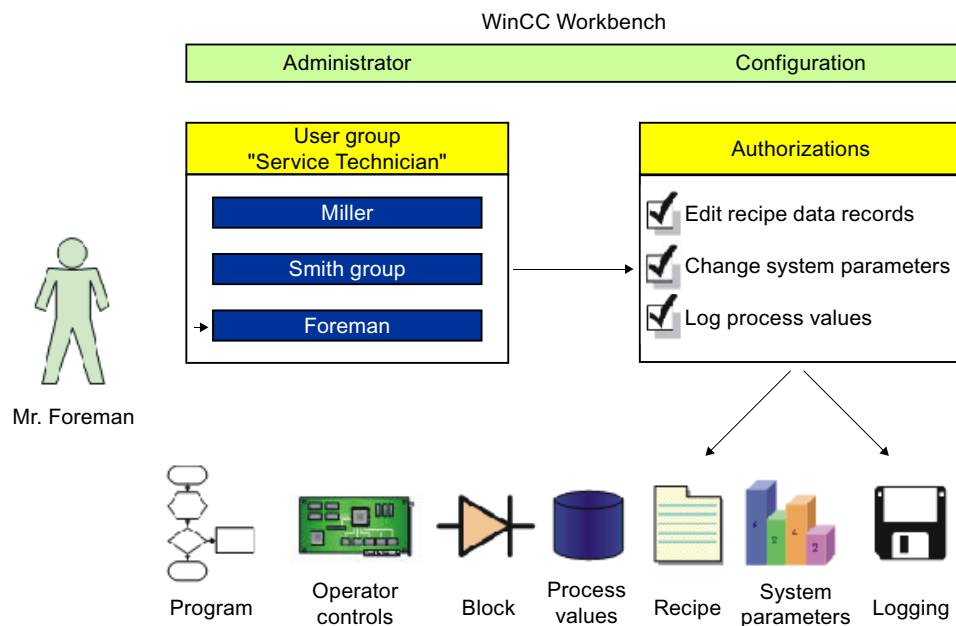

## Principle

To minimize the work required for management, authorizations are assigned via user groups and not directly to individual users.

A user group assembles configured authorizations according to common jobs. For example, all permissions required for a service job are collected in a "Service technician" group. When you create a user who should be responsible for servicing, you simply assign him to the "Service technician" group.

The user view enables user administration in Runtime. Use user view to create, delete and assign an authorization to users in Runtime.

The user administration separates the administration of the users from the configuration of the authorizations. This ensures flexibility at the access protection.

Defaults can be set for the user administration during the configuration phase in the Engineering System.

## 10.7.3 Basics

### 10.7.3.1 Users

#### Introduction

You can create users in the "Users" tab of the "User administration" editor and assign them to user groups. The "Users" tab is part of the user administration in WinCC.

## Open

To open the "Users" tab, double-click "User administration" in the project window.

## Work area

The users are managed in the work area:

- You create or delete users.
- You assign users to user groups.

---

### Note

You can assign a user to exactly one user group.

---

## Inspector window

When you select a user, you can change the password in the "General" group. Under "Automatic logoff" you can specify if the user is to be automatically logged off by the HMI device when there is no operator activity after the specified time.

### 10.7.3.2 Users work area

#### Introduction

The "Users" work area lists the users and user groups in table form. You administrate the users and assign them to a user group.

#### Principle

The work area consists of the "Users" and "Groups" tables.

The screenshot shows the WinCC Users work area interface. At the top, there are two tabs: "Users" (selected) and "User groups". Below the tabs, there are two tables.

**Users Table:**

	Name	Password	Automatic logoff	Web language	Comment
	Administrator	*****	<input checked="" type="checkbox"/>		The user 'Administrator' is a...
	<Add new>				

**Groups Table:**

	Member of	Name	Comment
	<input checked="" type="radio"/>	Administrator group	The 'Administrators' group is initially granted all rights.
	<input type="radio"/>	Users	The 'Users' group is initially granted 'Operating' rights.
	<Add new>		

The "Users" table shows the existing users. When you select a user in this table, the "Groups" table shows the user group to which the user belongs.

---

**Note**

For the user "Administrator", the default password is "administrator". For security reasons, you should change the password of this user.

---

### 10.7.3.3 User groups

#### Introduction

You can create users and authorizations in the "User groups" tab of the "User Administration" editor. The "User groups" tab is part of the user administration in WinCC.

#### Open

Double-click the "User administration" in the project window. Open the "User groups" tab.

#### Work area

The user groups and authorizations are managed in the work area:

- You create new user groups and authorizations or delete them.
- You assign the authorizations to the user groups.

#### Inspector window

When a user group or an authorization is selected, you can edit the name in the "General" group. You can also enter a brief description in the "Comment" group.

### 10.7.3.4 User groups work area

#### Introduction

The "User groups" work area shows a table of the groups and their authorizations. You administer the user groups and assign authorizations to them.

## Principle

The work area consists of the "Groups" and "Authorizations" tables.

The screenshot shows a software interface with two main tables. At the top, there are tabs for 'Users' and 'User groups'. The 'Groups' table has columns for 'Name' and 'Comment'. It lists 'Administrator group' and 'Users' with their respective comments. Below it is an '<Add new>' button. The 'Authorizations' table has columns for 'Active', 'Name', 'Display name', 'Number', and 'Comment'. It lists three active authorizations: 'User administration' (Number 1), 'Monitor' (Number 2), and 'Operate' (Number 3). Each row in the 'Authorizations' table has a key icon and a checkbox in the 'Active' column.

Groups		Name	Comment
		Administrator group	The 'Administrators' group is initially granted all rights.
		Users	The 'Users' group is initially granted 'Operating' rights.
		<Add new>	

Authorizations					
Active	Name	Display name	Number	Comment	
<input checked="" type="checkbox"/>	User administration	User administration	1	Authorize 'User administra	▲
<input checked="" type="checkbox"/>	Monitor	Monitor	2	'Monitor' authorization.	☰
<input checked="" type="checkbox"/>	Operate	Authorization	3	'Operate' authorization.	▼

The "Groups" table shows the existing user groups. When you select a user group in this table, the "Active" column of the "Authorizations" table shows the authorizations which were assigned to the user group.

The number of the user group and of the authorization is assigned by the user administration. The designations and descriptions are assigned by you.

The number of predefined authorizations are fixed. Authorizations that you create can be freely edited. Ensure that the assigned numbers are unique.

### 10.7.3.5 Settings for the user administration

#### Introduction

In the "Runtime settings > User administration" editor, configure the security settings for users and their passwords in runtime.

#### Open

Double-click the "Runtime settings" editor in the project window. Click "User administration".

#### Work area

You carry out the settings for the validity of passwords in runtime in the work area. You determine the complexity of the password, for example.

## Effects in Runtime

The security settings have the following effects in runtime, depending on the configuration.

- "General" group
  - "Enable limit for logon attempts" check box selected  
The number entered in the "Number of incorrect logon attempts" box defines the number of logon attempts a user is allowed before being assigned to the "Unauthorized" group.  
"Enable limit for logon attempts" check box not selected  
The user has an unlimited number of logon attempts in runtime.
  - "Number of incorrect logon attempts" field  
If you enter "4" in the field, for example, and the fourth logon attempt fails, the user is automatically assigned to the "Unauthorized" group.  
You can specify 1 to 9 attempts.
  - "Logon only with password" check box  
When the check box is selected, the user will be authenticated by the password. The user name is not required.  
To match users to passwords, you cannot configure passwords more than once.
- "Hierarchy level" group
  - "Group-specific rights for user administration" check box  
When this check box is selected, administrators only manage users whose group number is less than or equal to their own.  
For example, an administrator whose group number is 5 can only manage users whose group number is less than or equal to 5. This means that the administrator can assign users only to groups with a group number less than or equal to 5.

## 10.7 Configuring user administration

- "Password" group
  - "Enable password aging" checkbox selected  
The password expires after the number of days set in the "Validity of the password (days)" field.  
The "Password aging" column is selected in the "User groups" editor. This enables you to specify group-by-group, if the passwords should expire or if the password generations should be saved. Passwords never expire for groups for which password aging is not enabled.
  - "Prewarning time (days)" field  
The user is informed that the password will expire the specified number of days before the password expires.
  - "Password generations" field  
If the user changes the password, the new password must be different from the specified number of previous passwords. The number of password generations ranges from 1 to 5.
- "Password complexity" group
  - "Must include special characters" check box selected  
The user must enter a password containing at least one special character at any position.
  - "Must include number" check box selected  
The user must enter a password containing at least one number at any position.
  - "Minimum password length" field  
The user must enter a password with a minimum length, as specified in the "Minimum password length" field.  
The minimum length of the password is 3 characters.

### 10.7.3.6 Settings for the user administration

#### Introduction

In the "Runtime settings > User administration" editor, configure the security settings for users and their passwords in runtime.

#### Open

Double-click the "Runtime settings" editor in the project window. Click "User administration".

#### Work area

You carry out the settings for the validity of passwords in runtime in the work area. You determine the complexity of the password, for example.

## Effects in Runtime

The security settings have the following effects in runtime, depending on the configuration.

- "General" group
  - "Change initial password" check box selected  
The user must change the administrator-assigned password when logging on for the first time.
  - "Change logoff time" checkbox selected  
Simple user rights are sufficient for changing the logoff time.  
The logoff time is the period after which the user administration automatically logs off a user when no operator activity is detected in the system.  
The logoff time for the SIMATIC Logon user corresponds to the logoff time of the default user "Administrator".  
Any user changes of the logoff time are logged in the Audit Trail.
  - "Enable limit for logon attempts" check box selected  
The number entered in the "Number of incorrect logon attempts" box defines the number of logon attempts a user is allowed before being assigned to the "Unauthorized" group.  
"Enable limit for logon attempts" check box not selected  
The user has an unlimited number of logon attempts in runtime.
  - "Number of incorrect logon attempts" field  
If you enter "4" in the field, for example, and the fourth logon attempt fails, the user is automatically assigned to the "Unauthorized" group.  
You can specify 1 to 9 attempts.
  - "Logon only with password" check box  
When the check box is selected, the user will be authenticated by the password. The user name is not required.  
To match users to passwords, you cannot configure passwords more than once.
- "Hierarchy level" group
  - "Group-specific rights for user administration" check box  
When this check box is selected, administrators only manage users whose group number is less than or equal to their own.  
For example, an administrator whose group number is 5 can only manage users whose group number is less than or equal to 5. This means that the administrator can assign users only to groups with a group number less than or equal to 5.

## 10.7 Configuring user administration

- "Password" group
  - "Enable password aging" checkbox selected  
The password expires after the number of days set in the "Validity of the password (days)" field.  
The "Password aging" column is selected in the "User groups" editor. This enables you to specify group-by-group, if the passwords should expire or if the password generations should be saved. Passwords never expire for groups for which password aging is not enabled.
  - "Prewarning time (days)" field  
The user is informed that the password will expire the specified number of days before the password expires.
  - "Password generations" field  
If the user changes the password, the new password must be different from the specified number of previous passwords. The number of password generations ranges from 1 to 5.
- "Password complexity" group
  - "Must include special characters" check box selected  
The user must enter a password containing at least one special character at any position.
  - "Must include number" check box selected  
The user must enter a password containing at least one number at any position.
  - "Minimum password length" field  
The user must enter a password with a minimum length, as specified in the "Minimum password length" field.  
The minimum length of the password is 3 characters.
- "SIMATIC Logon" group
  - "Activate SIMATIC Logon" check box selected  
A connection is established to the server. Authorization is performed via SIMATIC Logon.
  - "Encrypted transfer" checkbox selected  
The data is encrypted before it is transferred to the server.

### 10.7.4 Building up and structuring a user administration

#### 10.7.4.1 Basics of user administration

##### Principle

This section addresses four target groups. The topics are organized correspondingly. The target groups serve as examples for different groups of persons who use the user administration.

1. Administrator OEM
2. Administrator RT



3. Planners

4. Operator

As Administrator OEM you create the user groups, users and authorizations for Runtime in the Engineering System of, for example, an equipment manufacturer.

As Administrator RT you administer users in Runtime by means of the "User view."

As the project engineer you assign the authorizations to the user groups in the Engineering System. In addition, you configure the authorizations for objects.

As Operator you log on in runtime. You can only access a protected object if you have the required authorization.

---

**Note**

The Administrator RT target group already exists in the Runtime user administration as the predefined user group "Administrator group." For a better understanding the predefined user groups and authorizations are not used below.

---

## 10.7.4.2 Administering users for Runtime

### Creating an authorization

#### Introduction

You create an authorization and assign it to one or more user groups.

#### Requirements

The "User groups" work area is open.

#### Procedure

1. Double-click "Add" in the "Authorizations" table.
2. Enter "Stop runtime" as the name of the authorization.
3. Enter a brief description as the "Comment".

#### See also

Creating a user group (Page 3506)

## Creating a user group

### Introduction

User groups are created so that you do not have to assign an authorization to every single user. You create a user group, assign authorizations and then assign users to it.

---

#### Note

The name of the user group has to be unique within the project. Otherwise the input is not accepted.

---

---

#### Note

##### Using SIMATIC Logon

Ensure that the names of the user groups in Windows and WinCC are identical.

---

### Requirements

The "User groups" work area is open.

### Procedure

1. Double-click "Add" in the "Groups" table.
2. Enter "Operators" as the "Name" of the user group.
3. Change the "Number" of the user group as required.
4. Enter "Display name" of the "Operators" user group.
5. Enter a brief description as the "Comment".

In runtime, the user view shows the display name of the user group. The display name of the user group depends on the language. You can specify the name in several languages and switch between languages in runtime.

### See also

Creating an authorization (Page 3505)

Example: Configuring a button with logon dialog box (Page 3531)

Example: Logging the logon and logoff events (Page 3532)

## Assigning an authorization

### Introduction

When you allocate an authorization to a user group, all assigned users have this authorization.

### Requirements

- A "Stop runtime" authorization has been created.
- An "Operators" user group has been created.
- The "User groups" work area is open.

### Procedure

1. Click on the "Operators" user group in the "Groups" table. The "Authorizations" table shows all authorizations.
2. Enable the "Stop runtime" authorization in the "Authorizations" table.

---

#### Note

The "Stop runtime" authorization is only a designation and does not have any relation to the function "StopRuntime". You have to establish this relation yourself. To do so, configure the "StopRuntime" system functions at a button and select "Stop runtime" as the "Authorization".

---

## Creating users

### Introduction

You create a user so that users can log on with their user names in runtime after loading to the device.

As an alternative, you can create and change users by means of the "User view" in Runtime.

In order for a created user to have authorizations you have to assign him to a user group and allocate authorizations to the user group.

The logon is successful when the user name entered during the logon matches a user in Runtime. In addition, the entered password must agree with the stored password of the user.

---

#### Note

Note that the entry is case-sensitive.

---

### Requirements

The "Users" work area is open.

## Procedure



1. Double-click "Add" in the "Users" table.
2. Enter "Foreman" as the user name.

---

### Note

The user name must be unique within the project. Otherwise the input is not accepted.

---

3. Click the  button in the "Password" column. A dialog box for entering the password is displayed.
4. Enter the password of the user.
5. To confirm the password enter it a second time in the lower field.
6. Close the dialog box by using the  icon.
7. If a user is to be logged off after a specific time period, activate "Automatic logoff".
8. Click in the "Logoff time" column. The preset value for "Logoff time" is 5 minutes.
9. Enter a brief description as the "Comment".

## Assigning a user to a user group

### Introduction

When you assign a user to a user group, the user has the authorizations of the user group.

---

### Note

You have to assign a user to exactly one user group. The assignment is checked during the consistency check and generation of the project.

---

### Requirements

- The user "Foreman" has been created.
- An "Operators" user group has been created.
- The "Users" work area is open.

### Procedure

1. Click on the "Foreman" user in the "Users" table. The "Groups" table shows all user groups.
2. Activate the "Operators" user group in the "Groups" table.

## Managing users

### Introduction

In the work area, you can administer users and assign them to user groups.

### Requirements

The "Users" work area is open.

### Changing the user name

1. In the "Users" table, double-click the field in the "Name" column to change the user name.
2. Change the user name.
3. Confirm your entry with <Return>.

Alternatively, select the user in the work area. Change the user name under "Properties > Properties > General" in the Inspector window.

### Changing the password of the user

1. Click the  button in the "Password" column of the "Users" table. A dialog for entering the password opens.
2. In the "Enter password" field, enter the new password.
3. Reenter the new password in the "Confirm password" field.
4. Confirm your entry with <Return>.

Alternatively, select the user in the work area. Change the password under "Properties > Properties > General" in the Inspector window.

### Displaying invisible columns

1. Position the mouse cursor on the title of the "Users" table.
2. Right-click to open the shortcut menu and enable the display of the "Logoff time" column, for example.

### Changing the logoff time of the user

1. In the "Users" area, double-click on the field in the "Logoff time" column to change the logoff time.
2. Change the logoff time.
3. Confirm your entry with <Return>.

Alternatively, select the user in the work area. Change the logoff time under "Properties > Properties > Automatic logoff" in the Inspector window.

### Deleting a user

1. Select the line of the user to be deleted.
2. Open the shortcut menu with the right mouse button and select the "Delete" command.

---

**Note**

Predefined users cannot be deleted.

---

### Managing user groups

#### Introduction

In the workplace you administer user groups and assign authorizations for use in runtime.

#### Requirements

The "User groups" work area is open.

#### Changing the name of the user group

1. In the "Groups" table, double-click the field in the "Name" column to change the name of the user group.
2. Change the name of the user group.
3. Confirm your entry with <Return>.

Alternatively, select the user group in the work area. Change the name under "Properties > Properties > General" in the Inspector window.

---

**Note**

Predefined user groups cannot be deleted.

---

#### Displaying invisible columns

1. Position the mouse cursor on the title of the "Users" table.
2. Right-click to open the shortcut menu and enable the display of the "Display name" column, for example.

#### Changing the displayed name of the user group

1. In the "Groups" table, double-click the field in the "Display name" column to change the display name of the user group.
2. Change the displayed name of the user group.
3. Confirm your entry with <Return>.

Alternatively, select the user group in the work area. Change the display name under "Properties > Properties > General" in the Inspector window.

### Deleting a user group

1. Mark the line of the user group to be deleted.
2. Open the shortcut menu with the right mouse button and select the "Delete" command.

---

#### Note

Predefined user groups cannot be deleted.

---

### Changing the name of the authorization

1. In the "Authorizations" table, double-click the field in the "Name" column to change the name of the authorization.
2. Change the name of the authorization.
3. Confirm your entry with <Return>.

Alternatively, select the authorization in the work area. Change the name under "Properties > Properties > General" in the Inspector window.

### Deleting authorizations

1. Mark the line of the authorization to be deleted.
2. Open the shortcut menu with the right mouse button and select the "Delete" command.

---

#### Note

Predefined authorizations cannot be deleted.

---

## 10.7.4.3 Managing users on the server

### Central user administration using SIMATIC Logon

#### Introduction

To manage users and user groups for several applications or HMI devices, activate SIMATIC Logon.

#### Principle

SIMATIC Logon is a tool for system-wide user administration. If you use SIMATIC Logon, the users are centrally managed outside the application or HMI device.

*10.7 Configuring user administration*

You configure the user groups and their permissions as you usually do with the local user administration in WinCC. You assign identical names to the user groups on the server and in WinCC. Authorizations are assigned in runtime to a user group when the names are identical.

You do not have to create users in WinCC because they are taken dynamically from Windows user management during the logon process. The application or HMI device forwards each logon or password change to SIMATIC Logon for processing.

---

**Note**

SIMATIC Logon is a product requiring a license. For more information on SIMATIC Logon go to <<http://support.automation.siemens.com>>.

Enter the ID "34519648" in the search field and start searching. The "SIMATIC Logon - Electronic Signature" manual is available to download.

---



## Log on process via SIMATIC Logon Service

The following diagram illustrates the process that runs automatically when a user logs onto Runtime.

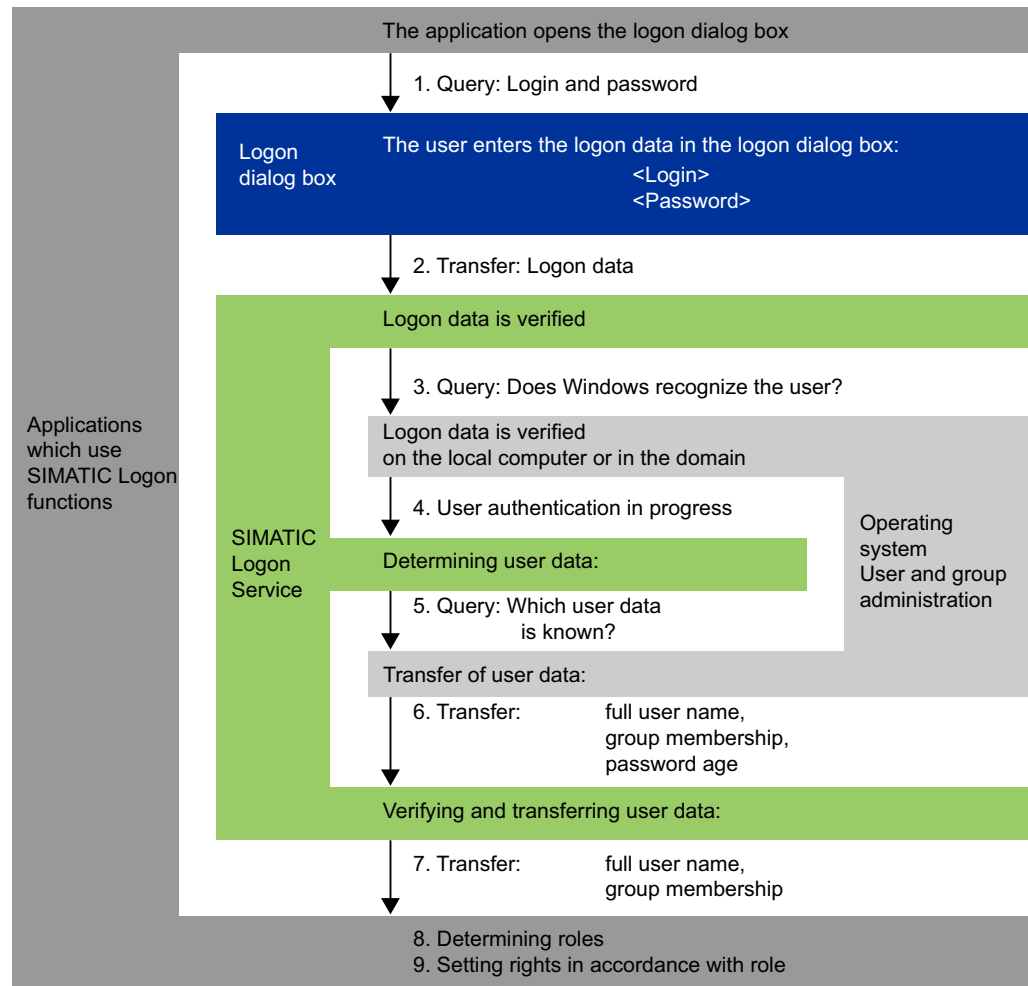

## Making settings on the server

### Introduction

Perform the following steps on your sever to ensure correct operation of SIMATIC Logon.

### Procedure

1. Install SIMATIC Logon Services.
2. Create the user group in the user administration of the operating system.

3. Create the users in the user administration of the operating system.

---

**Note**

Users of SIMATIC Logon must be members of a user group of the operating system. Members of a subgroup cannot be logged on.

---

4. Assign the new users to a group.
5. Transfer the licenses for each HMI device on the server.

---

**Note**

You can find more detailed information in the documentation supplied with SIMATIC Logon.

---

**Note**

The password policies stored on the server are valid if users are authorized by means of SIMATIC Logon.

The logoff time for the SIMATIC Logon user corresponds to that of the predefined "Administrator" user.

---

## Logging on using SIMATIC Logon

### Requirements

- User administration exists.
- The groups created in WinCC agree with the Windows groups on the server.
- There is a server with SIMATIC Logon Service installed.

---

**Note**

A user may only be a member of one user group in WinCC. When a user is a member of several user groups on the server, only one of these user groups can be made known in WinCC.

"Administrators" and "Users" are predefined groups in both Windows and WinCC. Any new user created in Windows is automatically a member of the "Users" group. A user will be a member of two groups if assigned to a new group, for example, to the "SL user" group.

Remove this user from the "Users" group of the operating system to enable logon of this user using SIMATIC Logon.

A system message in runtime always confirms the successful logon of a user on the server.

---

## Procedure

1. Open the "Runtime settings > User administration" editor in the Project window.
2. Activate "Activate SIMATIC Logon".
3. Select "Windows domain" or "Windows computer", depending on where you run user administration.
4. Enter the name or IP address of the SIMATIC Logon server in the "Server name" text box.

---

### Note

Make sure your SIMATIC Logon Server always has the same IP address if you use IP addresses.

---

5. Enter the port number for TCP/IP communication in the "Port number" text box. The valid range of values lies between 1024 and 49151. The preset port number is "16389" and used by SIMATIC Logon as the default.
6. Enter the Windows domain or the logon server with the user data in the "Windows domain" text box.  
Enter the name of the sever to access users on the logon server.  
Enter the name of the domain if the logon sever is in a domain and you wish to access users of the domain.

---

### Note

Local Windows users are not accepted when the logon server is in a domain.

---

7. Activate the "Encrypted transfer" check box in order to encrypt the data before sending it to the server.

## Emergency user

If the server cannot be accessed, all local users that were created in WinCC user administration can also be used as emergency users.

Emergency users have the rights of the user group to which they were assigned.

---

### Note

For additional information, refer to the included SIMATIC Logon documentation.

This documentation is available at: [SIMATIC Logon installation directory] \manuals

---

#### 10.7.4.4 Administering users in Runtime

##### Users in runtime

##### Principle

You create users and user groups and assign authorizations to them. You configure objects with authorizations. After download to the HMI device, all objects which were configured with an authorization are protected against unauthorized access in Runtime.

##### User view

When you configure a user view in the Engineering System, you administer users in this user view following download to the HMI device.

<b>NOTICE</b>
---------------

Changes in the user view are effective immediately in Runtime. Changes in runtime are not updated in the engineering system. When downloading the user administration to the HMI device, all changes in the user view are overwritten after a security prompt and based on the settings.
--

Users who have a "User administration" authorization have unlimited access to the user view. This allows them to administer all users. Any other user has only limited access to the user view for self administration.

##### See also

Complex user view (Page 3518)

##### Basic user view

##### Purpose

You configure a user view in the engineering system to also administer the users in Runtime.

##### Structure

The user view shows the following in each line:

- The user
- The corresponding user group.

If no user is logged on, the user view is empty. The content of the individual fields is displayed after logon.



### User view of an administrator

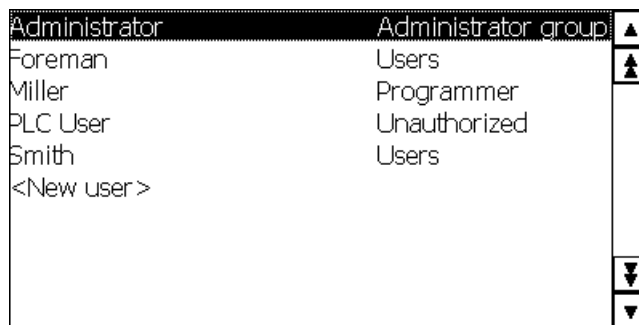

When an administrator is logged on, the user view shows all the users. The administrator changes the user name and the password. The administrator creates new users and assigns them to an existing user group.

### User view of a user

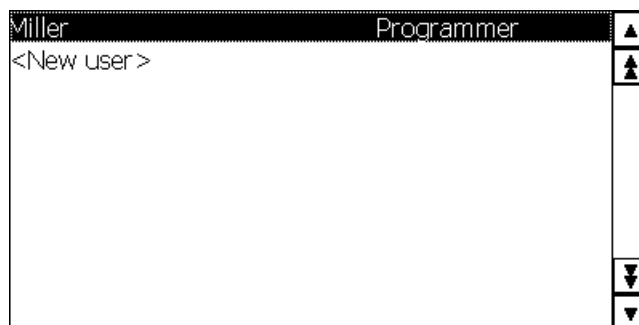

When no administrator is logged on, the user view shows only the logged-on user. Users can change their own passwords.

## Complex user view

### Purpose

You configure a user view in the engineering system to also administer the users in Runtime.

### Structure

The user view shows the following in each line:

- The user
- The encrypted password
- The corresponding user group
- The logoff time

If no user is logged on, the user view is empty. The content of the individual fields is displayed after logon.

### User view of an administrator

User	Password	Group	Logoff time	
Administrator	*****	Admini...	5	▲
Meier	*****	Inbetri...	5	
Meister	*****	Bediener	5	
Mueller	*****	Progra...	5	▼

When an administrator is logged on, the user view shows all the users. The administrator changes the user name and the password. The administrator creates new users and assigns them to an existing user group.

### User view of a user

Benutzer	Kennwort	Gruppe	Abmeldezeit
Mueller	*****	Progra...	5

When no administrator is logged on, the user view shows only the logged-on user. Users can change their own passwords and logoff time.

## See also

Users in runtime (Page 3516)

## Configuring a user view

### Introduction

You configure a user view in the Engineering System to also administer users in Runtime.

### Requirements

A screen has been created.

### Procedure

1. Select the "User view" object from the "Controls" category in the toolbox.
2. Drag-and-drop the "User view" object into the screen.
3. Click on "Properties > Properties" in the Inspector window.
4. Specify the appearance of the "User view".
5. You can, for example, select "Display mode > Fit to size > Fit object to contents".

### Result

You have created a user view in the screen.

## Creating users

### Introduction

You create a user so that users can log on under their user name in runtime.

As an alternative, you can create users in the engineering system and download them to the HMI device.

The logon is successful only when the user name entered during the logon matches a user in runtime. In addition, the password entered at logon has to match that of the user.

---

#### Note

Note that the entry is case-sensitive.

---

You assign the user to a user group. The user then has the authorizations of the user group.

**Note**

Runtime users must be assigned to a user group. The user group is created in the Engineering System. The designation of the user group is language-dependent.

**Requirements**

- The user view is open.
- A "Group 2" user group has been created.

**Procedure**

1. Click "<New User>" in the user view. A dialog opens.
2. Enter "Foreman" as the user name.
3. Press the <Return> button.
4. Click "Password."
5. Enter the password of the user.
6. Press the <Return> button. The password is hidden.
7. Click in the "Group" column.
8. Select "Group 2" as the "Group".

User	Password	Group	Logoff time
Administrator	*****	Administ..	5
Johnson	*****	Administ..	5
Meister	*****	Group 2	5
PLC User	*****	Unautho...	5

9. Press the <Return> button.
10. Click in the "Logoff time" column.
11. Enter the time after which the user is logged off automatically.



## Managing users in the simple user view

### Introduction

If you have configured a user view in the engineering system, the users and user groups can be managed in runtime.

#### NOTICE

Changes in the user view are effective immediately in runtime. Changes in runtime are not updated in the Engineering System. When downloading the user administration to the HMI device, all changes in the user view are overwritten after a security prompt and based on the settings.

### Requirements

- Runtime is enabled.
- The simple user view has been created.
- The screen with the simple user view is open.
- You have the default "User administration" authorization.

#### Note

If you do not have a "User administration" authorization, you can only change your own password and your logoff time.

### Changing a user name

1. Click on the line of the user whose name you want to change. A dialog box opens.
2. Enter a new user name.
3. Click "OK" to confirm your entry.

#### Note

The user can then no longer log on with his previous password in runtime. If you delete the name and press <Return>, the user is deleted.

### Changing the user password in basic user display

1. Click on the line of the user whose password you want to change. A dialog box opens.
2. Enter a new password.
3. Click "OK" to confirm your entry.

---

#### Note

The user can then no longer log on with his previous password in runtime.

If you delete the password in the basic user view and press <Return>, a message will be generated. The message specifies that the password does not lie within the defined limits.

---

### Changing the logoff time of the user

1. Click on the line of the user whose logoff time you want to change. A dialog box opens.
2. Enter a new logoff time.
3. Click "OK" to confirm your entry.

### Deleting a user

1. Click the name of the user to be deleted.
2. Delete the name.
3. Press the <Return> button.

---

#### Note

The user can no longer log on in runtime.

---

### Assigning a user to a different user group

1. Click on the line of the user whose user group you want to change. A dialog box opens.
2. Click on the "User group" box.
3. Select a user group.
4. Click "OK" to confirm your selection.

## Managing users in the complex user view

### Introduction

If you have configured a user view in the engineering system, the users and user groups can be managed in runtime.

#### NOTICE

Changes in the user view are effective immediately in runtime. Changes in runtime are not updated in the engineering system. When downloading the user administration to the HMI device, all changes in the user view are overwritten after a security prompt and based on the settings.

### Requirements

- Runtime is enabled.
- A complex user view has been created.
- The screen with the user view is open.
- You have the default "User administration" authorization.

#### Note

If you do not have a "User administration" authorization, you can only change your own password and your logoff time.

### Changing the user name

1. Enter a new user name in the "Users" column in the user display.
2. Confirm your entry with <Return>.

#### Note

The user can then no longer log on with his previous password in runtime. If you delete the name and press <Return>, the user is deleted.

### Changing the password of the user

Availability of complex user display in selected devices only.

1. Enter a new password in the "Password" column in the user display.
2. Confirm your entry with <Return>.

---

#### Note

The user can then no longer log on with his previous password in runtime.

If you delete the password in the complex user view and press <Return>, the user will be deleted.

---

### Changing the logoff time of the user

1. Enter a new logoff time in the "Logoff time" column in the user display.
2. Confirm your entry with <Return>.

### Deleting a user

1. Click the name of the user to be deleted.
2. Delete the name.
3. Press the <Return> button.

---

#### Note

The user can no longer log on in runtime.

---

### Assigning a user to a different user group

1. Activate the user group field for the corresponding user.
2. Select a user group.
3. Confirm your selection with <Return>.

### Unlock locked out users

#### Unlock locked out users

The check box "Activate limit for login attempts" is activated in the "Runtime settings > User administration".

The number 3 is entered in the field "Number of invalid login attempts".

If users have three failed attempts at login, e.g. by entering an incorrect password, they are assigned to the "Unauthorized" group. The user loses all authorizations. The user can still log on, but no longer has any authorizations. Only a user with administrator rights re-assigns the unauthorized user to a user group.

## Exporting the user administration

### Introduction

The users and user groups are transferred to the HMI device from the Engineering System. If you have configured a user view, you administer the users at the HMI device via the user view.

If a user has access to several HMI devices, the same user and the same password must be configured on each HMI device. Create a standard for user administration of the different HMI devices. Export the users and passwords on an HMI device to a storage medium, such as a floppy, memory card or a network drive. You import the users and passwords from this storage medium at all the other HMI devices.

You program a function which exports the user data at a button.

The system function "ExportImportUserAdministration" is not available on all HMI devices.

<b>NOTICE</b>
---------------

When exporting, the user data are encrypted and written from the HMI device to the target file. The target file is overwritten.
---

### Requirements

- You have created an HMI device with Runtime Advanced.
- A screen has been created.
- A button has been created in the screen.
- The Inspector window is open.

### Procedure

1. Click the button in the screen.
2. Click "Properties > Events > Release" in the Inspector window.
3. Click the entry "Add function" in the function list.
4. Select the "ExportImportUserAdministration" system function.
5. Select "Export" as the "Direction". When exporting, the target file is overwritten with the user data.
6. Enter the full path of the destination file as the "File name", for example "a:\test\usersview.txt".

---

**Note**

Ensure that the file name is written correctly. If the directory, for example "\test\", does not exist, it will be created without a prompt.

---

## Importing the user administration

### Introduction

If a user has access to several HMI devices, the same user and the same password must be configured on each HMI device. Create a standard for user administration of the different HMI devices. Export the users and passwords on an HMI device to a storage medium, such as a floppy, memory card or a network drive. You import the users and passwords from this storage medium at all the other HMI devices.

You configure a function which imports the user data at a command button.

The system function "ExportImportUserAdministration" is not available on all HMI devices.

NOTICE
When importing, the user data are read in from the source file and written into the HMI device. The users and passwords currently valid in the HMI device are overwritten. The imported users and passwords are valid immediately.

### Requirements

- A screen has been created.
- A command button has been created in the screen.
- The Inspector window is open.

### Procedure

1. Click the button in the screen.
2. Click "Properties > Events > Release" in the Inspector window.
3. Click the entry "Add function" in the function list.
4. Select the "ExportImportUserAdministration" system function.
5. Select "Import" as the "Direction." When importing, the user data in the HMI device are overwritten.
6. Enter the full path of the source file as the "File name", for example "a:\test\usersview.txt".

---

**Note**

Ensure that the file name is written correctly. If the folder, for example "\\test\\", or the file does not exist, an error message will be displayed.

---

## Logging on as a user

### Introduction

As a rule you log-on as a user by means of a special button. The logon dialog box is displayed to this purpose.

The logon dialog box is displayed by default during access to a protected object if

- No user is logged on in runtime.
- The logged-on user does not have the required authorization.

---

#### Note

The system always opens the logon dialog on the OP 73, OP 77A, TP 177A and Basic Panels HMI devices when you press an access-protected button:

---

### Requirements

- Under "Runtime settings > User administration" the
  - "Enable limit for logon attempts" check box has been selected.
  - The number 3 is entered in the field "Number of incorrect login attempts".
- The "ShowLogonDialog" system function is configured on a button called "Logon".

### Procedure

1. Click the "Logon" button. The logon dialog box is displayed.

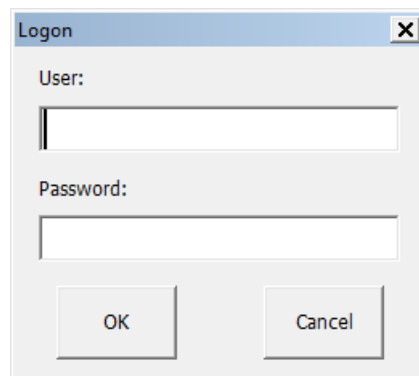

2. Enter your user name as it was specified in the user administration, for example "Foreman". If someone has logged on before you, the name of the user will be displayed.
3. Enter the corresponding password. The input is concealed.
4. Click "OK" to close the dialog box.

### Logon was successful

If you have entered the user name "Foreman" and the entered password corresponds with the stored password, you are logged on as the user "Foreman" in runtime. You have the authorizations of the user "Foreman".

When the user "Foreman" accesses a protected object such as the "Logging" button, access to this protected object will only be authorized if the user "Foreman" has the required authorization. The programmed function is executed immediately.

If you do not have the required authorization after the successful log-on, a corresponding error message is displayed. However, you remain logged on in runtime.

### Logon was unsuccessful

An error message is displayed.

In order to maintain security, you or the user logged-on before you no longer has any authorizations. However, access to unprotected objects remains possible. The user view does not, however, show any entries. The user view and the authorizations change after the next successful log-on.

If the third login attempt has failed, the user will be assigned to the "Unauthorized" group. For this reason, do not configure a user group with this display name.

If the "Log off" function is called up or the logoff time of the user has expired, the user is logged off.

## 10.7.4.5 Configuring access protection

### Access protection

#### Introduction

You configure an authorization at an object in order to protect it against access. All logged-on users who have this authorization can then access the object. If a user does not have authorization to operate an object, the logon dialog is displayed automatically.

---

#### Note

Several system functions are available under "User administration" so that user, password, and user group can be edited, for example, in the PLC.

---

### Configuring operating authorizations

#### Introduction

You configure the "Stop runtime" authorization for a button. Then only those users who have the appropriate authorization have access to this button, for example all the users of the "Operators" user group.



This ensures that access to the command button is protected. If a logged-on user who belongs to the "Operators" user group and has the required authorizations clicks the button, runtime is stopped.

An example describes in detail how to configure a command button with access protection.

## Requirements

- The "Operators" user group has been created.
- The "Stop runtime" authorization has been created.
- A screen has been created and opened.
- The screen contains a button.

## Procedure

1. Click the button in the screen.
2. Click "Properties > Properties > Security" in the Inspector window.
3. Select "Stop runtime" as the "Authorization".
4. In the Inspector window, select "Properties > Events > Click".
5. Select a system function from the function list, for example, "StopRuntime".

---

### Note

The "Enable" and "Disable" events are only used to detect whether an object was selected or deselected. The events do not, however, trigger a password prompt.

Do not use the "Enable" or "Disable" event if you want to configure access protection at the function call of the object.

---

## 10.7.5 Reference

### 10.7.5.1 Objects with access protection

#### Introduction

The following objects can be configured with an authorization:

- Date/time field
- I/O field
- Graphic I/O field
- Recipe view
- Switch

### 10.7 Configuring user administration

- Button
- Symbolic I/O field
- System diagnostic view

#### 10.7.5.2 Objects with access protection

##### Introduction

The following objects can be configured with an authorization:

- Date/time field
- I/O field
- f(x) trend view
- Graphic I/O field
- HTML Browser
- Alarm view
- Alarm window
- Recipe view
- Switch
- Button
- Slider
- Symbol library
- Symbolic I/O field
- System diagnostic view
- System diagnostic window

#### 10.7.5.3 Default user groups and authorizations

##### Principle

The predefined user groups and authorizations have the following numbers:

User group	Number
"Administrator group"	1
"Users"	2

Authorization	Number
"User administration"	1
"Monitor"	2
"Operate"	3

## 10.7.6 Examples

### 10.7.6.1 Example: Configuring a button with logon dialog box

#### Task

In the following example, you configure the function "ShowLogonDialog" for a button. A different user can then log on in runtime when the shift changes, for example. In the process the user previously logged on is logged off.

---

#### Note

In runtime the logon dialog box is not displayed by default until you access a protected object. Either no user is logged on or the logged-on user does not have the required authorization.

---

#### Requirements

- A screen has been created.
- A button has been created in the screen.

#### Procedure

1. Click the button in the screen.
2. Click "Properties > Events > Release" in the Inspector window.

### 10.7 Configuring user administration

3. Click the entry "Add function" in the "Function list" table.
4. Select the system function "ShowLogonDialog" from the "User administration" group.

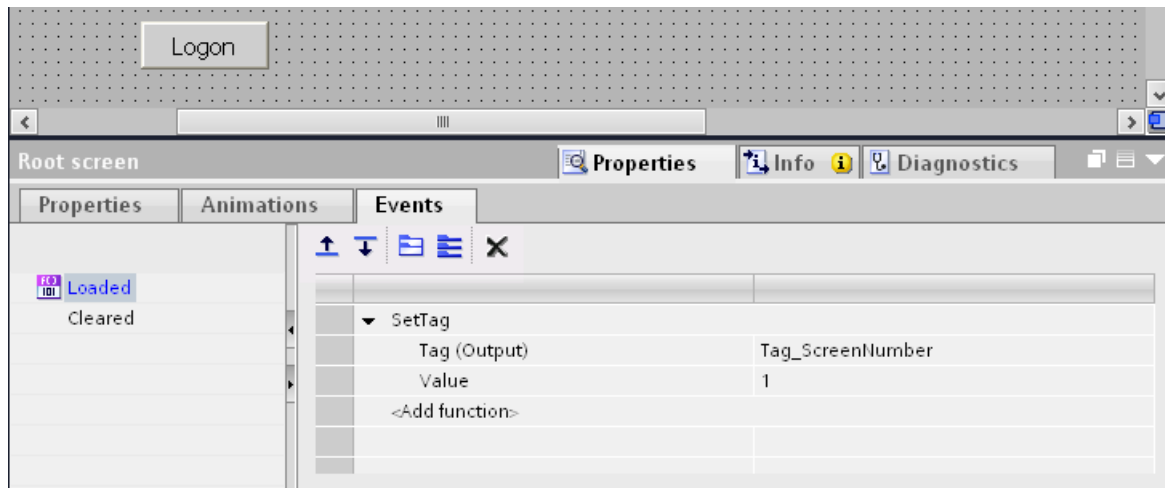

### Result

If the user clicks on the button in runtime, the function "ShowLogonDialog" is called up. When the function "ShowLogonDialog" is called up, the logon dialog box is displayed. The user logs on with his user name and password.

#### 10.7.6.2 Example: Logging the logon and logoff events

### Task

In the following example, you configure the function "TraceUserChange" to the event "User change".

### Principle

The "TraceUserChange" function is called when a user logs on or off. When a function is called up, a system message with information about the corresponding user is output.

This system message can be archived. When archiving, the system message is provided with a date stamp and time stamp. This ensures that you can track which user was logged on at the HMI device at which time and for how long.

### Requirements

- You have created an HMI device with Runtime Advanced.
- The Inspector window is open.

## Procedure

1. Double-click the "Scheduler" in the Project view.
2. Double-click "Add" in the table of the tasks.
3. Enter "Logon-Protocol" as the "Name".
4. Select "User change" as the "Trigger".
5. Open "Properties > Events" in the Inspector window.
6. Click the entry "Add function" in the "Function list" table.
7. Select the "TraceUserChange" system function.

## Result

A system message is output when a user logs on or logs off.

### 10.7.6.3 Example of a user administration

#### Example: Structure of user administration

## Task

In the following example you set up a user administration for different users and user groups. The example orientates itself to a typical requirement profile from manufacturing engineering.

## Principle

Completely different groups of persons are involved in a plant or project. Each group of persons protects its respective data and functions against access by others. For this purpose, users are created and assigned to a user group.

You can reproduce different views through user groups.

Example:

- Organizational view: Commissioners, Operators, Shift I, Shift II
- Technological view: Axis control, Tool changers, Plant North, Plant South

The following example orientates itself to the organizational view.

Every user group has characteristic requirements regarding access protection: A user group has operating authorizations for specific application cases. A programmer changes, for example, recipe data records.

In the example the users Miller, Group Smith and Foreman are created and assigned to different user groups.

Ms. Miller works as a programmer in the engineering system. The Group Smith are commissioners. Mr. Foreman is an operator.

## Requirements

- A new project has been created.
- The "User administration" editor is open.

## Procedures overview

Working with user administration has the following procedure in the example:

1. Creating authorizations The planner specifies which authorizations are required for access protection.
2. Configuring authorizations: The planner specifies which objects may be operated and which functions may be executed.
3. Creating user groups and allocating authorizations: The administrator creates the user groups together with the planner. The planner uses the authorizations to specify who may operate objects and change parameters.
4. Creating users and assigning them to a user group: The administrator administers the users.

## Result

The aim is the following structure of the user administration of users, user groups and authorizations:

Users			User groups	Authorizations			
Miller	Smith	Foreman	Roles	Changing recipe records	Changing system parameters	Changing process parameters	Managing
			Administrator group				x
X			Programmer	X			
	X		Commissioning engineers	X	X	X	
		X	Operators	x			

The user "Foreman" who belongs to the "Operators" user group has access to the configured "To Recipe view" button.

### Note

Alternatively, you can create several users as operators with different operating authorizations, for example, Operator Level 1, Operator Level 2.

## Example: Creating and configuring authorizations

### Task

The following example shows you how to create the authorizations

## Procedure

1. Open the "User groups" work area.
2. Double-click "Add" in the "Authorizations" table.
3. Enter "Change recipe data records" as the "Name" of the authorization.
4. Repeat steps 2 and 3 to create additional authorizations: "Change system parameters", "Change process parameters".

## Result

The screenshot shows the 'User administration' window with two main sections: 'Groups' and 'Authorizations'.

**Groups Table:**

Name	Number	Display name	Password aging	Comment
Administrator group	1	Administrator group	<input type="checkbox"/>	The 'Administrators' group i...
Users	2	Users	<input type="checkbox"/>	The 'Users' group is initially ...
<Add new>				

**Authorizations Table:**

Enabled	Name	Display name	Number	Comment
<input checked="" type="checkbox"/>	User administration	User administration	1	Authorize 'User administration' for managing users in ...
<input checked="" type="checkbox"/>	Monitor	Monitor	2	'Monitor' authorizations.
<input checked="" type="checkbox"/>	Operate	Operate	3	'Operate' authorization.
<input checked="" type="checkbox"/>	Change recipe data reco...	Change recipe data records	4	
<input checked="" type="checkbox"/>	Change system paramet...	Change system parameters	5	
<input checked="" type="checkbox"/>	Change process parame...	Change process parameters	6	
<Add new>				

## Example: Configuring a button with access protection

### Task

In the following example you use a system function to create a button for a screen change. You protect the "To Recipe view" button against unauthorized operation. To do so, you configure the "Change recipe data records" authorization at the "To Recipe view" button.

### Requirements

- A "Change recipe data records" authorization has been created.
- A "Recipes" screen has been created.
- A "Start" screen has been created and opened.
- A button has been created and marked in the "Start" screen.

## Procedure

1. Click "Properties > Properties > General" in the Inspector window.
2. Enter "To Recipe view" as the text.
3. Click "Properties > Events > Click" in the Inspector window.
4. Click the "Add function" entry in the first line of the "Function list" table.
5. Select the "ActivateScreen" system function in the "Screens" group.
6. Click the [...] button in the "Screen name" field. A dialog box for selecting the screen opens.
7. Select the "Recipes" screen and use the  button to close the dialog box.
8. Click "Properties > Properties > Security" in the Inspector window.
9. Select "Change recipe data records" as the "Authorization."

## Result

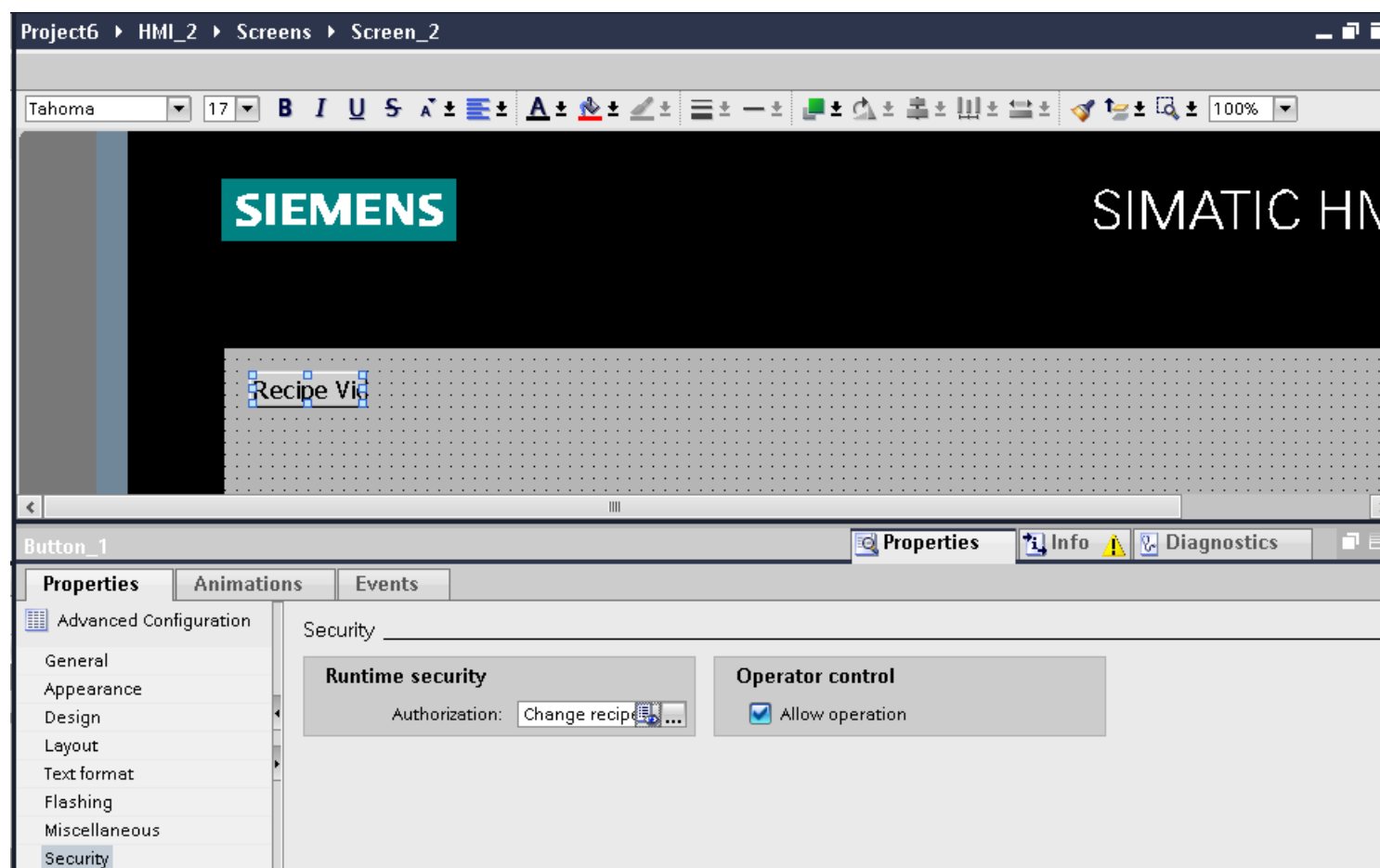

Access to the "To Recipe view" button is protected. If, for example, the user "Smith" clicks the button in Runtime, the function "Recipe view" screen is called up. Prerequisite is that the user "Smith" has logged on correctly and has the required authorization. The "Recipes" screen contains a recipe view and other screen objects.



If the logged-on user does not have the required authorization or if no user is logged on, the "Logon dialog box" is displayed.

### Example: Creating user groups and assigning authorizations:

#### Task

In the following example you create the user groups and assign authorizations to them.

#### Procedure

1. Open the "User groups" work area.
2. Double-click "Add" in the "Groups" table.
3. Enter "Programmer" as the "Name".
4. Repeat steps 2 and 3 to create the "Commissioner" and "Operator" user groups.
5. Click "Administrator" in the "Groups" table.
6. Activate the "Change system parameters" authorization in the "Authorizations" table.

#### Interim result

Project6 ▶ HMI\_2 [TP700 Comfort] ▶ User administration

Users User groups

#### Groups

	Name	Number	Display name	Password aging	Comment
	Administrator group	1	Administrator group	<input type="checkbox"/>	The 'Administrators' group i...
	Users	2	Users	<input type="checkbox"/>	The 'Users' group is initially ...
	Programmer	3	Programmer	<input type="checkbox"/>	
	Commissioner	4	Commissioner	<input type="checkbox"/>	
	Operator	5	Operator	<input type="checkbox"/>	

#### Authorizations

	Enabled	Name	Display name	Number	Comment
	<input checked="" type="checkbox"/>	User administration	User administration	1	Authorize 'User administration' for managing u...
	<input checked="" type="checkbox"/>	Monitor	Monitor	2	'Monitor' authorizations.
	<input checked="" type="checkbox"/>	Operate	Operate	3	'Operate' authorization.
	<input type="checkbox"/>	Change recipe data records	Change recipe data records	4	
	<input checked="" type="checkbox"/>	Change system parameters	Change system parameters	5	
	<input type="checkbox"/>	Change process parameters	Change process parameters	6	
		<Add new>			

**Procedure**

1. Click "Operator" in the "Groups" table.
2. Activate the "Change recipe data records" authorization in the "Authorizations" table.
3. Click "Commissioner" in the "Groups" table.
4. Activate the authorizations "Change recipe data records", "Change system parameters" and "Change process parameters" in the "Authorizations" table.
5. Click "Programmer" in the "Groups" table.
6. Activate the "Change recipe data records" authorization in the "Authorizations" table.

**Result**

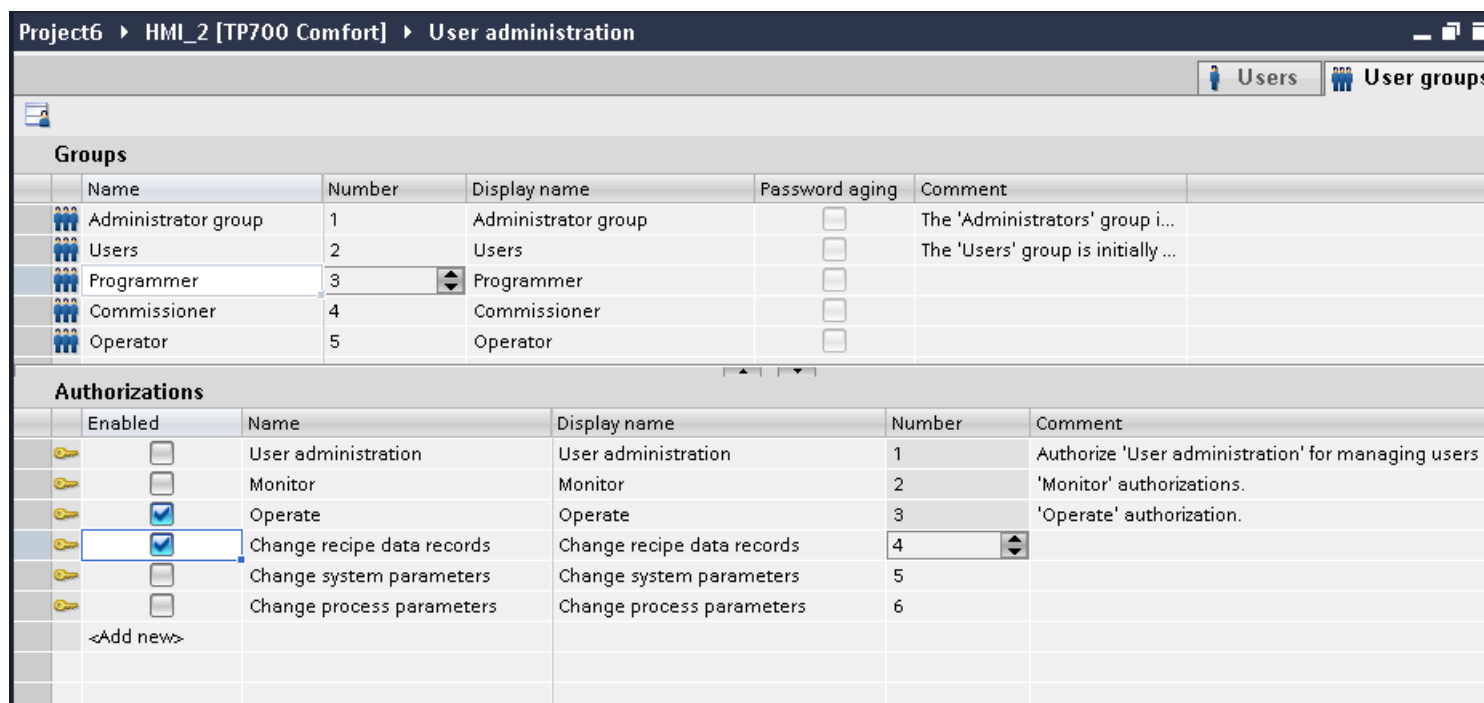



**Example: Creating users and assigning them to a user group**

**Task**

In the following example you create the users and assign user groups to them. The users are sorted alphabetically immediately after the name has been entered.

**Procedure**

1. Open the "Users" work area.
2. Double-click "Add" in the "Users" table.



3. Enter "Miller" as the user name.
4. Click the  button in the "Password" column. The dialog box for entering the password is displayed.
5. Enter "miller" as the password.
6. To confirm the password enter it a second time in the lower field.
7. Close the dialog box by using the  icon.
8. Activate the "Programmer" user group in the "Groups" table.

### Interim result





Project6 ▶ HMI\_2 [TP700 Comfort] ▶ User administration

Users User gr



#### Users

	Name	Password	Automatic logoff	Logout time	Number	Comment
	Administrator	*****	<input checked="" type="checkbox"/>	5	1	The user 'Administrator' is a...
	Miller	***** 	<input checked="" type="checkbox"/>	5	2	
	<Add new>					

#### Groups

	Member of	Name	Number	Display name	Password aging	Comment
	<input type="radio"/>	Administrator group	1	Administrator group	<input type="checkbox"/>	The 'Administrators' group i...
	<input type="radio"/>	Users	2	Users	<input type="checkbox"/>	The 'Users' group is initially...
	<input checked="" type="radio"/>	Programmer	3	Programmer	<input type="checkbox"/>	
	<input type="radio"/>	Commissioner	4	Commissioner	<input type="checkbox"/>	
	<input type="radio"/>	Operator	5	Operator	<input type="checkbox"/>	
		<Add new>				

### Procedure

1. Double-click "Add" in the "Users" table.
2. Enter "Smith" as the user name.
3. Click the  button in the "Password" column. The dialog box for entering the password is displayed.
4. Enter "smith" as the password.
5. To confirm the password enter it a second time in the lower field.
6. Close the dialog box by using the  icon.
7. Activate the "Commissioner" user group in the "Groups" table.
8. Repeat steps 2 to 6 for the user "Foreman."
9. Activate the "Operators" user group in the "Groups" table.

Result

Project6 ▶ HMI\_2 [TP700 Comfort] ▶ User administration

Users User groups

### Users

	Name	Password	Automatic logoff	Logout time	Number	Comment
	Administrator	*****	<input checked="" type="checkbox"/>	5	1	The user 'Administrator' is a...
	Miller	*****	<input checked="" type="checkbox"/>	5	2	
	Smith	*****	<input checked="" type="checkbox"/>	5	3	
	Foreman	*****	<input checked="" type="checkbox"/>	5	4	
	<Add new>					

### Groups

	Member of	Name	Number	Display name	Password aging	Comment
	<input type="radio"/>	Administrator group	1	Administrator group	<input type="checkbox"/>	The 'Administrators' group i...
	<input type="radio"/>	Users	2	Users	<input type="checkbox"/>	The 'Users' group is initially ...
	<input type="radio"/>	Programmer	3	Programmer	<input type="checkbox"/>	
	<input type="radio"/>	Commissioner	4	Commissioner	<input type="checkbox"/>	
	<input checked="" type="radio"/>	Operator	5	Operator	<input type="checkbox"/>	
	<Add new>					

## 10.8 Working with system functions and Runtime scripting

### 10.8.1 Basics

#### 10.8.1.1 Runtime scripting

##### Term definition

The following terms are used in the documentation:

Term	
Runtime scripting	Generic term for all activities in user-defined functions.
Function	Generic term for system functions and user-defined functions.
System functions	System functions are all functions supplied with WinCC. The system functions are used either in function lists or user-defined functions.
User-defined functions	User-defined functions are functions written in the "Scripts" editor. For more precise specification, the term "User-defined VB function" is used in the documentation.
VBS / VBScript	Abbreviation for Visual Basic Script

##### Applying Runtime scripting

The following figure serves as a decision guide for programming tasks at hand:

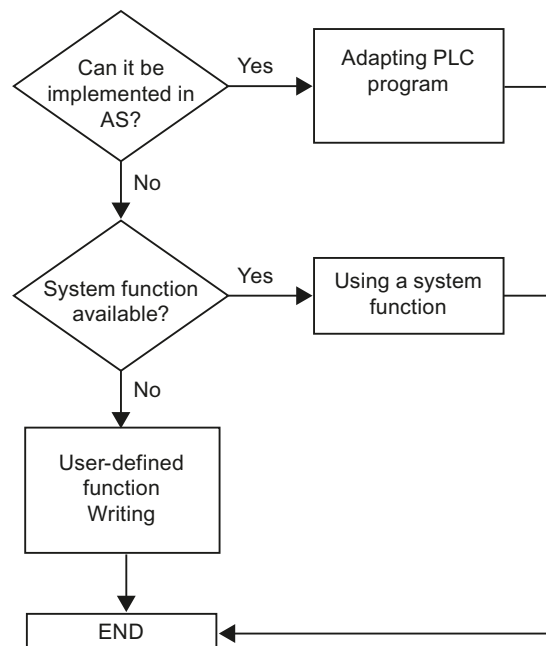

## 10.8.1.2 System functions

### Applications

You use system functions for the following:

- **Function lists**  
A function list is executed from top to bottom in Runtime. If a function list includes system functions with longer runtime, these are processed asynchronously. See "Auto-Hotspot" for additional information.
- **User-defined functions**  
If the HMI device supports customized functions, you use system functions in combination with instructions and conditions in the code of a customized function. In this way you execute a customized function depending on a specific system state. In addition, you can evaluate return values of system functions, for example. Depending on the return value, you then perform test functions, for example, that in turn affect the user-defined function flow.

### Application examples of system functions

- Calculations, increase tag value by a defined or variable amount.
- Log function, e.g. to start a process value log.
- Settings, e.g. to switch the PLC or set a bit in the PLC.
- Alarms, e.g. after changing the user.

## Usage

- **Function list**  
When configuring a function list, you select the system functions from a selection list that is sorted by categories:

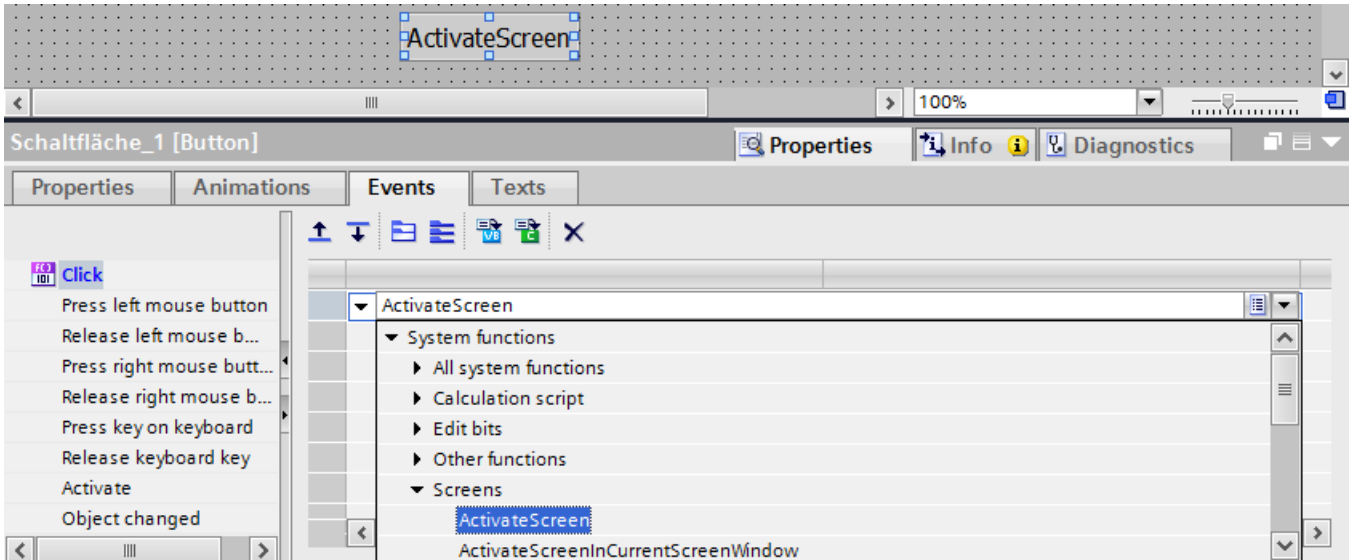

- **User-defined function**  
If you are using a system function in a user-defined function, you choose it from a selection list. To open the selection list, use the key shortcut <Ctrl+Space> or click .

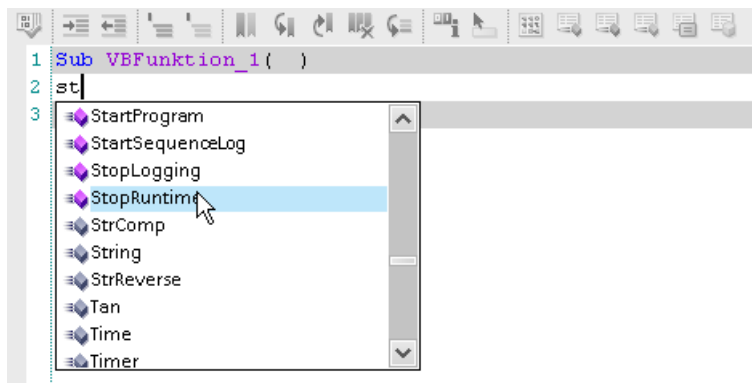

## Language dependency

In the function list, the names of the system functions are dependent on the set project language. The functionality can then be recognized immediately by the project planner.

You use the English name of the system function in user-defined functions. You will find the English name of the system function in the reference.

## Availability

Which system functions are available depends on the selected HMI device.

## HMI device replacement

If you use system functions in a function list that are not available on the set HMI device, these system functions are marked in color.

If you use a system function in a user-defined function which is not available on the set HMI device, a warning is issued. In addition, the respective system function will be underlined with a wavy blue line.

## See also

System functions for logs (Page 3227)

### 10.8.1.3 User-defined functions

#### Applications

You use customized functions for the following for example: :

- Configuring an extended function list  
In a customized function you have the option to have customized functions and system functions executed depending on conditions or executed repeatedly. You then add the customized function to a function list.
- Programming new functions  
Customized functions are only valid in the project in which they are defined. For user-defined functions you define transfer parameters and return values, for example, for conversion of values.

#### Properties of customized functions

A customized function has the following properties:

- Name
- Parameter (optional)
- Return value and type (optional)
- Can be modified centrally
- has no trigger. You have to call the customized function explicitly, e.g. in a function list.
- behaves like a system function

#### Usage

You create customized functions with the "Scripts" editor. See "Scripts" editor (Page 3550) for additional information.

Customized functions are saved in the project. To protect user-defined functions, set up know-how protection. See Auto-Hotspot for additional information.



- **Project tree**  
The user-defined functions are listed in the project tree under "VB scripts".

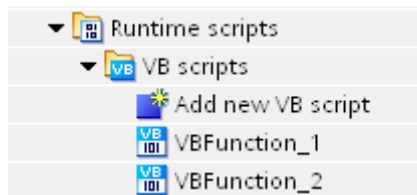

- **Function list**  
The user-defined functions are listed in a function list under "VB functions".

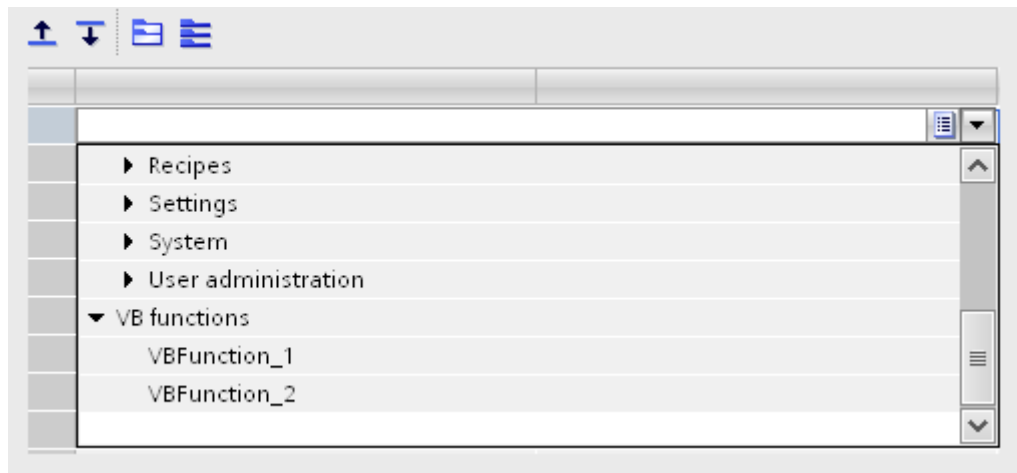

- **User-defined function**  
If you are using a system function in a user-defined function, you choose it from a selection list. To open the selection list, use the key shortcut <Ctrl+Space> or click .

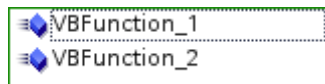

## Recursion level

The recursion level in user-defined functions is limited by the stack size of the HMI device. If the number is exceeded, a system error message is output in Runtime. This means you should limit the number of recursions in a user-defined function.

## 10.8.2 Working with function lists

### 10.8.2.1 Basics of the function list

#### Introduction

A function list performs one or more system functions and user-defined functions when the configured event occurs.

## Principle

The function list is configured for an event of an object, for example, for a screen object or a task. You can configure a function list precisely on every event. The events which are available depend on the selected object and the HMI device.

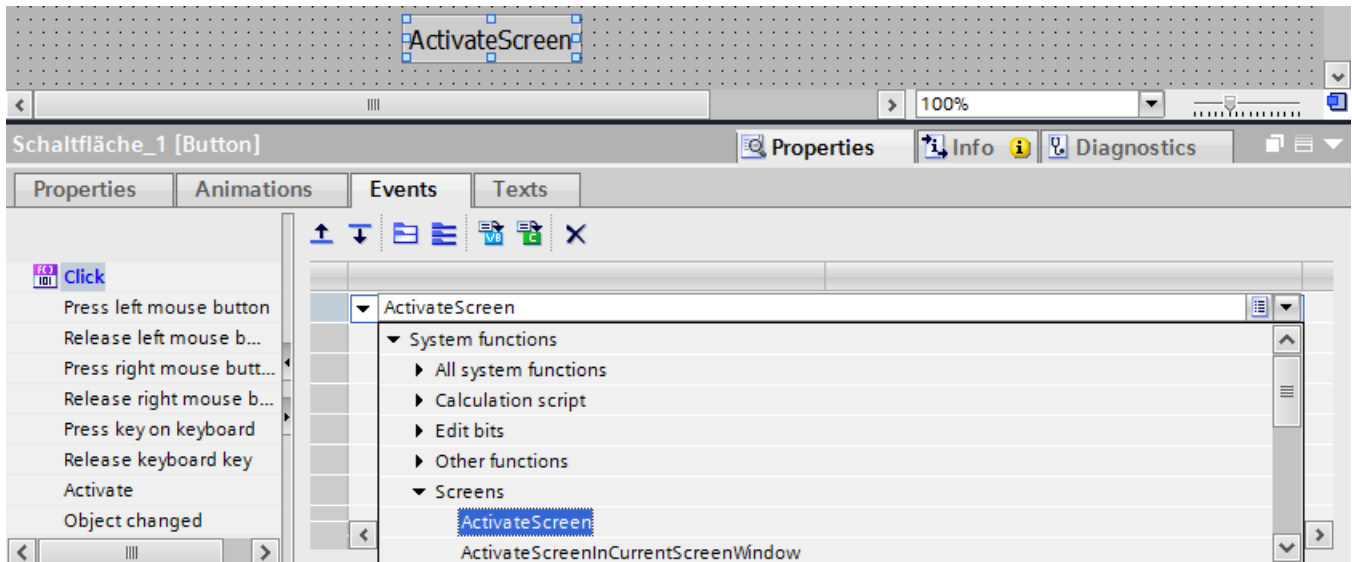

Events occur only when the project is in Runtime. Events include:

- Execution of a task
- Pressing of a button
- Acknowledging an alarm

### Note

The choice of configurable system functions in a function list is dependent on the selected HMI device. For additional information, refer to "Availability for specific devices of system functions".

### 10.8.2.2 Properties of a function list

#### Status information

During configuration the project data is tested in the background.

With the following causes the function list is not executed in Runtime and the incorrect entries are marked red:

- At least one system function or one user-defined function is not completely supplied with parameters.
- At least one system function or one user-defined function is contained which is not supported by the selected HMI device, e.g. by changing the device type.

## Processing of system functions and user-defined functions (WinCC Runtime Advanced and Panels)

A function list is executed from top to bottom in Runtime. If a function list includes system functions with longer runtime, these are processed asynchronously. You can find additional information about this in the sections "Calling system functions" and "Calling user-defined functions".

### See also

Executing a function list in Runtime (Page 3573)

Processing sequence for user-defined functions and system functions (Page 3574)

### 10.8.2.3 Configuring a function list

#### Introduction

You configure a function list by selecting the system functions and customized functions from a drop-down list. The system functions are arranged in the selection list according to categories.

You only use customized functions of a programming language in a function list. Your selection of the first user-defined function determines whether user-defined VB functions or user-defined C functions can be selected in the function list. Which programming languages are available depends on the selected HMI device.

If you have created a user-defined VB function, for example, the user-defined function is available under the entry "VB functions".

#### Requirement

Object has at least one configurable event.

#### Procedure

Proceed as follows to configure a function list:

1. Open the editor in which the object is located.
2. Select the object.
3. Click "Properties > Events" in the Inspector window. Choose the event for which you want to configure the function list.
4. Mark the "<Add function>" entry in the inspector window in the drop-down list.

5. Select the desired system function or the desired user-defined function from the selection list. You can also enter the name of the system function or the user-defined function.

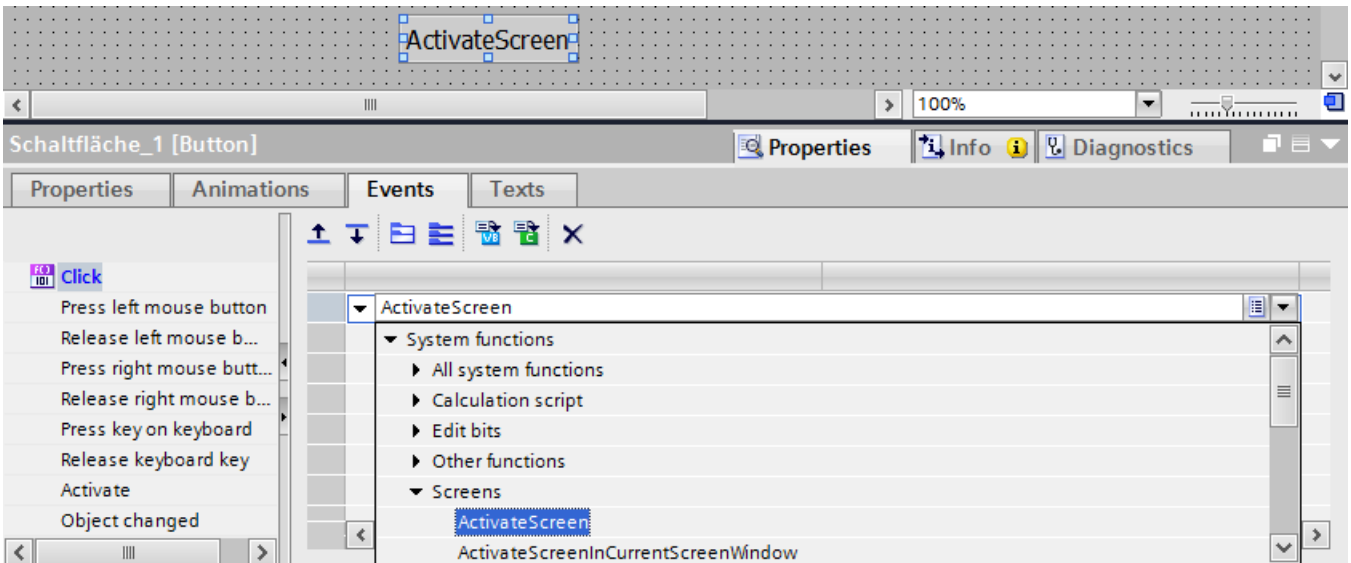

The system function or the customized function is entered in the function list.

6. If the system function or the customized function has parameters, select the appropriate values for the parameters.

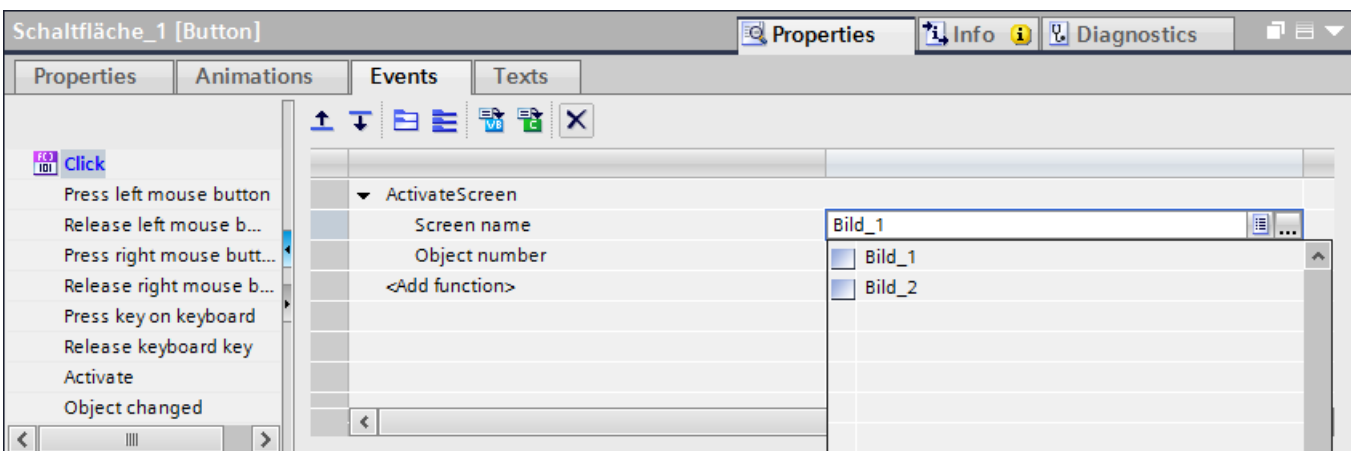

7. If you want to add other system functions or user-defined functions to the function list, repeat steps 4) to 6).

## Result

The function list is configured. In addition, to the configured event, the status of the function list is displayed in the Inspector window. When the configured event occurs in Runtime, the function list is completed from top to bottom.

### 10.8.2.4 Editing a function list

#### Introduction

A function list can be edited as follows:

- Change the order of system functions and user-defined functions.
- Remove system functions or user-defined functions.

#### Requirement

The function list is configured and opened.

#### Changing the order of a system function or a customized function

1. Select the desired system function or customized function in the function list.
2. Then click the appropriate direction arrow in the inspector window until the system function or customized function is in the desired position.

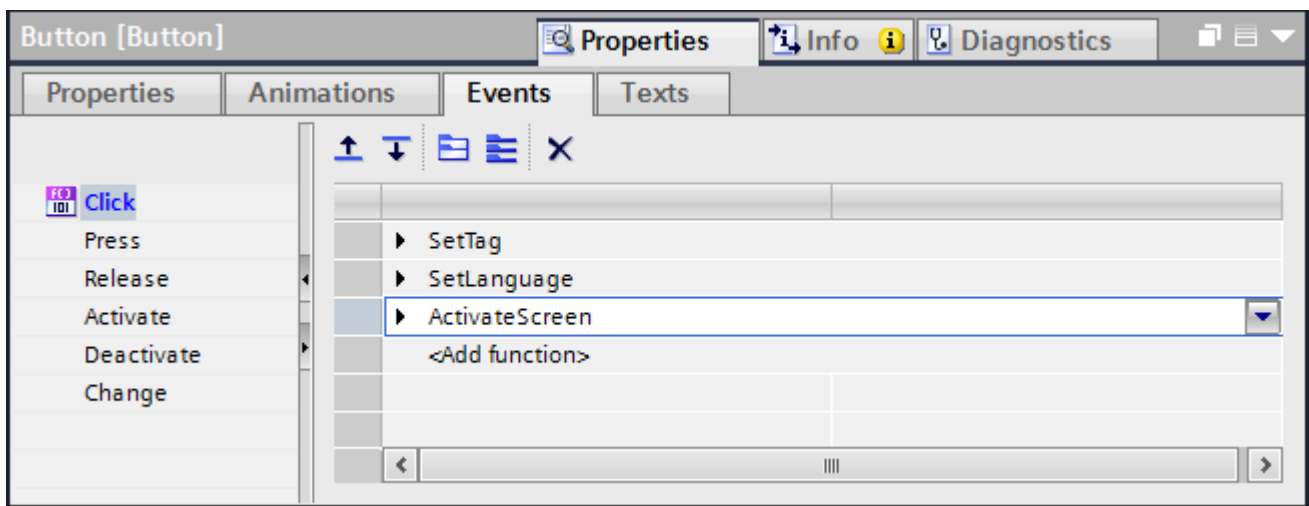

#### Changing the order of several system functions and customized functions

1. Hold down the <Shift> key.
2. Click desired system functions or customized functions one after another with the mouse.
3. Move the selection to the desired position by drag&drop.

#### Removing a system function or customized function

1. Select the desired system function or customized function in the function list.
2. Select "Delete" in the shortcut menu.

## 10.8.3 Working with user-defined VB functions

### 10.8.3.1 "Scripts" editor

#### Introduction

The "Scripts" editor supports you in the creating of user-defined functions with functionalities such as auto-completion and syntax highlighting. You can insert code templates for frequently used instructions with the "Instructions" task card for example.

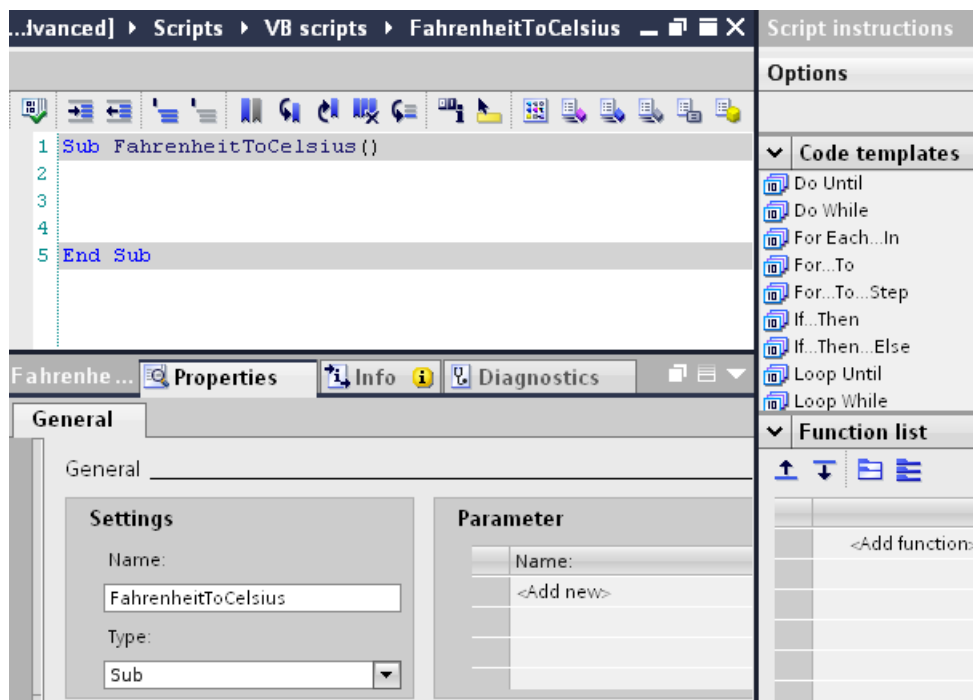

#### Autocompletion and parameter entry

The "Scripts" editor provides you context-dependent programming support with autocompletion parameter entry support.

When you use system functions, the parameters of the function are shown as a tooltip.

#### <Ctrl+J>

The object list can be called context-specifically by using the shortcut <Ctrl+J>. Use the object list to supply values to system functions, methods, and properties: For example, you select

screens, screen objects, tags, or colors. You transfer a selected object from the object list into the code by double-clicking it.

---

**Note**

Tags and screens can also be inserted using a drag-and-drop operation. Use, for example, drag-and-drop to assign values to parameters.

---

### <Ctrl+Space>

With the key combination <Ctrl+Space> you call a list with the following contents:

- Constants and functions of the programming language used in the "Scripts" editor.
- User-defined functions
- System functions

### "Instructions" task card

The "Instructions" task card contains the "Code templates" and "Function list" palettes.

- Code templates  
To insert frequently used instructions, double click the desired instruction in the "Code templates" palette. Replace the space holders with the used expressions.
- Function list  
In the function list you select the system functions and user-defined functions from a drop-down list. Proceed as for configuring a function list. To transfer the function list to the code, click the "Transfer" button. The function list is automatically converted into the correct syntax.

---

**Note**

Not all system functions are available in the "Scripts" editor. For additional information, refer to the reference.

---

### Edit functions

Use the buttons of the toolbar "Advanced Edit" to make the code more readable by means of indentation and the use of comments.

Bookmarks help you keep an overview, even of many lines of code.

Further information regarding each button can be obtained in the accompanying direct help.

### Synchronization of tags and objects

If you change tag names or object names in the project which you use in a user-defined function, the names are adapted automatically in the user-defined function.

If you change the tag name or object name in the function, the tag names or object names are not adapted in the project. An appropriate error message is output when executing the user-defined function.

### Syntax highlighting

Keywords in the "Scripts" editor are highlighted using different colors. Unknown words are underlined with a red wavy line.

The table shows the preset colors for the most important keywords:

Color	Meaning	Example
Blue	Keyword	If, Then
Dark violet	Function	FahrenheitToCelsius
Chocolate	System function	SetTag
Orange	HMI tag	Tag_1
Green	Comment	'This is a comment'

### Adapting display properties

When you have opened a user-defined function, you can customize the display properties in the editor. Select the "Options > Settings" menu command. Click "General > Text editors" in the "Settings" editor. For example, you can change the colors for syntax highlighting or adapt the indents for code in the work area.

### See also

Create customized VB functions (Page 3558)

### 10.8.3.2 Access to HMI tags

#### Introduction

In user-defined VB functions, you have access to HMI tags which you have created in the project. Change or read the tag value with a user-defined VB function in Runtime.

In addition, you can create local tags as counters or buffers in the user-defined VB function. You must declare each tag to avoid errors due to misspelled tags.

#### HMI tags

The user-defined VB function accesses the tag value which is saved in Runtime memory. Next, the tag value will be updated to the set cycle time. The user-defined VB function first accesses the tag values which were read at the previous cycle time.

If the tag name matches the VBS name conventions in the project, you can use the HMI tag directly in the function.

```
'VBS_Example_03
```



```
If BeltDriveOilTemperature > 100 Then [instruction]
```

If the tag name in the project does not match the VBS name conventions, you must reference the HMI tag using the "SmartTags list". In the following example the tag name contains the "&" character that is not permitted in accordance with the VBS name conventions:

```
'VBS_Example_04  
SmartTags("Test&Trial")= 2005
```

## Local tags

You define local tags with the Dim instruction. You can only use local tags within user-defined VB functions. They therefore do not appear in the "HMI Tags" editor. You use a local tag in the user-defined VB function, for example, as a counter in a For instruction.

```
'VBS_Example_05  
Dim intCount  
For intCount = 1 To 10 [instruction] Next
```

## Access to HMI tags with a dynamic name

The user-defined VB function accesses the tag value using the tag name. You can specify the tag name in such a way that the tag name is composed at the runtime of the user-defined function.

If you only call the user-defined VB function in a screen in which the HMI tag is also used elsewhere, for example in an I/O field, you should for performance reasons configure the HMI tag with "Cyclic in operation" acquisition mode.

If the user-defined VB function is accessed and the HMI tag is not being used in the screen currently displayed, configure the HMI tag with "Cyclic continuous" acquisition mode. This ensures that the current value of the tag is always available.

## See also

SmartTags (Page 3910)

### 10.8.3.3 Access to objects

#### Introduction

The objects of the VBS object model with the appropriate properties and methods are available in user-defined VB functions.

The object properties can be read and changed in Runtime.

#### Referencing objects

In customized VB functions you reference the objects by the corresponding list. To identify the object, use its name or the position number within the list.

If you access the properties of an object more often, create an object reference. You can access object properties with and without object reference.

With the following instruction the first object is referenced in the "MainScreen":

```
'VBS_Example_01
Dim objObject
'Change to Screen "MainScreen"
HMIRuntime.BaseScreenName = "MainScreen"
Set objObject = HMIRuntime.Screens(1).ScreenItems(1)
```

With the following instruction an object is referenced by its name and an object property is changed. You must have created the object with this name in the screen.

```
'VBS_Example_02
Dim objCircle
HMIRuntime.BaseScreenName = "MainScreen"
Set objCircle = HMIRuntime.Screens(1).ScreenItems("Circle_01")
objCircle.BackColor = vbGreen
```

### 10.8.3.4 Calling system functions

#### Introduction

You can insert system functions in a user-defined VB function.

This can be done in the following ways:

- With <Ctrl+Space> or with 
- Direct input
- With the "Function list" palette

#### With <Ctrl+Space> or with

Open the list of system functions with <Ctrl+Space> or with  and select the desired system function.

#### Direct input

You enter the system functions directly into the code. You use the English name of the system function. You can find the English name of the system function in the system function reference under "Syntax". The editing language setting is not taken into consideration.

References to objects, e.g. screens, connections and logs are transferred in inverted commas:

## Calling system functions without return value in VBS

```
SetTag "Tag1",64
```

## Calling system functions with return value in VBS

```
InverseLinearScaling "XValue","Tag1", 0, 1
```

### With the "Function list" palette

Select the system functions from a selection list that is sorted by categories in the "Function list" palette. Proceed as for configuring a function list. You will find further information about this under "Configuring a function list".

To transfer the list to the code, click the "Transfer" button. The list is automatically converted into the correct syntax.

### HMI device replacement

The code of a customized function depends on the selected HMI device. If you use system functions in the customized function which are not supported by the selected HMI device, you receive an error message in the output window. See "Auto-Hotspot" for additional information.

#### 10.8.3.5 Calling user-defined VB functions

##### Introduction

You can only insert user-defined VB functions in a user-defined VB function.

This can be done in the following ways:

- With <Ctrl+Space> or with 
- Direct input
- With the "Function list" palette

##### With <Ctrl+Space> or with

Open the list of user-defined VB functions with <Ctrl+Space> or with  and select the desired user-defined VB function.

### Direct input

You enter the user-defined VB function directly into the code. References to objects, e.g. screens, connections and logs are transferred in inverted commas.

```
Function Average(ByVal Var1, ByVal Var2)
  Average = (Var1+Var2)*(1/2)
End Function
```

### Calling user-defined VB functions without return value in VBS

```
Average 4,10
```

### Calling user-defined VB functions with return value in VBS

```
Dim ValueA
ValueA = Average (4,10)
```

If you do not want to evaluate the return value, use the call as for a user-defined VB function without return value.

### With the "Function list" palette

Select the desired user-defined VB function from a selection list in the "Function list" palette. Proceed as for configuring a function list. You will find additional information under "Configuring a function list".

To transfer the list to the code, click the "Transfer" button. The list is automatically converted into the correct syntax.

### 10.8.3.6 Transfer and return of values in VBS

#### Transfer of a value

The following options are available for transferring parameters.

- "Call by Value" - ByVal  
ByVal transfers the parameter value. If you transfer a tag as a parameter, the tag value is transferred to the user-defined function when the user-defined function is executed.
- "Call by Reference" - ByRef  
ByRef transfers the address of the parameter. If you transfer a tag as a parameter, the tag address is transferred to the user-defined function when the user-defined function is executed.  
When user-defined functions and system functions are called in user-defined functions, the parameter is transferred as ByRef.

#### Return of a value

Return values can return the result of a calculation (e.g., average value of two numbers). But a return value can also give information about whether an instruction was executed correctly.

Therefore, the system functions that perform file operations such as "Delete" also have return values.

For a user-defined function to return a value, you must set the "Function" type. You assign the function name to the return value in the user-defined function:

```

1 Function Average( Value1 , Value2 )
2 'Check if Parameters are not numeric:
3 If IsNumeric (Value1) = False Then Value1 = 1
4 If IsNumeric (Value2) = False Then Value2 = 1
5 Average = (Value1+Value2)/2
6
7 End Function

```

To form an average value of two numbers, call the user-defined VB function Average and transfer the result to the HMI tag for example AverageValue.

- In a customized VB function

```
SmartTags("AverageValue") = Average ("4", "10")
```

- In the function list

Average	
Return value	AverageValue
Value1	10
Value2	4

You can output the value of the HMI tag AverageValue in an I/O field.

## See also

Create customized VB functions (Page 3558)

### 10.8.3.7 Create customized VB functions

#### Introduction

When you create a customized VB function, you define the following settings:

- The name with which you call the user-defined VB function.
- The type of user-defined VB function.
- The parameters which are transferred to the user-defined VB function in Runtime.

Use only the following characters for the name:

- "A" to "Z"
- "a" to "z"
- "0" to "9"
- "\_" as a separator

---

#### Note

When you change the parameters or the function type, the change is color marked at the application point, e.g. in the function list.

---

#### Procedure

To create a user-defined VB function, follow these steps:

1. Open "Scripts" in the project tree.
2. Double click "Add new VB function" in the project tree under "VB scripts".

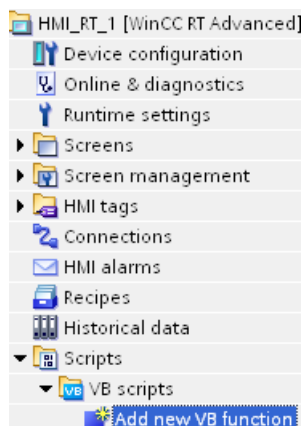

The user-defined VB function is created as a new tab in the work area. The input mask for the configuration settings of the user-defined VB function opens in the Inspector window.

3. Configure the user-defined VB function in the Inspector window "Properties > General > General".
4. Enter a descriptive "Name" for the user-defined VB function.
5. Select the "Type" of the user-defined VB function.
  - "Function" have a return value.
  - "Sub" have no return value.
6. Click "<Add>" in the "Parameters" list to add parameters. Enter the parameter name and specify the parameter type.
 

Further information can be found in "Transfer and return of values in VBS (Page 3557)".

  - "ByVal" transfers the parameter value.
  - "ByRef" transfers the address of the parameter.
7. Enter its code in the work area.
 

You will find further information about this in ""Scripts" Editor" (Page 3550)".

## Result

The user-defined VB function has been created. The type, name, and function parameters are displayed in the title bar.

The start and end are inserted automatically when the user-defined function is created.

If you have protected the user-defined VB functions by a password, it is saved encrypted in the project. For additional information, refer to "Protecting user-defined functions".

The figure below shows a user-defined VB function which converts the temperature from "Fahrenheit" to "Degrees Celsius":

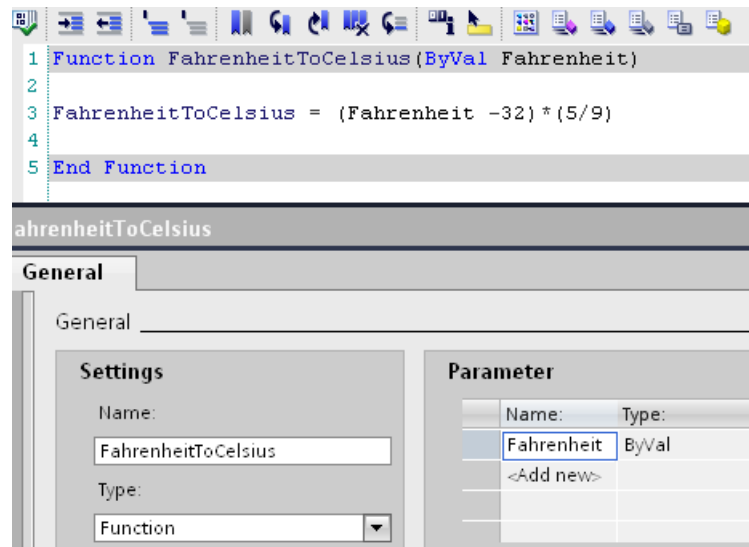

### 10.8.3.8 Testing the syntax of customized functions

#### Introduction

During programming, the code is tested in the background. Syntactical errors are marked with a wavy red line. The customized function is checked for correct syntax and valid object references.

Check the syntax in the "Scripts" editor to identify all the errors in the code and output the appropriate error messages. In this case, error messages generated by the script parser are output.

Use a separate debugger to check customized VB functions for logical programming errors.

#### Error types

The following error types are detected in the syntax test and output in the "output window":

- Unknown string (e.g., not a keyword)
- Assignment of value to a constant
- The name of a local tag created with the Dim instruction is already known, e.g.: as a parameter, object, or component of the object model
- Syntax error

#### Requirements

- Customized function is open.

#### Procedure

Proceed as follows to check the syntax:

1. Click  to start the syntax check.  
The syntax is checked. The result of the syntax check is displayed in the Inspector window under "Info > Compilation." Syntax errors are output with the line number.
2. Correct the errors in the customized function if necessary.

#### Special consideration in the syntax checking of customized functions

Customized functions are not interpreted until in Runtime. When an HMI device is being compiled, the system checks its user-defined functions for correct syntax. However, runtime errors may occur in certain circumstances.

#### See also

Configuring a function list (Page 3547)



### 10.8.3.9 Renaming customized VB functions

#### Renaming a user-defined VB function in the project tree

Proceed as follows to rename a user-defined VB function in the project tree:

1. Select the desired user-defined VB function in the project tree.
2. Select the "Rename" (F2) command in the shortcut menu of the user-defined VB function.
3. Enter a new name for the user-defined VB function.

#### Renaming a user-defined VB function in the Inspector window

Proceed as follows to rename a user-defined VB function in the Inspector window:

1. Open the user-defined VB function in the "Scripts" editor.
2. In the Inspector window, click "Properties > Properties > General".
3. Enter the new function name.

#### Result

The user-defined VB function is renamed. The application points are adapted automatically.

### 10.8.3.10 Executing customized VB functions

#### Introduction

In WinCC you have the following options to execute a customized function:

- Function list
- Customized VB function

#### Calling a customized VB function in a function list

1. Add the user-defined VB function to a function list like a system function. You will find the customized VB functions in the drop-down list under "VB functions". You will find further information in "Configuring a function list (Page 3547)".
2. If the VB function has parameters, supply the parameters with static values or HMI tags.
3. If the VB function has a return value, select an HMI tag. The value to be processed is transferred to the HMI tag.

### Calling a customized VB function in a customized VB function

1. Open the user-defined VB function in which you want to call the user-defined VB function.
2. Call the customized VB function in the syntax of the programming language. You will find further information in "Calling user-defined VB functions (Page 3555)".
3. If the VB function has a return value, assign an expression, e.g. a local tag, to the VB function.

### See also

- Configuring a function list (Page 3547)
- Calling system functions (Page 3554)
- Calling user-defined VB functions (Page 3555)

### 10.8.3.11 Protecting user-defined functions

#### Setting up know-how protection

#### Procedure

To set up know-how protection for user-defined functions, follow these steps:

1. Select the user-defined function without know-how protection that you want to protect.
2. Select the command "Know-how protection" in the "Edit" menu.  
The "Know-how protection" dialog will open.
3. Click "Define".  
The "Define password" dialog box opens.
4. Enter a password in the "New" field.
5. Enter the same password in the "Confirm" field.
6. Confirm your entries with "OK".
7. Close the "Know-how protection" dialog by clicking on "OK".

#### Result

The user-defined function receives know-how protection. User-defined functions with know-how protection are marked with a lock in the project tree. The password entered is valid for all user-defined functions selected.

#### Opening user-defined functions with know-how protection

You can only open multiple user-defined functions with know-how protection at once if they are protected with the same password.

## Procedure

To create a user-defined function with know-how protection, follow these steps:

1. Double-click the user-defined function you want to open.  
The "Access protection" dialog will open.
2. Enter the password for the user-defined function with know-how protection.
3. Confirm your entry with "OK".

## Result

The user-defined function with know-how protection will open provided you have entered the correct password. However, the function will remain know-how protected.

Once you have opened the user-defined function, you can edit it for as long as the user-defined function or TIA portal is open. You must enter the password again the next time you open the user-defined function. If you close the "Access protection" dialog with "Cancel" or "Close", the user-defined function is opened but the code is not displayed. You cannot edit the user-defined function.

## Removing know-how protection

### Procedure

To remove the know-how protection of a user-defined function, follow these steps:

1. Select the user-defined function for which you want to remove know-how protection.

---

#### Note

To remove know-how protection for several user-defined functions at once, all selected user-defined functions must have the same password.

---

2. Select the command "Know-how protection" in the "Edit" menu.  
The "Know-how protection" dialog will open.
3. Deactivate the check box "Hide code (know-how protection)".
4. Enter the password.
5. Confirm your entries with "OK".

## Result

Know-how protection will be disabled for the selected user-defined function.

## Changing a password

### Procedure

To change the password, follow these steps:

1. Select the user-defined function with know-how protection for which you want to change the password.

---

#### Note

To change the password for several user-defined functions at once, all selected user-defined functions must have the same password.

---

2. Select the command "Know-how protection" in the "Edit" menu. The "Know-how protection" dialog will open.
3. Click the "Change" button.
4. Enter the old password in the "Old" field.
5. Enter the new password in the "New" field.
6. Enter the new password again in the "Confirm" field.
7. Confirm your entries with "OK".
8. Close the "Know-how protection" dialog by clicking on "OK".

## 10.8.4 Debugging user-defined VB functions

### 10.8.4.1 Debugging user-defined VB functions

#### Introduction

Debugging allows you to test the user-defined VB functions for logical programming errors in Runtime. For example, you can test whether the proper values were transferred to the tags, and whether cancellation terms are realized correctly.

The following VBScript-capable debuggers have been tested and approved:

- "Microsoft Script Debugger"
- "Microsoft Script Editor": The debugger is included in Microsoft Office XP.

"Microsoft Script Debugger" provides the following functionality:

- Viewing the source code of the function you are debugging
- Checking the step-by-step execution of the functions
- Viewing and editing tags and property values

---

**Note**

**Difference with regard to VBScript for Windows and Windows CE**

The debugger checks the syntax for VBScript for Windows. If the function contains a VBScript function for Windows CE, a corresponding error message is output. Some VBScript functions are different, e.g., CreateObject. You can find a list of these VBScript functions under "VBScript for Windows CE (Page 3880)".

---

## Microsoft Script Debugger

If you want to use the Microsoft Script Debugger for debugging, the English version "scd10en.exe" must be used. The German version "scd10de.exe" may not be installed.

"Microsoft Script Debugger" provides the following functionality:

- Viewing the source code of the function you are debugging
- Checking the step-by-step execution of the functions
- Viewing and editing tags and property values

---

**Note**

For tips and tricks on debugging, common sources of errors, and additional information, refer to the online help for the Microsoft Script Debugger.

---

The Microsoft Script Debugger is located in the Microsoft Download Center under the following URL:

- <http://www.microsoft.com/downloads/Search.aspx?displaylang=en833a6a92-961e-4ce1-9069-528d22605127>

Use the "Search" field to search for "Script Debugger" and select the required download.

## Basic procedure

The debugger is only intended for identifying error locations in the user-defined VB function. For this purpose, for example, you use break points or execute the user-defined VB function step-by-step. For detailed information, refer to the documentation of the debugger you are using. In order to correct errors, you change to the "Scripts" editor in WinCC. After having recompiled and reloaded the script, you test the user-defined VB function once again using the debugger.

---

**Note**

Your code is displayed in the debugger, but is write-protected. You cannot edit the code directly in the debugger; you can only test the required changes.

---

## Error types

The following error types are distinguished when debugging:

- **Logical error**  
A logical error occurs when the event you are expecting does not take place, e.g., because a condition was checked incorrectly. To debug logical errors, you go through the user-defined VB function step by step. This way, you identify the portion of the user-defined VB function that is not working.
- **Runtime error**  
A runtime error is generated if an attempt is made to execute an invalid or faulty instruction, e.g., if a tag is not defined.  
To intercept runtime errors, use the "On Error Resume Next" instruction in the user-defined VB function. With this instruction, the next instruction is executed after a runtime error. You check the error code with the Err object in the next line. To stop the handling of runtime errors in the user-defined VB function again, use the "On Error Goto 0" instruction.  
Example for error handling

```
Sub OnClick(ByVal Item)
'VBS27
  Dim objScreenItem
  '
  'Activation of errorhandling:
  On Error Resume Next
  For Each objScreenItem In ScreenItems
    If "HMIRectangle" = objScreenItem.Type Then
      '
      '=== Property "RoundCornerHeight" only available for RoundedRectangle
      objScreenItem.RoundCornerHeight = objScreenItem.RoundCornerHeight * 2
      If 0 <> Err.Number Then
        HMIRuntime.Trace objScreenItem.Name & ": no RoundedRectangle" & vbCrLf
        '
        'Delete error message
        Err.Clear
      End If
    End If
  Next
  On Error Goto 0 'Deactivation of errorhandling
End Sub
```

## Screen change while debugging

If you change to another screen while debugging, the user-defined VB function of the previous screen stays open but is no longer valid. The debugger could return invalid error messages in this case, as the objects called will no longer exist after the screen change.

## 10.8.4.2 Integrating the Debugger

### Installing a script debugger for WinCC

A VBScript-capable debugger must be installed to search for errors in user-defined VB functions.

The following VBScript-capable debuggers have been tested and released:

- Microsoft Script Editor by Office XP
- Microsoft Script Debugger: The English version "scd10en.exe" must be used. The German version "scd10de.exe" may not be installed.

An installed debugger is started as follows:

- If a runtime error occurs during execution
- Via "Online > Simulate Runtime > With script debugger"

### Microsoft Script Editor

The Microsoft Office XP component "Microsoft Script Editor" contains a Script Debugger. If the default configuration was installed by Microsoft Office Setup, the "Microsoft Script Editor" component is not installed until called the first time ("Installed on First Use"). If you wish to explicitly install these components, you must specify it in the Microsoft Office setup. Select the

component selection menu, click "Web Debugging" component and then select the "Run from My Computer" option.

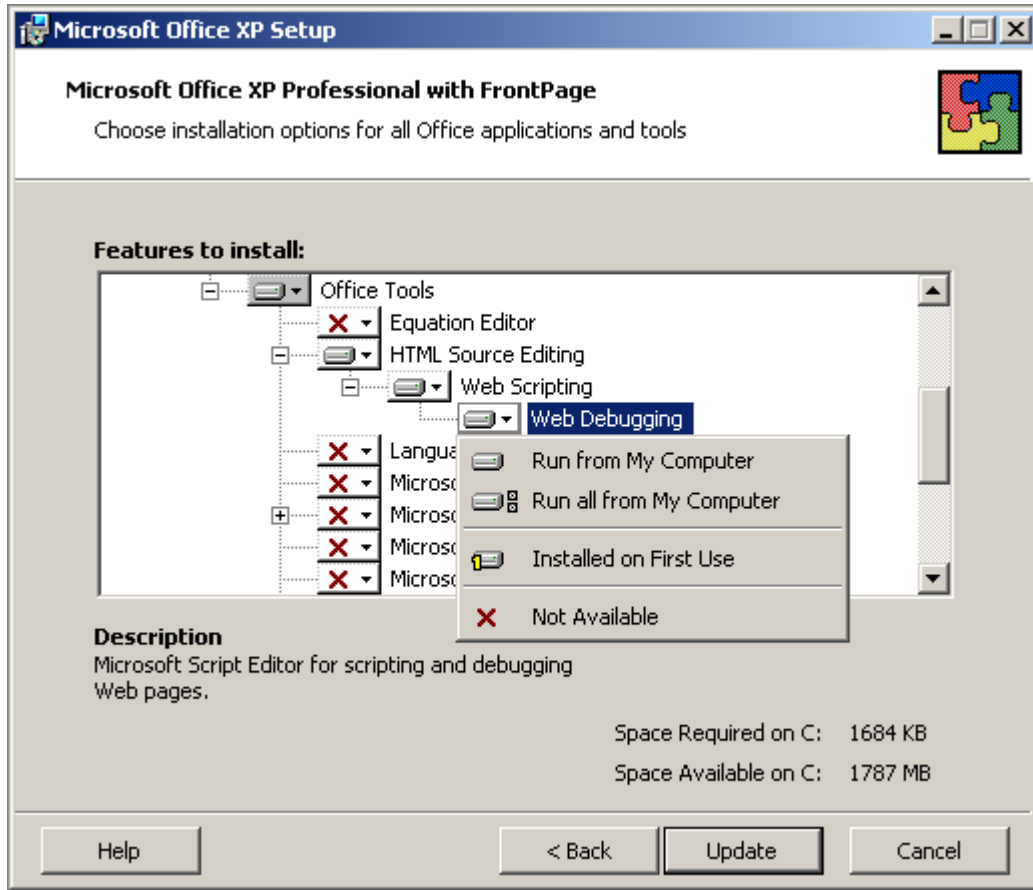

If a project is activated in WinCC via "Online > Simulate Runtime > With script debugger", a dialog containing the list of available script debuggers appears when the first user-defined function is run.

Other installed script debuggers such as "Microsoft Visual Interdev" or "Microsoft Visual Studio .NET" may also appear in the list. Select "Microsoft Script Editor" and confirm your selection with "Yes".



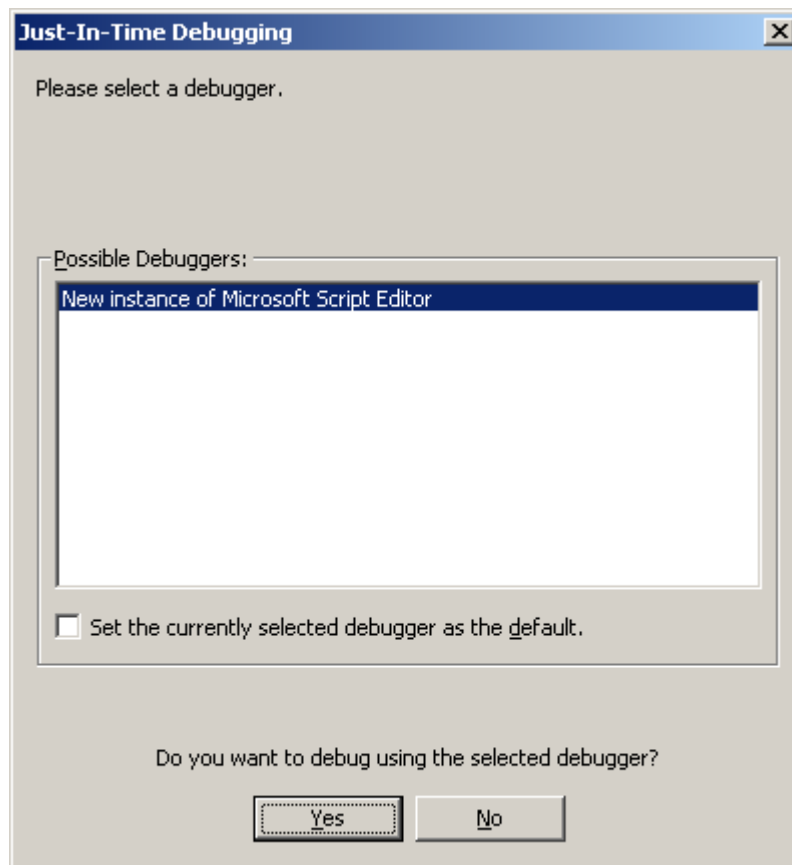

Activate the "Script" program object in the "Step Into Remote Procedure Call" dialog and confirm your selection with "OK".

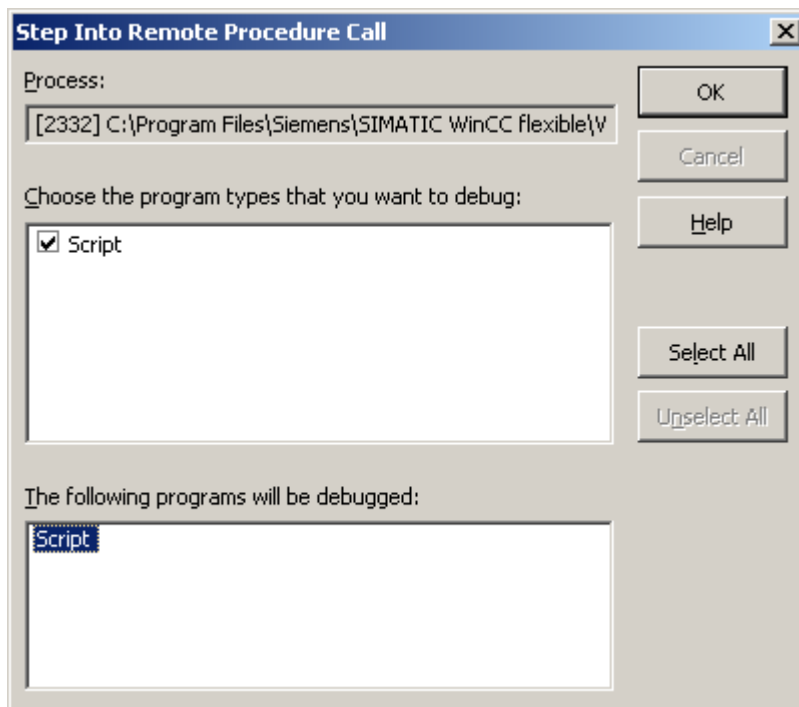

The "Microsoft Script Editor" is launched. The execution pauses at the first line of the first function.

## Microsoft Script Debugger

If a script debugger is not available, download "Microsoft Script Debugger" (scd10en.exe) free of charge from Microsoft ([www.microsoft.com](http://www.microsoft.com)). It will be started automatically in WinCC once it is installed.

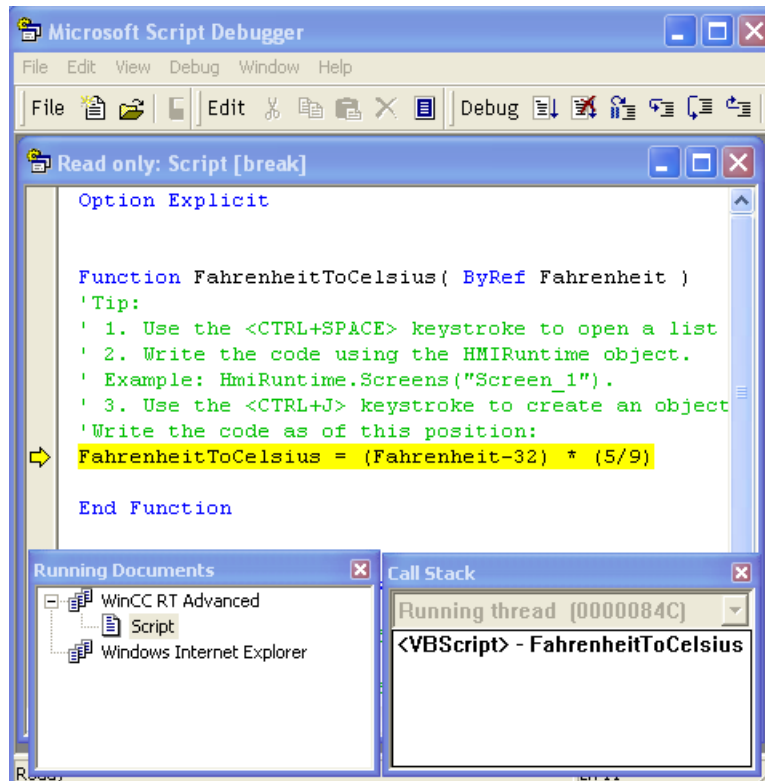

### Note

The "Microsoft Script Debugger" can no longer be called or installed when another VBScript-capable script debugger is available on your computer.

## Script Debugger is not started at the start of Runtime

If you installed a script debugger and the "Start Runtime with Script Debugger" command still fails to start it, make the following settings in the Windows registry to set Microsoft Script Debugger as default Just-In-Time (JIT) Debugger:

- "HKEY\_CLASSES\_ROOT\CLSID\{834128A2-51F4-11D0-8F20-00805F2CD064} (Default)="ScriptDebugSvc Class"  
"AppID"="{A87F84D0-7A74-11D0-B216-080000185165}"
- [HKEY\_CLASSES\_ROOT\CLSID\{834128A2-51F4-11D0-8F20-00805F2CD064}\LocalServer32 (Default)="c:\Program Files\Microsoft Script Debugger\msscdbg.exe"

## 10.8 Working with system functions and Runtime scripting

- [HKEY\_CLASSES\_ROOT\CLSID\{834128A2-51F4-11D0-8F20-00805F2CD064}\ProgID] (Default)="ScriptDebugSvc.ScriptDebugSvc.1"
- [HKEY\_CLASSES\_ROOT\CLSID\{834128A2-51F4-11D0-8F2000805F2CD064}\VersionIndependentProgID] (Default)="ScriptDebugSvc.ScriptDebugSvc"

The "LocalServer32" file path must point to the installation folder of Microsoft Script Debugger. If you have installed Microsoft Script Debugger in a different folder, adapt the path information.

### 10.8.4.3 Starting and stopping the debugger

#### Requirement

- VBScript-capable debugger (e.g., MS Script Debugger) and WinCC Runtime are installed on the configuration PC.
- Project is open.

#### Starting the debugger

To start the debugger, proceed as follows:

1. Select the HMI device and then select the "Online > Simulation > With script debugger" menu command.  
The Runtime software searches for debuggers installed on the configuration PC.
2. If several debuggers are found click on the one required.

Or:

1. Click "Start > Run".
2. Enter the following command: "HmiRtm /ScriptDebug /<ProjectFile>".  
Further information about the project file can be found in "Starting Runtime Advanced and Panels (Page 5616)".

Or:

1. Select the "debug" command in the project file shortcut menu in the Windows Explorer.

#### Result

The debugger is connected automatically with the runtime software.

#### Stopping the debugger

The debugger is not closed automatically when you close the Runtime software. Therefore, close the debugger separately.

## 10.8.5 Runtime behavior in Runtime

### 10.8.5.1 Executing a function list in Runtime

#### Principle

A function list is executed from top to bottom in Runtime. A distinction is made between synchronous and asynchronous execution, so that no waiting periods ensue during execution. The distinction is made by the system by evaluating the different runtimes of the system functions. User-defined functions are always executed synchronously independent of the runtime. If a system function returns an error status, the execution of the function list is cancelled.

#### Synchronous execution

During synchronous execution, the system functions in a function list are executed one after the other. The previous system function must be finished before the next system function can be executed.

#### Asynchronous execution

System functions that perform file operations such as saving and reading have a longer runtime than system functions that, for example, set a tag value.

Therefore, system functions with longer runtimes are executed asynchronously. For example, while a system function is writing a recipe data record to a storage medium, the next system function is already being executed. Due to the parallel execution of system functions, waiting periods at the HMI device are avoided.

### 10.8.5.2 Executing user-defined functions in Runtime

#### Principle

Only one user-defined function at a time is executed in Runtime. If several user-defined functions are waiting to be executed, they are lined up in a queue and executed one after the other.

---

#### Note

A loop in a user-defined function therefore blocks the execution of the other functions in the queue even if the functions were initiated asynchronously.

---

WinCC supports a maximum nesting depth of eight user-defined functions. Note that the nesting depth is not checked.

---

**Note**

If a user-defined function is configured for the "Runtime stop" event, the only system functions that may be used in this user-defined function are those which are available at the "Runtime stop" event.

Ensure that the ending of the Runtime is not interfered with by the execution of the user-defined function.

---

**Note**

**Configuration of user-defined functions**

During configuration make sure that not too many user-defined functions are activated at the same time. Avoid a continuous system load of 100%.

User-defined functions are processed at a lower priority so as not to interfere with the display of values and operability. If system utilization is extreme, the user-defined functions to be executed are therefore first only reserved for execution. The maximum size of the reservation list is dependent on the HMI device and is limited by the maximum permitted number of user-defined functions. For additional information, see the performance features. If more user-defined functions are activated at one time than can be reserved, excess calls are discarded and a system alarm displayed.

---

## HMI device changeover

If you use system functions in a customized function which are not available on the set HMI device, you get a warning. In addition, the corresponding system function in the user-defined function will be underlined with a wavy blue line.

## See also

Runtime Stop (Page 3795)

### 10.8.5.3 Processing sequence for user-defined functions and system functions

 **WARNING**

Adherence to the expected processing sequence for user-defined functions and system functions in Runtime cannot always be guaranteed. This fact may lead to unexpected operating states.

Please note the following description in which the correlations are explained. Instructions for a solution are available under "Remedy".

### Use of user-defined functions for events



It is not always possible to adhere to the processing sequence for user-defined functions and system functions expected in the configuration, for example, when the processing of a user-defined function lasts beyond the trigger time of a subsequent event. In this case, system functions that are configured for the following event may be executed before the system functions that were configured with the user-defined function for the same event.

### Background

User-defined functions are arranged in a low-priority queue. The queue is processed in sequence. If system functions and user-defined functions are configured for an event, all system functions and user-defined functions configured for this event are executed in this queue.

### Example

On a button, you have configured:

	Event	Functions
	Press	User-defined function (1) SetBit(Tag) (2)
	Release	ResetBit(Tag) (3)

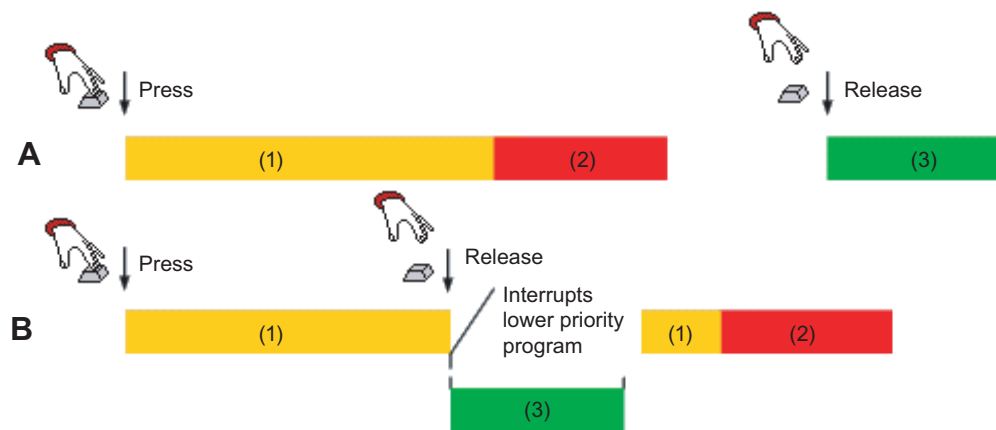

- (1) Execution time of the user-defined function
- (2) Execution time of system function SetBit(Tag)
- (3) Execution time of system function ResetBit(Tag)

A: Expected execution of the user-defined function and system functions in the configuration.

When you press the button, user-defined function (1) and then system function SetBit(Tag) (2) are executed. When you release the key, system function ResetBit(Tag) (3) is then executed.



B: Processing of the user-defined function is not yet complete when you release the key.

When you press the key, the user-defined function (1) is then executed. The execution of the user-defined function (1) is not yet complete and you have already released the key. System function ResetBit(Tag) (3) interrupts the execution of the function. In this case, system function ResetBit(Tag) (3) is executed before system function SetBit(Tag) (2). As a result, the bit remains placed.

System function "SetBitWhileKeyPressed" shows the same behavior, if the system function is configured together with user-defined functions.

## Remedy

The processing sequence of the previous Example A is adhered to, if you additionally configure a user-defined function for the "Release" event. The user-defined function does not require functionality for this purpose.

	Event	Functions
	Press	User-defined function (1) SetBit(Tag) (2)
	Release	User-defined function_2 (3) ResetBit(Tag) (4)

### Note

Make sure that the user-defined function queue does not overflow; otherwise the system function for the following event may not be executed.

An overflow is recognizable by "Overload: Script <name> is rejected" or "Adherence to the expected processing order for user-defined functions and system functions in Runtime cannot always be ensured".

## 10.8.5.4 Making object properties dynamic in Runtime

### Introduction

You can use user-defined functions to access object properties of screen objects as well as tags in Runtime. If you use a user-defined function to change values of object properties, this will not affect the project data.



## Changes to object properties

If you use a user-defined function in Runtime to change an object property of a screen element, this change will only remain effective while the screen is active. If you change to the screen, or reload the screen, the configured object properties are displayed once more.

## Language switching

If you switch the language in Runtime, the foreign language labels are loaded from the project data. If you use a user-defined function to change texts, the texts changed by the user-defined function are overwritten again.

## 10.8.6 Examples

### 10.8.6.1 Example: Converting Fahrenheit into degrees Celsius

#### Scheduled task

In this example, create a user-defined VB function which converts the values of a temperature sensor from Fahrenheit to degrees Celsius. The temperature is displayed in an output field on the HMI device.

#### Settings

For the example you need two HMI tags and a user-defined VB function with the following settings:

HMI tags:

Name	PLC connection	Type
Fahrenheit	Yes	Real
Centigrade	No	Real

User-defined VB function:

Name	Type	Parameters
FahrenheitToCelsius	Function	Fahrenheit

## Procedure

1. Create the two HMI-tags "Fahrenheit" and "Celsius" with the settings named above.

HMI tags			
Name	Data type	Connection	
Fahrenheit	Real	Connection_1	
Celsius	Real	<Internal tag>	

2. Create the user-defined VB function "FahrenheitToCelsius" with the settings given above.

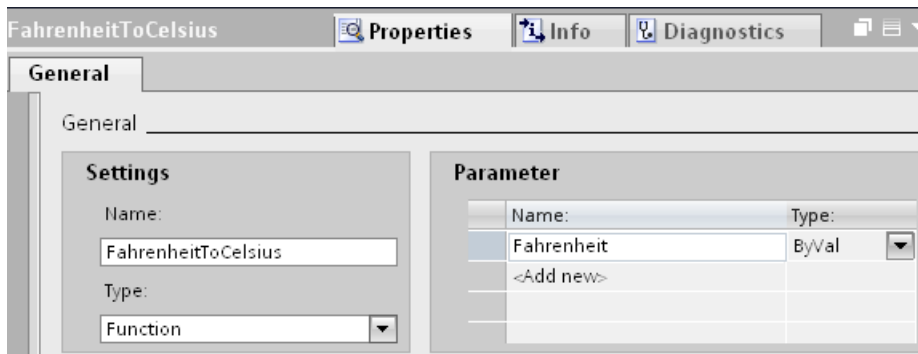

3. Write the following VBS code:

```
FahrenheitToCelsius = (Fahrenheit-32) * (5/9)
```

```

1 Function FahrenheitToCelsius( ByVal Fahrenheit )
2     FahrenheitToCelsius = (Fahrenheit-32) * (5/9)
3 End Function

```

## Interim result

The HMI tags and the VB user-defined function are created.

## Procedure

1. Open the "HMI Tag" editor and click on the "Fahrenheit" tag.
2. Click the "Properties > Events" tab in the Inspector window. Select the "Value change" event.
3. Configure the user-defined VB function "FahrenheitToCelsius" to the "Value change" event.
4. Select the tag "Fahrenheit" for the parameter "Fahrenheit".
5. Select the HMI-tag "Celsius" for the return value "Fahrenheit to Celsius".
6. Configure an output field in a screen and connect it with the tag "Celsius".

## Alternative procedure

Instead of using a user-defined VB function of the "Function" type, you can also use the "Sub" type. In this case, assign the converted value directly to the HMI-tag "Celsius".

```
SmartTags("Celsius") = (Fahrenheit-32) * (5/9)
```

In this case the return value of the user-defined VB function is not applicable.

## Result

When the tag value of "Fahrenheit" changes in Runtime, the user-defined VB function "Fahrenheit to Celsius" is performed. The converted temperature value is returned to the HMI-tag "Celsius" and displayed in the output field.

### 10.8.6.2 Example: Converting inches into meters

#### Scheduled task

In this example you create a user-defined VB function that converts the value of a length measuring system from inches into meters. The length in meters is displayed on the HMI device in an output field.

#### Settings

For the example you need two HMI tags and a user-defined VB function with the following settings:

HMI tags:

Name	PLC connection	Type
VarInch	Yes	Real
VarMeter	No	Real

Customized VB function

Name	Type	Parameters
InchToMeter	Sub	Inch

## Procedure

1. Create the two HMI tags "VarInch" and "VarMeter" with the above settings.

HMI tags		
Name	Data type	Connection
VarMeter	Real	<Internal tag>
VarInch	Real	Connection_1

2. Create the user-defined VB function "InchToMeter" with the settings given above.

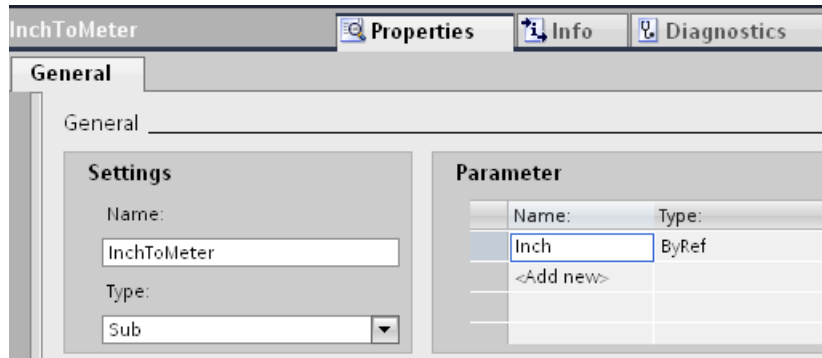

3. Write the following VBS code:

```
VarMeter = Inch*0.0254
```

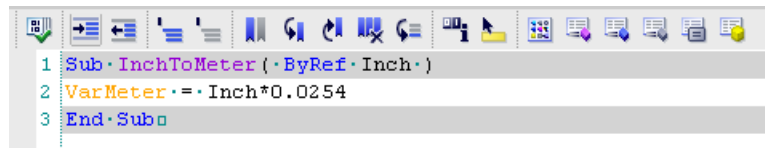

## Interim result

The tags and the user-defined VB function are created.

## Procedure

1. Open the "HMI tags" editor and click the "VarInch" tag.
2. Click "Properties> Events" in the Inspector window. Select the "Value change" event.
3. Configure the user-defined VB function "InchToMeter" to the "Value change" event.
4. Select the "VarInch" HMI tag for the "Inch" parameter.
5. Configure an output field in a screen and connect it with the "VarMeter" HMI tag.

## Result

When the tag value of "VarInch" changes in Runtime, the "InchToMeter" user-defined VB function is performed. The calculated value is written into the "VarMeter" HMI tag and displayed in the output field.

### 10.8.6.3 Example: Changing the operating mode on the HMI device with the current display

#### Scheduled task

In this example, you use the "SetDeviceMode" system function to switch between the "online" and "offline" modes on the HMI device. You also display the current set operating mode on the HMI device.

#### Requirements

A screen has been created.

#### Settings

For this example you require a HMI-tag and a text list with the following settings:

HMI tag:

Name	PLC connection	Type
OperatingMode	No	Bool

Text list:

Name	Contains	Values
ShowOperatingMode	Bit (0/1)	1: Operating mode: "Online" 0: Operating mode: "Offline"

#### Procedure

1. Create the "OperatingMode" HMI-tag indicated above.

HMI tags		
Name	Data type	Connection
OperationMode	Bool	<Internal tag>

2. Create the "ShowOperatingMode" text list indicated above.

Text lists	
Name	Selection
ShowOperatingMode	Bit (0, 1)
<Add new>	

Text list entries	
Value	Text
0	Operating mode: "Offline"
1	Operating mode: "Online"

3. Open the screen and insert a button for which you configure the operating mode change to "online".
4. Click "Properties> Events" in the Inspector window. Select the "Press" event.

5. Configure the "SetDeviceMode" system function for the "Press" event. The system function is found in the selection list under "Settings".
6. For the "Mode" parameter, select the "Online" entry.
7. Configure the system function "SetBit" on the event "Press". The system function is found in the selection list under "Bit processing".
8. Select the HMI-tag "Operating mode" from the selection list for the parameter "Tag".

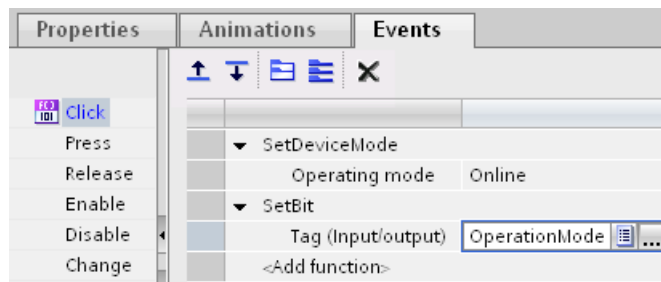

9. Add a button in the process screen for which you configure the operating mode change to "offline".
10. Repeat steps four to seven. For the "Mode" parameter, select the "Offline" entry. Configure the system function "ResetBit" in place of the system function "SetBit."

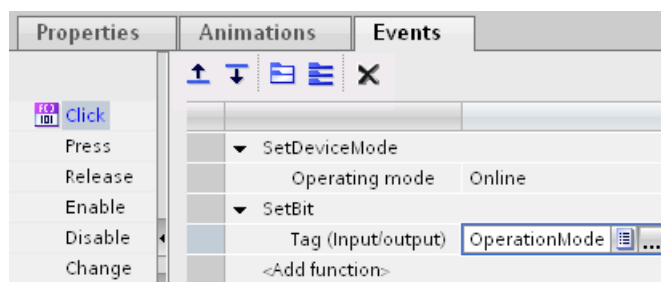

### Interim result

You can toggle the operating mode of the HMI device with the two buttons in Runtime.  
You want to display the current set operating mode in an output field on the HMI device.

## Procedure

1. Create a "Symbolic I/O field" in the process image. Click "Properties > Properties" in the Inspector window.
2. Make the following settings in the "General" group:
  - Select "Output" as the "Mode".
  - Select the text list "Show operating mode" as "Text list".
  - Select "Operating mode" as "Tag".

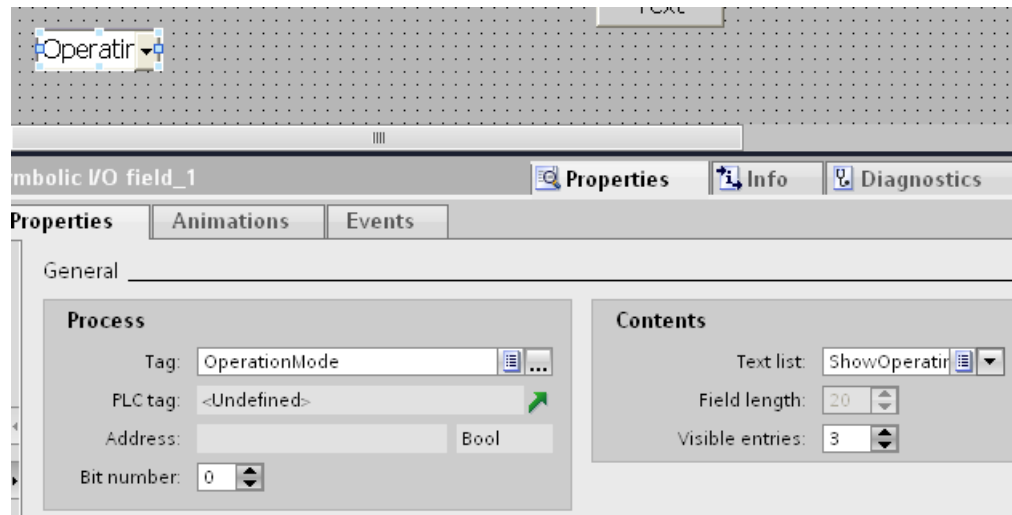

## Result

When you change the operating mode with the buttons, the currently set operating mode on the HMI device is always shown.

## 10.8.7 Reference

### 10.8.7.1 Function list

#### Device dependency

#### System functions for Basic Panels

#### Availability of system functions

The following table shows the availability of the system functions on the Basic Panels.

Technical data subject to change.

Overview

	KP300 Basic PN	KTP400 Basic PN	KTP600 Basic DP	KTP600 Basic PN	KTP1000 Basic DP	KTP1000 Basic PN	TP1500 Basic PN
User-defined functions	No	No	No	No	No	No	No
Logoff (Page 3619)	Yes	Yes	Yes	Yes	Yes	Yes	Yes
ActivateScreen (Page 3620)	Yes	Yes	Yes	Yes	Yes	Yes	Yes
ActivateScreenByNumber (Page 3621)	Yes	Yes	Yes	Yes	Yes	Yes	Yes
ActivateCleanScreen (Page 3622)	No	Yes	Yes	Yes	Yes	Yes	Yes
ActivateSystemDiagnosticsView (Page 3740)	No	No	No	No	No	No	No
ActivatePreviousScreen (Page 3623)	Yes	Yes	Yes	Yes	Yes	Yes	Yes
UpdateTag (Page 3623)	Yes	Yes	Yes	Yes	Yes	Yes	Yes
AdjustContrast (Page 3624)	Yes	Yes	No	Yes <sup>1)</sup>	Yes	Yes	Yes
Logon (Page 3625)	Yes	Yes	Yes	Yes	Yes	Yes	Yes
ArchiveLogFile (Page 3626)	No	No	No	No	No	No	No
LogTag (Page 3627)	No	No	No	No	No	No	No
EditAlarm (Page 3628)	Yes	Yes	Yes	Yes	Yes	Yes	No
ScreenObjectCursorDown (Page 3629)	Yes	Yes	Yes	Yes	Yes	Yes	Yes
ScreenObjectCursorUp (Page 3629)	Yes	Yes	Yes	Yes	Yes	Yes	Yes
ScreenObjectPageDown (Page 3630)	Yes	Yes	Yes	Yes	Yes	Yes	Yes
ScreenObjectPageUp (Page 3631)	Yes	Yes	Yes	Yes	Yes	Yes	Yes
Encode (Page 3631)	No	No	No	No	No	No	No
EncodeEx (Page 3632)	No	No	No	No	No	No	No
DirectKey (Page 3633)	No	No	No	No	No	No	No
DirectKeyScreenNumber (Page 3636)	No	No	No	No	No	No	No
PrintScreen (Page 3637)	No	No	No	No	No	No	No
PrintReport (Page 3637)	No	No	No	No	No	No	No
NotifyUserAction (Page 3638)	No	No	No	No	No	No	No
IncreaseFocusedValue (Page 3639)	Yes	Yes	Yes	Yes	Yes	Yes	No
IncreaseTag (Page 3640)	Yes	Yes	Yes	Yes	Yes	Yes	Yes
ExportDataRecords (Page 3641)	No	No	No	No	No	No	No
ExportDataRecordsWithChecksu m (Page 3643)	No	No	No	No	No	No	No
ExportImportUserAdministration (Page 3646)	No	No	No	No	No	No	No



	KP300 Basic PN	KTP400 Basic PN	KTP600 Basic DP	KTP600 Basic PN	KTP1000 Basic DP	KTP1000 Basic PN	TP1500 Basic PN
GoToHome (Page 3647)	Yes	Yes	Yes	Yes	Yes	Yes	No
GoToEnd (Page 3647)	Yes	Yes	Yes	Yes	Yes	Yes	No
SafelyRemoveHardware (Page 3648)	No	No	No	No	No	No	No
HTMLBrowserStop (Page 3649)	No	No	No	No	No	No	No
HTMLBrowserRefresh (Page 3649)	No	No	No	No	No	No	No
HTMLBrowserForward (Page 3650)	No	No	No	No	No	No	No
HTMLBrowserBack (Page 3650)	No	No	No	No	No	No	No
ImportDataRecords (Page 3651)	No	No	No	No	No	No	No
ImportDataRecordsWithChecksu m (Page 3653)	No	No	No	No	No	No	No
InvertBit (Page 3654)	Yes	Yes	Yes	Yes	Yes	Yes	Yes
InvertBitInTag (Page 3655)	Yes	Yes	Yes	Yes	Yes	Yes	Yes
InvertLinearScaling (Page 3656)	Yes	Yes	Yes	Yes	Yes	Yes	Yes
CalibrateTouchScreen (Page 3658)	No	Yes	Yes	Yes	Yes	Yes	Yes
CopyLog (Page 3659)	No	No	No	No	No	No	No
TrendViewScrollForward (Page 3660)	Yes	Yes	Yes	Yes	Yes	Yes	Yes
TrendViewScrollBack (Page 3660)	Yes	Yes	Yes	Yes	Yes	Yes	Yes
TrendViewExtend (Page 3661)	Yes	Yes	Yes	Yes	Yes	Yes	Yes
TrendViewCompress (Page 3661)	Yes	Yes	Yes	Yes	Yes	Yes	Yes
TrendViewRulerLeft (Page 3662)	Yes	Yes	Yes	Yes	Yes	Yes	Yes
TrendViewRulerRight (Page 3663)	Yes	Yes	Yes	Yes	Yes	Yes	Yes
TrendViewSetRulerMode (Page 3663)	Yes	Yes	Yes	Yes	Yes	Yes	Yes
TrendViewStartStop (Page 3664)	Yes	Yes	Yes	Yes	Yes	Yes	Yes
TrendViewBackToBeginning (Page 3664)	Yes	Yes	Yes	Yes	Yes	Yes	Yes
LoadDataRecord (Page 3665)	No	No	No	No	No	No	No
GetUserName (Page 3666)	Yes	Yes	Yes	Yes	Yes	Yes	Yes
GetDataRecordFromPLC (Page 3667)	No	No	No	No	No	No	No
GetDataRecordName (Page 3668)	No	No	No	No	No	No	No
GetDataRecordTagsFromPLC (Page 3670)	No	No	No	No	No	No	No
GetGroupNumber (Page 3671)	Yes	Yes	Yes	Yes	Yes	Yes	Yes
GetBrightness (Page 3671)	No	No	No	No	No	No	No
GetPassword (Page 3672)	Yes	Yes	Yes	Yes	Yes	Yes	Yes

10.8 Working with system functions and Runtime scripting

	KP300 Basic PN	KTP400 Basic PN	KTP600 Basic DP	KTP600 Basic PN	KTP1000 Basic DP	KTP1000 Basic PN	TP1500 Basic PN
LinearScaling (Page 3673)	Yes	Yes	Yes	Yes	Yes	Yes	Yes
ClearLog (Page 3675)	No	No	No	No	No	No	No
ClearDataRecord (Page 3676)	No	No	No	No	No	No	No
ClearDataRecordMemory (Page 3677)	No	No	No	No	No	No	No
ClearAlarmBuffer (Page 3678)	Yes	Yes	Yes	Yes	Yes	Yes	Yes
ClearAlarmBufferProTool (Page 3679)	Yes	Yes	Yes	Yes	Yes	Yes	Yes
AlarmViewUpdate (Page 3680)	No	No	No	No	No	No	No
AlarmViewEditAlarm (Page 3680)	Yes	Yes	Yes	Yes	Yes	Yes	Yes
AlarmViewAcknowledgeAlarm (Page 3681)	Yes	Yes	Yes	Yes	Yes	Yes	Yes
AlarmViewShowOperatorNotes (Page 3682)	Yes	Yes	Yes	Yes	Yes	Yes	Yes
OpenAllLogs (Page 3683)	No	No	No	No	No	No	No
OpenScreenKeyboard (Page 3684)	No	No	No	No	No	No	No
OpenControlPanelDialog	Yes <sup>2)</sup>	Yes <sup>2)</sup>	Yes <sup>2)</sup>	Yes <sup>2)</sup>	Yes <sup>2)</sup>	Yes <sup>2)</sup>	Yes <sup>2)</sup>
OpenCommandPrompt (Page 3686)	No	No	No	No	No	No	No
OpenInternetExplorer (Page 3687)	No	No	No	No	No	No	No
OpenControlPanel	No	No	No	No	No	No	No
OpenTaskManager (Page 3689)	No	No	No	No	No	No	No
AcknowledgeAlarm (Page 3689)	Yes	Yes	Yes	Yes	Yes	Yes	No
RecipeViewNewDataRecord (Page 3690)	Yes	Yes	Yes	Yes	Yes	Yes	Yes
RecipeViewGetDataRecordFromP LC (Page 3690)	Yes	Yes	Yes	Yes	Yes	Yes	Yes
RecipeViewClearDataRecord (Page 3691)	Yes	Yes	Yes	Yes	Yes	Yes	Yes
RecipeViewMenu (Page 3691)	Yes	Yes	Yes	Yes	Yes	Yes	Yes
RecipeViewOpen (Page 3692)	Yes	Yes	Yes	Yes	Yes	Yes	Yes
RecipeViewSetDataRecordToPLC (Page 3693)	Yes	Yes	Yes	Yes	Yes	Yes	Yes
RecipeViewSaveDataRecord (Page 3693)	Yes	Yes	Yes	Yes	Yes	Yes	Yes
RecipeViewSaveAsDataRecord (Page 3694)	Yes	Yes	Yes	Yes	Yes	Yes	Yes
RecipeViewSynchronizeDataReco rdWithTags (Page 3694)	No	No	No	No	No	No	No
RecipeViewRenameDataRecord (Page 3695)	Yes	Yes	Yes	Yes	Yes	Yes	Yes

	KP300 Basic PN	KTP400 Basic PN	KTP600 Basic DP	KTP600 Basic PN	KTP1000 Basic DP	KTP1000 Basic PN	TP1500 Basic PN
RecipeViewShowOperatorNotes (Page 3696)	Yes	Yes	Yes	Yes	Yes	Yes	Yes
RecipeViewBack (Page 3696)	Yes	Yes	Yes	Yes	Yes	Yes	Yes
ResetBit (Page 3697)	Yes	Yes	Yes	Yes	Yes	Yes	Yes
ResetBitInTag (Page 3698)	Yes	Yes	Yes	Yes	Yes	Yes	Yes
PressButton (Page 3699)	Yes	Yes	Yes	Yes	Yes	Yes	No
ReleaseButton (Page 3700)	Yes	Yes	Yes	Yes	Yes	Yes	No
ShiftAndMask (Page 3701)	Yes	Yes	Yes	Yes	Yes	Yes	Yes
CloseAllLogs (Page 3702)	No	No	No	No	No	No	No
SetDataRecordToPLC (Page 3703)	No	No	No	No	No	No	No
SetDataRecordTagsToPLC (Page 3704)	No	No	No	No	No	No	No
PageDown (Page 3705)	Yes	Yes	Yes	Yes	Yes	Yes	No
PageUp (Page 3706)	Yes	Yes	Yes	Yes	Yes	Yes	No
SendEMail (Page 3706)	No	No	No	No	No	No	No
SetAcousticSignal (Page 3707)	No	No	No	No	No	No	No
SetDisplayMode (Page 3708)	No	No	No	No	No	No	No
SetDeviceMode (Page 3709)	Yes	Yes	Yes	Yes	Yes	Yes	Yes
SetBit (Page 3710)	Yes	Yes	Yes	Yes	Yes	Yes	Yes
SetBitInTag (Page 3711)	Yes	Yes	Yes	Yes	Yes	Yes	Yes
SetBitWhileKeyPressed (Page 3712)	Yes	Yes	Yes	Yes	Yes	Yes	Yes
SetBacklightColor (Page 3713)	Yes	No	No	No	No	No	No
SetBrightness (Page 3714)	No	No	No	No	No	No	No
SetScreenKeyboardMode (Page 3715)	No	No	No	No	No	No	No
SetAlarmReportMode (Page 3717)	No	No	No	No	No	No	No
SetRecipeTags (Page 3718)	No	No	No	No	No	No	No
SetDaylightSavingTime (Page 3719)	No	No	No	No	No	No	No
SetLanguage (Page 3720)	Yes	Yes	Yes	Yes	Yes	Yes	Yes
SetTag (Page 3722)	Yes	Yes	Yes	Yes	Yes	Yes	Yes
SetConnectionMode (Page 3723)	Yes	Yes	Yes	Yes	Yes	Yes	Yes
SetWebAccess (Page 3724)	No	No	No	No	No	No	No
BackupRAMFileSystem (Page 3725)	No	No	No	No	No	No	No
SimulateSystemKey (Page 3726)	Yes	Yes	Yes	Yes	Yes	Yes	No
SimulateTag (Page 3727)	Yes	Yes	Yes	Yes	Yes	Yes	Yes
SmartClientViewRefresh (Page 3728)	No	No	No	No	No	No	No

10.8 Working with system functions and Runtime scripting

	KP300 Basic PN	KTP400 Basic PN	KTP600 Basic DP	KTP600 Basic PN	KTP1000 Basic DP	KTP1000 Basic PN	TP1500 Basic PN
SmartClientViewReadOnlyOff (Page 3728)	No	No	No	No	No	No	No
SmartClientViewReadOnlyOn (Page 3729)	No	No	No	No	No	No	No
SmartClientViewDisconnect (Page 3729)	No	No	No	No	No	No	No
SmartClientViewConnect (Page 3730)	No	No	No	No	No	No	No
SmartClientViewLeave (Page 3731)	No	No	No	No	No	No	No
SaveDataRecord (Page 3731)	No	No	No	No	No	No	No
StartLogging (Page 3732)	No	No	No	No	No	No	No
StartNextLog (Page 3733)	No	No	No	No	No	No	No
StartProgram (Page 3734)	No	No	No	No	No	No	No
StatusForceGetValues (Page 3736)	No	No	No	No	No	No	No
StatusForceSetValues (Page 3736)	No	No	No	No	No	No	No
ControlSmartServer (Page 3737)	No	No	No	No	No	No	No
ControlWebServer (Page 3737)	No	No	No	No	No	No	No
StopLogging (Page 3738)	No	No	No	No	No	No	No
StopRuntime (Page 3739)	Yes	Yes	Yes	Yes	Yes	Yes	Yes
LookupText (Page 3743)	No	No	No	No	No	No	No
ResetTagToHandWheel (Page 3744)	No	No	No	No	No	No	No
SetTagToHandWheel (Page 3745)	No	No	No	No	No	No	No
TraceUserChange (Page 3745)	Yes	Yes	Yes	Yes	Yes	Yes	Yes
DecreaseFocusedValue (Page 3746)	Yes	Yes	Yes	Yes	Yes	Yes	No
DecreaseTag (Page 3746)	Yes	Yes	Yes	Yes	Yes	Yes	Yes
ChangeConnection (Page 3747)	Yes	Yes	Yes	Yes	Yes	Yes	Yes
WinACMPUpdateStartupCharacteristics (Page 3753)	No	No	No	No	No	No	No
WinACMPUpdateKeySwitchSetting (Page 3754)	No	No	No	No	No	No	No
WinACMPUpdateBUSF1LED (Page 3755)	No	No	No	No	No	No	No
WinACMPUpdateBUSF2LED (Page 3756)	No	No	No	No	No	No	No
WinACMPUpdateAverageExecutionTime (Page 3757)	No	No	No	No	No	No	No
WinACMPUpdateAverageCycleTime (Page 3758)	No	No	No	No	No	No	No

	KP300 Basic PN	KTP400 Basic PN	KTP600 Basic DP	KTP600 Basic PN	KTP1000 Basic DP	KTP1000 Basic PN	TP1500 Basic PN
WinACMPUpdateEXTFLED (Page 3759)	No	No	No	No	No	No	No
WinACMPUpdateHMIEnableTime (Page 3760)	No	No	No	No	No	No	No
WinACMPUpdateINTFLED (Page 3760)	No	No	No	No	No	No	No
WinACMPUpdateLastCycleTime (Page 3761)	No	No	No	No	No	No	No
WinACMPUpdateMaximumCycleTime (Page 3762)	No	No	No	No	No	No	No
WinACMPUpdateMinimumCycleTime (Page 3763)	No	No	No	No	No	No	No
WinACMPUpdatePowerLED (Page 3764)	No	No	No	No	No	No	No
WinACMPUpdateSleepTime (Page 3765)	No	No	No	No	No	No	No
WinACMPUpdateRUNLED (Page 3766)	No	No	No	No	No	No	No
WinACMPUpdateSTOPLED (Page 3767)	No	No	No	No	No	No	No
WinACMPArchive (Page 3768)	No	No	No	No	No	No	No
WinACMPGetStartCharacteristics (Page 3768)	No	No	No	No	No	No	No
WinACMPGetVersion (Page 3769)	No	No	No	No	No	No	No
WinACMPClearCycleTimeBuffer (Page 3770)	No	No	No	No	No	No	No
WinACMPSetStartAtBoot (Page 3770)	No	No	No	No	No	No	No
WinACMPSetKeySwitch (Page 3771)	No	No	No	No	No	No	No
WinACMPSetHMIExecutionTime (Page 3771)	No	No	No	No	No	No	No
WinACMPSetRestartMethod (Page 3772)	No	No	No	No	No	No	No
WinACMPSetSleepTime (Page 3772)	No	No	No	No	No	No	No
WinACMPSetStartMode (Page 3773)	No	No	No	No	No	No	No
WinACMPStartHistogram (Page 3773)	No	No	No	No	No	No	No
WinACMPControl (Page 3774)	No	No	No	No	No	No	No
WinACMPStopHistogram (Page 3774)	No	No	No	No	No	No	No
WinACMPRestore (Page 3775)	No	No	No	No	No	No	No

	KP300 Basic PN	KTP400 Basic PN	KTP600 Basic DP	KTP600 Basic PN	KTP1000 Basic DP	KTP1000 Basic PN	TP1500 Basic PN
ShowLogonDialog (Page 3749)	Yes	Yes	Yes	Yes	Yes	Yes	Yes
ShowOperatorNotes (Page 3749)	Yes	Yes	Yes	Yes	Yes	Yes	Yes
ShowAlarmWindow (Page 3750)	Yes	Yes	Yes	Yes	Yes	Yes	Yes
ShowSoftwareVersion (Page 3751)	No	No	No	No	No	No	No
ShowSystemDiagnosticsWindow (Page 3752)	No	No	No	No	No	No	No
ShowSystemAlarm (Page 3752)	No	No	No	No	No	No	No

- 1) For KTP600 Basic mono PN only
- 2) Only for editing the IP settings

### See also

OpenControlPanelDialog (Page 3685)

## System functions for Panels

### Availability of system functions

The following table shows the availability of the system functions on the Panels.

Technical data subject to change.

### Overview

	OP 73	OP 77A	OP 77B	TP 177A	TP 177B OP 177B	TP 277 OP 277
User-defined functions	No	No	No	No	No	Yes
Logoff (Page 3619)	Yes	Yes	Yes	Yes	Yes	Yes
ActivateScreen (Page 3620)	Yes	Yes	Yes	Yes	Yes	Yes
ActivateScreenByNumber (Page 3621)	Yes	Yes	Yes	Yes	Yes	Yes
ActivateCleanScreen (Page 3622)	No	No	No	Yes	Yes <sup>4)</sup>	Yes <sup>2)</sup>
ActivateSystemDiagnosticsView (Page 3740)	No	No	No	No	No	No
ActivatePreviousScreen (Page 3623)	Yes	Yes	Yes	Yes	Yes	Yes
UpdateTag (Page 3623)	Yes	Yes	No	Yes	Yes	Yes
AdjustContrast (Page 3624)	Yes	Yes	Yes	Yes	Yes	No
Logon (Page 3625)	Yes	Yes	Yes	Yes	Yes	Yes

	OP 73	OP 77A	OP 77B	TP 177A	TP 177B OP 177B	TP 277 OP 277
ArchiveLogFile (Page 3626)	No	No	No	No	No	Yes
LogTag (Page 3627)	No	No	No	No	No	Yes
EditAlarm (Page 3628)	Yes	Yes	Yes	No	Yes	Yes <sup>1)</sup>
ScreenObjectCursorDown (Page 3629)	Yes	Yes	Yes	Yes	Yes	Yes
ScreenObjectCursorUp (Page 3629)	Yes	Yes	Yes	Yes	Yes	Yes
ScreenObjectPageDown (Page 3630)	Yes	Yes	Yes	Yes	Yes	Yes
ScreenObjectPageUp (Page 3631)	Yes	Yes	Yes	Yes	Yes	Yes
Encode (Page 3631)	No	No	Yes	Yes	Yes	Yes
EncodeEx (Page 3632)	No	No	Yes	Yes	Yes	Yes
DirectKey (Page 3633)	No	No	No	No	Yes <sup>1)</sup>	Yes <sup>2)</sup>
DirectKeyScreenNumber (Page 3636)	No	No	No	No	Yes <sup>1)</sup>	Yes <sup>2)</sup>
PrintScreen (Page 3637)	No	No	Yes	No	Yes	Yes
PrintReport (Page 3637)	No	No	Yes	No	Yes	Yes
NotifyUserAction (Page 3638)	No	No	No	No	No	Yes
IncreaseFocusedValue (Page 3639)	Yes	Yes	Yes	No	Yes <sup>1)</sup>	Yes <sup>1)</sup>
IncreaseTag (Page 3640)	Yes	Yes	Yes	Yes	Yes	Yes
ExportDataRecords (Page 3641)	No	No	Yes	No	Yes	Yes
ExportDataRecordsWithChecksum (Page 3643)	No	No	No	No	No	Yes
ExportImportUserAdministration (Page 3646)	No	No	Yes	No	Yes	Yes
GoToHome (Page 3647)	Yes	Yes	Yes	No	Yes <sup>1)</sup>	Yes <sup>1)</sup>
GoToEnd (Page 3647)	Yes	Yes	Yes	No	Yes <sup>1)</sup>	Yes <sup>1)</sup>
SafelyRemoveHardware (Page 3648)	No	No	No	No	Yes <sup>5)</sup>	No
HTMLBrowserStop (Page 3649)	No	No	No	No	No	No
HTMLBrowserRefresh (Page 3649)	No	No	No	No	No	No
HTMLBrowserForward (Page 3650)	No	No	No	No	No	No
HTMLBrowserBack (Page 3650)	No	No	No	No	No	No
ImportDataRecords (Page 3651)	No	No	Yes	No	Yes	Yes
ImportDataRecordsWithChecksum (Page 3653)	No	No	No	No	No	Yes
InvertBit (Page 3654)	Yes	Yes	Yes	Yes	Yes	Yes
InvertBitInTag (Page 3655)	Yes	Yes	Yes	Yes	Yes	Yes
InvertLinearScaling (Page 3656)	Yes	Yes	Yes	Yes	Yes	Yes
CalibrateTouchScreen (Page 3658)	No	No	No	Yes	Yes	Yes <sup>2)</sup>
CopyLog (Page 3659)	No	No	No	No	No	Yes

Visualizing processes (Comfort/Advanced)

10.8 Working with system functions and Runtime scripting

	OP 73	OP 77A	OP 77B	TP 177A	TP 177B OP 177B	TP 277 OP 277
TrendViewScrollForward (Page 3660)	No	No	No	Yes	Yes	Yes
TrendViewScrollBack (Page 3660)	No	No	No	Yes	Yes	Yes
TrendViewExtend (Page 3661)	No	No	No	Yes	Yes	Yes
TrendViewCompress (Page 3661)	No	No	No	Yes	Yes	Yes
TrendViewRulerLeft (Page 3662)	No	No	No	Yes	Yes	Yes
TrendViewRulerRight (Page 3663)	No	No	No	Yes	Yes	Yes
TrendViewSetRulerMode (Page 3663)	No	No	No	Yes	Yes	Yes
TrendViewStartStop (Page 3664)	No	No	No	Yes	Yes	Yes
TrendViewBackToBeginning (Page 3664)	No	No	No	Yes	Yes	Yes
LoadDataRecord (Page 3665)	No	No	No	No	Yes	Yes
GetUserName (Page 3666)	Yes	Yes	Yes	Yes	Yes	Yes
GetDataRecordFromPLC (Page 3667)	No	No	No	No	Yes	Yes
GetDataRecordName (Page 3668)	No	No	No	No	Yes	Yes
GetDataRecordTagsFromPLC (Page 3670)	No	No	No	No	Yes	Yes
GetGroupNumber (Page 3671)	Yes	Yes	Yes	Yes	Yes	Yes
GetBrightness (Page 3671)	No	No	No	No	No	No
GetPassword (Page 3672)	Yes	Yes	Yes	Yes	Yes	Yes
LinearScaling (Page 3673)	Yes	Yes	Yes	Yes	Yes	Yes
ClearLog (Page 3675)	No	No	No	No	No	Yes
ClearDataRecord (Page 3676)	No	No	No	No	Yes	Yes
ClearDataRecordMemory (Page 3677)	No	No	No	No	Yes	Yes
ClearAlarmBuffer (Page 3678)	Yes	Yes	Yes	Yes	Yes	Yes
ClearAlarmBufferProTool (Page 3679)	Yes	Yes	Yes	No	Yes	Yes
AlarmViewUpdate (Page 3680)	No	No	Yes	No	Yes	Yes
AlarmViewEditAlarm (Page 3680)	Yes	Yes	Yes	Yes	Yes	Yes
AlarmViewAcknowledgeAlarm (Page 3681)	Yes	Yes	Yes	Yes	Yes	Yes
AlarmViewShowOperatorNotes (Page 3682)	Yes	Yes	Yes	Yes	Yes	Yes
OpenAllLogs (Page 3683)	No	No	No	No	No	Yes
OpenScreenKeyboard (Page 3684)	No	No	No	No	No	Yes
OpenControlPanelDialog	No	No	No	No	No	No
OpenCommandPrompt (Page 3686)	No	No	No	No	No	Yes
OpenInternetExplorer (Page 3687)	No	No	No	No	Yes <sup>3)</sup>	Yes
OpenControlPanel	No	No	No	No	Yes	Yes



	OP 73	OP 77A	OP 77B	TP 177A	TP 177B OP 177B	TP 277 OP 277
OpenTaskManager (Page 3689)	No	No	No	No	No	Yes
AcknowledgeAlarm (Page 3689)	Yes	Yes	Yes	No	Yes <sup>1) 4)</sup>	Yes <sup>1)</sup>
RecipeViewNewDataRecord (Page 3690)	No	Yes	Yes	Yes	Yes	Yes
RecipeViewGetDataRecordFromPL C (Page 3690)	No	Yes	Yes	Yes	Yes	Yes
RecipeViewClearDataRecord (Page 3691)	No	Yes	Yes	Yes	Yes	Yes
RecipeViewMenu (Page 3691)	No	Yes	Yes	Yes	Yes	Yes
RecipeViewOpen (Page 3692)	No	Yes	Yes	Yes	Yes	Yes
RecipeViewSetDataRecordToPLC (Page 3693)	No	Yes	Yes	Yes	Yes	Yes
RecipeViewSaveDataRecord (Page 3693)	No	Yes	Yes	Yes	Yes	Yes
RecipeViewSaveAsDataRecord (Page 3694)	No	Yes	Yes	Yes	Yes	Yes
RecipeViewSynchronizeDataReco rdWithTags (Page 3694)	No	No	No	No	Yes	Yes
RecipeViewRenameDataRecord (Page 3695)	No	Yes	Yes	Yes	Yes	Yes
RecipeViewShowOperatorNotes (Page 3696)	No	Yes	Yes	Yes	Yes	Yes
RecipeViewBack (Page 3696)	No	Yes	Yes	Yes	Yes	Yes
ResetBit (Page 3697)	Yes	Yes	Yes	Yes	Yes	Yes
ResetBitInTag (Page 3698)	Yes	Yes	Yes	Yes	Yes	Yes
PressButton (Page 3699)	Yes	Yes	Yes	No	Yes <sup>3)</sup>	Yes <sup>3)</sup>
ReleaseButton (Page 3700)	Yes	Yes	Yes	No	Yes	Yes <sup>1)</sup>
ShiftAndMask (Page 3701)	Yes	Yes	Yes	Yes	Yes	Yes
CloseAllLogs (Page 3702)	No	No	No	No	No	Yes
SetDataRecordToPLC (Page 3703)	No	No	No	No	Yes	Yes
SetDataRecordTagsToPLC (Page 3704)	No	No	No	No	Yes	Yes
PageDown (Page 3705)	Yes	Yes	Yes	No	Yes <sup>1) 4)</sup>	Yes <sup>1)</sup>
PageUp (Page 3706)	Yes	Yes	Yes	No	yes <sup>1),4)</sup>	Yes <sup>1)</sup>
SendEMail (Page 3706)	Yes	Yes	Yes	No	Yes <sup>3)</sup>	Yes
SetAcousticSignal (Page 3707)	No	No	No	No	No	No
SetDisplayMode (Page 3708)	No	No	No	No	No	No
SetDeviceMode (Page 3709)	Yes	Yes	Yes	Yes	Yes	Yes
SetBit (Page 3710)	Yes	Yes	Yes	Yes	Yes	Yes
SetBitInTag (Page 3711)	Yes	Yes	Yes	Yes	Yes	Yes
SetBitWhileKeyPressed (Page 3712)	Yes	Yes	Yes	Yes	Yes	Yes
SetBacklightColor (Page 3713)	No	No	No	No	No	No

Visualizing processes (Comfort/Advanced)

10.8 Working with system functions and Runtime scripting

	OP 73	OP 77A	OP 77B	TP 177A	TP 177B OP 177B	TP 277 OP 277
SetBrightness (Page 3714)	No	No	No	No	No	No
SetScreenKeyboardMode (Page 3715)	No	No	No	No	No	Yes
SetAlarmReportMode (Page 3717)	No	No	Yes	No	Yes	Yes
SetRecipeTags (Page 3718)	No	No	Yes	No	Yes	Yes
SetDaylightSavingTime (Page 3719)	No	No	No	No	No	No
SetLanguage (Page 3720)	Yes	Yes	Yes	Yes	Yes	Yes
SetTag (Page 3722)	Yes	Yes	Yes	Yes	Yes	Yes
SetConnectionMode (Page 3723)	Yes	Yes	Yes	Yes	Yes	Yes
SetWebAccess (Page 3724)	No	No	No	No	Yes	Yes
BackupRAMFileSystem (Page 3725)	No	No	No	No	No	No
SimulateSystemKey (Page 3726)	No	No	Yes	No	yes <sup>1) 4)</sup>	Yes <sup>1)</sup>
SimulateTag (Page 3727)	Yes	Yes	Yes	Yes	Yes	Yes
SmartClientViewRefresh (Page 3728)	No	No	No	No	Yes <sup>3)</sup>	Yes
SmartClientViewReadOnlyOff (Page 3728)	No	No	No	No	Yes <sup>3)</sup>	Yes
SmartClientViewReadOnlyOn (Page 3729)	No	No	No	No	Yes <sup>3)</sup>	Yes
SmartClientViewDisconnect (Page 3729)	No	No	No	No	Yes <sup>3)</sup>	Yes
SmartClientViewConnect (Page 3730)	No	No	No	No	Yes <sup>3)</sup>	Yes
SmartClientViewLeave (Page 3731)	No	No	No	No	Yes <sup>3)</sup>	Yes
SaveDataRecord (Page 3731)	No	No	No	No	Yes	Yes
StartLogging (Page 3732)	No	No	No	No	No	Yes
StartNextLog (Page 3733)	No	No	No	No	No	Yes
StartProgram (Page 3734)	No	No	No	No	No	Yes
StatusForceGetValues (Page 3736)	No	No	No	No	Yes	Yes
StatusForceSetValues (Page 3736)	No	No	No	No	Yes	Yes
ControlSmartServer (Page 3737)	No	No	No	No	Yes <sup>3)</sup>	Yes
ControlWebServer (Page 3737)	No	No	No	No	Yes <sup>3)</sup>	Yes
StopLogging (Page 3738)	No	No	No	No	No	Yes
StopRuntime (Page 3739)	Yes	Yes	Yes	Yes	Yes	Yes
LookupText (Page 3743)	No	No	Yes	No	Yes	Yes
ResetTagToHandWheel (Page 3744)	No	No	No	No	No	No
SetTagToHandWheel (Page 3745)	No	No	No	No	No	No
TraceUserChange (Page 3745)	Yes	Yes	Yes	Yes	Yes	Yes
DecreaseFocusedValue (Page 3746)	Yes	Yes	Yes	No	yes <sup>1)4)</sup>	Yes <sup>1)</sup>

	OP 73	OP 77A	OP 77B	TP 177A	TP 177B OP 177B	TP 277 OP 277
DecreaseTag (Page 3746)	Yes	Yes	Yes	Yes	Yes	Yes
ChangeConnection (Page 3747)	Yes	Yes	Yes	Yes	Yes	Yes
WinACMPUpdateStartupCharacteristics (Page 3753)	No	No	No	No	No	No
WinACMPUpdateKeySwitchSetting (Page 3754)	No	No	No	No	No	No
WinACMPUpdateBUSF1LED (Page 3755)	No	No	No	No	No	No
WinACMPUpdateBUSF2LED (Page 3756)	No	No	No	No	No	No
WinACMPUpdateAverageExecTime (Page 3757)	No	No	No	No	No	No
WinACMPUpdateAverageCycleTime (Page 3758)	No	No	No	No	No	No
WinACMPUpdateEXTFLED (Page 3759)	No	No	No	No	No	No
WinACMPUpdateHMIEnableTime (Page 3760)	No	No	No	No	No	No
WinACMPUpdateINTFLED (Page 3760)	No	No	No	No	No	No
WinACMPUpdateLastCycleTime (Page 3761)	No	No	No	No	No	No
WinACMPUpdateMaximumCycleTime (Page 3762)	No	No	No	No	No	No
WinACMPUpdateMinimumCycleTime (Page 3763)	No	No	No	No	No	No
WinACMPUpdatePowerLED (Page 3764)	No	No	No	No	No	No
WinACMPUpdateSleepTime (Page 3765)	No	No	No	No	No	No
WinACMPUpdateRUNLED (Page 3766)	No	No	No	No	No	No
WinACMPUpdateSTOPLED (Page 3767)	No	No	No	No	No	No
WinACMPArchive (Page 3768)	No	No	No	No	No	No
WinACMPGetStartCharacteristics (Page 3768)	No	No	No	No	No	No
WinACMPGetVersion (Page 3769)	No	No	No	No	No	No
WinACMPClearCycleTimeBuffer (Page 3770)	No	No	No	No	No	No
WinACMPSetStartAtBoot (Page 3770)	No	No	No	No	No	No
WinACMPSetKeySwitch (Page 3771)	No	No	No	No	No	No
WinACMPSetHMIExecutionTime (Page 3771)	No	No	No	No	No	No

	OP 73	OP 77A	OP 77B	TP 177A	TP 177B OP 177B	TP 277 OP 277
WinACMPSetRestartMethod (Page 3772)	No	No	No	No	No	No
WinACMPSetSleepTime (Page 3772)	No	No	No	No	No	No
WinACMPSetStartMode (Page 3773)	No	No	No	No	No	No
WinACMPStartHistogram (Page 3773)	No	No	No	No	No	No
WinACMPControl (Page 3774)	No	No	No	No	No	No
WinACMPStopHistogram (Page 3774)	No	No	No	No	No	No
WinACMPRestore (Page 3775)	No	No	No	No	No	No
ShowLogonDialog (Page 3749)	Yes	Yes	Yes	Yes	Yes	Yes
ShowOperatorNotes (Page 3749)	Yes	Yes	Yes	Yes	Yes	Yes
ShowAlarmWindow (Page 3750)	Yes	Yes	Yes	Yes	Yes	Yes
ShowSoftwareVersion (Page 3751)	No	No	No	No	No	Yes
ShowSystemDiagnosticsWindow (Page 3752)	No	No	No	No	No	No
ShowSystemAlarm (Page 3752)	No	No	Yes	No	Yes	Yes

- 1) only with keyboard units
- 2) only with touch screen devices
- 3) only with PROFINET Bus (PN devices)
- 4) only with TP 177B
- 5) Only for TP 177B 4" PN/DP

## See also

OpenControlPanelDialog (Page 3685)

## System functions for Multi Panels

### Availability of system functions

The following table shows the availability of the system functions on the Multi Panels.

Technical data subject to change.

## Overview

	MP 177	MP 277	MP 377
User-defined functions	No	Yes	Yes
Logoff (Page 3619)	Yes	Yes	Yes
ActivateScreen (Page 3620)	Yes	Yes	Yes
ActivateScreenByNumber (Page 3621)	Yes	Yes	Yes
ActivateCleanScreen (Page 3622)	Yes <sup>2)</sup>	Yes <sup>2)</sup>	Yes <sup>2)</sup>
ActivateSystemDiagnosticsView (Page 3740)	No	No	No
ActivatePreviousScreen (Page 3623)	Yes	Yes	Yes
UpdateTag (Page 3623)	Yes	Yes	Yes
AdjustContrast (Page 3624)	Yes <sup>2)</sup>	No	No
Logon (Page 3625)	Yes	Yes	Yes
ArchiveLogFile (Page 3626)	No	Yes	Yes
LogTag (Page 3627)	No	Yes	Yes
EditAlarm (Page 3628)	No	Yes <sup>1)</sup>	No
ScreenObjectCursorDown (Page 3629)	Yes	Yes	Yes
ScreenObjectCursorUp (Page 3629)	Yes	Yes	Yes
ScreenObjectPageDown (Page 3630)	Yes	Yes	Yes
ScreenObjectPageUp (Page 3631)	Yes	Yes	Yes
Encode (Page 3631)	Yes	Yes	Yes
EncodeEx (Page 3632)	Yes	Yes	Yes
DirectKey (Page 3633)	Yes <sup>2)</sup>	Yes <sup>2)</sup>	Yes <sup>2)</sup>
DirectKeyScreenNumber (Page 3636)	Yes <sup>2)</sup>	Yes <sup>2)</sup>	Yes <sup>2)</sup>
PrintScreen (Page 3637)	Yes	Yes	Yes
PrintReport (Page 3637)	Yes	Yes	Yes
NotifyUserAction (Page 3638)	No	Yes	Yes
IncreaseFocusedValue (Page 3639)	Yes <sup>1)</sup>	Yes <sup>1)</sup>	Yes <sup>1)</sup>
IncreaseTag (Page 3640)	Yes	Yes	Yes
ExportDataRecords (Page 3641)	Yes	Yes	Yes
ExportDataRecordsWithChecksum (Page 3643)	Yes	Yes	Yes
ExportImportUserAdministration (Page 3646)	Yes	Yes	Yes
GoToHome (Page 3647)	Yes <sup>1)</sup>	Yes <sup>1)</sup>	Yes <sup>1)</sup>
GoToEnd (Page 3647)	Yes <sup>1)</sup>	Yes <sup>1)</sup>	Yes <sup>1)</sup>
SafelyRemoveHardware (Page 3648)	No	Yes	Yes
HTMLBrowserStop (Page 3649)	No	No	No
HTMLBrowserRefresh (Page 3649)	No	No	No
HTMLBrowserForward (Page 3650)	No	No	No
HTMLBrowserBack (Page 3650)	No	No	No

Visualizing processes (Comfort/Advanced)

10.8 Working with system functions and Runtime scripting

	MP 177	MP 277	MP 377
ImportDataRecords (Page 3651)	Yes	Yes	Yes
ImportDataRecordsWithChecksum (Page 3653)	Yes	Yes	Yes
InvertBit (Page 3654)	Yes	Yes	Yes
InvertBitInTag (Page 3655)	Yes	Yes	Yes
InvertLinearScaling (Page 3656)	Yes	Yes	Yes
CalibrateTouchScreen (Page 3658)	Yes <sup>2)</sup>	Yes <sup>2)</sup>	Yes <sup>2)</sup>
CopyLog (Page 3659)	No	Yes	Yes
TrendViewScrollForward (Page 3660)	Yes	Yes	Yes
TrendViewScrollBack (Page 3660)	Yes	Yes	Yes
TrendViewExtend (Page 3661)	Yes	Yes	Yes
TrendViewCompress (Page 3661)	Yes	Yes	Yes
TrendViewRulerLeft (Page 3662)	Yes	Yes	Yes
TrendViewRulerRight (Page 3663)	Yes	Yes	Yes
TrendViewSetRulerMode (Page 3663)	Yes	Yes	Yes
TrendViewStartStop (Page 3664)	Yes	Yes	Yes
TrendViewBackToBeginning (Page 3664)	Yes	Yes	Yes
LoadDataRecord (Page 3665)	Yes	Yes	Yes
GetUserName (Page 3666)	Yes	Yes	Yes
GetDataRecordFromPLC (Page 3667)	Yes	Yes	Yes
GetDataRecordName (Page 3668)	Yes	Yes	Yes
GetDataRecordTagsFromPLC (Page 3670)	Yes	Yes	Yes
GetGroupNumber (Page 3671)	Yes	Yes	Yes
GetBrightness (Page 3671)	No	No	No
GetPassword (Page 3672)	Yes	Yes	Yes
LinearScaling (Page 3673)	Yes	Yes	Yes
ClearLog (Page 3675)	No	Yes	Yes
ClearDataRecord (Page 3676)	Yes	Yes	Yes
ClearDataRecordMemory (Page 3677)	Yes	Yes	Yes
ClearAlarmBuffer (Page 3678)	Yes	Yes	Yes
ClearAlarmBufferProTool (Page 3679)	Yes	Yes	Yes
AlarmViewUpdate (Page 3680)	Yes	Yes	Yes
AlarmViewEditAlarm (Page 3680)	Yes	Yes	Yes
AlarmViewAcknowledgeAlarm (Page 3681)	Yes	Yes	Yes
AlarmViewShowOperatorNotes (Page 3682)	Yes	Yes	Yes
OpenAllLogs (Page 3683)	No	Yes	Yes
OpenScreenKeyboard (Page 3684)	No	Yes	Yes
OpenControlPanelDialog	No	No	No

	MP 177	MP 277	MP 377
OpenCommandPrompt (Page 3686)	No	Yes	Yes
OpenInternetExplorer (Page 3687)	No	Yes	Yes
OpenControlPanel	Yes	Yes	Yes
OpenTaskManager (Page 3689)	No	Yes	Yes
AcknowledgeAlarm (Page 3689)	Yes <sup>1)</sup>	Yes <sup>1)</sup>	Yes <sup>1)</sup>
RecipeViewNewDataRecord (Page 3690)	Yes	Yes	Yes
RecipeViewGetDataRecordFromPLC (Page 3690)	Yes	Yes	Yes
RecipeViewClearDataRecord (Page 3691)	Yes	Yes	Yes
RecipeViewMenu (Page 3691)	Yes	Yes	Yes
RecipeViewOpen (Page 3692)	Yes	Yes	Yes
RecipeViewSetDataRecordToPLC (Page 3693)	Yes	Yes	Yes
RecipeViewSaveDataRecord (Page 3693)	Yes	Yes	Yes
RecipeViewSaveAsDataRecord (Page 3694)	Yes	Yes	Yes
RecipeViewSynchronizeDataRecordWithTags (Page 3694)	Yes	Yes	Yes
RecipeViewRenameDataRecord (Page 3695)	Yes	Yes	Yes
RecipeViewShowOperatorNotes (Page 3696)	Yes	Yes	Yes
RecipeViewBack (Page 3696)	Yes	Yes	Yes
ResetBit (Page 3697)	Yes	Yes	Yes
ResetBitInTag (Page 3698)	Yes	Yes	Yes
PressButton (Page 3699)	Yes	Yes	Yes <sup>1)</sup>
ReleaseButton (Page 3700)	Yes <sup>1)</sup>	Yes <sup>1)</sup>	Yes <sup>1)</sup>
ShiftAndMask (Page 3701)	Yes	Yes	Yes
CloseAllLogs (Page 3702)	No	Yes	Yes
SetDataRecordToPLC (Page 3703)	Yes	Yes	Yes
SetDataRecordTagsToPLC (Page 3704)	Yes	Yes	Yes
PageDown (Page 3705)	Yes <sup>1)</sup>	Yes <sup>1)</sup>	Yes <sup>1)</sup>
PageUp (Page 3706)	Yes <sup>1)</sup>	Yes <sup>1)</sup>	Yes <sup>1)</sup>
SendEMail (Page 3706)	Yes	Yes	Yes
SetAcousticSignal (Page 3707)	No	Yes <sup>2)</sup>	Yes <sup>2)</sup>
SetDisplayMode (Page 3708)	No	No	No
SetDeviceMode (Page 3709)	Yes	Yes	Yes
SetBit (Page 3710)	Yes	Yes	Yes
SetBitInTag (Page 3711)	Yes	Yes	Yes
SetBitWhileKeyPressed (Page 3712)	Yes	Yes <sup>1)</sup>	Yes <sup>1)</sup>

Visualizing processes (Comfort/Advanced)

10.8 Working with system functions and Runtime scripting

	MP 177	MP 277	MP 377
SetBacklightColor (Page 3713)	No	No	No
SetBrightness (Page 3714)	No	No	No
SetScreenKeyboardMode (Page 3715)	No	Yes	Yes
SetAlarmReportMode (Page 3717)	Yes	Yes	Yes
SetRecipeTags (Page 3718)	Yes	Yes	Yes
SetDaylightSavingTime (Page 3719)	No	Yes	Yes
SetLanguage (Page 3720)	Yes	Yes	Yes
SetAndGetBrightness (Page 3721)	No	No	Yes <sup>3)</sup>
SetTag (Page 3722)	Yes	Yes	Yes
SetConnectionMode (Page 3723)	Yes	Yes	Yes
SetWebAccess (Page 3724)	Yes	Yes	Yes
BackupRAMFileSystem (Page 3725)	No	Yes	Yes
SimulateSystemKey (Page 3726)	No	Yes <sup>1)</sup>	Yes <sup>1)</sup>
SimulateTag (Page 3727)	Yes	Yes	Yes
SmartClientViewRefresh (Page 3728)	Yes	Yes	Yes
SmartClientViewReadOnlyOff (Page 3728)	Yes	Yes	Yes
SmartClientViewReadOnlyOn (Page 3729)	Yes	Yes	Yes
SmartClientViewDisconnect (Page 3729)	Yes	Yes	Yes
SmartClientViewConnect (Page 3730)	Yes	Yes	Yes
SmartClientViewLeave (Page 3731)	Yes	Yes	Yes
SaveDataRecord (Page 3731)	Yes	Yes	Yes
StartLogging (Page 3732)	No	Yes	Yes
StartNextLog (Page 3733)	No	Yes	Yes
StartProgram (Page 3734)	Yes	Yes	Yes
StatusForceGetValues (Page 3736)	Yes	Yes	Yes
StatusForceSetValues (Page 3736)	Yes	Yes	Yes
ControlSmartServer (Page 3737)	Yes	Yes	Yes
ControlWebServer (Page 3737)	Yes	Yes	Yes
StopLogging (Page 3738)	No	Yes	Yes
StopRuntime (Page 3739)	Yes	Yes	Yes
LookupText (Page 3743)	Yes	Yes	Yes
ResetTagToHandWheel (Page 3744)	No	No	No
SetTagToHandWheel (Page 3745)	No	No	No
TraceUserChange (Page 3745)	Yes	Yes	Yes
DecreaseFocusedValue (Page 3746)	Yes <sup>1)</sup>	Yes <sup>1)</sup>	Yes <sup>1)</sup>
DecreaseTag (Page 3746)	Yes	Yes	Yes
ChangeConnection (Page 3747)	Yes	Yes	Yes
WinACMPUpdateStartupCharacteristics (Page 3753)	Yes	Yes	Yes



	MP 177	MP 277	MP 377
WinACMPUpdateKeySwitchSetting (Page 3754)	Yes	Yes	Yes
WinACMPUpdateBUSF1LED (Page 3755)	Yes	Yes	Yes
WinACMPUpdateBUSF2LED (Page 3756)	Yes	Yes	Yes
WinACMPUpdateAverageExecTime (Page 3757)	Yes	Yes	Yes
WinACMPUpdateAverageCycleTime (Page 3758)	Yes	Yes	Yes
WinACMPUpdateEXTFLED (Page 3759)	Yes	Yes	Yes
WinACMPUpdateHMIEnableTime (Page 3760)	Yes	Yes	Yes
WinACMPUpdateINTFLED (Page 3760)	Yes	Yes	Yes
WinACMPUpdateLastCycleTime (Page 3761)	Yes	Yes	Yes
WinACMPUpdateMaximumCycleTime (Page 3762)	Yes	Yes	Yes
WinACMPUpdateMinimumCycleTime (Page 3763)	Yes	Yes	Yes
WinACMPUpdatePowerLED (Page 3764)	Yes	Yes	Yes
WinACMPUpdateSleepTime (Page 3765)	Yes	Yes	Yes
WinACMPUpdateRUNLED (Page 3766)	Yes	Yes	Yes
WinACMPUpdateSTOPLED (Page 3767)	Yes	Yes	Yes
WinACMPArchive (Page 3768)	Yes	Yes	Yes
WinACMPGetStartCharacteristics (Page 3768)	Yes	Yes	Yes
WinACMPGetVersion (Page 3769)	Yes	Yes	Yes
WinACMPClearCycleTimeBuffer (Page 3770)	Yes	Yes	Yes
WinACMPSetStartAtBoot (Page 3770)	Yes	Yes	Yes
WinACMPSetKeySwitch (Page 3771)	Yes	Yes	Yes
WinACMPSetHMIExecutionTime (Page 3771)	Yes	Yes	Yes
WinACMPSetRestartMethod (Page 3772)	Yes	Yes	Yes
WinACMPSetSleepTime (Page 3772)	Yes	Yes	Yes
WinACMPSetStartMode (Page 3773)	Yes	Yes	Yes
WinACMPStartHistogram (Page 3773)	Yes	Yes	Yes
WinACMPControl (Page 3774)	Yes	Yes	Yes

	MP 177	MP 277	MP 377
WinACMPStopHistogram (Page 3774)	Yes	Yes	Yes
WinACMPRestore (Page 3775)	Yes	Yes	Yes
ShowLogonDialog (Page 3749)	Yes	Yes	Yes
ShowOperatorNotes (Page 3749)	Yes	Yes	Yes
ShowAlarmWindow (Page 3750)	Yes	Yes	Yes
ShowSoftwareVersion (Page 3751)	No	Yes	Yes
ShowSystemDiagnosticsWindow (Page 3752)	No	No	No
ShowSystemAlarm (Page 3752)	Yes	Yes	Yes

- 1) only with keyboard units
- 2) only with touch screen devices
- 3) only with MP 377 Touch daylight readable

### See also

OpenControlPanelDialog (Page 3685)

## System functions for Comfort Panels

### Availability of system functions

The following table shows the availability of the system functions on the Comfort Panels.

Technical data subject to change.

### Overview

	KTP400 KP400	TP700 TP900 TP1200 TP1500 TP1900 TP2200	KP700 KP900 KP1200 KP1500
User-defined functions	Yes	Yes	Yes
Logoff (Page 3619)	Yes	Yes	Yes
ActivateScreen (Page 3620)	Yes	Yes	Yes
ActivateScreenByNumber (Page 3621)	Yes	Yes	Yes
ActivateCleanScreen (Page 3622)	Yes <sup>1)</sup>	Yes	No
ActivateSystemDiagnosticsView (Page 3740)	Yes	Yes	Yes
ActivatePreviousScreen (Page 3623)	Yes	Yes	Yes

	KTP400 KP400	TP700 TP900 TP1200 TP1500 TP1900 TP2200	KP700 KP900 KP1200 KP1500
UpdateTag (Page 3623)	Yes	Yes	Yes
AdjustContrast (Page 3624)	No	No	No
Logon (Page 3625)	Yes	Yes	Yes
ArchiveLogFile (Page 3626)	Yes	Yes	Yes
LogTag (Page 3627)	Yes	Yes	Yes
EditAlarm (Page 3628)	Yes	No	Yes
ScreenObjectCursorDown (Page 3629)	Yes	Yes	Yes
ScreenObjectCursorUp (Page 3629)	Yes	Yes	Yes
ScreenObjectPageDown (Page 3630)	Yes	Yes	Yes
ScreenObjectPageUp (Page 3631)	Yes	Yes	Yes
Encode (Page 3631)	Yes	Yes	Yes
EncodeEx (Page 3632)	Yes	Yes	Yes
DirectKey (Page 3633)	Yes <sup>1)</sup>	Yes	No
DirectKeyScreenNumber (Page 3636)	Yes <sup>1)</sup>	Yes	No
PrintScreen (Page 3637)	Yes	Yes	Yes
PrintReport (Page 3637)	Yes	Yes	Yes
NotifyUserAction (Page 3638)	Yes	Yes	Yes
IncreaseFocusedValue (Page 3639)	Yes	No	Yes
IncreaseTag (Page 3640)	Yes	Yes	Yes
ExportDataRecords (Page 3641)	Yes	Yes	Yes
ExportDataRecordsWithChecksum (Page 3643)	Yes	Yes	Yes
ExportImportUserAdministration (Page 3646)	Yes	Yes	Yes
GoToHome (Page 3647)	Yes	No	Yes
GoToEnd (Page 3647)	Yes	No	Yes
SafelyRemoveHardware (Page 3648)	Yes	Yes	Yes
HTMLBrowserStop (Page 3649)	No	No	No
HTMLBrowserRefresh (Page 3649)	No	No	No
HTMLBrowserForward (Page 3650)	No	No	No
HTMLBrowserBack (Page 3650)	No	No	No
ImportDataRecords (Page 3651)	Yes	Yes	Yes
ImportDataRecordsWithChecksum (Page 3653)	Yes	Yes	Yes
InvertBit (Page 3654)	Yes	Yes	Yes
InvertBitInTag (Page 3655)	Yes	Yes	Yes
InvertLinearScaling (Page 3656)	Yes	Yes	Yes

Visualizing processes (Comfort/Advanced)

10.8 Working with system functions and Runtime scripting

	KTP400 KP400	TP700 TP900 TP1200 TP1500 TP1900 TP2200	KP700 KP900 KP1200 KP1500
CalibrateTouchScreen (Page 3658)	Yes <sup>1)</sup>	Yes	No
CopyLog (Page 3659)	Yes	Yes	Yes
TrendViewScrollForward (Page 3660)	Yes	Yes	Yes
TrendViewScrollBack (Page 3660)	Yes	Yes	Yes
TrendViewExtend (Page 3661)	Yes	Yes	Yes
TrendViewCompress (Page 3661)	Yes	Yes	Yes
TrendViewRulerLeft (Page 3662)	Yes	Yes	Yes
TrendViewRulerRight (Page 3663)	Yes	Yes	Yes
TrendViewSetRulerMode (Page 3663)	Yes	Yes	Yes
TrendViewStartStop (Page 3664)	Yes	Yes	Yes
TrendViewBackToBeginning (Page 3664)	Yes	Yes	Yes
LoadDataRecord (Page 3665)	Yes	Yes	Yes
GetUserName (Page 3666)	Yes	Yes	Yes
GetDataRecordFromPLC (Page 3667)	Yes	Yes	Yes
GetDataRecordName (Page 3668)	Yes	Yes	Yes
GetDataRecordTagsFromPLC (Page 3670)	Yes	Yes	Yes
GetGroupNumber (Page 3671)	Yes	Yes	Yes
GetBrightness (Page 3671)	Yes	Yes	Yes
GetPassword (Page 3672)	Yes	Yes	Yes
LinearScaling (Page 3673)	Yes	Yes	Yes
ClearLog (Page 3675)	Yes	Yes	Yes
ClearDataRecord (Page 3676)	Yes	Yes	Yes
ClearDataRecordMemory (Page 3677)	Yes	Yes	Yes
ClearAlarmBuffer (Page 3678)	Yes	Yes	Yes
ClearAlarmBufferProTool (Page 3679)	Yes	Yes	Yes
AlarmViewUpdate (Page 3680)	Yes	Yes	Yes
AlarmViewEditAlarm (Page 3680)	Yes	Yes	Yes
AlarmViewAcknowledgeAlarm (Page 3681)	Yes	Yes	Yes
AlarmViewShowOperatorNotes (Page 3682)	Yes	Yes	Yes
OpenAllLogs (Page 3683)	Yes	Yes	Yes
OpenScreenKeyboard (Page 3684)	Yes	Yes	Yes

	KTP400 KP400	TP700 TP900 TP1200 TP1500 TP1900 TP2200	KP700 KP900 KP1200 KP1500
OpenControlPanelDialog	Yes	Yes	Yes
OpenCommandPrompt (Page 3686)	Yes	Yes	Yes
OpenInternetExplorer (Page 3687)	Yes	Yes	Yes
OpenControlPanel	Yes	Yes	Yes
OpenTaskManager (Page 3689)	Yes	Yes	Yes
AcknowledgeAlarm (Page 3689)	Yes	No	Yes
RecipeViewNewDataRecord (Page 3690)	Yes	Yes	Yes
RecipeViewGetDataRecordFromPLC (Page 3690)	Yes	Yes	Yes
RecipeViewClearDataRecord (Page 3691)	Yes	Yes	Yes
RecipeViewMenu (Page 3691)	Yes	Yes	Yes
RecipeViewOpen (Page 3692)	Yes	Yes	Yes
RecipeViewSetDataRecordToPLC (Page 3693)	Yes	Yes	Yes
RecipeViewSaveDataRecord (Page 3693)	Yes	Yes	Yes
RecipeViewSaveAsDataRecord (Page 3694)	Yes	Yes	Yes
RecipeViewSynchronizeDataRecord WithTags (Page 3694)	Yes	Yes	Yes
RecipeViewRenameDataRecord (Page 3695)	Yes	Yes	Yes
RecipeViewShowOperatorNotes (Page 3696)	Yes	Yes	Yes
RecipeViewBack (Page 3696)	Yes	Yes	Yes
ResetBit (Page 3697)	Yes	Yes	Yes
ResetBitInTag (Page 3698)	Yes	Yes	Yes
PressButton (Page 3699)	Yes	Yes	Yes
ReleaseButton (Page 3700)	Yes	Yes	Yes
ShiftAndMask (Page 3701)	Yes	Yes	Yes
CloseAllLogs (Page 3702)	Yes	Yes	Yes
SetDataRecordToPLC (Page 3703)	Yes	Yes	Yes
SetDataRecordTagsToPLC (Page 3704)	Yes	Yes	Yes
PageDown (Page 3705)	Yes	No	Yes
PageUp (Page 3706)	Yes	No	Yes
SendEMail (Page 3706)	Yes	Yes	Yes
SetAcousticSignal (Page 3707)	Yes <sup>1)</sup>	Yes	No

10.8 Working with system functions and Runtime scripting

	KTP400 KP400	TP700 TP900 TP1200 TP1500 TP1900 TP2200	KP700 KP900 KP1200 KP1500
SetDisplayMode (Page 3708)	No	No	No
SetDeviceMode (Page 3709)	Yes	Yes	Yes
SetBit (Page 3710)	Yes	Yes	Yes
SetBitInTag (Page 3711)	Yes	Yes	Yes
SetBitWhileKeyPressed (Page 3712)	Yes	Yes	Yes
SetBacklightColor (Page 3713)	No	No	No
SetBrightness (Page 3714)	Yes	Yes	Yes
SetScreenKeyboardMode (Page 3715)	Yes	Yes	Yes
SetAlarmReportMode (Page 3717)	Yes	Yes	Yes
SetRecipeTags (Page 3718)	Yes	Yes	Yes
SetDaylightSavingTime (Page 3719)	Yes	Yes	Yes
SetLanguage (Page 3720)	Yes	Yes	Yes
SetTag (Page 3722)	Yes	Yes	Yes
SetConnectionMode (Page 3723)	Yes	Yes	Yes
SetWebAccess (Page 3724)	Yes	Yes	Yes
BackupRAMFileSystem (Page 3725)	Yes	Yes	Yes
SimulateSystemKey (Page 3726)	Yes	No	Yes
SimulateTag (Page 3727)	Yes	Yes	Yes
SmartClientViewRefresh (Page 3728)	Yes	Yes	Yes
SmartClientViewReadOnlyOff (Page 3728)	Yes	Yes	Yes
SmartClientViewReadOnlyOn (Page 3729)	Yes	Yes	Yes
SmartClientViewDisconnect (Page 3729)	Yes	Yes	Yes
SmartClientViewConnect (Page 3730)	Yes	Yes	Yes
SmartClientViewLeave (Page 3731)	Yes	Yes	Yes
SaveDataRecord (Page 3731)	Yes	Yes	Yes
StartLogging (Page 3732)	Yes	Yes	Yes
StartNextLog (Page 3733)	Yes	Yes	Yes
StartProgram (Page 3734)	Yes	Yes	Yes
StatusForceGetValues (Page 3736)	Yes	Yes	Yes
StatusForceSetValues (Page 3736)	Yes	Yes	Yes
ControlSmartServer (Page 3737)	Yes	Yes	Yes
ControlWebServer (Page 3737)	Yes	Yes	Yes
StopLogging (Page 3738)	Yes	Yes	Yes
StopRuntime (Page 3739)	Yes	Yes	Yes

	KTP400 KP400	TP700 TP900 TP1200 TP1500 TP1900 TP2200	KP700 KP900 KP1200 KP1500
LookupText (Page 3743)	Yes	Yes	Yes
ResetTagToHandWheel (Page 3744)	No	No	No
SetTagToHandWheel (Page 3745)	No	No	No
TraceUserChange (Page 3745)	Yes	Yes	Yes
DecreaseFocusedValue (Page 3746)	Yes	No	Yes
DecreaseTag (Page 3746)	Yes	Yes	Yes
ChangeConnection (Page 3747)	Yes	Yes	Yes
WinACMPUpdateStartupCharacteristics (Page 3753)	No	No	No
WinACMPUpdateKeySwitchSetting (Page 3754)	No	No	No
WinACMPUpdateBUSF1LED (Page 3755)	No	No	No
WinACMPUpdateBUSF2LED (Page 3756)	No	No	No
WinACMPUpdateAverageExecTime (Page 3757)	No	No	No
WinACMPUpdateAverageCycleTime (Page 3758)	No	No	No
WinACMPUpdateEXTFLED (Page 3759)	No	No	No
WinACMPUpdateHMIEnableTime (Page 3760)	No	No	No
WinACMPUpdateINTFLED (Page 3760)	No	No	No
WinACMPUpdateLastCycleTime (Page 3761)	No	No	No
WinACMPUpdateMaximumCycleTime (Page 3762)	No	No	No
WinACMPUpdateMinimumCycleTime (Page 3763)	No	No	No
WinACMPUpdatePowerLED (Page 3764)	No	No	No
WinACMPUpdateSleepTime (Page 3765)	No	No	No
WinACMPUpdateRUNLED (Page 3766)	No	No	No
WinACMPUpdateSTOPLED (Page 3767)	No	No	No
WinACMPArchive (Page 3768)	No	No	No
WinACMPGetStartCharacteristics (Page 3768)	No	No	No

	KTP400 KP400	TP700 TP900 TP1200 TP1500 TP1900 TP2200	KP700 KP900 KP1200 KP1500
WinACMPGetVersion (Page 3769)	No	No	No
WinACMPClearCycleTimeBuffer (Page 3770)	No	No	No
WinACMPSetStartAtBoot (Page 3770)	No	No	No
WinACMPSetKeySwitch (Page 3771)	No	No	No
WinACMPSetHMIEExecutionTime (Page 3771)	No	No	No
WinACMPSetRestartMethod (Page 3772)	No	No	No
WinACMPSetSleepTime (Page 3772)	No	No	No
WinACMPSetStartMode (Page 3773)	No	No	No
WinACMPStartHistogram (Page 3773)	No	No	No
WinACMPControl (Page 3774)	No	No	No
WinACMPStopHistogram (Page 3774)	No	No	No
WinACMPRestore (Page 3775)	No	No	No
ShowLogonDialog (Page 3749)	Yes	Yes	Yes
ShowOperatorNotes (Page 3749)	Yes	Yes	Yes
ShowAlarmWindow (Page 3750)	Yes	Yes	Yes
ShowSoftwareVersion (Page 3751)	Yes	Yes	Yes
ShowSystemDiagnosticsWindow (Page 3752)	Yes	Yes	Yes
ShowSystemAlarm (Page 3752)	Yes	Yes	Yes

<sup>1)</sup> Only on KTP 400 Comfort

## See also

OpenControlPanelDialog (Page 3685)

## System functions for Mobile Panels

### Availability of system functions

The following table shows the availability of the system functions on the mobile panels.  
 Technical data subject to change.



## Overview

	Mobile Panel 177 DP	Mobile Panel 177 PN	Mobile Panel 277 Mobile Panel 277 IWLAN Mobile Panel 277 F IWLAN
User-defined functions	No	No	Yes
Logoff (Page 3619)	Yes	Yes	Yes
ActivateScreen (Page 3620)	Yes	Yes	Yes
ActivateScreenByNumber (Page 3621)	Yes	Yes	Yes
ActivateCleanScreen (Page 3622)	No	No	No
ActivateSystemDiagnosticsView (Page 3740)	No	No	No
ActivatePreviousScreen (Page 3623)	Yes	Yes	Yes
UpdateTag (Page 3623)	Yes	Yes	Yes
AdjustContrast (Page 3624)	No	No	No
Logon (Page 3625)	Yes	Yes	Yes
ArchiveLogFile (Page 3626)	No	No	Yes
LogTag (Page 3627)	No	No	Yes
EditAlarm (Page 3628)	Yes	Yes	Yes
ScreenObjectCursorDown (Page 3629)	Yes	Yes	Yes
ScreenObjectCursorUp (Page 3629)	Yes	Yes	Yes
ScreenObjectPageDown (Page 3630)	Yes	Yes	Yes
ScreenObjectPageUp (Page 3631)	Yes	Yes	Yes
Encode (Page 3631)	Yes	Yes	Yes
EncodeEx (Page 3632)	Yes	Yes	Yes
DirectKey (Page 3633)	Yes	Yes	Yes
DirectKeyScreenNumber (Page 3636)	Yes	Yes	Yes
PrintScreen (Page 3637)	No	Yes	Yes
PrintReport (Page 3637)	No	Yes	Yes
NotifyUserAction (Page 3638)	No	No	Yes
IncreaseFocusedValue (Page 3639)	Yes	Yes	Yes
IncreaseTag (Page 3640)	Yes	Yes	Yes
ExportDataRecords (Page 3641)	Yes	Yes	Yes
ExportDataRecordsWithChecksum (Page 3643)	No	No	Yes
ExportImportUserAdministration (Page 3646)	Yes	Yes	Yes
GoToHome (Page 3647)	Yes	Yes	Yes
GoToEnd (Page 3647)	Yes	Yes	Yes
SafelyRemoveHardware (Page 3648)	No	No	Yes
HTMLBrowserStop (Page 3649)	No	No	No
HTMLBrowserRefresh (Page 3649)	No	No	No
HTMLBrowserForward (Page 3650)	No	No	No

	Mobile Panel 177 DP	Mobile Panel 177 PN	Mobile Panel 277 Mobile Panel 277 IWLAN Mobile Panel 277 F IWLAN
HTMLBrowserBack (Page 3650)	No	No	No
ImportDataRecords (Page 3651)	Yes	Yes	Yes
ImportDataRecordsWithChecksum (Page 3653)	No	No	Yes
InvertBit (Page 3654)	Yes	Yes	Yes
InvertBitInTag (Page 3655)	Yes	Yes	Yes
InvertLinearScaling (Page 3656)	Yes	Yes	Yes
CalibrateTouchScreen (Page 3658)	Yes	Yes	Yes <sup>2)</sup>
CopyLog (Page 3659)	No	No	Yes
TrendViewScrollForward (Page 3660)	Yes	Yes	Yes
TrendViewScrollBack (Page 3660)	Yes	Yes	Yes
TrendViewExtend (Page 3661)	Yes	Yes	Yes
TrendViewCompress (Page 3661)	Yes	Yes	Yes
TrendViewRulerLeft (Page 3662)	Yes	Yes	Yes
TrendViewRulerRight (Page 3663)	Yes	Yes	Yes
TrendViewSetRulerMode (Page 3663)	Yes	Yes	Yes
TrendViewStartStop (Page 3664)	Yes	Yes	Yes
TrendViewBackToBeginning (Page 3664)	Yes	Yes	Yes
LoadDataRecord (Page 3665)	Yes	Yes	Yes
GetUserName (Page 3666)	Yes	Yes	Yes
GetDataRecordFromPLC (Page 3667)	Yes	Yes	Yes
GetDataRecordName (Page 3668)	Yes	Yes	Yes
GetDataRecordTagsFromPLC (Page 3670)	Yes	Yes	Yes
GetGroupNumber (Page 3671)	Yes	Yes	Yes
GetBrightness (Page 3671)	No	No	No
GetPassword (Page 3672)	Yes	Yes	Yes
ClearLog (Page 3675)	No	No	Yes
ClearDataRecord (Page 3676)	Yes	Yes	Yes
ClearDataRecordMemory (Page 3677)	Yes	Yes	Yes
ClearAlarmBuffer (Page 3678)	Yes	Yes	Yes
ClearAlarmBufferProTool (Page 3679)	Yes	Yes	Yes
AlarmViewUpdate (Page 3680)	Yes	Yes	Yes
AlarmViewEditAlarm (Page 3680)	Yes	Yes	Yes
AlarmViewAcknowledgeAlarm (Page 3681)	Yes	Yes	Yes
AlarmViewShowOperatorNotes (Page 3682)	Yes	Yes	Yes
OpenAllLogs (Page 3683)	No	No	Yes
OpenScreenKeyboard (Page 3684)	No	No	Yes
OpenCommandPrompt (Page 3686)	No	No	Yes
OpenControlPanelDialog (Page 3685)	No	No	No
OpenInternetExplorer (Page 3687)	No	Yes	Yes

	Mobile Panel 177 DP	Mobile Panel 177 PN	Mobile Panel 277 Mobile Panel 277 IWLAN Mobile Panel 277 F IWLAN
Auto-Hotspot	No	No	Yes
OpenControlPanel (Page 3688)	No	No	Yes
AcknowledgeAlarm (Page 3689)	Yes	Yes	Yes
RecipeViewNewDataRecord (Page 3690)	Yes	Yes	Yes
RecipeViewGetDataRecordFromPLC (Page 3690)	Yes	Yes	Yes
RecipeViewClearDataRecord (Page 3691)	Yes	Yes	Yes
RecipeViewMenu (Page 3691)	Yes	Yes	Yes
RecipeViewOpen (Page 3692)	Yes	Yes	Yes
RecipeViewSetDataRecordToPLC (Page 3693)	Yes	Yes	Yes
RecipeViewSaveDataRecord (Page 3693)	Yes	Yes	Yes
RecipeViewSaveAsDataRecord (Page 3694)	Yes	Yes	Yes
RecipeViewSynchronizeDataRecordWithTa gs (Page 3694)	Yes	Yes	Yes
RecipeViewRenameDataRecord (Page 3695)	Yes	Yes	Yes
RecipeViewShowOperatorNotes (Page 3696)	Yes	Yes	Yes
RecipeViewBack (Page 3696)	Yes	Yes	Yes
ResetBit (Page 3697)	Yes	Yes	Yes
ResetBitInTag (Page 3698)	Yes	Yes	Yes
PressButton (Page 3699)	Yes	Yes	Yes
ReleaseButton (Page 3700)	Yes	Yes	Yes
ShiftAndMask (Page 3701)	Yes	Yes	Yes
CloseAllLogs (Page 3702)	No	No	Yes
SetDataRecordToPLC (Page 3703)	Yes	Yes	Yes
SetDataRecordTagsToPLC (Page 3704)	Yes	Yes	Yes
PageDown (Page 3705)	Yes	Yes	Yes
PageUp (Page 3706)	Yes	Yes	Yes
SendEMail (Page 3706)	No	Yes	Yes
SetAcousticSignal (Page 3707)	No	No	No
SetDisplayMode (Page 3708)	No	No	No
SetDeviceMode (Page 3709)	Yes	Yes	Yes
SetBit (Page 3710)	Yes	Yes	Yes
SetBitInTag (Page 3711)	Yes	Yes	Yes
SetBitWhileKeyPressed (Page 3712)	Yes	Yes	Yes
SetBacklightColor (Page 3713)	No	No	No
SetBrightness (Page 3714)	No	No	No
SetScreenKeyboardMode (Page 3715)	No	No	Yes

	Mobile Panel 177 DP	Mobile Panel 177 PN	Mobile Panel 277 Mobile Panel 277 IWLAN Mobile Panel 277 F IWLAN
SetAlarmReportMode (Page 3717)	No	No	Yes
SetRecipeTags (Page 3718)	Yes	Yes	Yes
SetDaylightSavingTime (Page 3719)	Yes	Yes	Yes
SetLanguage (Page 3720)	Yes	Yes	Yes
SetTag (Page 3722)	Yes	Yes	Yes
SetConnectionMode (Page 3723)	Yes	Yes	Yes
SetWebAccess (Page 3724)	No	Yes	Yes
BackupRAMFileSystem (Page 3725)	No	No	Yes
SimulateSystemKey (Page 3726)	Yes	Yes	Yes
SimulateTag (Page 3727)	Yes	Yes	Yes
SmartClientViewRefresh (Page 3728)	No	Yes	Yes
SmartClientViewReadOnlyOff (Page 3728)	No	Yes	Yes
SmartClientViewReadOnlyOn (Page 3729)	No	Yes	Yes
SmartClientViewDisconnect (Page 3729)	No	Yes	Yes
SmartClientViewConnect (Page 3730)	No	Yes	Yes
SmartClientViewLeave (Page 3731)	No	Yes	Yes
SaveDataRecord (Page 3731)	Yes	Yes	Yes
StartLogging (Page 3732)	No	No	Yes
StartNextLog (Page 3733)	No	No	Yes
StartProgram (Page 3734)	No	No	Yes
StatusForceGetValues (Page 3736)	Yes	Yes	Yes
StatusForceSetValues (Page 3736)	No	Yes	Yes
ControlSmartServer (Page 3737)	No	Yes	Yes
ControlWebServer (Page 3737)	No	Yes	Yes
StopLogging (Page 3738)	No	No	Yes
StopRuntime (Page 3739)	Yes	Yes	Yes
LookupText (Page 3743)	Yes	Yes	Yes
ResetTagToHandWheel (Page 3744)	Yes	Yes	Yes
SetTagToHandWheel (Page 3745)	Yes	Yes	Yes
TraceUserChange (Page 3745)	Yes	Yes	Yes
DecreaseFocusedValue (Page 3746)	Yes	Yes	Yes
DecreaseTag (Page 3746)	Yes	Yes	Yes <sup>1)</sup>
ChangeConnection (Page 3747)	Yes	Yes	Yes
WinACMPUpdateStartupCharacteristics (Page 3753)	No	No	No
WinACMPUpdateKeySwitchSetting (Page 3754)	No	No	No
WinACMPUpdateBUSF1LED (Page 3755)	No	No	No
WinACMPUpdateBUSF2LED (Page 3756)	No	No	No

	Mobile Panel 177 DP	Mobile Panel 177 PN	Mobile Panel 277 Mobile Panel 277 IWLAN Mobile Panel 277 F IWLAN
WinACMPUpdateAverageExecTime (Page 3757)	No	No	No
WinACMPUpdateAverageCycleTime (Page 3758)	No	No	No
WinACMPUpdateEXTFLED (Page 3759)	No	No	No
WinACMPUpdateHMIEnableTime (Page 3760)	No	No	No
WinACMPUpdateINTFLED (Page 3760)	No	No	No
WinACMPUpdateLastCycleTime (Page 3761)	No	No	No
WinACMPUpdateMaximumCycleTime (Page 3762)	No	No	No
WinACMPUpdateMinimumCycleTime (Page 3763)	No	No	No
WinACMPUpdatePowerLED (Page 3764)	No	No	No
WinACMPUpdateSleepTime (Page 3765)	No	No	No
WinACMPUpdateRUNLED (Page 3766)	No	No	No
WinACMPUpdateSTOPLED (Page 3767)	No	No	No
WinACMPArchive (Page 3768)	No	No	No
WinACMPGetStartCharacteristics (Page 3768)	No	No	No
WinACMPGetVersion (Page 3769)	No	No	No
WinACMPClearCycleTimeBuffer (Page 3770)	No	No	No
WinACMPSetStartAtBoot (Page 3770)	No	No	No
WinACMPSetKeySwitch (Page 3771)	No	No	No
WinACMPSetHMIExecutionTime (Page 3771)	No	No	No
WinACMPSetRestartMethod (Page 3772)	No	No	No
WinACMPSetSleepTime (Page 3772)	No	No	No
WinACMPSetStartMode (Page 3773)	No	No	No
WinACMPStartHistogram (Page 3773)	No	No	No
WinACMPControl (Page 3774)	No	No	No
WinACMPStopHistogram (Page 3774)	No	No	No
WinACMPRestore (Page 3775)	No	No	No
ShowLogonDialog (Page 3749)	Yes	Yes	Yes
ShowOperatorNotes (Page 3749)	Yes	Yes	Yes
ShowAlarmWindow (Page 3750)	Yes	Yes	Yes
ShowSoftwareVersion (Page 3751)	No	No	Yes
ShowSystemDiagnosticsWindow (Page 3752)	No	No	No
ShowSystemAlarm (Page 3752)	Yes	Yes	Yes

- 1) only for Mobile Panel 277
- 2) Only for Mobile Panel 277, Mobile Panel 277 IWLAN

**See also**

- LinearScaling (Page 3673)
- OpenTaskManager (Page 3689)

**System functions for Runtime Advanced**

**Availability of system functions**

The following table shows the availability of the system functions for WinCC RT Advanced.  
 Technical data subject to change.

**Overview**

	WinCC RT Advanced
User-defined functions	Yes
Logoff (Page 3619)	Yes
ActivateScreen (Page 3620)	Yes
ActivateScreenByNumber (Page 3621)	Yes
ActivateCleanScreen (Page 3622)	Yes
ActivateSystemDiagnosticsView (Page 3740)	No
ActivatePreviousScreen (Page 3623)	Yes
UpdateTag (Page 3623)	Yes
AdjustContrast (Page 3624)	No
Logon (Page 3625)	Yes
ArchiveLogFile (Page 3626)	Yes
LogTag (Page 3627)	Yes
EditAlarm (Page 3628)	Yes
ScreenObjectCursorDown (Page 3629)	Yes
ScreenObjectCursorUp (Page 3629)	Yes
ScreenObjectPageDown (Page 3630)	Yes
ScreenObjectPageUp (Page 3631)	Yes
Encode (Page 3631)	Yes
EncodeEx (Page 3632)	Yes
DirectKey (Page 3633)	No
DirectKeyScreenNumber (Page 3636)	No
PrintScreen (Page 3637)	Yes
PrintReport (Page 3637)	Yes

	WinCC RT Advanced
NotifyUserAction (Page 3638)	Yes
IncreaseFocusedValue (Page 3639)	Yes
IncreaseTag (Page 3640)	Yes
ExportDataRecords (Page 3641)	Yes
ExportDataRecordsWithChecksum (Page 3643)	No
ExportImportUserAdministration (Page 3646)	Yes
GoToHome (Page 3647)	Yes
GoToEnd (Page 3647)	Yes
SafelyRemoveHardware (Page 3648)	No
HTMLBrowserStop (Page 3649)	Yes
HTMLBrowserRefresh (Page 3649)	Yes
HTMLBrowserForward (Page 3650)	Yes
HTMLBrowserBack (Page 3650)	Yes
ImportDataRecords (Page 3651)	Yes
ImportDataRecordsWithChecksum (Page 3653)	No
InvertBit (Page 3654)	Yes
InvertBitInTag (Page 3655)	Yes
InvertLinearScaling (Page 3656)	Yes
CalibrateTouchScreen (Page 3658)	No
CopyLog (Page 3659)	Yes
TrendViewScrollForward (Page 3660)	Yes
TrendViewScrollBack (Page 3660)	Yes
TrendViewExtend (Page 3661)	Yes
TrendViewCompress (Page 3661)	Yes
TrendViewRulerLeft (Page 3662)	Yes
TrendViewRulerRight (Page 3663)	Yes
TrendViewSetRulerMode (Page 3663)	Yes
TrendViewStartStop (Page 3664)	Yes
TrendViewBackToBeginning (Page 3664)	Yes
LoadDataRecord (Page 3665)	Yes
GetUserName (Page 3666)	Yes
GetDataRecordFromPLC (Page 3667)	Yes
GetDataRecordName (Page 3668)	Yes
GetDataRecordTagsFromPLC (Page 3670)	Yes
GetGroupNumber (Page 3671)	Yes
GetBrightness (Page 3671)	No
GetPassword (Page 3672)	Yes
LinearScaling (Page 3673)	Yes
ClearLog (Page 3675)	Yes
ClearDataRecord (Page 3676)	Yes
ClearDataRecordMemory (Page 3677)	No

	WinCC RT Advanced
ClearAlarmBuffer (Page 3678)	Yes
ClearAlarmBufferProTool (Page 3679)	Yes
AlarmViewUpdate (Page 3680)	Yes
AlarmViewEditAlarm (Page 3680)	Yes
AlarmViewAcknowledgeAlarm (Page 3681)	Yes
AlarmViewShowOperatorNotes (Page 3682)	Yes
OpenAllLogs (Page 3683)	Yes
OpenScreenKeyboard (Page 3684)	Yes
OpenControlPanelDialog (Page 3685)	No
OpenCommandPrompt (Page 3686)	No
OpenInternetExplorer (Page 3687)	No
OpenControlPanel (Page 3688)	No
OpenTaskManager (Page 3689)	Yes
AcknowledgeAlarm (Page 3689)	Yes
RecipeViewNewDataRecord (Page 3690)	Yes
RecipeViewGetDataRecordFromPLC (Page 3690)	Yes
RecipeViewClearDataRecord (Page 3691)	Yes
RecipeViewMenu (Page 3691)	Yes
RecipeViewOpen (Page 3692)	Yes
RecipeViewSetDataRecordToPLC (Page 3693)	Yes
RecipeViewSaveDataRecord (Page 3693)	Yes
RecipeViewSaveAsDataRecord (Page 3694)	Yes
RecipeViewSynchronizeDataRecordWithTags (Page 3694)	Yes
RecipeViewRenameDataRecord (Page 3695)	Yes
RecipeViewShowOperatorNotes (Page 3696)	Yes
RecipeViewBack (Page 3696)	Yes
ResetBit (Page 3697)	Yes
ResetBitInTag (Page 3698)	Yes
PressButton (Page 3699)	Yes
ReleaseButton (Page 3700)	Yes
ShiftAndMask (Page 3701)	Yes
CloseAllLogs (Page 3702)	Yes
SetDataRecordToPLC (Page 3703)	Yes
SetDataRecordTagsToPLC (Page 3704)	Yes
PageDown (Page 3705)	Yes
PageUp (Page 3706)	Yes
SendEMail (Page 3706)	Yes
SetAcousticSignal (Page 3707)	No
SetDisplayMode (Page 3708)	Yes
SetDeviceMode (Page 3709)	Yes
SetBit (Page 3710)	Yes



	WinCC RT Advanced
SetBitInTag (Page 3711)	Yes
SetBitWhileKeyPressed (Page 3712)	Yes
SetBacklightColor (Page 3713)	No
SetBrightness (Page 3714)	No
SetScreenKeyboardMode (Page 3715)	Yes
SetAlarmReportMode (Page 3717)	Yes
SetRecipeTags (Page 3718)	Yes
SetDaylightSavingTime (Page 3719)	Yes
SetLanguage (Page 3720)	Yes
SetTag (Page 3722)	Yes
SetConnectionMode (Page 3723)	Yes
SetWebAccess (Page 3724)	Yes
BackupRAMFileSystem (Page 3725)	No
SimulateSystemKey (Page 3726)	Yes
SimulateTag (Page 3727)	Yes
SmartClientViewRefresh (Page 3728)	Yes
SmartClientViewReadOnlyOff (Page 3728)	Yes
SmartClientViewReadOnlyOn (Page 3729)	Yes
SmartClientViewDisconnect (Page 3729)	Yes
SmartClientViewConnect (Page 3730)	Yes
SmartClientViewLeave (Page 3731)	Yes
SaveDataRecord (Page 3731)	Yes
StartLogging (Page 3732)	Yes
StartNextLog (Page 3733)	Yes
StartProgram (Page 3734)	Yes
StatusForceGetValues (Page 3736)	Yes
StatusForceSetValues (Page 3736)	Yes
ControlSmartServer (Page 3737)	Yes
ControlWebServer (Page 3737)	Yes
StopLogging (Page 3738)	Yes
StopRuntime (Page 3739)	Yes
LookupText (Page 3743)	Yes
ResetTagToHandWheel (Page 3744)	No
SetTagToHandWheel (Page 3745)	No
TraceUserChange (Page 3745)	Yes
DecreaseFocusedValue (Page 3746)	Yes
DecreaseTag (Page 3746)	Yes
ChangeConnection (Page 3747)	Yes
WinACMPUpdateStartupCharacteristics (Page 3753)	No
WinACMPUpdateKeySwitchSetting (Page 3754)	No
WinACMPUpdateBUSF1LED (Page 3755)	No

	WinCC RT Advanced
WinACMPUpdateBUSF2LED (Page 3756)	No
WinACMPUpdateAverageExecTime (Page 3757)	No
WinACMPUpdateAverageCycleTime (Page 3758)	No
WinACMPUpdateEXTFLED (Page 3759)	No
WinACMPUpdateHMIEnableTime (Page 3760)	No
WinACMPUpdateINTFLED (Page 3760)	No
WinACMPUpdateLastCycleTime (Page 3761)	No
WinACMPUpdateMaximumCycleTime (Page 3762)	No
WinACMPUpdateMinimumCycleTime (Page 3763)	No
WinACMPUpdatePowerLED (Page 3764)	No
WinACMPUpdateSleepTime (Page 3765)	No
WinACMPUpdateRUNLED (Page 3766)	No
WinACMPUpdateSTOPLED (Page 3767)	No
WinACMPArchive (Page 3768)	No
WinACMPGetStartCharacteristics (Page 3768)	No
WinACMPGetVersion (Page 3769)	No
WinACMPClearCycleTimeBuffer (Page 3770)	No
WinACMPSetStartAtBoot (Page 3770)	No
WinACMPSetKeySwitch (Page 3771)	No
WinACMPSetHMIExecutionTime (Page 3771)	No
WinACMPSetRestartMethod (Page 3772)	No
WinACMPSetSleepTime (Page 3772)	No
WinACMPSetStartMode (Page 3773)	No
WinACMPStartHistogram (Page 3773)	No
WinACMPControl (Page 3774)	No
WinACMPStopHistogram (Page 3774)	No
WinACMPRestore (Page 3775)	No
ShowLogonDialog (Page 3749)	Yes
ShowOperatorNotes (Page 3749)	Yes
ShowAlarmWindow (Page 3750)	Yes
ShowSoftwareVersion (Page 3751)	Yes
ShowSystemDiagnosticsWindow (Page 3752)	No
ShowSystemAlarm (Page 3752)	Yes

## System functions

### Logoff

#### Description

Logs off the current user on the HMI device.

### Use in the function list

Logoff

### Use in user-defined functions

Logoff

Can be used if the configured device supports user-defined functions. For additional information, refer to "Device dependency".

### Parameter

--

### See also

Device dependency (Page 3583)

## ActivateScreen

### Description

Performs a screen change to the given screen.

Use the "ActivateScreenByNumber" system function to change from the root screen to the permanent window or vice versa.

### Use in the function list

ActivateScreen (Screen name, Object number)

### Use in user-defined functions

ActivateScreen (Screen\_name, Object\_number)

Can be used if the configured device supports user-defined functions. For additional information, refer to "Device dependency".

### Parameters

#### Screen name

Name of the screen to which you change.

#### Object number

The operator control element which receives the focus in the given screen after the screen change. The number of the operator control element is to be determined using the tabulator sequence during configuration.

When "0" is specified:

- If the focus is in the permanent window when the system function is called up, the permanent window maintains the focus.
- If the focus is in the root screen when the system function is called up, the first operator control element in the given screen receives the focus.

---

**Note**

If the "Reach margin" event is assigned to the "ActivateScreen" system function, only the value "0" is valid for the "Object number" parameter. The active object is not defined by the object number, but rather by the X position it had prior to the screen change.

---

### Example

The ActivateScreen function is used in the following program code to activate the "Screen\_2" screen when you click a button.

```
{  
  
// User defined code  
// i.e. when pressing a button  
ActivateScreen ("Screen_2", 0);  
...  
}
```

### See also

[ActivateScreenByNumber \(Page 3621\)](#)

[Device dependency \(Page 3583\)](#)

### ActivateScreenByNumber

#### Description

Performs a screen change to a screen depending on a tag value.

The screen is identified by its screen number.

#### Use in the function list

[ActivateScreenByNumber \(Screen number, Object number\)](#)

#### Use in user-defined functions

[ActivateScreenByNumber \(Screen\\_number, Object\\_number\)](#)

Can be used if the configured device supports user-defined functions. For additional information, refer to "Device dependency".

## Parameter

### Screen number

Tag which contains the screen number of the destination screen.

When a change from the root screen to the permanent window is desired, "0" or "-1" is specified:

0 = Change from root screen to permanent window

-1 = Change from permanent window to root screen

### Object number

The number of the screen object which receives the focus in the given screen after the screen change. The number of the operator control element is to be determined using the tabulator sequence during configuration.

When "0" is specified:

- If the focus is in the permanent window when the system function is called up, the permanent window maintains the focus.
- If the focus is in the root screen when the system function is called up, the first operator control element in the given screen receives the focus.

## See also

ActivateScreen (Page 3619)

Device dependency (Page 3583)

## ActivateCleanScreen

### Description

Activates the clean screen on the HMI device. The display of the HMI device is disabled for the given time period.

When the display of the HMI device is deactivated, it can be cleaned without triggering touch functions by mistake.

### Use in the function list

ActivateCleanScreen (Time period)

### Use in user-defined functions

--

## Parameters

### Time period

Time period for which the display is disabled. The time remaining is displayed as a progress bar.

Value range in seconds from 10 through 300.

---

### Note

The system function ActivateCleanScreen cannot be simulated.

---

## See also

Logoff (Page 3618)

Device dependency (Page 3583)

## ActivatePreviousScreen

### Description

Performs a screen change to the screen which was activated before the current screen. The screen change is not performed if no screen was activated beforehand.

The last 10 screens that were called up are saved. A system alarm is output when you change to a screen which is no longer saved.

---

### Note

If you want to use the system function, the screen to which you change has to be used in the navigation structure.

---

## Use in the function list

ActivatePreviousScreen

## Use in user-defined functions

ActivatePreviousScreen

Can be used if the configured device supports user-defined functions. For additional information, refer to "Device dependency".

**Parameter**

--

**See also**

Device dependency (Page 3583)

**UpdateTag**

**Description**

Reads the current value of the tag with the specified Update ID from the PLC.

**Use in the function list**

UpdateTag (Update ID)

**Use in user-defined functions**

-

**Parameters**

**Update ID**

Update ID assigned to the tag that will be updated.

**See also**

Device dependency (Page 3583)

Logoff (Page 3618)

**AdjustContrast**

**Description**

Changes the contrast of the display one level on the HMI device.

**Use in the function list**

AdjustContrast (Adjust)

**Use in user-defined functions**

-

## Parameters

### Adjust

Specifies how the contrast is changed:

0 (hmiDecrease) = Decrease: Decreases the contrast one level.

1 (hmiIncrease) = Increase: Increases the contrast one level.

## Application example

### Objective

One button each for increasing and decreasing the screen contrast is desired.

### Notes on configuring

Configure two buttons and configure the "AdjustContrast" system function on the "Press" event. The parameters "Increase" and "Decrease" are allocated.

### Procedure on HMI device

When one of the two buttons is pressed in runtime, the contrast is increased or decreased one level.

## See also

Logoff (Page 3618)

Device dependency (Page 3583)

## Logon

### Description

Logs on the current user on the HMI device.

### Use in the function list

Logon (Password, User name)

### Use in user-defined functions

Logon (Password, User\_name)

Can be used if the configured device supports user-defined functions. For additional information, refer to "Device dependency".



## Parameter

### Password

The tag from which the password for the user logging on is read.

If the user is logged on, the password in the tag is deleted.

### User name

The tag from which the user name for the user logging on is read.

## See also

Device dependency (Page 3583)

## ArchiveLogFile

### Description

This system function moves or copies a log to another storage location for long-term logging.

With Audit Trails, always use the "Move" (hmiMove)" mode, otherwise you will be violating the FDA guideline by duplicating the data stored.

Prior to "ArchiveLogFile" always run the system function "CloseAllLogs".

After this system function, run the "OpenAllLogs" system function.

In "Copy log" mode, the logs are not reopened until the log has been successfully copied, or unless a timeout occurs during the copy process. In "Move log" mode, the logs to be moved are renamed and the new logs are opened immediately. To move the renamed logs, a job is submitted which attempts to move them every 300 seconds if the server cannot be reached. The job is also retained after Runtime is restarted until it is executed.

### Use in the function list

ArchiveLogFile (Log type, Log, Directory name, Mode)

### Use in user-defined functions

ArchiveLogFile (Log\_type, Log, Directory\_name, Mode)

Can be used if the configured device supports user-defined functions. For additional information, refer to "Device dependency".

## Parameter

### Log type

Determines the type of log:

0 (hmiTagArchive) = Data log

1 (miAlarmArchive) = Alarm log

2 (hmiAudittrailArchive) = Audit trail log available for GMP compliant projects. Additional information is available under "Activating GMP-compliant configuration".

**Log**

Name of the log being archived.

**Directory name**

Path for saving the log.

**Mode**

0 (hmiCopy) = Copy log

1 (hmiMove) = Move log

**Application example**

You want to move a log file from a local storage medium to the server in order to generate a backup copy of this file at cyclic intervals.

**Notes on configuring**

Set up a task in the scheduler which is executed at a specific time on a daily basis. Configure the following function list for the task:

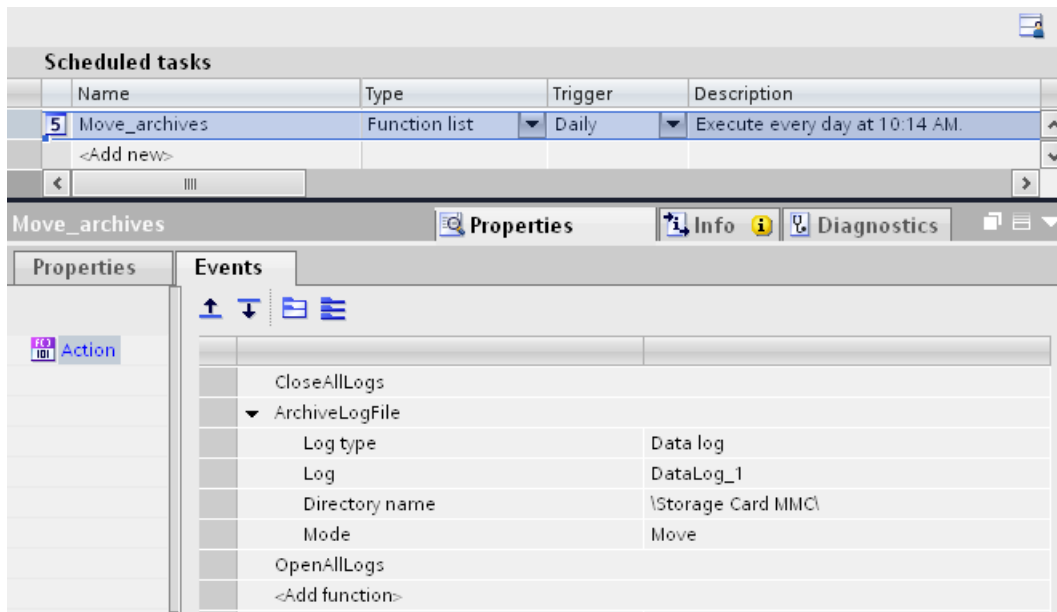

**Procedure on HMI device**

- All log files will be closed.
- The log file you specified is moved to the server.
- All closed log files will be opened again.

### See also

Device dependency (Page 3583)

### LogTag

#### Description

Saves the value of the given tags in the given data log.

This system function is used to archive a process value at a certain point in time.

#### Use in the function list

LogTag (Tag)

#### Use in user-defined functions

-

#### Parameters

##### Tag

The tag whose value is logged. The tag is stored in the log which is configured for the specified tag.

### See also

Device dependency (Page 3583)

### EditAlarm

#### Description

Triggers the "Edit" event for all selected alarms.

If the alarms to be edited have not yet been acknowledged, the acknowledgment takes place automatically when this system function is called up.

This system function can only be used for function keys.

#### Use in the function list

EditAlarm

### Use in user-defined functions

EditAlarm

Can be used if the configured device supports user-defined functions. For additional information, refer to "Device dependency".

### Parameter

--

### See also

Device dependency (Page 3583)

## ScreenObjectCursorDown

### Description

Results in a line-by-line, downward cursor movement in the specified screen object.

The system function can be used for the following screen objects:

- User view
- Alarm view
- Recipe view

### Use in the function list

ScreenObjectCursorDown (Screen object)

### Use in user-defined functions

-

### Parameters

#### Screen object

Name of the screen object in which the key function is triggered.

### See also

Device dependency (Page 3583)

## ScreenObjectCursorUp

### Description

Results in a line-by-line, upward cursor movement in the specified screen object.

The system function can be used for the following screen objects:

- User view
- Alarm view
- Recipe view

### Use in the function list

ScreenObjectCursorUp (Screen object)

### Use in user-defined functions

-

### Parameters

#### Screen object

Name of the screen object in which the key function is triggered.

### See also

Device dependency (Page 3583)

## ScreenObjectPageDown

### Description

Results in a page-by-page, downward cursor movement in the specified screen object.

The system function can be used for the following screen objects:

- User view
- Alarm view
- Recipe view

### Use in the function list

ScreenObjectPageDown (Screen object)

## Use in user-defined functions

-

## Parameters

### Screen object

Name of the screen object in which the key function is triggered.

## See also

Device dependency (Page 3583)

## ScreenObjectPageUp

## Description

Results in a page-by-page, upward cursor movement in the specified screen object.

The system function can be used for the following screen objects:

- User view
- Alarm view
- Recipe view

## Use in the function list

ScreenObjectPageUp (Screen object)

## Use in user-defined functions

-

## Parameters

### Screen object

Name of the screen object in which the key function is triggered.

## See also

Device dependency (Page 3583)

## Encode

### Description

Adapts the "String" data type of a tag for transfer to the automation system (AS). The tag of WinCC data type "String" is converted into the AS data type "Array of byte". The result is written to a tag.

### Use in the function list

Encode (Byte array, String, Coding)

### Use in user-defined functions

Encode (Byte\_array, String, Encoding)

Can be used if the configured device supports user-defined functions. For additional information, refer to "Device dependency".

### Parameter

#### Byte array

The tag that contains the converted value.

---

#### Note

The Byte array must be twice the size of the string length + 2. The Byte array must contain 242 array elements if the string has a length of 120 characters.

Characters are either truncated or not converted if the size is insufficient.

---

#### String

The tag of data type "String" that is converted.

#### Encode

0 (hmiEncodeUTF16LE) - String is encoded in UTF16LE (Unicode 16 Little Endian).

### See also

Device dependency (Page 3583)

## EncodeEx

### Description

Adapts the "String" data type of a tag for transfer to the automation system (AS). The tag of WinCC data type "String" is converted into the AS data type "Array of byte". The result is written to a tag.

By contrast to the Encode system function, you can define the Line break parameter. Using the Line break parameter you can delete line breaks or replace these with predefined characters.

### Use in the function list

EncodeEx (Byte array, String , Encode , Line break)

### Use in user-defined functions

EncodeEx (Byte\_array, String, Encoding, Line\_break)

Can be used if the configured device supports user-defined functions. For additional information, refer to "Device dependency".

### Parameter

#### Byte array

The tag that contains the converted value.

---

#### Note

The byte array must be twice the size of the string length +2. If the string has a length of 120 characters, the byte array must contain 242 array elements.

Characters are either truncated or not converted if the size is insufficient.

---

#### String

The tag of data type "String" that is converted.

#### Encode

0 (hmiEncodeUTF16LE) - String is encoded in UTF16LE (Unicode 16 Little Endian).

#### Line break

All line breaks are either deleted or replaced with predefined characters. Do not replace line breaks if set as the default value.

0 (replace with "\r\n" (0x000D, 0x000A)) - the line break is replaced with "\r\n".

1 (replace with "\n" (0x000A)) - the line break is replaced with "\n".

2 (do not replace) - the line break is not replaced.



3 (remove line breaks) - the line breaks are removed.

## See also

Device dependency (Page 3583)

## DirectKey

## Description

Allows rapid operation of keys on an HMI device without having communication caused delays occur.

Use this system function, for example, to set bits in the I/O area of a SIMATIC S7 directly from the HMI device.

---

### Note

If you have integrated WinCC in SIMATIC STEP 7 and have configured a DP area in SIMATIC STEP 7: When the button on which the system function was configured is activated, a bit is set in the IO area of the CPU. Releasing the button resets the bit.

---

## Notes on configuring the system function

When a button is configured with the "DirectKey" system function, a fixed area of the touch display is reserved for DirectKey operation.

Screen objects that are above the button with the "DirectKey" system function in this area in runtime will hide the button visually. However, the screen objects do not interfere with the triggering of the "DirectKey" system function.

---

### Note

If an external application, such as Pocket Internet Explorer or Control Panel is started, it will run in the foreground and Runtime is placed in the background. The bit for the "DirectKeyScreenNumber" function is no longer set and the keys or buttons which are assigned the "DirectKey" function no longer trigger the associated bit in the PLC.

---

 <b>WARNING</b>
--

Triggering the "DirectKey" system function by mistake will endanger personnel or result in damage to the machine.
---

In order to avoid this danger, the following must be observed:

- When the process screen is configured, the button with the "DirectKey" system function must not be covered by a screen object.
  - The dynamic positioning or display (release) of a screen object in relation to process values must not cover the button with the "DirectKey" system function in runtime.
- 

**Note**

Please observe this guideline during configuration. Check also existing configurations and adjust them immediately.

---

In the following cases, the covering of a button with the "DirectKey" system function does not lead to the problems described above:

- Operation of the alarm window
- Operation of the Recipe view
- Cancellation of the screen saver
- Use of the screen keyboard
- Running the "ActivateCleanScreen" system function

### Actions of DP direct-keys in offline operation

When the "ChangeConnection" system function is performed with the "Offline" parameter on the HMI device, the connection to the specified PLC is disconnected.

---

**Note**

Please note the following on the SIMATIC STEP 7 side as well as the WinCC side:

The DP DirectKeys are still active in this case. If you activate a button with the "DirectKey" system function in "Offline" operating mode or activate the DirectKey on a keyboard device, the corresponding bit is set in the PLC.

---

### Use in the function list

DirectKey (Bit)

### Use in user-defined functions

-

### Parameters

**Bit**

Specifies the bit which is set. Depending on the HMI device, the bit numbers 0 to 31 or 0 to 39 are possible.

## Application example

### Objective

You want to set bits in the IO area of a SIMATIC S7 directly from the HMI device using a button.

### Requirement

WinCC integrated in SIMATIC STEP 7 is installed.

During operation, the HMI device is coupled to a SIMATIC S7 through PROFIBUS-DP.

WinCC integrated was installed when you compiled your project.

The bit area for DirectKeys is determined in SIMATIC STEP 7. For configuration see the "Communication" user's manual.

### Notes on configuring

Configure the button to be used as the DirectKey. Assign the "DirectKey" system function to the button. As a parameter, enter the number of the bit which is set when the key is pressed.

### Procedure on HMI device

When the DirectKey is touched, the bit is set, and reset when the key is released or the screen is exited.

## See also

Device dependency (Page 3583)

## DirectKeyScreenNumber

### Description

Sets the bit within the given bit area of a DirectKey and transfers it to the S7 controller to which the HMI device is connected. This ensures unambiguous allocation of a control bit to screen number at all times.

Without the use of the system function, the S7 controller must distinguish the respective functionality by means of the screen number. This delays the updating of the screen number after a screen change.

---

### Note

If an external application, such as Pocket Internet Explorer or Control Panel is started, it will run in the foreground and Runtime is placed in the background. Nevertheless, the bit for the "DirectKeyScreenNumber" function is set and the keys or buttons with the configured "DirectKey" function continue to trigger the associated bit in the PLC.

---

## Use in the function list

DirectKeyScreenNumber (Bit)

### Use in user-defined functions

-

### Parameters

#### Bit

Specifies the bit which is set. Depending on the HMI device, the bit numbers 0 to 31 or 0 to 39 are possible.

### See also

Device dependency (Page 3583)

### PrintScreen

### Description

Prints the screen currently being displayed on the HMI device from the printer which is connected to the HMI device.

Opened windows are also printed.

---

#### Note

The printer settings are taken over from the current settings in the Windows operation system.

---

### Use in the function list

PrintScreen

### Use in user-defined functions

PrintScreen

Can be used if the configured device supports user-defined functions. For additional information, refer to "Device dependency".

### Parameter

--

### See also

Device dependency (Page 3583)

## PrintReport

### Description

Prints the given report from the printer which is connected to the HMI device. The report is printed in the language which is set on the HMI device.

---

#### Note

If runtime is closed whilst log data are being printed using the system function, the report will cease to be supplied with data as soon as runtime stops.

---

### Use in the function list

PrintReport (Report)

### Use in user-defined functions

PrintReport (Report)

Can be used if the configured device supports user-defined functions. For additional information, refer to "Device dependency".

### Parameter

#### Report

Name of the report to be printed.

---

#### Note

If you have set up via the "Function list" dialog box a new report for the "PrintReport" function, when compiling, the following warning appears: "The report "Report\_1" has no printed pages."

In order to remedy the warning, open the "Report\_1" via the project view and recompile the project.

---

### See also

Device dependency (Page 3583)

## NotifyUserAction

### Description

This system function is used to log user actions that are not automatically logged in the audit trail. You can also use this system function to require the user to enter an acknowledgment or an electronic signature and a comment for the operator action. Requirement for the use of the system function is that the GMP-compliant configuration is activated under "Runtime settings".

If you use the "NotifyUserAction" system function in a function, the debugger may open if you cancel your input by clicking "Cancel". To compensate for this reaction, you can use the "On Error Resume Next" statement in a function. With this instruction, the next instruction is executed after a runtime error. If you use the "On Error Resume Next" statement, output of system events is also suppressed.

### Use in the function list

NotifyUserAction (Confirmation type, Mandatory commenting, Category, Object name, Description)

### Use in user-defined functions

NotifyUserAction (Confirmation\_type, Mandatory\_commenting, Category, Object\_name, Description)

Can be used if the configured device supports user-defined functions. For additional information, refer to "Device dependency".

### Parameter

#### Confirmation type

Establishes how the action must be confirmed

0 = (None): No confirmation required, an entry is created in the audit trail

1 = (Acknowledgement): Acknowledgment, the user must acknowledge the action; an entry is created in the audit trail

2 = (Digital Signature): Electronic signature, a dialog window opens in which the user must enter his electronic signature - an entry is created in the audit trail

#### Mandatory commenting

Establishes if the user has to enter a comment. The comment is logged in the audit trail.

0 = (True): True; a dialog window opens in which the user must enter a comment

1 = (False): False; no mandatory commenting

#### Category

Category or class name of the modified object

#### Object name

Name of the modified object

#### Description

Text which describes the archiving user action.

## See also

Device dependency (Page 3583)

## IncreaseFocusedValue

### Description

Adds the given value to the value of the tag which is connected to the input field (drop-down list, graphic selection list, slider bar) which has the current focus.

This system function can only be used for function keys.

### Use in the function list

IncreaseFocusedValue (Value)

### Use in user-defined functions

-

### Parameters

#### Value

The value which is added to the tag value.

## See also

Device dependency (Page 3583)

## IncreaseTag

### Description

Adds the given value to the value of the tags.

$X = X + a$

---

#### Note

The system function uses the same tag as input and output values. When this system function is used to convert a value, help tags must be used. You can use the "SetTag" system function to assign the tag value to the auxiliary tags.

---

If you configure the system function on the events of an alarm and the tag is not being used in the current screen, it is not ensured that the actual value of the tags is being used in the PLC. You can improve the situation by setting the "Cyclic continuous" acquisition mode.

### Use in the function list

IncreaseTag (Tag, Value)

### Use in user-defined functions

IncreaseTag (Tag, Value)

Can be used if the configured device supports user-defined functions. For additional information, refer to "Device dependency".

### Parameter

#### Tag

The tag to which the given value is added.

#### Value

The value that is added.

### See also

Device dependency (Page 3583)

SetTag (Page 3722)

## ExportDataRecords

### Description

Exports one or all data records of a recipe to a CSV file.

One file is created per recipe.

### Use in the function list

ExportDataRecords (Recipe number/name, Data record number/name, File name, Overwrite, Output status message, Processing status)

### Use in user-defined functions

ExportDataRecords (Recipe\_number/name, Data\_record number/name, File\_name, Overwrite, Output\_status\_message, Processing\_status)

Can be used if the configured device supports user-defined functions. For additional information, refer to "Device dependency".



## Parameter

### Recipe number/name

Number or name of the recipe from which the data records are exported. Specify "0" if recipe data records are to be exported from all available recipes.

### File name

Name of the CSV file to which the recipe data records are exported. Enter the file location and the file extension (\*.csv), for example, "C:\TEMP\Orange.csv".

---

### Note

#### Storage of the CSV file

- If a storage card is used as storage location, specify the storage location as follows: "\StorageCard\".
  - If you only enter one file name and no path, the file will be saved in a system directory, for example, "C:\Documents and Settings\[User]".
  - When only one path for the export is specified, the file name is automatically created from the respective recipe name. It is a requirement that the folder "D:\Temp\", for example, has been created. If the folder "D:\Temp" has not been created, the folder name will be used as the prefix of the file name, Temp\_Recipe names.csv.
- 

### Data record number/name

Number or name of the recipe data record to be exported. Specify "0" if all recipe data records are to be exported.

### Overwrite

Determines whether an existing CSV file with the same name is overwritten:

0 (hmiOverwriteForbidden) = No: CSV file will not be overwritten. The export process will not be carried out.

1 (hmiOverwriteAlways) = Yes: CSV file is overwritten without a prompt for confirmation.

2 (hmiOverwriteWithPrompting) = With confirmation: CSV file is not overwritten until confirmed.

### Output status message

Determines whether a status message is output after the export:

0 (hmiOff) = Off: Status message is not output.

1 (hmiOn) = On: Status message is output.

### Processing status

Returns the processing status of the system function. You can use the return value, for example, to delay execution of other system functions until this system function has been successfully completed:

2 = System function is being performed.

4 = System function was successfully completed.

12 = System function was not performed because an error has occurred.

### Export format of the recipe data records

If ".csv" is chosen as a file extension for the export file, then only valid characters from the ANSI character set will be supported. This also applies to separators in decimal numbers and list elements. The separators used are defined in the country/regional settings of the operating system of the exporting computer.

You may also set "Unicode text" (".txt") format for the export file. This file format supports the WinCC and WinCC Runtime character set. Again, the separators used are specified in the country/regional settings of the operating system of the exporting computer. This file format always uses tab separators in list elements.

The corresponding file import function also supports the ".csv" and ".txt" (Unicode) file formats.

### Application example

You want to export all data records using a key.

#### Notes on configuring

Configure the "ExportDataRecords" system function on the "Press" event for the desired key. Transfer the following parameters:

- Recipe number/name = 1
- Data record number/name = 0
- File name = c:\temp\orange.csv
- Overwrite = 1
- Output status message = 1

Tags can also be specified in place of the constants. Depending on the configuration, the operator can enter the desired values in the I/O field or read from the PLC. In this way, the operator can determine which recipe data records are exported.

#### Procedure on HMI device

As soon as the key is activated, the system function is triggered. The constants or tags are evaluated. All data records of Recipe 1 are exported to the orange.csv file. If the file already exists, it will be overwritten.

After exporting the data records, a system message is output.

### See also

Device dependency (Page 3583)

### ExportDataRecordsWithChecksum

#### Description

Exports one or all data records of a recipe to a CSV file and generates a checksum for each line in the file.

One file is created per recipe.

### Use in the function list

ExportDataRecordsWithChecksum (Recipe number/name, Data record number/name, File name, Overwrite, Output status message, Processing status)

### Use in user-defined functions

ExportDataRecordsWithChecksum (Recipe\_number/name, Data\_record number/name, File\_name, Overwrite, Output\_status\_message, Processing\_status)

Can be used if the configured device supports user-defined functions. For additional information, refer to "Device dependency".

### Parameter

#### Recipe number/name

Number or name of the recipe from which the data records are exported. Specify "0" if recipe data records are to be exported from all available recipes.

#### Data record number/name

Number or name of the recipe data record to be exported. Specify "0" if all recipe data records are to be exported.

#### File name

Name of the CSV file to which the recipe data records are exported. Enter the path and the file extension e.g. "C:\TEMP\Orange.CSV".

If a storage card is used as storage location, specify the storage location as follows: "\StorageCard\".

If you define only a file name without specifying a path, the file is saved to the directory from which Runtime was started. If write access to this directory is not enabled in the Windows 7 operating system, the file is saved to the "VirtualStore" folder of the user directory.

When only one path for the export is specified, the file name is automatically created from the respective recipe name. This requires, for example, that the directory "D:\Temp\" has been created. If the directory "D:\Temp" does not exist, the directory name is used as the prefix for the file name, Temp\_Recipe names.csv.

#### Overwrite

Determines whether an existing CSV file with the same name is overwritten:

0 (hmiOverwriteForbidden) = No: CSV file will not be overwritten. The export process will not be carried out.

1 (hmiOverwriteAlways) = Yes: CSV file is overwritten without a prompt for confirmation.

2 (hmiOverwriteWithConfirmation) = With confirmation: CSV file is not overwritten until confirmed.

### Output status message

Determines whether a status message is output after the export:

0 (hmiOff) = Off: Status message is not output.

1 (hmiOn) = On: Status message is output.

### Processing status

Returns the processing status of the system function. You can use the return value, for example, to delay execution of other system functions until this system function has been successfully completed:

2 = System function is being performed.

4 = System function was successfully completed.

12 = System function was not performed because an error has occurred.

## Export format of the recipe data records

If ".csv" is chosen as a file extension for the export file, then only valid characters from the ANSI character set will be supported. This also applies to separators in decimal numbers and list elements. The separators used are defined in the country/regional settings of the operating system of the exporting computer.

You may also set "Unicode text" (".txt") format for the export file. This file format supports the WinCC and WinCC Runtime character set. Again, the separators used are specified in the country/regional settings of the operating system of the exporting computer. This file format always uses tab separators in list elements.

The corresponding file import function also supports the ".csv" and ".txt" (Unicode) file formats.

## Application example

Using a key, you want to export all data records and assign a checksum.

### Notes on configuring

Configure the "ExportDataRecordsWithChecksum" system function on the "Press" event for the desired key. Transfer the following parameters:

- Recipe number/name = 1
- Data record number/name = 0
- File name = c:\temp\orange.csv
- Overwrite = 1
- Output status message = 1

Tags can also be specified in place of the constants. Depending on the configuration, the operator can enter the desired values in the I/O field or read from the PLC. In this way, the operator can determine which recipe data records are exported.

### Procedure on HMI device

As soon as the key is activated, the system function is triggered. The constants or tags are evaluated. All data records of Recipe 1 are exported to the orange.csv file and assigned checksums. If the file already exists, it will be overwritten.

After exporting the data records, a system message is output.

## See also

Device dependency (Page 3583)

## ExportImportUserAdministration

### Description

Exports all users of the user administration of the currently active project to the given file or imports the users from the given file into the currently active project.

Users, their passwords and rights are saved in the user administration.

All users are overwritten when importing. The imported users are valid immediately.

### Use in the function list

ExportImportUserAdministration (File name, Direction)

### Use in user-defined functions

ExportImportUserAdministration (File\_name, Direction)

Can be used if the configured device supports user-defined functions. For additional information, refer to "Device dependency".

## Parameter

### File name

Name of the file which contains the passwords or to which the passwords are written. Enter the file location and the file extension (\*.txt), for example, "C:\TEMP\Passwords.txt".

---

### Note

If a storage card is used as file location, specify the file location as follows: "\\StorageCard \<File name>".

---

### Direction

Specifies whether passwords are exported or imported:

0 (hmiExport) = Export: Passwords are exported.

1 (hmiImport) = Import: Passwords are imported.

### See also

Device dependency (Page 3583)

## GoToHome

### Description

Executes the key function <Home> on the HMI device.

This system function is used when the HMI device does not have this functionality by default.

The system function can only be used for the following function keys.

### Use in the function list

GoToHome

### Use in user-defined functions

GoToHome

Can be used if the configured device supports user-defined functions. For additional information, refer to "Device dependency".

### Parameter

--

### See also

Device dependency (Page 3583)

## GoToEnd

### Description

Executes the key function <End> on the HMI device.

This system function is used when the HMI device does not have this functionality by default.

The system function can only be used for the following function keys.

### Use in the function list

GoToEnd

### Use in user-defined functions

GoToEnd

Can be used if the configured device supports user-defined functions. For additional information, refer to "Device dependency".

### Parameter

--

### See also

Device dependency (Page 3583)

## SafelyRemoveHardware

### Description

Checks whether there is read or write access to the external storage medium. If there is no access, the external storage medium can be removed without data loss.

### Use in the function list

SafelyRemoveHardware(Path, Result)

### Use in user-defined functions

SafelyRemoveHardware(Path, Result)

Can be used if the configured device supports user-defined functions. For additional information, refer to "Device dependency".

### Parameter

#### Path

Path of storage medium , e.g. \Storage Card USB\

#### Result

The tag in which the result is entered.

TRUE : The storage medium can be removed safely. A corresponding system message will be issued.

FALSE : The storage medium can be removed safely. A corresponding system message will be issued.

**See also**

Device dependency (Page 3583)

**HTMLBrowserStop**

**Description**

Performs the function "Stop" the HTML browser.

**Use in the function list**

HTMLBrowserStop (Screen object)

**Use in user-defined functions**

-

**Parameters**

**Screen object**

Object name of the HTML browser in which the command is performed.

**See also**

Device dependency (Page 3583)

**HTMLBrowserRefresh**

**Description**

Performs the function "Refresh" of the HTML browser.

**Use in the function list**

HTMLBrowserRefresh (Screen object)

**Use in user-defined functions**

-

**Parameters**

**Screen object**

Object name of the HTML browser in which the command is performed.



**See also**

Device dependency (Page 3583)

**HTMLBrowserForward**

**Description**

Performs the function "Forward" of the HTML browser.

**Use in the function list**

HTMLBrowserForward (Screen object)

**Use in user-defined functions**

-

**Parameters**

**Screen object**

Object name of the HTML browser in which the command is performed.

**See also**

Device dependency (Page 3583)

**HTMLBrowserBack**

**Description**

Performs the "Back" function of the HTML browser.

**Use in the function list**

HTMLBrowserBack (Screen object)

**Use in user-defined functions**

-

**Parameters**

**Screen object**

Object name of the HTML browser in which the command is performed.

## See also

Device dependency (Page 3583)

## ImportDataRecords

### Description

Imports one or all data records of a recipe from a CSV file.

When a path is specified, all records of the given directory are imported.

### Use in the function list

ImportDataRecords (File name, Data record number/name, Overwrite, Output status message, Processing status)

### Use in user-defined functions

ImportDataRecords (File\_name, Data\_record number/name, Overwrite, Output\_status\_message, Processing\_status)

Can be used if the configured device supports user-defined functions. For additional information, refer to "Device dependency".

## Parameter

### File name

Name of the CSV file from which the recipe data records are imported. Enter the file location and the file extension (\*.csv), for example "C:\TEMP\Orange.csv".

---

### Note

If a storage card is used as file location, specify the file location as follows: "\StorageCard \<File name>".

---

### Data record number/name

Number or name of the recipe data record to be imported. Specify "0" if all recipe data records are to be imported.

### Overwrite

Determines whether existing recipe data records are to be overwritten:

0 (hmiOverwriteForbidden) = No: Recipe data records are not overwritten. The import process will not be carried out.

1 (hmiOverwriteAlways) = Yes: Recipe data records are overwritten without prompting.

2 (hmiOverwriteWithPrompting) = With confirmation: Recipe data records are not overwritten until confirmed.

**Output status message**

Determines whether a status message is output after the import:

0 (hmiOff) = Off: Status message is not output.

1 (hmiOn) = On: Status message is output.

**Processing status**

Returns the processing status of the system function. You can use the return value, for example, to delay execution of other system functions until this system function has been successfully completed:

2 = System function is being performed.

4 = System function was successfully completed.

12 = System function was not performed because an error has occurred.

**Configurable objects**

Object	Event
Tag	Value change High limit violated Low limit violated
Function key (global)	Release Press
Function key (local)	Release Press
Screen	Loaded Cleared
Screen object	Press Release Click Change (or toggle for switch) Switch on Switch off Enable Disable
Scheduler	Time expired

**See also**

Device dependency (Page 3583)

## ImportDataRecordsWithChecksum

### Description

Imports one or all data records of a recipe from a CSV file with a checksum and verifies the checksum.

### Use in the function list

ImportDataRecordsWithChecksum (File name, Data record number/name, Overwrite, Output status message, Processing status, verify checksum)

### Use in user-defined functions

ImportDataRecordsWithChecksum (File\_name, Data\_record number/name, Overwrite, Output\_status\_message, Processing\_status, Verify\_Checksum)

Can be used if the configured device supports user-defined functions. For additional information, refer to "Device dependency".

### Parameter

#### File name

Name of the CSV file from which the recipe data records are imported. Enter the path and the file extension, for example, "C:\TEMP\Orange.CSV".

If a storage card is used as storage medium, specify the storage location as follows: "\\StorageCard\<File name>".

If you specify a directory instead of an individual CSV file, all files in the specified directory will be imported.

#### Data record number/name

Number or name of the recipe data record to be imported. Specify "0" if all recipe data records are to be imported.

#### Overwrite

Determines whether existing recipe data records are to be overwritten:

0 (hmiOverwriteForbidden) = No: Recipe data records are not overwritten. The import process will not be carried out.

1 (hmiOverwriteAlways) = Yes: Recipe data records are overwritten without prompting.

2 (hmiOverwriteWithConfirmation) = With confirmation: Recipe data records are not overwritten until confirmed.

#### Output status message

Determines whether a status message is output after the import:

0 (hmiOff) = Off: Status message is not output.

1 (hmiOn) = On: Status message is output.

#### Processing status

Returns the processing status of the system function. You can use the return value, for example to delay execution of other system functions, until this system function has been successfully completed.

2 = System function is being performed.

4 = System function was successfully completed.

12 = System function was not performed because an error has occurred.

#### Verify checksum

Determines if the checksum should be verified during import:

0 (hmiFalse) = No: Checksum is not verified.

1 (hmiTrue) = Yes: Checksum is verified.

#### See also

Device dependency (Page 3583)

#### InvertBit

#### Description

Inverts the value of the given tag of the "Bool" type:

- If the tag has the value of 1 (TRUE), it will be set to 0 (FALSE).
- If the tag has the value of 0 (FALSE), it will be set to 1 (TRUE).

#### Use in the function list

InvertBit (Tag)

#### Use in user-defined functions

InvertBit (Tag)

Can be used if the configured device supports user-defined functions. For additional information, refer to "Device dependency".

#### Parameters

##### Tag

The tag whose bit is set.

## Example

The following program code inverts the value of the boolean tag `b_value` and outputs the result along with the original `b_saved` value.

```
{
BOOL b_value = 0;
BOOL b_saved = b_value;

//Invert variable
invertBit(b_value);

//print current and saved value
printf ("Current value: %d\r\n, Saved value: %d\r\n",b_value, b_saved);
    ...
}
```

## See also

Device dependency (Page 3583)

## InvertBitInTag

### Description

Inverts a bit in the given tag:

- If the bit in the tag has the value of 1 (TRUE), it will be set to 0 (FALSE).
- If the bit in the tag has the value of 0 (FALSE), it will be set to 1 (TRUE).

After changing the given bit, the system function transfers the entire tag back to the PLC. It is not checked whether other bits in the tags have changed in the meantime. Operator and PLC have read-only access to the indicated tag until it is transferred back to the PLC.

---

### Note

If the PLC supports BOOL tags, do not use this system function. Use the "InvertBit" system function instead.

---

## Use in the function list

InvertBitInTag (Tag, Bit)

## Use in user-defined functions

InvertBitInTag (Tag, Bit)

Can be used if the configured device supports user-defined functions. For additional information, refer to "Device dependency".

## Parameters

### Tag

The tag in which the given bit is set.

### Bit

The number of the bit that is set.

When this system function is used in a user-defined function, the bits in a tag are counted from right to left. The counting begins with 0.

## Example

The following program code inverts a bit at the specified bitposition in the bvalue tag and outputs the result along with the original bsaved value.

```
{
BYTE bvalue;
BYTE bsaved = bvalue;
BYTE bitposition = 2;

//Invert bit in bitposition
InvertBitInTag (bvalue, bitposition);
//print current and saved value
printf ("Current value: %d\r\n, Saved value: %d\r\n",bvalue, bsaved);
...
}
```

## See also

Device dependency (Page 3583)

## InvertLinearScaling

### Description

Assigns a value to the tag X, which is calculated from the value of the given tag Y using the linear function  $X = (Y - b) / a$ .

The tags X and Y must not be identical. This system function is the inverse of the "LinearScaling" system function.

---

### Note

The tags X and Y must not be identical. If a tag is to be converted into itself, an auxiliary tag must be used.

The "SetTag" system function can be used to assign the value of the tags to be converted to the auxiliary tags.

---

### Use in the function list

InvertLinearScaling (X, Y, b, a)

### Use in user-defined functions

InverseLinearScaling (X, Y, b, a)

Can be used if the configured device supports user-defined functions. For additional information, refer to "Device dependency".

### Parameters

#### X

The tag which is assigned the value calculated from the linear equation.

#### Y

The tag that contains the value used for calculation.

#### b

The value which is subtracted.

#### a

The value through which is divided.

### Example

The following program code assigns a value to the varX tag by means of the InverseLinearScaling function.

```
{
BYTE varX;
BYTE Yvalue = 10;
BYTE bvalue = 3;
BYTE avalue = 4;

//Inverse linear scaling
InverseLinearScaling (varX, Yvalue, bvalue, avalue);

printf ("varX = %d\r\n", varX);
...
}
```

The saved return value can be processed in the following code.

### See also

Device dependency (Page 3583)



## CalibrateTouchScreen

### Description

Calls a program for calibrating the touch screen.

During the calibration process, there is a prompt to touch five positions on the screen display. Touch the screen display within 30 seconds, to confirm the calibration process. If the calibration is not completed within this time span, the calibration settings are discarded. The user prompt is in English.

Use this system function the first time you start the HMI device.

### Use in the function list

CalibrateTouchScreen

### Use in user-defined functions

CalibrateTouchScreen

Can be used if the configured device supports user-defined functions. For additional information, refer to "Device dependency".

### Parameter

--

---

#### Note

The CalibrateTouchScreen system function cannot be simulated.

---

### See also

Device dependency (Page 3583)

## CopyLog

### Description

Copies the contents of a log to another log. Tag values can only be copied to other data logs and alarms only to other alarm logs, however.

---

#### Note

If you copy a log using the "CopyLog" system function, it is possible that external applications will be unable to read certain country-specific special characters in the logged message text of the log copy. This does not apply to WinCC Runtime. WinCC Runtime can read the copied log files without errors.

---

### Use in the function list

CopyLog (Log type, Destination log, Source log, Mode, Delete source log)

### Use in user-defined functions

CopyLog (Log\_type, Destination log, Source\_log, Mode, Delete\_source\_log)

Can be used if the configured device supports user-defined functions. For additional information, refer to "Device dependency".

### Parameter

#### Log type

Determines the type of log:

0 (hmiTagArchive) = Data log

1 (hmiAlarmArchive) = Alarm log

#### Destination log

Name of the log into which the entries are copied (Destination log).

#### Source log

Name of the log from which the entries are copied (Source log).

#### Mode

Determines what is done with copied entries in the destination log:

0 (hmiOverwrite) = Overwrite: Existing entries are overwritten.

2 (hmiAppend) = Append: The entries are inserted at the end of the destination log. When the configured size of the log has been reached, the destination log is treated like a circular log.

#### Delete source log

Determines whether the source log is deleted after copying.

0 (hmiNo) = No: Is not deleted.

1 (hmiYes) = Yes: Is deleted.

### See also

Storage locations of logs (Page 3216)

Device dependency (Page 3583)

## TrendViewScrollForward

### Description

Scrolls forward one display width in the Trend view.

### Use in the function list

TrendViewScrollForward (Screen object)

### Use in user-defined functions

-

### Parameters

#### Screen object

Name of the trend view in which is scrolled forward.

### See also

Device dependency (Page 3583)

## TrendViewScrollBack

### Description

Scrolls back one display width to the left in the trend view.

### Use in the function list

TrendViewScrollBack (Screen object)

### Use in user-defined functions

-

## Parameters

### Screen object

Name of the trend view in which is scrolled back.

## See also

Device dependency (Page 3583)

## TrendViewExtend

### Description

Reduces the time period which is displayed in the trend view.

### Use in the function list

TrendViewExtend (Screen object)

### Use in user-defined functions

-

## Parameters

### Screen object

Name of the trend view in which the displayed time period is reduced.

## See also

Device dependency (Page 3583)

## TrendViewCompress

### Description

Increases the time period which is displayed in the trend view.

### Use in the function list

TrendViewCompress (Screen object)

### Use in user-defined functions

-

## Parameters

### Screen object

Name of the trend view in which the displayed time period is increased.

## See also

Device dependency (Page 3583)

## TrendViewRulerLeft

## Description

Moves the read-line backwards (to the left) in the trend view.

---

### Note

In order to be able to move the read-line, the read-line must have been switched on. This is done using the "TrendViewSetRulerMode" system function.

---

## Use in the function list

TrendViewRulerLeft (Screen object)

## Use in user-defined functions

-

## Parameters

### Screen object

Name of the trend view in which the read-line is moved backwards.

## See also

TrendViewSetRulerMode (Page 3663)

Device dependency (Page 3583)

## TrendViewRulerRight

### Description

Moves the read-line forwards (to the right) in the trend view.

---

#### Note

In order to be able to move the read-line, the read-line must have been switched on. This is done using the "TrendViewSetRulerMode" system function.

---

### Use in the function list

TrendViewRulerRight (Screen object)

### Use in user-defined functions

-

### Parameters

#### Screen object

Name of the trend view in which the read-line is moved forward.

### See also

TrendViewSetRulerMode (Page 3663)

Device dependency (Page 3583)

## TrendViewSetRulerMode

### Description

Hides or shows the read-line in the trend view. The read-line displays the Y value belonging to the X value.

---

#### Note

To ensure that the ruler is displayed, you have to activate the setting "Show ruler" in the trend view properties.

---

### Use in the function list

TrendViewSetRulerMode (Screen object)

## Use in user-defined functions

-

## Parameters

### Screen object

Name of the trend view in which the read-line is hidden or shown.

## See also

TrendViewRulerRight (Page 3662)

TrendViewRulerLeft (Page 3661)

Device dependency (Page 3583)

## TrendViewStartStop

### Description

Stops the trend recording or continues the trend recording in the trend view.

### Use in the function list

TrendViewStartStop (Screen object)

## Use in user-defined functions

-

## Parameters

### Screen object

Name of the trend view in which the recording of the trend is started or stopped.

## See also

Device dependency (Page 3583)

## TrendViewBackToBeginning

### Description

Scrolls back to the beginning of the display range in the trend view.

### Use in the function list

TrendViewBackToBeginning (Screen object)

### Use in user-defined functions

-

### Parameters

#### Screen object

Name of the trend view in which you scroll to the beginning of the display range.

### See also

Device dependency (Page 3583)

## LoadDataRecord

### Description

Loads the given recipe data record from the memory medium of the HMI device in the recipe tags. This system function is used, for example, to display a recipe data record in the recipe screen.

Activate the "Synchronize recipe view and recipe tags" option in the synchronization settings of the recipe. If this option is deactivated, the system function has no effect.

### Use in the function list

LoadDataRecord (Recipe number/name, Data record number/name, Processing status)

### Use in user-defined functions

LoadDataRecord (Recipe\_number/name, Data\_record\_number/name, Confirmation, Output\_status\_message, Processing\_status)

Can be used if the configured device supports user-defined functions. For additional information, refer to "Device dependency".

### Parameter

#### Recipe number/name

Number or name of the recipe from which a recipe data record is loaded.

#### Data record number/name

Number or name of the recipe data record to be loaded.



### Processing status

Returns the processing status of the system function. You can use the return value, for example, to delay execution of other system functions until this system function has been successfully completed:

2 = System function is being performed.

4 = System function was successfully completed.

12 = System function was not performed because an error has occurred.

### See also

Device dependency (Page 3583)

## GetUserName

### Description

Writes the user name of the user currently logged on to the HMI device in the given tag.

If the given tag has a control connection, the user name is also available in the PLC connection. This system function makes it possible, for example, to implement a user-dependent release of certain functionalities.

### Use in the function list

GetUserName (Tag)

### Use in user-defined functions

GetUserName (Tag)

Can be used if the configured device supports user-defined functions. For additional information, refer to "Device dependency".

### Parameter

#### Tag

The tag to which the user name is written.

### See also

Device dependency (Page 3583)

## GetDataRecordFromPLC

### Description

Transfers the selected recipe data record from the PLC to the storage medium of the HMI device.

### Use in the function list

GetDataRecordFromPLC (Recipe number/name, Data record number/name, Overwrite, Output status message, Processing status)

### Use in user-defined functions

GetDataRecordFromPLC (Recipe\_number/name, Data\_record\_number/name, Overwrite, Output\_status\_message, Processing\_status)

Can be used if the configured device supports user-defined functions. For additional information, refer to "Device dependency".

### Parameter

#### Recipe number/name

Number or name of the recipe from which recipe data records are transferred.

#### Data record number/name

Number or name of the recipe data record which is transferred from the PLC to the data medium of the HMI device.

#### Overwrite

Determines whether an existing recipe data record with the same name is overwritten:

0 (hmiOverwriteForbidden) = No: Recipe data record is not overwritten. The transfer process will not be carried out.

1 (hmiOverwriteAlways) = Yes: Recipe data record is overwritten without prompting.

2 (hmiOverwriteWithPrompting) = With confirmation: Recipe data record is not overwritten until confirmed.

#### Output status message

Determines whether a status message is output after the transfer:

0 (hmiOff) = Off: Status message is not output.

1 (hmiOn) = On: Status message is output.

#### Processing status

Returns the processing status of the system function. You can use the return value, for example, to delay execution of other system functions until this system function has been successfully completed:

2 = System function is being performed.

4 = System function was successfully completed.

12 = System function was not performed because an error has occurred.

### Application example

You want to transfer a data record from the PLC to the data medium of the HMI device using a key.

#### Notes on configuring

Configure the "GetDataRecordFromPLC" system function on the "Press" event for the desired key. Transfer the following parameters:

Recipe number/name = 1

Data record number/name = 1

Overwrite = 1

Output status message = 1

Tags can also be specified in place of the constants. Depending on the configuration, the operator can enter the desired values in the I/O field or read from the PLC. In this way, the operator can determine which recipe data record is transferred from the PLC.

#### Procedure on HMI device

As soon as the key is activated, the system function is triggered. The constants or tags are evaluated and the first data record of Recipe 1 is transferred from the PLC to the data medium of the HMI device. If the recipe data record already exists, it will be overwritten.

A system message is output after the transfer.

### See also

Device dependency (Page 3583)

## GetDataRecordName

### Description

Writes the name of the given recipe and recipe data record to the given tags.

---

#### Note

If the recipe or the recipe data record do not exist, wildcards ("###") are written to the tags.

---

### Use in the function list

GetDataRecordName (Recipe number, Data record number, Recipe name, Data record name, Processing status)

## Use in user-defined functions

GetDataRecordName (Recipe\_number, Data\_record\_number, Recipe\_name, Data\_record\_name, Processing\_status)

Can be used if the configured device supports user-defined functions. For additional information, refer to "Device dependency".

## Parameter

### Recipe number

Number of the recipe whose name is written to the given tag.

### Data record number

Number of the recipe data record whose name is written to the given tag.

### Recipe name

The tag to which the recipe name is written. The tag must be of the STRING type.

### Data record name

The tag to which the name of the recipe data record is written. The tag must be of the STRING type.

### Processing status

Returns the processing status of the system function. You can use the return value, for example, to delay execution of other system functions until this system function has been successfully completed:

2 = System function is being performed.

4 = System function was successfully completed.

12 = System function was not performed because an error has occurred.

## Application example

You want to output the names of the displayed recipes and the name of the displayed recipe data record on the HMI device.

Configure the following tags:

- "RecNumber" of type INTEGER
- "RecDataNumber" of type INTEGER
- "RecName" of type STRING
- "RecDataName" of type STRING

Configure a recipe view with the tags "RecNumber" for the recipe number and "RecDataNumber" for the data record number.

Configure the "GetDataRecordName" system function on the "Press" event for a button and pass the following parameters:

- Recipe number: RecNumber
- Data record number: RecDataNumber
- Recipe name: RecName
- Data record name: RecDataName

Configure two output fields and connect these to the "RecName" and "RecDataName" tags.

Select a recipe and a data record number from the recipe view. As soon as the button is activated, the system function is triggered and the name of the recipe and the recipe data record are displayed in both output fields.

### See also

Device dependency (Page 3583)

## GetDataRecordTagsFromPLC

### Description

Transfers the values of the recipe data record loaded in the PLC to the corresponding recipe tags.

This system function is used, for example, during teach-in mode on a machine.

### Use in the function list

GetDataRecordTagsFromPLC (Recipe number/name, Processing status)

### Use in user-defined functions

GetDataRecordTagsFromPLC (Recipe\_number/name, Processing\_status)

Can be used if the configured device supports user-defined functions. For additional information, refer to "Device dependency".

### Parameter

#### Recipe number/name

Number or name of the recipe data record whose values are written from the PLC to the tags.

#### Processing status

Returns the processing status of the system function. You can use the return value, for example, to delay execution of other system functions until this system function has been successfully completed:

2 = System function is being performed.

4 = System function was successfully completed.

12 = System function was not performed because an error has occurred.

### See also

Device dependency (Page 3583)

## GetGroupNumber

### Description

Reads the number of the group to which the user logged on to the HMI device belongs, and writes it to the given tag.

### Use in the function list

GetGroupNumber (Tag)

### Use in user-defined functions

GetGroupNumber (Tag)

Can be used if the configured device supports user-defined functions. For additional information, refer to "Device dependency".

### Parameter

#### Tag

The tag to which the number of the group is written.

### See also

Device dependency (Page 3583)

## GetBrightness

### Description

Reads the value of the brightness.

### Use in the function list

GetBrightness (Brightness)

### Use in user-defined functions

GetBrightness (Brightness)

Can be used if the configured device supports user-defined functions. For additional information, refer to "Device dependency".

### Parameter

#### **Brightness**

The tag to which the value is written.

### See also

Device dependency (Page 3583)

### GetPassword

### Description

Writes the password of the user currently logged on to the HMI device in the given tag.

---

#### **Note**

Make sure that the value of the given tag is not displayed in another place in the project.

---

#### **Note**

The passwords of SIMATIC Logon users cannot be read.

---

### Use in the function list

GetPassword (Tag)

### Use in user-defined functions

GetPassword (Tag)

Can be used if the configured device supports user-defined functions. For additional information, refer to "Device dependency".

### Parameter

#### **Tag**

The tag to which the password is written.

## See also

Device dependency (Page 3583)

System functions for Runtime Advanced (Page 3614)

## ReadPLCMode

### Description

Evaluates the current state of the connected PLC.

The system function "ReadPLCMode" can only be configured for the following PLCs:

- SIMATIC S7 1200
- SIMATIC S7 1500

### Use in the function list

ReadPLCMode (connection, mode)

### Use in user-defined functions

GetPLCMode (Connection, Mode)

### Parameter

#### Connection

Connection of PLC and HMI device.

#### Mode

Evaluates the state of the connected PLC.

For the evaluation, select the tag "@DiagnosticsIndicatorTag".

## LinearScaling

### Description

Assigns a value to the tag Y, which is calculated from the value of the given tag X using the linear function  $Y = (a * X) + b$ .



The inverse of this function is the "InvertLinearScaling" system function.

---

**Note**

The tags X and Y must not be identical. If a tag is to be converted into itself, an auxiliary tag must be used.

The "SetTag" system function can be used to assign the value of the tags to be converted to the auxiliary tags.

---

**Use in the function list**

LinearScaling (Y, a, X, b)

**Use in user-defined functions**

LinearScaling (Y, a, X, b)

Can be used if the configured device supports user-defined functions. For additional information, refer to "Device dependency".

**Parameters****Y**

The tag which is assigned the value calculated from the linear equation.

**a**

The value with which is multiplied.

**X**

The tag that contains the value used for calculation.

**b**

The value that is added.

**Example**

The following program code uses the LinearScaling function to assign a value to the Yvar tag.

```
{  
BYTE Yvar;  
BYTE Xvalue = 10;  
BYTE bvalue = 3;  
BYTE avalue = 4;  
  
// linear scaling  
LinearScaling ( Yvar, avalue, Xvalue, bvalue);  
}
```

```
printf ("Yvar = %d\r\n", Yvar);  
...  
}
```

The saved return value can be processed in the following code.

### See also

Device dependency (Page 3583)

### ClearLog

#### Description

Deletes all data records in the given log.

#### Use in the function list

ClearLog (Log type, Log)

#### Use in user-defined functions

ClearLog (Log\_type, Log)

Can be used if the configured device supports user-defined functions. For additional information, refer to "Device dependency".

#### Parameter

##### Log type

Determines the type of log:

0 (hmiTagArchive) = Data log

1 (hmiAlarmArchive) = Alarm log

2 (hmiAudittrailArchive) = Audit trail log Available for GMP-compliant projects Additional information is available under "Activating GMP-compliant configuration".

##### Log

Name of the log from which all entries are deleted.

### See also

Device dependency (Page 3583)

## ClearDataRecord

### Description

Deletes a recipe data record.

Several data records can be deleted from one or more recipes.

### Use in the function list

ClearDataRecord (Recipe number/name, Data record number/name, Confirmation, Output status message, Processing status)

### Use in user-defined functions

ClearDataRecord

Can be used if the configured device supports user-defined functions. For additional information, refer to "Device dependency".

### Parameter

#### Recipe number/name

Number or name of the recipe from which recipe data records are deleted. "0" is specified if you want to delete recipe data records from all available recipes.

#### Data record number/name

Number or name of the recipe data record to be deleted. "0" is specified if you want to delete all recipe data records.

#### Confirmation

Determines whether the operator should confirm the deletion:

0 (hmiOff) = Off: Deletion is begun without confirmation.

1 (hmiOn) = On: The starting of the deletion process must be confirmed.

#### Output status message

Determines whether a status message is output after the deletion:

0 (hmiOff) = Off: Status message is not output.

1 (hmiOn) = On: Status message is output.

#### Processing status

Returns the processing status of the system function. You can use the return value, for example, to delay execution of other system functions until this system function has been successfully completed:

2 = System function is being performed.

4 = System function was successfully completed.

12 = System function was not performed because an error has occurred.

### See also

Device dependency (Page 3583)

## ClearDataRecordMemory

### Description

Deletes all recipes data records from the specified storage medium.

### Use in the function list

ClearDataRecordMemory (Storage location, Confirmation, Output status message, Processing status)

### Use in user-defined functions

ClearDataRecordMemory (Storage\_location, Confirmation, Output\_status\_message, Processing\_status)

Can be used if the configured device supports user-defined functions. For additional information, refer to "Device dependency".

### Parameter

#### Storage location

Determines the storage location:

0 (hmiFlashMemory) = Flash memory: Internal flash memory of the HMI device

1 (hmiStorageCard) = Storage card

2 (hmiStorageCard2) = Storage card 2

3 (hmiStorageCard3) = Storage card MultiMediaCard

4 (hmiStorageCard4) = Storage card USB

#### Confirmation

Determines whether the operator should confirm the deletion:

0 (hmiOff) = Off: Deletion is begun without confirmation.

1 (hmiOn) = On: The starting of the deletion process must be confirmed.

#### Output status message

Determines whether a status message is output after the deletion:

0 (hmiOff) = Off: Status message is not output.

1 (hmiOn) = On: Status message is output.

#### Processing status

Returns the processing status of the system function. You can use the return value, for example, to delay execution of other system functions until this system function has been successfully completed:

2 = System function is being performed.

4 = System function was successfully completed.

12 = System function was not performed because an error has occurred.

#### See also

Device dependency (Page 3583)

#### ClearAlarmBuffer

#### Description

Deletes alarms from the alarm buffer on the HMI device.

---

#### Note

Alarms which have not yet been acknowledged are also deleted.

---

#### Use in the function list

ClearAlarmBuffer (Alarm class number)

#### Use in user-defined functions

ClearAlarmBuffer (Alarm\_class\_number)

Can be used if the configured device supports user-defined functions. For additional information, refer to "Device dependency".

#### Parameter

##### Alarm class number

Determines which alarms are to be deleted from the alarm buffer:

0 (hmiAll) = All alarms/events

1 (hmiAlarms) = Alarms of alarm class "Errors"

2 (hmiEvents) = Alarms of alarm class "Warnings"

3 (hmiSystem) = Alarms of alarm class "System"

4 (hmiS7Diagnosis) = Alarms of alarm class "Diagnosis Events"

---

**Note**

**Device dependency**

Alarms of alarm class "Diagnosis Events" are not available on Basic Panels.

---

**See also**

Device dependency (Page 3583)

**ClearAlarmBufferProTool**

**Description**

The system function exists to ensure compatibility.

It has the same functionality as the "ClearAlarmBuffer" system function, but uses the old ProTool numbering.

**Use in the function list**

ClearAlarmBufferProTool (Alarm class number)

**Use in user-defined functions**

ClearAlarmBufferProtoolLegacy (Alarm\_class\_number)

Can be used if the configured device supports user-defined functions. For additional information, refer to "Device dependency".

**Parameter**

**Alarm class number**

Alarm class number whose messages are to be deleted:

-1 (hmiAllProtoolLegacy) = All alarms/events

0 (hmiAlarmsProtoolLegacy) = Alarms of alarm class "Errors"

1 (hmiEventsProtoolLegacy) = Alarms of alarm class "Warnings"

2 (hmiSystemProtoolLegacy) = Alarms of alarm class "System"

3 (hmiS7DiagnosisProtoolLegacy) = Alarms of alarm class "Diagnosis Events"

---

**Note**

**Device dependency**

Alarms of alarm class "Diagnosis Events" are not available on Basic Panels.

---

**See also**

Device dependency (Page 3583)

**AlarmViewUpdate**

**Description**

Updates the enhanced alarm view.

**Use in the function list**

AlarmViewUpdate (Screen object)

**Use in user-defined functions**

-

**Parameters**

**Screen object**

Name of the alarm view which is updated.

**See also**

Device dependency (Page 3583)

**AlarmViewEditAlarm**

**Description**

Triggers the event "Edit" for all alarms selected in the given alarm view.

This system function is used when the integrated button of the ActiveX control should not be used.

A system function can in turn be configured on the "Edit" event. For example, it is possible to change to the process screen in which the alarm appeared.

---

**Note**

If the alarms to be edited have not yet been acknowledged, the acknowledgment takes place automatically when this system function is called up.

---

**Use in the function list**

AlarmViewEditAlarm (Screen object)

**Use in user-defined functions**

-

**Parameters**

**Screen object**

Name of the alarm view in which the event is triggered.

---

**Note**

The HMI devices listed below do not support this system function for the "screen" object: OP 73, OP 77A, TP 177A.

---

**See also**

Device dependency (Page 3583)

**AlarmViewAcknowledgeAlarm**

**Description**

Acknowledges the alarms selected in the given alarm view.

This system function is used when the integrated button of the ActiveX control should not be used.

**Use in the function list**

AlarmViewAcknowledgeAlarm (Screen object)



### Use in user-defined functions

-

### Parameters

#### Screen object

Name of the alarm view in which the event is triggered.

---

#### Note

The HMI devices listed below do not support this system function for the "screen" object: OP 73, OP 77A, TP 177A.

---

### See also

Device dependency (Page 3583)

### AlarmViewShowOperatorNotes

### Description

Displays the configured tooltip of the alarm selected in the given alarm view.

### Use in the function list

AlarmViewShowOperatorNotes (Screen object)

### Use in user-defined functions

-

### Parameters

#### Screen object

Name of the alarm view in which the event is triggered.

---

#### Note

The HMI devices listed below do not support this system function for the "screen" object: OP 73, OP 77A, TP 177A.

---

### See also

Device dependency (Page 3583)

## OpenAllLogs

### Description

Reestablishes the connection between WinCC and the logs. Logging can be continued.

---

#### Note

Run the "StartLogging" system function in order to restart logging.

---

### Use in the function list

OpenAllLogs

### Use in user-defined functions

OpenAllLogs

Can be used if the configured device supports user-defined functions. For additional information, refer to "Device dependency".

### Parameter

--

### Application example

You are in runtime and want to change the data medium on which the process values are logged.

#### Notes on configuring

Configure the "StopLogging" and "CloseAllLogs" system functions on the "Close Archive" button.

Configure the "OpenAllLogs" and "StartLogging" system functions on the "Open Archive" button.

As parameter transfer the respective name of the log that is to be stopped and started.

#### Procedure on HMI device

When the button "Close Archive" is pressed, the specified log is stopped and all open logs are closed. The data medium can be changed. You open all logs with the "Open Archive" button. Logging will be continued in the specified log.

### See also

Device dependency (Page 3583)

## OpenScreenKeyboard

### Description

Hides or shows the screen keyboard.

The screen keyboard remains open until the screen keyboard is explicitly closed. In this way, the screen keyboard can also be used in other applications.

### Use in the function list

OpenScreenKeyboard (Layout)

### Use in user-defined functions

OpenScreenKeyboard (Display\_mode)

Can be used if the configured device supports user-defined functions. For additional information, refer to "Device dependency".

### Parameter

#### Layout

Specifies whether the window is opened minimized or maximized with the screen keyboard:

0 (hmiScreenKeyboardMinimized) = Minimized

1 (hmiScreenKeyboardMaximized) = Maximized

### See also

Device dependency (Page 3583)

## OpenFileBrowser

### Description

Opens a file browser dialog.

Depending on the mode the user can select a file or a folder.

### Use in the function list

OpenFileBrowser (Mask, Output Folder, File, Navigation Back, Navigation Up, New folder, Path, Status)

### Use in user-defined functions

-

## Parameters

### Mask

Sets a mask for filtering the displayed files. This parameter is only evaluated in "File" mode. The filter criteria must be delimited by ; semicolon. Example: \*.htm;\*.html

### Output Folder

Sets the output folder that is used to start the file selection dialog.

### File

Sets the mode for opening the dialog.

0 = file search mode

1 = folder search mode

### Navigation Back

Specifies whether or not the "Back" button is activated. This button offers simple navigation to the last folder you opened.

### Navigation Up

Specifies whether or not the "Up" button is activated. This button offers simple navigation to the parent folder.

### Navigation Back

Specifies whether or not the "Back" button is activated. This button offers simple navigation to the last folder you opened.

### New folder

Specifies whether or not the button can be used to create a new folder.

### Path

Contains the path name of the last folder opened after you close the dialog.

### Status

Returns information about the dialog closing mode

-1 = dialog was canceled

0 = dialog was closed with "OK".

## OpenControlPanelDialog

### Description

Opens a dialog that you can use to edit selected Control Panel settings.

This system function lets you set the following on the HMI device:

- Properties and value of the IP address
- User identification on the network
- WinCC Internet settings

---

**Note**

**Project security**

The "OpenControlPanelDialog" system function is used to bypass the SecureMode on the HMI device. Take the corresponding precautions to ensure the security of your project.

---

**Use in the function list**

OpenControlPanelDialog (Dialog)

**Use in user-defined functions**

-

**Parameters**

**Dialog**

Sets the Control Panel dialog to be opened.

- PROFINET\_X1: Setting of the IP address and Ethernet parameters
- PROFINET\_X3: Setting of the IP address and Ethernet parameters; only for Comfort Panel KP 1500, TP 1500; TP1900, TP2200
- WinCC Internet settings: Setting for Web Server, e-mail notification, provided the HMI device supports these functions
- Network ID: Setting for identification on the network, provided the HMI device supports these functions

**See also**

Device dependency (Page 3583)

**OpenCommandPrompt**

**Description**

Opens a Windows system prompt.

This function is used, e.g., to copy files or to call up another application.

### Use in the function list

OpenCommandPrompt

### Use in user-defined functions

OpenCommandPrompt

Can be used if the configured device supports user-defined functions. For additional information, refer to "Device dependency".

### Parameter

--

### See also

Device dependency (Page 3583)

## OpenInternetExplorer

### Description

Opens the Internet Explorer on the HMI device.

If the Internet Explorer is already open, it will be closed and reopened when you call the system function.

---

#### Note

The Internet Explorer saves data temporarily in the DRAM file system of the HMI device, e.g. the last web sites that were be called up.

This data can be saved using the "BackupRAMFileSystem" system function so that it is still available when the HMI device is restarted.

---

### Use in the function list

OpenInternetExplorer (Start page)

### Use in user-defined functions

OpenInternetExplorer (Start\_page)

Can be used if the configured device supports user-defined functions. For additional information, refer to "Device dependency".

## Parameter

### Start page

The page which is loaded when Internet Explorer is started, e.g. "www.siemens.com".

## See also

Device dependency (Page 3583)

## OpenControlPanel

### Description

Opens the window that displays the Windows CE control panel. You cannot use this system function on a PC.

This system function enables you to set the following on the Windows CE-based HMI device:

- Select printer
- Select transfer properties
- Configure screen saver
- Configure flash memory

---

### Note

#### No backup or restore during Runtime

Backup and restore functions may only be executed if Runtime has been terminated. Otherwise, this could result in undesired effects, such as display errors.

---

### Use in the function list

OpenControlPanel

### Use in user-defined functions

OpenControlPanel

Can be used if the configured device supports user-defined functions. For additional information, refer to "Device dependency".

### Parameters

--

## OpenTaskManager

### Description

Shows the task manager.

The task manager allows changing to other open applications on the HMI device.

---

#### Note

The appearance of the task manager depends on the operating system installed.

---

### Use in the function list

OpenTaskManager

### Use in user-defined functions

OpenTaskManager

Can be used if the configured device supports user-defined scripts. For additional information, refer to "Device dependency".

### Parameter

--

### See also

Device dependency (Page 3583)

## AcknowledgeAlarm

### Description

Acknowledges all selected alarms.

This system function is used when the HMI device does not have an ACK key or when the integrated key of the alarm view should not be used.

This system function can only be used for function keys.

### Use in the function list

AcknowledgeAlarm



### Use in user-defined functions

AcknowledgeAlarm

Can be used if the configured device supports user-defined functions. For additional information, refer to "Device dependency".

### Parameter

--

### See also

Device dependency (Page 3583)

## RecipeViewNewDataRecord

### Description

Creates a new data record in the given recipe view.

### Use in the function list

RecipeViewNewDataRecord (Screen object)

### Use in user-defined functions

-

### Parameters

#### Screen object

Name of the recipe view in which the new recipe data record is created.

### See also

Device dependency (Page 3583)

## RecipeViewGetDataRecordFromPLC

### Description

Transfers the data record that is currently loaded in the PLC to the HMI device and displays it in the recipe view.

### Use in the function list

RecipeViewGetDataRecordFromPLC (Screen object)

### Use in user-defined functions

-

### Parameters

#### Screen object

Name of the recipe view in which the recipe data record from the PLC is displayed.

### See also

Device dependency (Page 3583)

## RecipeViewClearDataRecord

### Description

Deletes the data record which is currently displayed in the recipe view.

### Use in the function list

RecipeViewClearDataRecord (Screen object)

### Use in user-defined functions

-

### Parameters

#### Screen object

Name of the recipe view in which the displayed recipe data record is deleted.

### See also

Device dependency (Page 3583)

## RecipeViewMenu

### Description

Opens the menu of the specified simple recipe view.

Only use this system function at a simple recipe view.

### Use in the function list

RecipeViewMenu (Screen object)

### Use in user-defined functions

-

### Parameters

#### Screen object

Name of the recipe view in which the menu is to be opened.

### See also

Device dependency (Page 3583)

## RecipeViewOpen

### Description

Displays the data record values in the given recipe view or changes to the next selection field. The system function has no effect if the selection field for the recipe data record values is displayed on the HMI device.

Operation sequence of the selection lists in runtime:

- Recipe name
- Data record name
- RecipeDataRecordValues

This system function is used when a simple recipe view has been configured. In the simple recipe view, only one selection list is displayed at a time on the HMI device. Use the "RecipeViewBack" system function to display the previous selection list.

### Use in the function list

RecipeViewOpen (Screen object)

### Use in user-defined functions

-

## Parameters

### Screen object

Name of the recipe view in which the command is triggered.

## See also

Device dependency (Page 3583)

RecipeViewBack (Page 3696)

## RecipeViewSetDataRecordToPLC

### Description

Transfers the recipe data record which is currently displayed in the recipe view to the PLC.

### Use in the function list

RecipeViewSetDataRecordToPLC (Screen object)

### Use in user-defined functions

-

## Parameters

### Screen object

Name of the recipe view from which the recipe data record is transferred to the connected PLC.

## See also

Device dependency (Page 3583)

## RecipeViewSaveDataRecord

### Description

Saves the recipe data record which is currently displayed in the recipe view.

### Use in the function list

RecipeViewSaveDataRecord (Screen object)

### Use in user-defined functions

-

### Parameters

#### Screen object

Name of the recipe view in which the recipe data record is saved.

### See also

Device dependency (Page 3583)

### RecipeViewSaveAsDataRecord

### Description

Saves the data record currently being displayed in the recipe view under a new name.

### Use in the function list

RecipeViewSaveAsDataRecord (Screen object)

### Use in user-defined functions

-

### Parameters

#### Screen object

Saves the data record currently being displayed in the recipe view under a new name and/or new number.

### See also

Device dependency (Page 3583)

### RecipeViewSynchronizeDataRecordWithTags

### Description

Synchronizes the values of the data record which is currently displayed in the recipe view with their recipe tags. Only use this system function at an advanced recipe view.

During synchronization, all values of the data record are written to their recipe tags.

### Use in the function list

RecipeViewSynchronizeDataRecordWithTags (Screen object)

### Use in user-defined functions

-

### Parameters

#### Screen object

Name of the recipe view in which the values are synchronized with their tags.

---

#### Note

The OP 77A and TP 177A HMI devices do not support this function for the screen object.

---

### See also

Device dependency (Page 3583)

## RecipeViewRenameDataRecord

### Description

Renames the selected data record in the given recipe view.

Only use this system function at a simple recipe view.

### Use in the function list

RecipeViewRenameDataRecord (Screen object)

### Use in user-defined functions

-

### Parameters

#### Screen object

Name of the recipe view in which the recipe data record is renamed.

### See also

Device dependency (Page 3583)

## RecipeViewShowOperatorNotes

### Description

Displays the configured tooltip of the specified recipe view.

### Use in the function list

RecipeViewShowOperatorNotes (Screen object)

### Use in user-defined functions

-

### Parameters

#### Screen object

Name of the recipe view whose configured tooltip is displayed.

### See also

Device dependency (Page 3583)

## RecipeViewBack

### Description

Returns to the previous selection list in the given recipe view.

The system function has no effect if the selection field for the recipe is displayed on the HMI device. Operation sequence of the selection lists in runtime:

- Recipe name
- Data record name
- RecipeDataRecordValues

This system function is used when a simple recipe view has been configured. In the simple recipe view, only one selection list is displayed at a time on the HMI device. Use the "RecipeViewOpen" system function to display the recipe data record values or the next selection field.

### Use in the function list

RecipeViewBack (Screen object)

## Use in user-defined functions

-

## Parameters

### Screen object

Name of the recipe view in which the command is triggered.

## See also

Device dependency (Page 3583)

## ResetBit

## Description

Sets the value of a "Bool" type tag to 0 (FALSE).

## Use in the function list

ResetBit (Tag)

## Use in user-defined functions

ResetBit (Tag)

Can be used if the configured device supports user-defined functions. For additional information, refer to "Device dependency".

## Parameters

### Tag

The BOOL type tag which is set to 0 (FALSE).

## Example

The following program code resets the value of the boolean tag b\_value to 0 by means of the ResetBit function and outputs the result along with the original b\_saved value.

```
{  
BOOL b_value = 1;  
BOOL b_saved = b_value;  
  
//Reset bit  
ResetBit (b_value);
```



```
//print current and saved value
printf ("Current value: %d\r\n, Saved value: %d\r\n",b_value, b_saved);
...
}
```

## See also

ResetBitInTag (Page 3698)

Device dependency (Page 3583)

## ResetBitInTag

### Description

Sets a bit in the specified tag to 0 (FALSE).

After changing the given bit, the system function transfers the entire tag back to the PLC. It is not checked whether other bits in the tags have changed in the meantime. Operator and PLC have read-only access to the indicated tag until it is transferred back to the PLC.

---

#### Note

If the PLC supports BOOL tags, do not use this system function. Use the "ResetBit" system function instead.

---

### Use in the function list

ResetBitInTag (Tag, Bit)

### Use in user-defined functions

ResetBitInTag (Tag, Bit)

Can be used if the configured device supports user-defined functions. For additional information, refer to "Device dependency".

### Parameters

#### Tag

The tag in which a bit is set to 0 (FALSE).

#### Bit

The number of the bit that is set to 0 (FALSE).

When this system function is used in a user-defined function, the bits in the specified tag will be counted from right to left independent of the PLC used. The counting begins with 0.

## Example

The following program code sets a bit at the specified bitposition in the bvalue tag to 0 and outputs the result along with the original bsaved value.

```
{
BYTE bvalue;
BYTE bsaved = bvalue;
BYTE bitposition = 2;

//Reset bit in bitposition
ResetBitInTag (bvalue, bitposition);

//print current and saved value
printf ("Current value: %d\r\n, Saved value: %d\r\n",bvalue, bsaved);
    ...
}
```

## See also

Device dependency (Page 3583)

ResetBit (Page 3696)

## PressButton

### Description

The system function can only be configured on the function keys of an HMI device and triggers the "Press key" event at the specified screen object.

Use this system function when you want to operate a button in a screen with a function key of the HMI device, for example.

---

#### Note

The "PressButton" and "ReleaseButton" system functions must always be configured together. If you configure the "PressButton" system function on the "Press key" event for a function key, the "ReleaseButton" system function is configured on the "Release" event for the same function key.

---

### Use in the function list

PressButton (Screen object)

### Use in user-defined functions

-

## Parameters

### Screen object

Name of the screen object on which the event is triggered.

## See also

Device dependency (Page 3583)

## ReleaseButton

## Description

The system function can only be configured on the function keys of an HMI device and triggers the "Release button" event at the specified screen object.

Use this system function when you want to operate a button in a screen with a function key of the HMI device, for example.

---

### Note

The "PressButton" and "ReleaseButton" system functions must always be configured together. If you configure the "PressButton" system function on the "Press key" event for a function key, then the "ReleaseButton" system function is configured on the "Release key" event for the same function key.

---

## Use in the function list

ReleaseButton (Screen object)

## Use in user-defined functions

-

## Parameters

### Screen object

Name of the screen object on which the event is triggered.

## See also

Device dependency (Page 3583)

## ShiftAndMask

### Description

This system function converts the input bit pattern of the source tags into an output bit pattern of the target tags. This involves bit shifting and masking.

---

#### Note

If the source and target tag have a different number of bits, using the system function in the target tag can result in a violation of the value range.

---

### Use in the function list

ShiftAndMask (Source tag, Target tag, Bits to shift, Bits to mask)

### Use in user-defined functions

ShiftAndMask (Source\_tag, Target\_tag, Bits\_to\_shift, Bits\_to\_mask)

Can be used if the configured device supports user-defined functions. For additional information, refer to "Device dependency".

### Parameter

#### Source tag

The tag includes the input bit pattern. Integer-type tags, e.g. "Byte", "Char", "Int", "UInt", "Long" and "ULong" are permitted.

Example: The actual value 72 is set at the 16-bit integer source tag: 0000000001001000.

#### Target tag

The output bit pattern is saved in the tag. Integer type tags, e.g. "Byte", "Char", "Int", "UInt", "Long" and "ULong" are permitted.

Example: The shifted input bit pattern is multiplied by the bit mask, with bit-by-bit logical AND operation: 0000000000001001. The resultant decimal value "8" is saved to the target tag.

Please note the following:

- The source and target tags have the same number of bits.
- The number of bits to shift is less than the number of bits in the source tag and target tag.
- Bits to mask does not have more bits than the source tag and the target tag.

#### Bits to shift

Number of bits by which the input bit pattern is shifted right. A negative value shifts the input bit pattern to the left.

Example: "Bits to shift" has the value "+3". The input bit pattern is shifted right by three bits when the system function is called: 0000000000001001.

Bits to the left are padded with "0". Three bits are truncated on the right. The new decimal value is "9".

---

**Note**

The left bit is "1" in a source tag of the data type with negative signed integer. This sign bit is padded with "0" when the bits are shifted right. The sign changes to "+".

---

**Bits to mask**

An integer serves as bit mask. The bit pattern is used to multiply the shifted input bit pattern. Example: Integer "2478" with the bit pattern "0000100110101110".

You can enter the bit mask in three different ways:

- Hexadecimal: First enter the prefix "0h" or "0H", followed by an optional space for better readability. Then group the bit pattern in blocks of four (0000)(1001)(1010)(1110) and set each block in hexadecimal code: (0)(9)(A)(E). Only the characters 0-9, A-F, a-f are allowed: "0h 09AE".
- Binary: First enter the prefix "0b" or "0B", followed by an optional space for better readability. Then group the binary bit pattern into blocks of four 0000 1001 1010 1110 with spaces in between as a check. Only the characters "0" or "1" are allowed: "0b 0000 1001 1010 1110".
- Decimal: Enter the value "2478" directly, without a prefix.

**See also**

Device dependency (Page 3583)

**CloseAllLogs****Description**

Disconnects the connection between WinCC and all logs.

---

**Note**

Before you close a log, the logging function must first be stopped in the log. Use the "StopLogging" system function.

---

**Use in the function list**

CloseAllLogs

**Use in user-defined functions**

CloseAllLogs

Can be used if the configured device supports user-defined functions. For additional information, refer to "Device dependency".

### Parameter

--

### Application example

You are in runtime and want to change the data medium on which the process values are logged.

#### Notes on configuring

Configure the "StopLogging" and "CloseAllLogs" system functions on the "Close Archive" button.

Configure the "OpenAllLogs" and "StartLogging" system functions on the "Open Archive" button.

As parameter transfer the respective name of the log that is to be stopped and started.

#### Procedure on HMI device

When the button "Close Archive" is pressed, the specified log is stopped and all open logs are closed. The data medium can be changed. You open all logs with the "Open Archive" button. The logging process will continue in the specified log.

### See also

Device dependency (Page 3583)

## SetDataRecordToPLC

### Description

Transfers the given recipe data record directly from the data medium of the HMI device to the PLC with which the HMI device is connected.

---

#### Note

The values of the recipe data record don't need to be displayed on the HMI device.

---

### Use in the function list

SetDataRecordToPLC (Recipe number/name, Data record number/name, Output status message, Processing status)

## Use in user-defined functions

SetDataRecordToPLC (Recipe\_number/name, Data\_record\_number/name, Output\_status\_message, Processing\_status)

Can be used if the configured device supports user-defined functions. For additional information, refer to "Device dependency".

## Parameter

### Recipe number/name

Number or name of the recipe from which recipe data record is transferred to the PLC.

### Data record number/name

Number or name of the recipe data record to be transferred to the PLC.

### Output status message

Determines whether a status message is output after the transfer:

0 (hmiOff) = Off: Status message is not output.

1 (hmiOn) = On: Status message is output.

### Processing status

Returns the processing status of the system function. You can use the return value, for example, to delay execution of other system functions until this system function has been successfully completed:

2 = System function is being performed.

4 = System function was successfully completed.

12 = System function was not performed because an error has occurred.

## See also

Device dependency (Page 3583)

## SetDataRecordTagsToPLC

### Description

Transfers the values of the recipe tags to the PLC. The recipe tags contain the values of the data record which is displayed on the HMI device.

### Use in the function list

SetDataRecordTagsToPLC (Recipe number/name, Processing status)

### Use in user-defined functions

SetDataRecordTagsToPLC (Recipe\_number/name, Processing\_status)

Can be used if the configured device supports user-defined functions. For additional information, refer to "Device dependency".

### Parameter

#### Recipe number/name

Number or name of the recipe from which recipe data record is transferred to the PLC.

#### Processing status

Returns the processing status of the system function. You can use the return value, for example, to delay execution of other system functions until this system function has been successfully completed:

2 = System function is being performed.

4 = System function was successfully completed.

12 = System function was not performed because an error has occurred.

### See also

Device dependency (Page 3583)

### PageDown

### Description

Executes the key function <Pagedown> on the HMI device.

This system function can only be used for function keys.

### Use in the function list

PageDown

### Use in user-defined functions

PageDown

Can be used if the configured device supports user-defined functions. For additional information, refer to "Device dependency".

### Parameter

-



**See also**

Device dependency (Page 3583)

**PageUp**

**Description**

Executes the key function <PageUp> on the HMI device.

This system function can only be used for function keys and tasks with a time trigger.

**Use in the function list**

PageUp

**Use in user-defined functions**

PageUp

Can be used if the configured device supports user-defined functions. For additional information, refer to "Device dependency".

**Parameter**

-

**See also**

Device dependency (Page 3583)

**SendEMail**

**Description**

Sends an e-mail from the HMI device to the given addressee.

This system function is used, for example, when, in the case of service, the alarm is to be passed on directly to the service technician.

---

**Note**

To send alarms as e-mails, the HMI system must have an e-mail client at its disposal.

---

**Use in the function list**

SendEMail (Address, Subject, Text, Return address)

### Use in user-defined functions

SendEMail (Address, Subject, Text, Return\_address)

Can be used if the configured device supports user-defined functions. For additional information, refer to "Device dependency".

### Parameter

#### Address

The e-mail address of the addressee.

#### Subject

The subject line of the e-mail.

#### Text

The text sent in the e-mail.

#### Return address

The e-mail address to which the addressee of this e-mail should send the reply.

### See also

Device dependency (Page 3583)

## SetAcousticSignal

### Description

Configures the acoustic feedback of touch screen operation on the HMI device.

---

#### Note

The configuration that was set at Switch off is reestablished when restarting the HMI device.

---

### Use in the function list

SetAcousticSignal (Volume)

### Use in user-defined functions

SetAcousticSignal (Volume)

Can be used if the configured device supports user-defined functions. For additional information, refer to "Device dependency".

## Parameter

### Volume

Determines whether and how loud an acoustic signal is emitted:

-1 (hmiToggle) = Toggle: Toggles the emission of the acoustic signal as follows: Muted > Quiet > Loud.

0 (hmiMuted) = Mute: no acoustic signal

1 (hmiQuiet) = Quiet: quiet acoustic signal

2 (hmiLoud) = Loud: loud acoustic signal

## See also

Device dependency (Page 3583)

## SetDisplayMode

### Description

Changes the settings of the screen in which the runtime software runs.

The runtime software runs in full-screen mode as default. The Windows task switch is disabled.

### Use in the function list

SetDisplayMode (Layout)

### Use in user-defined functions

SetDisplayMode (Display mode)

Can be used if the configured device supports user-defined functions. For additional information, refer to "Device dependency".

## Parameter

### Display mode

Determines the settings for the screen in which the runtime software runs.

1 (hmiScreenFull): Full-screen: Title bar of the screen is not visible

2 (hmiScreenMaximized): Maximized

3 (hmiScreenRestore): Restore: The last used screen setting is used. This layout can only be used when the window is displayed minimized or maximized.

4 (hmiScreenMinimized): Minimized

5 (hmiScreenAutoAdjust): Automatic: The size of the window is set so that all screen objects in it will be visible.

6 (hmiScreenOnTop): On top; either the window appears in the foreground or the program icon associated with the window flashes on the taskbar depending on the Windows setting. The setting can be changed in the Windows configuration and applies to all Windows applications.

### See also

Device dependency (Page 3583)

## SetDeviceMode

### Description

Toggles the operating mode on the HMI device. The following types of operation are possible: "Online", "Offline" and "Load".

### Use in the function list

SetDeviceMode (Operating mode)

### Use in user-defined functions

SetDeviceMode (Operating\_mode)

Can be used if the configured device supports user-defined functions. For additional information, refer to "Device dependency".

### Parameter

#### Operating mode

Determines the operating mode of the HMI device:

0 (hmiOnline) = Online: The connection to the PLC is established.

1 (hmiOffline) = Offline: The connection to the PLC is disconnected.

2 (hmiTransfer) = load: A project can be transferred from the configuration computer to the HMI device.

---

#### Note

If you use a PC as an HMI device, the runtime software will be exited when you change operating mode after "Load".

---

### See also

Device dependency (Page 3583)

SetConnectionMode (Page 3723)

## SetBit

### Description

Sets the value of a "Bool" type tag to 1 (TRUE).

### Use in the function list

SetBit (Tag)

### Use in user-defined functions

SetBit (Tag)

Can be used if the configured device supports user-defined functions. For additional information, refer to "Device dependency".

### Parameters

#### Tag

The BOOL type tag which is set to 1 (TRUE).

### Example

The following program code sets the value of the boolean tag b\_value to 1 by means of the SetBit function and outputs the result along with the original b\_saved value.

```
{
BOOL b_value = 0;
BOOL b_saved = b_value;

//Set bit
  SetBit (b_value);

//print current and saved value
printf ("Current value: %d\r\n, Saved value: %d\r\n",b_value, b_saved);
...
}
```

### See also

Device dependency (Page 3583)

## SetBitInTag

### Description

Sets a bit in the given tag to 1 (TRUE).

After changing the given bit, the system function transfers the entire tag back to the PLC. It is not checked whether other bits in the tags have changed in the meantime. Operator and PLC have read-only access to the indicated tag until it is transferred back to the PLC.

---

#### Note

If the PLC supports BOOL tags, do not use this system function. Use the "SetBit" system function instead.

---

### Use in the function list

SetBitInTag (Tag, Bit)

### Use in user-defined functions

SetBitInTag(Tag, Bit)

Can be used if the configured device supports user-defined functions. For additional information, refer to "Device dependency".

### Parameters

#### Tag

The tag in which a bit is set to 1 (TRUE).

#### Bit

The number of the bit that is set to 1 (TRUE).

When this system function is used in a user-defined function, the bits in the specified tag will be counted from right to left independent of the PLC used. The counting begins with 0.

---

#### Note

The guaranteed update of the tags used with actual process values is absolutely conditional in terms of reliable functionality. You should therefore configure the tag in an I/O field or assign the system function to a screen object, such as a button.

If you have configured a short event such as the activation of an alarm for the system function you can only access the actual process values by setting the tag for continuous reading.

---

## Example

The following program code sets a bit to 1 at the specified bitposition in the bvalue tag and outputs the result along with the original bsaved value.

```
{
BYTE bvalue;
BYTE bsaved = bvalue;
BYTE bitposition = 2;

//Reset bit in bitposition
SetBitInTag (bvalue, bitposition);

//print current and saved value
printf ("Current value: %d\r\n, Saved value: %d\r\n",bvalue, bsaved);
...
}
```

## See also

[SetBit \(Page 3709\)](#)

[Device dependency \(Page 3583\)](#)

## SetBitWhileKeyPressed

### Description

Sets the bit of the given tag to 1 (TRUE) as long as the user keeps the configured key pressed.

After changing the given bit, the system function transfers the entire tag back to the PLC. It is not checked whether other bits in the tags have changed in the meantime. Operator and PLC have read-only access to the indicated tag until it is transferred back to the PLC. You should only access tags of the BOOL type with this system function to avoid problems with overlapping access to the same tag.

---

#### Note

All functions on the event "Release" are performed immediately by means of a screen change configured for a key, even if the key is kept pressed.

If the "SetBitWhileKeyPressed" system function is configured for a function key, the bit will be reset immediately following a screen change. This action is necessary since the key assignments change after the screen change.

If the PLC supports BOOL tags, do not use this system function. Use the "SetBit" system function instead.

---

### Use in the function list

SetBitWhileKeyPressed (Tag, Bit)

### Use in user-defined functions

-

### Parameters

#### Tag

The tag in which a bit is temporarily set to 1 (TRUE). Use only tags of the type BOOL, as far as allowed by the PLC.

#### Bit

The number of the bit that is temporarily set to 1 (TRUE).

---

#### Note

The guaranteed update of the tags used with actual process values is absolutely conditional in terms of reliable functionality. You should therefore configure the tag in an IO field, or assign the function to a screen element such as a button.

If you configured a short event such as the activation of an alarm for the function you can only access the actual process values by setting the tag for continuous reading.

---

### See also

SetBit (Page 3709)

Device dependency (Page 3583)

### SetBacklightColor

#### Description

Defines the background lighting of the button.

---

#### Note

The configuration that was set at Switch off is reestablished when restarting the HMI device.

---

### Use in the function list

SetBacklightColor (Value)



## Use in user-defined functions

-

## Parameters

### Value

Defines the background lighting of the button:

0 (hmiWhite) = White: No color

1 (hmiGreen) = Green: Green color

2 (hmiYellow) = Yellow: Yellow color

3 (hmiRed) = Red: Red color

## See also

Device dependency (Page 3583)

## SetBrightness

### Description

Determines the brightness of the display.

---

### Note

The configuration that is set in the Control Panel will be reestablished when you restart the HMI device.

---

## Use in the function list

SetBrightness (value)

## Use in user-defined functions

SetBrightness (Value)

Can be used if the configured device supports user-defined functions. For additional information, refer to "Device dependency".

## Parameter

### Value

New value for the brightness.

## See also

Device dependency (Page 3583)

## SetScreenKeyboardMode

### Description

Enables or disables the automatic display of the screen keyboard on the HMI device.

This system function is also used to prevent the display of the screen keyboard, e.g. because an external keyboard is connected to the HMI device.

---

#### Note

To enable the "SetScreenKeyboardMode" ("SetScreenKeyboardMode") system function on an HMI other than a Touch Panel device, set the "Use on-screen keyboard" check box in the "Runtime settings" dialog of the device settings.

---

### Use in the function list

SetScreenKeyboardMode (Mode)

### Use in user-defined functions

SetScreenKeyboardMode (Mode)

Can be used if the configured device supports user-defined functions. For additional information, refer to "Device dependency".

### Parameter

#### Mode

Determines whether the screen keyboard is hidden or shown:

0 (hmiOff) = Off: Screen keyboard is hidden

1 (hmiOn) = On: Screen keyboard is shown

-1 (hmiToggle) = Toggle: Toggles between the two modes.

## See also

Device dependency (Page 3583)

## SetPLCDateTime

### Description

Changes the data and the time of the linked PLC

The system function "ReadPLCDateTime" can only be configured for the following PLCs:

- SIMATIC S7 1200
- SIMATIC S7 1500

### Use in the function list

ReadPLCDateTime (connection, time)

### Use in user-defined functions

GetPLCDateTime (Connection, Time)

### Parameters

#### Connection

Connection of PLC and HMI device.

#### Time

Transfers the date and the time of the HMI device to the PLC. The PLC applies the date and the time of the HMI device.

## SetPLCMode

### Description

Switches the operating mode of the PLC to one of the following states:

- RUN
- STOP

The system function "SetPLCMode" can only be configured for the following PLCs:

- SIMATIC S7 1200
- SIMATIC S7 1500

### Use in the function list

SetPLCMode (connection, mode)

### Use in user-defined functions

SetPLCMode (Connection, Mode)

### Parameters

#### Connection

Connection of PLC and HMI device.

#### Mode

Specifies the operating mode of the PLC:

RUN = the PLC is switched to the RUN state. The PLC program is executed.

STOP = the PLC is switched to the STOP state. The PLC program is interrupted.

### SetAlarmReportMode

### Description

Switches the automatic reporting of alarms on the printer on or off.

### Use in the function list

SetAlarmReportMode (Mode)

### Use in user-defined functions

SetAlarmReportMode (Mode)

Can be used if the configured device supports user-defined functions. For additional information, refer to "Device dependency".

### Parameter

#### Mode

Determines whether alarms are reported automatically on the printer:

0 (hmiDisablePrinting) = Reporting off: Alarms are not printed automatically.

1 (hmiEnablePrinting) = Reporting On: Alarms are printed automatically.

-1 (hmiToggle) = Toggle: Toggles between the two modes.

### See also

Device dependency (Page 3583)

## SetRecipeTags

### Description

Changes the status of the recipe tags from "Online" to "Offline" and vice versa.

This system function is used, for example, when recipe data record values are fine tuned when starting up a machine.

### Use in the function list

SetRecipeTags (Recipe number/name, Status, Output status message, Processing status)

### Use in user-defined functions

SetRecipeTags (Recipe\_number/name, Status, Output\_status\_message, Processing\_status)

Can be used if the configured device supports user-defined functions. For additional information, refer to "Device dependency".

### Parameter

#### Recipe number/name

Number or name of the recipe in which the recipe data record is saved.

#### Status

Determines the status of the recipe tags:

0 (hmiOnline) = Online: Value changes of the recipe tags are transferred immediately to the PLC connected to the HMI device.

1 (hmiOffline) = Offline: Value changes to the recipe tags are only transferred to the PLC connected to the HMI device when, for example, the "SetDataRecordTagsToPLC" system function is executed.

#### Output status message

Determines whether a status message is output after saving:

0 (hmiOff) = Off: Status message is not output.

1 (hmiOn) = On: Status message is output.

#### Processing status

Returns the processing status of the system function. You can use the return value, for example, to delay execution of other system functions until this system function has been successfully completed:

2 = System function is being performed.

4 = System function was successfully completed.

12 = System function was not performed because an error has occurred.

## See also

Device dependency (Page 3583)

## SetDaylightSavingTime

### Description

The system function "SetDaylightSavingTime" changes the setting of the HMI device from daylight saving to standard time and vice versa.

Time settings will take place immediately following system function.

---

#### Note

The "SetDaylightSavingTime" system function does not support time zones without daylight saving time.

---

#### Note

##### Windows 7

The system function "SetDaylightSavingTime" is not supported for PC-based HMI devices under Windows 7.

---

### Use in the function list

SetDaylightSavingTime(DaylightSavingTime)

### Use in user-defined functions

SetDaylightSavingTime (Daylight\_saving\_time)

Can be used if the configured device supports user-defined functions. For additional information, refer to "Device dependency".

### Parameters

#### Daylight Saving Time

Determines whether Daylight Saving Time is set on the HMI device:

0 = Daylight Saving Time is not activated

1 = Daylight Saving Time is activated

## See also

Device dependency (Page 3583)

## SetLanguage

### Description

Toggles the language on the HMI device. All configured text and system events are displayed on the HMI device in the newly set language.

### Use in the function list

SetLanguage (Language)

### Use in user-defined functions

SetLanguage (Language)

Can be used if the configured device supports user-defined functions. For additional information, refer to "Device dependency".

### Parameter

#### Language

Determines which language is set on the HMI device. The following specifications are possible:

- -1 (hmiToggle) = Toggle: Changes to the next language. The sequence is determined during configuration in the "Project languages" editor.
- Number you have defined under "Languages and fonts" in the "Runtime Settings" editor. Changes to the language with the given number.
- Language you have defined under "Languages and fonts" in the "Runtime Settings" editor.
- Language abbreviation in accordance with the VBScript5 reference: This changes to the language corresponding to the specified language code, e.g. "de-DE" for German (Germany) or "en-US" for English (United States).  
An overview of the language abbreviations is available in the basic information of VBScript under the topic "Area diagram-ID (LCID) Diagram".

### See also

Device dependency (Page 3583)

## SetAndGetBrightness

### Description

Determines the brightness of the MP 377 Touch daylight readable display. The brightness value can be interpreted as absolute or relative to the current value.

---

#### Note

The configuration that is set in the Control Panel will be reestablished when you restart the HMI device.

---

### Use in the function list

SetAndGetBrightness (Brightness, Mode, Current value)

### Use in user-defined functions

SetAndGetBrightness (Brightness, Mode, Actual brightness)

Can be used if the configured device supports user-defined functions. For additional information, refer to "Device dependency".

### Parameter

#### Brightness

New value for the brightness.

#### Mode

Specifies if the new brightness value is set as absolute or relative to the current value.

#### Current value

Tag in which the current brightness value is stored.

### See also

Device dependency (Page 3583)



## SetTag

### Description

Assigns a new value to the given tag.

---

**Note**

This system function can be used to assign strings and numbers, depending on the type of tag.

---

### Use in the function list

SetTag (Tag, Value)

### Use in user-defined functions

SetTag (Tag, Value)

Can be used if the configured device supports user-defined functions. For additional information, refer to "Device dependency".

### Parameters

**Tag**

The tag to which the given value is assigned.

**Value**

The value which the given tag is assigned.

---

**Note**

The "SetTag" system function is only executed after a connection has been established.

---

### Example

The following program code uses the SetTag function to set the value of the gs\_tag\_bit tag to TRUE and saves the return value to the ok tag.

```
{
BOOL ok;
BOOL bvalue;

//Set the tag to true
ok = SetTag("gs_tag_bit", TRUE);
//error handling
```

```
if(ok)
{
    // succeeded
    printf ( "Function has run through.\r\n" );
    bvalue = GetTagBit("gs_tag_bit");
    printf ("Value of gs_tag_bit: %d\r\n", bvalue);
}
else
{
    // failed
    printf ( "Error - function failed." );
}
...
}
```

The saved return value can be processed in the following code.

### See also

Device dependency (Page 3583)

### SetConnectionMode

#### Description

Connects or disconnects the given connection.

---

#### Note

A connection to the PLC cannot be established until the operating mode ONLINE has been set on the HMI device. Use the "SetDeviceMode" system function for this purpose.

---

#### Use in the function list

SetConnectionMode (Mode, Connection)

#### Use in user-defined functions

SetConnectionMode (Mode, Connection)

Can be used if the configured device supports user-defined functions. For additional information, refer to "Device dependency".

#### Parameter

##### Mode

Determines whether a connection to the PLC is established or disconnected:

0 (hmiOnline) = Online: Connection is established.

1 (hmiOffline) = Offline: Connection is disconnected.

### Connection

The PLC to which the HMI device is connected. You specify the name of the PLC in the connection editor.

### Multiple use of the system function in a user-defined function

If you use the "SetConnectionMode" system function for different connections, it may be possible that not all system functions are executed correctly. Proceed as follows to prevent this situation:

1. Create a "BOOL" type tag with the start value "0".
2. Configure the "SetConnectionMode" system function on the "Value change" event of the HMI tags. If you want to disconnect three connections, for example, you must configure the system function three times.
3. In the user-defined function, apply the "InvertBit" system function to the HMI tag.

### Application example

Two typical application examples for this system function are as follows:

- Test  
As long as no PLC is connected to the HMI device, no error messages will be output during the test on the HMI device. If the HMI device is connected to a PLC, the connection to the PLC can be established by pressing a key.
- Commissioning  
Several PLCs are to be configured for a system. At first, all PLCs except one are configured "Offline". After commissioning of the first PLC, the connection to each of the other PLCs is established by pressing a key. In this way, the other PLCs are started up one after another.

### See also

Device dependency (Page 3583)

### SetWebAccess

#### Description

Determines the access mode to the runtime application using the Internet.

#### Use in the function list

SetWebAccess (Access mode)

## Use in user-defined functions

-

## Parameters

### Access mode

Determines the access mode to the runtime application:

-1 (hmiToggle) = Toggle: Toggles between the two modes.

0 (hmiReadOnly) = Read-only.

1 (hmiReadWrite) = Read-write.

## See also

Device dependency (Page 3583)

## BackupRAMFileSystem

### Description

Backs up the RAM file system in the memory medium of the HMI device.

After restarting the HMI device, the data is automatically reloaded in the RAM file system.

Applications such as the Internet Explorer save data (e.g. the last web sites called up) temporarily to the DRAM file system of the HMI device.

### Use in the function list

BackupRAMFileSystem

### Use in user-defined functions

BackupRAMFileSystem

Can be used if the configured device supports user-defined functions. For additional information, refer to "Device dependency".

### Parameter

--

## See also

Device dependency (Page 3583)

## SimulateSystemKey

### Description

Simulates the behavior of a System Key. Use this system function if a system key, such as the "ACK" key, "Input" key or the number pad is not available on the HMI device.

### Use in the function list

SimulateSystemKey (System key)

### Use in user-defined functions

-

### Parameters

#### System key

System Key, the behavior for which is to be simulated.

### System key "+/-"

With the SimulateSystemKey system function, the system key "+/-" is only supported for the following HMI devices:

- KP300 Basic
- KP400 Basic
- KTP400 Basic mono PN
- KTP400 Basic color PN
- KTP400 Basic color PN Portrait
- KTP600 Basic mono PN
- KTP600 Basic color PN
- KTP600 Basic color DP
- KTP1000 Basic PN
- KTP1000 Basic DP

Use the system keys "+" and "-" separately for all other HMI devices.

### See also

Device dependency (Page 3583)

## SimulateTag

### Description

Simulates the behavior of tags and dynamic objects such as text lists, without having the HMI device connected to a PLC. You can, for example, configure the system function to the "Loaded" event of a screen.

This system function is used, for example, to demonstrate the functionality of a project.

Only tags of the data type Integer can be used for simulation. Tags of the data types Integer and Double Integer, however, can be used with OP 73, OP 77A, TP 177A.

---

#### Note

If you use the system function "SimulateTag" with a short cycle time on a Basic Panel, the HMI device may be overloaded.

---

### Use in the function list

SimulateTag (Tag, Cycle, Maximum value, Minimum value, Value)

### Use in user-defined functions

-

### Parameter

#### Tag

The tag whose value is changed.

#### Cycle

The factor by which the basic cycle of 200 milliseconds is multiplied. The cycle defines when the tag value is changed by the specified value. Possible cycles between 1 and 32767.

#### Maximum value

The maximum value that the tag can assume during simulation. The maximum value must be greater than the minimum value but less than / equal to 32767.

#### Minimum value

The minimum value that the tag can assume during simulation. The minimum value must be greater than the maximum value but less than / equal to -32768.

#### Value

The value by which the tag value is changed during each cycle. Possible values between -32768 and 32767.

- A positive value increases the tag value. When the maximum value is reached, the tag value is set to the minimum value after the next update cycle.
- A negative value reduces the tag value. When the minimum value is reached, the tag value is set to the maximum value after the next update cycle.

### See also

Device dependency (Page 3583)

## SmartClientViewRefresh

### Description

Updates the contents displayed in the Sm@rtClient view.

### Use in the function list

SmartClientViewRefresh (Screen object)

### Use in user-defined functions

-

### Parameters

#### Screen object

Name of the Sm@rtClient view in which the command is triggered.

### See also

Device dependency (Page 3583)

## SmartClientViewReadOnlyOff

### Description

Sets read-only access to "Off" in the Sm@rtClient view.

This setting allows a distant HMI device to be operated. The "SmartClientViewReadOnlyOn" system function is used to switch read-only access on again.

### Use in the function list

SmartClientViewReadOnlyOff (Screen object)

### Use in user-defined functions

-

### Parameters

#### Screen object

Name of the Sm@rtClient view in which the command is triggered.

### See also

Device dependency (Page 3583)

## SmartClientViewReadOnlyOn

### Description

Sets read-only access to "On" in the Sm@rtClient view.

This setting allows a distant HMI device to be monitored only. The "SmartClientViewReadOnlyOff" system function is used to switch read-only access off again.

### Use in the function list

SmartClientViewReadOnlyOn (Screen object)

### Use in user-defined functions

-

### Parameters

#### Screen object

Name of the Sm@rtClient view in which the command is triggered.

### See also

Device dependency (Page 3583)

## SmartClientViewDisconnect

### Description

Executes the "Disconnect" command in the Sm@rtClient view.



This system function is used when the integrated button of the screen object should not be used.

### Use in the function list

SmartClientViewDisconnect (Screen object)

### Use in user-defined functions

-

### Parameters

#### Screen object

Name of the Sm@rtClient view in which the command is triggered.

### See also

Device dependency (Page 3583)

## SmartClientViewConnect

### Description

Executes the "Connect" command in the Sm@rtClient view.

This system function is used when the integrated button of the screen object should not be used. The Sm@rtClient view establishes a connection with the configured HMI device.

### Use in the function list

SmartClientViewConnect (Screen object)

### Use in user-defined functions

-

### Parameters

#### Screen object

Name of the Sm@rtClient view in which the command is triggered.

### See also

Device dependency (Page 3583)

## SmartClientViewLeave

### Description

Exits the Sm@rtClient view and returns to operation of the HMI device.  
The connection to the HMI device configured in the smart client view is retained.

### Use in the function list

SmartClientViewLeave (Screen object)

### Use in user-defined functions

-

### Parameters

#### Screen object

Name of the Sm@rtClient view in which the command is triggered.

### See also

Device dependency (Page 3583)

## SaveDataRecord

### Description

Saves the current values of the recipe tags as data record to the memory medium of the HMI device.

This system function is used, for example, to save a recipe data record in the recipe screen.

### Use in the function list

SaveDataRecord (Recipe number/name, Data record number/name, Overwrite, Output status message, Processing status)

### Use in user-defined functions

SaveDataRecord (Recipe\_number/name, Data\_record\_number/name, Overwrite, Output\_status\_message, Processing\_status)

Can be used if the configured device supports user-defined functions. For additional information, refer to "Device dependency".

## Parameters

### Recipe number/name

Number or name of the recipe to which a recipe data record is saved.

### Data record number/name

Number or name of the recipe data record to be saved. A new data record will be created if no record of this name or number was found in the recipe, independent of the value at the "Overwrite" parameter.

### Overwrite

Specifies whether an existing data record is overwritten:

0 (hmiOverwriteForbidden) = No: The recipe data record is not overwritten, the data record is not saved.

1 (hmiOverwriteAlways) = Yes: The recipe data record is overwritten without a prompt for confirmation.

2 (hmiOverwriteWithPrompting) = With confirmation: The recipe data record is overwritten only with confirmation by the user.

### Output status message

Determines whether a status message is output after saving:

0 (hmiOff) = Off: Status message is not output.

1 (hmiOn) = On: Status message is output.

### Processing status

Returns the processing status of the system function. You can use the return value, for example, to delay execution of other system functions until this system function has been successfully completed:

2 = System function is being performed.

4 = System function was successfully completed.

12 = System function was not performed because an error has occurred.

## See also

Device dependency (Page 3583)

## StartLogging

### Description

Starts the logging of data or alarms in the specified log. The function can also be applied to audit trails.

You can interrupt logging at runtime using the "StopLogging" system function.

### Use in the function list

StartLogging (Log type, Log)

### Use in user-defined functions

StartLogging (Log\_type, Log)

Can be used if the configured device supports user-defined functions. For additional information, refer to "Device dependency".

### Parameter

#### Log type

Determines the type of log:

0 (hmiTagArchive) = Data log

1 (hmiAlarmArchive) = Alarm log

2 (hmiAudittrailArchive) = Audit trail

#### Log

Name of the log which is started.

### See also

Managing logging behavior when Runtime starts (Page 3222)

Device dependency (Page 3583)

### StartNextLog

### Description

Stops the logging of data or alarms for the given log.

Logging is continued in the next log of the segmented circular log you configured for the specified log.

If you did not configure a segmented circular log for the specified log, the system function has no effect.

### Use in the function list

StartNextLog (Log type, Log)

### Use in user-defined functions

StartNextLog (Log\_type, Log)

Can be used if the configured device supports user-defined functions. For additional information, refer to "Device dependency".

## Parameter

### Log type

Determines the type of log:

0 (hmiTagArchive) = Data log

1 (hmiAlarmArchive) = Alarm log

### Log

Name of the log for which the logging is stopped and continued in the next log.

## See also

Device dependency (Page 3583)

## StartProgram

### Description

Starts the specified program on the HMI device.

The runtime software continues running in the background. Alarms continue to be output and data continues to be updated.

When the given application is exited, the screen which was active during the performance of the system function is displayed on the HMI device.

This system function is used, for example, to edit recipe data records in MS Excel on the HMI device.

---

### Note

If Windows CE is installed on the HMI device, during the configuration it must be checked whether the desired application can be started with this system function.

This system function allows all applications to be started which can be started in the "Execute" dialog of Windows CE.

The application to be started must be installed on the HMI device.

---

## Use in the function list

StartProgram (Program name, Program parameters, Layout, Wait for program to end)

## Use in user-defined functions

StartProgram (Program\_name, Program\_parameters, Display\_mode, Wait\_for\_program\_to\_end)

Can be used if the configured device supports user-defined functions. For additional information, refer to "Device dependency".

## Parameter

### Program name

Name and path of the program which is started. Upper and lower case are taken into account in this parameter.

---

### Note

If the path contains spaces, the program can only be started correctly if the path is specified in inverted commas, e.g. "C:\Program Files\START\start.exe".

---

### Program parameters

The parameters you transfer at the start of the program, for example a file that is opened after the start of the program.

The description of the necessary parameters is found in the documentation of the program to be started.

### Layout

Determines how the program window is displayed on the HMI device:

0 (hmiShowNormal) = Normal

1 (hmiShowMinimized) = Minimized

2 (hmiShowMaximized) = Maximized

3 (ShowMinimizedAndInactive) = Minimized and inactive

### Wait for program to end

Determines whether there is a change back to the project after the called up program has ended:

0 (hmiNo) = No: No change to project

1 (hmiYes) = Yes: Change to project

---

### Note

The "Wait for program to end" parameter is only available for Runtime Advanced and Panels.

---

## See also

Device dependency (Page 3583)

## StatusForceGetValues

### Description

Starts or stops the updating of values in the Status/Force display. The values are read from the PLC connected to the HMI device until the update is stopped.

---

#### Note

As long as the values are updated, no entries are possible in the input fields of the Status/Force display.

---

### Use in the function list

StatusForceGetValues (Screen object)

### Use in user-defined functions

-

### Parameters

#### Screen object

Name of the Status/Force display to which data from the PLC is written.

### See also

Device dependency (Page 3583)

## StatusForceSetValues

### Description

Writes the values from the Status/Force display to the PLC to which the HMI device is connected.

### Use in the function list

StatusForceSetValues (Screen object)

### Use in user-defined functions

-

## Parameters

### Screen object

Name of the Status/Force display from which data is written to the PLC.

## See also

Device dependency (Page 3583)

## ControlSmartServer

### Description

Starts or stops the Sm@rtServer.

### Use in the function list

ControlSmartServer (Mode)

### Use in user-defined functions

ControlSmartServer (Mode)

Can be used if the configured device supports user-defined functions. For additional information, refer to "Device dependency".

## Parameter

### Mode

Specifies whether the Sm@rtServer is started or stopped.

-1 (hmiToggle) = Toggle: Toggles between the two modes

0 (hmiStop) = Stop: Sm@rtServer is stopped

1 (hmiStart) = Start: Sm@rtServer is started

## See also

Device dependency (Page 3583)

## ControlWebServer

### Description

Starts or stops the Web server.



### Use in the function list

ControlWebServer (Mode)

### Use in user-defined functions

ControlWebServer (Mode)

Can be used if the configured device supports user-defined functions. For additional information, refer to "Device dependency".

### Parameter

#### Mode

Specifies whether the Web server is started or stopped.

-1 (hmiToggle) = Toggle: Toggles between the two modes

0 (hmiStop) = Stop: The Web server is stopped.

1 (hmiStart) = Start: The Web server is started.

### See also

Device dependency (Page 3583)

### StopLogging

#### Description

Stops the logging of process values or alarms in the specified log. The function can also be applied to audit trails.

The "StartLogging" system function is used to resume logging at runtime.

---

#### Note

When logging is stopped, a connection between WinCC and the log files or log database still exists. Use the "CloseAllLogs" system function to disconnect this connection.

---

### Use in the function list

StopLogging (Log type, Log)

### Use in user-defined functions

StopLogging (Log\_type, Log)

Can be used if the configured device supports user-defined functions. For additional information, refer to "Device dependency".

## Parameter

### Log type

Determines the type of log:

0 (hmiTagArchive) = Data log

1 (hmiAlarmArchive) = Alarm log

2 (hmiAudittrailArchive) = Audit trail

### Log

Name of the log that is stopped.

## Application example

You are in runtime and want to change the data medium on which the process values are logged.

### Notes on configuring

Configure the "StopLogging" and "CloseAllLogs" system functions on the "Close Archive" button.

Configure the "OpenAllLogs" and "StartLogging" system functions on the "Open Archive" button.

As parameter transfer the respective name of the log that is to be stopped and started.

### Procedure on HMI device

When the button "Close Archive" is pressed, the specified log is stopped and all open logs are closed. The data medium can be changed. The "Open Archive" button opens all logs and continues logging in the specified log.

## See also

Device dependency (Page 3583)

## StopRuntime

### Description

Exits the runtime software and thereby the project running on the HMI device.

### Use in the function list

StopRuntime (Mode)

### Use in user-defined functions

StopRuntime (Mode)

Can be used if the configured device supports user-defined functions. For additional information, refer to "Device dependency".

## Parameters

### Mode

Determines whether the operating system is shut down after exiting runtime.

0 (hmiStopRuntime) = Runtime: Operating system is not shut down

1 (hmiStopRuntimeAndOperatingSystem) = Runtime and operating system: The operating system is shut down (not possible with WinCE)

## Example

The following program code shuts down Runtime and the operating system.

```
{  
  
//Stop runtime and shutdown  
StopRuntime (hmiStopRuntimeAndOperationSystem);  
  
}
```

The saved return value can be processed in the following code.

## See also

Device dependency (Page 3583)

## ActivateSystemDiagnosticsView

### Description

Activates the system diagnostics view. The system diagnostics view shows the detail view of the device concerned.

### Use in the function list

ActivateSystemDiagnosticsView (Screen name, Object name)

### Use in user-defined functions

ActivateSystemDiagnosticsView (Screen\_name, Object\_name)

Can be used if the configured device supports user-defined functions. For additional information, refer to "Device dependency".

## Parameter

### Screen name

Name of the screen contained in the system diagnostics view.

### Object name

Object name of the system diagnostics view.

## See also

Device dependency (Page 3583)

## SystemDiagnosticsViewRefreshPLCBuffer

### Description

Refreshes the data from the diagnostics buffer of the PLC in the system diagnostics view.

### Use in the function list

SystemDiagnosticsViewRefreshPLCBuffer (Object name)

### Use in user-defined functions

-

## Parameters

### Object name

Name of the system diagnostics view.

## SystemDiagnosticsViewDetailView

### Description

The detail view returns detailed information about the selected connection and errors pending.

### Use in the function list

SystemDiagnosticsViewDetailView (Object name)

### Use in user-defined functions

-

## Parameters

### Object name

Name of the system diagnostics view that is switched to the detail view.

## SystemDiagnosticsViewDiagnosticsBuffer

### Description

Opens a view in a system diagnostics for displaying the current data of the diagnostics buffer.

### Use in the function list

SystemDiagnosticsViewDiagnosticsBuffer (Object name)

### Use in user-defined functions

-

## Parameters

### Object name

Name of the system diagnostics view that is switched to the detail view.

## SystemDiagnosticsViewDeviceView

### Description

Opens a view in a system diagnostics for displaying all available connections.

### Use in the function list

SystemDiagnosticsViewDeviceView (Object name)

### Use in user-defined functions

-

## Parameters

### Object name

Name of the system diagnostics view.

## SystemDiagnosticsViewBack

### Description

Changes in a system diagnostics to the higher-level view.

- The function opens the device view if the diagnostics buffer view is set in the system diagnostics view.
- The function opens the diagnostics buffer view if the detail view is displayed in the system diagnostics view.

### Use in the function list

SystemDiagnosticsViewBack (Object name)

### Use in user-defined functions

-

### Parameters

#### Object name

Name of the system diagnostics view.

## LookupText

### Description

Identifies an entry from a text list. The result depends on the value and on the selected runtime language. The result is saved to a tag of data type "String".

### Use in the function list

LookupText (Output text, Value, Language, Text list)

### Use in user-defined functions

LookupText (Output\_text, Index, Language, Text\_list)

Can be used if the configured device supports user-defined functions. For additional information, refer to "Device dependency".

### Parameter

#### Output text

The tag to which the result is written.

### Index

The tag that defines the value of the list entry.

### Language

Defines the runtime language in which the list entry is identified.

- Tag  
The tag that contains the language. Enter the runtime language as decimal value of the country ID, for example, 1031 for German - Standard, 1033 for English - USA. Details are available in the VBScript basics, "Locale identifier (LCID) diagram".
- Runtime language  
Language code as per VBScript reference, for example, "de-DE" for German (Germany) or "en-US" for English (United States of America). The selection depends on the activated runtime languages.

### Text list

Defines the text list. The list entry is read from the text list.

### See also

Device dependency (Page 3583)

## ResetTagToHandWheel

### Description

Separates the tag that is connected with the operating element handwheel, and reconnects the handwheel with the global tags.

### Use in the function list

ResetTagToHandWheel

### Use in user-defined functions

-

### Parameters

--

### See also

Device dependency (Page 3583)

## SetTagToHandWheel

### Description

Connect the tag with the operating device handwheel. If the handwheel is operated, the tag value changes. The connection can be reset using the "ResetTagToHandWheel" system function.

### Use in the function list

SetTagToHandWheel (Value)

### Use in user-defined functions

-

### Parameters

#### Value

Tag names which are connected to the operating device handwheel.

### See also

Device dependency (Page 3583)

## TraceUserChange

### Description

Outputs a system event that shows which user is currently logged in on the HMI device. This system function can only be used in the Scheduler.

### Use in the function list

TraceUserChange

### Use in user-defined functions

-

### Parameters

--



## See also

Device dependency (Page 3583)

## DecreaseFocusedValue

### Description

Subtracts the specified value from the value of the tag which is connected to the screen object and currently has the focus.

This system function can only be used for function keys.

### Use in the function list

DecreaseFocusedValue (Value)

### Use in user-defined functions

-

### Parameters

#### Value

The value which is subtracted from the tag value.

## See also

Device dependency (Page 3583)

## DecreaseTag

### Description

Subtracts the given value from the tag value.

$X = X - a$

---

#### Note

The system function uses the same tag as input and output values. When this system function is used to convert a value, auxiliary tags must be used. The auxiliary tags are assigned to the tag value with the "SetTag" system function.

---

If you configure the system function on the events of an alarm and the tag is not being used in the current screen, it is not ensured that the actual value of the tags is being used in the PLC. You can improve the situation by setting the "Cyclic continuous" acquisition mode.

### Use in the function list

DecreaseTag (Tag, Value)

### Use in user-defined functions

DecreaseTag (Tag, Value)

Can be used if the configured device supports user-defined functions. For additional information, refer to "Device dependency".

### Parameter

#### Tag

The tag from which the given value is subtracted.

#### Value

The value which is subtracted.

### See also

Device dependency (Page 3583)

### ChangeConnection

### Description

Disconnects the connection to the currently used PLC in use and establishes a connection to a PLC with another address. The newly connected PLC must belong to the same device class (S7-1200, S7-300, ...etc). With S7-1200, the use of the function is also only permitted for absolute addressing.

---

#### Note

When changing to another address, ensure that the address is not already being used by another HMI device.

---

The follows address types are supported:

- IP address
- MPI address

The follows PLC types are supported:

- SIMATIC S7 300/400
- SIMATIC S7-NC
- SIMOTION

### Use in the function list

ChangeConnection (Connection, Address, Slot, Rack)

### Use in user-defined functions

ChangeConnection (Connection, Address, Slot, Rack)

Can be used if the configured device supports user-defined functions. For additional information, refer to "Device dependency".

### Parameter

#### Connection

Name of the connection that is disconnected. The name is set during configuration, for example, in the "Connections" editor.

#### Address

MPI/PROFIBUS or IP address of the PLC to which the connection will be established.

---

#### Note

Set the address by means of a tag. The objects list displays the tags of all data types. Select only tags of the following data types:

- Ethernet connection: "String" data type
  - MPI connection: "Int" data type
- 

#### Slot

Slot of the PLC to which the connection will be established.

#### Rack

Rack of the PLC to which the connection will be established.

### Application example

You want to operate one HMI device on several machines. Configure the necessary PLCs in the project, to which you want to change by pressing a key. When changing the PLC, the connection to the PLC in use is disconnected. Then the connection to the new PLC with other address parameters is reestablished. To access the values of the new PLC, configure the same tags for the PLC used.

The PLC which you have indicated when creating the project will be used as default.

1. Enter the name and address of the PLC in the "Connections" editor.
2. Configure a button in the process screen.
3. Configure the "ChangeConnection" system function on the "Press" event.
4. Enter the name of the connection and address of the PLC as parameters.

**See also**

Device dependency (Page 3583)

**ShowLogonDialog**

**Description**

Opens a dialog on the HMI device with which the user can log on to the HMI device.

**Use in the function list**

ShowLogonDialog

**Use in user-defined functions**

-

**Parameters**

--

**See also**

Device dependency (Page 3583)

**ShowOperatorNotes**

**Application**

Displays the tooltip configured for the selected object.

If the system function is configured on a function key, the tooltip for the screen object that currently has the focus is displayed. If a tooltip is configured for the screen itself, you can switch to this text by pressing <Enter> or by double-clicking on the help window.

If the system function is configured on a button, only the tooltip for the current screen is displayed. If a tooltip is configured on the button itself, initially only the tooltip for the button is displayed. You can press <Enter> or double-click on the help window to switch to the tooltip for the current screen.

---

**Note**

No other screen object can be used while the help window is open. To use the screen object, close the help window.

---

## Closing the help window

You can close the help window in the following ways:

Using the keys:

- By pressing the <HELP> key again
- By pressing the <ESC> key

Using the touch screen:

- By pressing the  button

## Use in the function list

ShowOperatorNotes (Layout)

## Use in user-defined functions

ShowOperatorNotes (Display\_mode)

Can be used if the configured device supports user-defined functions. For additional information, refer to "Device dependency".

## Parameter

### Display mode

Determines whether the configured tooltip is hidden or shown:

0 (hmiOff) = Off: Configured tooltip is hidden

1 (hmiOn) = On: Configured tooltip is shown

-1 (hmiToggle) = Toggle: Toggles between the two modes

## See also

Device dependency (Page 3583)

## ShowAlarmWindow

### Description

Hides or shows the alarm window on the HMI device.

### Use in the function list

ShowAlarmWindow (Object name, Layout)

### Use in user-defined functions

ShowAlarmWindow (Object\_name, Display\_mode)

Can be used if the configured device supports user-defined functions. For additional information, refer to "Device dependency".

### Parameter

#### Object name

Name of the alarm view which is hidden or shown.

#### Layout

Determines whether the alarm window is hidden or shown:

0 (hmiOff) = Off: Alarm view is hidden

1 (hmiOn) = On: Alarm view is shown

-1 (hmiToggle) = Toggle: Toggles between the two modes

### See also

Device dependency (Page 3583)

## ShowSoftwareVersion

### Description

Hides or shows the version number of the runtime software.

Use this system function if during servicing, for example, you required the version of the runtime software used.

### Use in the function list

ShowSoftwareVersion (Layout)

### Use in user-defined functions

ShowSoftwareVersion (Display\_mode)

Can be used if the configured device supports user-defined functions. For additional information, refer to "Device dependency".

### Parameter

#### Layout

Determines whether the version number is shown:

- 0 (hmiOff) = Off: Version number is not shown
- 1 (hmiOn) = On: Version number is shown
- 1 (hmiToggle) = Toggle: Toggles between the two modes

### See also

Device dependency (Page 3583)

## ShowSystemDiagnosticsWindow

### Description

Hides or shows the system diagnostic window on the HMI device. The system diagnostic view is only available in the global screen for Comfort Panels and for WinCC Runtime Advanced.

### Use in the function list

ShowSystemDiagnosticsWindow (Screen object)

### Use in user-defined functions

ShowSystemDiagnosticsWindow (Target\_Object\_name)

Can be used if the configured device supports user-defined functions. For additional information, refer to "Device dependency".

### Parameters

#### Screen object

Name of the system diagnostic window which is hidden or shown.

### See also

Device dependency (Page 3583)

## ShowSystemAlarm

### Description

Displays the value of the parameter passed as a system event to the HMI device.

### Use in the function list

ShowSystemAlarm (Text/value)

### Use in user-defined functions

ShowSystemAlarm (Text/value)

Can be used if the configured device supports user-defined functions. For additional information, refer to "Device dependency".

### Parameter

#### Text/Value

The text or the value, which was output as a system alarm.

### See also

Device dependency (Page 3583)

## Functions for WinAC MP

### WinACMPUpdateStartupCharacteristics

#### Description

Reads whether WinAC MP is automatically started after startup of the HMI device. The LED display of the "StartAtBoot" button is updated.

#### Use in the function list

WinACMPUpdateControllerForStartAtBoot(Start at boot, Action)

#### Use in user-defined functions

-

### Parameters

#### Start at boot

The tag that contains the value.

#### Action

Determines whether the display is updated:

0 (SwitchOff) = Off: LED display is gray. WinAC MP is not started on startup of the HMI device.

1 (SwitchOn) = On: LED display has the color "cyan". WinAC MP is started automatically on startup of the HMI device.



## Notes on configuring

You configure this system function on the "Loaded" event or on the "Cleared" event of a screen.

Note the following during configuration:

- System function on the "Loaded" event  
Set the "Update" parameter to "On".
- System function on the "Cleared" event  
Set the "Update" parameter to "Off".
- If you call the system function repeatedly in a screen, always use the same tag. Otherwise, only the last activated tag will be updated.
- If you want to configure all system functions with the prefix "WinACMPUpdate" in a screen, each system function is only permitted once per screen.

## WinACMPUpdateKeySwitchSetting

### Description

Updates the status display of the position of the mode selector switch.

### Use in the function list

WinACMPUpdateKeySwitchSetting (Key switch, Action)

### Use in user-defined functions

-

### Parameters

#### Key switch

The tag that contains the value of the key switch:

0 (MRES) = MRES: PLC memory reset

1 (STOP) = STOP: STOP mode

3 (RUN) = RUN: RUN mode

#### Action

Determines whether the status display will be updated:

0 (SwitchOff) = Off: Status display is not updated.

1 (SwitchOn) = On: Status display is updated.

## Notes on configuring

You configure this system function on the "Loaded" event or on the "Cleared" event of a screen.

Note the following during configuration:

- System function on the "Loaded" event  
Set the "Update" parameter to "On".
- System function on the "Cleared" event  
Set the "Update" parameter to "Off".
- If you call the system function repeatedly in a screen, always use the same tag. Otherwise, only the last activated tag will be updated.
- If you want to configure all system functions with the prefix "WinACMPUpdate" in a screen, each system function is only permitted once per screen.

## WinACMPUpdateBUSF1LED

### Description

Updates the status display of the BUSF1 LED tag.

### Use in the function list

WinACMPUpdateBUSF1LED(BUSF1, Update)

### Use in user-defined functions

-

### Parameters

#### BUSF1

The tag that contains the value of the status display.

0 = Off

1 = Slow flashing

2 = Quick flashing

3 = On

#### Update

Defines whether the status display of the BUSF1 LED tag is updated:

0 (SwitchOff) = Off: Status display is not updated.

1 (SwitchOn) = On: Status display is updated.

### Notes on configuring

You configure this system function on the "Loaded" event or on the "Cleared" event of a screen.

Note the following during configuration:

- System function on the "Loaded" event  
Set the "Update" parameter to "On".
- System function on the "Cleared" event  
Set the "Update" parameter to "Off".
- If you call the system function repeatedly in a screen, always use the same tag. Otherwise, only the last activated tag will be updated.
- If you want to configure all system functions with the prefix "WinACMPUpdate" in a screen, each system function is only permitted once per screen.

## WinACMPUpdateBUSF2LED

### Description

Updates the status display of the BUSF2 LED tag.

### Use in the function list

WinACMPUpdateBUSF2LED(BUSF2, Update)

### Use in user-defined functions

-

### Parameters

#### **BUSF2**

The tag that contains the value of the status display.

0 = Off

1 = Slow flashing

2 = Quick flashing

3 = On

#### **Update**

Defines whether the status display of the BUSF2 LED tag is updated:

0 (SwitchOff) = Off: Status display is not updated.

1 (SwitchOn) = On: Status display is updated.

### Notes on configuring

You configure this system function on the "Loaded" event or on the "Cleared" event of a screen.

Note the following during configuration:

## 10.8 Working with system functions and Runtime scripting

- System function on the "Loaded" event  
Set the "Update" parameter to "On".
- System function on the "Cleared" event  
Set the "Update" parameter to "Off".
- If you call the system function repeatedly in a screen, always use the same tag. Otherwise, only the last activated tag will be updated.
- If you want to configure all system functions with the prefix "WinACMPUpdate" in a screen, each system function is only permitted once per screen.

### WinACMPUpdateAverageExecTime

#### Description

Updates the display of the average OB 1 execution time. The OB 1 execution time will be displayed in milliseconds.

#### Use in the function list

WinACMPUpdateAverageExecTime(Cycle time, Update)

#### Use in user-defined functions

-

#### Parameters

##### Cycle time

Tag that contains the value of the average OB 1 execution time.

##### Update

Determines whether the display is updated:

0 (SwitchOff) = Off: Display is not updated.

1 (SwitchOn) = On: Display is updated.

#### Notes on configuring

You configure this system function on the "Loaded" event or on the "Cleared" event of a screen.

Note the following during configuration:

- System function on the "Loaded" event  
Set the "Update" parameter to "On".
- System function on the "Cleared" event  
Set the "Update" parameter to "Off".

- If you call the system function repeatedly in a screen, always use the same tag. Otherwise, only the last activated tag will be updated.
- If you want to configure all system functions with the prefix "WinACMPUpdate" in a screen, each system function is only permitted once per screen.

## WinACMPUpdateAverageCycleTime

### Description

Updates the display of the average cycle time. The cycle time is displayed in milliseconds.

### Use in the function list

WinACMPUpdateAverageCycleTime(Cycle time, Action)

### Use in user-defined functions

-

### Parameters

#### Cycle time

The tag that contains the value of the average cycle time.

#### Update

Determines whether the display is updated:

0 (SwitchOff) = Off: Display is not updated.

1 (SwitchOn) = On: Display is updated.

### Notes on configuring

You configure this system function on the "Loaded" event or on the "Cleared" event of a screen.

Note the following during configuration:

- System function on the "Loaded" event  
Set the "Update" parameter to "On".
- System function on the "Cleared" event  
Set the "Update" parameter to "Off".
- If you call the system function repeatedly in a screen, always use the same tag. Otherwise, only the last activated tag will be updated.
- If you want to configure all system functions with the prefix "WinACMPUpdate" in a screen, each system function is only permitted once per screen.

## WinACMPUpdateEXTFLED

### Description

Updates the status display of the EXTF LED tag.

### Use in the function list

WinACMPUpdateEXTFLED(EXTF, Update)

### Use in user-defined functions

-

### Parameters

#### EXTF

The tag that contains the value of the status display.

0 = Off

1 = Slow flashing

2 = Quick flashing

3 = On

#### Update

Defines whether the status display of the EXTF LED tag is updated:

0 (SwitchOff) = Off: Status display is not updated.

1 (SwitchOn) = On: Status display is updated.

### Notes on configuring

You configure this system function on the "Loaded" event or on the "Cleared" event of a screen.

Note the following during configuration:

- System function on the "Loaded" event  
Set the "Update" parameter to "On".
- System function on the "Cleared" event  
Set the "Update" parameter to "Off".
- If you call the system function repeatedly in a screen, always use the same tag. Otherwise, only the last activated tag will be updated.
- If you want to configure all system functions with the prefix "WinACMPUpdate" in a screen, each system function is only permitted once per screen.

## WinACMPUpdateHMIEnableTime

### Description

Updates the value of the HMI Execution Time from WinAC MP (in ms).

### Use in the function list

WinACMPUpdateHMIEnableTime(Enable Time, Update)

### Use in user-defined functions

-

### Parameters

#### HMI Enable time

The tag that contains the value of the HMI Enable Time.

#### Action

Determines whether the value is updated:

0 (SwitchOff) = Off: Value is not updated.

1 (SwitchOn) = On: Value is updated.

### Notes on configuring

You configure this system function on the "Loaded" event or on the "Cleared" event of a screen.

Note the following during configuration:

- System function on the "Loaded" event  
Set the "Update" parameter to "On".
- System function on the "Cleared" event  
Set the "Update" parameter to "Off".
- If you call the system function repeatedly in a screen, always use the same tag. Otherwise, only the last activated tag will be updated.
- If you want to configure all system functions with the prefix "WinACMPUpdate" in a screen, each system function is only permitted once per screen.

## WinACMPUpdateINTFLED

### Description

Updates the status display of the INTF LED tag.

### Use in the function list

WinACMPUpdateINTFLED(INTF, Update)

### Use in user-defined functions

-

### Parameters

#### INTF

The tag that contains the value of the status display.

0 = Off

1 = Slow flashing

2 = Quick flashing

3 = On

#### Update

Defines whether the status display of the INTF LED tag is updated:

0 (SwitchOff) = Off: Status display is not updated.

1 (SwitchOn) = On: Status display is updated.

### Notes on configuring

You configure this system function on the "Loaded" event or on the "Cleared" event of a screen.

Note the following during configuration:

- System function on the "Loaded" event  
Set the "Update" parameter to "On".
- System function on the "Cleared" event  
Set the "Update" parameter to "Off".
- If you call the system function repeatedly in a screen, always use the same tag. Otherwise, only the last activated tag will be updated.
- If you want to configure all system functions with the prefix "WinACMPUpdate" in a screen, each system function is only permitted once per screen.

### WinACMPUpdateLastCycleTime

#### Description

Updates the display of the last cycle time. The cycle time is displayed in milliseconds.



### Use in the function list

WinACMPUpdateLastCycleTime (Cycle time , Update)

### Use in user-defined functions

-

### Parameters

#### Cycle time

The tag that contains the value of the last cycle time.

#### Update

Determines whether the display is updated:

0 (SwitchOff) = Off: Display is not updated.

1 (SwitchOn) = On: Display is updated.

### Notes on configuring

You configure this system function on the "Loaded" event or on the "Cleared" event of a screen.

Note the following during configuration:

- System function on the "Loaded" event  
Set the "Update" parameter to "On".
- System function on the "Cleared" event  
Set the "Update" parameter to "Off".
- If you call the system function repeatedly in a screen, always use the same tag. Otherwise, only the last activated tag will be updated.
- If you want to configure all system functions with the prefix "WinACMPUpdate" in a screen, each system function is only permitted once per screen.

### WinACMPUpdateMaximumCycleTime

#### Description

Updates the display of the longest cycle time. The cycle time is displayed in milliseconds.

### Use in the function list

WinACMPUpdateMaximumCycleTime(Cycle time, Update)

### Use in user-defined functions

-

## Parameters

### Cycle time

The tag that contains the value of the longest cycle time.

### Update

Determines whether the display is updated:

0 (SwitchOff) = Off: Display is not updated.

1 (SwitchOn) = On: Display is updated.

## Notes on configuring

You configure this system function on the "Loaded" event or on the "Cleared" event of a screen.

Note the following during configuration:

- System function on the "Loaded" event  
Set the "Update" parameter to "On".
- System function on the "Cleared" event  
Set the "Update" parameter to "Off".
- If you call the system function repeatedly in a screen, always use the same tag. Otherwise, only the last activated tag will be updated.
- If you want to configure all system functions with the prefix "WinACMPUpdate" in a screen, each system function is only permitted once per screen.

## WinACMPUpdateMinimumCycleTime

### Description

Updates the display of the shortest cycle time. The cycle time is displayed in milliseconds.

### Use in the function list

WinACMPUpdateMinimumCycleTime (Cycle Time, Update)

### Use in user-defined functions

-

## Parameters

### Cycle time

The tag that contains the value of the shortest cycle time.

### Update

Determines whether the display is updated:

0 (SwitchOff) = Off: The display is not updated.

1 (SwitchOn) = On: The display is updated.

### Notes on configuring

You configure this system function on the "Loaded" event or on the "Cleared" event of a screen.

Note the following during configuration:

- System function on the "Loaded" event  
Set the "Update" parameter to "On".
- System function on the "Cleared" event  
Set the "Update" parameter to "Off".
- If you call the system function repeatedly in a screen, always use the same tag. Otherwise, only the last activated tag will be updated.
- If you want to configure all system functions with the prefix "WinACMPUpdate" in a screen, each system function is only permitted once per screen.

### WinACMPUpdatePowerLED

#### Description

Updates the status display ON/OFF of the Power LED tag.

#### Use in the function list

WinACMPUpdatePowerLED (Power, Update)

#### Use in user-defined functions

-

#### Parameters

##### Power

The tag that contains the value of the status display.

0 = Off

1 = Slow flashing

2 = Quick flashing

3 = On

### Update

Determines whether the status display ON/OFF is updated:

0 (SwitchOff) = Off: Status display is not updated.

1 (SwitchOn) = On: Status display is updated.

### Notes on configuring

You configure this system function on the "Loaded" event or on the "Cleared" event of a screen.

Note the following during configuration:

- System function on the "Loaded" event  
Set the "Update" parameter to "On".
- System function on the "Cleared" event  
Set the "Update" parameter to "Off".
- If you call the system function repeatedly in a screen, always use the same tag. Otherwise, only the last activated tag will be updated.
- If you want to configure all system functions with the prefix "WinACMPUpdate" in a screen, each system function is only permitted once per screen.

### WinACMPUpdateSleepTime

#### Description

Updates the value of the HMI Execution Time from WinAC MP (in ms).

#### Use in the function list

WinACMPUpdateSleepTime(SleepTime, Update)

#### Use in user-defined functions

-

#### Parameters

##### SleepTime

The tag that contains the value.

##### Update

Determines whether the value is updated:

0 (SwitchOff) = Off: Value is not updated.

1 (SwitchOn) = On: Value is updated.

## Notes on configuring

You configure this system function on the "Loaded" event or on the "Cleared" event of a screen.

Note the following during configuration:

- System function on the "Loaded" event  
Set the "Update" parameter to "On".
- System function on the "Cleared" event  
Set the "Update" parameter to "Off".
- If you call the system function repeatedly in a screen, always use the same tag. Otherwise, only the last activated tag will be updated.
- If you want to configure all system functions with the prefix "WinACMPUpdate" in a screen, each system function is only permitted once per screen.

## WinACMPUpdateRUNLED

### Description

Updates the status display of the RUN LED tag.

### Use in the function list

WinACMPUpdateRUNLED(RUN, Update)

### Use in user-defined functions

-

### Parameters

#### RUN

The tag that contains the value of the status display.

0 = Off

1 = Slow flashing

2 = Quick flashing

3 = On

#### Update

Defines whether the status display of the RUN LED tag is updated:

0 (SwitchOff) = Off: Status display is not updated.

1 (SwitchOn) = On: Status display is updated.

## Notes on configuring

You configure this system function on the "Loaded" event or on the "Cleared" event of a screen.

Note the following during configuration:

- System function on the "Loaded" event  
Set the "Update" parameter to "On".
- System function on the "Cleared" event  
Set the "Update" parameter to "Off".
- If you call the system function repeatedly in a screen, always use the same tag. Otherwise, only the last activated tag will be updated.
- If you want to configure all system functions with the prefix "WinACMPUpdate" in a screen, each system function is only permitted once per screen.

## WinACMPUpdateSTOPLED

### Description

Updates the status display of the STOP LED tag.

### Use in the function list

UpdateSTOPLEDtag (STOP, Update)

### Use in user-defined functions

-

### Parameters

#### STOP

The tag that contains the value of the status display.

0 = Off

1 = Slow flashing

2 = Quick flashing

3 = On

#### Update

Defines whether the status display of the STOP LED tag is updated:

0 (SwitchOff) = Off: Status display is not updated.

1 (SwitchOn) = On: Status display is updated.

## Notes on configuring

You configure this system function on the "Loaded" event or on the "Cleared" event of a screen.

Note the following during configuration:

- System function on the "Loaded" event  
Set the "Update" parameter to "On".
- System function on the "Cleared" event  
Set the "Update" parameter to "Off".
- If you call the system function repeatedly in a screen, always use the same tag. Otherwise, only the last activated tag will be updated.
- If you want to configure all system functions with the prefix "WinACMPUpdate" in a screen, each system function is only permitted once per screen.

## WinACMPArchive

### Description

Saves the current STEP 7 user program, the current system configuration and the current values of the DBs in a log file.

### Use in the function list

WinACMPArchive (File name)

### Use in user-defined functions

-

### Parameters

#### File name

Name of the log file in which the data is saved. Enter the file location and the file extension (\*.wld), for example, "\\flash\AddOn\WinACMP\Default.wld".

## WinACMPGetStartCharacteristics

### Description

Reads in the 'desired' operating state after startup of the HMI device of WinAC MP.

### Use in the function list

WinACMPGetStartCharacteristics (Operating state, Update)

## Use in user-defined functions

-

## Parameters

### Operating state

The tag that defines the value of the operating mode.

### Update

Determines whether the operating mode is read out:

0 (SwitchOff) = Off: Operating mode is not read out.

1 (SwitchOn) = On: Operating mode is read out.

## WinACMPGetVersion

### Description

Reads out the value of the version number of WinAC MP.

### Use in the function list

WinACMPGetVersion (Version, Action)

### Use in user-defined functions

WinACMPGetVersion (Version, Action)

Can be used if the configured device supports user-defined functions. For more information, refer to Auto-Hotspot.

## Parameters

### Version

The tag that contains the value.

### Action

Determines whether the version number is read out:

0 (SwitchOff) = Off: Version number is not read out.

1 (SwitchOn) = On: Version number is read out.



## WinACMPClearCycleTimeBuffer

### Description

Clears the cycle time data of the histogram.

### Use in the function list

WinACMPClearCycleTimeBuffer

### Use in user-defined functions

-

### Parameters

--

## WinACMPSetStartAtBoot

### Description

Determines whether or not WinAC MP is started automatically after startup of the HMI device.

### Use in the function list

WinACMPSetStart at boot(Start at boot)

### Use in user-defined functions

WinACMPSetStartAtBoot (Start at boot)

Can be used if the configured device supports user-defined functions. For more information, refer to Auto-Hotspot.

### Parameters

#### StartAtBoot

Defines whether WinAC MP is started automatically.

0 (StartAtBootOff) = Off: WinAC MP is not started on startup of the HMI device.

1 (StartAtBootOn) = On: WinAC MP is started automatically on startup of the HMI device.

## WinACMPSetKeySwitch

### Description

Sets the mode selector switch to RUN or STOP and is also used for memory reset.

### Use in the function list

WinACMPSetKeySwitch(Key switch)

### Use in user-defined functions

-

### Parameters

#### Key switch

Defines the position of the key switch:

0 (MRES) = MRES: PLC memory reset

1 (STOP) = STOP: STOP mode

3 (RUN) = RUN: RUN mode

## WinACMPSetHMIExecutionTime

### Description

Sets the value of the HMI Execution Time of WinAC MP.

### Use in the function list

WinACMPSetHMIExecutionTime (Execution Time)

### Use in user-defined functions

-

### Parameters

#### Execution time

The tag that contains the value.

## WinACMPSetRestartMethod

### Description

Sets the restart method, either cold restart (CRST) or warm restart (WRST).

### Use in the function list

WinACMPSetRestartMethod (Action)

### Use in user-defined functions

-

### Parameters

#### RestartAction

Defines the restart action:

0 (WarmRestart) = Warm restart: A warm restart is performed.

1 (ColdRestart) = Cold restart: A cold restart is performed.

## WinACMPSetSleepTime

### Description

Sets the value of the HMI Execution Time of WinAC MP.

### Use in the function list

WinACMPSetSleeptime (SleepTime)

### Use in user-defined functions

-

### Parameters

#### Sleep time

The tag that contains the value.

## WinACMPSetStartMode

### Description

Sets the operating mode of WinAC MP after startup of the HMI device.

### Use in the function list

WinACSetStartMode (Autostart)

### Use in user-defined functions

WinACSetStartMode (Autostart)

Can be used if the configured device supports user-defined functions. For more information, refer to Auto-Hotspot.

### Parameters

#### Action

Defines whether the Autostart function of WinAC MP is activated.

0 (AutoStartOff) = Off: After startup, WinAC MP remains in the STOP operating mode.

1 (AutoStartOn) = On: After startup, WinAC MP changes to the operating mode it was in before it was closed.

## WinACMPStartHistogram

### Description

Starts the cyclic sending of histogram values and updates the display. The histogram shows the percentual distribution of the measured cycle times.

### Use in the function list

WinACMPStartHistogram (Update, Percentage, Cycle time, Y axis, ID)

### Use in user-defined functions

-

### Parameters

#### Update

Defines whether WinAC returns histogram values:

0 (SwitchOff) = Off: The cyclic sending of the histogram values is not started. The display is not updated.

1 (SwitchOn) = On: The cyclic sending of the histogram values is started. The display is updated.

**Percentage**

Percentage of the cycles which are performed during the recorded cycle times.

**Cycle time**

Histogram of cycle times.

**Y axis**

Maximum value of Y axis

**ID**

Histogram ID

**WinACMPControl**

**Description**

Starts or stops WinAC MP.

**Use in the function list**

WinACMPControl (WinAC)

**Use in user-defined functions**

-

**Parameters**

**WinAC**

Determines whether WinAC MP is started or stopped.

0 (ShutdownWinACMP) = Stop: WinAC MP is stopped.

1 (StartWinACMP) = Start: WinAC MP is started.

**WinACMPStopHistogram**

**Description**

Stops the cyclic sending of histogram data and deletes the history data.

### Use in the function list

WinACMPStopHistogram (ID)

### Use in user-defined functions

-

### Parameters

#### ID

Histogram ID

### WinACMPRestore

### Description

Loads the STEP 7 user program, the system configuration and the DBs from a log file.

### Use in the function list

WinACMPRestore (File name)

### Use in user-defined functions

-

### Parameters

#### File name

Name of the log file in which the data is saved. Enter the file location and the log file, for example, ""flash\AddOn\WinACMP\Default.wld "".

## 10.8.7.2 Events





### Overview

### Editors

### Introduction

The following table shows which events occur in which editor.

Technical data subject to change.

Icon	Editor
	Screens
	HMI alarms
	HMI tags
	Scheduler







					
1	Cleared (Page 3786)	X	--	--	--
2	Activate (Page 3787)	--	--	--	--
3	Change (Page 3787)	--	--	--	--
4	Loaded (Page 3787)	X	--	--	--
5	Execute (Page 3788)	--	--	--	X
6	Selection changed (Page 3788)	--	--	--	--
7	In the event of high limit violation (Page 3788)	--	--	X	--
8	In the event of low limit violation (Page 3788)	--	--	X	--
9	When dialog is opened (Page 3789)	--	--	--	X
10	When dialog is closed (Page 3789)	--	--	--	X
11	User change (Page 3789)	--	--	--	X
12	Screen change (Page 3789)	--	--	--	X
13	Deactivate (Page 3790)	--	--	--	X
14	Double-click (Page 3790)	--	--	--	--
15	Press (Page 3791)	--	--	--	--
16	On Finish Input (Page 3791)	--	--	--	--
17	Press ESC twice (Page 3791)	--	--	--	--
18	Outgoing (Page 3792)	--	X	--	--
19	Incoming (Page 3792)	--	X	--	--
20	Click (Page 3792)	--	--	--	--
21	Click when flashing (Page 3793)	--	--	--	--
22	Loop-in alarm (Page 3793)	--	X	--	--
23	Release (Page 3793)	--	--	--	--
24	Alarm buffer overflow (Page 3794)	--	--	--	X
25	Acknowledge (Page 3794)	--	X	--	--
26	Reach margin (Page 3794)	--	--	--	--
27	Runtime Stop (Page 3795)	--	--	--	X
28	Press key (Page 3795)	--	--	--	--
29	Release key (Page 3795)	--	--	--	--
30	Overflow (Page 3796)	--	--	--	--
31	Switch OFF (Page 3796)	--	--	--	--
32	Switch ON (Page 3796)	--	--	--	--
33	Low free storage space (Page 3797)	--	--	--	--
34	Free space critically low (Page 3797)	--	--	--	--
35	Value change (Page 3797)	--	--	X	--
36	Time expired (Page 3797)	--	--	--	--







## Basic objects

### Introduction

The following table shows which events occur on which objects.

Technical data subject to change.

Icon	Object
	Line
	Ellipse
	Circle
	Rectangle
	Text field
	Graphic view

							
1	Cleared (Page 3786)	--	--	--	--	--	--
2	Activate (Page 3787)	--	--	--	--	--	--
3	Change (Page 3787)	--	--	--	--	--	--
4	Loaded (Page 3787)	--	--	--	--	--	--
5	Execute (Page 3788)	--	--	--	--	--	--
6	Selection changed (Page 3788)	--	--	--	--	--	--
7	In the event of high limit violation (Page 3788)	--	--	--	--	--	--
8	In the event of low limit violation (Page 3788)	--	--	--	--	--	--
9	When dialog is opened (Page 3789)	--	--	--	--	--	--
10	When dialog is closed (Page 3789)	--	--	--	--	--	--
11	User change (Page 3789)	--	--	--	--	--	--
12	Screen change (Page 3789)	--	--	--	--	--	--
13	Deactivate (Page 3790)	--	--	--	--	--	--
14	Double-click (Page 3790)	--	--	--	--	--	--
15	Press (Page 3791)	--	--	--	--	--	--
16	On Finish Input (Page 3791)	--	--	--	--	--	--
17	Press ESC twice (Page 3791)	--	--	--	--	--	--
18	Outgoing (Page 3792)	--	--	--	--	--	--
19	Incoming (Page 3792)	--	--	--	--	--	--
20	Click (Page 3792)	--	--	--	--	--	--
21	Click when flashing (Page 3793)	--	--	--	--	--	--



22	Loop-in alarm (Page 3793)	--	--	--	--	--	--
23	Release (Page 3793)	--	--	--	--	--	--
24	Alarm buffer overflow (Page 3794)	--	--	--	--	--	--
25	Acknowledge (Page 3794)	--	--	--	--	--	--
26	Reach margin (Page 3794)	--	--	--	--	--	--
27	Runtime Stop (Page 3795)	--	--	--	--	--	--
28	Press key (Page 3795)	--	--	--	--	--	--
29	Release key (Page 3795)	--	--	--	--	--	--
30	Overflow (Page 3796)	--	--	--	--	--	--
31	Switch OFF (Page 3796)	--	--	--	--	--	--
32	Switch ON (Page 3796)	--	--	--	--	--	--
33	Low free storage space (Page 3797)	--	--	--	--	--	--
34	Free space critically low (Page 3797)	--	--	--	--	--	--
35	Value change (Page 3797)	--	--	--	--	--	--
36	Time expired (Page 3797)	--	--	--	--	--	--

## Elements







### Introduction

The following table shows which events occur on which objects.

Technical data subject to change.

Icon	Object
	IO field
	Button
	Symbolic IO field
	Graphic IO field
	Date/time field
	Bar
	Switch

1	Cleared (Page 3786)	--	--	--	--	--	--	--
2	Activate (Page 3787)	X	X	X	X	--	--	X
3	Change (Page 3787)	--	X	X	--	--	--	X
4	Loaded (Page 3787)	--	--	--	--	--	--	--
5	Execute (Page 3788)	--	--	--	--	--	--	--
6	Selection changed (Page 3788)	--	--	--	--	--	--	--
7	In the event of high limit violation (Page 3788)	--	--	--	--	--	--	--
8	In the event of low limit violation (Page 3788)	--	--	--	--	--	--	--





								
9	When dialog is opened (Page 3789)	--	--	--	--	--	--	--
10	When dialog is closed (Page 3789)	--	--	--	--	--	--	--
11	User change (Page 3789)	--	--	--	--	--	--	--
12	Screen change (Page 3789)	--	--	--	--	--	--	--
13	Deactivate (Page 3790)	X	X	X	X	--	--	X
14	Double-click (Page 3790)	--	--	--	--	--	--	--
15	Press (Page 3791)	--	X	--	--	--	--	--
16	On Finish Input (Page 3791)	--	--	--	--	--	--	--
17	Press ESC twice (Page 3791)	--	--	--	--	--	--	--
18	Outgoing (Page 3792)	--	--	--	--	--	--	--
19	Incoming (Page 3792)	--	--	--	--	--	--	--
20	Click (Page 3792)	--	X	--	--	--	--	--
21	Click when flashing (Page 3793)	--	--	--	--	--	--	--
22	Loop-in alarm (Page 3793)	--	--	--	--	--	--	--
23	Release (Page 3793)	--	X	--	--	--	--	--
24	Alarm buffer overflow (Page 3794)	--	--	--	--	--	--	--
25	Acknowledge (Page 3794)	--	--	--	--	--	--	--
26	Reach margin (Page 3794)	--	--	--	--	--	--	--
27	Runtime Stop (Page 3795)	--	--	--	--	--	--	--
28	Press key (Page 3795)	--	--	--	--	--	--	--
29	Release key (Page 3795)	--	--	--	--	--	--	--
30	Overflow (Page 3796)	--	--	--	--	--	--	--
31	Switch OFF (Page 3796)	--	--	--	--	--	--	X
32	Switch ON (Page 3796)	--	--	--	--	--	--	X
33	Low free storage space (Page 3797)	--	--	--	--	--	--	--
34	Free space critically low (Page 3797)	--	--	--	--	--	--	--
35	Value change (Page 3797)	--	--	--	--	--	--	--
36	Time expired (Page 3797)	--	--	--	--	--	--	--

## Controls

### Introduction

The following table shows which events occur on which objects.

Technical data subject to change.

Icon	Object
	Alarm view/alarm window
	Alarm indicator
	Trend view
	User view

Icon	Object
	Recipe view
	Auxiliary indicator

							
1	Cleared (Page 3786)	--	--	--	--	--	--
2	Activate (Page 3787)	X	--	X	X	--	--
3	Change (Page 3787)	--	--	--	--	--	--
4	Loaded (Page 3787)	--	--	--	--	--	--
5	Execute (Page 3788)	--	--	--	--	--	--
6	Selection changed (Page 3788)	--	--	--	--	--	--
7	In the event of high limit violation (Page 3788)	--	--	--	--	--	--
8	In the event of low limit violation (Page 3788)	--	--	--	--	--	--
9	When dialog is opened (Page 3789)	--	--	--	--	--	--
10	When dialog is closed (Page 3789)	--	--	--	--	--	--
11	User change (Page 3789)	--	--	--	--	--	--
12	Screen change (Page 3789)	--	--	--	--	--	--
13	Deactivate (Page 3790)	X	--	X	X	--	--
14	Double-click (Page 3790)	--	--	--	--	--	--
15	Press (Page 3791)	--	--	--	--	--	--
16	On Finish Input (Page 3791)	--	--	--	--	--	--
17	Press ESC twice (Page 3791)	--	--	--	--	--	--
18	Outgoing (Page 3792)	--	--	--	--	--	--
19	Incoming (Page 3792)						
20	Click (Page 3792)	--	X	--	--	--	--
21	Click when flashing (Page 3793)	--	X	--	--	--	--
22	Loop-in alarm (Page 3793)	--	--	--	--	--	--
23	Release (Page 3793)	--	--	--	--	--	--
24	Alarm buffer overflow (Page 3794)	--	--	--	--	--	--
25	Acknowledge (Page 3794)	--	--	--	--	--	--
26	Reach margin (Page 3794)	--	--	--	--	--	--
27	Runtime Stop (Page 3795)	--	--	--	--	--	--
28	Press key (Page 3795)	--	--	--	--	--	--
29	Release key (Page 3795)	--	--	--	--	--	--
30	Overflow (Page 3796)	--	--	--	--	--	--
31	Switch OFF (Page 3796)	--	--	--	--	--	--
32	Switch ON (Page 3796)	--	--	--	--	--	--
33	Low free storage space (Page 3797)	--	--	--	--	--	--
34	Free space critically low (Page 3797)	--	--	--	--	--	--
35	Value change (Page 3797)	--	--	--	--	--	--
36	Time expired (Page 3797)	--	--	--	--	--	--







## Overview







## Editors







### Introduction

The following table shows which events occur in which editor.

Technical data subject to change.

Icon	Editor
	Screens
	HMI alarms
	HMI tags
	Logs
	Scheduler
	Audit Trail

							
1	Cleared (Page 3786)	X	--	--	--	--	--
2	Activate (Page 3787)	--	--	--	--	--	--
3	Change (Page 3787)	--	--	--	--	--	--
4	Loaded (Page 3787)	X	--	--	--	--	--
5	Execute (Page 3788)	--	--	--	--	X	--
6	Selection changed (Page 3788)	--	--	--	--	--	--
7	In the event of high limit violation (Page 3788)	--	--	X	--	--	--
8	In the event of low limit violation (Page 3788)	--	--	X	--	--	--
9	When dialog is opened (Page 3789)	--	--	--	--	X	--
10	When dialog is closed (Page 3789)	--	--	--	--	X	--
11	User change (Page 3789)	--	--	--	--	X	--
12	Screen change (Page 3789)	--	--	--	--	X	--
13	Deactivate (Page 3790)	--	--	--	--	--	--
14	Double-click (Page 3790)	--	--	--	--	--	--
15	Press (Page 3791)	--	--	--	--	--	--
16	On Finish Input (Page 3791)	--	--	--	--	--	--
17	Press ESC twice (Page 3791)	--	--	--	--	--	--
18	Incoming (Page 3792)	--	X	--	--	--	--
19	Outgoing (Page 3792)	--	X	--	--	--	--
20	Click (Page 3792)	--	--	--	--	--	--
21	Click when flashing (Page 3793)	--	--	--	--	--	--
22	Loop-in alarm (Page 3793)	--	X	--	--	--	--
23	Release (Page 3793)	--	--	--	--	--	--
24	Alarm buffer overflow (Page 3794)	--	--	--	--	X	--
25	Acknowledge (Page 3794)	--	X	--	--	--	--









							
26	Reach margin (Page 3794)	--	--	--	--	--	--
27	Runtime Stop (Page 3795)	--	--	--	--	X	--
28	Press key (Page 3795)	--	--	--	--	--	--
29	Release key (Page 3795)	--	--	--	--	--	--
30	Overflow (Page 3796)	--	--	--	X	--	--
31	Switching (Page 3796)	--	--	--	--	--	--
32	Switch OFF (Page 3796)	--	--	--	--	--	--
33	Switch ON (Page 3796)	--	--	--	--	--	--
34	Low free storage space (Page 3797)	--	--	--	X	--	X
35	Free space critically low (Page 3797)	--	--	--	X	--	X
36	Value change (Page 3797)	--	--	X	--	--	--
37	Time expired (Page 3797)	--	--	--	--	--	--









## Basic objects









### Introduction

The following table shows which events occur on which objects.

Technical data subject to change.

Icon	Object
	Line
	Polyline
	Polygon
	Ellipse
	Circle
	Rectangle
	Text field
	Graphic view

									
1	Cleared (Page 3786)	--	--	--	--	--	--	--	--
2	Activate (Page 3787)	--	--	--	--	--	--	--	--
3	Change (Page 3787)	--	--	--	--	--	--	--	--
4	Loaded (Page 3787)	--	--	--	--	--	--	--	--
5	Execute (Page 3788)	--	--	--	--	--	--	--	--
6	Selection changed (Page 3788)	--	--	--	--	--	--	--	--
7	In the event of high limit violation (Page 3788)	--	--	--	--	--	--	--	--
8	In the event of low limit violation (Page 3788)	--	--	--	--	--	--	--	--





									
9	When dialog is opened (Page 3789)	--	--	--	--	--	--	--	--
10	When dialog is closed (Page 3789)	--	--	--	--	--	--	--	--
11	User change (Page 3789)	--	--	--	--	--	--	--	--
12	Screen change (Page 3789)	--	--	--	--	--	--	--	--
13	Deactivate (Page 3790)	--	--	--	--	--	--	--	--
14	Double-click (Page 3790)	--	--	--	--	--	--	--	--
15	Press (Page 3791)	--	--	--	--	--	--	--	--
16	On Finish Input (Page 3791)	--	--	--	--	--	--	--	--
17	Press ESC twice (Page 3791)	--	--	--	--	--	--	--	--
18	Outgoing (Page 3792)	--	--	--	--	--	--	--	--
19	Incoming (Page 3792)	--	--	--	--	--	--	--	--
20	Click (Page 3792)	--	--	--	--	--	--	--	--
21	Click when flashing (Page 3793)	--	--	--	--	--	--	--	--
22	Loop-in alarm (Page 3793)	--	--	--	--	--	--	--	--
23	Release (Page 3793)	--	--	--	--	--	--	--	--
24	Alarm buffer overflow (Page 3794)	--	--	--	--	--	--	--	--
25	Acknowledge (Page 3794)	--	--	--	--	--	--	--	--
26	Reach margin (Page 3794)	--	--	--	--	--	--	--	--
27	Runtime Stop (Page 3795)	--	--	--	--	--	--	--	--
28	Press key (Page 3795)	--	--	--	--	--	--	--	--
29	Release key (Page 3795)	--	--	--	--	--	--	--	--
30	Overflow (Page 3796)	--	--	--	--	--	--	--	--
31	Switching (Page 3796)	--	--	--	--	--	--	--	--
32	Switch OFF (Page 3796)	--	--	--	--	--	--	--	--
33	Switch ON (Page 3796)	--	--	--	--	--	--	--	--
34	Low free storage space (Page 3797)	--	--	--	--	--	--	--	--
35	Free space critically low (Page 3797)	--	--	--	--	--	--	--	--
36	Value change (Page 3797)	--	--	--	--	--	--	--	--
37	Time expired (Page 3797)	--	--	--	--	--	--	--	--







## Elements

### Introduction

The following table shows which events occur on which objects.

Technical data subject to change.

Icon	Object
	IO field
	Button
	Symbolic IO field
	Graphic IO field

Icon	Object
	Date/time field
	Bar
	Switch
	Symbol library
	Slider
	Gauge
	Clock

												
1	Cleared (Page 3786)	--	--	--	--	--	--	--	--	--	--	--
2	Activate (Page 3787)	X	X	X	X	--	--	X	X	X	--	--
3	Change (Page 3787)	--	X	X	--	--	--	X	--	X	X	--
4	Loaded (Page 3787)	--	--	--	--	--	--	--	--	--	--	--
5	Execute (Page 3788)	--	--	--	--	--	--	--	--	--	--	--
6	Selection changed (Page 3788)	--	--	--	--	--	--	--	--	--	--	--
7	In the event of high limit violation (Page 3788)	--	--	--	--	--	--	--	--	--	--	--
8	In the event of low limit violation (Page 3788)	--	--	--	--	--	--	--	--	--	--	--
9	When dialog is opened (Page 3789)	--	--	--	--	--	--	--	--	--	--	--
10	When dialog is closed (Page 3789)	--	--	--	--	--	--	--	--	--	--	--
11	User change (Page 3789)	--	--	--	--	--	--	--	--	--	--	--
12	Screen change (Page 3789)	--	--	--	--	--	--	--	--	--	--	--
13	Deactivate (Page 3790)	X	X	X	X	--	--	X	X	X	--	--
14	Double-click (Page 3790)	--	--	--	--	--	--	--	X	--	--	--
15	Press (Page 3791)	--	X	--	--	--	--	--	X	--	--	--
16	On Finish Input (Page 3791)	X	--	X	X	--	--	--	--	--	--	--
17	Press ESC twice (Page 3791)	--	--	--	--	--	--	--	--	--	--	--
18	Outgoing (Page 3792)	--	--	--	--	--	--	--	--	--	--	--
19	Incoming (Page 3792)	--	--	--	--	--	--	--	--	--	--	--
20	Click (Page 3792)	--	X	--	--	--	--	--	X	--	--	--
21	Click when flashing (Page 3793)	--	--	--	--	--	--	--	--	--	--	--
22	Loop-in alarm (Page 3793)	--	--	--	--	--	--	--	--	--	--	--
23	Release (Page 3793)	--	X	--	--	--	--	--	X	--	--	--
24	Alarm buffer overflow (Page 3794)	--	--	--	--	--	--	--	--	--	--	--
25	Acknowledge (Page 3794)	--	--	--	--	--	--	--	--	--	--	--
26	Reach margin (Page 3794)	--	--	--	--	--	--	--	--	--	--	--
27	Runtime Stop (Page 3795)	--	--	--	--	--	--	--	--	--	--	--
28	Press key (Page 3795)	--	--	--	--	--	--	--	--	--	--	--
29	Release key (Page 3795)	--	--	--	--	--	--	--	--	--	--	--
30	Overflow (Page 3796)	--	--	--	--	--	--	--	--	--	--	--
31	Switching (Page 3796)	--	--	--	--	--	--	--	--	--	--	--
32	Switch OFF (Page 3796)	--	--	--	--	--	--	X	--	--	--	--

33	Switch ON (Page 3796)	--	--	--	--	--	--	--	X	--	--	--	--	--
34	Low free storage space (Page 3797)	--	--	--	--	--	--	--	--	--	--	--	--	X
35	Free space critically low (Page 3797)	--	--	--	--	--	--	--	--	--	--	--	--	X
36	Value change (Page 3797)	--	--	--	--	--	--	--	--	--	--	--	--	--
37	Time expired (Page 3797)	--	--	--	--	--	--	--	--	--	--	--	--	--

## Controls

### Introduction











The following table shows which events occur on which objects.

Technical data subject to change.

Icon	Object
	Alarm view/alarm window
	Alarm indicator
	Trend view
	User view
	HTML browser
	Status/Force
	Sm@rtClient view
	Recipe view
	f(x) trend view
	System diagnostics view / system diagnostics window
	Function key

1	Cleared (Page 3786)	--	--	--	--	--	--	--	--	--	--	--
2	Activate (Page 3787)	X	--	X	X	X	X	X	X	--	X	--
3	Change (Page 3787)	--	--	--	--	--	--	--	--	--	--	--
4	Loaded (Page 3787)	--	--	--	--	--	--	--	--	--	--	--
5	Execute (Page 3788)	--	--	--	--	--	--	--	--	--	--	--
6	Selection changed (Page 3788)	X	--	--	--	--	--	--	--	--	--	--
7	In the event of high limit violation (Page 3788)	--	--	--	--	--	--	--	--	--	--	--
8	In the event of low limit violation (Page 3788)	--	--	--	--	--	--	--	--	--	--	--
9	When dialog is opened (Page 3789)	--	--	--	--	--	--	--	--	--	--	--
10	When dialog is closed (Page 3789)	--	--	--	--	--	--	--	--	--	--	--
11	User change (Page 3789)	--	--	--	--	--	--	--	--	--	--	--
12	Screen change (Page 3789)	--	--	--	--	--	--	--	--	--	--	--



												
13	Deactivate (Page 3790)	X	--	X	X	X	X	X	X	--	--	--
14	Double-click (Page 3790)	--	--	--	--	--	--	--	--	--	--	--
15	Press (Page 3791)	--	--	--	--	--	--	--	--	--	--	--
16	On Finish Input (Page 3791)	--	--	--	--	--	--	--	--	--	--	--
17	Press ESC twice (Page 3791)	--	--	--	--	--	--	--	--	--	--	--
18	Outgoing (Page 3792)	--	--	--	--	--	--	--	--	--	--	--
19	Incoming (Page 3792)	--	--	--	--	--	--	--	--	--	--	--
20	Click (Page 3792)	--	X	--	--	--	--	--	--	--	--	--
21	Click when flashing (Page 3793)	--	X	--	--	--	--	--	--	--	--	--
22	Loop-in alarm (Page 3793)	--	--	--	--	--	--	--	--	--	--	--
23	Release (Page 3793)	--	--	--	--	--	--	--	--	--	--	--
24	Alarm buffer overflow (Page 3794)	--	--	--	--	--	--	--	--	--	--	--
25	Acknowledge (Page 3794)	--	--	--	--	--	--	--	--	--	--	--
26	Reach margin (Page 3794)	--	--	--	--	--	--	--	--	--	--	--
27	Runtime Stop (Page 3795)	--	--	--	--	--	--	--	--	--	--	--
28	Press key (Page 3795)	--	--	--	--	--	--	--	--	--	--	X
29	Release key (Page 3795)	--	--	--	--	--	--	--	--	--	--	X
30	Overflow (Page 3796)	--	--	--	--	--	--	--	--	--	--	--
31	Switching (Page 3796)	--	--	--	--	--	--	--	--	--	--	--
32	Switch OFF (Page 3796)	--	--	--	--	--	--	--	--	--	--	--
33	Switch ON (Page 3796)	--	--	--	--	--	--	--	--	--	--	--
34	Low free storage space (Page 3797)	--	--	--	--	--	--	--	--	--	--	--
35	Free space critically low (Page 3797)	--	--	--	--	--	--	--	--	--	--	--
36	Value change (Page 3797)	--	--	--	--	--	--	--	--	--	--	--
37	Time expired (Page 3797)	--	--	--	--	--	--	--	--	--	--	--

**Events**

**Cleared**

**Description**

Occurs when the active screen on the HMI device is cleared.

**Note**

Please note that the availability of the event is dependent upon the HMI device and object type.

## Activate

### Description

Occurs when the user selects a display or operating object using the configured tab sequence.

---

#### Note

Note that the availability of the event depends on the HMI device and object type.

---

#### Note

If the user e.g. clicks a button with the mouse, the "Click" event is triggered. Users wishing to trigger the "Enable" event must select the button using the tab key.

---

The "Enable" event is only used to detect whether an object was selected. The event does not trigger a password prompt.

For this reason, do not use the "Enable" event if you want to configure access protection on the function call of the object.

## Change

### Description

Occurs if the status of a display and operator control object changes.

The status of an object changes if, for example, the user presses the key.

---

#### Note

Note that the availability of the event depends on the HMI device and object type.

---

## Loaded

### Description

Occurs when all configured display and operating objects are loaded in the active screen after a screen change.

---

#### Note

Please note that the availability of the event is dependent upon the HMI device and object type.

---

---

**Note**

Enable a screen change to ensure that the connection with the control is established after switch-on.

---

**Execute**

**Description**

Occurs when the scheduled task has been executed.

**Selection changed**

**Description**

Occurs when the user changes the selection.

---

**Note**

Please note that the availability of the event is dependent upon the HMI device and object type.

---

**In the event of high limit violation**

**Description**

Occurs when the high limit of a tag is exceeded.

---

**Note**

Note that the availability of the event depends on the HMI device and object type.

---

**In the event of low limit violation**

**Description**

Occurs when the low limit of a tag is undershot.

---

**Note**

Note that the availability of the event depends on the HMI device and object type.

---

### When dialog is opened

#### Description

The event is triggered when a modal dialog opens.

---

#### Note

Please note that the availability of the event depends on the HMI device and object type.

---

### When dialog is closed

#### Description

The event is triggered when a modal dialog closes.

---

#### Note

Please note that the availability of the event depends on the HMI device and object type.

---

### User change

#### Description

Occurs when a user logs off at an HMI device or another user logs on at the HMI device.

---

#### Note

Please note that the availability of the event is dependent upon the HMI device and object type.

---

### Screen change

#### Description

Occurs when all configured display and operating objects are loaded in the screen after a screen change.

Use the "Loaded" event if you want to perform other system functions during a screen change to a certain screen.

---

**Note**

Please note that the availability of the event is dependent upon the HMI device and object type.

---

## Deactivate

### Description

Occurs when the user takes the focus from a display and operating object.

A screen object can be disabled using the configured tab order or by performing another action with the mouse.

---

**Note**

Please note that the availability of the event is dependent upon the HMI device and object type.

---

---

**Note**

System functions or user-defined functions on the "Deactivate" event of a screen are not executed when a screen is being closed.

---

The "Deactivate" event is only used to detect whether an object was deselected. The event does not trigger a password prompt.

For this reason, do not use the "Deactivate" event if you want to configure access protection on the function call of the object.

## Double-click

### Description

Occurs when the user double-clicks on an object from the symbol library.

---

**Note**

Please note that the availability of the event is dependent upon the HMI device and object type.

---

## Press

### Description

Occurs when the user clicks on a button with the left mouse button, presses <RETURN> or <SPACE>.

Also occurs when the user right-clicks on an object of the symbol library.

---

#### Note

Please note that the availability of the event is dependent upon the HMI device and object type.

---

## On Finish Input

### Description

Triggered when you confirm input at an I/O field by pressing ENTER, or by mouse click, or by touch screen operation.

The "On Finish Input" event is also started if the value of a tag does not change, for example, if a value is exceeded, or if a user cancels the dialog to acknowledge a tag (Audit option package) that has to be acknowledged.

The event is not triggered, on the other hand, by user logon or by input fields configured with an authorization.

---

#### Note

Note that the availability of the event depends on the HMI device and object type.

---

## Press ESC twice

### Description

Occurs when the user presses the <ESC> key twice at the HMI device.

---

#### Note

Note that the availability of the event depends on the HMI device and object type.

---

## Outgoing

### Description

Occurs when an alarm is deactivated.

---

**Note**

Please note that the availability of the event depends on the HMI device and object type.

---

## Incoming

### Description

Occurs when an alarm is triggered and displayed in the alarm view.

---

**Note**

Please note that the availability of the event depends on the HMI device and object type.

---

## Click

### Description

Occurs if the user clicks a display and operating object with the mouse or touches the touch display with a finger.

In case you click the incorrect object, prevent processing of configured function list as follows:

- Move the mouse pointer away from the object while keeping the mouse button pressed. Release the mouse button as soon as the mouse pointer leaves the object. The function list will then not be processed.
- On touch displays, the display must be touched with the finger until a reaction occurs, e.g., a screen change.

---

**Note**

Please note that the availability of the event is dependent upon the HMI device and object type.

---

## Click when flashing

### Description

Occurs when the user clicks a flashing alarm indicator with the mouse or touches it with a finger.

---

#### Note

Note that the availability of the event depends on the HMI device and object type.

---

## Loop-in alarm

### Description

Occurs as soon as the user selects an alarm in the alarm view and then clicks on the "Loop-In-Alarm" button or double clicks on the alarm.

For the "Loop-In-Alarm" event, you configure system functions, such as a change to the screen in which the alarm occurred.

You cannot configure local scripts for the "Loop-In-Alarm" event in Runtime Professional.

---

#### Note

Please note that the availability of the event is dependent upon the HMI device and object type.

---

## Release

### Description

Occurs when the user releases a button.

This even does not occur, as long as the button remains pressed.

---

#### Note

Please note that the availability of the event is dependent upon the HMI device and object type.

---



## Alarm buffer overflow

### Description

Occurs when the configured size of the alarm buffer is reached.

---

#### Note

Please note that the availability of the event is dependent upon the HMI device and object type.

---

## Acknowledge

### Description

Occurs when the user acknowledges an alarm.

---

#### Note

Please note that the availability of the event is dependent upon the HMI device and object type.

---

## Reach margin

### Description

Occurs when the user reaches the beginning or the end of a scrollable area.

---

#### Note

Note that the availability of the event depends on the HMI device and object type.

---

#### Note

A user-defined function must not be configured for the "Boundary reached" event.

---

## Configurable objects

The event can only be configured on the <Up> and <Down> keys, or on the keys on which you have configured the "ScreenObjectPageUp" or "ScreenObjectPageDown" system functions.

## Runtime Stop

### Description

Occurs when the user exits the Runtime software on the HMI device.

---

**Note**

Please note that the availability of the event is dependent upon the HMI device and object type.

---

**Note**

A user-defined function must not be configured for the "Runtime stop" event.

---

## Press key

### Description

Occurs when the user presses a function key.

---

**Note**

Please note that the availability of the event is dependent upon the HMI device and object type.

---

## Release key

### Description

Occurs when the user releases a function key.

---

**Note**

Note that the availability of the event depends on the HMI device and object type.

---

## Overflow

### Description

Occurs when the configured size of the log is reached. You use the log type "Trigger event".

---

#### Note

Please note that the availability of the event is dependent upon the HMI device and object type.

---

## Switching

### Description

Occurs when the user toggles a display and operating object, e.g. a switch from "ON" to "OFF".

---

#### Note

Please note that the availability of the event is dependent upon the HMI device and object type.

---

## Switch OFF

### Description

Occurs when the user moves the display and operating object "Switch" to the OFF position.

---

#### Note

Note that the availability of the event depends on the HMI device and object type.

---

## Switch ON

### Description

Occurs when the user moves the display and operating object "Switch" to the ON position.

---

#### Note

Note that the availability of the event depends on the HMI device and object type.

---

## Low free storage space

### Description

This event is triggered if the storage space available on the medium to which the Audit Trail is less than the configured minimum.

## Free space critically low

### Description

This event is triggered if the storage medium to which an Audit Trail is saved provides insufficient storage space due to hardware restrictions.

## Value change

### Description

Occurs when the value of an object or the value of an array element changes.

The value change of a tag is triggered by the PLC or by the user, e.g. when a new value is entered.

---

#### Note

Please note that the availability of the event is dependent upon the HMI device and object type.

---

## Time expired

### Description

Occurs when the time configured in the scheduler expires.

---

#### Note

Please note that the availability of the event is dependent upon the HMI device and object type.

---

### 10.8.7.3 VB scripts

#### System functions

#### AcknowledgeAlarm

##### Description

Acknowledges all selected alarms.

This system function is used when the HMI device does not have an ACK key or when the integrated key of the alarm view should not be used.

This system function can only be used for function keys.

##### Use in the function list

AcknowledgeAlarm

##### Use in user-defined functions

AcknowledgeAlarm

Can be used if the configured device supports user-defined functions. For additional information, refer to "Device dependency".

##### Parameter

--

#### ActivatePreviousScreen

##### Description

Performs a screen change to the screen which was activated before the current screen. The screen change is not performed if no screen was activated beforehand.

The last 10 screens that were called up are saved. A system alarm is output when you change to a screen which is no longer saved.

---

##### Note

If you want to use the system function, the screen to which you change has to be used in the navigation structure.

---

### Use in the function list

ActivatePreviousScreen

### Use in user-defined functions

ActivatePreviousScreen

Can be used if the configured device supports user-defined functions. For additional information, refer to "Device dependency".

### Parameter

--

### ActivateScreen

### Description

Performs a screen change to the given screen.

Use the "ActivateScreenByNumber" system function to change from the root screen to the permanent window or vice versa.

### Use in the function list

ActivateScreen (Screen name, Object number)

### Use in user-defined functions

ActivateScreen (Screen\_name, Object\_number)

Can be used if the configured device supports user-defined functions. For additional information, refer to "Device dependency".

### Parameters

#### Screen name

Name of the screen to which you change.

#### Object number

The operator control element which receives the focus in the given screen after the screen change. The number of the operator control element is to be determined using the tabulator sequence during configuration.

When "0" is specified:

- If the focus is in the permanent window when the system function is called up, the permanent window maintains the focus.
- If the focus is in the root screen when the system function is called up, the first operator control element in the given screen receives the focus.

---

**Note**

If the "Reach margin" event is assigned to the "ActivateScreen" system function, only the value "0" is valid for the "Object number" parameter. The active object is not defined by the object number, but rather by the X position it had prior to the screen change.

---

**Example**

The ActivateScreen function is used in the following program code to activate the "Screen\_2" screen when you click a button.

```
{  
  
// User defined code  
// i.e. when pressing a button  
ActivateScreen ("Screen_2", 0);  
...  
}
```

**ActivateScreenByNumber****Description**

Performs a screen change to a screen depending on a tag value.  
The screen is identified by its screen number.

**Use in the function list**

ActivateScreenByNumber (Screen number, Object number)

**Use in user-defined functions**

ActivateScreenByNumber (Screen\_number, Object\_number)

Can be used if the configured device supports user-defined functions. For additional information, refer to "Device dependency".

## Parameter

### Screen number

Tag which contains the screen number of the destination screen.

When a change from the root screen to the permanent window is desired, "0" or "-1" is specified:

0 = Change from root screen to permanent window

-1 = Change from permanent window to root screen

### Object number

The number of the screen object which receives the focus in the given screen after the screen change. The number of the operator control element is to be determined using the tabulator sequence during configuration.

When "0" is specified:

- If the focus is in the permanent window when the system function is called up, the permanent window maintains the focus.
- If the focus is in the root screen when the system function is called up, the first operator control element in the given screen receives the focus.

## ActivateSystemDiagnosticsView

### Description

Activates the system diagnostics view. The system diagnostics view shows the detail view of the device concerned.

### Use in the function list

ActivateSystemDiagnosticsView (Screen name, Object name)

### Use in user-defined functions

ActivateSystemDiagnosticsView (Screen\_name, Object\_name)

Can be used if the configured device supports user-defined functions. For additional information, refer to "Device dependency".

## Parameter

### Screen name

Name of the screen contained in the system diagnostics view.

### Object name

Object name of the system diagnostics view.



## ArchiveLogFile

### Description

This system function moves or copies a log to another storage location for long-term logging.

With Audit Trails, always use the "Move" (hmiMove)" mode, otherwise you will be violating the FDA guideline by duplicating the data stored.

Prior to "ArchiveLogFile" always run the system function "CloseAllLogs".

After this system function, run the "OpenAllLogs" system function.

In "Copy log" mode, the logs are not reopened until the log has been successfully copied, or unless a timeout occurs during the copy process. In "Move log" mode, the logs to be moved are renamed and the new logs are opened immediately. To move the renamed logs, a job is submitted which attempts to move them every 300 seconds if the server cannot be reached. The job is also retained after Runtime is restarted until it is executed.

### Use in the function list

ArchiveLogFile (Log type, Log, Directory name, Mode)

### Use in user-defined functions

ArchiveLogFile (Log\_type, Log, Directory\_name, Mode)

Can be used if the configured device supports user-defined functions. For additional information, refer to "Device dependency".

### Parameter

#### Log type

Determines the type of log:

0 (hmiTagArchive) = Data log

1 (miAlarmArchive) = Alarm log

2 (hmiAudittrailArchive) = Audit trail log available for GMP compliant projects. Additional information is available under "Activating GMP-compliant configuration".

#### Log

Name of the log being archived.

#### Directory name

Path for saving the log.

#### Mode

0 (hmiCopy) = Copy log

1 (hmiMove) = Move log

### Application example

You want to move a log file from a local storage medium to the server in order to generate a backup copy of this file at cyclic intervals.

#### Notes on configuring

Set up a task in the scheduler which is executed at a specific time on a daily basis. Configure the following function list for the task:

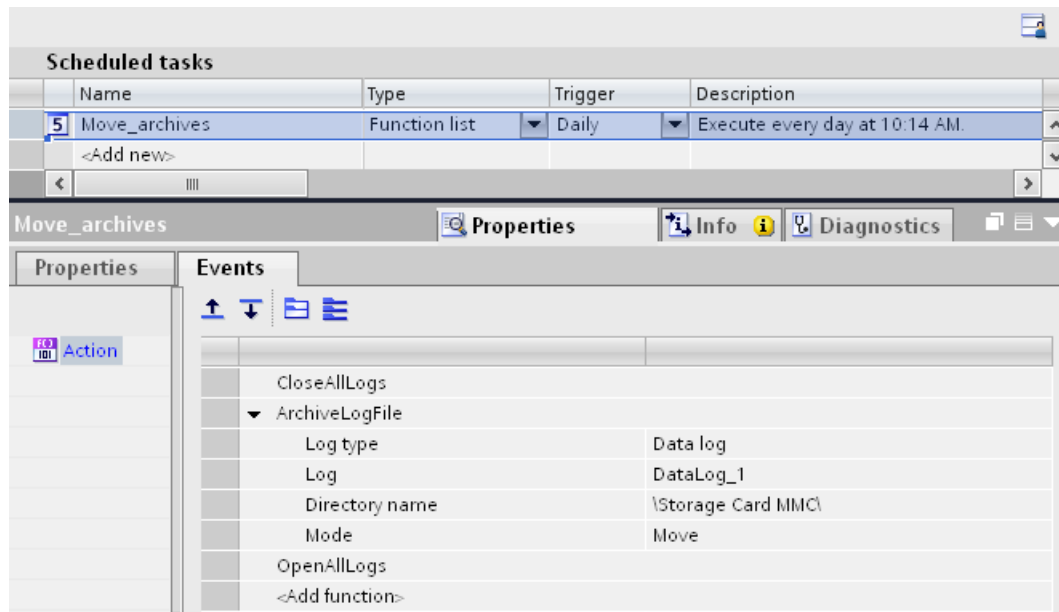

#### Procedure on HMI device

- All log files will be closed.
- The log file you specified is moved to the server.
- All closed log files will be opened again.

### Back up RAM file system

#### Description

Backs up the RAM file system in the memory medium of the HMI device.

After restarting the HMI device, the data is automatically reloaded in the RAM file system.

Applications such as the Internet Explorer save data (e.g. the last web sites called up) temporarily to the DRAM file system of the HMI device.

#### Use in the function list

BackupRAMFileSystem

### Use in user-defined functions

BackupRAMFileSystem

Can be used if the configured device supports user-defined functions. For additional information, refer to "Device dependency".

### Parameter

--

### CalibrateTouchScreen

#### Description

Calls a program for calibrating the touch screen.

During the calibration process, there is a prompt to touch five positions on the screen display. Touch the screen display within 30 seconds, to confirm the calibration process. If the calibration is not completed within this time span, the calibration settings are discarded. The user prompt is in English.

Use this system function the first time you start the HMI device.

### Use in the function list

CalibrateTouchScreen

### Use in user-defined functions

CalibrateTouchScreen

Can be used if the configured device supports user-defined functions. For additional information, refer to "Device dependency".

### Parameter

--

---

#### Note

The CalibrateTouchScreen system function cannot be simulated.

---

### ChangeConnection

#### Description

Disconnects the connection to the currently used PLC in use and establishes a connection to a PLC with another address. The newly connected PLC must belong to the same device class

(S7-1200, S7-300, ...etc). With S7-1200, the use of the function is also only permitted for absolute addressing.

---

**Note**

When changing to another address, ensure that the address is not already being used by another HMI device.

---

The follows address types are supported:

- IP address
- MPI address

The follows PLC types are supported:

- SIMATIC S7 300/400
- SIMATIC S7-NC
- SIMOTION

### Use in the function list

ChangeConnection (Connection, Address, Slot, Rack)

### Use in user-defined functions

ChangeConnection (Connection, Address, Slot, Rack)

Can be used if the configured device supports user-defined functions. For additional information, refer to "Device dependency".

### Parameter

#### Connection

Name of the connection that is disconnected. The name is set during configuration, for example, in the "Connections" editor.

#### Address

MPI/PROFIBUS or IP address of the PLC to which the connection will be established.

---

**Note**

Set the address by means of a tag. The objects list displays the tags of all data types. Select only tags of the following data types:

- Ethernet connection: "String" data type
  - MPI connection: "Int" data type
-

**Slot**

Slot of the PLC to which the connection will be established.

**Rack**

Rack of the PLC to which the connection will be established.

**Application example**

You want to operate one HMI device on several machines. Configure the necessary PLCs in the project, to which you want to change by pressing a key. When changing the PLC, the connection to the PLC in use is disconnected. Then the connection to the new PLC with other address parameters is reestablished. To access the values of the new PLC, configure the same tags for the PLC used.

The PLC which you have indicated when creating the project will be used as default.

1. Enter the name and address of the PLC in the "Connections" editor.
2. Configure a button in the process screen.
3. Configure the "ChangeConnection" system function on the "Press" event.
4. Enter the name of the connection and address of the PLC as parameters.

**ClearAlarmBuffer**

**Description**

Deletes alarms from the alarm buffer on the HMI device.

---

**Note**

Alarms which have not yet been acknowledged are also deleted.

---

**Use in the function list**

ClearAlarmBuffer (Alarm class number)

**Use in user-defined functions**

ClearAlarmBuffer (Alarm\_class\_number)

Can be used if the configured device supports user-defined functions. For additional information, refer to "Device dependency".

**Parameter**

**Alarm class number**

Determines which alarms are to be deleted from the alarm buffer:

- 0 (hmiAll) = All alarms/events
  - 1 (hmiAlarms) = Alarms of alarm class "Errors"
  - 2 (hmiEvents) = Alarms of alarm class "Warnings"
  - 3 (hmiSystem) = Alarms of alarm class "System"
  - 4 (hmiS7Diagnosis) = Alarms of alarm class "Diagnosis Events"
- 

**Note**

**Device dependency**

Alarms of alarm class "Diagnosis Events" are not available on Basic Panels.

---

## ClearAlarmBufferProtool

### Description

The system function exists to ensure compatibility.

It has the same functionality as the "ClearAlarmBuffer" system function, but uses the old ProTool numbering.

### Use in the function list

ClearAlarmBufferProTool (Alarm class number)

### Use in user-defined functions

ClearAlarmBufferProtoolLegacy (Alarm\_class\_number)

Can be used if the configured device supports user-defined functions. For additional information, refer to "Device dependency".

### Parameter

**Alarm class number**

Alarm class number whose messages are to be deleted:

- 1 (hmiAllProtoolLegacy) = All alarms/events
- 0 (hmiAlarmsProtoolLegacy) = Alarms of alarm class "Errors"
- 1 (hmiEventsProtoolLegacy) = Alarms of alarm class "Warnings"
- 2 (hmiSystemProtoolLegacy) = Alarms of alarm class "System"

---

3 (hmiS7DiagnosisProtoolLegacy) = Alarms of alarm class "Diagnosis Events"

---

**Note****Device dependency**

Alarms of alarm class "Diagnosis Events" are not available on Basic Panels.

---

## ClearDataRecord

### Description

Deletes a recipe data record.

Several data records can be deleted from one or more recipes.

### Use in the function list

ClearDataRecord (Recipe number/name, Data record number/name, Confirmation, Output status message, Processing status)

### Use in user-defined functions

ClearDataRecord

Can be used if the configured device supports user-defined functions. For additional information, refer to "Device dependency".

### Parameter

**Recipe number/name**

Number or name of the recipe from which recipe data records are deleted. "0" is specified if you want to delete recipe data records from all available recipes.

**Data record number/name**

Number or name of the recipe data record to be deleted. "0" is specified if you want to delete all recipe data records.

**Confirmation**

Determines whether the operator should confirm the deletion:

0 (hmiOff) = Off: Deletion is begun without confirmation.

1 (hmiOn) = On: The starting of the deletion process must be confirmed.

**Output status message**

Determines whether a status message is output after the deletion:

0 (hmiOff) = Off: Status message is not output.

1 (hmiOn) = On: Status message is output.

#### Processing status

Returns the processing status of the system function. You can use the return value, for example, to delay execution of other system functions until this system function has been successfully completed:

2 = System function is being performed.

4 = System function was successfully completed.

12 = System function was not performed because an error has occurred.

## ClearDataRecordMemory

### Description

Deletes all recipes data records from the specified storage medium.

### Use in the function list

ClearDataRecordMemory (Storage location, Confirmation, Output status message, Processing status)

### Use in user-defined functions

ClearDataRecordMemory (Storage\_location, Confirmation, Output\_status\_message, Processing\_status)

Can be used if the configured device supports user-defined functions. For additional information, refer to "Device dependency".

### Parameter

#### Storage location

Determines the storage location:

0 (hmiFlashMemory) = Flash memory: Internal flash memory of the HMI device

1 (hmiStorageCard) = Storage card

2 (hmiStorageCard2) = Storage card 2

3 (hmiStorageCard3) = Storage card MultiMediaCard

4 (hmiStorageCard4) = Storage card USB

#### Confirmation

Determines whether the operator should confirm the deletion:

0 (hmiOff) = Off: Deletion is begun without confirmation.

1 (hmiOn) = On: The starting of the deletion process must be confirmed.



### Output status message

Determines whether a status message is output after the deletion:

0 (hmiOff) = Off: Status message is not output.

1 (hmiOn) = On: Status message is output.

### Processing status

Returns the processing status of the system function. You can use the return value, for example, to delay execution of other system functions until this system function has been successfully completed:

2 = System function is being performed.

4 = System function was successfully completed.

12 = System function was not performed because an error has occurred.

## ClearLog

### Description

Deletes all data records in the given log.

### Use in the function list

ClearLog (Log type, Log)

### Use in user-defined functions

ClearLog (Log\_type, Log)

Can be used if the configured device supports user-defined functions. For additional information, refer to "Device dependency".

## Parameter

### Log type

Determines the type of log:

0 (hmiTagArchive) = Data log

1 (hmiAlarmArchive) = Alarm log

2 (hmiAudittrailArchive) = Audit trail log Available for GMP-compliant projects Additional information is available under "Activating GMP-compliant configuration".

### Log

Name of the log from which all entries are deleted.

## CloseAllLogs

### Description

Disconnects the connection between WinCC and all logs.

---

#### Note

Before you close a log, the logging function must first be stopped in the log. Use the "StopLogging" system function.

---

### Use in the function list

CloseAllLogs

### Use in user-defined functions

CloseAllLogs

Can be used if the configured device supports user-defined functions. For additional information, refer to "Device dependency".

### Parameter

--

### Application example

You are in runtime and want to change the data medium on which the process values are logged.

#### Notes on configuring

Configure the "StopLogging" and "CloseAllLogs" system functions on the "Close Archive" button.

Configure the "OpenAllLogs" and "StartLogging" system functions on the "Open Archive" button.

As parameter transfer the respective name of the log that is to be stopped and started.

#### Procedure on HMI device

When the button "Close Archive" is pressed, the specified log is stopped and all open logs are closed. The data medium can be changed. You open all logs with the "Open Archive" button. The logging process will continue in the specified log.

## ControlSmartServer

### Description

Starts or stops the Sm@rtServer.

### Use in the function list

ControlSmartServer (Mode)

### Use in user-defined functions

ControlSmartServer (Mode)

Can be used if the configured device supports user-defined functions. For additional information, refer to "Device dependency".

### Parameter

#### Mode

Specifies whether the Sm@rtServer is started or stopped.

-1 (hmiToggle) = Toggle: Toggles between the two modes

0 (hmiStop) = Stop: Sm@rtServer is stopped

1 (hmiStart) = Start: Sm@rtServer is started

## ControlWebServer

### Description

Starts or stops the Web server.

### Use in the function list

ControlWebServer (Mode)

### Use in user-defined functions

ControlWebServer (Mode)

Can be used if the configured device supports user-defined functions. For additional information, refer to "Device dependency".

## Parameter

### Mode

Specifies whether the Web server is started or stopped.

-1 (hmiToggle) = Toggle: Toggles between the two modes

0 (hmiStop) = Stop: The Web server is stopped.

1 (hmiStart) = Start: The Web server is started.

## CopyLog

### Description

Copies the contents of a log to another log. Tag values can only be copied to other data logs and alarms only to other alarm logs, however.

---

### Note

If you copy a log using the "CopyLog" system function, it is possible that external applications will be unable to read certain country-specific special characters in the logged message text of the log copy. This does not apply to WinCC Runtime. WinCC Runtime can read the copied log files without errors.

---

### Use in the function list

CopyLog (Log type, Destination log, Source log, Mode, Delete source log)

### Use in user-defined functions

CopyLog (Log\_type, Destination log, Source\_log, Mode, Delete\_source\_log)

Can be used if the configured device supports user-defined functions. For additional information, refer to "Device dependency".

## Parameter

### Log type

Determines the type of log:

0 (hmiTagArchive) = Data log

1 (hmiAlarmArchive) = Alarm log

### Destination log

Name of the log into which the entries are copied (Destination log).

**Source log**

Name of the log from which the entries are copied (Source log).

**Mode**

Determines what is done with copied entries in the destination log:

0 (hmiOverwrite) = Overwrite: Existing entries are overwritten.

2 (hmiAppend) = Append: The entries are inserted at the end of the destination log. When the configured size of the log has been reached, the destination log is treated like a circular log.

**Delete source log**

Determines whether the source log is deleted after copying.

0 (hmiNo) = No: Is not deleted.

1 (hmiYes) = Yes: Is deleted.

**DecreaseTag****Description**

Subtracts the given value from the tag value.

$X = X - a$

---

**Note**

The system function uses the same tag as input and output values. When this system function is used to convert a value, auxiliary tags must be used. The auxiliary tags are assigned to the tag value with the "SetTag" system function.

---

If you configure the system function on the events of an alarm and the tag is not being used in the current screen, it is not ensured that the actual value of the tags is being used in the PLC. You can improve the situation by setting the "Cyclic continuous" acquisition mode.

**Use in the function list**

DecreaseTag (Tag, Value)

**Use in user-defined functions**

DecreaseTag (Tag, Value)

Can be used if the configured device supports user-defined functions. For additional information, refer to "Device dependency".

## Parameter

### Tag

The tag from which the given value is subtracted.

### Value

The value which is subtracted.

## EditAlarm

### Description

Triggers the "Edit" event for all selected alarms.

If the alarms to be edited have not yet been acknowledged, the acknowledgment takes place automatically when this system function is called up.

This system function can only be used for function keys.

### Use in the function list

EditAlarm

### Use in user-defined functions

EditAlarm

Can be used if the configured device supports user-defined functions. For additional information, refer to "Device dependency".

## Parameter

--

## Encode

### Description

Adapts the "String" data type of a tag for transfer to the automation system (AS). The tag of WinCC data type "String" is converted into the AS data type "Array of byte". The result is written to a tag.

### Use in the function list

Encode (Byte array, String, Coding)

## Use in user-defined functions

Encode (Byte\_array, String, Encoding)

Can be used if the configured device supports user-defined functions. For additional information, refer to "Device dependency".

## Parameter

### Byte array

The tag that contains the converted value.

---

### Note

The Byte array must be twice the size of the string length + 2. The Byte array must contain 242 array elements if the string has a length of 120 characters.

Characters are either truncated or not converted if the size is insufficient.

---

### String

The tag of data type "String" that is converted.

### Encode

0 (hmiEncodeUTF16LE) - String is encoded in UTF16LE (Unicode 16 Little Endian).

## EncodeEx

## Description

Adapts the "String" data type of a tag for transfer to the automation system (AS). The tag of WinCC data type "String" is converted into the AS data type "Array of byte". The result is written to a tag.

By contrast to the Encode system function, you can define the Line break parameter. Using the Line break parameter you can delete line breaks or replace these with predefined characters.

## Use in the function list

EncodeEx (Byte array, String , Encode , Line break)

## Use in user-defined functions

EncodeEx (Byte\_array, String, Encoding, Line\_break)

Can be used if the configured device supports user-defined functions. For additional information, refer to "Device dependency".

## Parameter

### Byte array

The tag that contains the converted value.

---

### Note

The byte array must be twice the size of the string length +2. If the string has a length of 120 characters, the byte array must contain 242 array elements.

Characters are either truncated or not converted if the size is insufficient.

---

### String

The tag of data type "String" that is converted.

### Encode

0 (hmiEncodeUTF16LE) - String is encoded in UTF16LE (Unicode 16 Little Endian).

### Line break

All line breaks are either deleted or replaced with predefined characters. Do not replace line breaks if set as the default value.

0 (replace with "\r\n" (0x000D, 0x000A)) - the line break is replaced with "\r\n".

1 (replace with "\n" (0x000A)) - the line break is replaced with "\n".

2 (do not replace) - the line break is not replaced.

3 (remove line breaks) - the line breaks are removed.

## ExportDataRecords

### Description

Exports one or all data records of a recipe to a CSV file.

One file is created per recipe.

### Use in the function list

ExportDataRecords (Recipe number/name, Data record number/name, File name, Overwrite, Output status message, Processing status)

### Use in user-defined functions

ExportDataRecords (Recipe\_number/name,Data\_record number/name, File\_name, Overwrite, Output\_status\_message, Processing\_status)

Can be used if the configured device supports user-defined functions. For additional information, refer to "Device dependency".



## Parameter

### Recipe number/name

Number or name of the recipe from which the data records are exported. Specify "0" if recipe data records are to be exported from all available recipes.

### File name

Name of the CSV file to which the recipe data records are exported. Enter the file location and the file extension (\*.csv), for example, "C:\TEMP\Orange.csv".

---

### Note

#### Storage of the CSV file

- If a storage card is used as storage location, specify the storage location as follows: "\StorageCard\".
  - If you only enter one file name and no path, the file will be saved in a system directory, for example, "C:\Documents and Settings\[User]".
  - When only one path for the export is specified, the file name is automatically created from the respective recipe name. It is a requirement that the folder "D:\Temp\", for example, has been created. If the folder "D:\Temp" has not been created, the folder name will be used as the prefix of the file name, Temp\_Recipe names.csv.
- 

### Data record number/name

Number or name of the recipe data record to be exported. Specify "0" if all recipe data records are to be exported.

### Overwrite

Determines whether an existing CSV file with the same name is overwritten:

0 (hmiOverwriteForbidden) = No: CSV file will not be overwritten. The export process will not be carried out.

1 (hmiOverwriteAlways) = Yes: CSV file is overwritten without a prompt for confirmation.

2 (hmiOverwriteWithPrompting) = With confirmation: CSV file is not overwritten until confirmed.

### Output status message

Determines whether a status message is output after the export:

0 (hmiOff) = Off: Status message is not output.

1 (hmiOn) = On: Status message is output.

### Processing status

Returns the processing status of the system function. You can use the return value, for example, to delay execution of other system functions until this system function has been successfully completed:

2 = System function is being performed.

4 = System function was successfully completed.

12 = System function was not performed because an error has occurred.

### Export format of the recipe data records

If ".csv" is chosen as a file extension for the export file, then only valid characters from the ANSI character set will be supported. This also applies to separators in decimal numbers and list elements. The separators used are defined in the country/regional settings of the operating system of the exporting computer.

You may also set "Unicode text" (".txt") format for the export file. This file format supports the WinCC and WinCC Runtime character set. Again, the separators used are specified in the country/regional settings of the operating system of the exporting computer. This file format always uses tab separators in list elements.

The corresponding file import function also supports the ".csv" and ".txt" (Unicode) file formats.

### Application example

You want to export all data records using a key.

#### Notes on configuring

Configure the "ExportDataRecords" system function on the "Press" event for the desired key. Transfer the following parameters:

- Recipe number/name = 1
- Data record number/name = 0
- File name = c:\temp\orange.csv
- Overwrite = 1
- Output status message = 1

Tags can also be specified in place of the constants. Depending on the configuration, the operator can enter the desired values in the I/O field or read from the PLC. In this way, the operator can determine which recipe data records are exported.

#### Procedure on HMI device

As soon as the key is activated, the system function is triggered. The constants or tags are evaluated. All data records of Recipe 1 are exported to the orange.csv file. If the file already exists, it will be overwritten.

After exporting the data records, a system message is output.

### ExportDataRecordsWithChecksum

#### Description

Exports one or all data records of a recipe to a CSV file and generates a checksum for each line in the file.

One file is created per recipe.

## Use in the function list

ExportDataRecordsWithChecksum (Recipe number/name, Data record number/name, File name, Overwrite, Output status message, Processing status)

## Use in user-defined functions

ExportDataRecordsWithChecksum (Recipe\_number/name, Data\_record number/name, File\_name, Overwrite, Output\_status\_message, Processing\_status)

Can be used if the configured device supports user-defined functions. For additional information, refer to "Device dependency".

## Parameter

### Recipe number/name

Number or name of the recipe from which the data records are exported. Specify "0" if recipe data records are to be exported from all available recipes.

### Data record number/name

Number or name of the recipe data record to be exported. Specify "0" if all recipe data records are to be exported.

### File name

Name of the CSV file to which the recipe data records are exported. Enter the path and the file extension e.g. "C:\TEMP\Orange.CSV".

If a storage card is used as storage location, specify the storage location as follows: "\StorageCard\".

If you define only a file name without specifying a path, the file is saved to the directory from which Runtime was started. If write access to this directory is not enabled in the Windows 7 operating system, the file is saved to the "VirtualStore" folder of the user directory.

When only one path for the export is specified, the file name is automatically created from the respective recipe name. This requires, for example, that the directory "D:\Temp" has been created. If the directory "D:\Temp" does not exist, the directory name is used as the prefix for the file name, Temp\_Recipe names.csv.

### Overwrite

Determines whether an existing CSV file with the same name is overwritten:

0 (hmiOverwriteForbidden) = No: CSV file will not be overwritten. The export process will not be carried out.

1 (hmiOverwriteAlways) = Yes: CSV file is overwritten without a prompt for confirmation.

2 (hmiOverwriteWithConfirmation) = With confirmation: CSV file is not overwritten until confirmed.

### Output status message

Determines whether a status message is output after the export:

0 (hmiOff) = Off: Status message is not output.

1 (hmiOn) = On: Status message is output.

#### Processing status

Returns the processing status of the system function. You can use the return value, for example, to delay execution of other system functions until this system function has been successfully completed:

2 = System function is being performed.

4 = System function was successfully completed.

12 = System function was not performed because an error has occurred.

#### Export format of the recipe data records

If ".csv" is chosen as a file extension for the export file, then only valid characters from the ANSI character set will be supported. This also applies to separators in decimal numbers and list elements. The separators used are defined in the country/regional settings of the operating system of the exporting computer.

You may also set "Unicode text" (.txt) format for the export file. This file format supports the WinCC and WinCC Runtime character set. Again, the separators used are specified in the country/regional settings of the operating system of the exporting computer. This file format always uses tab separators in list elements.

The corresponding file import function also supports the ".csv" and ".txt" (Unicode) file formats.

#### Application example

Using a key, you want to export all data records and assign a checksum.

#### Notes on configuring

Configure the "ExportDataRecordsWithChecksum" system function on the "Press" event for the desired key. Transfer the following parameters:

- Recipe number/name = 1
- Data record number/name = 0
- File name = c:\temp\orange.csv
- Overwrite = 1
- Output status message = 1

Tags can also be specified in place of the constants. Depending on the configuration, the operator can enter the desired values in the I/O field or read from the PLC. In this way, the operator can determine which recipe data records are exported.

#### Procedure on HMI device

As soon as the key is activated, the system function is triggered. The constants or tags are evaluated. All data records of Recipe 1 are exported to the orange.csv file and assigned checksums. If the file already exists, it will be overwritten.

After exporting the data records, a system message is output.

## ExportImportUserAdministration

### Description

Exports all users of the user administration of the currently active project to the given file or imports the users from the given file into the currently active project.

Users, their passwords and rights are saved in the user administration.

All users are overwritten when importing. The imported users are valid immediately.

### Use in the function list

ExportImportUserAdministration (File name, Direction)

### Use in user-defined functions

ExportImportUserAdministration (File\_name, Direction)

Can be used if the configured device supports user-defined functions. For additional information, refer to "Device dependency".

### Parameter

#### File name

Name of the file which contains the passwords or to which the passwords are written. Enter the file location and the file extension (\*.txt), for example, "C:\TEMP\Passwords.txt".

---

#### Note

If a storage card is used as file location, specify the file location as follows: "\StorageCard \<File name>".

---

#### Direction

Specifies whether passwords are exported or imported:

0 (hmiExport) = Export: Passwords are exported.

1 (hmiImport) = Import: Passwords are imported.

## GetBrightness

### Description

Reads the value of the brightness.

### Use in the function list

GetBrightness (Brightness)

### Use in user-defined functions

GetBrightness (Brightness)

Can be used if the configured device supports user-defined functions. For additional information, refer to "Device dependency".

### Parameter

#### **Brightness**

The tag to which the value is written.

## GetDataRecordFromPLC

### Description

Transfers the selected recipe data record from the PLC to the storage medium of the HMI device.

### Use in the function list

GetDataRecordFromPLC (Recipe number/name, Data record number/name, Overwrite, Output status message, Processing status)

### Use in user-defined functions

GetDataRecordFromPLC (Recipe\_number/name, Data\_record\_number/name, Overwrite, Output\_status\_message, Processing\_status)

Can be used if the configured device supports user-defined functions. For additional information, refer to "Device dependency".

### Parameter

#### **Recipe number/name**

Number or name of the recipe from which recipe data records are transferred.

#### **Data record number/name**

Number or name of the recipe data record which is transferred from the PLC to the data medium of the HMI device.

#### **Overwrite**

Determines whether an existing recipe data record with the same name is overwritten:

0 (hmiOverwriteForbidden) = No: Recipe data record is not overwritten. The transfer process will not be carried out.

1 (hmiOverwriteAlways) = Yes: Recipe data record is overwritten without prompting.

2 (hmiOverwriteWithPrompting) = With confirmation: Recipe data record is not overwritten until confirmed.

#### **Output status message**

Determines whether a status message is output after the transfer:

0 (hmiOff) = Off: Status message is not output.

1 (hmiOn) = On: Status message is output.

#### **Processing status**

Returns the processing status of the system function. You can use the return value, for example, to delay execution of other system functions until this system function has been successfully completed:

2 = System function is being performed.

4 = System function was successfully completed.

12 = System function was not performed because an error has occurred.

### **Application example**

You want to transfer a data record from the PLC to the data medium of the HMI device using a key.

#### **Notes on configuring**

Configure the "GetDataRecordFromPLC" system function on the "Press" event for the desired key. Transfer the following parameters:

Recipe number/name = 1

Data record number/name = 1

Overwrite = 1

Output status message = 1

Tags can also be specified in place of the constants. Depending on the configuration, the operator can enter the desired values in the I/O field or read from the PLC. In this way, the operator can determine which recipe data record is transferred from the PLC.

#### **Procedure on HMI device**

As soon as the key is activated, the system function is triggered. The constants or tags are evaluated and the first data record of Recipe 1 is transferred from the PLC to the data medium of the HMI device. If the recipe data record already exists, it will be overwritten.

A system message is output after the transfer.

## GetDataRecordName

### Description

Writes the name of the given recipe and recipe data record to the given tags.

---

#### Note

If the recipe or the recipe data record do not exist, wildcards ("###") are written to the tags.

---

### Use in the function list

GetDataRecordName (Recipe number, Data record number, Recipe name, Data record name, Processing status)

### Use in user-defined functions

GetDataRecordName (Recipe\_number, Data\_record\_number, Recipe\_name, Data\_record\_name, Processing\_status)

Can be used if the configured device supports user-defined functions. For additional information, refer to "Device dependency".

### Parameter

#### Recipe number

Number of the recipe whose name is written to the given tag.

#### Data record number

Number of the recipe data record whose name is written to the given tag.

#### Recipe name

The tag to which the recipe name is written. The tag must be of the STRING type.

#### Data record name

The tag to which the name of the recipe data record is written. The tag must be of the STRING type.

#### Processing status

Returns the processing status of the system function. You can use the return value, for example, to delay execution of other system functions until this system function has been successfully completed:

2 = System function is being performed.

4 = System function was successfully completed.

12 = System function was not performed because an error has occurred.



## Application example

You want to output the names of the displayed recipes and the name of the displayed recipe data record on the HMI device.

Configure the following tags:

- "RecNumber" of type INTEGER
- "RecDataNumber" of type INTEGER
- "RecName" of type STRING
- "RecDataName" of type STRING

Configure a recipe view with the tags "RecNumber" for the recipe number and "RecDataNumber" for the data record number.

Configure the "GetDataRecordName" system function on the "Press" event for a button and pass the following parameters:

- Recipe number: RecNumber
- Data record number: RecDataNumber
- Recipe name: RecName
- Data record name: RecDataName

Configure two output fields and connect these to the "RecName" and "RecDataName" tags.

Select a recipe and a data record number from the recipe view. As soon as the button is activated, the system function is triggered and the name of the recipe and the recipe data record are displayed in both output fields.

## GetDataRecordTagsFromPLC

### Description

Transfers the values of the recipe data record loaded in the PLC to the corresponding recipe tags.

This system function is used, for example, during teach-in mode on a machine.

### Use in the function list

GetDataRecordTagsFromPLC (Recipe number/name, Processing status)

### Use in user-defined functions

GetDataRecordTagsFromPLC (Recipe\_number/name, Processing\_status)

Can be used if the configured device supports user-defined functions. For additional information, refer to "Device dependency".

## Parameter

### Recipe number/name

Number or name of the recipe data record whose values are written from the PLC to the tags.

### Processing status

Returns the processing status of the system function. You can use the return value, for example, to delay execution of other system functions until this system function has been successfully completed:

2 = System function is being performed.

4 = System function was successfully completed.

12 = System function was not performed because an error has occurred.

## GetGroupNumber

### Description

Reads the number of the group to which the user logged on to the HMI device belongs, and writes it to the given tag.

### Use in the function list

GetGroupNumber (Tag)

### Use in user-defined functions

GetGroupNumber (Tag)

Can be used if the configured device supports user-defined functions. For additional information, refer to "Device dependency".

## Parameter

### Tag

The tag to which the number of the group is written.

## GetPassword

### Description

Writes the password of the user currently logged on to the HMI device in the given tag.

---

**Note**

Make sure that the value of the given tag is not displayed in another place in the project.

---

**Note**

The passwords of SIMATIC Logon users cannot be read.

---

### Use in the function list

GetPassword (Tag)

### Use in user-defined functions

GetPassword (Tag)

Can be used if the configured device supports user-defined functions. For additional information, refer to "Device dependency".

### Parameter

**Tag**

The tag to which the password is written.

## GetUserName

### Description

Writes the user name of the user currently logged on to the HMI device in the given tag.

If the given tag has a control connection, the user name is also available in the PLC connection. This system function makes it possible, for example, to implement a user-dependent release of certain functionalities.

### Use in the function list

GetUserName (Tag)

### Use in user-defined functions

GetUserName (Tag)

Can be used if the configured device supports user-defined functions. For additional information, refer to "Device dependency".

#### Parameter

##### Tag

The tag to which the user name is written.

#### GoToEnd

#### Description

Executes the key function <End> on the HMI device.

This system function is used when the HMI device does not have this functionality by default.

The system function can only be used for the following function keys.

#### Use in the function list

GoToEnd

#### Use in user-defined functions

GoToEnd

Can be used if the configured device supports user-defined functions. For additional information, refer to "Device dependency".

#### Parameter

--

#### GoToHome

#### Description

Executes the key function <Home> on the HMI device.

This system function is used when the HMI device does not have this functionality by default.

The system function can only be used for the following function keys.

#### Use in the function list

GoToHome

### Use in user-defined functions

GoToHome

Can be used if the configured device supports user-defined functions. For additional information, refer to "Device dependency".

### Parameter

--

### ImportDataRecords

#### Description

Imports one or all data records of a recipe from a CSV file.

When a path is specified, all records of the given directory are imported.

#### Use in the function list

ImportDataRecords (File name, Data record number/name, Overwrite, Output status message, Processing status)

### Use in user-defined functions

ImportDataRecords (File\_name, Data\_record number/name, Overwrite, Output\_status\_message, Processing\_status)

Can be used if the configured device supports user-defined functions. For additional information, refer to "Device dependency".

### Parameter

#### File name

Name of the CSV file from which the recipe data records are imported. Enter the file location and the file extension (\*.csv), for example "C:\TEMP\Orange.csv".

---

#### Note

If a storage card is used as file location, specify the file location as follows: "\\StorageCard \<File name>".

---

#### Data record number/name

Number or name of the recipe data record to be imported. Specify "0" if all recipe data records are to be imported.

**Overwrite**

Determines whether existing recipe data records are to be overwritten:

0 (hmiOverwriteForbidden) = No: Recipe data records are not overwritten. The import process will not be carried out.

1 (hmiOverwriteAlways) = Yes: Recipe data records are overwritten without prompting.

2 (hmiOverwriteWithPrompting) = With confirmation: Recipe data records are not overwritten until confirmed.

**Output status message**

Determines whether a status message is output after the import:

0 (hmiOff) = Off: Status message is not output.

1 (hmiOn) = On: Status message is output.

**Processing status**

Returns the processing status of the system function. You can use the return value, for example, to delay execution of other system functions until this system function has been successfully completed:

2 = System function is being performed.

4 = System function was successfully completed.

12 = System function was not performed because an error has occurred.

**Configurable objects**

Object	Event
Tag	Value change High limit violated Low limit violated
Function key (global)	Release Press
Function key (local)	Release Press
Screen	Loaded Cleared
Screen object	Press Release Click Change (or toggle for switch) Switch on Switch off Enable Disable
Scheduler	Time expired

## ImportDataRecordsWithChecksum

### Description

Imports one or all data records of a recipe from a CSV file with a checksum and verifies the checksum.

### Use in the function list

ImportDataRecordsWithChecksum (File name, Data record number/name, Overwrite, Output status message, Processing status, verify checksum)

### Use in user-defined functions

ImportDataRecordsWithChecksum (File\_name, Data\_record number/name, Overwrite, Output\_status\_message, Processing\_status, Verify\_Checksum)

Can be used if the configured device supports user-defined functions. For additional information, refer to "Device dependency".

### Parameter

#### File name

Name of the CSV file from which the recipe data records are imported. Enter the path and the file extension, for example, "C:\TEMP\Orange.CSV".

If a storage card is used as storage medium, specify the storage location as follows: "\StorageCard\".

If you specify a directory instead of an individual CSV file, all files in the specified directory will be imported.

#### Data record number/name

Number or name of the recipe data record to be imported. Specify "0" if all recipe data records are to be imported.

#### Overwrite

Determines whether existing recipe data records are to be overwritten:

0 (hmiOverwriteForbidden) = No: Recipe data records are not overwritten. The import process will not be carried out.

1 (hmiOverwriteAlways) = Yes: Recipe data records are overwritten without prompting.

2 (hmiOverwriteWithConfirmation) = With confirmation: Recipe data records are not overwritten until confirmed.

### Output status message

Determines whether a status message is output after the import:

0 (hmiOff) = Off: Status message is not output.

1 (hmiOn) = On: Status message is output.

### Processing status

Returns the processing status of the system function. You can use the return value, for example to delay execution of other system functions, until this system function has been successfully completed.

2 = System function is being performed.

4 = System function was successfully completed.

12 = System function was not performed because an error has occurred.

### Verify checksum

Determines if the checksum should be verified during import:

0 (hmiFalse) = No: Checksum is not verified.

1 (hmiTrue) = Yes: Checksum is verified.

## IncreaseTag

### Description

Adds the given value to the value of the tags.

$X = X + a$

---

### Note

The system function uses the same tag as input and output values. When this system function is used to convert a value, help tags must be used. You can use the "SetTag" system function to assign the tag value to the auxiliary tags.

---

If you configure the system function on the events of an alarm and the tag is not being used in the current screen, it is not ensured that the actual value of the tags is being used in the PLC. You can improve the situation by setting the "Cyclic continuous" acquisition mode.

### Use in the function list

IncreaseTag (Tag, Value)

### Use in user-defined functions

IncreaseTag (Tag, Value)

Can be used if the configured device supports user-defined functions. For additional information, refer to "Device dependency".



## Parameter

### Tag

The tag to which the given value is added.

### Value

The value that is added.

## InverseLinearScaling

### Description

Assigns a value to the tag X, which is calculated from the value of the given tag Y using the linear function  $X = (Y - b) / a$ .

The tags X and Y must not be identical. This system function is the inverse of the "LinearScaling" system function.

---

### Note

The tags X and Y must not be identical. If a tag is to be converted into itself, an auxiliary tag must be used.

The "SetTag" system function can be used to assign the value of the tags to be converted to the auxiliary tags.

---

### Use in the function list

InvertLinearScaling (X, Y, b, a)

### Use in user-defined functions

InverseLinearScaling (X, Y, b, a)

Can be used if the configured device supports user-defined functions. For additional information, refer to "Device dependency".

### Parameters

#### X

The tag which is assigned the value calculated from the linear equation.

#### Y

The tag that contains the value used for calculation.

#### b

The value which is subtracted.

**a**

The value through which is divided.

**Example**

The following program code assigns a value to the varX tag by means of the InverseLinearScaling function.

```
{
BYTE varX;
BYTE Yvalue = 10;
BYTE bvalue = 3;
BYTE avalue = 4;

//Inverse linear scaling
InverseLinearScaling (varX, Yvalue, bvalue, avalue);

printf ("varX = %d\r\n, varX);
...
}
```

The saved return value can be processed in the following code.

**InvertBit**

**Description**

Inverts the value of the given tag of the "Bool" type:

- If the tag has the value of 1 (TRUE), it will be set to 0 (FALSE).
- If the tag has the value of 0 (FALSE), it will be set to 1 (TRUE).

**Use in the function list**

InvertBit (Tag)

**Use in user-defined functions**

InvertBit (Tag)

Can be used if the configured device supports user-defined functions. For additional information, refer to "Device dependency".

**Parameters**

**Tag**

The tag whose bit is set.

## Example

The following program code inverts the value of the boolean tag `b_value` and outputs the result along with the original `b_saved` value.

```
{
BOOL b_value = 0;
BOOL b_saved = b_value;

//Invert variable
invertBit(b_value);

//print current and saved value
printf ("Current value: %d\r\n, Saved value: %d\r\n",b_value, b_saved);
    ...
}
```

## InvertBitInTag

### Description

Inverts a bit in the given tag:

- If the bit in the tag has the value of 1 (TRUE), it will be set to 0 (FALSE).
- If the bit in the tag has the value of 0 (FALSE), it will be set to 1 (TRUE).

After changing the given bit, the system function transfers the entire tag back to the PLC. It is not checked whether other bits in the tags have changed in the meantime. Operator and PLC have read-only access to the indicated tag until it is transferred back to the PLC.

---

#### Note

If the PLC supports BOOL tags, do not use this system function. Use the "InvertBit" system function instead.

---

### Use in the function list

InvertBitInTag (Tag, Bit)

### Use in user-defined functions

InvertBitInTag (Tag, Bit)

Can be used if the configured device supports user-defined functions. For additional information, refer to "Device dependency".

## Parameters

### Tag

The tag in which the given bit is set.

### Bit

The number of the bit that is set.

When this system function is used in a user-defined function, the bits in a tag are counted from right to left. The counting begins with 0.

## Example

The following program code inverts a bit at the specified bitposition in the bvalue tag and outputs the result along with the original bsaved value.

```
{
BYTE bvalue;
BYTE bsaved = bvalue;
BYTE bitposition = 2;

//Invert bit in bitposition
InvertBitInTag (bvalue, bitposition);
//print current and saved value
printf ("Current value: %d\r\n, Saved value: %d\r\n",bvalue, bsaved);
...
}
```

## LinearScaling

### Description

Assigns a value to the tag Y, which is calculated from the value of the given tag X using the linear function  $Y = (a * X) + b$ .

The inverse of this function is the "InvertLinearScaling" system function.

---

#### Note

The tags X and Y must not be identical. If a tag is to be converted into itself, an auxiliary tag must be used.

The "SetTag" system function can be used to assign the value of the tags to be converted to the auxiliary tags.

---

### Use in the function list

LinearScaling (Y, a, X, b)

## Use in user-defined functions

LinearScaling (Y, a, X, b)

Can be used if the configured device supports user-defined functions. For additional information, refer to "Device dependency".

## Parameters

**Y**

The tag which is assigned the value calculated from the linear equation.

**a**

The value with which is multiplied.

**X**

The tag that contains the value used for calculation.

**b**

The value that is added.

## Example

The following program code uses the LinearScaling function to assign a value to the Yvar tag.

```
{  
BYTE Yvar;  
BYTE Xvalue = 10;  
BYTE bvalue = 3;  
BYTE avalue = 4;  
  
// linear scaling  
LinearScaling ( Yvar, avalue, Xvalue, bvalue);  
  
printf ("Yvar = %d\r\n", Yvar);  
...  
}
```

The saved return value can be processed in the following code.

## LoadDataRecord

### Description

Loads the given recipe data record from the memory medium of the HMI device in the recipe tags. This system function is used, for example, to display a recipe data record in the recipe screen.

Activate the "Synchronize recipe view and recipe tags" option in the synchronization settings of the recipe. If this option is deactivated, the system function has no effect.

### Use in the function list

LoadDataRecord (Recipe number/name, Data record number/name, Processing status)

### Use in user-defined functions

LoadDataRecord (Recipe\_number/name, Data\_record\_number/name, Confirmation, Output\_status\_message, Processing\_status)

Can be used if the configured device supports user-defined functions. For additional information, refer to "Device dependency".

### Parameter

#### Recipe number/name

Number or name of the recipe from which a recipe data record is loaded.

#### Data record number/name

Number or name of the recipe data record to be loaded.

#### Processing status

Returns the processing status of the system function. You can use the return value, for example, to delay execution of other system functions until this system function has been successfully completed:

2 = System function is being performed.

4 = System function was successfully completed.

12 = System function was not performed because an error has occurred.

### LogOff

#### Description

Logs off the current user on the HMI device.

#### Use in the function list

Logoff

#### Use in user-defined functions

Logoff

Can be used if the configured device supports user-defined functions. For additional information, refer to "Device dependency".

**Parameter**

--

**Logon**

**Description**

Logs on the current user on the HMI device.

**Use in the function list**

Logon (Password, User name)

**Use in user-defined functions**

Logon (Password, User\_name)

Can be used if the configured device supports user-defined functions. For additional information, refer to "Device dependency".

**Parameter**

**Password**

The tag from which the password for the user logging on is read.

If the user is logged on, the password in the tag is deleted.

**User name**

The tag from which the user name for the user logging on is read.

**LookupText**

**Description**

Identifies an entry from a text list. The result depends on the value and on the selected runtime language. The result is saved to a tag of data type "String".

**Use in the function list**

LookupText (Output text, Value, Language, Text list)

## Use in user-defined functions

LookupText (Output\_text, Index, Language, Text\_list)

Can be used if the configured device supports user-defined functions. For additional information, refer to "Device dependency".

## Parameter

### Output text

The tag to which the result is written.

### Index

The tag that defines the value of the list entry.

### Language

Defines the runtime language in which the list entry is identified.

- Tag  
The tag that contains the language. Enter the runtime language as decimal value of the country ID, for example, 1031 for German - Standard, 1033 for English - USA. Details are available in the VBScript basics, "Locale identifier (LCID) diagram".
- Runtime language  
Language code as per VBScript reference, for example, "de-DE" for German (Germany) or "en-US" for English (United States of America). The selection depends on the activated runtime languages.

### Text list

Defines the text list. The list entry is read from the text list.

## NotifyUserAction

### Description

This system function is used to log user actions that are not automatically logged in the audit trail. You can also use this system function to require the user to enter an acknowledgment or an electronic signature and a comment for the operator action. Requirement for the use of the system function is that the GMP-compliant configuration is activated under "Runtime settings".

If you use the "NotifyUserAction" system function in a function, the debugger may open if you cancel your input by clicking "Cancel". To compensate for this reaction, you can use the "On Error Resume Next" statement in a function. With this instruction, the next instruction is executed after a runtime error. If you use the "On Error Resume Next" statement, output of system events is also suppressed.



### Use in the function list

NotifyUserAction (Confirmation type, Mandatory commenting, Category, Object name, Description)

### Use in user-defined functions

NotifyUserAction (Confirmation\_type, Mandatory\_commenting, Category, Object\_name, Description)

Can be used if the configured device supports user-defined functions. For additional information, refer to "Device dependency".

### Parameter

#### Confirmation type

Establishes how the action must be confirmed

0 = (None): No confirmation required, an entry is created in the audit trail

1 = (Acknowledgement): Acknowledgment, the user must acknowledge the action; an entry is created in the audit trail

2 = (Digital Signature): Electronic signature, a dialog window opens in which the user must enter his electronic signature - an entry is created in the audit trail

#### Mandatory commenting

Establishes if the user has to enter a comment. The comment is logged in the audit trail.

0 = (True): True; a dialog window opens in which the user must enter a comment

1 = (False): False; no mandatory commenting

#### Category

Category or class name of the modified object

#### Object name

Name of the modified object

#### Description

Text which describes the archiving user action.

## OpenAllLogs

### Description

Reestablishes the connection between WinCC and the logs. Logging can be continued.

---

#### Note

Run the "StartLogging" system function in order to restart logging.

---

### Use in the function list

OpenAllLogs

### Use in user-defined functions

OpenAllLogs

Can be used if the configured device supports user-defined functions. For additional information, refer to "Device dependency".

### Parameter

--

### Application example

You are in runtime and want to change the data medium on which the process values are logged.

#### Notes on configuring

Configure the "StopLogging" and "CloseAllLogs" system functions on the "Close Archive" button.

Configure the "OpenAllLogs" and "StartLogging" system functions on the "Open Archive" button.

As parameter transfer the respective name of the log that is to be stopped and started.

#### Procedure on HMI device

When the button "Close Archive" is pressed, the specified log is stopped and all open logs are closed. The data medium can be changed. You open all logs with the "Open Archive" button. Logging will be continued in the specified log.

## OpenCommandPrompt

### Description

Opens a Windows system prompt.

This function is used, e.g., to copy files or to call up another application.

### Use in the function list

OpenCommandPrompt

### Use in user-defined functions

OpenCommandPrompt

Can be used if the configured device supports user-defined functions. For additional information, refer to "Device dependency".

### Parameter

--

### OpenControlPanel

### Description

Opens a dialog that you can use to edit selected Control Panel settings.

This system function lets you set the following on the HMI device:

- Properties and value of the IP address
- User identification on the network
- WinCC Internet settings

---

#### Note

##### Project security

The "OpenControlPanelDialog" system function is used to bypass the SecureMode on the HMI device. Take the corresponding precautions to ensure the security of your project.

---

### Use in the function list

OpenControlPanelDialog (Dialog)

### Use in user-defined functions

-

## Parameters

### Dialog

Sets the Control Panel dialog to be opened.

- PROFINET\_X1: Setting of the IP address and Ethernet parameters
- PROFINET\_X3: Setting of the IP address and Ethernet parameters; only for Comfort Panel KP 1500, TP 1500; TP1900, TP2200
- WinCC Internet settings: Setting for Web Server, e-mail notification, provided the HMI device supports these functions
- Network ID: Setting for identification on the network, provided the HMI device supports these functions

## OpenInternetExplorer

### Description

Opens the Internet Explorer on the HMI device.

If the Internet Explorer is already open, it will be closed and reopened when you call the system function.

---

### Note

The Internet Explorer saves data temporarily in the DRAM file system of the HMI device, e.g. the last web sites that were be called up.

This data can be saved using the "BackupRAMFileSystem" system function so that it is still available when the HMI device is restarted.

---

### Use in the function list

OpenInternetExplorer (Start page)

### Use in user-defined functions

OpenInternetExplorer (Start\_page)

Can be used if the configured device supports user-defined functions. For additional information, refer to "Device dependency".

### Parameter

#### Start page

The page which is loaded when Internet Explorer is started, e.g. "www.siemens.com".

## OpenScreenKeyboard

### Description

Hides or shows the screen keyboard.

The screen keyboard remains open until the screen keyboard is explicitly closed. In this way, the screen keyboard can also be used in other applications.

### Use in the function list

OpenScreenKeyboard (Layout)

### Use in user-defined functions

OpenScreenKeyboard (Display\_mode)

Can be used if the configured device supports user-defined functions. For additional information, refer to "Device dependency".

### Parameter

#### Layout

Specifies whether the window is opened minimized or maximized with the screen keyboard:

0 (hmiScreenKeyboardMinimized) = Minimized

1 (hmiScreenKeyboardMaximized) = Maximized

## OpenTaskManager

### Description

Shows the task manager.

The task manager allows changing to other open applications on the HMI device.

---

#### Note

The appearance of the task manager depends on the operating system installed.

---

### Use in the function list

OpenTaskManager

### Use in user-defined functions

OpenTaskManager

Can be used if the configured device supports user-defined scripts. For additional information, refer to "Device dependency".

**Parameter**

--

**PageDown**

**Description**

Executes the key function <Pagedown> on the HMI device.  
This system function can only be used for function keys.

**Use in the function list**

PageDown

**Use in user-defined functions**

PageDown

Can be used if the configured device supports user-defined functions. For additional information, refer to "Device dependency".

**Parameter**

-

**PageUp**

**Description**

Executes the key function <PageUp> on the HMI device.  
This system function can only be used for function keys and tasks with a time trigger.

**Use in the function list**

PageUp

**Use in user-defined functions**

PageUp

Can be used if the configured device supports user-defined functions. For additional information, refer to "Device dependency".

---

**Parameter**

-

**PrintReport**

**Description**

Prints the given report from the printer which is connected to the HMI device. The report is printed in the language which is set on the HMI device.

---

**Note**

If runtime is closed whilst log data are being printed using the system function, the report will cease to be supplied with data as soon as runtime stops.

---

**Use in the function list**

PrintReport (Report)

**Use in user-defined functions**

PrintReport (Report)

Can be used if the configured device supports user-defined functions. For additional information, refer to "Device dependency".

**Parameter**

**Report**

Name of the report to be printed.

---

**Note**

If you have set up via the "Function list" dialog box a new report for the "PrintReport" function, when compiling, the following warning appears: "The report "Report\_1" has no printed pages."

In order to remedy the warning, open the "Report\_1" via the project view and recompile the project.

---

**PrintScreen**

**Description**

Prints the screen currently being displayed on the HMI device from the printer which is connected to the HMI device.

Opened windows are also printed.

---

**Note**

The printer settings are taken over from the current settings in the Windows operation system.

---

**Use in the function list**

PrintScreen

**Use in user-defined functions**

PrintScreen

Can be used if the configured device supports user-defined functions. For additional information, refer to "Device dependency".

**Parameter**

--

**ResetBit**

**Description**

Sets the value of a "Bool" type tag to 0 (FALSE).

**Use in the function list**

ResetBit (Tag)

**Use in user-defined functions**

ResetBit (Tag)

Can be used if the configured device supports user-defined functions. For additional information, refer to "Device dependency".

**Parameters**

**Tag**

The BOOL type tag which is set to 0 (FALSE).



## Example

The following program code resets the value of the boolean tag `b_value` to 0 by means of the `ResetBit` function and outputs the result along with the original `b_saved` value.

```
{
BOOL b_value = 1;
BOOL b_saved = b_value;

//Reset bit
ResetBit (b_value);

//print current and saved value
printf ("Current value: %d\r\n, Saved value: %d\r\n",b_value, b_saved);
...
}
```

## ResetBitInTag

### Description

Sets a bit in the specified tag to 0 (FALSE).

After changing the given bit, the system function transfers the entire tag back to the PLC. It is not checked whether other bits in the tags have changed in the meantime. Operator and PLC have read-only access to the indicated tag until it is transferred back to the PLC.

---

#### Note

If the PLC supports BOOL tags, do not use this system function. Use the "ResetBit" system function instead.

---

### Use in the function list

ResetBitInTag (Tag, Bit)

### Use in user-defined functions

ResetBitInTag (Tag, Bit)

Can be used if the configured device supports user-defined functions. For additional information, refer to "Device dependency".

### Parameters

#### Tag

The tag in which a bit is set to 0 (FALSE).

### Bit

The number of the bit that is set to 0 (FALSE).

When this system function is used in a user-defined function, the bits in the specified tag will be counted from right to left independent of the PLC used. The counting begins with 0.

### Example

The following program code sets a bit at the specified bitposition in the bvalue tag to 0 and outputs the result along with the original bsaved value.

```
{
BYTE bvalue;
BYTE bsaved = bvalue;
BYTE bitposition = 2;

//Reset bit in bitposition
ResetBitInTag (bvalue, bitposition);

//print current and saved value
printf ("Current value: %d\r\n, Saved value: %d\r\n",bvalue, bsaved);
    ...
}
```

### SafelyRemoveHardware

#### Description

Checks whether there is read or write access to the external storage medium. If there is no access, the external storage medium can be removed without data loss.

#### Use in the function list

SafelyRemoveHardware(Path, Result)

#### Use in user-defined functions

SafelyRemoveHardware(Path, Result)

Can be used if the configured device supports user-defined functions. For additional information, refer to "Device dependency".

#### Parameter

##### Path

Path of storage medium , e.g. \Storage Card USB\

### Result

The tag in which the result is entered.

TRUE : The storage medium can be removed safely. A corresponding system message will be issued.

FALSE : The storage medium can be removed safely. A corresponding system message will be issued.

## SaveDataRecord

### Description

Saves the current values of the recipe tags as data record to the memory medium of the HMI device.

This system function is used, for example, to save a recipe data record in the recipe screen.

### Use in the function list

SaveDataRecord (Recipe number/name, Data record number/name, Overwrite, Output status message, Processing status)

### Use in user-defined functions

SaveDataRecord (Recipe\_number/name, Data\_record\_number/name, Overwrite, Output\_status\_message, Processing\_status)

Can be used if the configured device supports user-defined functions. For additional information, refer to "Device dependency".

### Parameters

#### Recipe number/name

Number or name of the recipe to which a recipe data record is saved.

#### Data record number/name

Number or name of the recipe data record to be saved. A new data record will be created if no record of this name or number was found in the recipe, independent of the value at the "Overwrite" parameter.

#### Overwrite

Specifies whether an existing data record is overwritten:

0 (hmiOverwriteForbidden) = No: The recipe data record is not overwritten, the data record is not saved.

1 (hmiOverwriteAlways) = Yes: The recipe data record is overwritten without a prompt for confirmation.

2 (hmiOverwriteWithPrompting) = With confirmation: The recipe data record is overwritten only with confirmation by the user.

#### **Output status message**

Determines whether a status message is output after saving:

0 (hmiOff) = Off: Status message is not output.

1 (hmiOn) = On: Status message is output.

#### **Processing status**

Returns the processing status of the system function. You can use the return value, for example, to delay execution of other system functions until this system function has been successfully completed:

2 = System function is being performed.

4 = System function was successfully completed.

12 = System function was not performed because an error has occurred.

## **SendEMail**

### **Description**

Sends an e-mail from the HMI device to the given addressee.

This system function is used, for example, when, in the case of service, the alarm is to be passed on directly to the service technician.

---

#### **Note**

To send alarms as e-mails, the HMI system must have an e-mail client at its disposal.

---

### **Use in the function list**

SendEMail (Address, Subject, Text, Return address)

### **Use in user-defined functions**

SendEMail (Address, Subject, Text, Return\_address)

Can be used if the configured device supports user-defined functions. For additional information, refer to "Device dependency".

### **Parameter**

#### **Address**

The e-mail address of the addressee.

**Subject**

The subject line of the e-mail.

**Text**

The text sent in the e-mail.

**Return address**

The e-mail address to which the addressee of this e-mail should send the reply.

**SetAcousticSignal**

**Description**

Configures the acoustic feedback of touch screen operation on the HMI device.

---

**Note**

The configuration that was set at Switch off is reestablished when restarting the HMI device.

---

**Use in the function list**

SetAcousticSignal (Volume)

**Use in user-defined functions**

SetAcousticSignal (Volume)

Can be used if the configured device supports user-defined functions. For additional information, refer to "Device dependency".

**Parameter**

**Volume**

Determines whether and how loud an acoustic signal is emitted:

-1 (hmiToggle) = Toggle: Toggles the emission of the acoustic signal as follows: Muted > Quiet > Loud.

0 (hmiMuted) = Mute: no acoustic signal

1 (hmiQuiet) = Quiet: quiet acoustic signal

2 (hmiLoud) = Loud: loud acoustic signal

## SetAlarmReportMode

### Description

Switches the automatic reporting of alarms on the printer on or off.

### Use in the function list

SetAlarmReportMode (Mode)

### Use in user-defined functions

SetAlarmReportMode (Mode)

Can be used if the configured device supports user-defined functions. For additional information, refer to "Device dependency".

### Parameter

#### Mode

Determines whether alarms are reported automatically on the printer:

0 (hmiDisablePrinting) = Reporting off: Alarms are not printed automatically.

1 (hmiEnablePrinting) = Reporting On: Alarms are printed automatically.

-1 (hmiToggle) = Toggle: Toggles between the two modes.

## SetAndGetBrightness

### Description

Determines the brightness of the MP 377 Touch daylight readable display. The brightness value can be interpreted as absolute or relative to the current value.

---

#### Note

The configuration that is set in the Control Panel will be reestablished when you restart the HMI device.

---

### Use in the function list

SetAndGetBrightness (Brightness, Mode, Current value)

### Use in user-defined functions

SetAndGetBrightness (Brightness, Mode, Actual brightness)

Can be used if the configured device supports user-defined functions. For additional information, refer to "Device dependency".

## Parameter

### Brightness

New value for the brightness.

### Mode

Specifies if the new brightness value is set as absolute or relative to the current value.

### Current value

Tag in which the current brightness value is stored.

## SetBit

### Description

Sets the value of a "Bool" type tag to 1 (TRUE).

### Use in the function list

SetBit (Tag)

### Use in user-defined functions

SetBit (Tag)

Can be used if the configured device supports user-defined functions. For additional information, refer to "Device dependency".

## Parameters

### Tag

The BOOL type tag which is set to 1 (TRUE).

## Example

The following program code sets the value of the boolean tag `b_value` to 1 by means of the `SetBit` function and outputs the result along with the original `b_saved` value.

```
{  
  BOOL b_value = 0;  
  BOOL b_saved = b_value;
```

```
//Set bit
SetBit (b_value);

//print current and saved value
printf ("Current value: %d\r\n, Saved value: %d\r\n",b_value, b_saved);
...
}
```

## SetBitInTag

### Description

Sets a bit in the given tag to 1 (TRUE).

After changing the given bit, the system function transfers the entire tag back to the PLC. It is not checked whether other bits in the tags have changed in the meantime. Operator and PLC have read-only access to the indicated tag until it is transferred back to the PLC.

---

#### Note

If the PLC supports BOOL tags, do not use this system function. Use the "SetBit" system function instead.

---

### Use in the function list

SetBitInTag (Tag, Bit)

### Use in user-defined functions

SetBitInTag(Tag, Bit)

Can be used if the configured device supports user-defined functions. For additional information, refer to "Device dependency".

### Parameters

#### Tag

The tag in which a bit is set to 1 (TRUE).

#### Bit

The number of the bit that is set to 1 (TRUE).



When this system function is used in a user-defined function, the bits in the specified tag will be counted from right to left independent of the PLC used. The counting begins with 0.

---

**Note**

The guaranteed update of the tags used with actual process values is absolutely conditional in terms of reliable functionality. You should therefore configure the tag in an I/O field or assign the system function to a screen object, such as a button.

If you have configured a short event such as the activation of an alarm for the system function you can only access the actual process values by setting the tag for continuous reading.

---

**Example**

The following program code sets a bit to 1 at the specified bitposition in the bvalue tag and outputs the result along with the original bsaved value.

```
{
BYTE bvalue;
BYTE bsaved = bvalue;
BYTE bitposition = 2;

//Reset bit in bitposition
SetBitInTag (bvalue, bitposition);

//print current and saved value
printf ("Current value: %d\r\n, Saved value: %d\r\n",bvalue, bsaved);
...
}
```

**SetBrightness****Description**

Determines the brightness of the display.

---

**Note**

The configuration that is set in the Control Panel will be reestablished when you restart the HMI device.

---

**Use in the function list**

SetBrightness (value)

### Use in user-defined functions

SetBrightness (Value)

Can be used if the configured device supports user-defined functions. For additional information, refer to "Device dependency".

### Parameter

#### Value

New value for the brightness.

### SetConnectionMode

### Description

Connects or disconnects the given connection.

---

#### Note

A connection to the PLC cannot be established until the operating mode ONLINE has been set on the HMI device. Use the "SetDeviceMode" system function for this purpose.

---

### Use in the function list

SetConnectionMode (Mode, Connection)

### Use in user-defined functions

SetConnectionMode (Mode, Connection)

Can be used if the configured device supports user-defined functions. For additional information, refer to "Device dependency".

### Parameter

#### Mode

Determines whether a connection to the PLC is established or disconnected:

0 (hmiOnline) = Online: Connection is established.

1 (hmiOffline) = Offline: Connection is disconnected.

#### Connection

The PLC to which the HMI device is connected. You specify the name of the PLC in the connection editor.

### Multiple use of the system function in a user-defined function

If you use the "SetConnectionMode" system function for different connections, it may be possible that not all system functions are executed correctly. Proceed as follows to prevent this situation:

1. Create a "BOOL" type tag with the start value "0".
2. Configure the "SetConnectionMode" system function on the "Value change" event of the HMI tags. If you want to disconnect three connections, for example, you must configure the system function three times.
3. In the user-defined function, apply the "InvertBit" system function to the HMI tag.

### Application example

Two typical application examples for this system function are as follows:

- Test  
As long as no PLC is connected to the HMI device, no error messages will be output during the test on the HMI device. If the HMI device is connected to a PLC, the connection to the PLC can be established by pressing a key.
- Commissioning  
Several PLCs are to be configured for a system. At first, all PLCs except one are configured "Offline". After commissioning of the first PLC, the connection to each of the other PLCs is established by pressing a key. In this way, the other PLCs are started up one after another.

### SetDataRecordTagsToPLC

#### Description

Transfers the values of the recipe tags to the PLC. The recipe tags contain the values of the data record which is displayed on the HMI device.

#### Use in the function list

SetDataRecordTagsToPLC (Recipe number/name, Processing status)

#### Use in user-defined functions

SetDataRecordTagsToPLC (Recipe\_ number/name, Processing\_status)

Can be used if the configured device supports user-defined functions. For additional information, refer to "Device dependency".

#### Parameter

##### Recipe number/name

Number or name of the recipe from which recipe data record is transferred to the PLC.

### Processing status

Returns the processing status of the system function. You can use the return value, for example, to delay execution of other system functions until this system function has been successfully completed:

2 = System function is being performed.

4 = System function was successfully completed.

12 = System function was not performed because an error has occurred.

## SetDataRecordToPLC

### Description

Transfers the given recipe data record directly from the data medium of the HMI device to the PLC with which the HMI device is connected.

---

#### Note

The values of the recipe data record don't need to be displayed on the HMI device.

---

### Use in the function list

SetDataRecordToPLC (Recipe number/name, Data record number/name, Output status message, Processing status)

### Use in user-defined functions

SetDataRecordToPLC (Recipe\_number/name, Data\_record\_number/name, Output\_status\_message, Processing\_status)

Can be used if the configured device supports user-defined functions. For additional information, refer to "Device dependency".

### Parameter

#### Recipe number/name

Number or name of the recipe from which recipe data record is transferred to the PLC.

#### Data record number/name

Number or name of the recipe data record to be transferred to the PLC.

#### Output status message

Determines whether a status message is output after the transfer:

0 (hmiOff) = Off: Status message is not output.

1 (hmiOn) = On: Status message is output.

### Processing status

Returns the processing status of the system function. You can use the return value, for example, to delay execution of other system functions until this system function has been successfully completed:

2 = System function is being performed.

4 = System function was successfully completed.

12 = System function was not performed because an error has occurred.

## SetDaylightSavingTime

### Description

The system function "SetDaylightSavingTime" changes the setting of the HMI device from daylight saving to standard time and vice versa.

Time settings will take place immediately following system function.

---

#### Note

The "SetDaylightSavingTime" system function does not support time zones without daylight saving time.

---

#### Note

##### Windows 7

The system function "SetDaylightSavingTime" is not supported for PC-based HMI devices under Windows 7.

---

### Use in the function list

SetDaylightSavingTime(DaylightSavingTime)

### Use in user-defined functions

SetDaylightSavingTime (Daylight\_saving\_time)

Can be used if the configured device supports user-defined functions. For additional information, refer to "Device dependency".

### Parameters

#### Daylight Saving Time

Determines whether Daylight Saving Time is set on the HMI device:

0 = Daylight Saving Time is not activated

1 = Daylight Saving Time is activated

## SetDeviceMode

### Description

Toggles the operating mode on the HMI device. The following types of operation are possible: "Online", "Offline" and "Load".

### Use in the function list

SetDeviceMode (Operating mode)

### Use in user-defined functions

SetDeviceMode (Operating\_mode)

Can be used if the configured device supports user-defined functions. For additional information, refer to "Device dependency".

### Parameter

#### Operating mode

Determines the operating mode of the HMI device:

0 (hmiOnline) = Online: The connection to the PLC is established.

1 (hmiOffline) = Offline: The connection to the PLC is disconnected.

2 (hmiTransfer) = load: A project can be transferred from the configuration computer to the HMI device.

---

#### Note

If you use a PC as an HMI device, the runtime software will be exited when you change operating mode after "Load".

---

## SetDisplayMode

### Description

Changes the settings of the screen in which the runtime software runs.

The runtime software runs in full-screen mode as default. The Windows task switch is disabled.

### Use in the function list

SetDisplayMode (Layout)

## Use in user-defined functions

SetDisplayMode (Display mode)

Can be used if the configured device supports user-defined functions. For additional information, refer to "Device dependency".

## Parameter

### Display mode

Determines the settings for the screen in which the runtime software runs.

1 (hmiScreenFull): Full-screen: Title bar of the screen is not visible

2 (hmiScreenMaximized): Maximized

3 (hmiScreenRestore): Restore: The last used screen setting is used. This layout can only be used when the window is displayed minimized or maximized.

4 (hmiScreenMinimized): Minimized

5 (hmiScreenAutoAdjust): Automatic: The size of the window is set so that all screen objects in it will be visible.

6 (hmiScreenOnTop): On top; either the window appears in the foreground or the program icon associated with the window flashes on the taskbar depending on the Windows setting. The setting can be changed in the Windows configuration and applies to all Windows applications.

## SetLanguage

### Description

Toggles the language on the HMI device. All configured text and system events are displayed on the HMI device in the newly set language.

### Use in the function list

SetLanguage (Language)

## Use in user-defined functions

SetLanguage (Language)

Can be used if the configured device supports user-defined functions. For additional information, refer to "Device dependency".

## Parameter

### Language

Determines which language is set on the HMI device. The following specifications are possible:

- -1 (hmiToggle) = Toggle: Changes to the next language. The sequence is determined during configuration in the "Project languages" editor.
- Number you have defined under "Languages and fonts" in the "Runtime Settings" editor. Changes to the language with the given number.
- Language you have defined under "Languages and fonts" in the "Runtime Settings" editor.
- Language abbreviation in accordance with the VBScript5 reference: This changes to the language corresponding to the specified language code, e.g. "de-DE" for German (Germany) or "en-US" for English (United States).  
An overview of the language abbreviations is available in the basic information of VBScript under the topic "Area diagram-ID (LCID) Diagram".

## SetRecipeTags

### Description

Changes the status of the recipe tags from "Online" to "Offline" and vice versa.

This system function is used, for example, when recipe data record values are fine tuned when starting up a machine.

### Use in the function list

SetRecipeTags (Recipe number/name, Status, Output status message, Processing status)

### Use in user-defined functions

SetRecipeTags (Recipe\_number/name, Status, Output\_status\_message, Processing\_status)

Can be used if the configured device supports user-defined functions. For additional information, refer to "Device dependency".

### Parameter

#### Recipe number/name

Number or name of the recipe in which the recipe data record is saved.

#### Status

Determines the status of the recipe tags:

0 (hmiOnline) = Online: Value changes of the recipe tags are transferred immediately to the PLC connected to the HMI device.

1 (hmiOffline) = Offline: Value changes to the recipe tags are only transferred to the PLC connected to the HMI device when, for example, the "SetDataRecordTagsToPLC" system function is executed.

#### Output status message

Determines whether a status message is output after saving:



0 (hmiOff) = Off: Status message is not output.

1 (hmiOn) = On: Status message is output.

#### **Processing status**

Returns the processing status of the system function. You can use the return value, for example, to delay execution of other system functions until this system function has been successfully completed:

2 = System function is being performed.

4 = System function was successfully completed.

12 = System function was not performed because an error has occurred.

## **SetScreenKeyboardMode**

### **Description**

Enables or disables the automatic display of the screen keyboard on the HMI device.

This system function is also used to prevent the display of the screen keyboard, e.g. because an external keyboard is connected to the HMI device.

---

#### **Note**

To enable the "SetScreenKeyboardMode" ("SetScreenKeyboardMode") system function on an HMI other than a Touch Panel device, set the "Use on-screen keyboard" check box in the "Runtime settings" dialog of the device settings.

---

### **Use in the function list**

SetScreenKeyboardMode (Mode)

### **Use in user-defined functions**

SetScreenKeyboardMode (Mode)

Can be used if the configured device supports user-defined functions. For additional information, refer to "Device dependency".

### **Parameter**

#### **Mode**

Determines whether the screen keyboard is hidden or shown:

0 (hmiOff) = Off: Screen keyboard is hidden

1 (hmiOn) = On: Screen keyboard is shown

-1 (hmiToggle) = Toggle: Toggles between the two modes.

## SetTag

### Description

Assigns a new value to the given tag.

---

#### Note

This system function can be used to assign strings and numbers, depending on the type of tag.

---

### Use in the function list

SetTag (Tag, Value)

### Use in user-defined functions

SetTag (Tag, Value)

Can be used if the configured device supports user-defined functions. For additional information, refer to "Device dependency".

### Parameters

#### Tag

The tag to which the given value is assigned.

#### Value

The value which the given tag is assigned.

---

#### Note

The "SetTag" system function is only executed after a connection has been established.

---

### Example

The following program code uses the SetTag function to set the value of the gs\_tag\_bit tag to TRUE and saves the return value to the ok tag.

```
{
BOOL ok;
BOOL bvalue;

//Set the tag to true
ok = SetTag("gs_tag_bit", TRUE);
//error handling
```

```
if(ok)
{
    // succeeded
    printf ( "Function has run through.\r\n" );
    bvalue = GetTagBit("gs_tag_bit");
    printf ("Value of gs_tag_bit: %d\r\n", bvalue);
}
else
{
    // failed
    printf ( "Error - function failed." );
}
...
}
```

The saved return value can be processed in the following code.

## ShiftAndMask

### Description

This system function converts the input bit pattern of the source tags into an output bit pattern of the target tags. This involves bit shifting and masking.

---

#### Note

If the source and target tag have a different number of bits, using the system function in the target tag can result in a violation of the value range.

---

### Use in the function list

ShiftAndMask (Source tag, Target tag, Bits to shift, Bits to mask)

### Use in user-defined functions

ShiftAndMask (Source\_tag, Target\_tag, Bits\_to\_shift, Bits\_to\_mask)

Can be used if the configured device supports user-defined functions. For additional information, refer to "Device dependency".

### Parameter

#### Source tag

The tag includes the input bit pattern. Integer-type tags, e.g. "Byte", "Char", "Int", "UInt", "Long" and "ULong" are permitted.

Example: The actual value 72 is set at the 16-bit integer source tag: 0000000001001000.

### Target tag

The output bit pattern is saved in the tag. Integer type tags, e.g. "Byte", "Char", "Int", "UInt", "Long" and "ULong" are permitted.

Example: The shifted input bit pattern is multiplied by the bit mask, with bit-by-bit logical AND operation: 0000000000001001. The resultant decimal value "8" is saved to the target tag.

Please note the following:

- The source and target tags have the same number of bits.
- The number of bits to shift is less than the number of bits in the source tag and target tag.
- Bits to mask does not have more bits than the source tag and the target tag.

### Bits to shift

Number of bits by which the input bit pattern is shifted right. A negative value shifts the input bit pattern to the left.

Example: "Bits to shift" has the value "+3". The input bit pattern is shifted right by three bits when the system function is called: 0000000000001001.

Bits to the left are padded with "0". Three bits are truncated on the right. The new decimal value is "9".

---

### Note

The left bit is "1" in a source tag of the data type with negative signed integer. This sign bit is padded with "0" when the bits are shifted right. The sign changes to "+".

---

### Bits to mask

An integer serves as bit mask. The bit pattern is used to multiply the shifted input bit pattern. Example: Integer "2478" with the bit pattern "0000100110101110".

You can enter the bit mask in three different ways:

- Hexadecimal: First enter the prefix "0h" or "0H", followed by an optional space for better readability. Then group the bit pattern in blocks of four (0000)(1001)(1010)(1110) and set each block in hexadecimal code: (0)(9)(A)(E). Only the characters 0-9, A-F, a-f are allowed: "0h 09AE".
- Binary: First enter the prefix "0b" or "0B", followed by an optional space for better readability. Then group the binary bit pattern into blocks of four 0000 1001 1010 1110 with spaces in between as a check. Only the characters "0" or "1" are allowed: "0b 0000 1001 1010 1110".
- Decimal: Enter the value "2478" directly, without a prefix.

## ShowAlarmWindow

### Description

Hides or shows the alarm window on the HMI device.

### Use in the function list

ShowAlarmWindow (Object name, Layout)

### Use in user-defined functions

ShowAlarmWindow (Object\_name, Display\_mode)

Can be used if the configured device supports user-defined functions. For additional information, refer to "Device dependency".

### Parameter

#### Object name

Name of the alarm view which is hidden or shown.

#### Layout

Determines whether the alarm window is hidden or shown:

0 (hmiOff) = Off: Alarm view is hidden

1 (hmiOn) = On: Alarm view is shown

-1 (hmiToggle) = Toggle: Toggles between the two modes

### ShowOperatorNotes

#### Application

Displays the tooltip configured for the selected object.

If the system function is configured on a function key, the tooltip for the screen object that currently has the focus is displayed. If a tooltip is configured for the screen itself, you can switch to this text by pressing <Enter> or by double-clicking on the help window.

If the system function is configured on a button, only the tooltip for the current screen is displayed. If a tooltip is configured on the button itself, initially only the tooltip for the button is displayed. You can press <Enter> or double-click on the help window to switch to the tooltip for the current screen.

---

#### Note

No other screen object can be used while the help window is open. To use the screen object, close the help window.

---

### Closing the help window

You can close the help window in the following ways:

Using the keys:

- By pressing the <HELP> key again
- By pressing the <ESC> key

Using the touch screen:

- By pressing the  button

### Use in the function list

ShowOperatorNotes (Layout)

### Use in user-defined functions

ShowOperatorNotes (Display\_mode)

Can be used if the configured device supports user-defined functions. For additional information, refer to "Device dependency".

### Parameter

#### Display mode

Determines whether the configured tooltip is hidden or shown:

0 (hmiOff) = Off: Configured tooltip is hidden

1 (hmiOn) = On: Configured tooltip is shown

-1 (hmiToggle) = Toggle: Toggles between the two modes

### ShowSoftwareVersion

#### Description

Hides or shows the version number of the runtime software.

Use this system function if during servicing, for example, you required the version of the runtime software used.

### Use in the function list

ShowSoftwareVersion (Layout)

### Use in user-defined functions

ShowSoftwareVersion (Display\_mode)

Can be used if the configured device supports user-defined functions. For additional information, refer to "Device dependency".

## Parameter

### Layout

Determines whether the version number is shown:

0 (hmiOff) = Off: Version number is not shown

1 (hmiOn) = On: Version number is shown

-1 (hmiToggle) = Toggle: Toggles between the two modes

## ShowSystemAlarm

### Description

Displays the value of the parameter passed as a system event to the HMI device.

### Use in the function list

ShowSystemAlarm (Text/value)

### Use in user-defined functions

ShowSystemAlarm (Text/value)

Can be used if the configured device supports user-defined functions. For additional information, refer to "Device dependency".

## Parameter

### Text/Value

The text or the value, which was output as a system alarm.

## ShowSystemDiagnosticsWindow

### Description

Hides or shows the system diagnostic window on the HMI device. The system diagnostic view is only available in the global screen for Comfort Panels and for WinCC Runtime Advanced.

### Use in the function list

ShowSystemDiagnosticsWindow (Screen object)

### Use in user-defined functions

ShowSystemDiagnosticsWindow (Target\_Object\_name)

Can be used if the configured device supports user-defined functions. For additional information, refer to "Device dependency".

## Parameters

### Screen object

Name of the system diagnostic window which is hidden or shown.

## StartLogging

### Description

Starts the logging of data or alarms in the specified log. The function can also be applied to audit trails.

You can interrupt logging at runtime using the "StopLogging" system function.

### Use in the function list

StartLogging (Log type, Log)

### Use in user-defined functions

StartLogging (Log\_type, Log)

Can be used if the configured device supports user-defined functions. For additional information, refer to "Device dependency".

## Parameter

### Log type

Determines the type of log:

0 (hmiTagArchive) = Data log

1 (hmiAlarmArchive) = Alarm log

2 (hmiAudittrailArchive) = Audit trail

### Log

Name of the log which is started.

## StartNextLog

### Description

Stops the logging of data or alarms for the given log.



Logging is continued in the next log of the segmented circular log you configured for the specified log.

If you did not configure a segmented circular log for the specified log, the system function has no effect.

### Use in the function list

StartNextLog (Log type, Log)

### Use in user-defined functions

StartNextLog (Log\_type, Log)

Can be used if the configured device supports user-defined functions. For additional information, refer to "Device dependency".

### Parameter

#### Log type

Determines the type of log:

0 (hmiTagArchive) = Data log

1 (hmiAlarmArchive) = Alarm log

#### Log

Name of the log for which the logging is stopped and continued in the next log.

### StartProgram

#### Description

Starts the specified program on the HMI device.

The runtime software continues running in the background. Alarms continue to be output and data continues to be updated.

When the given application is exited, the screen which was active during the performance of the system function is displayed on the HMI device.

This system function is used, for example, to edit recipe data records in MS Excel on the HMI device.

---

**Note**

If Windows CE is installed on the HMI device, during the configuration it must be checked whether the desired application can be started with this system function.

This system function allows all applications to be started which can be started in the "Execute" dialog of Windows CE.

The application to be started must be installed on the HMI device.

---

**Use in the function list**

StartProgram (Program name, Program parameters, Layout, Wait for program to end)

**Use in user-defined functions**

StartProgram (Program\_name, Program\_parameters, Display\_mode, Wait\_for\_program\_to\_end)

Can be used if the configured device supports user-defined functions. For additional information, refer to "Device dependency".

**Parameter**

**Program name**

Name and path of the program which is started. Upper and lower case are taken into account in this parameter.

---

**Note**

If the path contains spaces, the program can only be started correctly if the path is specified in inverted commas, e.g. "C:\Program Files\START\start.exe".

---

**Program parameters**

The parameters you transfer at the start of the program, for example a file that is opened after the start of the program.

The description of the necessary parameters is found in the documentation of the program to be started.

**Layout**

Determines how the program window is displayed on the HMI device:

0 (hmiShowNormal) = Normal

1 (hmiShowMinimized) = Minimized

2 (hmiShowMaximized) = Maximized

3 (ShowMinimizedAndInactive) = Minimized and inactive

**Wait for program to end**

Determines whether there is a change back to the project after the called up program has ended:

0 (hmiNo) = No: No change to project

1 (hmiYes) = Yes: Change to project

---

**Note**

The "Wait for program to end" parameter is only available for Runtime Advanced and Panels.

---

**StopLogging****Description**

Stops the logging of process values or alarms in the specified log. The function can also be applied to audit trails.

The "StartLogging" system function is used to resume logging at runtime.

---

**Note**

When logging is stopped, a connection between WinCC and the log files or log database still exists. Use the "CloseAllLogs" system function to disconnect this connection.

---

**Use in the function list**

StopLogging (Log type, Log)

**Use in user-defined functions**

StopLogging (Log\_type, Log)

Can be used if the configured device supports user-defined functions. For additional information, refer to "Device dependency".

**Parameter****Log type**

Determines the type of log:

0 (hmiTagArchive) = Data log

1 (hmiAlarmArchive) = Alarm log

2 (hmiAudittrailArchive) = Audit trail

### Log

Name of the log that is stopped.

### Application example

You are in runtime and want to change the data medium on which the process values are logged.

#### Notes on configuring

Configure the "StopLogging" and "CloseAllLogs" system functions on the "Close Archive" button.

Configure the "OpenAllLogs" and "StartLogging" system functions on the "Open Archive" button.

As parameter transfer the respective name of the log that is to be stopped and started.

#### Procedure on HMI device

When the button "Close Archive" is pressed, the specified log is stopped and all open logs are closed. The data medium can be changed. The "Open Archive" button opens all logs and continues logging in the specified log.

## StopRuntime

### Description

Exits the runtime software and thereby the project running on the HMI device.

### Use in the function list

StopRuntime (Mode)

### Use in user-defined functions

StopRuntime (Mode)

Can be used if the configured device supports user-defined functions. For additional information, refer to "Device dependency".

### Parameters

#### Mode

Determines whether the operating system is shut down after exiting runtime.

0 (hmiStopRuntime) = Runtime: Operating system is not shut down

1 (hmiStopRuntimeAndOperatingSystem) = Runtime and operating system: The operating system is shut down (not possible with WinCE)

## Example

The following program code shuts down Runtime and the operating system.

```
{  
  
//Stop runtime and shutdown  
StopRuntime (hmiStopRuntimeAndOperationSystem);  
  
}
```

The saved return value can be processed in the following code.

## WinACMPGetVersion

### Description

Reads out the value of the version number of WinAC MP.

### Use in the function list

WinACMPGetVersion (Version, Action)

### Use in user-defined functions

WinACMPGetVersion (Version, Action)

Can be used if the configured device supports user-defined functions. For more information, refer to Auto-Hotspot.

### Parameters

#### Version

The tag that contains the value.

#### Action

Determines whether the version number is read out:

0 (SwitchOff) = Off: Version number is not read out.

1 (SwitchOn) = On: Version number is read out.

## WinACMPSetStartAtBoot

### Description

Determines whether or not WinAC MP is started automatically after startup of the HMI device.

### Use in the function list

WinACMPSetStart at boot(Start at boot)

### Use in user-defined functions

WinACMPSetStartAtBoot (Start at boot)

Can be used if the configured device supports user-defined functions. For more information, refer to Auto-Hotspot.

### Parameters

#### StartAtBoot

Defines whether WinAC MP is started automatically.

0 (StartAtBootOff) = Off: WinAC MP is not started on startup of the HMI device.

1 (StartAtBootOn) = On: WinAC MP is started automatically on startup of the HMI device.

### WinACSetStartMode

#### Description

Sets the operating mode of WinAC MP after startup of the HMI device.

### Use in the function list

WinACSetStartMode (Autostart)

### Use in user-defined functions

WinACSetStartMode (Autostart)

Can be used if the configured device supports user-defined functions. For more information, refer to Auto-Hotspot.

### Parameters

#### Action

Defines whether the Autostart function of WinAC MP is activated.

0 (AutoStartOff) = Off: After startup, WinAC MP remains in the STOP operating mode.

1 (AutoStartOn) = On: After startup, WinAC MP changes to the operating mode it was in before it was closed.

## VBScript for Windows

## VBScript for Windows

## VBScript

If you have worked with Visual Basic or Visual Basic for applications, then VBScript will seem familiar to you. If you do not know Visual Basic and are getting familiar with it, then you will learn all Visual Basic programming languages at once. The step-by-step guides from Microsoft Press are a good introduction to programming.

You will find fundamental information on VBScript language elements on the Microsoft homepage:

<http://msdn.microsoft.com/en-us/library/t0aew7h6.aspx>

## Local ID (LCID)

An overview of all language codes can be found on the Microsoft homepage:

<http://msdn.microsoft.com/en-us/goglobal/bb964664>

## VBScript for Windows CE

## VBScript for Windows CE

## Attr

## Function

This property of the File control returns a number indicating the file mode that was used to open the file.

## Syntax

file.Attr

## Parameters

### File

Reference to a File control.

### Return values

The return values listed in the following table indicate the file access mode. If the return value is 0, the file is closed.

Constant	Value
None	0
fsModeInput	1
fsModeOutput	2
fsModeRandom	4
fsModeAppend	8
fsModeBinary	32

### Remarks

The Attr property is read-only. Use the Open method of the File control to set the file mode.

### Close

### Function

This method closes an open File control.

### Syntax

file.Close

### Parameters

#### File

Name of a File control.

### Return Values

None.

### Remarks

Use the Open method to open a file.



## CreateObject

### Function

This function creates a reference to an Automation object.

### Syntax

```
CreateObject (Object)
```

### Parameters

#### Object

A string containing the ProgID of the object to create.

### Return values

Returns a reference to an Automation object.

### Remarks

Use CreateObject to create non-visible ActiveX controls at runtime. You cannot use CreateObject to create graphical objects such as a TreeView control or a ListView control. CreateObject produces objects that cannot respond to events. To produce objects that can respond to events, use the CreateObjectWithEvents function. The following table lists the ProgIDs for the ActiveX controls without events.

Control	ProgID
Microsoft CE File control 6.0	.file
Microsoft CE FileSystem control 6.0	.filesystem
Microsoft CE ImageList control 6.0	CEimageList.imagelistctrl

### Example

```
Dim f, fwModeAppend
Set f = CreateObject("FileCtl.File")
fwModeAppend=8
f.Open "\Storage Card\testfile.txt", fwModeAppend
f.Close
```

## Dir

### Function

This method returns the name of a file, directory, or folder that matches a specified pattern or file attribute.

### Syntax

File.Dir (Pathname,[Attributes])

### Parameters

#### File

Reference to a FileSystem control.

#### Pathname

Optional. String expression that specifies a file name or path.

#### Attributes

Optional. Numeric expression whose sum specifies file attributes. If omitted, all files that match pathname are returned.

The following table describes the parameter settings of attributes.

Constant	Value	Description
fsAttrNormal	0	Normal
fsAttrReadOnly	1	Read only
fsAttrHidden	2	Hidden
fsAttrSystem	4	System file
fsAttrVolume	8	Volume label. If specified, all other attributes are ignored.
fsAttrDirectory	16	Directory or folder
fsAttrArchive	32	Logs

### Return values

String. File name that matches pathname and attributes. Dir returns a zero-length string ("" ) if pathname is not found.

### Remarks

Dir supports the use of multiple-character (\*) and single-character (?) wildcards to specify multiple files. You must specify pathname the first time you call the Dir method. In addition, if you specify file attributes you must include pathname.

The Dir method returns the first file name that matches pathname. To get any additional file names that match pathname, call Dir again with no parameters. When no more file names

match, Dir returns a zero-length string (" "). Once a zero-length string is returned, you must specify pathname in subsequent calls.

## EOF

### Function

This property returns True when the end of a file opened for random or sequential input is reached.

### Syntax

File.EOF

### Parameters

#### File

Reference to a File control.

### Remarks

Use the EOF property to avoid the error generated by attempting to read past the end of a file.

The EOF property returns False until the end of the file has been reached. For files opened with a fsModeRandom or fsModeBinary file mode, EOF returns False until the last executed Get statement is unable to read an entire record.

For files opened with a fsModeBinary file mode, an attempt to read through the file using the Input function until EOF returns True generates an error. Use the LOF and LOC properties instead of EOF when reading binary files with Input, or use Get when using the EOF property. For files opened with a fsModeOutput file mode, EOF always returns True.

## FileCopy

### Function

This method copies an existing file to a new file.

### Syntax

Filesystem.FileCopy PathName, NewPathName

### Parameters

#### Filesystem

Reference to a FileSystem object.

**PathName**

String that contains the path and file name.

**NewPathName**

String that contains the file name and path of the new file.

**Return Values**

None.

**Remarks**

FileCopy returns an error if the new file does not exist.

**FileLen**

**Function**

This method returns a value specifying the length, in bytes, of a file.

**Syntax**

Filesystem.FileLen(pathname)

**Parameters**

**Filesystem**

Reference to a FileSystem control.

**Pathname**

Required. String expression that specifies a file. The pathname can include a directory or folder.

**Return Values**

Returns the number of bytes in a file.

**Remarks**

If the specified file is open when the FileLen method is called, the value returned represents the size of the file immediately before it was opened.

## FileDateTime

### Function

This method returns a variant (Date) that indicates the date and time when a file was created or last modified.

### Syntax

```
filesystem.FileDateTime(pathname)
```

### Parameters

#### Filesystem

Reference to a FileSystem control.

#### Pathname

Required. String expression that specifies a file name. The pathname can include a directory or folder.

### Return Values

Returns the date the file was last modified.

### Remarks

FileDateTime returns an error if the new file does not exist.

### Get

### Function

This method reads data from an open disk file into a variable.

### Syntax

```
file.Get Data, [Recnumber]
```

### Parameters

#### File

Reference to a File control.

### Data

Required. Variant variable into which data is read.

### Recnumber

Optional. Variant. Record number at which reading begins. For files opened in binary mode, Recnumber specifies the byte position.

## Return Values

None

## Remarks

Data read with the Get method usually is written to a file with the Put method. The first record or byte in a file is at position 1, the second record or byte is at position 2, and so on. If you omit Recnumber, the next record or byte following the last Get or Put method (or pointed to by the last Seek function) is read.

For files opened in Random mode, the following rules apply:

- If the length of the data being read is less than the length specified in the Len clause of the Open method, Get reads subsequent records on record-length boundaries. The space between the end of one record and the beginning of the next record is padded with the existing contents of the file buffer. Because the amount of padding data cannot be determined with any certainty, it is generally advisable to match the record length with the length of the data being read.
- If Data is a Variant of numeric type, Get reads 2 bytes identifying the VarType of the Variant and then reads the data that goes into the variable. For example, when reading a Variant of VarType 3, Get reads 6 bytes: 2 bytes identifying the Variant as VarType 3 (Long) and 4 bytes containing the Long data. The record length specified by the Len clause in the Open method must be at least 2 bytes greater than the actual number of bytes required to store the variable.
- You can use the Get method to read a Variant array from a disk, but you cannot use Get to read a scalar Variant containing an array. You also cannot use Get to read objects from a disk.
- If the variable being read into is a Variant of VarType 8 (String), Get reads 2 bytes identifying the VarType and 2 bytes indicating the length of the string. Then it reads the string data. The record length specified by the Len clause in the Open method must be at least 4 bytes greater than the actual length of the string.
- If the variable being read into is a dynamic array, Get reads a descriptor whose length equals 2 plus 8 times the number of dimensions, that is,  $2 + 8 * \text{NumberOfDimensions}$ . The record length specified by the Len clause in the Open method must be greater than or equal to the sum of all the bytes required to read the array data and the array descriptor.

For files opened in Binary mode, the Len clause in the Open method has no effect. Get reads all variables from a disk contiguously; that is, with no padding between records.

## GetAttr

### Function

This method returns a number representing the attributes of a file, directory, or folder.

### Syntax

```
filesystem.GetAttr(pathname)
```

### Parameters

#### File system

Reference to a FileSystem control.

#### Pathname

Required. String expression that specifies a file name or directory or a folder name. The pathname can include the directory or folder.

### Return values

Sum of attribute values. The following table shows the sums that can be returned.

Constant	Value	Description
vbNormal	0	Normal
VbReadOnly	1	Read only
VbHidden	2	Hidden
VbSystem	4	System
VbDirectory	16	Directory or folder
VbArchive	32	File has changed since last backup

### Remarks

To determine which attributes are set, use the And operator to perform a bitwise comparison of the value returned by the GetAttr method and the value of the individual file attribute you want. If the result is not zero, that attribute is set for the named file.

### Input

### Function

This method returns a string containing characters from a file opened in Input or Binary mode.

## Syntax

file.Input(number)

## Parameters

### File

Reference to a File control.

### Number

Any valid numeric expression that specifies the number of characters to return.

## Return Values

String containing characters read from file.

## Remarks

Data read with the Input method usually is written to a file with the LinePrint or Put functions. Use this method only with files opened in Input or Binary mode.

Unlike the LineInputString method, the Input method returns all the characters it reads, including commas, carriage returns, line feeds, quotation marks, and leading spaces.

With files opened for Binary access, an attempt to read through the file using the Input method until the EOF function returns True generates an error. To avoid an error, use the LOF and Loc functions instead of EOF when reading binary files with the Input method or use Get when using the EOF function.

## InputFields

## Function

This method reads data from an open sequential file and returns a single dimension Variant array.

## Syntax

file.InputFields(number)

## Parameters

### File

Reference to a File control.

### Number

Number of comma-delimited fields to read from the file.



**Return values**

Array containing the fields read from the file.

**Remarks**

Data read with the InputFields method usually is written to a file with WriteFields. Use this method only with files opened in Input or Binary mode.

InputFields reads standard string or numeric data without modification. The following table shows how InputFields reads other input data.

Data	Value Assigned to Variable
Delimiting comma or blank line	Empty
#ZERO#	Zero
#TRUE# or #FALSE#	True or False
#yyyy-mm-dd hh:mm:ss#	The date and/or time represented by the expression

Double quotation marks ("" ) within input data are discarded.

If you reach the end of the file while you are inputting a data item, the input is terminated and an error occurs.

To correctly read data from a file into variables using InputFields, use the WriteFields method instead of the LinePrint method to write the data to the files. Using WriteFields ensures each separate data field is properly delimited.

**InputB****Function**

This method returns bytes from a file opened in Input or Binary mode.

**Syntax**

```
file.InputB(number)
```

**Parameters****File**

Reference to a File control.

**Number**

Any valid numeric expression that specifies the number of bytes to return.

**Return Values**

Array containing bytes read from file.

## Remarks

Data read with the InputB method usually is written to a file with the LinePrint or Put functions. Use this method only with files opened in Input or Binary mode.

## Kill

### Function

This method deletes files from a disk.

### Syntax

```
filesystem.Kill pathname
```

### Parameters

#### Filesystem

Reference to a FileSystem control.

#### Pathname

Required. String expression that specifies one or more file names to be deleted. The pathname can include the directory or folder.

### Return Values

None.

## Remarks

The Kill method supports the use of multiple-character (\*) and single-character (?) wildcards to specify multiple files. An error occurs if you try to use Kill to delete an open file.

## LineInputString

### Function

This method reads a single line from an open sequential file and assigns it to a string variable.

### Syntax

```
file.LineInputString
```

### Parameters

**File**

Reference to a File control.

### Return Values

None.

### Remarks

Data read with LineInputString usually is written from a file with LinePrint. The LineInputString method reads from a file one character at a time until it encounters a carriage return (Chr(13)) or carriage return/line feed (Chr(13) + Chr(10)) sequence. Carriage return/line feed sequences are skipped rather than appended to the character string.

### LinePrint

### Function

This method writes a single line to an open sequential file.

### Syntax

file.LinePrint output

### Parameters

**File**

Reference to a File control.

**Output**

String expression to write to a file.

### Return Values

None.

### Remarks

Data written with LinePrint is usually read from a file with LineInputString. A carriage return/line feed (Chr(13) + Chr(10)) sequence is appended to the end of the string.

## Loc

### Function

This property returns a number specifying the current read/write position.

### Syntax

file.Loc

### Parameters

#### File

Reference to a File control.

### Remarks

For files opened with the fsModeRandom file mode, Loc returns the number of the last record read or written. For files opened with all other modes, Loc returns the position of the last byte read or written.

## LOF

### Function

This property returns a number representing the size, in bytes, of a file.

### Syntax

file.LOF

### Parameters

#### File

Reference to a File control.

### Remarks

The LOF property can be used with the Loc property to guarantee that a read operation does not continue past the end of a file.

## MkDir

### Function

This method creates a new directory.

### Syntax

```
filesystem.MkDir PathName
```

### Parameters

#### Filesystem

Reference to a FileSystem control.

#### Pathname

String expression that contains the directory name.

### Return Values

None.

### Remarks

MkDir generates an error if the directory already exists.

## MoveFile

### Function

This method renames an existing file or a directory, including all its subdirectories.

### Syntax

```
filesystem.MoveFile PathName, NewPathName
```

### Parameters

#### Filesystem

Reference to a FileSystem control.

#### PathName

String that contains the file name.

**NewPathName**

String that contains the file name to copy to.

**Return Values**

None.

**Open**

**Function**

This method opens a file in either the Input (1), Output (2), Random (4), Append (8), or Binary mode (32).

**Syntax**

file.Open pathname, mode, [access], [lock], [reclength]

**Parameters**

**File**

Reference to a File control.

**Pathname**

String expression that specifies a file name.

**Mode**

Specifies the file mode: Input (1), Output (2), Random (4) , Append (8), or Binary (32).

**Access**

Operation permitted on the open file: Read, Write, or ReadWrite [Default]. (1, 2, 3)

**Lock**

Operations permitted on the open file by other processes: Shared, LockRead, LockWrite [Default], and LockReadWrite. (1, 2, 3, 0)

**Reclength**

Number, in bytes, that is less than 32,767. For files opened for random access, this value is the record length. For sequential files, this value is the number of characters buffered.

**Return Values**

None.

## Remarks

The reclength parameter is ignored if the mode is Binary. When opening a file in Random mode, you must specify a record size of greater than zero or an error will occur.

## Put

## Function

This method writes data from a variable to a disk file.

## Syntax

file.Put data, [recnumber]

## Parameters

### Data

Required. Variant variable that contains data to be written to disk.

### Recnumber

Optional. Variant (Long). Record number (Random mode files) or byte number (Binary mode files) at which writing begins.

## Return Values

None.

## Remarks

Data written with Put usually is read from a file with Get.

The first record or byte in a file is at position 1, the second record or byte is at position 2, and so on. If you omit recnumber, the next record or byte after the last Get or Put method or pointed to by the last Seek function is written.

For files opened in Random mode, the following rules apply:

- If the length of the data being written is less than the length specified in the Len clause of the Open method, Put writes subsequent records on record-length boundaries. The space between the end of one record and the beginning of the next record is padded with the existing contents of the file buffer. Because the amount of padding data cannot be determined with any certainty, it generally is a good idea to have the record length match the length of the data being written. If the length of the data being written is greater than the length specified in the Len clause of the Open method, an error occurs.
- If the variable being written is a Variant of a numeric type, Put writes 2 bytes identifying the VarType of the Variant and then writes the variable. For example, when writing a Variant of VarType 3, Put writes 6 bytes: 2 bytes identifying the Variant as VarType 3 (Long) and 4 bytes containing the Long data. The record length specified by the Len clause in the Open method must be at least 2 bytes greater than the actual number of bytes required to store the variable.

You can use the Put method to write a Variant array to disk, but you cannot use Put to write a scalar Variant containing an array to disk. You also cannot use Put to write objects to disk. If the variable being written is a Variant of VarType 8 (String), Put writes 2 bytes identifying the VarType and 2 bytes indicating the length of the string. It then writes the string data. The record length specified by the Len clause in the Open method must be at least 4 bytes greater than the actual length of the string.

If the variable being written is a dynamic array, Put writes a descriptor whose length equals 2 plus 8 times the number of dimensions, that is,  $2 + 8 * \text{NumberOfDimensions}$ . The record length specified by the Len clause in the Open method must be greater than or equal to the sum of all the bytes required to write the array data and the array descriptor. For example, the following array declaration requires 118 bytes when the array is written to disk.

For files opened in Binary mode, the Len clause in the Open method has no effect. Put writes all variables to disk contiguously; that is, with no padding between records.

## Rmdir

### Function

This method deletes an existing empty directory.

### Syntax

```
filesystem.Rmdir PathName
```

### Parameters

#### Filesystem

Reference to a FileSystem control.

#### PathName

String that contains the directory name.



### Return Values

None.

### Remarks

The directory must be empty before it can be removed. You must specify a complete file path.

### Seek

### Function

This property returns and sets the next position in a file that will be read or written.

### Syntax

file.Seek [= position]

### Parameters

#### File

Reference to a File control.

#### Position

Numeric expression that specifies a position within a file.

### Remarks

The Seek property specifies the next file position, whereas the Loc property specifies the current position. Seek always will be one more than Loc, except when a file is first opened and Seek and Loc are both 1.

Negative Seek or 0 causes an error.

### SetAttr

### Function

This method sets attribute data for a file.

### Syntax

filesystem.SetAttr pathname, attributes

## Parameters

### File system

Reference to a FileSystem control.

### Pathname

Required. String expression that specifies a file name.

### Attributes

Required. Numeric expression whose sum specifies file attributes. The following table shows the parameter settings of attributes.

Constant	Value	Description
vbNormal	0	Normal (default)
vbReadOnly	1	Read only
vbHidden	2	Hidden
VbSystem	4	System file
VbArchive	32	File has changed since last backup

## Return values

None.

## Remarks

A run-time error occurs if you try to set the attributes of an open file.

## WriteFields

## Function

This method writes data to a sequential file.

## Syntax

file.WriteFields [data]

## Parameters

### File

Reference to a File control.

### Data

Variant or Variant array of numeric or string expressions to write to a file.

Prinzip

## Return Values

None.

## Remarks

Data written with WriteFields is usually read from a file with InputFields. If you omit data, a blank line is printed to the file.

- Numeric data is always written using the period as the decimal separator.
- For Boolean data, either #TRUE# or #FALSE# is printed. The True and False keywords are not translated, regardless of locale.
- Date data is written to the file using the universal date format. When either the date or the time component is missing or is zero, only the component provided gets written to the file.
- Nothing is written to the file if Data is Empty. However, for Null data, #NULL# is written.
- If data is Null, #NULL# is written to the file.

The WriteFields method inserts commas between items and quotation marks around strings as they are written to the file. You do not have to put explicit delimiters in the list. WriteFields inserts a newline character—that is, a carriage return/line feed (Chr(13) + Chr(10))—after it has written the final character in data to the file.

## VBS object model

## VBS object model

## VBS object model in WinCC

The following screen shows the VBS object model in WinCC:

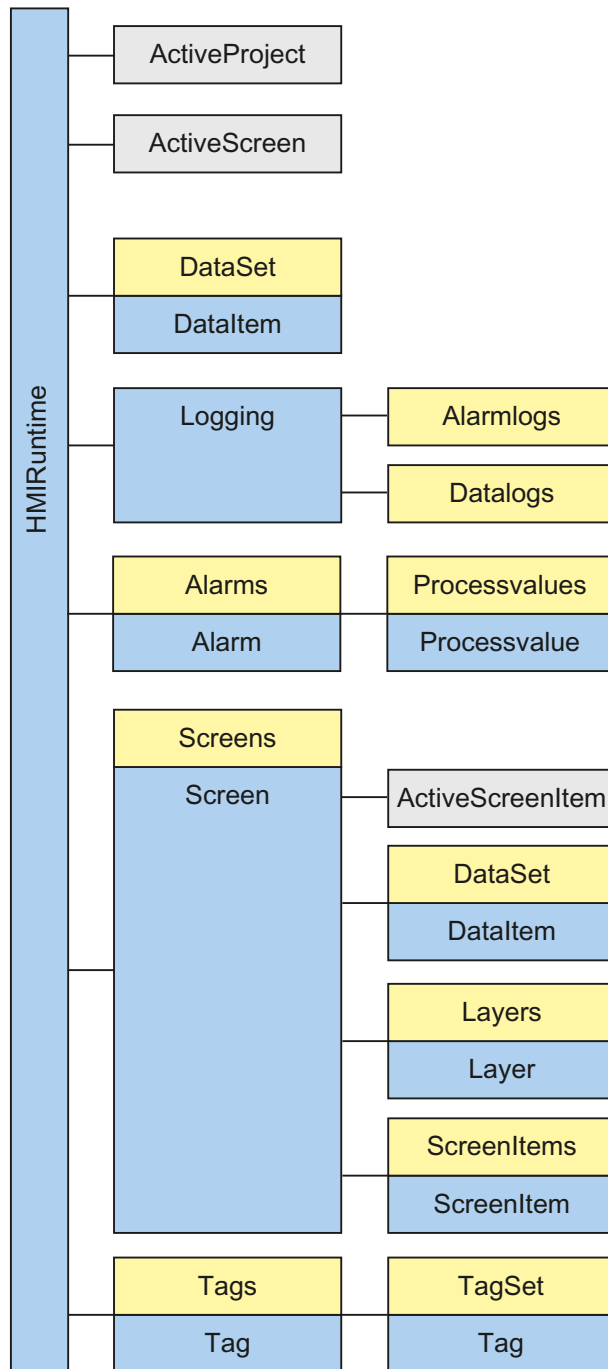

Use the WinCC object model of the graphic Runtime system to access objects and tags in Runtime.

## **Objects**

Objects and lists are provided for access to all the objects in the graphic Runtime systems:

- Display and operating objects
- Screens
- Layers
- Tags

## **Properties**

You can specifically change the display and operating elements and tags in Runtime via the properties of the individual objects. For example, you can enable a button with a click or trigger a color change by changing a tag value.

## **Methods**

Methods which are applied to individual objects can be used to read out tag values for further processing or displaying alarms in Runtime.

**See also**

- ActiveProject (Page 4151)
- ActiveScreen (Page 4151)
- ActiveScreenItem (Page 4153)
- AlarmLogs (list) (Page 3916)
- DataItem (Page 3917)
- DataLogs (list) (Page 3919)
- DataSet (list) (Page 3920)
- Logging (Page 3928)
- Screen (Page 3931)
- Layer (Page 3925)
- Layers (list) (Page 3927)
- ScreenItems (list) (Page 3935)
- ScreenItem (Page 3933)
- Tag (Page 3942)
- Tags (list) (Page 3945)
- TagSet (list) (Page 3946)
- HMIRuntime (Page 3923)
- Alarm (Page 3913)
- Alarms (list) (Page 3914)
- Processvalue (Page 4461)
- Screen object (list) (Page 3937)

## Objects

### HMIRuntime

#### Description

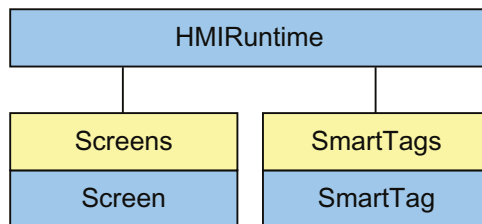

Portrays the graphic runtime system.

The HMIRuntime object contains properties and methods which return the objects to the main layer, e.g. returns the ActiveScreen property of a screen object.

#### Application

You use the "HMIRuntime" object, e.g. as follows:

- Read or set the current Runtime language ("Language" property).
- Read name of current base screen or trigger a base screen change by setting a new screen name (property "BaseScreenName")
- Access tags (List "SmartTags")
- End runtime (Method "Stop")
- Output information on sequence tracing output (Method "Trace")
- Access the screens displayed during runtime (List "Screens")

#### See also

ActiveScreen (Page 4152)

Screen (Page 3906)

## Screen object (list)

### Description

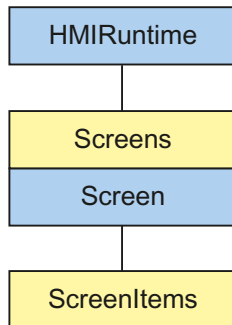

A list of screen objects.

The list contains the following two elements:

- The first element with the index 0 represents the permanent window.
- The second element with the index 1 represents the root screen.

Alternatively, the two elements can be addressed with their their names as follows:

- Permanent window: "Overview"
- Root screen: Name of the screen displayed in the root screen

If the named screen is not displayed, an error occurs during access.

Permanent window "Overview" is displayed in the objects list and in Auto complete.

---

#### Note

The alarm window and the alarm indicator are not contained in the screens list, even if they have the focus in Runtime.

---

### Application

Use the screen property to return the screen list. In the following example, the background color is changed from black to green:

Use the object name as an index.



```
'VBS_Example_BackColor  
HMIRuntime.Screens("Rootscreen").BackColor = vbGreen
```

---

**Note**

If you perform a screen change, the open references to the screen that is no longer available will become invalid. As a result, it is no longer possible to work with these references.

---

**See also**

Screen (Page 3906)

ScreenItems (Page 3909)

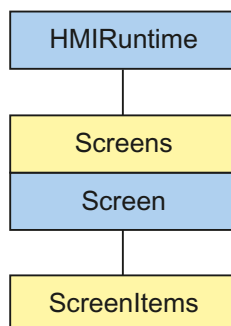
**Screen****Description**

Represents the process screen which is being displayed on the HMI device at the moment or the permanent window in runtime. The screen object is returned to you as a result of accessing the screen list.

The screen object also contains a list of all graphic objects in the screen that can be addressed through the list "ScreenItems".

## Application

You can also use the screen object to do the following:

- Read the height and width of a screen (properties "Height" and "Width").
- Change the background color (property "BackColor").

Use the object name as an index.

In the following example, the background color is changed from black to green:

```
'VBS example background color
HMIRuntime.Screens("Rootscreen").BackColor = vbGreen
```

## See also

- ScreenItem (Page 3907)
- ScreenItems (Page 3909)
- HMIRuntime (Page 3903)
- Screen object (list) (Page 3904)

## ScreenItem

### Description

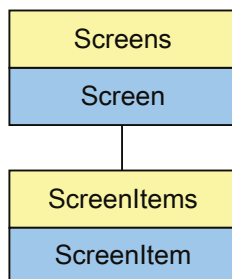

Represents an object in the specified screen. The ScreenItem object is an element of the ScreenItems list.

## Application

You can use the ScreenItem object to access the properties of graphic objects within a screen, depending on certain events.

You use the "ScreenItem" object as follows, for example:

- "Visible" property  
Switch the visibility of an object on or off.
- "Height" and "Width" properties  
Query the width and height of an object.
- "Top" and "Left" properties  
Change the position of an object.
- "ObjectName" property  
Read the name of a graphic object
- "Parent" property  
Set a reference to the parent screen

Use the ScreenItems property to return an object to the screen. Use the object name as an index.

## Example

In the following example, the background color of the "RootScreen" circle in the "myCircle" screen is set to green.

```
'VBS_Example_ScreenItems  
  
Dim objCircle  
Set objCircle = HMIRuntime.Screens("RootScreen").ScreenItems("myCircle")  
objCircle.BackColor = vbGreen
```

---

### Note

To save memory space in the HMI device, no object names are loaded during transfer of the project. If you still want to transfer object names, call up the Runtime settings for the respective HMI device in WinCC. You can change the setting under "General". The object name is required when the object should be accessed via the object name or for debugging a project.

---

The "ScreenItem" object has different properties depending on its features. The following properties are provided for every "ScreenItem" object:

- Enabled
- Height
- Left
- ObjectName
- Parent

- Top
- Type
- Visible
- Width

If a specific object type is addressed, further properties are added to the standard properties. The additional properties are provided in the descriptions of the individual object types.

### See also

Screen (Page 3905)

Screen object (list) (Page 3904)

ScreenItems (Page 3909)

### ScreenItems

### Description

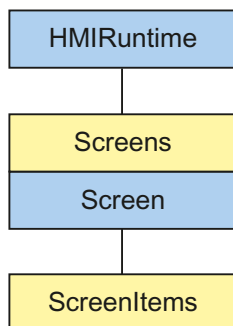

A list of screen item objects with all screen objects of the given process screen. The list has a parent property. This property provides a reference to the process screen in which the screen object is located.

## Application

By means of the "ScreenItems" list you are able

- To edit or output all objects within the list (that is, all objects within a screen)
- To count the objects of a screen (property "Count").
- To work on a particular object in the list (method "Item").

Use the screen items property to return an object from the process screen. Use the object name as an index.

In the following example, the background color of the "RootScreen" circle in the "myCircle" screen is set to green.

```
Dim objCircle
Set objCircle = HMIRuntime.Screens("RootScreen").ScreenItems("myCircle")
objCircle.BackColor = vbGreen
```

## See also

Screen (Page 3905)

HMIRuntime (Page 3903)

Screen object (list) (Page 3904)

## SmartTags

## Description

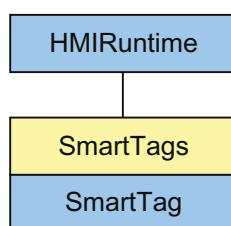

A list of SmartTag objects which represent all of the tags in WinCC Runtime.

---

**Note**

The SmartTags list has a limited range of functions. You can only use the tag names to access a SmartTag object. Access via the index or by using "For each" instruction is not supported.

---

**Note**

In order to access a tag, which has still not been created in the project, using the SmartTags list, no value is returned. Assignment to a non-existing tag is not executed:

```
Dim intVar  
intVar = SmartTags("FillLevel")
```

"intVar" remains empty when the "FillLevel" tag has not been created.

---

## Application

Use the SmartTags list to return a SmartTag object. Use the tag name to reference the SmartTag object.

```
'VBS_Example_SmartTags  
'Writes tag value to local tag and returns a user-defined text through the  
operating system channel for debug alarms.  
Dim strAirPressure  
strAirPressure = "Current air pressure: " + CStr(SmartTags("AirPressure"))  
HMIRuntime.Trace strAirPressure
```

In Runtime Advanced and Panels you address the tag directly using its name. If the tag name corresponds to the VBS name conventions, you do not need to use the SmartTags list. Follow the example below:

```
Dim strAirPressure  
strAirPressure = "Current air pressure: " + CStr(AirPressure)  
HMIRuntime.Trace strAirPressure
```

## See also

[Access to HMI tags \(Page 3552\)](#)

## SmartTag

### Description

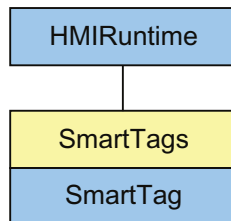

Represents the value of the specified process tag. The SmartTag object is an element of the SmartTag list.

### Application

The SmartTag object provides read and write access to the value of the specified process tag. The SmartTag object does not return an object reference. Use the SmartTags list to return the value of a process tag. Use the tag name as an index.

### Example

```
'VBS_Example_SmartTags
'Writes tag value to local tag and returns a user-defined text through the
operating system channel for debug alarms.
Dim strAirPressure
strAirPressure = "Current air pressure: " + CStr(SmartTags("AirPressure"))
HMIRuntime.Trace strAirPressure
```

---

**Note**

In order to access a tag, which has still not been created in the project, using the SmartTags list, no value is returned. Assignment to a non-existing tag is not executed:

```
Dim intVar
```

```
intVar = SmartTags("FillLevel")
```

"intVar" remains empty when the "FillLevel" tag has not been created.

---

**Note**

If you want to return the "TypeName" of a SmartTag object data type with the VBS function "TypeName", use the following syntax:

```
TypeName(SmartTags("FillLevel").value)
```

---

Use "SmartTags("<tag>")(index)" to access the value of an array element. Set the number of the desired array element for "index", for example, "SmartTags("AirPressure")(2)".

**Objects**

**Alarm**

**Description**

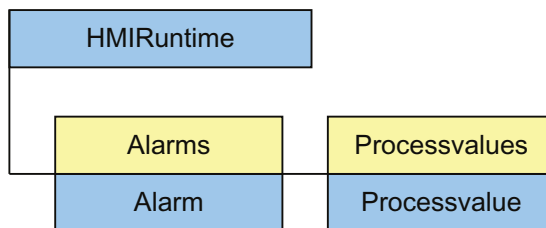



The alarm object is used to access the Alarms object list.

---

**Note**

The properties of the alarm object are not automatically updated when the values of the properties change.

---

**See also**

Alarms (list) (Page 3914)

HMIRuntime (Page 3923)

Processvalue (Page 4461)

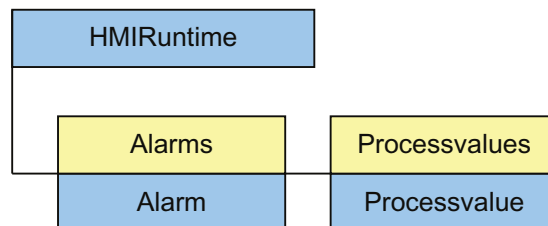
**Alarms (list)****Description**

Use the alarm object to trigger existing messages.

**Usage**

Using the "Alarms" list you can:

- Access a message in the list (Item method)
- Create a new alarm object (Create method)
- Read the alarm ID of the message (AlarmID attribute)

- Read the status of a message (State property)
- Read the time stamp of the message (Timestamp property)
- Generate an instance of the alarm object (Instance property)
- Read the name of the computer on which the message came (ComputerName property)
- Read or set the name of the user who triggered the message (UserName property)
- Read or set the name of the process value blocks (ProcessValues property)
- Read or set the message commentary (Comment property)
- Read or set the message server prefix (Context property)

### Example

In the following example the alarm with the alarm number "1" configured in the "HMI alarms" editor is activated.

```
'VBS360
Dim MyAlarm
Set MyAlarm = HMIRuntime.Alarms(1)
MyAlarm.State = 5 'hmiAlarmStateCome + hmiAlarmStateComment
MyAlarm.Comment = "MyComment"
MyAlarm.UserName = "Hans-Peter"
MyAlarm.ProcessValues(1) = "Process Value 1"
MyAlarm.ProcessValues(4) = "Process Value 4"
MyAlarm.Create "MyApplication"
```

### See also

[AlarmID \(Page 4161\)](#)

[Processvalue \(Page 4461\)](#)

[Alarm \(Page 3912\)](#)

[HMIRuntime \(Page 3923\)](#)

## AlarmLogs (list)

### Description

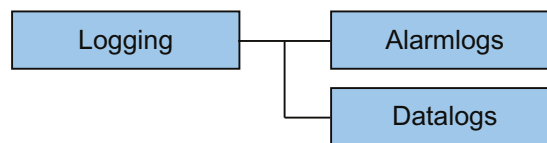

You can use the object to reconnect swapped-out log segments of the alarm log to Runtime or to remove previously swapped-in log segments of the alarm log. The log segments to be swapped in are copied to the "Common logging" folder of the WinCC project. The previously swapped-in log segments are removed from the "Common logging" folder.

You use parameters to control the location from which log segments are to be swapped in. You specify the time period over which the log segments are to be swapped in or removed.

If an error occurs during the operation with log segments, the applied method returns an error alarm.

### Usage

- "Restore" method  
Previously swapped-out log segments of the alarm log are connected to Runtime.
- "Remove" method  
Previously swapped-in log segments of the alarm log are removed from the Runtime project.

### Example

In the following example, log segments from the alarm log are swapped in and the return value is output as a trace.

```
'VBS187
```

```
HMIRuntime.Trace "Ret: " & HMIRuntime.Logging.AlarmLogs.Restore("D:\Folder","2004-09-14","2004-09-20",-1) & vbNewLine
```

### See also

- Restore (Page 4834)
- Remove (Page 4829)
- DataLogs (list) (Page 3919)
- Logging (Page 3928)

### Dataltem

### Description

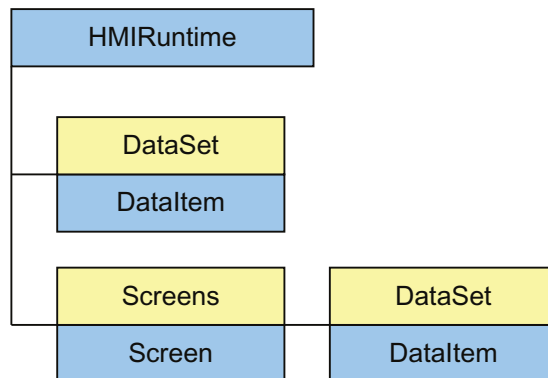

You can use the Dataltem object to access the contents of the DataSet list. Values or object references are stored in the list as Dataltem.

Access uses the name under which the value was added to the list. Single access using an index is not recommended since the index changes during adding or deleting of values. You can use the index to output the complete contents of the list. The output is in alphabetical order.

---

### Note

For object references, ensure that the objects are capable of multi-threading.

---

## Example

The example shows how the value of 'Motor1' is output as a trace.

```
'VBS163
HMIRuntime.Trace "motor1: " & HMIRuntime.DataSet("motor1").Value & vbNewLine
```

The following example enumerates all DataItem objects of the DataSet list. Name and value are output as a trace.

```
'VBS164
Dim data
For Each data In HMIRuntime.DataSet
HMIRuntime.Trace data.Name & ": " & data.Value & vbNewLine
Next
```

---

### Note

The value may not be output directly for objects.

---

## See also

- Screen (Page 3931)
- HMIRuntime (Page 3923)
- DataSet (list) (Page 3920)
- Value (Page 4691)
- Name (Page 4417)
- Screen object (list) (Page 3937)

## DataLogs (list)

### Description

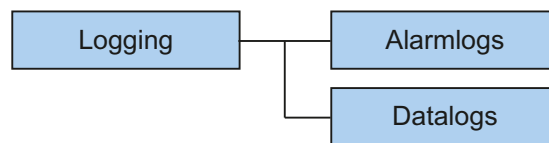

You can use the object to reconnect swapped-out log segments of the data log to Runtime or to delete previously swapped-in log segments of the data log. The log segments to be swapped in are copied to the "Common logging" folder of the WinCC project. The previously swapped-in log segments are removed from the "Common logging" folder.

You use parameters to control the location from which log segments are to be swapped in. You specify the time period over which the log segments are to be swapped in or removed. You also set the type of log ("Fast data log", "Slow data log", "Fast data log and Slow data log").

If an error occurs during the operation with log segments, the applied method returns an error alarm.

### Usage

- "Restore" method  
Previously swapped out log segments of the data log are connected to Runtime.
- "Remove" method  
Previously swapped-in log segments of the data log are removed from the Runtime project.

### Example

In the following example, log segments from the Fast data log are swapped in and the return value is output as a trace.

```
'VBS188
HMIRuntime.Trace "Ret: " & HMIRuntime.Logging.DataLogs.Restore("D:
\Folder", "2004-09-14", "2004-09-20", -1, 1) & vbNewLine
```

### See also

- Restore (Page 4834)
- Remove (Page 4829)
- AlarmLogs (list) (Page 3915)
- Logging (Page 3928)

### DataSet (list)

### Description

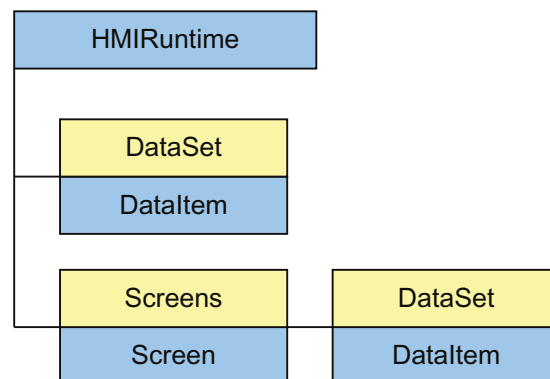

Using the DataSet object, you can exchange data throughout several actions.

A DataSet object is global and defined by the screen object. You can access the data from any VBS action.

You address the screen object according to the screen hierarchy. The DataSet object persists as long as the screen is displayed. The global object persists over the entire runtime time period.

Access uses the DataItem object.

---

**Note**

You cannot include objects with the types Screen, Screens, ScreenItem, ScreenItems, Tag and TagSet in the DataSet list.

The DataSet object does not support any classes.

---

## Usage

Use the "DataSet" list as follows:

- Enumeration  
Output or process all objects in the list
- "Count" property  
Output the number of elements contained
- "Item" method  
Work on a particular object in the list
- "Add" method  
Add an object to the list
- "Remove" method  
Remove a particular object from the list
- "RemoveAll" method  
Remove all objects from the list

Access to list elements is made as follows:

```
HMIRuntime.DataSet("Itemname")
```

For a picture-specific list, access is performed as follows:

```
HMIRuntime.Screens("Screenname").DataSet("Itemname")
```

You access the DataSet object of the screen as follows:

```
DataSet("Itemname")
```

If upon access the stated name does not exist in the list, VT\_Empty is returned and an Exception is triggered.



## Example

The example shows how a value can be entered in the list, read and removed from the list throughout various actions.

```
'VBS162
HMIRuntime.DataSet.Add "motor1", 23
HMIRuntime.Trace "motor1: " & HMIRuntime.DataSet("motor1").Value & vbNewLine
HMIRuntime.DataSet.Remove("motor1")
```

## See also

- [RemoveAll \(Page 4833\)](#)
- [Remove \(Page 4829\)](#)
- [Item \(Page 4810\)](#)
- [Add \(Page 4749\)](#)
- [DataItem \(Page 3916\)](#)
- [HMIRuntime \(Page 3923\)](#)
- [Screen \(Page 3931\)](#)
- [Screen object \(list\) \(Page 3937\)](#)

## HMIRuntime

### Description

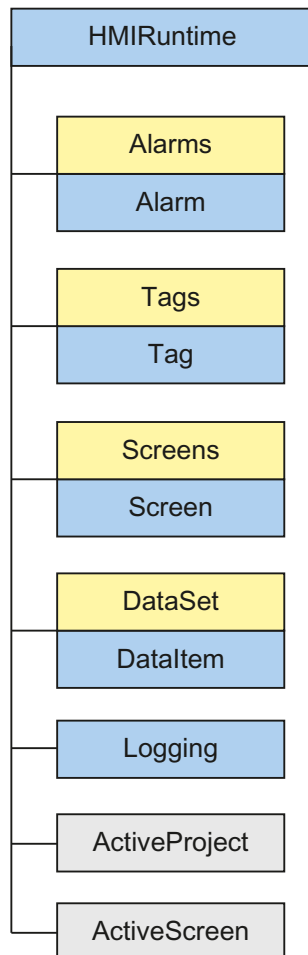

The HMIRuntime object represents the graphic Runtime environment.

### Usage

You can use the "HMIRuntime" object as follows:

- "Language" property  
Read or set the current Runtime language
- "BaseScreenName" property  
Read or set the name of the current root screen
- "ActiveProject" property  
Read the path of the active Runtime project

- "Tags" property  
Accessing tags
- "DataSet" property  
Accessing tags in a list
- "Stop" method  
Stop Runtime
- "Trace" method  
Display messages in a diagnostics window

## Example

The following command closes WinCC Runtime:

```
'VBS3  
HMIRuntime.Stop
```

## See also

[Trace \(Page 4854\)](#)  
[Stop \(Page 4853\)](#)  
[Logging \(Page 3928\)](#)  
[DataSet \(list\) \(Page 3919\)](#)  
[Language \(Page 4351\)](#)  
[Tags \(Page 4571\)](#)  
[Logging \(Page 4386\)](#)  
[DataSet \(Page 4262\)](#)  
[CurrentContext \(Page 4254\)](#)  
[ActiveProject \(Page 4151\)](#)  
[MenuToolBarConfig \(Page 4396\)](#)  
[Alarm \(Page 3912\)](#)  
[Alarms \(list\) \(Page 3913\)](#)  
[Tag \(Page 3942\)](#)  
[Tags \(list\) \(Page 3945\)](#)  
[Dataltem \(Page 3916\)](#)  
[Screen \(Page 3931\)](#)  
[Screen object \(list\) \(Page 3937\)](#)  
[ActiveScreen \(Page 4151\)](#)

## Item

### Description

The Item object provides a reference to the current object.

### Usage

Use the Item object, for example, to address the properties of the object currently selected in the screen.

### Example

In the following example, you set the background color of the object selected in the screen to red:

```
'VBS195  
Item.BackColor = RGB(255,0,0)
```

## Layer

### Description

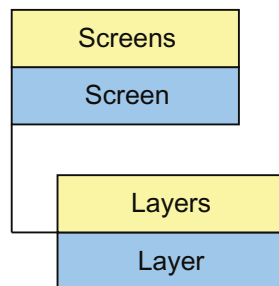

The Layer object returns the result of access to the layers list.

## Parent object

Screen in which the screen layer is located

## Usage

Depending on certain events, you can use the Layer object to obtain access to the properties of a complete layer to hide or display a layer with operating elements according to the operator authorization.

You can use the "Layer" object as follows:

- "Visible" property  
Activate or deactivate visibility of a layer
- "Name" property  
Read the name of a layer

---

### Note

The layer property specifies the layer in which the object is located. The layer "0" is output as layer "0".

When accessed, the layers are counted up from 1 in VBS. Therefore, address level "1" with "Layers(2)".

---

## Example

In the following example, Layer 1 is set to "invisible":

```
'VBS4  
Layers(2).Visible = vbFalse
```

## See also

Name (Page 4417)  
Layers (list) (Page 3927)  
Screen (Page 3931)  
Screen object (list) (Page 3937)

## Layers (list)

### Description

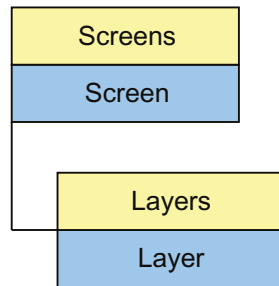

Use the layers list to access all 32 layers of the graphical Runtime system.

### Parent object

Screen in which the screen layer is located

### Usage

You use the "Layers" list as follows:

- "\_NewEnum" property  
Process all layers in the list
- "Count" property  
Count all layers contained in the list
- "Item" method  
Process a layer from the list

The properties represent default properties and methods of a list and are not described in detail in the WinCC documentation.

**See also**

Item (Page 4810)  
Layer (Page 3924)  
Screen (Page 3931)  
Screen object (list) (Page 3937)

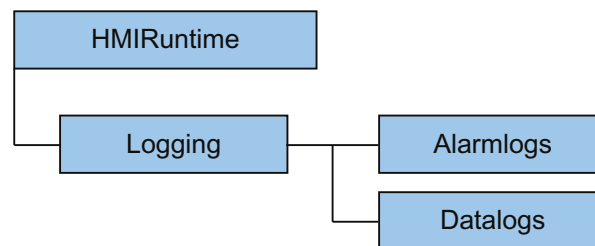
**Logging****Description**

You can use the object to reconnect swapped-out log segments to Runtime or to remove previously swapped-in log segments. The log segments to be swapped in are copied to the "Common logging" folder of the WinCC project. The previously swapped-in log segments are removed from the "Common logging" folder.

You use parameters to control the location from which log segments are to be swapped in. You specify the time period over which the log segments are to be swapped in or removed.

If an error occurs during the operation with log segments, the applied method returns an error alarm.

## Usage

- "Restore" method  
Previously swapped out log segments of the alarm log and the data log are connected to Runtime.
- "Remove" method  
Previously swapped-in log segments of the alarm log and data log are removed from the Runtime project.

## Example

In the following example, log segments from the alarm log and data log are swapped in and the return value is output as a trace.

```
'VBS189  
HMIRuntime.Trace "Ret: " & HMIRuntime.Logging.Restore("D:  
\Folder", "2004-09-14", "2004-09-20", -1) & vbNewLine
```

## See also

[Restore \(Page 4834\)](#)  
[Remove \(Page 4829\)](#)  
[DataLogs \(list\) \(Page 3918\)](#)  
[AlarmLogs \(list\) \(Page 3915\)](#)  
[DataLogs \(Page 4261\)](#)  
[AlarmLogs \(Page 4162\)](#)  
[HMIRuntime \(Page 3922\)](#)



## Project

## Description

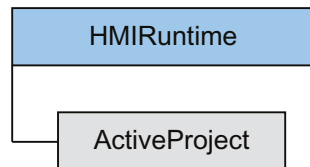

Using the object, you can query information from the current Runtime project.  
The project object is returned as the result of ActiveProject.

## Usage

You can read the following using the "Project" object:

- The path of the current Runtime project ("Path" property)
- The name of the current Runtime project, without path or file extension ("Name" property)

## Example

The following example returns name and path of the current Runtime project as a trace:

```
'VBS159
HMIRuntime.Trace "Name: " & HMIRuntime.ActiveProject.Name & vbNewLine
HMIRuntime.Trace "Path: " & HMIRuntime.ActiveProject.Path & vbNewLine
```

## See also

[ActiveProject \(Page 4151\)](#)

[Name \(Page 4417\)](#)

[Path \(Page 4447\)](#)

## Screen

### Description

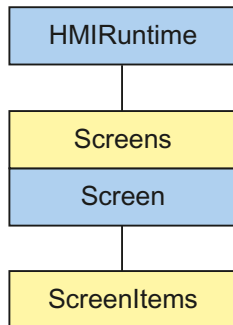

Represents the screen which is being displayed on the HMI device at the moment or the permanent window in Runtime. The screen object is returned as a result of accessing the screen list.

The screen object also contains the following lists:

- You can address all the graphic objects in the addressed screen using the "ScreenItems" list.
- You can address all the layers in the addressed screen using the "Layers" object.

### Application

You can use the screen object for the following actions, for example:

- "Width" and "Height" properties  
Reading the width and height of a screen
- "BackColor" property  
Changing the background color

Use the object name as an index.

### Example

In the following example, the background color is changed from black to green:

```
'VBS_Example_BackColor
```

```
HMIRuntime.Screens("Rootscreen").BackColor = vbGreen
```

## Parent object

Screen window in which the screen object is embedded.

If the screen object is the root screen, the parent object is not defined and set to zero.

---

### Note

If you perform a screen change, the open references to screens that are no longer available will become invalid. As a result, it is no longer possible to work with these references.

---

## Example

In the following example, the width of the first screen is increased by 20 pixels in Runtime:

```
'VBS7
Dim objScreen
Set objScreen = HMIRuntime.Screens(1)
MsgBox "Screen width before changing: " & objScreen.Width
objScreen.Width = objScreen.Width + 20
MsgBox "Screen width after changing: " & objScreen.Width
```

## Notes on Cross References

All the screens you address with the standard formulation are automatically compiled by the CrossReference of WinCC and then listed in the screen properties.

```
HMIRuntime.BaseScreenName = "Screenname"
```

If you call screens with different formulations in the code, you make them known by the following section of the CrossReference:

```
' ' WINCC:SCREENNAME_SECTION_START
Const ScreenNameInAction = "ScreenName"
' WINCC:SCREENNAME_SECTION_END
The section can be inserted in VBS actions as often as required.
```

## See also

- Refresh (Page 4828)
- Activate (Page 4744)
- ObjectSizeDeclutteringEnable (Page 4426)
- ObjectSizeDeclutteringMax (Page 4426)
- ObjectSizeDeclutteringMin (Page 4427)
- LayerDeclutteringEnable (Page 4364)
- Layers (Page 4365)
- DataSet (Page 4262)
- ExtendedZoomingEnable (Page 4292)
- AccessPath (Page 4149)
- HMIRuntime (Page 3922)
- ScreenItems (list) (Page 3935)
- Screen object (list) (Page 3937)

## ScreenItem

### Description

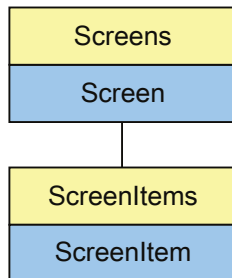

Represents an object in the specified screen. The ScreenItem object is an element of the ScreenItems list.

## Application

You can use the ScreenItem object to access the properties of graphic objects within a screen, depending on certain events.

You use the "ScreenItem" object as follows, for example:

- "Visible" property  
Switch the visibility of an object on or off.
- "Height" and "Width" properties  
Query the width and height of an object.
- "Top" and "Left" properties  
Change the position of an object.
- "ObjectName" property  
Read the name of a graphic object
- "Parent" property  
Set a reference to the parent screen

Use the ScreenItems property to return an object to the screen. Use the object name as an index.

## Example

In the following example, the background color of the "RootScreen" circle in the "myCircle" screen is set to green.

```
'VBS_Example_ScreenItems  
  
Dim objCircle  
Set objCircle = HMIRuntime.Screens("RootScreen").ScreenItems("myCircle")  
objCircle.BackColor = vbGreen
```

---

### Note

To save memory space in the HMI device, no object names are loaded during transfer of the project. If you still want to transfer object names, call up the Runtime settings for the respective HMI device in WinCC. You can change the setting under "General". The object name is required when the object should be accessed via the object name or for debugging a project.

---

The "ScreenItem" object has different properties depending on its features. The following properties are provided for every "ScreenItem" object:

- Enabled
- Height
- Left
- ObjectName
- Parent

- Top
- Type
- Visible
- Width

If a specific object type is addressed, further properties are added to the standard properties. The additional properties are provided in the descriptions of the individual object types.

### See also

Activate (Page 4744)

Layer (Page 4355)

Screen (Page 3930)

ScreenItems (list) (Page 3935)

Screen object (list) (Page 3937)

### ScreenItems (list)

#### Description

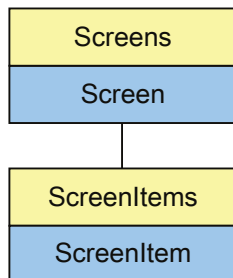

A list of ScreenItem objects with all screen objects of the specified screen. The list has a "Parent" property. This "Parent" property provides a reference to the screen in which the screen object is located.

## Usage

You use the "ScreenItems" list as follows:

- To edit or output all objects within the list (that is, all objects within a screen)
- "Count" property  
Count the objects of a screen
- "Item" method  
Work on a particular object in the list

Use the screen items property to return an object from the screen. Use the object name as an index.

## Example

In the following example, the background color of the "RootScreen" circle in the "myCircle" screen is set to green.

```
Dim objCircle
Set objCircle = HMIRuntime.Screens("RootScreen").ScreenItems("myCircle")
objCircle.BackColor = vbGreen
```

## Peculiarities of the ScreenItem object

If you embed an external control (ActiveX control or OLE object) in WinCC, the properties of the embedded control may have the same names as the general properties of the ScreenItem object. In this case, the ScreenItem properties take priority.

You can address the properties of the embedded controls, however, via the "object" property. The "object" property is only available in ActiveX controls and OLE objects.

Example:

```
'Controll is an embedded ActiveX-Control with property "type"
'VBS196
Dim Control
Set Control=ScreenItems("Controll")
Control.object.type

'Controll is a WinCC-Control
'VBS197
Dim Control
Set Control=ScreenItems("Controll")
Control.type
```

## Example

In the following example, you output the name of the objects in the current screen in a message box:

```
Sub OnClick(ByVal Item)
  'VBS6
  Dim lngAnswer
  Dim lngIndex
  lngIndex = 1
  For lngIndex = 1 To ScreenItems.Count
    lngAnswer = MsgBox(ScreenItems(lngIndex).Objectname, vbOKCancel)
    If vbCancel = lngAnswer Then Exit For
  Next
End Sub
```

## See also

- [Item \(Page 4810\)](#)
- [ScreenItem \(Page 3932\)](#)
- [Screen \(Page 3930\)](#)
- [Screen object \(list\) \(Page 3937\)](#)

## Screen object (list)

### Description

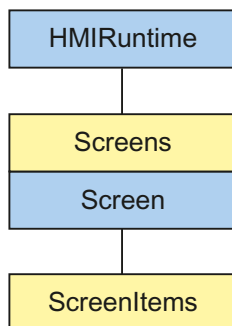



Several screens can be opened simultaneously in WinCC Runtime by means of the screen window technique, whereby there is only one main screen. The "Screens" list allows access to all open screens in Runtime using the screen name. The screen list contains all hidden screens.

The access key required in the VBS environment in the HMIRuntime.Screens(<access key>) instruction must conform to the following syntax description:

```
[<Root screen name>.]<Screen window name>[:<Screen name>] ...  
.<Screen window name>[:<Screen name>]
```

- The access key represents the screen hierarchy.
- You can omit the screen name at all locations in the key.
- The "AccessPath" property of the "Screen" object corresponds to the full access key.
- The root screen can be addressed via the "" access key.

## Examples

The screens are addressed by specifying the hierarchy in the list. You can address the screens with or without using the screen names. In the following example, a "BaseScreenName" root screen is configured with a "ScreenWindow". The screen window contains a "ScreenName" screen.

### Addressing using the screen name

```
'VBS8  
Set objScreen = HMIRuntime.Screens("BaseScreenName.ScreenWindow:ScreenName")
```

### Addressing without using the screen name

```
'VBS9  
Set objScreen = HMIRuntime.Screens("ScreenWindow")
```

### Referencing the root screen in various ways

```
'VBS10  
Set objScreen = HMIRuntime.Screens(1)
```

```
'VBS11  
Set objScreen = HMIRuntime.Screens("")
```

```
'VBS12  
Set objScreen = HMIRuntime.Screens("BaseScreenName")
```

## See also

HMIRuntime (Page 3922)

Screen (Page 3930)

ScreenItem (Page 3932)

## SmartTag

### Description

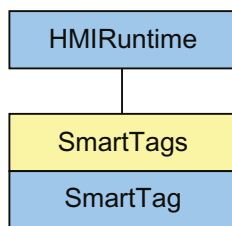

Represents the value of the specified process tag. The SmartTag object is an element of the SmartTag list.

### Application

The SmartTag object provides read and write access to the value of the specified process tag. The SmartTag object does not return an object reference. Use the SmartTags list to return the value of a process tag. Use the tag name as an index.

### Example

```
'VBS_Example_SmartTags  
'Writes tag value to local tag and returns a user-defined text through the  
operating system channel for debug alarms.  
Dim strAirPressure  
strAirPressure = "Current air pressure: " + CStr(SmartTags("AirPressure"))  
HMIRuntime.Trace strAirPressure
```

---

**Note**

In order to access a tag, which has still not been created in the project, using the SmartTags list, no value is returned. Assignment to a non-existing tag is not executed:

```
Dim intVar  
intVar = SmartTags("FillLevel")
```

"intVar" remains empty when the "FillLevel" tag has not been created.

---

**Note**

If you want to return the "TypeName" of a SmartTag object data type with the VBS function "TypeName", use the following syntax:

```
TypeName(SmartTags("FillLevel").value)
```

---

Use "SmartTags("<tag>")(index)" to access the value of an array element. Set the number of the desired array element for "index", for example, "SmartTags("AirPressure")(2)".

**See also**

[HMIRuntime \(Page 3922\)](#)

[SmartTags \(Page 3941\)](#)

## SmartTags

### Description

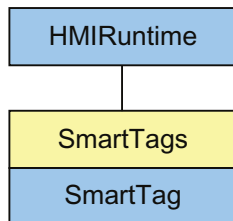

A list of SmartTag objects which represent all of the tags in WinCC Runtime.

---

#### Note

The SmartTags list has a limited range of functions. You can only use the tag names to access a SmartTag object. Access via the index or by using "For each" instruction is not supported.

---

#### Note

In order to access a tag, which has still not been created in the project, using the SmartTags list, no value is returned. Assignment to a non-existing tag is not executed:

```
Dim intVar  
intVar = SmartTags("FillLevel")
```

"intVar" remains empty when the "FillLevel" tag has not been created.

---

### Application

Use the SmartTags list to return a SmartTag object. Use the tag name to reference the SmartTag object.

```
'VBS_Example_SmartTags  
'Writes tag value to local tag and returns a user-defined text through the  
operating system channel for debug alarms.
```

```
Dim strAirPressure
strAirPressure = "Current air pressure: " + CStr(SmartTags("AirPressure"))
HMIRuntime.Trace strAirPressure
```

In Runtime Advanced and Panels you address the tag directly using its name. If the tag name corresponds to the VBS name conventions, you do not need to use the SmartTags list. Follow the example below:

```
Dim strAirPressure
strAirPressure = "Current air pressure: " + CStr(AirPressure)
HMIRuntime.Trace strAirPressure
```

## See also

HMIRuntime (Page 3922)

SmartTag (Page 3938)

## Tag

## Description

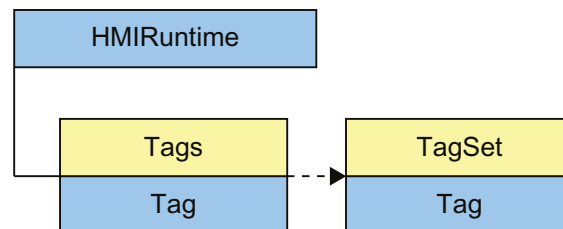

A tag object is returned via the "Tags" list. A tag object can be used to address all the properties and methods of a tag.

When creating a tag object, all the properties are initialized with the following values:

- Value = VT\_EMPTY
- Name = Tag name

- QualityCode = BAD NON-SPECIFIC
- TimeStamp = 0
- LastError = 0
- ErrorDescription = " "

---

**Note**

A summary of possible Quality Codes can be found in WinCC Information System under key word "Communication" > "Diagnostics" or "Communication" > "Quality Codes".

---

## Usage

Use the "Tag" object as follows:

- "Name", "QualityCode", "TimeStamp", "LastError" and "ErrorDescription" properties  
Read information on the tag
- "Write" method, "Value" property  
Set a value for a tag
- "Read" method, "Value" property  
Read a value for a tag

## Example

The following example reads the value in the "Tag1" tag:

```
'VBS13
Dim objTag
Set objTag = HMIRuntime.Tags("Tag1")
objTag.Read()
MsgBox objTag.Value
```

## Declaration of tags in WinCC

Always define internal tags in VB script using the "Dim" instruction in order to prevent writing tags wrongly.

When creating a new action, the "Option explicit" instruction is automatically entered in the declaration area and cannot be deleted.

Do not use the "Option explicit" statement in your code as it can lead to Runtime errors.

## Example

The following example reads the declaration value in the "IngVar" VB Script tag:

```
'VBS14
```

```
Dim lngVar  
lngVar = 5  
MsgBox lngVar
```

---

**Note**

Tag names must not contain any special characters.

When creating a tag, ensure it does not contain a value (Value = VT\_EMPTY). Initialize the tags after declaration with the corresponding value.

---

### Notes on Cross References

All the pictures which are addressed with the standard formulation

```
HMIRuntime.Tags ("Tagname")
```

are automatically compiled by the CrossReference of WinCC and then listed in the picture properties.

If you address tags with different formulations in the code, you can make them known by the following section of the CrossReference:

```
' ' WINCC:TAGNAME_SECTION_START  
Const TagNameInAction = "TagName"  
' WINCC:TAGNAME_SECTION_END
```

The section can be inserted in VBS actions as often as required.

---

**Note**

Composed tag names may not be recognized by the CrossReference.

---

**See also**

- Name (Page 4417)
- Value (Page 4691)
- ErrorDescription (Page 4284)
- LastError (Page 4354)
- QualityCode (Page 4464)
- Timestamp (Page 4605)
- HMIRuntime (Page 3922)
- Tags (list) (Page 3945)
- TagSet (list) (Page 3946)

**Tags (list)**

**Description**

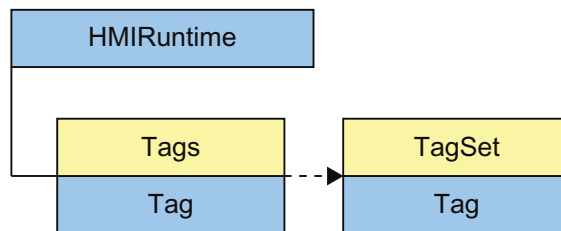

The "Tags" list enables access to tags in WinCC Runtime. The result of access to the "Tags" list is returned by an object of the type "Tag". The Tag object can be used to access all the tag properties and methods.

---

**Note**

"Tags" is a list with a restricted functional scope. The tags in the list cannot be accessed via the index but only by using the tag names. The standard methods `get_Count` and `get_NewEnum` cannot be used in the Tags list.

---



## Application

Tags in the list are accessed via:

```
HMIRuntime.Tags("Tagname")
```

The Tags list is used to declare tags (tag objects) for read and write access. The appropriate HMI tags must exist in order for the write and read access to be executed without error.

You can address HMI tags directly in VBScript and set and read values. If you wish to inquire about additional tag properties, such as quality code or time stamp, or wish to execute error processing, you must address the tag through tags list. The tag object returned enables access to all tag properties and methods.

Using the "CreateTagSet" method, you may generate a TagSet object which allows simultaneous access to several tags.

## Example

You use tag names when you set tags.

```
'VBS16  
Dim objTag  
Set objTag = HMIRuntime.Tags("Tagname")  
If you only use the tag name, the "TagPrefix" property is assigned the values from the  
current context (the current screen window).
```

## See also

[HMIRuntime](#) (Page 3922)

[Tag](#) (Page 3941)

[TagSet \(list\)](#) (Page 3946)

## TagSet (list)

### Description

The "TagSet" object enables simultaneous access to several tags in one call. Simultaneous access demonstrates better performance and lower communication load than single access to multiple tags.

## Usage

You can use the TagSet object as follows:

- "Add" method  
Add tags to the list
- "Item" method  
Access tag objects contained in the list and their properties
- "Write" method  
Write all tags of the list
- "Read" method  
Read all tags of the list
- "Remove" method  
Remove single tags from the list
- "RemoveAll" method  
Remove all tags from the list

Tags in the list are accessed via:

```
'VBS169
Dim myTags
myTags = HMIRuntime.Tags.CreateTagSet
myTags ("Tagname")
```

In order to have error-free read/write access to tags (tag objects) of the list, the respective tags must exist in WinCC.

If a read/write access error has occurred, the method used will return an error message using the "LastError" and "ErrorDescription" properties.

## Example

The following example shows how to generate a TagSet object, how to add tags, and how to write values.

```
'VBS168
'Build a Reference to the TagSet Object
Dim group
Set group = HMIRuntime.Tags.CreateTagSet
'Add Tags to the Collection
group.Add "Motor1"
group.Add "Motor2"
'Set the Values of the Tags
group("Motor1").Value = 3
group("Motor2").Value = 9
'Write the Values to the DataManager
group.Write
```

**See also**

ErrorDescription (Page 4284)

LastError (Page 4354)

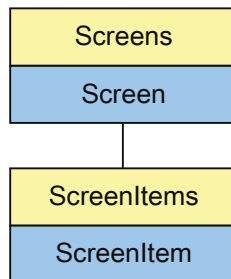
**Object types****Objects A-I****AlarmControl****Description**

Represents the "Alarm view" object. The AlarmControl object is an element of the ScreenItems list.

**Type identifier in VBS**

HMIAAlarmControl

**Example**

In the following example, the object with the name "Control1" is moved 10 pixels to the right:

```
'VBS54
Dim objControl
```

10.8 Working with system functions and Runtime scripting

```
Set objControl = ScreenItems("Control1")
objControl.Left = objControl.Left + 10
```

Abbreviation	Validity
Pa	Panels
A	RT Advanced
P	RT Professional

Table 10-19 Properties

Properties	Read	Write	Description
Activate (Page 4149)	P	P	Specifies whether the data to be visualized is requested by the alarm server.
AlarmListType	P	P	Specifies the alarm classes to be reported in runtime.
AllServer	P	P	Sets the display of the alarms of all available servers.
ApplyProjectSettings (Page 4172)	P	P	Specifies whether the project settings from the "HMI alarms" editor are applied.
ApplyProjectSettingsForDesignMode	P	P	Specifies that the project settings are used for the design.
AutoCompleteColumns (Page 4177)	P	P	Specifies whether empty columns are shown if the control is wider than the configured columns.
AutoCompleteRows (Page 4177)	P	P	Specifies whether empty rows are shown if the control is longer than the number of configured rows.
AutoSelectionColors (Page 4178)	P	P	Specifies whether the colors defined by the system are used as the selection colors for cells and rows.
AutoSelectionRectColor (Page 4179)	P	P	Specifies whether the selection frame is shown with the color defined by the system.
BackColor (Page 4181)	P	P	Specifies the background color of the selected object.
Blocks	P	P	Sets the alarm blocks.
BorderColor (Page 4202)	P	P	Specifies the line color of the object.
BorderWidth (Page 4216)	P	P	Specifies the line thickness of the object.
Caption (Page 4221)	P	P	Specifies the text that is displayed in the header of the selected object.
CellCut (Page 4225)	P	P	Specifies whether the contents of the cells are abbreviated if the cells are too narrow.
CellSpaceBottom (Page 4226)	P	P	Specifies the bottom margin of the table cells.
CellSpaceLeft (Page 4227)	P	P	Sets the left indent for the table cells.
CellSpaceRight (Page 4227)	P	P	Specifies the right indent of the table cells.
CellSpaceTop (Page 4228)	P	P	Specifies the top margin of the table cells.
Closeable (Page 4236)	P	P	Specifies that the control can be closed in runtime.
ColumnResize (Page 4242)	P	P	Enables changes to the width of columns.
ColumnScrollbar (Page 4244)	P	P	Specifies the scroll bar type.

Properties	Read	Write	Description
ColumnTitleAlignment (Page 4244)	P	P	Specifies the type of column title alignment.
ColumnTitles (Page 4245)	P	P	Specifies whether the column title is displayed.
ControlDesignMode (Page 4538)	P	P	Specifies the design.
DefaultMsgFilterSQL	P	P	Specifies an SQL statement as default for alarm filters.
DefaultSort	P	P	Specifies the sorting order.
DefaultSort2	P	P	Specifies the sorting order.
DefaultSort2Column	P	P	Specifies the sorting order.
DisplayOptions (Page 4268)	P	P	Specifies the alarms to be displayed.
DoubleClickAction (Page 4269)	P	P	Specifies the action to be executed in runtime by double-clicking an alarm row.
ExportDirectoryChangeable (Page 4286)	P	P	Specifies whether the data export directory can be changed in runtime.
ExportDirectoryname (Page 4286)	P	P	Specifies the target directory for the exported Runtime data.
ExportFileExtension (Page 4287)	P	P	Specifies the file extension of the export file. Only the "csv" file extension is currently supported.
ExportFilename (Page 4288)	P	P	Specifies the name of the target file for the exported Runtime data.
ExportFilenameChangeable (Page 4288)	P	P	Specifies whether the export file name can be changed in runtime.
ExportFormatGuid (Page 4289)	P	P	Default assignment of the ID number and export provider.
ExportFormatName (Page 4289)	P	P	Specifies the export file format. Only the "csv" file format is currently available for the export.
ExportParameters (Page 4290)	P	P	Specifies the parameters of the selected format by means of the "Properties" dialog.
ExportSelection (Page 4290)	P	P	Specifies the file extension of the export file. Only the "csv" file extension is currently supported.
ExportShowDialog (Page 4291)	P	P	Specifies whether the data export dialog is shown in runtime.
Filters	P	P	Specifies database criteria in SQL syntax.
Font (Page 4311)	P	P	Specifies or returns the font.
GridLineColor (Page 4325)	P	P	Specifies the color for the grid lines.
GridLineWidth (Page 4326)	P	P	Specifies the width of the separation lines in pixels.
Height (Page 4327)	P	P	Sets the height of the specified "Ellipsis", "Circle" and "Rectangle" objects.
HitlistColumnAdd (Page 4332) *	P	P	Transfers the selected alarm block from the list of available alarm blocks to the list of selected alarm blocks.
HitlistColumnCount (Page 4333) *	P	P	Sets the number of selected alarm blocks to be displayed in the hitlist in runtime.
HitlistColumnIndex (Page 4333)	P	P	References an alarm block that is selected for the hitlist.
HitlistColumnName (Page 4334) *	P	P	Displays the name of the alarm block of the hitlist that is referenced by means of the "HitlistColumnIndex" attribute.
HitlistColumnRemove (Page 4334) *	P	P	Cuts the marked alarm block from the list of selected alarm blocks and pastes it into the list of existing alarm blocks.
HitlistColumnRepos (Page 4334) *	P	P	Changes the sorting order of the alarm blocks. The "Up" and "Down" commands move the selected alarm block accordingly in the list.

10.8 Working with system functions and Runtime scripting

Properties	Read	Write	Description
HitlistColumnSort (Page 4335) *	P	P	Specifies the sorting order in the hitlist for the alarm block that is referenced in "MessageColumnIndex".
HitlistColumnSortIndex (Page 4335) *	P	P	Specifies the sorting order in the hitlist for the alarm block that is referenced in "HitlistColumnIndex".
HitlistColumnVisible (Page 4336) *	P	P	The list displays the selected alarm blocks from the alarm list or hitlist that are to be used in the control in runtime.
HitListDefaultSort (Page 4336)	P	P	Sets the default sorting order in the table columns of the hitlist.
HitListMaxSourceItems (Page 4337)	P	P	Sets the maximum number of data records from the alarm log that are to be used to create the hit list.
HitListMaxSourceItemsWarn (Page 4337)	P	P	Sets the output of a warning on reaching the maximum number of data records that was specified in "HitlistMaxSourceItems".
HitListRelTime (Page 4339)	P	P	Sets a time range for the statistics.
HitListRelTimeFactor	P	P	Sets the time factor that is used in combination with the "HitlistRelativeTimeFactorType" to calculate the period for creating the hitlist statistics.
HitListRelTimeFactorType	P	P	Sets the time type that is used in combination with the "HitlistRelativeTimeFactor" to calculate the period for creating the hitlist statistics.
HorizontalGridLines (Page 4341)	P	P	Specifies whether horizontal separation lines are displayed.
IconSpace (Page 4344)	P	P	Specifies the spacing between icons and text in the table cells.
Layer (Page 4355)	P	P	Returns the layer that contains an object as LONG in the screen.
Left (Page 4366)	P	P	Specifies the value of the X coordinate of the object.
LineColor (Page 4379)	P	P	Sets the color of the window separation lines.
LineWidth (Page 4381)	P	P	Specifies the line thickness of the selected object.
LongTermArchiveConsistency (Page 4387)	P	P	If "LongTimeArchiveConsistency" is set to "No", 1000 alarms will be displayed in the historical alarm list (long-term) on the single station, on the server, or on the client for each server or redundant server pair.
MessageBlockAlign (Page 4397) *	P	P	Sets the mode of alignment for the table contents of the selected alarm block.
MessageBlockAutoPrecisions (Page 4397) *	P	P	Enables automatic setting of the number of decimal places.
MessageBlockCaption (Page 4398) *	P	P	Specifies the caption of the column header in the alarm view for the selected alarm block.
MessageBlockCount (Page 4398)	P	P	Specifies the number of alarm blocks that are available for the alarm list and hitlist.
MessageBlockDateFormat (Page 4399) *	P	P	Specifies the date format for displaying the alarms.
MessageBlockExponentialFormat (Page 4399) *	P	P	Specifies the exponential notation for visualization of the values of a selected alarm block.
MessageBlockFlashOn (Page 4400) *	P	P	Enables flashing of the selected alarm block in runtime when an alarm appears.
MessageBlockHideText (Page 4400) *	P	P	Enables the textual display of the content of the selected alarm block.
MessageBlockHideTitleText (Page 4401) *	P	P	Specifies textual display of the caption of the selected alarm block.
MessageBlockId (Page 4401)	P	P	Specified assignment of ID number and alarm block in the alarm view.

Properties	Read	Write	Description
MessageBlockIndex (Page 4402)	P	P	References an existing alarm block.
MessageBlockLeadingZeros (Page 4402) *	P	P	Enables the display of the selected alarm block with leading zeroes.
MessageBlockLength (Page 4403) *	P	P	Specifies the length of the selected alarm block based on the number of characters.
MessageBlockName (Page 4403)	P	P	Displays the name of the selected alarm block.
MessageBlockPrecision (Page 4404) *	P	P	Specifies the number of decimal places for the values of the selected alarm block.
MessageBlockSelected (Page 4404) *	P	P	Existing alarm blocks are blocks that are available for use in the control in runtime for the alarm list or hitlist.
MessageBlockShowDate (Page 4405) *	P	P	Specifies whether to display both the date and time in the "Time" alarm block.
MessageBlockShowIcon (Page 4405) *	P	P	Enables the display of the content of the selected alarm block as icon.
MessageBlockShowTitleIcon (Page 4406) *	P	P	Specifies textual display of the caption of the selected alarm block.
MessageBlockTextId (Page 4406)	P	P	Specifies naming of the selected alarm block by means of a text ID that was taken from the text library.
MessageBlockTimeFormat (Page 4407) *	P	P	Specifies the format for the time or period used to display the alarms.
MessageColumnAdd (Page 4408) *	P	P	Adds the selected alarm block from the list of available alarm blocks to the list of selected alarm blocks.
MessageColumnCount (Page 4409) *	P	P	Specifies the number of alarm blocks to be displayed in the alarm list in runtime.
MessageColumnIndex (Page 4409)	P	P	References an alarm block selected for the alarm list.
MessageColumnName (Page 4410) *	P	P	Shows the name of the alarm block from the alarm list, which is referenced by means of the "MessageColumnIndex" property.
MessageColumnRemove (Page 4410) *	P	P	Cuts the marked alarm block from the list of selected alarm blocks and pastes it into the list of existing alarm blocks.
MessageColumnRepos (Page 4411) *	P	P	Changes the sorting order of the alarm blocks. The "Up" and "Down" commands move the selected alarm block accordingly in the list.
MessageColumnSort (Page 4411) *	P	P	Specifies the sorting order for the alarm block that is referenced in "MessageColumnIndex" .
MessageColumnSortIndex (Page 4412) *	P	P	Specifies the sorting order for the alarm block that is referenced in "MessageColumnIndex".
MessageColumnVisible (Page 4412) *	P	P	The list shows the selected alarm blocks of the alarm list or hitlist that are used in the alarm view in runtime.
Moveable (Page 4416)	P	P	Specifies whether the window can be moved in runtime.
MsgFilterSQL (Page 4417)	P	P	Specifies one or several SQL statements for user-defined selection of the alarms.
Name (Page 4417)	P	P	Returns the object name as STRING.
OperatorAlarms	P	P	Specifies the operator message settings.
OperatorMessageId (Page 4430) *	P	P	Default assignment of the ID number and trigger event in the alarm view.
OperatorMessageIndex (Page 4430) *	P	P	References the operator message event.

10.8 Working with system functions and Runtime scripting

Properties	Read	Write	Description
OperatorMessageName (Page 4431) *	P	P	On alarm events, this displays the name that is referenced by means of "OperatorMessageIndex" for operator alarms.
OperatorMessageNumber (Page 4432) *	P	P	Specify an alarm number for the operator message of the selected alarm event if you do not use the operator message of WinCC.
OperatorMessageSelected (Page 4432) *	P	P	Activate the alarm events of the list that trigger operator messages.
OperatorMessageSource1 (Page 4432) *	P	P	Specify the alarm block of the operated alarm to be added to "Process value block 1" of the operator message configured in Source.
OperatorMessageSource10 (Page 4437) *	P	P	Specify the alarm block of the operated alarm to be added to "Process value block 10" of the operator message configured in Source.
OperatorMessageSource2 (Page 4433) *	P	P	Specify the alarm block of the operated alarm to be added to "Process value block 2" of the operator message configured in Source.
OperatorMessageSource3 (Page 4433) *	P	P	Specify the alarm block of the operated alarm to be added to "Process value block 3" of the operator message configured in Source.
OperatorMessageSource4 (Page 4434) *	P	P	Specify the alarm block of the operated alarm to be added to "Process value block 4" of the operator message configured in Source.
OperatorMessageSource5 (Page 4434) *	P	P	Specify the alarm block of the operated alarm to be added to "Process value block 5" of the operator message configured in Source.
OperatorMessageSource6 (Page 4435) *	P	P	Specify the alarm block of the operated alarm to be added to "Process value block 6" of the operator message configured in Source.
OperatorMessageSource7 (Page 4435) *	P	P	Specify the alarm block of the operated alarm to be added to "Process value block 7" of the operator message configured in Source.
OperatorMessageSource8 (Page 4436) *	P	P	Specify the alarm block of the operated alarm to be added to "Process value block 8" of the operator message configured in Source.
OperatorMessageSource9 (Page 4436) *	P	P	Specify the alarm block of the operated alarm to be added to "Process value block 9" of the operator message configured in Source.
OperatorMessageSourceType1 (Page 4437) *	P	P	Specifies the format of the source content to be transferred.
OperatorMessageSourceType10 (Page 4442) *	P	P	Specifies the format of the source content to be transferred.
OperatorMessageSourceType2 (Page 4438) *	P	P	Specifies the format of the source content to be transferred.
OperatorMessageSourceType3 (Page 4438) *	P	P	Specifies the format of the source content to be transferred.
OperatorMessageSourceType4 (Page 4439) *	P	P	Specifies the format of the source content to be transferred.
OperatorMessageSourceType5 (Page 4439) *	P	P	Specifies the format of the source content to be transferred.



Properties	Read	Write	Description
OperatorMessageSourceType6 (Page 4440) *	P	P	Specifies the format of the source content to be transferred.
OperatorMessageSourceType7 (Page 4440) *	P	P	Specifies the format of the source content to be transferred.
OperatorMessageSourceType8 (Page 4441) *	P	P	Specifies the format of the source content to be transferred.
OperatorMessageSourceType9 (Page 4441) *	P	P	Specifies the format of the source content to be transferred.
PageMode (Page 4444)	P	P	Sets the page orientation (portrait / landscape).
PageModeMessageNumber (Page 4444)	P	P	Defines the number of alarm shown per page when paging the historical alarm list (long-term).
PrintJob	P	P	Specifies a print job
RowScrollbar (Page 4475)	P	P	Specifies whether row scroll bars are displayed.
RowTitleAlignment	P	P	Specifies the type of row title alignment.
RowTitles	P	P	Specifies that row headers will be displayed.
RTPersistence (Page 4477)	P	P	Specifies how online configurations of WinCC are retained.
RTPersistenceAuthorization	P	P	Specifies the authorization required for online configuration in runtime.
RTPersistenceType (Page 4478)	-	-	Specifies how online configurations of WinCC are retained.
SelectedCellColor (Page 4493)	P	P	Specifies the background color of the selected cell.
SelectedCellForeColor (Page 4494)	P	P	Specifies the font color of the selected cell.
SelectedRowColor (Page 4495)	P	P	Specifies the background color of the selected row.
SelectedRowForeColor (Page 4495)	P	P	Specifies the font color of the selected row.
SelectedTitleColor (Page 4496)	P	P	Specifies the background color of a selected table header.
SelectedTitleForeColor (Page 4497)	P	P	Specifies the font color of the selected table header.
SelectionColoring (Page 4499)	P	P	Specifies whether selection colors are used for cells or rows.
SelectionRect (Page 4502)	P	P	Specifies whether a selection frame is used for the selected cells or rows.
SelectionRectColor (Page 4503)	P	P	Specifies the color of the selection rectangle in the alarm window if SelectionType equals "1".
SelectionRectWidth (Page 4504)	P	P	Specifies the line width of the selection rectangle in the alarm window if SelectionType equals "1".
SelectionType (Page 4504)	P	P	Specifies the number of lines you can mark.
ServerNames (Page 4508)	P	P	Specifies the servers of a distributed system that form the data source for the alarm view.
ShowSortButton (Page 4528)	P	P	Specifies whether the sorting button is shown above the vertical scroll bar.
ShowSortIcon (Page 4529)	P	P	Specifies whether the sorting icon is displayed.
ShowSortIndex (Page 4530)	P	P	Specifies whether the sorting icon is displayed.
ShowTitle (Page 4534)	P	P	Specifies the representation of the control's window title.
Sizeable (Page 4538)	P	P	Specifies that the size of an object can be changed in runtime.
SortSequence (Page 4542)	P	P	Specifies how the sorting order can be changed by mouse click.
StatusbarBackColor (Page 4547)	P	P	Specifies the background color of the status bar.

10.8 Working with system functions and Runtime scripting

Properties	Read	Write	Description
StatusbarElementAdd (Page 4547) *	P	P	Creates a new, user-defined status bar element.
StatusbarElementAutoSize (Page 4548) *	P	P	Specifies whether the width of the selected status bar element is set automatically.
StatusbarElementCount (Page 4548) *	P	P	Specifies the number of configurable status bar elements.
StatusbarElementIconId (Page 4549) *	P	P	Default assignment of the ID number and icon of a status bar element.
StatusbarElementId (Page 4549) *	P	P	Unique ID of the selected status bar element.
StatusbarElementIndex (Page 4550)	P	P	References a status bar element. You can use this property to assign the values of other properties to a specific element of the status bar.
StatusbarElementName (Page 4550) *	P	P	Displays the object name of the selected status bar element.
StatusbarElementRemove (Page 4551) *	P	P	Removes the selected status bar element.
StatusbarElementRename (Page 4551) *	P	P	Renames the user-defined status bar element that is referenced by means of the "StatusbarElementIndex" property.
StatusbarElementRepos *	P	P	Specifies the index that is assigned to the element.
StatusbarElements (Page 4552)	-	-	Specifies the elements that are to be shown in the status bar.
StatusbarElementText *	P	P	Specifies the text of the currently selected status bar element.
StatusbarElementTooltipText (Page 4552) *	P	P	Specifies the tooltip text for the user-defined status bar element.
StatusbarElementUserDefined (Page 4553) *	P	P	Indicates whether the project engineer has added the toolbar button as a new user-defined element.
StatusbarElementVisible (Page 4554) *	P	P	In the list, activate the status bar elements that you wish to display in runtime.
StatusbarElementWidth (Page 4554) *	P	P	Specifies the width of the selected status bar element in pixels.
StatusbarFont	-	-	Status bar font
StatusbarFontColor (Page 4554)	P	P	Specifies the color of the text in the status bar.
StatusbarShowTooltips (Page 4557)	P	P	Specifies whether tooltips are displayed for the elements of the status bar in runtime.
StatusbarText (Page 4558)	P	P	Default text in the status bar.
StatusbarUseBackColor (Page 4558)	P	P	Specifies whether the background color of the status bar is shown.
StatusbarVisible (Page 4559)	P	P	Specifies whether the status bar of the control is displayed.
TableColor	P	P	Specifies the background color of the rows. Use this to open the color selection dialog.
TableColor2	P	P	Specifies the background color of "Row color 2".
TableForeColor	P	P	Specifies the font color of "Row color".
TableForeColor2	P	P	Specifies the font color of "Row color 2".
TimeBase (Page 4584)	P	P	Sets the timebase.
TitleColor	P	P	Specifies the color of the header.
TitleCut	P	P	Specifies whether the contents of the fields of a header should be abbreviated if the column is too narrow.

Properties	Read	Write	Description
TitleDarkShadowColor	P	P	Specifies the color of the dark side of shading.
TitleForeColor	P	P	Specifies the font color of the table header for the selected status.
TitleGridLineColor	P	P	Specifies the color of separation lines in the table header.
TitleLightShadowColor	P	P	Specifies the color of the bright side of shading.
TitleSort	P	P	Specifies how sorting by column title is triggered.
TitleStyle	P	P	Specifies whether a shading color is used for the table header.
ToolBarAlignment	P	P	Specifies or returns the position of the toolbar.
ToolBarBackColor	P	P	Specifies the background color of the toolbar.
ToolBarButtonActive *	P	P	Specifies whether the function linked to the button is activated in runtime.
ToolBarButtonAdd *	P	P	Creates a new, user-defined button function.
ToolBarButtonBeginGroup *	P	P	Specifies whether a separator is inserted before the selected button function.
ToolBarButtonClick	P	P	Clicks a toolbar button.
ToolBarButtonCount *	P	P	Specifies the number of configurable button functions.
ToolBarButtonEnabled *	P	P	Specifies whether a user-defined toolbar button can be operated.
ToolBarButtonHotKey *	P	P	Shows the hotkey for the selected button function.
ToolBarButtonId *	P	P	Unique ID number for the selected button function.
ToolBarButtonIndex	P	P	References a button function.
ToolBarButtonLocked *	P	P	Specifies whether the clicked, pressed in state is displayed for a user-defined toolbar button.
ToolBarButtonName *	P	P	Shows the name of the selected button function.
ToolBarButtonPasswordLevel *	P	P	Shows the authorization for the selected button function.
ToolBarButtonRemove *	P	P	Removes the selected button function from the list.
ToolBarButtonRename *	P	P	Renames the user-defined toolbar element that is referenced by means of the "ToolBarButtonIndex" property.
ToolBarButtonRepos *	P	P	Changes the sequence of button functions.
ToolBarButtons	-	-	Specifies which buttons are available for the toolbar.
ToolBarButtonTooltipText *	P	P	Specifies the tooltip text for the button.
ToolBarButtonUserDefined *	P	P	Indicates whether the project engineer has added the toolbar button as a new user-defined button.
ToolBarButtonVisible *	P	P	Specifies that the button is visible.
ToolBarShowTooltips	P	P	Specifies whether the tooltips for the button functions are displayed in runtime.
ToolBarUseBackColor	P	P	Specifies whether the background color for the toolbar is shown.
ToolBarUseHotKeys	P	P	Specifies whether the hotkeys for the button functions are activated in runtime.
ToolBarVisible	P	P	Specifies whether the toolbar of the control is displayed.
Top (Page 4629)	P	P	Specifies the value of the Y coordinate of the object.
UseMessageColor (Page 4680)	P	P	Specifies whether scrolling is enabled.
UseSelectedTitleColor (Page 4682)	P	P	Specifies whether a selection color is used for the headers of selected table cells.
UseTableColor2 (Page 4684)	P	P	Specifies whether a second row color is used for the representation of the table.
VerticalGridLines (Page 4702)	P	P	Specifies whether vertical separation lines are displayed.

Properties	Read	Write	Description
Visible (Page 4703)	P	P	Specifies whether the selected object is visible.
Width (Page 4714)	P	P	Sets the width of the specified "Ellipsis", "Circle" and "Rectangle" objects.

\* not visible in the ES

Table 10-20 Methods

Methods	Valid	Description
Activate (Page 4744)	P, A	Activates the permanent window or the root screen.
ActivateDynamic (Page 4747)	P	Dynamically activates a trigger and the specified cycle for a property at runtime.
AttachDB (Page 4750)	P, A	Executes the "Connect backup" button function of the control.
CopyRows (Page 4751)	P	Executes the "Copy rows" button function of the control.
DeactivateDynamic (Page 4754)	P	Deactivates the trigger of the "ActivateDynamic" method used for the specified property in/during Runtime.
DetachDB (Page 4756)	P, A	Executes the "Disconnect backup" button function of the control.
Export (Page 4757)	P, A	Executes the "Export log" or "Export data" button function of the control.
GetHistlistColumnCollection (Page 4760)	P	Returns the list of all column objects of the alarm view hitlist as "ICCAxCollection" type.
GetHitlistColumn (Page 4761)	P	Returns the column object of the alarm view hitlist designated by name or index as "ICCAxMessageColumn" type.
GetMessageBlock (Page 4762)	P	Returns the alarm block object of the alarm view designated by name or index as "ICCAxMessageBlock" type.
GetMessageBlockCollection (Page 4763)	P	Returns the list of all alarm block objects of the alarm view as "ICCAxCollection" type.
GetMessageColumn (Page 4765)	P	Returns the column object of the alarm view designated by name or index as "ICCAxMessageColumn" type.
GetOperatorMessage (Page 4766)	P	Returns the operator message object of the alarm view designated by name or index as "ICCAxOperatorMessage" type.
GetMessageColumnCollection (Page 4767)	P	Returns the list of all column objects of the message view as "ICCAxCollection" type.
GetOperatorMessageCollection (Page 4768)	P	Returns the list of all operator message objects of the alarm view as "ICCAxCollection" type.
GetRow (Page 4769)	P	Returns the row object defined by its row number in the table-based controls as "ICCAxDataRow" type.
GetRowCollection (Page 4770)	P	Returns the list of all row objects of the table-based controls as "ICCAxDataRowCollection" type.
GetSelectedRow (Page 4777)	P	Returns the selected row object of a table-based control as "ICCAxDataRow" type.
GetSelectedRows (Page 4778)	P	Returns the selected row objects of a table-based control as type "ICCAxDataRow" for multiple selection.
GetStatusbarElement (Page 4784)	P, A	Returns the element of the control's status bar designated by name or index as "ICCAxStatusbarElement" type.
GetStatusbarElementCollection (Page 4785)	P, A	Returns the list of all status bar elements of the control as "ICCAxCollection" type.
GetToolBarButton (Page 4792)	P, A	Returns the button function designated by name or index on the control toolbar as "ICCAxToolBarButton" type.

Methods	Valid	Description
GetToolBarButtonCollection (Page 4793)	P, A	Returns the list of all button functions of the control toolbar as "ICCAxCollection" type.
HideAlarm (Page 4809)	P	Executes the "Hide alarm" button function of the alarm view.
LockAlarm (Page 4812)	P	Executes the "Disable alarm" button function of the alarm view.
LoopInAlarm (Page 4812)	P	Executes the "Loop in alarm" button function of the alarm view.
MoveToFirstLine (Page 4814)	P	Executes the "First alarm" button function of the alarm view.
MoveToFirstPage (Page 4814)	P	Executes the "First page" button function of the alarm view.
MoveToLastLine (Page 4815)	P	Executes the "Last alarm" button function of the alarm view.
MoveToLastPage (Page 4816)	P	Executes the "Last page" button function of the alarm view.
MoveToNextLine (Page 4817)	P	Executes the "Next alarm" button function of the alarm view.
MoveToNextPage (Page 4817)	P	Executes the "Next page" button function of the alarm view.
MoveToPreviousLine (Page 4818)	P	Executes the "Previous alarm" button function of the alarm view.
MoveToPreviousPage (Page 4819)	P	Executes the "Previous page" button function of the alarm view.
Print (Page 4822)	P, A	Executes the "Print" button function of the control.
QuitHorn (Page 4823)	P	Executes the "Acknowledge central alarm generator" button function of the alarm view.
QuitSelected (Page 4823)	P	Executes the "Single acknowledgment" button function of the alarm view.
QuitVisible (Page 4824)	P	Executes the "Group acknowledgment" button function of the alarm view.
SelectAll (Page 4837)	P	Selects all rows in a table-based control.
SelectRow (Page 4838)	P	Selects a specific row in a table-based control.
ShowComment (Page 4841)	P	Executes the "Comment dialog" button function of the recipe view.
ShowDisplayOptionsDialog (Page 4841)	P	Executes the "Display options dialog" button function of the alarm view.
ShowEmergencyQuitDialog (Page 4842)	P	Executes the "Single acknowledgment" button function of the alarm view.
ShowHelp (Page 4842)	P, A	Executes the "Help" button function of the control.
ShowHideList (Page 4843)	P	Executes the "List of alarm to hide" button function of the alarm view.
ShowHitList (Page 4843)	P	Executes the "Hitlist" button function of the alarm view.
ShowInfoText (Page 4844)	P	Executes the "About dialog" button function of the alarm view.
ShowLockDialog (Page 4844)	P	Executes the "Lock dialog" button function of the alarm view.
ShowLockList (Page 4845)	P	Executes the "Lock list" button function of the alarm view.
ShowLongTermArchiveList (Page 4845)	P	Executes the "Historical alarm list (long-term)" button function of the alarm view.
ShowMessageList (Page 4846)	P	Executes the "Alarm list" button function of the alarm view.
ShowPropertyDialog (Page 4847)	P, A	Executes the "Configuration dialog" button function of the control.
ShowSelectionDialog (Page 4848)	P	Executes the "Selection dialog" button function of the alarm view.
ShowShortTermArchiveList (Page 4849)	P	Executes the "Historical alarm list (short-term)" button function of the alarm view.
ShowSortDialog (Page 4850)	P	Executes the "Sorting dialog" button function of the alarm view.
ShowTimebaseDialog (Page 4851)	P	Executes the "Timebase dialog" button function of the alarm view.
UnhideAlarm (Page 4854)	P	Executes the "Unhide alarm" button function of the alarm view.
UnlockAlarm (Page 4855)	P	Executes the "Unlock alarm" button function of the alarm view.
UnselectAll (Page 4855)	P	Removes all selections from the cells of a table-based control.
UnselectRow (Page 4856)	P	Removes the selections from a specific cell of a table-based control.

**See also**

Screen object (list) (Page 3936)

**AlarmView**

**Description**

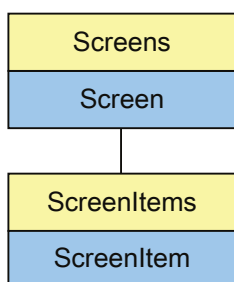

Represents the "Alarm view" object. The MessageView object is an element of the ScreenItems list.

If you change the settings for this object with a user-defined function, the changed settings are retained even after the screen is called again.

---

**Note**

The object "Simple AlarmView" cannot be dynamized with a user-defined function.

---

Abbreviation	Validity
Pa	Panels
A	RT Advanced
P	RT Professional

Table 10-21 Properties

Properties	Read	Write	Description
AlarmAreaHeight **			
AlarmAreaWidth **			
AlarmClasses	-	-	Specifies the alarm classes to be reported in runtime.
AlarmLog	-	-	Specifies the alarm types to be displayed in the alarm view.
AlarmSource	-	-	Specifies that alarms should be displayed.
Authorization (Page 4175)	-	-	Specifies the operating rights of the selected object in runtime.
BackColor	A	A	Specifies the background color of the selected object.
ButtonBarElements **			Specifies that the buttons will be displayed.
ButtonBarStyle	-	-	
Columns	-	-	Specifies the columns to be displayed.
ColumnsMoveable	-	-	Specifies that the columns can be moved.
ColumnTextAckGroup	-	-	Specifies the header for the "AckGroup" column.
ColumnTextAlarmState	-	-	Specifies the header for the "State" column.
ColumnTextAlarmText	-	-	Specifies the header for the "Text" column.
ColumnTextClassName	-	-	Specifies the header for the "Class Name" column.
ColumnTextDate	-	-	Specifies the header for the "Date" column.
ColumnTextDevice	-	-	Specifies the header for the "Device" column.
ColumnTextDiagnosable	-	-	Specifies the header for the "Diagnosable" column.
ColumnTextNumber	-	-	Specifies the header for the "Number" column.
ColumnTextTime	-	-	Specifies the header of the "Time" column.
CountOfLinesPerAlarms	-	-	
CountOfVisibleAlarms	-	-	
Enabled (Page 4279)	A	A	Specifies whether the selected object can be operated in runtime.
FilterTag **			Specifies a tag of the string type for filtering alarm texts.
FilterText **			Specifies the text for filtering the alarm text.
FitToSize	-	-	Specifies that the size of the object should be automatically adapted to the content.
Flashing	-	-	Specifies that the text block flashes.
FocusColor (Page 4309)	A	A	Specifies the color for the focus frame of the selected object when it is in focus.
FocusWidth (Page 4310)	A	A	Specifies the border width of the specified object when the object is in focus.
ForeColor (Page 4319)	-	-	Specifies the font color of the text for the selected object.
GridlineColor (Page 4326)	A	A	Specifies the color for the grid lines.
Height (Page 4327)	A	A	Sets the height of the specified "Ellipsis", "Circle" and "Rectangle" objects.
HorizontalScrollingEnabled	-	-	
IsRunningUnderCE *	-	-	
Layer (Page 4355)	-	-	Returns the layer that contains an object as LONG in the screen.
Left (Page 4366)	A	A	Specifies the value of the X coordinate of the object.
LineAlarmView **			
Name (Page 4417)	A	A	Returns the object name as STRING.

10.8 Working with system functions and Runtime scripting

Properties	Read	Write	Description
PreferredUseOnAck	-	-	
S7Device	-	-	
SecurityForSimpleViewEnabled **			
SelectionBackColor (Page 4499)	A	A	Specifies the background color of the selected cells.
SelectionForeColor (Page 4501)	A	A	Specifies the foreground color of the selected cells.
SeparateLineForAlarmText	-	-	
ShowAcknowledgeButton	-	-	
ShowAlarmsFromDate (Page 4515)	A	A	Specifies that only those message events are displayed that are saved in this tag.
ShowAlarmsToAcknowledge	-	-	Specifies that unacknowledged alarms should be displayed.
ShowColumnHeaders	-	-	
ShowHelpButton	-	-	
ShowHorizontalGridlines	-	-	
ShowLoopInAlarmButton	-	-	Specifies that the "Loop-In-Alarm" button will be displayed.
ShowMilliseconds	-	-	Display time in milliseconds.
ShowPendingAlarms	-	-	
SortByTimeDirection (Page 4540)	-	-	Specifies whether the last incoming alarm is displayed at the top of the "AlarmControl" object.
SortByTimeEnabled (Page 4540)	A	A	Specifies whether the sorting order of alarms based on the time in the "AlarmControl" object can be changed.
TableBackColor (Page 4563)	A	A	Specifies the background color of the table cells for the selected object.
TableFont	-	-	Specifies the font in the table.
TableForeColor (Page 4566)	A	A	Specifies the font color of "Row color".
TableHeaderBackColor (Page 4568)	A	A	Specifies the background color in the header of the table of the selected object.
TableHeaderFont	-	-	Specifies the text color of the header.
TableHeaderForeColor (Page 4569)	A	A	Specifies the text color in the header of the table of the selected object.
Top (Page 4629)	A	A	Specifies the value of the Y coordinate of the object.
VerticalScrollbarEnabled	-	-	
VerticalScrollingEnabled	-	-	
ViewType	-	-	Specifies the alarm view type.
ViewTypeForSaveStream **			Specifies the display type for the Save Stream.
Visible (Page 4703) *	A	A	Specifies whether the selected object is visible.
Width (Page 4714)	A	A	Sets the width of the specified "Ellipsis", "Circle" and "Rectangle" objects.

\* not visible in the ES, \*\* no relevant information available

Table 10-22 Methods

Methods	Valid	Description
Activate (Page 4744)	???	Activates the permanent window or the root screen.
???		



Methods	Valid	Description

**See also**

- Screen object (list) (Page 3904)
- Screen (Page 3905)
- ScreenItem (Page 3906)
- ScreenItems (Page 3908)

**Bar**

**Description**

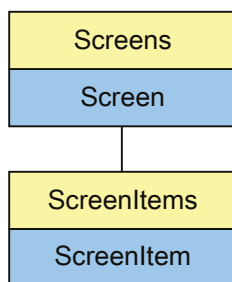

Represents the "Bar" object. The Bar object is an element of the ScreenItems list.

## Type identifier in VBS

HMIBar

Abbreviation	Validity
Pa	Panels
A	RT Advanced
P	RT Professional

Table 10-23 Properties

Properties	Read	Write	Description
AlarmLowerLimit (Page 4163)	P	P	Specifies the low limit at which the interrupt is triggered.
AlarmLowerLimitColor (Page 4163)	P	P	Specifies the bar color of the "AlarmLowerLimit" limit.
AlarmLowerLimitEnabled (Page 4164)	P	P	Specifies whether the "AlarmLowerLimit" limit is monitored.
AlarmLowerLimitRelative (Page 4164)	P	P	Specifies whether the low limit at which the interrupt is triggered is evaluated as a percentage or an absolute value.
AlarmUpperLimit (Page 4165)	P	P	Specifies the high limit that triggers the interrupt.
AlarmUpperLimitColor (Page 4165)	P	P	Specifies the bar color of the "AlarmUpperLimit" limit.
AlarmUpperLimitEnabled (Page 4166)	P	P	Specifies whether the "AlarmUpperLimit" limit is monitored.
AlarmUpperLimitRelative (Page 4167)	P	P	Specifies whether the high limit at which the interrupt is triggered is evaluated as a percentage or an absolute value.
Authorization (Page 4175)	P	P	Specifies the operating rights of the selected object in runtime.
AverageLast15Values	P	P	Specifies that the average of the last 15 values is shown.
BackColor (Page 4181)	P, A	P, A	Specifies the background color of the selected object.
BackFillStyle (Page 4185)	P	P	Defines the fill pattern of the specified object.
BackFlashingColorOff (Page 4188) *	P	P	Specifies the background color for flash state "Off".
BackFlashingColorOn (Page 4188) *	P	P	Specifies the background color for flash state "On".
BackFlashingEnabled (Page 4189) *	P	P	Specifies whether the background of the specified object flashes in runtime.
BackFlashingRate (Page 4190) *	P	P	Specifies the flash rate of the background for the selected object.
BarBackColor (Page 4191)	P, A	P, A	Specifies the color of the bar background for the selected object.
BarBackFillStyle (Page 4191)	P	P	Specifies the fill style for the bar.
BarBackFlashingColorOff	-	-	Specifies the border background color of the object for the "OFF" state.
BarBackFlashingColorOn	-	-	Specifies the border background color of the object for the "ON" state.
BarBackFlashingEnabled	-	-	
BarBackFlashingRate	-	-	Specifies the flash rate of the background.
BarEdgeStyle	-	-	Specifies the style of the border line.

Properties	Read	Write	Description
BarOrientation	P	P	Specifies the alignment of the bar.
BorderBackColor (Page 4199)	P	P	Specifies the background color of the broken border line for the selected object.
BorderColor (Page 4202)	P	P	Specifies the line color of the object.
BorderFlashingColorOff (Page 4206)	P	P	Specifies the border line color of the selected object for the flash state "Off".
BorderFlashingColorOn (Page 4207)	P	P	Specifies the border line color of the selected object for the flash state "On".
BorderFlashingEnabled (Page 4208)	P	P	Specifies whether the border line of the selected object flashes in runtime.
BorderFlashingRate (Page 4209)	P	P	Specifies the flash rate of the border line for the selected object.
BorderStyle (Page 4213)	P	P	Specifies the type of border lines for the selected object.
BorderStyle3D (Page 4215)	-	-	Specifies whether the object has a 3D border shading.
BorderWidth (Page 4216)	P	P	Specifies the line thickness of the object.
ColorChangeHysteresis (Page 4238)	P	P	Specifies the hysteresis as a percentage of the display value.
ColorChangeHysteresisEnabled (Page 4239)	P	P	Specifies whether the object is displayed with hysteresis.
CornerStyle (Page 4250)	P	P	Specifies the type of border lines for the selected object.
CountDivisions (Page 4252)	P	P	Specifies the number of segments into which the bar will be split by means of the large scale tick marks.
CountSubDivisions (Page 4252)	A	A	Specifies the number of scale tick marks between two main tick marks of the "Bar" object.
DrawInsideFrame (Page 4270)	P	P	Specifies whether the border line of the selected object with a line thickness greater than 1 should be drawn within the border or symmetrically to the border.
EdgeStyle (Page 4274)	P	P	Specifies the line style of the selected object.
Enabled (Page 4277)	P	P	Specifies whether the selected object can be operated in runtime.
FillPatternColor (Page 4296)	P	P	Specifies the color of the fill pattern for the selected object.
Flashing	-	-	Specifies that the text block flashes.
FlashingColorOff (Page 4300) *	-	-	Specifies the border line color of the selected object for the flash state "Off".
FlashingColorOn (Page 4302) *	-	-	Specifies the border line color of the selected object for the flash state "On".
FlashingEnabled (Page 4303) *	-	-	Specifies whether the border line of the selected object flashes in runtime.
FlashingOnLimitViolation	-	-	Specifies that flashing is activated when a limit is violated.
FlashingRate (Page 4304) *	-	-	Specifies the flash rate of the border line for the selected object.
Font (Page 4311)	-	-	Specifies or returns the font.
FontBold (Page 4313)	P	P	Specifies whether the text of the selected object is shown in bold.
FontName (Page 4315)	P	P	Specifies the font of the selected object.
FontSize (Page 4316)	P	P	Specifies the font size of the text for the selected object.
ForeColor (Page 4318)	P, A	P, A	Specifies the font color of the text for the selected object.
Height (Page 4327)	P, A	P, A	Sets the height of the specified "Ellipsis", "Circle" and "Rectangle" objects.

10.8 Working with system functions and Runtime scripting

Properties	Read	Write	Description
IntegerDigits (Page 4348)	P	P, A	Specifies the number of digits to the left of the decimal point (0 to 20).
LargeTickLabelingStep	-	-	Specifies which scale sections are labeled.
LargeTicksBold (Page 4352)	P	P	Specifies whether the long tick marks of a scale are shown in bold.
LargeTicksSize (Page 4352)	P	P	Specifies the length of the long tick marks of a scale.
Layer (Page 4355)	-	-	Returns the layer that contains an object as LONG in the screen.
Left (Page 4366)	P, A	P, A	Specifies the value of the X coordinate of the object.
Limit4LowerLimit (Page 4369)	P	P	Specifies the low limit for "Reserve4".
Limit4LowerLimitColor (Page 4370)	P	P	Specifies the color for the "Reserve4" low limit.
Limit4LowerLimitEnabled (Page 4370)	P	P	Specifies whether the "Reserve4" low limit is monitored.
Limit4LowerLimitRelative (Page 4371)	P	P	Specifies whether the "Reserve4" low limit is evaluated as a percentage or an absolute value.
Limit4UpperLimit (Page 4371)	P	P	Specifies the high limit for "Reserve4".
Limit4UpperLimitColor (Page 4372)	P	P	Specifies the color for the "Reserve4" high limit.
Limit4UpperLimitEnabled (Page 4373)	P	P	Specifies whether the "Reserve4" high limit is monitored.
Limit4UpperLimitRelative (Page 4373)	P	P	Specifies whether the "Reserve4" high limit is evaluated as a percentage or an absolute value.
Limit5LowerLimit (Page 4374)	P	P	Specifies the low limit for "Reserve5".
Limit5LowerLimitColor (Page 4374)	P	P	Sets the color for the "Reserve5" low limit.
Limit5LowerLimitEnabled (Page 4375)	P	P	Specifies whether the "Reserve5" low limit is monitored.
Limit5LowerLimitRelative (Page 4376)	P	P	Specifies whether the "Reserve5" low limit is evaluated as a percentage or an absolute value.
Limit5UpperLimit (Page 4376)	P	P	Specifies the high limit for "Reserve5".
Limit5UpperLimitColor (Page 4377)	P	P	Specifies the color for the "Reserve5" high limit.
Limit5UpperLimitEnabled (Page 4377)	P	P	Specifies whether the "Reserve5" high limit is monitored.
Limit5UpperLimitRelative (Page 4378)	P	P	Specifies whether the "Reserve5" high limit is evaluated as a percentage or an absolute value.
LineEndShapeStyle (Page 4380)	P	P	Specifies the shape of the line ends.
MaximumValue (Page 4392)	P, A	P, A	Specifies the maximum value of the scale in the selected object.
MinimumValue (Page 4413)	P, A	P, A	Specifies the minimum value of the scale in the selected object.
Name (Page 4417)	P, A	-	Returns the object name as STRING.
Precision (Page 4459)	P	P	Specifies the number of decimal places (0 to 20).
ProcessValue (Page 4461)	P, A	P, A	Specifies the default for the value to be displayed.
ScaleColor (Page 4481)	P, A	P, A	Specifies the color of the scale of the selected object.
ScaleGradation (Page 4482)	P, A	P, A	Specifies the distance between two large tick marks of the scale.
ScaleLabelFieldLength *	-	-	Distance to the position of the axis label.

Properties	Read	Write	Description
ScaleLabelingDoubleLined	-	-	Specifies that the horizontal bar orientation of the scale has two lines.
ScalePosition (Page 4484)	P	P	Specifies the position of the scale of the selected object.
ScaleStart	-	-	Specifies the minimum of the scale.
ScalingType (Page 4488)	P	P	Specifies the type of bar scaling.
SegmentColoring (Page 4492)	P, A	P, A	Specifies the type of color change to be displayed in the "Bar" object if limits are exceeded.
ShowBadTagState (Page 4516)	P	P	Specifies whether an object is grayed out if its associated tag has a bad quality code or tag state.
ShowLargeTicksOnly (Page 4521)	P	P	Specifies or returns the length of axis sections in pixels.
ShowLimitLines	-	-	Specifies the display of a line at the limits.
ShowLimitMarkers (Page 4521)	P	P	Specifies whether the limit values are shown as a scale value.
ShowScale (Page 4527)	P	P	Specifies whether the values are also shown in a scale.
ShowSignForPositiveLabel	-	-	Specifies that a "+" is displayed for positive labels.
ShowTickLabels (Page 4532)	-	-	Specifies whether the label is shown in the scale.
ShowTrendIndicator (Page 4536)	P	P	Specifies whether the trend (rising or falling) of the measured value to be monitored is indicated by means of a small arrow.
StartValue (Page 4546)	P	P	Specifies the zero point value for the scale display.
ToleranceLowerLimit (Page 4612)	P	P	Specifies whether the "ToleranceLowerLimit" limit is monitored.
ToleranceLowerLimitColor (Page 4612)	P	P	Specifies the color for the "ToleranceLowerLimit" low limit.
ToleranceLowerLimitEnabled (Page 4613)	P	P	Specifies whether the "ToleranceLowerLimit" limit is monitored.
ToleranceUpperLimit (Page 4614)	P	P	Specifies whether the "ToleranceUpperLimit" limit is monitored.
ToleranceUpperLimitColor (Page 4614)	P	P	Specifies the color for the "ToleranceUpperLimit" high limit.
ToleranceUpperLimitEnabled (Page 4615)	P	P	Specifies whether the "ToleranceUpperLimit" limit is monitored.
ToleranceUpperLimitRelative (Page 4616)	P	P	Specifies whether the "ToleranceHigh" low limit is evaluated as a percentage or an absolute value.
ToolTipText (Page 4627)	P	P	Specifies the tooltip text.
Top (Page 4629)	P, A	P, A	Specifies the value of the Y coordinate of the object.
Transparency (Page 4633)	P	P	Specifies and returns the transparency percentage of the object.
TrendIndicatorColor (Page 4641)	P	P	Specifies the color for the trend view.
Unit (Page 4667)	P, A	P, A	Specifies the unit of measurement in the "IOField" object.
UseAutoScaling	-	-	Specifies auto-scaling.
UseDesignColorScheme (Page 4674)	P	P	Specifies the font used for printing.
UseDesignShadowSettings (Page 4676)	P	P	Specifies whether the object is displayed with the shading defined in the active design.
UseExponentialFormat (Page 4678)	P	P	Specifies whether the numbers are displayed with exponentials (e.g. "1.00e+000").

Properties	Read	Write	Description
Visible (Page 4703)	P, A	P, A	Specifies whether the selected object is visible.
WarningLowerLimit (Page 4707)	P	P	Specifies the "WarningLowerLimit" low limit.
WarningLowerLimitColor (Page 4708)	P	P	Specifies the color for the "WarningLowerLimit" low limit.
WarningLowerLimitEnabled (Page 4708)	P	P	Specifies whether the "WarningLowerLimit" limit is monitored.
WarningLowerLimitRelative (Page 4709)	P	P	Specifies whether the "WarningLowerLimit" low limit is evaluated as a percentage or an absolute value.
WarningUpperLimit (Page 4712)	P	P	Specifies the "WarningUpperLimit" high limit.
WarningUpperLimitColor (Page 4712)	P	P	Specifies the color for the "WarningUpperLimit" high limit.
WarningUpperLimitEnabled (Page 4713)	P	P	Specifies whether the "WarningUpperLimit" limit is monitored.
WarningUpperLimitRelative (Page 4713)	P	P	Specifies whether the "WarningUpperLimit" high limit is evaluated as a percentage or an absolute value.
Width (Page 4714)	P, A	P, A	Sets the width of the specified "Ellipsis", "Circle" and "Rectangle" objects.
ZeroPoint (Page 4742)	P	P	Specifies the position of the zero point as a percentage of the bar height.

\* not visible in the ES

Table 10-24 Methods

Methods	Valid	Description
Activate (Page 4744)	P, A	Activates the permanent window or the root screen.
ActivateDynamic (Page 4747)	P	Dynamically activates a trigger and the specified cycle for a property at runtime.
DeactivateDynamic (Page 4754)	P	Deactivates the trigger of the "ActivateDynamic" method used for the specified property in/during Runtime.

## See also

Screen object (list) (Page 3936)

## BatteryView

### Description

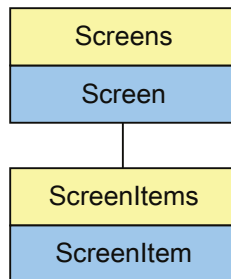

Represents the "Charge condition" object. The BatteryView object is an element of the ScreenItems list.

Abbreviation	Validity
Pa	Panels
A	RT Advanced
P	RT Professional

Table 10-25 Properties

Properties	Read	Write	Description
Height (Page 4327)	A	A	Sets the height of the specified "Ellipsis", "Circle" and "Rectangle" objects.
Layer (Page 4355)	-	-	Returns the layer that contains an object as LONG in the screen.
Left (Page 4366)	A	A	Specifies the value of the X coordinate of the object.
Name (Page 4417)	A	-	Returns the object name as STRING.
Top (Page 4629)	A	A	Specifies the value of the Y coordinate of the object.
Width (Page 4714)	A	A	Sets the width of the specified "Ellipsis", "Circle" and "Rectangle" objects.

Table 10-26 Methods

Methods	Valid	Description
		Not found

**See also**

Screen object (list) (Page 3904)

Screen (Page 3905)

ScreenItem (Page 3906)

ScreenItems (Page 3908)

**Button**

**Description**

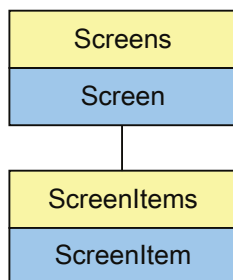

Represents the "Button" object. The Button object is an element of the ScreenItems list.

The availability of the following object properties depends on the selected mode of the "button":

Property	"Text"	"Text list"	"Graphic"
TextOff	x	--	--
TextOn	x	--	--



**Type identifier in VBS**

HMIButton

Abbreviation	Validity
Pa	Panels
A	RT Advanced
P	RT Professional

Table 10-27 Properties

Properties	Read	Write	Description
AdaptBorder (Page 4156)	P	P	Specifies whether the border of the specified object is dynamically adapted to the text size.
Authorization (Page 4175)	P	P	Specifies the operating rights of the selected object in runtime.
BackColor (Page 4181)	P	P	Specifies the background color of the selected object.
BackFillStyle (Page 4185)	P	P	Defines the fill pattern of the specified object.
BackFlashingColorOff (Page 4188)	P	P	Specifies the background color for flash state "Off".
BackFlashingColorOn (Page 4188)	P	P	Specifies the background color for flash state "On".
BackFlashingEnabled (Page 4189)	P	P	Specifies whether the background of the specified object flashes in runtime.
BackFlashingRate (Page 4190)	P	P	Specifies the flash rate of the background for the selected object.
BitNumber (Page 4197)	-	-	Specifies the bit whose status must change to trigger a value change.
BorderBackColor (Page 4199)	P	P	Specifies the background color of the broken border line for the selected object.
BorderBrightColor3D (Page 4200)	P	P	Specifies the border color of the following border parts in the 3D display of the selected object.
BorderColor (Page 4202)	P	P	Specifies the line color of the object.
BorderFlashingColorOff (Page 4206)	P	P	Specifies the border line color of the selected object for the flash state "Off".
BorderFlashingColorOn (Page 4207)	P	P	Specifies the border line color of the selected object for the flash state "On".
BorderFlashingEnabled (Page 4208)	P	P	Specifies whether the border line of the selected object flashes in runtime.
BorderFlashingRate (Page 4209)	P	P	Specifies the flash rate of the border line for the selected object.
BorderShadeColor3D (Page 4212)	P	P	Specifies the border color of the following border parts in the 3D display of the selected object.
BorderStyle (Page 4213)	P	P	Specifies the type of border lines for the selected object.
BorderStyle3D (Page 4215)	A	A	Specifies whether the object has a 3D border shading.
BorderWidth (Page 4216)	P	P	Specifies the line thickness of the object.
BorderWidth3D (Page 4218)	P	P	Specifies the width of the border for 3D display of the selected object.

10.8 Working with system functions and Runtime scripting

Properties	Read	Write	Description
CornerStyle (Page 4250)	P	P	Specifies the type of border lines for the selected object.
DrawInsideFrame (Page 4270)	P	P	Specifies whether the border line of the selected object with a line thickness greater than 1 should be drawn within the border or symmetrically to the border.
EdgeStyle (Page 4274)	P	P	Specifies the line style of the selected object.
Enabled (Page 4277)	P, A	P, A	Specifies whether the selected object can be operated in runtime.
FillPatternColor (Page 4296)	P	P	Specifies the color of the fill pattern for the selected object.
FitToLargest	-	-	Specifies that the size of the object depends on the text length in all languages.
Flashing	-	-	Specifies that the text block flashes.
FlashingColorOff (Page 4300)	P	P	Specifies the border line color of the selected object for the flash state "Off".
FlashingColorOn (Page 4302)	P	P	Specifies the border line color of the selected object for the flash state "On".
FlashingEnabled (Page 4303)	P	P	Specifies whether the border line of the selected object flashes in runtime.
FlashingRate (Page 4304)	P	P	Specifies the flash rate of the border line for the selected object.
FocusColor (Page 4308)	A	A	Specifies the color for the focus frame of the selected object when it is in focus.
FocusWidth (Page 4310)	A	A	Specifies the border width of the specified object when the object is in focus.
Font (Page 4311)	-	-	Specifies or returns the font.
FontBold (Page 4313)	P	P	Specifies whether the text of the selected object is shown in bold.
FontItalic (Page 4314)	P	P	Specifies whether the text of the selected object is shown in italics.
FontName (Page 4315)	P	P	Specifies the font of the selected object.
FontSize (Page 4316)	P	P	Specifies the font size of the text for the selected object.
FontUnderline (Page 4317)	P	P	Specifies whether the text of the selected object is underlined.
ForeColor (Page 4318)	P, A	P, A	Specifies the font color of the text for the selected object.
Height (Page 4327)	P, A	P, A	Sets the height of the specified "Ellipsis", "Circle" and "Rectangle" objects.
HelpText (Page 4330)	A	-	Returns the tooltip that is shown in runtime as user help for the specified object.
HorizontalAlignment (Page 4340)	P, A	P, A	Specifies the horizontal alignment of the text within the selected object.
HotKey (Page 4342)	-	-	Specifies the hotkey.
Layer (Page 4355)	-	-	Returns the layer that contains an object as LONG in the screen.
Left (Page 4366)	P, A	P, A	Specifies the value of the X coordinate of the object.
LineEndShapeStyle (Page 4380)	P	P	Specifies the shape of the line ends.
Mode (Page 4415)	P	P	Specifies the field type of the selected object.
Name (Page 4417)	P, A	-	Returns the object name as STRING.
PictureAlignment (Page 4454)	P	P	Specifies or returns the display type of the background image in the process picture.
PictureList	-	-	Specifies the graphic list that supplies the object with values.
PictureOff (Page 4455)	P	P	Specifies the screen to be displayed in the "Off" state.
PictureOn (Page 4455)	P	P	Specifies the screen to be displayed in the "On" state.

Properties	Read	Write	Description
Pressed (Page 4459)	P	P	Specifies whether the selected object is displayed in a pressed state.
ProcessValue (Page 4463)	-	-	Specifies the default for the value to be displayed.
RelativeFillLevel (Page 4470)	P	P	Specifies the fill percentage for the object.
ShowFillLevel (Page 4519)	P	P	Specifies whether the selected object is filled.
StyleSettings (Page 4561)	P	P	Specifies the display style for the object:
TextList (Page 4573)	-	-	A list that contains the assignments between the output value and the output text to be actually output.
TextOff (Page 4574)	P, A	P, A	Specifies the text to be displayed in the "Off" state of the selected object.
TextOn (Page 4575)	A	A	Specifies the text to be displayed in the "On" state of the selected object.
TextOrientation (Page 4576)	P	P	Specifies the text orientation of the selected object.
Toggle (Page 4610)	P	P	Specifies whether the selected object engages after it has been operated in runtime.
ToolTipText (Page 4627)	P	P, A	Specifies the tooltip text.
Top (Page 4629)	P, A	P, A	Specifies the value of the Y coordinate of the object.
Transparency (Page 4633)	P	P	Specifies and returns the transparency percentage of the object.
TransparentColorPictureOff (Page 4636)	P	P	Specifies the color to be set to "transparent" for the "Off" state of the assigned bitmap object.
TransparentColorPictureOn (Page 4636)	P	P	Specifies the color to be set to "transparent" for the "On" state of the assigned bitmap object.
UseDesignColorScheme (Page 4674)	P	P	Specifies the font used for printing.
UseDesignShadowSettings (Page 4676)	P	P	Specifies whether the object is displayed with the shading defined in the active design.
UseTransparentColorPictureOff (Page 4686)	P	P	Specifies whether the transparent color defined in the "TransparentColorPictureOff" property is used for the "Off" state.
UseTransparentColorPictureOn (Page 4687)	P	P	Specifies whether the transparent color defined in the "TransparentColorPictureOn" property is used for the "On" state.
VerticalAlignment (Page 4701)	P, A	P, A	Specifies the vertical alignment of the text for the selected object.
Visible (Page 4703)	P, A	P, A	Specifies whether the selected object is visible.
Width (Page 4714)	P, A	P, A	Sets the width of the specified "Ellipsis", "Circle" and "Rectangle" objects.
WindowsStyle (Page 4718)	P	P	Specifies whether the object is displayed in the general Windows style.

Table 10-28 Methods

Methods	Valid	Description
Activate (Page 4744)	P, A	Activates the permanent window or the root screen.
ActivateDynamic (Page 4747)	P	Dynamically activates a trigger and the specified cycle for a property at runtime.
DeactivateDynamic (Page 4754)	P	Deactivates the trigger of the "ActivateDynamic" method used for the specified property in/during Runtime.

**See also**

Screen object (list) (Page 3936)

**ChannelDiagnose**

**Description**

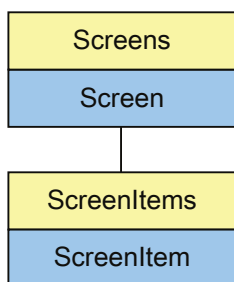

Represents the "ChannelDiagnose" object. The ChannelDiagnose object is an element of the ScreenItems list.

**Type identifier in VBS**

HMICChannelDiagnose

Abbreviation	Validity
Pa	Panels
A	Runtime Advanced
P	Runtime Professional

Table 10-29 Properties

Properties	Read	Write	Description
Enabled (Page 4277)	P	P	Specifies whether the selected object can be operated in runtime.
Flashing *	-	-	Specifies that the text block flashes.
Height (Page 4327)	P	P	Sets the height of the specified "Ellipsis", "Circle" and "Rectangle" objects.
Layer (Page 4355)	-	-	Returns the layer that contains an object as LONG in the screen.
Left (Page 4366)	P	P	Specifies the value of the X coordinate of the object.
Name (Page 4417)	P	-	Returns the object name as STRING.
Top (Page 4629)	P	P	Specifies the value of the Y coordinate of the object.
Visible (Page 4703)	P	P	Specifies whether the selected object is visible.
Width (Page 4714)	P	P	Sets the width of the specified "Ellipsis", "Circle" and "Rectangle" objects.

\* not visible in the ES

Table 10-30 Methods

Methods	Valid	Description
Activate (Page 4744)	P, A	Activates the permanent window or the root screen.
ActivateDynamic (Page 4747)	P	Dynamically activates a trigger and the specified cycle for a property at runtime.
DeactivateDynamic (Page 4754)	P	Deactivates the trigger of the "ActivateDynamic" method used for the specified property in/during Runtime.

**See also**

Screen object (list) (Page 3936)

## CheckBox

### Description

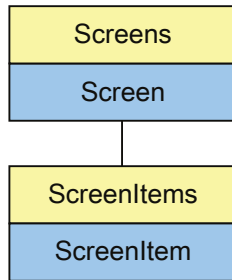

Represents the "Check box" object. The CheckBox object is an element of the ScreenItems list.

### Type identifier in VBS

HMICheckBox

Abbreviation	Validity
Pa	Panels
A	Runtime Advanced
P	Runtime Professional

Table 10-31 Properties

Properties	Read	Write	Description
AdaptBorder (Page 4156)	P	P	Specifies whether the border of the specified object is dynamically adapted to the text size.
Authorization (Page 4175)	P	P	Specifies the operating rights of the selected object in runtime.
BackColor (Page 4181)	P	P	Specifies the background color of the selected object.
BackFillStyle (Page 4185)	P	P	Defines the fill pattern of the specified object.

Properties	Read	Write	Description
BackFlashingColorOff (Page 4188)	P	P	Specifies the background color for flash state "Off".
BackFlashingColorOn (Page 4188)	P	P	Specifies the background color for flash state "On".
BackFlashingEnabled (Page 4189)	P	P	Specifies whether the background of the specified object flashes in runtime.
BackFlashingRate (Page 4190)	P	P	Specifies the flash rate of the background for the selected object.
BorderBackColor (Page 4199)	P	P	Specifies the background color of the broken border line for the selected object.
BorderColor (Page 4202)	P	P	Specifies the line color of the object.
BorderFlashingColorOff (Page 4206)	P	P	Specifies the border line color of the selected object for the flash state "Off".
BorderFlashingColorOn (Page 4207)	P	P	Specifies the border line color of the selected object for the flash state "On".
BorderFlashingEnabled (Page 4208)	P	P	Specifies whether the border line of the selected object flashes in runtime.
BorderFlashingRate (Page 4209)	P	P	Specifies the flash rate of the border line for the selected object.
BorderStyle (Page 4213)	P	P	Specifies the type of border lines for the selected object.
BorderWidth (Page 4216)	P	P	Specifies the line thickness of the object.
CheckmarkAlignment (Page 4233)	P	P	Specifies whether the fields are right aligned.
CheckmarkCount (Page 4233)	P	P	Specifies the number of fields.
CornerStyle (Page 4250)	-	-	Specifies the type of border lines for the selected object.
DrawInsideFrame (Page 4270)	P	P	Specifies whether the border line of the selected object with a line thickness greater than 1 should be drawn within the border or symmetrically to the border.
EdgeStyle (Page 4274)	-	-	Specifies the line style of the selected object.
Enabled (Page 4277)	P	P	Specifies whether the selected object can be operated in runtime.
FillPatternColor (Page 4296)	P	P	Specifies the color of the fill pattern for the selected object.
Flashing	-	-	Specifies that the text block flashes.
FlashingColorOff (Page 4300)	P	P	Specifies the border line color of the selected object for the flash state "Off".
FlashingColorOn (Page 4302)	P	P	Specifies the border line color of the selected object for the flash state "On".
FlashingEnabled (Page 4303)	P	P	Specifies whether the border line of the selected object flashes in runtime.
FlashingRate (Page 4304)	P	P	Specifies the flash rate of the border line for the selected object.
Font (Page 4311)	-	-	Specifies or returns the font.
FontBold (Page 4313)	P	P	Specifies whether the text of the selected object is shown in bold.
FontItalic (Page 4314)	P	P	Specifies whether the text of the selected object is shown in italics.
FontName (Page 4315)	P	P	Specifies the font of the selected object.
FontSize (Page 4316)	P	P	Specifies the font size of the text for the selected object.
FontUnderline (Page 4317)	P	P	Specifies whether the text of the selected object is underlined.
ForeColor (Page 4318)	P	P	Specifies the font color of the text for the selected object.

Properties	Read	Write	Description
Height (Page 4327)	P	P	Sets the height of the specified "Ellipsis", "Circle" and "Rectangle" objects.
HorizontalAlignment (Page 4340)	P	P	Specifies the horizontal alignment of the text within the selected object.
Index (Page 4344)	P	P	Specifies the background for grid control elements.
Layer (Page 4355)	-	-	Returns the layer that contains an object as LONG in the screen.
Left (Page 4366)	P	P	Specifies the value of the X coordinate of the object.
LineEndShapeStyle (Page 4380)	-	-	Specifies the shape of the line ends.
LogOperation (Page 4386)	P	P	Specifies whether, after operating this object, an alarm is output to the alarm system.
Name (Page 4417)	P	P	Returns the object name as STRING.
ProcessValue (Page 4461)	P	P	Specifies the default for the value to be displayed.
RelativeFillLevel (Page 4470)	P	P	Specifies the fill percentage for the object.
ShowBadTagState (Page 4516)	P	P	Specifies whether an object is grayed out if its associated tag has a bad quality code or tag state.
ShowFillLevel (Page 4519)	P	P	Specifies whether the selected object is filled.
Text (Page 4572)	P	P	Specifies the label for the text field.
TextOrientation (Page 4576)	P	P	Specifies the text orientation of the selected object.
Texts	-	-	Specifies the texts for the check boxes.
ToolTipText (Page 4627)	P	P	Specifies the tooltip text.
Top (Page 4629)	P	P	Specifies the value of the Y coordinate of the object.
Transparency (Page 4633)	P	P	Specifies and returns the transparency percentage of the object.
UseDesignColorScheme (Page 4674)	P	P	Specifies the font used for printing.
UseDesignShadowSettings (Page 4676)	P	P	Specifies whether the object is displayed with the shading defined in the active design.
VerticalAlignment (Page 4701)	P	P	Specifies the vertical alignment of the text for the selected object.
Visible (Page 4703)	P	P	Specifies whether the selected object is visible.
Width (Page 4714)	P	P	Sets the width of the specified "Ellipsis", "Circle" and "Rectangle" objects.

Table 10-32 Methods

Methods	Valid	Description
Activate (Page 4744)	P, A	Activates the permanent window or the root screen.
ActivateDynamic (Page 4747)	P	Dynamically activates a trigger and the specified cycle for a property at runtime.
DeactivateDynamic (Page 4754)	P	Deactivates the trigger of the "ActivateDynamic" method used for the specified property in/during Runtime.

**See also**

Screen object (list) (Page 3936)



**Circle**

**Description**

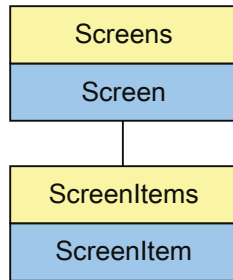

Represents the "Circle" object. The Circle object is an element of the ScreenItems list.

**Type identifier in VBS**

HMICircle

Abbreviation	Validity
Pa	Panels
A	Runtime Advanced
P	Runtime Professional

Table 10-33 Properties

Properties	Read	Write	Description
Authorization (Page 4175)	P	P	Specifies the operating rights of the selected object in runtime.
BackColor (Page 4181)	P, A	P, A	Specifies the background color of the selected object.
BackFillStyle (Page 4185)	P, A	P, A	Defines the fill pattern of the specified object.
BorderBackColor (Page 4199)	P	P	Specifies the background color of the broken border line for the selected object.
BorderColor (Page 4202)	P, A	P, A	Specifies the line color of the object.

10.8 Working with system functions and Runtime scripting

Properties	Read	Write	Description
BorderFlashingColorOff (Page 4206)	P	P	Specifies the border line color of the selected object for the flash state "Off".
BorderFlashingColorOn (Page 4207)	P	P	Specifies the border line color of the selected object for the flash state "On".
BorderFlashingEnabled (Page 4208)	P	P	Specifies whether the border line of the selected object flashes in runtime.
BorderFlashingRate (Page 4209)	P	P	Specifies the flash rate of the border line for the selected object.
BorderStyle (Page 4213)	P	P	Specifies the type of border lines for the selected object.
BorderWidth (Page 4216)	P, A	P, A	Specifies the line thickness of the object.
CornerStyle (Page 4250)	P	P	Specifies the type of border lines for the selected object.
DrawInsideFrame (Page 4270)	P	P	Specifies whether the border line of the selected object with a line thickness greater than 1 should be drawn within the border or symmetrically to the border.
EdgeStyle (Page 4274)	A	A	Specifies the line style of the selected object.
Enabled (Page 4277)	P	P	Specifies whether the selected object can be operated in runtime.
FillPatternColor (Page 4296)	P	P	Specifies the color of the fill pattern for the selected object.
Flashing	-	-	Specifies that the text block flashes.
FlashingColorOff (Page 4300)	P	P	Specifies the border line color of the selected object for the flash state "Off".
FlashingColorOn (Page 4302)	P	P	Specifies the border line color of the selected object for the flash state "On".
FlashingEnabled	P	P	Specifies whether the border line of the selected object flashes in runtime.
FlashingRate (Page 4304)	P	P	Specifies the flash rate of the border line for the selected object.
Height (Page 4327)	P, A	P, A	Sets the height of the specified "Ellipse", "Circle" and "Rectangle" objects.
Layer (Page 4355)	-	-	Returns the layer that contains an object as LONG in the screen.
Left (Page 4366)	P, A	P, A	Specifies the value of the X coordinate of the object.
LineEndShapeStyle (Page 4380)	P	P	Specifies the shape of the line end.
Name (Page 4417)	P, A	-	Returns the object name as STRING.
Radius (Page 4465)	P	P, A	Specifies the radius of the selected object "Circle".
RelativeFillLevel (Page 4470)	P	P	Specifies the fill percentage for the object.
ShowFillLevel (Page 4519)	P	P	Specifies whether the selected object is filled.
ToolTipText (Page 4627)	P	P	Specifies the tooltip text.
Top (Page 4629)	P, A	P, A	Specifies the value of the Y coordinate of the object.
Transparency (Page 4633)	P	P	Specifies and returns the transparency percentage of the object.
UseDesignColorScheme (Page 4674)	P	P	Specifies the font used for printing.
UseDesignShadowSettings (Page 4676)	P	P	Specifies whether the object is displayed with the shading defined in the active design.
Visible (Page 4703)	P, A	P, A	Specifies whether the selected object is visible.
Width (Page 4714)	P, A	P, A	Sets the width of the specified "Ellipse", "Circle" and "Rectangle" objects.

Table 10-34 Methods

Methods	Valid	Description
Activate (Page 4744)	P, A	Activates the permanent window or the root screen.
ActivateDynamic (Page 4747)	P	Dynamically activates a trigger and the specified cycle for a property at runtime.
DeactivateDynamic (Page 4754)	P	Deactivates the trigger of the "ActivateDynamic" method used for the specified property in/during Runtime.

**See also**

Screen object (list) (Page 3936)

**CircleSegment**

**Description**

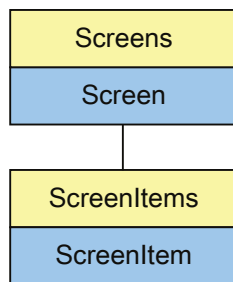

Represents the "CircleSegment" object. The CircleSegment object is an element of the ScreenItems list.

**Type identifier in VBS**

HMICircleSegment

Abbreviation	Validity
Pa	Panels
A	Runtime Advanced
P	Runtime Professional

Table 10-35 Properties

Properties	Read	Write	Description
Authorization (Page 4175)	P	P	Specifies the operating rights of the selected object in runtime.
BackColor (Page 4181)	P	P	Specifies the background color of the selected object.
BackFillStyle (Page 4185)	P	P	Defines the fill pattern of the specified object.
BorderBackColor (Page 4199)	P	P	Specifies the background color of the broken border line for the selected object.
BorderColor (Page 4202)	P	P	Specifies the line color of the object.
BorderFlashingColorOff (Page 4206)	P	P	Specifies the border line color of the selected object for the flash state "Off".
BorderFlashingColorOn (Page 4207)	P	P	Specifies the border line color of the selected object for the flash state "On".
BorderFlashingEnabled (Page 4208)	P	P	Specifies whether the border line of the selected object flashes in runtime.
BorderFlashingRate (Page 4209)	P	P	Specifies the flash rate of the border line for the selected object.
BorderStyle (Page 4213)	P	P	Specifies the type of border lines for the selected object.
BorderWidth (Page 4216)	P	P	Specifies the line thickness of the object.
CornerStyle (Page 4250)	P	P	Specifies the type of border lines for the selected object.
DrawInsideFrame (Page 4270)	P	P	Specifies whether the border line of the selected object with a line thickness greater than 1 should be drawn within the border or symmetrically to the border.
EdgeStyle (Page 4273)	P	P	Specifies the line style of the selected object.
Enabled (Page 4277)	P	P	Specifies whether the selected object can be operated in runtime.
EndAngle (Page 4280)	P	P	Specifies the angle at which the end point of the selected object deviates from the zero position (0°).
FillPatternColor (Page 4296)	P	P	Specifies the color of the fill pattern for the selected object.
Flashing	-	-	Specifies that the text block flashes.
FlashingColorOff (Page 4300)	P	P	Specifies the border line color of the selected object for the flash state "Off".
FlashingColorOn (Page 4302)	P	P	Specifies the border line color of the selected object for the flash state "On".
FlashingEnabled	P	P	Specifies whether the border line of the selected object flashes in runtime.
FlashingRate (Page 4304)	P	P	Specifies the flash rate of the border line for the selected object.
Height (Page 4327)	P	P	Sets the height of the specified "Ellipsis", "Circle" and "Rectangle" objects.

Properties	Read	Write	Description
Layer (Page 4355)	-	-	Returns the layer that contains an object as LONG in the screen.
Left (Page 4366)	P	P	Specifies the value of the X coordinate of the object.
LineEndShapeStyle (Page 4380)	P	P	Specifies the shape of the line end.
Name (Page 4417)	P	-	Returns the object name as STRING.
Radius (Page 4465)	P	P	Specifies the radius of the selected object "Circle".
RelativeFillLevel (Page 4470)	P	P	Specifies the fill percentage for the object.
ShowFillLevel (Page 4519)	P	P	Specifies whether the selected object is filled.
StartAngle (Page 4543)	P	P	Specifies the SQL statement.
ToolTipText (Page 4627)	P	P	Specifies the tooltip text.
Top (Page 4629)	P	P	Specifies the value of the Y coordinate of the object.
Transparency (Page 4633)	P	P	Specifies and returns the transparency percentage of the object.
UseDesignColorScheme (Page 4674)	P	P	Specifies the font used for printing.
UseDesignShadowSettings (Page 4676)	P	P	Specifies whether the object is displayed with the shading defined in the active design.
Visible (Page 4703)	P	P	Specifies whether the selected object is visible.
Width (Page 4714)	P	P	Sets the width of the specified "Ellipsis", "Circle" and "Rectangle" objects.

Table 10-36 Methods

Methods	Valid	Description
Activate (Page 4744)	P, A	Activates the permanent window or the root screen.
ActivateDynamic (Page 4747)	P	Dynamically activates a trigger and the specified cycle for a property at runtime.
DeactivateDynamic (Page 4754)	P	Deactivates the trigger of the "ActivateDynamic" method used for the specified property in/during Runtime.

**See also**

Screen object (list) (Page 3936)

## CircularArc

### Description

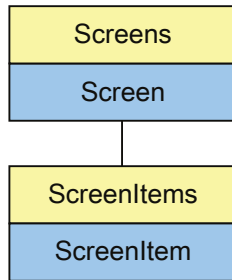

Represents the "CircularArc" object. The CircularArc object is an element of the ScreenItems list.

### Type identifier in VBS

HMICircularArc

Abbreviation	Validity
Pa	Panels
A	Runtime Advanced
P	Runtime Professional

Table 10-37 Properties

Properties	Read	Write	Description
Authorization (Page 4175)	P	P	Specifies the operating rights of the selected object in runtime.
BackColor (Page 4181)	P	P	Specifies the background color of the selected object.
BorderStyle (Page 4213)	P	P	Specifies the type of border lines for the selected object.
Color (Page 4236)	P	P	Specifies the line color of the selected object.
CornerStyle (Page 4250)	P	P	Specifies the type of border lines for the selected object.

Properties	Read	Write	Description
DrawInsideFrame (Page 4270)	P	P	Specifies whether the border line of the selected object with a line thickness greater than 1 should be drawn within the border or symmetrically to the border.
Enabled (Page 4277)	P	P	Specifies whether the selected object can be operated in runtime.
EndAngle (Page 4280)	P	P	Specifies the angle at which the end point of the selected object deviates from the zero position (0°).
Flashing	-	-	Specifies that the text block flashes.
FlashingColorOff (Page 4300)	P	P	Specifies the border line color of the selected object for the flash state "Off".
FlashingColorOn (Page 4302)	P	P	Specifies the border line color of the selected object for the flash state "On".
FlashingEnabled	P	P	Specifies whether the border line of the selected object flashes in runtime.
FlashingRate (Page 4304)	P	P	Specifies the flash rate of the border line for the selected object.
Height (Page 4327)	P	P	Sets the height of the specified "Ellipsis", "Circle" and "Rectangle" objects.
Layer (Page 4355)	-	-	Returns the layer that contains an object as LONG in the screen.
Left (Page 4366)	P	P	Specifies the value of the X coordinate of the object.
LineEndShapeStyle (Page 4380)	P	P	Specifies the shape of the line end.
LineWidth (Page 4381)	P	P	Specifies the line thickness of the selected object.
Name (Page 4417)	P	-	Returns the object name as STRING.
Radius (Page 4465)	P	P	Specifies the radius of the selected object "Circle".
StartAngle (Page 4543)	P	P	Specifies the SQL statement.
Style (Page 4560)	P	P	Specifies the line style of the selected object.
ToolTipText (Page 4627)	P	P	Specifies the tooltip text.
Top (Page 4629)	P	P	Specifies the value of the Y coordinate of the object.
Transparency (Page 4633)	P	P	Specifies and returns the transparency percentage of the object.
UseDesignColorScheme (Page 4674)	P	P	Specifies the font used for printing.
UseDesignShadowSettings (Page 4676)	P	P	Specifies whether the object is displayed with the shading defined in the active design.
Visible (Page 4703)	P	P	Specifies whether the selected object is visible.
Width (Page 4714)	P	P	Sets the width of the specified "Ellipsis", "Circle" and "Rectangle" objects.

Table 10-38 Methods

Methods	Valid	Description
Activate (Page 4744)	P, A	Activates the permanent window or the root screen.
ActivateDynamic (Page 4747)	P	Dynamically activates a trigger and the specified cycle for a property at runtime.
DeactivateDynamic (Page 4754)	P	Deactivates the trigger of the "ActivateDynamic" method used for the specified property in/during Runtime.

**See also**

Screen object (list) (Page 3936)

**Clock**

**Description**

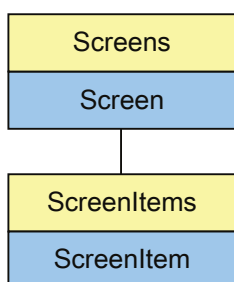

Represents the "Clock" object. The Clock object is an element of the ScreenItems list.

**Type identifier in VBS**

Clock

Abbreviation	Validity
Pa	Panels
A	Runtime Advanced
P	Runtime Professional

Table 10-39 Properties

Properties	Read	Write	Description
Analog (Page 4170)	P	P	Specifies whether the clock is displayed as an analog clock.
BackFillStyle (Page 4185)	P	P	Defines the fill pattern of the specified object.



Properties	Read	Write	Description
DialColor (Page 4265)	P, A	P, A	Specifies the color of the dial in the selected object.
Enabled (Page 4277)	P	P	Specifies whether the selected object can be operated in runtime.
Flashing	-	-	Specifies that the text block flashes.
Font (Page 4311)	-	-	Specifies or returns the font.
Height (Page 4327)	P, A	P, A	Sets the height of the specified "Ellipsis", "Circle" and "Rectangle" objects.
HourNeedleHeight (Page 4342)	P, A	P, A	Specifies the length of the hour hand in the "Clock" object.
HourNeedleWidth (Page 4343)	P, A	P, A	Specifies the width of the hour hand in the "Clock" object.
Layer (Page 4355)	-	-	Returns the layer that contains an object as LONG in the screen.
Left (Page 4366)	P, A	P, A	Specifies the value of the X coordinate of the object.
LockSquaredExtent (Page 4385)	P	P	Specifies whether the tag values are downloaded from the logs for the time range to be displayed when you call a screen.
MinuteNeedleHeight (Page 4414)	P, A	P, A	Specifies the length of the minute hand in the "Clock" object.
MinuteNeedleWidth (Page 4415)	P, A	P, A	Specifies the width of the minute hand in the "Clock" object.
Name (Page 4417)	P, A	-	Returns the object name as STRING.
NeedleBorderColor (Page 4420)	P, A	P, A	Specifies the name of the data source.
NeedleColor (Page 4420)	P, A	P, A	Specifies the hand color in the "Clock" object.
NeedleFillStyle (Page 4421)	P	P	Specifies the fill style for the clock hand.
Picture (Page 4453)	-	-	Specifies the screen to be displayed in the graphics object in runtime.
SecondNeedleHeight (Page 4491)	P, A	P, A	Specifies the length of the seconds hand in the "Clock" object.
SecondNeedleWidth (Page 4491)	P, A	P, A	Specifies the width of the seconds hand in the "Clock" object.
ShowFocusRectangle (Page 4520)	P	P	Specifies whether the button receives a selection border when it is activated in runtime.
ShowTicks (Page 4533)	P, A	P, A	Specifies whether the tick marks are displayed in the scale of the object.
TicksColor (Page 4578)	P, A	P, A	Specifies the scale display.
Top (Page 4629)	P, A	P, A	Specifies the value of the Y coordinate of the object.
Transparency (Page 4633)	P	P	Specifies and returns the transparency percentage of the object.
UseDesignColorScheme (Page 4674)	P	P	Specifies the font used for printing.
UseDesignShadowSettings (Page 4676)	P	P	Specifies whether the object is displayed with the shading defined in the active design.
Visible (Page 4703)	P, A	P, A	Specifies whether the selected object is visible.
Width (Page 4714)	P, A	P, A	Sets the width of the specified "Ellipsis", "Circle" and "Rectangle" objects.

Table 10-40 Methods

Methods	Valid	Description
Activate (Page 4744)	P, A	Activates the permanent window or the root screen.
ActivateDynamic (Page 4747)	P	Dynamically activates a trigger and the specified cycle for a property at runtime.
DeactivateDynamic (Page 4754)	P	Deactivates the trigger of the "ActivateDynamic" method used for the specified property in/during Runtime.

**See also**

Screen object (list) (Page 3936)

**Connector**

**Description**

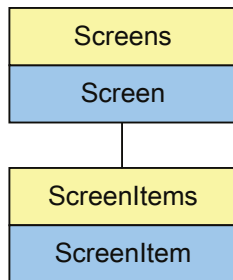

Represents the "Connector" object. The Connector object is an element of the ScreenItems list.

**Type identifier in VBS**

HMIConnector

Abbreviation	Validity
Pa	Panels
A	Runtime Advanced
P	Runtime Professional

Table 10-41 Properties

Properties	Read	Write	Description
Authorization (Page 4175)	P	P	Specifies the operating rights of the selected object in runtime.
BackColor (Page 4181)	P	P	Specifies the background color of the selected object.
BorderEndStyle (Page 4205)	P	P	Specifies the type of line ends for the selected object.
BorderStyle (Page 4213)	P	P	Specifies the type of border lines for the selected object.
Color (Page 4236)	P	P	Specifies the line color of the selected object.
ConnectionType (Page 4248)	P	P	Specifies the type of connector. You can select one of two connection types.
CornerStyle (Page 4250)	P	P	Specifies the type of border lines for the selected object.
Enabled (Page 4277)	P	P	Specifies whether the selected object can be operated in runtime.
EndStyle (Page 4283)	-	-	Specifies how the line end of the selected object is displayed.
FirstConnectedObjectIndex (Page 4298)	P	P	Specifies the index number of the upper connector point.
FirstConnectedObjectName (Page 4299)	P	P	Specifies the name of the object that is docked to the upper connector point.
Flashing	-	-	Specifies that the text block flashes.
FlashingColorOff (Page 4300)	P	P	Specifies the border line color of the selected object for the flash state "Off".
FlashingColorOn (Page 4302)	P	P	Specifies the border line color of the selected object for the flash state "On".
FlashingEnabled (Page 4303)	P	P	Specifies whether the border line of the selected object flashes in runtime.
FlashingRate (Page 4304)	P	P	Specifies the flash rate of the border line for the selected object.
Height (Page 4327)	P	P	Sets the height of the specified "Ellipse", "Circle" and "Rectangle" objects.
LastConnectedObjectIndex (Page 4353)	P	P	Specifies the index number of the connection point to the last connected object.
LastConnectedObjectName (Page 4353)	P	P	Specifies the name of the object that is docked to the lower connector point.
Layer (Page 4355)	-	-	Returns the layer that contains an object as LONG in the screen.
Left (Page 4366)	P	P	Specifies the value of the X coordinate of the object.
LineEndShapeStyle (Page 4380)	P	P	Specifies the shape of the line end.
LineWidth (Page 4381)	P	P	Specifies the line thickness of the selected object.
Name (Page 4417)	P	P	Returns the object name as STRING.
Points *	-	-	Specifies the corner points.
StartStyle (Page 4545)	-	-	Specifies how the line start of the selected object is displayed.
Style (Page 4560)	P	P	Specifies the line style of the selected object.

Properties	Read	Write	Description
SwapFirstWithLastConnection (Page 4562)	P	P	Specifies whether the text in the object is shown horizontally.
ToolTipText (Page 4627)	P	P	Specifies the tooltip text.
Top (Page 4629)	P	P	Specifies the value of the Y coordinate of the object.
Transparency (Page 4633)	P	P	Specifies and returns the transparency percentage of the object.
UseDesignColorScheme (Page 4674)	P	P	Specifies the font used for printing.
UseDesignShadowSettings (Page 4676)	P	P	Specifies that the font size from the data source should be used.
Visible (Page 4703)	P	P	Specifies whether the selected object is visible.
Width (Page 4714)	P	-	Sets the width of the specified "Ellipsis", "Circle" and "Rectangle" objects.

\* not visible in the ES

Table 10-42 Methods

Methods	Valid	Description
Activate (Page 4744)	P, A	Activates the permanent window or the root screen.
ActivateDynamic (Page 4747)	P	Dynamically activates a trigger and the specified cycle for a property at runtime.
DeactivateDynamic (Page 4754)	P	Deactivates the trigger of the "ActivateDynamic" method used for the specified property in/during Runtime.

## See also

Screen object (list) (Page 3936)

## DateTimeField

### Description

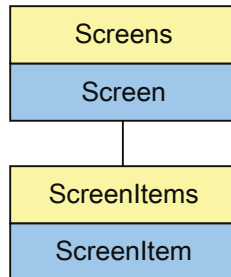

Represents the "Date/time field" object. The DateTimeField object is an element of the ScreenItems list.

### Type identifier in VBS

HMIDateTimeField

Abbreviation	Validity
Pa	Panels
A	Runtime Advanced
P	Runtime Professional

Table 10-43 Properties

Properties	Read	Write	Description
Authorization (Page 4175)	-	-	Specifies the operating rights of the selected object in runtime.
BackColor (Page 4183)	A	A	Specifies the background color of the selected object.
BackFillStyle (Page 4186)	-	-	Defines the fill pattern of the specified object.
BorderBackColor (Page 4199) *	-	-	Specifies the background color of the broken border line for the selected object.

Properties	Read	Write	Description
BorderColor (Page 4203)	A	A	Specifies the line color of the object.
BorderStyle3D (Page 4215)	A	A	Specifies whether the object has a 3D border shading.
DisplaySystemTime	-	-	Specifies that the system time is displayed.
EdgeStyle (Page 4273)	-	-	Specifies the line style of the selected object.
Enabled (Page 4279)	A	A	Specifies whether the selected object can be operated in runtime.
FitToLargest	-	-	Specifies that the size of the object depends on the text length in all languages.
Flashing	-	-	Specifies that the text block flashes.
Font (Page 4311) *	-	-	Specifies or returns the font.
ForeColor (Page 4319)	A	A	Specifies the font color of the text for the selected object.
Format	-	-	Specifies that the format of the text block is displayed.
Height (Page 4327)	A	A	Sets the height of the specified "Ellipsis", "Circle" and "Rectangle" objects.
HelpText (Page 4330)	A	-	Returns the tooltip that is shown in runtime as user help for the specified object.
HorizontalAlignment (Page 4341)	A	A	Specifies the horizontal alignment of the text within the selected object.
Layer (Page 4355)	-	-	Returns the layer that contains an object as LONG in the screen.
Left (Page 4366)	A	A	Specifies the value of the X coordinate of the object.
LineWrap *	-	-	Specifies the line break within the object.
LongDateTimeFormat	-	-	Specifies that the date and time are displayed in long format.
Mode (Page 4415)	-	-	Specifies the field type of the selected object.
Name (Page 4417)	A	-	Returns the object name as STRING.
ProcessValue (Page 4461)	A	A	Specifies the default for the value to be displayed.
ShowDate	-	-	Specifies that the date is to be displayed.
ShowTime	-	-	Specifies that only the time is displayed.
Top (Page 4629)	A	A	Specifies the value of the Y coordinate of the object.
VerticalAlignment (Page 4701)	A	A	Specifies the vertical alignment of the text for the selected object.
Visible (Page 4703) *	A	A	Specifies whether the selected object is visible.
Width (Page 4714)	A	A	Sets the width of the specified "Ellipsis", "Circle" and "Rectangle" objects.

\* not visible in the ES

Table 10-44 Methods

Methods	Valid	Description
Activate (Page 4744)	P, A	Activates the permanent window or the root screen.

**See also**

- Screen (Page 3930)
- ScreenItem (Page 3932)
- ScreenItems (list) (Page 3934)
- Screen object (list) (Page 3936)

**DiskSpaceView**

**Description**

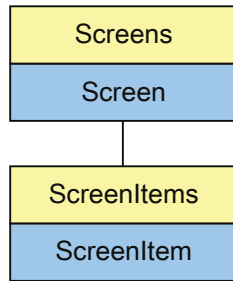

Represents the "Disk space view" object. The DiskSpaceView object is an element of the ScreenItems list.

**Type identifier in VBS**

IXDiskSpaceView

Abbreviation	Validity
Pa	Panels
A	Runtime Advanced
P	Runtime Professional

Table 10-45 Properties

Properties	Read	Write	Description
Alarm (Page 4159)	P	P	Specifies the limit for the memory space view from which an alarm is output.
AlarmColor (Page 4160)	P	P	Specifies the alarm types to be displayed in the alarm view.
Drive (Page 4272)	P	P	Specifies the characters of the drive that is to be monitored.
Enabled (Page 4277)	P	P	Specifies whether the selected object can be operated in runtime.
Free (Page 4322)	P	P	Returns the size of the free memory space.
FreePercent (Page 4322)	P	P	Returns the measured values for the free disk space as a percentage.
Height (Page 4327)	P	P	Sets the height of the specified "Ellipsis", "Circle" and "Rectangle" objects.
Interval (Page 4348)	P	P	Specifies the time interval for updating the displayed measured values.
Layer (Page 4355)	-	-	Returns the layer that contains an object as LONG in the screen.
Left (Page 4366)	P	P	Specifies the value of the X coordinate of the object.
Name (Page 4417)	P	-	Returns the object name as STRING.
NormalColor	P	P	Specifies the color of the object in the normal range.
Tolerance (Page 4610)	P	P	Specifies the limit for the storage space display as of which a deviation will be reported.
ToleranceColor (Page 4611)	P	P	Specifies the colors in which the bars of the memory space display are shown as soon as the tolerance range is exceeded.
Top (Page 4629)	P	P	Specifies the value of the Y coordinate of the object.
Total (Page 4632)	P	P	Returns the storage capacity.
Used (Page 4688)	P	P	Specifies whether scrolling is enabled.
UsedPercent (Page 4688)	P	P	Returns the measured values for the occupied memory space as a percentage.
Visible (Page 4703)	P	P	Specifies whether the selected object is visible.
Warning (Page 4706)	P	P	Specifies the limit for the memory space view from which a warning is output.
Width (Page 4714)	P	P	Sets the width of the specified "Ellipsis", "Circle" and "Rectangle" objects.

Table 10-46 Methods

Methods	Valid	Description
Activate (Page 4744)	P, A	Activates the permanent window or the root screen.
ActivateDynamic (Page 4747)	P	Dynamically activates a trigger and the specified cycle for a property at runtime.
DeactivateDynamic (Page 4754)	P	Deactivates the trigger of the "ActivateDynamic" method used for the specified property in/during Runtime.

**See also**

Screen object (list) (Page 3936)



## Ellipse

### Description

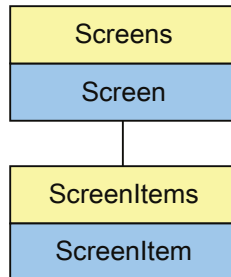

Represents the "Ellipse" object. The Ellipse object is an element of the ScreenItems list.

### Type identifier in VBS

HMIIEllipse

Abbreviation	Validity
Pa	Panels
A	Runtime Advanced
P	Runtime Professional

Table 10-47 Properties

Properties	Read	Write	Description
Authorization (Page 4175)	P	P	Specifies the operating rights of the selected object in runtime.
BackColor (Page 4181)	P, A	P, A	Specifies the background color of the selected object.
BackFillStyle (Page 4185)	P, A	P, A	Defines the fill pattern of the specified object.
BorderBackColor (Page 4199)	P	P	Specifies the background color of the broken border line for the selected object.
BorderColor (Page 4202)	P, A	P, A	Specifies the line color of the object.

10.8 Working with system functions and Runtime scripting

Properties	Read	Write	Description
BorderFlashingColorOff (Page 4206)	P	P	Specifies the border line color of the selected object for the flash state "Off".
BorderFlashingColorOn (Page 4207)	P	P	Specifies the border line color of the selected object for the flash state "On".
BorderFlashingEnabled (Page 4208)	P	P	Specifies whether the border line of the selected object flashes in runtime.
BorderFlashingRate (Page 4209)	P	P	Specifies the flash rate of the border line for the selected object.
BorderStyle (Page 4213)	P	P	Specifies the type of border lines for the selected object.
BorderWidth (Page 4216)	P, A	P, A	Specifies the line thickness of the object.
CornerStyle (Page 4250)	P	P	Specifies the type of border lines for the selected object.
DrawInsideFrame (Page 4270)	P	P	Specifies whether the border line of the selected object with a line thickness greater than 1 should be drawn within the border or symmetrically to the border.
EdgeStyle (Page 4273)	A	A	Specifies the line style of the selected object.
Enabled (Page 4277)	P	P	Specifies whether the selected object can be operated in runtime.
FillPatternColor (Page 4296)	P	P	Specifies the color of the fill pattern for the selected object.
Flashing	-	-	Specifies that the text block flashes.
FlashingColorOff (Page 4300)	P	P	Specifies the border line color of the selected object for the flash state "Off".
FlashingColorOn (Page 4302)	P	P	Specifies the border line color of the selected object for the flash state "On".
FlashingEnabled (Page 4303)	P	P	Specifies whether the border line of the selected object flashes in runtime.
FlashingRate (Page 4304)	P	P	Specifies the flash rate of the border line for the selected object.
Height (Page 4327)	P, A	P, A	Sets the height of the specified "Ellipsis", "Circle" and "Rectangle" objects.
Layer (Page 4355)	-	-	Returns the layer that contains an object as LONG in the screen.
Left (Page 4366)	P, A	P, A	Specifies the value of the X coordinate of the object.
LineEndShapeStyle (Page 4380)	P	P	Specifies the shape of the line end.
Name (Page 4417)	P, A	-	Returns the object name as STRING.
RadiusHeight (Page 4466)	P	P	Specifies the minor axis of the "Ellipsis" object.
RadiusWidth (Page 4467)	P	P	Specifies the major axis of the "Ellipsis" object.
RelativeFillLevel (Page 4470)	P	P	Specifies the fill percentage for the object.
ShowFillLevel (Page 4519)	P	P	Specifies whether the selected object is filled.
ToolTipText (Page 4627)	P	P	Specifies the tooltip text.
Top (Page 4629)	P, A	P, A	Specifies the value of the Y coordinate of the object.
Transparency (Page 4633)	P	P	Specifies and returns the transparency percentage of the object.
UseDesignColorScheme (Page 4674)	P	P	Specifies the font used for printing.
UseDesignShadowSettings (Page 4676)	P	P	Specifies whether the object is displayed with the shading defined in the active design.
Visible (Page 4703)	P, A	P, A	Specifies whether the selected object is visible.
Width (Page 4714)	P, A	P, A	Sets the width of the specified "Ellipsis", "Circle" and "Rectangle" objects.

Table 10-48 Method

Method	Valid	Description
Activate (Page 4744)	P, A	Activates the permanent window or the root screen.
ActivateDynamic (Page 4747)	P	Dynamically activates a trigger and the specified cycle for a property at runtime.
DeactivateDynamic (Page 4754)	P	Deactivates the trigger of the "ActivateDynamic" method used for the specified property in/during Runtime.

## EllipseSegment

### Description

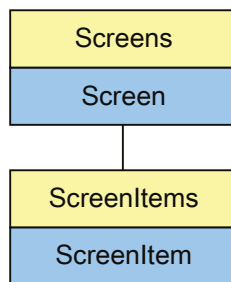

Represents the "EllipseSegment" object. The EllipseSegment object is an element of the ScreenItems list.

### Type identifier in VBS

HMIEllipseSegment

10.8 Working with system functions and Runtime scripting

Abbreviation	Validity
Pa	Panels
A	Runtime Advanced
P	Runtime Professional

Table 10-49 Properties

Properties	Read	Write	Description
Authorization (Page 4175)	P	P	Specifies the operating rights of the selected object in runtime.
BackColor (Page 4181)	P	P	Specifies the background color of the selected object.
BackFillStyle (Page 4185)	P	P	Defines the fill pattern of the specified object.
BorderBackColor (Page 4199)	P	P	Specifies the background color of the broken border line for the selected object.
BorderColor (Page 4202)	P	P	Specifies the line color of the object.
BorderFlashingColorOff (Page 4206)	P	P	Specifies the border line color of the selected object for the flash state "Off".
BorderFlashingColorOn (Page 4207)	P	P	Specifies the border line color of the selected object for the flash state "On".
BorderFlashingEnabled (Page 4208)	P	P	Specifies whether the border line of the selected object flashes in runtime.
BorderFlashingRate (Page 4209)	P	P	Specifies the flash rate of the border line for the selected object.
BorderStyle (Page 4213)	P	P	Specifies the type of border lines for the selected object.
BorderWidth (Page 4216)	P	P	Specifies the line thickness of the object.
CornerStyle (Page 4250)	P	P	Specifies the type of border lines for the selected object.
DrawInsideFrame (Page 4270)	P	P	Specifies whether the border line of the selected object with a line thickness greater than 1 should be drawn within the border or symmetrically to the border.
EdgeStyle (Page 4274)	P	P	Specifies the line style of the selected object.
Enabled (Page 4277)	P	P	Specifies whether the selected object can be operated in runtime.
EndAngle (Page 4280)	P	P	Specifies the angle at which the end point of the selected object deviates from the zero position (0°).
FillPatternColor (Page 4296)	P	P	Specifies the color of the fill pattern for the selected object.
Flashing	-	-	Specifies that the text block flashes.
FlashingColorOff (Page 4300)	P	P	Specifies the border line color of the selected object for the flash state "Off".
FlashingColorOn (Page 4302)	P	P	Specifies the border line color of the selected object for the flash state "On".
FlashingEnabled (Page 4303)	P	P	Specifies whether the border line of the selected object flashes in runtime.
FlashingRate (Page 4304)	P	P	Specifies the flash rate of the border line for the selected object.
Height (Page 4327)	P	P	Sets the height of the specified "Ellipsis", "Circle" and "Rectangle" objects.
Layer (Page 4355)	-	-	Returns the layer that contains an object as LONG in the screen.
Left (Page 4366)	P	P	Specifies the value of the X coordinate of the object.

Properties	Read	Write	Description
LineEndShapeStyle (Page 4380)	P	P	Specifies the shape of the line end.
Name (Page 4417)	P	-	Returns the object name as STRING.
RadiusHeight (Page 4466)	P	P	Specifies the minor axis of the "Ellipsis" object.
RadiusWidth (Page 4467)	P	P	Specifies the major axis of the "Ellipsis" object.
RelativeFillLevel (Page 4470)	P	P	Specifies the fill percentage for the object.
ShowFillLevel (Page 4519)	P	P	Specifies whether the selected object is filled.
StartAngle (Page 4543)	P	P	Specifies the SQL statement.
ToolTipText (Page 4627)	P	P	Specifies the tooltip text.
Top (Page 4629)	P	P	Specifies the value of the Y coordinate of the object.
Transparency (Page 4633)	P	P	Specifies and returns the transparency percentage of the object.
UseDesignColorScheme (Page 4674)	P	P	Specifies the font used for printing.
UseDesignShadowSettings (Page 4676)	P	P	Specifies whether the object is displayed with the shading defined in the active design.
Visible (Page 4703)	P	P	Specifies whether the selected object is visible.
Width (Page 4714)	P	P	Sets the width of the specified "Ellipsis", "Circle" and "Rectangle" objects.

Table 10-50 Methods

Methods	Valid	Description
Activate (Page 4744)	P, A	Activates the permanent window or the root screen.
ActivateDynamic (Page 4747)	P	Dynamically activates a trigger and the specified cycle for a property at runtime.
DeactivateDynamic (Page 4754)	P	Deactivates the trigger of the "ActivateDynamic" method used for the specified property in/during Runtime.

**See also**

Screen object (list) (Page 3936)

## EllipticalArc

### Description

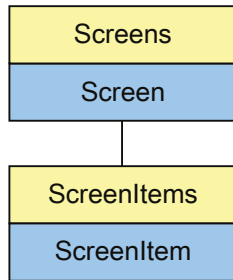

Represents the "EllipticalArc" object. The EllipticalArc object is an element of the ScreenItems list.

### Type identifier in VBS

HMIEllipticalArc

Abbreviation	Validity
Pa	Panels
A	Runtime Advanced
P	Runtime Professional

Table 10-51 Properties

Properties	Read	Write	Description
Authorization (Page 4175)	P	P	Specifies the operating rights of the selected object in runtime.
BackColor (Page 4181)	P	P	Specifies the background color of the selected object.
BorderStyle (Page 4213)	P	P	Specifies the type of border lines for the selected object.
Color (Page 4236)	P	P	Specifies the line color of the selected object.
CornerStyle (Page 4250)	P	P	Specifies the type of border lines for the selected object.

Properties	Read	Write	Description
DrawInsideFrame (Page 4270)	P	P	Specifies whether the border line of the selected object with a line thickness greater than 1 should be drawn within the border or symmetrically to the border.
Enabled (Page 4277)	P	P	Specifies whether the selected object can be operated in runtime.
EndAngle (Page 4280)	P	P	Specifies the angle at which the end point of the selected object deviates from the zero position (0°).
Flashing	-	-	Specifies that the text block flashes.
FlashingColorOff (Page 4300)	-	-	Specifies the border line color of the selected object for the flash state "Off".
FlashingColorOn (Page 4302)	-	-	Specifies the border line color of the selected object for the flash state "On".
FlashingEnabled (Page 4303)	-	-	Specifies whether the border line of the selected object flashes in runtime.
FlashingRate (Page 4304)	-	-	Specifies the flash rate of the border line for the selected object.
Height (Page 4327)	P	P	Sets the height of the specified "Ellipsis", "Circle" and "Rectangle" objects.
Layer (Page 4355)	-	-	Returns the layer that contains an object as LONG in the screen.
Left (Page 4366)	P	P	Specifies the value of the X coordinate of the object.
LineEndShapeStyle (Page 4380)	P	P	Specifies the shape of the line end.
LineWidth (Page 4381)	P	P	Specifies the line thickness of the selected object.
Name (Page 4417)	P	-	Returns the object name as STRING.
RadiusHeight (Page 4466)	P	P	Specifies the minor axis of the "Ellipsis" object.
RadiusWidth (Page 4467)	P	P	Specifies the major axis of the "Ellipsis" object.
StartAngle (Page 4543)	P	P	Specifies the SQL statement.
Style (Page 4560)	P	P	Specifies the line style of the selected object.
ToolTipText (Page 4627)	P	P	Specifies the tooltip text.
Top (Page 4629)	P	P	Specifies the value of the Y coordinate of the object.
Transparency (Page 4633)	P	P	Specifies and returns the transparency percentage of the object.
UseDesignColorScheme (Page 4674)	P	P	Specifies the font used for printing.
UseDesignShadowSettings (Page 4676)	P	P	Specifies whether the object is displayed with the shading defined in the active design.
Visible (Page 4703)	P	P	Specifies whether the selected object is visible.
Width (Page 4714)	P	P	Sets the width of the specified "Ellipsis", "Circle" and "Rectangle" objects.

Table 10-52 Methods

Methods	Valid	Description
Activate (Page 4744)	P, A	Activates the permanent window or the root screen.
ActivateDynamic (Page 4747)	P	Dynamically activates a trigger and the specified cycle for a property at runtime.
DeactivateDynamic (Page 4754)	P	Deactivates the trigger of the "ActivateDynamic" method used for the specified property in/during Runtime.

## See also

Screen object (list) (Page 3936)

## ForeignControl

## Description

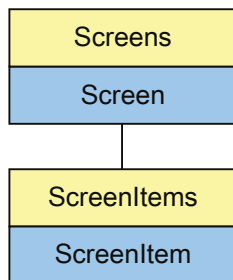

Object Type of ScreenItem Object. Represents the graphic object "Control"

The control object type always assumes the properties of the control type selected. In the case of controls provided by WinCC, the properties are indicated under the description of the corresponding control.

In the case of controls from external suppliers, the control properties are supplied and thus not a part of this description. However, the control properties can be queried using the "Item" property.

## Type Identifier in VBS

Special WinCC type descriptions or version-independent ProgID

## Use

In the following example, the object with the name "Control1" is moved 10 pixels to the right:

```
'VBS36  
Dim objControl  
Set objControl = ScreenItems("Control1")
```



```
objControl.Left = objControl.Left + 10
```

## Special feature

The controls provided by WinCC return a special ID as the type. It can be found under the topic "Type Identification in VBS" in the individual descriptions of the WinCC controls.

## Access to specific properties instead of event parameters of the third-party controls

The parameter list of an event with third-party control is not read in WinCC. To have access to custom parameters of control events, you need to implement properties in the control instead of parameters.

The following code example shows the source code of the "UserControlTestModify" control, in which the "Title" and "Description" properties are defined instead of parameters.

```
public partial class UserControlTestModify : UserControl
{
    public event MyEventHandler MyEvent = null;

    public string Title
    {
        get;
        private set;
    }

    public string Description
    {
        get;
        set;
    }

    public UserControlTestModify()
    {
        InitializeComponent();
    }

    private void OnMyEvent(Exception e)
    {
        if (this.MyEvent!= null)
        {
            // Place place data in Properties before invoking event.
            Title = "title";
            Description = "description";
            this.MyEvent.Invoke();
        }
    }

    private void button1_Click(object sender, EventArgs e)
    {
        this.OnMyEvent (null);
    }
}
```

The specific properties of a third-party control are not displayed in WinCC with IntelliSense.

The following example shows how to access the specific "Title" property of the third-party control "FControl" in WinCC :

```
HMIRuntime.Screens("StartScreen").ScreenItems("FControl").Title = "MyForeignControl"
```

### ProgID and UserfriendlyName of third-party controls

The version-independent ProgID is returned as the type if non-WinCC controls are used.

It is possible to determine the version-dependent ProgID or "UserfriendlyName" from the ProgID: In the following example, "Control1" is a control embedded in the picture which already returns the version-independent ProgID as a result of the Type property.

---

#### Note

Since not every control has a version-dependent ProgID, an error handling measure should be integrated to query the version-dependent ProgID or UserFriendlyName. If no error handling is used, the code is terminated immediately without any result when no ProgID is found.

---

Determine the version-dependent ProgID as follows:

```
'VBS37
Dim objControl
Dim strCurrentVersion
Set objControl = ScreenItems("Control1")
strCurrentVersion = CreateObject("WScript.Shell").RegRead("HKCR\" & objControl.Type &
"\CurVer\")
MsgBox strCurrentVersion
```

---

#### Note

In order that example above works, a multimedia control should be inserted in the picture.

---

Determine the UserFriendlyName as follows:

```
'VBS38
Dim objControl
Dim strFriendlyName
Set objControl = ScreenItems("Control1")
strFriendlyName = CreateObject("WScript.Shell").RegRead("HKCR\" & objControl.Type & "\")
MsgBox strFriendlyName
```

**Note**

In order that example above works, a multimedia control should be inserted in the picture.

If a non-WinCC control is used, it is possible that the properties provided by the control have the same names as the general ScreenItem properties. In such cases, the ScreenItem properties have priority. The "hidden" properties of an external control supplier can be accessed using the additional "object" property. Address the properties of an external control supplier as follows:

Control.object.type

The properties of the ScreenItem object are used in the case of identical names, if you use the following form:

Control.type

Abbreviation	Validity
Pa	Panels
A	Runtime Advanced
P	Runtime Professional

Table 10-53 Properties

Properties	Read	Write	Description
Height (Page 4327)	P	P	Sets the height of the specified "Ellipsis", "Circle" and "Rectangle" objects.
Layer (Page 4355)	-	-	Returns the layer that contains an object as LONG in the screen.
Left (Page 4366)	P	P	Specifies the value of the X coordinate of the object.
Name (Page 4417)	P	-	Returns the object name as STRING.
OCXState (Page 4428) *	-	-	Sets the OCX status.
ProgID (Page 4463) *	-	-	The version-independent ProgID is returned as the type if non-WinCC controls are used.
Top (Page 4629)	P	P	Specifies the value of the Y coordinate of the object.
Width (Page 4714)	P	P	Sets the width of the specified "Ellipsis", "Circle" and "Rectangle" objects.

\* not visible in the ES

Table 10-54 Methods

Methods	Valid	Description

**See also**

- Screen (Page 3930)
- ScreenItem (Page 3932)
- ScreenItems (list) (Page 3934)
- Screen object (list) (Page 3936)

**FunctionTrendControl**

**Description**

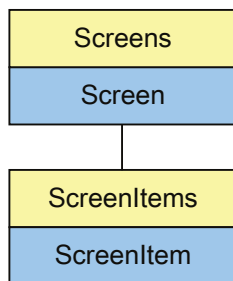

Represents the "f(x)FunctionTrendView" object. The FunctionTrendControl object is an element of the ScreenItems list.

**Type identifier in VBS**

HMIFunctionTrendControl

Abbreviation	Validity
Pa	Panels
A	Runtime Advanced
P	Runtime Professional

Table 10-55 Properties

Properties	Read	Write	Description
Enabled (Page 4277)	P	P	Specifies whether the selected object can be operated in runtime.
Height (Page 4327)	P	-	Sets the height of the specified "Ellipsis", "Circle" and "Rectangle" objects.
Left (Page 4366)	P	P	Specifies the value of the X coordinate of the object.
ObjectName (Page 4424)	P	-	Returns the object name as STRING.
Top (Page 4629)	P	P	Specifies the value of the Y coordinate of the object.
Type (Page 4664)	P	-	Returns the type of the specified object as STRING.
Visible (Page 4703)	P	P	Specifies whether the selected object is visible.
Width (Page 4714)	P	-	Sets the width of the specified "Ellipsis", "Circle" and "Rectangle" objects.

Table 10-56 Methods

Methods	Valid	Description
Activate (Page 4744)	P, A	Activates the permanent window or the root screen.
ActivateDynamic (Page 4747)	P	Dynamically activates a trigger and the specified cycle for a property at runtime.
AttachDB (Page 4750)	P, A	Executes the "Connect backup" button function of the control.
DeactivateDynamic (Page 4754)	P	Deactivates the trigger of the "ActivateDynamic" method used for the specified property in/during Runtime.
DetachDB (Page 4756)	P, A	Executes the "Disconnect backup" button function of the control.
Export (Page 4757)	P, A	Executes the "Export log" or "Export data" button function of the control.
GetStatusBarElement (Page 4784)	P, A	Returns the element of the control's status bar designated by name or index as "ICCAxStatusBarElement" type.
GetStatusBarElementCollection (Page 4785)	P, A	Returns the list of all status bar elements of the control as "ICCAxCollection" type.
GetToolBarButton (Page 4792)	P, A	Returns the button function designated by name or index on the control toolbar as "ICCAxToolBarButton" type.
GetToolBarButtonCollection (Page 4793)	P, A	Returns the list of all button functions of the control toolbar as "ICCAxCollection" type.
GetTrend (Page 4794)	P, A	Returns the f(t) or f(x) trend view designated by name or index as "ICCAxTrend" or "ICCAxFunctionTrend" type.
GetTrendCollection (Page 4795)	P, A	Returns the list of all trends of the f(t) or f(x) trend view as "ICCAxCollection" type.
GetTrendWindow (Page 4797)	P, A	Returns the trend window object of the f(t) or f(x) trend view designated by name or index as "ICCAxTrendWindow" type.

10.8 Working with system functions and Runtime scripting

Methods	Valid	Description
GetTrendWindowCollection (Page 4798)	P, A	Returns the list of all trend window objects of the f(t) or f(x) trend views as "ICCAxCollection" type.
GetXAxis (Page 4804)	P, A	Returns the X axis object of the f(x) trend view designated by name or index as "ICCAxValueAxis" type.
GetXAxisCollection (Page 4805)	P, A	Returns the list of all X axis objects of the f(x) trend view as "ICCAxCollection" type.
GetYAxis (Page 4806)	P, A	Returns the Y axis object of the f(x) trend view designated by name or index as "ICCAxValueAxis" type.
GetYAxisCollection (Page 4807)	P, A	Returns the list of all Y axis objects of the f(x) trend view as "ICCAxCollection" type.
MoveAxis (Page 4813)	P, A	Executes the "Move axes area" button function of the f(t) and f(x) trend views.
NextTrend (Page 4820)	P, A	Executes the "Next trend" button function of the f(t) and f(x) trend views.
OneToOneView (Page 4820)	P, A	Executes the "Original view" button function of the f(t) and f(x) trend views.
PreviousTrend (Page 4822)	P, A	Executes the "Previous trend" button function of the f(t) and f(x) trend views.
Print (Page 4822)	P, A	Executes the "Print" button function of the control.
ShowHelp (Page 4842)	P, A	Executes the "Help" button function of the control.
ShowPropertyDialog (Page 4847)	P, A	Executes the "Configuration dialog" button function of the control.
ShowTagSelection (Page 4851)	P, A	Executes the "Select data connection" button function of the control.
ShowTimeSelection (Page 4852)	P, A	Executes the "Select time range" button function of the control.
ShowTrendSelection (Page 4852)	P, A	Executes the "Select trends" button function of the f(t) and f(x) trend views.
StartStopUpdate (Page 4853)	P, A	Executes the "Start" or "Stop" button function of the control.
ZoomArea (Page 4860)	P, A	Executes the "Zoom area" button function of the f(t) and f(x) trend views.
ZoomInOut (Page 4861)	P, A	Executes the "Zoom +/-" button function of the f(t) and f(x) trend views.
ZoomInOutX (Page 4862)	P, A	Executes the "Zoom X axis +/-" button function of the f(x) trend view.
ZoomInOutY (Page 4863)	P, A	Executes the "Zoom Y axis +/-" button function of the f(x) trend view.
ZoomMove (Page 4863)	P, A	Executes the "Move trend area" button function of the f(t) and f(x) trend views.

## See also

BackColor (Page 4181)  
Caption (Page 4221)  
LoadDataImmediately (Page 4383)  
Online (Page 4428)  
TimeBase (Page 4584)  
ShowRuler (Page 4525)  
Screen object (list) (Page 3936)  
ApplyProjectSettings (Page 4172)  
BorderColor (Page 4202)  
BorderWidth (Page 4216)  
Closable (Page 4236)  
ConnectTrendWindows (Page 4248)  
ExportDirectoryChangeable (Page 4286)  
ExportDirectoryname (Page 4286)  
ExportFileExtension (Page 4287)  
ExportFilename (Page 4288)  
ExportFilenameChangeable (Page 4288)  
ExportFormatGuid (Page 4289)  
ExportFormatName (Page 4289)  
ExportParameters (Page 4290)  
ExportSelection (Page 4290)  
ExportShowDialog (Page 4291)  
Font (Page 4311)  
GraphDirection (Page 4324)  
Layer (Page 4355)  
LineColor (Page 4379)  
LineWidth (Page 4381)  
Movable (Page 4416)  
Name (Page 4417)  
RTPersistence (Page 4477)  
RTPersistenceType (Page 4478)  
UseTrendNameAsLabel (Page 4687)  
ToolBarAlignment (Page 4616)  
ToolBarBackColor (Page 4616)  
ToolBarButtonActive (Page 4617)  
ToolBarButtonAdd (Page 4618)  
ToolBarButtonBeginGroup (Page 4618)  
ToolBarButtonCount (Page 4619)  
ToolBarButtonEnabled (Page 4619)  
ToolBarButtonHotKey (Page 4620)

## Gauge

### Description

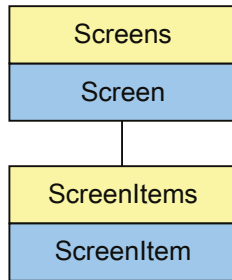

Represents the "Gauge" object. The Gauge object is an element of the ScreenItems list.

### Type identifier in VBS

HMI Gauge

Abbreviation	Validity
Pa	Panels
A	Runtime Advanced
P	Runtime Professional

Table 10-57 Properties

Properties	Read	Write	Description
AngleMax (Page 4170)	P, A	P, A	Specifies the angle for the scale end of the "Gauge" object.
AngleMin (Page 4171)	P, A	P, A	Specifies the angle for the scale start of the "Gauge" object.
BackColor (Page 4181)	P, A	P, A	Specifies the background color of the selected object.
BackFillStyle (Page 4185)	P	P	Defines the fill pattern of the specified object.
BackPicture	-	-	Specifies a graphic for the background.
BorderInnerStyle3D (Page 4210)	P	P	Specifies the representation of the inner part of the object border.



Properties	Read	Write	Description
BorderOuterStyle3D (Page 4211)	P	P	Specifies the representation of the outer part of the object border.
BorderWidth (Page 4216)	P	P	Specifies the line thickness of the object.
BorderWidth3D (Page 4218)	P	P	Specifies the width of the border for 3D display of the selected object.
CaptionColor (Page 4223)	P, A	P, A	Specifies the color of the text that is displayed in the header of the selected object.
CaptionFont	-	-	Specifies the character set for the caption.
CaptionText (Page 4224)	P, A	P, A	Specifies the text that is displayed in the header of the selected object.
CaptionTop (Page 4225)	P	P	Specifies the distance of the instrument label from the top edge of the selected object.
CenterColor (Page 4228)	P, A	P, A	Sets the color for the center point of the "Gauge" object.
CenterSize (Page 4229)	P	P	Sets the diameter of the round scale center point.
DangerRangeColor (Page 4259)	P, A	P, A	Sets the color of the danger range on the scale of the "Gauge" object.
DangerRangeStart (Page 4259)	P, A	P, A	Specifies the scale value at which the danger range of the "Gauge" object begins.
DangerRangeVisible (Page 4260)	P, A	P, A	Specifies whether the danger range is displayed in the scale of the "Gauge" object. {
DialColor (Page 4265)	P, A	P, A	Specifies the color of the dial in the selected object.
DialFillStyle (Page 4266)	P	P	Specifies the type of background for the selected object.
DialPicture	-	-	Specifies a graphic for the dial.
DialSize (Page 4267)	P	P	Specifies the diameter of the scale disc based on the smaller value of the "Width" and "Height" geometry attributes.
Enabled (Page 4277)	P	P	Specifies whether the selected object can be operated in runtime.
Flashing *	-	-	Specifies that the text block flashes.
Gradation (Page 4323)	P, A	P, A	Specifies the value difference between two main tick marks of the "Gauge" object.
Height (Page 4327)	P, A	P, A	Sets the height of the specified "Ellipsis", "Circle" and "Rectangle" objects.
Layer (Page 4355)	-	-	Returns the layer that contains an object as LONG in the screen.
Left (Page 4366)	P, A	P, A	Specifies the value of the X coordinate of the object.
LockSquaredExtent (Page 4385)	P	P	Specifies whether the tag values are downloaded from the logs for the time range to be displayed when you call a screen.
MaximumValue (Page 4392)	P, A	P, A	Specifies the maximum value of the scale in the selected object.
MinimumValue (Page 4413)	P, A	P, A	Specifies the minimum value of the scale in the selected object.
Name (Page 4417)	P, A	-	Returns the object name as STRING.
NormalRangeColor (Page 4422)	P, A	P, A	Specifies the color of the normal range on the scale of the "Gauge" object. "
NormalRangeVisible (Page 4422)	P, A	P, A	Specifies whether the normal range in the scale of the "Gauge" object will be displayed.
PointerColor (Page 4457)	P, A	P, A	Specifies the pointer color of the "Gauge" object.
ProcessValue (Page 4461)	P, A	P, A	Specifies the default for the value to be displayed.

10.8 Working with system functions and Runtime scripting

Properties	Read	Write	Description
ScaleLabelColor (Page 4483)	P, A	P, A	Specifies the color of the label for the scale tick marks of the "Gauge" object.
ScaleLabelFont	-	-	Specifies the font of the scale label.
ScaleTickColor (Page 4484)	P, A	P, A	Specifies the color of the scale tick marks of the "Gauge" object.
ScaleTickLabelPosition (Page 4485)	P	P	Specifies the diameter of the imaginary circle on which the scale tick label is location.
ScaleTickLength (Page 4485)	P	P	Specifies the length of the main scale ticks.
ScaleTickPosition (Page 4486)	P	P	Specifies the diameter of the assumed circle on which the scale divisions are located.
ShowDecimalPoint (Page 4519)	P	P	Specifies whether the scale is labeled with decimal figures (decimal point and one decimal place) or with whole integers.
ShowPeakValuePointer (Page 4523)	P, A	P, A	Specifies whether a slave pointer will be used for the selected object.
Top (Page 4629)	P, A	P, A	Specifies the value of the Y coordinate of the object.
Transparency (Page 4633)	P	P	Specifies and returns the transparency percentage of the object.
UnitColor (Page 4667)	P, A	P, A	Specifies the text color for the label of the measurement unit in the "Gauge" object.
UnitFont	-	-	Specifies the font for the unit.
UnitText (Page 4668)	P, A	P, A	Specifies the text for the measurement unit of the selected object.
UnitTop (Page 4669)	P	P	Specifies the distance of the measurement unit from the upper edge of the selected object.
UseDesignColorScheme (Page 4674)	P	P	Specifies the font used for printing.
UseDesignShadowSettings (Page 4676)	P	P	Specifies whether the object is displayed with the shading defined in the active design.
Visible (Page 4703)	P, A	P, A	Specifies whether the selected object is visible.
WarningRangeColor (Page 4710)	P, A	P, A	Specifies the color of the warning range on the scale of the "Gauge" object.
WarningRangeStart (Page 4710)	P, A	P, A	Specifies the scale value from which the warning range of the "Gauge" object begins.
WarningRangeVisible (Page 4711)	P, A	P, A	Specifies whether the warning range is displayed in the scale of the "Gauge" object.
Width (Page 4714)	P, A	P, A	Sets the width of the specified "Ellipsis", "Circle" and "Rectangle" objects.

\* not visible in the ES

Table 10-58 Methods

Methods	Valid	Description
Activate (Page 4744)	P, A	Activates the permanent window or the root screen.
ActivateDynamic (Page 4747)	P	Dynamically activates a trigger and the specified cycle for a property at runtime.
DeactivateDynamic (Page 4754)	P	Deactivates the trigger of the "ActivateDynamic" method used for the specified property in/during Runtime.

**See also**

Screen object (list) (Page 3936)

**GraphicIOField**

**Description**

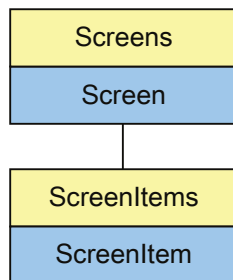

Represents the "Graphic I/O field" object. The GraphicIOField object is an element of the ScreenItems list.

The availability of the following object properties depends on the selected mode:

Property	"Input"	"Output"	"Input/Output"	"Two states"
BorderColor	--	--	--	x
BorderStyle3D	x	x	x	--
Enabled	x	--	x	--
FocusColor	x	--	x	--
FocusWidth	x	--	x	--
HelpText	x	--	x	--
TransparentColor	x	x	x	--
UseTransparentColor	x	x	x	--

**Type identifier in VBS**

HMIGraphicIOField

Abbreviation	Validity
Pa	Panels
A	Runtime Advanced
P	Runtime Professional

Table 10-59 Properties

Properties	Read	Write	Description
AboveUpperLimitColor (Page 4147)	-	-	Sets the color of the specified object for the "High limit violated" event.
AdaptPicture	-	-	Specifies that the size of the object is automatically adjusted in runtime.
Authorization (Page 4175)	P	P	Specifies the operating rights of the selected object in runtime.
AutoSizing	-	-	Specifies that the size of the object should be automatically adapted to the content.
BackColor (Page 4181)	A	A	Specifies the background color of the selected object.
BelowLowerLimitColor (Page 4196)	-	-	Sets the color of the specified object for the "Low limit violated" event.
BitNumber (Page 4197)	-	-	Specifies the bit whose status must change to trigger a value change.
BorderBackColor (Page 4199)	P	P	Specifies the background color of the broken border line for the selected object.
BorderColor (Page 4202)	P	P	Specifies the line color of the object.
BorderFlashingColorOff (Page 4206)	P	P	Specifies the border line color of the selected object for the flash state "Off".
BorderFlashingColorOn (Page 4207)	P	P	Specifies the border line color of the selected object for the flash state "On".
BorderFlashingEnabled (Page 4208)	P	P	Specifies whether the border line of the selected object flashes in runtime.
BorderFlashingRate (Page 4209)	P	P	Specifies the flash rate of the border line for the selected object.
BorderStyle (Page 4213)	P	P	Specifies the type of border lines for the selected object.
BorderStyle3D (Page 4215)	A	A	Specifies whether the object has a 3D border shading.
BorderWidth (Page 4216)	P	P	Specifies the line thickness of the object.
CornerStyle (Page 4250)	P	P	Specifies the type of border lines for the selected object.
DrawInsideFrame (Page 4270)	P	P	Specifies whether the border line of the selected object with a line thickness greater than 1 should be drawn within the border or symmetrically to the border.
EdgeStyle (Page 4274)	P	P	Specifies the line style of the selected object.
Enabled (Page 4277)	P, A	P, A	Specifies whether the selected object can be operated in runtime.
FitToLargest	-	-	Specifies that the size of the object depends on the text length in all languages.
Flashing	-	-	Specifies that the text block flashes.

Properties	Read	Write	Description
FlashingEnabled (Page 4303)	P	P	Specifies whether the border line of the selected object flashes in runtime.
FlashingOnLimitViolation	-	-	Specifies that flashing is activated when a limit is violated.
FlashingRate (Page 4304)	P	P	Specifies the flash rate of the border line for the selected object.
FlashTransparentColor (Page 4307)	P	P	Specifies the color of the bitmap object of a flashing graphic that is set to "transparent".
FocusColor (Page 4308)	A	A	Specifies the color for the focus frame of the selected object when it is in focus.
FocusWidth (Page 4310)	A	A	Specifies the border width of the specified object when the object is in focus.
Height (Page 4327)	P, A	P, A	Sets the height of the specified "Ellipsis", "Circle" and "Rectangle" objects.
HelpText (Page 4330)	A	-	Returns the tooltip that is shown in runtime as user help for the specified object.
Layer (Page 4355)	-	-	Returns the layer that contains an object as LONG in the screen.
Left (Page 4366)	P, A	P, A	Specifies the value of the X coordinate of the object.
LineEndShapeStyle (Page 4380)	P	P	Specifies the shape of the line ends.
Mode (Page 4415)	-	-	Specifies the field type of the selected object.
Name (Page 4417)	P, A	-	Returns the object name as STRING.
OnValue	-	-	Specifies the value for the "ON" state in "two-state" mode.
PictureList	-	-	Specifies the graphic list that supplies the object with values.
PictureOff (Page 4455)	-	-	Specifies the screen to be displayed in the "Off" state.
PictureOn (Page 4455)	-	-	Specifies the screen to be displayed in the "On" state.
ProcessValue (Page 4461)	P	P	Specifies the default for the value to be displayed.
ScrollBarOrientation	-	-	Specifies the orientation of the scroll bar.
ShowScrollBar	-	-	Specifies the scroll bar type.
ToolTipText (Page 4627)	P	P	Specifies the tooltip text.
Top (Page 4629)	P, A	P, A	Specifies the value of the Y coordinate of the object.
Transparency (Page 4633)	P	P	Specifies and returns the transparency percentage of the object.
TransparentColor (Page 4635)	P, A	P, A	Specifies which color of the allocated graphic (*.bmp, *.dib) of the specified object is set to "transparent".
UseDesignShadowSettings (Page 4676)	P	P	Specifies whether the object is displayed with the shading defined in the active design.
UseFlashTransparentColor (Page 4679)	P	P	Specifies whether the color of the bitmap object of a flashing graphic is set to "transparent".
UseTransparentColor (Page 4685)	P, A	P, A	Specifies whether the color defined with the property "TransparentColor" is shown as transparent for the selected object.
Visible (Page 4703)	P, A	P, A	Specifies whether the selected object is visible.
Width (Page 4714)	P, A	P, A	Sets the width of the specified "Ellipsis", "Circle" and "Rectangle" objects.

Table 10-60 Methods

Methods	Valid	Description
Activate (Page 4744)	P, A	Activates the permanent window or the root screen.
ActivateDynamic (Page 4747)	P	Dynamically activates a trigger and the specified cycle for a property at runtime.
DeactivateDynamic (Page 4754)	P	Deactivates the trigger of the "ActivateDynamic" method used for the specified property in/during Runtime.

**See also**

Screen object (list) (Page 3936)

**GraphicView**

**Description**

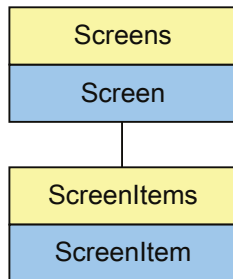

Represents the "Graphic view" object. The GraphicView object is an element of the ScreenItems list.

**Type identifier in VBS**

HMIGraphicView

Abbreviation	Validity
Pa	Panels
A	Runtime Advanced
P	Runtime Professional

Table 10-61 Properties

Properties	Read	Write	Description
AdaptPicture	A	-	Specifies that the size of the object is automatically adjusted in runtime.
Authorization (Page 4175)	P	P	Specifies the operating rights of the selected object in runtime.
AutoSizing	-	-	Specifies that the size of the object should be automatically adapted to the content.
BackColor (Page 4181)	P	P	Specifies the background color of the selected object.
BackFillStyle (Page 4185)	P	P	Defines the fill pattern of the specified object.
BackFlashingColorOff (Page 4188)	P	P	Specifies the background color for flash state "Off".
BackFlashingColorOn (Page 4188)	P	P	Specifies the background color for flash state "On".
BackFlashingEnabled (Page 4189)	P	P	Specifies whether the background of the specified object flashes in runtime.
BackFlashingRate (Page 4190)	P	P	Specifies the flash rate of the background for the selected object.
BorderBackColor (Page 4199)	P	P	Specifies the background color of the broken border line for the selected object.
BorderColor (Page 4202)	P	P	Specifies the line color of the object.
BorderFlashingColorOff (Page 4206)	P	P	Specifies the border line color of the selected object for the flash state "Off".
BorderFlashingColorOn (Page 4207)	P	P	Specifies the border line color of the selected object for the flash state "On".
BorderFlashingEnabled (Page 4208)	P	P	Specifies whether the border line of the selected object flashes in runtime.
BorderFlashingRate (Page 4209)	P	P	Specifies the flash rate of the border line for the selected object.
BorderStyle (Page 4213)	P	P	Specifies the type of border lines for the selected object.
BorderStyle3D (Page 4215)	A	A	Specifies whether the object has a 3D border shading.
BorderWidth (Page 4216)	P	P	Specifies the line thickness of the object.
CornerStyle (Page 4250)	P	P	Specifies the type of border lines for the selected object.
DrawInsideFrame (Page 4270)	P	P	Specifies whether the border line of the selected object with a line thickness greater than 1 should be drawn within the border or symmetrically to the border.
EdgeStyle (Page 4274)	P	P	Specifies the line style of the selected object.
Enabled (Page 4277)	P	P	Specifies whether the selected object can be operated in runtime.
FillPatternColor (Page 4296)	P	P	Specifies the color of the fill pattern for the selected object.
FitToLargest	-	-	Specifies that the size of the object depends on the text length in all languages.
Flashing	-	-	Specifies that the text block flashes.

Properties	Read	Write	Description
Height (Page 4327)	P, A	P, A	Sets the height of the specified "Ellipsis", "Circle" and "Rectangle" objects.
Layer (Page 4355)	-	-	Returns the layer that contains an object as LONG in the screen.
Left (Page 4366)	P, A	P, A	Specifies the value of the X coordinate of the object.
LineEndShapeStyle (Page 4380)	P	P	Specifies the shape of the line ends.
Name (Page 4417)	P, A	-	Returns the object name as STRING.
Picture (Page 4453)	P	P	Specifies the screen to be displayed in the graphics object in runtime.
RelativeFillLevel (Page 4470)	P	P	Specifies the fill percentage for the object.
ShowFillLevel (Page 4519)	P	P	Specifies whether the selected object is filled.
ToolTipText (Page 4627)	P	P	Specifies the tooltip text.
Top (Page 4629)	P, A	P, A	Specifies the value of the Y coordinate of the object.
Transparency (Page 4633)	P	P	Specifies and returns the transparency percentage of the object.
TransparentColor (Page 4635)	P, A	P, A	Specifies which color of the allocated graphic (*.bmp, *dib) of the specified object is set to "transparent".
UseDesignColorScheme (Page 4674)	P	P	Specifies the font used for printing.
UseDesignShadowSettings (Page 4676)	P	P	Specifies whether the object is displayed with the shading defined in the active design.
UseTransparentColor (Page 4685)	P, A	P, A	Specifies whether the color defined with the property "TransparentColor" is shown as transparent for the selected object.
Visible (Page 4703)	P, A	P, A	Specifies whether the selected object is visible.
Width (Page 4714)	P, A	P, A	Sets the width of the specified "Ellipsis", "Circle" and "Rectangle" objects.

Table 10-62 Methods

Methods	Valid	Description
Activate (Page 4744)	P, A	Activates the permanent window or the root screen.
ActivateDynamic (Page 4747)	P	Dynamically activates a trigger and the specified cycle for a property at runtime.
DeactivateDynamic (Page 4754)	P	Deactivates the trigger of the "ActivateDynamic" method used for the specified property in/during Runtime.

**See also**

Screen object (list) (Page 3936)



**Group**

**Description**

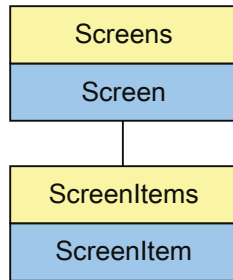

Represents the "Group" object. The Group object is an element of the ScreenItems list.

**Type identifier in VBS**

HMIGroup

Abbreviation	Validity
Pa	Panels
A	Runtime Advanced
P	Runtime Professional

Table 10-63 Properties

Properties	Read	Write	Description
Authorization (Page 4175)	P	P	Specifies the operating rights of the selected object in runtime.
BackColor (Page 4181)	P	P	Specifies the background color of the selected object.
Enabled (Page 4277)	P	P	Specifies whether the selected object can be operated in runtime.
ForeColor (Page 4318)	P	P	Specifies the font color of the text for the selected object.
Height (Page 4327)	P	P	Sets the height of the specified "Ellipsis", "Circle" and "Rectangle" objects.

Properties	Read	Write	Description
Layer (Page 4355)	-	-	Returns the layer that contains an object as LONG in the screen.
Left (Page 4366)	P	P	Specifies the value of the X coordinate of the object.
Name (Page 4417)	-	-	Returns the object name as STRING.
Top (Page 4629)	P	P	Specifies the value of the Y coordinate of the object.
Visible (Page 4703)	P	P	Specifies whether the selected object is visible.
Width (Page 4714)	P	P	Sets the width of the specified "Ellipsis", "Circle" and "Rectangle" objects.

Table 10-64 Methods

Methods	Valid	Description

**See also**

Screen object (list) (Page 3936)

## HTMLBrowser

### Description

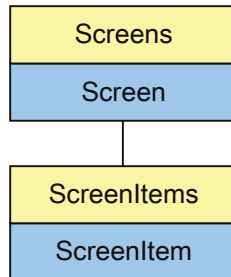

Represents the object "HTML Browser". The HTMLBrowser-object is an element of the ScreenItems-list.

### Type identifier in VBS

HMIHTMLBrowser

Abbreviation	Validity
Pa	Panels
A	Runtime Advanced
P	Runtime Professional

Table 10-65 Properties

Properties	Read	Write	Description
Address (Page 4158)	P, A	P, A	Defines the Web address which is opened in the HTML browser.
Enabled (Page 4277)	P, A	P, A	Specifies whether the selected object can be operated in runtime.
Flashing *	-	-	Specifies that the text block flashes.
Height (Page 4327)	P, A	P, A	Sets the height of the specified "Ellipsis", "Circle" and "Rectangle" objects.

Properties	Read	Write	Description
Layer (Page 4355)	-	-	Returns the layer that contains an object as LONG in the screen.
Left (Page 4366)	P, A	P, A	Specifies the value of the X coordinate of the object.
Name (Page 4417)	P, A	-	Returns the object name as STRING.
ShowStatusBar (Page 4530)	P	P	Specifies whether the status bar is shown.
ShowToolBar (Page 4534) *	-	-	Specifies whether the toolbar is shown.
Top (Page 4629)	P, A	P, A	Specifies the value of the Y coordinate of the object.
Visible (Page 4703)	P, A	P, A	Specifies whether the selected object is visible.
Width (Page 4714)	P, A	P, A	Sets the width of the specified "Ellipsis", "Circle" and "Rectangle" objects.

\* not visible in the ES

Table 10-66 Methods

Methods	Valid	Description
Activate (Page 4744)	P, A	Activates the permanent window or the root screen.
ActivateDynamic (Page 4747)	P	Dynamically activates a trigger and the specified cycle for a property at runtime.
DeactivateDynamic (Page 4754)	P	Deactivates the trigger of the "ActivateDynamic" method used for the specified property in/during Runtime.
SetHtml	??	

**See also**

Screen object (list) (Page 3936)

## IOField

### Description

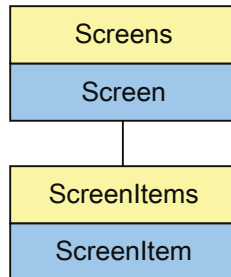

Represents the "I/O field" object. The IOField object is an element of the ScreenItems list.

### Type identifier in VBS

HMIIOField

Abbreviation	Validity
Pa	Panels
A	Runtime Advanced
P	Runtime Professional

Table 10-67 Properties

Properties	Read	Write	Description
AboveUpperLimitColor (Page 4147)	-	-	Sets the color of the specified object for the "High limit violated" event.
AcceptOnExit (Page 4148)	P	P	Specifies whether the input field is confirmed automatically when it is left.
AcceptOnFull (Page 4148)	P	P	Specifies whether the input field will be left and confirmed automatically when the defined number of values has been entered.

10.8 Working with system functions and Runtime scripting

Properties	Read	Write	Description
AdaptBorder (Page 4156)	P	P	Specifies whether the border of the specified object is dynamically adapted to the text size.
AskOperationMotive (Page 4173)	P	P	Specifies whether the reason for operating this object is logged.
Authorization (Page 4175)	P	P	Specifies the operating rights of the selected object in runtime.
BackColor (Page 4181)	P, A	P, A	Specifies the background color of the selected object.
BackFillStyle (Page 4185)	P	P	Defines the fill pattern of the specified object.
BackFlashingColorOff (Page 4188)	P	P	Specifies the background color for flash state "Off".
BackFlashingColorOn (Page 4188)	P	P	Specifies the background color for flash state "On".
BackFlashingEnabled (Page 4189)	P	P	Specifies whether the background of the specified object flashes in runtime.
BackFlashingRate (Page 4190)	P	P	Specifies the flash rate of the background for the selected object.
BelowLowerLimitColor (Page 4196)	-	-	Sets the color of the specified object for the "Low limit violated" event.
BorderBackColor (Page 4199)	P	P	Specifies the background color of the broken border line for the selected object.
BorderColor (Page 4202)	P, A	P, A	Specifies the line color of the object.
BorderFlashingColorOff (Page 4206)	P	P	Specifies the border line color of the selected object for the flash state "Off".
BorderFlashingColorOn (Page 4207)	P	P	Specifies the border line color of the selected object for the flash state "On".
BorderFlashingEnabled (Page 4208)	P	P	Specifies whether the border line of the selected object flashes in runtime.
BorderFlashingRate (Page 4209)	P	P	Specifies the flash rate of the border line for the selected object.
BorderStyle (Page 4213)	P	P	Specifies the type of border lines for the selected object.
BorderStyle3D (Page 4215)	A	A	Specifies whether the object has a 3D border shading.
BorderWidth (Page 4216)	P	P	Specifies the line thickness of the object.
BottomMargin	-	-	Sets the margin between the text and the bottom edge of the object.
ClearOnError (Page 4234)	P	P	Specifies whether an invalid input in this object is deleted automatically.
ClearOnFocus (Page 4235)	P	P	Specifies whether the field entry is deleted as soon as the I/O field is activated.
CornerStyle (Page 4250)	P	P	Specifies the type of border lines for the selected object.
CursorControl (Page 4256)	P	P	Specifies whether the mouse cursor jumps to the next field of the TAB sequence after leaving a field.
DataFormat (Page 4261)	P	P	Returns the data type of the IOField object.
EdgeStyle (Page 4274)	A	A	Specifies the line style of the selected object.
EditOnFocus (Page 4276)	P	P	Specifies whether data input is immediately possible if the input field is selected using the "Tab" key.
Enabled (Page 4277)	P, A	P, A	Specifies whether the selected object can be operated in runtime.
FieldLength (Page 4293)	-	-	Specifies that the "Field length string" field is read-only.
FillPatternColor (Page 4296)	P	P	Specifies the color of the fill pattern for the selected object.
FitToLargest	-	-	Specifies that the size of the object depends on the text length in all languages.

Properties	Read	Write	Description
Flashing	-	-	Specifies that the text block flashes.
FlashingColorOff (Page 4300)	P	P	Specifies the border line color of the selected object for the flash state "Off".
FlashingColorOn (Page 4302)	P	P	Specifies the border line color of the selected object for the flash state "On".
FlashingEnabled (Page 4303)	P	P	Specifies whether the border line of the selected object flashes in runtime.
FlashingOnLimitViolation	-	-	Specifies that flashing is activated when a limit is violated.
FlashingRate (Page 4304)	P	P	Specifies the flash rate of the border line for the selected object.
Font (Page 4311)	-	-	Specifies or returns the font.
FontBold (Page 4313)	P	P	Specifies whether the text of the selected object is shown in bold.
FontItalic (Page 4314)	P	P	Specifies whether the text of the selected object is shown in italics.
FontName (Page 4315)	P	P	Specifies the font of the selected object.
FontSize (Page 4316)	P	P	Specifies the font size of the text for the selected object.
FontUnderline (Page 4317)	P	P	Specifies whether the text of the selected object is underlined.
ForeColor (Page 4318)	P, A	P, A	Specifies the font color of the text for the selected object.
FormatPattern (Page 4320)	P	P	Specifies the format of the output value.
Height (Page 4327)	P	P	Sets the height of the specified "Ellipsis", "Circle" and "Rectangle" objects.
HelpText (Page 4330)	A	-	Returns the tooltip that is shown in runtime as user help for the specified object.
HiddenInput (Page 4331)	P	P	Specifies whether the input value or a * for each character is shown during the input.
HorizontalAlignment (Page 4340)	P, A	P, A	Specifies the horizontal alignment of the text within the selected object.
InputValue (Page 4346)	P	P	Defines the value entered by the user in the IO field.
Layer (Page 4355)	-	-	Returns the layer that contains an object as LONG in the screen.
Left (Page 4366)	P, A	P, A	Specifies the value of the X coordinate of the object.
LeftMargin	-	A	Sets the margin between the text and the left edge of the object.
LineEndShapeStyle (Page 4380)	P	P	Specifies the shape of the line end.
LogOperation (Page 4386)	P	P	Specifies whether, after operating this object, an alarm is output to the alarm system.
LowerLimit (Page 4388)	P	P	Specifies the low limit for input values.
Mode (Page 4415)	P	P	Specifies the field type of the selected object.
Name (Page 4417)	P, A	-	Returns the object name as STRING.
ProcessValue (Page 4461)	P, A	P, A	Specifies the default for the value to be displayed.
RightMargin	-	-	Sets the margin between the text and the right edge of the object.
ShiftDecimalPoint (Page 4514)	-	-	Specifies that the "Shift decimal point" field is read-only.
ShowBadTagState (Page 4516)	P	P	Specifies whether an object is grayed out if its associated tag has a bad quality code or tag state.
ShowLeadingZeros	-	-	Specifies that leading zeros should be displayed.
TextOrientation (Page 4576)	P	P	Specifies the text orientation of the selected object.

Properties	Read	Write	Description
ToolTipText (Page 4627)	P	P	Specifies the tooltip text.
Top (Page 4629)	P, A	P, A	Specifies the value of the Y coordinate of the object.
TopMargin	-	-	Sets the margin between the text and the top edge of the object.
Transparency (Page 4633)	P	P	Specifies and returns the transparency percentage of the object.
Unit (Page 4667)	P	P	Specifies the unit of measurement in the "IOField" object.
UpperLimit (Page 4670)	P	P	Specifies the high limit for input values.
UseDesignColorScheme (Page 4674)	P	P	Specifies the font used for printing.
UseDesignShadowSettings (Page 4676)	P	P	Specifies whether the object is displayed with the shading defined in the active design.
UseTagLimitColors	P	P	Specifies whether the configured colors are used when limits are violated.
VerticalAlignment (Page 4701)	P, A	P, A	Specifies the vertical alignment of the text for the selected object.
Visible (Page 4703)	P, A	P, A	Specifies whether the selected object is visible.
Width (Page 4714)	P, A	P, A	Sets the width of the specified "Ellipsis", "Circle" and "Rectangle" objects.

Table 10-68 Methods

Methods	Valid	Description
Activate (Page 4744)	P, A	Activates the permanent window or the root screen.
ActivateDynamic (Page 4747)	P	Dynamically activates a trigger and the specified cycle for a property at runtime.
DeactivateDynamic (Page 4754)	P	Deactivates the trigger of the "ActivateDynamic" method used for the specified property in/during Runtime.

**See also**

Screen object (list) (Page 3936)



**Objects K-Z**

**Line**

**Description**

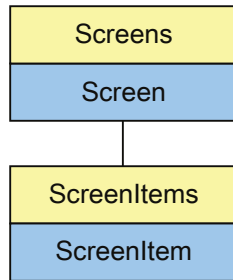

Represents the "Line" object. The Line object is an element of the ScreenItems list.

**Type identifier in VBS**

HMLLine

Abbreviation	Validity
Pa	Panels
A	Runtime Advanced
P	Runtime Professional

Table 10-69 Properties

Properties	Read	Write	Description
Authorization (Page 4175)	P	P	Specifies the operating rights of the selected object in runtime.
BackColor (Page 4181)	P, A	P, A	Specifies the background color of the selected object.
BorderEndStyle (Page 4205)	P, A	P, A	Specifies the type of line ends for the selected object.

10.8 Working with system functions and Runtime scripting

Properties	Read	Write	Description
BorderStyle (Page 4213)	P, A	P, A	Specifies the type of line ends for the selected object.
Color (Page 4236)	P, A	P, A	Specifies the line color of the selected object.
CornerStyle (Page 4250)	P	P	Specifies the type of border lines for the selected object.
Enabled (Page 4277)	P	P	Specifies whether the selected object can be operated in runtime.
EndLeft	-	-	Specifies the X position of the end point.
EndStyle (Page 4283)	P, A	P, A	Specifies how the line end of the selected object is displayed.
EndTop	-	-	Sets the Y position of the end point.
FillStyle (Page 4297)	A	A	Defines the fill pattern of the specified object.
Flashing	-	-	Specifies that the text block flashes.
FlashingColorOff (Page 4300)	P	P	Specifies the border line color of the selected object for the flash state "Off".
FlashingColorOn (Page 4302)	P	P	Specifies the border line color of the selected object for the flash state "On".
FlashingEnabled (Page 4303)	P	P	Specifies whether the border line of the selected object flashes in runtime.
FlashingRate (Page 4304)	P	P	Specifies the flash rate of the border line for the selected object.
Height (Page 4327)	P, A	P, A	Sets the height of the specified "Ellipsis", "Circle" and "Rectangle" objects.
Layer (Page 4355)	-	-	Returns the layer that contains an object as LONG in the screen.
Left (Page 4366)	P, A	P, A	Specifies the value of the X coordinate of the object.
LineEndShapeStyle (Page 4380)	P	P	Specifies the shape of the line end.
LineWidth (Page 4381)	P, A	P, A	Specifies the line thickness of the selected object.
Name (Page 4417)	P, A	-	Returns the object name as STRING.
RotationAngle (Page 4472)	P	P	Specifies the angle of rotation in degrees.
RotationCenterLeft (Page 4473)	P	P	Specifies the X coordinate of the pivot point for the object in runtime.
RotationCenterTop (Page 4474)	P	P	Specifies the Y coordinate of the pivot point for the object in runtime.
StartLeft	-	-	Specifies the X position of the starting point.
StartStyle (Page 4545)	A	A	Specifies how the line start of the selected object is displayed.
StartTop (Page 4546)	-	-	Specifies the vertical distance in pixels between the start point and the top edge of the screen.
Style (Page 4560)	P, A	P, A	Specifies the line style of the selected object.
ToolTipText (Page 4627)	P	P	Specifies the tooltip text.
Top (Page 4629)	P, A	P, A	Specifies the value of the Y coordinate of the object.
Transparency (Page 4633)	P	P	Specifies and returns the transparency percentage of the object.
UseDesignColorScheme (Page 4674)	P	P	Specifies the font used for printing.
UseDesignShadowSettings (Page 4676)	P	P	Specifies whether the object is displayed with the shading defined in the active design.
Visible (Page 4703)	P, A	P, A	Specifies whether the selected object is visible.
Width (Page 4714)	P, A	P, A	Sets the width of the specified "Ellipsis", "Circle" and "Rectangle" objects.

Table 10-70 Methods

Methods	Valid	Description
Activate (Page 4744)	P, A	Activates the permanent window or the root screen.
ActivateDynamic (Page 4747)	P	Dynamically activates a trigger and the specified cycle for a property at runtime.
DeactivateDynamic (Page 4754)	P	Deactivates the trigger of the "ActivateDynamic" method used for the specified property in/during Runtime.

**See also**

Screen object (list) (Page 3936)

**Listbox**

**Description**

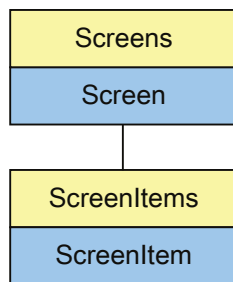

Represents the "Listbox" object. The Listbox object is an element of the ScreenItems list.

**Type identifier in VBS**

HMIListBox

**Application**

In the following example, the object with the name "ListBox1" is moved 10 pixels to the right:

```
'VBS21
Dim objListBox
Set objListBox = ScreenItems("ListBox1")
objListBox.Left = objListBox.Left + 10
```

Abbreviation	Validity
Pa	Panels
A	Runtime Advanced
P	Runtime Professional

Table 10-71 Properties

Properties	Read	Write	Description
AskOperationMotive (Page 4173)	P	P	Specifies whether the reason for operating this object is logged.
Authorization (Page 4175)	P	P	Specifies the operating rights of the selected object in runtime.
BackColor (Page 4181)	P	P	Specifies the background color of the selected object.
BackFillStyle (Page 4185)	P	P	Defines the fill pattern of the specified object.
BorderBackColor (Page 4199)	P	P	Specifies the background color of the broken border line for the selected object.
BorderColor (Page 4202)	P	P	Specifies the line color of the object.
BorderStyle (Page 4213)	P	P	Specifies the type of border lines for the selected object.
BorderWidth (Page 4216)	P	P	Specifies the line thickness of the object.
CornerStyle (Page 4250)	P	P	Specifies the type of border lines for the selected object.
CountVisibleItems (Page 4253)	P	P	Specifies the number of lines contained in the selection list.
EdgeStyle (Page 4274)	-	-	Specifies the line style of the selected object.
Enabled (Page 4277)	P	P	Specifies whether the selected object can be operated in runtime.
FillPatternColor (Page 4296)	P	P	Specifies the color of the fill pattern for the selected object.
FitToLargest	-	-	Specifies that the size of the object depends on the text length in all languages.
Font (Page 4311)	-	-	Specifies or returns the font.
FontBold (Page 4313)	P	P	Specifies whether the text of the selected object is shown in bold.
FontItalic (Page 4314)	P	P	Specifies whether the text of the selected object is shown in italics.
FontName (Page 4315)	P	P	Specifies the font of the selected object.
FontSize (Page 4316)	P	P	Specifies the font size of the text for the selected object.
FontUnderline (Page 4317)	P	P	Specifies whether the text of the selected object is underlined.

Properties	Read	Write	Description
ForeColor (Page 4318)	P	P	Specifies the font color of the text for the selected object.
Height (Page 4327)	P	P	Sets the height of the specified "Ellipsis", "Circle" and "Rectangle" objects.
HorizontalAlignment (Page 4340)	P	P	Specifies the horizontal alignment of the text within the selected object.
Index (Page 4344)	P	P	Specifies the background for grid control elements.
Layer (Page 4355)	-	-	Returns the layer that contains an object as LONG in the screen.
Left (Page 4366)	P	P	Specifies the value of the X coordinate of the object.
LineEndShapeStyle (Page 4380)	P	P	Specifies the shape of the line end.
LogOperation (Page 4386)	P	P	Specifies whether, after operating this object, an alarm is output to the alarm system.
Name (Page 4417)	P	-	Returns the object name as STRING.
SelectedIndex (Page 4495)	P	P	Specifies and returns the index whose associated text is highlighted in the combo or list box.
SelectedText (Page 4493)	P	P	Displays the text that is defined with the "Selected field" (SelIndex) attribute and highlighted in the combo box or list box.
Text (Page 4572)	P	P	Specifies the label for the text field.
Texts	-	-	Specifies the texts for the check boxes.
ToolTipText (Page 4627)	P	P	Specifies the tooltip text.
Top (Page 4629)	P	P	Specifies the value of the Y coordinate of the object.
Transparency (Page 4633)	P	P	Specifies and returns the transparency percentage of the object.
UseDesignColorScheme (Page 4674)	P	P	Specifies the font used for printing.
UseDesignShadowSettings (Page 4676)	P	P	Specifies whether the object is displayed with the shading defined in the active design.
Visible (Page 4703)	P	P	Specifies whether the selected object is visible.
Width (Page 4714)	P	P	Sets the width of the specified "Ellipsis", "Circle" and "Rectangle" objects.

Table 10-72 Methods

Methods	Valid	Description
Activate (Page 4744)	P, A	Activates the permanent window or the root screen.
ActivateDynamic (Page 4747)	P	Dynamically activates a trigger and the specified cycle for a property at runtime.
DeactivateDynamic (Page 4754)	P	Deactivates the trigger of the "ActivateDynamic" method used for the specified property in/during Runtime.

## See also

- Screen (Page 3930)
- ScreenItem (Page 3932)
- ScreenItems (list) (Page 3934)
- Screen object (list) (Page 3936)

## MediaPlayer

### Description

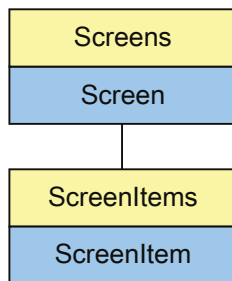

Represents the "Media Player" object. The MediaControl object is an element of the ScreenItems list.

### Type Identifier in VBS

HMIMediaControl

### Application

In the following example, the object with the name "Control1" is moved 16 pixels to the right:

```
'VBS60
Dim objControl
Set objControl = ScreenItems("Control1")
objControl.Left = objControl.Left + 16
```

Abbreviation	Validity
Pa	Panels
A	Runtime Advanced
P	Runtime Professional

Table 10-73 Properties

Properties	Read	Write	Description
AspectRatio	P	P	Specifies whether the aspect ratio is maintained when the size is changed.
AutoStart	P	P	Specifies that the Media Player should start automatically.
Enabled (Page 4277)	P	P	Specifies whether the selected object can be operated in runtime.
FileName	P, A	P, A	Specifies the name of the file to be loaded.
Height (Page 4327)	P, A	P, A	Sets the height of the specified "Ellipsis", "Circle" and "Rectangle" objects.
Layer (Page 4355)	-	-	Returns the layer that contains an object as LONG in the screen.
Left (Page 4366)	P, A	P, A	Specifies the value of the X coordinate of the object.
Name (Page 4417)	P, A	-	Returns the object name as STRING.
PictureSizeMode	P	P	Specifies that the status bar is displayed.
PlayCount	A	A	Plays the files several times.
PlayEndless	P	P	Specifies that the media file should play endlessly.
PopupMenuEnabled	P	P	Specifies that the shortcut menu can be used.
ShowControls	P, A	P, A	Specifies that a toolbar is displayed.
ShowFeatureBackward	P	P	Specifies that the "Backward" button is displayed in runtime.
ShowFeatureForward	P	P	Specifies that the "Forward" button is displayed in runtime.
ShowFeatureFullScreen	P	P	Specifies that the Media Player can be displayed as a full screen.
ShowFeaturePause	P	P	Specifies that the Media Player can be displayed as a full screen
ShowFeaturePlay	P	P	Specifies that the "Play" button is displayed in runtime.
ShowFeatureStop	P	P	Specifies that the "Stop" button is displayed in runtime.
ShowFeatureVolume	P	P	Sets the volume.
ShowStatusBar (Page 4530)	A	A	Specifies whether the status bar is shown.
ShowTracker	A	A	Specifies that the tracker is displayed.
StepSeconds	P	P	Specifies a time in seconds that is to be skipped when the "Forward" or "Backward" button is pressed.
Top (Page 4629)	P, A	P, A	Specifies the value of the Y coordinate of the object.
Visible (Page 4703)	P	P	Specifies whether the selected object is visible.
Width (Page 4714)	P, A	P, A	Sets the width of the specified "Ellipsis", "Circle" and "Rectangle" objects.

Table 10-74 Methods

Methods	Valid	Description
Activate (Page 4744)	P, A	Activates the permanent window or the root screen.
ActivateDynamic (Page 4747)	P	Dynamically activates a trigger and the specified cycle for a property at runtime.
DeactivateDynamic (Page 4754)	P	Deactivates the trigger of the "ActivateDynamic" method used for the specified property in/during Runtime.

**See also**

- Screen (Page 3930)
- ScreenItem (Page 3932)
- ScreenItems (list) (Page 3934)
- Screen object (list) (Page 3936)

**MultiLineEdit**

**Description**

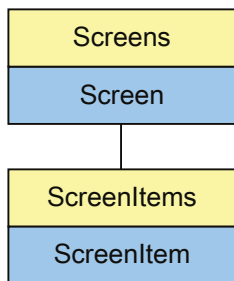

Represents the "MultiLine text" object. The MultiLineEdit object is an element of the ScreenItems list.

**Type identifier in VBS**

HMIMultiLineEdit



## Application

In the following example, the object with the name "MultiLineEdit1" is moved 10 pixels to the right:

```
'VBS21
Dim objMultiLineEdit
Set objMultiLineEdit = ScreenItems("MultiLineEdit1")
objMultiLineEdit.Left = objMultiLineEdit.Left + 10
```

Abbreviation	Validity
Pa	Panels
A	Runtime Advanced
P	Runtime Professional

Table 10-75 Properties

Properties	Read	Write	Description
Authorization (Page 4175)	P	P	Specifies the operating rights of the selected object in runtime.
BackColor (Page 4181)	P	P, A	Specifies the background color of the selected object.
BorderBackColor (Page 4199)	P	P	Specifies the background color of the broken border line for the selected object.
BorderColor (Page 4202)	P	P	Specifies the background color of the selected object.
BorderStyle (Page 4213)	P	P	Specifies the type of border lines for the selected object.
BorderWidth (Page 4216)	P	P	Specifies the line thickness of the object.
CornerStyle (Page 4250)	P	P	Specifies the type of border lines for the selected object.
EdgeStyle (Page 4274)	-	-	Specifies the line style of the selected object.
Enabled (Page 4277)	P	P	Specifies whether the selected object can be operated in runtime.
Font (Page 4311)	-	-	Specifies or returns the font.
FontBold (Page 4313)	P	P	Specifies whether the text of the selected object is shown in bold.
FontItalic (Page 4314)	P	P	Specifies whether the text of the selected object is shown in italics.
FontName (Page 4315)	P	P	Specifies the font of the selected object.
FontSize (Page 4316)	P	P	Specifies the font size of the text for the selected object.
FontUnderline (Page 4317)	P	P	Specifies whether the text of the selected object is underlined.
ForeColor (Page 4318)	P	P	Specifies the font color of the text for the selected object.
Height (Page 4327)	P	P	Sets the height of the specified "Ellipsis", "Circle" and "Rectangle" objects.
HorizontalAlignment (Page 4340)	P	P	Specifies the horizontal alignment of the text within the selected object.
Layer (Page 4355)	-	-	Returns the layer that contains an object as LONG in the screen.
Left (Page 4366)	P	P	Specifies the value of the X coordinate of the object.
LineEndShapeStyle (Page 4380)	P	P	Specifies the shape of the line end.

Properties	Read	Write	Description
Name (Page 4417)	P	-	Returns the object name as STRING.
Text (Page 4572)	P	P	Specifies the label for the text field.
ToolTipText (Page 4627)	P	P	Specifies the tooltip text.
Top (Page 4629)	P	P	Specifies the value of the Y coordinate of the object.
Transparency (Page 4633)	P	P	Specifies and returns the transparency percentage of the object.
UseDesignColorScheme (Page 4674)	P	P	Specifies the font used for printing.
UseDesignShadowSettings (Page 4676)	P	P	Specifies whether the object is displayed with the shading defined in the active design.
Visible (Page 4703)	P	P	Specifies whether the selected object is visible.
Width (Page 4714)	P	P	Sets the width of the specified "Ellipse", "Circle" and "Rectangle" objects.

Table 10-76 Methods

Methods	Validity	Description
Activate (Page 4744)	P, A	Activates the permanent window or the root screen.
ActivateDynamic (Page 4747)	P	Dynamically activates a trigger and the specified cycle for a property at runtime.
DeactivateDynamic (Page 4754)	P	Deactivates the trigger of the "ActivateDynamic" method used for the specified property in/during Runtime.
GetSelectionText	??	
SetSelection	??	
SetSelectionText	??	

**See also**

- Screen (Page 3930)
- ScreenItem (Page 3932)
- ScreenItems (list) (Page 3934)
- Screen object (list) (Page 3936)

**OLEView**

**Description**

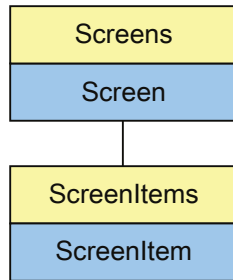

Represents the "OLE object" object. The OLEView object is an element of the ScreenItems list.

**Type identifier in VBS**

Version-independent ProgID

Abbreviation	Validity
Pa	Panels
A	Runtime Advanced
P	Runtime Professional

Table 10-77 Properties

Properties	Read	Write	Description

Properties	Read	Write	Description

Table 10-78 Methods

Methods	Can be dynamized	Validity	Description

**See also**

- Screen (Page 3930)
- ScreenItem (Page 3932)
- ScreenItems (list) (Page 3934)
- Screen object (list) (Page 3936)

## OnlineTableControl

### Description

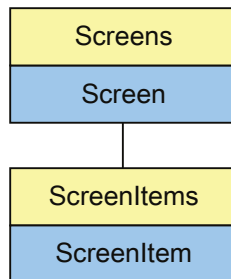

Represents the "Table view" object. The OnlineTableControl object is an element of the ScreenItems list.

### Type identifier in VBS

HMIOnlineTableControl

Abbreviation	Validity
Pa	Panels
A	Runtime Advanced
P	Runtime Professional

Table 10-79 Properties

Properties	Read	Write	Description
ApplyProjectSettingsForDesignMode (Page 4172)	-	-	Specifies that the project settings are used for the design.
AutoCompleteColumns (Page 4177)	P	P	Specifies whether empty columns are shown if the control is wider than the configured columns.
AutoCompleteRows (Page 4177)	P	P	Specifies whether empty rows are shown if the control is longer than the number of configured rows.

Properties	Read	Write	Description
AutoSelectionColors (Page 4178)	P	P	Specifies whether the colors defined by the system are used as the selection colors for cells and rows.
AutoSelectionRectColor (Page 4179)	P	P	Specifies whether the selection frame is shown with the color defined by the system.
BackColor (Page 4181)	P	P	Specifies the background color of the selected object.
BorderColor (Page 4202)	P	P	Specifies the line color of the object.
BorderWidth (Page 4216)	P	P	Specifies the line thickness of the object.
Caption (Page 4221)	P	P	Specifies the text that is displayed in the header of the selected object.
CellCut (Page 4225)	P	P	Specifies whether the contents of the cells are abbreviated if the cells are too narrow.
CellSpaceBottom (Page 4226)	P	P	Specifies the bottom margin of the table cells.
CellSpaceLeft (Page 4227)	P	P	Sets the left indent for the table cells.
CellSpaceRight (Page 4227)	P	P	Specifies the right indent of the table cells.
CellSpaceTop (Page 4228)	P	P	Specifies the top margin of the table cells.
Closeable (Page 4236)	P	P	Specifies that the control can be closed in runtime.
ColumnResize (Page 4242)	P	P	Enables changes to the width of columns.
ColumnScrollbar (Page 4244)	P	P	Specifies the scroll bar type.
ColumnTitleAlignment	P	P	Specifies the type of column title alignment.
ColumnTitles (Page 4245)	P	P	Specifies whether the column title is displayed.
ControlDesignMode (Page 4538)	P	P	Specifies the design.
EnableEdit (Page 4280)	P	P	Specifies whether the data shown can be edited in runtime.
ExportDirectoryChangeable (Page 4286)	P	P	Specifies whether the data export directory can be changed in runtime.
ExportDirectoryname (Page 4286)	P	P	Specifies the target directory for the exported Runtime data.
ExportFileExtension (Page 4287)	P	P	Specifies the file extension of the export file. Only the "csv" file extension is currently supported.
ExportFilename (Page 4288)	P	P	Specifies the name of the target file for the exported Runtime data.
ExportFilenameChangeable (Page 4288)	P	P	Specifies whether the export file name can be changed in runtime.
ExportFormatGuid (Page 4289)	P	P	Default assignment of the ID number and export provider.
ExportFormatName (Page 4289)	P	P	Specifies the export file format. Only the "csv" file format is currently available for the export.
ExportParameters (Page 4290)	P	P	Specifies the parameters of the selected format by means of the "Properties" dialog.
ExportSelection (Page 4290)	P	P	Specifies the file extension of the export file. Only the "csv" file extension is currently supported.
ExportShowDialog (Page 4291)	P	P	Specifies whether the data export dialog is shown in runtime.
Font (Page 4311)	-	-	Specifies or returns the font.
GridLineColor (Page 4325)	P	P	Specifies the color for the grid lines.
GridLineWidth (Page 4326)	P	P	Specifies the width of the separation lines in pixels.
Height (Page 4327)	P	-	Sets the height of the specified "Ellipsis", "Circle" and "Rectangle" objects.
HorizontalGridLines (Page 4341)	P	P	Specifies whether horizontal separation lines are displayed.

Properties	Read	Write	Description
IconSpace (Page 4344)	P	P	Specifies the spacing between icons and text in the table cells.
Layer (Page 4355)	-	-	Returns the layer that contains an object as LONG in the screen.
Left (Page 4366)	P	P	Specifies the value of the X coordinate of the object.
LineColor (Page 4379)	P	P	Sets the color of the window separation lines.
LineWidth (Page 4381)	P	P	Specifies the line thickness of the selected object.
LoadDataImmediately (Page 4383)	P	P	Specifies whether the tag values are downloaded from the logs for the time range to be displayed when you call a screen.
Moveable (Page 4416)	P	P	Specifies whether the window can be moved in runtime.
Name (Page 4417)	P	-	Returns the object name as STRING.
Online (Page 4428)	P	P	Specifies the name of the data source.
PrintJob	P	P	Specifies a print job
RowScrollbar (Page 4475)	P	P	Specifies whether row scroll bars are displayed.
RowTitleAlignment	P	P	Specifies the type of row title alignment.
RowTitles	P	P	Specifies that row headers will be displayed.
RTPersistence (Page 4477)	P	P	Specifies how online configurations of WinCC are retained.
RTPersistenceAuthorization	P	P	Specifies the authorization required for online configuration in runtime.
RTPersistenceType (Page 4478)	-	-	Specifies how online configurations of WinCC are retained.
SelectedCellColor (Page 4493)	P	P	Specifies the background color of the selected cell.
SelectedCellForeColor (Page 4494)	P	P	Specifies the font color of the selected cell.
SelectedRowColor (Page 4495)	P	P	Specifies the background color of the selected row.
SelectedRowForeColor (Page 4495)	P	P	Specifies the font color of the selected row.
SelectedTitleColor (Page 4496)	P	P	Specifies the background color of a selected table header.
SelectedTitleForeColor (Page 4497)	P	P	Specifies the font color of the selected table header.
SelectionColoring (Page 4499)	P	P	Specifies whether selection colors are used for cells or rows.
SelectionRect (Page 4502)	P	P	Specifies whether a selection frame is used for the selected cells or rows.
SelectionRectColor (Page 4503)	P	P	Specifies the color of the selection rectangle in the alarm window if SelectionType equals "1".
SelectionRectWidth (Page 4504)	P	P	Specifies the line width of the selection rectangle in the alarm window if SelectionType equals "1".
SelectionType (Page 4504)	P	P	Specifies the number of lines you can mark.
ShowSortButton (Page 4528)	P	P	Specifies whether the sorting button is shown above the vertical scroll bar.
ShowSortIcon (Page 4529)	P	P	Specifies whether the sorting icon is displayed.
ShowSortIndex (Page 4530)	P	P	Specifies whether the sorting icon is displayed.
ShowTitle (Page 4534)	P	P	Specifies the representation of the control's window title.
Sizeable (Page 4538)	P	P	Specifies that the size of an object can be changed in runtime.
SortSequence (Page 4542)	P	P	Specifies how the sorting order can be changed by mouse click.
StatusbarBackColor (Page 4547)	P	P	Specifies the background color of the status bar.

Properties	Read	Write	Description
StatusbarElementAdd (Page 4547) *	P	P	Creates a new, user-defined status bar element.
StatusbarElementAutoSize (Page 4548) *	P	P	Specifies whether the width of the selected status bar element is set automatically.
StatusbarElementCount (Page 4548) *	P	P	Specifies the number of configurable status bar elements.
StatusbarElementIconId (Page 4549) *	P	P	Default assignment of the ID number and icon of a status bar element.
StatusbarElementId (Page 4549) *	P	P	Unique ID of the selected status bar element.
StatusbarElementIndex (Page 4550)	P	P	References a status bar element. You can use this property to assign the values of other properties to a specific element of the status bar.
StatusbarElementName (Page 4550) *	P	P	Displays the object name of the selected status bar element.
StatusbarElementRemove (Page 4551) *	P	P	Removes the selected status bar element.
StatusbarElementRename (Page 4551) *	P	P	Renames the user-defined status bar element that is referenced by means of the "StatusbarElementIndex" property.
StatusbarElementRepos *	P	P	Specifies the index that is assigned to the element.
StatusbarElements (Page 4552)	-	-	Specifies the elements that are to be shown in the status bar.
StatusbarElementText *	P	P	Specifies the text of the currently selected status bar element.
StatusbarElementTooltipText (Page 4552) *	P	P	Specifies the tooltip text for the user-defined status bar element.
StatusbarElementUserDefined (Page 4553) *	P	P	Indicates whether the project engineer has added the toolbar button as a new user-defined element.
StatusbarElementVisible (Page 4554) *	P	P	In the list, activate the status bar elements that you wish to display in runtime.
StatusbarElementWidth (Page 4554) *	P	P	Specifies the width of the selected status bar element in pixels.
StatusbarFont	-	-	Status bar font
StatusbarFontColor (Page 4554)	P	P	Specifies the color of the text in the status bar.
StatusbarShowTooltips (Page 4557)	P	P	Specifies whether tooltips are displayed for the elements of the status bar in runtime.
StatusbarText (Page 4558)	P	P	Default text in the status bar.
StatusbarUseBackColor (Page 4558)	P	P	Specifies whether the background color of the status bar is shown.
StatusbarVisible (Page 4559)	P	P	Specifies whether the status bar of the control is displayed.
TableColor (Page 4564)	P	P	Specifies the background color of the rows. Use this to open the color selection dialog.
TableColor2 (Page 4564)	P	P	Specifies the background color of "Row color 2".
TableForeColor (Page 4565)	P	P	
TableForeColor2 (Page 4566)	P	P	Specifies the font color of "Row color 2".
TimeBase (Page 4584)	P	P	Sets the time zone that forms the basis for the display of time values.
TimeColumnActualize (Page 4585) *	P	P	Specifies whether the values of the selected column are updated.
TimeColumnAdd (Page 4586) *	P	P	Creates a new time column.
TimeColumnAlign (Page 4586) *	P	P	Specifies how the selected time column is aligned.



Properties	Read	Write	Description
TimeColumnBackColor (Page 4587) *	P	P	Specifies the background color of the time column selected.
TimeColumnBeginTime (Page 4588) *	P	P	Specifies the starting time of the time range for a selected time column.
TimeColumnCaption (Page 4588) *	P	P	Specifies the label of the time column.
TimeColumnCount (Page 4589) *	P	P	Specifies the number of configured time columns.
TimeColumnDateFormat (Page 4589) *	P	P	Specifies which date format is used to display the selected time column.
TimeColumnEndTime (Page 4590) *	P	P	Specifies the end point of the time range for the selected time column.
TimeColumnForeColor (Page 4590) *	P	P	Specifies the font color of the time column selected.
TimeColumnHideText (Page 4591) *	P	P	Sets text format for displaying the content of a time column.
TimeColumnHideTitleText (Page 4592) *	P	P	Sets text format for displaying the time column header.
TimeColumnIndex (Page 4592)	P	P	References a configured time column.
TimeColumnLength (Page 4593) *	P	P	Specifies the width of a selected time column.
TimeColumnMeasurePoints (Page 4593) *	P	P	Specifies the number of measuring points to be displayed in the selected time column.
TimeColumnName (Page 4594) *	P	P	Specifies the name of the selected time column.
TimeColumnRangeType (Page 4594) *	P	P	Specifies the time range used for the selected time column.
TimeColumnRemove (Page 4595) *	P	P	Removes the selected time column from the list.
TimeColumnRename (Page 4595) *	P	P	Renames the time column that is referenced by means of the "TimeColumnIndex" property.
TimeColumnRepos (Page 4595) *	P	P	Changes the sorting order of the time columns, including the corresponding value columns.
TimeColumnShowDate (Page 4596) *	P	P	Specifies whether the selected time column is displayed with date and time.
TimeColumnShowIcon (Page 4596) *	P	P	Specifies whether the contents of the time column are shown as an icon.
TimeColumnShowTitleIcon (Page 4597) *	P	P	Specifies whether the values of the selected column are updated.
TimeColumnSort (Page 4597) *	P	P	Specifies how the time column referenced in "TimeColumnIndex" is sorted.
TimeColumnSortIndex (Page 4598) *	P	P	Specifies the sorting order of the time column referenced in "TimeColumnIndex".
TimeColumnTimeFormat (Page 4598) *	P	P	Defines the time format used to display a selected time column.
TimeColumnTimeRangeBase (Page 4599) *	P	P	Specifies the unit of time for calculating the time range.
TimeColumnTimeRangeFactor (Page 4600) *	P	P	Specifies the factor for calculating the time range.
TimeColumnUseValueColumnColors (Page 4600) *	P	P	Specifies whether the selected time column is displayed in the value column colors.
TimeColumnVisible (Page 4601) *	P	P	The list shows the time columns you have created.
TimeStepBase	P	P	A time range is set via a base and a factor.
TimeStepFactor	P	P	A time range is set via a base and a factor.
TitleColor	P	P	Specifies the color of the header.

Properties	Read	Write	Description
TitleCut (Page 4606)	P	P	Specifies whether the contents of the fields of a header should be abbreviated if the column is too narrow.
TitleDarkShadowColor (Page 4607)	P	P	Specifies the color of the dark side of shading.
TitleForeColor (Page 4607)	P	P	Specifies the font color of the table header for the selected status.
TitleGridLineColor (Page 4607)	P	P	Specifies the color of separation lines in the table header.
TitleLightShadowColor (Page 4608)	P	P	Specifies the color of the bright side of shading.
TitleSort (Page 4608)	P	P	Specifies how sorting by column title is triggered.
TitleStyle (Page 4609)	P	P	Specifies whether a shading color is used for the table header.
ToolBarAlignment (Page 4616)	P	P	Specifies or returns the position of the toolbar.
ToolBarBackColor (Page 4616)	P	P	Specifies the background color of the toolbar.
ToolBarButtonActive (Page 4617) *	P	P	Specifies whether the function linked to the button is activated in runtime.
ToolBarButtonAdd (Page 4618) *	P	P	Creates a new, user-defined button function.
ToolBarButtonBeginGroup (Page 4618) *	P	P	Specifies whether a separator is inserted before the selected button function.
ToolBarButtonClick	P	P	Clicks a toolbar button.
ToolBarButtonCount (Page 4619) *	P	P	Specifies the number of configurable button functions.
ToolBarButtonEnabled (Page 4619) *	P	P	Specifies whether a user-defined toolbar button can be operated.
ToolBarButtonHotKey (Page 4620) *	P	P	Shows the hotkey for the selected button function.
ToolBarButtonId (Page 4620) *	P	P	Unique ID number for the selected button function.
ToolBarButtonIndex (Page 4620)	P	P	References a button function.
ToolBarButtonLocked (Page 4621) *	P	P	Specifies whether the clicked, pressed in state is displayed for a user-defined toolbar button.
ToolBarButtonName (Page 4621) *	P	P	Shows the name of the selected button function.
ToolBarButtonPasswordLevel (Page 4622) *	P	P	Shows the authorization for the selected button function.
ToolBarButtonRemove (Page 4622) *	P	P	Removes the selected button function from the list.
ToolBarButtonRename (Page 4622) *	P	P	Renames the user-defined toolbar element that is referenced by means of the "ToolBarButtonIndex" property.
ToolBarButtonRepos (Page 4623) *	P	P	Changes the sequence of button functions.
ToolBarButtons	-	-	Specifies which buttons are available for the toolbar.
ToolBarButtonTooltipText (Page 4623) *	P	P	Specifies the tooltip text for the button.
ToolBarButtonUserDefined (Page 4624) *	P	P	Indicates whether the project engineer has added the toolbar button as a new user-defined button.
ToolBarButtonVisible *	P	P	Specifies that the button is visible.
ToolBarShowTooltips (Page 4624)	P	P	Specifies whether the tooltips for the button functions are displayed in runtime.
ToolBarUseBackColor (Page 4625)	P	P	Specifies whether the background color for the toolbar is shown.
ToolBarUseHotKeys (Page 4626)	P	P	Specifies whether the hotkeys for the button functions are activated in runtime.
ToolBarVisible (Page 4626)	P	P	Specifies whether the toolbar of the control is displayed.
Top (Page 4629)	P	P	Specifies the value of the Y coordinate of the object.

Properties	Read	Write	Description
UseColumnBackColor	P	P	Specifies whether scrolling is enabled.
UseColumnForeColor	P	P	Specifies the font used for printing.
UseSelectedTitleColor (Page 4682)	P	P	Specifies whether a selection color is used for the headers of selected table cells.
UseTableColor2 (Page 4684)	P	P	Specifies whether a second row color is used for the representation of the table.
ValueColumnAdd *	P	P	Adds a value column.
ValueColumnAlign *	P	P	Specifies the alignment of a column.
ValueColumnAutoPrecisions *	P	P	Specifies whether the number of decimal places to be displayed is determined automatically.
ValueColumnBackColor *	P	P	Specifies the background color.
ValueColumnCaption *	P	P	Specifies a header.
ValueColumnCount *	P	P	Displays the number of value columns.
ValueColumnExponentialFormat *	P	P	Specifies that exponential notation is used in a column.
ValueColumnForeColor *	P	P	Specifies the foreground color for a value column.
ValueColumnHideText *	P	P	Specifies whether the text is displayed.
ValueColumnHideTitleText *	P	P	Specifies whether the text is displayed.
ValueColumnIndex	P	P	The index specifies on which column other properties, e.g. initial value are based.
ValueColumnLength *	P	P	Specifies the number of displayed characters.
ValueColumnName *	P	P	Specifies the name of a column.
ValueColumnPrecisions *	P	P	Specifies the number of decimal places.
ValueColumnProvider *	P	P	
ValueColumnProviderCLSID *	P	P	Specifies the provider CLSID of the data for a column.
ValueColumnRemove *	P	P	Deletes a value column.
ValueColumnRename *	P	P	Renames a value column.
ValueColumnRepos *	P	P	Specifies that a value axis is repositioned.
ValueColumnSelectTagName *	P	P	Specifies a tag.
ValueColumnShowIcon *	P	P	Specifies whether an icon is shown.
ValueColumnShowTitleIcon *	P	P	Specifies whether an icon is shown in the title.
ValueColumnSort *	P	P	Specifies the sorting type of a column.
ValueColumnSortIndex *	P	P	Specifies the sorting order.
ValueColumnTagName *	P	P	Specifies the names of the tags whose values are displayed in a column.
ValueColumnTimeColumn *	P	P	Specifies the corresponding time column.
ValueColumnVisible *	P	P	Specifies the visibility of a value column.
VerticalGridLines (Page 4702)	P	P	Specifies whether vertical separation lines are displayed.
Visible (Page 4703)	P	P	Specifies whether the selected object is visible.
Width (Page 4714)	P	-	Sets the width of the specified "Ellipsis", "Circle" and "Rectangle" objects.

\* not visible in the ES

Table 10-80 Methods

Methods	Valid	Description
Activate (Page 4744)	P, A	Activates the permanent window or the root screen.
ActivateDynamic (Page 4747)	P	Dynamically activates a trigger and the specified cycle for a property at runtime.
AttachDB (Page 4750)	P	Executes the "Connect backup" button function of the control.
CalculateStatistic (Page 4751)	P	Executes the "Calculate statistics" button function of the f(t) trend view and table view.
CopyRows (Page 4751)	P	Executes the "Copy rows" button function of the control.
DeactivateDynamic (Page 4754)	P	Deactivates the trigger of the "ActivateDynamic" method used for the specified property in/during Runtime.
DetachDB (Page 4756)	P, A	Executes the "Disconnect backup" button function of the control.
Edit (Page 4757)	P	Executes the "Edit" button function of the table view.
Export (Page 4757)	P, A	Executes the "Export log" or "Export data" button function of the control.
GetRow (Page 4769)	P	Returns the row object defined by its row number in the table-based controls as "ICCAxDataRow" type.
GetRowCollection (Page 4770)	P	Returns the list of all row objects of the table-based controls as "ICCAxDataRowCollection" type.
GetSelectedRow (Page 4777)	P	Returns the selected row object of a table-based control as "ICCAxDataRow" type.
GetSelectedRows (Page 4778)	P	Returns the selected row objects of a table-based control as type "ICCAxDataRow" for multiple selection.
GetStatusBarElement (Page 4784)	P, A	Returns the element of the control's status bar designated by name or index as "ICCAxStatusBarElement" type.
GetStatusBarElementCollection (Page 4785)	P, A	Returns the list of all status bar elements of the control as "ICCAxCollection" type.
GetTimeColumn (Page 4789)	P	Returns the time column object of the table view designated by name or index as "ICCAxTime Column" type.
GetTimeColumnCollection (Page 4790)	P	Returns the list of all time column objects of the table view as "ICCAxCollection" type.
GetToolBarButton (Page 4792)	P, A	Returns the button function designated by name or index on the control toolbar as "ICCAxToolBarButton" type.
GetToolBarButtonCollection (Page 4793)	P, A	Returns the list of all button functions of the control toolbar as "ICCAxCollection" type.
GetValueColumn (Page 4801)	P	Returns the value column object of the f(t) trend view designated by name or index as "ICCAxValueColumn" type.
GetValueColumnCollection (Page 4802)	P	Returns the list of all value column objects of the f(t) trend view as "ICCAxCollection" type.
MoveToFirst (Page 4813)	P	Executes the "First line" button function of the control.
MoveToLast (Page 4815)	P	Executes the "Last data record" button function of the control.
MoveToNext (Page 4816)	P	Executes the "Next data record" button function of the control.
MoveToPrevious (Page 4818)	P	Executes the "Previous data record" button function of the control.
NextColumn (Page 4819)	P	Executes the "Next column" button function of the table view.
PreviousColumn (Page 4821)	P	Executes the "Previous column" button function of the table view.
Print (Page 4822)	P, A	Executes the "Print" button function of the control.
SelectAll (Page 4837)	P	Selects all rows in a table-based control.
SelectRow (Page 4838)	P	Selects a specific row in a table-based control.

Methods	Valid	Description
SelectStatisticArea (Page 4838)	P	Executes the "Set statistics range" button function of the table view.
ShowColumnSelection (Page 4840)	P	Executes the "Select columns" button function of the table view.
ShowHelp (Page 4842)	P, A	Executes the "Help" button function of the control.
ShowPropertyDialog (Page 4847)	P, A	Executes the "Configuration dialog" button function of the control.
ShowTagSelection (Page 4851)	P, A	Executes the "Select data connection" button function of the control.
ShowTimeSelection (Page 4852)	P, A	Executes the "Select time range" button function of the control.
StartStopUpdate (Page 4853)	P, A	Executes the "Start" or "Stop" button function of the control.
UnselectAll (Page 4855)	P	Removes all selections from the cells of a table-based control.
UnselectRow (Page 4856)	P	Removes the selections from a specific cell of a table-based control.

**See also**

Screen object (list) (Page 3936)

**OnlineTrendControl**

**Description**

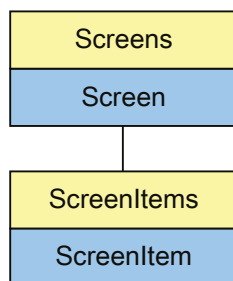

Represents the "f(t)FunctionTrendView" object. The OnlineTrendControl object is an element of the ScreenItems list.

**Type identifier in VBS**

HMIOnlineTrendControl

Abbreviation	Validity
Pa	Panels
A	Runtime Advanced
P	Runtime Professional

Table 10-81 Properties

Properties	Read	Write	Description
ApplyProjectSettingsForDesignMode (Page 4172)	-	-	Specifies that the project settings are used for the design.
BackColor (Page 4181)	P	P	Specifies the background color of the selected object.
BorderColor (Page 4202)	P	P	Specifies the line color of the object.
BorderWidth (Page 4216)	P	P	Specifies the line thickness of the object.
Caption (Page 4221)	P	P	Specifies the text that is displayed in the header of the selected object.
Closeable (Page 4236)	P	P	Specifies that the control can be closed in runtime.
ConnectTrendWindows (Page 4248)	P	P	Specifies whether the configured trend views are connected.
ControlDesignMode (Page 4538)	P	P	Specifies the design.
ExportDirectoryChangeable (Page 4286)	P	P	Specifies whether the data export directory can be changed in runtime.
ExportDirectoryname (Page 4286)	P	P	Specifies the target directory for the exported Runtime data.
ExportFileExtension (Page 4287)	P	P	Specifies the file extension of the export file. Only the "csv" file extension is currently supported.
ExportFilename (Page 4288)	P	P	Specifies the name of the target file for the exported Runtime data.
ExportFilenameChangeable (Page 4288)	P	P	Specifies whether the export file name can be changed in runtime.
ExportFormatGuid (Page 4289)	P	P	Default assignment of the ID number and export provider.
ExportFormatName (Page 4289)	P	P	Specifies the export file format. Only the "csv" file format is currently available for the export.
ExportParameters (Page 4290)	P	P	Specifies the parameters of the selected format by means of the "Properties" dialog.
ExportSelection (Page 4290)	P	P	Specifies the file extension of the export file. Only the "csv" file extension is currently supported.
ExportShowDialog (Page 4291)	P	P	Specifies whether the data export dialog is shown in runtime.
Font (Page 4311)	-	-	Specifies or returns the font.
GraphDirection (Page 4324)	P	P	Specifies at which border of the trend window the current values are displayed.
Height (Page 4327)	P	-	Sets the height of the specified "Ellipsis", "Circle" and "Rectangle" objects.
Layer (Page 4355)	-	-	Returns the layer that contains an object as LONG in the screen.
Left (Page 4366)	P	P	Specifies the value of the X coordinate of the object.
LineColor (Page 4379)	P	P	Sets the color of the window separation lines.

Properties	Read	Write	Description
LineWidth (Page 4382)	P	P	Specifies the line thickness of the selected object.
LoadDataImmediately (Page 4383)	P	P	Specifies whether the tag values are downloaded from the logs for the time range to be displayed when you call a screen.
Moveable (Page 4416)	P	P	Specifies whether the window can be moved in runtime.
Name (Page 4417)	P	-	Returns the object name as STRING.
Online (Page 4428)	P	P	Specifies the name of the data source.
PercentageAxis	P	P	Specifies that an axis with percentage scaling is shown.
PercentageAxisAlign	P	P	
PercentageAxisColor	P	P	Specifies the color of the percentage axis.
PrintJob	P	P	Specifies a print job
RTPersistence (Page 4477)	P	P	Specifies how online configurations of WinCC are retained.
RTPersistenceAuthorization	P	P	Specifies the authorization required for online configuration in runtime.
RTPersistenceType (Page 4478)	-	-	Specifies how online configurations of WinCC are retained.
ShowRuler (Page 4525)	P	P	Specifies whether a scale gradation (auxiliary line) is shown for the axis label of the "OnlineTrendControl" object.
ShowRulerInAxis (Page 4526)	P	P	Specifies whether rulers are also displayed in the time axes.
ShowScrollbars (Page 4527)	P	P	Specifies the scroll bar type.
ShowStatisticRuler	P	P	Specifies the SQL statement.
ShowTitle (Page 4534)	P	P	Specifies the representation of the control's window title.
ShowTrendIcon (Page 4535)	P	P	Specifies whether an icon is displayed below the value axes.
Sizeable (Page 4538)	P	P	Specifies that the size of an object can be changed in runtime.
StatusbarBackColor (Page 4547)	P	P	Specifies the background color of the status bar.
StatusbarElementAdd (Page 4547) *	P	P	Creates a new, user-defined status bar element.
StatusbarElementAutoSize (Page 4548) *	P	P	Specifies whether the width of the selected status bar element is set automatically.
StatusbarElementCount (Page 4548) *	P	P	Specifies the number of configurable status bar elements.
StatusbarElementIconId (Page 4549) *	P	P	Default assignment of the ID number and icon of a status bar element.
StatusbarElementId (Page 4549) *	P	P	Unique ID of the selected status bar element.
StatusbarElementIndex (Page 4550)	P	P	References a status bar element. You can use this property to assign the values of other properties to a specific element of the status bar.
StatusbarElementName (Page 4550) *	P	P	Displays the object name of the selected status bar element.
StatusbarElementRemove (Page 4551) *	P	P	Removes the selected status bar element.
StatusbarElementRename (Page 4551) *	P	P	Renames the user-defined status bar element that is referenced by means of the "StatusbarElementIndex" property.
StatusbarElementRepos *	P	P	Specifies the index that is assigned to the element.
StatusbarElements (Page 4552)	-	-	Specifies the elements that are to be shown in the status bar.
StatusbarElementText *	P	P	Specifies the text of the currently selected status bar element.
StatusbarElementTooltipText (Page 4552) *	P	P	Specifies the tooltip text for the user-defined status bar element.

Properties	Read	Write	Description
StatusbarElementUserDefined (Page 4553) *	P	P	Indicates whether the project engineer has added the toolbar button as a new user-defined element.
StatusbarElementVisible (Page 4554) *	P	P	In the list, activate the status bar elements that you wish to display in runtime.
StatusbarElementWidth (Page 4554) *	P	P	Specifies the width of the selected status bar element in pixels.
StatusbarFont	-	-	Status bar font
StatusbarFontColor (Page 4554)	P	P	Specifies the color of the text in the status bar.
StatusbarShowTooltips (Page 4557)	P	P	Specifies whether tooltips are displayed for the elements of the status bar in runtime.
StatusbarText (Page 4558)	P	P	Default text in the status bar.
StatusbarUseBackColor (Page 4558)	P	P	Specifies whether the background color of the status bar is shown.
StatusbarVisible (Page 4559)	P	P	Specifies whether the status bar of the control is displayed.
TimeAxes	-	-	Specifies the settings for the time axes.
TimeAxisActualize *	P	P	
TimeAxisAdd *	P	P	Inserts an axis.
TimeAxisAlignment *	P	P	Specifies the alignment of an axis.
TimeAxisBeginTime (Page 4580) *	P	P	Specifies the starting time for the display of the selected trend.
TimeAxisColor *	P	P	Specifies the color of an axis.
TimeAxisCount *	P	P	Displays the number of time axes.
TimeAxisDateFormat *	P	P	Specifies the date format.
TimeAxisEndTime (Page 4580) *	P	P	Specifies the end time for the display of the selected trend.
TimeAxisIndex	P	P	The index specifies on which axis other properties, e.g. initial value are based.
TimeAxisInTrendColor *	P	P	Specifies that the color of the trend is used for an axis.
TimeAxisLabel (Page 4581) *	P	P	Specifies the header for the time axis. Whether or not the information is evaluated depends on the "ConfigureTimeAxis(i)" property.
TimeAxisMeasurePoints *	P	P	Specifies the measuring points.
TimeAxisName *	P	P	Specifies the name of an axis.
TimeAxisRangeType *	P	P	Specifies the type of time range.
TimeAxisRemove *	P	P	Deletes a time axis
TimeAxisRename *	P	P	Renames a time axis.
TimeAxisRepos *	P	P	Specifies that the time axis is repositioned
TimeAxisShowDate *	P	P	Specifies that the date is to be displayed.
TimeAxisTimeFormat (Page 4584) *	P	P	Specifies the time format.
TimeAxisTimeRangeBase *	P	P	A time range is set via a base and a factor.
TimeAxisTimeRangeFactor *	P	P	A time range is set via a base and a factor.
TimeAxisTrendWindow *	P	P	Specifies the trend view.
TimeAxisVisible *	P	P	Specifies that the time axis is visible.
TimeBase (Page 4584)	P	P	Sets the time zone that forms the basis for the display of time values.
ToolbarAlignment (Page 4616)	P	P	Specifies or returns the position of the toolbar.



Properties	Read	Write	Description
ToolBarBackColor (Page 4616)	P	P	Specifies the background color of the toolbar.
ToolBarButtonActive (Page 4617) *	P	P	Specifies whether the function linked to the button is activated in runtime.
ToolBarButtonAdd (Page 4618) *	P	P	Creates a new, user-defined button function.
ToolBarButtonBeginGroup (Page 4618) *	P	P	Specifies whether a separator is inserted before the selected button function.
ToolBarButtonClick	P	P	Clicks a toolbar button.
ToolBarButtonCount (Page 4619) *	P	P	Specifies the number of configurable button functions.
ToolBarButtonEnabled (Page 4619) *	P	P	Specifies whether a user-defined toolbar button can be operated.
ToolBarButtonHotKey (Page 4620) *	P	P	Shows the hotkey for the selected button function.
ToolBarButtonId (Page 4620) *	P	P	Unique ID number for the selected button function.
ToolBarButtonIndex (Page 4620)	P	P	References a button function.
ToolBarButtonLocked (Page 4621) *	P	P	Specifies whether the clicked, pressed in state is displayed for a user-defined toolbar button.
ToolBarButtonName (Page 4621) *	P	P	Shows the name of the selected button function.
ToolBarButtonPasswordLevel (Page 4622) *	P	P	Shows the authorization for the selected button function.
ToolBarButtonRemove (Page 4622) *	P	P	Removes the selected button function from the list.
ToolBarButtonRename (Page 4622) *	P	P	Renames the user-defined toolbar element that is referenced by means of the "ToolBarButtonIndex" property.
ToolBarButtonRepos (Page 4623) *	P	P	Changes the sequence of button functions.
ToolBarButtons	-	-	Specifies which buttons are available for the toolbar.
ToolBarButtonTooltipText (Page 4623) *	P	P	Specifies the tooltip text for the button.
ToolBarButtonUserDefined (Page 4624) *	P	P	Indicates whether the project engineer has added the toolbar button as a new user-defined button.
ToolBarButtonVisible *	P	P	Specifies that the button is visible.
ToolBarShowTooltips (Page 4624)	P	P	Specifies whether the tooltips for the button functions are displayed in runtime.
ToolBarUseBackColor (Page 4625)	P	P	Specifies whether the background color for the toolbar is shown.
ToolBarUseHotKeys (Page 4626)	P	P	Specifies whether the hotkeys for the button functions are activated in runtime.
ToolBarVisible (Page 4626)	P	P	Specifies whether the toolbar of the control is displayed.
Top (Page 4629)	P	P	Specifies the value of the Y coordinate of the object.
TrendAdd (Page 4638) *	P	P	Creates a new trend.
TrendAutoRangeBeginTagName *	P	P	Specifies a tag that defines the initial value.
TrendAutoRangeBeginValue *	P	P	Specifies the initial value for the automatically adjusted display range.
TrendAutoRangeEndTagName *	P	P	Specifies a tag that defines the end value.
TrendAutoRangeEndValue *	P	P	Specifies a tag that defines the end value.
TrendAutoRangeSource *	P	P	Specifies the source of the display range.
TrendColor (Page 4638) *	P	P	Specifies or returns the trend view color.
TrendCount (Page 4639) *	P	P	Specifies the number of configured trends.

10.8 Working with system functions and Runtime scripting

Properties	Read	Write	Description
TrendExtendedColorSet (Page 4639) *	P	P	Specifies whether you can configure the point color and the fill color and whether the colors are shown in runtime.
TrendFill (Page 4640) *	P	P	Specifies whether the area below the trend is shown filled.
TrendFillColor (Page 4640) *	P	P	Sets the fill color of the trend.
TrendIndex (Page 4641)	P	P	References a configured trend.
TrendLabel (Page 4642) *	P	P	Specifies the label of the selected trend.
TrendLineStyle (Page 4642) *	P	P	Specifies which line type is used for display of the trend.
TrendLineType (Page 4643) *	P	P	Specifies how the trend is displayed.
TrendLineWidth (Page 4643) *	P	P	Specifies the line thickness of the line displayed.
TrendLowerLimit (Page 4644) *	P	P	Specifies the low limit of a tag.
TrendLowerLimitColor (Page 4644) *	P	P	Specifies the color which indicates tag values below the value of "TrendLowerLimit".
TrendLowerLimitColoring (Page 4644) *	P	P	Specifies whether the selection frame is shown with the color defined by the system.
TrendName (Page 4645) *	P	P	Displays the name of the selected trend.
TrendPointColor (Page 4645) *	P	P	Specifies the color of trend points.
TrendPointStyle (Page 4646) *	P	P	Specifies how the points are displayed on the trend.
TrendPointWidth (Page 4646) *	P	P	Specifies the point width in pixels.
TrendProvider (Page 4647) *	P	P	Specifies the data supply for the selected trend.
TrendProviderCLSID *	P	P	Specifies the provider CLSID of the data for a trend.
TrendRemove (Page 4648) *	P	P	Removes selected trends from the list.
TrendRename (Page 4648) *	P	P	Renames the trend that is referenced by means of the "TrendIndex" property.
TrendRepos (Page 4649) *	P	P	Repositions the selected trend in the sequence in the trend window.
TrendSelectTagName *	P	P	Specifies a tag.
TrendTagName *	P	P	Specifies the name of the tag for the Y direction.
TrendTimeAxis *	P	P	Specifies the time axis.
TrendTrendWindow (Page 4652) *	P	P	Specifies the trend window in which the selected trend is shown.
TrendUncertainColor (Page 4652) *	P	P	Values have an uncertain status if the initial value is unknown after Runtime has been activated, or if a substitute value is used.
TrendUncertainColoring (Page 4653) *	P	P	Values have an uncertain status if the initial value is unknown after Runtime has been activated, or if a substitute value is used.
TrendUpperLimit (Page 4653) *	P	P	Specifies the high limit of a tag. If the tag drops below the value of "TrendLowerLimit", the values are marked with the color set in "TrendUpperLimitColor".
TrendUpperLimitColor (Page 4654) *	P	P	Specifies the color which indicates tag values below the value of "TrendLowerLimit".
TrendUpperLimitColoring (Page 4654) *	P	P	Specifies whether the selection frame is shown with the color defined by the system.
TrendValueAxis *	P	P	Specifies the value axis.
TrendVisible (Page 4654) *	P	P	The list contains all the trends that you have created.
TrendWindowAdd (Page 4655) *	P	P	Creates a new trend view.

Properties	Read	Write	Description
TrendWindowCoarseGrid (Page 4655) *	P	P	Specifies whether grid lines are displayed for the main scaling.
TrendWindowCoarseGridColor (Page 4656) *	P	P	Specifies the color of the grid lines for the main scaling.
TrendWindowCount *	P	P	Displays the number of trend views.
TrendWindowFineGrid (Page 4656) *	P	P	Specifies whether grid lines are displayed for the secondary scaling.
TrendWindowFineGridColor (Page 4657) *	P	P	Specifies the grid color of the main scaling.
TrendWindowForegroundTrendGrid (Page 4657) *	P	P	Specifies whether only the grid lines for the foreground trend are displayed in the selected trend window.
TrendWindowGridInTrendColor (Page 4657) *	P	P	Specifies whether the grid lines for the main scaling are displayed in the trend color.
TrendWindowHorizontalGrid (Page 4658) *	P	P	Specifies whether the horizontal grid lines are shown.
TrendWindowIndex (Page 4659)	P	P	References a configured trend window.
TrendWindowName (Page 4659) *	P	P	Specifies the name of the selected trend window.
TrendWindowRemove (Page 4659) *	P	P	Removes the selected trend view from the list.
TrendWindowRename (Page 4659) *	P	P	Changes the name of the trend window which is referenced by the "TrendWindowIndex" property.
TrendWindowRepos (Page 4660) *	P	P	Changes the order of the trend view.
TrendWindowRulerColor (Page 4660) *	P	P	Specifies the ruler color.
TrendWindowRulerLayer (Page 4660) *	P	P	Specifies the display layer of the ruler in the trend view.
TrendWindowRulerStyle (Page 4661) *	P	P	Specifies the representation of the ruler.
TrendWindowRulerWidth (Page 4662) *	P	P	Specifies the ruler width in pixels.
TrendWindows	-	-	Specifies the settings for trend views.
TrendWindowSpacePortion (Page 4662) *	P	P	Specifies the proportion of the selected trend window for display in the control.
TrendWindowStatisticRulerColor *	P	P	Specifies the color of the statistics ruler.
TrendWindowStatisticRulerStyle *	P	P	Specifies the style of the statistics ruler.
TrendWindowStatisticRulerWidth *	P	P	Specifies the width of the statistics ruler.
TrendWindowVerticalGrid (Page 4662) *	P	P	Specifies whether the vertical grid lines are displayed.
TrendWindowVisible (Page 4663) *	P	P	The list contains the trend views that you have created.
UseTrendNameAsLabel (Page 4687)	P	P	Specifies whether the "Name" or "Label" property is used as a designation for the trend in runtime.
ValueAxes	-	-	Specifies the settings for the value axes.
ValueAxisAdd *	P	P	Inserts an axis.
ValueAxisAlignment *	P	P	Specifies the alignment of an axis.
ValueAxisAutoPrecisions *	P	P	Specifies that the number of decimal places displayed for an axis is adjusted automatically.
ValueAxisAutoRange *	P	P	Specifies that the value range is determined automatically.

Properties	Read	Write	Description
ValueAxisBeginValue *	P	P	Specifies the initial value of an axis.
ValueAxisColor *	P	P	Specifies the color of a value axis.
ValueAxisCount *	P	P	Shows the number of value axes.
ValueAxisEndValue *	P	P	Specifies the end value of an axis.
ValueAxisExponentialFormat *	P	P	Specifies that the label of an axis uses exponential notation.
ValueAxisIndex	P	P	The index specifies on which axis other properties, e.g. initial value are based.
ValueAxisInTrendColor *	P	P	Specifies that the color of the trend is used for an axis.
ValueAxisLabel (Page 4695) *	P	P	Specifies the label of the value axis.
ValueAxisName *	P	P	Specifies the name of an axis.
ValueAxisPrecisions *	P	P	Specifies the number of displayed decimal places.
ValueAxisRemove *	P	P	Renames an axis.
ValueAxisRename *	P	P	Renames an axis.
ValueAxisRepos *	P	P	Specifies that the value axis is repositioned.
ValueAxisScalingType (Page 4696) *	P	P	Specifies the type of axis scaling.
ValueAxisTrendWindow *	P	P	Specifies the trend view.
ValueAxisVisible *	P	P	Specifies whether a value axis is visible.
Visible (Page 4703)	P	P	Specifies whether the selected object is visible.
Width (Page 4714)	P	-	Sets the width of the specified "Ellipsis", "Circle" and "Rectangle" objects.

\* not visible in the ES

Table 10-82 Methods

Methods	Valid	Description
Activate (Page 4744)	P, A	Activates the permanent window or the root screen.
ActivateDynamic (Page 4747)	P	Dynamically activates a trigger and the specified cycle for a property at runtime.
AttachDB (Page 4750)	P, A	Executes the "Connect backup" button function of the control.
CalculateStatistic (Page 4751)	P	Executes the "Calculate statistics" button function of the f(t) trend view and table view.
DeactivateDynamic (Page 4754)	P	Deactivates the trigger of the "ActivateDynamic" method used for the specified property in/during Runtime.
DetachDB (Page 4756)	P, A	Executes the "Disconnect backup" button function of the control.
Export (Page 4757)	P, A	Executes the "Export log" or "Export data" button function of the control.
GetRulerData (Page 4776)	P	Returns the value of the called trend at the ruler position.
GetStatusbarElement (Page 4784)	P, A	Returns the element of the control's status bar designated by name or index as "ICCAxStatusbarElement" type.
GetStatusbarElementCollection (Page 4790)	P, A	Returns the list of all status bar elements of the control as "ICCAxCollection" type.
GetTimeAxis (Page 4786)	P	Returns the time axis object of the f(t) trend view designated by name or index as "ICCAxTimeAxis" type.
GetTimeAxisCollection (Page 4788)	P	Returns the list of all time axis objects of the f(t) trend view as "ICCAxCollection" type.

Methods	Valid	Description
GetToolBarButton (Page 4792)	P	Returns the button function designated by name or index on the control toolbar as "ICCAxToolBarButton" type.
GetToolBarButtonCollection (Page 4793)	P	Returns the list of all button functions of the control toolbar as "ICCAxCollection" type.
GetTrend (Page 4794)	P, A	Returns the f(t) or f(x) trend view designated by name or index as "ICCAxTrend" or "ICCAxFunctionTrend" type.
GetTrendCollection (Page 4795)	P, A	Returns the list of all trends of the f(t) or f(x) trend view as "ICCAxCollection" type.
GetTrendWindow (Page 4797)	P, A	Returns the trend window object of the f(t) or f(x) trend view designated by name or index as "ICCAxTrendWindow" type.
GetTrendWindowCollection (Page 4798)	P, A	Returns the list of all trend window objects of the f(t) or f(x) trend views as "ICCAxCollection" type.
GetValueAxis (Page 4799)	P	Returns the value axis object of the f(t) trend view designated by name or index as "ICCAxValueAxis" type.
GetValueAxisCollection (Page 4800)	P	Returns the list of all value axis objects of the f(t) trend view as "ICCAxCollection" type.
MoveAxis (Page 4813)	P, A	Executes the "Move axes area" button function of the f(t) and f(x) trend views.
MoveToFirst (Page 4813)	P	Executes the "First line" button function of the control.
MoveToLast (Page 4815)	P	Executes the "Last data record" button function of the control.
MoveToNext (Page 4816)	P	Executes the "Next data record" button function of the control.
MoveToPrevious (Page 4818)	P	Executes the "Previous data record" button function of the control.
NextTrend (Page 4820)	P, A	Executes the "Next trend" button function of the f(t) and f(x) trend views.
OneToOneView (Page 4820)	P, A	Executes the "Original view" button function of the f(t) and f(x) trend views.
PreviousTrend (Page 4822)	P, A	Executes the "Previous trend" button function of the f(t) and f(x) trend views.
Print (Page 4822)	P, A	Executes the "Print" button function of the control.
ShowHelp (Page 4842)	P, A	Executes the "Help" button function of the control.
ShowPercentageAxis (Page 4846)	P	Executes the "Relative axis" button function of the f(t) trend view.
ShowPropertyDialog (Page 4847)	P, A	Executes the "Configuration dialog" button function of the control.
ShowTagSelection (Page 4851)	P, A	Executes the "Select data connection" button function of the control.
ShowTimeSelection (Page 4852)	P, A	Executes the "Select time range" button function of the control.
ShowTrendSelection (Page 4852)	P, A	Executes the "Select trends" button function of the f(t) and f(x) trend views.
StartStopUpdate (Page 4853)	P, A	Executes the "Start" or "Stop" button function of the control.
ZoomArea (Page 4860)	P, A	Executes the "Zoom area" button function of the f(t) and f(x) trend views.
ZoomInOut (Page 4861)	P, A	Executes the "Zoom +/-" button function of the f(t) and f(x) trend views.
ZoomInOutTime (Page 4861)	P	Executes the "Zoom time axis +/-" button function of the f(t) trend view.
ZoomInOutValues (Page 4862)	P	Executes the "Zoom value axis +/-" button function of the f(t) trend view.
ZoomMove (Page 4863)	P, A	Executes the "Move trend area" button function of the f(t) and f(x) trend views.

**See also**

Screen object (list) (Page 3936)

**OptionGroup**

**Description**

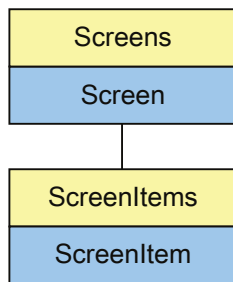

Represents the "Option button" object. The OptionGroup object is an element of the ScreenItems list.

**Type identifier in VBS**

HMIOptionGroup

Abbreviation	Validity
Pa	Panels
A	Runtime Advanced
P	Runtime Professional

Table 10-83 Properties

Properties	Read	Write	Description
AdaptBorder (Page 4156)	P	P	Specifies whether the border of the specified object is dynamically adapted to the text size.
Authorization (Page 4175)	P	P	Specifies the operating rights of the selected object in runtime.
BackColor (Page 4181)	P	P	Specifies the background color of the selected object.
BackFillStyle (Page 4185)	P	P	Defines the fill pattern of the specified object.
BackFlashingColorOff (Page 4188)	P	P	Specifies the background color for flash state "Off".
BackFlashingColorOn (Page 4188)	P	P	Specifies the background color for flash state "On".
BackFlashingEnabled (Page 4189)	P	P	Specifies whether the background of the specified object flashes in runtime.
BackFlashingRate (Page 4190)	P	P	Specifies the flash rate of the background for the selected object.
BorderBackColor (Page 4199)	P	P	Specifies the background color of the broken border line for the selected object.
BorderColor (Page 4202)	P	P	Specifies the line color of the object.
BorderFlashingColorOff (Page 4206)	P	P	Specifies the border line color of the selected object for the flash state "Off".
BorderFlashingColorOn (Page 4207)	P	P	Specifies the border line color of the selected object for the flash state "On".
BorderFlashingEnabled (Page 4208)	P	P	Specifies whether the border line of the selected object flashes in runtime.
BorderFlashingRate (Page 4209)	P	P	Specifies the flash rate of the border line for the selected object.
BorderStyle (Page 4213)	P	P	Specifies the type of border lines for the selected object.
BorderWidth (Page 4216)	P	P	Specifies the line thickness of the object.
CheckmarkAlignment (Page 4233)	P	P	Specifies whether the fields are right aligned.
CheckmarkCount (Page 4233)	P	P	Specifies the number of fields.
CornerStyle (Page 4250)	-	-	Specifies the type of border lines for the selected object.
DrawInsideFrame (Page 4270)	P	P	Specifies whether the border line of the selected object with a line thickness greater than 1 should be drawn within the border or symmetrically to the border.
EdgeStyle (Page 4274)	-	-	Specifies the line style of the selected object.
Enabled (Page 4277)	P	P	Specifies whether the selected object can be operated in runtime.
FillPatternColor (Page 4296)	P	P	Specifies the color of the fill pattern for the selected object.
Flashing	-	-	Specifies that the text block flashes.
FlashingColorOff (Page 4300)	P	P	Specifies the border line color of the selected object for the flash state "Off".
FlashingColorOn (Page 4302)	P	P	Specifies the border line color of the selected object for the flash state "On".
FlashingEnabled (Page 4303)	P	P	Specifies whether the border line of the selected object flashes in runtime.
FlashingRate (Page 4304)	P	P	Specifies the flash rate of the border line for the selected object.
Font (Page 4311)	-	-	Specifies or returns the font.

Properties	Read	Write	Description
FontBold (Page 4313)	P	P	Specifies whether the text of the selected object is shown in bold.
FontItalic (Page 4314)	P	P	Specifies whether the text of the selected object is shown in italics.
FontName (Page 4315)	P	P	Specifies the font of the selected object.
FontSize (Page 4316)	P	P	Specifies the font size of the text for the selected object.
FontUnderline (Page 4317)	P	P	Specifies whether the text of the selected object is underlined.
ForeColor (Page 4318)	P	P	Specifies the font color of the text for the selected object.
Height (Page 4327)	P	P	Sets the height of the specified "Ellipsis", "Circle" and "Rectangle" objects.
HorizontalAlignment (Page 4340)	P	P	Specifies the horizontal alignment of the text within the selected object.
Index (Page 4344)	P	P	Specifies the background for grid control elements.
Layer (Page 4355)	-	-	Returns the layer that contains an object as LONG in the screen.
Left (Page 4366)	P	P	Specifies the value of the X coordinate of the object.
LineEndShapeStyle (Page 4380)	-	-	Specifies the shape of the line ends.
LogOperation (Page 4386)	P	P	Specifies whether, after operating this object, an alarm is output to the alarm system.
Name (Page 4417)	P	-	Returns the object name as STRING.
ProcessValue (Page 4461)	P	P	Specifies the default for the value to be displayed.
RelativeFillLevel (Page 4470)	P	P	Specifies the fill percentage for the object.
ShowBadTagState (Page 4516)	P	P	Specifies whether an object is grayed out if its associated tag has a bad quality code or tag state.
ShowFillLevel (Page 4519)	P	P	Specifies whether the selected object is filled.
Text (Page 4572)	P	P	Specifies the label for the text field.
TextOrientation (Page 4576)	P	P	Specifies the text orientation of the selected object.
Texts	-	-	Specifies the texts for the check boxes.
ToolTipText (Page 4627)	P	P	Specifies the tooltip text.
Top (Page 4629)	P	P	Specifies the value of the Y coordinate of the object.
Transparency (Page 4633)	P	P	Specifies and returns the transparency percentage of the object.
UseDesignColorScheme (Page 4674)	P	P	Specifies the font used for printing.
UseDesignShadowSettings (Page 4676)	P	P	Specifies whether the object is displayed with the shading defined in the active design.
VerticalAlignment (Page 4701)	P	P	Specifies the vertical alignment of the text for the selected object.
Visible (Page 4703)	P	P	Specifies whether the selected object is visible.
Width (Page 4714)	P	P	Sets the width of the specified "Ellipsis", "Circle" and "Rectangle" objects.



Table 10-84 Methods

Methods	Valid	Description
Activate (Page 4744)	P, A	Activates the permanent window or the root screen.
ActivateDynamic (Page 4747)	P	Dynamically activates a trigger and the specified cycle for a property at runtime.
DeactivateDynamic (Page 4754)	P	Deactivates the trigger of the "ActivateDynamic" method used for the specified property in/during Runtime.

**See also**

Screen object (list) (Page 3936)

**Polygon**

**Description**

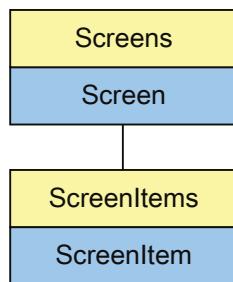

Represents the "Polygon" object. The Polygon object is an element of the ScreenItems list.

**Type identifier in VBS**

HMIPolygon

Abbreviation	Validity
Pa	Panels
A	Runtime Advanced
P	Runtime Professional

Table 10-85 Properties

Properties	Read	Write	Description
ActualPointIndex (Page 4154)	P	P	Specifies the number of the current corner point of the selected object.
ActualPointLeft (Page 4154)	P	P	Specifies the X coordinate of the current corner point with reference to the screen origin.
ActualPointTop (Page 4155)	P	P	Specifies the Y coordinate of the current corner point with reference to the screen origin.
Authorization (Page 4175)	P	P	Specifies the operating rights of the selected object in runtime.
BackColor (Page 4181)	P, A	P, A	Specifies the background color of the selected object.
BackFillStyle (Page 4185)	P, A	P, A	Defines the fill pattern of the specified object.
BorderBackColor (Page 4199)	P	P	Specifies the background color of the broken border line for the selected object.
BorderColor (Page 4202)	P, A	P, A	Specifies the line color of the object.
BorderFlashingColorOff (Page 4206)	P	P	Specifies the border line color of the selected object for the flash state "Off".
BorderFlashingColorOn (Page 4207)	P	P	Specifies the border line color of the selected object for the flash state "On".
BorderFlashingEnabled (Page 4208)	P	P	Specifies whether the border line of the selected object flashes in runtime.
BorderFlashingRate (Page 4209)	P	P	Specifies the flash rate of the border line for the selected object.
BorderStyle (Page 4213)	P	P	Specifies the type of border lines for the selected object.
BorderWidth (Page 4216)	P, A	P, A	Specifies the line thickness of the object.
CornerStyle (Page 4250)	P	P	Specifies the type of border lines for the selected object.
EdgeStyle (Page 4274)	A	A	Specifies the line style of the selected object.
Enabled (Page 4277)	P	P	Specifies whether the selected object can be operated in runtime.
FillPatternColor (Page 4296)	P	P	Specifies the color of the fill pattern for the selected object.
Flashing	-	-	Specifies that the text block flashes.
FlashingColorOff (Page 4300)	P	P	Specifies the border line color of the selected object for the flash state "Off".
FlashingColorOn (Page 4302)	P	P	Specifies the border line color of the selected object for the flash state "On".
FlashingEnabled (Page 4303)	P	P	Specifies whether the border line of the selected object flashes in runtime.
FlashingRate (Page 4304)	P	P	Specifies the flash rate of the border line for the selected object.
Height (Page 4327)	P, A	P, A	Sets the height of the specified "Ellipsis", "Circle" and "Rectangle" objects.
Layer (Page 4355)	-	-	Returns the layer that contains an object as LONG in the screen.
Left (Page 4366)	P, A	P, A	Specifies the value of the X coordinate of the object.

Properties	Read	Write	Description
LineEndShapeStyle (Page 4380)	P	P	Specifies the shape of the line end.
Name (Page 4417)	P, A	-	Returns the object name as STRING.
Points	-	-	Specifies the corner points.
PointsCount (Page 4458)	P	-	Specifies the number of corner points of the polyline or of the polygon.
RelativeFillLevel (Page 4470)	P	P	Specifies the fill percentage for the object.
RotationAngle (Page 4472)	P	P	Specifies the angle of rotation in degrees.
RotationCenterLeft (Page 4473)	P	P	Specifies the X coordinate of the pivot point for the object in runtime.
RotationCenterTop (Page 4474)	P	P	Specifies the Y coordinate of the pivot point for the object in runtime.
ShowFillLevel (Page 4519)	P	P	Specifies whether the selected object is filled.
ToolTipText (Page 4627)	P	P	Specifies the tooltip text.
Top (Page 4629)	P, A	P, A	Specifies the value of the Y coordinate of the object.
Transparency (Page 4633)	P	P	Specifies and returns the transparency percentage of the object.
UseDesignColorScheme (Page 4674)	P	P	Specifies the font used for printing.
UseDesignShadowSettings (Page 4676)	P	P	Specifies whether the object is displayed with the shading defined in the active design.
Visible (Page 4703)	P, A	P, A	Specifies whether the selected object is visible.
Width (Page 4714)	P, A	P, A	Sets the width of the specified "Ellipsis", "Circle" and "Rectangle" objects.

Table 10-86 Methods

Methods	Valid	Description
Activate (Page 4744)	P, A	Activates the permanent window or the root screen.
ActivateDynamic (Page 4747)	P	Dynamically activates a trigger and the specified cycle for a property at runtime.
DeactivateDynamic (Page 4754)	P	Deactivates the trigger of the "ActivateDynamic" method used for the specified property in/during Runtime.

**See also**

Screen object (list) (Page 3936)

## Polyline

### Description

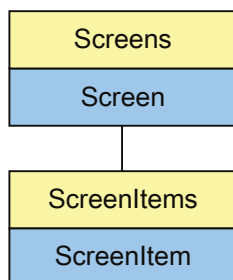

Represents the "Polyline" object. The Polyline object is an element of the ScreenItems list.

### Type identifier in VBS

HMIPolyline

Abbreviation	Validity
Pa	Panels
A	Runtime Advanced
P	Runtime Professional

Table 10-87 Properties

Properties	Read	Write	Description
ActualPointIndex (Page 4154)	P	P	Specifies the number of the current corner point of the selected object.
ActualPointLeft (Page 4154)	P	P	Specifies the X coordinate of the current corner point with reference to the screen origin.
ActualPointTop (Page 4155)	P	P	Specifies the Y coordinate of the current corner point with reference to the screen origin.

Properties	Read	Write	Description
Authorization (Page 4175)	P	P	Specifies the operating rights of the selected object in runtime.
BackColor (Page 4181)	P, A	P, A	Specifies the background color of the selected object.
BorderEndStyle (Page 4205)	P; A	P	Specifies the type of line ends for the selected object.
BorderStyle (Page 4213)	P, A	P	Specifies the type of border lines for the selected object.
Color (Page 4236)	P, A	P, A	Specifies the line color of the selected object.
CornerStyle (Page 4250)	P	P	Specifies the type of border lines for the selected object.
Enabled (Page 4277)	P	P	Specifies whether the selected object can be operated in runtime.
EndStyle (Page 4283)	A	A	Specifies how the line end of the selected object is displayed.
FillStyle (Page 4297)	A	A	Defines the fill pattern of the specified object.
Flashing	-	-	Specifies that the text block flashes.
FlashingColorOff (Page 4300)	P	P	Specifies the border line color of the selected object for the flash state "Off".
FlashingColorOn (Page 4302)	P	P	Specifies the border line color of the selected object for the flash state "On".
FlashingEnabled (Page 4303)	P	P	Specifies whether the border line of the selected object flashes in runtime.
FlashingRate (Page 4304)	P	P	Specifies the flash rate of the border line for the selected object.
Height (Page 4327)	P, A	P, A	Sets the height of the specified "Ellipsis", "Circle" and "Rectangle" objects.
Layer (Page 4355)	-	-	Returns the layer that contains an object as LONG in the screen.
Left (Page 4366)	P, A	P, A	Specifies the value of the X coordinate of the object.
LineEndShapeStyle (Page 4380)	P	P	Specifies the shape of the line end.
LineWidth (Page 4381)	P, A	P, A	Specifies the line thickness of the selected object.
Name (Page 4417)	P, A	-	Returns the object name as STRING.
Points	-	-	Specifies the corner points.
PointsCount (Page 4458)	P	-	Specifies the number of corner points of the polyline or of the polygon.
RotationAngle (Page 4472)	P	P	Specifies the angle of rotation in degrees.
RotationCenterLeft (Page 4473)	P	P	Specifies the X coordinate of the pivot point for the object in runtime.
RotationCenterTop (Page 4474)	P	P	Specifies the Y coordinate of the pivot point for the object in runtime.
StartStyle (Page 4545)	A	A	Specifies how the line start of the selected object is displayed.
Style (Page 4560)	A	A	Specifies the line style of the selected object.
ToolTipText (Page 4627)	P	P	Specifies the tooltip text.
Top (Page 4629)	P, A	P, A	Specifies the value of the Y coordinate of the object.
Transparency (Page 4633)	P	P	Specifies and returns the transparency percentage of the object.
UseDesignColorScheme (Page 4674)	P	P	Specifies the font used for printing.
UseDesignShadowSettings (Page 4676)	P	P	Specifies whether the object is displayed with the shading defined in the active design.
Visible (Page 4703)	P, A	P, A	Specifies whether the selected object is visible.
Width (Page 4714)	P, A	P, A	Sets the width of the specified "Ellipsis", "Circle" and "Rectangle" objects.

Table 10-88 Methods

Methods	Valid	Description
Activate (Page 4744)	P, A	Activates the permanent window or the root screen.
ActivateDynamic (Page 4747)	P	Dynamically activates a trigger and the specified cycle for a property at runtime.
DeactivateDynamic (Page 4754)	P	Deactivates the trigger of the "ActivateDynamic" method used for the specified property in/during Runtime.

**See also**

Screen object (list) (Page 3936)

**ProjectName**

**Description**

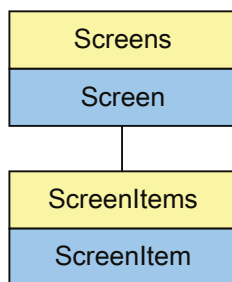

Represents the "Project name" object. The ProjectName object is an element of the ScreenItems list.

Abbreviation	Validity
Pa	Panels
A	Runtime Advanced
P	Runtime Professional

Table 10-89 Properties

Properties	Read	Write	Description
BackColor (Page 4183)	-	-	Specifies the background color of the selected object.
BackFillStyle (Page 4186)	-	-	Defines the fill pattern of the specified object.
BorderBackColor (Page 4199)	-	-	Specifies the background color of the broken border line for the selected object.
BorderColor (Page 4203)	-	-	Specifies the line color of the object.
BorderWidth (Page 4217)	-	-	Specifies the line thickness of the object.
EdgeStyle (Page 4274)		-	Specifies the line style of the selected object.
FillPatternColor (Page 4296)	-	-	Specifies the color of the fill pattern for the selected object.
Font (Page 4311)	-	-	Specifies or returns the font.
FontBold (Page 4313)	-	-	Specifies whether the text of the selected object is shown in bold.
FontItalic (Page 4314)	-	-	Specifies whether the text of the selected object is shown in italics.
FontName (Page 4315)	-	-	Specifies the font of the selected object.
FontSize (Page 4316)	-	-	Specifies the font size of the text for the selected object.
FontUnderline (Page 4317)	-	-	Specifies whether the text of the selected object is underlined.
ForeColor (Page 4319)	-	-	Specifies the font color of the text for the selected object.
Format	-	-	Specifies that the format of the text block is displayed.
Height (Page 4327)	-	-	Sets the height of the specified "Ellipsis", "Circle" and "Rectangle" objects.
HorizontalAlignment (Page 4341)	-	-	Specifies the horizontal alignment of the text within the selected object.
Layer (Page 4355)	-	-	Returns the layer that contains an object as LONG in the screen.
Left (Page 4366)	-	-	Specifies the value of the X coordinate of the object.
LineWrap	-	-	Specifies the line break within the object.
Name (Page 4417)	-	-	Returns the object name as STRING.
Top (Page 4629)	-	-	Specifies the value of the Y coordinate of the object.
VerticalAlignment (Page 4701)	-	-	Specifies the vertical alignment of the text for the selected object.
Visible (Page 4703)	-	-	Specifies whether the selected object is visible.
Width (Page 4714)	-	-	Sets the width of the specified "Ellipsis", "Circle" and "Rectangle" objects.

None of the properties are visible in the ES.

Table 10-90 Methods

Methods	Validity	Description

Methods	Validity	Description

**See also**

- Screen (Page 3930)
- ScreenItem (Page 3932)
- ScreenItems (list) (Page 3934)
- Screen object (list) (Page 3936)

**ProtectedAreaName**

**Description**

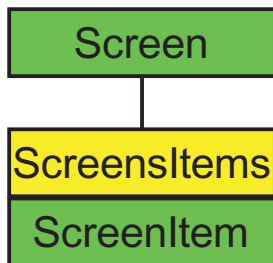

Represents the "EffectiveRangeName" (RFID)" object. The ProtectedAreaName object is an element of the ScreenItems list.

Abbreviation	Validity
Pa	Panels
A	Runtime Advanced
P	Runtime Professional



Table 10-91 Properties

Properties	Read	Write	Description
Authorization (Page 4175)	-	-	Specifies the operating rights of the selected object in runtime.
Font (Page 4311)	-	-	Specifies or returns the font.
Height (Page 4327)	A	A	Sets the height of the specified "Ellipsis", "Circle" and "Rectangle" objects.
Layer (Page 4355)	-	-	Returns the layer that contains an object as LONG in the screen.
Left (Page 4366)	A	A	Specifies the value of the X coordinate of the object.
Name (Page 4417)	A	-	Returns the object name as STRING.
Top (Page 4629)	A	A	Specifies the value of the Y coordinate of the object.
Width (Page 4714)	A	A	Sets the width of the specified "Ellipsis", "Circle" and "Rectangle" objects.

Table 10-92 Methods

Methods	Valid	Description

**See also**

- Screen (Page 3905)
- ScreenItem (Page 3906)
- ScreenItems (Page 3908)

**RangeLabelView**

**Description**

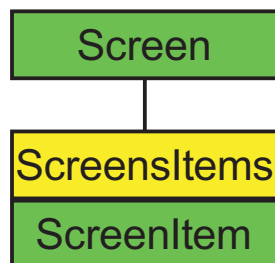

Represents the "EffectiveRangeName" object. The RangeLabelView object is an element of the ScreenItems list.

Abbreviation	Validity
Pa	Panels
A	Runtime Advanced
P	Runtime Professional

Table 10-93 Properties

Properties	Read	Write	Description
Authorization (Page 4175)	-	-	Specifies the operating rights of the selected object in runtime.
Font (Page 4311)	-	-	Specifies or returns the font.
Height (Page 4327)	A	A	Sets the height of the specified "Ellipsis", "Circle" and "Rectangle" objects.
Layer (Page 4355)	-	-	Returns the layer that contains an object as LONG in the screen.
Left (Page 4366)	A	A	Specifies the value of the X coordinate of the object.
Name (Page 4417)	A	-	Returns the object name as STRING.
Top (Page 4629)	A	A	Specifies the value of the Y coordinate of the object.
Width (Page 4714)	A	A	Sets the width of the specified "Ellipsis", "Circle" and "Rectangle" objects.

Table 10-94 Methods

Methods	Valid	Description

**See also**

- Screen (Page 3905)
- ScreenItem (Page 3906)
- ScreenItems (Page 3908)

## RangeQualityView

### Description

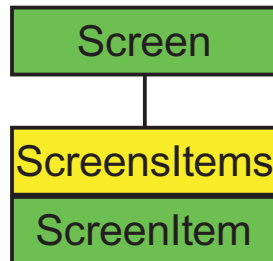

Represents the "EffectiveRangeSignal" object. The RangeQualityView object is an element of the ScreensItems list.

Abbreviation	Validity
Pa	Panels
A	Runtime Advanced
P	Runtime Professional

Table 10-95 Properties

Properties	Read	Write	Description
Height (Page 4327)	A	A	Sets the height of the specified "Ellipsis", "Circle" and "Rectangle" objects.
Layer (Page 4355)	-	-	Returns the layer that contains an object as LONG in the screen.
Left (Page 4366)	A	A	Specifies the value of the X coordinate of the object.
Name (Page 4417)	A	-	Returns the object name as STRING.
Top (Page 4629)	A	A	Specifies the value of the Y coordinate of the object.
Width (Page 4714)	A	A	Sets the width of the specified "Ellipsis", "Circle" and "Rectangle" objects.

Table 10-96 Methods

Methods	Valid	Description

Methods	Valid	Description

**See also**

Screen (Page 3905)

ScreenItem (Page 3906)

ScreenItems (Page 3908)

**RecipeView**

**Description**

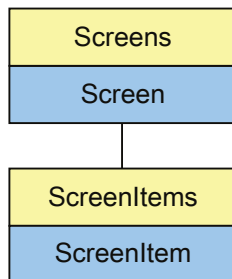

Represents the "RecipeView" object. The RecipeView object is an element of the ScreenItems list.

If you change the settings for this object with a user-defined function, the changed settings are retained even after the screen is called again.

---

**Note**

The object "Simple RecipeView" cannot be dynamized with a user-defined function.

---

Abbreviation	Validity
Pa	Panels
A	Runtime Advanced
P	Runtime Professional

Table 10-97 Properties

Properties	Read	Write	Description
AllowEdit	-	-	Enables editing.
Authorization (Page 4175)	-	-	Specifies the operating rights of the selected object in runtime.
BackButtonVisible	-	-	Enables display of the "Back" button.
BackColor (Page 4183)	A	A	Specifies the background color of the selected object.
ComboBoxFont	-	-	Sets the font type for selection list.
DataRecordNameCaption	-	-	Sets the caption for the name of the data record.
DataRecordNrCaption	-	-	Sets the caption for the number of the data record.
Display3D	-	-	Sets the 3D view.
DisplayButton2Plc	-	-	Enables the display of the "Write to PLC" button.
DisplayButtonComparison	-	-	Enables the display of the "Synchronization" button.
DisplayButtonDelete	-	-	Enables the display of the "Delete data record" button.
DisplayButtonFromPlc	-	-	Enables the display of the "Read from PLC" button.
DisplayButtonHelp	-	-	Enables the display of the "Tooltip" button.
DisplayButtonNew	-	-	Enables the display of the "Add data record" button.
DisplayButtonSave	-	-	Enables the display of the "Save" button.
DisplayButtonSaveAs	-	-	Enables the display of the "Save As" button.
DisplayComboBox	-	-	Enables the display of the selection list.
DisplayGridlines	-	-	Enables the display of grid lines.
DisplayLabeling	-	-	Enables the display labelings.
DisplayNumbers	-	-	Enables the display of numbers.
DisplaySize *	-	-	
DisplayStatusBar	-	-	Specifies that the status bar is displayed.
DisplayTable	-	-	Enablers the display of the table.
Enabled (Page 4279)	A	A	Specifies whether the selected object can be operated in runtime.
EntryNameCaption	-	-	Sets the caption for the name of the recipe element.
EntryValueColFirst	-	-	Sets the "Entry value" column to first place.
EntryValueFieldLength	-	-	Sets the field length for the element value.
EntryValuePos	-	-	Sets the position of the first value.
FitToSize	-	-	Specifies that the size of the object should be automatically adapted to the content.
FixedRecipeNumber *	-	-	
Flashing	-	-	Specifies that the text block flashes.

10.8 Working with system functions and Runtime scripting

Properties	Read	Write	Description
FocusColor (Page 4309)	A	A	Specifies the color for the focus frame of the selected object when it is in focus.
FocusWidth (Page 4310)	A	A	Specifies the border width of the specified object when the object is in focus.
Font (Page 4311)	-	-	Specifies or returns the font.
ForeColor (Page 4319)	A	A	Specifies the font color of the text for the selected object.
HeaderFont	-	-	Sets the header font.
Height (Page 4327)	A	-	Sets the height of the specified "Ellipsis", "Circle" and "Rectangle" objects.
KeyboardOnline	-	-	Enables the use of key combinations.
Layer (Page 4355)	-	-	Returns the layer that contains an object as LONG in the screen.
Left (Page 4366)	A	A	Specifies the value of the X coordinate of the object.
ListAreaHeight	-	-	
ListAreaWidth	-	-	
MenuButtonVisible	-	-	Enables visibility of the menu buttons.
Name (Page 4417)	A	-	Returns the object name as STRING.
NameColumnWidth	-	-	
NumberOfLines	-	-	Sets the number of rows of the selection list for the text list object, or returns the value.
Recipe	-	-	Sets the recipe.
RecipeNameCaption	-	-	Sets the caption for the name of the recipe.
RecipeNameSelected *	-	-	
RecipeNrCaption	-	-	Specifies that the "Recipe number" column is in first place.
RecipeNrColFirst	-	-	Specifies that the "Recipe number" column is in first place.
RecipeVarSelected *	-	-	
Record *	-	-	
RecordNameSelected *	-	-	
RecordNrColFirst	-	-	Specifies that the "Data record number" column is in first place.
RecordVarSelected *	-	-	
RenameButtonVisible	-	-	Enables the display of the "Rename" button.
SelectionBackColor (Page 4499)	A	A	Specifies the background color of the selected cells.
SelectionForeColor (Page 4501)	A	A	Specifies the foreground color of the selected cells.
StatusFont	-	-	
TableBackColor (Page 4563)	A	A	Specifies the background color of the table cells for the selected object.
TableForeColor (Page 4566)	A	A	
TableGridlineColor (Page 4567)	A	A	Specifies the color for the grid lines.
TableHeaderBackColor (Page 4568)	A	A	Specifies the background color in the header of the table of the selected object.
TableHeaderForeColor (Page 4569)	A	A	Specifies the text color in the header of the table of the selected object.
Top (Page 4629)	A	A	Specifies the value of the Y coordinate of the object.
ValueCaption	-	-	Sets the labeling for values.
ValueColumnWidth	-	-	

Properties	Read	Write	Description
VerticalScrolling	-	-	Sets the display of a scroll bar for the selected object.
ViewType	-	-	Specifies the alarm view type.
ViewTypeForSaveStream *	-	-	Specifies the display type for the Save Stream.
Visible (Page 4703)	A	A	Specifies whether the selected object is visible.
VisibleItems	-	-	Sets the maximum number of visible entries.
Width (Page 4714)	A	-	Sets the width of the specified "Ellipsis", "Circle" and "Rectangle" objects.

\* not visible in the ES

Table 10-98 Methods

Methods	Valid	Description

**See also**

Screen object (list) (Page 3904)

Screen (Page 3905)

ScreenItem (Page 3906)

ScreenItems (Page 3908)

## Rectangle

### Description

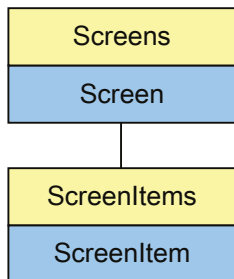

Represents the "Rectangle" object. The Rectangle object is an element of the ScreenItems list.

### Type identifier in VBS

HMIRectangle

Abbreviation	Validity
Pa	Panels
A	Runtime Advanced
P	Runtime Professional

Table 10-99 Properties

Properties	Read	Write	Description
Authorization (Page 4175)	P	P	Specifies the operating rights of the selected object in runtime.
BackColor (Page 4181)	P, A	P, A	Specifies the background color of the selected object.
BackFillStyle (Page 4185)	P, A	P, A	Defines the fill pattern of the specified object.
BorderBackColor (Page 4199)	P	P	Specifies the background color of the broken border line for the selected object.
BorderColor (Page 4202)	P, A	P, A	Specifies the line color of the object.



Properties	Read	Write	Description
BorderFlashingColorOff (Page 4206)	P	P	Specifies the border line color of the selected object for the flash state "Off".
BorderFlashingColorOn (Page 4207)	P	P	Specifies the border line color of the selected object for the flash state "On".
BorderFlashingEnabled (Page 4208)	P	P	Specifies whether the border line of the selected object flashes in runtime.
BorderFlashingRate (Page 4209)	P	P	Specifies the flash rate of the border line for the selected object.
BorderStyle (Page 4213)	P	P	Specifies the type of border lines for the selected object.
BorderWidth (Page 4216)	P, A	P, A	Specifies the line thickness of the object.
CornerStyle (Page 4250)	P	P	Specifies the type of border lines for the selected object.
DrawInsideFrame (Page 4270)	P	P	Specifies whether the border line of the selected object with a line thickness greater than 1 should be drawn within the border or symmetrically to the border.
EdgeStyle (Page 4274)	A	A	Specifies the line style of the selected object.
Enabled (Page 4277)	P	P	Specifies whether the selected object can be operated in runtime.
FillPatternColor (Page 4296)	P	P	Specifies the color of the fill pattern for the selected object.
Flashing	-	-	Specifies that the text block flashes.
FlashingColorOff (Page 4300)	P	P	Specifies the border line color of the selected object for the flash state "Off".
FlashingColorOn (Page 4302)	P	P	Specifies the border line color of the selected object for the flash state "On".
FlashingEnabled (Page 4303)	P	P	Specifies whether the border line of the selected object flashes in runtime.
FlashingRate (Page 4304)	P	P	Specifies the flash rate of the border line for the selected object.
Height (Page 4327)	P, A	P, A	Sets the height of the specified "Ellipsis", "Circle" and "Rectangle" objects.
Layer (Page 4355)	-	-	Returns the layer that contains an object as LONG in the screen.
Left (Page 4366)	P, A	P, A	Specifies the value of the X coordinate of the object.
LineEndShapeStyle (Page 4380)	P	P	Specifies the shape of the line end.
Name (Page 4417)	P, A	-	Returns the object name as STRING.
RelativeFillLevel (Page 4470)	P	P	Specifies the fill percentage for the object.
RoundCornerHeight (Page 4474)	P	P	Sets or returns the corner radius.
RoundCornerWidth (Page 4475)	P	P	Sets or returns the corner radius.
ShowFillLevel (Page 4519)	P	P	Specifies whether the selected object is filled.
ToolTipText (Page 4627)	P	P	Specifies the tooltip text.
Top (Page 4629)	P, A	P, A	Specifies the value of the Y coordinate of the object.
Transparency (Page 4633)	P	P	Specifies and returns the transparency percentage of the object.
UseDesignColorScheme (Page 4674)	P	P	Specifies the font used for printing.
UseDesignShadowSettings (Page 4676)	P	P	Specifies whether the object is displayed with the shading defined in the active design.
Visible (Page 4703)	P, A	P, A	Specifies whether the selected object is visible.
Width (Page 4714)	P, A	P, A	Sets the width of the specified "Ellipsis", "Circle" and "Rectangle" objects.

Table 10-100 Methods

Methods	Validity	Description
Activate (Page 4744)	P, A	Activates the permanent window or the root screen.
ActivateDynamic (Page 4747)	P	Dynamically activates a trigger and the specified cycle for a property at runtime.
DeactivateDynamic (Page 4754)	P	Deactivates the trigger of the "ActivateDynamic" method used for the specified property in/during Runtime.

**See also**

Screen object (list) (Page 3936)

**RoundButton**

**Description**

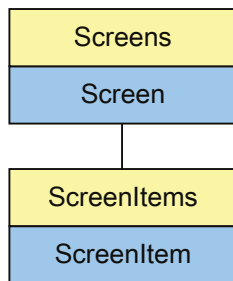

Represents the "RoundButton" object. The RoundButton object is an element of the ScreenItems list.

**Type identifier in VBS**

HMIRoundButton

Abbreviation	Validity
Pa	Panels
A	Runtime Advanced
P	Runtime Professional

Table 10-101 Properties

Properties	Read	Write	Description
Authorization (Page 4175)	P	P	Specifies the operating rights of the selected object in runtime.
BackColor (Page 4181)	P	P	Specifies the background color of the selected object.
BackFillStyle (Page 4185)	P	P	Defines the fill pattern of the specified object.
BackFlashingColorOff (Page 4188)	P	P	Specifies the background color for flash state "Off".
BackFlashingColorOn (Page 4188)	P	P	Specifies the background color for flash state "On".
BackFlashingEnabled (Page 4189)	P	P	Specifies whether the background of the specified object flashes in runtime.
BackFlashingRate (Page 4190)	P	P	Specifies the flash rate of the background for the selected object.
BorderBackColor (Page 4199)	P	P	Specifies the background color of the broken border line for the selected object.
BorderBrightColor3D (Page 4200)	P	P	Specifies the border color of the following border parts in the 3D display of the selected object.
BorderColor (Page 4202)	P	P	Specifies the line color of the object.
BorderFlashingColorOff (Page 4206)	P	P	Specifies the border line color of the selected object for the flash state "Off".
BorderFlashingColorOn (Page 4207)	P	P	Specifies the border line color of the selected object for the flash state "On".
BorderFlashingEnabled (Page 4208)	P	P	Specifies whether the border line of the selected object flashes in runtime.
BorderFlashingRate (Page 4209)	P	P	Specifies the flash rate of the border line for the selected object.
BorderShadeColor3D (Page 4212)	P	P	Specifies the border color of the following border parts in the 3D display of the selected object.
BorderStyle (Page 4213)	P	P	Specifies the type of border lines for the selected object.
BorderWidth (Page 4216)	P	P	Specifies the line thickness of the object.
BorderWidth3D (Page 4218)	P	P	Specifies the width of the border for 3D display of the selected object.
CornerStyle (Page 4250) *	-	-	Specifies the type of border lines for the selected object.
DrawInsideFrame (Page 4270)	P	P	Specifies whether the border line of the selected object with a line thickness greater than 1 should be drawn within the border or symmetrically to the border.
EdgeStyle (Page 4274)	P	P	Specifies the line style of the selected object.
Enabled (Page 4277)	P	P	Specifies whether the selected object can be operated in runtime.
FillPatternColor (Page 4296)	P	P	Specifies the color of the fill pattern for the selected object.
Flashing	-	-	Specifies that the text block flashes.

10.8 Working with system functions and Runtime scripting

Properties	Read	Write	Description
FlashingColorOff (Page 4300)	P	P	Specifies the border line color of the selected object for the flash state "Off".
FlashingColorOn (Page 4302)	P	P	Specifies the border line color of the selected object for the flash state "On".
FlashingEnabled (Page 4303)	P	P	Specifies whether the border line of the selected object flashes in runtime.
FlashingRate (Page 4304)	P	P	Specifies the flash rate of the border line for the selected object.
Font (Page 4311)	-	-	Specifies or returns the font.
FontBold (Page 4313)	P	P	Specifies whether the text of the selected object is shown in bold.
FontItalic (Page 4314)	P	P	Specifies whether the text of the selected object is shown in italics.
FontName (Page 4315)	P	P	Specifies the font of the selected object.
FontSize (Page 4316)	P	P	Specifies the font size of the text for the selected object.
FontUnderline (Page 4317)	P	P	Specifies whether the text of the selected object is underlined.
ForeColor (Page 4318)	P	P	Specifies the font color of the text for the selected object.
Height (Page 4327)	P	P	Sets the height of the specified "Ellipsis", "Circle" and "Rectangle" objects.
HorizontalAlignment (Page 4340)	P	P	Specifies the horizontal alignment of the text within the selected object.
Layer (Page 4355)	-	-	Returns the layer that contains an object as LONG in the screen.
Left (Page 4366)	P	P	Specifies the value of the X coordinate of the object.
LineEndShapeStyle (Page 4380) *	-	-	Specifies the shape of the line ends.
Mode (Page 4415)	P	P	Specifies the field type of the selected object.
Name (Page 4417)	P	-	Returns the object name as STRING.
PictureAlignment (Page 4454)	P	P	Specifies or returns the display type of the background image in the process picture.
PictureDeactivated (Page 4454)	P	P	Specifies the picture that is displayed in the "Disabled" state.
PictureOff (Page 4455)	P	P	Specifies the screen to be displayed in the "Off" state.
PictureOn (Page 4455)	P	P	Specifies the screen to be displayed in the "On" state.
Pressed (Page 4459)	P	P	Specifies whether the selected object is displayed in a pressed state.
Radius (Page 4465)	P	P	Sets the radius of the specified "Circle" object.
RelativeFillLevel (Page 4470)	P	P	Specifies the fill percentage for the object.
ShowFillLevel (Page 4519)	P	P	Specifies whether the selected object is filled.
StyleSettings (Page 4561)	P	P	Specifies the display style for the object:
Text (Page 4572)	P	P	Specifies the label for the text field.
TextOrientation (Page 4576)	P	P	Specifies the text orientation of the selected object.
Toggle (Page 4610)	P	P	Specifies whether the selected object engages after it has been operated in runtime.
ToolTipText (Page 4627)	P	P	Specifies the tooltip text.
Top (Page 4629)	P	P	Specifies the value of the Y coordinate of the object.
Transparency (Page 4633)	P	P	Specifies and returns the transparency percentage of the object.

Properties	Read	Write	Description
TransparentColorDeactivatedPicture (Page 4635)	P	P	Specifies the color to be set to "transparent" for the "Off" state of the assigned bitmap object.
TransparentColorPictureOff (Page 4636)	P	P	Specifies the color to be set to "transparent" for the "Off" state of the assigned bitmap object.
TransparentColorPictureOn (Page 4636)	P	P	Specifies the color to be set to "transparent" for the "On" state of the assigned bitmap object.
UseDesignColorScheme (Page 4674)	P	P	Specifies the font used for printing.
UseDesignShadowSettings (Page 4676)	P	P	Specifies whether the object is displayed with the shading defined in the active design.
UseTransparentColorDeactivatedPicture (Page 4686)	P	P	Enables the use of the transparency color specified with the "TransparentColorDeactivatedPicture" property for the "Disabled" state.
UseTransparentColorPictureOff (Page 4686)	P	P	Specifies whether the transparent color defined in the "TransparentColorPictureOff" property is used for the "Off" state.
UseTransparentColorPictureOn (Page 4687)	P	P	Specifies whether the transparent color defined in the "TransparentColorPictureOn" property is used for the "On" state.
VerticalAlignment (Page 4701)	P	P	Specifies the vertical alignment of the text for the selected object.
Visible (Page 4703)	P	P	Specifies whether the selected object is visible.
Width (Page 4714)	P	P	Sets the width of the specified "Ellipsis", "Circle" and "Rectangle" objects.

\* not visible in the ES

Table 10-102 Methods

Methods	Valid	Description
Activate (Page 4744)	P, A	Activates the permanent window or the root screen.
ActivateDynamic (Page 4747)	P	Dynamically activates a trigger and the specified cycle for a property at runtime.
DeactivateDynamic (Page 4754)	P	Deactivates the trigger of the "ActivateDynamic" method used for the specified property in/during Runtime.

## See also

Screen object (list) (Page 3936)

## ScreenWindow

### Description

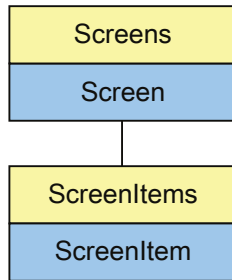

Represents the "ScreenWindow" object. The ScreenWindow object is an element of the ScreenItems list.

### Type identifier in VBS

HMIScreenWindow

Abbreviation	Validity
Pa	Panels
A	Runtime Advanced
P	Runtime Professional

Table 10-103 Properties

Properties	Read	Write	Description
AdaptScreenToWindow (Page 4157)	-	-	Specifies whether or not the screen visualized in a screen window is adapted to fit the size of the screen window in runtime.
AdaptWindowToScreen (Page 4157)	-	-	Specifies whether or not the screen window is adapted to fit the screen it visualizes in runtime.
BorderEnabled (Page 4204)	-	-	TRUE, if the window is visualized with a border in runtime.

Properties	Read	Write	Description
CaptionText (Page 4224)	P	P	Specifies the text that is displayed in the header of the selected object.
Flashing *	-	-	Specifies that the text block flashes.
Height (Page 4327)	P	P	Sets the height of the specified "Ellipsis", "Circle" and "Rectangle" objects.
HorizontalScrollbarPosition (Page 4342)	P	P	Sets horizontal positioning of the scroll bar in a screen window with slider, or returns its value.
IndependentWindow	-	-	Specifies whether the screen window is embedded in a screen or displayed as independent screen window.
Layer (Page 4355)	-	-	Returns the layer that contains an object as LONG in the screen.
Left (Page 4366)	P	P	Specifies the value of the X coordinate of the object.
LeftOffset (Page 4369)	P	P	Sets horizontal shift of the display of a graphic object that is larger than the screen window.
MenuToolBarConfig (Page 4396)	-	-	Loads the specified configuration file with configured menu and toolbars, or returns the name of the configuration file.
MonitorNumber	-	-	Sets the monitor number.
Name (Page 4417)	P	-	Returns the object name as STRING.
ScreenName (Page 4489)	P	P	Specifies the screen to be displayed in the screen window, or returns the screen name.
ShowCaption (Page 4517)	-	-	Hides or shows the caption.
ShowScrollBars (Page 4527)	-	-	Enables the display of scroll bars.
TagPrefix (Page 4570)	P	P	Sets the prefix for all tags that exist in the screen.
Top (Page 4629)	P	P	Specifies the value of the Y coordinate of the object.
TopOffset (Page 4632)	P	P	Sets or returns the offset of the screen from the top edge of the screen window.
VerticalScrollbarPosition (Page 4703)	P	P	Specifies the vertical positioning of the scroll bar in a screen window with slider, or returns its value.
Visible (Page 4703)	P	P	Specifies whether the selected object is visible.
Width (Page 4714)	P	P	Sets the width of the specified "Ellipsis", "Circle" and "Rectangle" objects.
WindowCloseEnabled (Page 4716)	-	-	Enables closing of the window in runtime.
WindowMaximizeEnabled (Page 4717)	-	-	TRUE, if the window can be maximized in runtime.
WindowMovingEnabled (Page 4717)	-	-	TRUE, if the window can be moved in runtime.
WindowOnTop (Page 4717)	-	-	TRUE, if the object is always in the foreground in runtime.
WindowSizingEnabled (Page 4718)	-	-	Enables resizing of the specified object in runtime.
WindowStartupPosition	-	-	??
ZoomFactor (Page 4743)	P	P	Sets or reads the zoom factor of a screen or screen window.

\* not visible in the ES

Table 10-104 Methods

Methods	Valid	Description
Activate (Page 4744)	P, A	Activates the permanent window or the root screen.
ActivateDynamic (Page 4747)	P	Dynamically activates a trigger and the specified cycle for a property at runtime.
DeactivateDynamic (Page 4754)	P	Deactivates the trigger of the "ActivateDynamic" method used for the specified property in/during Runtime.

**See also**

Screen object (list) (Page 3936)

**ScriptDiagnostics**

**Description**

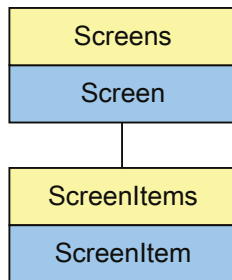

Represents the "ApplicationWindow" object. The ApplicationWindow object is an element of the ScreenItems list.

**Type identifier in VBS**

HMIApplicationWindow



Abbreviation	Validity
Pa	Panels
A	Runtime Advanced
P	Runtime Professional

Table 10-105 Properties

Properties	Read	Write	Description
BorderEnabled (Page 4204)	-	-	TRUE, if the window is visualized with a border in runtime.
Height (Page 4327)	P	P	Sets the height of the specified "Ellipsis", "Circle" and "Rectangle" objects.
Layer (Page 4355)	-	-	Returns the layer that contains an object as LONG in the screen.
Left (Page 4366)	P	P	Specifies the value of the X coordinate of the object.
Name (Page 4417)	P	P	Returns the object name as STRING.
ShowCaption (Page 4517)	-	-	Hides or shows the caption.
Template (Page 4571)	-	-	Returns the template for displaying the window content of the "Application window" object.
Top (Page 4629)	P	P	Specifies the value of the Y coordinate of the object.
Visible (Page 4703)	P	P	Specifies whether the selected object is visible.
Width (Page 4714)	P	P	Sets the width of the specified "Ellipsis", "Circle" and "Rectangle" objects.
WindowCloseEnabled (Page 4716)	-	-	Enables closing of the window in runtime.
WindowMaximizeEnabled (Page 4717)	-	-	TRUE, if the window can be maximized in runtime.
WindowMovingEnabled (Page 4717)	-	-	TRUE, if the window can be moved in runtime.
WindowOnTop (Page 4717)	-	-	TRUE, if the object is always in the foreground in runtime.
WindowsContents (Page 4717)	-	-	Returns the content of the application window
WindowSizingEnabled (Page 4718)	-	-	Enables resizing of the specified object in runtime.

Table 10-106 Methods

Methods	Valid	Description
Activate (Page 4744)	P, A	Activates the permanent window or the root screen.
ActivateDynamic (Page 4747)	P	Dynamically activates a trigger and the specified cycle for a property at runtime.
DeactivateDynamic (Page 4754)	P	Deactivates the trigger of the "ActivateDynamic" method used for the specified property in/during Runtime.

**See also**

Screen object (list) (Page 3936)

**Slider**

**Description**

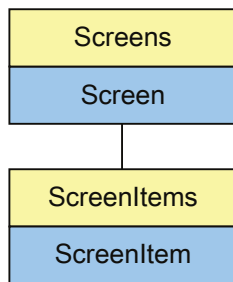

Represents the "Slider" object. The Slider object is an element of the ScreenItems list.

**Type identifier in VBS**

HMISlider

Abbreviation	Validity
Pa	Panels
A	Runtime Advanced
P	Runtime Professional

Table 10-107 Properties

Properties	Read	Write	Description
Authorization (Page 4175)	-	-	Specifies the operating rights of the selected object in runtime.
BackColor (Page 4181)	P, A	P, A	Specifies the background color of the selected object.
BackFillStyle (Page 4185)	P	P	Defines the fill pattern of the specified object.
BackPicture	-	-	Specifies a graphic for the background.

Properties	Read	Write	Description
BarBackColor (Page 4191)	P, A	P, A	Specifies the color of the bar background for the selected object.
BarColor (Page 4193)	P, A	P, A	Sets the color of the slider in the "Slider" object.
BorderBrightColor3D (Page 4200)	P, A	P, A	Specifies the border color of the following border parts in the 3D display of the selected object.
BorderInnerStyle3D (Page 4210)	P	P	Specifies the representation of the inner part of the object border.
BorderInnerWidth3D (Page 4210)	P, A	P, A	Specifies the width of the inner border for 3D presentation of the selected object.
BorderOuterStyle3D (Page 4211)	P	P	Specifies the representation of the outer part of the object border.
BorderOuterWidth3D (Page 4211)	P, A	P, A	Sets the width of the outer border for 3D presentation of the selected object.
BorderShadeColor3D (Page 4212)	P, A	P, A	Specifies the border color of the following border parts in the 3D display of the selected object.
BorderWidth (Page 4216)	P, A	P, A	Specifies the line thickness of the object.
Caption (Page 4221)	P, A	P, A	Specifies the text that is displayed in the header of the selected object.
ContinousChange (Page 4249)	P	P	Specifies whether to transfer the value of the "ProcessValue" when the mouse button is released, or immediately on a change of the slider position in runtime.
Enabled (Page 4277)	P, A	P, A	Specifies whether the selected object can be operated in runtime.
Flashing	-	-	Specifies that the text block flashes.
FocusColor (Page 4308)	P, A	P, A	Specifies the color for the focus frame of the selected object when it is in focus.
FocusWidth (Page 4310)	P, A	P, A	Specifies the border width of the specified object when the object is in focus.
Font	-	-	Specifies or returns the font.
ForeColor (Page 4318)	P, A	P, A	Specifies the font color of the text for the selected object.
Height (Page 4327)	P, A	P, A	Sets the height of the specified "Ellipsis", "Circle" and "Rectangle" objects.
LabelColor (Page 4350)	P, A	P, A	Sets the color of the scale labeling in the "Slider" object.
Layer (Page 4355)	-	-	Specifies the value of the X coordinate of the object.
Left (Page 4366)	P, A	P, A	Specifies the value of the X coordinate of the object.
MaximumValue (Page 4392)	P, A	P, A	Specifies the maximum value of the scale in the selected object.
MinimumValue (Page 4413)	P, A	P, A	Specifies the minimum value of the scale in the selected object.
Name (Page 4417)	P, A	-	Returns the object name as STRING.
PositionFont	-	-	Sets the font type for the labeling.
ProcessValue (Page 4461)	P, A	P, A	Specifies the default for the value to be displayed.
ShowBar (Page 4516)	P, A	P, A	Specifies whether to display the process value along with a filled bar in the "Slider" object.
ShowPosition (Page 4524)	P, A	P, A	Adds a numerical display of the value of the slider position.
ShowThumb (Page 4532)	P, A	P, A	Displays the slider of the "Slider" object.
ShowTickLabels (Page 4532)	P, A	P, A	Specifies whether the label is shown in the scale.

Properties	Read	Write	Description
ShowTicks (Page 4533)	P, A	P, A	Specifies whether the tick marks are displayed in the scale of the object.
ThumbBackColor (Page 4577)	P, A	P, A	Specifies the background color of the slider in the "Slider" object.
ThumbPicture	-	-	Specifies a graphic object for the slider.
TickStyle (Page 4579)	P	P	Specifies the scale display.
Top (Page 4629)	P, A	P, A	Specifies the value of the Y coordinate of the object.
Transparency (Page 4633)	P	P	Specifies and returns the transparency percentage of the object.
UseDesignColorScheme (Page 4674)	P	P	Specifies the font used for printing.
UseDesignShadowSettings (Page 4676)	P	P	Specifies whether the object is displayed with the shading defined in the active design.
Visible (Page 4703)	P, A	P, A	Specifies whether the selected object is visible.
Width (Page 4714)	P, A	P, A	Sets the width of the specified "Ellipse", "Circle" and "Rectangle" objects.

Table 10-108 Methods

Methods	Validity	Description
Activate (Page 4744)	P, A	Activates the permanent window or the root screen.
ActivateDynamic (Page 4747)	P	Dynamically activates a trigger and the specified cycle for a property at runtime.
DeactivateDynamic (Page 4754)	P	Deactivates the trigger of the "ActivateDynamic" method used for the specified property in/during Runtime.

**See also**

- ObjectName (Page 4424)
- Screen object (list) (Page 3936)
- Font (Page 4311)

## SmartClientView

### Description

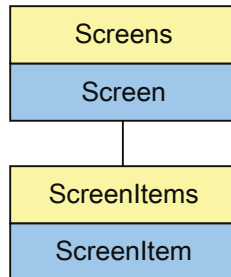

Represents the "Sm@rtClient View" object. The SmartClientView object is an element of the ScreenItems list.

### Type identifier in VBS

HMISmartClientView

Abbreviation	Validity
Pa	Panels
A	Runtime Advanced
P	Runtime Professional

Table 10-109 Properties

Properties	Read	Write	Description
AllowMenu (Page 4169)	-	-	Specifies whether the shortcut menu is enabled to control the Sm@rtClient view.
ConnectionType (Page 4248)	-	-	Specifies the type of connector. You can select one of two connection types.
ConnectOnStart	-	-	Sets up the connection at startup.

Properties	Read	Write	Description
Enabled (Page 4279)	A	A	Specifies whether the selected object can be operated in runtime.
Flashing	-	-	Specifies that the text block flashes.
Font (Page 4311)	-	-	Specifies or returns the font.
Height (Page 4327)	A	-	Sets the height of the specified "Ellipsis", "Circle" and "Rectangle" objects.
Layer (Page 4355)	-	-	Returns the layer that contains an object as LONG in the screen.
Left (Page 4366)	A	A	Specifies the value of the X coordinate of the object.
LocalCursor (Page 4384)	-	-	Specifies whether the cursor data is transferred separately in order to increase the performance.
MachineName (Page 4391)	A	A	Sets the network ID of the device that is to be monitored.
Name (Page 4417)	A	-	Returns the object name as STRING.
Password (Page 4447)	A	A	Sets the password for remote monitoring.
ScaleDenominator (Page 4487)	-	-	Sets the scaling numerator on the client.
ScaleNumerator (Page 4483)	-	-	Sets the scaling numerator on the client.
Scaling (Page 4487)	-	-	TRUE, if an additional scale is used to visualize the values.
ServerScale (Page 4507)	-	-	Specifies whether the Sm@rtClient view can be zoomed in or out.
Shared (Page 4513)	-	-	Specifies that an HMI device is shared by several Sm@rtClient Views.
ShowControls	-	-	Specifies that a toolbar is displayed.
Top (Page 4629)	A	A	Specifies the value of the Y coordinate of the object.
UseCursorKeyScroll	-	-	Sets the use of the background color of the object for printing.
ViewOnly (Page 4703)	A	A	Enables the use of the Sm@rtClient view for remote monitoring or remote maintenance.
Visible (Page 4703) *	A	A	Specifies whether the selected object is visible.
Width (Page 4714)	A	-	Sets the width of the specified "Ellipsis", "Circle" and "Rectangle" objects.

\* not visible in the ES

Table 10-110 Methods

Methods	Valid	Description
Activate (Page 4744)	A	Activates the permanent window or the root screen.

**See also**

- Screen object (list) (Page 3904)
- Screen (Page 3905)
- ScreenItem (Page 3906)
- ScreenItems (Page 3908)

## StatusForce

### Description

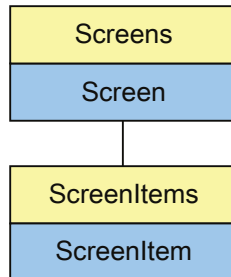

Represents the "Status/Force" object. The StatusForce object is an element of the ScreenItems list.

If you change the settings for this object with a user-defined function, the changed settings are retained even after the screen is called again.

### Type identifier in VBS

HMIStatusForce

Abbreviation	Validity
Pa	Panels
A	Runtime Advanced
P	Runtime Professional

Table 10-111 Properties

Properties	Read	Write	Description
Appearance	-	-	Specifies the layout for this NC subroutine.
BackColor (Page 4183)	A	A	Specifies the background color of the selected object.
ColumnsMoveable	-	-	Specifies that the columns can be moved.
CountVisibleItems (Page 4253) *	-	-	Specifies the number of lines contained in the selection list.
Enabled (Page 4279)	A	A	Specifies whether the selected object can be operated in runtime.

10.8 Working with system functions and Runtime scripting

Properties	Read	Write	Description
FitToSize	-	-	Specifies that the size of the object should be automatically adapted to the content.
Flashing	-	-	Specifies that the text block flashes.
FocusColor (Page 4309)	A	A	Specifies the color for the focus frame of the selected object when it is in focus.
FocusWidth (Page 4310)	A	A	Specifies the border width of the specified object when the object is in focus.
Height (Page 4327)	A	A	Sets the height of the specified "Ellipsis", "Circle" and "Rectangle" objects.
Layer (Page 4355)	-	-	Returns the layer that contains an object as LONG in the screen.
Left (Page 4366)	A	A	Specifies the value of the X coordinate of the object.
Name (Page 4417)	A	-	Returns the object name as STRING.
PLCFilter	-	-	Sets the controller type.
SelectionBackColor (Page 4499)	A	A	Specifies the background color of the selected cells.
SelectionForeColor (Page 4501)	A	A	Specifies the foreground color of the selected cells.
SetOfVisibleColumns	-	-	Sets the visible columns.
ShowReadButton	-	-	Enables the display of the "Read" button.
ShowTableGridlines (Page 4531)	A	A	Enables the display of gridlines in the table of the specified object.
ShowWriteButton	-	-	Enables the display of the "Write" button.
TableBackColor (Page 4563)	A	A	Specifies the background color of the table cells for the selected object.
TableFont	-	-	Specifies the font in the table.
TableForeColor (Page 4566)	A	A	??
TableHeaderBackColor (Page 4568)	A	A	Specifies the background color in the header of the table of the selected object.
TableHeaderFont	-	-	Specifies the text color of the header.
TableHeaderForeColor (Page 4569)	A	A	Specifies the text color in the header of the table of the selected object.
Top (Page 4629)	A	A	Specifies the value of the Y coordinate of the object.
Visible (Page 4703) *	A	A	Specifies whether the selected object is visible.
Width (Page 4714)	A	A	Sets the width of the specified "Ellipsis", "Circle" and "Rectangle" objects.

\* not visible in the ES

Table 10-112 Methods

Methods	Valid	Description
Activate (Page 4744)	A	Activates the permanent window or the root screen.



**See also**

- Screen object (list) (Page 3904)
- Screen (Page 3905)
- ScreenItem (Page 3906)
- ScreenItems (Page 3908)

**Switch**

**Description**

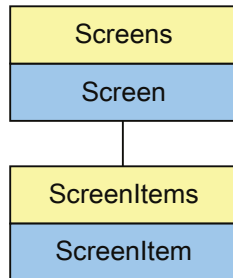

Represents the "Switch" object. The Switch object is an element of the ScreenItems list.

The availability of the following object properties depends on the selected mode:

Property	"Switch with text"	"Switch with graphic"	"Switch"
CaptionColor	--	--	x
CaptionText	--	--	x
HorizontalAlignment	X	--	--
InnerBackColorOff	--	--	x
InnerBackColorOn	--	--	x
TextOn	x	--	x
TextOff	x	--	x
VerticalAlignment	x	--	--

## Type identifier in VBS

HMISwitch

Abbreviation	Validity
Pa	Panels
A	Runtime Advanced
P	Runtime Professional

Table 10-113 Properties

Properties	Read	Write	Description
AboveUpperLimitColor (Page 4147)	-	-	Sets the color of the specified object for the "High limit violated" event.
Authorization (Page 4175)	-	-	Specifies the operating rights of the selected object in runtime.
AutoSizing	-	-	Specifies that the size of the object should be automatically adapted to the content.
BackColor (Page 4181)	A	A	Specifies the background color of the selected object.
BackFlashingColorOff (Page 4188) *	-	-	Specifies the background color for flash state "Off".
BackFlashingColorOn (Page 4188) *	-	-	Specifies the background color for flash state "On".
BackFlashingEnabled (Page 4189) *	-	-	Specifies whether the background of the specified object flashes in runtime.
BackFlashingRate (Page 4190) *	-	-	Specifies the flash rate of the background for the selected object.
BelowLowerLimitColor (Page 4196)	-	-	Sets the color of the specified object for the "Low limit violated" event.
BorderColor (Page 4202) *	-	-	Specifies the line color of the object.
BorderFlashingColorOff (Page 4206) *	-	-	Specifies the border line color of the selected object for the flash state "Off".
BorderFlashingColorOn (Page 4207) *	-	-	Specifies the border line color of the selected object for the flash state "On".
BorderFlashingEnabled (Page 4208) *	-	-	Specifies whether the border line of the selected object flashes in runtime.
BorderFlashingRate (Page 4209) *	-	-	Specifies the flash rate of the border line for the selected object.
BorderStyle3D (Page 4215)	A	A	Specifies whether the object has a 3D border shading.
BorderWidth (Page 4216) *	-	-	Specifies the line thickness of the object.
BorderWidth3D (Page 4218) *	-	-	Specifies the width of the border for 3D display of the selected object.
CaptionColor (Page 4223)	A	A	Specifies the color of the text that is displayed in the header of the selected object.
CaptionFont	-	-	Specifies the character set for the caption.

Properties	Read	Write	Description
CaptionText (Page 4224)	A	A	Specifies the text that is displayed in the header of the selected object.
CornerStyle (Page 4250) *	-	-	Specifies the type of border lines for the selected object.
EdgeStyle (Page 4273) *	-	-	Specifies the line style of the selected object.
Enabled (Page 4277)	A	A	Specifies whether the selected object can be operated in runtime.
FitToLargest	-	-	Specifies that the size of the object depends on the text length in all languages.
Flashing	-	-	Specifies that the text block flashes.
FlashingColorOff (Page 4300) *	-	-	Specifies the border line color of the selected object for the flash state "Off".
FlashingColorOn (Page 4302) *	-	-	Specifies the border line color of the selected object for the flash state "On".
FlashingEnabled (Page 4303) *	-	-	Specifies whether the border line of the selected object flashes in runtime.
FlashingOnLimitViolation	-	-	Specifies that flashing is activated when a limit is violated.
FlashingRate (Page 4304) *	-	-	Specifies the flash rate of the border line for the selected object.
FocusColor (Page 4308)	A	A	Specifies the color for the focus frame of the selected object when it is in focus.
FocusWidth (Page 4310)	A	A	Specifies the border width of the specified object when the object is in focus.
Font (Page 4311)	-	-	Specifies or returns the font.
ForeColor (Page 4318)	A	A	Specifies the font color of the text for the selected object.
Height (Page 4327)	A	A	Sets the height of the specified "Ellipsis", "Circle" and "Rectangle" objects.
HelpText (Page 4330)	A	-	Returns the tooltip that is shown in runtime as user help for the specified object.
HorizontalAlignment (Page 4340)	A	A	Specifies the horizontal alignment of the text within the selected object.
InnerBackColorOff (Page 4345)	A	A	Sets the color underneath the slider of the "Switch" object for the object in OFF state.
InnerBackColorOn (Page 4346)	A	A	Sets the color underneath the slider of the "Switch" object for the object in ON state.
Layer (Page 4355)	-	-	Returns the layer that contains an object as LONG in the screen.
Left (Page 4366)	A	A	Specifies the value of the X coordinate of the object.
LineEndShapeStyle (Page 4380) *	-	-	Specifies the shape of the line end.
Mode (Page 4415)	-	-	Specifies the field type of the selected object.
Name (Page 4417)	A	-	Returns the object name as STRING.
OnValue	-	-	Specifies the value for the "ON" state in "two-state" mode.
PictureOff (Page 4455)	-	-	Specifies the screen to be displayed in the "Off" state.
PictureOn (Page 4455)	-	-	Specifies the screen to be displayed in the "On" state.
ProcessValue (Page 4463)	-	-	Specifies the default for the value to be displayed.
SwitchOrientation	-	-	Specifies the line color of the object.

Properties	Read	Write	Description
TextOff (Page 4574)	A	A	Specifies the text to be displayed in the "Off" state of the selected object.
TextOn (Page 4575)	A	A	Specifies the text to be displayed in the "On" state of the selected object.
TextOrientation (Page 4576) *	-	-	Specifies the text orientation of the selected object.
Top (Page 4629)	A	A	Specifies the value of the Y coordinate of the object.
VerticalAlignment (Page 4701)	A	A	Specifies the vertical alignment of the text for the selected object.
Visible (Page 4703) *	A	A	Specifies whether the selected object is visible.
Width (Page 4714)	A	A	Sets the width of the specified "Ellipsis", "Circle" and "Rectangle" objects.

\* not visible in the ES

Table 10-114 Methods

Methods	Valid	Description
Activate (Page 4744)	P, A	Activates the permanent window or the root screen.

**See also**

Screen object (list) (Page 3936)

## SymbolicIOField

### Description

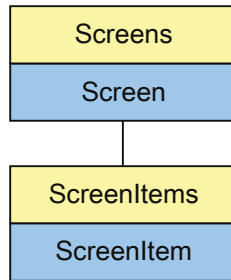

Represents the "SymbolicIOField" object. The SymbolicIOField object is an element of the ScreenItems list.

The availability of the following object properties depends on the selected mode:

Property	"Input"	"Output"	"Input/Output"	"Two states"
BackColor	x	x	x	x
BorderColor	--	x	--	x
BorderWidth	--	--	--	x
BorderStyle3D	--	x	--	--
Enabled	x	--	x	--
HelpText	x	--	x	--
VerticalAlignment	--	x	--	x
HorizontalAlignment	--	x	--	x

### Type identifier in VBS

HMISymbolicIOField

Abbreviation	Validity
Pa	Panels
A	Runtime Advanced
P	Runtime Professional

Table 10-115 Properties

Properties	Read	Write	Description
AboveUpperLimitColor (Page 4147)	-	-	Sets the color of the specified object for the "High limit violated" event.
AcceptOnExit (Page 4148)	P	P	Specifies whether the input field is confirmed automatically when it is left.
AdaptBorder (Page 4156)	-	-	Specifies whether the border of the specified object is dynamically adapted to the text size.
AskOperationMotive (Page 4173)	P	P	Specifies whether the reason for operating this object is logged.
Authorization (Page 4175)	P	P	Specifies the operating rights of the selected object in runtime.
BackColor (Page 4181)	P, A	P, A	Specifies the background color of the selected object.
BackFillStyle (Page 4185)	P	P	Defines the fill pattern of the specified object.
BackFlashingColorOff (Page 4188)	P	P	Specifies the background color for flash state "Off".
BackFlashingColorOn (Page 4188)	P	P	Specifies the background color for flash state "On".
BackFlashingEnabled (Page 4189)	P	P	Specifies whether the background of the specified object flashes in runtime.
BackFlashingRate (Page 4190)	P	P	Specifies the flash rate of the background for the selected object.
BelowLowerLimitColor (Page 4196)	-	-	Sets the color of the specified object for the "Low limit violated" event.
BitNumber (Page 4197)	P	P	Specifies the bit whose status must change to trigger a value change.
BorderBackColor (Page 4199)	P	P	Specifies the background color of the broken border line for the selected object.
BorderColor (Page 4202)	P, A	P, A	Specifies the line color of the object.
BorderFlashingColorOff (Page 4206)	P	P	Specifies the border line color of the selected object for the flash state "Off".
BorderFlashingColorOn (Page 4207)	P	P	Specifies the border line color of the selected object for the flash state "On".
BorderFlashingEnabled (Page 4208)	P	P	Specifies whether the border line of the selected object flashes in runtime.
BorderFlashingRate (Page 4209)	P	P	Specifies the flash rate of the border line for the selected object.
BorderStyle (Page 4213)	P	P	Specifies the type of border lines for the selected object.
BorderStyle3D (Page 4215)	A	A	Specifies whether the object has a 3D border shading.
BorderWidth (Page 4216)	P, A	P, A	Specifies the line thickness of the object.
BottomMargin	-	-	Sets the margin between the text and the bottom edge of the object.

Properties	Read	Write	Description
CaptionBackColor (Page 4222)	P	P	Specifies the background color of the caption for the selected object.
CaptionColor (Page 4223)	P	P	Specifies the color of the text that is displayed in the header of the selected object.
CornerStyle (Page 4250)	P	P	Specifies the type of border lines for the selected object.
CountVisibleItems (Page 4253)	P	P	Specifies the number of lines contained in the selection list.
CursorControl (Page 4256)	P	P	Specifies whether the mouse cursor jumps to the next field of the TAB sequence after leaving a field.
DrawInsideFrame (Page 4270)	-	-	Specifies whether the border line of the selected object with a line thickness greater than 1 should be drawn within the border or symmetrically to the border.
EdgeStyle (Page 4274)	P	P	Specifies the line style of the selected object.
EditOnFocus (Page 4276)	P	P	Specifies whether data input is immediately possible if the input field is selected using the "Tab" key.
Enabled (Page 4277)	P, A	P, A	Specifies whether the selected object can be operated in runtime.
FieldLength	-	-	Specifies that the "field length string" field is read-only.
FillPatternColor (Page 4296)	P	P	Specifies the color of the fill pattern for the selected object.
FitToLargest	-	-	Specifies that the size of the object depends on the text length in all languages.
Flashing	-	-	Specifies that the text block flashes.
FlashingColorOff (Page 4300)	P	P	Specifies the border line color of the selected object for the flash state "Off".
FlashingColorOn (Page 4302)	P	P	Specifies the border line color of the selected object for the flash state "On".
FlashingEnabled (Page 4303)	P	P	Specifies whether the border line of the selected object flashes in runtime.
FlashingOnLimitViolation	-	-	Specifies that flashing is activated when a limit is violated.
FlashingRate (Page 4304)	P	P	Specifies the flash rate of the border line for the selected object.
FocusColor (Page 4308)	-	-	Specifies the color for the focus frame of the selected object when it is in focus.
FocusWidth (Page 4310)	-	-	Specifies the border width of the specified object when the object is in focus.
Font (Page 4311)	-	-	Specifies or returns the font.
FontBold (Page 4313)	P	P	Specifies whether the text of the selected object is shown in bold.
FontItalic (Page 4314)	P	P	Specifies whether the text of the selected object is shown in italics.
FontName (Page 4315)	P	P	Specifies the font of the selected object.
FontSize (Page 4316)	P	P	Specifies the font size of the text for the selected object.
FontUnderline (Page 4317)	P	P	Specifies whether the text of the selected object is underlined.
ForeColor (Page 4318)	P, A	P, A	Specifies the font color of the text for the selected object.
Height (Page 4327)	P, A	P, A	Sets the height of the specified "Ellipsis", "Circle" and "Rectangle" objects.
HelpText (Page 4330)	A	-	Returns the tooltip that is shown in runtime as user help for the specified object.

10.8 Working with system functions and Runtime scripting

Properties	Read	Write	Description
HorizontalAlignment (Page 4340)	P, A	P, A	Specifies the horizontal alignment of the text within the selected object.
InputValue (Page 4346)	-	-	Defines the value entered by the user in the IO field.
ItemBorderStyle (Page 4349)	P	P	Sets the separation line style in the selection list of the specified object.
Layer (Page 4355)	-	-	Returns the layer that contains an object as LONG in the screen.
Left (Page 4366)	P, A	P, A	Specifies the value of the X coordinate of the object.
LeftMargin	-	-	Sets the margin between the text and the left edge of the object.
LineEndShapeStyle (Page 4380)	P	P	Specifies the shape of the line end.
LogOperation (Page 4386)	P	P	Specifies whether, after operating this object, an alarm is output to the alarm system.
Mode (Page 4415)	P	P	Specifies the field type of the selected object.
Name (Page 4417)	P, A	-	Returns the object name as STRING.
OnValue	-	-	Specifies the value for the "ON" state in "two-state" mode.
ProcessValue (Page 4461)	P	P	Specifies the default for the value to be displayed.
RightMargin	-	-	Sets the margin between the text and the right edge of the object.
SelectBackColor (Page 4493)	P	P	Specifies the background color of the selected cells.
SelectForeColor (Page 4497)	P	P	Specifies the foreground color of the selected cells.
SeparatorBackColor (Page 4505)	P	P	Specifies the background color of the broken separation lines in the selection list of the specified object.
SeparatorColor (Page 4505)	P	P	Sets the color of the separation lines in the selection list of the specified object.
SeparatorCornerStyle (Page 4506)	P	P	Sets the shape of corners for the object of the type "ScreenItem" with "SymbolicIOField" format.
SeparatorLineEndShapeStyle (Page 4507)	P	P	Sets the shape of line ends for the object of the type "ScreenItem" with "SymbolicIOField" format.
SeparatorStyle (Page 4506)	P	P	Sets the separation line style in the selection list of the specified object.
SeparatorWidth (Page 4507)	P	P	Sets the width separation lines in the selection list of the specified object.
ShowBadTagState (Page 4516)	P	P	Specifies whether an object is grayed out if its associated tag has a bad quality code or tag state.
ShowDropDownButton	-	-	Sets the display of a button for the selection list.
ShowDropDownList	-	-	Specifies selection of the entry from a selection list.
TextList (Page 4573)	-	-	Specifies the label for the text field.
TextOff (Page 4574)	-	-	Specifies the text to be displayed in the "Off" state of the selected object.
TextOn (Page 4575)	-	-	Specifies the text to be displayed in the "On" state of the selected object.
TextOrientation (Page 4576)	P	P	Specifies the text orientation of the selected object.
ToolTipText (Page 4627)	P	P	Specifies the tooltip text.
Top (Page 4629)	P, A	P, A	Specifies the value of the Y coordinate of the object.



Properties	Read	Write	Description
TopMargin	-	-	Sets the margin between the text and the top edge of the object.
Transparency (Page 4633)	P	P	Specifies and returns the transparency percentage of the object.
UseDesignColorScheme (Page 4674)	P	P	Specifies the font used for printing.
UseDesignShadowSettings (Page 4676)	P	P	Specifies whether the object is displayed with the shading defined in the active design.
VerticalAlignment (Page 4701)	P, A	P, A	Specifies the vertical alignment of the text for the selected object.
Visible (Page 4703)	P, A	P, A	Specifies whether the selected object is visible.
Width (Page 4714)	P, A	P, A	Sets the width of the specified "Ellipsis", "Circle" and "Rectangle" objects.

Table 10-116 Methods

Methods	Valid	Description
Activate (Page 4744)	P, A	Activates the permanent window or the root screen.
ActivateDynamic (Page 4747)	P	Dynamically activates a trigger and the specified cycle for a property at runtime.
DeactivateDynamic (Page 4754)	P	Deactivates the trigger of the "ActivateDynamic" method used for the specified property in/during Runtime.

**See also**

Screen object (list) (Page 3936)

## SymbolLibrary

### Description

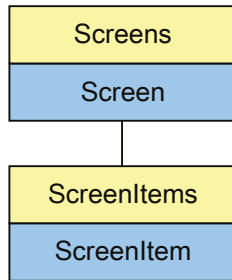

Represents the "SymbolLibrary" object. The SymbolLibrary object is an element of the ScreenItems list.

### Type identifier in VBS

HMISymbolLibrary

Abbreviation	Validity
Pa	Panels
A	Runtime Advanced
P	Runtime Professional

Table 10-117 Properties

Properties	Read	Write	Description
AboveUpperLimitColor (Page 4147)	-	-	Sets the color of the specified object for the "High limit violated" event.
Authorization (Page 4175)	-	-	Specifies the operating rights of the selected object in runtime.
BackColor (Page 4181)	P, A	P, A	Specifies the background color of the selected object.
BackFillStyle (Page 4185)	P	P	Defines the fill pattern of the specified object.

Properties	Read	Write	Description
BelowLowerLimitColor (Page 4196)	-	-	Sets the color of the specified object for the "Low limit violated" event.
BlinkColor (Page 4197)	P, A	P, A	Sets the flashing color for the "SymbolLibrary" object.
BlinkMode (Page 4198)	P	P	Sets the type of flashing graphic for the specified object.
BlinkSpeed (Page 4199)	P	P	Sets the flash rate.
ChangeMouseCursor (Page 4231)	P	P	Specifies the appearance of the cursor after its transformation in mouse over icon mode in runtime.
Enabled (Page 4277)	P, A	P, A	Specifies whether the selected object can be operated in runtime.
FillColorMode (Page 4295)	P	P	Sets the type of foreground for the specified object.
FixedAspectRatio (Page 4299)	P	P	Specifies whether the aspect ratio should be retained on changes of the icon size, or follow the change dynamically.
Flashing	-	-	Specifies that the text block flashes.
FlashingOnLimitViolation	-	-	Specifies that flashing is activated when a limit is violated.
Flip (Page 4308)	P	P	Flips the symbol on the vertical and / or horizontal center axis of the icon.
ForeColor (Page 4318)	P, A	P, A	Specifies the font color of the text for the selected object.
Height (Page 4327)	P, A	P, A	Sets the height of the specified "Ellipsis", "Circle" and "Rectangle" objects.
Layer (Page 4355)	-	-	Returns the layer that contains an object as LONG in the screen.
Left (Page 4366)	P, A	P, A	Specifies the value of the X coordinate of the object.
Name (Page 4417)	P, A	-	Returns the object name as STRING.
ProcessValue (Page 4463)	-	-	Specifies the default for the value to be displayed.
Rotation (Page 4472)	P	P	Specifies the angle of rotation in degrees of the selected object.
Top (Page 4629)	P, A	P, A	Specifies the value of the Y coordinate of the object.
Visible (Page 4703)	P, A	P, A	Specifies whether the selected object is visible.
Width (Page 4714)	P, A	P, A	Sets the width of the specified "Ellipsis", "Circle" and "Rectangle" objects.

Table 10-118 Methods

Methods	Valid	Description
Activate (Page 4744)	P, A	Activates the permanent window or the root screen.
ActivateDynamic (Page 4747)	P	Dynamically activates a trigger and the specified cycle for a property at runtime.
DeactivateDynamic (Page 4754)	P	Deactivates the trigger of the "ActivateDynamic" method used for the specified property in/during Runtime.

**See also**

Screen object (list) (Page 3936)

## SystemDiagnoseView

### Description

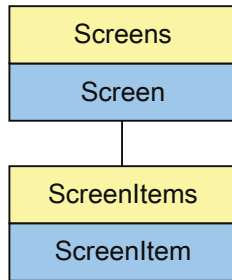

Represents the "System diagnostic view" object. The SystemDiagnoseView object is an element of the ScreenItems list.

### Type identifier in VBS

HMISysDiagView

Abbreviation	Validity
Pa	Panels
A	Runtime Advanced
P	Runtime Professional

Table 10-119 Properties

Properties	Read	Write	Description
Authorization (Page 4175)	A	A	Specifies the operating rights of the selected object in runtime.
BackgroundColor	A	A	Specifies the background color.
ComponentInfoText	A	A	Specifies the tooltip of the system diagnostics view in runtime.

Properties	Read	Write	Description
Enabled (Page 4279)	A	A	Specifies whether the selected object can be operated in runtime.
Height (Page 4327)	A	A	Sets the height of the specified "Ellipsis", "Circle" and "Rectangle" objects.
InfoArea_BackgroundColor	A	A	Specifies the background for grid control elements.
InfoArea_ColumnsMovable	A	A	Specifies the mobility of columns.
InfoArea_DefaultTextColor	A	A	Sets the text color.
InfoArea_ErrorTextBackgroundColor	A	A	Specifies the background color of a cell in error case.
InfoArea_ErrorTextColor	A	A	Sets the text color of a cell in error case.
InfoArea_FocusFrameColor	A	A	Sets the color of the focus frame.
InfoArea_FocusFrameWidth	A	A	Sets the line thickness of the focus rectangle.
InfoArea_Font	A	A	Sets the fonts of the grid views.
InfoArea_ShowGridLines	A	A	Sets the grid lines.
InfoArea_TableHeaderBackgroundColor	A	A	Specifies the background color of the table header.
InfoArea_TableHeaderTextColor	A	A	Sets the text color of the table header.
InputAddressText	A	A	Sets the input address.
ItemText_AKZ	A	A	Specifies the header for the "AKZ" column.
ItemText_Descriptor	A	A	Specifies the header for the "Descriptor" column.
ItemText_ErrorText	A	A	Specifies the header for the "ErrorText" column.
ItemText_InstallationDate	A	A	Specifies the header for the "InstallationDate" column.
ItemText_LADDR	A	A	Specifies the header for the "LADDR" column.
ItemText_Name	A	A	Sets the labeling of the "Name" column.
ItemText_OKZ	A	A	Specifies the header for the "OKZ" column.
ItemText_OperationState	A	A	Specifies the header for the "OperationState" column.
ItemText_OrderID	A	A	Specifies the header for the "OrderID" column.
ItemText_Rack	A	A	Specifies the header for the "Rack" column.
ItemText_Slot	A	A	Specifies the header for the "Slot" column.
ItemText_SoftwareRevision	A	A	Specifies the header for the "SoftwareRevision" column.
ItemText_State	A	A	Specifies the header for the "State" column.
ItemText_Station	A	A	Specifies the header for the "Station" column.
ItemText_SubAddress	A	A	Specifies the header for the "SubAddress" column.
ItemText_SubSlot	A	A	Specifies the header for the "SubSlot" column.
ItemText_SubSystem	A	A	Specifies the header for the "SubSystem" column.
ItemText_Type	A	A	Specifies the header for the "Type" column.
IV_ShowItem_AKZ	A	A	Enables the display of the "AKZ" column.
IV_ShowItem_Descriptor	A	A	Enables the display of the "Descriptor" column.
IV_ShowItem_ErrorText	A	A	Enables the display of the "ErrorText" column.
IV_ShowItem_InstallationDate	A	A	Enables the display of the "InstallationDate" column.
IV_ShowItem_LADDR	A	A	Enables the display of the "LADDR" column.
IV_ShowItem_Name	A	A	Enables the display of the "Name" column.
IV_ShowItem_OKZ	A	A	Enables the display of the "OKZ" column.
IV_ShowItem_OperationState	A	A	Enables the display of the "OperationState" column.

10.8 Working with system functions and Runtime scripting

Properties	Read	Write	Description
IV_ShowItem_OrderID	A	A	Enables the display of the "OrderID" column.
IV_ShowItem_Rack	A	A	Enables the display of the "Rack" column.
IV_ShowItem_Slot	A	A	Enables the display of the "Slot" column.
IV_ShowItem_SoftwareRevision	A	A	Enables the display of the "SoftwareRevision" column.
IV_ShowItem_State	A	A	Enables the display of the "State" column.
IV_ShowItem_Station	A	A	Enables the display of the "Station" column.
IV_ShowItem_SubAddress	A	A	Enables the display of the "SubAddress" column.
IV_ShowItem_SubSlot	A	A	Enables the display of the "SubSlot" column.
IV_ShowItem_SubSystem	A	A	Enables the display of the "SubSystem" column.
IV_ShowItem_Type	A	A	Enables the display of the "Type" column.
Layer (Page 4355)	A	-	Returns the layer that contains an object as LONG in the screen.
Left (Page 4366)	A	A	Specifies the value of the X coordinate of the object.
NavigationPath_Font	A	A	Sets the font type of the navigation path.
NavigationPath_TextColor	A	A	Sets the text color of the navigation path.
ObjectName (Page 4424)	A	-	Returns the object name as STRING.
OutputAddressText	A	A	Specifies the text for the output address.
ShowNavigationButtons	A	A	Enables the display of navigation buttons.
ShowPathInformation	A	A	Enables the display of the navigation path.
ShowSplittedView	A	A	Enables a split view.
TableHeaderFont	A	A	Specifies the text color of the header.
Top (Page 4629)	A	A	Specifies the value of the Y coordinate of the object.
Type (Page 4664)	A	-	Returns the type of the specified object as STRING.
Parent (Page 4445)	A	-	Returns the screen in which the specified object is embedded.
UV_ShowItem_AKZ	A	A	Enables the display of the "AKZ" column.
UV_ShowItem_Descriptor	A	A	Enables the display of the "Descriptor" column.
UV_ShowItem_InstallationDate	A	A	Enables the display of the "InstallationDate" column.
UV_ShowItem_LADDR	A	A	Enables the display of the "LADDR" column.
UV_ShowItem_Name	A	A	Enables the display of the "Name" column.
UV_ShowItem_OKZ	A	A	Enables the display of the "OKZ" column.
UV_ShowItem_OperationState	A	A	Enables the display of the "OperationState" column.
UV_ShowItem_OrderID	A	A	Enables the display of the "OrderID" column.
UV_ShowItem_Rack	A	A	Enables the display of the "Rack" column.
UV_ShowItem_Slot	A	A	Enables the display of the "Slot" column.
UV_ShowItem_SoftwareRevision	A	A	Enables the display of the "SoftwareRevision" column.
UV_ShowItem_State	A	A	Enables the display of the "State" column.
UV_ShowItem_Station	A	A	Enables the display of the "Station" column.
UV_ShowItem_SubAddress	A	A	Enables the display of the "SubAddress" column.
UV_ShowItem_SubSlot	A	A	Enables the display of the "SubSlot" column.
UV_ShowItem_SubSystem	A	A	Enables the display of the "SubSystem" column.
UV_ShowItem_Type	A	A	Enables the display of the "Type" column.

Properties	Read	Write	Description
Visible (Page 4703)	A	A	Specifies whether the selected object is visible.
Width (Page 4714)	A	A	Enables the display of the "Slot" column.

Table 10-120 Methods

Methods	Valid	Description
Activate (Page 4744)	A	Activates the permanent window or the root screen.

### See also

Screen object (list) (Page 3904)

Screen (Page 3905)

ScreenItem (Page 3906)

ScreenItems (Page 3908)

Name (Page 4417)

## SystemDiagnoseWindow

### Description

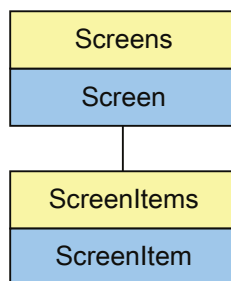

Represents the "System diagnostic window" object. The SystemDiagnoseWindow object is an element of the ScreenItems list.

## Type identifier in VBS

HMISysDiagWindow

Abbreviation	Validity
Pa	Panels
A	Runtime Advanced
P	Runtime Professional

Table 10-121 Properties

Properties	Read	Write	Description
Authorization (Page 4175)	A	A	Specifies the operating rights of the selected object in runtime.
BackgroundColor	A	A	Specifies the background color.
Caption (Page 4221)	A	A	Specifies the text that is displayed in the header of the selected object.
CaptionActive	A	A	Enables display of the caption.
Closable (Page 4236)	A	A	Specifies that the control can be closed in runtime.
ComponentInfoText	A	A	Specifies the tooltip of the system diagnostics view in runtime.
Enabled (Page 4279)	A	A	Specifies whether the selected object can be operated in runtime.
Height (Page 4327)	A	A	Sets the height of the specified "Ellipsis", "Circle" and "Rectangle" objects.
InfoArea_BackgroundColor	A	A	Specifies the background for grid control elements.
InfoArea_ColumnsMovable	A	A	Specifies the mobility of columns.
InfoArea_DefaultTextColor	A	A	Sets the text color.
InfoArea_ErrorTextBackgroundColor	A	A	Specifies the background color of a cell in error case.
InfoArea_ErrorTextColor	A	A	Sets the text color of a cell in error case.
InfoArea_FocusFrameColor	A	A	Sets the color of the focus frame.
InfoArea_FocusFrameWidth	A	A	Sets the line thickness of the focus rectangle.
InfoArea_Font	A	A	Sets the fonts of the grid views.
InfoArea_ShowGridLines	A	A	Sets the grid lines.
InfoArea_TableHeaderBackgroundColor	A	A	Specifies the background color of the table header.
InfoArea_TableHeaderTextColor	A	A	Sets the text color of the table header.
InputAddressText	A	A	Sets the input address.
ItemText_AKZ	A	A	Specifies the header for the "AKZ" column.
ItemText_Descriptor	A	A	Specifies the header for the "Descriptor" column.
ItemText_ErrorText	A	A	Specifies the header for the "ErrorText" column.
ItemText_InstallationDate	A	A	Specifies the header for the "InstallationDate" column.
ItemText_LADDR	A	A	Specifies the header for the "LADDR" column.



Properties	Read	Write	Description
ItemText_Name	A	A	Sets the labeling of the "Name" column.
ItemText_OKZ	A	A	Specifies the header for the "OKZ" column.
ItemText_OperationState	A	A	Specifies the header for the "OperationState" column.
ItemText_OrderID	A	A	Specifies the header for the "OrderID" column.
ItemText_Rack	A	A	Specifies the header for the "Rack" column.
ItemText_Slot	A	A	Specifies the header for the "Slot" column.
ItemText_SoftwareRevision	A	A	Specifies the header for the "SoftwareRevision" column.
ItemText_State	A	A	Specifies the header for the "State" column.
ItemText_Station	A	A	Specifies the header for the "Station" column.
ItemText_SubAddress	A	A	Specifies the header for the "SubAddress" column.
ItemText_SubSlot	A	A	Specifies the header for the "SubSlot" column.
ItemText_SubSystem	A	A	Specifies the header for the "SubSystem" column.
ItemText_Type	A	A	Specifies the header for the "Type" column.
IV_ShowItem_AKZ	A	A	Enables the display of the "AKZ" column.
IV_ShowItem_Descriptor	A	A	Enables the display of the "Descriptor" column.
IV_ShowItem_ErrorText	A	A	Enables the display of the "ErrorText" column.
IV_ShowItem_InstallationDate	A	A	Enables the display of the "InstallationDate" column.
IV_ShowItem_LADDR	A	A	Enables the display of the "LADDR" column.
IV_ShowItem_Name	A	A	Enables the display of the "Name" column.
IV_ShowItem_OKZ	A	A	Enables the display of the "OKZ" column.
IV_ShowItem_OperationState	A	A	Enables the display of the "OperationState" column.
IV_ShowItem_OrderID	A	A	Enables the display of the "OrderID" column.
IV_ShowItem_Rack	A	A	Enables the display of the "Rack" column.
IV_ShowItem_Slot	A	A	Enables the display of the "Slot" column.
IV_ShowItem_SoftwareRevision	A	A	Enables the display of the "SoftwareRevision" column.
IV_ShowItem_State	A	A	Enables the display of the "State" column.
IV_ShowItem_Station	A	A	Enables the display of the "Station" column.
IV_ShowItem_SubAddress	A	A	Enables the display of the "SubAddress" column.
IV_ShowItem_SubSlot	A	A	Enables the display of the "SubSlot" column.
IV_ShowItem_SubSystem	A	A	Enables the display of the "SubSystem" column.
IV_ShowItem_Type	A	A	Enables the display of the "Type" column.
Layer (Page 4355)	A	-	Returns the layer that contains an object as LONG in the screen.
Left (Page 4366)	A	A	Specifies the value of the X coordinate of the object.
Modal	A	A	Specifies that you must acknowledge the alarm view before continuing with your work.
NavigationPath_Font	A	A	Sets the font type of the navigation path.
NavigationPath_TextColor	A	A	Sets the text color of the navigation path.
ObjectName (Page 4424)	A	-	Returns the object name as STRING.
OutputAddressText	A	A	Specifies the text for the output address.
Resizable	A	A	Enables resizing of the window.
ShowNavigationButtons	A	A	Enables the display of navigation buttons.
ShowPathInformation	A	A	Enables the display of the navigation path.

Properties	Read	Write	Description
ShowSplittedView	A	A	Enables a split view.
TableHeaderFont	A	A	Specifies the text color of the header.
Top (Page 4629)	A	A	Specifies the value of the Y coordinate of the object.
Type (Page 4664)	A	-	Returns the type of the specified object as STRING.
Parent (Page 4445)	A	-	Returns the screen in which the specified object is embedded.
UV_ShowItem_AKZ	A	A	Enables the display of the "AKZ" column.
UV_ShowItem_Descriptor	A	A	Enables the display of the "Descriptor" column.
UV_ShowItem_InstallationDate	A	A	Enables the display of the "InstallationDate" column.
UV_ShowItem_LADDR	A	A	Enables the display of the "LADDR" column.
UV_ShowItem_Name	A	A	Enables the display of the "Name" column.
UV_ShowItem_OKZ	A	A	Enables the display of the "OKZ" column.
UV_ShowItem_OperationState	A	A	Enables the display of the "OperationState" column.
UV_ShowItem_OrderID	A	A	Enables the display of the "OrderID" column.
UV_ShowItem_Rack	A	A	Enables the display of the "Rack" column.
UV_ShowItem_Slot	A	A	Enables the display of the "Slot" column.
UV_ShowItem_SoftwareRevision	A	A	Enables the display of the "SoftwareRevision" column.
UV_ShowItem_State	A	A	Enables the display of the "State" column.
UV_ShowItem_Station	A	A	Enables the display of the "Station" column.
UV_ShowItem_SubAddress	A	A	Enables the display of the "SubAddress" column.
UV_ShowItem_SubSlot	A	A	Enables the display of the "SubSlot" column.
UV_ShowItem_SubSystem	A	A	Enables the display of the "SubSystem" column.
UV_ShowItem_Type	A	A	Enables the display of the "Type" column.
Visible (Page 4703)	A	A	Specifies whether the selected object is visible.
Width (Page 4714)	A	A	Sets the width of the specified "Ellipsis", "Circle" and "Rectangle" objects.
WindowMode	A	A	Sets the window mode.

Table 10-122 Methods

Methods	Valid	Description
Activate (Page 4744)	A	Activates the permanent window or the root screen.

**See also**

- Screen object (list) (Page 3904)
- Screen (Page 3905)
- ScreenItem (Page 3906)
- ScreenItems (Page 3908)
- Name (Page 4417)

## TextField

### Description

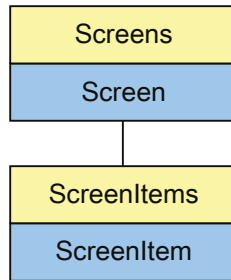

Represents the "TextField" object. The TextField object is an element of the ScreenItems list.

### Type identifier in VBS

HMITextField

Abbreviation	Validity
Pa	Panels
A	Runtime Advanced
P	Runtime Professional

Table 10-123 Properties

Properties	Read	Write	Description
AdaptBorder (Page 4156)	P	P	Specifies whether the border of the specified object is dynamically adapted to the text size.
Authorization (Page 4175)	P	P	Specifies the operating rights of the selected object in runtime.
BackColor (Page 4181)	P, A	P, A	Specifies the background color of the selected object.
BackFillStyle (Page 4185)	P	P	Defines the fill pattern of the specified object.
BackFlashingColorOff (Page 4188)	P	P	Specifies the background color for flash state "Off".

Properties	Read	Write	Description
BackFlashingColorOn (Page 4188)	P	P	Specifies the background color for flash state "On".
BackFlashingEnabled (Page 4189)	P	P	Specifies whether the background of the specified object flashes in runtime.
BackFlashingRate (Page 4190)	P	P	Specifies the flash rate of the background for the selected object.
BorderBackColor (Page 4199)	P	P	Specifies the background color of the broken border line for the selected object.
BorderColor (Page 4202)	P, A	P, A	Specifies the line color of the object.
BorderFlashingColorOff (Page 4206)	P	P	Specifies the border line color of the selected object for the flash state "Off".
BorderFlashingColorOn (Page 4207)	P	P	Specifies the border line color of the selected object for the flash state "On".
BorderFlashingEnabled (Page 4208)	P	P	Specifies whether the border line of the selected object flashes in runtime.
BorderFlashingRate (Page 4209)	P	P	Specifies the flash rate of the border line for the selected object.
BorderStyle (Page 4213)	P	P	Specifies the type of border lines for the selected object.
BorderStyle3D (Page 4215)	A	A	Specifies whether the object has a 3D border shading.
BorderWidth (Page 4216)	P, A	P, A	Specifies the line thickness of the object.
BottomMargin	-	-	Sets the margin between the text and the bottom edge of the object.
CornerStyle (Page 4250)	P	P	Specifies the type of border lines for the selected object.
DrawInsideFrame (Page 4270)	P	P	Specifies whether the border line of the selected object with a line thickness greater than 1 should be drawn within the border or symmetrically to the border.
EdgeStyle (Page 4274)	A	A	Specifies the line style of the selected object.
Enabled (Page 4277)	P	P	Specifies whether the selected object can be operated in runtime.
FillPatternColor (Page 4296)	P	P	Specifies the color of the fill pattern for the selected object.
FitToLargest	-	-	Specifies that the size of the object depends on the text length in all languages.
Flashing	-	-	Specifies that the text block flashes.
FlashingColorOff (Page 4300)	P	P	Specifies the border line color of the selected object for the flash state "Off".
FlashingColorOn (Page 4302)	P	P	Specifies the border line color of the selected object for the flash state "On".
FlashingEnabled (Page 4303)	P	P	Specifies whether the border line of the selected object flashes in runtime.
FlashingRate (Page 4304)	P	P	Specifies the flash rate of the border line for the selected object.
Font (Page 4311)	-	-	Specifies or returns the font.
FontBold (Page 4313)	P	P	Specifies whether the text of the selected object is shown in bold.
FontItalic (Page 4314)	P	P	Specifies whether the text of the selected object is shown in italics.
FontName (Page 4315)	P	P	Specifies the font of the selected object.
FontSize (Page 4316)	P	P	Specifies the font size of the text for the selected object.
FontUnderline (Page 4317)	P	P	Specifies whether the text of the selected object is underlined.

Properties	Read	Write	Description
ForeColor (Page 4318)	P, A	P, A	Specifies the font color of the text for the selected object.
Height (Page 4327)	P, A	P, A	Sets the height of the specified "Ellipsis", "Circle" and "Rectangle" objects.
HorizontalAlignment (Page 4340)	P, A	P, A	Specifies the horizontal alignment of the text within the selected object.
Layer (Page 4355)	-	-	Returns the layer that contains an object as LONG in the screen.
Left (Page 4366)	P, A	P, A	Specifies the value of the X coordinate of the object.
LeftMargin	-	-	Sets the margin between the text and the left edge of the object.
LineEndShapeStyle (Page 4380)	P	P	Specifies the shape of the line end.
LineWrap *	-	-	Specifies the line break within the object.
Name (Page 4417)	P, A	-	Returns the object name as STRING.
RelativeFillLevel (Page 4470)	P	P	Specifies the fill percentage for the object.
RightMargin	-	-	Sets the margin between the text and the right edge of the object.
RotationAngle (Page 4472)	P	P	Specifies the angle of rotation in degrees.
RotationCenterLeft (Page 4473)	P	P	Specifies the X coordinate of the pivot point for the object in runtime.
RotationCenterTop (Page 4474)	P	P	Specifies the Y coordinate of the pivot point for the object in runtime.
ShowFillLevel (Page 4519)	P	P	Specifies whether the selected object is filled.
Text (Page 4572)	P, A	P, A	Specifies the label for the text field.
TextOrientation (Page 4576)	P	P	Specifies the text orientation of the selected object.
ToolTipText (Page 4627)	P	P	Specifies the tooltip text.
Top (Page 4629)	P, A	P, A	Specifies the value of the Y coordinate of the object.
TopMargin	-	-	Sets the margin between the text and the top edge of the object.
Transparency (Page 4633)	P	P	Specifies and returns the transparency percentage of the object.
UseDesignColorScheme (Page 4674)	P	P	Specifies the font used for printing.
UseDesignShadowSettings (Page 4676)	P	P	Specifies whether the object is displayed with the shading defined in the active design.
VerticalAlignment (Page 4701)	P, A	P, A	Specifies the vertical alignment of the text for the selected object.
Visible (Page 4703)	P, A	P, A	Specifies whether the selected object is visible.
Width (Page 4714)	P, A	P, A	Sets the width of the specified "Ellipsis", "Circle" and "Rectangle" objects.

\* not visible in the ES

Table 10-124 Methods

Methods	Valid	Description
Activate (Page 4744)	P, A	Activates the permanent window or the root screen.
ActivateDynamic (Page 4747)	P	Dynamically activates a trigger and the specified cycle for a property at runtime.
DeactivateDynamic (Page 4754)	P	Deactivates the trigger of the "ActivateDynamic" method used for the specified property in/during Runtime.

**See also**

Screen object (list) (Page 3936)

**TrendRulerControl**

**Description**

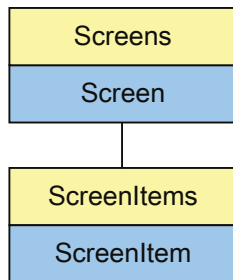

Represents the "Value table" object. The TrendRulerControl object is an element of the ScreenItems list.

**Type identifier in VBS**

HMITrendRulerControl

**Example**

In the following example, the object with the name "Control1" is moved 16 pixels to the right:

```
'VBS60
Dim objControl
Set objControl = ScreenItems("Control1")
objControl.Left = objControl.Left + 16
```

Abbreviation	Validity
Pa	Panels
A	Runtime Advanced
P	Runtime Professional

Table 10-125 Properties

Properties	Read	Write	Description
ApplyProjectSettingsForDesignMode	-	-	Specifies that the project settings are used for the design.
AutoCompleteColumns (Page 4177)	P	P	Specifies whether empty columns are shown if the control is wider than the configured columns.
AutoCompleteRows (Page 4177)	P	P	Specifies whether empty rows are shown if the control is longer than the number of configured rows.
AutoPosition	P	P	Sets the automatic repositioning mode.
AutoSelectionColors (Page 4178)	P	P	Specifies whether the colors defined by the system are used as the selection colors for cells and rows.
AutoSelectionRectColor (Page 4179)	P	P	Specifies whether the selection frame is shown with the color defined by the system.
AutoShow	P	P	Specifies the automatic display of the table of values.
BackColor (Page 4181)	P	P	Specifies the background color of the selected object.
BlockAlign *	P	P	Sets the alignment.
BlockAutoPrecisions *	P	P	Specifies that the number of decimal places displayed for an axis is adjusted automatically.
BlockCaption *	P	P	Sets the caption.
BlockCount *	P	P	Sets the number of blocks.
BlockDateFormat *	P	P	Specifies the date format.
BlockExponentialFormat *	P	P	Enables the use of the exponential notation.
BlockHideText *	P	P	Specifies whether the text is displayed.
BlockHideTitleText *	P	P	Specifies whether the text is displayed.
BlockId *	P	P	Sets the ID.
BlockIndex	P	P	The index specifies the block to which other properties such as names are referenced.
BlockLength *	P	P	Specifies the number of displayed characters.
BlockName *	P	P	Sets the name of a block.

10.8 Working with system functions and Runtime scripting

Properties	Read	Write	Description
BlockPrecisions *	P	P	Specifies the number of displayed decimal places.
Blocks	-	-	Sets the alarm blocks.
BlockShowDate *	P	P	Specifies that the date is to be displayed.
BlockShowIcon *	P	P	Specifies the tooltip text.
BlockShowTitleIcon *	P	P	Enables the display of title as icon.
BlockTimeFormat *	P	P	Specifies the time format.
BlockUseSourceFormat *	P	P	Enables the use of the source format.
BorderColor (Page 4202)	P	P	Specifies the line color of the object.
BorderWidth (Page 4216)	P	P	Specifies the line thickness of the object.
Caption (Page 4221)	P	P	Specifies the text that is displayed in the header of the selected object.
CellCut (Page 4225)	P	P	Specifies whether the contents of the cells are abbreviated if the cells are too narrow.
CellSpaceBottom (Page 4226)	P	P	Specifies the bottom margin of the table cells.
CellSpaceLeft (Page 4227)	P	P	Sets the left indent for the table cells.
CellSpaceRight (Page 4227)	P	P	Specifies the right indent of the table cells.
CellSpaceTop (Page 4228)	P	P	Specifies the top margin of the table cells.
Closeable (Page 4236)	P	P	Specifies that the control can be closed in runtime.
ColumnAdd *	P	P	Adds a column.
ColumnCount *	P	P	Displays the number of columns.
ColumnIndex	P	P	The index specifies on which column other properties, e.g. initial value are based.
ColumnName *	P	P	Specifies the name of a column.
ColumnRemove *	P	P	Removes a column.
ColumnRepos *	P	P	Repositions the column.
ColumnResize (Page 4242)	P	P	Enables changes to the width of columns.
ColumnScrollbar (Page 4244)	P	P	Specifies the scroll bar type.
ColumnSort *	P	P	Sets the type of sorting.
ColumnSortIndex *	P	P	Specifies the sorting order.
ColumnTitleAlignment	P	P	Specifies the type of column title alignment.
ColumnTitles (Page 4245)	P	P	Specifies whether the column title is displayed.
ColumnVisible *	P	P	Enables the visibility of a column.
ControlDesignMode (Page 4538)	P	P	Specifies the design.
ExportDirectoryChangeable (Page 4286)	P	P	Specifies whether the data export directory can be changed in runtime.
ExportDirectoryname (Page 4286)	P	P	Specifies the target directory for the exported Runtime data.
ExportFileExtension (Page 4287)	P	P	Specifies the file extension of the export file. Only the "csv" file extension is currently supported.
ExportFilename (Page 4288)	P	P	Specifies the name of the target file for the exported Runtime data.
ExportFilenameChangeable (Page 4288)	P	P	Specifies whether the export file name can be changed in runtime.
ExportFormatGuid (Page 4289)	P	P	Default assignment of the ID number and export provider.



Properties	Read	Write	Description
ExportFormatName (Page 4289)	P	P	Specifies the export file format. Only the "csv" file format is currently available for the export.
ExportParameters (Page 4290)	P	P	Specifies the parameters of the selected format by means of the "Properties" dialog.
ExportSelection (Page 4290)	P	P	Specifies the file extension of the export file. Only the "csv" file extension is currently supported.
ExportShowDialog (Page 4291)	P	P	Specifies whether the data export dialog is shown in runtime.
Font (Page 4311)	-	-	Specifies or returns the font.
GridLineColor (Page 4325)	P	P	Specifies the color for the grid lines.
GridLineWidth (Page 4326)	P	P	Specifies the width of the separation lines in pixels.
Height (Page 4327)	P	-	Sets the height of the specified "Ellipsis", "Circle" and "Rectangle" objects.
HorizontalGridLines (Page 4341)	P	P	Specifies whether horizontal separation lines are displayed.
IconSpace (Page 4344)	P	P	Specifies the spacing between icons and text in the table cells.
Layer (Page 4355)	-	-	Returns the layer that contains an object as LONG in the screen.
Left (Page 4366)	P	P	Specifies the value of the X coordinate of the object.
LineColor (Page 4379)	P	P	Sets the color of the window separation lines.
LineWidth (Page 4381)	P	P	Specifies the line thickness of the selected object.
Moveable (Page 4416)	P	P	Specifies whether the window can be moved in runtime.
Name (Page 4417)	P	-	Returns the object name as STRING.
PrintJob	P	P	Specifies a print job
RowScrollbar (Page 4475)	P	P	Specifies whether row scroll bars are displayed.
RowTitleAlignment	P	P	Specifies the type of row title alignment.
RowTitles	P	P	Specifies that row headers will be displayed.
RTPersistence (Page 4477)	P	P	Specifies how online configurations of WinCC are retained.
RTPersistenceAuthorization	P	P	Specifies the authorization required for online configuration in runtime.
RTPersistenceType (Page 4478)	-	-	Specifies how online configurations of WinCC are retained.
RulerType	P	P	Sets the ruler type.
SelectedCellColor (Page 4493)	P	P	Specifies the background color of the selected cell.
SelectedCellForeColor (Page 4494)	P	P	Specifies the font color of the selected cell.
SelectedRowColor (Page 4495)	P	P	Specifies the background color of the selected row.
SelectedRowForeColor (Page 4495)	P	P	Specifies the font color of the selected row.
SelectedTitleColor (Page 4496)	P	P	Specifies the background color of a selected table header.
SelectedTitleForeColor (Page 4497)	P	P	Specifies the font color of the selected table header.
SelectionColoring (Page 4499)	P	P	Specifies whether selection colors are used for cells or rows.
SelectionRect (Page 4502)	P	P	Specifies whether a selection frame is used for the selected cells or rows.

Properties	Read	Write	Description
SelectionRectColor (Page 4503)	P	P	Specifies the color of the selection rectangle in the alarm window if SelectionType equals "1".
SelectionRectWidth (Page 4504)	P	P	Specifies the line width of the selection rectangle in the alarm window if SelectionType equals "1".
SelectionType (Page 4504)	P	P	Specifies the number of lines you can mark.
ShareSpaceWithSourceControl	P	P	Enables the display of the table of values in the visualization range of the data source.
ShowSortButton (Page 4528)	P	P	Specifies whether the sorting button is shown above the vertical scroll bar.
ShowSortIcon (Page 4529)	P	P	Specifies whether the sorting icon is displayed.
ShowSortIndex (Page 4530)	P	P	
ShowTitle (Page 4534)	P	P	Specifies the representation of the control's window title.
Sizeable (Page 4538)	P	P	Specifies that the size of an object can be changed in runtime.
SortSequence (Page 4542)	P	P	Specifies how the sorting order can be changed by mouse click.
SourceControl	P	P	Sets the data source.
SourceControlType	P	P	Sets the data source type.
StatusbarBackColor (Page 4547)	P	P	Specifies the background color of the status bar.
StatusbarElementAdd (Page 4547) *	P	P	Creates a new, user-defined status bar element.
StatusbarElementAutoSize (Page 4548) *	P	P	Specifies whether the width of the selected status bar element is set automatically.
StatusbarElementCount (Page 4548) *	P	P	Specifies the number of configurable status bar elements.
StatusbarElementIconId (Page 4549) *	P	P	Default assignment of the ID number and icon of a status bar element.
StatusbarElementId (Page 4549) *	P	P	Unique ID of the selected status bar element.
StatusbarElementIndex (Page 4550)	P	P	References a status bar element. You can use this property to assign the values of other properties to a specific element of the status bar.
StatusbarElementName (Page 4550) *	P	P	Displays the object name of the selected status bar element.
StatusbarElementRemove (Page 4551) *	P	P	Removes the selected status bar element.
StatusbarElementRename (Page 4551) *	P	P	Renames the user-defined status bar element that is referenced by means of the "StatusbarElementIndex" property.
StatusbarElementRepos *	P	P	Specifies the index that is assigned to the element.
StatusbarElements (Page 4552)	-	-	Specifies the elements that are to be shown in the status bar.
StatusbarElementText	P	P	Specifies the text of the currently selected status bar element.
StatusbarElementTooltipText (Page 4552) *	P	P	Specifies the tooltip text for the user-defined status bar element.
StatusbarElementUserDefined (Page 4553) *	P	P	Indicates whether the project engineer has added the toolbar button as a new user-defined element.
StatusbarElementVisible (Page 4554) *	P	P	In the list, activate the status bar elements that you wish to display in runtime.

Properties	Read	Write	Description
StatusbarElementWidth (Page 4554) *	P	P	Specifies the width of the selected status bar element in pixels.
StatusbarFont	-	-	Status bar font
StatusbarFontColor (Page 4554)	P	P	Specifies the color of the text in the status bar.
StatusbarShowTooltips (Page 4557)	P	P	Specifies whether tooltips are displayed for the elements of the status bar in runtime.
StatusbarText (Page 4558)	P	P	Default text in the status bar.
StatusbarUseBackColor (Page 4558)	P	P	Specifies whether the background color of the status bar is shown.
StatusbarVisible (Page 4559)	P	P	Specifies whether the status bar of the control is displayed.
TableColor (Page 4564)	P	P	Specifies the background color of the rows. Use this to open the color selection dialog.
TableColor2 (Page 4564)	P	P	Specifies the background color of "Row color 2".
TableForeColor (Page 4565)	P	P	
TableForeColor2 (Page 4566)	P	P	Specifies the font color of "Row color 2".
TimeBase (Page 4584)	P	P	Sets the timebase.
TitleColor	P	P	Specifies the color of the header.
TitleCut (Page 4606)	P	P	Specifies whether the contents of the fields of a header should be abbreviated if the column is too narrow.
TitleDarkShadowColor (Page 4607)	P	P	Specifies the color of the dark side of shading.
TitleForeColor (Page 4607)	P	P	Specifies the font color of the table header for the selected status.
TitleGridLineColor (Page 4607)	P	P	Specifies the color of separation lines in the table header.
TitleLightShadowColor (Page 4608)	P	P	Specifies the color of the bright side of shading.
TitleSort (Page 4608)	P	P	Specifies how sorting by column title is triggered.
TitleStyle (Page 4609)	P	P	Specifies whether a shading color is used for the table header.
ToolBarAlignment (Page 4616)	P	P	Specifies or returns the position of the toolbar.
ToolBarBackColor (Page 4616)	P	P	Specifies the background color of the toolbar.
ToolBarButtonActive (Page 4617) *	P	P	Specifies whether the function linked to the button is activated in runtime.
ToolBarButtonAdd (Page 4618) *	P	P	Creates a new, user-defined button function.
ToolBarButtonBeginGroup (Page 4618) *	P	P	Specifies whether a separator is inserted before the selected button function.
ToolBarButtonClick	P	P	Clicks a toolbar button.
ToolBarButtonCount (Page 4619) *	P	P	Specifies the number of configurable button functions.
ToolBarButtonEnabled (Page 4619) *	P	P	Specifies whether a user-defined toolbar button can be operated.
ToolBarButtonHotKey (Page 4620) *	P	P	Shows the hotkey for the selected button function.
ToolBarButtonId (Page 4620) *	P	P	Unique ID number for the selected button function.
ToolBarButtonIndex (Page 4620)	P	P	References a button function.
ToolBarButtonLocked (Page 4621) *	P	P	Specifies whether the clicked, pressed in state is displayed for a user-defined toolbar button.
ToolBarButtonName (Page 4621) *	P	P	Shows the name of the selected button function.

Properties	Read	Write	Description
ToolbarButtonPasswordLevel (Page 4622) *	P	P	Shows the authorization for the selected button function.
ToolbarButtonRemove (Page 4622) *	P	P	Removes the selected button function from the list.
ToolbarButtonRename (Page 4622) *	P	P	Renames the user-defined toolbar element that is referenced by means of the "ToolbarButtonIndex" property.
ToolbarButtonRepos (Page 4623) *	P	P	Changes the sequence of button functions.
ToolbarButtons	-	-	Specifies which buttons are available for the toolbar.
ToolbarButtonTooltipText (Page 4623) *	P	P	Specifies the tooltip text for the button.
ToolbarButtonUserDefined (Page 4624) *	P	P	Indicates whether the project engineer has added the toolbar button as a new user-defined button.
ToolbarButtonVisible *	P	P	Specifies that the button is visible.
ToolbarShowTooltips (Page 4624)	P	P	Specifies whether the tooltips for the button functions are displayed in runtime.
ToolbarUseBackColor (Page 4625)	P	P	Specifies whether the background color for the toolbar is shown.
ToolbarUseHotKeys (Page 4626)	P	P	Specifies whether the hotkeys for the button functions are activated in runtime.
ToolbarVisible (Page 4626)	P	P	Specifies whether the toolbar of the control is displayed.
Top (Page 4629)	P	P	Specifies the value of the Y coordinate of the object.
UseSelectedTitleColor (Page 4682)	P	P	Specifies whether a selection color is used for the headers of selected table cells.
UseSourceBackColors	P	P	Specifies the use of the background color of the data source.
UseSourceForeColor	P	P	Specifies the use of the foreground color of the data source.
UseTableColor2 (Page 4684)	P	P	Specifies whether a second row color is used for the representation of the table.
VerticalGridLines (Page 4702)	P	P	Specifies whether vertical separation lines are displayed.
Visible (Page 4703)	P	P	Specifies whether the selected object is visible.
Width (Page 4714)	P	-	Sets the width of the specified "Ellipse", "Circle" and "Rectangle" objects.

\* not visible in the ES

Table 10-126 Methods

Methods	Valid	Description
Activate (Page 4744)	P, A	Activates the permanent window or the root screen.
ActivateDynamic (Page 4747)	P	Dynamically activates a trigger and the specified cycle for a property at runtime.
DeactivateDynamic (Page 4754)	P	Deactivates the trigger of the "ActivateDynamic" method used for the specified property in/during Runtime.
Export (Page 4757)	P, A	Executes the "Export log" or "Export data" button function of the control.
GetRow (Page 4769)	P	Returns the row object defined by its row number in the table-based controls as "ICCAxDataRow" type.

Methods	Valid	Description
GetRowCollection (Page 4770)	P	Returns the list of all row objects of the table-based controls as "ICCAxDataRowCollection" type.
GetRulerBlock (Page 4771)	P	Returns the block object of the evaluation table designated by name or index as "ICCAxRulerBlock" type.
GetRulerBlockCollection (Page 4772)	P	Returns the list of all block objects of the evaluation table as "ICCAxCollection" type.
GetRulerColumn (Page 4774)	P	Returns the column object of the evaluation table designated by name or index as "ICCAxRulerColumn" type.
GetRulerColumnCollection (Page 4775)	P	Returns the list of all column objects of the evaluation table as "ICCAxCollection" type.
GetSelectedRow (Page 4777)	P	Returns the selected row object of a table-based control as "ICCAxDataRow" type.
GetSelectedRows (Page 4778)	P	Returns the selected row objects of a table-based control as type "ICCAxDataRow" for multiple selection.
GetStatisticAreaColumn (Page 4779)	P	Returns the column object of the statistic area window of the evaluation window designated by name or index as "ICCAxRulerColumn" type.
GetStatisticAreaColumnCollection (Page 4781)	P	Returns the list of all column objects of the statistic area window of the evaluation table as "ICCAxCollection" type.
GetStatisticResultColumn (Page 4782)	P	Returns the column object of the statistic window of the evaluation window designated by name or index as "ICCAxRulerColumn" type.
GetStatisticResultColumnCollection (Page 4783)	P	Returns the list of all column objects of the statistic window of the evaluation table as "ICCAxCollection" type.
GetStatusBarElement (Page 4784)	P, A	Returns the element of the control's status bar designated by name or index as "ICCAxStatusBarElement" type.
GetStatusBarElementCollection (Page 4785)	P, A	Returns the list of all status bar elements of the control as "ICCAxCollection" type.
GetToolBarButton (Page 4792)	P, A	Returns the button function designated by name or index on the control toolbar as "ICCAxToolBarButton" type.
GetToolBarButtonCollection (Page 4793)	P, A	Returns the list of all button functions of the control toolbar as "ICCAxCollection" type.
Print (Page 4822)	P, A	Executes the "Print" button function of the control.
SelectAll (Page 4837)	P	Selects all rows in a table-based control.
SelectRow (Page 4838)	P	Selects a specific row in a table-based control.
ShowHelp (Page 4842)	P, A	Executes the "Help" button function of the control.
ShowPropertyDialog (Page 4847)	P, A	Executes the "Configuration dialog" button function of the control.
UnselectAll (Page 4855)	P	Removes all selections from the cells of a table-based control.
UnselectRow (Page 4856)	P	Removes the selections from a specific cell of a table-based control.

## See also

- Screen (Page 3930)
- ScreenItem (Page 3932)
- ScreenItems (list) (Page 3934)
- Screen object (list) (Page 3936)

## TrendView

### Description

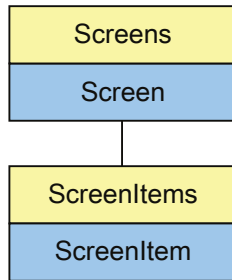

Represents the "TrendView" object. The TrendView object is an element of the ScreenItems list.

### Type identifier in VBS

HMITrendView

Abbreviation	Validity
Pa	Panels
A	Runtime Advanced
P	Runtime Professional

Table 10-127 Properties

Properties	Read	Write	Description
Authorization (Page 4175)	-	-	Specifies the operating rights of the selected object in runtime.
AxisXBunchCount	-	-	Sets the step width of the large ticks for the X axis.
AxisXMarkCount	-	-	Sets the step width of the ticks for the X axis.
AxisXNoOfDigits	-	-	

Properties	Read	Write	Description
AxisXShowBunchValues	-	-	Enables scale labeling of the interim values for the X axis.
AxisXStyle *	-	-	
AxisY1BunchCount	-	-	Sets the step width of the large ticks for the Y axis.
AxisY1MarkCount	-	-	Sets the step width of the large ticks for the left Y axis.
AxisY1ShowBunchValues	-	-	Enables scale labeling of the interim values for the left Y axis.
AxisY2BunchCount	-	-	Sets the step width of the large ticks for the right Y axis.
AxisY2MarkCount	-	-	Sets the step width of the ticks for the right Y axis.
AxisY2ShowBunchValues	-	-	Enables scale labeling of the interim values for the right Y axis.
BackColor (Page 4183)	A	A	Specifies the background color of the selected object.
ColumnsMoveable	-	-	Specifies that the columns can be moved.
CountVisibleItems (Page 4253)	-	-	Specifies the number of lines contained in the selection list.
Enabled (Page 4279)	A	A	Specifies whether the selected object can be operated in runtime.
EnableNavigateButtons	-	-	
EnableNavigateKeys	-	-	Specifies keyboard operation.
FitToSize	-	-	Specifies that the size of the object should be automatically adapted to the content.
Flashing	-	-	Specifies that the text block flashes.
FocusColor (Page 4309)	A	A	Specifies the color for the focus frame of the selected object when it is in focus.
FocusWidth (Page 4310)	A	A	Specifies the border width of the specified object when the object is in focus.
Font (Page 4311)	-	-	Specifies or returns the font.
Height (Page 4327)	A	-	Sets the height of the specified "Ellipsis", "Circle" and "Rectangle" objects.
HelpText (Page 4330)	A	-	Returns the tooltip that is shown in runtime as user help for the specified object.
Layer (Page 4355)	-	-	Returns the layer that contains an object as LONG in the screen.
Left (Page 4366)	A	A	Specifies the value of the X coordinate of the object.
Look3D	-	-	Activates 3D visualization.
Name (Page 4417)	A	-	Returns the object name as STRING.
RulerColor (Page 4479)	A	A	Specifies the color of the scale gradation (auxiliary line) of the axis labelling in the "OnlineTrendControl" object.
ScaleColor (Page 4481)	A	A	Specifies the color of the scale of the selected object.
SelectionBackColor (Page 4498) *	-	-	Specifies the background color of the selected cells.
SelectionForeColor (Page 4500) *	-	-	Specifies the foreground color of the selected cells.
ShowRuler (Page 4526)	A	A	Specifies whether a scale gradation (auxiliary line) is shown for the axis label of the "OnlineTrendControl" object.
ShowTableGridLines (Page 4531)	-	--	Enables the display of grid lines in the table.
ShowTimeAxis	-	-	Enables the display of the X axis.
ShowTimeAxisLabeling	-	-	Enables the display of the X axis labeling.
ShowValueAxis1	-	-	Enables the display of the left Y axis.
ShowValueAxis1Label	-	-	Enables the display of the labeling for left Y axis.

Properties	Read	Write	Description
ShowValueAxis2	-	-	Enables the display of the right Y axis.
ShowValueAxis2Label	-	-	Sets the window title.
ShowValueTable	-	-	Enables the display of the table of values.
ShowY1HlpLine	-	-	Enables the display of the auxiliary line.
ShowY2HlpLine	-	-	Enables the display of the auxiliary line.
TableBackColor (Page 4563)	A	A	Specifies the background color of the table cells for the selected object.
TableFont	-	-	Specifies the font in the table.
TableGridLineColor (Page 4567)	A	A	Sets the color of the gridlines in the table of the specified object.
TableHeaderBackColor (Page 4568)	A	A	Specifies the background color in the header of the table of the selected object.
TableHeaderFont	-	-	Specifies the text color of the header.
TableHeaderForeColor (Page 4569)	A	A	Specifies the text color in the header of the table of the selected object.
TagForExternalTime	-	-	Sets the tag for the external time.
TimeAxisBegin	-	-	Sets the start value for the time axis.
TimeAxisBeginTime	-	-	Specifies the starting time for the display of the selected trend.
TimeAxisCountPoints	-	-	Sets the number of values for the time axis.
TimeAxisEnd	-	-	Sets the end value for the time axis.
TimeAxisMode	-	-	Sets the time axis mode.
TimeAxisRange (Page 4581)	-	-	Period displayed by the time axis.
TimeAxisSide	-	-	Sets the page for new values on the time axis.
ToolbarButtons	-	-	Specifies which buttons are available for the toolbar.
ToolbarEnabled *	-	-	Enables the use of a toolbar in the trend view.
ToolbarStyle	-	-	Sets the appearance of the toolbar.
Top (Page 4629)	A	A	Specifies the value of the Y coordinate of the object.
TrendsForPrinting *	-	-	
ValueAxis1AutoRange *	-	-	Sets the automatic adaptation of the data area.
ValueAxis1Begin	-	-	Sets the start value for the axis.
ValueAxis1End	-	-	Sets the end value for the axis.
ValueAxis1LabelLength	-	-	Sets the length of axis labeling.
ValueAxis1Style *	-	-	
ValueAxis2AutoRange *	-	-	Sets the automatic adaptation of the data area.
ValueAxis2Begin	-	-	Sets the start value for the axis.
ValueAxis2End	-	-	Sets the end value for the axis.
ValueAxis2LabelLength	-	-	Sets the length of axis labeling.
ValueAxis2Style *	-	-	Sets the automatic adaptation of the data area.
ValueY1HlpLine	-	-	Sets the value for the auxiliary line.
ValueY2HlpLine	-	-	Value for the auxiliary line on the right Y axis.
Visible (Page 4703)	A	A	Specifies whether the selected object is visible.
Width (Page 4714)	A	-	Sets the width of the specified "Ellipse", "Circle" and "Rectangle" objects.



\* not visible in the ES

Table 10-128 Methods

Methods	Valid	Description
Activate (Page 4744)	P, A	Activates the permanent window or the root screen.

**See also**

Screen object (list) (Page 3904)

Screen (Page 3905)

ScreenItem (Page 3906)

ScreenItems (Page 3908)

**TubeArcObject**

**Description**

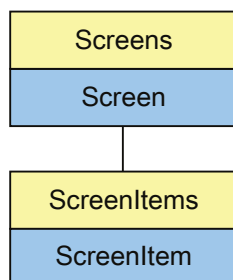

Represents the "TubeArc" object. The TubeArcObject is an element of the ScreenItems list.

**Type identifier in VBS**

HMITubeArcObject

### Application

In the following example, the object with the name "TubeArcObject1" is moved 10 pixels to the right:

```
'VBS24
Dim objTubeArcObject
Set objTubeArcObject = ScreenItems("TubeArcObject1")
objTubeArcObject.Left = objTubeArcObject.Left + 10
```

Abbreviation	Validity
Pa	Panels
A	Runtime Advanced
P	Runtime Professional

Table 10-129 Properties

Properties	Read	Write	Description
Authorization (Page 4175)	P	P	Specifies the operating rights of the selected object in runtime.
Color (Page 4236)	P	P	Specifies the line color of the selected object.
Enabled (Page 4277)	P	P	Specifies whether the selected object can be operated in runtime.
EndAngle (Page 4280)	P	P	Specifies the angle at which the end point of the selected object deviates from the zero position (0°).
Height (Page 4327)	P	P	Sets the height of the specified "Ellipsis", "Circle" and "Rectangle" objects.
Layer (Page 4355)	-	-	Returns the layer that contains an object as LONG in the screen.
Left (Page 4366)	P	P	Specifies the value of the X coordinate of the object.
LineWidth (Page 4381)	P	P	Specifies the line thickness of the selected object.
Name (Page 4417)	P	-	Returns the object name as STRING.
RadiusHeight (Page 4466)	P	P	Specifies the minor axis of the "Ellipsis" object.
RadiusWidth (Page 4467)	P	P	Specifies the major axis of the "Ellipsis" object.
StartAngle (Page 4543)	P	P	Specifies the SQL statement.
ToolTipText (Page 4627)	P	P	Specifies the tooltip text.
Top (Page 4629)	P	P	Specifies the value of the Y coordinate of the object.
Transparency (Page 4633)	P	P	Specifies and returns the transparency percentage of the object.
UseDesignColorScheme (Page 4674)	P	P	Specifies the font used for printing.
UseDesignShadowSettings (Page 4676)	P	P	Specifies whether the object is displayed with the shading defined in the active design.
Visible (Page 4703)	P	P	Specifies whether the selected object is visible.
Width (Page 4714)	P	P	Sets the width of the specified "Ellipsis", "Circle" and "Rectangle" objects.

Table 10-130 Methods

Methods	Valid	Description
Activate (Page 4744)	P, A	Activates the permanent window or the root screen.
ActivateDynamic (Page 4747)	P	Dynamically activates a trigger and the specified cycle for a property at runtime.
DeactivateDynamic (Page 4754)	P	Deactivates the trigger of the "ActivateDynamic" method used for the specified property in/during Runtime.

**See also**

- Screen (Page 3930)
- ScreenItem (Page 3932)
- ScreenItems (list) (Page 3934)
- Screen object (list) (Page 3936)

**TubeDoubleTeeObject**

**Description**

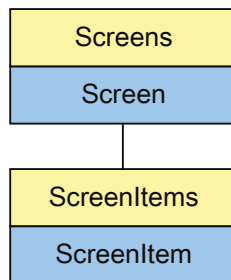

Represents the "DoubleTee" object. The TubeDoubleTeeObject is an element of the ScreenItems list.

## Type identifier in VBS

HMITubeDoubleTeeObject

### Application

In the following example, the object with the name "TubeDoubleTeeObject1" is moved 10 pixels to the right:

```
'VBS21
Dim objTubeDoubleTeeObject
Set objTubeDoubleTeeObject = ScreenItems("TubeDoubleTeeObject1")
objTubeDoubleTeeObject.Left = objTubeDoubleTeeObject.Left + 10
```

Abbreviation	Validity
Pa	Panels
A	Runtime Advanced
P	Runtime Professional

Table 10-131 Properties

Properties	Read	Write	Description
Authorization (Page 4175)	P	P	Specifies the operating rights of the selected object in runtime.
Color (Page 4236)	P	P	Specifies the line color of the selected object.
Enabled (Page 4277)	P	P	Specifies whether the selected object can be operated in runtime.
Height (Page 4327)	P	P	Sets the height of the specified "Ellipsis", "Circle" and "Rectangle" objects.
Layer (Page 4355)	-	-	Returns the layer that contains an object as LONG in the screen.
Left (Page 4366)	P	P	Specifies the value of the X coordinate of the object.
LineWidth (Page 4381)	P	P	Specifies the line thickness of the selected object.
Name (Page 4417)	P	-	Returns the object name as STRING.
ToolTipText (Page 4627)	P	P	Specifies the tooltip text.
Top (Page 4629)	P	P	Specifies the value of the Y coordinate of the object.
Transparency (Page 4633)	P	P	Specifies and returns the transparency percentage of the object.
UseDesignColorScheme (Page 4674)	P	P	Specifies the font used for printing.
UseDesignShadowSettings (Page 4676)	P	P	Specifies whether the object is displayed with the shading defined in the active design.
Visible (Page 4703)	P	P	Specifies whether the selected object is visible.
Width (Page 4714)	P	P	Sets the width of the specified "Ellipsis", "Circle" and "Rectangle" objects.

Table 10-132 Methods

Methods	Valid	Description
Activate (Page 4744)	P, A	Activates the permanent window or the root screen.
ActivateDynamic (Page 4747)	P	Dynamically activates a trigger and the specified cycle for a property at runtime.
DeactivateDynamic (Page 4754)	P	Deactivates the trigger of the "ActivateDynamic" method used for the specified property in/during Runtime.

**See also**

- Screen (Page 3930)
- ScreenItem (Page 3932)
- ScreenItems (list) (Page 3934)
- Screen object (list) (Page 3936)

**TubePolyline**

**Description**

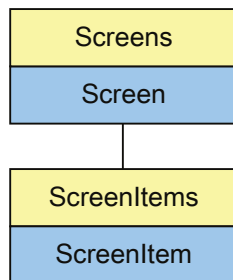

Represents the "TubePolyline" object. The TubePolyline object is an element of the ScreenItems list.

## Type identifier in VBS

HMITubePolyline

### Application

In the following example, the object with the name "TubePolyline1" is moved 10 pixels to the right:

```
'VBS24
Dim objTubePolyline
Set objTubePolyline = ScreenItems("TubePolyline1")
objTubePolyline.Left = objTubePolyline.Left + 10
```

Abbreviation	Validity
Pa	Panels
A	Runtime Advanced
P	Runtime Professional

Table 10-133 Properties

Properties	Read	Write	Description
ActualPointIndex (Page 4154)	P	P	Specifies the number of the current corner point of the selected object.
ActualPointLeft (Page 4154)	P	P	Specifies the X coordinate of the current corner point with reference to the screen origin.
ActualPointTop (Page 4155)	P	P	Specifies the Y coordinate of the current corner point with reference to the screen origin.
Authorization (Page 4175)	P	P	Specifies the operating rights of the selected object in runtime.
Color (Page 4236)	P	P	Specifies the line color of the selected object.
CornerStyle (Page 4250)	P	P	Specifies the type of border lines for the selected object.
Enabled (Page 4277)	P	P	Specifies whether the selected object can be operated in runtime.
Height (Page 4327)	P	P	Sets the height of the specified "Ellipsis", "Circle" and "Rectangle" objects.
Layer (Page 4355)	-	-	Returns the layer that contains an object as LONG in the screen.
Left (Page 4366)	P	P	Specifies the value of the X coordinate of the object.
LineWidth (Page 4381)	P	P	Specifies the line thickness of the selected object.
Name (Page 4417)	P	-	Returns the object name as STRING.
Points	-	-	Specifies the corner points.
PointsCount (Page 4458)	P	P	Specifies the number of corner points of the polyline or of the polygon.
ToolTipText (Page 4627)	P	P	Specifies the tooltip text.
Top (Page 4629)	P	P	Specifies the value of the Y coordinate of the object.
Transparency (Page 4633)	P	P	Specifies and returns the transparency percentage of the object.

Properties	Read	Write	Description
UseDesignColorScheme (Page 4674)	P	P	Specifies the font used for printing.
UseDesignShadowSettings (Page 4676)	P	P	Specifies whether the object is displayed with the shading defined in the active design.
Visible (Page 4703)	P	P	Specifies whether the selected object is visible.
Width (Page 4714)	P	P	Sets the width of the specified "Ellipsis", "Circle" and "Rectangle" objects.

Table 10-134 Methods

Methods	Valid	Description
Activate (Page 4744)	P, A	Activates the permanent window or the root screen.
ActivateDynamic (Page 4747)	P	Dynamically activates a trigger and the specified cycle for a property at runtime.
DeactivateDynamic (Page 4754)	P	Deactivates the trigger of the "ActivateDynamic" method used for the specified property in/during Runtime.

### See also

- Screen (Page 3930)
- ScreenItem (Page 3932)
- ScreenItems (list) (Page 3934)
- Screen object (list) (Page 3936)

## TubeTeeObject

### Description

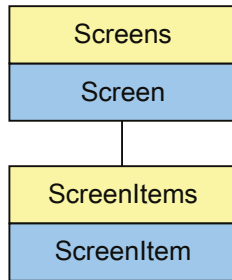

Represents the "Tee" object. The TubeTeeObject is an element of the ScreenItems list.  
Object Type of ScreenItem Object. Represents the "T-piece" graphic object.

### Type identifier in VBS

HMITubeTeeObject

### Application

In the following example, the object with the name "TubeTeeObject1" is moved 10 pixels to the right:

```
'VBS21  
Dim objTubeTeeObject  
Set objTubeTeeObject = ScreenItems("TubeTeeObject1")  
objTubeTeeObject.Left = objTubeTeeObject.Left + 10
```

Abbreviation	Validity
Pa	Panels
A	Runtime Advanced
P	Runtime Professional



Table 10-135 Properties

Properties	Read	Write	Description
Authorization (Page 4175)	P	P	Specifies the operating rights of the selected object in runtime.
Color (Page 4236)	P	P	Specifies the line color of the selected object.
Enabled (Page 4277)	P	P	Specifies whether the selected object can be operated in runtime.
Height (Page 4327)	P	P	Sets the height of the specified "Ellipsis", "Circle" and "Rectangle" objects.
Layer (Page 4355)	-	-	Returns the layer that contains an object as LONG in the screen.
Left (Page 4366)	P	P	Specifies the value of the X coordinate of the object.
LineWidth (Page 4381)	P	P	Specifies the line thickness of the selected object.
Name (Page 4417)	P	-	Returns the object name as STRING.
RotationAngle (Page 4472)	P	P	Specifies the angle of rotation in degrees.
ToolTipText (Page 4627)	P	P	Specifies the tooltip text.
Top (Page 4629)	P	P	Specifies the value of the Y coordinate of the object.
Transparency (Page 4633)	P	P	Specifies and returns the transparency percentage of the object.
UseDesignColorScheme (Page 4674)	P	P	Specifies the font used for printing.
UseDesignShadowSettings (Page 4676)	P	P	Specifies whether the object is displayed with the shading defined in the active design.
Visible (Page 4703)	P	P	Specifies whether the selected object is visible.
Width (Page 4714)	P	P	Sets the width of the specified "Ellipsis", "Circle" and "Rectangle" objects.

Table 10-136 Methods

Methods	Valid	Description
Activate (Page 4744)	P, A	Activates the permanent window or the root screen.
ActivateDynamic (Page 4747)	P	Dynamically activates a trigger and the specified cycle for a property at runtime.
DeactivateDynamic (Page 4754)	P	Deactivates the trigger of the "ActivateDynamic" method used for the specified property in/during Runtime.

**See also**

- Screen (Page 3930)
- ScreenItem (Page 3932)
- ScreenItems (list) (Page 3934)
- Screen object (list) (Page 3936)

## UserArchiveControl

### Description

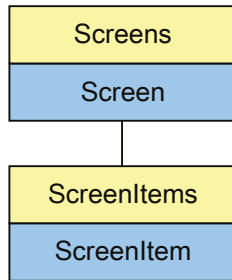

Represents the "RecipeView" object. The UserArchiveControl object is an element of the ScreenItems list.

### Type identifier in VBS

HMIUserArchiveControl

Abbreviation	Validity
Pa	Panels
A	Runtime Advanced
P	Runtime Professional

Table 10-137 Properties

Properties	Read	Write	Description
ApplyProjectSettingsForDesignMode	-	-	Specifies that the project settings are used for the design.
ArchiveName *	P	P	Sets the log name.
ArchiveType	P	-	Sets the log type.
AutoCompleteColumns (Page 4177)	P	P	Specifies whether empty columns are shown if the control is wider than the configured columns.
AutoCompleteRows (Page 4177)	P	P	Specifies whether empty rows are shown if the control is longer than the number of configured rows.

Properties	Read	Write	Description
AutoSelectionColors (Page 4178)	P	P	Specifies whether the colors defined by the system are used as the selection colors for cells and rows.
AutoSelectionRectColor (Page 4179)	P	P	Specifies whether the selection frame is shown with the color defined by the system.
BackColor (Page 4181)	P	P	Specifies the background color of the selected object.
Blocks	-	-	Sets the alarm blocks.
BorderColor (Page 4202)	P	P	Specifies the line color of the object.
BorderWidth (Page 4216)	P	P	Specifies the line thickness of the object.
Caption (Page 4221)	P	P	Specifies the text that is displayed in the header of the selected object.
CellCut (Page 4225)	P	P	Specifies whether the contents of the cells are abbreviated if the cells are too narrow.
CellSpaceBottom (Page 4226)	P	P	Specifies the bottom margin of the table cells.
CellSpaceLeft (Page 4227)	P	P	Sets the left indent for the table cells.
CellSpaceRight (Page 4227)	P	P	Specifies the right indent of the table cells.
CellSpaceTop (Page 4228)	P	P	Specifies the top margin of the table cells.
Closeable (Page 4236)	P	P	Specifies that the control can be closed in runtime.
ColumnAlign (Page 4241) *	P	P	Specifies how the selected column is aligned.
ColumnAutoPrecisions *	P	P	Specifies that the number of decimal places displayed for an axis is adjusted automatically.
ColumnCaption *	P	P	Sets the caption.
ColumnCount *	P	-	Displays the number of columns.
ColumnDateFormat *	P	P	Sets the display format for date information.
ColumnExponentialFormat *	P	P	Specifies that exponential notation is used in a column.
ColumnHideText *	P	P	Specifies whether the text is displayed.
ColumnHideTitleText *	P	P	Specifies whether the text is displayed.
ColumnIndex	P	P	The index specifies on which column other properties, e.g. initial value are based.
ColumnLeadingZeros *	P	P	Specifies that leading zeros should be displayed.
ColumnLength *	P	P	Specifies the number of displayed characters.
ColumnName *	P	-	Specifies the name of a column.
ColumnPrecisions *	P	P	Sets the number of decimal places.
ColumnReadOnly *	P	P	Sets the read-only mode for the values in the column.
ColumnRepos *	P	P	Repositions the column.
ColumnResize (Page 4242)	P	P	Enables changes to the width of columns.
ColumnScrollbar (Page 4244)	P	P	Specifies the scroll bar type.
ColumnShowDate *	P	P	Specifies that the date is to be displayed.
ColumnShowIcon *	P	P	Enables the display of an icon.
ColumnShowTitleIcon *	P	P	Enables the display of an icon.
ColumnSort *	P	P	Sets the type of sorting.
ColumnSortIndex *	P	P	Specifies the sorting order.
ColumnTimeFormat *	P	P	Sets the display format for time information.
ColumnTitleAlignment	P	P	Specifies the type of column title alignment.

10.8 Working with system functions and Runtime scripting

Properties	Read	Write	Description
ColumnTitles (Page 4245)	P	P	Specifies whether the column title is displayed.
ColumnVisible *	P	P	Enables the visibility of a column.
ControlDesignMode (Page 4538)	P	P	Specifies the design.
DataSource	-	-	Sets the data source.
Enabled (Page 4277)	P	P	Specifies whether the selected object can be operated in runtime.
EnableDelete	P	P	Enables the deletion of data.
EnableEdit (Page 4280)	P	P	Specifies whether the data shown can be edited in runtime.
EnableInsert	P	P	Enables insertion of data.
ExportDirectoryChangeable (Page 4286)	P	P	Specifies whether the data export directory can be changed in runtime.
ExportDirectoryname (Page 4286)	P	P	Specifies the target directory for the exported Runtime data.
ExportFileExtension (Page 4287)	P	P	Specifies the file extension of the export file. Only the "csv" file extension is currently supported.
ExportFilename (Page 4288)	P	P	Specifies the name of the target file for the exported Runtime data.
ExportFilenameChangeable (Page 4288)	P	P	Specifies whether the export file name can be changed in runtime.
ExportFormatGuid (Page 4289)	P	P	Default assignment of the ID number and export provider.
ExportFormatName (Page 4289)	P	P	Specifies the export file format. Only the "csv" file format is currently available for the export.
ExportParameters (Page 4290)	P	-	Specifies the parameters of the selected format by means of the "Properties" dialog.
ExportSelection (Page 4290)	P	P	Specifies which runtime data of the control is exported.
ExportShowDialog (Page 4291)	P	P	Specifies whether the data export dialog is shown in runtime.
Filters	-	-	Specifies database criteria in SQL syntax.
FilterSQL	P	-	Sets an SQL statement for the filter criterion.
Font (Page 4311)	-	-	Specifies or returns the font.
GridLineColor (Page 4325)	P	P	Specifies the color for the grid lines.
GridLineWidth (Page 4326)	P	P	Specifies the width of the separation lines in pixels.
Height (Page 4327)	P	P	Sets the height of the specified "Ellipsis", "Circle" and "Rectangle" objects.
HorizontalGridLines (Page 4341)	P	P	Specifies whether horizontal separation lines are displayed.
IconSpace (Page 4344)	P	P	Specifies the spacing between icons and text in the table cells.
Layer (Page 4355)	-	-	Returns the layer that contains an object as LONG in the screen.
Left (Page 4366)	P	P	Specifies the value of the X coordinate of the object.
LineColor (Page 4379)	P	P	Sets the color of the window separation lines.
LineWidth (Page 4381)	P	P	Specifies the line thickness of the selected object.
Moveable (Page 4416)	P	P	Specifies whether the window can be moved in runtime.
ObjectName (Page 4424)	P	-	Returns the object name as STRING.
PrintJobName (Page 4460)	P	P	Specifies a print job.

Properties	Read	Write	Description
RowScrollbar (Page 4475)	P	P	Specifies whether row scroll bars are displayed.
RowTitleAlignment	P	P	Specifies the type of row title alignment.
RowTitles	P	P	Specifies that row headers will be displayed.
RTPersistence (Page 4477)	P	P	Specifies how online configurations of WinCC are retained.
RTPersistenceAuthorization	P	P	Specifies the authorization required for online configuration in runtime.
RTPersistenceType (Page 4478)	-	-	Specifies how online configurations of WinCC are retained.
SelectArchiveName *	P	P	Specifies definition of the log by name.
SelectedCellColor (Page 4493)	P	P	Specifies the background color of the selected cell.
SelectedCellForeColor (Page 4494)	P	P	Specifies the font color of the selected cell.
SelectedRowColor (Page 4495)	P	P	Specifies the background color of the selected row.
SelectedRowForeColor (Page 4495)	P	P	Specifies the font color of the selected row.
SelectedTitleColor (Page 4496)	P	P	Specifies the background color of a selected table header.
SelectedTitleForeColor (Page 4497)	P	P	Specifies the font color of the selected table header.
SelectionColoring (Page 4499)	P	P	Specifies whether selection colors are used for cells or rows.
SelectionRect (Page 4502)	P	P	Specifies whether a selection frame is used for the selected cells or rows.
SelectionRectColor (Page 4503)	P	P	Specifies the color of the selection rectangle in the alarm window if SelectionType equals "1".
SelectionRectWidth (Page 4504)	P	P	Specifies the line width of the selection rectangle in the alarm window if SelectionType equals "1".
SelectionType (Page 4504)	P	P	Specifies the number of lines you can mark.
ShowSortButton (Page 4528)	P	P	Specifies whether the sorting button is shown above the vertical scroll bar.
ShowSortIcon (Page 4529)	P	P	Specifies whether the sorting icon is displayed.
ShowSortIndex (Page 4530)	P	P	Specifies whether a sort index is displayed.
ShowTitle (Page 4534)	P	P	Specifies the representation of the control's window title.
Sizeable	P	P	Specifies that the size of an object can be changed in runtime.
SortSequence	P	P	Specifies how the sorting order can be changed by mouse click.
StatusbarBackColor (Page 4547)	P	P	Specifies the background color of the status bar.
StatusbarElementAdd (Page 4547) *	-	P	Creates a new, user-defined status bar element.
StatusbarElementAutoSize (Page 4548) *	P	P	Specifies whether the width of the selected status bar element is set automatically.
StatusbarElementCount (Page 4548) *	P	-	Specifies the number of configurable status bar elements.
StatusbarElementIconId (Page 4549) *	P	P	Default assignment of the ID number and icon of a status bar element.
StatusbarElementId (Page 4549) *	P	-	Returns the ID number of the selected status bar element.
StatusbarElementIndex (Page 4550)	P	P	References a status bar element. You can use this property to assign the values of other properties to a specific element of the status bar.

Properties	Read	Write	Description
StatusbarElementName (Page 4550) *	P	P	Displays the object name of the selected status bar element.
StatusbarElementRemove (Page 4551) *	P	P	Removes the selected status bar element.
StatusbarElementRename (Page 4551) *	P	P	Renames the user-defined status bar element that is referenced by means of the "StatusbarElementIndex" property.
StatusbarElementRepos *	P	P	Specifies the index that is assigned to the element.
StatusbarElements (Page 4552)	-	-	Specifies the elements that are to be shown in the status bar.
StatusbarElementText *	P	P	Specifies the text of the currently selected status bar element.
StatusbarElementTooltipText (Page 4552) *	P	P	Specifies the tooltip text for the user-defined status bar element.
StatusbarElementUserDefined (Page 4553) *	P	-	Indicates whether the project engineer has added the toolbar button as a new user-defined element.
StatusbarElementVisible (Page 4554) *	P	P	In the list, activate the status bar elements that you wish to display in runtime.
StatusbarElementWidth (Page 4554) *	P	P	Specifies the width of the selected status bar element in pixels.
StatusbarFont	-	-	Status bar font
StatusbarFontColor (Page 4554)	P	P	Specifies the color of the text in the status bar.
StatusbarShowTooltips (Page 4557)	P	P	Specifies whether tooltips are displayed for the elements of the status bar in runtime.
StatusbarText (Page 4558)	P	-	Default text in the status bar.
StatusbarUseBackColor (Page 4558)	P	P	Specifies whether the background color of the status bar is shown.
StatusbarVisible (Page 4559)	P	P	Specifies whether the status bar of the control is displayed.
TableColor (Page 4564)	P	P	Specifies the background color of the rows. Use this to open the color selection dialog.
TableColor2 (Page 4564)	P	P	Specifies the background color of "Row color 2".
TableForeColor (Page 4565)	P	P	
TableForeColor2 (Page 4566)	P	P	Specifies the font color of "Row color 2".
TimeBase (Page 4584)	P	P	Sets the timebase.
TitleColor	P	P	Specifies the color of the header.
TitleCut (Page 4606)	P	P	Specifies whether the contents of the fields of a header should be abbreviated if the column is too narrow.
TitleDarkShadowColor (Page 4607)	P	P	Specifies the color of the dark side of shading.
TitleForeColor (Page 4607)	P	P	Specifies the font color of the table header for the selected status.
TitleGridLineColor (Page 4607)	P	P	Specifies the color of separation lines in the table header.
TitleLightShadowColor (Page 4608)	P	P	Specifies the color of the bright side of shading.
TitleSort (Page 4608)	P	P	Specifies how sorting by column title is triggered.
TitleStyle (Page 4609)	P	P	Specifies whether a shading color is used for the table header.
ToolbarAlignment (Page 4616)	P	P	Specifies or returns the position of the toolbar.

Properties	Read	Write	Description
ToolBarBackColor (Page 4616)	P	P	Specifies the background color of the toolbar.
ToolBarButtonActive (Page 4617) *	P	P	Specifies whether the function linked to the button is activated in runtime.
ToolBarButtonAdd (Page 4618) *	P	P	Creates a new, user-defined button function.
ToolBarButtonBeginGroup (Page 4618) *	P	P	Specifies whether a separator is inserted before the selected button function.
ToolBarButtonClick	P	P	Clicks a toolbar button.
ToolBarButtonCount (Page 4619) *	P	-	Specifies the number of configurable button functions.
ToolBarButtonEnabled (Page 4619) *	P	P	Specifies whether a user-defined toolbar button can be operated.
ToolBarButtonHotKey (Page 4620) *	P	P	Shows the hotkey for the selected button function.
ToolBarButtonId (Page 4620) *	P	P	Unique ID number for the selected button function.
ToolBarButtonIndex (Page 4620)	P	P	References a button function.
ToolBarButtonLocked (Page 4621) *	P	P	Specifies whether the clicked, pressed in state is displayed for a user-defined toolbar button.
ToolBarButtonName (Page 4621) *	P	-	Shows the name of the selected button function.
ToolBarButtonPasswordLevel (Page 4622) *	P	P	Shows the authorization for the selected button function.
ToolBarButtonRemove (Page 4622) *	P	-	Removes the selected button function from the list.
ToolBarButtonRename (Page 4622) *	P	-	Renames the user-defined toolbar element that is referenced by means of the "ToolBarButtonIndex" property.
ToolBarButtonRepos (Page 4623) *	P	P	Changes the sequence of button functions.
ToolBarButtons	-	-	Specifies which buttons are available for the toolbar.
ToolBarButtonTooltipText (Page 4623) *	P	P	Specifies the tooltip text for the button.
ToolBarButtonUserDefined (Page 4624) *	P	-	Indicates whether the project engineer has added the toolbar button as a new user-defined button.
ToolBarButtonVisible *	P	P	Specifies that the button is visible.
ToolBarShowTooltips (Page 4624)	P	P	Specifies whether the tooltips for the button functions are displayed in runtime.
ToolBarUseBackColor (Page 4625)	P	P	Specifies whether the background color for the toolbar is shown.
ToolBarUseHotKeys (Page 4626)	P	P	Specifies whether the hotkeys for the button functions are activated in runtime.
ToolBarVisible (Page 4626)	P	P	Specifies whether the toolbar of the control is displayed.
Top (Page 4629)	P	P	Specifies the value of the Y coordinate of the object.
UseSelectedTitleColor (Page 4682)	P	P	Specifies whether a selection color is used for the headers of selected table cells.
UseTableColor2 (Page 4684)	P	P	Specifies whether a second row color is used for the representation of the table.
VerticalGridLines (Page 4702)	P	P	Specifies whether vertical separation lines are displayed.
Visibility	P	P	Specifies whether the selected object is visible.
Width (Page 4714)	P	P	Sets the width of the specified "Ellipsis", "Circle" and "Rectangle" objects.

\* not visible in the ES

Table 10-138 Methods

Methods	Valid	Description
Activate (Page 4744)	P, A	Activates the permanent window or the root screen.
ActivateDynamic (Page 4747)	P	Dynamically activates a trigger and the specified cycle for a property with VBScript during runtime.
CopyRows (Page 4751)	P	Executes the "Copy rows" button function of the control.
CutRows (Page 4753)	P	Executes the "Cut rows" button function of the recipe view.
DeleteRows (Page 4756)	P	Executes the "Delete rows" button function of the recipe view.
Export (Page 4757)	P, A	Executes the "Export log" or "Export data" button function of the control.
GetColumn (Page 4758)	P	Returns the column object of the recipe view designated by name or index as "ICCAxUAColumn" type.
GetColumnCollection (Page 4759)	P	Returns the list of all column objects of the recipe view as "ICCAxCollection" type.
GetRow (Page 4769)	P	Returns the row object defined by its row number in the table-based controls as "ICCAxDataRow" type.
GetRowCollection (Page 4770)	P	Returns the list of all row objects of the table-based controls as "ICCAxDataRowCollection" type.
GetSelectedRow (Page 4777)	P	Returns the selected row object of a table-based control as "ICCAxDataRow" type.
GetSelectedRows (Page 4778)	P	Returns the selected row objects of a table-based control as type "ICCAxDataRow" for multiple selection.
GetStatusBarElement (Page 4784)	P, A	Returns the element of the control's status bar designated by name or index as "ICCAxStatusBarElement" type.
GetStatusBarElementCollection (Page 4785)	P, A	Returns the list of all status bar elements of the control as "ICCAxCollection" type.
GetToolBarButton (Page 4792)	P, A	Returns the button function designated by name or index on the control toolbar as "ICCAxToolBarButton" type.
GetToolBarButtonCollection (Page 4793)	P, A	Returns the list of all button functions of the control toolbar as "ICCAxCollection" type.
MoveToFirst (Page 4813)	P	Executes the "First line" button function of the control.
MoveToLast (Page 4815)	P	Executes the "Last data record" button function of the control.
MoveToNext (Page 4816)	P	Executes the "Next data record" button function of the control.
MoveToPrevious (Page 4818)	P	Executes the "Previous data record" button function of the control.
PasteRows (Page 4821)	P	Executes the "Insert rows" button function of the recipe view.
Print (Page 4822)	P, A	Executes the "Print" button function of the control.
ReadTags (Page 4824)	P	Executes the "Read tags" button function of the recipe view.
SelectAll (Page 4837)	P	Selects all rows in a table-based control.
SelectRow (Page 4838)	P	Selects a specific row in a table-based control.
ServerExport (Page 4839)	P	Executes the "Export log" button function of the recipe view.
ServerImport (Page 4840)	P	Executes the "Import log" button function of the recipe view.
ShowHelp (Page 4842)	P, A	Executes the "Help" button function of the control.
ShowPropertyDialog (Page 4847)	P, A	Executes the "Configuration dialog" button function of the control.
ShowSelectArchive (Page 4847)	P	Executes the "Select data connection" button function of the recipe view.
ShowSelection (Page 4848)	P	Executes the "Selection dialog" button function of the recipe view.



Methods	Valid	Description
ShowSelectTimeBase (Page 4849)	P	Executes the "Timebase dialog" button function of the recipe view.
ShowSort (Page 4850)	P	Executes the "Sorting dialog" button function of the recipe view.
UnselectAll (Page 4855)	P	Removes all selections from the cells of a table-based control.
UnselectRow (Page 4856)	P	Removes the selections from a specific cell of a table-based control.
WriteTags (Page 4860)	P	Executes the "Write tags" button function of the recipe view.

## See also

- Screen (Page 3930)
- ScreenItem (Page 3932)
- ScreenItems (list) (Page 3934)
- Screen object (list) (Page 3936)

## UserView

### Description

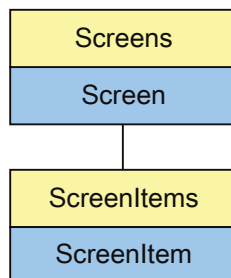

Represents the "UserView" object. The UserView object is an element of the ScreenItems list.

---

### Note

The object "Simple UserView" cannot be dynamized with a user-defined function.

---

## Type identifier in VBS

HMIUserView

Abbreviation	Validity
Pa	Panels
A	Runtime Advanced
P	Runtime Professional

Table 10-139 Properties

Properties	Read	Write	Description
Appearance (Page 3930)	-	-	Specifies the layout for this NC subroutine.
Authorization (Page 4175) *	-	-	Specifies the operating rights of the selected object in runtime.
BackColor (Page 4183)	A	A	Specifies the background color of the selected object.
Columns	-	-	Specifies the columns to be displayed.
ColumnsMoveable	-	-	Specifies that the columns can be moved.
CountVisibleItems (Page 4253)	-	-	Specifies the number of lines contained in the selection list.
Enabled (Page 4279)	A	A	Specifies whether the selected object can be operated in runtime.
FitToSize	-	-	Specifies that the size of the object should be automatically adapted to the content.
Flashing	-	-	Specifies that the text block flashes.
Height (Page 4327)	A	A	Sets the height of the specified "Ellipsis", "Circle" and "Rectangle" objects.
Layer (Page 4355)	-	-	Returns the layer that contains an object as LONG in the screen.
Left (Page 4366)	A	A	Specifies the value of the X coordinate of the object.
Name (Page 4417)	A	-	Returns the object name as STRING.
SelectionBackColor (Page 4499)	A	A	Specifies the background color of the selected cells.
SelectionForeColor (Page 4501)	A	A	Specifies the foreground color of the selected cells.
ShowTableGridlines (Page 4531)	-	-	Enables the display of gridlines in the table of the specified object.
TableBackColor (Page 4563)	A	A	Specifies the background color of the table cells for the selected object.
TableFont	-	-	Specifies the font in the table.
TableForeColor (Page 4566)	A	A	
TableGridlineColor (Page 4567)	A	A	Specifies the color for the grid lines.
TableHeaderBackColor (Page 4568)	A	A	Specifies the background color in the header of the table of the selected object.
TableHeaderFont	-	-	Specifies the text color of the header.
TableHeaderForeColor (Page 4569)	A	A	Specifies the text color in the header of the table of the selected object.

Properties	Read	Write	Description
Top (Page 4629)	A	A	Specifies the value of the Y coordinate of the object.
Visible (Page 4703) *	A	A	Specifies whether the selected object is visible.
Width (Page 4714)	A	A	Sets the width of the specified "Ellipsis", "Circle" and "Rectangle" objects.

\* not visible in the ES

Table 10-140 Methods

Methods	Valid	Description
Activate (Page 4744)	P, A	Activates the permanent window or the root screen.
ActivateDynamic (Page 4747)	P	Dynamically activates a trigger and the specified cycle for a property at runtime.
DeactivateDynamic (Page 4754)	P	Deactivates the trigger of the "ActivateDynamic" method used for the specified property in/during Runtime.

### See also

ScreenItem (Page 3932)

ScreenItems (list) (Page 3934)

Screen object (list) (Page 3936)

### WindowSlider

### Description

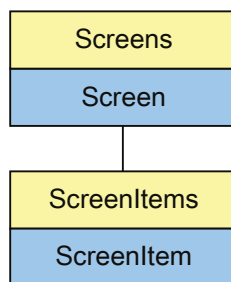

Represents the "Window slider" object. The WindowSlider object is an element of the ScreenItems list.

### Type identifier in VBS

HMIWindowSlider

Abbreviation	Validity
Pa	Panels
A	Runtime Advanced
P	Runtime Professional

Table 10-141 Properties

Properties	Read	Write	Description
AskOperationMotive (Page 4173)	P	P	Specifies whether the reason for operating this object is logged.
Authorization (Page 4175)	P	P	Specifies the operating rights of the selected object in runtime.
BackColor (Page 4181)	P	P	Specifies the background color of the selected object.
BackColorBottom (Page 4184)	P	P	Specifies the color for the lower / right part of the .
BackColorTop (Page 4184)	P	P	Sets the color for the upper / left part of the slider.
BackFillStyle (Page 4185)	P	P	Defines the fill pattern of the specified object.
BackFlashingColorOff (Page 4188)	P	P	Specifies the background color for flash state "Off".
BackFlashingColorOn (Page 4188)	P	P	Specifies the background color for flash state "On".
BackFlashingEnabled (Page 4189)	P	P	Specifies whether the background of the specified object flashes in runtime.
BackFlashingRate (Page 4190)	P	P	Specifies the flash rate of the background for the selected object.
BorderBackColor (Page 4199)	P	P	Specifies the background color of the broken border line for the selected object.
BorderColor (Page 4202)	P	P	Specifies the line color of the object.
BorderFlashingColorOff (Page 4206)	P	P	Specifies the border line color of the selected object for the flash state "Off".
BorderFlashingColorOn (Page 4207)	P	P	Specifies the border line color of the selected object for the flash state "On".
BorderFlashingEnabled (Page 4208)	P	P	Specifies whether the border line of the selected object flashes in runtime.
BorderFlashingRate (Page 4209)	P	P	Specifies the flash rate of the border line for the selected object.
BorderStyle (Page 4213)	P	P	Specifies the type of border lines for the selected object.
BorderWidth (Page 4216)	P	P	Specifies the line thickness of the object.
CornerStyle (Page 4250)	-	-	Specifies the type of border lines for the selected object.
DrawInsideFrame (Page 4270)	P	P	Specifies whether the border line of the selected object with a line thickness greater than 1 should be drawn within the border or symmetrically to the border.

Properties	Read	Write	Description
EdgeStyle (Page 4274)	-	-	Specifies the line style of the selected object.
Enabled (Page 4277)	P	P	Specifies whether the selected object can be operated in runtime.
FillPatternColor (Page 4296)	P	P	Specifies the color of the fill pattern for the selected object.
Flashing	-	-	Specifies that the text block flashes.
Height (Page 4327)	P	P	Sets the height of the specified "Ellipsis", "Circle" and "Rectangle" objects.
HighLimitColor (Page 4332)	P	P	Specifies the color of the top or right scroll button in a scroll bar.
JumpToLimitsAfterMouseClicked (Page 4350)	P	P	Specifies the length of the long tick marks of a scale.
Layer (Page 4355)	-	-	Returns the layer that contains an object as LONG in the screen.
Left (Page 4366)	P	P	Specifies the value of the X coordinate of the object.
LineEndShapeStyle (Page 4380)	-	-	Specifies the shape of the line end.
LogOperation (Page 4386)	P	P	Specifies whether, after operating this object, an alarm is output to the alarm system.
LowLimitColor (Page 4390)	P	P	Specifies the color of the bottom or left scroll button in a scroll bar.
MarginToBorder (Page 4391)	P	P	Specifies the width of the 3D border in pixels.
MaximumValue (Page 4392)	P	P	Specifies the maximum value of the scale in the selected object.
MinimumValue (Page 4413)	P	P	Specifies the minimum value of the scale in the selected object.
Name (Page 4417)	P	-	Returns the object name as STRING.
OperationSteps (Page 4429)	P	P	Specifies by how many steps the slider of the scrollbar is moved with one mouseclick.
ProcessValue (Page 4461)	P	P	Specifies the default for the value to be displayed.
RelativeFillLevel (Page 4470)	P	P	Specifies the fill percentage for the object.
ShowBadTagState (Page 4516)	P	P	Specifies whether an object is grayed out if its associated tag has a bad quality code or tag state.
ShowFillLevel (Page 4519)	P	P	Specifies whether the selected object is filled.
StyleSettings (Page 4561)	P	P	Specifies the display style for the object:
TextOrientation (Page 4576)	P	P	Specifies the text orientation of the selected object.
ThumbBackColor (Page 4577)	P	P	Specifies the background color of the slider in the "Slider" object.
ToolTipText (Page 4627)	P	P	Specifies the tooltip text.
Top (Page 4629)	P	P	Specifies the value of the Y coordinate of the object.
Transparency (Page 4633)	P	P	Specifies and returns the transparency percentage of the object.
UseDesignColorScheme (Page 4674)	P	P	Specifies the font used for printing.
UseDesignShadowSettings (Page 4676)	P	P	Specifies whether the object is displayed with the shading defined in the active design.
Visible (Page 4703)	P	P	Specifies whether the selected object is visible.
Width (Page 4714)	P	P	Sets the width of the specified "Ellipsis", "Circle" and "Rectangle" objects.
WindowsStyle (Page 4718)	P	P	Specifies whether the object is displayed in the general Windows style.

Table 10-142 Methods

Methods	Valid	Description
Activate (Page 4744)	P, A	Activates the permanent window or the root screen.
ActivateDynamic (Page 4747)	P	Dynamically activates a trigger and the specified cycle for a property at runtime.
DeactivateDynamic (Page 4754)	P	Deactivates the trigger of the "ActivateDynamic" method used for the specified property in/during Runtime.

**See also**

Screen object (list) (Page 3936)

**WLANQualityView**

**Description**

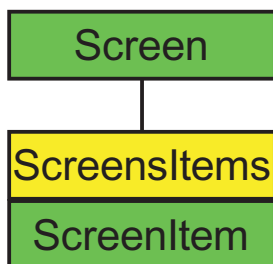

Represents the "WLAN reception" object. The WLANQualityView object is an element of the ScreensItems list.

Abbreviation	Validity
Pa	Panels
A	Runtime Advanced
P	Runtime Professional

Table 10-143 Properties

Properties	Read	Write	Description
Height (Page 4327)	A	A	Sets the height of the specified "Ellipse", "Circle" and "Rectangle" objects.
Layer (Page 4355)	-	-	Returns the layer that contains an object as LONG in the screen.
Left (Page 4366)	A	A	Specifies the value of the X coordinate of the object.
Name (Page 4417)	A	-	Returns the object name as STRING.

Properties	Read	Write	Description
Top (Page 4629)	A	A	Specifies the value of the Y coordinate of the object.
Width (Page 4714)	A	A	Sets the width of the specified "Ellipsis", "Circle" and "Rectangle" objects.

Table 10-144 Methods

Methods	Valid	Description
????		

**See also**

- Screen (Page 3905)
- ScreenItem (Page 3906)
- ScreenItems (Page 3908)

**ZoneLabelView**

**Description**

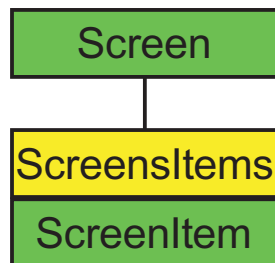

Represents the "Zone name" object. The ZoneLabelView object is an element of the ScreenItems list.

Abbreviation	Validity
Pa	Panels
A	Runtime Advanced
P	Runtime Professional

Table 10-145 Properties

Properties	Read	Write	Description
Font (Page 4311)	-	-	Specifies or returns the font.
Height (Page 4327)	A	A	Sets the height of the specified "Ellipsis", "Circle" and "Rectangle" objects.
Layer (Page 4355)	-	-	Returns the layer that contains an object as LONG in the screen.
Left (Page 4366)	A	A	Specifies the value of the X coordinate of the object.
Name (Page 4417)	A	-	Returns the object name as STRING.
Top (Page 4629)	A	A	Specifies the value of the Y coordinate of the object.
Width (Page 4714)	A	A	Sets the width of the specified "Ellipsis", "Circle" and "Rectangle" objects.

Table 10-146 Methods

Methods	Valid	Description
???		

**See also**

- Screen (Page 3905)
- ScreenItem (Page 3906)
- ScreenItems (Page 3908)

**ZoneQualityView**

**Description**

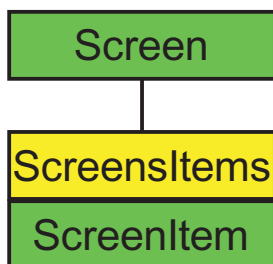

Represents the "ZoneSignal" object. The ZoneQualityView object is an element of the ScreenItems list.



Abbreviation	Validity
Pa	Panels
A	Runtime Advanced
P	Runtime Professional

Table 10-147 Properties

Properties	Read	Write	Description
Height (Page 4327)	A	A	Sets the height of the specified "Ellipsis", "Circle" and "Rectangle" objects.
Layer (Page 4355)	-	-	Returns the layer that contains an object as LONG in the screen.
Left (Page 4366)	A	A	Specifies the value of the X coordinate of the object.
Name (Page 4417)	A	-	Returns the object name as STRING.
Top (Page 4629)	A	A	Specifies the value of the Y coordinate of the object.
Width (Page 4714)	A	A	Sets the width of the specified "Ellipsis", "Circle" and "Rectangle" objects.

Table 10-148 Methods

Methods	Valid	Description
?????		

**See also**

Screen (Page 3905)  
ScreenItem (Page 3906)  
ScreenItems (Page 3908)

**Properties****Properties A****AboveUpperLimitColor****Description**

Defines the color of the specified object for the case "High limit exceeded".

## See also

SymbolLibrary (Page 4098)  
GraphicIOField (Page 4011)  
Switch (Page 4089)  
SymbolicIOField (Page 4093)  
IOField (Page 4021)

## AcceptOnExit

### Description

Specifies whether the input field will be confirmed automatically when it is left.  
Access in Runtime: Read and write

### Syntax

Object.**AcceptOnExit**[=BOOLEAN]

#### Object

Required A "ScreenItem" object with the formats "IOField" or "SymbolicIOField".

#### BOOLEAN

Optional TRUE, if the input field will be confirmed automatically when it is left.

## See also

IOField (Page 4021)  
SymbolicIOField (Page 4093)

## AcceptOnFull

### Description

Specifies whether the input field will be left and confirmed automatically when the set number of values have been entered.  
Access in Runtime: Read and write

### Syntax

Object.**AcceptOnFull**[=BOOLEAN]

#### Object

Required A "ScreenItem" object with the format "IOField".

## BOOLEAN

Optional TRUE, if the input field will be left and confirmed automatically when the set number of values have been entered.

### See also

IOField (Page 4021)

### AccessPath

### Description

Returns the storage path of a screen.

Access during runtime: Read

### Syntax

Object.**AccessPath**

#### Object

Necessary. A "Screen" object.

### Example

In the following example, the path of the picture "ScreenWindow1" is issued:

```
'VBS67
Dim objScreen
Set objScreen = HMIRuntime.Screens("ScreenWindow1")
MsgBox objScreen.AccessPath
```

### See also

Screen (Page 3930)

### Activate

### Description

Determines whether the data to be displayed are requested by the alarm server.

Access in Runtime: Read and write

## Syntax

Object.**Activate**[=BOOLEAN]

### Object

Required A "ScreenItem" object with the format "AlarmControl".

### BOOLEAN

Optional TRUE, if the data to be displayed are requested by the alarm server.

## See also

AlarmControl (Page 3947)

## Active

## Description

Specifies whether the data that is to be shown is requested by the log server.

Access in Runtime: Read and write

## Syntax

Object.**Active**[=BOOLEAN]

### Object

Required An object of the "ScreenItem" type with the format "OnlineTrendControl," or "OnlineTableControl".

### BOOLEAN

Optional TRUE, if the data that is to be shown is requested by the log server.

## Comments

The screen opening times are reduced if you do not set this attribute. You can change the value dynamically.

To differentiate between the "Activate" property and the "Activate" methods, the property is addressed via "Object".

## See also

OnlineTrendControl (Page 4045)

OnlineTableControl (Page 4037)

## ActiveProject

### Description

Returns the specified project.

Access in Runtime: Read

### Syntax

Object.**ActiveProject**

#### Object

Required A "HMIRuntime" object.

### See also

HMIRuntime (Page 3922)

Project (Page 3929)

## ActiveScreen

### Description

Returns an object of type "Screen" which shows the screen that currently has the focus.

---

#### Note

If you query the "ActiveScreen" property in a function, it may be due to a ScreenSavers that the property does not return a valid "Screen" object but "Nothing" and a system alarm is displayed.

---

Access during runtime: Read

### Syntax

Object.ActiveScreen

#### Object

Necessary. An object of the "HMIRuntime" type.

### Comments

Which screen is returned depends on whether the root screen or the permanent window has the focus.

The ActiveScreen property returns NOTHING if no screen has the focus. This is the case, for example, if a different window has the focus. With the instruction "If not [printout] Is Nothing" you can query whether a screen is going to be returned:

```
'VBS_Example_ActiveScreen
Dim objActiveScreen
Set objActiveScreen = HmiRuntime.ActiveScreen
If Not objActiveScreen Is Nothing Then
'found an active screen
HmiRuntime.Trace("There is an active screen." & vbCrLf)
Else
'found NO active screen
HmiRuntime.Trace("There is NO active screen." & vbCrLf)
End If
```

## ActiveScreen

### Description

Returns a "Screen" type object, which represents the screen which has the focus at the moment.

---

#### Note

If you query the "ActiveScreen" property in a user-defined function, it may be due to a screen saver that the property does not return a valid "screen" object but "Nothing". A system message will be issued.

---

Access in Runtime: Read

### Syntax

Object.ActiveScreen

#### Object

Required An object of the "HMIRuntime" type.

### Comments

Which screen is returned depends on whether the root screen or the permanent window has the focus.

The ActiveScreen property returns NOTHING if no screen has the focus. That is the case, for example, when another window has the focus. With the statement "If not [expression] is nothing" you are able to interrogate whether a screen is to be returned:

```
VBS example ActiveScreen
```

```
Dim objActiveScreen
Set objActiveScreen = HmiRuntime.ActiveScreen
If not objActiveScreen is nothing then
'found an active screen
HmiRuntime.Trace("There is an active screen." & vbCrLf)
Else
'found NO active screen
HmiRuntime.Trace("There is NO active screen." & vbCrLf)
End if
```

## ActiveScreenItem

### Description

References the screen object that currently has the focus.

It is only if the screen of the respective "Screen" object is currently selected and has an input field that the "ActiveScreenItem" property of the "Screen" object will be occupied with a valid "ScreenItem" object. In all other cases if, for example, another screen from the "Screens" list, an independent window within WinCC or another application is selected, this property is not supplied on the screens, i.e. assigned "Nothing".

### Application

You use the "ActiveScreenItem" object to address the properties of the object that has the focus in Runtime.

## ActiveScreenItem

### Description

References the screen object which currently has the focus.

The "ActiveScreenItem" property of the "Screen" object is only assigned a valid "ScreenItem" object if the screen of the corresponding "Screen" object is active and has an input field. In all other cases, for example, with a different screen from the "Screens" list, an independent window within WinCC or a different application will be selected, this property will not apply to the screens and will be occupied with "Nothing".

### Application

The "ActiveScreenItem" object is used to address the object property which has the focus in runtime.

## ActualPointIndex

### Description

Specifies the number of the current corner point of the selected object.

Access in Runtime: Read and write

### Syntax

Object.**ActualPointIndex**[=Int]

#### Object

Required A "ScreenItem" object with the formats "Polyline" or "Polygon".

#### Int

Optional A value or a constant that specifies the number of the current corner point of the selected object.

### See also

Polyline (Page 4060)

Polygon (Page 4057)

TubePolyline (Page 4125)

## ActualPointLeft

### Description

Specifies the X coordinate of the current corner point with reference to the screen origin. The screen source is at the top left of the object. Every corner is identified by an index which is derived from the number ("PointCount") of the existing corners.

Access in Runtime: Read and write

### Syntax

Object.**ActualPointLeft**[=Int]

#### Object

Required An object of the "ScreenItem" type with the format "Polyline," or "Polygon".

#### Int

Optional A value or a constant that specifies the X coordinate of the current corner point with reference to the screen origin.



## Comments

Changing the value can have an effect on the properties "Width" (object width) and "Left" (X coordinate of the object position).

## See also

Polyline (Page 4060)

Polygon (Page 4057)

TubePolyline (Page 4125)

## ActualPointTop

### Description

Specifies the Y coordinate of the current corner point with reference to the screen origin. The screen source is at the top left of the object.

Access in Runtime: Read and write

### Syntax

Object.**ActualPointTop**[=Int]

#### Object

Required An object of the "ScreenItem" type with the format "Polyline," or "Polygon".

#### Int

Optional A value or a constant that specifies the Y coordinate of the current corner point with reference to the screen origin.

## Comments

Changing the value can have an effect on the properties "Height" (object height) and "Top" (X coordinate of the object position).

## See also

Polyline (Page 4060)

Polygon (Page 4057)

TubePolyline (Page 4125)

## AdaptBorder

### Description

Specifies whether the border of the selected object will be dynamically adapted to the text size.

Access in Runtime: Read and write

### Syntax

Object.**AdaptBorder**[=BOOLEAN]

#### Object

Required A "ScreenItem" object with the formats "TextField", "IOField", "SymbolicIOField", "Button", "Checkbox" or "OptionGroup".

#### BOOLEAN

Optional TRUE, if the border of the selected object will be dynamically adapted to the text size.

### See also

TextField (Page 4107)

IOField (Page 4021)

SymbolicIOField (Page 4093)

Button (Page 3968)

CheckBox (Page 3974)

OptionGroup (Page 4054)

## AdaptFontSizeToLineHeight

### Description

Specifies whether the font size will be adapted to the line height.

Access in Runtime: Read and write

### Syntax

Object.**AdaptFontSizeToLineHeight**[=BOOLEAN]

#### Object

Required A "ScreenItem" object with the format "AlarmControl".

#### BOOLEAN

Optional TRUE, if the font size will be adapted to the line height.

## See also

AlarmControl (Page 3947)

## AdaptScreenToWindow

### Description

Specifies whether or not the screen displayed in a screen window adapts to the size of the screen window in Runtime.

Access in Runtime: Read

### Syntax

Object.**AdaptScreenToWindow**[=BOOLEAN]

#### Object

Required A "ScreenItem" object with the format "AlarmControl".

#### BOOLEAN

TRUE, if the screen adapts to the screen window size.

FALSE, if the screen does not adapt to the screen window size.

## See also

AlarmControl (Page 3947)

ScreenWindow (Page 4078)

## AdaptWindowToScreen

### Description

Specifies whether or not the screen window adapts to the screen it displays in Runtime.

Access in Runtime: Read

### Syntax

Object.**AdaptWindowtoScreen**[=BOOLEAN]

#### Object

Required A "ScreenItem" object with the format "Screenwindow".

#### BOOLEAN

TRUE, if the screen window size adapts to the screen.

FALSE, if the screen window size does not adapt to the screen.

### See also

ScreenWindow (Page 4078)

## AddAssignment

### Description

Adds an entry.

### Address

### Description

Specifies the web address that will be opened in the HTML browser.

Access in Runtime: Read and write

### Syntax

Object.**Address**[=STRING]

#### Object

Required A "ScreenItem" object with the format "HTMLBrowser".

#### STRING

Optional A value or a constant that contains the web address.

### See also

HTMLBrowser (Page 4019)

## AdjustBorder3DWithStyle

### Description

Specifies whether the 3D border width will be displayed in the general Windows style.

Access in Runtime: Read and write

### Syntax

Object.**AdjustBorder3DWithStyle**[=BOOLEAN]

**Object**

Required A "ScreenItem" object with the format "Button".

**BOOLEAN**

Optional TRUE, if the 3D border width will be displayed in the general Windows style.

**See also**

Button (Page 3968)

**AdjustRulerWindow**

**Description**

Specifies whether the ruler window is adapted every time the trend view is displayed.

Access in Runtime: Read and write

**Syntax**

Object.**AdjustRulerWindow**[=BOOLEAN]

**Object**

Required A "ScreenItem" object with the format "OnlineTrendControl".

**BOOLEAN**

Optional TRUE, if the ruler window is adapted every time the trend view is displayed.

**Comments**

TRUE, if the ruler window will be moved and then shown and hidden, it will be displayed at the original position in the original size.

**See also**

OnlineTrendControl (Page 4045)

**Alarm**

**Description**

Specifies the limit for the storage space display as of which an alarm will be reported.

Access in Runtime: Read and write

## Syntax

Object.**Alarm**[=Int]

### Object

Required A "ScreenItem" object with the format "DiskSpaceView".

### Int

Optional A value or a constant that specifies the limit for the storage space display as of which an alarm will be reported.

## See also

DiskSpaceView (Page 3991)

## AlarmColor

### Description

Specifies the color in which the bars will be shown as soon as the alarm area is reached.

Access in Runtime: Read and write

## Syntax

Object.**AlarmColor**[=Color]

### Object

Required A "ScreenItem" object with the format "DiskSpaceView".

### Color

Optional A value or a constant that specifies the color in which the bar will be shown as soon as the warning area is exceeded.

## See also

DiskSpaceView (Page 3991)

## AlarmFilter

### Description

Specifies a SQL-Statement for selecting the alarms that will be shown in the alarm window.

Alarm list and hit list filtering and sorting settings

Access in Runtime: Read and write

## Syntax

Object.**AlarmFilter**[=String]

### Object

Required A "ScreenItem" object with the format "AlarmControl".

### String

Optional A value or a constant that specifies a SQL-Statement for selecting the alarms that will be shown in the alarm window.

## See also

AlarmControl (Page 3947)

## AlarmHigh

### Description

Defines the top limit value at which an alarm should be triggered or returned. The type of evaluation (percentage or absolute) is specified with the "TypeAlarmHigh" property.

Access in Runtime: Write and read

### Syntax

Object.**AlarmHigh**[=REAL]

### Object

Required A "ScreenItem" object with the format "Bar".

### REAL

Value for the upper limit

## See also

Bar (Page 3961)

## AlarmID

### Description

Returns the AlarmID of the Alarm object. The AlarmID is unique and is assigned by the system.

AlarmID (readonly)

**See also**

Alarms (list) (Page 3913)

**AlarmLogs**

**Description**

Returns an object of type "AlarmLogs".

Access in Runtime: Read

**Syntax**

Object.**AlarmLogs**

**Object**

Required A "Logging" object.

**See also**

Logging (Page 3927)

**AlarmLow**

**Description**

Defines the bottom limit value at which an alarm should be triggered or returned. The type of evaluation (percentage or absolute) is specified with the "TypeAlarmLow" property.

Access in Runtime: Write and read

**Syntax**

Object.AlarmLow[=REAL]

**Object**

Required A "ScreenItem" object with the format "Bar".

**REAL**

Value for the lower limit

**See also**

Bar (Page 3961)



## AlarmLowerLimit

### Description

Specifies the upper limit at which the alarm will be triggered.

Access in Runtime: Read and write

### Syntax

Object.**AlarmLowerLimit**[=Double]

#### Object

Required A "ScreenItem" object with the format "Bar".

#### Double

Optional A value or a constant that specifies the lower limit at which the alarm will be triggered.

### Comments

The type of evaluation (percentage or absolute) is established using the "AlarmLowerLimitRelative" property.

The "AlarmLowerLimitEnable" property establishes whether the monitoring of this limit is enabled.

### See also

Bar (Page 3961)

## AlarmLowerLimitColor

### Description

Specifies the bar color of the "AlarmLowerLimit" limit.

The "AlarmLowerLimitEnable" property must have the value TRUE if the bar color is to change once the limit has been reached.

Access in Runtime: Read and write

### Syntax

Object.**AlarmLowerLimitColor**[=Color]

#### Object

Required A "ScreenItem" object with the format "Bar".

### **Color**

Optional A value or a constant that specifies the bar color for the "AlarmLowerLimit" limit.

### **See also**

Bar (Page 3961)

## **AlarmLowerLimitEnabled**

### **Description**

Specifies whether the "AlarmLowerLimit" limit is to be monitored.

Access in Runtime: Read and write

### **Syntax**

Object.**AlarmLowerLimitEnabled**[=BOOLEAN]

#### **Object**

Required A "ScreenItem" object with the format "Bar".

#### **BOOLEAN**

Optional TRUE, if the "AlarmLowerLimit" limit is to be monitored.

### **Comments**

The following values will be established via the properties "AlarmLowerLimit", "AlarmLowerLimitColor" and "AlarmLowerLimitRelative":

Limit

Representation upon reaching the limit

Type of evaluation

### **See also**

Bar (Page 3961)

## **AlarmLowerLimitRelative**

### **Description**

Establish whether the lower limit at which the interrupt is triggered is evaluated as a percentage or an absolute value.

Access in Runtime: Read and write

## Syntax

Object.**AlarmLowerLimitRelative**[=BOOLEAN]

### Object

Required A "ScreenItem" object with the format "Bar".

### BOOLEAN

Optional TRUE, if the lower limit at which the interrupt is triggered is evaluated as a percentage.

## See also

Bar (Page 3961)

## AlarmUpperLimit

### Description

Establishes the upper limit at which the interrupt will be triggered.

Access in Runtime: Read and write

Syntax

Object.**AlarmUpperLimit**[=Double]

### Object

Required A "ScreenItem" object with the format "Bar".

### Double

Optional A value or a constant that defines the upper limit at which an interrupt will be triggered.

## Comments

The type of evaluation (percentage or absolute) is defined using the "AlarmUpperLimitRelative" property.

The "AlarmUpperLimitEnable" property defines whether or not monitoring of this limit is enabled.

## See also

Bar (Page 3961)

## AlarmUpperLimitColor

### Description

Defines the bar color for the "AlarmUpperLimit" limit.

The "AlarmUpperLimitEnable" property must have the value TRUE if the bar color is to change once the limit has been reached.

Access in Runtime: Read and write

### Syntax

Object.**AlarmUpperLimitColor**[=Color]

#### Object

Required A "ScreenItem" object with the format "Bar".

#### Color

Optional A value or a constant that defines the bar color for the "AlarmUpperLimit" limit.

### See also

Bar (Page 3961)

## AlarmUpperLimitEnabled

### Description

Specifies whether the "AlarmUpperLimit" value is to be monitored.

Access in Runtime: Read and write

### Syntax

Object.**AlarmUpperLimitEnabled**[=BOOLEAN]

#### Object

Required A "ScreenItem" object with the format "Bar".

#### BOOLEAN

Optional TRUE, if the "AlarmUpperLimit" value is monitored.

### Comments

The following values will be defined using the properties "AlarmUpperLimit", "AlarmUpperLimitColor" and "AlarmUpperLimitRelative":

Limit

Representation upon reaching the limit

Type of evaluation

## See also

Bar (Page 3961)

## AlarmUpperLimitRelative

### Description

Establish whether the upper limit at which the interrupt is triggered is evaluated as a percentage or an absolute value.

Access in Runtime: Read and write

### Syntax

Object.**AlarmUpperLimitRelative**[=BOOLEAN]

#### Object

Required A "ScreenItem" object with the format "Bar".

#### BOOLEAN

Optional TRUE, if the upper limit at which the interrupt is triggered is evaluated as a percentage or an absolute value.

## See also

Bar (Page 3961)

## Alignment

### Description

Determines the layout of the scale (left/right or top/bottom) depending on the position of the bar object or returns it.

Access in Runtime: Read and write

### Syntax

Object.**Alignment**[=ScalePosition]

#### Object

Required An object of the "ScreenItem" type with the format "Bar".

#### ScalePosition

1: Right or bottom .

0: Left or top.

## See also

Bar (Page 3961)

## AlignmentLeft

### Description

Defines or returns the horizontal alignment of the text. Value range from 0 to 2.

Access in Runtime: Read and write

### Syntax

Object.**AlignmentLeft**[=HorizontalAlignment]

#### Object

Required An object of the "ScreenItem" type with the format "TextField", "IOField", "SymbolicIOField", "Button", "RoundButton", "CheckBox", "OptionGroup", "MultilineEdit", "ComboBox", "ListBox".

#### HorizontalAlignment

0: Alignment left

1: Alignment centered

2: Alignment right

## AlignmentTop

### Description

Defines or returns the vertical alignment of the text. Value range from 0 to 2.

Access in Runtime: Read and write

### Syntax

Object.**AlignmentTop**[=VerticalAlignment]

#### Object

Required An object of the "ScreenItem" type with the format "TextField", "IOField", "SymbolicIOField", "Button", "RoundButton", "CheckBox", "OptionGroup".

#### VerticalAlignment

0: Alignment left

1: Alignment centered

2: Alignment right

## AllowMenu

### Description

Establishes whether the shortcut menu should be enabled to control the Sm@rtClient view.

### Syntax

Object.**AllowMenu**

#### Object

Required A "ScreenItem" object with the format "SmartClientView".

### See also

SmartClientView (Page 4085)

## AllowPersistence

### Description

Specifies whether the persistence is adjustable.

Access in Runtime: Read and write

### Syntax

Object.**AllowPersistence**[=BOOLEAN]

#### Object

Required An object of the "ScreenItem" type with the format "OnlineTrendControl", "FunctionTrendControl" or "OnlineTableControl".

#### BOOLEAN

Optional TRUE, if the persistence is adjustable.

### See also

OnlineTrendControl (Page 4045)

FunctionTrendControl (Page 4004)

OnlineTableControl (Page 4037)

## Analog

### Description

Specifies whether the clock should be shown as an analog clock.

Access in Runtime: Read and write

### Syntax

Object.**Analog**[=BOOLEAN]

#### Object

Required A "ScreenItem" object with the format "Clock".

#### BOOLEAN

Optional TRUE, if the clock should be shown as an analog clock.

### See also

Clock (Page 3984)

## AngleAlpha

### Description

Defines or returns depth angle a for the 3D-effect of the "3DBarGraph" object. Value range in degrees from 0 to 90.

## AngleBeta

### Description

Defines or returns depth angle b for the 3D-effect of the "3DBarGraph" object. Value range in degrees from 0 to 90.

## AngleMax

### Description

Specifies the angle of the scale end of the "Gauge" object.

Access in Runtime: Read and write



## Syntax

Object.**AngleMax**[= DOUBLE]

### Object

Required A "ScreenItem" object with the format "Gauge".

### DOUBLE

Optional A value or a constant that specifies the angle in degrees.

## Comments

The start and end of the scale gradations are described with the properties "AngleMin" and "AngleMax" in angle degrees.

The value of the AngleMin property must always be less than the value of the AngleMax property. The zero degree angle is located at the 3 o'clock position on the scale. Positive angle values are counted clockwise.

## See also

Gauge (Page 4008)

## AngleMin

## Description

Specifies the angle of the scale start of the "Gauge" object.

Access in Runtime: Read and write

## Syntax

Object.**AngleMin**[= DOUBLE]

### Object

Required A "ScreenItem" object with the format "Gauge".

### DOUBLE

Optional A value or a constant that specifies the angle in degrees.

## Comments

The start and end of the scale gradations are described with the properties "AngleMin" and "AngleMax" in angle degrees.

The value of the AngleMin property must always be less than the value of the AngleMax property.

The zero degree angle is located at the 3 o'clock position on the scale. Positive angle values are counted clockwise.

**See also**

Gauge (Page 4008)

**Application**

**Description**

Supplies the content of the application window Read only access.

**See also**

ScriptDiagnostics (Page 4080)

**ApplyProjectSettings**

**Description**

Specifies whether the project settings are applied from the "HMI alarms" editor.

Access in Runtime: Read and write

**Syntax**

Object.**ApplyProjectSettings**[=BOOLEAN]

**Object**

Required An object of the "ScreenItem" type with the format "AlarmControl".

**BOOLEAN**

TRUE: The message blocks configured in the "HMI messages" editor are applied to the message view with their properties. The message blocks are displayed with these properties in the message view.

FALSE: The properties are not applied.

**See also**

AlarmControl (Page 3947)

FunctionTrendControl (Page 4004)

OnlineTableControl (Page 4037)

OnlineTrendControl (Page 4045)

## AskOperationMotive

### Description

Specifies whether the reason for operating this object will be logged. When operating the specified object in Runtime, a dialog opens in which the operator enters the reason for the operation in text format.

Access in Runtime: Read and write

### Syntax

Object.**AskOperationMotive**[=BOOLEAN]

#### Object

Required A "ScreenItem" object with the formats "IOField", "SymbolicIOField" or "WindowSlider".

#### BOOLEAN

Optional TRUE, if the reason for operating this object will be logged.

### See also

IOField (Page 4021)

SymbolicIOField (Page 4093)

WindowSlider (Page 4139)

Listbox (Page 4027)

## Assignments

### Description

A list which contains the assignments between the output value and the output text actually to be output. The assignments are dependent on the set list type. You determine the list type with the ListType property.

Access in Runtime: Read

### Syntax

Object.**Assignments**

#### Object

Required A "ScreenItem" object with the format "SymbolicIOField".

## See also

SymbolicIOField (Page 4093)

## AssumeOnExit

### Description

Specifies whether the entered text is applied after leaving the input field, e.g. with the <TAB> key or a mouseclick.

Access in Runtime: Read and write

### Syntax

Object.**AssumeOnExit**

#### Object

Required An object of the "ScreenItem" type with the format "IOField", "SymbolicIOField".

## See also

IOField (Page 4021)

SymbolicIOField (Page 4093)

## AssumeOnFull

### Description

Specifies whether the input field is left automatically after a complete input (the specified number of characters was entered) and the input is applied.

Access in Runtime: Read and write

### Syntax

Object.AssumeOnFull[=**BOOLEAN**]

#### Object

Required An object of the "ScreenItem" type with the format "IOField", "SymbolicIOField".

#### **BOOLEAN**

TRUE: is applied.

FALSE: is not applied.

## See also

IOField (Page 4021)

SymbolicIOField (Page 4093)

## Authorization

### Description

Specifies the operating rights of the selected object in Runtime.

Access in Runtime: Read and write

### Syntax

Object.**Authorization**[=HMIRTAuthorization]

#### Object

Required An object of the "ScreenItem" type with the format "Line", "Polyline", "Ellipse", "Circle", "EllipseSegment", "CircleSegment", "EllipticalArc", "CircularArc", "Rectangle", "Polygon", "TextField", IOField, "SymbolicIOField", "DateTimeField", "Button", "Roundbutton", "Switch", "GraphicView", "GraphicIOField", "Bar", "UserArchiveControl", "StatusForce", "Slider", "SymbolLibrary", "OnlineTrendControl", "AlarmControl", "UserView", "Checkbox", "OptionGroup", "WindowSlider", "OleView", "Connector" oder "SoftKey".

#### HMIRTAuthorization

Optional A value or a constant that establishes the operating rights of the specified object in Runtime.

## See also

Line (Page 4025)  
Polyline (Page 4060)  
Ellipse (Page 3993)  
Circle (Page 3977)  
EllipseSegment (Page 3995)  
CircleSegment (Page 3979)  
EllipticalArc (Page 3998)  
CircularArc (Page 3982)  
Rectangle (Page 4072)  
Polygon (Page 4057)  
TextField (Page 4107)  
IOField (Page 4021)  
SymbolicIOField (Page 4093)  
Button (Page 3968)  
Switch (Page 4089)  
GraphicView (Page 4014)  
GraphicIOField (Page 4011)  
Bar (Page 3961)  
Slider (Page 4082)  
SymbolLibrary (Page 4098)  
CheckBox (Page 3974)  
OptionGroup (Page 4054)  
WindowSlider (Page 4139)  
Connector (Page 3986)  
Group (Page 4017)  
UserView (Page 4137)  
TubeTeeObject (Page 4128)  
TubePolyline (Page 4125)  
TubeDoubleTeeObject (Page 4123)  
TubeArcObject (Page 4121)  
ProtectedAreaName (Page 4064)  
RangeLabelView (Page 4065)  
MultiLineEdit (Page 4032)  
Listbox (Page 4027)  
AlarmView (Page 3958)  
DateTimeField (Page 3989)  
RecipeView (Page 4068)  
TrendView (Page 4118)  
SystemDiagnoseWindow (Page 4103)  
SystemDiagnoseView (Page 4100)

## AutoCompleteColumns

### Description

Adds empty columns if the Control width is greater than the width of columns configured.

Access in Runtime: Read and write

### Syntax

Object.**AutoCompleteColumns**[=BOOLEAN]

#### Object

Required An object of the "ScreenItem" type with the format "AlarmControl", "TrendRulerControl", "OnlineTableControl", "UserArchivControl".

#### BOOLEAN

TRUE: The empty columns are displayed.

FALSE: The empty columns are not displayed.

### See also

AlarmControl (Page 3947)

UserArchiveControl (Page 4130)

TrendRulerControl (Page 4110)

OnlineTableControl (Page 4037)

## AutoCompleteRows

### Description

Enables the insertion of empty rows if the Control length is greater than the number of rows configured.

Access in Runtime: Read and write

### Syntax

Object.**AutoCompleteRows**[=BOOLEAN]

#### Object

Required An object of the "ScreenItem" type with the format "AlarmControl", "TrendRulerControl", "OnlineTableControl", "UserArchivControl".

#### BOOLEAN

TRUE: The empty rows are displayed.

FALSE: The empty rows are not displayed.

## See also

AlarmControl (Page 3947)

UserArchiveControl (Page 4130)

TrendRulerControl (Page 4110)

OnlineTableControl (Page 4037)

## AutoScroll

### Description

Specifies how the alarm view behaves when new alarms appear.

The specific choice of alarm lines is only possible if "AutoScroll" is not enabled.

The "AutoScroll" property is disabled if the "MsgCtrlFlag" = "-1" attribute is set. The most up-to-date alarm is then shown at the top of the alarm view.

Access in Runtime: Read and write

### Syntax

Object.**AutoScroll**[=BOOLEAN]

#### Object

Required A "ScreenItem" object with the format "AlarmView".

#### BOOLEAN

Optional TRUE, if a new alarm is appended to and chosen from the list shown in the alarm window. If necessary, the visible area of the alarm window can be moved.

FALSE, if a new alarm is not selected. The visible area of the alarm window is not altered.

## See also

AlarmControl (Page 3947)

## AutoSelectionColors

### Description

Enables the display of default system colors as selection color for cells and rows.

Access in Runtime: Read and write



## Syntax

Object.**AutoSelectionColors**[=BOOLEAN]

### Object

Required An object of the "ScreenItem" type with the format "AlarmControl", "TrendRulerControl", "OnlineTableControl", "UserArchivControl".

### BOOLEAN

TRUE: The system color is used.

FALSE: The customized color is used.

## See also

UserArchiveControl (Page 4130)

TrendRulerControl (Page 4110)

OnlineTableControl (Page 4037)

AlarmControl (Page 3947)

## AutoSelectionRectColor

### Description

Defines a system color for the selection border.

Access in Runtime: Read and write

### Syntax

Object.**AutoSelectionRectColors** [=BOOLEAN]

### Object

Required An object of the "ScreenItem" type with the format "AlarmControl", "TrendRulerControl", "OnlineTableControl", "UserArchivControl".

### BOOLEAN

TRUE: The system color is used.

FALSE: The customized color is used.

## See also

AlarmControl (Page 3947)

UserArchiveControl (Page 4130)

TrendRulerControl (Page 4110)

OnlineTableControl (Page 4037)

## Average

### Description

Specifies whether a mean value is shown from the last 15 values.

Access in Runtime: Read and write

### Syntax

Object.**Average**[=BOOLEAN]

#### Object

Required A "ScreenItem" object with the format "Bar".

#### BOOLEAN

Optional TRUE, if a mean value is shown from the last 15 values.

## Axe property

### Description

Defines or returns the position of the 3D bar in the coordinate system. Value range from 0 to 2.

0: The 3D-bar is displayed on the X-axis.

1: The 3D-bar is displayed on the Y-axis.

2: The 3D-bar is displayed on the Z-axis.

## AxisSection

### Description

Defines or returns the distance between two long axis sections. The information on the distance is given in scale units and is dependent on the minimum and maximum values configured.

## Properties B

### BackColorWidth

#### Description

Defines or returns the width of the 3D border in pixels. The value for the width is dependent on the size of the object.

### BackColor

#### Description

Specifies the background color of the selected object.

Access in Runtime: Read and write

#### Syntax

Object.**BackColor**[= Color]

#### Object

Required An object of the "ScreenItem" type with the format "Line", "Polyline", "Ellipse", "Circle", "EllipseSegment", "CircleSegment", "EllipticalArc", "CircularArc", "Rectangle", "Polygon", "TextField", "IOField", "SymbolicIOField", "DateTimeField", "Button", "Roundbutton", "Switch", "GraphicIOField", "GraphicView", "Bar", "UserArchivControl", "StatusForce", "Gauge", "Slider", "SymbolLibrary", "RulerTrendControl", "OnlineTrendControl", "FunctionTrendControl", "OnlineTableControl", "AlarmControl", "UserView", "Checkbox", "OptionGroup", "WindowSlider", "Connector", "Group" or an object of the "Screen" type.

#### Color

Optional A value or a constant that specifies the background color.

#### Comments

Use the "RGB" function to establish the colors in RGB format (red, green blue). To do this, enter the appropriate decimal value for each of the three RGB values (range from 0 to 255). For example, the color "red" is shown as such: RGB(255, 0, 0). You can also use the VBS color constants like vbRed or vbGreen.

The background color is not visible if the "BorderStyle" property has the value "0".

## See also

Line (Page 4025)  
Polyline (Page 4060)  
Ellipse (Page 3993)  
Circle (Page 3977)  
EllipseSegment (Page 3995)  
CircleSegment (Page 3979)  
EllipticalArc (Page 3998)  
CircularArc (Page 3982)  
Rectangle (Page 4072)  
Polygon (Page 4057)  
TextField (Page 4107)  
IOField (Page 4021)  
SymbolicIOField (Page 4093)  
Button (Page 3968)  
Switch (Page 4089)  
GraphicView (Page 4014)  
GraphicIOField (Page 4011)  
Bar (Page 3961)  
Gauge (Page 4008)  
Slider (Page 4082)  
SymbolLibrary (Page 4098)  
OnlineTrendControl (Page 4045)  
FunctionTrendControl (Page 4004)  
OnlineTableControl (Page 4037)  
AlarmControl (Page 3947)  
CheckBox (Page 3974)  
OptionGroup (Page 4054)  
WindowSlider (Page 4139)  
Connector (Page 3986)  
Group (Page 4017)  
MultiLineEdit (Page 4032)  
Listbox (Page 4027)  
UserArchiveControl (Page 4130)  
TrendRulerControl (Page 4110)

## BackColor

### Description

Determines the background color of the given object.

Access during runtime: Read and Write

### Syntax

Object.**BackColor** [= Color]

#### Object

Required An object of type "ScreenItem" with the characteristic "Line", "Polyline", "Ellipse", "Circle", "Rectangle", "Polygon", "TextField", "IOField", "SymbolicIOField", "Button", "Switch", "GraphicIOField", "GraphicView", "Bar", "RecipeView", "StatusForce", "Gauge", "Slider", "SymbolLibrary", "TrendView", "MessageView" or "UserView" or an object of type "Screen".

#### Color

Optional A value or constant which determines the background color.

### Comments

You can use the "RGB" function to establish the colors in the RGB format (red, green, blue). To do this, enter the appropriate decimal value for each of the three RGB values (range from 0 to 255). For example, the color "red" is shown as: RGB(255, 0, 0). You can also use the VBScript color constants such as vbRed or vbGreen.

The background color is not visible if the "BorderStyle" property has the value of "0."

### See also

AlarmView (Page 3958)

RecipeView (Page 4068)

TrendView (Page 4118)

StatusForce (Page 4087)

Group (Page 4017)

UserView (Page 4137)

DateTimeField (Page 3989)

ProjectName (Page 4062)

## BackColor2

### Description

Defines or returns the bar color for the display of the current value. LONG write-read access.

## BackColor3 property

### Description

Defines or returns the color of the bar background. LONG write-read access.

## BackColorBottom

### Description

Specifies the color for the lower / right part of the Sliders.

Access in Runtime: Read and write

### Syntax

Object.**BackColorBottom**[=Color]

#### Object

Required A "ScreenItem" object with the format "WindowSlider".

#### Color

Optional A value or a constant that specifies the color for the lower / right part of the Sliders.

### See also

WindowSlider (Page 4139)

## BackColorTop

### Description

Specifies the color for the upper / left part of the Sliders.

Access in Runtime: Read and write

### Syntax

Object.**BackColorTop**[=Color]

#### Object

Required A "ScreenItem" object with the format "WindowSlider".

#### Color

Optional A value or a constant that specifies the color for the upper / left part of the Sliders.

## See also

WindowSlider (Page 4139)

## BackFillStyle

### Description

Specifies the fill style of the selected object.

Access in Runtime: Read and write

### Syntax

Object.**BackFillStyle**[= THmiFillStyle]

#### Object

Required An object of the "ScreenItem" type with the format "Ellipse", "Circle", "EllipseSegment", "CircleSegment", "Rectangle", "Polygon", "TextField", "IOField", "SymbolicIOField", "DateTimeField", "Button", "Roundbutton", "GraphicView", "Bar", "Clock", "Gauge", "Slider", "SymbolLibrary", "CheckBox", "OptionGroup" or "WindowSlider".

#### THmiFillStyle

Optional A value or a constant that specifies the fill style.

hmiFillStyleTransparent (65536): Transparent fill

hmiFillStyleSolid (0): Object is filled with the specified color

Default setting: Solid

## See also

Ellipse (Page 3993)  
Circle (Page 3977)  
EllipseSegment (Page 3995)  
CircleSegment (Page 3979)  
Rectangle (Page 4072)  
Polygon (Page 4057)  
TextField (Page 4107)  
IOField (Page 4021)  
SymbolicIOField (Page 4093)  
Button (Page 3968)  
GraphicView (Page 4014)  
Bar (Page 3961)  
Clock (Page 3984)  
Gauge (Page 4008)  
Slider (Page 4082)  
SymbolLibrary (Page 4098)  
CheckBox (Page 3974)  
OptionGroup (Page 4054)  
WindowSlider (Page 4139)  
Listbox (Page 4027)

## BackFillStyle

### Description

Determines the fill style of the specified object.

Access during runtime: Read and Write

### Syntax

Object.BackFillStyle [= THmiFillStyle]

#### Object

Required. An object of the "ScreenItem" type with the characteristic "Ellipse," "Circle", "Rectangle" or "Polygon".

#### THmiFillStyle

Optional. A value or constant which determines the fill style.



hmiFillStyleTransparent (65536): Transparent fill

hmiFillStyleTransparent (0): Object is filled with the specified color

Default setting: Solid

### See also

DateTimeField (Page 3989)

ProjectName (Page 4062)

## BackFillStyleReadOnlySpecial

### Description

Specifies that the "Background fill style" can only be read.

Access in Runtime: Read and write

### Syntax

Object.**BackFillStyleReadOnlySpecial**[=BOOLEAN]

#### Object

Required A "ScreenItem" object with the format "IOField".

#### BOOLEAN

Optional TRUE, if the "Background fill style" can only be read.

### See also

IOField (Page 4021)

## BackFlashColorOff

### Description

Defines or returns the color of the object background for the flash status "Off". LONG write-read access.

## BackFlashColorOn

### Description

Defines or returns the color of the object background for the flash status "On". LONG write-read access.

## BackFlashingColorOff

### Description

Specifies the color of the background for the flashing status "off".

Access in Runtime: Read and write

### Syntax

Object.**BackFlashingColorOff**[=Color]

#### Object

Required A "ScreenItem" object with the formats "TextField", "IOField", "SymbolicIOField", "Button", "Roundbutton", "Switch", "GraphicView", "GraphicIOField" or "Bar".

#### Color

Optional A value or a constant that specifies the color of the background for the flashing status "off".

### See also

[TextField \(Page 4107\)](#)

[IOField \(Page 4021\)](#)

[SymbolicIOField \(Page 4093\)](#)

[Button \(Page 3968\)](#)

[Switch \(Page 4089\)](#)

[GraphicView \(Page 4014\)](#)

[GraphicIOField \(Page 4011\)](#)

[Bar \(Page 3961\)](#)

## BackFlashingColorOn

### Description

Specifies the color of the background for the flashing status "on".

Access in Runtime: Read and write

## Syntax

Object.**BackFlashingColorOn**[=Color]

### Object

Required A "ScreenItem" object with the formats "TextField", "IOField", "SymbolicIOField", "Button", "Roundbutton", "Switch", "GraphicView", "GraphicIOField" or "Bar".

### Color

Optional A value or a constant that specifies the color of the background for the flashing status "on".

## See also

TextField (Page 4107)

IOField (Page 4021)

SymbolicIOField (Page 4093)

Button (Page 3968)

Switch (Page 4089)

GraphicView (Page 4014)

GraphicIOField (Page 4011)

Bar (Page 3961)

## BackFlashingEnabled

### Description

Specifies whether the background of the specified object will flash in Runtime.

Access in Runtime: Read and write

### Syntax

Object.**BackFlashingEnabled**[=BOOLEAN]

### Object

Required A "ScreenItem" object with the formats "TextField", "IOField", "SymbolicIOField", "Button", "Roundbutton", "Switch", "GraphicView", "GraphicIOField" or "Bar".

### BOOLEAN

Optional TRUE, if the background of the specified object is flashing in Runtime.

## See also

TextField (Page 4107)  
IOField (Page 4021)  
SymbolicIOField (Page 4093)  
Button (Page 3968)  
Switch (Page 4089)  
GraphicView (Page 4014)  
GraphicIOField (Page 4011)  
Bar (Page 3961)

## BackFlashingRate

### Description

Specifies the flash rate of the background for the specified object.  
Access in Runtime: Read and write

### Syntax

Object.**BackFlashingRate**[=FlashingRate]

#### Object

Required A "ScreenItem" object with the formats "TextField", "IOField", "SymbolicIOField", "Button", "Roundbutton", "Switch", "GraphicView", "GraphicIOField" or "Bar".

#### FlashingRate

hmiFlashingRateSlow ( 0): The length of the flashing rate is 250 ms.  
hmiFlashingRateMedium ( 1): The length of the flashing rate is 500 ms.  
hmiFlashingRateFast ( 2): The length of the flashing rate is 1000 ms.

## See also

TextField (Page 4107)  
IOField (Page 4021)  
SymbolicIOField (Page 4093)  
Button (Page 3968)  
Switch (Page 4089)  
GraphicView (Page 4014)  
GraphicIOField (Page 4011)  
Bar (Page 3961)

## Background

### Description

TRUE, when the background of the 3D-bar graph object should be visible. BOOLEAN write-read access.

## BarBackColor

### Description

Specifies the color of the bar background for the selected object.

Access during runtime: Read and write

### Syntax

Object.**BarBackColor**[= Color]

#### Object

Required An object of the "ScreenItem" type with the characteristics "Bar," or "Slider".

#### Color

Optional A value or a constant that specifies the color of the bar background.

### Comments

Use the "RGB" function to establish the colors in RGB format (red, green blue). To do this, enter the appropriate decimal value for each of the three RGB values (range from 0 to 255). For example, the color "red" is shown as: RGB(255, 0, 0). You can also use the VBScript color constants such as vbRed or vbGreen.

### See also

Bar (Page 3961)

Slider (Page 4082)

## BarBackFillStyle

### Description

Specifies the fill style for the bar.

Access in Runtime: Read and write

## Syntax

Object.**BarBackFillStyle**[=FillStyle]

### Object

Required A "ScreenItem" object with the format "Bar".

### FillStyle

hmiFillStyleTransparent ( 65536): Transparent fill style

hmiFillStyleSolid ( 0): Solid fill style

hmiFillStyleBackwardDiagonal ( 131075): Diagonal fill style striped towards the top right

hmiFillStyleCross ( 131076): Checked fill style

hmiFillStyleDiagonalCross ( 131077): Diagonal checked fill style

hmiFillStyleForwardDiagonal ( 131074): Diagonal fill style striped towards the top left

hmiFillStyleHorizontal ( 131072): Horizontal striped fill style

hmiFillStyleVertical ( 131073): Vertical striped fill style

hmiFillStylePattern1 ( 196608): Default fill style

hmiFillStylePattern2 ( 196609): Default fill style

hmiFillStylePattern3 ( 196610): Default fill style

hmiFillStylePattern4 ( 196611): Default fill style

hmiFillStylePattern5 ( 196612): Default fill style

hmiFillStylePattern6 ( 196613): Default fill style

hmiFillStylePattern7 ( 196614): Default fill style

hmiFillStylePattern8 ( 196615): Default fill style

hmiFillStylePattern9 ( 196616): Default fill style

hmiFillStylePattern10 ( 196617): Default fill style

hmiFillStylePattern11 ( 196618): Default fill style

hmiFillStylePattern12 ( 196619): Default fill style

hmiFillStylePattern13 ( 196620): Default fill style

hmiFillStylePattern14 ( 196621): Default fill style

hmiFillStylePattern15 ( 196622): Default fill style

hmiFillStylePattern16 ( 196623): Default fill style

hmiFillStylePattern17 ( 196624): Default fill style

hmiFillStylePattern18 ( 196625): Default fill style

hmiFillStylePattern19 ( 196626): Default fill style

hmiFillStylePattern20 ( 196627): Default fill style

hmiFillStylePattern21 ( 196628): Default fill style

hmiFillStylePattern22 ( 196629): Default fill style

hmiFillStylePattern23 ( 196630): Default fill style  
hmiFillStylePattern24 ( 196631): Default fill style  
hmiFillStylePattern25 ( 196632): Default fill style  
hmiFillStylePattern26 ( 196633): Default fill style  
hmiFillStylePattern27 ( 196634): Default fill style  
hmiFillStylePattern28 ( 196635): Default fill style  
hmiFillStylePattern29 ( 196636): Default fill style  
hmiFillStylePattern30 ( 196637): Default fill style  
hmiFillStylePattern31 ( 196638): Default fill style  
hmiFillStylePattern32 ( 196639): Default fill style  
hmiFillStylePattern33 ( 196640): Default fill style  
hmiFillStylePattern34 ( 196641): Default fill style  
hmiFillStylePattern35 ( 196642): Default fill style  
hmiFillStylePattern36 ( 196643): Default fill style  
hmiFillStylePattern37 ( 196644): Default fill style

### See also

Bar (Page 3961)

### BarColor

### Description

Specifies the color of the slider in the "Slider" object.

Access during runtime: Read and Write

### Syntax

Object.**BarColor**[= Color]

#### Object

Required An object of the "ScreenItem" type with the characteristic "Slider".

#### Color

Optional A value or a constant that specifies the color of the slider.

### Comments

Use the "RGB" function to establish the colors in RGB format (red, green blue). To do this, enter the appropriate decimal value for each of the three RGB values (range from 0 to 255).

For example, the color "red" is shown as: RGB(255, 0, 0). You can also use the VBScript color constants such as vbRed or vbGreen.

The range extends from "RangeMin" to the position of the controller.

### See also

Slider (Page 4082)

### BarDepth

#### Description

Defines or returns the depth of the bar in pixels.

### BarHeight property

#### Description

Defines or returns the height of the bar in pixels.

### BarStartValue

#### Description

Specifies the value of the zero point of the scale.

Access in Runtime: Read and write

### Syntax

Object.**BarStartValue**[=Double]

#### Object

Required A "ScreenItem" object with the format "Bar".

#### Double

Optional A value or a constant that specifies the value of the zero point for the scale.

### See also

Bar (Page 3961)



## BarWidth

### Description

Defines or returns the width of the bar in pixels.

## BaseScreenName

### Description

Reads the name of the current root screen or triggers a root screen change by setting a new screen name.

Access in Runtime: Read and write

### Syntax

Object.**BaseScreenName**[= STRING]

#### Object

Required An "HMIRuntime" object.

#### STRING

Optional A value or a constant that contains the screen name.

### Comments

You can also use the property to establish which screen is currently being displayed.

## BaseX property

### Description

Defines or returns the horizontal distance of the right bar edge to the left edge of the object field in pixels.

## BaseY property

### Description

Defines or returns the vertical distance of the bottom bar edge to the top edge of the object field.

## BeginTime(i)

### Description

Specifies the start time of the time range to be shown in the trend view. The property "TagProviderType(i)" must have the value -1.

Access in Runtime: Read and write

### Syntax

Object.**BeginTime(i)**[=Time]

#### Object

Required An object of the "ScreenItem" type with the format "FunctionTrendControl" oder "OnlineTableControl".

#### Time

Optional A value or a constant which determines the start time of the time range to be shown in the trend view.

### Comments

The parameter i indicates the number of the trend.

If "BeginTime(i)" is changed, illegal combinations with different attributes for the data connection could arise. This means you have to prevent an immediate acceptance of the change with "FreezeProviderConnections" before changing "BeginTime(i)".

### See also

FunctionTrendControl (Page 4004)

OnlineTableControl (Page 4037)

## BelowLowerLimitColor

### Description

Defines the color of the specified object for the case "Low limit exceeded".

## See also

SymbolLibrary (Page 4098)  
GraphicIOField (Page 4011)  
Switch (Page 4089)  
SymbolicIOField (Page 4093)  
IOField (Page 4021)

## BitNumber

### Description

Specifies the bit whose status must change to trigger a value change.  
Access in Runtime: Read and write

### Syntax

Object.**BitNumber**[=Int]

#### Object

Required A "ScreenItem" object with the formats "SymbolicIOField", "Button" or "GraphicIOField".

#### Int

Optional Specifies the bit whose status must change to trigger a value change.

### Comments

The tag being used must be of type BYTE, WORD or DWORD.

## See also

SymbolicIOField (Page 4093)  
Button (Page 3968)  
GraphicIOField (Page 4011)

## BlinkColor

### Description

Specifies the color in which the "SymbolLibrary" object will flash.  
Access during runtime: Read and Write

## Syntax

Object.**BlinkColor**[= Color]

### Object

Required An object of the "ScreenItem" type with the characteristic "SymbolLibrary".

### Color

Optional A value or a constant that specifies the flash color.

## Comments

Use the "RGB" function to establish the colors in RGB format (red, green blue). To do this, enter the appropriate decimal value for each of the three RGB values (range from 0 to 255). For example, the color "red" is shown as: RGB(255, 0, 0). You can also use the VBScript color constants such as vbRed or vbGreen.

## See also

SymbolLibrary (Page 4098)

## BlinkMode

## Description

Sets the type of flash picture for the specified object.

Access during runtime: Read and write

## Syntax

Object.**BlinkMode**[=SymbolLibBlinkMode]

### Object

Required A "ScreenItem" object with the format "SymbolLibrary".

### SymbolLibBlinkMode

hmiSymbolLibraryFlashingNone ( 0): Flashing is switched off.

hmiSymbolLibraryFlashingInvisible ( 1): The flash picture is invisible.

hmiSymbolLibraryFlashingShaded ( 2): The flash picture is given a colored, shaded surface. The color of the surface corresponds to the settings in the property "BlinkColor".

hmiSymbolLibraryFlashingSolid ( 3): The flash picture is given a colored, unshaded surface. The color of the surface corresponds to the settings in the property "BlinkColor".

## See also

SymbolLibrary (Page 4098)

## BlinkSpeed

### Description

Specifies the flash rate.

Fast - 250: The length of the flashing rate is 250 ms. Medium - 500: The length of the flashing rate is 500 ms.

Slow - 1000: The length of the flashing rate is 1000 ms. The default value is medium - 500.

Access in Runtime: Read and write

### Syntax

Object.**BlinkSpeed**[=FlashingRate]

#### Object

Required A "ScreenItem" object with the format "SymbolLibrary".

#### FlashingRate

hmiFlashingRateSlow ( 0): The length of the flashing rate is 250 ms.

hmiFlashingRateMedium ( 1): The length of the flashing rate is 500 ms.

hmiFlashingRateFast ( 2): The length of the flashing rate is 1000 ms.

### See also

SymbolLibrary (Page 4098)

## BorderBackColor

### Description

Specifies the background color of the broken border line for the specified object.

Access in Runtime: Read and write

### Syntax

Object.**BorderBackColor**[=Color]

#### Object

Required An object of the "ScreenItem" type with the format "Ellipse", "Circle", "EllipseSegment", "CircleSegment", "Rectangle", "Polygon", "TextField", "IOField", "SymbolicIOField", "Button", "Roundbutton", "GraphicView", "Bar", "Checkbox", "OptionGroup" or "WindowSlider".

### Color

Optional A value or a constant that specifies the background color of the broken border line for the specified object.

### See also

Ellipse (Page 3993)  
Circle (Page 3977)  
EllipseSegment (Page 3995)  
CircleSegment (Page 3979)  
Rectangle (Page 4072)  
Polygon (Page 4057)  
TextField (Page 4107)  
IOField (Page 4021)  
SymbolicIOField (Page 4093)  
Button (Page 3968)  
GraphicView (Page 4014)  
Bar (Page 3961)  
CheckBox (Page 3974)  
OptionGroup (Page 4054)  
WindowSlider (Page 4139)  
MultiLineEdit (Page 4032)  
Listbox (Page 4027)  
DateTimeField (Page 3989)  
ProjectName (Page 4062)

## BorderBrightColor3D

### Description

Specifies the frame color of the following frame parts in case of a 3D display of the specified object:

- External frame parts at the top and bottom
- Internal frame parts at the top and right

Access in Runtime: Read and write

### Syntax

Object.**BorderBrightColor3D**[= Color]

**Object**

Required A "ScreenItem" object with the formats "Button", "Roundbutton" or "Slider".

**Color**

Optional A value or a constant that specifies the frame color. Default setting is white.

**Comments**

Use the "RGB" function to establish the colors in RGB format (red, green blue). To do this, enter the appropriate decimal value for each of the three RGB values (range from 0 to 255). For example, the color "red" is shown as such: RGB(255, 0, 0). You can also use the VBS color constants like vbRed or vbGreen.

**See also**

Button (Page 3968)

Slider (Page 4082)

BorderShadeColor3D (Page 4212)

**BorderBrightColor3D**

**Description**

Determines the frame color of the following frame parts in the 3D display of the given object:

- Outer frame parts above and below
- Inner frame parts below and right

Access during runtime: Read and Write

**Syntax**

Object.BorderBrightColor3D [= Color]

**Object**

Required An object of the "ScreenItem" type with the characteristic "Slider".

**Color**

Optional A value or constant which determines the frame color. Default setting is white.

**Comments**

You can use the "RGB" function to establish the colors in the RGB format (red, green, blue). To do this, enter the appropriate decimal value for each of the three RGB values (range from 0 to 255). For example, the color "red" is shown as: RGB(255, 0, 0). You can also use the VBScript color constants such as vbRed or vbGreen.

## BorderColor

### Description

Specifies the line color of the specified object.

Access in Runtime: Read and write

### Syntax

Object.**BorderColor**[= Color]

#### Object

Required An object of the "ScreenItem" type with the format "Ellipse", "Circle", "EllipseSegment", "CircleSegment", "Rectangle", "Polygon", "TextField", "IOField", "SymbolicIOField", "DateTimeField", "Button", "Roundbutton", "Switch", "GraphicView", "GraphicIOField", "Bar", "Checkbox", "OptionGroup" or "WindowSlider".

#### Color

Optional A value or a constant that specifies the line color.

### Comments

Use the "RGB" function to establish the colors in RGB format (red, green blue). To do this, enter the appropriate decimal value for each of the three RGB values (range from 0 to 255). For example, the color "red" is shown as such: RGB(255, 0, 0). You can also use the VBS color constants like vbRed or vbGreen.



## See also

Ellipse (Page 3993)  
Circle (Page 3977)  
EllipseSegment (Page 3995)  
CircleSegment (Page 3979)  
Rectangle (Page 4072)  
Polygon (Page 4057)  
TextField (Page 4107)  
IOField (Page 4021)  
SymbolicIOField (Page 4093)  
Button (Page 3968)  
Switch (Page 4089)  
GraphicView (Page 4014)  
GraphicIOField (Page 4011)  
Bar (Page 3961)  
CheckBox (Page 3974)  
OptionGroup (Page 4054)  
WindowSlider (Page 4139)  
AlarmControl (Page 3947)  
MultiLineEdit (Page 4032)  
Listbox (Page 4027)  
UserArchiveControl (Page 4130)  
TrendRulerControl (Page 4110)  
FunctionTrendControl (Page 4004)  
OnlineTableControl (Page 4037)  
OnlineTrendControl (Page 4045)

## BorderColor

### Description

Specifies the line color of the selected object.  
Access during runtime: Read and Write

### Syntax

Object.BorderColor [= Color]

**Object**

Necessary. An object of the "ScreenItem" type with the characteristics "Ellipse", "Circle", "Rectangle", "Polygon", "TextField", "IOField" or "SymbolicIOField".

**Color**

Optional A value or constant which determines the line color.

**Comments**

You can use the "RGB" function to establish the colors in the RGB format (red, green, blue). To do this, enter the appropriate decimal value for each of the three RGB values (range from 0 to 255). For example, the color "red" is shown as: RGB(255, 0, 0). You can also use the VBScript color constants such as vbRed or vbGreen.

**Used for the following object types:**

Rectangle

**See also**

DateTimeField (Page 3989)

ProjectName (Page 4062)

**BorderColorBottom**

**Description**

Defines or returns the border color for the bottom/right part of the object. LONG write-read access.

**BorderColorTop**

**Description**

Defines or returns the border color for the top/left part of the object. LONG write-read access.

**BorderEnabled**

**Description**

TRUE, when the window is displayed with borders in Runtime. Read only access.

## See also

ScreenWindow (Page 4078)  
ScriptDiagnostics (Page 4080)

## BorderEndStyle

### Description

Specifies the type of line-end shapes for the specified object.  
Access in Runtime: Read and write

### Syntax

Object.**BorderEndStyle**[=Int]

#### Object

Required A "ScreenItem" object with the formats "Line", "Polyline" or "Connector".

#### Int

Optional A value or a constant that specifies the type of line-end shapes for the specified object.

## See also

Line (Page 4025)  
Polyline (Page 4060)  
Connector (Page 3986)

## BorderFlashColorOff

### Description

Defines or returns the color of the object lines for the flashing status "Off". LONG write-read access.

## BorderFlashColorOn

### Description

Defines or returns the color of the object lines for the flashing status "On". LONG write-read access.

## BorderFlashingColorOff

### Description

Specifies the color of the border line for the selected object for the flashing status "off".

Access in Runtime: Read and write

### Syntax

Object.**BorderFlashingColorOff**[=Color]

#### Object

Required A "ScreenItem" object with the formats "Ellipse", "Kreis", "EllipseSegment", "CircleSegment", "Rectangle", "Polygon", "TextField", "IOField", "SymbolicIOField", "Button", "Roundbutton", "Switch", "GraphicView", "GraphicIOField", "Bar", "Checkbox", "OptionGroup" or "WindowSlider".

#### Color

Optional A value or a constant that specifies the color of the border line of the selected object for the flashing status "off".

### See also

Ellipse (Page 3993)  
Circle (Page 3977)  
EllipseSegment (Page 3995)  
CircleSegment (Page 3979)  
Rectangle (Page 4072)  
Polygon (Page 4057)  
TextField (Page 4107)  
IOField (Page 4021)  
SymbolicIOField (Page 4093)  
Button (Page 3968)  
Switch (Page 4089)  
GraphicView (Page 4014)  
GraphicIOField (Page 4011)  
Bar (Page 3961)  
CheckBox (Page 3974)  
OptionGroup (Page 4054)  
WindowSlider (Page 4139)

## BorderFlashingColorOn

### Description

Specifies the color of the border line for the selected object for the flashing status "on".

Access in Runtime: Read and write

### Syntax

Object.**BorderFlashingColorOn**[=Color]

#### Object

Required A "ScreenItem" object with the formats "Ellipse", "Circle", "EllipseSegment", "CircleSegment", "Rectangle", "Polygon", "TextField", "IOField", "SymbolicIOField", "Button", "Roundbutton", "Switch", "GraphicView", "GraphicIOField", "Bar", "Checkbox", "OptionGroup" or "WindowSlider".

#### Color

Optional A value or a constant that specifies the color of the border line of the selected object for the flashing status "on".

### See also

Ellipse (Page 3993)  
Circle (Page 3977)  
EllipseSegment (Page 3995)  
CircleSegment (Page 3979)  
Rectangle (Page 4072)  
Polygon (Page 4057)  
TextField (Page 4107)  
IOField (Page 4021)  
SymbolicIOField (Page 4093)  
Button (Page 3968)  
Switch (Page 4089)  
GraphicView (Page 4014)  
GraphicIOField (Page 4011)  
Bar (Page 3961)  
CheckBox (Page 3974)  
OptionGroup (Page 4054)  
WindowSlider (Page 4139)

## BorderFlashingEnable

### Description

Specifies whether the border line of the selected object will flash in runtime.

Access in Runtime: Read and write

### Syntax

Object.**BorderFlashingEnable**[=BOOLEAN]

#### Object

Required A "ScreenItem" object with the formats "Ellipse", "Circle", "EllipseSegment", "CircleSegment", "Rectangle", "Polygon", "TextField", "IOField", "SymbolicIOField", "Button", "Roundbutton", "Switch", "GraphicView", "GraphicIOField", "Bar", "Checkbox", "OptionGroup" or "WindowSlider".

#### BOOLEAN

Optional TRUE, if the border line of the object is flashing.

### See also

[Ellipse \(Page 3993\)](#)

[Circle \(Page 3977\)](#)

[EllipseSegment \(Page 3995\)](#)

[CircleSegment \(Page 3979\)](#)

[Rectangle \(Page 4072\)](#)

[Polygon \(Page 4057\)](#)

[TextField \(Page 4107\)](#)

[IOField \(Page 4021\)](#)

[SymbolicIOField \(Page 4093\)](#)

[Button \(Page 3968\)](#)

[Switch \(Page 4089\)](#)

[GraphicView \(Page 4014\)](#)

[GraphicIOField \(Page 4011\)](#)

[Bar \(Page 3961\)](#)

[CheckBox \(Page 3974\)](#)

[OptionGroup \(Page 4054\)](#)

[WindowSlider \(Page 4139\)](#)

[RoundButton \(Page 4074\)](#)

## BorderFlashingRate

### Description

Specifies the flash rate of the border line for the selected object.

Access in Runtime: Read and write

### Syntax

Object.**BorderFlashingRate**[=FlashingRate]

#### Object

Required A "ScreenItem" object with the formats "Ellipse", "Circle", "EllipseSegment", "CircleSegment", "Rectangle", "Polygon", "TextField", "IOField", "SymbolicIOField", "Button", "Roundbutton", "Switch", "GraphicView", "GraphicIOField", "Bar", "Checkbox", "OptionGroup" or "WindowSlider".

#### FlashingRate

hmiFlashingRateSlow ( 0): The length of the flashing rate is 250 ms.

hmiFlashingRateMedium ( 1): The length of the flashing rate is 500 ms.

hmiFlashingRateFast ( 2): The length of the flashing rate is 1000 ms.

### See also

[Ellipse \(Page 3993\)](#)

[Circle \(Page 3977\)](#)

[EllipseSegment \(Page 3995\)](#)

[CircleSegment \(Page 3979\)](#)

[Rectangle \(Page 4072\)](#)

[Polygon \(Page 4057\)](#)

[TextField \(Page 4107\)](#)

[IOField \(Page 4021\)](#)

[SymbolicIOField \(Page 4093\)](#)

[Button \(Page 3968\)](#)

[Switch \(Page 4089\)](#)

[GraphicView \(Page 4014\)](#)

[GraphicIOField \(Page 4011\)](#)

[Bar \(Page 3961\)](#)

[CheckBox \(Page 3974\)](#)

[OptionGroup \(Page 4054\)](#)

[WindowSlider \(Page 4139\)](#)

## BorderInnerStyle3D

### Description

Specifies the display of the internal part of the object border.

Access in Runtime: Read and write

### Syntax

Object.**BorderInnerStyle3D**[=GaugeBorder3DStyle]

#### Object

Required A "ScreenItem" object with the formats "Gauge" or "Slider".

#### GaugeBorder3DStyle

hmiGaugeBorder3DStyleNone ( 0): There is no internal part of the object border.

hmiGaugeBorder3DStyleRecessed ( 1): The object border is shown in relief.

hmiGaugeBorder3DStyleRaised ( 2): The object border is shown raised.

hmiGaugeBorder3DStyleGray ( 3): The object border has a uniform gray border.

hmiGaugeBorder3DStyleColored ( 4): The object border has a uniform colored border. The border color corresponds to the background color.

### See also

Gauge (Page 4008)

Slider (Page 4082)

## BorderInnerWidth3D

### Description

Specifies the width of the inner border for the 3D presentation of the selected object.

Access in Runtime: Read and write

### Syntax

Object.**BorderInnerWidth3D**[= LONG]

#### Object

Required A "ScreenItem" object with the format "Slider".

#### LONG

Optional A value or a constant that specifies the width in pixels of the inner border.



## See also

Slider (Page 4082)

## BorderOuterStyle3D

### Description

Specifies the display of the external part of the object border.

Access in Runtime: Read and write

### Syntax

Object.**BorderOuterStyle3D**[=GaugeBorder3DStyle]

#### Object

Required A "ScreenItem" object with the formats "Gauge" or "Slider".

#### GaugeBorder3DStyle

hmiGaugeBorder3DStyleNone ( 0): There is no internal part of the object border.

hmiGaugeBorder3DStyleRecessed ( 1): The object border is shown in relief.

hmiGaugeBorder3DStyleRaised ( 2): The object border is shown raised.

hmiGaugeBorder3DStyleGray ( 3): The object border has a uniform gray border.

hmiGaugeBorder3DStyleColored ( 4): The object border has a uniform colored border. The border color corresponds to the background color.

## See also

Gauge (Page 4008)

Slider (Page 4082)

## BorderOuterWidth3D

### Description

Specifies the width of the outer border for the 3D presentation of the selected object.

Access in Runtime: Read and write

### Syntax

Object.**BorderOuterWidth3D**[= LONG]

#### Object

Required A "ScreenItem" object with the format "Slider".

### **LONG**

Optional A value or a constant that specifies the width in pixels of the outer border.

### **See also**

Slider (Page 4082)

## **BorderShadeColor3D**

### **Description**

Specifies the frame color of the following frame parts in case of a 3D display of the specified object:

- Internal frame parts at the top and bottom
- External frame parts at the bottom and right

Access in Runtime: Read and write

### **Syntax**

Object.**BorderShadeColor3D**[= Color]

#### **Object**

Required A "ScreenItem" object with the formats "Button", "Roundbutton" or "Slider".

#### **Color**

Optional A value or a constant that specifies the color of the shading. Default setting is

### **Comments**

Use the "RGB" function to establish the colors in RGB format (red, green blue). To do this, enter the appropriate decimal value for each of the three RGB values (range from 0 to 255). For example, the color "red" is shown as such: RGB(255, 0, 0). You can also use the VBS color constants like vbRed or vbGreen.

### **See also**

Button (Page 3968)

Slider (Page 4082)

## BorderShadeColor3D

### Description

Determines the frame color of the following frame parts in the 3D display of the given object:

- Inner frame parts above and below
- Outer frame parts below and right

Access during runtime: Read and Write

### Syntax

Object.BorderShadeColor3D [= Color]

#### Object

Required. An object of the "ScreenItem" type with the characteristic "Slider."

#### Color

Optional. A value or constant which determines the shade color. Default setting is

### Remarks

You can use the "RGB" function to establish the colors in the RGB format (red, green, blue). To do this, enter the corresponding decimal values (value range from 0 to 255) for each of the three RGB values. For example, the color "red" is represented as follows: RGB(255, 0, 0). Furthermore, you can use the VBS color constants such as vbRed or vbGreen.

## BorderStyle

### Description

Specifies the type of border lines for the specified object.

Access in Runtime: Read-only

### Syntax

Object.**BorderStyle**[=Int]

#### Object

Required A "ScreenItem" object with the formats "Line", "Polyline", "Ellipse", "Circle", "EllipseSegment", "CircleSegment", "EllipticalArc", "CircularArc", "Rectangle", "Polygon", "TextField", "IOField", "SymbolicIOField", "Button", "Roundbutton", "GraphicView", "GraphicIOField", "Bar", "Checkbox", "OptionGroup", "WindowSlider", "Connector", "PrintRecipe" or "PrintMessage".

### **Int**

Optional A value or a constant that specifies the type of border lines for the specified object.

0 = filled line

1 = broken line

2 = dotted line

3 = dashed and dotted line

4 = dash - dot - dot line

### **See also**

Line (Page 4025)

Polyline (Page 4060)

Ellipse (Page 3993)

Circle (Page 3977)

EllipseSegment (Page 3995)

CircleSegment (Page 3979)

EllipticalArc (Page 3998)

CircularArc (Page 3982)

Rectangle (Page 4072)

Polygon (Page 4057)

TextField (Page 4107)

IOField (Page 4021)

SymbolicIOField (Page 4093)

Button (Page 3968)

GraphicView (Page 4014)

GraphicIOField (Page 4011)

Bar (Page 3961)

CheckBox (Page 3974)

OptionGroup (Page 4054)

WindowSlider (Page 4139)

Connector (Page 3986)

MultiLineEdit (Page 4032)

Listbox (Page 4027)

## BorderStyle3D

### Description

Specifies whether the selected object has a 3D border shadow.

Access during runtime: Read and write

### Syntax

Object.**BorderStyle3D**[= BOOLEAN]

#### Object

Necessary. A "ScreenItem" object with the formats "TextField", "IOField", "SymbolicIOField", "DateTimeField", "Button", "Switch", "GraphicView", "GraphicIOField" or "Bar".

#### BOOLEAN

Optional TRUE, if the object has a 3D border shadow.

#### Used for the following object types:

Auto-Hotspot

### See also

TextField (Page 4107)

IOField (Page 4021)

SymbolicIOField (Page 4093)

Button (Page 3968)

Switch (Page 4089)

GraphicView (Page 4014)

GraphicIOField (Page 4011)

Bar (Page 3961)

## BorderStyle3D

### Description

Determines whether the given object has 3D border shading.

Access during runtime: Read and Write

## Syntax

Object.BorderStyle3D [= BOOLEAN]

### Object

Required. An object of the type "ScreenItem" with the characteristic "TextField", "IOField", "SymbolicIOField", "Button", "Switch", "GraphicView", "GraphicIOField" or "Bar".

### BOOLEAN

Optional. TRUE, if the object has 3D border shading.

## See also

DateTimeField (Page 3989)

## BorderWidth

## Description

Specifies the line thickness of the selected object.

Access during runtime: Read and write

## Syntax

Object.BorderWidth[= LONG]

### Object

Necessary. An object of the "ScreenItem" type with the format "Ellipse", "Circle", "EllipseSegment", "CircleSegment", "Rectangle", "Polygon", "TextField", "IOField", "SymbolicIOField", "Button", "Roundbutton", "Switch", "GraphicView", "GraphicIOField", "Bar", "Gauge", "Slider", "Checkbox", "OptionGroup" or "WindowSlider".

### LONG

Optional A value or a constant that specifies the line weight in pixels.

### Used for the following object types:

Rectangle

## See also

Ellipse (Page 3993)  
Circle (Page 3977)  
EllipseSegment (Page 3995)  
CircleSegment (Page 3979)  
Rectangle (Page 4072)  
Polygon (Page 4057)  
TextField (Page 4107)  
IOField (Page 4021)  
SymbolicIOField (Page 4093)  
Button (Page 3968)  
Switch (Page 4089)  
GraphicView (Page 4014)  
GraphicIOField (Page 4011)  
Bar (Page 3961)  
Gauge (Page 4008)  
Slider (Page 4082)  
CheckBox (Page 3974)  
OptionGroup (Page 4054)  
WindowSlider (Page 4139)  
AlarmControl (Page 3947)  
MultiLineEdit (Page 4032)  
Listbox (Page 4027)  
UserArchiveControl (Page 4130)  
TrendRulerControl (Page 4110)  
FunctionTrendControl (Page 4004)  
OnlineTableControl (Page 4037)  
OnlineTrendControl (Page 4045)

## BorderWidth

### Description

Determines the LineWidth of the given object.

Access during runtime: Read and Write

## Syntax

Object.BorderWidth [= LONG]

### Object

Required. An object of the type "ScreenItem" with the characteristic "Ellipse", "Circle", "Gauge", "Rectangle", "Polygon" or "TextField".

### LONG

Optional. A value or constant which determines the line width in pixels.

## See also

ProjectName (Page 4062)

## BorderWidth3D

### Description

Specifies the width of the border for the 3D representation of the selected object.

Access in Runtime: Read and write

## Syntax

Object.BorderWidth3D [= LONG]

### Object

Required A "ScreenItem" object with the format "Roundbutton".

### LONG

Optional A value or constant which determines the width of the inner border in pixels.

## See also

Switch (Page 4089)

Gauge (Page 4008)

RoundButton (Page 4074)

## BottomConnectedConnectionPointIndex

### Description

Specifies or sets the index number of the bottom connecting point.

LONG write-read access.



### BottomConnectedObjectName

#### Description

Specifies or sets the object name of the object which is docked on at the bottom connecting point.

LONG write-read access.

### BoxAlignment

#### Description

TRUE, when the fields are arranged aligned to the right. BOOLEAN write-read access.

### BoxCount

#### Description

Defines or returns the number of fields. Value range from 0 to 31.

### BoxType

#### Description

Defines or returns the field type. Value range from 0 to 2:

- 0: Edition
- 1: Input
- 2: I/O field

### Button1Width

#### Description

Defines or returns the width of the Button 1 in pixels.

When the SameSize property is set to TRUE, all the buttons are specified the same width.

### Button2Width

#### Description

Defines or returns the width of the Button 2 in pixels.

When the SameSize property is set to TRUE, all the buttons are specified the same width.

## Button3Width

### Description

Defines or returns the width of the Button 3 in pixels.  
When the SameSize property is set to TRUE, all the buttons are specified the same width.

## Button4Width

### Description

Defines or returns the width of the Button 4 in pixels.  
When the SameSize property is set to TRUE, all the buttons are specified the same width.

## ButtonColor

### Description

Defines or returns the color of the slider. LONG write-read access.

## ButtonCommand

### Description

Specifies the display in the message view.  
Access in Runtime: Read and write

### Syntax

Object.**ButtonCommand**[=Long]

#### Object

Required A "ScreenItem" object with the format "AlarmControl".

#### Long

Optional A value or a constant which specifies the display in the message view.

0x00000001; 1; alarm list

0x00000002; 2; historical alarm list (short-term)

0x00000004; 4; historical alarm list (long-term)

0x00200000; 2097152; lock list

0x00000008; 8; central annunciator acknowledgement

0x00000010; 16; single acknowledgement

0x00000020; 32; group acknowledgement·  
0x00000040; 64; Autoscroll·  
0x00000080; 128; selection dialog·  
0x00000100; 256; block dialog·  
0x00000200; 512; print alarm report·  
0x00000800; 2048; emergency acknowledgement·  
0x00001000; 4096; first alarm·  
0x00002000; 8192; last alarm·  
0x00004000; 16384; next alarm·  
0x00008000; 32768; previous alarm·  
0x00010000; 65536; Infotext dialog·  
0x00020000; 131072; comment dialog·  
0x00040000; 262144; Loop in interrupt·  
0x00100000; 1048576; print current view·  
0x00400000; 4194304; lock / unlock alarm·  
0x00800000; 8388608; sort dialog·  
0x01000000; 16777216; time base dialog·  
0x02000000; 33554432; hit list

### See also

AlarmControl (Page 3947)

### Properties C

### Caption

### Description

Specifies the text that will be displayed in the title line of the selected object.

Access in Runtime: Read and write

### Syntax

Object.**Caption**[= STRING]

### Object

Required An object of the "ScreenItem" type with the format "Slider", "FunctionTrendControl", "OnlineTableControl", "AlarmControl", "ScreenWindow" or "UserArchiveControl".

### **STRING**

Optional A value or a constant that contains the text that will be shown in the title line.

### **See also**

Slider (Page 4082)

FunctionTrendControl (Page 4004)

OnlineTableControl (Page 4037)

AlarmControl (Page 3947)

ScreenWindow (Page 4078)

UserArchiveControl (Page 4130)

SystemDiagnoseWindow (Page 4103)

TrendRulerControl (Page 4110)

### **Caption**

#### **Description**

Determines the text which is displayed in the caption line of the given object.

Access during runtime: Read and Write

#### **Syntax**

Object.Caption [= STRING]

#### **Object**

Required. An object of the "ScreenItem" type with the characteristic "Slider."

#### **STRING**

Optional. A value or a constant which contains the text which is displayed in the caption.

### **CaptionBackColor**

#### **Description**

Specifies the background color of the title line for the selected object.

Access in Runtime: Read and write

#### **Syntax**

Object.**CaptionBackColor**[=Color]

**Object**

Required A "ScreenItem" object with the format "SymbolicIOField".

**Color**

Optional A value or a constant that specifies the background color of the title line for the selected object.

**See also**

SymbolicIOField (Page 4093)

**CaptionColor**

**Description**

Specifies the color of the text that will be displayed in the title line of the selected object.

Access in Runtime: Read and write

**Syntax**

Object.**CaptionColor**[= Color]

**Object**

Required A "ScreenItem" object with the formats "SymbolicIOField", "Switch" or "Gauge".

**Color**

Optional A value or a constant that specifies the text color.

**Comments**

Use the "RGB" function to establish the colors in RGB format (red, green blue). To do this, enter the appropriate decimal value for each of the three RGB values (range from 0 to 255). For example, the color "red" is shown as such: RGB(255, 0, 0). You can also use the VBS color constants like vbRed or vbGreen.

**See also**

SymbolicIOField (Page 4093)

Switch (Page 4089)

Gauge (Page 4008)

## CaptionColor

### Description

Determines the color of the text which is displayed in the title bar of the given object.

Access during runtime: Read and Write

### Syntax

Object.CaptionColor [= Color]

#### Object

Required An object of the "ScreenItem" type with the characteristics "Switch," or "Gauge".

#### Color

Optional A value or constant which determines the text color.

### Comments

You can use the "RGB" function to establish the colors in the RGB format (red, green, blue). To do this, enter the appropriate decimal value for each of the three RGB values (range from 0 to 255). For example, the color "red" is shown as: RGB(255, 0, 0). You can also use the VBScript color constants such as vbRed or vbGreen.

## CaptionText

### Description

Specifies the text that will be displayed in the title line of the selected object.

Access in Runtime: Read and write

### Syntax

Object.**CaptionText**[= STRING]

#### Object

Required A "ScreenItem" object with the formats "Switch" or "Gauge".

#### STRING

Optional A value or a constant that contains the text that will be shown in the title line.

## See also

Switch (Page 4089)  
Gauge (Page 4008)  
ScreenWindow (Page 4078)

## CaptionTop

### Description

Specifies the distance of the instrument labels to the upper edge of the selected object. You can position the instrument labels only in line with the vertical diameter of the scale. The value of the attribute refers to the height of the specified object. The height establishes the upper edge of the specified object and the lower edge of the lettering.

Access in Runtime: Read and write

### Syntax

Object.**CaptionTop**[=Double]

#### Object

Required A "ScreenItem" object with the format "Gauge".

#### Double

Optional A value or a constant that specifies the distance of the instrument labels to the upper edge of the selected object.

Value range from 0 to 1

0: The lower edge of the lettering is positioned on the upper limit of the selected object. The text is no longer visible as it is positioned outside of the selected object.

1: The lower edge of the lettering is positioned on the lower limit of the selected object.

## See also

Gauge (Page 4008)

## CellCut

### Description

Specifies whether the contents of the cells are abbreviated if the cells are too narrow.

Access in Runtime: Read and write

## Syntax

Object.**CellCut** [=BOOLEAN]

### Object

Required An object of the "ScreenItem" type with the format "AlarmControl", "TrendRulerControl", "OnlineTableControl", "UserArchivControl".

### BOOLEAN

TRUE, if the contents are abbreviated.

## See also

AlarmControl (Page 3947)

UserArchiveControl (Page 4130)

TrendRulerControl (Page 4110)

OnlineTableControl (Page 4037)

## CellSpaceBottom

### Description

Defines the bottom margin of the table cells.

Access in Runtime: Read

### Syntax

Object.**CellSpaceBottom**

### Object

Required An object of the "ScreenItem" type with the format "AlarmControl", "TrendRulerControl", "OnlineTableControl", "UserArchivControl".

## See also

AlarmControl (Page 3947)

UserArchiveControl (Page 4130)

TrendRulerControl (Page 4110)

OnlineTableControl (Page 4037)



## CellSpaceLeft

### Description

Specifies the cell space left which is used in the table cells.

Access in Runtime: Read

### Syntax

Object.**CellSpaceLeft**

#### Object

Required An object of the "ScreenItem" type with the format "MessageView", "TrendRulerControl", "OnlineTableControl", "UserArchivControl".

### See also

[AlarmControl \(Page 3947\)](#)

[UserArchiveControl \(Page 4130\)](#)

[TrendRulerControl \(Page 4110\)](#)

[OnlineTableControl \(Page 4037\)](#)

## CellSpaceRight

### Description

Defines the right indent of the table cells.

Access in Runtime: Read

### Syntax

Object.**CellSpaceRight**

#### Object

Required An object of the "ScreenItem" type with the format "AlarmControl", "TrendRulerControl", "OnlineTableControl", "UserArchiveControl".

### See also

[AlarmControl \(Page 3947\)](#)

[UserArchiveControl \(Page 4130\)](#)

[TrendRulerControl \(Page 4110\)](#)

[OnlineTableControl \(Page 4037\)](#)

## CellSpaceTop

### Description

Defines the top margin of the table cells.

Access in Runtime: Read

### Syntax

Object.**CellSpaceTop**

#### Object

Required An object of the "ScreenItem" type with the format "AlarmControl", "TrendRulerControl", "OnlineTableControl", "UserArchiveControl".

### See also

AlarmControl (Page 3947)

UserArchiveControl (Page 4130)

TrendRulerControl (Page 4110)

OnlineTableControl (Page 4037)

## CenterColor

### Description

Specifies the color of the center of the "Gauge" object.

Access during runtime: Read and Write

### Syntax

Object.**CenterColor**[= Color]

#### Object

Required An object of the "ScreenItem" type with the characteristic "Gauge".

#### Color

Optional A value or a constant that specifies the color of the center.

### Comments

Use the "RGB" function to establish the colors in RGB format (red, green blue). To do this, enter the appropriate decimal value for each of the three RGB values (range from 0 to 255). For example, the color "red" is shown as: RGB(255, 0, 0). You can also use the VBScript color constants such as vbRed or vbGreen.

## See also

Gauge (Page 4008)

## CenterSize

### Description

Specifies the diameter of the round scale center point.

Access in Runtime: Read and write

### Syntax

Object.**CenterSize**[=Single]

#### Object

Required A "ScreenItem" object with the format "Gauge".

#### Single

Optional A value or a constant that specifies the diameter of the round scale center point.

Value range from 0.03 to 1

1: The diameter corresponds to the smaller value of the geometry attribute "Width" or "Height".

## See also

Gauge (Page 4008)

## CentrePoint

### Description

Specifies the position of the center point.

Access in Runtime: Read and write

### Syntax

Object.**CentrePoint**[=Point]

#### Object

Required A "ScreenItem" object with the formats "EllipseSegment", "CircleSegment", "EllipticalArc" or "CircularArc".

#### Point

Optional A value that specifies the position of the center point.

## See also

EllipseSegment (Page 3995)

CircleSegment (Page 3979)

EllipticalArc (Page 3998)

CircularArc (Page 3982)

## CentrePointLeft

### Description

Specifies the horizontal distance in pixels of the center point from the left edge of the screen.

Access in Runtime: Read and write

### Syntax

Object.**CentrePointLeft**[=Int]

#### Object

Required A "ScreenItem" object with the formats "EllipseSegment", "CircleSegment", "EllipticalArc" or "CircularArc".

#### Int

Optional A value that specifies the horizontal distance in pixels of the center point from the left edge of the screen.

## See also

EllipseSegment (Page 3995)

CircleSegment (Page 3979)

EllipticalArc (Page 3998)

CircularArc (Page 3982)

## CentrePointTop

### Description

Specifies the vertical distance in pixels of the center point from the upper edge of the screen.

Access in Runtime: Read and write

### Syntax

Object.**CentrePointTop**[=Int]

### Object

Required A "ScreenItem" object with the formats "EllipseSegment", "CircleSegment", "EllipticalArc" or "CircularArc".

### Int

Optional A value that specifies the vertical distance in pixels of the center point from the upper edge of the screen.

### See also

EllipseSegment (Page 3995)

CircleSegment (Page 3979)

EllipticalArc (Page 3998)

CircularArc (Page 3982)

## ChangeMouseCursor

### Description

Specifies how the appearance of the mouse cursor changes in Runtime when it is above the icon.

Access in Runtime: Read and write

### Syntax

Object.**ChangeMouseCursor**[=BOOLEAN]

### Object

Required A "ScreenItem" object with the format "SymbolLibrary".

### BOOLEAN

Optional TRUE, if the mouse cursor has the appearance of an arrow even when it is positioned above the icon.

FALSE, if the mouse cursor has the appearance of a 3D arrow with a green lightning symbol. This indicates in Runtime that the respective objective can be operated.

### See also

SymbolLibrary (Page 4098)

## CheckAlarmHigh

### Description

TRUE, when the "AlarmHigh" limit value is to be monitored. BOOLEAN write/read access.  
The limit value, the display on reaching the limit value and the type of evaluation are defined by means of the "AlarmHigh", "ColorAlarmHigh" and "TypeAlarmHigh" properties.

## CheckAlarmLow

### Description

TRUE, when the "AlarmLow" limit value is to be monitored. BOOLEAN write/read access.  
The limit value, the display on reaching the limit value and the type of evaluation are defined by means of the "AlarmLow", "ColorAlarmLow" and "TypeAlarmLow" properties.

## CheckLimitHigh4

### Description

TRUE, when the "Reserve 4" upper limit value should be monitored. BOOLEAN write/read access.  
The limit value, the display on reaching the limit value and the type of evaluation are defined by means of the "LimitHigh4", "ColorLimitHigh4" and "TypeLimitHigh4" properties.

## CheckLimitHigh5

### Description

TRUE, when the "Reserve 5" upper limit value should be monitored. BOOLEAN write/read access.  
The limit value, the display on reaching the limit value and the type of evaluation are defined by means of the "LimitHigh5", "ColorLimitHigh5" and "TypeLimitHigh5" properties.

## CheckLimitLow4

### Description

TRUE, when the "Reserve 4" lower limit value should be monitored. BOOLEAN write/read access.  
The limit value, the display on reaching the limit value and the type of evaluation are defined by means of the "LimitLow4", "ColorLimitLow4" and "TypeLimitLow4" properties.

## CheckLimitLow5

### Description

TRUE, when the "Reserve 5" lower limit value should be monitored. BOOLEAN write/read access.  
The limit value, the display on reaching the limit value and the type of evaluation are defined by means of the "LimitLow5", "ColorLimitLow5" and "TypeLimitLow5" properties.

## CheckMarkAlignment

### Description

Specifies whether the fields are right aligned.  
Access in Runtime: Read and write

### Syntax

Object.**CheckMarkAlignment**[=ContentAlignment]

#### Object

Required A "ScreenItem" object with the formats "Checkbox" or "OptionGroup".

#### ContentAlignment

- ( 0): The fields are arranged left aligned.
- ( 1): The fields are arranged right aligned.

### See also

OptionGroup (Page 4054)

## CheckMarkCount

### Description

Specifies the number of fields.  
Access in Runtime: Read and write

### Syntax

Object.**CheckMarkCount**[=Int]

#### Object

Required A "ScreenItem" object with the formats "Checkbox" or "OptionGroup".

### **Int**

Optional A value or a constant that specifies the number of fields. Value range from 0 to 31

### **See also**

OptionGroup (Page 4054)

### **CheckToleranceHigh**

#### **Description**

TRUE, when the "ToleranceHigh" limit value is to be monitored. BOOLEAN write/read access. The limit value, the display on reaching the limit value and the type of evaluation are defined by means of the "ToleranceHigh", "ColorToleranceHigh" and "TypeToleranceHigh" properties.

### **CheckToleranceLow**

#### **Description**

TRUE, when the "ToleranceLow" limit value is to be monitored. BOOLEAN write/read access. The limit value, the display on reaching the limit value and the type of evaluation are defined by means of the "ToleranceLow", "ColorToleranceLow" and "TypeToleranceLow" properties.

### **CheckWarningHigh**

#### **Description**

TRUE, when the "WarningHigh" limit value is to be monitored. BOOLEAN write/read access. The limit value, the display on reaching the limit value and the type of evaluation are defined by means of the "WarningHigh", "ColorWarningHigh" and "TypeWarningHigh" properties.

### **CheckWarningLow**

#### **Description**

TRUE, when the "WarningLow" limit value is to be monitored. BOOLEAN write/read access. The limit value, the display on reaching the limit value and the type of evaluation are defined by means of the "WarningLow", "ColorWarningLow" and "TypeWarningLow" properties.

### **ClearOnError**

#### **Description**

Specifies whether an invalid input in this object will be deleted automatically.



Access in Runtime: Read and write

### Syntax

Object.**ClearOnError**[=BOOLEAN]

#### Object

Required A "ScreenItem" object with the format "IOField".

#### BOOLEAN

Optional TRUE, if an invalid input in this object will be deleted automatically.

### See also

IOField (Page 4021)

### ClearOnFocus

#### Description

Specifies whether the field entry will be deleted as soon as the I/O field is activated.

Access in Runtime: Read and write

### Syntax

Object.**ClearOnFocus**[=BOOLEAN]

#### Object

Required A "ScreenItem" object with the format "IOField".

#### BOOLEAN

Optional TRUE, if the field entry is deleted as soon as the I/O field is activated.

### See also

IOField (Page 4021)

### ClearOnNew

#### Description

TRUE, when the field entry is deleted as soon as the I/O field has the focus. BOOLEAN write-read access.

## Closable

### Description

Specifies whether the window can be closed in Runtime.

Access in Runtime: Read and write

### Syntax

Object.**Closable**[=BOOLEAN]

#### Object

Required A "ScreenItem" object with the format "UserArchiveControl".

#### BOOLEAN

Optional TRUE, if the window can be closed in Runtime.

### See also

AlarmControl (Page 3947)

UserArchiveControl (Page 4130)

SystemDiagnoseWindow (Page 4103)

TrendRulerControl (Page 4110)

FunctionTrendControl (Page 4004)

OnlineTableControl (Page 4037)

OnlineTrendControl (Page 4045)

## CloseButton

### Description

TRUE, when the window is provided with a "Close" button. Read only access.

## Color

### Description

Specifies the line color of the specified object.

Access in Runtime: Read and write

### Syntax

Object.**Color**[= Color]

**Object**

Required A "ScreenItem" object with the formats "Line", "Polyline", "EllipticalArc" or "CircularArc".

**Color**

Optional A value or a constant that specifies the line color.

**Comments**

Use the "RGB" function to establish the colors in RGB format (red, green blue). To do this, enter the appropriate decimal value for each of the three RGB values (range from 0 to 255). For example, the color "red" is shown as such: RGB(255, 0, 0). You can also use the VBS color constants like vbRed or vbGreen.

**See also**

Line (Page 4025)

Polyline (Page 4060)

EllipticalArc (Page 3998)

CircularArc (Page 3982)

TubeArcObject (Page 4121)

TubeDoubleTeeObject (Page 4123)

TubePolyline (Page 4125)

TubeTeeObject (Page 4128)

**Color**

**Description**

Determines the line color of the given object.

Access during runtime: Read and Write

**Syntax**

Object.Color [= Color]

**Object**

Required An object of the "ScreenItem" type with the characteristics "Line," or "Polyline".

**Color**

Optional A value or constant which determines the line color.

## Comments

You can use the "RGB" function to establish the colors in the RGB format (red, green, blue). To do this, enter the appropriate decimal value for each of the three RGB values (range from 0 to 255). For example, the color "red" is shown as: RGB(255, 0, 0). You can also use the VBScript color constants such as vbRed or vbGreen.

## ColorAlarmHigh

### Description

Defines or returns the bar color for the "AlarmHigh" limit value. LONG write/read access. The "CheckAlarmHigh" property must have been set to TRUE if the bar color should change on reaching the limit value.

## ColorAlarmLow

### Description

Defines or returns the bar color for the "AlarmLow" limit value. LONG write/read access. The "CheckAlarmLow" property must have been set to TRUE if the bar color should change on reaching the limit value.

## ColorBottom

### Description

Defines or returns the color for the bottom/right stop of the slider object. LONG write-read access.

## ColorChangeHysteresis

### Description

Specifies hysteresis as a percentage of the display value.

The "ColorChangeHysteresisEnable" property must have the value TRUE so that the hysteresis can be calculated.

Access in Runtime: Read and write

### Syntax

Object.**ColorChangeHysteresis**[=Double]

#### Object

Required A "ScreenItem" object with the format "Bar".

### Double

Optional A value or a constant that specifies the hysteresis as a percentage of the display value.

### See also

Bar (Page 3961)

## ColorChangeHysteresisEnabled

### Description

Determines whether the object will be displayed with a hysteresis.

Access in Runtime: Read and write

### Syntax

Object.**ColorChangeHysteresisEnabled**[=BOOLEAN]

#### Object

Required A "ScreenItem" object with the format "Bar".

#### BOOLEAN

Optional TRUE, if the object will be displayed with a hysteresis.

### See also

Bar (Page 3961)

## ColorChangeType

### Description

TRUE, if the change of color should occur segment by segment in the case of a color change (e.g. on reaching a limit value). If set to FALSE, it defines the change of color for the entire bar. BOOLEAN write-read access.

## ColorLimitHigh4

### Description

Defines or returns the color for the "Reserve 4" upper limit value. LONG write/read access. The "CheckLimitHigh4" property must have been set to TRUE if the bar color should change on reaching the limit value.

## **ColorLimitHigh5**

### **Description**

Defines or returns the color for the "Reserve 5" upper limit value. LONG write/read access. The "CheckLimitHigh5" property must have been set to TRUE if the bar color should change on reaching the limit value.

## **ColorLimitLow4**

### **Description**

Defines or returns the color for the "Reserve 4" lower limit value. LONG write/read access. The "CheckLimitLow4" property must have been set to TRUE if the bar color should change on reaching the limit value.

## **ColorLimitLow5**

### **Description**

Defines or returns the color for the "Reserve 5" lower limit value. LONG write/read access. The "CheckLimitLow5" property must have been set to TRUE if the bar color should change on reaching the limit value.

## **ColorToleranceHigh**

### **Description**

Defines or returns the color for the "ToleranceHigh" upper limit value. LONG write/read access. The "CheckToleranceHigh" property must have been set to TRUE if the bar color should change on reaching the limit value.

## **ColorToleranceLow**

### **Description**

Defines or returns the color for the "ToleranceLow" lower limit value. LONG write/read access. The "CheckToleranceLow" property must have been set to TRUE if the bar color should change on reaching the limit value.

## ColorTop

### Description

Defines or returns the color for the top/left stop of the slider object. LONG write-read access.

## ColorWarningHigh

### Description

Defines or returns the color for the "WarningHigh" upper limit value. LONG write/read access. The "CheckWarningHigh" property must have been set to TRUE if the bar color should change on reaching the limit value.

## ColorWarningLow

### Description

Defines or returns the color for the "WarningLow" lower limit value. LONG write/read access. The "CheckWarningLow" property must have been set to TRUE if the bar color should change on reaching the limit value.

## ColumnAlign

### Description

Specifies how the selected column is aligned.

The following settings are possible:

Value	Description	Explanation
0	Left	The column selected is displayed left-justified.
1	Centered	The column selected is displayed centered.
2	Right	The column selected is displayed right-justified.

The attribute can be made dynamic with the name **ColumnAlign**. The data type is LONG.

## ColumnColor(i)

### Description

Determines the color of the i column pair. The parameter i indicates the number of the column pair.

Access in Runtime: Read and write

## Syntax

Object.**ColumnColor(i)**[=Color]

### Object

Required A "ScreenItem" object with the format "OnlineTableControl".

### Color

Optional A value or a constant that specifies the color of the i column pair.

## See also

OnlineTableControl (Page 4037)

## ColumnDisplayName(i)

### Description

Specifies the name for the selected column pair. The parameter i indicates the number of the column pair.

Access in Runtime: Read and write

## Syntax

Object.**ColumnDisplayName(i)**[=String]

### Object

Required A "ScreenItem" object with the format "OnlineTableControl".

### String

Optional A value or a constant that specifies the name for the selected column pair.

## See also

OnlineTableControl (Page 4037)

## ColumnResize

### Description

Enables changes to the width of columns.

Access in Runtime: Read and write



## Syntax

Object.**ColumnResize**[=BOOLEAN]

### Object

Required An object of the "ScreenItem" type with the format "AlarmControl", "TrendRulerControl", "OnlineTableControl", "UserArchivControl".

### BOOLEAN

TRUE: You can change the width of the columns.

FALSE: You cannot change the width of the columns.

## See also

AlarmControl (Page 3947)

UserArchiveControl (Page 4130)

TrendRulerControl (Page 4110)

OnlineTableControl (Page 4037)

## ColumnSizingEnable

### Description

Specifies whether the width of the columns in the alarm window can be changed. The width of the columns can be changed only if the "AutoScroll" property is not enabled.

Access in Runtime: Read and write

### Syntax

Object.**ColumnSizingEnable**[=BOOLEAN]

### Object

Required A "ScreenItem" object with the format "AlarmControl".

### BOOLEAN

Optional TRUE if the width of the columns in the alarm window can be changed.

## See also

AlarmControl (Page 3947)

## ColumnScrollbar

### Description

Enables the display of column scroll bars.

Access in Runtime: Read

### Syntax

Object.**ColumnScrollbar**[=Scrollbar]

#### Object

Required An object of the "ScreenItem" type with the format "AlarmControl", "TrendRulerControl", "OnlineTableControl", "UserArchivControl".

#### Scrollbar

0 = (No) The column scrollbars are not displayed.

1 = (if required) The column scrollbars are displayed if the space requirement of the control is greater in vertical direction than the available display area.

2 = (always) The column scrollbars are always displayed.

### See also

UserArchiveControl (Page 4130)

TrendRulerControl (Page 4110)

OnlineTableControl (Page 4037)

AlarmControl (Page 3947)

## ColumnTitleAlign

### Description

Specifies the type of column title alignment.

Access in Runtime: Read

### Syntax

Object.**ColumnTitleAlign**[=Align]

#### Object

Required An object of the "ScreenItem" type with the format "AlarmControl", "TrendRulerControl", "OnlineTableControl", "UserArchivControl".

### **Align**

0 = The column headers are shown left aligned.

1 = The column headers are shown centered.

2 = The column headers are shown right aligned.

3 = The column headers are aligned as the corresponding content.

### **See also**

AlarmControl (Page 3947)

### **ColumnTitles**

#### **Description**

Enables the display of the column header.

Access in Runtime: Read

#### **Syntax**

Object.**ColumnTitle**[=BOOLEAN]

#### **Object**

Required An object of the "ScreenItem" type with the format "AlarmControl", "TrendRulerControl", "OnlineTableControl", "UserArchivControl".

#### **BOOLEAN**

#### **BOOLEAN**

TRUE: The column header is displayed.

FALSEThe column header is not displayed.

### **See also**

AlarmControl (Page 3947)

UserArchiveControl (Page 4130)

TrendRulerControl (Page 4110)

OnlineTableControl (Page 4037)

### **ColumnUpdateEnabled(i)**

#### **Description**

Specifies whether the selected column pair will be shown statically or dynamically.

Access in Runtime: Read and write

### Syntax

Object.**ColumnUpdateEnabled**(i)[=BOOLEAN]

#### Object

Required A "ScreenItem" object with the format "OnlineTableControl".

#### BOOLEAN

Optional TRUE if the column pair is to be shown statically.

### Comments

The "CurrentColumnIndex" property references the column pair that is currently active.

### See also

OnlineTableControl (Page 4037)

### Command

### Description

Specifies whether there is a forced update of the values displayed in the control.

Access in Runtime: Read and write

### Syntax

Object.**Command**[=String]

#### Object

Required An object of the "ScreenItem" type with the format "OnlineTrendControl" or "OnlineTableControl".

#### String

Optional A value or a constant which specifies whether there is a forced update of the values displayed in the control.

### See also

OnlineTrendControl (Page 4045)

OnlineTableControl (Page 4037)

## Comment

## Description

Reads or sets the Alarm object comment.

## CommonTimeAxisColor

## Description

Specifies the color of the mutual X axis.

Access in Runtime: Read and write

## Syntax

Object.**CommonTimeAxisColor**[=Color]

### Object

Required A "ScreenItem" object with the format "OnlineTrendControl".

### Color

Optional A value or a constant that specifies the color of the common x axis.

## See also

OnlineTrendControl (Page 4045)

## ComputerName

## Description

Returns the name of the computer on which the alarm object was triggered.

ComputerName (readonly)

## ConfigureTimeAxis(i)

## Description

Specifies whether a common time axis is used for all the trends in the trend view.

Access in Runtime: Read and write

## Syntax

Object.**ConfigureTimeAxis(i)**[=BOOLEAN]

**Object**

Required A "ScreenItem" object with the format "OnlineTrendControl".

**BOOLEAN**

Optional TRUE, if a common axis is used for all the trends in the trend view.

**See also**

OnlineTrendControl (Page 4045)

**ConnectionType**

**Description**

Specifies the type of connector. It is possible to select between two connection types.

Access in Runtime: Read and write

**Syntax**

Object.**ConnectionType**[=ConnectorConnectionType]

**Object**

Required An object of the "ScreenItem" type with the format "Connector".

**ConnectorConnectionType**

( 0): Automatic: Both objects are connected by a polyline made up of horizontal and vertical parts.

( 1): Single: Both objects are connected by a straight line between the connecting points. The fields are arranged right-justified.

**See also**

SmartClientView (Page 4085)

Connector (Page 3986)

**ConnectTrendWindows**

**Description**

Specifies whether the configured trend views are connected. The requirement is that you have configured several trend views.

The connected trend views have the following properties:

- A common X axis
- A scrollbar
- A ruler

Access in Runtime: Read

## Syntax

Object.**ConnectTrendWindows**[=Boolean]

### Object

Required An object of the "ScreenItem" type with the format "FunctionTrendControl", "OnlineTrendControl", (Runtime Professional) or "HMITrendView" (Runtime Advanced).

### Boolean

TRUE = All configured trend views are connected.

FALSE = The trend views are displayed separately.

## See also

FunctionTrendControl (Page 4004)

OnlineTrendControl (Page 4045)

## Context

## Description

Reads or sets the alarm object server prefix.

## ContinuousChange

## Description

Specifies whether the value of the "ProcessValue" property will be transferred when the mouse button is released or as soon as the slider position changes in Runtime.

Access in Runtime: Read and write

## Syntax

Object.**ContinuousChange**[=BOOLEAN]

### Object

Required A "ScreenItem" object with the format "Slider".

## **BOOLEAN**

Optional TRUE, if the value of the property "ProcessValue" will be transferred when the mouse button is released or as soon as the slider position changes in Runtime.

### **See also**

Slider (Page 4082)

### **CornerStyle**

### **Description**

Specifies the type of border lines for the specified object.

Access in Runtime: Read-only

### **Syntax**

Object.**ConerStyle**[=Int]

#### **Object**

Required A "ScreenItem" object with the formats "Line", "Polyline", "Ellipse", "Circle", "EllipseSegment", "CircleSegment", "EllipticalArc", "CircularArc", "Rectangle", "Polygon", "TextField", "IOField", "SymbolicIOField", "Button", "Roundbutton", "TubePolyLone", "GraphicIOField", "Bar", "Checkbox", "OptionGroup", "WindowSlider", "Connector", "MultiLineEdit" or "ComboBox".

#### **Int**

Optional A value or a constant that specifies the type of border lines for the specified object.

0 = filled line

1 = broken line

2 = dotted line

3 = dashed and dotted line

4 = dash - dot - dot line



## See also

TubePolyline (Page 4125)  
CheckBox (Page 3974)  
GraphicIOField (Page 4011)  
Bar (Page 3961)  
GraphicView (Page 4014)  
WindowSlider (Page 4139)  
Switch (Page 4089)  
Rectangle (Page 4072)  
MultiLineEdit (Page 4032)  
Line (Page 4025)  
Listbox (Page 4027)  
Circle (Page 3977)  
CircleSegment (Page 3979)  
CircularArc (Page 3982)  
Connector (Page 3986)  
Ellipse (Page 3993)  
EllipseSegment (Page 3995)  
EllipticalArc (Page 3998)  
Polygon (Page 4057)  
Polyline (Page 4060)  
RoundButton (Page 4074)  
SymbolicIOField (Page 4093)  
IOField (Page 4021)  
TextField (Page 4107)  
OptionGroup (Page 4054)

## Count

### Description

Returns the number of elements in the specified list.

Access in Runtime: Read

### Syntax

Object.Count

**Object**

Required A "Collection" object.

**CountDivisions**

**Description**

Specifies the number of segments in which the bar will be divided by the large marking lengths of the scale.

Access in Runtime: Read and write

**Syntax**

Object.**CountDivisions**[=Int]

**Object**

Required A "ScreenItem" object with the format "Bar".

**Int**

Optional A value or a constant that specifies the number of segments in which the bar will be divided by the large marking lengths of the scale.

0-100: An object can be divided into a maximum of 100 segments

= 0: The optimum number of segments will be established automatically.

**See also**

Bar (Page 3961)

**CountSubDivisions**

**Description**

Specifies the number of scale marking lengths between two main marking lengths of the "Bar" object.

Access in Runtime: Read and write

**Syntax**

Object.**CountSubDivisions**[= LONG]

**Object**

Required A "ScreenItem" object with the format "Bar".

## LONG

Optional A value or a constant that specifies the number of scale segments.

### See also

Bar (Page 3961)

## CountValueColumns

### Description

Returns the number of configured trends or column pairs (visible and invisible) of the window.

Access in Runtime: Read and write

### Syntax

Object.**CountValueColumns**[=Int]

#### Object

Required A "ScreenItem" object with the format "OnlineTableControl".

#### Int

Optional A value or a constant that returns the number of configured trends or column pairs (visible and invisible) of the window.

### See also

OnlineTableControl (Page 4037)

## CountVisibleItems

### Description

Specifies how many lines the selection list will contain. If the number of configured texts is greater than this value, then the selection list will have a vertical scroll bar.

Access in Runtime: Read and write

### Syntax

Object.**CountVisibleItems**[=Int]

#### Object

Required An object of the "ScreenItem" type with the format "SymbolicIOField", "StatusForce", "OnlineTrendControl" or "UserArchivControl".

**Int**

Optional A value or a constant that specifies how many lines the selection list will contain.

**See also**

SymbolicIOField (Page 4093)

UserView (Page 4137)

StatusForce (Page 4087)

Listbox (Page 4027)

TrendView (Page 4118)

**CurrentColumnIndex**

**Description**

Specifies which settings can be assigned to a selected column pair. The property is evaluated by other properties. Valid values for the index have values from 0 to -1. The "CountValueColumns" property contains the number of column pairs that are to be shown.

Access in Runtime: Read and write

**Syntax**

Object.**CurrentColumnIndex**[=Int]

**Object**

Required A "ScreenItem" object with the format "OnlineTableControl".

**Int**

Optional A value or a constant that specifies which settings can be assigned to a particular column pair.

**Comments**

The "NumItems" property contains the number of trends / column pairs to be shown.

**See also**

OnlineTableControl (Page 4037)

**CurrentContext**

**Description**

Returns a character string depending on the use of the function.

If the function is contained in a screen in the screen window, CurrentContext returns the symbolic server name which supplies the screen. Example: "WinCCProject\_MyComputer::"

If the function is contained in the main screen, an empty character string is returned.

Access in Runtime: Read

## Syntax

Object.**CurrentContext**

### Object

Required A "HMIRuntime" object.

## See also

HMIRuntime (Page 3922)

## CurrentCurveIndex

### Description

Specifies the index for the active trends.

Access in Runtime: Read and write

### Syntax

Object.**CurrentCurveIndex**[=Int]

### Object

Required An object of the "ScreenItem" type with the format "FunctionTrendControl" or "OnlineTrendControl".

### Int

Optional A value or a constant that specifies the index of the trends that are currently active.

## Comments

The "CurrentCurveIndex" property is evaluated by other properties so that their settings can be assigned to a specific trend. Valid values range from 0 to -1. The "CurvesCount" property contains the number of trends to be shown.

## See also

OnlineTrendControl (Page 4045)

FunctionTrendControl (Page 4004)

## CursorControl

### Description

Specifies whether the mouse cursor jumps to the next field of the TAB order after leaving the field.

Access in Runtime: Read and write

### Syntax

Object.**CursorControl**[=BOOLEAN]

#### Object

Required A "ScreenItem" object with the formats "IOField" or "SymbolicIOField".

#### BOOLEAN

Optional. TRUE, if the mouse cursor jumps to the next field of the TAB-order after leaving the field.

### Comments

For this purpose, the "CursorMode" property must be set to TRUE.

### See also

IOField (Page 4021)

SymbolicIOField (Page 4093)

## CurveColor(i)

### Description

Specifies the color of the selected trend.

Access in Runtime: Read and write

### Syntax

Object.**CurveColor(i)**[=Color]

#### Object

Required An object of the "ScreenItem" type with the format "OnlineTrendControl" or "FunctionTrendControl".

#### Color

Optional A value or a constant that specifies the color of the selected trend.

### Comments

The parameter *i* indicates the number of the trend.

### See also

OnlineTrendControl (Page 4045)

FunctionTrendControl (Page 4004)

### CurveLineWidth(i)

#### Description

Specifies the line weight of the selected trend.

Access in Runtime: Read and write

#### Syntax

Object.**CurveLineWidth(i)**[=Int]

##### Object

Required A "ScreenItem" object with the format "OnlineTrendControl".

##### Int

Optional A value or a constant that specifies the line weight of the selected trend. Value range from 0 to 10.

### Comments

The parameter *i* indicates the number of the trend.

### See also

OnlineTrendControl (Page 4045)

### CurvesCount

#### Description

Returns the number of configured trends or column pairs (visible and invisible) of the window.

Access in Runtime: Read and write

#### Syntax

Object.**CurvesCount**[=Int]

**Object**

Required An object of the "ScreenItem" type with the format "OnlineTrendControl" or "FunctionTrendControl".

**Int**

Optional A value or a constant that returns the number of configured trends or column pairs (visible and invisible) of the window.

**See also**

OnlineTrendControl (Page 4045)

FunctionTrendControl (Page 4004)

**CurveUpdateEnabled(i)**

**Description**

Specifies whether the selected trend will be shown statically or dynamically.

Access in Runtime: Read and write

**Syntax**

Object.**CurveUpdateEnabled(i)**[=BOOLEAN]

**Object**

Required A "ScreenItem" object with the format "OnlineTrendControl".

**BOOLEAN**

Optional TRUE if the trend is to be shown statically.

**Comments**

The parameter i indicates the number of the trend.

**See also**

OnlineTrendControl (Page 4045)



## Properties D

### DangerRangeColor

#### Description

Specifies the color of the danger range of the scale of the "Gauge" object.

The "DangerRangeVisible" property must have the value TRUE so that the danger range is displayed.

Access during runtime: Read and write

#### Syntax

Object.**DangerRangeColor**[= Color]

##### Object

Required An object of the "ScreenItem" type with the characteristic "Gauge".

##### Color

Optional A value or a constant that specifies the color of the danger range.

#### Comments

Use the "RGB" function to establish the colors in RGB format (red, green blue). To do this, enter the appropriate decimal value for each of the three RGB values (range from 0 to 255). For example, the color "red" is shown as: RGB(255, 0, 0). You can also use the VBScript color constants such as vbRed or vbGreen.

#### See also

Gauge (Page 4008)

DangerRangeVisible (Page 4260)

### DangerRangeStart

#### Description

Specifies at which scale value the danger range of the "Gauge" object will start.

The "DangerRangeColor" property must have the value TRUE so that the danger range is displayed.

Access in Runtime: Read and write

## Syntax

Object.**DangerRangeStart**[= DOUBLE]

### Object

Required A "ScreenItem" object with the format "Gauge".

### DOUBLE

Optional A value or a constant that specifies the scale value for the start of the danger range.

## Comments

The range extends from the value "Gefahr" through to the end of the scale.

## See also

Gauge (Page 4008)

DangerRangeVisible (Page 4260)

## DangerRangeVisible

### Description

Specifies whether the danger range in the scale of the "Gauge" object will be displayed.

Access in Runtime: Read and write

### Syntax

Object.**DangerRangeVisible**[= BOOLEAN]

### Object

Required A "ScreenItem" object with the format "Gauge".

### BOOLEAN

Optional TRUE, if the danger range will be displayed in the scale.

## Comments

Specifies the color of the danger range with the "DangerRangeColor" property.

Specifies the start of the danger range with the "DangerRangeStart" property.

## See also

Gauge (Page 4008)

## DataFormat

### Description

Returns the data type of the I/O field object. Read only access.

Value range from 0 to 3.

0: Binary

1: Decimal

2: String

3: Hexadecimal

### See also

IOField (Page 4021)

## DataIndex(i)

### Description

Returns the current index for the data of the current trend.

Access in Runtime: Read and write

### Syntax

Object.**DataIndex(i)**[=Int]

#### Object

Required A "ScreenItem" object with the format "FunctionTrendControl".

#### Int

Optional A value or a constant that specifies the current index of the data for the current trend.

### See also

FunctionTrendControl (Page 4004)

## DataLogs

### Description

Returns an object of type "DataLogs".

Access in Runtime: Read

## Syntax

Object.**DataLogs**

### Object

Required A "Logging" object.

## See also

Logging (Page 3927)

## DataLogTag

## Description

Specifies which tag is linked with the selected trend.

Access in Runtime: Read and write

## Syntax

Object.**DataLogTag**[=HmiLoggingTag]

### Object

Required An object of the "ScreenItem" type with the format "OnlineTrendControl" or "OnlineTableControl".

### HmiLoggingTag

Optional A value or a constant that specifies which tags are linked to the selected trend.

## Comments

The parameter i indicates the number of the trend.

## See also

OnlineTrendControl (Page 4045)

OnlineTableControl (Page 4037)

## DataSet

## Description

Returns an object of type "DataSet".

Access in Runtime: Read

## Syntax

Object.**DataSet**

### Object

Required A "Screen" object.

## See also

HMIRuntime (Page 3922)

Screen (Page 3930)

## DataX(i)

## Description

Inserts one single data record and must be set prior to the call of "InsertData(i)".

Access in Runtime: Read and write

## Syntax

Object.**DataX(i)**[=object]

### Object

Required A "ScreenItem" object with the format "FunctionTrendControl".

### object

Optional A value or a constant that inserts one single data record.

## See also

FunctionTrendControl (Page 4004)

## DataXY(i)

## Description

Inserts several data records as Array with value pairs and must be set before calling "InsertData(i)".

The data in the Array are applied if "DataX(i)" is a VT\_EMPTY type. Otherwise, the single value pair resulting from "DataX(i)" and "DataY(i)" will be used in the attribute "InsertData(i)".

Access in Runtime: Read and write

### Syntax

Object.**DataXY**(i)[=object]

#### Object

Required A "ScreenItem" object with the format "FunctionTrendView".

#### object

Optional A value or a constant which inserts several data records as Array with value pairs.

### See also

FunctionTrendControl (Page 4004)

### DataY(i)

### Description

Inserts one single data record and must be set prior to the call of "InsertData(i)".

Access in Runtime: Read and write

### Syntax

Object.**DataY**(i)[=Double]

#### Object

Required A "ScreenItem" object with the format "FunctionTrendControl".

#### Double

Optional A value or a constant that inserts one single data record.

### See also

FunctionTrendControl (Page 4004)

### DeleteData(i)

### Description

Specifies which data from the data buffer of the active trend will be deleted.

TRUE:

Access in Runtime: Read and write

## Syntax

Object.**DeleteData**(i)[=BOOLEAN]

### Object

Required A "ScreenItem" object with the format "FunctionTrendControl".

### BOOLEAN

Optional TRUE, if all the data of the trend is to be deleted.

FALSE, if the value pair at position "DataIndex(i)" is to be deleted.

## See also

FunctionTrendControl (Page 4004)

## DeleteEnable

### Description

Specifies whether the recipe view can be cleared in Runtime.

Access in Runtime: Read and write

## Syntax

Object.**DeleteEnable**[=BOOLEAN]

### Object

Required An object of the "ScreenItem" type with the format "UserArchiveControl".

### BOOLEAN

Optional TRUE, if the recipe view can be cleared in Runtime.

## DialColor

### Description

Specifies the color of the dial for the selected object.

Access during runtime: Read and Write

## Syntax

Object.**DialColor**[= Color]

### Object

Required An object of the "ScreenItem" type with the characteristics "Clock," or "Gauge".

### Color

Optional A value or a constant that specifies the color of the dial.

### Comments

Use the "RGB" function to establish the colors in RGB format (red, green blue). To do this, enter the appropriate decimal value for each of the three RGB values (range from 0 to 255). For example, the color "red" is shown as: RGB(255, 0, 0). You can also use the VBScript color constants such as vbRed or vbGreen.

### See also

Gauge (Page 4008)

### DialFillStyle

### Description

Specifies the type of background of the selected object.

Access in Runtime: Read and write

### Syntax

Object.**DialFillStyle**[=**GaugeBackStyle**]

#### Object

Required A "ScreenItem" object with the format "Gauge".

#### GaugeBackStyle

hmiGaugeBackStyleSolid ( 0): The rectangular background of the display is filled with the specified border color. The scale is filled with the specified background color.

solid backstyle.

hmiGaugeBackStyleFrameTransparent ( 1): The rectangular background of the Gauge is transparent. The scale is filled with the specified background color. As a result, a circular display can be shown.

Identifies only frame is transparent.

hmiGaugeBackStyleTransparent ( 2): The rectangular background and the scale are transparent.

Identifies a transparent backstyle.

### See also

Gauge (Page 4008)



## DialSize

### Description

Specifies the diameter of the scale in relation to the smaller value of the geometry attributes "Width" and "Height".

Access in Runtime: Read and write

### Syntax

Object.**DialSize**[=Single]

#### Object

Required A "ScreenItem" object with the format "Gauge".

#### Single

Optional A value or a constant that establishes the diameter of the scale in relation to the smaller value of the geometry attributes "Width" and "Height".

### See also

Gauge (Page 4008)

## Direction

### Description

Defines or returns the bar direction or the position of the slider object.

Access in Runtime: Read and write

### Syntax

Object.**Direction** [=BOOLEAN]

#### Object

Required An object of the "ScreenItem" type with the format "Bar" or "Slider".

#### BOOLEAN

0 = top

1 = bottom

2 = left

3 = right

## DisplayName(i)

### Description

Specifies the name for the selected trend.

Access in Runtime: Read and write

### Syntax

Object.**DisplayName**(i)[=String]

#### Object

Required A "ScreenItem" object with the format "FunctionTrendControl".

#### String

Optional A value or a constant that specifies the name for the selected trend.

### Comments

The parameter i indicates the number of the trend.

### See also

FunctionTrendControl (Page 4004)

## DisplayOptions

### Description

Specifies which messages are displayed.

Access in Runtime: Read

### Syntax

Object.**DisplayOptions** [=DisplayOption]

#### Object

Required A "ScreenItem" object with the format "AlarmControl".

#### DisplayOption

0: All messages

1: Only displayed messages

2: Only hidden messages

**See also**

AlarmControl (Page 3947)

**DoubleClickAction****Description**

Specifies the action to be executed in Runtime by double-clicking on a message line.

Access in Runtime: Read

**Syntax**

Object.**DoubleClickAction**[=ClickAction]

**Object**

Required A "ScreenItem" object with the format "AlarmControl".

**ClickAction**

Value	Description	Description
0	none	No action.
1	Loop-in-alarm	Calls the "Loop-in-alarm" function.
2	Open comments dialog	Calls the "Comments dialog" button function.
3	Open Infotext dialog	Calls the "Infotext dialog" button function.
4	Column-dependent	The action is determined by the column in which you double-clicked.

**See also**

AlarmControl (Page 3947)

**DrawAlwaysInsideFrame****Description**

Specifies whether the border line of the selected object should be illustrated with a line weight greater than 1 within the border or symmetrically to the border.

Access in Runtime: Read and write

**Syntax**

Object.**DrawAlwaysInsideFrame**[=BOOLEAN]

**Object**

Required A "ScreenItem" object with the format "Rectangle".

**BOOLEAN**

Option TRUE, if the border line of the specified object will be illustrated with a line weight greater than 1 within the border.

**See also**

Rectangle (Page 4072)

**DrawEnhancedHTMLBrowser**

**Description**

Specifies the style of the HTML-Browsers.

Access in Runtime: Read and write

**Syntax**

Object.**DrawEnhancedHTMLBrowser**[=BOOLEAN]

**Object**

Required A "ScreenItem" object with the format "HTMLBrowser".

**BOOLEAN**

Optional TRUE, if an extended HTML-Browser will be displayed.

**See also**

HTMLBrowser (Page 4019)

**DrawInsideFrame**

**Description**

Specifies whether the border line of the selected object should be illustrated with a line weight greater than 1 within the border or symmetrically to the border.

Access in Runtime: Read and write

**Syntax**

Object.**DrawInsideFrame**[=BOOLEAN]

### **Object**

Required A "ScreenItem" object with the formats "Line", "Polyline", "Ellipse", "Circle", "EllipseSegment", "CircleSegment", "EllipticalArc", "CircularArc", "Rectangle", "Polygon", "TextField", "IOField", "SymbolicIOField", "Button", "GraphicView", "GraphicIOField", "Bar", "CheckBox", "OptionGroup", "WindowSlider" or "Connector".

### **BOOLEAN**

Optional TRUE, if the border line of the specified object will be illustrated with a line weight greater than 1 within the border.

### **See also**

Line (Page 4025)  
Polyline (Page 4060)  
Ellipse (Page 3993)  
Circle (Page 3977)  
EllipseSegment (Page 3995)  
CircleSegment (Page 3979)  
EllipticalArc (Page 3998)  
CircularArc (Page 3982)  
Rectangle (Page 4072)  
Polygon (Page 4057)  
TextField (Page 4107)  
IOField (Page 4021)  
SymbolicIOField (Page 4093)  
Button (Page 3968)  
GraphicView (Page 4014)  
GraphicIOField (Page 4011)  
Bar (Page 3961)  
CheckBox (Page 3974)  
OptionGroup (Page 4054)  
WindowSlider (Page 4139)  
Connector (Page 3986)  
RoundButton (Page 4074)

## DrawStylishButton

### Description

Specifies whether the button will be displayed in the general Windows style.

Access in Runtime: Read and write

### Syntax

Object.**DrawStylishButton**[=BOOLEAN]

#### Object

Required A "ScreenItem" object with the format "Button".

#### BOOLEAN

Optional TRUE, if the button will be displayed in the general Windows style.

### See also

Button (Page 3968)

## Drive

### Description

Specifies the characters of the drive that is to be monitored.

Access in Runtime: Read and write

### Syntax

Object.**Drive**[=String]

#### Object

Required A "ScreenItem" object with the format "DiskSpaceView".

#### String

Optional A value or a constant that specifies the characters of the drive that is to be monitored.

### See also

DiskSpaceView (Page 3991)

## Properties E-F

### EdgeStyle

#### Description

Determines the line style of the given object.

Access during runtime: Read and Write

#### Syntax

Object.EdgeStyle [= THmiLineStyle]

##### Object

Required. An object of the type "ScreenItem" with the characteristic "Ellipse", "Circle", "Rectangle", "Polygon", "TextField" or "IOField".

##### THmiLineStyle

Optional. A value or constant that defines the line style. Value range from -1 to 4.

The objects "Ellipse", "Circle", "Rectangle" and "Polygon" support the line style:

- hmiLineStyleSolid (0): solid line
- hmiLineStyleDash (1): dashed line
- hmiLineStyleDot (2): dotted line
- hmiLineStyleDashDot (3): dash dot line
- hmiLineStyleDashDotDot (4): dash dot dot line

The objects "TextField" and "IOField" support only the line style:

- hmiLineStyleNone (-1): no line
- hmiLineStyleSolid (0): solid line

Default setting: hmiLineStyleSolid

#### See also

GraphicIOField (Page 4011)

Switch (Page 4089)

CircleSegment (Page 3979)

DateTimeField (Page 3989)

Ellipse (Page 3993)

## EdgeStyle

### Description

Specifies the line style of the selected object.

Access in Runtime: Read and write

### Syntax

Object.**EdgeStyle**[= THmiLineStyle]

#### Object

Required An object of the "ScreenItem" type with the format "Ellipse", "Circle", "EllipseSegment", "CircleSegment", "Rectangle", "Polygon", "TextField", "IOField", "SymbolicIOField", "DateTimeField", "Button", "Roundbutton", "Switch", "GraphicView", "GraphicIOField", "Bar", "Checkbox", "OptionGroup" or "WindowSlider".

#### THmiLineStyle

Optional A value or a constant that specifies the line style. Value range from -1 to 4.

The objects "Ellipse", "Circle", "Rectangle" and "Polygon" support the line styles:

- hmiLineStyleSolid (0): solid line
- hmiLineStyleDash (1): broken line
- hmiLineStyleDot (2): dotted line
- hmiLineStyleDashDot (3): dash - dot line
- hmiLineStyleDashDotDot (4): dash - dot - dot line

The objects "TextField" and "IOField" support only the line styles:

- hmiLineStyleNone (-1): no line
- hmiLineStyleSolid (0): solid line

Default setting: hmiLineStyleSolid



## See also

Ellipse (Page 3993)  
Circle (Page 3977)  
EllipseSegment (Page 3995)  
CircleSegment (Page 3979)  
Rectangle (Page 4072)  
Polygon (Page 4057)  
TextField (Page 4107)  
IOField (Page 4021)  
SymbolicIOField (Page 4093)  
Button (Page 3968)  
RoundButton (Page 4074)  
Switch (Page 4089)  
GraphicView (Page 4014)  
GraphicIOField (Page 4011)  
Bar (Page 3961)  
CheckBox (Page 3974)  
OptionGroup (Page 4054)  
WindowSlider (Page 4139)  
MultiLineEdit (Page 4032)  
Listbox (Page 4027)  
ProjectName (Page 4062)

## Editable(i)

### Description

Specifies whether a column pair can be edited. The parameter *i* indicates the number of the column pair.

Access in Runtime: Read and write

### Syntax

Object.**Editable**(i)[=BOOLEAN]

#### Object

Required A "ScreenItem" object with the format "OnlineTableControl".

### **BOOLEAN**

Optional TRUE, if the column pair can be edited. The column pair is referenced by the parameter i.

#### **See also**

OnlineTableControl (Page 4037)

#### **EditAtOnce**

#### **Description**

TRUE, if accessing the field with the <TAB> key permits input immediately and without further action. BOOLEAN write-read access.

#### **EditEnabled**

#### **Description**

Specifies whether edit mode is enabled for a cell, if the property "Editable(i)" has the value TRUE.

Access in Runtime: Read and write

#### **Syntax**

Object.**EditEnabled**[=BOOLEAN]

#### **Object**

Required A "ScreenItem" object with the format "OnlineTableControl".

#### **BOOLEAN**

Optional TRUE, if the edit mode is enabled for a cell if the property "Editable(i)" has the value TRUE.

#### **See also**

OnlineTableControl (Page 4037)

#### **EditOnFocus**

#### **Description**

Specifies whether the data input is immediately possible if the input field is selected using the <Tab> key.

Access in Runtime: Read and write

## Syntax

Object.**EditOnFocus**[=BOOLEAN]

### Object

Required A "ScreenItem" object with the formats "IOField" or "SymbolicIOField".

### BOOLEAN

Optional TRUE, if the data input is immediately possible and the input field has been selected using the <Tab> key.

## See also

IOField (Page 4021)

SymbolicIOField (Page 4093)

## Enabled

## Description

Specifies whether the selected object can be operated in Runtime.

Access in Runtime: Read and write

## Syntax

Object.**Enabled**[= BOOLEAN]

### Object

Required An object of the "ScreenItem" type with the format "Line", "Polyline", "Ellipse", "Circle", "EllipseSegment", "CircleSegment", "EllipticalArc", "CircularArc", "Rectangle", "Polygon", "TextField", "IOField", "SymbolicIOField", "DateTimeField", "Button", "Roundbutton", "Switch", "GraphicView", "GraphicIOField", "Bar", "StatusForce", "Clock", "Gauge", "Slider", "SymbolLibrary", "OnlineTableControl", "OnlineTrendControl", "FunctionTrendControl", "UserView", "HTMLBrowser", "Checkbox", "OptionGroup", "WindowSlider", "OleView", "Connector", "DiskSpaceView", "ChannelDiagnose" or "UserArchiveControl".

### BOOLEAN

Optional TRUE, if the specified object can be operated in Runtime.

## See also

Line (Page 4025)  
Polyline (Page 4060)  
Ellipse (Page 3993)  
Circle (Page 3977)  
EllipseSegment (Page 3995)  
CircleSegment (Page 3979)  
EllipticalArc (Page 3998)  
CircularArc (Page 3982)  
Rectangle (Page 4072)  
Polygon (Page 4057)  
TextField (Page 4107)  
IOField (Page 4021)  
SymbolicIOField (Page 4093)  
Button (Page 3968)  
Switch (Page 4089)  
GraphicView (Page 4014)  
GraphicIOField (Page 4011)  
Bar (Page 3961)  
Clock (Page 3984)  
Gauge (Page 4008)  
Slider (Page 4082)  
SymbolLibrary (Page 4098)  
OnlineTrendControl (Page 4045)  
FunctionTrendControl (Page 4004)  
OnlineTableControl (Page 4037)  
AlarmControl (Page 3947)  
HTMLBrowser (Page 4019)  
CheckBox (Page 3974)  
OptionGroup (Page 4054)  
WindowSlider (Page 4139)  
Connector (Page 3986)  
DiskSpaceView (Page 3991)  
ChannelDiagnose (Page 3972)  
Group (Page 4017)  
TubeTeeObject (Page 4128)  
TubePolyline (Page 4125)  
TubeDoubleTeeObject (Page 4123)  
TubeArcObject (Page 4121)  
MultiLineEdit (Page 4032)  
MediaPlayer (Page 4030)

## Enabled

### Description

Determines whether the given object can be operated in runtime.

Access during runtime: Read and Write

### Syntax

Object.Enabled [= BOOLEAN]

#### Object

Required. An object of the type "ScreenItem" with the characteristic "IOField", "SymbolicIOField", "Button", "Switch", "GraphicIOField", "Bar", "RecipeView", "StatusForce", "Slider", "SymbolLibrary", "TrendView", "MessageView", "UserView" or "BrowserView".

#### BOOLEAN

Optional. TRUE, if the given object can be operated.

### See also

AlarmView (Page 3958)  
RecipeView (Page 4068)  
TrendView (Page 4118)  
SmartClientView (Page 4085)  
StatusForce (Page 4087)  
BatteryView (Page 3967)  
RangeLabelView (Page 4065)  
RangeQualityView (Page 4067)  
WLANQualityView (Page 4142)  
ZoneLabelView (Page 4143)  
ZoneQualityView (Page 4144)  
SystemDiagnoseWindow (Page 4103)  
SystemDiagnoseView (Page 4100)  
UserView (Page 4137)  
DateTimeField (Page 3989)

## EnableEdit

### Description

Enables editing of the data displayed during runtime.

Access in Runtime: Read and write

### Syntax

Object.**EnableEdit**[=BOOLEAN]

#### Object

Required An object of the "ScreenItem" type with the format "OnlineTableControl", "UserArchiveControl".

#### BOOLEAN

TRUE: The data can be changed in Runtime.

FALSE: The data cannot be changed.

### See also

UserArchiveControl (Page 4130)

OnlineTableControl (Page 4037)

## EndAngle

### Description

Specifies the angle at which the end point of the selected object deviates from the zero position (0°).

Access in Runtime: Read and write

### Syntax

Object.**EndAngle**[=Int]

#### Object

Required A "ScreenItem" object with the formats "EllipseSegment", "CircleSegment", "EllipticalArc" or "CircularArc".

#### Int

Optional A value or a constant that specifies the angle at which the end point of the selected object deviates from the zero position (0°).

## See also

EllipseSegment (Page 3995)

CircleSegment (Page 3979)

EllipticalArc (Page 3998)

CircularArc (Page 3982)

TubeArcObject (Page 4121)

## EndPoint

### Description

Specifies the position of the end point.

Access in Runtime:

### Syntax

Object.**EndPoint**[=Point]

#### Object

Required A "ScreenItem" object with the formats "EllipseSegment", "CircleSegment", "EllipticalArc" or "CircularArc".

#### Point

Optional A value that specifies the position of the end point.

## See also

EllipseSegment (Page 3995)

CircleSegment (Page 3979)

EllipticalArc (Page 3998)

CircularArc (Page 3982)

## EndPointLeft

### Description

Specifies the horizontal distance in pixels of the end point from the left edge of the screen.

Access in Runtime: Read and write

### Syntax

Object.**EndPointLeft**[=Int]

**Object**

Required A "ScreenItem" object with the formats "EllipseSegment", "CircleSegment", "EllipticalArc" or "CircularArc".

**Int**

Optional A value that specifies the horizontal distance in pixels of the end point from the left edge of the screen.

**See also**

EllipseSegment (Page 3995)

CircleSegment (Page 3979)

EllipticalArc (Page 3998)

CircularArc (Page 3982)

**EndPointTop**

**Description**

Specifies the vertical distance in pixels of the end point from the upper edge of the screen.

Access in Runtime: Read and write

**Syntax**

Object.**EndPointTop**[=Int]

**Object**

Required A "ScreenItem" object with the formats "EllipseSegment", "CircleSegment", "EllipticalArc" or "CircularArc".

**Int**

Optional A value that specifies the vertical distance in pixels of the end point from the upper edge of the screen.

**See also**

EllipseSegment (Page 3995)

CircleSegment (Page 3979)

EllipticalArc (Page 3998)

CircularArc (Page 3982)



## EndStyle

### Description

Specifies how the line-end shapes of the selected object will be displayed.

Access in Runtime: Read and write

### Syntax

Object.**EndStyle**[= THmiLineEndStyle]

#### Object

Required A "ScreenItem" object with the formats "Line", "Polyline" or "Connector".

#### THmiLineEndStyle

Optional A value or a constant that specifies the line-end shapes.

hmiLineEndStyleNone (0): The line has no end symbol.

hmiLineEndStyleFilledArrow (2): The line ends with a filled arrowhead.

### See also

Line (Page 4025)

Polyline (Page 4060)

Connector (Page 3986)

## EndStyle

### Description

Determines how the line end of the given object is displayed.

Access during runtime: Read and Write

### Syntax

Object.**EndStyle** [= THmiLineEndStyle]

#### Object

Required. An object of the "ScreenItem" type with the characteristic "Line," or "Polyline".

#### THmiLineEndStyle

Optional. A value or constant which determines the line end.

hmiLineEndStyleNone (0): The line has no end symbol.

hmiLineEndStyleFilledArrow (2): The line ends with a filled arrow.

## EndTime(i)

### Description

Specifies the end time of the time range to be shown in the trend view. The property "TagProviderType(i)" must have the value -1.

Access in Runtime: Read and write

### Syntax

Object.EndTime(i)[=Time]

#### Object

Required An object of the "ScreenItem" type with the format "FunctionTrendControl" or "OnlineTableControl".

#### Time

Optional A value or a constant that specifies the end time of the time range that is to be shown in the trend window.

### Comments

The parameter i indicates the number of the trend.

If "EndTime(i)" is changed, illegal combinations with different attributes for the data connection could arise. This means you have to prevent an immediate acceptance of the change with "FreezeProviderConnections" before changing "EndTime(i)".

### See also

FunctionTrendControl (Page 4004)

OnlineTableControl (Page 4037)

### ErrorDescription

#### Description

Returns one of the following error descriptions in English:

Output	Description
" "	OK
"Operation Failed"	Execution error
"Variable not found"	Tag error
"Server down"	Server not available.
"An error occurred for one or several tags"	Multi Tag Error (Error in one or several tags)

To obtain an error description, first of all carry out the Read method.

---

**Note**

If the error occurs when accessing via the TagSet object, evaluate the ErrorDescription property for each tag of the TagSet object.

---

Access in Runtime: Read

**Syntax**

Object.**ErrorDescription**

**Object**

Required A "Tag" object.

**Example**

The following example shows the error description for the "Tag1" tag:

```
'VBS72
Dim objTag
Set objTag = HMIRuntime.Tags("Tag1")
objtag.Read
MsgBox objTag.ErrorDescription
```

The following example adds two tags to the TagSet list and outputs the ErrorDescription property as Trace:

```
'VBS179
Dim group
Set group = HMIRuntime.Tags.CreateTagSet
group.Add "Motor1"
group.Add "Motor2"
HMIRuntime.Trace "ErrorDescription: " & group.ErrorDescription & vbNewLine
```

The ErrorDescription property of a tag contained in the list may be accessed as follows:

```
HMIRuntime.Trace "ErrorDescription: " & group("Motor1").ErrorDescription & vbNewLine
```

**See also**

[Tag \(Page 3941\)](#)

[TagSet \(list\) \(Page 3945\)](#)

## Exponent

### Description

TRUE, when the display of numbers should be with exponents (e.g. "1.00e+000"). BOOLEAN write-read access.

## ExportDirectoryChangeable

### Description

Enables changing of the directory for data export in Runtime.

### Syntax

Object.**ExportDirectoryChangeable**=[Boolean]

#### Object

Required An object of the "ScreenItem" type with the format "AlarmControl", "TrendRulerControl", "OnlineTableControl", "UserArchivControl", "FunctionTrendControl", "OnlineTrendControl" (Runtime Professional) or "HMITrendView" (Runtime Advanced).

#### Boolean

TRUE, the directory for the data export can be changed in Runtime.

FALSE, the directory for the data export cannot be changed in Runtime.

### See also

[AlarmControl](#) (Page 3947)

[UserArchiveControl](#) (Page 4130)

[TrendRulerControl](#) (Page 4110)

[FunctionTrendControl](#) (Page 4004)

[OnlineTableControl](#) (Page 4037)

[OnlineTrendControl](#) (Page 4045)

## ExportDirectoryname

### Description

Defines the directory to which the exported Runtime data is written.

Access in Runtime: Read and write

## Syntax

Object.**ExportDirectoryname**[=String]

### Object

Required An object of the "ScreenItem" type with the format "AlarmControl", "TrendRulerControl", "OnlineTableControl", "UserArchivControl", "FunctionTrendControl", "OnlineTrendControl" (Runtime Professional) or "HMITrendView" (Runtime Advanced).

### String

Optional A value or a constant which specifies the directory.

## See also

AlarmControl (Page 3947)

UserArchiveControl (Page 4130)

TrendRulerControl (Page 4110)

FunctionTrendControl (Page 4004)

OnlineTableControl (Page 4037)

OnlineTrendControl (Page 4045)

## ExportFileExtension

### Description

Specifies the file extension of the export file. Only the file extension "csv" is supported.

### Syntax

Object.**ExportFileExtension**

### Object

Required An object of the "ScreenItem" type with the format "AlarmControl", "TrendRulerControl", "OnlineTableControl", "UserArchivControl", "FunctionTrendControl", "OnlineTrendControl" (Runtime Professional) or "HMITrendView" (Runtime Advanced).

## See also

AlarmControl (Page 3947)

UserArchiveControl (Page 4130)

TrendRulerControl (Page 4110)

FunctionTrendControl (Page 4004)

OnlineTableControl (Page 4037)

OnlineTrendControl (Page 4045)

## ExportFilename

### Description

Defines the name of the file which is to receive the exported Runtime data.

### Syntax

Object.**ExportFilename**

#### Object

Required An object of the "ScreenItem" type with the format "AlarmControl", "TrendRulerControl", "OnlineTableControl", "UserArchivControl", "FunctionTrendControl", "OnlineTrendControl" (Runtime Professional) or "HMITrendView" (Runtime Advanced).

### See also

AlarmControl (Page 3947)

UserArchiveControl (Page 4130)

TrendRulerControl (Page 4110)

FunctionTrendControl (Page 4004)

OnlineTableControl (Page 4037)

OnlineTrendControl (Page 4045)

## ExportFilenameChangeable

### Description

Enables renaming of the export file in Runtime.

### Syntax

Object.**ExportFilenameChangeable**=[Boolean]

#### Object

Required An object of the "ScreenItem" type with the format "AlarmControl", "TrendRulerControl", "OnlineTableControl", "UserArchivControl", "FunctionTrendControl", "OnlineTrendControl" (Runtime Professional) or "HMITrendView" (Runtime Advanced).

#### Boolean

TRUE, , the file name of the export file can be changed in Runtime.

FALSE, , the file name of the export file cannot be changed in Runtime.

## See also

AlarmControl (Page 3947)

UserArchiveControl (Page 4130)

TrendRulerControl (Page 4110)

FunctionTrendControl (Page 4004)

OnlineTableControl (Page 4037)

OnlineTrendControl (Page 4045)

## ExportFormatGuid

### Description

Default assignment of the ID number and export provider.

### Syntax

Object.**ExportFormatGuid**

#### Object

Required An object of the "ScreenItem" type with the format "AlarmControl", "TrendRulerControl", "OnlineTableControl", "UserArchivControl", "FunctionTrendControl", "OnlineTrendControl" (Runtime Professional) or "HMITrendView" (Runtime Advanced).

## See also

AlarmControl (Page 3947)

UserArchiveControl (Page 4130)

TrendRulerControl (Page 4110)

FunctionTrendControl (Page 4004)

OnlineTableControl (Page 4037)

OnlineTrendControl (Page 4045)

## ExportFormatName

### Description

Defines the export file format. Only the "csv" file format is currently available for the export.

## See also

AlarmControl (Page 3947)  
UserArchiveControl (Page 4130)  
TrendRulerControl (Page 4110)  
FunctionTrendControl (Page 4004)  
OnlineTableControl (Page 4037)  
OnlineTrendControl (Page 4045)

## ExportParameters

### Description

Specifies the parameters of the selected format by means of the properties dialog.

Access in Runtime: Read and write

### Syntax

Object.**ExportParameters**

#### Object

Required An object of the "ScreenItem" type with the format "AlarmControl", "TrendRulerControl", "OnlineTableControl", "UserArchivControl", "FunctionTrendControl", "OnlineTrendControl" (Runtime Professional) or "HMITrendView" (Runtime Advanced).

## See also

AlarmControl (Page 3947)  
UserArchiveControl (Page 4130)  
TrendRulerControl (Page 4110)  
FunctionTrendControl (Page 4004)  
OnlineTableControl (Page 4037)  
OnlineTrendControl (Page 4045)

## ExportSelection

### Description

Specifies which runtime data of the control is exported.



## Syntax

Object.**ExportSelection**=[Boolean]

### Object

Required An object of the "ScreenItem" type with the format "AlarmControl", "TrendRulerControl", "OnlineTableControl", "UserArchivControl", "FunctionTrendControl", "OnlineTrendControl" (Runtime Professional) or "HMITrendView" (Runtime Advanced).

### Boolean

Value	Description	Explanation
0	all	All Runtime data of the control is exported.
1	Selection	Selected Runtime data of the control is exported.

## See also

AlarmControl (Page 3947)

UserArchiveControl (Page 4130)

TrendRulerControl (Page 4110)

FunctionTrendControl (Page 4004)

OnlineTableControl (Page 4037)

OnlineTrendControl (Page 4045)

## ExportShowDialog

### Description

Enables the display of the export dialog during runtime.

Access in Runtime: Read and write

### Syntax

Object.**ExportShowDialog** [=BOOLEAN]

### Object

Required An object of the "ScreenItem" type with the format "AlarmControl", "TrendRulerControl", "OnlineTableControl", "UserArchivControl", "FunctionTrendControl", "OnlineTrendControl" (Runtime Professional) or "HMITrendView" (Runtime Advanced).

### BOOLEAN

Optional TRUE, if the dialog box is shown in Runtime.

## See also

AlarmControl (Page 3947)  
UserArchiveControl (Page 4130)  
TrendRulerControl (Page 4110)  
FunctionTrendControl (Page 4004)  
OnlineTableControl (Page 4037)  
OnlineTrendControl (Page 4045)

## ExportXML

### ExportXML

Only used internally.

The attribute can be assigned dynamic properties by means of the name **ExportXML**.

## ExtendedOperation

### Description

TRUE, when the slider regulator is set at the respective end value (minimum/maximum value). This is done by clicking the mouse in an area outside the current regulator setting. BOOLEAN write-read access.

## ExtendedZoomingEnable

### Description

Specifies whether the operator can zoom the screen in or out in runtime by turning the mouse wheel.

Access during runtime: Read and write

### Syntax

Object.**ExtendedZoomingEnable**[=BOOLEAN]

#### Object

Necessary. A "Screen" object.

#### BOOLEAN

Optional TRUE, if the operator can zoom the screen in and out in runtime.

## Example

The following example shows how the extended zoom can be enabled for the NewPDL1 screen:

```
'VBS155  
Dim objScreen  
Set objScreen = HMIRuntime.Screens("NewPDL1")  
objScreen.ExtendedZoomingEnable = 1
```

## See also

Screen (Page 3930)

## ExtraSpaceForLabelDisplay

### Description

Specifies the extra space required for the label.

Access in Runtime: Read and write

### Syntax

Object.**ExtraSpaceForLabelDisplay**[=Int]

#### Object

Required A "ScreenItem" object with the format "Bar".

#### Int

Optional A value that specifies the extra space required for the label.

## See also

Bar (Page 3961)

## FieldLengthReadOnlySpecial

### Description

Specifies that the "field length string" field is read-only.

Access during runtime: Read and write

### Syntax

Object.**FieldLengthReadOnlySpecial**[=BOOLEAN]

**Object**

Necessary. A "ScreenItem" object with the format "IOField".

**BOOLEAN**

Optional TRUE, if the "field length string" can only be read.

**Used for the following object types:**

IOField

**See also**

IOField (Page 4021)

**FillColor**

**Description**

Defines or returns the fill pattern color for the object.

Access during runtime: Read and write

**Syntax**

Object.FillColor[=LONG]

**Object**

Necessary. An object of the "ScreenItem" type with the format "Line", "Polyline", "Ellipse", "Circle", "EllipseSegment", "CircleSegment", "EllipticalArc", "CircularArc", "Rectangle", "Polygon", "TextField", "IOField", "SymbolicIOField", "DateTimeField", "Button", "Roundbutton", "Switch", "Bar", "StatusForce", "Clock", "Gauge", "Slider", "Checkbox".

**Determination of Color Value**

The color is displayed in RGB format (Red, Green, Blue). Enter the appropriate decimal value for each of the three RGB values.

Example:

RGB(200, 150, 100)

**Example**

The following example defines the fill color for "ScreenWindow1" to blue:

```
'VBS73
Dim objScreen
Set objScreen = HMIRuntime.Screens("ScreenWindow1")
```

```
objScreen.FillStyle = 131075  
objScreen.FillColor = RGB(0, 0, 255)
```

## FillColorMode

### Description

Specifies the type of foreground for the selected object.

Access in Runtime: Read and write

### Syntax

Object.FillColorMode[=SymbolLibAppearance]

#### Object

Required A "ScreenItem" object with the format "SymbolLibrary".

#### SymbolLibAppearance

hmiSymbolLibraryAppearanceOriginal ( 0): The surface is gray.

hmiSymbolLibraryAppearanceShaded ( 1): The display is shaded.

hmiSymbolLibraryAppearanceSolid ( 2): The display is solid.

hmiSymbolLibraryAppearanceTransparent ( 3): The display is gray.

### See also

SymbolLibrary (Page 4098)

## Filling

### Description

TRUE, when the object can be filled by closed border lines (e.g. representing the fill level of a tank). BOOLEAN write-read access.

The fill level of the object is set by means of the "FillingIndex" property.

## FillingIndex

### Description

Defines the %age value (related to the height of the object) to which the object with closed border line is to be filled.

The fill level is represented by the current background color. The unfilled background is transparent.

## FillPatternColor

### Description

Specifies the color of the fill pattern for the selected object.

Access in Runtime: Read and write

### Syntax

Object.FillPatternColor[=Color]

#### Object

Required An object of the "ScreenItem" type with the format "Ellipse", "Circle", "EllipseSegment", "CircleSegment", "Rectangle", "Polygon", "TextField", "IOField", "SymbolicIOField", "Button", "Roundbutton", "GraphicView", "Bar", "Checkbox", "OptionGroup" or "WindowSlider".

#### Color

Optional A value or a constant that establishes the color of the fill pattern for the specified object.

### See also

Ellipse (Page 3993)  
Circle (Page 3977)  
EllipseSegment (Page 3995)  
CircleSegment (Page 3979)  
Rectangle (Page 4072)  
Polygon (Page 4057)  
TextField (Page 4107)  
IOField (Page 4021)  
SymbolicIOField (Page 4093)  
Button (Page 3968)  
GraphicView (Page 4014)  
Bar (Page 3961)  
CheckBox (Page 3974)  
OptionGroup (Page 4054)  
WindowSlider (Page 4139)  
Listbox (Page 4027)  
ProjectName (Page 4062)

## FillStyle

### Description

Specifies the fill style of the selected object.

Access in Runtime: Read and write

### Syntax

Object.**FillStyle**[= THmiLineFillStyle]

#### Object

Required A "ScreenItem" object with the formats "Line", "Polyline", "EllipticalArc" or "CircularArc".

#### THmiLineFillStyle

Optional A value or a constant that specifies the fill style.

hmiLineFillStyleTransparent (0): transparent fill

hmiLineFillStyleSolid (1): object is filled with the specified color

Default setting: hmiLineFillStyleSolid

### See also

Line (Page 4025)

Polyline (Page 4060)

EllipticalArc (Page 3998)

CircularArc (Page 3982)

## FillStyle

### Description

Determines the fill style of the specified object.

Access during runtime: Read and Write

### Syntax

Object.**FillStyle** [= THmiLineFillStyle]

#### Object

Required. An object of the "ScreenItem" type with the characteristic "Line," or "Polyline".

### **THmiLineFillStyle**

Optional. A value or constant which determines the fill style.

hmiLineFillStyleTransparent (0): Transparent fill

hmiLineFillStyleSolid (1): Object is filled with the specified color

Default setting: hmiLineFillStyleSolid

### **FillStyle2**

#### **Description**

Defines or returns the fill style of the bar.

### **FillstyleAlignment**

#### **Description**

Specifies the alignment within the specified object.

### **Filter**

#### **Description**

Specifies criteria in SQL syntax for the database.

Access in Runtime: Read and write

#### **Syntax**

Object.**Filter**[=String]

#### **Object**

Required A "ScreenItem" object with the format "PrintMessage".

#### **String**

Optional A value or a constant which specifies the criteria in SQL syntax for the database.

### **FirstConnectedObjectIndex**

#### **Description**

Specifies the index number of the upper connector point.

Access in Runtime: Read and write



## Syntax

Object.**FirstConnectedObjectIndex**[=Int]

Object

Required A "ScreenItem" object with the format "Connector".

**Int**

Int

## See also

Connector (Page 3986)

## FirstConnectedObjectName

### Description

Specifies the object name of the object that is docked at the upper connector point.

Access in Runtime: Read and write

## Syntax

Object.**FirstConnectedObjectName**[=String]

Object

Required A "ScreenItem" object with the format "Connector".

**String**

String

## See also

Connector (Page 3986)

## FixedAspectRatio

### Description

Specifies whether the aspect ratio should be maintained or changed when the symbol size is altered.

Access in Runtime: Read and write

## Syntax

Object.**FixedAspectRatio**[=BOOLEAN]

**Object**

Required A "ScreenItem" object with the format "SymbolLibrary".

**BOOLEAN**

Optional TRUE, if the aspect ratio should be maintained when the symbol size is altered.

**See also**

SymbolLibrary (Page 4098)

**FlashBackColor**

**Description**

TRUE, when flashing of the background is activated. BOOLEAN write-read access

**FlashBorderColor**

**Description**

TRUE, when flashing of the object lines is activated. BOOLEAN write-read access.

**FlashFlashPicture**

**Description**

TRUE, when flashing of the flash picture is activated. BOOLEAN write-read access.

**FlashForeColor**

**Description**

TRUE, when flashing of the text is activated. BOOLEAN write-read access.

**FlashingColorOff**

**Description**

Specifies the color of the border line for the selected object for the flashing status "off".

Access in Runtime: Read and write

## Syntax

Object.**FlashingColorOff**[=Color]

### Object

Required A "ScreenItem" object with the formats "Line", "Polyline", "Ellipse", "Circle", "EllipseSegment", "CircleSegment", "EllipticalArc", "CircularArc", "Rectangle", "Polygon", "TextField", "IOField", "SymbolicIOField", "Button", "Switch", "GraphicIOField", "Bar", "Checkbox", "OptionGroup" or "Connector".

### Color

Optional A value or a constant that specifies the color of the border line of the selected object for the flashing status "off".

## See also

Line (Page 4025)  
Polyline (Page 4060)  
Ellipse (Page 3993)  
Circle (Page 3977)  
EllipseSegment (Page 3995)  
CircleSegment (Page 3979)  
EllipticalArc (Page 3998)  
CircularArc (Page 3982)  
Rectangle (Page 4072)  
Polygon (Page 4057)  
TextField (Page 4107)  
IOField (Page 4021)  
SymbolicIOField (Page 4093)  
Button (Page 3968)  
Switch (Page 4089)  
GraphicIOField (Page 4011)  
Bar (Page 3961)  
CheckBox (Page 3974)  
OptionGroup (Page 4054)  
Connector (Page 3986)  
RoundButton (Page 4074)

## FlashingColorOn

### Description

Specifies the color of the border line for the selected object for the flashing status "on".

Access in Runtime: Read and write

### Syntax

Object.**FlashingColorOn**[=Color]

#### Object

Required A "ScreenItem" object with the formats "Line", "Polyline", "Ellipse", "Circle", "EllipseSegment", "CircleSegment", "EllipticalArc", "CircularArc", "Rectangle", "Polygon", "TextField", "IOField", "SymbolicIOField", "Button", "Switch", "GraphicIOField", "Bar", "Checkbox", "OptionGroup" or "Connector".

#### Color

Optional A value or a constant that specifies the color of the border line of the selected object for the flashing status "on".

## See also

Line (Page 4025)  
Polyline (Page 4060)  
Ellipse (Page 3993)  
Circle (Page 3977)  
EllipseSegment (Page 3995)  
CircleSegment (Page 3979)  
EllipticalArc (Page 3998)  
CircularArc (Page 3982)  
Rectangle (Page 4072)  
Polygon (Page 4057)  
TextField (Page 4107)  
IOField (Page 4021)  
SymbolicIOField (Page 4093)  
Button (Page 3968)  
Switch (Page 4089)  
GraphicIOField (Page 4011)  
Bar (Page 3961)  
CheckBox (Page 3974)  
OptionGroup (Page 4054)  
Connector (Page 3986)  
RoundButton (Page 4074)

## FlashingEnable

### Description

Specifies whether the border line of the selected object will flash in runtime.

Access in Runtime: Read and write

### Syntax

Object.**FlashingEnable**[=BOOLEAN]

#### Object

Required A "ScreenItem" object with the formats "Line", "Polyline", "Ellipse", "Circle", "EllipseSegment", "CircleSegment", "EllipticalArc", "CircularArc", "Rectangle", "Polygon", "TextField", "IOField", "SymbolicIOField", "Button", "Switch", "GraphicIOField", "Bar", "Checkbox", "OptionGroup" or "Connector".

## **BOOLEAN**

Optional TRUE, if the border line of the object is flashing.

### **See also**

Line (Page 4025)  
Polyline (Page 4060)  
Ellipse (Page 3993)  
Circle (Page 3977)  
EllipseSegment (Page 3995)  
CircleSegment (Page 3979)  
EllipticalArc (Page 3998)  
CircularArc (Page 3982)  
Rectangle (Page 4072)  
Polygon (Page 4057)  
TextField (Page 4107)  
IOField (Page 4021)  
SymbolicIOField (Page 4093)  
Button (Page 3968)  
Switch (Page 4089)  
GraphicIOField (Page 4011)  
Bar (Page 3961)  
CheckBox (Page 3974)  
OptionGroup (Page 4054)  
Connector (Page 3986)  
RoundButton (Page 4074)

## **FlashingRate**

### **Description**

Specifies the flash rate of the border line for the selected object.

Access in Runtime: Read and write

### **Syntax**

Object.**FlashingRate**[=FlashingRate]

### Object

Required A "ScreenItem" object with the formats "Line", "Polyline", "Ellipse", "Circle", "EllipseSegment", "CircleSegment", "EllipticalArc", "CircularArc", "Rectangle", "Polygon", "TextField", "IOField", "SymbolicIOField", "Button", "Switch", "GraphicIOField", "Bar", "Checkbox", "OptionGroup" or "Connector".

### FlashingRate

hmiFlashingRateSlow ( 0): The length of the flashing rate is 1000 ms.

hmiFlashingRateMedium ( 1): The length of the flashing rate is 500 ms.

hmiFlashingRateFast ( 2): The length of the flashing rate is 250 ms.

### See also

[Line \(Page 4025\)](#)

[Polyline \(Page 4060\)](#)

[Ellipse \(Page 3993\)](#)

[Circle \(Page 3977\)](#)

[EllipseSegment \(Page 3995\)](#)

[CircleSegment \(Page 3979\)](#)

[EllipticalArc \(Page 3998\)](#)

[CircularArc \(Page 3982\)](#)

[Rectangle \(Page 4072\)](#)

[Polygon \(Page 4057\)](#)

[TextField \(Page 4107\)](#)

[IOField \(Page 4021\)](#)

[SymbolicIOField \(Page 4093\)](#)

[Button \(Page 3968\)](#)

[Switch \(Page 4089\)](#)

[GraphicIOField \(Page 4011\)](#)

[Bar \(Page 3961\)](#)

[CheckBox \(Page 3974\)](#)

[OptionGroup \(Page 4054\)](#)

[Connector \(Page 3986\)](#)

[RoundButton \(Page 4074\)](#)

## FlashPicReferenced

### Description

TRUE, when the assigned flash picture is to be saved. Otherwise, only the associated object reference is saved. Read only access.

## FlashPicture

### Description

Returns the flash picture. Read-only access.

The graphic (\*.BMP or \*.DIB) must be located in the "GraCS" folder of the current project so that it can be integrated.

In this context, the "FlashPicReferenced" property defines whether the flash picture should be saved or referenced together with the object.

## FlashRate

### Description

Defines or returns the flash frequency. Value range from 0 to 2.

0 = slow

1 = medium

2 = fast

## FlashRateBackColor

### Description

Defines or returns the flash frequency for the object background. Value range from 0 to 2.

0 = slow

1 = medium

2 = fast

## FlashRateBorderColor

### Description

Defines or returns the flash frequency for the lines of the object. Value range from 0 to 2.

0 = slow

1 = medium



2 = fast

## FlashRateFlashPic

### Description

Defines or returns the flash frequency for the flash picture. Value range from 0 to 2.

0 = slow

1 = medium

2 = fast

## FlashRateForeColor

### Description

Defines or returns the flash frequency for the object label. Value range from 0 to 2.

0 = slow

1 = medium

2 = fast

## FlashTransparentColor

### Description

Specifies the color of the bitmap object of a flashing graphic that is set to "transparent".

Access in Runtime: Read and write

### Syntax

Object.**FlashTransparentColor**[=Color]

#### Object

Required A "ScreenItem" object with the format "GraphicIOField".

#### Color

Optional A value or a constant that specifies the color of the bitmap object of a flashing graphic that is set to "transparent".

### See also

GraphicIOField (Page 4011)

## Flip

### Description

Flips the symbol on the vertical and / or horizontal center axis of the symbol.

Access in Runtime: Read and write

### Syntax

Object.**Flip**[=SymbolLibFlip]

#### Object

Required A "ScreenItem" object with the format "SymbolLibrary".

#### SymbolLibFlip

hmiSymbolLibraryFlipNone ( 0): The symbol is not flipped.

hmiSymbolLibraryFlipHorizontal ( 1): The symbol is flipped horizontally.

hmiSymbolLibraryFlipVertical ( 2): The symbol is flipped vertically.

hmiSymbolLibraryFlipBoth ( 3): The symbol is flipped horizontally and vertically.

### See also

SymbolLibrary (Page 4098)

## FocusColor

### Description

Specifies that the color for the focus border of the selected object is currently active.

Access in Runtime: Read and write

### Syntax

Object.**FocusColor**[= Color]

#### Object

Required A "ScreenItem" object with the formats "SymbolicIOField", "Button", "Switch", "GraphicIOField", "RecipeView", "StatusForce", "Slider", "TrendView", "MessageView" or "AlarmView".

#### Color

Optional A value or a constant that specifies the frame color.

## Comments

Use the "RGB" function to establish the colors in RGB format (red, green blue). To do this, enter the appropriate decimal value for each of the three RGB values (range from 0 to 255). For example, the color "red" is shown as such: RGB(255, 0, 0). You can also use the VBS color constants like vbRed or vbGreen.

## See also

SymbolicIOField (Page 4093)

Button (Page 3968)

Switch (Page 4089)

GraphicIOField (Page 4011)

Slider (Page 4082)

AlarmControl (Page 3947)

## FocusColor

### Description

Determines the color for the focus frame of the given object that has the focus.

Access during runtime: Read and Write

### Syntax

Object.FocusColor [= Color]

#### Object

Required An object of the "ScreenItem" type with the characteristics "Button", "Switch", "GraphicIOField", "RecipeView", "StatusForce", "Slider", "TrendView" or "MessageView".

#### Color

Optional A value or constant which determines the frame color.

## Comments

You can use the "RGB" function to establish the colors in the RGB format (red, green, blue). To do this, enter the appropriate decimal value for each of the three RGB values (range from 0 to 255). For example, the color "red" is shown as: RGB(255, 0, 0). You can also use the VBScript color constants such as vbRed or vbGreen.

## See also

AlarmView (Page 3958)  
RecipeView (Page 4068)  
TrendView (Page 4118)  
StatusForce (Page 4087)

## FocusWidth

### Description

Specifies the border width of the specified object if the object is currently active.

Access in Runtime: Read and write

### Syntax

Object.**FocusWidth**[= LONG]

#### Object

Required A "ScreenItem" object with the formats "SymbolicIOField", "Button", "Switch", "GraphicIOField", "RecipeView", "StatusForce", "Slider", "TrendView", "MessageView" or "AlarmView".

#### LONG

Optional A value or a constant that specifies the border width in pixels. Value range from 1 to 10.

## See also

SymbolicIOField (Page 4093)  
Button (Page 3968)  
Switch (Page 4089)  
GraphicIOField (Page 4011)  
Slider (Page 4082)  
AlarmControl (Page 3947)

## FocusWidth

### Description

Determines the border width of the given object if the object has a focus.

Access during runtime: Read and Write

## Syntax

Object.FocusWidth [= LONG]

### Object

Required. An object of type "ScreenItem" with the characteristic "SymbolicIOField", "Button", "Switch", "GraphicIOField", "RecipeView", "StatusForce", "Slider", "TrendView" or "MessageView".

### LONG

Optional. A value or constant which determines the border width in pixels. Value range from 1 to 10.

## See also

AlarmView (Page 3958)

RecipeView (Page 4068)

TrendView (Page 4118)

StatusForce (Page 4087)

BatteryView (Page 3967)

## Font

### Description

Specifies or returns the font.

The font object has the following sub-properties

- Size (Font Size)
- Bold (yes/no)
- Name (font name)
- Italic (yes/no)
- Underline (underline yes/no)
- StrikeThrough (yes/no)

If two font properties are directly assigned, only the default property "Name" is assumed.

Access during runtime: Read and write

### Syntax

Object.Font [=Font]

**Object**

Necessary. An object of the "ScreenItem" type with the format "AlarmControl", "TrendRulerControl", "OnlineTableControl", "UserArchiveControl", "MediaPlayer", "FunctionTrendControl" or "Slider".

**Font**

Font

**Example**

```
'VBS74
Dim objControl1
Dim objControl2
Set objControl1 = ScreenItems("Control1")
Set objControl2 = ScreenItems("Control2")
objControl2.Font = objControl1.Font ' take over only the type of font
```

## See also

AlarmControl (Page 3947)  
ZoneLabelView (Page 4143)  
ProtectedAreaName (Page 4064)  
RangeLabelView (Page 4065)  
Slider (Page 4082)  
SmartClientView (Page 4085)  
CheckBox (Page 3974)  
Button (Page 3968)  
Bar (Page 3961)  
Switch (Page 4089)  
MultiLineEdit (Page 4032)  
Listbox (Page 4027)  
Clock (Page 3984)  
DateTimeField (Page 3989)  
RoundButton (Page 4074)  
SymbolicIOField (Page 4093)  
IOField (Page 4021)  
TextField (Page 4107)  
OptionGroup (Page 4054)  
RecipeView (Page 4068)  
TrendView (Page 4118)  
UserArchiveControl (Page 4130)  
TrendRulerControl (Page 4110)  
ProjectName (Page 4062)  
FunctionTrendControl (Page 4004)  
OnlineTableControl (Page 4037)  
OnlineTrendControl (Page 4045)

## FontBold

### Description

Specifies whether the text of the selected object should be shown in bold.

Access in Runtime: Read and write

## Syntax

Object.**FontBold**[=BOOLEAN]

### Object

Required An object of the "ScreenItem" type with the format "TextField", "IOField", "SymbolicIOField", "Button", "Bar", "Checkbox" or "OptionGroup".

### BOOLEAN

Optional TRUE, if the text of the selected object should be shown in bold.

## See also

TextField (Page 4107)

IOField (Page 4021)

SymbolicIOField (Page 4093)

Button (Page 3968)

Bar (Page 3961)

CheckBox (Page 3974)

MultiLineEdit (Page 4032)

Listbox (Page 4027)

RoundButton (Page 4074)

ProjectName (Page 4062)

## FontItalic

### Description

Specifies whether the text of the selected object should be shown in italic.

Access in Runtime: Read and write

### Syntax

Object.**FontItalic**[=BOOLEAN]

### Object

Required An object of the "ScreenItem" type with the format "TextField", "IOField", "SymbolicIOField", "Button", "Bar", "Checkbox" or "OptionGroup".

### BOOLEAN

Optional TRUE, if the text of the selected object should be shown in italic.



## See also

TextField (Page 4107)  
IOField (Page 4021)  
SymbolicIOField (Page 4093)  
Button (Page 3968)  
Bar (Page 3961)  
CheckBox (Page 3974)  
MultiLineEdit (Page 4032)  
Listbox (Page 4027)  
RoundButton (Page 4074)  
ProjectName (Page 4062)

## FontName

### Description

Specifies the font of the selected object.  
Access in Runtime: Read and write

### Syntax

Object.**FontName**[=String]

#### Object

Required An object of the "ScreenItem" type with the format "TextField", "IOField", "SymbolicIOField", "Button", "Bar", "Checkbox" or "OptionGroup".

#### String

Optional A value or a constant that specifies the font of the selected object.

## See also

TextField (Page 4107)  
IOField (Page 4021)  
SymbolicIOField (Page 4093)  
Button (Page 3968)  
Bar (Page 3961)  
CheckBox (Page 3974)  
MultiLineEdit (Page 4032)  
Listbox (Page 4027)  
RoundButton (Page 4074)  
ProjectName (Page 4062)

## FontSize

### Description

Specifies the font size of the text for the selected object.

Access in Runtime: Read and write

### Syntax

Object.**FontSize**[=Int]

#### Object

Required An object of the "ScreenItem" type with the format "TextField", "IOField", "SymbolicIOField", "Button", "Bar", "Checkbox" oder "OptionGroup".

#### Int

Optional A value or a constant that specifies the font size of the text for the selected object.

## See also

TextField (Page 4107)  
IOField (Page 4021)  
SymbolicIOField (Page 4093)  
Button (Page 3968)  
Bar (Page 3961)  
CheckBox (Page 3974)  
MultiLineEdit (Page 4032)  
Listbox (Page 4027)  
RoundButton (Page 4074)  
ProjectName (Page 4062)

## FontUnderline

### Description

Specifies whether the text of the selected object should be underlined.  
Access in Runtime: Read and write

### Syntax

Object.**FontUnderline**[=BOOLEAN]

#### Object

Required An object of the "ScreenItem" type with the format "TextField", "IOField", "SymbolicIOField", "Button", "Bar", "Checkbox" oder "OptionGroup".

#### BOOLEAN

Optional TRUE, if the text of the selected object should be shown underlined.

## See also

TextField (Page 4107)  
IOField (Page 4021)  
SymbolicIOField (Page 4093)  
Button (Page 3968)  
Bar (Page 3961)  
CheckBox (Page 3974)  
MultiLineEdit (Page 4032)  
Listbox (Page 4027)  
RoundButton (Page 4074)  
ProjectName (Page 4062)

## ForeColor

### Description

Specifies the font color of the text for the selected object.

Access in Runtime: Read and write

### Syntax

Object.**ForeColor**[=Color]

#### Object

Required An object of the "ScreenItem" type with the format "TextField", "IOField", "SymbolicIOField", "DateTimeField", "Button", "Switch", "Bar", "RecipeView", "Slider", "SymbolLibrary", "MessageView", "Checkbox" or "OptionGroup".

#### Color

Optional A value or a constant that specifies the font color of the text for the selected object.

## See also

TextField (Page 4107)  
IOField (Page 4021)  
SymbolicIOField (Page 4093)  
Button (Page 3968)  
Switch (Page 4089)  
Bar (Page 3961)  
Slider (Page 4082)  
SymbolLibrary (Page 4098)  
CheckBox (Page 3974)  
OptionGroup (Page 4054)  
Group (Page 4017)  
MultiLineEdit (Page 4032)  
Listbox (Page 4027)  
RoundButton (Page 4074)

## ForeColor

### Description

Determines the text color of the given object.  
Access during runtime: Read and Write

### Syntax

Object.ForeColor [= Color]

#### Object

Required An object of the "ScreenItem" type with the characteristics "TextField", "IOField", "SymbolicIOField", "Button", "Switch", "Bar", "RecipeView", "Slider" or "SymbolLibrary".

#### Color

Optional A value or constant which determines the text color.

### Comments

You can use the "RGB" function to establish the colors in the RGB format (red, green, blue). To do this, enter the appropriate decimal value for each of the three RGB values (range from 0 to 255). For example, the color "red" is shown as: RGB(255, 0, 0). You can also use the VBScript color constants such as vbRed or vbGreen.

## See also

RecipeView (Page 4068)  
AlarmView (Page 3958)  
DateTimeField (Page 3989)  
ProjectName (Page 4062)

## ForeFlashColorOff

### Description

Defines or returns the color of the text for flash status "Off". LONG write-read access.

## ForeFlashColorOn

### Description

Defines or returns the color of the text for flash status "On". LONG write-read access.

## FormatPattern

### Description

Specifies the format of the output value.  
Access in Runtime: Read and write

### Syntax

Object.**FormatPattern**[=String]

#### Object

Required A "ScreenItem" object with the format "IOField".

#### String

Optional A value or a constant that specifies the format of the output value.

## See also

IOField (Page 4021)

## FormatPatternReadOnlySpecial

### Description

Specifies that the "format pattern" field can only be read.

Access in Runtime: Read and write

### Syntax

Object.**FormatPatternReadOnlySpecial**[=BOOLEAN]

#### Object

Required A "ScreenItem" object with the format "IOField".

#### BOOLEAN

Optional TRUE, if the "format pattern" field can only be read.

### See also

IOField (Page 4021)

## FormatType

### Description

Specifies the data type of the selected object.

Access in Runtime: Read and write

### Syntax

Object.**FormatType**[=IOFieldDataFormat]

#### Object

Required A "ScreenItem" object with the format "IOField".

#### IOFieldDataFormat

hmiOutputFormatString ( 2): String

hmiOutputFormatDecimal ( 1): Decimal

hmiOutputFormatHexadecimal ( 3): Hexadecimal

hmiOutputFormatBinary ( 0): Binary

hmiOutputFormatDate ( 4): Date

hmiOutputFormatTime ( 5): Time

hmiOutputFormatDateTime ( 6): Date and time

## See also

IOField (Page 4021)

## Free

### Description

Returns the size of the free disk space.

Access in Runtime: Read and write

### Syntax

Object.**Free**[=Double]

#### Object

Required A "ScreenItem" object with the format "DiskSpaceView".

#### Double

Optional A value or a constant that returns the size of the free disk space.

## See also

DiskSpaceView (Page 3991)

## FreePercent

### Description

Returns the measured values for the free disk space as a percentage. The values can be queried in Runtime. The values cannot be predefined.

Access in Runtime: Read and write

### Syntax

Object.**FreePercent**[=Int]

#### Object

Required A "ScreenItem" object with the format "DiskSpaceView".

#### Int

Optional A value or a constant that returns the measured values for the free disk space as a percentage.



## See also

DiskSpaceView (Page 3991)

## FreezeProviderConnections

### Description

Specifies whether the properties for the data connection ("TagProviderType(i)", "Source.."...) can be changed without the change becoming effective immediately. If you change from, for example, "XDataLogTag(i)" illegal combinations with "YDataLogTag(i)" could arise.

This means attributes must have the value TRUE before changing the data connection "FreezeProviderConnections". After changing all the properties for the data connection, "FreezeProviderConnection" will be set to FALSE and the changes will become effective.

Access in Runtime: Read and write

### Syntax

Object.**FreezeProviderConnections**[=BOOLEAN]

#### Object

Required A "ScreenItem" object with the format "FunctionTrendControl".

#### BOOLEAN

Optional TRUE, if the properties for the data connection ("TagProviderType(i)", "Source.."...) can be changed without the change becoming effective immediately.

## See also

FunctionTrendControl (Page 4004)

## Properties G-H

### GetSelectionText

#### Description

Returns the selected text of the "MultiLineEdit" object.

### Gradation

#### Description

Specifies the value difference between two main marking lengths of the "Gauge" object.

Access in Runtime: Read and write

## Syntax

Object.**Gradation**[= LONG]

### Object

Required A "ScreenItem" object with the format "Gauge".

### LONG

Optional A value or a constant that specifies the value difference.

## See also

Gauge (Page 4008)

## GraphDirection

### Description

Specifies at which border of the trend view the current values are displayed.

Access in Runtime: Read and write

### Syntax

Object.**GraphDirection**[=Direction]

### Object

Required An object of the "ScreenItem" type with the format "FunctionTrendControl", "OnlineTrendControl", (Runtime Professional) or "HMITrendView" (Runtime Advanced).

### Direction

0: Positive values run to the right and upwards.

-1: Positive values run to the left and upwards.

-2: Positive values run to the right and upwards.

-3: Positive values run to the right and downwards.

## See also

FunctionTrendControl (Page 4004)

OnlineTrendControl (Page 4045)

## GridBackColor

### Description

Specifies the background color for the recipe view in Runtime.

Access in Runtime: Read and write

### Syntax

Object.**GridBackColor**[=Color]

#### Object

Required A "ScreenItem" object with the format "UserArchiveControl".

#### Color

Optional A value or a constant that specifies the background color in the recipe view in Runtime.

## GridForeColor

### Description

Defines the font color for the recipe view.

Access in Runtime: Read and write

### Syntax

Object.**GridForeColor**[=Color]

#### Object

Required A "ScreenItem" object with the format "UserArchiveControl".

#### Color

Optional A value or a constant that specifies the font color for the recipe view.

## GridLineColor

### Description

Specifies the color for the grid lines.

Access in Runtime: Read and write

### Syntax

Object.**GridlineColor**[=Color]

**Object**

Required A "ScreenItem" object with the format "AlarmControl".

**Color**

Optional A value or a constant that specifies the color of the grid lines.

**See also**

AlarmControl (Page 3947)

UserArchiveControl (Page 4130)

TrendRulerControl (Page 4110)

OnlineTableControl (Page 4037)

**GridLineColor**

**Color of the row divider / content - GridLineColor**

Defines the color of row/column dividers in table contents. The button opens the "Color selection" dialog.

The attribute can be assigned dynamic properties by means of the name **GridLineColor**.

**See also**

AlarmView (Page 3958)

**GridLineWidth**

**Description**

Defines the line weight of the row/column dividers in pixels.

Access in Runtime: Read and write

**Syntax**

Object.**GridLineWidth**[=Width]

**Object**

Required A "ScreenItem" object with the format "AlarmControl".

**Width**

Optional A value or a constant which specifies the width of the grid line.

## See also

AlarmControl (Page 3947)  
UserArchiveControl (Page 4130)  
TrendRulerControl (Page 4110)  
OnlineTableControl (Page 4037)

## Height

### Description

Specifies the height of the selected objects "Ellipse", "Circle" and "Rectangle".

Access during runtime: Read and write

The other objects only have read access to the property.

### Syntax

Object.**Height**[= LONG]

#### Object

Necessary. A "Screen" object or an object of type "ScreenItem". This property is a standard property of the ScreenItem-Objekts and is therefore available for all formats.

#### LONG

Optional A value or a constant that specifies the height in pixels. This parameter can be set only for the objects "Ellipse", "Circle" and "Rectangle".

### Example

The following example halves the height of all objects of the image "NewPDL1", whose name starts with "Circle":

```
'VBS75
Dim objScreen
Dim objCircle
Dim lngIndex
Dim strName
lngIndex = 1
Set objScreen = HMIRuntime.Screens("NewPDL1")
For lngIndex = 1 To objScreen.ScreenItems.Count
'
'Searching all circles
strName = objScreen.ScreenItems.Item(lngIndex).ObjectName
If "Circle" = Left(strName, 6) Then
'
'to halve the height of the circles
Set objCircle = objScreen.ScreenItems(strName)
```

```
objCircle.Height = objCircle.Height / 2  
End If  
Next
```

## See also

Line (Page 4025)  
Polyline (Page 4060)  
Ellipse (Page 3993)  
Circle (Page 3977)  
EllipseSegment (Page 3995)  
CircleSegment (Page 3979)  
EllipticalArc (Page 3998)  
CircularArc (Page 3982)  
Rectangle (Page 4072)  
Polygon (Page 4057)  
TextField (Page 4107)  
IOField (Page 4021)  
SymbolicIOField (Page 4093)  
Button (Page 3968)  
Switch (Page 4089)  
GraphicView (Page 4014)  
GraphicIOField (Page 4011)  
Bar (Page 3961)  
Clock (Page 3984)  
Gauge (Page 4008)  
Slider (Page 4082)  
SymbolLibrary (Page 4098)  
OnlineTrendControl (Page 4045)  
FunctionTrendControl (Page 4004)  
OnlineTableControl (Page 4037)  
AlarmControl (Page 3947)  
HTMLBrowser (Page 4019)  
CheckBox (Page 3974)  
OptionGroup (Page 4054)  
WindowSlider (Page 4139)  
Connector (Page 3986)  
ScreenWindow (Page 4078)  
DiskSpaceView (Page 3991)  
ChannelDiagnose (Page 3972)  
ScriptDiagnostics (Page 4080)  
Group (Page 4017)  
ForeignControl (Page 4000)  
ProtectedAreaName (Page 4064)  
UserView (Page 4137)  
TubeTeeObject (Page 4128)

## HelpText

### Description

Returns the tooltip that is shown in Runtime as an operating aid for the specified object.

Access in Runtime: Read

### Syntax

Object.HelpText

#### Object

Required An object of the "ScreenItem" type with the format "IOField", "SymbolicIOField", "DateTimeField", "Button", "Switch", "GraphicIOField" or "OnlineTrendControl".

### See also

IOField (Page 4021)

SymbolicIOField (Page 4093)

Button (Page 3968)

Switch (Page 4089)

GraphicIOField (Page 4011)

## HelpText

### Description

Returns the tooltip that is shown in Runtime as an operating aid for the specified object.

Access in Runtime: Read

### Syntax

Object.HelpText

#### Object

Required An object of the type "ScreenItem" with the characteristic "IOField", "SymbolicIOField", "Button", "Switch", "GraphicIOField" or "TrendView".

### See also

TrendView (Page 4118)

DateTimeField (Page 3989)



## HiddenInput

### Description

Specifies whether the input value or a \* for each character will be shown during the input.

Access in Runtime: Read and write

### Syntax

Object.**HiddenInput**[=BOOLEAN]

#### Object

Required A "ScreenItem" object with the format "IOField".

#### BOOLEAN

Optional TRUE, if the input value is not shown during the input. An \* is shown for each character.

### See also

IOField (Page 4021)

## HideTagNames

### Description

Specifies whether the tag name is shown in the f/t() trend view.

Access in Runtime: Read and write

### Syntax

Object.**HideTagNames**[=BOOLEAN]

#### Object

Required A "ScreenItem" object with the format "OnlineTrendControl".

#### BOOLEAN

Optional TRUE, if the tag names are displayed.

### See also

OnlineTrendControl (Page 4045)

## HighLimitColor

### Description

Specifies the color of the top or right scroll button in a scroll bar.

Access in Runtime: Read and write

### Syntax

Object.HighLimitColor[=Color]

#### Object

Required A "ScreenItem" object with the format "WindowSlider".

#### Color

Optional A value or a constant that specifies the color of the top or right scroll button in a scroll bar.

### See also

WindowSlider (Page 4139)

## HitlistColumnAdd

### Description

Transfers the selected message block from the list of available message blocks to the list of selected message blocks.

Access in Runtime: Read and write

### Syntax

Object.HitlistColumnAdd

#### Object

Required A "ScreenItem" object with the format "AlarmControl".

### See also

AlarmControl (Page 3947)

## HitlistColumnCount

### Description

Specifies the number of message blocks displayed in the hitlist in Runtime.

Access in Runtime: Read and write

### Syntax

Object.**HitlistColumnCount**

#### Object

Required A "ScreenItem" object with the format "AlarmControl".

### See also

AlarmControl (Page 3947)

## HitlistColumnIndex

### Description

References a message block selected for the hitlist. Using this attribute you can assign the values of other attributes to a specific message block of the hitlist.

Values between 0 and "HitlistColumnCount" minus 1 are valid for "HitlistColumnIndex".

Attribute "HitlistColumnCount" defines the number of message blocks selected for the hitlist. The "HitlistColumnIndex" attribute can be assigned dynamic properties by means of attribute **HitlistColumnRepos**.

Access in Runtime: Read and write

### Syntax

Object.**HitlistColumnIndex**

#### Object

Required A "ScreenItem" object with the format "AlarmControl".

### See also

AlarmControl (Page 3947)

## HitlistColumnName

### Description

Displays the name of the message block of the hitlist which is referenced with attribute "HitlistColumnIndex". You cannot edit this name.

Access in Runtime: Read and write

### Syntax

Object.HitlistColumnName

#### Object

Required An object of the "ScreenItem" type with the format "AlarmControl".

### See also

AlarmControl (Page 3947)

## HitlistColumnRemove

### Description

Removes the marked message block from the list of selected message blocks and inserts it in the list of existing message blocks.

Access in Runtime: Read and write

### Syntax

Object.HitlistColumnRemove [=BOOLEAN]

#### Object

Required An object of the "ScreenItem" type with the format "AlarmControl".

### See also

AlarmControl (Page 3947)

## HitlistColumnRepos

### Description

Resorts the message blocks. The "Up" and "Down" commands move the selected message block accordingly in the list. This moves the message block in Runtime Control towards the front or towards the back.

Access in Runtime: Read and write

## Syntax

For hitlist: Object.**HitlistColumnRepos** For message list: Object.**MessageColumnRepos**

### Object

Required An object of the "ScreenItem" type with the format "AlarmControl".

## See also

AlarmControl (Page 3947)

## HitlistColumnSort

### Description

Defines the sorting order of the message block referenced in "HitlistColumnIndex" in the hitlist.

Access in Runtime: Read and write

## Syntax

Object.**HitlistColumnSort** [=Sort]

### Object

Required An object of the "ScreenItem" type with the format "AlarmControl".

### Sort

0: No sorting.

1: Ascending sorting from the lowest to highest value

2 Descending sorting from the highest to lowest value

## See also

AlarmControl (Page 3947)

## HitlistColumnSortIndex

### Description

Defines the sorting order of the message block referenced in "HitlistColumnIndex" in the hitlist. The sorting criterion is removed from "HitlistColumnSort" if you set a "0" value..

Access in Runtime: Read and write

## Syntax

Object.**HitlistColumnSortIndex**

### Object

Required An object of the "ScreenItem" type with the format "AlarmControl".

## See also

AlarmControl (Page 3947)

## HitlistColumnVisible

### Description

The selected message blocks of the message list or hitlist which are used in Runtime in the control are displayed in the list.

Access in Runtime: Read and write

### Syntax

For hitlist: Object.**HitlistColumnVisible** For message list: Object.**MessageColumnVisible**

### Object

Required An object of the "ScreenItem" type with the format "AlarmControl".

## See also

AlarmControl (Page 3947)

## HitlistDefaultSort

### Description

Defines the default sorting order in the table columns of the hitlist.

Access in Runtime: Read and write

### Syntax

Object.**HitlistDefaultSort**[=Sort]

### Object

Required An object of the "ScreenItem" type with the format "AlarmControl".

### Sort

0: The list is sorted in ascending order of frequency.

1:: The list is sorted in descending order of frequency.

### See also

AlarmControl (Page 3947)

## HitlistMaxSourceItems

### Description

Specifies the maximum number of data records that can be used from the alarm log to create the hit list. The value can be anything between "0 - 10000".

Access in Runtime: Read and write

### Syntax

Object.**HitlistMaxSourceItems**[=Long]

#### Object

Required A "ScreenItem" object with the format "AlarmControl".

#### Long

Optional A value or a constant that specifies the maximum number of data records that can be used from the alarm log to create the hit list.

### See also

AlarmControl (Page 3947)

## HitlistMaxSourceItemsWarning

### Description

Specifies whether a warning should be given if the maximum number of data records that is defined in "HitlistMaxSourceItems" is reached.

Access in Runtime: Read and write

### Syntax

Object.**HitlistMaxSourceItemsWarning**[=BOOLEAN]

### Object

Required A "ScreenItem" object with the format "AlarmControl".

### BOOLEAN

Optional TRUE, if a warning is given as soon as the maximum number of data records that is defined in "HitlistMaxSourceItems" is reached.

### See also

AlarmControl (Page 3947)

## HitlistRelativeTimeFactor

### Description

Specifies the time factor which, alongside the time type "HitlistRelativeTimeFactorType", determines the time period in which the statistics of the hit list will be created.

If you do not wish to specify a period of time, set the time factor to "0".

Access in Runtime: Read and write

### Syntax

Object.HitlistRelativeTimeFactor[=Long]

### Object

Required A "ScreenItem" object with the format "AlarmControl".

### Long

Optional A value or a constant that specifies the time factor.

### See also

AlarmControl (Page 3947)

## HitlistRelativeTimeFactorType

### Description

Specifies the time type which, alongside the time factor "HitlistRelativeTimeFactor", determines the time period in which the statistics of the hit list will be created.

Access in Runtime: Read and write



## Syntax

Object.**HitlistRelativeTimeFactorType**[=AlarmViewAdvancedTimeFactorUnit]

### Object

Required A "ScreenItem" object with the format "AlarmControl".

### AlarmViewAdvancedTimeFactorUnit

hmiAlarmViewAdvancedTimeFactorUnitMinute ( 0): The time range for the statistics will be measured in minutes.

hmiAlarmViewAdvancedTimeFactorUnitHour ( 1): The time range for the statistics will be measured in hours.

hmiAlarmViewAdvancedFactorUnitDay ( 2): The time range for the statistics will be measured in days.

hmiAlarmViewAdvancedTimeFactorUnitWeek ( 3): The time range for the statistics will be measured in weeks.

hmiAlarmViewAdvancedTimeFactorUnitMonth ( 4): The time range for the statistics will be measured in months.

## See also

AlarmControl (Page 3947)

## HitListRelTime

### Description

Sets a time range for the statistics.

If you do not wish to specify a period of time, set the time factor to "0".

Access in Runtime: Read and write

## Syntax

Object.**HitListRelTime**[=BOOLEAN]

### Object

Required A "ScreenItem" object with the format "AlarmControl".

### BOOLEAN

TRUE: If no time range is specified in the selection, the specified time range is used for the statistics.

FALSE: The specified time range is not used.

## See also

AlarmControl (Page 3947)

## HorizontalAlignment

### Description

Specifies the horizontal alignment of the text within the specified object.

Access in Runtime: Read and write

### Syntax

Object.**HorizontalAlignment**[= THmiHorizontalAlignment]

#### Object

Required A "ScreenItem" object with the formats "TextField", "IOField", "SymbolicIOField", "DateTimeField", "Button", "Switch", "CheckBox", "OptionGroup", "PageNumber", "ProjectName", "ReportName", "OdbcDatabaseField".

#### THmiHorizontalAlignment

Optional A value or a constant that specifies the horizontal alignment of the text.

hmiAlignmentLeft (0): The text is arranged flush left in the object.

hmiAlignmentCentered (1): The text is arranged horizontally centered in the object.

hmiAlignmentRight (2): The text is arranged flush right in the object.

## See also

TextField (Page 4107)

IOField (Page 4021)

SymbolicIOField (Page 4093)

Button (Page 3968)

Switch (Page 4089)

CheckBox (Page 3974)

OptionGroup (Page 4054)

AlarmControl (Page 3947)

MultiLineEdit (Page 4032)

Listbox (Page 4027)

RoundButton (Page 4074)

## HorizontalAlignment

### Description

Determines the horizontal alignment of the text within the given object.

Access during runtime: Read and Write

### Syntax

Object.HorizontalAlignment [= THmiHorizontalAlignment]

#### Object

Required An object of the "ScreenItem" type with the characteristics "TextField", "IOField", "SymbolicIOField", "Button" or "Switch".

#### THmiHorizontalAlignment

Optional A value or constant which determines the horizontal alignment of the text.

hmiAlignmentLeft (0): The text is aligned left justified in the object.

hmiAlignmentCentered (1): The text is centered horizontally in the object.

hmiAlignmentRight (2): The text is aligned right justified in the object.

### See also

DateTimeField (Page 3989)

ProjectName (Page 4062)

## HorizontalGridLines

### Description

Defines whether horizontal separating lines will be displayed.

Access in Runtime: Read and write

### Syntax

Object.HorizontalGridLines[=BOOLEAN]

#### Object

Required A "ScreenItem" object with the format "AlarmControl".

#### BOOLEAN

TRUE: Horizontal grid lines are displayed.

FALSE: Horizontal grid lines are not displayed.

## See also

AlarmControl (Page 3947)

UserArchiveControl (Page 4130)

TrendRulerControl (Page 4110)

OnlineTableControl (Page 4037)

## HorizontalScrollbarPosition

### Description

Specifies the horizontal positioning of the scroll bar in a picture window with slider, or returns its value.

The picture is displayed in the picture window by positioning the horizontal and vertical scroll bars. If you wish to display the picture as a cutout where the scroll bars are located at the left and upper edge of the picture, use the properties "OffsetLeft" and "OffsetTop" as the origin of this cutout.

## See also

ScreenWindow (Page 4078)

## Hotkey property

### Description

Returns the function key related to the mouse operation in respect of a button object.

Read only access.

## See also

Button (Page 3968)

## HourNeedleHeight

### Description

Specifies the length of the hour hand in the "Clock" object.

Access in Runtime: Read and write

## Syntax

Object.HourNeedleHeight[= LONG]

**Object**

Required A "ScreenItem" object with the format "Clock".

**LONG**

Optional A value or a constant that specifies the length of the hour hand.

Specify the length of the hour hand as a percentage relating to the radius of the clock face.

**See also**

Clock (Page 3984)

**HourNeedleWidth**

**Description**

Specifies the width of the hour hand in the "Clock" object.

Access in Runtime: Read and write

**Syntax**

Object.HourNeedleWidth[= LONG]

**Object**

Required A "ScreenItem" object with the format "Clock".

**LONG**

Optional A value or a constant that specifies the width of the hour hand.

Specify the width of the hour hand as a percentage relating to double the length of the clock face.

**See also**

Clock (Page 3984)

**Hysteresis property**

**Description**

TRUE, when the display should appear with hysteresis. BOOLEAN write-read access.

## HysteresisRange

### Description

Defines the hysteresis in % of the displayed value or returns it.  
The Hysteresis property must be set to TRUE for the hysteresis to be calculated.

### Properties I-J

## IconSpace

### Description

Defines the spacing between the icons and text in the table cells. The value is active if and icon and text are displayed.

Access in Runtime: Read and write

### Syntax

Object.**IconSpace**[=Space]

#### Object

Required An object of the "ScreenItem" type with the format "AlarmControl", "TrendRulerControl", "OnlineTableControl", "UserArchiveControl".

#### Space

Optional Value which specifies the spacing.

### See also

AlarmControl (Page 3947)

UserArchiveControl (Page 4130)

TrendRulerControl (Page 4110)

OnlineTableControl (Page 4037)

## Index

### Description

Specifies the index for the selected text field.

Access in Runtime: Read and write

## Syntax

Object.**Index**[=Int]

### Object

Required A "ScreenItem" object with the formats "Checkbox" or "OptionGroup".

### Int

Optional A value or a constant that specifies the index of the selected text field.

## See also

OptionGroup (Page 4054)

Listbox (Page 4027)

## InnerBackColorOff

### Description

Specifies the color under the slider of the "Switch" object if the object is in OFF status.

Access during runtime: Read and Write

### Syntax

Object.**InnerBackColorOff**[= Color]

### Object

Required An object of the "ScreenItem" type with the characteristic "Switch".

### Color

Optional A value or a constant that specifies the color for the OFF status.

### Comments

Use the "RGB" function to establish the colors in RGB format (red, green blue). To do this, enter the appropriate decimal value for each of the three RGB values (range from 0 to 255). For example, the color "red" is shown as: RGB(255, 0, 0). You can also use the VBScript color constants such as vbRed or vbGreen.

## See also

Switch (Page 4089)

## InnerBackColorOn

### Description

Specifies the color under the slider of the "Switch" object if the object is in ON status.

Access during runtime: Read and Write

### Syntax

Object.InnerBackColorOn[= Color]

#### Object

Required An object of the "ScreenItem" type with the characteristic "Switch".

#### Color

Optional A value or a constant that specifies the color for the ON status.

### Comments

Use the "RGB" function to establish the colors in RGB format (red, green blue). To do this, enter the appropriate decimal value for each of the three RGB values (range from 0 to 255). For example, the color "red" is shown as: RGB(255, 0, 0). You can also use the VBScript color constants such as vbRed or vbGreen.

### See also

Switch (Page 4089)

## InputValue

### Description

Defines the value to be entered by the user in the I/O field. The value is not displayed in the I/O field when the property is set.

If you want the value to be displayed in the I/O field after confirmation with the <Return> key, configure a direct connection between the properties "input value" and "output value". The direct connection is only practical when no tag is connected to the output value, but the user can nevertheless query the specified value, for example, through a script.

LONG write-read access.

### See also

SymbolicIOField (Page 4093)

IOField (Page 4021)



## InsertData(i)

### Description

Specifies which data will be inserted for the active trend.

Access in Runtime: Read and write

### Syntax

Object.**InsertData**(i)[=BOOLEAN]

#### Object

Required A "ScreenItem" object with the format "FunctionTrendControl".

#### BOOLEAN

Optional TRUE, if "DataIndex(i)" is ignored and the data added to the rear of the data buffer.

FALSE, if the data is inserted at the position "DataIndex(i)" of the data buffer.

### Comments

The trend view is redrawn in every operation with "InsertData(i)".

### See also

FunctionTrendControl (Page 4004)

## InsertEnable

### Description

Specifies whether an entry can be made in the recipe view in Runtime.

Access in Runtime: Read and write

### Syntax

Object.**InsertEnable**[=BOOLEAN]

#### Object

Required A "ScreenItem" object with the format "UserArchiveControl".

#### BOOLEAN

Optional TRUE, if an entry can be made in the recipe view in Runtime.

## Instance

### Description

Returns an instance of the alarm object.

## IntegerDigits

### Description

Establishes the number of integer digits (0 to 20).

Access in Runtime: Read and write

### Syntax

Object.**IntegerDigits**[=Int]

#### Object

Required A "ScreenItem" object with the format "Bar".

#### Int

Optional A value or a constant that specifies the number of integer digits (0 to 20).

### See also

Bar (Page 3961)

## Interval

### Description

Specifies the time interval for updating the displayed measured value. You enter the value in minutes.

Access in Runtime: Read and write

### Syntax

Object.**Interval**[=Int]

#### Object

Required A "ScreenItem" object with the format "DiskSpaceView".

#### Int

Optional A value or a constant that specifies the time interval for updating the measured values.

## See also

DiskSpaceView (Page 3991)

## ItemBorderBackColor

### Description

Defines or returns the background color for dividing lines in the selection list of the text list object. LONG write-read access. The background color is only visible with the property setting `ItemBorderStyle > 0`.

## ItemBorderColor

### Description

Defines or returns the color for dividing lines in the selection list of the text list object. LONG write-read access.

## ItemBorderStyle

### Description

Specifies the line style of the separation lines in the selection list of the selected object.

Access in Runtime: Read and write

### Syntax

Object.**ItemBorderStyle**[=LineStyle]

#### Object

Required A "ScreenItem" object with the format "SymbolicIOField".

#### LineStyle

`hmiLineStyleNone (-1)`: The selection list has no separation lines.

`hmiLineStyleSolid ( 0)`: The selection list has solid separation lines.

`hmiLineStyleDash ( 1)`: The selection list has broken separation lines.

`hmiLineStyleDot ( 2)`: The selection list has dotted separation lines.

`hmiLineStyleDashDot ( 3)`: The selection list has dash - dot lines as separation lines.

`hmiLineStyleDashDotDot ( 4)`: The selection list has dash - dot - dot lines as separation lines.

## See also

SymbolicIOField (Page 4093)

## ItemBorderWidth

### Description

Defines or returns the dividing line weight in pixels in the selection list of the text list object.

## JumpToLimitsAfterMouseClicked

### Description

Specifies whether the slider will be set to the associated end value. The end value is the minimum or maximum value. To set the slider to the end value, users click on the area outside of the current slider setting.

Access in Runtime: Read and write

### Syntax

Object.**JumpToLimitsAfterMouseClicked**[=BOOLEAN]

#### Object

Required A "ScreenItem" object with the format "WindowSlider".

#### BOOLEAN

Optional TRUE, if the slider will be set to the associated end value.

## See also

WindowSlider (Page 4139)

## Properties K-L

### LabelColor

### Description

Specifies the color of the scale label in the "Slider" object.

Access in Runtime: Read and write

## Syntax

Object.**LabelColor**[= Color]

### Object

Required A "ScreenItem" object with the format "Slider".

### Color

Optional A value or a constant that specifies the color of the scale label.

## Comments

Use the "RGB" function to establish the colors in RGB format (red, green blue). To do this, enter the appropriate decimal value for each of the three RGB values (range from 0 to 255). For example, the color "red" is shown as such: RGB(255, 0, 0). You can also use the VBS color constants like vbRed or vbGreen.

## See also

Slider (Page 4082)

## Language

## Description

Determines the current Runtime language.

Access in Runtime: Read and write

## Syntax

Object.**Language**[= LONG]

### Object

Required A "HMIRuntime" object.

### LONG

Optional A value or a constant that specifies the national code.

## Comments

Specify the Runtime language in VBS with a national code, e.g. 1031 for German, 2057 for English etc.. Refer to the VBScript basics under the topic "Current local ID (LCID) diagram" for an overview of all the national codes.

## See also

HMIRuntime (Page 3922)

## LanguageSwitch

### Description

Returns the value which defines where the language dependent assigned texts are stored.  
Read only access.

TRUE, if the texts are managed in the project texts editor. Translations into other languages are made in the project texts editor.

FALSE, when the texts are managed directly in the object. Translations into other languages can be made by means of the export/import function.

## LargeTicksBold

### Description

Specifies whether the long marking lengths of a scale are shown in bold.

Access in Runtime: Read and write

### Syntax

Object.**LargeTicksBold**[=BOOLEAN]

#### Object

Required A "ScreenItem" object with the format ""Bar".

#### BOOLEAN

Optional. TRUE, if the long marking lengths of a scale are shown in bold.

### See also

Bar (Page 3961)

## LargeTicksSize

### Description

Specifies the length of the long marking lengths of a scale.

Access in Runtime: Read and write

### Syntax

Object.**LargeTicksSize**[=Int]

**Object**

Required A "ScreenItem" object with the format "Bar".

**Int**

Optional A value or a constant that specifies the length of the long marking lengths of a scale.

**See also**

Bar (Page 3961)

**LastConnectedObjectIndex**

**Description**

Specifies the index number of the connection point for the last, connected object.

Access in Runtime: Read and write

**Syntax**

Object.**LastConnectedObjectIndex**[=Int]

**Object**

Required A "ScreenItem" object with the format "Connector".

**Int**

Int

**See also**

Connector (Page 3986)

**LastConnectedObjectName**

**Description**

Specifies the object name of the object that is docked at the lower connector point.

Access in Runtime: Read and write

**Syntax**

Object.**LastConnectedObjectName**[=String]

**Object**

Required A "ScreenItem" object with the format "Connector".

**String**

String

**See also**

Connector (Page 3986)

**LastError**

**Description**

Returns an error code regarding the success of the last operation, e.g. information on a tag write or read process:

Code in hexadecimal notation	Description
0x00000000	OK
0x80040001	Execution error
0x80040002	Tag error
0x80040003	Server not available.
0x80040004	Multi Tag Error; error in one or several tags

To obtain an error description, first of all carry out the Read method.

**Note**

If the error occurs when accessing via the TagSet object, evaluate the LastError property for each tag of the TagSet object.

To obtain a statement about the quality of the supplied value, use the "QualityCode" property. To obtain a description of the error, use the "ErrorDescription" property.

Access during runtime: Read

**Syntax**

Object.**LastError**

**Object**

Necessary. A "Tag" object.

**Example**

The following example shows the error code for the "Tag1" tag:

```
'VBS77  
Dim objTag
```



```
Set objTag = HMIRuntime.Tags("Tag1")
objTag.Read
MsgBox objTag.LastError
```

The following example adds two tags to the TagSet list and outputs the LastError property as Trace:

```
'VBS178
Dim group
Set group = HMIRuntime.Tags.CreateTagSet
group.Add "Motor1"
group.Add "Motor2"
HMIRuntime.Trace "LastError: " & group.LastError & vbNewLine
```

The LastError property of a tag contained in the list may be accessed as follows:

```
HMIRuntime.Trace "LastError: " & group("Motor1").LastError & vbNewLine
```

## See also

[Tag \(Page 3941\)](#)

[TagSet \(list\) \(Page 3945\)](#)

## Layer

### Description

Returns the layer that contains an object as LONG in the screen. There is a total of 32 layers available, whereby Layer "0" is the bottom layer and Layer "31" the top layer.

The configured objects are initially in the background of a layer.

Access during runtime: Read

### Syntax

Object.**Layer**

### Object

Necessary. A "ScreenItem" object.

---

### Note

The Layer property specifies the layer in which the object is located. The layer "0" is output as layer "0".

When accessed, the layers are counted up from 1 in VBS. Therefore, address the level "1" with layers(2).

---

### Example

The following example displays the name and layer of all objects in the screen "NewPDL1":

```
'VBS78
Dim objScreen
Dim objScrItem
Dim lngAnswer
Dim lngIndex
Dim strName
lngIndex = 1
Set objScreen = HMIRuntime.Screens("NewPDL1")
For lngIndex = 1 To objScreen.ScreenItems.Count
strName = objScreen.ScreenItems.Item(lngIndex).ObjectName
Set objScrItem = objScreen.ScreenItems(strName)
lngAnswer = MsgBox(strName & " is in layer " & objScrItem.Layer, vbOKCancel)
If vbCancel = lngAnswer Then Exit For
Next
```

## See also

ScreenItem (Page 3932)  
HTMLBrowser (Page 4019)  
Group (Page 4017)  
ForeignControl (Page 4000)  
DateTimeField (Page 3989)  
ZoneQualityView (Page 4144)  
ZoneLabelView (Page 4143)  
WLANQualityView (Page 4142)  
ProtectedAreaName (Page 4064)  
RangeLabelView (Page 4065)  
RangeQualityView (Page 4067)  
ScreenWindow (Page 4078)  
ScriptDiagnostics (Page 4080)  
Slider (Page 4082)  
SmartClientView (Page 4085)  
StatusForce (Page 4087)  
SymbolLibrary (Page 4098)  
BatteryView (Page 3967)  
ChannelDiagnose (Page 3972)  
CheckBox (Page 3974)  
GraphicIOField (Page 4011)  
Button (Page 3968)  
Bar (Page 3961)  
WindowSlider (Page 4139)  
UserView (Page 4137)  
TubeTeeObject (Page 4128)  
TubePolyline (Page 4125)  
TubeDoubleTeeObject (Page 4123)  
TubeArcObject (Page 4121)  
Switch (Page 4089)  
Rectangle (Page 4072)  
MultiLineEdit (Page 4032)  
MediaPlayer (Page 4030)  
Line (Page 4025)  
Listbox (Page 4027)  
AlarmView (Page 3958)  
Circle (Page 3977)  
CircleSegment (Page 3979)  
CircularArc (Page 3982)  
Clock (Page 3984)

## Layer00Checked

### Description

TRUE, when limit 0 should be monitored. BOOLEAN write/read access.  
Limit value and representation are defined with the Layer00Value and Layer00Color properties.

## Layer00Color

### Description

Defines or returns the color for limit 0. LONG write/read access.  
When monitoring of the limit value is activated (Layer00Checked property), the bar turns to the color defined by this attribute on reaching the limit value.

## Layer00Value

### Description

Determines the value for "Limit 0" or returns it.  
Monitoring only takes effect when the Layer00Checked property value is set to TRUE.

## Layer01Checked

### Description

TRUE, when limit 1 should be monitored. BOOLEAN write/read access.  
Limit value and representation are defined with the Layer01Value and Layer01Color properties.

## Layer01Color

### Description

Defines or returns the color for limit 1. LONG write/read access.  
When monitoring of the limit value is activated (Layer01Checked property), the bar turns to the color defined by this attribute on reaching the limit value.

## **Layer01Value**

### **Description**

Determines the value for "Limit 1" or returns it.  
Monitoring only takes effect when the Layer01Checked property value is set to TRUE.

## **Layer02Checked**

### **Description**

TRUE, when limit 2 should be monitored. BOOLEAN write/read access.  
Limit value and representation are defined with the Layer02Value and Layer02Color properties.

## **Layer02Color**

### **Description**

Defines or returns the color for limit 2. LONG write/read access.  
When monitoring of the limit value is activated (Layer02Checked property), the bar turns to the color defined by this attribute on reaching the limit value.

## **Layer02Value**

### **Description**

Determines the value for "Limit 2" or returns it.  
Monitoring only takes effect when the Layer02Checked property value is set to TRUE.

## **Layer03Checked**

### **Description**

TRUE, when limit 3 should be monitored. BOOLEAN write/read access.  
Limit value and representation are defined with the Layer03Value and Layer03Color properties.

### Layer03Color

#### Description

Defines or returns the color for limit 3. LONG write/read access.  
When monitoring of the limit value is activated (Layer03Checked property), the bar turns to the color defined by this attribute on reaching the limit value.

### Layer03Value

#### Description

Determines the value for "Limit 3" or returns it.  
Monitoring only takes effect when the Layer03Checked property value is set to TRUE.

### Layer04Checked

#### Description

TRUE, when limit 4 should be monitored. BOOLEAN write/read access.  
Limit value and representation are defined with the Layer04Value and Layer04Color properties.

### Layer04Color

#### Description

Defines or returns the color for limit 4. LONG write/read access.  
When monitoring of the limit value is activated (Layer04Checked property), the bar turns to the color defined by this attribute on reaching the limit value.

### Layer04Value

#### Description

Determines the value for "Limit 4" or returns it.  
Monitoring only takes effect when the Layer04Checked property value is set to TRUE.

## Layer05Checked

### Description

TRUE, when limit 5 should be monitored. BOOLEAN write/read access.  
Limit value and representation are defined with the Layer05Value and Layer05Color properties.

## Layer05Color

### Description

Defines or returns the color for limit 5. LONG write/read access.  
When monitoring of the limit value is activated (Layer05Checked property), the bar turns to the color defined by this attribute on reaching the limit value.

## Layer05Value

### Description

Determines the value for "Limit 5" or returns it.  
Monitoring only takes effect when the Layer05Checked property value is set to TRUE.

## Layer06Checked

### Description

TRUE, when limit 6 should be monitored. BOOLEAN write/read access.  
Limit value and representation are defined with the Layer06Value and Layer06Color properties.

## Layer06Color

### Description

Defines or returns the color for limit 6. LONG write/read access.  
When monitoring of the limit value is activated (Layer06Checked property), the bar turns to the color defined by this attribute on reaching the limit value.

## Layer06Value

### Description

Determines the value for "Limit 6" or returns it.  
Monitoring only takes effect when the Layer06Checked property value is set to TRUE.

## Layer07Checked

### Description

TRUE, when limit 7 should be monitored. BOOLEAN write/read access.  
Limit value and representation are defined with the Layer07Value and Layer07Color properties.

## Layer07Color

### Description

Defines or returns the color for limit 7. LONG write/read access.  
When monitoring of the limit value is activated (Layer07Checked property), the bar turns to the color defined by this attribute on reaching the limit value.

## Layer07Value

### Description

Determines the value for "Limit 7" or returns it.  
Monitoring only takes effect when the Layer07Checked property value is set to TRUE.

## Layer08Checked

### Description

TRUE, when limit 8 should be monitored. BOOLEAN write/read access.  
Limit value and representation are defined with the Layer08Value and Layer08Color properties.



## Layer08Color

### Description

Defines or returns the color for limit 8. LONG write/read access.  
When monitoring of the limit value is activated (Layer08Checked property), the bar turns to the color defined by this attribute on reaching the limit value.

## Layer08Value

### Description

Determines the value for "Limit 8" or returns it.  
Monitoring only takes effect when the Layer08Checked property value is set to TRUE.

## Layer09Checked property

### Description

TRUE, when limit 9 should be monitored. BOOLEAN write/read access.  
Limit value and representation are defined with the Layer09Value and Layer09Color properties.

## Layer09Color

### Description

Defines or returns the color for limit 9. LONG write/read access.  
When monitoring of the limit value is activated (Layer09Checked property), the bar turns to the color defined by this attribute on reaching the limit value.

## Layer09Value

### Description

Determines the value for "Limit 9" or returns it.  
Monitoring only takes effect when the Layer09Checked property value is set to TRUE.

## Layer10Checked

### Description

TRUE, when limit 10 should be monitored. BOOLEAN write/read access.  
Limit value and representation are defined with the Layer10Value and Layer10Color properties.

## Layer10Color

### Description

Defines or returns the color for limit 10. LONG write/read access.  
When monitoring of the limit value is activated (Layer10Checked property), the bar turns to the color defined by this attribute on reaching the limit value.

## Layer10Value

### Description

Determines the value for "Limit 10" or returns it.  
Monitoring only takes effect when the Layer10Checked property value is set to TRUE.

## LayerDeclutteringEnable

### Description

Indicates whether the layers of a screen can be shown or hidden dependent on the set minimum and maximum zoom.

Access during runtime: Read

### Syntax

Object.LayerDeclutteringEnable

#### Object

Necessary. A "Screen" object.

### Example:

The example outputs the LayerDecluttering property of the "NewPDL1" screen as Trace.

```
'VBS156  
Dim objScreen
```

```
Set objScreen = HMIRuntime.Screens("NewPDL1")
HMIRuntime.Trace "Enable: " & objScreen.LayerDeclutteringEnable & vbNewLine
```

### See also

Screen (Page 3930)

### Layers

### Description

Returns an object of type "Layers".

Access in Runtime: Read

### Syntax

Object.**Layers**

#### Object

Required A "Screen" object.

### See also

Screen (Page 3930)

### LeaveMarginForBorder

### Description

Specifies whether an additional margin will be left for borders.

Access in Runtime: Read and write

### Syntax

Object.**LeaveMarginForBorder**[=BOOLEAN]

#### Object

Required A "ScreenItem" object with the format "Bar".

#### BOOLEAN

Optional TRUE, if an additional margin is enabled for borders.

## See also

Bar (Page 3961)

## LeaveMarginForMarkers

### Description

Specifies whether an additional margin will be left for markers.

Access in Runtime: Read and write

### Syntax

Object.**LeaveMarginForMarkers**[=BOOLEAN]

#### Object

Required A "ScreenItem" object with the format "Bar".

#### BOOLEAN

Optional TRUE, if an additional margin is enabled for markers.

## See also

Bar (Page 3961)

## Left

### Description

Specifies the value of the X coordinate of the selected object.

Access during runtime: Read and write

### Syntax

Object.**Left**[= DOUBLE]

#### Object

Necessary. A "ScreenItem" object. This property is a standard property of the ScreenItem-Objekts and is therefore available for all formats.

#### DOUBLE

Optional A value or a constant that contains the value of the X coordinate in pixels (measured from the top left edge of the screen).

## **Comments**

The X coordinate refers to the top left corner of the rectangle that surrounds the object. The screen limits are also monitored in runtime. If the assigned coordinate value exceeds the display size, the user-defined function is interrupted with an error message.

### **Used for the following object types:**

IOField

Rectangle

Slider

## See also

Line (Page 4025)  
Polyline (Page 4060)  
Ellipse (Page 3993)  
Circle (Page 3977)  
EllipseSegment (Page 3995)  
CircleSegment (Page 3979)  
EllipticalArc (Page 3998)  
CircularArc (Page 3982)  
Rectangle (Page 4072)  
Polygon (Page 4057)  
TextField (Page 4107)  
IOField (Page 4021)  
SymbolicIOField (Page 4093)  
Button (Page 3968)  
Switch (Page 4089)  
GraphicView (Page 4014)  
GraphicIOField (Page 4011)  
Bar (Page 3961)  
Clock (Page 3984)  
Gauge (Page 4008)  
Slider (Page 4082)  
SymbolLibrary (Page 4098)  
OnlineTrendControl (Page 4045)  
FunctionTrendControl (Page 4004)  
OnlineTableControl (Page 4037)  
AlarmControl (Page 3947)  
HTMLBrowser (Page 4019)  
CheckBox (Page 3974)  
OptionGroup (Page 4054)  
WindowSlider (Page 4139)  
Connector (Page 3986)  
ScreenWindow (Page 4078)  
DiskSpaceView (Page 3991)  
ChannelDiagnose (Page 3972)  
ScriptDiagnostics (Page 4080)  
Group (Page 4017)  
ForeignControl (Page 4000)  
DateTimeField (Page 3989)  
ProtectedAreaName (Page 4064)  
UIView (Page 4137)

## LeftComma property

### Description

Defines or returns the number of digits to the left of the decimal point (0 to 20).

## LeftOffset

### Description

Defines or returns the distance of the picture from the left edge of the picture window.

The picture is displayed as a cutout of the picture window. The picture scroll bars are located at the left and upper edge of the picture. If you wish to display the picture in the picture window by using the horizontal and vertical positioning of the picture scroll bars, use the properties "HorizontalScrollBarPosition" and "VerticalScrollBarPosition" for such positioning.

### See also

ScreenWindow (Page 4078)

## LightEffect property

### Description

TRUE, when the light effect should be activated. BOOLEAN write-read access.

## Limit4LowerLimit

### Description

Specifies the lower limit for ""Reserve4".

The "Limit4LowerLimitEnable" property must be set to TRUE so that the limit "Reserve4"" can be monitored.

Access in Runtime: Read and write

### Syntax

Object.Limit4LowerLimit[=Double]

#### Object

Required A "ScreenItem" object with the format "Bar".

#### Double

Optional A value or a constant that specifies the lower limit for "Reserve4".

## Comments

The "Limit4LowerLimitRelative" property specifies whether the object is evaluated as a percentage or absolutely.

## See also

Bar (Page 3961)

## Limit4LowerLimitColor

### Description

Specifies the color for the lower limit "Reserve4".

The "Limit4LowerLimitEnable" property must have the value TRUE if the bar color is to change once the limit has been reached.

Access in Runtime: Read and write

### Syntax

Object.Limit4LowerLimitColor[=Color]

#### Object

Required A ""ScreenItem" object with the format "Bar".

#### Color

Optional A value or a constant that specifies the color for the lower limit ""Reserve4".

## See also

Bar (Page 3961)

## Limit4LowerLimitEnabled

### Description

Specifies whether the lower limit ""Reserve4"" is to be monitored.

Access in Runtime: Read and write

### Syntax

Object.Limit4LowerLimitEnabled[=BOOLEAN]

#### Object

Required A "ScreenItem" object with the format "Bar".



## BOOLEAN

Optional TRUE, if the lower limit ""Reserve4" is to be monitored.

### Comments

The following values will be specified with the properties ""Limit4LowerLimit", "Limit4LowerLimitColor" and "Limit4LowerLimitRelative"":

Limit

Representation upon reaching the limit

Type of evaluation

### See also

Bar (Page 3961)

## Limit4LowerLimitRelative

### Description

Specifies whether the lower limit "Reserve4" is to be evaluated as a percentage or as an absolute value.

Access in Runtime: Read and write

### Syntax

Object.Limit4LowerLimitRelative[=BOOLEAN]

#### Object

Required A "ScreenItem" object with the format "Bar".

#### BOOLEAN

Optional. TRUE, if the lower limit "Reserve4" is to be evaluated as a percentage.

### See also

Bar (Page 3961)

## Limit4UpperLimit

### Description

Specifies the lower limit for "Reserve4".

The "Limit4UpperLimitEnable"" property must be set to TRUE so that the limit ""Reserve4" can be monitored.

Access in Runtime: Read and write

## Syntax

Object.Limit4UpperLimit[=Double]

### Object

Required A "ScreenItem" object with the format "Bar".

### Double

Optional A value or a constant that specifies the upper limit for "Reserve4".

## Comments

The "Limit4UpperLimitRelative" property specifies whether the object is evaluated as a percentage or absolutely.

## See also

Bar (Page 3961)

## Limit4UpperLimitColor

### Description

Specifies the color for the upper limit ""Reserve4".

The "Limit4UpperLimitEnable"" property must have the value TRUE if the bar color is to change once the limit has been reached.

Access in Runtime: Read and write

### Syntax

Object.Limit4UpperLimitColor[=Color]

### Object

Required A "ScreenItem" object with the format "Bar".

### Color

Optional A value or a constant that specifies the color for the upper limit "Reserve4".

## See also

Bar (Page 3961)

## Limit4UpperLimitEnabled

### Description

Specifies whether the upper limit "Reserve4" is to be monitored.

Access in Runtime: Read and write

### Syntax

Object.Limit4UpperLimitEnabled[=BOOLEAN]

#### Object

Required A "ScreenItem" object with the format "Bar".

#### BOOLEAN

Optional TRUE, if the upper limit "Reserve4" is to be monitored.

### Comments

The following values will be specified with the properties "Limit4UpperLimit", "Limit4UpperLimitColor" and "Limit4UpperLimitRelative":

Limit

Representation upon reaching the limit

Type of evaluation

### See also

Bar (Page 3961)

## Limit4UpperLimitRelative

### Description

Specifies whether the upper limit "Reserve4" is to be evaluated as a percentage or as an absolute value.

Access in Runtime: Read and write

### Syntax

Object.Limit4UpperLimitRelative[=BOOLEAN]

#### Object

Required A "ScreenItem" object with the format "Bar".

### **BOOLEAN**

Optional TRUE, if the upper limit "Reserve4" is to be evaluated as a percentage.

### **See also**

Bar (Page 3961)

## **Limit5LowerLimit**

### **Description**

Specifies the lower limit for "Reserve5".

The "Limit5LowerLimitEnable" property must be set to TRUE so that the limit ""Reserve5" can be monitored.

Access in Runtime: Read and write

### **Syntax**

Object.**Limit5LowerLimit**[=Double]

#### **Object**

Required A "ScreenItem" object with the format "Bar".

#### **Double**

Optional A value or a constant that specifies the lower limit for "Reserve5".

### **Comments**

The "Limit5LowerLimitRelative" property specifies whether the object is evaluated as a percentage or absolutely.

### **See also**

Bar (Page 3961)

## **Limit5LowerLimitColor**

### **Description**

Specifies the color for the lower limit ""Reserve5".

The "Limit5LowerLimitEnable" property must have the value TRUE if the bar color is to change once the limit has been reached.

Access in Runtime: Read and write

## Syntax

Object.Limit5LowerLimitColor[=Color]

### Object

Required A "ScreenItem" object with the format "Bar".

### Color

Optional A value or a constant that specifies the color for the lower limit ""Reserve5".

## See also

Bar (Page 3961)

## Limit5LowerLimitEnabled

### Description

Specifies whether the lower limit "Reserve5" is to be monitored.

Access in Runtime: Read and write

### Syntax

Object.Limit5LowerLimitEnabled[=BOOLEAN]

### Object

Required A "ScreenItem" object with the format "Bar".

### BOOLEAN

Optional TRUE, if the lower limit ""Reserve5" is to be monitored.

## Comments

The following values will be defined using the properties "Limit5LowerLimit", "Limit5LowerLimitColor" and "Limit5LowerLimitRelative":

Limit

Representation upon reaching the limit

Type of evaluation

## See also

Bar (Page 3961)

## Limit5LowerLimitRelative

### Description

Specifies whether the lower limit "Reserve5" is to be evaluated as a percentage or as an absolute value.

Access in Runtime: Read and write

### Syntax

Object.Limit5LowerLimitRelative[=BOOLEAN]

#### Object

Required A "ScreenItem" object with the format "Bar".

#### BOOLEAN

Optional TRUE, if the lower limit "Reserve5" is to be evaluated as a percentage.

### See also

Bar (Page 3961)

## Limit5UpperLimit

### Description

Specifies the lower limit for "Reserve5".

The "Limit5UpperLimitEnable" property must be set to TRUE so that the limit "Reserve5" can be monitored.

Access in Runtime: Read and write

### Syntax

Object.Limit5UpperLimit[=Double]

#### Object

Required A "ScreenItem" object with the format "Bar".

#### Double

Optional A value or a constant that specifies the upper limit for "Reserve5".

### Comments

The "TypeLimitHigh5" property specifies whether the object is evaluated as a percentage or absolutely.

## See also

Bar (Page 3961)

## Limit5UpperLimitColor

### Description

Specifies the color for the upper limit "Reserve5".

The "Limit5UpperLimitEnable" property must have the value TRUE if the bar color is to change once the limit has been reached.

Access in Runtime: Read and write

### Syntax

Object.Limit5UpperLimitColor[=Color]

#### Object

Required A "ScreenItem" object with the format "Bar".

#### Color

Optional A value or a constant that specifies the color for the upper limit ""Reserve5".

## See also

Bar (Page 3961)

## Limit5UpperLimitEnabled

### Description

Specifies whether the upper limit "Reserve5" is to be monitored.

Access in Runtime: Read and write

### Syntax

Object.Limit5UpperLimitEnabled[=BOOLEAN]

#### Object

Required A "ScreenItem" object with the format "Bar".

#### BOOLEAN

Optional TRUE, if the upper limit ""Reserve5"" is to be monitored.

## See also

Bar (Page 3961)

## Limit5UpperLimitRelative

### Description

Specifies whether the upper limit "Reserve5" is to be evaluated as a percentage or as an absolute value.

Access in Runtime: Read and write

### Syntax

Object.Limit5UpperLimitRelative[=BOOLEAN]

#### Object

Required A "ScreenItem" object with the format "Bar".

#### BOOLEAN

Optional TRUE, if the upper limit "Reserve5" is to be evaluated as a percentage.

## See also

Bar (Page 3961)

## LimitHigh4

### Description

Determines the upper limit value for "Reserve 4" or returns it.

The CheckLimitHigh4 property must be set to TRUE in order that the "Reserve 4" limit value can be monitored.

The type of the evaluation (in percent or absolute) is defined in the TypeLimitHigh4 property.

## LimitHigh5

### Description

Determines the upper limit value for "Reserve 5" or returns it.

The CheckLimitHigh5 property must be set to TRUE in order that the "Reserve 5" limit value can be monitored.

The type of the evaluation (in percent or absolute) is defined in the TypeLimitHigh5 property.



## LimitLow4

### Description

Determines the lower limit value for "Reserve 4" or returns it.  
The CheckLimitLow4 property must be set to TRUE in order that the "Reserve 4" limit value can be monitored.  
The type of the evaluation (in percent or absolute) is defined in the TypeLimitLow4 property.

## LimitLow5

### Description

Determines the lower limit value for "Reserve 5" or returns it.  
The CheckLimitLow5 property must be set to TRUE in order that the "Reserve 5" limit value can be monitored.  
The type of the evaluation (in percent or absolute) is defined in the TypeLimitLow5 property.

## LimitMax

### Description

Determines the upper limit value as an absolute value depending on the data format or returns it.  
If the displayed value exceeds the upper limit value, it is displayed by a sequence of \*\*\* (not displayable).

## LimitMin

### Description

Determines the lower limit value as an absolute value depending on the data format or returns it.  
If the displayed value exceeds the upper limit value, it is displayed by a sequence of \*\*\* (not displayable).

## LineColor

### Description

Specifies the color of the window dividers. The button opens the "Color selection" dialog.

## **See also**

AlarmControl (Page 3947)

UserArchiveControl (Page 4130)

TrendRulerControl (Page 4110)

FunctionTrendControl (Page 4004)

OnlineTableControl (Page 4037)

OnlineTrendControl (Page 4045)

## **LineendShapeStyle**

### **Description**

Specifies the shape of the line end.

## See also

CheckBox (Page 3974)  
GraphicIOField (Page 4011)  
Button (Page 3968)  
Bar (Page 3961)  
WindowSlider (Page 4139)  
Switch (Page 4089)  
Rectangle (Page 4072)  
MultiLineEdit (Page 4032)  
Line (Page 4025)  
Listbox (Page 4027)  
Circle (Page 3977)  
CircleSegment (Page 3979)  
CircularArc (Page 3982)  
Connector (Page 3986)  
Ellipse (Page 3993)  
EllipseSegment (Page 3995)  
EllipticalArc (Page 3998)  
GraphicView (Page 4014)  
Polygon (Page 4057)  
Polyline (Page 4060)  
RoundButton (Page 4074)  
SymbolicIOField (Page 4093)  
IOField (Page 4021)  
TextField (Page 4107)  
OptionGroup (Page 4054)

## LineWidth

### Description

Specifies the line weight of the selected object.

Access in Runtime: Read and write

### Syntax

Object.LineWidth [= LONG]

**Object**

Required A "ScreenItem" object with the formats "Line" "Polyline", "EllipticalArc", "CircularArc" or "Connector".

**LONG**

Optional A value or a constant that specifies the line weight in pixels.

**See also**

- Line (Page 4025)
- Polyline (Page 4060)
- EllipticalArc (Page 3998)
- CircularArc (Page 3982)
- Connector (Page 3986)
- AlarmControl (Page 3947)
- TubeTeeObject (Page 4128)
- TubePolyline (Page 4125)
- TubeDoubleTeeObject (Page 4123)
- TubeArcObject (Page 4121)
- UserArchiveControl (Page 4130)
- TrendRulerControl (Page 4110)
- FunctionTrendControl (Page 4004)
- OnlineTableControl (Page 4037)

**LineWidth**

**Description**

Determines the LineWidth of the given object.

Access during runtime: Read and Write

**Syntax**

Object.LineWidth [= LONG]

**Object**

Required. An object of the "ScreenItem" type with the characteristic "Line," or "Polyline".

**LONG**

Optional. A value or constant which determines the line width in pixels.

## See also

OnlineTrendControl (Page 4045)

## ListType property

### Description

Returns the data type displayed in the case of a text list object. Read only access.

Value range from 0 to 2.

0 = decimal

1 = binary

2 = bit

## LoadDataImmediately

### Description

Specifies whether in the event of a screen impact the tag values should be downloaded from the archives for the time range that is to be shown.

Access in Runtime: Read and write

### Syntax

Object.**LoadDataImmediately**[=BOOLEAN]

#### Object

Required An object of the "ScreenItem" type with the format "OnlineTrendControl", "FunctionTrendControl" or "OnlineTableControl" (Runtime Professional) or "HMITrendView" (Runtime Advanced).

#### BOOLEAN

Optional TRUE, if in the event of a screen impact the tag values should be downloaded from the archives for the time range that is to be shown.

## See also

OnlineTrendControl (Page 4045)

FunctionTrendControl (Page 4004)

OnlineTableControl (Page 4037)

## Localizable

### Description

Specifies whether a font should be assigned and can be formatted for each Runtime language.

Access in Runtime: Read and write

### Syntax

Object.**Localizable**[=BOOLEAN]

#### Object

Required An object of the "ScreenItem" type with the format "OnlineTrendControl", "FunctionTrendControl", "OnlineTableControl", "AlarmControl" or "UserArchiveControl".

#### BOOLEAN

Optional TRUE, if a font should be assigned and can be formatted for each Runtime language.

### See also

OnlineTrendControl (Page 4045)

FunctionTrendControl (Page 4004)

OnlineTableControl (Page 4037)

AlarmControl (Page 3947)

## LocalCursor

### Description

Establishes whether the cursor data is transferred separately in order to increase the performance.

### Syntax

Object.**LocalCursor**

#### Object

Required A "ScreenItem" object with the format "SmartClientView".

### See also

SmartClientView (Page 4085)

## LockSquaredExtent

### Description

Specifies whether the size of the clock can be adjusted with the mouse.

Access in Runtime: Read and write

### Syntax

Object.**LockSquaredExtent**[=BOOLEAN]

#### Object

Required A "ScreenItem" object with the formats "Clock" or "Gauge".

#### BOOLEAN

Optional TRUE, if the size of the clock can be adjusted by dragging the mouse on the selection points to the desired aspect ratio.

### See also

Clock (Page 3984)

Gauge (Page 4008)

## LockStatus

### Description

TRUE, when a locked measuring point should be displayed. BOOLEAN write-read access.

## LockText

### Description

Defines the label of a button for a locked measuring point.

The LockStatus property must be set to TRUE for the label to be displayed.

## LockTextColor

### Description

Defines or returns the color of the button label for a locked measuring point. LONG write/read access.

The LockStatus property must be set to TRUE for the background color to be displayed.

## Logging

### Description

Returns an object of type "Logging".

Access in Runtime: Read

### Syntax

Object.**Logging**

#### Object

Required A "HMIRuntime" object.

### See also

HMIRuntime (Page 3922)

## LogOperation

### Description

Specifies whether, after operating this object, an alarm is output on the alarm system.

Access in Runtime: Read and write

### Syntax

Object.**LogOperation**[=BOOLEAN]

#### Object

Required A "ScreenItem" object with the formats "IOField", "SymbolicIOField", "CheckBox", "OptionGroup" or "WindowSlider".

#### BOOLEAN

Optional. TRUE, if, after operating this object, an alarm is output on the alarm system.

### See also

IOField (Page 4021)

SymbolicIOField (Page 4093)

CheckBox (Page 3974)

OptionGroup (Page 4054)

WindowSlider (Page 4139)

Listbox (Page 4027)



## LongStrokesBold

### Description

TRUE, when the long sections of a scale should be displayed in bold face. BOOLEAN write-read access.

## LongStrokesOnly

### Description

TRUE, when only the long sections of a scale should be displayed . BOOLEAN write-read access.

## LongStrokesSize

### Description

Defines or returns the length of the axis section in pixels.

## LongStrokesTextEach

### Description

Returns the value which defines which sections of the scale displayed should be labeled (1 = every section, 2 = every second section, etc.). Read only access

## LongTermArchiveConsistency

## LongTermArchiveConsistency

If "LongTimeArchiveConsistency" is set to "No", 1000 messages are displayed in the long-term archive list on the single-user system, server or client for each server, or for each redundant server pair.

If the "LongTimeArchiveConsistency" is set to "yes", the most recent 1000 messages are displayed on the client of all servers or redundant server pair in the long-term archive list.

The attribute can be assigned dynamic properties by means of the name **LongTimeArchiveConsistency** .

### See also

AlarmControl (Page 3947)

## LowerLimit

### Description

Specifies the lower limit for input values.

Access in Runtime: Read and write

### Syntax

Object.**LowerLimit**[=Double]

#### Object

Required A "ScreenItem" object with the format "IOField".

#### Double

Optional A value or a constant that specifies the lower limit for input values.

### See also

IOField (Page 4021)

## LowerLimitColor(i)

### Description

Specifies the color that identifies the tag values for the selected trend and which lie below the value of "LowerLimitValue(i)". Whether the information is evaluated depends on the property "LowerLimitEnabled(i)".

Access in Runtime: Read and write

### Syntax

Object.**LowerLimitColor**(i)[=Color]

#### Object

Required An object of the "ScreenItem" type with the format "OnlineTrendControl", "FunctionTrendControl" or "OnlineTableControl".

#### Color

Optional A value or a constant which specifies the color which identifies tag values of the specified trend which are below the value of "LowerLimitValue(i)".

### Comments

The parameter i indicates the number of the trend.

## See also

OnlineTrendControl (Page 4045)

FunctionTrendControl (Page 4004)

OnlineTableControl (Page 4037)

## LowerLimitEnabled(i)

### Description

Specifies whether the information from "LowerLimitColor(i)" is used to identify the tag values that lie beneath the value of "LowerLimitValue(i)".

Access in Runtime: Read and write

### Syntax

Object.**LowerLimitEnabled(i)**[=BOOLEAN]

#### Object

Required An object of the "ScreenItem" type with the format "OnlineTrendControl", "FunctionTrendControl" or "OnlineTableControl".

#### BOOLEAN

Optional TRUE, if the information from "LowerLimitColor(i)" is used to identify the tag values that lie beneath the value of "LowerLimitValue(i)".

### Comments

The parameter i indicates the number of the trend.

## See also

OnlineTrendControl (Page 4045)

FunctionTrendControl (Page 4004)

OnlineTableControl (Page 4037)

## LowerLimitValue(i)

### Description

Specifies whether the tag values which drop below the value of "LowerLimitValue(i)" are marked by the color specified in "LowerLimitColor(i)". Whether the specification is evaluated depends on the attribute "LowerLimitEnabled(i)".

Access in Runtime: Read and write

## Syntax

Object.LowerLimitValue(i)[=Double]

### Object

Required An object of the "ScreenItem" type with the format "OnlineTrendControl" or "FunctionTrendControl".

### Double

Optional A value or a constant that determines if the tag values that fall short of the "LowerLimitValue(i)" are to be identified with the color specified in "LowerLimitColor(i)".

## Comments

The parameter i indicates the number of the trend.

## See also

OnlineTrendControl (Page 4045)

FunctionTrendControl (Page 4004)

## LowLimitColor

## Description

Specifies the color of the bottom or left scroll button in a scroll bar.

Access in Runtime: Read and write

## Syntax

Object.LowLimitColor[=Color]

### Object

Required A "ScreenItem" object with the format "WindowSlider".

### Color

Optional A value or a constant that specifies the color of the bottom or left scroll button in a scroll bar.

## See also

WindowSlider (Page 4139)

## Properties M-N

### MachineName

#### Description

Specifies the network code of the device that is to be monitored.

Enter the name or the port of the device as the network code.

Access in Runtime: Read and write

#### Syntax

Object.**MachineName**= [STRING]

##### Object

Required A "ScreenItem" object with the format "SmartClientView".

##### STRING

Optional A value or a constant that contains the network code.

#### See also

SmartClientView (Page 4085)

### MarginToBorder

#### Description

Specifies the width of the 3D border in pixels. The value of the width is dependent on the size of the object.

Access in Runtime: Read and write

#### Syntax

Object.**MarginToBorder**[=Int]

##### Object

Required A ""ScreenItem" object with the format "WindowSlider".

##### Int

Optional A value or a constant that specifies the width of the 3D border in pixels.

## See also

WindowSlider (Page 4139)

## Marker property

### Description

TRUE, when the limit values should be displayed as scale values. BOOLEAN write-read access.

## Max property

### Description

Defines or returns the absolute value in the case of a full value display. This value is displayed if the scale display is active.

## MaximizeButton property

### Description

TRUE, when the object can be maximized in Runtime. Read only access.

## MaximumValue

### Description

Specifies the maximum value of the scale in the selected object.

Access in Runtime: Read and write

## Syntax

Object.MaximumValue [= DOUBLE]

### Object

Required A "ScreenItem" object with the formats "Bar", "Gauge", "Slider" or "WindowSlider".

### DOUBLE

Optional A value or a constant that specifies the maximum value.

## See also

Bar (Page 3961)  
Gauge (Page 4008)  
Slider (Page 4082)  
WindowSlider (Page 4139)

## MaximumValue

### Description

Determines the maximum value of the scale in the given object.  
Access during runtime: Read and Write

### Syntax

Object.MaximumValue [= DOUBLE]

#### Object

Required. An object of the type "ScreenItem" with the characteristic "Bar", "Gauge" or "Slider".

#### DOUBLE

Optional. A value or constant which determines the maximum value.

## MCGUBBackColorOff

### Description

Defines or returns the background color for flash status "Off" in the case of the "Departed Unacknowledged" status. LONG write-read access.

## MCGUBBackColorOn

### Description

Defines or returns the background color for flash status "On" in the case of the "Departed Unacknowledged" status. LONG write-read access.

## MCGUBBackFlash

### Description

TRUE, when the background should flash when a message departs unacknowledged.  
BOOLEAN write-read access.

## MCGUTextColorOff

### Description

Defines or returns the color of the text for flash status "Off" for the "Outgoing unacknowledged" status. LONG write-read access.

## MCGUTextColorOn

### Description

Defines or returns the background color of the text for flash status "On" for the "Outgoing unacknowledged" status. LONG write-read access.

## MCGUTextFlash

### Description

TRUE, when the font should flash when a message departs unacknowledged. BOOLEAN write-read access.

## MCKOBackColorOff

### Description

Defines or returns the background color for flash status "Off" in the case of the "Arrived" status. LONG write-read access.

## MCKOBackColorOn

### Description

Defines or returns the background color for flash status "On" in the case of the "Arrived" status. LONG write-read access.

## MCKOBackFlash

### Description

TRUE, when the background should flash when a message arrives. BOOLEAN write-read access.



## MCKOTextColorOff

### Description

Defines or returns the color of the text for flash status "Off" for the "Incoming" status. LONG write-read access.

## MCKOTextColorOn

### Description

Defines or returns the background color of the text for flash status "On" for the "Incoming" status. LONG write-read access.

## MCKOTextFlash

### Description

TRUE, when the font should flash when a message arrives. BOOLEAN write-read access.

## MCKQBackColorOff

### Description

Defines or returns the background color for flash status "Off" in the case of the "Departed Acknowledged" status. LONG write-read access.

## MCKQBackColorOn

### Description

Defines or returns the background color for flash status "On" in the case of the "Departed Acknowledged" status. LONG write-read access.

## MCKQBackFlash

### Description

TRUE, when the background should flash when a message departs acknowledged. BOOLEAN write-read access.

## MCKQTextColorOff

### Description

Defines or returns the color of the text for flash status "Off" for the "Outgoing acknowledged" status. LONG write-read access.

## MCKQTextColorOn

### Description

Defines or returns the background color of the text for flash status "On" for the "Outgoing acknowledged" status. LONG write-read access.

## MCKQTextFlash

### Description

TRUE, when the font should flash when a message departs acknowledged. BOOLEAN write-read access.

## MCText

### Description

Defines or returns the label for the respective message class.

## MenuToolBarConfig

### Description

Loads the given configuration file with configured menu and toolbars or returns the name of the configuration file.

Access in Runtime: Read and write

### Syntax

Object.**MenuToolBarConfig**[=STRING]

#### Object

Required A "HMIRuntime" object.

#### STRING

Optional The configuration file with user-defined menu and toolbars.

**See also**

HMIRuntime (Page 3922)

ScreenWindow (Page 4078)

**MessageBlockAlign****Description**

Aligns the contents of a selected message block in the table.

Access in Runtime: Read and write

**Syntax**Object.**MessageBlockAlign** [=Align]**Object**

Required An object of the "ScreenItem" type with the format "AlarmControl", "TrendRulerControl", "OnlineTableControl", "UserArchiveControl".

**Align**

Value	Description	Explanation
0	Left	Aligns the contents of a selected message block to the left.
1	Centered	Aligns the contents of a selected message block to the center.
2	Right	Aligns the contents of a selected message block to the right.

**See also**

AlarmControl (Page 3947)

**MessageBlockAutoPrecisions****Description**

Enables automatic setting of the number of decimal places.

Access in Runtime: Read and write

**Syntax**Object.**MessageBlockAutoPrecisions**[=BOOLEAN]**Object**

Required A "ScreenItem" object with the format "AlarmControl".

## **BOOLEAN**

TRUE: The number of decimal places is specified automatically.

FALSE: The value in the "Decimal places" field is effective.

### **See also**

AlarmControl (Page 3947)

## **MessageBlockCaption**

### **Description**

Specifies the caption of the column header in the message view for the selected message block. You can only edit the labels after having disabled the "Apply project settings" option. The entered caption is effective in all Runtime languages.

Access in Runtime: Read and write

### **Syntax**

Object.**MessageBlockCaption**

#### **Object**

Required A "ScreenItem" object with the format "AlarmControl".

### **See also**

AlarmControl (Page 3947)

## **MessageBlockCount**

### **Description**

Specifies the number of available message blocks which are available for the message list and hit list.

Access in Runtime: Read

### **Syntax**

Object.**MessageBlockCount**

#### **Object**

Required A "ScreenItem" object with the format "AlarmControl".

**See also**

AlarmControl (Page 3947)

**MessageBlockDateFormat****Description**

Defines the date format for displaying messages.

Access in Runtime: Read and write

**Syntax**

Object.**MessageBlockDateFormat**[=DateFormat]

**Object**

Required A "ScreenItem" object with the format "AlarmControl".

**DateFormat**

Value	Description
Automatic	The date format is set automatically.
dd.MM.yy	Day.Month.Year, e.g. 24.12.10.
dd.MM.yyyy	Day.Month.Year, e.g. 24.12.2010.
dd/MM/yy	Day/Month/Year, e.g. 24/12/10.
dd/MM/yyyy	Day/Month/Year, e.g. 24/12/2010.

**See also**

AlarmControl (Page 3947)

**MessageBlockExponentialFormat****Description**

Specifies the exponential notation for visualization of the values of a selected message block.

Access in Runtime: Read and write

**Syntax**

Object.**MessageBlockExponentialFormat**[=BOOLEAN]

**Object**

Required A "ScreenItem" object with the format "AlarmControl".

### **BOOLEAN**

TRUE: The values are displayed in exponential format.

FALSE: The values are displayed in decimal format.

### **See also**

AlarmControl (Page 3947)

## **MessageBlockFlashOn**

### **Description**

Enables flashing of the selected message block in Runtime after a message was activated.

Access in Runtime: Read and write

### **Syntax**

Object.**MessageBlockFlashOn**[=BOOLEAN]

#### **Object**

Required A "ScreenItem" object with the format "AlarmControl".

### **BOOLEAN**

TRUE: The content of the message block flashes.

FALSE: The content of the message block does not flash.

### **See also**

AlarmControl (Page 3947)

## **MessageBlockHideText**

### **Description**

Enables the textual display of the content of a selected message block.

Access in Runtime: Read and write

### **Syntax**

Object.**MessageBlockHideText**[=BOOLEAN]

#### **Object**

Required A "ScreenItem" object with the format "AlarmControl".

## **BOOLEAN**

TRUE: The content is not shown as a text. The option is not activated.

FALSE: The content is shown as a text. The option is activated.

### **See also**

AlarmControl (Page 3947)

## **MessageBlockHideTitleText**

### **Description**

Enables the display of the header of a selected message block in text format.

### **Syntax**

Object.**MessageBlockHideTitleText**=[BOOLEAN]

#### **Object**

Required A "ScreenItem" object with the format "AlarmControl".

## **BOOLEAN**

TRUE : The header is not shown as a text. The option is not activated.

FALSE : The header is shown as a text. The option is activated.

### **See also**

AlarmControl (Page 3947)

## **MessageBlockId**

### **Description**

Specified assignment of ID number and message block in the message view.

Access in Runtime: Read

### **Syntax**

Object.**MessageBlockID**

#### **Object**

Required A "ScreenItem" object with the format "AlarmControl".

## See also

AlarmControl (Page 3947)

## MessageBlockIndex

### Description

References an existing message block. You can assign the values of other attributes to a certain message block by using the attribute. Valid values for "MessageBlockIndex" are between 0 and "MessageBlockCount" minus 1.

The "MessageBlockIndex" attribute can be dynamized by the **MessageBlockRepos** attribute.

Access in Runtime: Read

### Syntax

Object.**MessageBlockIndex**

#### Object

Required A "ScreenItem" object with the format "AlarmControl".

## See also

AlarmControl (Page 3947)

## MessageBlockLeadingZeros

### Description

Enables the display of selected message blocks with leading zero format.

Access in Runtime: Read and write

### Syntax

Object.**MessageBlockLeadingZeros**[=BOOLEAN]

#### Object

Required A "ScreenItem" object with the format "AlarmControl".

#### BOOLEAN

TRUE: Leading zeros are displayed. The number of leading zeros is specified in the properties.

FALSE: Leading zeros are not displayed.



## See also

AlarmControl (Page 3947)

## MessageBlockLength

### Description

Defines the length of the message block selected based on the number of characters. You can only enter a value if the "Apply project settings" field is disabled.

Access in Runtime: Read and write

### Syntax

Object.**MessageBlockLength**[=Int]

#### Object

Required A "ScreenItem" object with the format "AlarmControl".

#### Int

Value which specifies the length of the message block.

## See also

AlarmControl (Page 3947)

## MessageBlockName

### Description

Displays the object name of the message block selected. You cannot edit this name.

Access in Runtime: Read

### Syntax

Object.**MessageBlockName**

#### Object

Required A "ScreenItem" object with the format "AlarmControl".

## See also

AlarmControl (Page 3947)

## MessageBlockPrecisions

### Description

Specifies the decimal precision of the values of a selected message block. You can only enter the value if the "Automatic" option is deactivated.

Access in Runtime: Read and write

### Syntax

Object.**MessageBlockPrecisions**[=Precision]

#### Object

Required A "ScreenItem" object with the format "AlarmControl".

#### Precision

Number of decimal places

### See also

AlarmControl (Page 3947)

## MessageBlockSelected

### Description

The available message block can be used in Runtime control for the message list or hitlist.

Select the "Message blocks" tab to activate existing message blocks as required in the Control. Select the "Hitlist" and "Message list" tabs to configure the hitlist and message list based on the available blocks.

### Syntax

Object.**MessageBlockSelected**]

#### Object

Required A "ScreenItem" object with the format "AlarmControl".

### See also

AlarmControl (Page 3947)

## MessageBlockShowDate

### Description

Enables the display of a date in the "Time" message block in addition to the time.

Access in Runtime: Read and write

### Syntax

Object.**MessageBlockFlashOn**[=BOOLEAN]

#### Object

Required A "ScreenItem" object with the format "AlarmControl".

#### BOOLEAN

TRUE: The date and the time are displayed.

FALSE: The time is displayed.

### See also

AlarmControl (Page 3947)

## MessageBlockShowIcon

### Description

Enables the display of the content of a selected message block as icon.

Access in Runtime: Read and write

### Syntax

Object.**MessageBlockShowIcon**[=BOOLEAN]

#### Object

Required A "ScreenItem" object with the format "AlarmControl".

#### BOOLEAN

TRUE: The content is shown as an icon.

FALSE: The content is not shown as an icon.

### See also

AlarmControl (Page 3947)

## MessageBlockShowTitleIcon

### Description

Specifies whether the header of the selected message block is displayed as a text.

### Syntax

Object.**MessageBlockShowTitleIcon**=[BOOLEAN]

#### Object

Required A "ScreenItem" object with the format "AlarmControl".

#### BOOLEAN

TRUE : The header is shown as an icon.

FALSE : The header is not shown as an icon.

### See also

AlarmControl (Page 3947)

## MessageBlockTextId

### Description

Specifies the caption of the selected message block using a Text ID which was derived from the text library. The caption is adapted automatically if a user changes the Runtime language.

You can only enter a text ID after having disabled the "Apply project settings" option.

Access in Runtime: Read and write

### Syntax

Object.**MessageBlockTextId**

#### Object

Required A "ScreenItem" object with the format "AlarmControl".

### See also

AlarmControl (Page 3947)

## MessageBlockTimeFormat

### Description

Defines which time format or duration format is used for displaying the messages.

Access in Runtime: Read and write

### Syntax

Object.**MessageBlockTimeFormat**[=TimeFormat]

#### Object

Required A "ScreenItem" object with the format "AlarmControl".

#### TimeFormat

The following time formats are available:

Value	Explanation
Automatic	The time format is set automatically.
HH:mm:ss	Hours:Minutes:Seconds, e.g. 15:35:44
HH:mm:ss.ms	Hours:Minutes:Seconds.Milliseconds, e.g. 15:35:44.240.
hh:mm:ss tt	Hours:Minutes:Seconds AM/PM, e.g. 03:35:44 PM.
hh:mm:ss.ms tt	Hours:Minutes:Seconds.Milliseconds AM/PM, e.g. 03:35:44.240 PM.

The following duration formats are available:

Value	Explanation
Automatic	The duration format is determined automatically.
d H:mm:ss	Day Hours:Minutes:Seconds, e.g. 1 2:03:55.
H:mm:ss.	Hours:Minutes:Seconds, e.g. 26:03:55.
m:ss	Minutes:Seconds, Example: 1563:55.
s	Seconds, e.g. 93835.

### See also

AlarmControl (Page 3947)

## MessageBlockType

### Description

Specifies the number of available message blocks which are available for the message list and hit list.

Access in Runtime: Read and write

## Syntax

Object.**MessageBlockType**[=BlockType]

### Object

Required A "ScreenItem" object with the format "AlarmControl".

### BlockType

Value	Description	Description
0	System block	The message block belongs to the system block category
1	Text block	The message block belongs to the user text block category
2	Process value block	The message block belongs to the process value block category
3	Hitlist block	The message block belongs to the message blocks of the hitlist.

## See also

AlarmControl (Page 3947)

## MessageClass

### Description

Defines the respective limit violation (Alarm High, Alarm Low, Warning High, Warning Low, etc.) for which the "Display Text", "Incoming -", "Incoming acknowledged -", and "Outgoing unacknowledged -" settings have been configured.

## MessageColumnAdd

### Description

Adds the selected message block from the list of existing message blocks to the list of selected message blocks.

Access in Runtime: Read

## Syntax

Object.**MessageColumnAdd**

### Object

Required A "ScreenItem" object with the format "AlarmControl".

## See also

AlarmControl (Page 3947)

## MessageColumnCount

### Description

Specifies the number of message blocks to be displayed in the message list in Runtime.

Access in Runtime: Read

### Syntax

Object.**MessageColumnCount**

#### Object

Required A "ScreenItem" object with the format "AlarmControl".

## See also

AlarmControl (Page 3947)

## MessageColumnIndex

### Description

References a message block selected for the message list. Using this attribute you can assign the values of other attributes to a specific message block of the message list.

Valid values for "MessageColumnIndex" are between 0 and "MessageColumnCount" minus 1. The "MessageColumnIndex" attribute can be dynamized by the attribute **MessageColumnRepos**.

Access in Runtime: Read and write

### Syntax

Object.**MessageColumnIndex**

#### Object

Required A "ScreenItem" object with the format "AlarmControl".

## See also

AlarmControl (Page 3947)

## MessageColumnName

### Description

Shows the name of the message block in the message list which is referenced with the "MessageColumnIndex" property. You cannot edit this name.

Access in Runtime: Read

### Syntax

Object.**MessageColumnName**

#### Object

Required A "ScreenItem" object with the format "AlarmControl".

### See also

AlarmControl (Page 3947)

## MessageColumnRemove

### Description

Removes the marked message block from the list of selected message blocks and inserts it in the list of existing message blocks.

Access in Runtime: Read and write

### Syntax

Object.**MessageColumnRemove**

#### Object

Required A "ScreenItem" object with the format "AlarmControl".

### See also

AlarmControl (Page 3947)



## MessageColumnRepos

### Description

Resorts the message blocks. The "Up" and "Down" commands move the selected message block accordingly in the list. This places the message block further forward or back in the message view in Runtime.

### Syntax

Object.**MessageColumnRepos**

Object.**HitlistColumnRepos**

#### Object

Required A "ScreenItem" object with the format "AlarmControl".

### See also

AlarmControl (Page 3947)

## MessageColumnSort

### Description

Defines the sorting order of the message block referenced in "MessageColumnIndex" .

Access in Runtime: Read and write

### Syntax

Object.MessageColumnSort [=Sort]

#### Object

Required A "ScreenItem" object with the format "AlarmControl".

#### Sort

0: No sorting.

1: Ascending sorting from the lowest to highest value

2 Descending sorting from the highest to lowest value

### See also

AlarmControl (Page 3947)

## MessageColumnSortIndex

### Description

Defines the sorting order of the message block referenced in "MessageColumnIndex". The sorting criterion is removed from "MessageColumnSort" if you set a "0" value.

Access in Runtime: Read and write

### Syntax

Object.**MessageColumnSortIndex**

#### Object

Required A "ScreenItem" object with the format "AlarmControl".

### See also

AlarmControl (Page 3947)

## MessageColumnVisible

### Description

The selected message blocks of the message list or hit list which are used in Runtime in the message view are displayed in the list.

### Syntax

Object.**HitlistColumnVisible**

Object.**MessageColumnVisible**

#### Object

Required A "ScreenItem" object with the format "AlarmControl".

### See also

AlarmControl (Page 3947)

## MessageListType

### Description

Selection field for defining the active list for picture calls.

**Syntax**

Object.**MessageListType**=[ListType]

**Object**

Required A "ScreenItem" object with the format "AlarmControl".

**ListType**

Value	Description	Description
0	Message list	The currently active messages are displayed after a picture was called.
1	Short-term archive list	A short-term archive list displays the logged messages after the picture was called. The display is updated immediately on activation of new messages.
2	Long-term archive list	A long-term archive list displays the logged messages after a picture was called.
3	Lock list	Only the currently locked messages are displayed after a picture was called.
4	Hitlist	The configured statistics data is displayed after a picture was called.
5	List of messages to be hidden	The messages to be hidden are displayed at the call of a picture.

**See also**

AlarmControl (Page 3947)

**Min****Description**

Defines or returns the absolute value in the case of the smallest value display. This value is displayed if the scale display is active.

**MinimumValue****Description**

Specifies the minimum value of the scale in the selected object.

Access in Runtime: Read and write

**Syntax**

Object.MinimumValue [= DOUBLE]

**Object**

Required A "ScreenItem" object with the formats "Bar", "Gauge", "Slider" or "WindowSlider".

**DOUBLE**

Optional A value or a constant that specifies the minimum value.

**See also**

Bar (Page 3961)

Gauge (Page 4008)

Slider (Page 4082)

WindowSlider (Page 4139)

**MinimumValue**

**Description**

Determines the minimum value of the scale in the given object.

Access during runtime: Read and Write

**Syntax**

Object.MinimumValue [= DOUBLE]

**Object**

Required. An object of the type "ScreenItem" with the characteristic "Bar", "Gauge" or "Slider".

**DOUBLE**

Optional. A value or constant which determines the minimum value.

**MinuteNeedleHeight**

**Description**

Specifies the length of the minute hand in the ""Clock" object.

Access in Runtime: Read and write

**Syntax**

Object.MinuteNeedleHeight[= LONG]

**Object**

Required A "ScreenItem" object with the format "Clock".

### **LONG**

Optional A value or a constant that specifies the length of the minute hand.

Specify the length of the minute hand as a percentage relating to the radius of the clock face.

### **See also**

Clock (Page 3984)

## **MinuteNeedleWidth**

### **Description**

Specifies the width of the minute hand in the "Clock" object.

Access in Runtime: Read and write

### **Syntax**

Object.**MinuteNeedleWidth**[= LONG]

#### **Object**

Required A "ScreenItem" object with the format "Clock".

#### **LONG**

Optional A value or a constant that specifies the width of the minute hand.

Specify the width as a percentage relating to double the length of the minute hand.

### **See also**

Clock (Page 3984)

## **Mode**

### **Description**

Specifies the field type of the selected object.

Access during runtime: Read and write

### **Syntax**

Object.**Mode**[=IOFieldType]

#### **Object**

Necessary. A "ScreenItem" object with the formats "IOField", "SymbolicIOField", "DateTimeField", "Button", "Switch" or "GraphicIOField".

### **IOFieldType**

hmilOFieldInput ( 1): input field

hmilOFieldOutput ( 0): output field

hmilOFieldInOut ( 2): input and output field

### **Used for the following object types:**

IOField

### **See also**

IOField (Page 4021)

SymbolicIOField (Page 4093)

Button (Page 3968)

Switch (Page 4089)

GraphicIOField (Page 4011)

DateTimeField (Page 3989)

RoundButton (Page 4074)

### **Movable**

#### **Description**

Specifies whether the window can be moved in Runtime.

Access in Runtime: Read and write

#### **Syntax**

Object.**Movable**[=BOOLEAN]

#### **Object**

Required A "ScreenItem" object with the format "UserArchiveControl".

#### **BOOLEAN**

Optional. TRUE, if the window can be moved in Runtime.

## See also

AlarmControl (Page 3947)

UserArchiveControl (Page 4130)

TrendRulerControl (Page 4110)

FunctionTrendControl (Page 4004)

OnlineTableControl (Page 4037)

OnlineTrendControl (Page 4045)

## MsgFilterSQL

### Description

Specifies one or more SQL statements for the customized selection of the messages. Several customized selections are connected with "OR". If you have configured a fixed selection "DefaultMsgFilterSQL", the SQL statements of "DefaultMsgFilterSQL" and "MsgFilterSQL" are connected with "AND".

### Syntax

Object.**MsgFilterSQL**

#### Object

Required A "ScreenItem" object with the format "AlarmControl".

## See also

AlarmControl (Page 3947)

## Name

### Description

Returns the object name as STRING. The returned value is dependent upon the used object.

Access during runtime: Read

### Syntax

Object.**Name**

#### Object

Necessary. An object of the "Tag", "Project", "DataItem", "Layer" and "ScreenItem" type with the format "FunctionTrendControl"

## Comments

Dependent on the specified object, the following object names will be returned:

- Tag: Name of the tag without server and tag prefix.
- Project: Name of the current Runtime project.
- Dataltem: Name of the Dataltem object.
- Layer: Name of the layer.
- FunctionTrendControl : Name of the trend referenced by the "Index" property.

---

### Note

Use the "Name" property to address a tag in the Tags" list. Tag names are structured in WinCC according to the following scheme:

<Tag prefix><Name of tag>

If you only specify the tag name, the tag prefix is applied from the screen window shortcut.

---

## Example

The following example returns the name of the current Runtime project as Trace:

```
'\VBS160
HMIRuntime.Trace "Name: " & HMIRuntime.ActiveProject.Name & vbNewLine
```



## See also

Dataltem (Page 3916)  
Layer (Page 3924)  
Project (Page 3929)  
Tag (Page 3941)  
HTMLBrowser (Page 4019)  
Group (Page 4017)  
ForeignControl (Page 4000)  
DateTimeField (Page 3989)  
WlanQualityView (Page 4142)  
ZoneLabelView (Page 4143)  
ZoneQualityView (Page 4144)  
ProtectedAreaName (Page 4064)  
RangeLabelView (Page 4065)  
RangeQualityView (Page 4067)  
ScreenWindow (Page 4078)  
ScriptDiagnostics (Page 4080)  
Slider (Page 4082)  
SmartClientView (Page 4085)  
StatusForce (Page 4087)  
SymbolLibrary (Page 4098)  
BatteryView (Page 3967)  
ChannelDiagnose (Page 3972)  
CheckBox (Page 3974)  
GraphicIOField (Page 4011)  
Button (Page 3968)  
Bar (Page 3961)  
WindowSlider (Page 4139)  
UIView (Page 4137)  
TubeTeeObject (Page 4128)  
TubePolyline (Page 4125)  
TubeDoubleTeeObject (Page 4123)  
TubeArcObject (Page 4121)  
Switch (Page 4089)  
Rectangle (Page 4072)  
MultiLineEdit (Page 4032)  
MediaPlayer (Page 4030)  
Line (Page 4025)  
Listbox (Page 4027)  
AlarmView (Page 3958)  
Circle (Page 3977)

## NeedleBorderColor

### Description

Specifies the line color of the pointer in the ""Clock"" object.

Access in Runtime: Read and write

### Syntax

Object.**NeedleBorderColor**[= Color]

#### Object

Required A "ScreenItem" object with the format "Clock".

#### Color

Optional A value or a constant that specifies the line color of the pointer.

### Comments

Use the "RGB" function to establish the colors in RGB format (red, green blue). To do this, enter the appropriate decimal value for each of the three RGB values (range from 0 to 255). For example, the color "red" is shown as such: RGB(255, 0, 0). You can also use the VBS color constants like vbRed or vbGreen .

### See also

Clock (Page 3984)

## NeedleColor

### Description

Specifies the hand color of the "Clock" object.

You must have configured the "NeedleFillStyle" property as "Transparent" for the pointer color to be shown.

Access in Runtime: Read and write

### Syntax

Object.**NeedleColor**[= Color]

#### Object

Required A "ScreenItem" object with the format "Clock".

### Color

Optional A value or a constant that specifies the pointer color.

### Comments

Use the "RGB" function to establish the colors in RGB format (red, green blue). To do this, enter the appropriate decimal value for each of the three RGB values (range from 0 to 255). For example, the color "red" is shown as such: RGB(255, 0, 0). You can also use the VBS color constants like vbRed or vbGreen.

### See also

Clock (Page 3984)

### NeedleFillStyle

### Description

Specifies whether the pointers are filled or transparent:

0: The pointers are filled in the pointer fill color and shown with a margin in the foreground color.

1: The pointers appear to be transparent and will be indicated by a margin in the foreground color.

Access in Runtime: Read and write

### Syntax

Object.**NeedleFillStyle**[=NeedleFillStyle]

#### Object

Required A "ScreenItem" object with the format ""Clock".

#### NeedleFillStyle

hmiNeedleFillStyleTransparent ( 1): The pointers are filled in the pointer fill color and shown with a margin in the foreground color.

Identifies a transparent clock hand.

hmiNeedleFillStyleSolid ( 0): The pointers appear to be transparent and will be indicated by a margin in the foreground color.

Identifies a opaque clock hand.

### See also

Clock (Page 3984)

## NormalRangeColor

### Description

Specifies the color of the normal range on the scale of the "Gauge" object.

The "NormalRangeVisible" property must have the value TRUE so that the normal range is displayed.

Access during runtime: Read and write

### Syntax

Object.**NormalRangeColor**[= Color]

#### Object

Required An object of the "ScreenItem" type with the characteristic "Gauge".

#### Color

Optional A value or a constant that specifies the color of the normal range.

### Comments

Use the "RGB" function to establish the colors in RGB format (red, green blue). To do this, enter the appropriate decimal value for each of the three RGB values (range from 0 to 255). For example, the color "red" is shown as: RGB(255, 0, 0). You can also use the VBScript color constants such as vbRed or vbGreen.

### See also

Gauge (Page 4008)

## NormalRangeVisible

### Description

Specifies whether the normal range in the scale of the ""Gauge" object will be displayed.

Access in Runtime: Read and write

### Syntax

Object.**NormalRangeVisible**[= BOOLEAN]

#### Object

Required A "ScreenItem" object with the format "Gauge".

## BOOLEAN

Optional TRUE, if the normal range will be displayed in the scale.

### Comments

Specify the color of the normal range with the ""NormalRangeColor" property.

### See also

Gauge (Page 4008)

### NumberLines

### Description

Defines or return the number of lines the text list object should contain. If the amount of configured text is larger than this value, the selection list receives a vertical scroll bar.

### NumberOfValues(i)

### Description

Specifies the number of values that are shown in the trend window. The property "TagProviderType(i)" must have the value -1. Whether the information is evaluated depends on the property "UseMeasurePoints(i)".

Access in Runtime: Read and write

### Syntax

Object.**NumberOfValues**(i)[=Int]

#### Object

Required An object of the "ScreenItem" type with the format "FunctionTrendControl".

#### Int

Optional A value or a constant that specifies the number of values that are shown in the trend window.

### Comments

Number of value pairs for trend i (from tag provider)

### See also

FunctionTrendControl (Page 4004)

## Properties O-P

### Object

#### Description

If you use a Control that is not a standard WinCC control, it could be that the properties provided by the Control have the same names as the general ScreenItem properties. In this case, the ScreenItem properties take priority. You can access the "hidden" properties of an outside provider Controls via the additional ""object" property.

#### Syntax

Object.Object

##### Object

Required A "ScreenItem" object with the format ""ForeignControl".

#### Application example

To do this, address the properties of an outside provider control in the following way:

Control.object.type

If you are using only the form Control.type, the properties of the ScreenItem object will be used in case of identical names.

### ObjectName

#### Description

Returns the name of the specified object.

Access in Runtime: Read

#### Syntax

Object.ObjectName

##### Object

Required A "ScreenItem" object. This property is a standard property of the ScreenItem object and is therefore available for all formats.

## See also

Line (Page 4025)  
Polyline (Page 4060)  
Ellipse (Page 3993)  
Circle (Page 3977)  
EllipseSegment (Page 3995)  
CircleSegment (Page 3979)  
EllipticalArc (Page 3998)  
CircularArc (Page 3982)  
Rectangle (Page 4072)  
Polygon (Page 4057)  
TextField (Page 4107)  
IOField (Page 4021)  
SymbolicIOField (Page 4093)  
Button (Page 3968)  
Switch (Page 4089)  
GraphicView (Page 4014)  
GraphicIOField (Page 4011)  
Bar (Page 3961)  
Clock (Page 3984)  
Gauge (Page 4008)  
Slider (Page 4082)  
SymbolLibrary (Page 4098)  
OnlineTrendControl (Page 4045)  
FunctionTrendControl (Page 4004)  
OnlineTableControl (Page 4037)  
AlarmControl (Page 3947)  
HTMLBrowser (Page 4019)  
CheckBox (Page 3974)  
OptionGroup (Page 4054)  
WindowSlider (Page 4139)  
Connector (Page 3986)  
ScreenWindow (Page 4078)  
DiskSpaceView (Page 3991)  
ChannelDiagnose (Page 3972)  
ScriptDiagnostics (Page 4080)  
Group (Page 4017)

## ObjectSizeDeclutteringEnable

### Description

Specifies whether only the objects within a set size range are displayed.  
Access during runtime: Read

### Syntax

Object.**ObjectSizeDeclutteringEnable**

#### Object

Necessary. A "Screen" object.

### Example

The example outputs the Decluttering properties of the screen "NewPDL1" as Trace.

```
'VBS157
Dim objScreen
Set objScreen = HMIRuntime.Screens("NewPDL1")
HMIRuntime.Trace "Min: " & objScreen.ObjectSizeDeclutteringMin & vbNewLine
HMIRuntime.Trace "Max: " & objScreen.ObjectSizeDeclutteringMax & vbNewLine
HMIRuntime.Trace "Enable: " & objScreen.LayerDeclutteringEnable & vbNewLine
```

### See also

Screen (Page 3930)

## ObjectSizeDeclutteringMax

### Description

Returns the upper size range for the display suppression of objects of the specified screen as LONG.  
Access during runtime: Read

### Syntax

Object.**ObjectSizeDeclutteringMax**

#### Object

Necessary. A "Screen" object.



## Example

The example outputs the Decluttering properties of the screen "NewPDL1" as Trace.

```
'VBS157
Dim objScreen
Set objScreen = HMIRuntime.Screens("NewPDL1")
HMIRuntime.Trace "Min: " & objScreen.ObjectSizeDeclutteringMin & vbNewLine
HMIRuntime.Trace "Max: " & objScreen.ObjectSizeDeclutteringMax & vbNewLine
HMIRuntime.Trace "Enable: " & objScreen.LayerDeclutteringEnable & vbNewLine
```

## See also

Screen (Page 3930)

## ObjectSizeDeclutteringMin

### Description

Returns the lower size range for the display suppression of objects of the specified screen as LONG.

Access during runtime: Read

### Syntax

Object.**ObjectSizeDeclutteringMin**

#### Object

Necessary. A "Screen" object.

## Example

The example outputs the Decluttering properties of the screen "NewPDL1" as Trace.

```
'VBS157
Dim objScreen
Set objScreen = HMIRuntime.Screens("NewPDL1")
HMIRuntime.Trace "Min: " & objScreen.ObjectSizeDeclutteringMin & vbNewLine
HMIRuntime.Trace "Max: " & objScreen.ObjectSizeDeclutteringMax & vbNewLine
HMIRuntime.Trace "Enable: " & objScreen.LayerDeclutteringEnable & vbNewLine
```

## See also

Screen (Page 3930)

## OCXState

### Description

Specifies the status of the OCX.

Access in Runtime: Read and write

### Syntax

Object.**OCXState**[=Stream]

#### Object

Required A "ScreenItem" object with the format "ForeignControl".

#### Stream

Optional A value or a constant that specifies the status of the OCX.

### See also

ForeignControl (Page 4000)

## Online

### Description

Specifies start and stop of the updating.

Access in Runtime: Read and write

### Syntax

Object.**Online**[=BOOLEAN]

#### Object

Required An object of the "ScreenItem" type with the format "OnlineTrendControl", "FunctionTrendControl" or "OnlineTableControl" (Runtime Professional) or "HMITrendView" (Runtime Advanced).

#### BOOLEAN

Optional TRUE, if the updated display should be stopped. The values are stored in the cache and when the button is reactivated they are added . FALSE, if the updated display is to be continued.

## See also

OnlineTrendControl (Page 4045)

FunctionTrendControl (Page 4004)

OnlineTableControl (Page 4037)

## OnTop

### Description

TRUE, when the object should remain in the foreground in Runtime. Read only access.

## OperationMessage property

### Description

TRUE, if an alarm should be output when an operation is performed. BOOLEAN write-read access.

The operation is sent to the alarm system and is logged. The alarm system can be used to output an alarm in an alarm line, for example.

#### Particularities for I/O field, text list, and slider

The reason for the operation can only be entered if the "OperationReport" property has been set to TRUE.

## OperationReport property

### Description

TRUE, if the reason for an operation should be recorded. BOOLEAN write/read access.

When the object is used or operated in Runtime, a dialog opens in which the operator can input the reason for the operation in the form of text. The operation is sent to the message system, and is archived.

## OperationSteps

### Description

Specifies by how many steps the slider of the scrollbar is moved with one mouseclick.

Access in Runtime: Read and write

### Syntax

Object.**OperationSteps**[=Int]

**Object**

Required A ""ScreenItem" object with the format "WindowSlider".

**Int**

Optional A value or a constant which specifies by how many steps the slider of the scrollbar is moved with one mouseclick.

**See also**

WindowSlider (Page 4139)

**OperatorMessageID**

**Description**

Specified assignment of ID number and trigger event in the message view.

**Syntax**

Object.**OperatorMessageID**[=MessageID]

**Object**

Required A "ScreenItem" object with the format "AlarmControl".

**MessageID**

Value	Description	Description
0	Lock	Trigger event "Lock"
1	Unlock	"Unlock" Trigger Event
2	Hide	Trigger event "Hide"
3	Unhide	Trigger event "Unhide"
4	Ackn	Trigger event "Acknowledge"

**See also**

AlarmControl (Page 3947)

**OperatorMessageIndex**

**Description**

References an operator message event. You can assign the values of other properties to a specific operator message by using the property.

**Syntax**

Object.**OperatorMessageIndex** [=MessageIndex]

**Object**

Required A "ScreenItem" object with the format "AlarmControl".

**MessageIndex**

Value	Description
0	Message event "Lock"
1	"Unlock" Message Event
2	Message event "Hide"
3	Message event "Unhide"
4	Message event "Acknowledge"

**See also**

AlarmControl (Page 3947)

**OperatorMessageName****Description**

Indicates the name which is referenced with the "OperatorMessageIndex" in message events for operator messages. You cannot edit this name.

**Syntax**

Object.**OperatorMessageName** [=Name]

**Object**

Required A "ScreenItem" object with the format "AlarmControl".

**Name**

Value	Description
Lock	Message event "Lock"
Unlock	Message event "Enable"
Hide	Message event "Hide"
Unhide	Message event "Unhide"
Quit	Message event "Ackn."

**See also**

AlarmControl (Page 3947)

## OperatorMessageNumber

### Description

Specify a message number for the operator message of the selected message event if you do not use the operator message of WinCC.

### Syntax

Object.**OperatorMessageNumber**

#### Object

Required A "ScreenItem" object with the format "AlarmControl".

### See also

AlarmControl (Page 3947)

## OperatorMessageSelected

### Description

Activate the message events which trigger operator messages in the list.

### Syntax

Object.**OperatorMessageSelected**

#### Object

Required A "ScreenItem" object with the format "AlarmControl".

### See also

AlarmControl (Page 3947)

## OperatorMessageSource1

### Description

Define the message block of an operated message to be added to "Process value block 1" of the operator message configured in Source.

An operator message is to be generated to indicate that a message was locked. The content of "User text block 1" of the locked message, e.g. "Motor faulty" should be displayed in "Process value block 1" of the operator message. Select "1" at process value as the message lock of the operated message "User text block 1".

## Syntax

Object.**OperatorMessageSource1**

### Object

Required A "ScreenItem" object with the format "AlarmControl".

## See also

AlarmControl (Page 3947)

## OperatorMessageSource2

### Description

Define the message block of an operated message to be added to "Process value block 2" of the operator message configured in Source.

An operator message is to be generated to indicate that a message was locked. The content of "User text block 1" of the locked message, e.g. "Motor faulty" should be displayed in "Process value block 2" of the operator message. Select "2" at process value as the message lock of the operated message "User text block 1".

## Syntax

Object.**OperatorMessageSource2**

### Object

Required A "ScreenItem" object with the format "AlarmControl".

## See also

AlarmControl (Page 3947)

## OperatorMessageSource3

### Description

Define the message block of an operated message to be added to "Process value block 3" of the operator message configured in Source.

An operator message is to be generated to indicate that a message was locked. The content of "User text block 1" of the locked message, e.g. "Motor faulty" should be displayed in "Process value block 3" of the operator message. Select "3" at process value as the message lock of the operated message "User text block 1".

## Syntax

Object.**OperatorMessageSource3**

### Object

Required A "ScreenItem" object with the format "AlarmControl".

## See also

AlarmControl (Page 3947)

## OperatorMessageSource4

### Description

Define the message block of an operated message to be added to "Process value block 4" of the operator message configured in Source.

An operator message is to be generated to indicate that a message was locked. The content of "User text block 4" of the locked message, e.g. "Motor faulty" should be displayed in "Process value block 4" of the operator message. Select "4" at process value as the message lock of the operated message "User text block 1".

## Syntax

Object.**OperatorMessageSource4**

### Object

Required A "ScreenItem" object with the format "AlarmControl".

## See also

AlarmControl (Page 3947)

## OperatorMessageSource5

### Description

Define the message block of an operated message to be added to "Process value block 5" of the operator message configured in Source.

An operator message is to be generated to indicate that a message was locked. The content of "User text block 1" of the locked message, e.g. "Motor faulty", is to be displayed in "Process value block 5" of the operator message. Select "User text block 1" under process value "5" as the message block of the operated message.



## Syntax

Object.**OperatorMessageSource5**

### Object

Required A "ScreenItem" object with the format "AlarmControl".

## See also

AlarmControl (Page 3947)

## OperatorMessageSource6

### Description

Define the message block of an operated message to be added to "Process value block 6" of the operator message configured in Source.

An operator message is to be generated to indicate that a message was locked. The content of "User text block 1" of the locked message, e.g. "Motor faulty", is to be displayed in "Process value block 6" of the operator message. Select "6" at process value as the message lock of the operated message "User text block 1".

## Syntax

Object.**OperatorMessageSource6**

### Object

Required A "ScreenItem" object with the format "AlarmControl".

## See also

AlarmControl (Page 3947)

## OperatorMessageSource7

### Description

Define the message block of an operated message to be added to "Process value block 7" of the operator message configured in Source.

An operator message is to be generated to indicate that a message was locked. The content of "User text block 1" of the locked message, e.g. "Motor faulty", is to be displayed in "Process value block 7" of the operator message. Select "7" at process value as the message lock of the operated message "User text block 1".

## Syntax

Object.**OperatorMessageSource7**

### Object

Required A "ScreenItem" object with the format "AlarmControl".

## See also

AlarmControl (Page 3947)

## OperatorMessageSource8

### Description

Define the message block of an operated message to be added to "Process value block 8" of the operator message configured in Source.

An operator message is to be generated to indicate that a message was locked. The content of "User text block 1" of the locked message, e.g. "Motor faulty", is to be displayed in "Process value block 8" of the operator message. Select "8" at process value as the message lock of the operated message "User text block 1".

## Syntax

Object.**OperatorMessageSource8**

### Object

Required A "ScreenItem" object with the format "AlarmControl".

## See also

AlarmControl (Page 3947)

## OperatorMessageSource9

### Description

Define the message block of an operated message to be added to "Process value block 9" of the operator message configured in Source.

An operator message is to be generated to indicate that a message was locked. The content of "User text block 1" of the locked message, e.g. "Motor faulty", is to be displayed in "Process

value block 9" of the operator message. Select "9" at process value as the message lock of the operated message "User text block 1".

### Syntax

Object.**OperatorMessageSource9**

#### Object

Required A "ScreenItem" object with the format "AlarmControl".

### See also

AlarmControl (Page 3947)

## OperatorMessageSource10

### Description

Define the message block of an operated message to be added to "Process value block 10" of the operator message configured in Source.

An operator message is to be generated to indicate that a message was locked. The content of "User text block 1" of the locked message, e.g. "Motor faulty", is to be displayed in "Process value block 10" of the operator message. Select "10" at process value as the message lock of the operated message "User text block 1".

### Syntax

Object.**OperatorMessageSource10**

#### Object

Required A "ScreenItem" object with the format "AlarmControl".

### See also

AlarmControl (Page 3947)

## OperatorMessageSourceType1

### Description

Specifies the format of the source content for the transfer.

## Syntax

Object.**OperatorMessageType1**[=Type]

### Object

Required A "ScreenItem" object with the format "AlarmControl".

### Type

Value	Description	Description
0	Text	Transfer the source content in text format.
1	Value	Transfer the source content as value.

## See also

AlarmControl (Page 3947)

## OperatorMessageSourceType2

### Description

Specifies in what format the content of the source is transferred.

### Syntax

Object.**OperatorMessageType2**[=Type]

### Object

Required A "ScreenItem" object with the format "AlarmControl".

### Type

Value	Description	Explanation
0	Text	The content of the source is transferred as a text.
1	Value	The content of the source is transferred as a value.

## See also

AlarmControl (Page 3947)

## OperatorMessageSourceType3

### Description

Specifies in what format the content of the source is transferred.

**Syntax**

Object.**OperatorMessageType1**[=Type]

**Object**

Required A "ScreenItem" object with the format "AlarmControl".

**Type**

Value	Description	Explanation
0	Text	The content of the source is transferred as a text.
1	Value	The content of the source is transferred as a value.

**See also**

AlarmControl (Page 3947)

**OperatorMessageSourceType4****Description**

Specifies in what format the content of the source is transferred.

**Syntax**

Object.**OperatorMessageType4**[=Type]

**Object**

Required A "ScreenItem" object with the format "AlarmControl".

**Type**

Value	Description	Explanation
0	Text	The content of the source is transferred as a text.
1	Value	The content of the source is transferred as a value.

**See also**

AlarmControl (Page 3947)

**OperatorMessageSourceType5****Description**

Specifies in what format the content of the source is transferred.

## Syntax

Object.**OperatorMessageType5**[=Type]

### Object

Required A "ScreenItem" object with the format "AlarmControl".

### Type

Value	Description	Explanation
0	Text	The content of the source is transferred as a text.
1	Value	The content of the source is transferred as a value.

## See also

AlarmControl (Page 3947)

## OperatorMessageSourceType6

### Description

Specifies in what format the content of the source is transferred.

### Syntax

Object.**OperatorMessageType6**[=Type]

### Object

Required A "ScreenItem" object with the format "AlarmControl".

### Type

Value	Description	Explanation
0	Text	The content of the source is transferred as a text.
1	Value	The content of the source is transferred as a value.

## See also

AlarmControl (Page 3947)

## OperatorMessageSourceType7

### Description

Specifies in what format the content of the source is transferred.

**Syntax**

Object.OperatorMessageType7[=Type]

**Object**

Required A "ScreenItem" object with the format "AlarmControl".

**Type**

Value	Description	Explanation
0	Text	The content of the source is transferred as a text.
1	Value	The content of the source is transferred as a value.

**See also**

AlarmControl (Page 3947)

**OperatorMessageSourceType8****Description**

Specifies in what format the content of the source is transferred.

**Syntax**

Object.OperatorMessageType8[=Type]

**Object**

Required A "ScreenItem" object with the format "AlarmControl".

**Type**

Value	Description	Explanation
0	Text	The content of the source is transferred as a text.
1	Value	The content of the source is transferred as a value.

**See also**

AlarmControl (Page 3947)

**OperatorMessageSourceType9****Description**

Specifies in what format the content of the source is transferred.

### Syntax

Object.**OperatorMessageType9**[=Type]

#### Object

Required A "ScreenItem" object with the format "AlarmControl".

#### Type

Value	Description	Explanation
0	Text	The content of the source is transferred as a text.
1	Value	The content of the source is transferred as a value.

### See also

AlarmControl (Page 3947)

## OperatorMessageSourceType10

### Description

Specifies in what format the content of the source is transferred.

### Syntax

Object.**OperatorMessageType10**[=Type]

#### Object

Required A "ScreenItem" object with the format "AlarmControl".

#### Type

Value	Description	Explanation
0	Text	The content of the source is transferred as a text.
1	Value	The content of the source is transferred as a value.

### See also

AlarmControl (Page 3947)

### Orientation

### Description

Specifies the text direction (orientation) of the selected object.



Access in Runtime: Read and write

## Syntax

Object.**Orientation**[=TextOrientation]

### Object

Required An object of the "ScreenItem" type with the format "TextField", "IOField", "SymbolicIOField", "Button", "Switch", "Bar", "OnlineTrendControl", "FunctionTrendControl", "Checkbox", "OptionGroup" or "WindowSlider".

### TextOrientation

hmiTextHorizontal ( 0): The text is shown horizontally.

hmiTextRotated90Degree (-1): The text is shown vertically and left justified.

hmiTextRotated270Degree ( 1): The text is shown vertically and right justified.

## See also

[TextField \(Page 4107\)](#)

[IOField \(Page 4021\)](#)

[SymbolicIOField \(Page 4093\)](#)

[Button \(Page 3968\)](#)

[Switch \(Page 4089\)](#)

[Bar \(Page 3961\)](#)

[OnlineTrendControl \(Page 4045\)](#)

[FunctionTrendControl \(Page 4004\)](#)

[CheckBox \(Page 3974\)](#)

[OptionGroup \(Page 4054\)](#)

[WindowSlider \(Page 4139\)](#)

## OutputFormat

## Description

Returns the value for the representation of the output value. The representation is dependent on the data format. Read only access.

## OutputValue

### Description

Determines the default setting for the value to be displayed or returns it. This value is used in Runtime when the associated tag cannot be connected or updated when a picture is started.

## PageMode

### Description

Enables paging in the long-term archive list. Allows you to display all messages of the short-term archive in the long-term archive list. Use the "Messages per page" property to determine the number of messages output per page.

The page up/down buttons of the toolbar can be used if paging is enabled.

### Syntax

Object.**PageMode**[=BOOLEAN]

#### Object

Required A "ScreenItem" object with the format "AlarmControl".

#### BOOLEAN

TRUE: Scrolling in the long-term log list is possible.

FALSE: Scrolling in the long-term log list is not possible.

### See also

AlarmControl (Page 3947)

## PageModeMessageNumber

### Description

Defines the number of messages shown per page when paging the long-term archive list.

### Syntax

Object.**PageModeMessageNumber**

#### Object

Required A "ScreenItem" object with the format "AlarmContro".

## **BOOLEAN**

Optional TRUE, if the dialog box is shown in Runtime.

### **See also**

AlarmControl (Page 3947)

### **Parent**

### **Description**

Returns the screen in which the specified object is embedded.

Access in Runtime: Read

### **Syntax**

Object.Parent

#### **Object**

Required A "ScreenItem" object. This property is a standard property of the ScreenItem object and is therefore available for all formats.

### **Application example**

The following example writes the name of the root screen in "BaseScreenName" tag:

```
'VBS_Example_Parent
Dim objScrItem, BaseScreenName
Set objScrItem = HMIRuntime.Screens(1).ScreenItems(1)
BaseScreenName = "Name of BaseScreen: " & objScrItem.Parent.ObjectName
```

## See also

Line (Page 4025)  
Polyline (Page 4060)  
Ellipse (Page 3993)  
Circle (Page 3977)  
EllipseSegment (Page 3995)  
CircleSegment (Page 3979)  
EllipticalArc (Page 3998)  
CircularArc (Page 3982)  
Rectangle (Page 4072)  
Polygon (Page 4057)  
TextField (Page 4107)  
IOField (Page 4021)  
SymbolicIOField (Page 4093)  
Button (Page 3968)  
Switch (Page 4089)  
GraphicView (Page 4014)  
GraphicIOField (Page 4011)  
Bar (Page 3961)  
Clock (Page 3984)  
Gauge (Page 4008)  
Slider (Page 4082)  
SymbolLibrary (Page 4098)  
OnlineTrendControl (Page 4045)  
FunctionTrendControl (Page 4004)  
OnlineTableControl (Page 4037)  
AlarmControl (Page 3947)  
HTMLBrowser (Page 4019)  
CheckBox (Page 3974)  
OptionGroup (Page 4054)  
WindowSlider (Page 4139)  
Connector (Page 3986)  
ScreenWindow (Page 4078)  
DiskSpaceView (Page 3991)  
ChannelDiagnose (Page 3972)  
ScriptDiagnostics (Page 4080)  
Group (Page 4017)

## Path

### Description

Returns the path of the current project without the file names as STRING. For a WinCC client without its own path, the path is returned in UNC format, otherwise the local path is returned.

Access during runtime: Read

### Syntax

Object.**Path**

#### Object

Necessary. A "Project" object.

### Example

The following example returns the project path as Trace:

```
'VBS161  
HMIRuntime.Trace "Path: " & HMIRuntime.ActiveProject.Path & vbNewLine
```

### See also

Project (Page 3929)

## Password

### Description

Determines the password for the loading of the remote monitor.

Access during runtime: Read and Write

### Syntax

Object.Password = [STRING]

#### Object

Required. An object of the "ScreenItem" type with the characteristic "SmartClientView."

#### STRING

Optional. A value or constant which contains the password.

## See also

SmartClientView (Page 4085)

## PersistentRTAuthorization

### Description

Specifies the authorization for operators which is necessary to change the persistence setting in Runtime. The value to be entered corresponds to the number which has the desired authorization in the user administration. Whether the information is evaluated depends on the value of the property "AllowPersistence". This does not apply for the message view.

Access in Runtime: Read and write

### Syntax

Object.**PersistentRTAuthorization**[=RtAuthorization]

#### Object

Required An object of the "ScreenItem" type with the format "AlarmControl", "OnlineTrendControl", "FunctionTrendControl" or "OnlineTableControl".

#### RtAuthorization

Optional A value or a constant that specifies the authorization for operators to change the persistence setting.

## See also

AlarmControl (Page 3947)

## PersistentRTCSAuthorization

### Description

Specifies the operator authorization to be able to change the persistence setting in Runtime. The value to be entered corresponds to the number which has the desired authorization in the user administration. Whether the information is evaluated depends on the value of the property "AllowPersistence". This does not apply for the message view.

Access in Runtime: Read and write

### Syntax

Object.**PersistentRTCSAuthorization**[=RtAuthorization]

**Object**

Required An object of the "ScreenItem" type with the format "AlarmControl", "OnlineTrendControl", "FunctionTrendControl" or "OnlineTableControl".

**RtAuthorization**

Optional A value or a constant that specifies the operator authorization to change the persistence setting.

**See also**

AlarmControl (Page 3947)

**PersistentRuntime**

**Description**

Specifies whether changed settings in the window will also be maintained after a screen change.

Access in Runtime: Read and write

**Syntax**

Object.**PersistentRuntime**[=BOOLEAN]

**Object**

Required An object of the "ScreenItem" type with the format "OnlineTrendControl", "FunctionTrendControl" oder "OnlineTableControl".

**BOOLEAN**

Optional. TRUE, if changed settings in the window will also be maintained after a screen change.

**Comments**

The "AllowPersistence" property specifies whether the information will be evaluated.

**See also**

OnlineTrendControl (Page 4045)

FunctionTrendControl (Page 4004)

OnlineTableControl (Page 4037)

## PersistentRuntimeAuthorization

### Description

Specifies the access authorization to change the persistence setting in Runtime. The value to be entered corresponds to the number which has the desired authorization in the user administration.

Access in Runtime: Read and write

### Syntax

Object.**PersistentRuntimeAuthorization**[=HmiRTAuthorization]

#### Object

Required An object of the "ScreenItem" type with the format "OnlineTrendControl", "FunctionTrendControl" or "OnlineTableControl".

#### HmiRTAuthorization

Optional A value or a constant that specifies the access authorization required to change the persistence setting in Runtime.

### Comments

The "AllowPersistence" property specifies whether the information will be evaluated. This does not apply for the message view.

### See also

OnlineTrendControl (Page 4045)

FunctionTrendControl (Page 4004)

OnlineTableControl (Page 4037)

## PersistentToDownload

### Description

Specifies whether the settings will be maintained until the next ES download.

Access in Runtime: Read and write

### Syntax

Object.**PersistentToDownload**[=BOOLEAN]



**Object**

Required An object of the "ScreenItem" type with the format "OnlineTrendControl", "FunctionTrendControl" or "OnlineTableControl".

**BOOLEAN**

Optional TRUE, if the settings will be maintained until the next ES download.

**See also**

OnlineTrendControl (Page 4045)

FunctionTrendControl (Page 4004)

OnlineTableControl (Page 4037)

**PersistentToDownloadAuthorization**

**Description**

Specifies the access authorization required to change the settings until the next ES download.

Access in Runtime: Read and write

**Syntax**

Object.**PersistentToDownloadAuthorization**[=HmiRTAuthorization]

**Object**

Required An object of the "ScreenItem" type with the format "OnlineTrendControl", "FunctionTrendControl" or "OnlineTableControl".

**HmiRTAuthorization**

Optional A value or a constant that specifies the access authorization required to change the settings until the next ES download.

**See also**

OnlineTrendControl (Page 4045)

FunctionTrendControl (Page 4004)

OnlineTableControl (Page 4037)

**PicAlignment**

**Description**

Specifies the alignment within the specified object.

### **PicDeactReferenced**

#### **Description**

TRUE, when the picture assigned for the "Disable" status should be saved in the RoundButton object. Otherwise, only the associated object reference is saved. Read only access.

### **PicDeactTransparent**

#### **Description**

Defines or returns which color of the bitmap object (.bmp, .dib) assigned to the "Disabled" status should be set to "transparent". LONG Write/Read Access.  
The color is only set to "Transparent" if the value of the "PicDeactUseTransColor" property is "True".

### **PicDeactUseTransColor**

#### **Description**

TRUE, when the transparent color defined by the "PicDeactTransparent" property for the "Disable" status should be used. BOOLEAN write-read access.

### **PicDownReferenced**

#### **Description**

TRUE, when the picture assigned for the "On" status is to be saved. Otherwise, only the associated object reference is saved. Read only access.

### **PicDownTransparent**

#### **Description**

Defines or returns which color of the bitmap object (.bmp, .dib) assigned to the "On" status should be set to "transparent". LONG Write/Read Access.  
The color is only set to "Transparent" if the value of the "PicDownUseTransColor" property is "True".

## PicDownUseTransColor

### Description

TRUE, when the transparent color defined by the "PicDownTransparent" property for the "On" status should be used. BOOLEAN write-read access.

## PicReferenced

### Description

TRUE, when the assigned picture is references the object and is not saved in it. Read only access.

## PicTransColor

### Description

Defines or returns which color of the assigned bitmap object (.bmp, .dib) should be set to "transparent". LONG Write/Read Access.  
The color is only set to "Transparent" if the value of the "PicUseTransColor" property is "True".

## Picture

### Description

Specifies the screen that will be displayed in the graphics object in Runtime.

Access in Runtime: Read and write

### Syntax

Object.**Picture**[=Image]

#### Object

Required A ""ScreenItem" object with the formats "GraphicView", "Clock" or ""SymbolLibrary".

#### Image

Optional A value or a constant that specifies the screen that will be displayed in the graphics object in Runtime.

### Comments

The picture (\*.BMP or \*.DIB) must be located in the "GraCS" folder of the current project so that it can be integrated.

## See also

GraphicView (Page 4014)  
Clock (Page 3984)  
SymbolLibrary (Page 4098)

## PictureAlignment

### Description

Defines or returns the mode of representation of the background image in the process picture.  
LONG write-read access.

## See also

Button (Page 3968)  
RoundButton (Page 4074)

## PictureDeactivated

### Description

Specifies the picture that is displayed in the "Deactivated" state.  
Access during runtime: Read and write

### Syntax

Object.**PictureDeactivated**[=Image]

#### Object

Required A ""ScreenItem" object with the format ""Roundbutton".

#### Image

Optional A value or a constant that specifies the picture that will be displayed in the "Deactivated" status.

### Comments

The picture must be located in the "GraCS" folder of the current project in order to integrate it.

## PictureName

### Description

Defines the path and file name of the background image in the process picture or returns it.  
LONG write-read access.

## PictureOff

### Description

Specifies the picture that is displayed in the "Off" status.

Access during runtime: Read and write

### Syntax

Object.**PictureOff**[=Image]

#### Object

Required A "ScreenItem" object with the formats "Button", "Roundbutton", "Switch" or "GraphicIOField".

#### Image

Optional A value or a constant that specifies the picture that will be displayed in the "Off" status.

### Comments

The picture (\*.BMP or \*.DIB) must be in the "GraCS" folder of the current project so that you can integrate it.

### See also

Button (Page 3968)

Switch (Page 4089)

GraphicIOField (Page 4011)

## PictureOn

### Description

Specifies the screen that will be displayed in the "on" state.

Access in Runtime: Read and write

## Syntax

Object.**PictureOn**[=Image]

### Object

Required A "ScreenItem" object with the formats "Button", "Roundbutton", "Switch" or "GraphicIOField".

### Image

Optional A value or a constant that specifies the screen that will be displayed in the "on" state.

## Comments

The screen (\*.BMP or \*.DIB) must be in the "GraCS" folder of the current project in order to be able to integrate it.

## See also

Button (Page 3968)

Switch (Page 4089)

GraphicIOField (Page 4011)

## PictureUp

### Description

Defines the picture to be displayed in the "Off" status or returns the picture name. The picture (\*.BMP or \*.DIB) must be located in the "GraCS" folder of the current project so that it can be integrated.

## PicUpReferenced

### Description

TRUE, when the picture assigned for the "Off" status should be saved in the object. Otherwise, only the associated object reference is saved. Read only access.

## PicUpTransparent

### Description

Defines or returns which color of the bitmap object (.bmp, .dib) assigned to the "Off" status should be set to "transparent". LONG Write/Read Access. The color is only set to "Transparent" if the value of the "PicUpUseTransColor" property is "True".

## PicUpUseTransparentColor

### Description

TRUE, when the transparent color defined by the "PicUpTransparent" property for "Off" status should be used. BOOLEAN write-read access.

## PicUseTransparentColor

### Description

TRUE, when the transparent color defined by the "PicDeactTransparent" property for the "Disable" status should be used. BOOLEAN write-read access.

## Pinned

### Description

Defines whether the display of the picture window in Runtime depends on the process picture in which the picture window was configured.

## PointCount

### Description

Defines or returns the number of corner points. Each corner point has position coordinates and is identified via an index.

## PointerColor

### Description

Specifies the pointer color of the "Gauge" object.

Access during runtime: Read and Write

### Syntax

Object.**PointerColor**[= Color]

#### Object

Required An object of the ""ScreenItem" type with the characteristic "Gauge".

#### Color

Optional A value or a constant that specifies the pointer color.

## Comments

Use the "RGB" function to establish the colors in RGB format (red, green blue). To do this, enter the appropriate decimal value for each of the three RGB values (range from 0 to 255). For example, the color "red" is shown as: RGB(255, 0, 0). You can also use the VBScript color constants such as vbRed or vbGreen.

## See also

Gauge (Page 4008)

## PointsCount

### Description

Specifies the number of corner points of the polyline or of the polygon.

Access in Runtime: Read and write

### Syntax

Object.**PointsCount**[=Int]

#### Object

Required A "ScreenItem" object with the formats "Polyline" or "Polygon".

#### Int

Optional A value or a constant that specifies the number of corner points of the polyline.

## See also

Polyline (Page 4060)

Polygon (Page 4057)

TubePolyline (Page 4125)

## Position

### Description

Defines the presetting for the position of the slider.

This value is used as the start value in Runtime.

To operate the process value linked to this attribute, it is necessary that the process value is also linked to the "Position" event. You will find the event "Position" in the "Event" tab, in the topic tree under SliderCtrl\Property Topics\Control Properties\Value.



## Precision

### Description

Specifies the number of decimal places (0 to 20).

Access in Runtime: Read and write

### Syntax

Object.**Precision**[=Int]

#### Object

Required A "ScreenItem" object with the format "Bar".

#### Int

Optional A value or a constant that specifies the number of decimal places (0 to 20).

### See also

Bar (Page 3961)

## PredefinedAngles

### Description

Defines or returns the depth of the display of the 3DBarGraph object. Value range from 0 to 3.

0 = cavalier

1 = isometric

2 = axionometric

3 = freely defined

## Pressed

### Description

Specifies whether the selected object is displayed in a pressed state.

Access in Runtime: Read and write

### Syntax

Object.**Pressed**[=BOOLEAN]

**Object**

Required A "ScreenItem" object with the format "Roundbutton".

**BOOLEAN**

Optional TRUE, if the selected object is displayed in a pressed state.

**See also**

Button (Page 3968)

**PrintConfiguration**

**Description**

Specifies the log for the printout.

Access in Runtime: Read and write

**Syntax**

Object.**PrintConfiguration**[=HMIPrintConfiguration]

**Object**

Required An object of the "ScreenItem" type with the format "OnlineTrendControl", "FunctionTrendControl", "OnlineTableControl", "AlarmControl" or "UserArchiveControl".

**HMIPrintConfiguration**

Optional A value or a constant which specifies the log for the printout.

**See also**

OnlineTrendControl (Page 4045)

FunctionTrendControl (Page 4004)

OnlineTableControl (Page 4037)

AlarmControl (Page 3947)

**PrintJobName**

**Description**

Defines the print job triggered by the print function of the "Print" toolbar button. The recommended print job is set for the control by default.

Open the "Select Print Job" dialog using the selection button.

## Syntax

Object.**PrintJobName**]

### Object

Required An object of the "ScreenItem" type with the format "AlarmControl", "FunctionTrendControl", "OnlineTableControl", "OnlineTrendControl", "TrendRulerControl", "UserArchiveControl".

## See also

AlarmControl (Page 3947)

## PrintVisibleColumnsOnly

### Description

Specifies whether only the current visible columns should be output in quick print.

Access in Runtime: Read and write

### Syntax

Object.**PrintVisibleColumnsOnly**[=BOOLEAN]

### Object

Required A "ScreenItem" object with the format "UserArchiveControl".

### BOOLEAN

Optional TRUE, if only the current visible columns should be output in quick print.

## Process

### Description

Defines or returns presetting for the value to be displayed.

This value is used in Runtime when the associated tag cannot be connected or updated when a picture is started.

## Processvalue

### Description

Specifies the default for the value to be displayed.

This value will be used in runtime if the associated tag is not connected or has not been updated when the screen starts.

Access during runtime: Read and write

## Syntax

Object.**Processvalue**[=DOUBLE]

### Object

Necessary. A "ScreenItem" object with the formats "IOField", "SymbolicIOField", "DateTimeField", "Button", "Switch", "GraphicIOField", "Bar", "Gauge", "Slider", "SymbolLibrary", "CheckBox", "OptionGroup" or "WindowSlider".

### DOUBLE

Optional A value or a constant that includes the default value.

## Comments

If you want to assign the "ProcessValue" SmartTags property, then you must formulate the assignment as follows:

'Examples for the assignment of SmartTags

'Example 1

```
IOField.ProcessValue = SmartTags("TagName").Value
```

'Example 2

```
HmiRuntime.Screens("Screen_1").ScreenItems("IOField_1").ProcessValue =  
SmartTags("Tag_1").Value
```

## See also

IOField (Page 4021)  
SymbolicIOField (Page 4093)  
Button (Page 3968)  
Switch (Page 4089)  
GraphicIOField (Page 4011)  
Bar (Page 3961)  
Gauge (Page 4008)  
Slider (Page 4082)  
SymbolLibrary (Page 4098)  
CheckBox (Page 3974)  
OptionGroup (Page 4054)  
WindowSlider (Page 4139)  
DateTimeField (Page 3989)

## Processvalue

### Description

Defines the presetting for the value to be displayed.

This value is used in runtime when a screen is started and the associated tag has not been connected nor updated.

Access during runtime: Read and Write

### Syntax

Object.Processvalue [=DOUBLE]

#### Object

Required. An object of the "ScreenItem" type with the characteristic "Bar," "Gauge", "IOField" or "Slider".

#### DOUBLE

Optional. A value or constant which contains preset the Web address.

### Remarks

To assign SmartTags to the "ProcessValue" property, you must formulate the assignment as follows:

Examples of the assignment of SmartTags

'Example 1

```
IOField.ProcessValue = SmartTags("TagName").Value
```

'Example 2

```
HmiRuntime.Screens("Screen_1").ScreenItems("IOField_1").ProcessValue  
= SmartTags("Tag_1").Value
```

### See also

SymbolLibrary (Page 4098)

Button (Page 3968)

Switch (Page 4089)

### ProgID

### Description

In the case of non-WinCC controls, the version-independent ProgID is returned as the type.

## See also

ForeignControl (Page 4000)

## ProjectPath

### Description

Contains the path and name of the associated project.

Access in Runtime: Read-only

### Syntax

Object.**ProjectPath**[=String]

#### Object

Required A "ScreenItem" object with the format "AlarmControl".

#### String

Optional A value or a constant that specifies which path and name the associated project will contain.

## See also

AlarmControl (Page 3947)

## Properties Q-R

### QualityCode

#### Description

Returns the quality of a tag value after reading the tag as SHORT. After a tag has been written, the value is invalid.

Access during runtime: Read

#### Syntax

Object.**QualityCode**

#### Object

Necessary. An object of the "HMIRuntime" type.

## Example

The following example indicates the quality of the read value when no errors have occurred during the reading process:

```
'VBS83
Dim objTag
Dim lngLastErr
Set objTag = HMIRuntime.Tags ("Tag1")
objTag.Read
lngLastErr = objTag.LastError
If 0 = lngLastErr Then
MsgBox objTag.QualityCode
End If
```

## See also

Tag (Page 3941)

## Radius

### Description

Determines the radius of the given object "Circle."

Access during runtime: Read and Write

### Syntax

Object.Radius [= LONG]

#### Object

Required. An object of the "ScreenItem" type with the characteristic "Circle".

#### LONG

Optional. A value or constant which determines the radius in pixels.

## Radius

### Description

Specifies the radius of the selected object "Circle".

Access in Runtime: Read and write

## Syntax

Object.**Radius**[= LONG]

### Object

Required An object of the "ScreenItem" type with the format "Circle", "CircleSegment", "CircularArc" or "Roundbutton".

### LONG

Optional A value or a constant that specifies the radius in pixels.

## See also

Circle (Page 3977)

CircleSegment (Page 3979)

CircularArc (Page 3982)

## RadiusHeight

### Description

Determines the secondary axis of the object "Ellipse".

Access during runtime: Read and Write

### Syntax

Object.**RadiusHeight**

#### Object

Required. An object of the "ScreenItem" type with the characteristic "Ellipse."

#### LONG

Optional. A value or constant which determines the secondary axis in pixels.

## RadiusHeight

### Description

Specifies the minor axis of the ""Ellipse" object.

Access in Runtime: Read and write

### Syntax

Object.**RadiusHeight**



**Object**

Required A "ScreenItem" object with the formats "Ellipse", "EllipseSegment" or "EllipticalArc".

**LONG**

Optional A value or a constant that specifies the minor axis in pixels.

**See also**

Ellipse (Page 3993)

EllipseSegment (Page 3995)

EllipticalArc (Page 3998)

TubeArcObject (Page 4121)

**RadiusWidth**

**Description**

Determines the main axis of the object "Ellipse".

Access during runtime: Read and Write

**Syntax**

Object.RadiusWidth

**Object**

Required. An object of the "ScreenItem" type with the characteristic "Ellipse."

**LONG**

Optional. A value or constant which determines the main axis in pixels.

**RadiusWidth**

**Description**

Specifies the major axis of the "Ellipse" object.

Access in Runtime: Read and write

**Syntax**

Object.RadiusWidth

**Object**

Required A "ScreenItem" object with the formats "Ellipse", "EllipseSegment" or "EllipticalArc".

**LONG**

Optional A value or a constant that specifies the major axis in pixels.

**See also**

Ellipse (Page 3993)

EllipseSegment (Page 3995)

EllipticalArc (Page 3998)

TubeArcObject (Page 4121)

**ReadOnly**

**Description**

Specifies whether the Control has read and write access in Runtime.

Access in Runtime: Read and write

**Syntax**

Object.**ReadOnly**[=BOOLEAN]

**Object**

Required A "ScreenItem" object with the format "UserArchiveControl".

**BOOLEAN**

Optional TRUE, if the Control has read and write access in Runtime.

**RecipeName**

**Description**

Returns the name of the recipe that is currently being displayed in the "RecipeView".

Access in Runtime: Read

**Syntax**

Object.**RecipeName**

**Object**

Required A "ScreenItem" object with the format "RecipeView".

## RecipeNumber

### Description

Returns the number of the recipe that is currently being displayed in the "RecipeView".

Access in Runtime: Read

### Syntax

Object.RecipeNumber

#### Object

Required A "ScreenItem" object with the format "RecipeView".

## RecordName

### Description

Returns the name of the recipe data record that is currently being displayed in the "RecipeView".

Access in Runtime: Read

### Syntax

Object.RecordName

#### Object

Required A "ScreenItem" object with the formats "RecipeView" or "PrintRecipe".

## RecordNumber

### Description

Returns the number of the recipe data record that is currently being displayed in the "RecipeView".

Access in Runtime: Read

### Syntax

Object.RecordNumber

#### Object

Required A "ScreenItem" object with the format "RecipeView".

## ReferenceRotationLeft

### Description

Defines or returns the X-coordinate of the reference point about which the object should be rotated in Runtime.

The value of the x coordinate is relative to the object width. Enter the value in percent starting from the left edge of the rectangle enclosing the object.

## ReferenceRotationTop

### Description

Defines or returns the Y-coordinate of the reference point about which the object should be rotated in Runtime.

The value of the Y-coordinate is relative to the object height. Enter the value in percent starting from the top edge of the rectangle enclosing the object.

## RelativeFillLevel

### Description

Specifies the fill percentage for the object.

Access in Runtime: Read and write

### Syntax

Object.**RelativeFillLevel**[=Int]

#### Object

Required A "ScreenItem" object with the formats "Ellipse", "Circle", "EllipseSegment", "CircleSegment", "Rectangle", "Polygon", "TextField", "Button", "Roundbutton", "GraphicView", "Checkbox", "OptionGroup" or "WindowSlider".

#### Int

Optional A value or a constant that specifies the fill percentage of the object.

## See also

Ellipse (Page 3993)  
Circle (Page 3977)  
EllipseSegment (Page 3995)  
CircleSegment (Page 3979)  
Rectangle (Page 4072)  
Polygon (Page 4057)  
TextField (Page 4107)  
Button (Page 3968)  
GraphicView (Page 4014)  
OptionGroup (Page 4054)  
WindowSlider (Page 4139)

## Relevant property

### Description

TRUE, when the object will be taken into account when forming the group display. BOOLEAN write-read access.

## RemoveAssignment

### Description

Removes an entry.

## RemoveAllAssignment

### Description

Deletes all entries.

## RightComma property

### Description

Defines or returns the number of decimal places (0 to 20).

## Rotation

### Description

Specifies the angle of rotation in degrees of the selected object. The angle of rotation is measured counterclockwise.

Access in Runtime: Read and write

### Syntax

Object.**Rotation**[=SymbolLibRotation]

#### Object

Required A "ScreenItem" object with the format "SymbolLibrary".

#### SymbolLibRotation

hmiSymbolLibraryRotationNone ( 0): The object rotates by 0 degrees.

hmiSymbolLibraryRotation90Degree ( 90): The object rotates by 90 degrees.

hmiSymbolLibraryRotation180Degree ( 180): The object rotates by 180 degrees.

hmiSymbolLibraryRotation270Degree ( 270): The object rotates by 270 degrees.

### See also

SymbolLibrary (Page 4098)

## RotationAngle

### Description

Specifies the angle of rotation in degrees.

Access in Runtime: Read and write

### Syntax

Object.**RotationAngle**[=Int]

#### Object

Required A "ScreenItem" object with the formats "Line", "Polyline", "Polygon" or "TextField".

#### Int

Optional A value or a constant that specifies the angle of rotation in degrees.

## Comments

In Runtime the object rotates clockwise on the reference point.

## See also

Line (Page 4025)

Polyline (Page 4060)

Polygon (Page 4057)

TextField (Page 4107)

TubeTeeObject (Page 4128)

## RotationCenterLeft

### Description

Establishes the X coordinates of the pivot point to rotate the object in Runtime.

Access in Runtime: Read and write

### Syntax

Object.**RotationCenterLeft**[=Int]

#### Object

Required A "ScreenItem" object with the formats "Line", "Polyline", "Polygon" or "TextField".

#### Int

Optional A value or a constant that specifies the X coordinates of the pivot point to rotate the object in runtime.

## Comments

The value of the X coordinate is relative to the object width. Specify the value as a percentage from the left edge of the rectangle that surrounds the object.

## See also

Line (Page 4025)

Polyline (Page 4060)

Polygon (Page 4057)

TextField (Page 4107)

## RotationCenterTop

### Description

Specifies the Y coordinates of the pivot point to rotate the object in Runtime.

Access in Runtime: Read and write

### Syntax

Object.**RotationCenterTop**[=Int]

#### Object

Required A "ScreenItem" object with the formats "Line", "Polyline", "Polygon" or "TextField".

#### Int

Optional A value or a constant that specifies the Y coordinates of the pivot point to rotate the object in Runtime.

### Comments

The value of the Y coordinate is relative to the object width. Specify the value as a percentage from the upper edge of the rectangle that surrounds the object.

### See also

Line (Page 4025)

Polyline (Page 4060)

Polygon (Page 4057)

TextField (Page 4107)

## RoundCornerHeight

### Description

Defines or returns the corner radius.

Enter the value as a percentage of half the height of the object.

### See also

Rectangle (Page 4072)



**RoundCornerWidth****Description**

Defines or returns the corner radius.  
Enter the value as a percentage of half the width of the object.

**See also**

Rectangle (Page 4072)

**RowNumber****Description**

Specifies the row number of the Row object of a Table Control.

**See also**

AlarmControl (Page 3947)

**RowScrollbar****Description**

Enables the display of row scroll bars.

**Syntax**

Object.**RowScrollbar**[=ScrollbarVisibility]

**Object**

Required An object of the "ScreenItem" type with the format "AlarmControl", "OnlineTrendControl", "TrendRulerControl" or "OnlineTableControl".

**ScrollbarVisibility**

Value	Description	Description
0	no	No row scroll bars.
1	as required	Row scroll bars are displayed if horizontal space requirements of the control are greater than the actually available display area.
2	always	Row scroll bars are always displayed.

## See also

AlarmControl (Page 3947)

UserArchiveControl (Page 4130)

TrendRulerControl (Page 4110)

OnlineTableControl (Page 4037)

## RowSizingEnable

### Description

Specifies whether the row height can be changed.

The "RowSizingEnable" property is then only disabled if both properties "RowSizingEnable" and "AdaptFontSizeToLineHeight" have the value FALSE.

Access in Runtime: Read and write

### Syntax

Object.**RowSizingEnable**[=BOOLEAN]

#### Object

Required A "ScreenItem" object with the format "AlarmControl".

#### BOOLEAN

Optional TRUE, if the row height can be changed.

## See also

AlarmControl (Page 3947)

## RowTitleAlign

### Row label alignment - RowTitleAlign

Specifies the type of row label alignment.

The following settings are available:

Value	Description	Description
0	left	The row headers are aligned left.
1	centered	The row headers are aligned to center.
2	right	The row headers are aligned right.

The attribute can be assigned dynamic properties by means of the name **RowTitleAlign**.

**See also**

AlarmControl (Page 3947)

**RTPersistence****Description**

Specifies how online configurations of WinCC are retained.

**Syntax**

Object.**RTPersistence**[=RTPersistence]

**Object**

Required An object of the "ScreenItem" type with the format "AlarmControl", "OnlineTrendControl", "TrendRulerControl" or "OnlineTableControl" (Runtime Professional) or "HMITrendView" (Runtime Advanced).

**RTPersistence**

Value	Description	Explanation
0	Discard	The current online configurations are discarded at the next picture change.
1	Retain	The current online configurations are retained at the next picture change.
2	Reset	All online configurations made are lost. The picture is set to the contents found in the configuration system.

**See also**

AlarmControl (Page 3947)

UserArchiveControl (Page 4130)

TrendRulerControl (Page 4110)

FunctionTrendControl (Page 4004)

OnlineTableControl (Page 4037)

OnlineTrendControl (Page 4045)

**RTPersistencePasswordLevel****Description**

Displays the authorization for online configuration. You can edit the authorization using the selection button. Authorizations are configured in the user administration.

## Syntax

Object.**RTPersistencePasswordLevel**

### Object

Required An object of the "ScreenItem" type with the format "AlarmControl", "OnlineTrendControl", "TrendRulerControl" or "OnlineTableControl" (Runtime Professional) or "HMITrendView" (Runtime Advanced).

## See also

AlarmControl (Page 3947)

## RTPersistenceType

### Description

Specifies how online configurations of WinCC are retained.

### Syntax

Object.**RTPersistenceType**[=RTPersistenceType]

### Object

Required An object of the "ScreenItem" type with the format "AlarmControl", "OnlineTrendControl", "TrendRulerControl" or "OnlineTableControl" (Runtime Professional) or "HMITrendView" (Runtime Advanced).

### RTPersistenceType

Value	Description	Explanation
0	Do not retain	Online configurations are not retained. These are lost at the next picture change.
1	Retain during runtime	Online configurations are retained during runtime. These are lost on exiting.
2	Retain permanently	Online configurations are retained permanently. These are also available after restart.

## See also

AlarmControl (Page 3947)

UserArchiveControl (Page 4130)

TrendRulerControl (Page 4110)

FunctionTrendControl (Page 4004)

OnlineTableControl (Page 4037)

OnlineTrendControl (Page 4045)

## RulerColor

### Description

Specifies the color of the scale gradation (help line) of the axis label in the "OnlineTrendControl" object.

Access in Runtime: Read and Write

### Syntax

Object.**RulerColor**[= Color]

#### Object

Required An object of the "ScreenItem" type with the format "OnlineTrendControl" (Runtime Professional) or "HMITrendView" (Runtime Advanced).

#### Color

Optional A value or a constant that specifies the color of the scale gradation.

### Comments

Use the "RGB" function to establish the colors in RGB format (red, green blue). To do this, enter the appropriate decimal value for each of the three RGB values (range from 0 to 255). For example, the color "red" is shown as: RGB(255, 0, 0). You can also use the VBScript color constants such as vbRed or vbGreen.

### See also

TrendView (Page 4118)

## RulerPrecision(i)

### Description

Specifies the number of decimal places with which a measurement value of the specified trend will be displayed if it is measured via the function "Display value here".

Access in Runtime: Read and write

### Syntax

Object.**RulerPrecision(i)**[=Int]

#### Object

Required A "ScreenItem" object with the format "OnlineTrendControl".

**Int**

Optional A value or a constant that specifies the number of decimal places with which a measurement value of the specified trend will be displayed if it is measured via the function "Display value here".

**See also**

OnlineTrendControl (Page 4045)

**RulerXPrecision(i)**

**Description**

Specifies the number of decimal places with which a measurement value of the X coordinate will be displayed. Whether the information is evaluated depends on the value of the property "XAxisMode(i)".

Access in Runtime: Read and write

**Syntax**

Object.**RulerXPrecision(i)**[=Int]

**Object**

Required A "ScreenItem" object with the format "FunctionTrendControl".

**Int**

Optional A value or a constant that specifies the number of decimal places with which a measurement value of the X coordinate will be displayed.

**Comments**

The parameter i indicates the number of the trend.

You use the function "Display value here" to view the X coordinate of the measurement value.

**See also**

FunctionTrendControl (Page 4004)

**RulerYPrecision(i)**

**Description**

Specifies the number of decimal places with which a measurement value of the Y coordinate will be displayed. Whether the information is evaluated depends on the value of the property "XAxisMode(i)".

Access in Runtime: Read and write

## Syntax

Object.**RulerYPrecision**(i)[=Int]

### Object

Required An object of the "ScreenItem" type with the format "FunctionTrendControl".

### Int

Optional A value or a constant that specifies the number of decimal places with which a measurement value of the Y coordinate will be displayed.

## Comments

The parameter i indicates the number of the trend.

You use the function "Display value here" to view the Y coordinate of the measurement value.

## See also

FunctionTrendControl (Page 4004)

## Properties S

### SameSize

### Description

TRUE, when all four buttons of a Group Display object have the same size. BOOLEAN write-read access.

### ScaleColor

### Description

Specifies the color of the scale of the selected object.

Access in Runtime: Read and write

## Syntax

Object.**ScaleColor**[= Color]

**Object**

Required An object of the "ScreenItem" type with the format "Bar" or "OnlineTrendControl" (Runtime Professional) or "HMITrendView" (Runtime Advanced).

**Color**

Optional A value or a constant that specifies the color of the scale.

**Comments**

Use the "RGB" function to establish the colors in RGB format (red, green blue). To do this, enter the appropriate decimal value for each of the three RGB values (range from 0 to 255). For example, the color "red" is shown as: RGB(255, 0, 0). You can also use the VBS color constants like vbRed or vbGreen.

ScreenItem object with the format "Bar": For the color to be displayed, the property ""ShowScale" must have the value TRUE.

**See also**

Bar (Page 3961)

TrendView (Page 4118)

**ScaleGradation**

**Description**

Specifies the distance between two large marking lengths of the scale.

Access in Runtime: Read and write

**Syntax**

Object.**ScaleGradation**[=Double]

**Object**

Required A "ScreenItem" object with the format "Bar".

**Double**

Optional A value or a constant that specifies the distance between two large marking lengths of the scale.

**See also**

Bar (Page 3961)



## ScaleLabelColor

### Description

Specifies the color of the label for the scale gradation of the "Gauge" object.

Access during runtime: Read and Write

### Syntax

Object.**ScaleLabelColor**[= Color]

#### Object

Required An object of the "ScreenItem" type with the characteristic "Gauge".

#### Color

Optional A value or a constant that specifies the label color of the scale gradation.

### Comments

Use the "RGB" function to establish the colors in RGB format (red, green blue). To do this, enter the appropriate decimal value for each of the three RGB values (range from 0 to 255). For example, the color "red" is shown as: RGB(255, 0, 0). You can also use the VBScript color constants such as vbRed or vbGreen.

### See also

Gauge (Page 4008)

## ScaleNumerator

### Description

Defines the counter for scaling on the client.

### Syntax

Object.**ScaleNumerator** =[Int]

#### Object

Required A "ScreenItem" object with the format "SmartClientView".

#### Int

Optional A value or a constant that specifies the value.

## See also

SmartClientView (Page 4085)

## ScalePosition

### Description

Specifies the position of the scale of the selected object. The "ShowScale" property must be set to TRUE so that the scale can be displayed.

Access in Runtime: Read and write

### Syntax

Object.**ScalePosition**[=ScalePosition]

#### Object

Required A "ScreenItem" object with the format "Bar".

#### ScalePosition

hmiScalePositionLeftUp ( 0): For a vertical bar the scale will be displayed at the top. For a horizontal bar the scale will be shown at the left.

hmiScalePositionRightDown ( 1): For a vertical bar the scale will be displayed at the bottom. For a horizontal bar the scale will be shown at the right.

## See also

Bar (Page 3961)

## ScaleTickColor

### Description

Specifies the color of the scale gradation of the "Gauge" object.

Access in Runtime: Read and write

### Syntax

Object.**ScaleTickColor**[= Color]

#### Object

Required A "ScreenItem" object with the format "Gauge".

#### Color

Optional A value or a constant that specifies the color of the scale gradation.

## Comments

Use the "RGB" function to establish the colors in RGB format (red, green blue). To do this, enter the appropriate decimal value for each of the three RGB values (range from 0 to 255). For example, the color "red" is shown as such: RGB(255, 0, 0). You can also use the VBS color constants like vbRed or vbGreen.

## See also

Gauge (Page 4008)

## ScaleTickLabelPosition

### Description

Specifies the diameter of the assumed circle on which the label of the scale divisions is located.

Access in Runtime: Read and write

### Syntax

Object.**ScaleTickLabelPosition**[=Double]

#### Object

Required A "ScreenItem" object with the format "Gauge".

#### Double

Optional A value or a constant that specifies the diameter of the assumed circle on which the label of the scale division is located.

Value range from 0 to 1

0: The label is located in the center of the scale.

1: The diameter of the assumed circle for the label is the smaller value of the geometry properties "Width" and "Height". A part of the label can lie outside the object limits and is therefore invisible.

## See also

Gauge (Page 4008)

## ScaleTickLength

### Description

Specifies the length of the main markings for the scale division. The value refers to half the smaller value of the geometry properties "Width" and "Height".

The length of the marking lengths for the fine divisions is 0.5\* scale width.

Access in Runtime: Read and write

## Syntax

Object.**ScaleTickLength**[=Double]

### Object

Required A "ScreenItem" object with the format "Gauge".

### Double

Optional A value or a constant that specifies the length of the main markings of the scale.

Value range 0 to scale end value

0: There are no scale divisions. The divisions of the scale in the areas are not visible.

Scale end value: The scale division ranges from the mid point of the scale disc to the value specified by the scale end value.

## See also

Gauge (Page 4008)

## ScaleTickPosition

### Description

Specifies the diameter of the assumed circle on which the scale divisions are located.

The main markings of the scale divisions lie with their outward-facing ends on this circle.

Access in Runtime: Read and write

### Syntax

Object.**ScaleTickPosition**[=Double]

### Object

Required A "ScreenItem" object with the format "Gauge".

### Double

Optional A value or a constant that specifies the diameter of the assumed circle on which the scale divisions are located.

Value range from 0 to 1

0: The scale divisions are located in the center of the scale.

1: The diameter of the assumed circle for the label is the scale divisions is the smaller value of the geometry properties ""Width" and "Height".

**See also**

Gauge (Page 4008)

**ScaleTicks**

**Description**

Defines the number of segments into which the bar will be subdivided by large tick marks of the scale:

0-100: Object can be divided into a maximum of 100 segments

= 0: The optimum number of segments is set automatically.

**ScaleDenominator**

**Description**

Defines the counter for scaling on the client.

**Syntax**

Object.**ScaleDenominator**=[Int]

**Object**

Required A "ScreenItem" object with the format "SmartClientView".

**Int**

Optional A value or a constant that specifies the value.

**See also**

SmartClientView (Page 4085)

**Scaling**

**Description**

TRUE, when a scale should also be used to represent a value. BOOLEAN write-read access.

**See also**

SmartClientView (Page 4085)

## ScalingType

### Description

Specifies the type of bar scaling.

Access in Runtime: Read and write

### Syntax

Object.**ScalingType**[=BarScalingType]

#### Object

Required A "ScreenItem" object with the format "Bar".

#### BarScalingType

Optional A value or a constant that specifies the type of bar scaling.

- hmiBarScalingLinear ( 0): Linear  
The large marks are distributed evenly over the scale. The distance between the large marks corresponds to the value of the "axis section" attribute.
- hmiBarScalingLogarithmic ( 1): Logarithmic  
The distribution of the large marks on the scale follows a logarithmic function. The representation of low values is very strongly highlighted.
- hmiBarScalingNegativeLogarithmic ( 2): Negative logarithmic  
The distribution of the large marks on the scale follows a negative logarithmic function. The representation of high values is very strongly highlighted.
- hmiBarScalingAutomatic ( 3): Automatic  
The large marks are distributed evenly over the scale. The distance between the large marks is specified automatically.
- hmiBarScalingTangent ( 4): Tangents  
The distribution of the large marks on the scale highlights the representation of the low and high values.
- hmiBarScalingQuadratic( 5): Square  
The distribution of the large marks follows a square function. The representation of high values is highlighted.
- hmiBarScalingCubic ( 6): Cubic  
The distribution of the large marks on the scale follows a cubic function. This highlights the representation of large values.

### Comments

For the color to be displayed, the property "ShowScale" must have the value TRUE.

### See also

Bar (Page 3961)

## ScreenItems

### Description

Returns the ScreenItems list.

Access in Runtime: Read

### Syntax

Object.ScreenItems

#### Object

Required A "ScreenItems"." object.

## ScreenName

### Description

Defines the picture to be displayed in the picture window in Runtime or returns the picture name.

---

#### Note

Always enter picture names without the extension "PDL" for reasons of compatibility with future versions.

---

### See also

ScreenWindow (Page 4078)

## Screens

### Description

Returns the Screens list. The Screens list contains two elements: The first element with the index 0 represents the permanent window. The second element with the index 1 represents the root screen. Alternatively, the two elements can be addressed by means of their names. Use "Overview" for the permanent window and "Base" for the root screen.

#### Note

The alarm window and the alarm indicator are not contained in the Screens list, even if they have the focus in Runtime.

Access in Runtime: Read

## Syntax

Object.Screens

### Object

Required A "Screens" object.

## Scrollable

### Description

Specifies whether the DXF screen display supports the Scroll functions in Runtime mode.

Access in Runtime: Read and write

## Syntax

Object.**Scrollable**[=BOOLEAN]

### Object

Required A "ScreenItem" object with the format "DXFView".

### BOOLEAN

Optional TRUE, if the DXF screen display supports the Scroll functions in Runtime mode.

## ScrollBars

### Description

TRUE, when the object is equipped with a scroll bar in Runtime. Read only access.

## ScrollPositionX

### Description

Specifies the horizontal positioning of the scroll bar in a picture window with slider, or returns its value.

The picture is displayed in the picture window by positioning the horizontal and vertical scroll bars. If you wish to display the picture as a cutout where the scroll bars are located at the left and upper edge of the picture, use the properties "OffsetLeft" and "OffsetTop" as the origin of this cutout.



## ScrollPositionY

### Description

Specifies the vertical positioning of the scroll bar in a picture window with slider, or returns its value.

The picture is displayed in the picture window by positioning the horizontal and vertical scroll bars. If you wish to display the picture as a cutout where the scroll bars are located at the left and upper edge of the picture, use the properties "OffsetLeft" and "OffsetTop" as the origin of this cutout.

## SecondNeedleHeight

### Description

Specifies the length of the second hand in the "Clock" object.

Access in Runtime: Read and write

### Syntax

Object.**SecondNeedleHeight**[= LONG]

#### Object

Required A ""ScreenItem" object with the format "Clock".

#### LONG

Optional A value or a constant that specifies the length of the second hand.

Specify the length of the second hand as a percentage relating to the radius of the clock face.

### See also

Clock (Page 3984)

## SecondNeedleWidth

### Description

Specifies the width of the second hand in the "Clock" object.

Access in Runtime: Read and write

### Syntax

Object.**SecondNeedleWidth**[= LONG]

**Object**

Required An object of the type "ScreenItem" with the definition "Clock".

**LONG**

Optional A value or a constant that specifies the width of the second hand. Specify the width as a percentage relating to double the length of the second hand.

**See also**

Clock (Page 3984)

**SegmentColoring**

**Description**

Specifies the type of color change that should be displayed in the "Bar" if the limits are exceeded.

Access in Runtime: Read and write

**Syntax**

Object.**SegmentColoring**[= THmiBarColorType]

**Object**

Required A "ScreenItem" object with the format "Bar".

**THmiBarColorType**

Optional A value or a constant that specifies the type of color change. Value range from 0 to 1.

hmiBarColorEntire (0): Color change applied to the entire bar.

hmiBarColorSegmented (1): Color change applied to segments.

**See also**

Bar (Page 3961)

**SelBGColor**

**Description**

Defines or returns the background color of the selected entry in a text list object. LONG write-read access.

## SelectedText

### Description

Shows the text defined with the "Selected field" (SelIndex) attribute which is highlighted in the combobox or list box.

### See also

Listbox (Page 4027)

## SelectBackColor

### Description

Specifies the background color of the selected text entry for the selected object.

Access in Runtime: Read and write

### Syntax

Object.**SelectBackColor**[=Color]

#### Object

Required A "ScreenItem" object with the format "SymbolicIOField".

#### Color

Optional A value or a constant that specifies the background color of the selected text entry of the selected object.

### See also

SymbolicIOField (Page 4093)

## SelectedCellColor

### Description

Specifies the background color of a selected cell. You open a color selection dialog box with the button.

Access in Runtime: Read and write

### Syntax

Object.**SelectedCellColor**=[Color]

**Object**

Required An object of the "ScreenItem" type with the format "AlarmControl", "OnlineTableControl", "UserArchiveControl", "TrendRulerControl".

**Color**

Optional A value or a constant which specifies the background color.

**See also**

UserArchiveControl (Page 4130)

TrendRulerControl (Page 4110)

OnlineTableControl (Page 4037)

AlarmControl (Page 3947)

**SelectedCellForeColor**

**Description**

Specifies the font color of the selected cell. You open a color selection dialog box with the button.

Access in Runtime: Read and write

**Syntax**

Object.**SelectedCellForeColor**=[Color]

**Object**

Required An object of the "ScreenItem" type with the format "AlarmControl", "OnlineTableControl", "UserArchiveControl", "TrendRulerControl".

**Color**

Optional A value or a constant which specifies the font color.

**See also**

UserArchiveControl (Page 4130)

TrendRulerControl (Page 4110)

OnlineTableControl (Page 4037)

AlarmControl (Page 3947)

## SelectedIndex

### Description

Defines and returns the index of which the associated text is highlighted in the combobox or list box.

The maximum value is the number of lines (NumberLines) of the object.

### See also

Listbox (Page 4027)

## SelectedRowColor

### Description

Specifies the background color of the selected line. You open a color selection dialog box with the button.

Access in Runtime: Read and write

### Syntax

Object.**SelectedRowColor**[=Color]

#### Object

Required An object of the "ScreenItem" type with the format "MessageView", "OnlineTableControl", "RecipeView", "RulerControl".

#### Color

Optional A value or a constant which specifies the background color.

### See also

UserArchiveControl (Page 4130)

TrendRulerControl (Page 4110)

OnlineTableControl (Page 4037)

AlarmControl (Page 3947)

## SelectedRowForeColor

### Description

Specifies the font color of the selected row. You open a color selection dialog box with the button.

Access in Runtime: Read and write

## Syntax

Object.**SelectedRowForeColor**[=Color]

### Object

Required An object of the "ScreenItem" type with the format "MessageView", "OnlineTableControl", "RecipeView", "RulerControl".

### Color

Optional A value or a constant which specifies the font color.

## See also

UserArchiveControl (Page 4130)

TrendRulerControl (Page 4110)

OnlineTableControl (Page 4037)

AlarmControl (Page 3947)

## SelectedTitleColor

### Description

Specifies the background color of a selected table header. You open a color selection dialog box with the button.

The settings are only active in Runtime if the "Marking color" option is enabled.

Access in Runtime: Read and write

### Syntax

Object.**SelectedTitleColor**[=Color]

### Object

Required An object of the "ScreenItem" type with the format "MessageView", "OnlineTableControl", "RecipeView", "RulerControl".

### Color

Optional A value or a constant which specifies the background color.

## See also

UserArchiveControl (Page 4130)

TrendRulerControl (Page 4110)

OnlineTableControl (Page 4037)

AlarmControl (Page 3947)

## SelectedTitleForeColor

### Description

Specifies the font color of the marked table header. You open the color selection dialog box with the button.

The setting is only effective in Runtime when the "Marking color" option is activated.

Access in Runtime: Read and write

### Syntax

Object.**SelectedTitleForeColor**[=Color]

#### Object

Required An object of the "ScreenItem" type with the format "MessageView", "OnlineTableControl", "RecipeView", "RulerControl".

#### Color

Optional A value or a constant which specifies the font color.

## See also

UserArchiveControl (Page 4130)

TrendRulerControl (Page 4110)

OnlineTableControl (Page 4037)

AlarmControl (Page 3947)

## SelectForeColor

### Description

Specifies the color of the selected text entry for the selected object.

Access in Runtime: Read and write

## Syntax

Object.**SelectForeColor**[=Color]

### Object

Required A "ScreenItem" object with the format "SymbolicIOField".

### Color

Optional A value or a constant that specifies the color of the selected text entry of the selected object.

## See also

SymbolicIOField (Page 4093)

## SelectionBackColor

### Description

Specifies the background color of the selected cells.

Access in Runtime: Read and write

### Syntax

Object.**SelectionBackColor**[= Color]

### Object

Required An object of the "ScreenItem" type with the format "UserArchiveControl", "StatusForce", "OnlineTrendControl", "AlarmControl", "UserView".

### Color

Optional A value or a constant that specifies the background color of the selected row.

### Comments

Use the "RGB" function to establish the colors in RGB format (red, green blue). To do this, enter the appropriate decimal value for each of the three RGB values (range from 0 to 255). For example, the color "red" is shown as such: RGB(255, 0, 0). You can also use the VBS color constants like vbRed or vbGreen.

## See also

TrendView (Page 4118)



## SelectionBackColor

### Description

Determines the background color of the selected cells.

Access during runtime: Read and Write

### Syntax

Object.SelectionBackColor [= Color]

#### Object

Required An object of the "ScreenItem" type with the characteristics "RecipeView," "StatusForce", "MessageView" or "UserView".

#### Color

Optional A value or constant which determines the background color of the selected row.

### Comments

You can use the "RGB" function to establish the colors in the RGB format (red, green, blue). To do this, enter the appropriate decimal value for each of the three RGB values (range from 0 to 255). For example, the color "red" is shown as: RGB(255, 0, 0). You can also use the VBScript color constants such as vbRed or vbGreen.

### See also

AlarmView (Page 3958)

RecipeView (Page 4068)

StatusForce (Page 4087)

UserView (Page 4137)

## SelectionColoring

### Description

Enables the use of selection colors for cells or rows.

Access in Runtime: Read and write

### Syntax

Object.**SelectionColoring**[=GridSelectionColoring]

**Object**

Required An object of the "ScreenItem" type with the format "MessageView", "OnlineTableControl", "RecipeView", "RulerControl".

GridSelectionColoring:

Value	Description	Description
0	None	No selection colors for cells and rows.
1	Cell	Selection color for cell.
2	Row	Selection color for row.
3	Cell and row	Selection colors for cell and row.

**See also**

- UserArchiveControl (Page 4130)
- TrendRulerControl (Page 4110)
- OnlineTableControl (Page 4037)
- AlarmControl (Page 3947)

**SelectionForeColor**

**Description**

Specifies the foreground color of the selected cells.

Access in Runtime: Read and write

**Syntax**

Object.**SelectionForeColor**

**Object**

Required An object of the "ScreenItem" type with the format "OnlineTrendControl", "FunctionTrendControl" or "OnlineTableControl".

**Comments**

You can use the "RGB" function to specify the color in RGB format (red, green blue). To do this, enter the appropriate decimal value for each of the three RGB values (range from 0 to 255). For example, the color "red" is shown as such: RGB(255, 0, 0). You can also use the VBS color constants like vbRed or vbGreen.

**See also**

- TrendView (Page 4118)

## SelectionForeColor

### Description

Determines the foreground color of the selected cells.

Access during runtime: Read and Write

### Syntax

Object.SelectionForeColor

#### Object

Required An object of the "ScreenItem" type with the characteristics "RecipeView," "StatusForce", "MessageView" or "UserView".

### Comments

You can use the "RGB" function to establish the colors in the RGB format (red, green, blue). To do this, enter the appropriate decimal value for each of the three RGB values (range from 0 to 255). For example, the color "red" is shown as: RGB(255, 0, 0). You can also use the VBScript color constants such as vbRed or vbGreen.

### See also

AlarmView (Page 3958)

RecipeView (Page 4068)

StatusForce (Page 4087)

UserView (Page 4137)

## SelectionMode

### Description

Defines whether and how a message line can be selected.

.

Access in Runtime: Read and write

### Syntax

Object.**SelectionMode**[=Mode]

#### Object

Required A "ScreenItem" object with the format "MessageView".

### Mode

0 - NoSelection: Prevents the selection of a message. Acknowledgement affects the oldest pending message.

1 - Cell: Enables the selection of fields in the message line. Acknowledgement affects the selected message.

2 - Line: Enables the selection of a message line. Acknowledgement affects the selected message.

## SelectionMode

### Description

Specifies whether and how the alarm line can be selected.

Access in Runtime: Read and write

### Syntax

Object.**SelectionMode**[=AlarmViewAdvancedSelectionMode]

### Object

Required An object of the "ScreenItem" type with the format "AlarmControl".

### AlarmViewAdvancedSelectionMode

hmiAlarmViewAdvancedSelectionModeNone ( 0): Prevents the selection of an alarm. An acknowledgement always affects the oldest pending alarm.

hmiAlarmViewAdvancedSelectionModeCell ( 1): Enables the selection of fields in the alarm line. An acknowledgement always effects the selected alarm.

hmiAlarmViewAdvancedSelectionModeLine ( 2): Enables the selection of an alarm line. An acknowledgement always effects the selected alarm.

### See also

AlarmControl (Page 3947)

## SelectionRect

### Description

Enables the use of a selection border for selected cells or rows.

Access in Runtime: Read and write

### Syntax

Object.**SelectionRect**[=GridSelectionBorder]

**Object**

Required An object of the "ScreenItem" type with the format "AlarmControl", "OnlineTableControl", "UserArchiveControl", "TrendRulerControl".

**GridSelectionBorder.**

Value	Description	Description
0	None	No selection border is drawn for selected cells or rows.
1	Cell	A selection border is drawn for the selected cell.
2	Row	A selection border is drawn for the selected row.

**See also**

UserArchiveControl (Page 4130)

TrendRulerControl (Page 4110)

OnlineTableControl (Page 4037)

AlarmControl (Page 3947)

**SelectionRectColor****Description**

Specifies the color of the rectangle in the message window if SelectionType equals "1".

Access in Runtime: Read and write

**Syntax**

Object.**SelectionRectColor**[=Color]

**Object**

Required A "ScreenItem" object with the format "MessageView".

**Color**

Optional A value or a constant which specifies the color.

**See also**

UserArchiveControl (Page 4130)

TrendRulerControl (Page 4110)

OnlineTableControl (Page 4037)

AlarmControl (Page 3947)

## SelectionRectWidth

### Description

Specifies the line width of the selection rectangle in the message window when the the SelectionType is "1".

Access in Runtime: Read and write

### Syntax

Object.**SelectionRectWidth**[=Int]

#### Object

Required A "ScreenItem" object with the format "MessageView".

#### Int

Optional A value or a constant which specifies the line width.

### See also

UserArchiveControl (Page 4130)

TrendRulerControl (Page 4110)

OnlineTableControl (Page 4037)

AlarmControl (Page 3947)

## SelectionType

### Description

Specifies the number of lines you can mark.

The following settings are available:

Value	Description	Explanation
0	None	No line is marked.
1	Single selection	One line can be marked.
2	Multiple selection	Several lines can be marked.

The attribute can be made dynamic with the name SelectionType. The data type is LONG.

## SelTextColor

### Description

Defines or returns the color of the text of the selected entry in the text list object. LONG write-read access.

## SeparatorBackColor

### Description

Specifies the background color of the broken separation lines in the selection list of the specified object.

Access in Runtime: Read and write

### Syntax

Object.**SeparatorBackColor**[=Color]

#### Object

Required A "ScreenItem" object with the format "SymbolicIOField".

#### Color

Optional A value or a constant that specifies the background color of the broken separation lines in the selection list of the specified object.

### See also

SymbolicIOField (Page 4093)

## SeparatorColor

### Description

Specifies the color of the separation lines in the selection list of the specified object.

Access in Runtime: Read and write

### Syntax

Object.**SeparatorColor**[=Color]

#### Object

Required A "ScreenItem" object with the format "SymbolicIOField".

### Color

Optional A value or a constant that specifies the color of the separation lines in the selection list of the specified object.

### See also

SymbolicIOField (Page 4093)

## SeparatorCornerStyle

### Description

Specifies the shape of the corners for the object of the type "ScreenItem" with the format "SymbolicIOField".

### See also

SymbolicIOField (Page 4093)

## SeparatorStyle

### Description

Specifies the line style of the separation lines in the selection list of the selected object.  
Access in Runtime: Read and write

### Syntax

Object.**SeperatorStyle**[=LineStyle]

### Object

Required A "ScreenItem" object with the format "SymbolicIOField".

### LineStyle

hmiLineStyleNone (-1): The selection list has no separation lines.

hmiLineStyleSolid ( 0): The selection list has solid separation lines.

hmiLineStyleDash ( 1): The selection list has broken separation lines.

hmiLineStyleDot ( 2): The selection list has dotted separation lines.

hmiLineStyleDashDot ( 3): The selection list has dash - dot lines as separation lines.

hmiLineStyleDashDotDot ( 4): The selection list has dash - dot - dot lines as separation lines.



### See also

SymbolicIOField (Page 4093)

## SeparatorWidth

### Description

Specifies the width of the separation lines in the selection list of the specified object.

Access in Runtime: Read and write

### Syntax

Object.**SeparatorWidth**[=Int]

#### Object

Required A "ScreenItem" object with the format "SymbolicIOField".

#### Int

Optional A value or a constant that specifies the width of the separation lines in the selection list of the specified object.

### See also

SymbolicIOField (Page 4093)

## SeperatorLineEndShapeStyle

### Description

Specifies the shape of the line ends for the object of the type "ScreenItem" with the format "SymbolicIOField".

### See also

SymbolicIOField (Page 4093)

## ServerScale

### Description

Establishes whether the Sm@rtClient view should be zoomed in or out.

## Syntax

Object.**ServerScale** =[Int]

### Object

Required A "ScreenItem" object with the format "SmartClientView".

### Int

Optional A value or a constant that specifies the value.

## See also

SmartClientView (Page 4085)

## ServerNames

### Description

Specifies the servers of a distributed system from which the message view draws data. The information is given in form of: NameServer1;NameServer2;NameServer3.

Access in Runtime: Read-only

## Syntax

Object.**ServerNames**[=String]

### Object

Required An object of the "ScreenItem" type with the format "AlarmControl" or "UserName".

### String

Optional A value or a constant that specifies the server of a distributed system from which the alarm window receives information.

## See also

AlarmControl (Page 3947)

## ServerPrefix

### Description

Defines the server containing the picture to be displayed in the picture window in Runtime or returns the server name.

Enter the server name followed by two colons: "<Servername>:". No check is made as to whether the server actually exists.

## SetAllAssignment

### Description

Sets all entries.

## SetSelection

### Description

Sets a list of the lines which are selected.

## SetpointTrendArchiveStartId(i)

### Description

Specifies the starting position from which the values of the setpoint trend will be read from the recipe. Whether the information is evaluated depends on the value of the property "ShowSetpointTrend(i)".

Access in Runtime: Read and write

### Syntax

Object.**SetpointTrendArchiveStartId(i)**[=Int]

#### Object

Required A "ScreenItem" object with the format "FunctionTrendControl".

#### Int

Optional A value or a constant that specifies the starting position from which the values of the setpoint trend will be read from the recipe.

### Comments

The parameter i indicates the number of the trend.

### See also

FunctionTrendControl (Page 4004)

## SetpointTrendColor(i)

### Description

Specifies the color of a setpoint trend. Whether the information is evaluated depends on the value of the property "ShowSetpointTrend(i)".

Access in Runtime: Read and write

### Syntax

Object.**SetpointTrendColor(i)**[=Color]

#### Object

Required An object of the "ScreenItem" type with the format "FunctionTrendControl".

#### Color

Optional A value or a constant that specifies the color of a setpoint trend.

### Comments

The parameter i indicates the number of the trend.

### See also

FunctionTrendControl (Page 4004)

## SetpointTrendNumberOfValues(i)

### Description

Specifies the number of value pairs of a setpoint trend. Whether the information is evaluated depends on the value of the property "ShowSetpointTrend(i)".

Access in Runtime: Read and write

### Syntax

Object.**SetpointTrendNumberOfValues(i)**[=Int]

#### Object

Required A "ScreenItem" object with the format "FunctionTrendControl".

#### Int

Optional A value or a constant that specifies the number of value pairs of a setpoint trend.

## Comments

The parameter *i* indicates the number of the trend.

## See also

FunctionTrendControl (Page 4004)

## SetProps

## Description

Sets the value of the property.

## ShareTimeAxis

## Description

Specifies whether the trends of a trend window are displayed with a shared X axis.

Access in Runtime: Read and write

## Syntax

Object.**ShareTimeAxis**[=BOOLEAN]

### Object

Required A "ScreenItem" object with the format "OnlineTrendControl".

### BOOLEAN

Optional. TRUE, if the trends of the trend window are displayed with a shared X axis.

## See also

OnlineTrendControl (Page 4045)

## ShareTimeColumn

## Description

Specifies whether a shared time column will be used in the table window.

Access in Runtime: Read and write

## Syntax

Object.**ShareTimeColumn**[=BOOLEAN]

**Object**

Required A "ScreenItem" object with the format "OnlineTableControl".

**BOOLEAN**

Optional TRUE, if a shared time column will be used in the table window.

**See also**

OnlineTableControl (Page 4037)

**ShareValueAxis**

**Description**

Specifies whether the trends of a trend window are displayed with a shared Y axis.

Access in Runtime: Read and write

**Syntax**

Object.**ShareValueAxis**[=BOOLEAN]

**Object**

Required A "ScreenItem" object with the format "OnlineTrendControl".

**BOOLEAN**

Optional TRUE, if the trends of the trend window are displayed with a shared Y axis.

**See also**

OnlineTrendControl (Page 4045)

**ShareXAxis**

**Description**

Specifies whether the trends of a trend window are displayed with a shared X axis.

Access in Runtime: Read and write

**Syntax**

Object.**ShareXAxis**[=BOOLEAN]

**Object**

Required A "ScreenItem" object with the format "FunctionTrendControl".

**BOOLEAN**

Optional TRUE, if the trends of the trend window are displayed with a shared X axis.

**See also**

FunctionTrendControl (Page 4004)

**ShareYAxis**

**Description**

Specifies whether the trends of a trend window are displayed with a shared Y axis.

Access in Runtime: Read and write

**Syntax**

Object.**ShareYAxis**[=BOOLEAN]

**Object**

Required An object of the "ScreenItem" type with the format "FunctionTrendControl".

**BOOLEAN**

Optional TRUE, if the trends of the trend window are displayed with a shared Y axis.

**See also**

FunctionTrendControl (Page 4004)

**Shared**

**Description**

Specifies that an HMI device is shared by several Sm@rtClient Views.

**Syntax**

Object.**Shared**[=BOOLEAN]

**Object**

Required A "ScreenItem" object with the format "SmartClientView".

**See also**

SmartClientView (Page 4085)

## ShiftDecimalPointReadOnlySpecial

### Description

Specifies that the "Shift decimal point" field can only be read.

Access in Runtime: Read and write

### Syntax

Object.**ShiftDecimalPointReadOnlySpecial**[=BOOLEAN]

#### Object

Required A "ScreenItem" object with the format "IOField".

#### BOOLEAN

Optional TRUE, if the "Shift decimal point" field can only be read.

### See also

IOField (Page 4021)

## ShortenCellText

### Description

Specifies whether the content of the fields of an alarm line should be shortened if the column width is too small.

Access in Runtime: Read and write

### Syntax

Object.**ShortenCellText**[=BOOLEAN]

#### Object

Required A "ScreenItem" object with the format "AlarmControl".

#### BOOLEAN

Optional TRUE, if the content of the fields of an alarm line should be shortened if the column width is too small.

### See also

AlarmControl (Page 3947)



## ShortenColumnHeaderText

### Description

Specifies whether the content of the fields of a title line should be shortened if the column width is too small.

Access in Runtime: Read and write

### Syntax

Object.**ShortenColumnHeaderText**[=BOOLEAN]

#### Object

Required A "ScreenItem" object with the format "AlarmControl".

#### BOOLEAN

Optional TRUE, if the content of the fields of a title line should be shortened if the column width is too small.

### See also

AlarmControl (Page 3947)

## ShowAlarmsFromDate

### Description

Specifies that only those message events are displayed that are saved in this tag.

Access in Runtime: Read and write

### Syntax

Object.**ShowAlarmsFromDate**[=Tag]

#### Object

Required An object of the "ScreenItem" type with the format "AlarmControl".

#### Tag

Optional A value or a constant which specifies that only those message events are displayed that are saved in this tag.

### See also

AlarmView (Page 3958)

## ShowBadTagState

Defines whether the object is grayed out when a bad QualityCode or tag status is detected.

- |     |   |
|-----|---|
| Yes | If the quality code or the the tag status are poor, the object is grayed out or the settings for the grid color are used.         |
| No  | If the quality code or the the tag status are poor, the object is not grayed out or the settings for the grid color are not used. |

## See also

- CheckBox (Page 3974)
- Bar (Page 3961)
- WindowSlider (Page 4139)
- SymbolicIOField (Page 4093)
- IOField (Page 4021)
- OptionGroup (Page 4054)

## ShowBar

### Description

Specifies whether the displayed process value in the "Slider" object is also shown by a filled bar.

Access in Runtime: Read and write

### Syntax

Object.ShowBar

#### Object

Required A "ScreenItem" object with the format "Slider".

Optional TRUE, if the process value is also shown by a filled bar.

## See also

- Slider (Page 4082)

## ShowBorder

### Description

Specifies whether the window will be shown with a border.

Access in Runtime: Read and write

## Syntax

Object.**ShowBorder**[=BOOLEAN]

### Object

Required A "ScreenItem" object with the format "UserArchiveControl".

### BOOLEAN

Optional TRUE if the window is to be shown with a border.

## ShowCaption

### Description

Specifies whether the title line is hidden or shown.

+C1763

Access in Runtime: Read and write

### Syntax

Object.**ShowCaption**[=BOOLEAN]

### Object

Required An object of the "ScreenItem" type with the format "OnlineTrendControl", "FunctionTrendControl", "OnlineTableControl", "AlarmControl", "ScreenWindow", "ApplicationWindow" or "UserArchiveControl".

### BOOLEAN

Optional TRUE, if the title line is shown.

### See also

[OnlineTrendControl \(Page 4045\)](#)

[FunctionTrendControl \(Page 4004\)](#)

[OnlineTableControl \(Page 4037\)](#)

[AlarmControl \(Page 3947\)](#)

[ScreenWindow \(Page 4078\)](#)

[ScriptDiagnostics \(Page 4080\)](#)

## ShowColumn(i)

### Description

Specifies whether a column pair that is referenced via the "CurrentColumnIndex" property is shown.

Access in Runtime: Read and write

### Syntax

Object.**ShowColumn**(i)[=BOOLEAN]

#### Object

Required A "ScreenItem" object with the format "OnlineTableControl".

#### BOOLEAN

Optional TRUE, if a column pair that is referenced via the "CurrentColumnIndex" property is shown.

### See also

OnlineTableControl (Page 4037)

## ShowCurve(i)

### Description

Specifies whether a trend that is referenced via the "CurrentCurveIndex" property is shown.

Access in Runtime: Read and write

### Syntax

Object.**ShowCurve**(i)[=BOOLEAN]

#### Object

Required An object of the "ScreenItem" type with the format "OnlineTrendControl" or "FunctionTrendControl".

#### BOOLEAN

Optional TRUE, if a trend that is referenced via the "CurrentCurveIndex" property is shown.

### See also

OnlineTrendControl (Page 4045)

FunctionTrendControl (Page 4004)

## ShowDecimalPoint

### Description

Specifies whether the scale is identified with decimal figures (decimal point and one decimal place) or with whole integers.

Access in Runtime: Read and write

### Syntax

Object.**ShowDecimalPoint**[=BOOLEAN]

#### Object

Required A "ScreenItem" object with the format "Gauge".

#### BOOLEAN

Optional TRUE, if the scale is identified with decimal figures (decimal point and one decimal place).

### See also

Gauge (Page 4008)

## ShowFillLevel

### Description

Specifies whether the selected object is filled.

Access in Runtime: Read and write

### Syntax

Object.**ShowFillLevel**[=BOOLEAN]

#### Object

Required A "ScreenItem" object with the formats "Ellipse", "Circle", "EllipseSegment", "CircleSegment", "Rectangle", "Polygon", "TextField", "Button", "Roundbutton", "GraphicView", "Checkbox", "OptionGroup" or "WindowSlider".

#### BOOLEAN

Optional TRUE, if the selected object is filled.

## See also

Ellipse (Page 3993)  
Circle (Page 3977)  
EllipseSegment (Page 3995)  
CircleSegment (Page 3979)  
Rectangle (Page 4072)  
Polygon (Page 4057)  
TextField (Page 4107)  
Button (Page 3968)  
GraphicView (Page 4014)  
OptionGroup (Page 4054)  
WindowSlider (Page 4139)

## ShowFocusRectangle

### Description

Specifies whether the button is given a selection border when it is activated in Runtime.  
Access in Runtime: Read and write

### Syntax

Object.**ShowFocusRectangle**[=BOOLEAN]

#### Object

Required A "ScreenItem" object with the format "Clock".

#### BOOLEAN

Optional TRUE, if the button is given a selection border when it is activated in Runtime.

## See also

Clock (Page 3984)

## ShowInputControls

### Description

Establishes whether additional fields exist for entering the address and password.

## Syntax

Object.**ShowInputControls**

### Object

Required A "ScreenItem" object with the format "SmartClientView".

## ShowLargeTicksOnly

### Description

Defines or returns the length of the axis section in pixels.

### See also

Bar (Page 3961)

## ShowLimitMarkers

### Description

Specifies whether the limit value is shown as a scale value.

Access in Runtime: Read and write

## Syntax

Object.**ShowLimitMarkers**[=BOOLEAN]

### Object

Required A "ScreenItem" object with the format "Bar".

### BOOLEAN

Optional TRUE, if the limit value is shown as a scale value.

### See also

Bar (Page 3961)

## ShowMainFrame

### Description

Specifies whether the entire bar object is provided with a border.

Access in Runtime: Read and write

## Syntax

Object.ShowMainFrame[=BOOLEAN]

### Object

Required A "ScreenItem" object with the format "Bar".

### BOOLEAN

Option TRUE, if the entire bar object is shown with a border.

## See also

Bar (Page 3961)

## ShowMessagesAtDate

### Description

Determines at which time the alarms will be displayed.

---

#### Note

This function does not filter out alarms, it positions the display range of the alarm list as of the specified date.

---

Access during runtime: Read and Write

## Syntax

Object.ShowMessagesAtDate [= DATE]

### Object

Required. An object of the "MessageView" type.

### Remarks

To assign SmartTags to the "ShowMessagesAtDate" property, you must formulate the assignment as follows:

'Example 1

```
HmiRuntime.Screens("Screen_1").ScreenItems("Alarm  
view_1").ShowMessagesAtDate = SmartTags("intern_1").Value
```

'Example 2

```
HmiRuntime.Screens("Screen_1").ScreenItems("Alarm  
view_1").ShowMessagesAtDate = CDate(SmartTags("intern_1"))
```

SmartTag "intern\_1" must be of the "DateTime" type.



## See also

AlarmView (Page 3958)

## ShowOverflowIndicator

### Description

Specifies whether an overflow indicator is shown when the process value exceeds or falls short of the limit value.

Access in Runtime: Read and write

### Syntax

Object.**ShowOverflowIndicator**[=BOOLEAN]

#### Object

Required A "ScreenItem" object with the format ""Bar".

#### BOOLEAN

TRUE, if an overflow indicator is shown when the process value exceeds or falls short of the limit value.

## See also

Bar (Page 3961)

## ShowPeakValuePointer

### Description

Specifies whether a slave pointer will be used for the selected object.

The slave pointer shows the maximum pointer deflection provided in Runtime while the process screen is loaded. If you reload the process screen, the slave pointer will be reset.

Access in Runtime: Read and write

### Syntax

Object.**ShowPeakValuePointer**[= BOOLEAN]

#### Object

Required A "ScreenItem" object with the format "Gauge".

#### BOOLEAN

Optional TRUE, if the slave pointer is used.

## See also

Gauge (Page 4008)

## ShowPeakValuePointer

### Description

Determines whether a pointer for the given object is to be used.

The pointer shows the maximum hand deflection in runtime as long as the process screen is loaded. When you reload the process screen, the pointer is reset.

Access during runtime: Read and Write

### Syntax

Object.ShowPeakValuePointer [= BOOLEAN]

#### Object

Required. An object of the "ScreenItem" type with the characteristic "Gauge".

#### BOOLEAN

Optional. TRUE, if the pointer is used.

## ShowPosition

### Description

Specifies whether the value of the current slider position should also be displayed numerically. The value is then displayed beneath the slider.

Access in Runtime: Read and write

### Syntax

Object.ShowPosition[= BOOLEAN]

#### Object

Required A "ScreenItem" object with the format "Slider".

#### BOOLEAN

Optional TRUE, if the value is also shown.

## See also

Slider (Page 4082)

## ShowRowHeaders

### Description

Specifies whether the message view contains a column with consecutive numbering of the existing messages.

Access in Runtime: Read and write

### Syntax

Object.**ShowRowHeaders**[=BOOLEAN]

#### Object

Required A "ScreenItem" object with the format "AlarmControl".

#### BOOLEAN

Optional TRUE, if the message view contains a column with consecutive numbering of the existing messages.

### See also

AlarmControl (Page 3947)

## ShowRuler

### Description

Specifies whether a scale division (help line) is displayed for an axis label of the object "OnlineTrendControl".

Access in Runtime: Read and write

### Syntax

Object.**ShowRuler**[= BOOLEAN]

#### Object

Required An object of the "ScreenItem" type with the format "OnlineTrendControl", "OnlineTrendControl" or "FunctionTrendControl".

#### BOOLEAN

Optional TRUE, if the scale gradation is shown.

## See also

OnlineTrendControl (Page 4045)

FunctionTrendControl (Page 4004)

## ShowRuler

### Description

Determines whether a scale gradation (help lines) is expanded for the axis label of the object "TrendView".

Access during runtime: Read and Write

### Syntax

Object.ShowRuler [= BOOLEAN]

#### Object

Required. An object of the "ScreenItem" type with the characteristic "TrendView".

#### BOOLEAN

Optional. TRUE, if the scale gradation is shown.

## See also

TrendView (Page 4118)

## ShowRulerInAxis

### Description

Enables the display of rulers in the time axis.

Access in Runtime: Read and write

### Syntax

Object.ShowRulerInAxis[=BOOLEAN]

#### Object

Required An object of the "ScreenItem" type with the format "FunctionTrendControl", "OnlineTrendControl", (Runtime Professional) or "HMITrendView" (Runtime Advanced).

#### BOOLEAN

TRUE: The rulers are also displayed in the time axes.

FALSE: The rulers are not displayed in the time axes.

### See also

FunctionTrendControl (Page 4004)

OnlineTrendControl (Page 4045)

### ShowScale

#### Description

Specifies whether the values will also be shown in a scale.

Access in Runtime: Read and write

#### Syntax

Object.**ShowScale**[=BOOLEAN]

##### Object

Required A "ScreenItem" object with the format "Bar".

##### BOOLEAN

Optional TRUE, if the values will also be shown in a scale.

### See also

Bar (Page 3961)

### ShowScrollbars

#### Description

Scroll bars - ShowScrollbars

Enables the display of scroll bars.

Access in Runtime: Read and write

#### Syntax

Object.**ShowScrollbars**[=ShowScrollbars]

##### Object

Required An object of the "ScreenItem" type with the format "FunctionTrendControl", "OnlineTrendControl", (Runtime Professional) or "HMITrendView" (Runtime Advanced).

### ShowScrollbars

Value	Description	Explanation
0	no	The display of scroll bars is disabled.
1	as required	Scroll bars are displayed if space requirements of the control are greater than the actual display area.
2	always	The scroll bars are always displayed.

### See also

ScreenWindow (Page 4078)

FunctionTrendControl (Page 4004)

OnlineTrendControl (Page 4045)

### ShowSetpointTrend(i)

#### Description

Specifies whether a setpoint trend that belongs to a trend that is referenced via "CurrentCurveIndex" should be shown.

Access in Runtime: Read and write

#### Syntax

Object.**ShowSetpointTrend**(i)[=BOOLEAN]

#### Object

Required A "ScreenItem" object with the format "FunctionTrendControl".

#### BOOLEAN

Optional TRUE, if a setpoint trend that belongs to a trend that is referenced via "CurrentCurveIndex" should be shown.

### See also

FunctionTrendControl (Page 4004)

### ShowSortButton

#### Description

Enables the display of a sorting button above the vertical scroll bar. Click this sorting button to sort the selected column based on the configured sorting criteria. The sorting button is not displayed if the table does not contain a vertical scroll bar.

Access in Runtime: Read and write

## Syntax

Object.**ShowSortButton**[=BOOLEAN]

### Object

Required An object of the "ScreenItem" type with the format "AlarmControl", "OnlineTableControl", "UserArchiveControl", "TrendRulerControl".

### BOOLEAN

TRUE: The sorting key is displayed. You can sort the selected column.

FALSE: The sorting key is not displayed.

## See also

UserArchiveControl (Page 4130)

TrendRulerControl (Page 4110)

OnlineTableControl (Page 4037)

AlarmControl (Page 3947)

## ShowSortIcon

### Description

Enables the display of the sorting icon.

Access in Runtime: Read and write

### Syntax

Object.**ShowSortIcon**[=BOOLEAN]

### Object

Required An object of the "ScreenItem" type with the format "AlarmControl", "OnlineTableControl", "UserArchiveControl", "TrendRulerControl".

### BOOLEAN

TRUE: The sorting icon is displayed.

FALSE: The sorting icon is not displayed.

## See also

UserArchiveControl (Page 4130)

TrendRulerControl (Page 4110)

OnlineTableControl (Page 4037)

AlarmControl (Page 3947)

## ShowSortIndex

### Description

Specifies whether a sort index is displayed.

Access in Runtime: Read and write

### Syntax

Object.**ShowSortIcon**[=BOOLEAN]

#### Object

Required An object of the "ScreenItem" type with the format "AlarmControl", "OnlineTableControl", "UserArchiveControl", "TrendRulerControl".

#### BOOLEAN

TRUE: A sort index is displayed.

FALSE: A sort index is not displayed.

## See also

UserArchiveControl (Page 4130)

TrendRulerControl (Page 4110)

OnlineTableControl (Page 4037)

AlarmControl (Page 3947)

## ShowStatusBar

### Description

Specifies whether the status bar is shown.

Access in Runtime: Read and write

### Syntax

Object.**ShowStatusBar**[=BOOLEAN]



**Object**

Required An object of the "ScreenItem" type with the format "AlarmControl", "OnlineTableControl", "UserArchiveControl", "TrendRulerControl" or "HTMLBrowser".

**BOOLEAN**

Optional TRUE, if the status bar is shown.

**See also**

OnlineTrendControl (Page 4045)

FunctionTrendControl (Page 4004)

OnlineTableControl (Page 4037)

AlarmControl (Page 3947)

HTMLBrowser (Page 4019)

MediaPlayer (Page 4030)

**ShowTableGridlines**

**Description**

Specifies whether the gridlines are shown in the table of the selected object.

Access in Runtime: Read and write

**Syntax**

Object.**ShowTableGridlines**[= BOOLEAN]

**Object**

Required An object of the "ScreenItem" type with the format "StatusForce", "OnlineTrendControl" or "UserView".

**BOOLEAN**

Optional TRUE, if gridlines are shown.

**See also**

TrendView (Page 4118)

**ShowTableGridlines**

**Description**

Determines whether gridlines are shown in the table of the given object.

Access during runtime: Read and Write

## Syntax

Object.ShowTableGridlines [= BOOLEAN]

### Object

Required. An object of the "ScreenItem" type with the characteristic "StatusForce".

### BOOLEAN

Optional. TRUE, if gridlines are displayed.

## See also

StatusForce (Page 4087)

UserView (Page 4137)

## ShowThumb

### Description

Specifies whether the slider of the "Slider" object will be displayed.

Access in Runtime: Read and write

### Syntax

Object.ShowThumb[= BOOLEAN]

### Object

Required A "ScreenItem" object with the format "Slider".

### BOOLEAN

Optional TRUE, if the slider is shown.

## See also

Slider (Page 4082)

## ShowTickLabels

### Description

Specifies whether the label is shown in the scale.

Access during runtime: Read and write

## Syntax

Object.**ShowTickLabels**[= BOOLEAN]

### Object

Necessary. A "ScreenItem" object with the formats "Bar" or "Slider".

### BOOLEAN

Optional TRUE, if the label is shown.

## Comments

The increments for the measured value are automatically established dependent upon the specified measurement range and the size of the object.

### Used for the following object types:

Slider

## See also

Bar (Page 3961)

Slider (Page 4082)

## ShowTicks

## Description

Specifies whether the marking lengths are shown in the scale of the selected object.

Access during runtime: Read and write

## Syntax

Object.**ShowTicks**[= BOOLEAN]

### Object

Necessary. A "ScreenItem" object with the formats "Clock" or "Slider".

### BOOLEAN

Optional TRUE, if the marking lengths are shown.

### Used for the following object types:

Slider

### See also

Clock (Page 3984)

Slider (Page 4082)

### ShowTitle

#### Description

Defines representation the Control window header.

Access in Runtime: Read and write

#### Syntax

Object.**ShowTitle**[=WindowHeaderStyle]

#### Object

Required An object of the "ScreenItem" type with the format "AlarmControl", "OnlineTableControl", "FunctionTrendControl", "UserArchiveControl", "TrendRulerControl", "OnlineTrendControl" (Runtime Professional) or "HMITrendView" (Runtime Advanced).

#### WindowHeaderStyle

Value	Designation	Description
0	No	No window title.
1	Normal	The window title consists of a WinCC icon and text. The text is entered in the "Text" field.
2	Narrow	The window title consists only of text. The text is entered in the "Text" field.

### See also

UserArchiveControl (Page 4130)

TrendRulerControl (Page 4110)

FunctionTrendControl (Page 4004)

OnlineTableControl (Page 4037)

OnlineTrendControl (Page 4045)

AlarmControl (Page 3947)

### ShowToolBar

#### Description

Specifies whether the toolbar is shown.

Access in Runtime: Read and write

## Syntax

Object.**ShowToolBar**[=BOOLEAN]

### Object

Required An object of the "ScreenItem" type with the format "AlarmControl" or "HTMLBrowser".

### BOOLEAN

Optional TRUE, if a toolbar will be displayed.

## See also

AlarmControl (Page 3947)

HTMLBrowser (Page 4019)

## ShowTrendIcon

### Description

Enables the display of an icon below the value axes. The icon indicates the trend currently displayed in the foreground.

Access in Runtime: Read and write

### Syntax

Object.**ShowTrendIcon**[=BOOLEAN]

### Object

Required An object of the "ScreenItem" type with the format "FunctionTrendControl", "OnlineTrendControl", (Runtime Professional) or "HMITrendView" (Runtime Advanced).

### BOOLEAN

TRUE: The icon is displayed.

FALSE: The icon is not displayed.

## See also

FunctionTrendControl (Page 4004)

OnlineTrendControl (Page 4045)

## ShowTrendIndicator

### Description

Specifies whether the tendency (increasing or falling) of the measurement value that is to be monitored is shown with a small arrow.

Access in Runtime: Read and write

### Syntax

Object.**ShowTrendIndicator**[=BOOLEAN]

#### Object

Required A "ScreenItem" object with the format "Bar".

#### BOOLEAN

Optional TRUE, if the tendency (increasing or falling) of the measurement value that is to be monitored is shown with a small arrow.

### See also

Bar (Page 3961)

## ShowVerticalGridlines

### Description

Specifies whether the columns of the message view are separated by vertical lines.

Access in Runtime: Read and write

### Syntax

Object.**ShowVerticalGridlines**[=BOOLEAN]

#### Object

Required A "ScreenItem" object with the format "AlarmControl".

#### BOOLEAN

Optional TRUE, if the columns of the alarm window will be separated by vertical separation lines.

### See also

AlarmControl (Page 3947)

## ShowXValuesExponential(i)

### Description

Specifies whether a value of the X coordinate is shown in exponential format. Whether the information is evaluated depends on the property "XAxisMode(i)".

Access in Runtime: Read and write

### Syntax

Object.**ShowXValuesExponential(i)[=BOOLEAN]**

#### Object

Required An object of the "ScreenItem" type with the format "FunctionTrendControl".

#### BOOLEAN

Optional TRUE, if a value of the X coordinate is shown in exponential format.

### Comments

The parameter i indicates the number of the trend.

You use the function "Display value here" to view the X coordinate of the measurement value.

### See also

FunctionTrendControl (Page 4004)

## ShowYValuesExponential(i)

### Description

Specifies whether a value of the Y coordinate is shown in exponential format. Whether the information is evaluated depends on the property "XAxisMode(i)".

Access in Runtime: Read and write

### Syntax

Object.**ShowYValuesExponential(i)[=BOOLEAN]**

#### Object

Required An object of the "ScreenItem" type with the format "FunctionTrendControl".

#### BOOLEAN

Optional TRUE, if a value of the Y coordinate is shown in exponential format.

## Comments

The parameter *i* indicates the number of the trend.

You use the function "Display value here" to view the Y coordinate of the measurement value.

## See also

FunctionTrendControl (Page 4004)

## SignificantMask property

### Description

Is required in Runtime to display the active message class with the highest priority. The value of the SignificantMask property represents an internal system output value does not require any specific configuration by the user. Updating is initiated in Runtime by clicking on the object.

## Sizeable property

### Description

TRUE, when it should be possible to change the size of the object in Runtime. BOOLEAN write-read access.

In the case of application window and picture window: Read only access

## See also

TrendRulerControl (Page 4110)

OnlineTableControl (Page 4037)

OnlineTrendControl (Page 4045)

AlarmControl (Page 3947)

## SkinName

### Description

The control style can be defined in this selection field.

Access in Runtime: Read and write

## Syntax

Object.**SkinName**[=SkinName]



**Object**

Required An object of the "ScreenItem" type with the format "MessageView", "OnlineTableControl", "OnlineTrendControl", "FunctionTrendControl", "RecipeView", "RulerControl".

**SkinName**

The following settings are available:

Value	Designation	Description
	Project setting	The style corresponds to the project settings in WinCC Explorer.
0	Classic	"Classic" WinCC style
1	Standard	New WinCC V7 style

**SmallChange****Description**

Defines how many steps the controller can be moved with one mouse click or returns the value.

**SmartTags****Description**

Returns the SmartTags list.

Access in Runtime: Read

**Syntax**

Object.SmartTags

**Object**

Required A ""HMIRuntime" object.

**Sort****Description**

Specifies the sorting criteria in SQL syntax for the database.

Access in Runtime: Read and write

## Syntax

Object.**Sort**[=String]

### Object

Required An object of the "ScreenItem" type with the format "UserArchiveControl".

### String

Optional A value or a constant that specifies the sort criteria in SQL syntax for the database.

## SortByTimeDirection

### Description

Specifies whether the last incoming message is shown at the top of the "AlarmControl" object (ascending sorting order).

Access in Runtime: Read and write

### Syntax

Object.**SortByTimeDirection**[= BOOLEAN]

### Object

Required A "ScreenItems" object with the format "AlarmControl".

### BOOLEAN

Optional TRUE, if the last incoming alarm is shown at the top.

### See also

AlarmControl (Page 3947)

AlarmView (Page 3958)

## SortByTimeEnable

### Description

Specifies whether the sorting direction can be altered in Runtime.

Access in Runtime: Read and write

### Syntax

Object.**SortByTimeEnable**[=BOOLEAN]

**Object**

Required An object of the "ScreenItem" type with the format "AlarmControl".

**BOOLEAN**

Optional TRUE, if the sorting direction can be altered in Runtime.

**See also**

AlarmView (Page 3958)

**SortByTimeEnabled**

**Description**

Specifies whether the sorting of the messages can be altered according to the time in the "AlarmControl" object.

Access in Runtime: Read and write

**Syntax**

Object.**SortByTimeEnabled**[= BOOLEAN]

**Object**

Required A "ScreenItems" object with the format "AlarmControl".

**BOOLEAN**

Optional TRUE, if the sorting can be altered by the device operator.

**SortOnColumnHeaderClick**

**Description**

Specifies whether the alarm text blocks can be sorted via the column header of the alarm text block.

Access in Runtime: Read and write

**Syntax**

Object.**SortOnColumnHeaderClick**[=BOOLEAN]

**Object**

Required An object of the "ScreenItem" type with the format "AlarmControl".

### BOOLEAN

Optional TRUE, if the message blocks can be sorted by the column header of the message blocks.

### See also

AlarmControl (Page 3947)

### SortSequence

### Description

Specifies how to change the sorting order by mouse click.

Access in Runtime: Read and write

### Syntax

Object.**SortSequence**[=BOOLEAN]

### Object

Required An object of the "ScreenItem" type with the format "MessageView", "OnlineTableControl", "RecipeView", "RulerControl".

BOOLEAN.

Value	Description	Description
0	Up/down/none	You can toggle between ascending, descending and no sorting by means of mouse click.
1	Up/down	You can toggle between ascending and descending sorting order by means of mouse click.

### See also

TrendRulerControl (Page 4110)

OnlineTableControl (Page 4037)

AlarmControl (Page 3947)

### SortTimeAscending

### Description

Determines whether the last message received is displayed on top (ascending sorting order) in the "MessageView" object.

Access during runtime: Read and Write

## Syntax

Object.SortTimeAscending [= BOOLEAN]

### Object

Required. An object of the "MessageView" type.

### BOOLEAN

Optional. TRUE, if the last message received is displayed on top.

## SortTimeEnable

### Description

Determines whether the sorting of messages can be changed according to time in the "MessageView" object.

Access during runtime: Read and Write

## Syntax

Object.SortTimeEnable [= BOOLEAN]

### Object

Required. An object of the "MessageView" type.

### BOOLEAN

Optional. TRUE, if the sorting can be changed by the operator on the device.

## StartAngle

### Description

Specifies the angle at which the start point of the selected object deviates from the zero position (0°).

Access in Runtime: Read and write

## Syntax

Object.**StartAngle**[=Int]

### Object

Required A "ScreenItem" object with the formats "EllipseSegment", "CircleSegment", "EllipticalArc" or "CircularArc".

**Int**

Optional A value or a constant that specifies the angle at which the start point of the specified object deviates from the zero position (0°).

**See also**

EllipseSegment (Page 3995)

CircleSegment (Page 3979)

EllipticalArc (Page 3998)

CircularArc (Page 3982)

TubeArcObject (Page 4121)

**StartPoint**

**Description**

Specifies the beginning of the object or returns it.

**StartPointLeft**

**Description**

Specifies the horizontal distance in pixels from the left edge of the screen.

Access in Runtime: Read and write

**Syntax**

Object.**StartPointLeft**[=Int]

**Object**

Required An object of the "ScreenItem type with the format "Line"".

**Int**

Optional A value that specifies the horizontal distance in pixels of the start point from the left edge of the screen.

**See also**

EllipseSegment (Page 3995)

CircleSegment (Page 3979)

EllipticalArc (Page 3998)

CircularArc (Page 3982)

## StartStyle

### Description

Specifies how the line-start style of the specified object will be displayed.

Access in Runtime: Read and write

### Syntax

Object.**StartStyle**[= THmiLineEndStyle]

#### Object

Required A ""ScreenItem" object with the formats ""Line", "Polyline" or ""Connector".

#### THmiLineEndStyle

Optional A value or a constant that specifies the line-start style. Value range from 0 to 1.

hmiLineEndStyleNone (0): The line has no start symbol.

hmiLineEndStyleFilledArrow (2): The line starts with a filled arrowhead.

### See also

Line (Page 4025)

Polyline (Page 4060)

Connector (Page 3986)

## StartStyle

### Description

Determines how the line start of the given object is displayed.

Access in Runtime: Read and write

### Syntax

Object.StartStyle [= THmiLineEndStyle]

#### Object

Required An object of the "ScreenItem" type with the characteristic "Line," or "Polyline".

#### THmiLineEndStyle

Optional A value or constant which determines the line start. Value range from 0 to 2.

hmiLineEndStyleNone (0): The line has no start symbol.

hmiLineEndStyleFilledArrow (2): The line starts with a filled arrow.

## StartTop

### Description

Specifies the vertical distance in pixels of the start point from the upper edge of the screen.

Access in Runtime: Read and write

### Syntax

Object.**StartTop**[=Int]

#### Object

Required An object of the "ScreenItem" type with the format "Line".

#### Int

Optional A value that specifies the vertical distance in pixels of the start point from the upper edge of the screen.

### See also

[EllipseSegment \(Page 3995\)](#)

[CircleSegment \(Page 3979\)](#)

[EllipticalArc \(Page 3998\)](#)

[CircularArc \(Page 3982\)](#)

[Line \(Page 4025\)](#)

## StartValue

### Description

Defines the value of the zero point of the scale indicator.

Defines or returns the absolute value for the zero point.

### See also

[Bar \(Page 3961\)](#)

## State

### Description

Returns the status of a message.

The following table shows the possible states of a message:



State	Alarm Log Status
1	Came In
2	Went Out
5	Came in and comment
6	Gone and comment

## StatusbarBackColor

### Description

Defines the background color of the status bar. You open a color selection dialog box with the button. Enable the "Display" option to active the setting.

### See also

UserArchiveControl (Page 4130)

TrendRulerControl (Page 4110)

FunctionTrendControl (Page 4004)

OnlineTableControl (Page 4037)

OnlineTrendControl (Page 4045)

AlarmControl (Page 3947)

## StatusbarElementAdd

### Description

Defines a new, user-defined status bar element. You can change the name assigned by WinCC in the "Object name" field.

### See also

UserArchiveControl (Page 4130)

TrendRulerControl (Page 4110)

FunctionTrendControl (Page 4004)

OnlineTableControl (Page 4037)

OnlineTrendControl (Page 4045)

AlarmControl (Page 3947)

## StatusbarElementAutoSize

### Description

Enables autosizing of the width of a status bar element selected.

Access in Runtime: Read and write

### Syntax

Object.**StatusbarElementAutoSize**

#### Object

Required An object of the "ScreenItem" type with the format "MessageView", "OnlineTableControl", "FunctionTrendControl", "RecipeView", "RulerControl", "OnlineTrendControl" (Runtime Professional) or "HMITrendView" (Runtime Advanced).

#### BOOLEAN

TRUE: The width of the selected element is set automatically.

FALSE: The width of the selected element is not set automatically.

### See also

UserArchiveControl (Page 4130)

TrendRulerControl (Page 4110)

FunctionTrendControl (Page 4004)

OnlineTableControl (Page 4037)

OnlineTrendControl (Page 4045)

AlarmControl (Page 3947)

## StatusbarElementCount

### Description

Defines the number of configurable status bar elements.

## See also

UserArchiveControl (Page 4130)  
TrendRulerControl (Page 4110)  
FunctionTrendControl (Page 4004)  
OnlineTableControl (Page 4037)  
OnlineTrendControl (Page 4045)  
AlarmControl (Page 3947)

## StatusbarElementIconId

### Description

Default assignment of the ID number and icon of a status bar element.

The property can be dynamized for customized elements of the status bar with the StatusbarElementIconId name.

## See also

UserArchiveControl (Page 4130)  
TrendRulerControl (Page 4110)  
FunctionTrendControl (Page 4004)  
OnlineTableControl (Page 4037)  
OnlineTrendControl (Page 4045)  
AlarmControl (Page 3947)

## StatusbarElementID

### Description

Returns the ID number of the selected status bar element.

WinCC sets this read only ID.

## See also

UserArchiveControl (Page 4130)  
TrendRulerControl (Page 4110)  
FunctionTrendControl (Page 4004)  
OnlineTableControl (Page 4037)  
OnlineTrendControl (Page 4045)  
AlarmControl (Page 3947)

## StatusbarElementIndex

### Description

References a status bar element. You can assign the values of other properties to a specific element of the status bar by using this property.

Values between 0 and "StatusbarElementCount" minus 1 are valid for "StatusbarElementIndex". Attribute "StatusbarElementCount" defines the number of configurable status bar elements.

## See also

UserArchiveControl (Page 4130)  
TrendRulerControl (Page 4110)  
FunctionTrendControl (Page 4004)  
OnlineTableControl (Page 4037)  
OnlineTrendControl (Page 4045)  
AlarmControl (Page 3947)

## StatusbarElementName

### Description

Displays the object name of the status bar element selected. You can rename the objects of custom status bar elements. The "StatusbarElementName" property for customized elements can be dynamized by the " StatusbarElementRename" property.

## See also

UserArchiveControl (Page 4130)  
TrendRulerControl (Page 4110)  
FunctionTrendControl (Page 4004)  
OnlineTableControl (Page 4037)  
OnlineTrendControl (Page 4045)  
AlarmControl (Page 3947)

## StatusbarElementRemove

### Description

Removes the selected status bar element. Only customized elements of the status bar can be removed from the list.

## See also

UserArchiveControl (Page 4130)  
TrendRulerControl (Page 4110)  
FunctionTrendControl (Page 4004)  
OnlineTableControl (Page 4037)  
OnlineTrendControl (Page 4045)  
AlarmControl (Page 3947)

## StatusbarElementRename

### Description

Change the name of the customized element of the status bar that is referenced by the "StatusbarElementIndex" property.

The property with the name StatusbarElementRename can be dynamized for customized elements. With "StatusbarElementRename" you also dynamize the "StatusbarElementName" property.

## See also

UserArchiveControl (Page 4130)  
TrendRulerControl (Page 4110)  
FunctionTrendControl (Page 4004)  
OnlineTableControl (Page 4037)  
OnlineTrendControl (Page 4045)  
AlarmControl (Page 3947)

## StatusbarElements

### Description

Specifies the elements that are to be shown in the status bar.

Access in Runtime: Read and write

### Syntax

Object.**StatusbarElements**[=Long]

#### Object

Required A "ScreenItem" object with the format "AlarmView".

#### Long

Optional A value or a constant that specifies the elements that are shown in the status bar.

## See also

AlarmControl (Page 3947)  
UserArchiveControl (Page 4130)  
TrendRulerControl (Page 4110)  
FunctionTrendControl (Page 4004)  
OnlineTableControl (Page 4037)  
OnlineTrendControl (Page 4045)

## StatusbarElementTooltipText

### Description

Defines the tooltip text for the custom status bar element.

## See also

UserArchiveControl (Page 4130)  
TrendRulerControl (Page 4110)  
FunctionTrendControl (Page 4004)  
OnlineTableControl (Page 4037)  
OnlineTrendControl (Page 4045)  
AlarmControl (Page 3947)

## StatusbarElementUserDefined

### Description

Indicates whether the project engineer has added the status bar element as a new custom element.

Access in Runtime: Read and write

### Syntax

Object.**StatusbarElementUserDefined**[=BOOLEAN]

#### Object

Required An object of the "ScreenItem" type with the format "MessageView", "OnlineTrendControl", "OnlineTableControl", "FunctionTrendControl", "RecipeView", "RulerControl".

#### BOOLEAN

TRUE: The element of the status bar is customized.

FALSE: The element of the status bar is specified by the system.

## See also

UserArchiveControl (Page 4130)  
TrendRulerControl (Page 4110)  
FunctionTrendControl (Page 4004)  
OnlineTableControl (Page 4037)  
OnlineTrendControl (Page 4045)  
AlarmControl (Page 3947)

## StatusbarElementVisible

### Description

Activate the elements in the list of status bar elements for their display in Runtime.

Click a list entry to adapt the properties, or to change its position in the status bar of the Control by means of the "Up" and "Down" buttons.

### See also

UserArchiveControl (Page 4130)

TrendRulerControl (Page 4110)

FunctionTrendControl (Page 4004)

OnlineTableControl (Page 4037)

OnlineTrendControl (Page 4045)

AlarmControl (Page 3947)

## StatusbarElementWidth

### Description

Shows the width of the status bar element selected in pixels. You can define the width if the "Automatic" option is not activated.

### See also

UserArchiveControl (Page 4130)

TrendRulerControl (Page 4110)

FunctionTrendControl (Page 4004)

OnlineTableControl (Page 4037)

OnlineTrendControl (Page 4045)

AlarmControl (Page 3947)

## StatusbarFontColor

### Description

Defines the color of the text in the status bar.



## See also

UserArchiveControl (Page 4130)  
TrendRulerControl (Page 4110)  
FunctionTrendControl (Page 4004)  
OnlineTableControl (Page 4037)  
OnlineTrendControl (Page 4045)  
AlarmControl (Page 3947)

## StatusbarShowArchiveName

### Description

Specifies whether the archive name will be displayed in the status bar.  
Access in Runtime: Read and write

### Syntax

Object.**StatusbarShowArchiveName**[=BOOLEAN]

#### Object

Required A "ScreenItem" object with the format "UserArchiveControl".

#### BOOLEAN

Optional TRUE, if the archive name will be displayed in the status bar.

## StatusbarShowColumn

### Description

Specifies whether the current number of selected data record columns will be displayed.  
Access in Runtime: Read and write

### Syntax

Object.**StatusbarShowColumn**[=BOOLEAN]

#### Object

Required A "ScreenItem" object with the format "UserArchiveControl".

#### BOOLEAN

Optional TRUE, specifies whether the current number of selected data record columns will be displayed.

## StatusbarShowRecord

### Description

Specifies whether the field coordinates of the selected data record will be displayed in the status bar.

Access in Runtime: Read and write

### Syntax

Object.**StatusbarShowRecord**[=BOOLEAN]

#### Object

Required A "ScreenItem" object with the format "UserArchiveControl".

#### BOOLEAN

Optional TRUE, if the field coordinates of the selected data record will be displayed in the status bar.

## StatusbarShowRow

### Description

Specifies whether the current number of selected data record rows will be displayed.

Access in Runtime: Read and write

### Syntax

Object.**StatusbarShowRow**[=BOOLEAN]

#### Object

Required An object of the "ScreenItem" type with the format "UserArchiveControl".

#### BOOLEAN

Optional TRUE, if the current number of selected data record rows will be displayed.

## StatusbarShowText

### Description

Specifies whether the current status of the database will be displayed in the status bar.

Access in Runtime: Read and write

## Syntax

Object.**StatusbarShowText**[=BOOLEAN]

### Object

Required A "ScreenItem" object with the format "UserArchiveControl".

### BOOLEAN

Optional TRUE, specifies whether the current status of the database will be displayed in the status bar.

## StatusbarShowTooltips

### Description

Enables the display of tooltips for the status bar elements in Runtime.

Access in Runtime: Read and write

### Syntax

Object.**StatusbarShowTooltips**[=BOOLEAN]

### Object

Required An object of the "ScreenItem" type with the format "MessageView", "OnlineTableControl", "OnlineTrendControl", "FunctionTrendControl", "UserArchiveControl", "TrendRulerControl".

### BOOLEAN

TRUE: The tooltips are displayed.

FALSE: The tooltips are not displayed.

### See also

UserArchiveControl (Page 4130)

TrendRulerControl (Page 4110)

FunctionTrendControl (Page 4004)

OnlineTableControl (Page 4037)

OnlineTrendControl (Page 4045)

AlarmControl (Page 3947)

## StatusbarText

### Description

Default text in the status bar.

### See also

UserArchiveControl (Page 4130)  
TrendRulerControl (Page 4110)  
FunctionTrendControl (Page 4004)  
OnlineTableControl (Page 4037)  
OnlineTrendControl (Page 4045)  
AlarmControl (Page 3947)

## StatusbarUseBackColor

### Description

Sets a background color for the status bar.

Access in Runtime: Read and write

### Syntax

Object.**StatusbarUseBackColor**[=BOOLEAN]

#### Object

Required An object of the "ScreenItem" type with the format "MessageView", "OnlineTableControl", "OnlineTrendControl", "FunctionTrendControl", "UserArchiveControl", "TrendRulerControl".

#### BOOLEAN

TRUE: The background color of the status bar is displayed.

FALSE: The background color of the status bar is not displayed.

## See also

UserArchiveControl (Page 4130)  
TrendRulerControl (Page 4110)  
FunctionTrendControl (Page 4004)  
OnlineTableControl (Page 4037)  
OnlineTrendControl (Page 4045)  
AlarmControl (Page 3947)

## StatusbarVisible

### Description

Enables the display of the status bar of a control.

Access in Runtime: Read and write

### Syntax

Object.**StatusbarVisible**[=BOOLEAN]

#### Object

Required An object of the "ScreenItem" type with the format "MessageView", "OnlineTableControl", "OnlineTrendControl", "FunctionTrendControl", "RecipeView", "RulerControl".

#### BOOLEAN

TRUE: The status bar is displayed.

FALSE: The status bar is not displayed.

## See also

UserArchiveControl (Page 4130)  
TrendRulerControl (Page 4110)  
FunctionTrendControl (Page 4004)  
OnlineTableControl (Page 4037)  
OnlineTrendControl (Page 4045)  
AlarmControl (Page 3947)

## Style

### Description

Specifies the line style of the selected object.

Access in Runtime: Read and write

### Syntax

Object.**Style**[= THmiLineStyle]

#### Object

Required A "ScreenItem" object with the formats "Line", "Polyline", "EllipticalArc", "CircularArc" or "Connector".

#### THmiLineStyle

Optional A value or a constant that specifies the line style. Value range from 0 to 4.

hmiLineStyleSolid (0): solid line

hmiLineStyleDash (1): broken line

hmiLineStyleDot (2): dotted line

hmiLineStyleDashDot (3): dash - dot line

hmiLineStyleDashDotDot (4): dash - dot - dot line

Default setting: hmiLineStyleSolid

### See also

Line (Page 4025)

Polyline (Page 4060)

EllipticalArc (Page 3998)

CircularArc (Page 3982)

Connector (Page 3986)

## Style

### Description

Determines the line style of the given object.

Access during runtime: Read and Write

### Syntax

Object.Style [= THmiLineStyle]

**Object**

Required. An object of the "screen item" type with the characteristic "Line," or "Polyline".

**THmiLineStyle**

Optional. A value or constant that defines the line style. Value range from 0 to 4.

hmiLineStyleSolid (0): solid line

hmiLineStyleDash (1): dashed line

hmiLineStyleDot (2): dotted line

hmiLineStyleDashDot (3): dash dot line

hmiLineStyleDashDotDot (4): dash dot dot line

Default setting: hmiLineStyleSolid

**StyleSettings****Description**

Defines the style in which the object is displayed.

User Defined	Shows the object according to the respective settings.
Global	Shows the object in a globally defined design.
Windows Style	Shows the object in Windows style.

**See also**

Button (Page 3968)

WindowSlider (Page 4139)

RoundButton (Page 4074)

**SwapDimensionsWithOrientation****Description**

Specifies whether the values for the height and width of the bar should be automatically replaced if the bar alignment is changed.

Access in Runtime: Read and write

**Syntax**

Object.**SwapDimensionsWithOrientation**[=BOOLEAN]

**Object**

Required A "ScreenItem" object with the format "Bar".

### **BOOLEAN**

Optional TRUE, if the values for the height and width of the bar should be automatically replaced if the bar alignment is changed.

### **See also**

Bar (Page 3961)

## **SwapFirstWithLastConnection**

### **Description**

Specifies whether the text in the object is shown horizontally.

Access in Runtime: Read and write

### **Syntax**

Object.**SwapFirstWithLastConnection**[=BOOLEAN]

#### **Object**

Required A "ScreenItem" object with the format "Connector".

### **BOOLEAN**

Optional TRUE, if the text in the object is shown horizontally.

### **See also**

Connector (Page 3986)

## **Properties T**

### **TableBackColor**

### **Description**

Specifies the background color of the table cells for the selected object.

Access in Runtime: Read and write

### **Syntax**

Object.**TableBackColor**[= Color]



**Object**

Required An object of the "ScreenItem" type with the format "UserArchivControl", "StatusForce", "OnlineTrendControl", "AlarmControl" or "UserView".

**Color**

Optional A value or a constant that specifies the background color of the table cells.

**Comments**

Use the "RGB" function to establish the colors in RGB format (red, green blue). To do this, enter the appropriate decimal value for each of the three RGB values (range from 0 to 255). For example, the color "red" is shown as such: RGB(255, 0, 0). You can also use the VBS color constants like vbRed or vbGreen.

**TableBackColor**

**Description**

Determines the background color of the table cells of the given object.

Access during runtime: Read and Write

**Syntax**

Object.TableBackColor [= Color]

**Object**

Required An object of the "ScreenItem" type with the characteristics "RecipeView", "StatusForce", "TrendView", "MessageView" or "UserView".

**Color**

Optional A value or constant which determines the background color of the table cells.

**Comments**

You can use the "RGB" function to establish the colors in the RGB format (red, green, blue). To do this, enter the appropriate decimal value for each of the three RGB values (range from 0 to 255). For example, the color "red" is shown as: RGB(255, 0, 0). You can also use the VBScript color constants such as vbRed or vbGreen.

### See also

AlarmView (Page 3958)  
RecipeView (Page 4068)  
TrendView (Page 4118)  
StatusForce (Page 4087)  
UserView (Page 4137)

## TableColor

### Description

Defines the background color of the rows. You open a color selection dialog box with the button.

### See also

UserArchiveControl (Page 4130)  
TrendRulerControl (Page 4110)  
OnlineTableControl (Page 4037)

## TableColor2

### Description

Specifies the background color of "Row color 2". You open a color selection dialog box with the button.

The settings are only active in Runtime if the "Row color 2" option is enabled. The background colors of "Row color 2" and "Row color 1" are used alternately in this case.

### See also

UserArchiveControl (Page 4130)  
TrendRulerControl (Page 4110)  
OnlineTableControl (Page 4037)

## TableFocusOnButtonCommand

### Description

Specifies whether by clicking on a Button in a script in Runtime the table of the Controls will be activated.

Access in Runtime: Read and write

## Syntax

Object.**TableFocusOnButtonCommand**[=BOOLEAN]

### Object

Required A "ScreenItem" object with the format "AlarmView".

### BOOLEAN

Optional TRUE, if by clicking on a Button in a script in Runtime the table of the Controls will be activated.

## See also

AlarmControl (Page 3947)

## TableForeColor

### Description

Specifies the font color of the rows. You open a color selection dialog box with the button.

## TableForeColor

### Description

Specifies the text color used in the table cells of the selected object.

Access in Runtime: Read and write

## Syntax

Object.**TableForeColor**[= Color]

### Object

Required A "ScreenItem" object with the formats "RecipeView", ""StatusForce", "MessageView" or ""UserView".

### Color

Optional A value or a constant that specifies the text color used in the table cells.

## Comments

Use the "RGB" function to establish the colors in RGB format (red, green blue). To do this, enter the appropriate decimal value for each of the three RGB values (range from 0 to 255). For example, the color "red" is shown as such: RGB(255, 0, 0). You can also use the VBS color constants like vbRed or vbGreen.

## See also

UserArchiveControl (Page 4130)

TrendRulerControl (Page 4110)

OnlineTableControl (Page 4037)

## TableForeColor

### Description

Determines the text color in the table cells of the given object.

Access during runtime: Read and Write

### Syntax

Object.TableForeColor [= Color]

#### Object

Required An object of the "ScreenItem" type with the characteristics "RecipeView," "StatusForce", "MessageView" or "UserView".

#### Color

Optional A value or constant which determines the text color of the table cells.

### Comments

You can use the "RGB" function to establish the colors in the RGB format (red, green, blue). To do this, enter the appropriate decimal value for each of the three RGB values (range from 0 to 255). For example, the color "red" is shown as: RGB(255, 0, 0). You can also use the VBScript color constants such as vbRed or vbGreen.

## See also

AlarmView (Page 3958)

RecipeView (Page 4068)

StatusForce (Page 4087)

UserView (Page 4137)

## TableForeColor2

### Description

Specifies the font color of "Row color 2". You open a color selection dialog box with the button.

The settings are only active in Runtime if the "Row color 2" option is enabled. The font colors of "Row color 2" and "Row color 1" are used alternately in this case.

### See also

UserArchiveControl (Page 4130)

TrendRulerControl (Page 4110)

OnlineTableControl (Page 4037)

## TableGridLineColor

### Description

Specifies the color of the gridlines in the table of the selected object.

Access in Runtime: Read and write

### Syntax

Object.**TableGridLineColor**[= Color]

#### Object

Required A "ScreenItem" object with the formats "RecipeView", "TrendView" or "UserView".

#### Color

Optional A value or a constant that specifies the color of the gridlines in a table.

### Comments

Use the "RGB" function to establish the colors in RGB format (red, green blue). To do this, enter the appropriate decimal value for each of the three RGB values (range from 0 to 255). For example, the color "red" is shown as such: RGB(255, 0, 0). You can also use the VBS color constants like vbRed or vbGreen.

## TableGridLineColor

### Description

Determines the color of the gridlines in the table of the given object.

Access during runtime: Read and Write

### Syntax

Object.**TableGridLineColor** [= Color]

**Object**

Required An object of the "ScreenItem" type with the characteristics "RecipeView," "MessageView", "TrendView" or "UserView".

**Color**

Optional A value or constant which determines the color of the gridlines of the table.

**Comments**

You can use the "RGB" function to establish the colors in the RGB format (red, green, blue). To do this, enter the appropriate decimal value for each of the three RGB values (range from 0 to 255). For example, the color "red" is shown as: RGB(255, 0, 0). You can also use the VBScript color constants such as vbRed or vbGreen.

**See also**

RecipeView (Page 4068)

TrendView (Page 4118)

UserView (Page 4137)

**TableHeaderBackColor**

**Description**

Specifies the background color in the header of the table of the selected object.

Access during runtime: Read and Write

**Syntax**

Object.**TableHeaderBackColor**[= Color]

**Object**

Required An object of the "ScreenItem" type with the characteristics "RecipeView", "StatusForce", "TrendView", "MessageView," or "UserView".

**Color**

Optional A value or a constant that specifies the background color in the header.

**Comments**

Use the "RGB" function to establish the colors in RGB format (red, green blue). To do this, enter the appropriate decimal value for each of the three RGB values (range from 0 to 255). For example, the color "red" is shown as: RGB(255, 0, 0). You can also use the VBScript color constants such as vbRed or vbGreen.

## See also

UserView (Page 4137)  
AlarmView (Page 3958)  
RecipeView (Page 4068)  
StatusForce (Page 4087)  
TrendView (Page 4118)

## TableHeaderForeColor

### Description

Specifies the text color in the header of the table of the selected object.  
Access during runtime: Read and Write

### Syntax

Object.**TableHeaderForeColor**[= Color]

#### Object

Required An object of the "ScreenItem" type with the characteristics "RecipeView", "StatusForce", "TrendView", "MessageView" or "UserView".

#### Color

Optional A value or a constant that specifies the text color in the header.

### Comments

Use the "RGB" function to establish the colors in RGB format (red, green blue). To do this, enter the appropriate decimal value for each of the three RGB values (range from 0 to 255). For example, the color "red" is shown as: RGB(255, 0, 0). You can also use the VBScript color constants such as vbRed or vbGreen.

## See also

UserView (Page 4137)  
AlarmView (Page 3958)  
RecipeView (Page 4068)  
StatusForce (Page 4087)  
TrendView (Page 4118)

## TagName

### Description

The "Index" property references a trend. "TagName" defines the tag linked to this trend. It is specified in the form "Archivname\Variablenname" to display tags in a process value archive or "TasgName" to display an internal or external tag which is not stored in an archive.

## TagPrefix

### Description

A tag prefix can be assigned for a screen window that is prefixed to all tags which are used in the screen. In this way, a picture that is embedded in a picture window retains access to its own tags while another accesses other tags.

The "TagPrefix" property specifies the prefix that is prefixed to all tags which are available in the screen.

The change to the tag prefix does not become effective until the screen is reloaded. This happens automatically when changing screens, otherwise the screen name must be reassigned.

The prefix is freely definable but must match the name of the structure tag.

## Example

The "InOutput" screen should be displayed in the screen window. The "InOutput" screen contains 3 I/O fields which are bound to a structure tag. The structure tag consists of the elements EA1, EA2, EA3; one element each for every I/O field.

Three such structure tags with the structure names Struct1, Struct2 and Struct3 are defined in the project for example.

The tag prefix is the structure name with a following period in this case. If you specify Struct2., for example, as a tag prefix (the period is necessary to address the elements of the structure tags syntactically correctly as structure elements), the I/O fields in the "InOutput" screen are bound with the elements of structure tag Struct2:

Tag prefix: "Struct2."

- Output value (first I/O field): EA1
- Output value (second I/O field): EA2
- Output value (third I/O field): EA3

The current tag binding in the screen window is therefore

- Output value (first I/O field): Struct2.EA1
- Output value (second I/O field): Struct2.EA2
- Output value (third I/O field): Struct2.EA3



**See also**

ScreenWindow (Page 4078)

**Tags****Description**

Returns an object of type "Tags".

Access during runtime: Read

**Syntax**

Object.**Tags**

**Object**

Necessary. An object of the "HMIRuntime" type.

**Example**

The following example accesses the tag "Tag1":

```
'VBS86
Dim objTag
Set objTag = HMIRuntime.Tags("Tag1")
```

**See also**

HMIRuntime (Page 3922)

**Template****Description**

Returns the template for displaying the window content of the "Application Window" object.  
Read only access.

The following templates are possible depending on the property value:

**Window Contents = Global Script**

"GSC diagnostics"

The application window is supplied by applications of the Global Script. The results of the diagnosis system are displayed.

**"GSC Runtime"**

The application window is supplied by applications of the Global Script. The analysis results regarding characteristics in Runtime are displayed.

**Window Contents = Print Jobs**

**"All Jobs":**

The application window is supplied by the logging system. The available reports are displayed as a list.

**"All Jobs - Context Menu":**

The application window is supplied by the logging system. The available reports are displayed as a list. The shortcut menu enables the selection of print options, display of a print preview as well as a printout of the log.

**"Job Detail View":**

The application window is supplied by the logging system. The available reports are displayed in a selection menu. Detailed information is displayed for the selected report.

**"Selected Jobs - Context Menu":**

The application window is supplied by the logging system. The available reports are displayed as a list. This list only contains reports which you have activated the option "Mark for print job list" in the "Print Job Properties" dialog. The shortcut menu enables the selection of print options, display of a print preview as well as a printout of the log.

**See also**

ScriptDiagnostics (Page 4080)

**Text**

**Description**

Specifies the labeling for the text field.

Access in Runtime: Read and write

**Syntax**

Object.**Text**[= STRING]

**Object**

Required A "ScreenItem" " object with the formats "TextField", "CheckBox" or "OptionGroup".

**STRING**

Optional A value or a constant that specifies the labeling.

## See also

TextField (Page 4107)  
CheckBox (Page 3974)  
OptionGroup (Page 4054)  
MultiLineEdit (Page 4032)  
Listbox (Page 4027)  
RoundButton (Page 4074)

## Text

### Description

Determines the labeling of the text field.  
Access during runtime: Read and Write

### Syntax

Object.Text [= STRING]

#### Object

Required. An object of the "ScreenItem" type with the characteristic "TextField".

#### STRING

Optional. A value or constant which determines the label text color.

## TextList

### Description

A list which contains the assignments between the output value and the output text actually to be output. The assignments are dependent on the set list type. You determine the list type with the ListType property.

Access in Runtime: Read

### Syntax

Object.**TextList**

#### Object

Required A "ScreenItem" object with the format "SymbolicIOField".

## See also

Button (Page 3968)

SymbolicIOField (Page 4093)

## TextOff

### Description

Specifies the text that will be displayed in the status "off" of the selected object.

Access in Runtime: Read and write

### Syntax

Object.**TextOff**[= STRING]

#### Object

Required A "ScreenItem" object with the formats "SymbolicIOField", "Button" or "Switch".

#### STRING

Optional A value or a constant that specifies the labeling for the status "off".

### Comments

The property is only available if the referenced object "SymbolicIOField", "Button" or "Switch" is type "Text".

## See also

SymbolicIOField (Page 4093)

Button (Page 3968)

Switch (Page 4089)

## TextOff

### Description

Determines the text which is displayed in the "Off" status of the given object.

Access during runtime: Read and Write

### Syntax

Object.**TextOff**[= STRING]

**Object**

Required. An object of the "ScreenItem" type with the characteristic "Button," and "Switch".

**STRING**

Optional. A value or constant which determines the label for the "Off" status.

**Remarks**

The property is only available if the referenced "Button" or "Switch" object is of the "Text" type.

**TextOn**

**Description**

Specifies the text that will be displayed in the status "on" of the selected object.

Access in Runtime: Read and write

**Syntax**

Object.TextOn[= STRING]

**Object**

Required A "ScreenItem" object with the formats "SymbolicIOField", "Button" or ""Switch".

**STRING**

Optional A value or a constant that specifies the labeling for the status "on".

**Comments**

The property is only available if the referenced object "Button" or Switch" is type ""Text".

**See also**

SymbolicIOField (Page 4093)

Button (Page 3968)

Switch (Page 4089)

**TextOn**

**Description**

Determines the text which is displayed in the "On" status of the given object.

Access during runtime: Read and Write

## Syntax

Object.TextOn[= STRING]

### Object

Required. An object of the "ScreenItem" type with the characteristic "Button," and "Switch".

### STRING

Optional. A value or constant which determines the label for the "On" status.

## Remarks

The property is only available if the referenced "Button" or "Switch" object is of the "Text" type.

## TextOrientation

## Description

Specifies the text direction (orientation) of the selected object.

Access in Runtime: Read and write

## Syntax

Object.**TextOrientation**[=TextOrientation]

### Object

Required An object of the "ScreenItem" type with the format "TextField", "IOField", "SymbolicIOField", "Button", "Switch", "Bar", "OnlineTrendControl", "FunctionTrendControl", "Checkbox", "OptionGroup" or "WindowSlider".

### TextOrientation

hmiTextHorizontal ( 0): The text is shown horizontally.

hmiTextRotated90Degree (-1): The text is shown vertically and left justified.

hmiTextRotated270Degree ( 1): The text is shown vertically and right justified.

## See also

CheckBox (Page 3974)  
Button (Page 3968)  
WindowSlider (Page 4139)  
RoundButton (Page 4074)  
Switch (Page 4089)  
SymbolicIOField (Page 4093)  
IOField (Page 4021)  
TextField (Page 4107)  
OptionGroup (Page 4054)

## ThumbBackColor

### Description

Specifies the background color of the slider in the ""Slider" object.

Access in Runtime: Read and write

### Syntax

Object.**ThumbBackColor**[= Color]

#### Object

Required A "ScreenItem" object with the formats ""Slider" or "WindowSlider".".

#### Color

Optional A value or a constant that specifies the background color of the slider.

### Comments

Use the "RGB" function to establish the colors in RGB format (red, green blue). To do this, enter the appropriate decimal value for each of the three RGB values (range from 0 to 255). For example, the color "red" is shown as such: RGB(255, 0, 0). You can also use the VBS color constants like vbRed or vbGreen.

## See also

Slider (Page 4082)  
WindowSlider (Page 4139)

## ThumbBackColor

### Description

Determines the background color of the slider in the "Slider" object.

Access during runtime: Read and Write

### Syntax

Object.ThumbBackColor[= Color]

#### Object

Required An object of the "ScreenItem" type with the characteristic "Slider".

#### Color

Optional A value or constant which determines the background color of the slider.

### Comments

You can use the "RGB" function to establish the colors in the RGB format (red, green, blue). To do this, enter the appropriate decimal value for each of the three RGB values (range from 0 to 255). For example, the color "red" is shown as: RGB(255, 0, 0). You can also use the VBScript color constants such as vbRed or vbGreen.

## TicksColor

### Description

Specifies the color of the hour markers on the face of the "Clock" object.

Access during runtime: Read and Write

### Syntax

Object.TicksColor[= Color]

#### Object

Required An object of the "ScreenItem" type with the characteristic "Clock".

#### Color

Optional A value or a constant that specifies the color of the hour markers.

### Comments

Use the "RGB" function to establish the colors in RGB format (red, green blue). To do this, enter the appropriate decimal value for each of the three RGB values (range from 0 to 255).



For example, the color "red" is shown as: RGB(255, 0, 0). You can also use the VBScript color constants such as vbRed or vbGreen.

## See also

Clock (Page 3984)

## TickStyle

## Description

Specifies the scale display.

Access during runtime: Read and write

## Syntax

Object.**TickStyle**[=SliderTickStyle]

### Object

Necessary. A "ScreenItem" object with the format "Slider".

### SliderTickStyle

hmiSliderTickStyleNone ( 0): The object has no scale.

Identifies no strokes.

hmiSliderTickStyleEffect1 ( 1): The scale consists of main gradations only. The scale is black on a white background.

Identifies main strokes (black-white).

hmiSliderTickStyleEffect2 ( 2): The scale consists of main gradations only. The scale is white on a black background.

Identifies main strokes (white-black).

hmiSliderTickStyleNormal ( 3): The scale consists of simple gradations.

Identifies normal strokes.

## Comments

Because of the automatic scaling it is possible that in some parts two marking lengths of the scale can be positioned directly adjacent to one another (looks like a wider marking length). You can correct this effect by slightly lengthening or shortening the slider object.

You you can also completely suppress the display of the scale ("WithAxes").

### Used for the following object types:

Slider

## See also

Slider (Page 4082)

## TimeAxisBeginTime(i)

### Description

Specifies the start time of the display for the selected trend. Whether the information that is evaluated should be dependent on the properties ""UseTimeRange(i)" and "ShareTimeAxis".

Access in Runtime: Read and write

### Syntax

Object.**TimeAxisBeginTime**(i)[=Time]

#### Object

Required A "ScreenItem" object with the format "OnlineTrend".

#### Time

Optional A value or a constant that specifies the start time of the display for the selected trend.

## See also

OnlineTrendControl (Page 4045)

## TimeAxisEndTime

### Description

Specifies the end time of the display for the selected trend. Whether the information is evaluated depends on the properties "Autorange", "UseTimeRange(i)" and "ShareTimeAxis".

Access in Runtime: Read and write

### Syntax

Object.**TimeAxisEndTime**[=Time]

#### Object

Required A "ScreenItem" object with the format "OnlineTrend".

#### Time

Optional A value or a constant that specifies the end time of the display for the selected trend.

## See also

OnlineTrendControl (Page 4045)

## TimeAxisLabel(i)

### Description

Specifies the labeling of the time axis. Whether the information is evaluated depends on the property "ConfigureTimeAxis(i)".

Access in Runtime: Read and write

### Syntax

Object.**TimeAxisLabel**(i)[=String]

#### Object

Required A "ScreenItem" object with the format "OnlineTrend".

#### String

Optional A value or a constant that specifies the labeling of the time axis.

### Comments

The parameter i indicates the number of the trend.

## See also

OnlineTrendControl (Page 4045)

## TimeAxisRange

### Description

Time span that will be displayed by the time axis.

Access in Runtime: Read and write

### Syntax

Object.**TimeAxisRange**[=Decimal]

#### Object

Required A "ScreenItem" object with the format "TrendView".

**Decimal**

Optional Time span that will be displayed by the time axis.

**See also**

TrendView (Page 4118)

**TimeAxisShowGridLines(i)**

**Description**

Specifies whether the trend window is shown with grid lines that run parallel to the x axis.

Access in Runtime: Read and write

**Syntax**

Object.**TimeAxisShowGridLines**(i)[=BOOLEAN]

**Object**

Required A "ScreenItem" object with the format "OnlineTrend".

**BOOLEAN**

Optional TRUE, if the trend window is shown with grid lines that run parallel to the x axis.

**Comments**

The distance between two grid lines can be altered with the "TimeAxisGridLineInterval(i)" property.

**See also**

OnlineTrendControl (Page 4045)

**TimeAxisShowLargeIncrements(i)**

**Description**

Specifies whether the time axis is scaled with long marking lengths.

Access in Runtime: Read and write

**Syntax**

Object.**TimeAxisShowLargeIncrements**(i)[=BOOLEAN]

**Object**

Required A "ScreenItem" object with the format "OnlineTrend".

**BOOLEAN**

Optional TRUE, if the time axis is scaled with long marking lengths.

**Comments**

The distance of two long marking lines can be altered with the ""TimeAxisLargeIncrementSize(i) property.

**See also**

OnlineTrendControl (Page 4045)

**TimeAxisShowSmallIncrements(i)**

**Description**

Specifies whether the time axis is scaled with short marking lengths.

Access in Runtime: Read and write

**Syntax**

Object.**TimeAxisShowSmallIncrements(i)**[=BOOLEAN]

**Object**

Required A "ScreenItem" object with the format "OnlineTrend".

**BOOLEAN**

Optional TRUE, if the time axis is scaled with short marking lengths.

**Comments**

The distance of two short marking lines can be altered with the "TimeAxisSmallIncrementSize(i)" property.

**See also**

OnlineTrendControl (Page 4045)

## TimeAxisTimeFormat(i)

### Description

Specifies the format of the information along the time axis for the selected trend.

Access in Runtime: Read and write

### Syntax

Object.**TimeAxisTimeFormat**(i)[=TimeFormat]

#### Object

Required An object of the "ScreenItem" type with the format "OnlineTrendControl", "FunctionTrendControl" or "OnlineTableControl".

#### TimeFormat

- ( 0): The information is carried out in the form hh:mm.
- ( 1): The information is carried out in the form hh:mm:ss.
- ( 2): The information is carried out in the form hh:mm:ss.ms.
- ( 3): The information is carried out in the form hh:mm (full hours).
- ( 4): The information is carried out in the form hh:mm:ss (full minutes).
- ( 5): The information is carried out in the form hh:mm:ss:ms (full seconds).
- ( 6): The information is carried out in the form dd\_mm\_yy\_hh\_mm.
- ( 7): The information is carried out in the form dd\_mm\_yy\_hh\_mm (full hours).
- ( 8): The information is carried out in the form dd\_mm\_yy.
- ( 9): The information is carried out in the form dd\_mm\_yy\_ (full days).

### Comments

The parameter i indicates the number of the trend.

### See also

- OnlineTrendControl (Page 4045)
- FunctionTrendControl (Page 4004)
- OnlineTableControl (Page 4037)

## TimeBase

### Description

Specifies the time zone in which the time values will be displayed.

Access in Runtime: Read and write

## Syntax

Object.**TimeBase**[=TimeBase]

### Object

Required An object of the "ScreenItem" type with the format "OnlineTrendControl", "FunctionTrendControl", "OnlineTableControl", "AlarmControl" or "UserArchiveControl".

### TimeBase

hmiTimeBaseLocalTimezone ( 0): Local time

hmiTimeBaseServerTimezone ( 1): Time zone of the server

hmiTimeBaseUTC ( 2): UTC (Universal Time Coordinated)

hmiTimeBaseProjectSetting ( 3): Project settings

## Comments

Set the time mode in accordance with the computer settings on the properties page of the computer in WinCC Explorer. The following selection is offered:

## See also

[OnlineTrendControl \(Page 4045\)](#)

[FunctionTrendControl \(Page 4004\)](#)

[OnlineTableControl \(Page 4037\)](#)

[AlarmControl \(Page 3947\)](#)

[UserArchiveControl \(Page 4130\)](#)

[TrendRulerControl \(Page 4110\)](#)

## TimeColumnActualize

### Description

Enables the update of values in the selected column.

Access in Runtime: Read and write

### Syntax

Object.**TimeColumnActualize**[=BOOLEAN]

#### Object

Required A "ScreenItem" object with the format "OnlineTableControl".

### **BOOLEAN**

TRUE: The time column is actualized.

FALSE: The time column is not actualized. This setting can be useful when comparing tables.

### **See also**

OnlineTableControl (Page 4037)

## **TimeColumnAdd**

### **Description**

Creates a new time column.

### **Syntax**

Object.**TimeColumnAdd**

#### **Object**

Required A "ScreenItem" object with the format "OnlineTableControl".

### **See also**

OnlineTableControl (Page 4037)

## **TimeColumnAlign**

### **Description**

Defines the mode of alignment of the time column selected.

Access in Runtime: Read and write

### **Syntax**

Object.**TimeColumnAlign**[=HorizontalAlignment]

#### **Object**

Required A "ScreenItem" object with the format "OnlineTableControl".



**HorizontalAlignment**

Value	Description	Description
0	left	The time column selected is displayed on the left.
1	Centered	The time column selected is aligned to center.
2	right	The time column selected is displayed on the right.

**See also**

OnlineTableControl (Page 4037)

**TimeColumnAlignment(i)****Description**

Specifies the alignment of the time column of a column pair *i*. The parameter *i* indicates the number of the column pair.

Access in Runtime: Read and write

**Syntax**

Object.**TimeColumnAlignment**(i)[=AlignmentHorizontal]

**Object**

Required A "ScreenItem" object with the format "TableView".

**AlignmentHorizontal**

hmiAlignmentLeft ( 0): The text is shown left justified.

hmiAlignmentCentered ( 1): The text is shown centered.

hmiAlignmentRight ( 2): The text is shown right justified.

**See also**

OnlineTableControl (Page 4037)

**TimeColumnBackColor****Description**

Specifies the background color of the time column selected. You open a color selection dialog box with the button.

The setting is useful if:

- The "Use value column colors" option is disabled
- The "Font color" option is set in the "Use column color" field of the "General" tab.

Access in Runtime: Read and write

### Syntax

Object.**TimeColumnBackColor**

#### Object

Required A "ScreenItem" object with the format "OnlineTableControl".

### See also

OnlineTableControl (Page 4037)

## TimeColumnBeginTime

### Description

Defines the start of the time range for a selected time column. .

### Syntax

Object.**TimeColumnBeginTime**

#### Object

Required A "ScreenItem" object with the format "OnlineTableControl".

### See also

OnlineTableControl (Page 4037)

## TimeColumnCaption

### Description

Defines the caption of the time column.

### Syntax

Object.**TimeColumnCaption**

**Object**

Required A "ScreenItem" object with the format "OnlineTableControl".

**See also**

OnlineTableControl (Page 4037)

**TimeColumnCount****Description**

Defines the number of time columns configured.

**Syntax**

Object.**TimeColumnCount**

**Object**

Required A "ScreenItem" object with the format "OnlineTableControl".

**See also**

OnlineTableControl (Page 4037)

**TimeColumnDateFormat****Description**

Defines the date format for visualizing a selected time column.

Access in Runtime: Read and write

**Syntax**

Object.**TimeColumnDateFormat**[=DateFormat]

**Object**

Required A "ScreenItem" object with the format "OnlineTableControl".

**DateFormat**

Value	Description
Automatic	The date format is set automatically.
dd.MM.yy	Day.Month.Year, e.g. 24.12.10.
dd.MM.yyyy	Day.Month.Year, e.g. 24.12.2010.

Value	Description
dd/MM/yy	Day/Month/Year, e.g. 24/12/10.
dd/MM/yyyy	Day/Month/Year, e.g. 24/12/2010.

### See also

OnlineTableControl (Page 4037)

## TimeColumnEndTime

### Description

Defines the end of the time range of a selected time column.

### Syntax

Object.**TimeColumnBeginTime**

#### Object

Required A "ScreenItem" object with the format "OnlineTableControl".

### See also

OnlineTableControl (Page 4037)

## TimeColumnForeColor

### Description

Specifies the font color of the time column selected. You open a color selection dialog box with the button.

The setting is effective:

- When the option "in the colors of the value column" is not activated.
- When the "Font color" option is activated in the "Use column color" area of the "General" tab.

Access in Runtime: Read and write

### Syntax

Object.**TimeColumnForeColor**

#### Object

Required A "ScreenItem" object with the format "OnlineTableControl".

## See also

OnlineTableControl (Page 4037)

## TimeColumnFormat(i)

### Description

Specifies the format of the time columns for the selected column pair. The parameter *i* indicates the number of the column pair.

Access in Runtime: Read and write

### Syntax

Object.**TimeColumnFormat**(i)[=TimeFormat]

#### Object

Required A "ScreenItem" object with the format "OnlineTableControl".

#### TimeFormat

- ( 0): The information is carried out in the form hh:mm.
- ( 1): The information is carried out in the form hh:mm:ss.
- ( 2): The information is carried out in the form hh:mm:ss.ms.
- ( 3): The information is carried out in the form hh:mm (full hours).
- ( 4): The information is carried out in the form hh:mm:ss (full minutes).
- ( 5): The information is carried out in the form hh:mm:ss.ms (full seconds).
- ( 6): The information is carried out in the form dd\_mm\_yy\_hh\_mm.
- ( 7): The information is carried out in the form dd\_mm\_yy\_hh\_mm (full hours).
- ( 8): The information is carried out in the form dd\_mm\_yy.
- ( 9): The information is carried out in the form dd\_mm\_yy\_ (full days).

## See also

OnlineTableControl (Page 4037)

## TimeColumnHideText

### Description

Sets text format for displaying the content of a time column.

Access in Runtime: Read and write

## Syntax

Object.**TimeColumnActualize**[=BOOLEAN]

### Object

Required A "ScreenItem" object with the format "OnlineTableControl".

### BOOLEAN

TRUE: The content is not shown as a text.

FALSE: The content is shown as a text.

## See also

OnlineTableControl (Page 4037)

## TimeColumnHideTitleText

### Description

Sets text format for displaying the time column header.

Access in Runtime: Read and write

## Syntax

Object.**TimeColumnActualize**[=BOOLEAN]

### Object

Required A "ScreenItem" object with the format "OnlineTableControl".

### BOOLEAN

TRUE: The header is not shown as a text.

FALSE: The header is shown as a text.

## See also

OnlineTableControl (Page 4037)

## TimeColumnIndex

### Description

References a configured time column. You can assign the values of other properties to a specific time column by using the property.

Valid values for "TimeColumnIndex" are between 0 and "TimeColumnCount" minus 1. The "TimeColumnCount" property indicates the number of configured time columns.

## Syntax

Object.**TimeColumnIndex**

### Object

Required An object of the "ScreenItem" type with the format "OnlineTableControl"

## See also

OnlineTableControl (Page 4037)

## TimeColumnLength

### Description

Specifies the width of a selected time column.

### Syntax

Object.**TimeColumnLength**

### Object

Required A "ScreenItem" object with the format "OnlineTableControl".

## See also

OnlineTableControl (Page 4037)

## TimeColumnMeasurePoints

### Description

Defines the number of measurement points to be displayed in the time column selected.

### Syntax

Object.**TimeColumnMeasurePoints**

### Object

Required A "ScreenItem" object with the format "OnlineTableControl".

**See also**

OnlineTableControl (Page 4037)

**TimeColumnName**

**Description**

Specifies the name of a selected time column.

**Syntax**

Object.**TimeColumnName**

**Object**

Required A "ScreenItem" object with the format "OnlineTableControl".

**See also**

OnlineTableControl (Page 4037)

**TimeColumnRangeType**

**Description**

Defines the time range setting for the time column selected.

Access in Runtime: Read and write

**Syntax**

Object.**TimeColumnRangeType**[=TimeRangeType]

**Object**

Required A "ScreenItem" object with the format "OnlineTableControl".

**TimeRangeType**

Value	Description	Description
0	Time range	Defines the start time and time range of the time column.
1	Start to end time	Defines the start and end time for the time column.
2	Number of measurement points	Defines the start time and the number of measurement points for the time column.



**See also**

OnlineTableControl (Page 4037)

**TimeColumnRemove**

**Description**

Removes the selected time column from the list.

**Syntax**

Object.**TimeColumnRemove**

**Object**

Required A "ScreenItem" object with the format "OnlineTableControl".

**See also**

OnlineTableControl (Page 4037)

**TimeColumnRename**

**Description**

Changes the name of the time column which is referenced by the "TimeColumnIndex" property. With "TimeColumnRename" you also dynamize the "TimeColumnName" property.

**Syntax**

Object.**TimeColumnRename**

**Object**

Required A "ScreenItem" object with the format "OnlineTableControl".

**See also**

OnlineTableControl (Page 4037)

**TimeColumnRepos**

**Description**

Repositions the order of time columns and of corresponding value columns. "Up" and "Down" move the time column selected up or down in the list. This moves the time column and corresponding value columns in the table towards the front or towards the back.

## Syntax

Object.**TimeColumnRepos**

### Object

Required A "ScreenItem" object with the format "OnlineTableControl".

## See also

OnlineTableControl (Page 4037)

## TimeColumnShowDate

### Description

Enables the display of the date and time in the time column selected.

Access in Runtime: Read and write

### Syntax

Object.**TimeColumnShowDate**[=BOOLEAN]

### Object

Required A "ScreenItem" object with the format "OnlineTableControl".

### BOOLEAN

TRUE: The date and the time are displayed. The date format is defined in the "Date format" field.

FALSE: The date is not displayed. Only the time is displayed.

## See also

OnlineTableControl (Page 4037)

## TimeColumnShowIcon

### Description

Enables the display of time column contents as icon.

Access in Runtime: Read and write

### Syntax

Object.**TimeColumnActualize**[=BOOLEAN]

**Object**

Required A "ScreenItem" object with the format "OnlineTableControl".

**BOOLEAN**

TRUE: The content is shown as an icon.

FALSE: The content is not shown as an icon.

**See also**

OnlineTableControl (Page 4037)

**TimeColumnShowTitleIcon**

**Description**

Specifies whether the values of the selected column are updated.

Access in Runtime: Read and write

**Syntax**

Object.**TimeColumnShowTitleIcon** [=BOOLEAN]

**Object**

Required A "ScreenItem" object with the format "OnlineTableControl".

**BOOLEAN**

TRUE: The header is shown as an icon.

FALSE: The header is not shown as an icon.

**See also**

OnlineTableControl (Page 4037)

**TimeColumnSort**

**Description**

Specifies how the time column referenced in "TimeColumnIndex" is sorted.

Access in Runtime: Read and write

### Syntax

Object.**TimeColumnSort** [=TimeColumnSort]

#### Object

Required A "ScreenItem" object with the format "OnlineTableControl".

#### TimeColumnSort

Value	Description	Description
0	no	No sorting
1	Ascending	Ascending order, starting at the lowest value.
2	Descending	Descending order, starting at the highest value.

### See also

OnlineTableControl (Page 4037)

### TimeColumnSortIndex

#### Description

Specifies the sorting order of the time column referenced in "TimeColumnIndex". If you set the value to "0", the sorting criterion is removed in "TimeColumnSort".

### Syntax

Object.**TimeColumnSortIndex**

#### Object

Required An object of the "ScreenItem" type with the format "OnlineTableControl"

### See also

OnlineTableControl (Page 4037)

### TimeColumnTimeFormat

#### Description

Defines the time format for visualizing a selected time column.

Access in Runtime: Read and write

**Syntax**

Object.**TimeColumnTimeFormat**[=TimeFormat]

**Object**

Required A "ScreenItem" object with the format "OnlineTableControl".

**TimeFormat**

Value	Description
Automatic	The time format is set automatically.
HH:mm:ss.ms	Hours:Minutes:Seconds, e.g. 15:35:44.240.
hh:mm:ss tt	Hours:Minutes:Seconds AM/PM, e.g. 03:35:44 PM.
hh:mm:ss.ms tt	Hours:Minutes:Seconds AM/PM, e.g. 03:35:44.240 PM.

**See also**

OnlineTableControl (Page 4037)

**TimeColumnTimeRangeBase****Description**

Defines the time unit for calculating the time range.

Access in Runtime: Read and write

**Syntax**

Object.**TimeColumnTimeRangeBase**[=TimeRangeBase]

**Object**

Required A "ScreenItem" object with the format "OnlineTableControl".

**TimeRangeBase**

Value	Description
500	500 ms
1000	1 second
60000	1 minute
3600000	1 hour
86400000	1 day

**See also**

OnlineTableControl (Page 4037)

## TimeColumnTimeRangeFactor

### Description

Defines the factor for calculating the time range. Only integer factors are valid.

### Syntax

Object.**TimeColumnTimeRangeFactor**

#### Object

Required A "ScreenItem" object with the format "OnlineTableControl".

### See also

OnlineTableControl (Page 4037)

## TimeColumnUseValueColumnColors

### Description

Defines whether the selected time column will be displayed in the value column colors.

Access in Runtime: Read and write

### Syntax

Object.**TimeColumnUseValueColumnColors**[=BOOLEAN]

#### Object

Required A "ScreenItem" object with the format "OnlineTableControl".

#### BOOLEAN

TRUE: The selected time column is displayed in the colors of the value column. The settings in the "Font color" and "Background color" fields are disabled.

FALSE: The selected time column is displayed in the colors which are specified in the "Font color" and "Background color" fields.

### See also

OnlineTableControl (Page 4037)

## TimeColumnVisible

### Description

The list shows the time columns you created. Select the time columns to be displayed in the table from the list.

Click a time column entry in the list to adapt the properties and to define the time range of the time column.

### Syntax

Object.**TimeColumnVisible**

#### Object

Required A "ScreenItem" object with the format "OnlineTableControl".

### See also

OnlineTableControl (Page 4037)

## TimeJumpColor(i)

### Description

Specifies the color that is identified in the time jump available in the log. Whether the information is evaluated depends on the property "TimeJumpEnabled(i)".

Access in Runtime: Read and write

### Syntax

Object.**TimeJumpColor(i)**[=Color]

#### Object

Required A "ScreenItem" object with the formats "OnlineTrend" or "TableView".

#### Color

Optional A value or a constant that specifies the color that identifies the time jump available in the log.

### See also

OnlineTrendControl (Page 4045)

OnlineTableControl (Page 4037)

## TimeJumpEnabled(i)

### Description

Specifies if the time jumps available in the log are identified in the color set up in "TimeJumpColor(i)".

Access in Runtime: Read and write

### Syntax

Object.**TimeJumpEnabled(i)**[=BOOLEAN]

#### Object

Required A "ScreenItem" object with the formats "OnlineTrend" or ""TableView".

#### BOOLEAN

Optional TRUE, if the time jumps available in the log are identified in the color specified in "TimeJumpColor(i)".

### See also

OnlineTrendControl (Page 4045)

OnlineTableControl (Page 4037)

## TimeOverlapColor(i)

### Description

Specifies the color that is identified in the time overlap available in the log. Whether the information is evaluated depends on the attribute "TimeOverlapEnabled(i)".

Access in Runtime: Read and write

### Syntax

Object.**TimeOverlapColor(i)**[=Color]

#### Object

Required A "ScreenItem" object with the formats "OnlineTrend" or ""TableView".

#### Color

Optional A value or a constant that specifies the color that identifies the time overlap available in the log.



## See also

OnlineTrendControl (Page 4045)

OnlineTableControl (Page 4037)

## TimeOverlapEnabled(i)

### Description

Specifies if the time overlaps available in the log are identified in the color set up in "TimeOverlapColor(i)".

Access in Runtime: Read and write

### Syntax

Object.**TimeOverlapEnabled(i)**[=BOOLEAN]

#### Object

Required A "ScreenItem" object with the formats "OnlineTrend" or "TableView".

#### BOOLEAN

Optional TRUE, if the time jumps overlaps available in the log are identified in the color specified in ""TimeOverlapColor(i)".

## See also

OnlineTrendControl (Page 4045)

OnlineTableControl (Page 4037)

## TimeRangeBase(i)

### Description

Specifies the unit for determining the time interval of the selected trend.

Access in Runtime: Read and write

### Syntax

Object.**TimeRangeBase(i)**[=TagLoggingTimeUnit]

#### Object

Required An object of the "ScreenItem" type with the format "OnlineTrendControl", "FunctionTrendControl" or "OnlineTableControl".

### TagLoggingTimeUnit

( 1): The time intervals are set up in milliseconds.

hmiCurveTimeRangeBase500ms (500): The time intervals are set up in 500 ms.

hmiCurveTimeRangeBaseSecond ( 1000): The time intervals are set up in seconds.

hmiCurveTimeRangeBaseMinute ( 60000): The time intervals are set up in minutes.

hmiCurveTimeRangeBaseHour ( 3600000): The time intervals are set up in hours.

hmiCurveTimeRangeBaseDay ( 86400000): The time intervals are set up in days.

### Comments

The time range to be displayed for the trend *i* is achieved by multiplying the values "TimeRangeBase(*i*)" and "TimeRangeFactor(*i*)", whereby the value of "TimeRangeBase(*i*)" is interpreted in milliseconds. The "TimeRangeBase(*i*)" and "TimeRangeFactor(*i*)" properties are only evaluated if the "TimeRange" property has the value "-1".

### See also

OnlineTrendControl (Page 4045)

FunctionTrendControl (Page 4004)

OnlineTableControl (Page 4037)

### TimeRangeFactor(*i*)

#### Description

Specifies the factor for determining the time interval of the selected trend.

Access in Runtime: Read and write

#### Syntax

Object.**TimeRangeFactor**(*i*)[=Int]

#### Object

Required A "ScreenItem" object with the formats "OnlineTrend", "FunctionTrendView" or "TableView".

#### Int

Optional A value or a constant that specifies the factor for determining the time interval of the selected trend.

### Comments

The time range to be displayed for the trend *i* is achieved by multiplying the values ""TimeRangeBase(*i*)" and "TimeRangeFactor(*i*)", whereby the value of "TimeRangeBase(*i*)" is

interpreted in milliseconds. The "TimeRangeBase(i)" and "TimeRangeFactor(i)" " properties are only evaluated if the property "TimeRange" has the value "-1".

## See also

OnlineTrendControl (Page 4045)

FunctionTrendControl (Page 4004)

OnlineTableControl (Page 4037)

## Timestamp

### Description

Returns the time stamp of the last read access of a tag in local time as DATE.

Access in Runtime: Read

### Syntax

Object.**TimeStamp**

#### Object

Required A "Tag" object.

### Comments

To show the TimeStamp property in plain text, use the VBS function "FormatDateTime(Date[, NamedFormat])". The output is dependent on the language setting. To adjust the language, use the VBS function "SetLocale'()".

If you want to return the time stamp sorted by date, day and time, use the NamedFormat parameter or the VBS functions like Year, WeekDay, Day, Hour, Minute, Second. The name of a week day can be obtained using the VBS function WeekdayName.

### Examples

The following example issues the time stamp of the tag "Tag11" with the aid of the function "FormatDateTime":

```
'VBS87
Dim objTag
Dim lngCount
lngCount = 0
Set objTag = HMIRuntime.Tags("Tag11")
objTag.Read
SetLocale("en-gb")
MsgBox FormatDateTime(objTag.TimeStamp)      'Output: e.g. 06/08/2002 9:07:50
```

## 10.8 Working with system functions and Runtime scripting

```
MsgBox Year(objTag.TimeStamp)      'Output: e.g. 2002
MsgBox Month(objTag.TimeStamp)     'Output: e.g. 8
MsgBox Weekday(objTag.TimeStamp)   'Output: e.g. 3
MsgBox WeekdayName(Weekday(objTag.TimeStamp)) 'Output: e.g. Tuesday
MsgBox Day(objTag.TimeStamp)       'Output: e.g. 6
MsgBox Hour(objTag.TimeStamp)      'Output: e.g. 9
MsgBox Minute(objTag.TimeStamp)    'Output: e.g. 7
MsgBox Second(objTag.TimeStamp)    'Output: e.g. 50
For lngCount = 0 To 4
MsgBox FormatDateTime(objTag.TimeStamp, lngCount)
Next
'lngCount = 0: Output: e.g. 06/08/2002 9:07:50
'lngCount = 1: Output: e.g. 06 August 2002
'lngCount = 2: Output: e.g. 06/08/2002
'lngCount = 3: Output: e.g. 9:07:50
'lngCount = 4: Output: e.g. 9:07
```

The following example issues the time stamp of the tag "Tag1":

```
'VBS88
Dim objTag
Set objTag = HMIRuntime.Tags("Tag1")
objTag.Read
MsgBox objTag.TimeStamp
```

### See also

[Tag \(Page 3941\)](#)

### TitleBackColor

#### Description

Specifies the background color of the table headers for the selected status. You open a color selection dialog box with the button.

### TitleCut

#### Description

Defines whether the content of the fields of a title bar should be shortened if the column width is too small. Write/Read access.

**See also**

UserArchiveControl (Page 4130)

TrendRulerControl (Page 4110)

OnlineTableControl (Page 4037)

**TitleDarkShadowColor**

**Description**

Specifies the color of the dark side of shading. You open a color selection with the button. The settings are only active if the "Shading Color" option is enabled.

**See also**

UserArchiveControl (Page 4130)

TrendRulerControl (Page 4110)

OnlineTableControl (Page 4037)

**TitleForeColor**

**Description**

Specifies the font color of the table headers for the selected status. You open a color selection dialog box with the button.

**See also**

UserArchiveControl (Page 4130)

TrendRulerControl (Page 4110)

OnlineTableControl (Page 4037)

**TitleGridLineColor**

**Description**

Defines the color of row/column dividers in the table header. You open a color selection dialog box with the button.

## See also

UserArchiveControl (Page 4130)

TrendRulerControl (Page 4110)

OnlineTableControl (Page 4037)

## TitleLightShadowColor

### Description

Specifies the color of the bright side of shading. You open a color selection dialog box with the button. The setting is only effective when the "Shading color" option is activated.

## See also

UserArchiveControl (Page 4130)

TrendRulerControl (Page 4110)

OnlineTableControl (Page 4037)

## Titleline

### Description

TRUE, when the control has a title bar and it can be moved in Runtime. BOOLEAN write-read access.

## TitleSort

### Description

Defines how to trigger sorting by column title. You can only sort by column title if the "Auto-scrolling" option is disabled.

Access in Runtime: Read and write

## Syntax

Object.**TitleSort**[=GridSortTrigger]

### Object

Required An object of the "ScreenItem" type with the format "OnlineTableControl", "OnlineTrendControl", "MessageView", "RecipeView".

**GridSortTrigger**

Value	Description	Explanation
0	No	Sorting by column header is disabled.
1	With click	Sorting is triggered by clicking in the column header.
2	With double-click	Sorting is triggered by double-clicking in the column title.

**See also**

UserArchiveControl (Page 4130)

TrendRulerControl (Page 4110)

OnlineTableControl (Page 4037)

**TitleStyle****Description**

Specifies whether to set a shading color for the table header.

Access in Runtime: Read and write

**Syntax**

Object.**TitleStyle**[=BOOLEAN]

**Object**

Required An object of the "ScreenItem" type with the format "OnlineTableControl", "OnlineTrendControl", "MessageView", "RecipeView".

**BOOLEAN**

Value	Description	Description
0	Flat	Disables the use of shading colors. Flat header style.
1	Button	Enables the use of shading colors. 3D representation of the header.

**See also**

UserArchiveControl (Page 4130)

TrendRulerControl (Page 4110)

OnlineTableControl (Page 4037)

## Toggle

### Description

Specifies whether the selected object engages after it has been operated in Runtime.

Access in Runtime: Read and write

### Syntax

Object.**Toggle**[=BOOLEAN]

#### Object

Required A "ScreenItem" object with the format ""Roundbutton".

#### BOOLEAN

Optional TRUE, if the selected object engages after it has been operated in Runtime.

### See also

Button (Page 3968)

## Tolerance

### Description

Specifies the limit for the storage space display as of which a deviation will be reported.

Access in Runtime: Read and write

### Syntax

Object.**Tolerance**[=Int]

#### Object

Required A "ScreenItem" object with the format "DiskSpaceView".

#### Int

Optional A value or a constant that specifies the limit for the storage space display as of which a deviation will be reported.

### See also

DiskSpaceView (Page 3991)



## ToleranceColor

### Description

Specifies the colors in which the bars of the storage space display will be shown as soon as the tolerance range is exceeded.

Access in Runtime: Read and write

### Syntax

Object.**ToleranceColor**[=Color]

#### Object

Required A "ScreenItem" object with the format "DiskSpaceView".

#### Color

Optional A value or a constant that specifies the colors in which the bars of the storage space display will be shown as soon as the tolerance range is exceeded.

### See also

DiskSpaceView (Page 3991)

## ToleranceHigh property

### Description

Defines or returns the limit value for "Tolerance high".

The type of the evaluation (in percent or absolute) is defined in the "TypeToleranceHigh" property.

The monitoring of the limit value is only valid if the "CheckToleranceHigh" property is set to "TRUE".

## ToleranceLow property

### Description

Defines or returns the limit value for "Tolerance low".

The type of the evaluation (in percent or absolute) is defined in the "TypeToleranceLow" property.

The monitoring of the limit value is only valid if the "CheckToleranceLow" property is set to "TRUE".

## ToleranceLowerLimit

### Description

Specifies whether the "ToleranceLowerLimit" limit is to be monitored.

Access in Runtime: Read and write

### Syntax

Object.ToleranceLowerLimit[=Double]

#### Object

Required A "ScreenItem" object with the format "Bar".

#### Double

Optional A value or a constant that specifies whether the limit "ToleranceLowerLimit" is monitored.

### See also

Bar (Page 3961)

## ToleranceLowerLimitColor

### Description

Specifies the color for the lower limit "ToleranceLowerLimit".

Access in Runtime: Read and write

### Syntax

Object.ToleranceLowerLimitColor[=Color]

#### Object

Required A "ScreenItem" object with the format "Bar".

#### Color

Optional A value or a constant that specifies the color for the lower limit "ToleranceLowerLimit".

### Comments

The "ToleranceLowerLimitEnable" property must have the value TRUE if the bar color is to change once the limit has been reached.

## See also

Bar (Page 3961)

## ToleranceLowerLimitEnabled

### Description

Specifies whether the "ToleranceLowerLimit" limit is to be monitored. The limit, the display when the limit has been reached, and the type of evaluation are set with the properties "ToleranceLowerLimit", "ToleranceLowerLimitColor" and "ToleranceLowerLimitRelative".

Access in Runtime: Read and write

### Syntax

Object.**ToleranceLowerLimitEnabled**[=BOOLEAN]

#### Object

Required A "ScreenItem" object with the format "Bar".

#### BOOLEAN

Optional TRUE, if the "ToleranceLowerLimit" limit is to be monitored.

## See also

Bar (Page 3961)

## ToleranceLowerLimitRelative

### Description

Specifies whether the lower limit "ToleranceLowerLimit" is to be evaluated as a percentage or as an absolute value.

Access in Runtime: Read and write

### Syntax

Object.**ToleranceLowerLimitRelative**[=BOOLEAN]

#### Object

Required A ""ScreenItem" object with the format "Bar".

#### BOOLEAN

Optional TRUE, if the lower limit "ToleranceLowerLimit" is to be evaluated as a percentage or an absolute value.

## See also

Bar (Page 3961)

## ToleranceUpperLimit

### Description

Specifies whether the "ToleranceUpperLimit" limit is to be monitored.

Access in Runtime: Read and write

### Syntax

Object.**ToleranceUpperLimit**[=Double]

#### Object

Required A "ScreenItem" object with the format ""Bar".

#### Double

Optional A value or a constant that specifies whether the limit "ToleranceUpperLimit" is monitored.

### Comments

The following values will be specified with the properties "ToleranceUpperLimit", "ToleranceUpperLimitColor" and "ToleranceUpperLimitRelative":

Limit

Representation upon reaching the limit

Type of evaluation

## See also

Bar (Page 3961)

## ToleranceUpperLimitColor

### Description

Specifies the color for the upper limit "ToleranceUpperLimit".

Access in Runtime: Read and write

### Syntax

Object.**ToleranceUpperLimitColor**[=Color]

**Object**

Required A "ScreenItem" object with the format "Bar".

**Color**

Optional A value or a constant that specifies the color of the upper limit "ToleranceUpperLimit".

**See also**

Bar (Page 3961)

**ToleranceUpperLimitEnabled**

**Description**

Specifies whether the "ToleranceUpperLimit" limit is to be monitored.

Access in Runtime: Read and write

**Syntax**

Object.**ToleranceUpperLimitEnabled**[=BOOLEAN]

**Object**

Required A "ScreenItem" object with the format "Bar".

**BOOLEAN**

Optional TRUE, if the "ToleranceUpperLimit" limit is to be monitored.

**Comments**

The following values will be specified with the properties "ToleranceUpperLimit", "ToleranceUpperLimitColor" and "ToleranceUpperLimitRelative":

Limit

Representation upon reaching the limit

Type of evaluation

**See also**

Bar (Page 3961)

## ToleranceUpperLimitRelative

### Description

Specifies whether the lower limit "ToleranzHigh" is to be evaluated as a percentage or as an absolute value.

Access in Runtime: Read and write

### Syntax

Object.**ToleranceUpperLimitRelative**[=BOOLEAN]

#### Object

Required A "ScreenItem" object with the format ""Bar".

#### BOOLEAN

Optional TRUE, if the lower limit "ToleranzHigh" is to be evaluated as a percentage or an absolute value.

### See also

Bar (Page 3961)

## ToolbarAlignment

### Description

Defines or returns the position of the toolbar. Write/Read access.

### See also

UserArchiveControl (Page 4130)

TrendRulerControl (Page 4110)

FunctionTrendControl (Page 4004)

OnlineTableControl (Page 4037)

OnlineTrendControl (Page 4045)

## ToolbarBackColor

### Description

Background color - ToolbarBackColor

Specifies the background color of the toolbar. Open the "Color selection" dialog by clicking the button.

The background color you configured is only displayed if the "Display" option is enabled.

Access in Runtime: Read and write

## Syntax

Object.**ToolbarBackColor**[=Color]

### Object

Required An object of the "ScreenItem" type with the format "AlarmControl", "TrendRulerControl", "OnlineTableControl", "OnlineTrendControl", "FunctionTrendControl", "RecipeView".

### Color

Optional A value or a constant which specifies the background color.

## See also

UserArchiveControl (Page 4130)

TrendRulerControl (Page 4110)

FunctionTrendControl (Page 4004)

OnlineTableControl (Page 4037)

OnlineTrendControl (Page 4045)

## ToolbarButtonActive

### Description

Activates a button function in Runtime. Clicking the button in Runtime triggers the corresponding function.

Access in Runtime: Read and write

### Syntax

Object.**ToolbarButtonActive**[=BOOLEAN]

### Object

Required An object of the "ScreenItem" type with the format "AlarmControl", "TrendRulerControl", "OnlineTableControl", "OnlineTrendControl", "FunctionTrendControl", "RecipeView".

### BOOLEAN

TRUE: The function connected to the key is active.

FALSE: The function connected to the key is not active. You can connect your own functions to the key by local scripts.

## See also

UserArchiveControl (Page 4130)  
TrendRulerControl (Page 4110)  
FunctionTrendControl (Page 4004)  
OnlineTableControl (Page 4037)  
OnlineTrendControl (Page 4045)

## ToolbarButtonAdd

### Description

Creates a new, user-defined button function. The name set by WinCC can be edited in the "Object name" field.

## See also

UserArchiveControl (Page 4130)  
TrendRulerControl (Page 4110)  
FunctionTrendControl (Page 4004)  
OnlineTableControl (Page 4037)  
OnlineTrendControl (Page 4045)

## ToolbarButtonBeginGroup

### Description

Inserts a leading separator (vertical line) for the selected button function on the toolbar. These separators can be used to group the icons of the button functions.

Access in Runtime: Read and write

### Syntax

Object.**ToolbarButtonBeginGroup**[=BOOLEAN]

#### Object

Required An object of the "ScreenItem" type with the format "AlarmControl", "TrendRulerControl", "OnlineTableControl", "OnlineTrendControl", "FunctionTrendControl", "RecipeView".

#### BOOLEAN

TRUE: The separator is inserted in front of the selected key function.

FALSE: The separator is not inserted in front of the selected key function.



**See also**

- UserArchiveControl (Page 4130)
- TrendRulerControl (Page 4110)
- FunctionTrendControl (Page 4004)
- OnlineTableControl (Page 4037)
- OnlineTrendControl (Page 4045)

**ToolbarButtonCount**

**Description**

Defines the number of configurable button functions.

**See also**

- UserArchiveControl (Page 4130)
- TrendRulerControl (Page 4110)
- FunctionTrendControl (Page 4004)
- OnlineTableControl (Page 4037)
- OnlineTrendControl (Page 4045)

**ToolbarButtonEnabled**

**Description**

Enables operation of custom toolbar buttons.

**See also**

- UserArchiveControl (Page 4130)
- TrendRulerControl (Page 4110)
- FunctionTrendControl (Page 4004)
- OnlineTableControl (Page 4037)
- OnlineTrendControl (Page 4045)

## ToolbarButtonHotKey

### Description

Shows the hotkey for a button function selected.

You create or edit a hotkey by clicking in the "Hotkey" field and pressing the button or key shortcut required. .

### See also

UserArchiveControl (Page 4130)

TrendRulerControl (Page 4110)

FunctionTrendControl (Page 4004)

OnlineTableControl (Page 4037)

OnlineTrendControl (Page 4045)

## ToolbarButtonID

### Description

Unique ID number for the selected button function. WinCC assigns this read only ID number. .

### See also

UserArchiveControl (Page 4130)

TrendRulerControl (Page 4110)

FunctionTrendControl (Page 4004)

OnlineTableControl (Page 4037)

OnlineTrendControl (Page 4045)

## ToolbarButtonIndex

### Description

References a button function. Using this attribute you can assign the values of other attributes to a specific button function.

Valid values for "ToolbarButtonIndex" are between 0 and "ToolbarButtonCount" minus 1. The "ToolbarButtonCount" attribute specifies the number of configurable key functions.

### See also

UserArchiveControl (Page 4130)  
TrendRulerControl (Page 4110)  
FunctionTrendControl (Page 4004)  
OnlineTableControl (Page 4037)  
OnlineTrendControl (Page 4045)

## ToolBarButtonLocked

### Description

Enables/disables the display of the pressed state of a user-defined toolbar button.

### See also

UserArchiveControl (Page 4130)  
TrendRulerControl (Page 4110)  
FunctionTrendControl (Page 4004)  
OnlineTableControl (Page 4037)  
OnlineTrendControl (Page 4045)

## ToolBarButtonName

### Description

Shows the name for the selected button function. You rename user-defined button functions. The "ToolBarButtonName" property for customized functions can be dynamized by the ToolBarButtonRename property.

### See also

UserArchiveControl (Page 4130)  
TrendRulerControl (Page 4110)  
FunctionTrendControl (Page 4004)  
OnlineTableControl (Page 4037)  
OnlineTrendControl (Page 4045)

## ToolbarButtonPasswordLevel

### Description

Shows the authorization for a button function selected. You can edit the authorization using the selection button. The authorizations are configured in the user administration.

### See also

UserArchiveControl (Page 4130)  
TrendRulerControl (Page 4110)  
FunctionTrendControl (Page 4004)  
OnlineTableControl (Page 4037)  
OnlineTrendControl (Page 4045)

## ToolbarButtonRemove

### Description

Removes the selected button function from the list. Only user-defined button functions can be removed.

### See also

UserArchiveControl (Page 4130)  
TrendRulerControl (Page 4110)  
FunctionTrendControl (Page 4004)  
OnlineTableControl (Page 4037)  
OnlineTrendControl (Page 4045)

## ToolbarButtonRename

### Description

Changes the name of the customized element of the toolbar which is referenced by the "ToolbarButtonIndex" property.

With "ToolbarButtonRename" you also dynamize the "ToolbarButtonName" property.

### See also

UserArchiveControl (Page 4130)  
TrendRulerControl (Page 4110)  
FunctionTrendControl (Page 4004)  
OnlineTableControl (Page 4037)  
OnlineTrendControl (Page 4045)

## ToolbarButtonRepos

### Description

Changes the sorting order of button functions. "Up" and "Down" move the button function selected up or down in the list. This moves the button function in the toolbar of a Control towards the front or towards the back.

### See also

UserArchiveControl (Page 4130)  
TrendRulerControl (Page 4110)  
FunctionTrendControl (Page 4004)  
OnlineTableControl (Page 4037)  
OnlineTrendControl (Page 4045)

## ToolbarButtonTooltipText

### Description

Specifies the tooltip text for the button.

### See also

UserArchiveControl (Page 4130)  
TrendRulerControl (Page 4110)  
FunctionTrendControl (Page 4004)  
OnlineTableControl (Page 4037)  
OnlineTrendControl (Page 4045)

## ToolBarButtonUserDefined

### Description

Indicates whether the project engineer has added a new user-defined toolbar button.

### Syntax

Object.**ToolBarButtonUserDefined**[=BOOLEAN]

#### Object

Required An object of the "ScreenItem" type with the format "AlarmControl", "FunctionTrendControl", "TrendRulerControl", "UserArchiveControl".

#### Boolean

TRUE: The key of the toolbar is customized.

FALSE: The key of the toolbar is specified by the system.

### See also

UserArchiveControl (Page 4130)

TrendRulerControl (Page 4110)

FunctionTrendControl (Page 4004)

OnlineTableControl (Page 4037)

OnlineTrendControl (Page 4045)

## ToolBarShowTooltips

### Description

Enables the display of tooltips for the button functions in Runtime. The property can be dynamized with the ToolBarShowTooltips name. The property for specifying the tooltip text is "ToolBarButtonTooltipText".

Access in Runtime: Read and write

### Syntax

Object.**ToolBarShowTooltips**[=BOOLEAN]

#### Object

Required An object of the "ScreenItem" type with the format "AlarmControl", "TrendRulerControl", "OnlineTableControl", "FunctionTrendControl", "RecipeView", "OnlineTrendControl" (Runtime Professional) or "HMITrendView" (Runtime Advanced).

### **BOOLEAN**

TRUE: The tooltips are displayed.

FALSE: The tooltips are not displayed.

### **See also**

UserArchiveControl (Page 4130)

TrendRulerControl (Page 4110)

FunctionTrendControl (Page 4004)

OnlineTableControl (Page 4037)

OnlineTrendControl (Page 4045)

## **ToolbarUseBackColor**

### **Description**

Enables the display of the background color for a toolbar.

Access in Runtime: Read and write

### **Syntax**

Object.**ToolbarUseBackColor**[=BOOLEAN]

### **Object**

Required An object of the "ScreenItem" type with the format "AlarmControl", "TrendRulerControl", "OnlineTableControl", "FunctionTrendControl", "RecipeView", "OnlineTrendControl" (Runtime Professional) or "HMITrendView" (Runtime Advanced).

### **BOOLEAN**

TRUE: The background color of the toolbar is displayed.

FALSE: The background color of the toolbar is not displayed.

### **See also**

UserArchiveControl (Page 4130)

TrendRulerControl (Page 4110)

FunctionTrendControl (Page 4004)

OnlineTableControl (Page 4037)

OnlineTrendControl (Page 4045)

## ToolbarUseHotKeys

### Description

Activates the hotkeys for button functions in Runtime. Insert the hotkeys for button functions in the "Hotkey" field.

Access in Runtime: Read and write

### Syntax

Object.**ToolbarUseHotKeys**[=BOOLEAN]

#### Object

Required An object of the "ScreenItem" type with the format "AlarmControl", "TrendRulerControl", "OnlineTableControl", "FunctionTrendControl", "RecipeView", "OnlineTrendControl" (Runtime Professional) or "HMITrendView" (Runtime Advanced).

#### BOOLEAN

TRUE: The hotkeys are activated.

FALSE: The hotkeys are not activated.

### See also

UserArchiveControl (Page 4130)

TrendRulerControl (Page 4110)

FunctionTrendControl (Page 4004)

OnlineTableControl (Page 4037)

OnlineTrendControl (Page 4045)

## ToolbarVisible

### Description

Specifies whether the toolbar of the control is displayed.

Access in Runtime: Read and write

### Syntax

Object.**ToolbarVisible**[=BOOLEAN]

#### Object

Required An object of the "ScreenItem" type with the format "AlarmControl", "TrendRulerControl", "OnlineTableControl", "FunctionTrendControl", "UserArchiveControl", "OnlineTrendControl" (Runtime Professional) or "HMITrendView" (Runtime Advanced).



**BOOLEAN**

TRUE: The toolbar is displayed.

FALSE: The toolbar is not displayed.

**See also**

UserArchiveControl (Page 4130)

TrendRulerControl (Page 4110)

FunctionTrendControl (Page 4004)

OnlineTableControl (Page 4037)

OnlineTrendControl (Page 4045)

**ToolbarVisible**

**Description**

Enables the display of the Control toolbar.

Access in Runtime: Read and write

**Syntax**

Object.**ToolbarVisible**[=BOOLEAN]

**Object**

Required An object of the "ScreenItem" type with the format "MessageView", "RulerControl", "OnlineTableControl", "OnlineTrendControl", "FunctionTrendControl", "RecipeView".

**BOOLEAN**

TRUE: The toolbar is displayed.

FALSE: The toolbar is not displayed.

**ToolTipText**

**Description**

Specifies the tooltip text.

Access in Runtime: Read and write

**Syntax**

Object.**ToolTipText**[=String]

**Object**

Required A "ScreenItem" object with the formats "Line", "Polyline", "Ellipse", "Circle", "EllipseSegment", "CircleSegment", "EllipticalArc", "CircularArc", "Rectangle", "Polygon", "TextField", "IOField", "SymbolicIOField", "Button", "Roundbutton", "Switch", "GraphicView", "GraphicIOField", "Bar", "StatusForce", "Checkbox", "OptionGroup", "WindowSlider", "OleView" or "Connector".

**String**

Optional A value or a constant that specifies the tooltip text.

## See also

Line (Page 4025)  
Polyline (Page 4060)  
Ellipse (Page 3993)  
Circle (Page 3977)  
EllipseSegment (Page 3995)  
CircleSegment (Page 3979)  
EllipticalArc (Page 3998)  
CircularArc (Page 3982)  
Rectangle (Page 4072)  
Polygon (Page 4057)  
TextField (Page 4107)  
IOField (Page 4021)  
SymbolicIOField (Page 4093)  
Button (Page 3968)  
Switch (Page 4089)  
GraphicView (Page 4014)  
GraphicIOField (Page 4011)  
Bar (Page 3961)  
CheckBox (Page 3974)  
OptionGroup (Page 4054)  
WindowSlider (Page 4139)  
Connector (Page 3986)  
TubeTeeObject (Page 4128)  
TubePolyline (Page 4125)  
TubeDoubleTeeObject (Page 4123)  
TubeArcObject (Page 4121)  
MultiLineEdit (Page 4032)  
Listbox (Page 4027)

## Top

## Description

Specifies the value of the Y coordinate of the selected object.

Access during runtime: Read and write

## Syntax

Object.Top[= DOUBLE]

### Object

Necessary. A "ScreenItem" object. This property is a standard property of the ScreenItem object and is therefore available for all formats.

### DOUBLE

Optional A value or a constant that contains the value of the Y coordinate in pixels (measured from the top left edge of the screen).

## Comments

The Y coordinate refers to the top left corner of the rectangle that surrounds the object. The screen limits are also monitored in runtime. If the assigned coordinate value exceeds the display size, the user-defined function is interrupted with an error message.

### Used for the following object types:

IOField

Rectangle

Slider

## See also

Line (Page 4025)  
Polyline (Page 4060)  
Ellipse (Page 3993)  
Circle (Page 3977)  
EllipseSegment (Page 3995)  
CircleSegment (Page 3979)  
EllipticalArc (Page 3998)  
CircularArc (Page 3982)  
Rectangle (Page 4072)  
Polygon (Page 4057)  
TextField (Page 4107)  
IOField (Page 4021)  
SymbolicIOField (Page 4093)  
Button (Page 3968)  
Switch (Page 4089)  
GraphicView (Page 4014)  
GraphicIOField (Page 4011)  
Bar (Page 3961)  
Clock (Page 3984)  
Gauge (Page 4008)  
Slider (Page 4082)  
SymbolLibrary (Page 4098)  
OnlineTrendControl (Page 4045)  
FunctionTrendControl (Page 4004)  
OnlineTableControl (Page 4037)  
AlarmControl (Page 3947)  
HTMLBrowser (Page 4019)  
CheckBox (Page 3974)  
OptionGroup (Page 4054)  
WindowSlider (Page 4139)  
Connector (Page 3986)  
ScreenWindow (Page 4078)  
DiskSpaceView (Page 3991)  
ChannelDiagnose (Page 3972)  
ScriptDiagnostics (Page 4080)  
Group (Page 4017)  
ForeignControl (Page 4000)  
DateTimeField (Page 3989)  
ProtectedAreaName (Page 4064)  
UserView (Page 4137)

## TopConnectedConnectionPointIndex

### Description

Specifies or sets the index number of the top connecting point.  
LONG write-read access.

## TopConnectedObjectName

### Description

Specifies or sets the object name of the object which is docked on at the bottom connecting point.  
LONG write-read access.

## TopOffset

### Description

Defines or returns the distance of the picture from the top edge of the picture window.  
The picture is displayed as a cutout of the picture window. The picture scroll bars are located at the left and upper edge of the picture. If you wish to display the picture in the picture window by using the horizontal and vertical positioning of the picture scroll bars, use the properties "HorizontalScrollBarPosition" and "VerticalScrollBarPosition" for such positioning.

### See also

ScreenWindow (Page 4078)

## Total

### Description

Returns the storage capacity.  
Access in Runtime: Read and write

### Syntax

Object.**Total**[=Double]

#### Object

Required A "ScreenItem" object with the format "DiskSpaceView".

**Double**

Optional A value or a constant that returns the storage capacity.

**See also**

DiskSpaceView (Page 3991)

**Transparency**

**Description**

Defines and returns the percentage transparency of the object.

0 = no transparency; 100 = complete transparency (invisible)

The text and fields of the graphic objects are only transparent at "100."

In runtime, a completely transparent object (invisible) is also functional.

**See also**

Slider (Page 4082)  
CheckBox (Page 3974)  
GraphicIOField (Page 4011)  
Bar (Page 3961)  
WindowSlider (Page 4139)  
TubeTeeObject (Page 4128)  
TubePolyline (Page 4125)  
TubeDoubleTeeObject (Page 4123)  
TubeArcObject (Page 4121)  
Rectangle (Page 4072)  
MultiLineEdit (Page 4032)  
Line (Page 4025)  
Listbox (Page 4027)  
Button (Page 3968)  
Circle (Page 3977)  
CircleSegment (Page 3979)  
CircularArc (Page 3982)  
Clock (Page 3984)  
Connector (Page 3986)  
Ellipse (Page 3993)  
EllipseSegment (Page 3995)  
EllipticalArc (Page 3998)  
Gauge (Page 4008)  
GraphicView (Page 4014)  
Polygon (Page 4057)  
Polyline (Page 4060)  
RoundButton (Page 4074)  
SymbolicIOField (Page 4093)  
IOField (Page 4021)  
TextField (Page 4107)  
OptionGroup (Page 4054)



## TransparentColor

### Description

Specifies which color of the allocated graphic (\*.bmp, \*dib) of the specified object will be set to "transparent".

The "UseTransparentColor" property must have the value TRUE so that the color will be shown as transparent.

Access in Runtime: Read and write

### Syntax

Object.**TransparentColor**[= Color]

#### Object

Required An object of type "ScreenItem" with the formats "GraphicView" or "GraphicIOField".

#### Color

Optional A value or a constant that specifies the color that will be shown transparent.

### Comments

Use the "RGB" function to establish the colors in RGB format (red, green blue). To do this, enter the appropriate decimal value for each of the three RGB values (range from 0 to 255). For example, the color "red" is shown as such: RGB(255, 0, 0). You can also use the VBS color constants like vbRed or vbGreen.

### See also

GraphicView (Page 4014)

GraphicIOField (Page 4011)

UseTransparentColor (Page 4685)

## TransparentColorDeactivatedPicture

### Description

Specifies which color of the allocated bitmap object will be set to "transparent" for the status "disabled".

Access in Runtime: Read and write

### Syntax

Object.**TransparentColorDeactivatedPicture**[=Color]

**Object**

Required A ""ScreenItem" object with the format ""Roundbutton".

**Color**

Optional A value or a constant that specifies which color of the allocated bitmap object will be set to transparent" for the status "disabled".

**Comments**

The "PicDeactUseTransColor" property must have the value TRUE so that the color can be set to ""transparent".

**TransparentColorPictureOff**

**Description**

Specifies which color of the allocated bitmap object will be set to transparent" for the status "off".

Access in Runtime: Read and write

**Syntax**

Object.TransparentColorPictureOff[=Color]

**Object**

Required A "ScreenItem" object with the format "Roundbutton".

**Color**

Optional A value or a constant that specifies which color of the allocated bitmap object will be set to transparent" for the status "off".

**See also**

Button (Page 3968)

**TransparentColorPictureOn**

**Description**

Specifies which color of the allocated bitmap object will be set to transparent" for the status "on".

Access in Runtime: Read and write

## Syntax

Object.**TransparentColorPictureOn**[=Color]

### Object

Required A "ScreenItem" object with the format "Roundbutton".

### Color

Optional A value or a constant that specifies which color of the allocated bitmap object will be set to "transparent" for the status "on".

## Comments

The "PicDownUseTransColor" property must have the value TRUE so that the color can be set to "transparent".

## See also

Button (Page 3968)

## Trend

### Description

TRUE, when the tendency (rising or falling) of the measuring value being monitored should be displayed by a small arrow. BOOLEAN write-read access.

## TrendActualize

### Description

Enables the update of a selected trend.

Access in Runtime: Read and write

## Syntax

Object.**TrendActualize**[=BOOLEAN]

### Object

Required An object of the "ScreenItem" type with the format "FunctionTrendControl", "OnlineTrendControl", (Runtime Professional) or "HMITrendView" (Runtime Advanced).

### BOOLEAN

TRUE: The selected trend is always actualized.

FALSE: The selected trend is not actualized. This setting is useful when a logged trend is compared with a current trend.

**See also**

FunctionTrendControl (Page 4004)

**TrendAdd**

**Description**

Creates a new trend.

**See also**

FunctionTrendControl (Page 4004)

OnlineTrendControl (Page 4045)

**TrendBeginTime**

**Description**

Defines the start time of the time range for data transfer to the selected trend. .

**See also**

FunctionTrendControl (Page 4004)

**TrendColor**

**Description**

Determines the color of the trend display or returns it.  
The trend display indicates the tendency (rising or falling) of the measuring value being monitored by a small arrow. In order to activate the trend display, the Trend property must be set to "True". LONG write-read access.

**See also**

FunctionTrendControl (Page 4004)

**TrendColor**

**Description**

Determines the color of the trend display or returns it.  
The trend display indicates the tendency (rising or falling) of the measuring value being

monitored by a small arrow. In order to activate the trend display, the Trend property must be set to "True". LONG write-read access.

### See also

OnlineTrendControl (Page 4045)

## TrendCount

### Description

Defines the number of configured trends.

### See also

FunctionTrendControl (Page 4004)

OnlineTrendControl (Page 4045)

## TrendEndTime

### Description

Defines the end of the time range for data connections of a selected trend.

### See also

FunctionTrendControl (Page 4004)

## TrendExtendedColorSet

### Description

Enables configuration of the point and fill colors and the display of colors in Runtime.

Access in Runtime: Read and write

### Syntax

Object.**TrendExtendedColorSet**[=BOOLEAN]

#### Object

Required An object of the "ScreenItem" type with the format "FunctionTrendControl", "OnlineTrendControl", (Runtime Professional) or "HMITrendView" (Runtime Advanced).

### **BOOLEAN**

TRUE: The settings in the "Point color" and "Fill color" fields are configurable and effective in Runtime.

FALSE: The settings in the "Point color" and "Fill color" fields are not configurable and effective in Runtime.

### **See also**

FunctionTrendControl (Page 4004)

OnlineTrendControl (Page 4045)

### **TrendFill**

#### **Description**

Specifies if the area beneath the trend is to be filled.

Access in Runtime: Read and write

#### **Syntax**

Object.**TrendFill**[=BOOLEAN]

#### **Object**

Required An object of the "ScreenItem" type with the format "FunctionTrendControl", "OnlineTrendControl", (Runtime Professional) or "HMITrendView" (Runtime Advanced).

### **BOOLEAN**

TRUE: The area beneath the trend is shown filled. You can define the trend color as fill color if the "Advanced" option is deactivated.

FALSE: The trend is not shown filled.

### **See also**

FunctionTrendControl (Page 4004)

OnlineTrendControl (Page 4045)

### **TrendFillColor**

#### **Description**

Specifies the fill color of the trend. The settings are only active if the "Filled" option is enabled. Open the "Color selection" dialog by clicking the button.

The settings are only active if the "Advanced" option is enabled.

## See also

FunctionTrendControl (Page 4004)

OnlineTrendControl (Page 4045)

## TrendIndex

### Description

References a configured trend. You can assign the values of other properties to a specific trend by using the property. The index must always be set before you change the properties of a trend in runtime.

Valid values for "TrendIndex" are between 0 and "TrendCount" minus 1. The "TrendCount" property indicates the number of configured trends.

## See also

FunctionTrendControl (Page 4004)

OnlineTrendControl (Page 4045)

## TrendIndicatorColor

### Description

Specifies the color for the trend indicator. The trend indicator represents the tendency (increasing or falling) of the measurement value that is to be monitored with a small arrow. To activate the trend indicator, the property "ShowTrendIndicator" must have the value TRUE.

Access in Runtime: Read and write

### Syntax

Object.**TrendIndicatorColor**[=Color]

#### Object

Required A "ScreenItem" object with the format "Bar".

#### Color

Optional A value or a constant that specifies the color of the trend indicator.

## See also

Bar (Page 3961)

## TrendLabel

### Description

Defines the label of the trend selected. The label is displayed in Runtime if the value at attribute "UseTrendNameAsLabel" is "FALSE".

### See also

FunctionTrendControl (Page 4004)

OnlineTrendControl (Page 4045)

## TrendLineStyle

### Example

Defines the line style for trend visualization.

Access in Runtime: Read and write

### Syntax

Object.**TrendLineStyle**[=LineStyle]

#### Object

Required An object of the "ScreenItem" type with the format "FunctionTrendControl", "OnlineTrendControl", (Runtime Professional) or "HMITrendView" (Runtime Advanced).

#### LineStyle

Value	Description	Explanation
0	Solid	The trend is visualized as solid line.
1	Dashed	The trend is visualized as dashed line.
2	Dotted	The trend is visualized as dotted line.
3	Dash dot	The trend is visualized as dot-dash line.
4	Dash Dot Dot	The trend is visualized as dash-dot-dot line.

### See also

FunctionTrendControl (Page 4004)

OnlineTrendControl (Page 4045)



## TrendLineType

### Description

Defines how to visualize a trend.

Access in Runtime: Read and write

### Syntax

Object.TrendLineType[=LineType]

#### Object

Required An object of the "ScreenItem" type with the format "FunctionTrendControl", "OnlineTrendControl", (Runtime Professional) or "HMITrendView" (Runtime Advanced).

#### LineType

Value	Description	Explanation
0	None	Only the dots are displayed.
1	Line	Visualizes a trend with linear interconnection of points.
2	Stepped	Visualizes a stepped trend and its interconnected points.

### See also

FunctionTrendControl (Page 4004)

OnlineTrendControl (Page 4045)

## TrendLineWidth

### Description

Defines the line weight of the line displayed.

### See also

FunctionTrendControl (Page 4004)

OnlineTrendControl (Page 4045)

## TrendLowerLimit

### Description

Specifies the low limit of a tag. If the tag drops below the value of "TrendLowerLimit", the values are marked with the color set in "TrendLowerLimitColor". The specification is effective if the "TrendLowerLimitColoring" property has the value "TRUE".

### See also

FunctionTrendControl (Page 4004)

OnlineTrendControl (Page 4045)

## TrendLowerLimitColor

### Description

Specifies the color which marks tag values which are below the value of "TrendLowerLimit". The setting is effective if the "TrendLowerLimitColoring" attribute has the value "TRUE".

### See also

FunctionTrendControl (Page 4004)

OnlineTrendControl (Page 4045)

## TrendLowerLimitColoring

### Description

Enables the "TrendLowerLimitColor" attribute for identifying tag values which are less than the value at "TrendLowerLimitValue".

### Syntax

Object.**TrendLowerLimitColoring** [=BOOLEAN]

#### Object

Required An object of the "ScreenItem" type with the format "FunctionTrendControl", "OnlineTrendControl" (Runtime Professional) or "HMITrendView" (Runtime Advanced).

#### Boolean

TRUE: The "TrendLowerLimitColor" property is effective.

FALSE: The "TrendLowerLimitColor" property is not effective.

## See also

FunctionTrendControl (Page 4004)

OnlineTrendControl (Page 4045)

## TrendMeasurePoints

### Number of measurement points - TrendMeasurePoints

Defines the number of measurement points for visualization of selected trends.

Defines the number of value pairs provided to the trend from a user archive.

The attribute can be assigned dynamic properties by means of the name **TrendMeasurePoints**.

## See also

FunctionTrendControl (Page 4004)

## TrendName

### Description

Displays the name of the selected trend. The name is defined on the "Trends" tab. The "TrendName" property can be dynamized by the TrendRename property.

Access in Runtime: Read and write

### Syntax

Object.**TrendName**

#### Object

Required An object of the "ScreenItem" type with the format "FunctionTrendControl", "OnlineTrendControl", (Runtime Professional) or "HMITrendView" (Runtime Advanced).

## See also

FunctionTrendControl (Page 4004)

OnlineTrendControl (Page 4045)

## TrendPointColor

### Description

Defines the color of trend points. Open the "Color selection" dialog by clicking the button.

The settings are only active if the "Advanced" option is enabled.

### See also

FunctionTrendControl (Page 4004)

OnlineTrendControl (Page 4045)

## TrendPointStyle

### Description

Defines the dot style for trend visualization.

Access in Runtime: Read and write

### Syntax

Object.**TrendPointStyle**[=PointStyle]

### Object

Required An object of the "ScreenItem" type with the format "FunctionTrendControl", "OnlineTrendControl", (Runtime Professional) or "HMITrendView" (Runtime Advanced).

### PointStyle

Value	Description	Explanation
0	None	The points are not displayed.
1	Dots	The trend points are visualized with a size of one pixel. The setting in the "Dot width" field is deactivated.
2	Squares	The dots are displayed as square. The setting in the "Dot width" field is active.
3	Circles	The dots are displayed as circles. The setting in the "Dot width" field is active.

### See also

FunctionTrendControl (Page 4004)

OnlineTrendControl (Page 4045)

## TrendPointWidth

### Description

Sets the dot width in pixels. You can only define the dot width for the "square" and "circular" type.

**See also**

FunctionTrendControl (Page 4004)

OnlineTrendControl (Page 4045)

**TrendProvider****Description**

Specifies the data source for a selected trend.

Access in Runtime: Read and write

**Syntax**

Object.**TrendProvider**[=Provider]

**Object**

Required An object of the "ScreenItem" type with the format "FunctionTrendControl", "OnlineTrendControl", (Runtime Professional) or "HMITrendView" (Runtime Advanced).

**Provider**

Value	Description	Explanation
0	None	No data source configured for implementation in Runtime by means of a user-defined function.
1	Archive tags	Data source with archive tags of a process value archive.
2	HMI tags	Data supply with tag values of HMI tags
3	Recipe data	Data supply with columns of a recipe

**See also**

FunctionTrendControl (Page 4004)

OnlineTrendControl (Page 4045)

**TrendRangeType****Description**

Defines the time range for providing data to the selected trend.

You can only define the number of measuring points if you select user archives as the data source.

Access in Runtime: Read and write

## Syntax

Object.TrendRangeType[=RangeType]

### Object

Required An object of the "ScreenItem" type with the format "FunctionTrendControl", "OnlineTrendControl", (Runtime Professional) or "HMITrendView" (Runtime Advanced).

### RangeType

Value	Description	Explanation
0	Time range	Defines the start time and the time range for the data connection.
1	Start to end time	Defines the start and end time for the data connection.
2	Number of measurement points	Defines the start time and the number of measurement points for the data connection.

## See also

FunctionTrendControl (Page 4004)

## TrendRemove

### Description

Removes selected trends from the list.

## See also

FunctionTrendControl (Page 4004)

OnlineTrendControl (Page 4045)

## TrendRename

### Description

Changes the name of the trend which is referenced by the "TrendIndex" property.  
With "TrendRename" you also dynamize the "TrendName" property.

## See also

FunctionTrendControl (Page 4004)

OnlineTrendControl (Page 4045)

## TrendRepos

### Description

Repositions the trend in the trend window. "Up" and "Down" move the selected trend up or down in the list. This moves the trend towards the foreground or background for visualization in Runtime.

### See also

FunctionTrendControl (Page 4004)

OnlineTrendControl (Page 4045)

## TrendSelectTagNameX

### Description

Opens the dialog box for selecting the tag name for the data supply of the X axis in the f(x) trend view. Programmers can use the property to let the user select a tag name with a button for example.

### See also

FunctionTrendControl (Page 4004)

## TrendSelectTagNameY

### Description

Opens the dialog box for selecting the tag name for the data supply of the Y axis in the f(x) trend view. Programmers can use the property to let the user select a tag name with a button for example.

### See also

FunctionTrendControl (Page 4004)

## TrendTag

### Description

Specifies which tag is linked with the selected trend.

You enter the value either in the form "archive name/tag name", to show tags of a process value archive, or in the form "tag name" to show an internal or an external tag that will now be saved in an archive.

Access in Runtime: Read and write

### Syntax

Object.**TrendTag**[=HmiTag]

#### Object

Required A ""ScreenItem" object with the format "OnlineTrend".

#### HmiTag

Optional A value or a constant that specifies which tags are linked with the selected trend.

### Comments

The parameter i indicates the number of the trend.

### See also

OnlineTrendControl (Page 4045)

### TrendTagNameX

#### Description

Shows the name of the bound HMI tag or column for the X axis. You select an HMI tag or a column with the selection button.

Access in Runtime: Read and write

#### Syntax

Object.**TrendTagNameX**

#### Object

Required An object of the "ScreenItem" type with the format "FunctionTrendControl", "OnlineTrendControl", (Runtime Professional) or "HMITrendView" (Runtime Advanced).

### See also

FunctionTrendControl (Page 4004)



## TrendTagNameY

### Description

Shows the name of the bound HMI tag or column for the Y axis. You select an HMI tag or a column with the selection button.

Access in Runtime: Read and write

### Syntax

Object.TrendTagNameX

#### Object

Required. An object of the "ScreenItem" type with the format "FunctionTrendControl", "OnlineTrendControl", (Runtime Professional) or "HMITrendView" (Runtime Advanced).

### See also

FunctionTrendControl (Page 4004)

## TrendTimeRangeBase

### Description

Defines the time unit for calculating the time range.

Access in Runtime: Read and write

### Syntax

Object.TrendTimeRangeBase[=TimeRangeBase]

#### Object

Required An object of the "ScreenItem" type with the format "FunctionTrendControl", "OnlineTrendControl", (Runtime Professional) or "HMITrendView" (Runtime Advanced).

#### TimeRangeBase

Value	Description
500	500 ms
1000	1 second
60000	1 minute
3600000	1 hour
86400000	1 day

**See also**

FunctionTrendControl (Page 4004)

**TrendTimeRangeFactor**

**Description**

Defines the factor for calculating the time range. Only integer factors are valid. .

**See also**

FunctionTrendControl (Page 4004)

**TrendTrendWindow**

**Description**

Defines the trend window for visualizing the trend selected. Define the available trend windows in the "Trend window" tab.

**See also**

FunctionTrendControl (Page 4004)

OnlineTrendControl (Page 4045)

**TrendUncertainColor**

**Description**

Value are in uncertain state if the initial value is unknown after runtime has been activated, or if a substitute value is used. With the "TrendUncertainColor" property you specify the color which is used for marking these values. Whether the information is evaluated depends on the "TrendUncertainColoring" property.

**See also**

FunctionTrendControl (Page 4004)

OnlineTrendControl (Page 4045)

## TrendUncertainColoring

### Description

Value are in uncertain state if the initial value is unknown after runtime has been activated, or if a substitute value is used. The "TrendUncertainColoring" attribute is used to enable identification of such values based on the color set in "TrendUncertainColor".

Access in Runtime: Read and write

### Syntax

Object.**TrendUncertainColoring**[=BOOLEAN]

Object

Required An object of the "ScreenItem" type with the format "FunctionTrendControl", "OnlineTrendControl", (Runtime Professional) or "HMITrendView" (Runtime Advanced).

#### **BOOLEAN**

TRUE: The setting of the "TrendUncertainColor" property is effective.

FALSE: The setting of the "TrendUncertainColor" property is not effective.

### See also

FunctionTrendControl (Page 4004)

OnlineTrendControl (Page 4045)

## TrendUpperLimit

### Description

Specifies the high limit of a tag. If the tag drops below the value of "TrendUpperLimit", the values are marked by the color set in "TrendUpperLimitColor". The specification is effective if the "TrendUpperLimitColoring" attribute has the value "TRUE".

### See also

FunctionTrendControl (Page 4004)

OnlineTrendControl (Page 4045)

## TrendUpperLimitColor

### TrendUpperLimitColor

Specifies the color of tag values which are less than the value at "TrendLowerLimit". This setting is only active if the value at attribute "TrendUpperLimitColoring" is "TRUE".

The attribute can be assigned dynamic properties by means of the name **TrendUpperLimitColor**.

### See also

FunctionTrendControl (Page 4004)

OnlineTrendControl (Page 4045)

## TrendUpperLimitColoring

### Description

Specifies whether the selection frame is shown with the specified color.

Access in Runtime: Read and write

### Syntax

Object.**TrendUpperLimitColoring**[=BOOLEAN]

#### Object

Required An object of the "ScreenItem" type with the format "FunctionTrendControl", "OnlineTrendControl", (Runtime Professional) or "HMITrendView" (Runtime Advanced).

#### BOOLEAN

TRUE: The setting of the "TrendUpperLimitColor" attribute is effective.

FALSE: The setting of the "TrendUpperLimitColor" attribute is not effective.

### See also

FunctionTrendControl (Page 4004)

OnlineTrendControl (Page 4045)

## TrendVisible

### Description

The list shows all trends you created.

Select the trends to be displayed in the trend window from the list.

Click a trend entry in the list to adapt the properties and to assign axes and trend windows to the trend.

### See also

FunctionTrendControl (Page 4004)

OnlineTrendControl (Page 4045)

## TrendWindowAdd

### Description

Create a new trend view.

### See also

FunctionTrendControl (Page 4004)

OnlineTrendControl (Page 4045)

## TrendWindowCoarseGrid

### Description

Enables the display of grid lines for the main scale.

Access in Runtime: Read and write

### Syntax

Object.**TrendWindowCoarseGrid**[=BOOLEAN]

#### Object

Required An object of the "ScreenItem" type with the format "FunctionTrendControl", "OnlineTrendControl", (Runtime Professional) or "HMITrendView" (Runtime Advanced).

#### BOOLEAN

TRUE: The grid lines for the main scaling are displayed.

FALSE: The grid lines for the main scaling are not displayed.

### See also

FunctionTrendControl (Page 4004)

OnlineTrendControl (Page 4045)

## TrendWindowCoarseGridColor

### Description

Specifies the grid color of the main scale. Open the "Color selection" dialog by clicking the button.

### See also

FunctionTrendControl (Page 4004)

OnlineTrendControl (Page 4045)

## TrendWindowFineGrid

### Description

Enables the display of grid lines for the secondary scale.

Access in Runtime: Read and write

### Syntax

Object.**TrendWindowFineGrid**[=BOOLEAN]

#### Object

Required An object of the "ScreenItem" type with the format "FunctionTrendControl", "OnlineTrendControl", (Runtime Professional) or "HMITrendView" (Runtime Advanced).

#### BOOLEAN

TRUE: The grid lines for the auxiliary scaling are displayed.

FALSE: The grid lines for the auxiliary scaling are not displayed.

### See also

FunctionTrendControl (Page 4004)

OnlineTrendControl (Page 4045)

## TrendWindowFineGridColor

### Description

Specifies the grid color of the main scale. Open the "Color selection" dialog by clicking the button.

### See also

FunctionTrendControl (Page 4004)

OnlineTrendControl (Page 4045)

## TrendWindowForegroundTrendGrid

### Description

Enables the display of grid lines only for the foreground trend in the trend window.

Access in Runtime: Read and write

### Syntax

Object.TrendWindowForegroundTrendGrid[=BOOLEAN]

#### Object

Required An object of the "ScreenItem" type with the format "FunctionTrendControl", "OnlineTrendControl", (Runtime Professional) or "HMITrendView" (Runtime Advanced).

#### BOOLEAN

TRUE: The grid lines for the foreground trend are displayed.

FALSE: The grid lines for the foreground trend are not displayed.

### See also

FunctionTrendControl (Page 4004)

OnlineTrendControl (Page 4045)

## TrendWindowGridInTrendColor

### Description

Sets the trend color for the visualization of the grid lines for the main scale.

Access in Runtime: Read and write

## Syntax

Object.**AutoSelectionRectColors** [=BOOLEAN]

### Object

Required An object of the "ScreenItem" type with the format "FunctionTrendControl", "OnlineTrendControl", (Runtime Professional) or "HMITrendView" (Runtime Advanced).

### BOOLEAN

TRUE: The grid lines are displayed in the trend color.

FALSE: The grid lines are displayed with the color set in the "Color" field.

## See also

FunctionTrendControl (Page 4004)

OnlineTrendControl (Page 4045)

## TrendWindowHorizontalGrid

### Description

Enables the display of horizontal grid lines.

Access in Runtime: Read and write

### Syntax

Object.**TrendWindowHorizontalGrid** [=BOOLEAN]

### Object

Required An object of the "ScreenItem" type with the format "FunctionTrendControl", "OnlineTrendControl", (Runtime Professional) or "HMITrendView" (Runtime Advanced).

### BOOLEAN

TRUE: The horizontal grid lines are displayed.

FALSE: The horizontal grid lines are not displayed.

## See also

FunctionTrendControl (Page 4004)

OnlineTrendControl (Page 4045)



## TrendWindowIndex

### Description

References a configured trend view. You can assign the values of other properties to a specific trend window by using the property.

Valid values for "TrendWindowIndex" are between 0 and "TrendWindowCount" minus 1. The "TrendWindowCount" property indicates the number of configured trend windows.

### See also

FunctionTrendControl (Page 4004)

OnlineTrendControl (Page 4045)

## TrendWindowName

### Description

Defines the name of the trend window selected.

### See also

FunctionTrendControl (Page 4004)

OnlineTrendControl (Page 4045)

## TrendWindowRemove

### Description

Removes the selected trend view from the list.

### See also

FunctionTrendControl (Page 4004)

OnlineTrendControl (Page 4045)

## TrendWindowRename

### Description

Changes the name of the trend window which is referenced by the "TrendWindowIndex" property.

With "TrendWindowRename" you also dynamize the "TrendWindowName" property.

### See also

FunctionTrendControl (Page 4004)

OnlineTrendControl (Page 4045)

## TrendWindowRepos

### Description

Changes the order of the trend view. "Up" and "Down" move the selected trend up or down in the list.

The sorting order in the list defines the position in the Control. The first trend view is shown in the lowest position, the last trend view in the highest position.

### See also

FunctionTrendControl (Page 4004)

OnlineTrendControl (Page 4045)

## TrendWindowRulerColor

### Description

Specifies the ruler color. Open the "Color selection" dialog by clicking the button.

The color can be configured and displayed if "1 - graphic" is set for visualization.

### See also

FunctionTrendControl (Page 4004)

OnlineTrendControl (Page 4045)

## TrendWindowRulerLayer

### Description

Specifies the display layer of the ruler in the trend view.

Access in Runtime: Read and write

### Syntax

Object.**TrendWindowRulerLayer**[=RulerLayer]

**Object**

Required An object of the "ScreenItem" type with the format "FunctionTrendControl", "OnlineTrendControl", (Runtime Professional) or "HMITrendView" (Runtime Advanced).

**RulerLayer**

Value	Description	Explanation
0	Under grid	The ruler is visualized on a layer under the grid.
1	Between grid and trend	The ruler is positioned on top of the trend and under the grid.
2	On top of trend	The ruler is positioned on top of the trend.

**See also**

FunctionTrendControl (Page 4004)

OnlineTrendControl (Page 4045)

**TrendWindowRulerStyle****Description**

Defines the appearance of the ruler.

Access in Runtime: Read and write

**Syntax**

Object.**TrendWindowRulerStyle** [=BOOLEAN]

**Object**

Required An object of the "ScreenItem" type with the format "FunctionTrendControl", "OnlineTrendControl", (Runtime Professional) or "HMITrendView" (Runtime Advanced).

**BOOLEAN**

TRUE: The ruler is displayed as a single black line.

FALSE: The ruler is is displayed in the configured "Color" and "Width".

**See also**

FunctionTrendControl (Page 4004)

OnlineTrendControl (Page 4045)

## TrendWindowRulerWidth

### Description

Defines the width of the ruler in pixels.  
The width can be configured and displayed if "1 - graphic" is set for visualization.

### See also

FunctionTrendControl (Page 4004)  
OnlineTrendControl (Page 4045)

## TrendWindowSpacePortion

### Description

Specifies the proportion of the trend widow to be used for the selected curve.

### See also

FunctionTrendControl (Page 4004)  
OnlineTrendControl (Page 4045)

## TrendWindowVerticalGrid

### Description

Enables the display of vertical grid lines.  
Access in Runtime: Read and write

### Syntax

Object.**TrendWindowVerticalGrid**[=BOOLEAN]

#### Object

Required An object of the "ScreenItem" type with the format "FunctionTrendControl", "OnlineTrendControl" (Runtime Professional) or "HMITrendView" (Runtime Advanced).

#### BOOLEAN

TRUE: The vertical grid lines are displayed.  
FALSE: The vertical grid lines are not displayed.

### See also

FunctionTrendControl (Page 4004)

OnlineTrendControl (Page 4045)

## TrendWindowVisible

### Description

The trend lines which you have created are listed in the list.

Activate the trend views in the list which you want to display in the control.

Click a list entry to adapt the ruler and grid line properties.

### See also

FunctionTrendControl (Page 4004)

OnlineTrendControl (Page 4045)

## TrendXAxis

### Description

Defines the X axis to be used for the trend selected. Define the available X axes inn the "X Axes" tab.

### See also

FunctionTrendControl (Page 4004)

## TrendYAxis

### Description

Defines the Y axis to be used for the trend selected. Define the available Y axes inn the "Y Axes" tab.

### See also

FunctionTrendControl (Page 4004)

## Type

### Description

Returns the type of the specified object as STRING. Name diagram: Hmi<ObjectName>, e.g. HmiCircle for the "circle" screen object.

Access in Runtime: Read

### Syntax

Object.Type

#### Object

Required A "ScreenItem" object.

## TypeAlarmHigh

### Description

TRUE, when the upper limit value, at which an alarm is triggered, should be evaluated as a percentage. FALSE, when the evaluation should be as an absolute value. BOOLEAN write-read access.

## TypeAlarmLow

### Description

TRUE, when the lower limit value, at which an alarm is triggered, should be evaluated as a percentage. FALSE, when the evaluation should be as an absolute value. BOOLEAN write-read access.

## TypeLimitHigh4

### Description

TRUE, when the "Reserve 4" upper limit value should be evaluated as a percentage. FALSE, when the evaluation should be as an absolute value. BOOLEAN write-read access.

## TypeLimitHigh5

### Description

TRUE, when the "Reserve 5" upper limit value should be evaluated as a percentage. FALSE, when the evaluation should be as an absolute value. BOOLEAN write-read access.

#### TypeLimitLow4

##### Description

TRUE, when the "Reserve 4" lower limit value should be evaluated as a percentage. FALSE, when the evaluation should be as an absolute value. BOOLEAN write-read access.

#### TypeLimitLow5

##### Description

TRUE, when the "Reserve 5" lower limit value should be evaluated as a percentage. FALSE, when the evaluation should be as an absolute value. BOOLEAN write-read access.

#### TypeToleranceHigh

##### Description

TRUE, when the "Tolerance high" lower limit value should be evaluated as a percentage. FALSE, when the evaluation should be as an absolute value. BOOLEAN write-read access.

#### TypeToleranceLow

##### Description

TRUE, when the "Tolerance low" lower limit value should be evaluated as a percentage. FALSE, when the evaluation should be as an absolute value. BOOLEAN write-read access.

#### TypeWarningHigh

##### Description

TRUE, when the "Warning high" lower limit value should be evaluated as a percentage. FALSE, when the evaluation should be as an absolute value. BOOLEAN write-read access.

#### TypeWarningLow

##### Description

TRUE, when the "Warning low" lower limit value should be evaluated as a percentage. FALSE, when the evaluation should be as an absolute value. BOOLEAN write-read access.

## Properties U-W

### UncertainStateColor(i)

#### Description

Specifies the color for the identification of values with an uncertain status.

Access in Runtime: Read and write

#### Syntax

Object.**UncertainStateColor**(i)[=Color]

#### Object

Required An object of the "ScreenItem" type with the format "OnlineTrendControl" or "FunctionTrendControl".

#### Color

Optional A value or a constant that specifies the color for the identification of values with an uncertain status.

#### Comments

The parameter i indicates the number of the trend.

If the start value of a value is not known after Runtime has been activated or a substitute value is used, then this value has an uncertain status.

#### See also

OnlineTrendControl (Page 4045)

FunctionTrendControl (Page 4004)

### UncertainStateEnabled(i)

#### Description

Specifies if values with an uncertain status are identified with the color set up in "ReplacementColor(i)".

If the start value of a value is not known after Runtime has been activated or a substitute value is being used, then this value is considered to have an uncertain status.

Access in Runtime: Read and write



## Syntax

Object.**UncertainStateEnabled**(i)[=BOOLEAN]

### Object

Required An object of the "ScreenItem" type with the format "OnlineTrendControl" or "FunctionTrendControl".

### BOOLEAN

Optional TRUE, if values with an uncertain status are identified with the color specified in ""ReplacementColor(i)".

## Comments

The parameter i indicates the number of the trend.

## See also

OnlineTrendControl (Page 4045)

FunctionTrendControl (Page 4004)

## Unit

## Description

Specifies the unit of measurement in the "IOField" object.

## See also

Bar (Page 3961)

IOField (Page 4021)

## UnitColor

## Description

Specifies the text color for the label of the measurement unit in the "Gauge" object

Access in Runtime: Read and write

## Syntax

Object.**UnitColor**[= Color]

### Object

Required A "ScreenItem" object with the format "Gauge".

### Color

Optional A value or a constant that specifies the text color for the measurement unit.

### Comments

Use the "RGB" function to establish the colors in RGB format (red, green blue). To do this, enter the appropriate decimal value for each of the three RGB values (range from 0 to 255). For example, the color "red" is shown as such: RGB(255, 0, 0). You can also use the VBS color constants like vbRed or vbGreen.

### See also

Gauge (Page 4008)

### UnitText

### Description

Specifies the text for the measurement unit of the selected object.

Access in Runtime: Read and write

### Syntax

Object.**UnitText**[= STRING]

#### Object

Required A "ScreenItem" object with the format ""Gauge".

#### STRING

Optional A value or a constant that specifies the text for the measurement unit.

### Comments

Enter a text to show, for example, the physical unit of the displayed value. It is standard for no text to be set as a default.

### See also

Gauge (Page 4008)

## UnitTop

### Description

Specifies the distance of the measurement unit to the upper edge of the selected object. The lettering can be positioned only in line with the vertical diameter of the scale. The value of the property refers to the height of the selected object and is measured from the upper edge of the selected object to the lower edge of the lettering.

Access in Runtime: Read and write

### Syntax

Object.UnitTop[=Double]

#### Object

Required A ""ScreenItem" object with the format "Gauge".

#### Double

Optional A value or a constant that specifies the distance of the measurement unit to the upper edge of the selected object.

Value range from 0 to 1

0: The lower edge of the lettering is positioned on the upper limit of the selected object. The text is no longer visible as it is positioned outside of the selected object.

1: The lower edge of the lettering is positioned on the lower limit of the selected object.

### See also

Gauge (Page 4008)

## UnselBGColor property

### Description

Defines or returns the background color of entries in the text list object which are not selected. LONG write-read access.

## UnselTextColor property

### Description

Defines or returns the color of the text for entries in the text list object which are not selected. LONG write-read access.

## UpdateCycle property

### Description

Returns the type and frequency of updating the picture window in Runtime. Read only access.

## UpdateEnable

### Description

Specifies whether the recipe view can be altered in Runtime.

Access in Runtime: Read and write

### Syntax

Object.**UpdateEnable**[=BOOLEAN]

#### Object

Required An object of the "ScreenItem" type with the format "UserArchiveControl".

#### BOOLEAN

Optional TRUE, if the recipe view can be altered in Runtime.

## UpperLimit

### Description

Specifies the upper limit for input values.

Access in Runtime: Read and write

### Syntax

Object.**UpperLimit**[=Double]

#### Object

Required A "ScreenItem" object with the format "IOField".

#### Double

Optional A value or a constant that specifies the upper limit for input values.

### See also

IOField (Page 4021)

## UpperLimitColor(i)

### Description

Specifies the color that identifies the tag values that lie above the value of ""UpperLimitValue(i)". Whether the information is evaluated depends on the value of the property ""UpperLimitEnabled(i)".

Access in Runtime: Read and write

### Syntax

Object.**UpperLimitColor(i)**[=Color]

#### Object

Required An object of the "ScreenItem" type with the format "OnlineTrendControl", "FunctionTrendControl" or "OnlineTableControl".

#### Color

Optional A value or a constant that identifies the tag values that lie above the value of ""UpperLimitValue(i)".

### Comments

The parameter i indicates the number of the trend.

### See also

OnlineTrendControl (Page 4045)

FunctionTrendControl (Page 4004)

OnlineTableControl (Page 4037)

## UpperLimitEnabled(i)

### Description

Specifies whether the information from "UpperLimitColor(i)" is used to identify the tag values that lie above the value of "UpperLimitValue(i)".

Access in Runtime: Read and write

### Syntax

Object.**UpperLimitEnabled(i)**[=BOOLEAN]

**Object**

Required An object of the "ScreenItem" type with the format "OnlineTrendControl", "FunctionTrendControl" or "OnlineTableControl".

**BOOLEAN**

Optional TRUE, if the information from "UpperLimitColor(i)"" is used to identify the tag values that lie above the value of "UpperLimitValue(i)".

**Comments**

The parameter i indicates the number of the trend.

**See also**

- OnlineTrendControl (Page 4045)
- FunctionTrendControl (Page 4004)
- OnlineTableControl (Page 4037)

**UpperLimitValue(i)**

**Description**

Specifies whether the tag values that exceed the "UpperLimitValue(i)" are to be identified with the color specified in "UpperLimitColor(i)"". Whether the information is evaluated depends on the value of the property "UpperLimit(i)".

Access in Runtime: Read and write

**Syntax**

Object.UpperLimitValue(i)[=Double]

**Object**

Required An object of the "ScreenItem" type with the format "OnlineTrendControl" or "FunctionTrendControl".

**Double**

Optional A value or a constant that specifies whether the tag values that exceed the ""UpperLimitValue(i)" value are to be identified with the color specified in UpperLimitColor(i)"".

**Comments**

The parameter i indicates the number of the trend.

## See also

OnlineTrendControl (Page 4045)

FunctionTrendControl (Page 4004)

## UseAllServers

### Description

Specifies whether the data to be shown in the alarm window can be requested from all servers in a distributed system. Alarm Logging must be activated on the respective servers.

Access in Runtime: Read-only

### Syntax

Object.**UseAllServers**[=BOOLEAN]

#### Object

Required A "ScreenItem" object with the format "AlarmView".

#### BOOLEAN

Optional. TRUE, if the data to be shown in the alarm window can be requested from all servers in a distributed system.

## See also

AlarmControl (Page 3947)

## UseBarBorderConstraints

### Description

Specifies whether the bar border is restricted to specific values.

Access in Runtime: Read and write

### Syntax

Object.**UseBarBorderConstraints**[=BOOLEAN]

#### Object

Required A "ScreenItem" object with the format "Bar".

#### BOOLEAN

Optional. TRUE, if the bar border is restricted to specific values.

**See also**

Bar (Page 3961)

**UseTagLimitColors**

**Description**

Specifies that colors are used.

**UseDesignColorShema**

**Description**

Defines whether the colors defined for the current design in the global color scheme will be used for this object.

TRUE if the object is displayed with the colors from the global color scheme defined for this object type.

FALSE if the object is displayed with the colors as per the settings in the object.

BOOLEAN write-read access.



## See also

Slider (Page 4082)  
CheckBox (Page 3974)  
Button (Page 3968)  
Bar (Page 3961)  
WindowSlider (Page 4139)  
TubeTeeObject (Page 4128)  
TubePolyline (Page 4125)  
TubeDoubleTeeObject (Page 4123)  
TubeArcObject (Page 4121)  
Rectangle (Page 4072)  
MultiLineEdit (Page 4032)  
Line (Page 4025)  
Listbox (Page 4027)  
Circle (Page 3977)  
CircleSegment (Page 3979)  
CircularArc (Page 3982)  
Clock (Page 3984)  
Connector (Page 3986)  
Ellipse (Page 3993)  
EllipseSegment (Page 3995)  
EllipticalArc (Page 3998)  
Gauge (Page 4008)  
GraphicView (Page 4014)  
Polygon (Page 4057)  
Polyline (Page 4060)  
RoundButton (Page 4074)  
SymbolicIOField (Page 4093)  
IOField (Page 4021)  
TextField (Page 4107)  
OptionGroup (Page 4054)

## **UseDesignShadowSettings**

### **Description**

Defines whether the object will be displayed with the shadowing defined in the active design.

TRUE if the object is displayed with the global shadow defined for this object type.

FALSE if no shadow is displayed.

BOOLEAN write-read access.

## See also

Slider (Page 4082)  
CheckBox (Page 3974)  
GraphicIOField (Page 4011)  
Button (Page 3968)  
Bar (Page 3961)  
WindowSlider (Page 4139)  
TubeTeeObject (Page 4128)  
TubePolyline (Page 4125)  
TubeDoubleTeeObject (Page 4123)  
TubeArcObject (Page 4121)  
Rectangle (Page 4072)  
MultiLineEdit (Page 4032)  
Line (Page 4025)  
Listbox (Page 4027)  
Circle (Page 3977)  
CircleSegment (Page 3979)  
CircularArc (Page 3982)  
Clock (Page 3984)  
Connector (Page 3986)  
Ellipse (Page 3993)  
EllipseSegment (Page 3995)  
EllipticalArc (Page 3998)  
Gauge (Page 4008)  
GraphicView (Page 4014)  
Polygon (Page 4057)  
Polyline (Page 4060)  
RoundButton (Page 4074)  
SymbolicIOField (Page 4093)  
IOField (Page 4021)  
TextField (Page 4107)  
OptionGroup (Page 4054)

## UseEffectiveProcessValue

### Description

Specifies whether an actual percentage made up of maximum value, minimum value, average of the last 15 values and hysteresis will be used.

Access in Runtime: Read and write

### Syntax

Object.UseEffectiveProcessValue[=BOOLEAN]

#### Object

Required A "ScreenItem" object with the format "Bar".

#### BOOLEAN

Optional TRUE, if an actual percentage made up of maximum value, minimum value, average of the last 15 values and hysteresis will be used.

### See also

Bar (Page 3961)

## UseExponentialFormat

### Description

Specifies whether the figures are shown exponentially (e.g. "1,00e+000").

Access in Runtime: Read and write

### Syntax

Object.UseExponentialFormat[=BOOLEAN]

#### Object

Required A "ScreenItem" object with the format "Bar".

#### BOOLEAN

Optional TRUE, if the figures are shown exponentially (e.g. "1,00e+000").

### See also

Bar (Page 3961)

## UseFlashTransparentColor

### Description

Specifies whether the color of the bitmap object of a flashing graphic will be set to "transparent".

Access in Runtime: Read and write

### Syntax

Object.**UseFlashTransparentColor**[=BOOLEAN]

#### Object

Required A "ScreenItem" object with the format "GraphicIOField".

#### BOOLEAN

Optional TRUE, if the color of the bitmap object of a flashing graphic will be set to "transparent".

### See also

GraphicIOField (Page 4011)

## UseGDI

### Description

Specifies whether the ellipse is shown via GDI or GDI+.

Access in Runtime: Read and write

### Syntax

Object.**UseGDI**[=BOOLEAN]

#### Object

Required A "ScreenItem" object with the format "Ellipse".

#### BOOLEAN

Optional TRUE, if the ellipse is shown via GDI.

### See also

Ellipse (Page 3993)

## UseMeasurePoints(i)

### Description

Specifies whether the time range for the selected trend will be determined by measuring points or the end time. Whether the information is evaluated depends on the properties "TimeAxisEndTime", "TimeAxisBeginTime(i)".

Define time range for curve i through measure points (TRUE) or end time (FALSE) (for time based tag providers)

Access in Runtime: Read and write

Syntax

Object.**UseMeasurePoints**(i)[=BOOLEAN]

### Object

Required An object of the "ScreenItem" type with the format "OnlineTrendControl" or "FunctionTrendControl".

### BOOLEAN

Optional TRUE, if the time range for the selected trend will be determined by measuring points.

### Comments

The parameter i indicates the number of the trend.

### See also

OnlineTrendControl (Page 4045)

FunctionTrendControl (Page 4004)

## UseMessageColor

### Description

Specifies whether the agreed colors of the message classes are displayed.

Access in Runtime: Read and write

### Syntax

Object.**UseMessageColor**[=BOOLEAN]

### Object

Required An object of the "ScreenItem" type with the format "AlarmControl".

## **BOOLEAN**

TRUE: The colors are displayed.

FALSE: The color settings specified for the table content on the "Layout" tab are effective.

### **See also**

AlarmControl (Page 3947)

## **UseMultipleLimits**

### **Description**

Specifies whether one or more pairs of limits are shown as a selection or a line.

Access in Runtime: Read and write

### **Syntax**

Object.**UseMultipleLimits**[=BOOLEAN]

#### **Object**

Required A "ScreenItem" object with the format ""Bar".

#### **BOOLEAN**

Optional TRUE, if one or more pairs of limits are displayed as a selection or a line.

### **See also**

Bar (Page 3961)

## **UseScaleConstraints**

### **Description**

Specifies whether the distance between two large marking lengths of the scale are calculated from the minimum and maximum values.

Access in Runtime: Read and write

### **Syntax**

Object.**UseScaleConstraints**[=BOOLEAN]

#### **Object**

Required A "ScreenItem" object with the format "Bar".

### **BOOLEAN**

Optional TRUE, if the distance between two large marking lengths of the scale are calculated from the minimum and maximum values.

### **See also**

Bar (Page 3961)

## **UseScaledBarBorder**

### **Description**

Specifies whether the rectangle that surrounds the object is shown dependent of the scale or as a default.

Access in Runtime: Read and write

### **Syntax**

Object.**UseScaledBarBorder**[=BOOLEAN]

#### **Object**

Required A "ScreenItem" object with the format "Bar".

### **BOOLEAN**

Optional TRUE, if the rectangle that surrounds the object is shown dependent on the scale.

### **See also**

Bar (Page 3961)

## **UseSelectedTitleColor**

### **Description**

Specifies whether to use a selection color for the headers of selected table cells.

Access in Runtime: Read and write

### **Syntax**

Object.**UseSelectedTitleColor**[=BOOLEAN]

#### **Object**

Required An object of the "ScreenItem" type with the format "OnlineTrendControl", "FunctionTrendControl", "AlarmControl", "TrendRulerControl".



## BOOLEAN

TRUE: A marking color is used. The "Background" and "Font" settings are active in Runtime.

FALSE: A marking color is not used. The "Background" and "Font" settings are disabled in Runtime.

### See also

UserArchiveControl (Page 4130)

TrendRulerControl (Page 4110)

OnlineTableControl (Page 4037)

AlarmControl (Page 3947)

## UseSeparateDiagrams

### Description

Specifies whether the trends are shown staggered.

Access in Runtime: Read and write

### Syntax

Object.**UseSeparateDiagrams**[=BOOLEAN]

#### Object

Required A "ScreenItem" object with the formats "OnlineTrend" or "FunctionTrendView".

#### BOOLEAN

Optional TRUE, if the trends are shown staggered.

### See also

OnlineTrendControl (Page 4045)

FunctionTrendControl (Page 4004)

## UseSimplePrecisionOffset

### Description

Specifies how the field length will be calculated for the labeling of the scale.

Access in Runtime: Read and write

## Syntax

Object.**UseSimplePresicionOffset**[=BOOLEAN]

### Object

Required A "ScreenItem" object with the format "Bar".

### BOOLEAN

Optional TRUE, if the field length will be calculated for the labeling of the scale.

## See also

Bar (Page 3961)

## UseTableColor2

### Description

Specifies whether to use a second row color for the representation of the table.

Access in Runtime: Read and write

### Syntax

Object.**UseTableColor2**[=BOOLEAN]

### Object

Required An object of the "ScreenItem" type with the format "OnlineTrendControl", "FunctionTrendControl", "AlarmControl", "TrendRulerControl".

### BOOLEAN

TRUE: The settings of "RowColor 2" are used in alternation with "RowColor1".

FALSE: The settings of "RowColor 1" are used for all rows.

## See also

UserArchiveControl (Page 4130)

TrendRulerControl (Page 4110)

OnlineTableControl (Page 4037)

AlarmControl (Page 3947)

## UseTimeRange(i)

### Description

Specifies how the time range that is to be shown for the selected trend will be defined.

Access in Runtime: Read and write

### Syntax

Object.**UseTimeRange**(i)[=BOOLEAN]

#### Object

Required A "ScreenItem" object with the formats "OnlineTrend", "FunctionTrendView" or "TableView".

#### BOOLEAN

Optional TRUE, if the time range that is to be shown is defined by means of a start time ("TimeAxisBeginTime(i)") and an end time ("TimeAxisEndTime").

FALSE,, if the time range that is to be shown is defined by means of a start time ("TimeAxisBeginTime(i)") and an end time "TimeRangeBase(i)" and "TimeRangeFactor(i)".

### Comments

The parameter i indicates the number of the trend.

### See also

OnlineTrendControl (Page 4045)

FunctionTrendControl (Page 4004)

OnlineTableControl (Page 4037)

## UseTransparentColor

### Description

Specifies whether the color described with the property "TransparentColor" will be shown as transparent for the selected object.

Access in Runtime: Read and write

### Syntax

Object.**UseTransparentColor**[= BOOLEAN]

#### Object

Required A "ScreenItem" object with the formats "GraphicView" or "GraphicIOField".

### **BOOLEAN**

Optional TRUE, if the specified color is to be shown as transparent.

### **See also**

GraphicView (Page 4014)

GraphicIOField (Page 4011)

## **UseTransparentColorDeactivatedPicture**

### **Description**

Specifies if the transparent color defined with the property "TransparentColorDeactivatedPicture" for the status "disabled" will be used.

Access in Runtime: Read and write

### **Syntax**

Object.**UseTransparentColorDeactivatedPicture**[=BOOLEAN]

#### **Object**

Required A "ScreenItem" object with the format ""Roundbutton".

#### **BOOLEAN**

Optional TRUE, if the transparent color defined with the property "TransparentColorDeactivatedPicture" for the status "disabled" will be used.

## **UseTransparentColorPictureOff**

### **Description**

Specifies if the transparent color defined with the property "TransparentColorPictureOff" for the status "off" will be used.

Access in Runtime: Read and write

### **Syntax**

Object.**UseTransparentColorPictureOff**[=BOOLEAN]

#### **Object**

Required A "ScreenItem" object with the format "Roundbutton".

#### **BOOLEAN**

Optional TRUE, if the transparent color defined with the property "TransparentColorPictureOff" for the status "off" will be used.

## See also

Button (Page 3968)

## UseTransparentColorPictureOn

### Description

Specifies if the transparent color defined with the property "TransparentColorPictureOn" for the status "on" will be used.

Access in Runtime: Read and write

### Syntax

Object.**UseTransparentColorPictureOn**[=BOOLEAN]

#### Object

Required A "ScreenItem" object with the format "Roundbutton".

#### BOOLEAN

Optional TRUE, if the transparent color defined with the property "TransparentColorPictureOn" for the status "on" will be used.

## See also

Button (Page 3968)

## UseTrendNameAsLabel

### Description

Specifies whether the "Name" or "Label" property is used as a designation for the trend in Runtime.

Access in Runtime: Read and write

### Syntax

Object.**UseTrendNameAsLabel**[=BOOLEAN]

#### Object

Required An object of the "ScreenItem" type with the format "FunctionTrendControl", "OnlineTrendControl" (Runtime Professional) or "HMITrendView" (Runtime Advanced).

#### BOOLEAN

TRUE: The name configured under "Properties > Properties > Trends > Name" is used.

FALSE: The name configured under "Properties > Properties > Trends > Label" is used.

### See also

FunctionTrendControl (Page 4004)

OnlineTrendControl (Page 4045)

### Used

### Description

Returns the size of the used disk space.

Access in Runtime: Read and write

### Syntax

Object.**Used**[=Double]

#### Object

Required A "ScreenItem" object with the format ""DiskSpaceView".

#### Double

Optional A value or a constant that returns the size of the used disk space.

### See also

DiskSpaceView (Page 3991)

### UsedPercent

### Description

Returns the measured value for the used disk space as a percentage. The values can be queried in Runtime. The values cannot be predefined.

Access in Runtime: Read and write

### Syntax

Object.**UsedPercent**[=Int]

#### Object

Required A "ScreenItem" object with the format "DiskSpaceView".

**Int**

Optional A value or a constant that returns the measured value for the used disk space as a percentage.

**See also**

DiskSpaceView (Page 3991)

**UserArchiveNumberOfValues(i)**

**Description**

Specifies the number of values that are loaded from the recipe. The "TagProviderType(i)" property must have the value -2.

Access in Runtime: Read and write

**Syntax**

Object.**UserArchiveNumberOfValues(i)[=Int]**

**Object**

Required A "ScreenItem" object with the format "FunctionTrendView".

**Int**

Optional A value or a constant that specifies the number of values that are loaded from the recipe.

**Comments**

The parameter i indicates the number of the trend.

If "UserArchiveNumberOfValues(i)" is changed, illegal combinations with different attributes for the data connection could arise. This means you have to prevent immediate acceptance of the change with "FreezeProviderConnections" before changing "UserArchiveNumberOfValues(i)".

**See also**

FunctionTrendControl (Page 4004)

**UserArchiveStartId(i)**

**Description**

Specifies the data record starting from which the values for the selected trend are loaded from the recipe. The "TagProviderType(i)" property must have the value -2.

Access in Runtime: Read and write

## Syntax

Object.**UserArchiveStartId**(i)[=Int]

### Object

Required An object of the "ScreenItem" type with the format "FunctionTrendControl".

### Int

Optional A value or a constant that specifies the data record starting from which the values for the selected trend are loaded from the recipe.

## Comments

The parameter i indicates the number of the trend.

If "UserArchiveStartId(i)" is changed, illegal combinations with different attributes for the data connection could arise. This means you have to prevent immediate acceptance of the change with ""FreezeProviderConnections" before changing ""UserArchiveStartId(i)".

## See also

FunctionTrendControl (Page 4004)

## UserName

### Description

Returns the name of the user who triggered the alarm object.

## UserValue1 property

### Description

Defines or returns a value.

The value can be evaluated by a script, for example. This value is neither evaluated nor displayed in Runtime.

## UserValue2 property

### Description

Defines or returns a value.

The value can be evaluated by a script, for example. This value is neither evaluated nor displayed in Runtime.



## UserValue3 property

### Description

Defines or returns a value.  
The value can be evaluated by a script, for example. This value is neither evaluated nor displayed in Runtime.

## UserValue4 property

### Description

Defines or returns a value.  
The value can be evaluated by a script, for example. This value is neither evaluated nor displayed in Runtime.

## ValidateFormatPattern

### Description

Specifies that the "format pattern" field can be checked for specific characters.  
Access in Runtime: Read and write

### Syntax

Object.**ValidateFormatPattern**[=BOOLEAN]

#### Object

Required A "ScreenItem" object with the format "IOField".

#### BOOLEAN

Optional TRUE, if the "format pattern" field can be checked for specific characters.

### See also

IOField (Page 4021)

### Value

### Description

Specifies a value for the object being used or returns it.  
Access during runtime: Read and write

## Syntax

Object.Value[=VARIANT]

### Object

Necessary. An object of type "Tag", "DataItem" or "ScreenItem" with the format "Gauge".

### VARIANT

Optional The value that is specified dependent on the object being used:

- Tag.Value: returns the tag value for the last read access or specifies the future tag value. Use the "Read" method to read the tag value from the "Value" property. You assign a new tag value to the "Value" property with the "Write" method.
- Dataset.Value: Specifies a value or returns a copy of the value or the object reference. When returning object references, ensure that the object reference is multithread-capable.
- ScreenItem("Gauge\_1").Value: Specifies the value to which the pointer points. The value range within the values set via the properties "ValueMin", and "ValueMax".

## Examples

The following example writes a new value in the "Tag1" tag:

```
'VBS94
Dim objTag
Set objTag = HMIRuntime.Tags("Tag1")
objTag.Value = 50
objTag.Write
```

The example shows how to add a value to a list of tags and output it as a trace. After that, the value is changed, output again and then removed. It make sense to perform this in several different actions:

```
'VBS198
HMIRuntime.DataSet.Add "motor1", 23
HMIRuntime.Trace "motor1: " & HMIRuntime.DataSet("motor1").Value & vbNewLine
HMIRuntime.DataSet("motor1").Value = 55
HMIRuntime.Trace "motor1: " & HMIRuntime.DataSet("motor1").Value & vbNewLine
HMIRuntime.DataSet.Remove("motor1")
```

## See also

[DataItem \(Page 3916\)](#)

[Tag \(Page 3941\)](#)

## ValueAxisAutorange(i)

### Description

Specifies whether the value range of the Y axis is determined automatically or via the values "ValueAxisBegin(i)" and "ValueAxisEnd(i)".

Access in Runtime: Read and write

### Syntax

Object.**ValueAxisAutorange(i)**[=BOOLEAN]

#### Object

Required A "ScreenItem" object with the format "FunctionTrendControl".

#### BOOLEAN

Optional TRUE, if the value range of the Y axis is established automatically or via the values "ValueAxisBegin(i)" and "ValueAxisEnd(i)".

### See also

FunctionTrendControl (Page 4004)

## ValueAxisBegin(i)

### Description

Specifies the lower limit of the value range for the selected trend that is to be displayed. Whether the information is evaluated depends on the properties "Autorange" and "ShareValueAxis".

Access in Runtime: Read and write

### Syntax

Object.**ValueAxisBegin(i)**[=Double]

#### Object

Required An object of the "ScreenItem" type with the format "OnlineTrendControl" or "FunctionTrendControl".

#### Double

Optional A value or a constant that specifies the lower limit of the value range of the selected trend that is to be shown.

## See also

OnlineTrendControl (Page 4045)

FunctionTrendControl (Page 4004)

## ValueAxisDecimalPrecision(i)

### Description

Specifies the number of decimal places for the value range of the selected trend.

Access in Runtime: Read and write

### Syntax

Object.**ValueAxisDecimalPrecision**(i)[=Int]

#### Object

Required A "ScreenItem" object with the formats "OnlineTrend" or "FunctionTrendView".

#### Int

Optional A value or a constant that specifies the number of decimal places for the value range of the selected trend.

## See also

OnlineTrendControl (Page 4045)

FunctionTrendControl (Page 4004)

## ValueAxisEnd(i)

### Description

Specifies the upper limit of the value range of the selected trend that is to be displayed. Whether the information is evaluated depends on the properties "Autorange" and "ShareValueAxis".

Access in Runtime: Read and write

### Syntax

Object.**ValueAxisEnd**(i)[=Double]

#### Object

Required An object of the "ScreenItem" type with the format "OnlineTrendControl" or "FunctionTrendControl".

### Double

Optional A value or a constant that specifies the upper limit of the value range of the selected trend that is to be shown.

### See also

OnlineTrendControl (Page 4045)

FunctionTrendControl (Page 4004)

## ValueAxisGridLineInterval(i)

### Description

Specifies the distance between two grid lines. Whether the information is evaluated depends on the properties "ValueAxisShowGridLines(i)" and "TimeAxisShowGridLines(i)".

Access in Runtime: Read and write

### Syntax

Object.**ValueAxisGridLineInterval**(i)[=Double]

#### Object

Required An object of the "ScreenItem" type with the format "OnlineTrendControl" or "FunctionTrendControl".

#### Double

Optional A value or a constant that specifies the distance between two grid lines.

### See also

OnlineTrendControl (Page 4045)

FunctionTrendControl (Page 4004)

## ValueAxisLabel(i)

### Description

Specifies the labeling of the value axis. Whether the information is evaluated depends on the property "ConfigureTimeAxis(i)".

Access in Runtime: Read and write

### Syntax

Object.**ValueAxisLabel**(i)[=String]

**Object**

Required An object of the "ScreenItem" type with the format "OnlineTrendControl" or "FunctionTrendControl".

**String**

Optional A value or a constant that specifies the labeling of the value axis.

**See also**

OnlineTrendControl (Page 4045)

FunctionTrendControl (Page 4004)

**ValueAxisLargeIncrementSize(i)**

**Description**

Specifies the distance between two long marking lengths of the scale. Whether the information is evaluated depends on the properties "ValueAxisShowLargeIncrements(i)" and "TimeAxisShowLargeIncrements(i)".

Access in Runtime: Read and write

**Syntax**

Object.**ValueAxisLargeIncrementSize(i)**[=Double]

**Object**

Required An object of the "ScreenItem" type with the format "OnlineTrendControl" or "FunctionTrendControl".

**Double**

Optional A value or a constant that specifies the distance between two marking lengths of the scale.

**See also**

OnlineTrendControl (Page 4045)

FunctionTrendControl (Page 4004)

**ValueAxisScalingType(i)**

**Description**

Specifies the type of axis scaling.

Access in Runtime: Read and write

## Syntax

Object.**ValueAxisScalingType**(i)[=AxisScalingType]

### Object

Required An object of the "ScreenItem" type with the format "OnlineTrendControl" or "FunctionTrendControl".

### AxisScalingType

hmiBarScalingLinear ( 0): Linear axis scaling.

hmiBarScalingLogarithmic ( 1): Logarithmic axis scaling

hmiBarScalingNegativeLogarithmic ( 2): Negative logarithmic axis scaling

## Comments

The parameter i indicates the number of the trend. The parameter i indicates the number of the trend.

## See also

OnlineTrendControl (Page 4045)

FunctionTrendControl (Page 4004)

## ValueAxisShowGridLines(i)

### Description

Specifies whether the trend window is shown with grid lines that run parallel to the y axis.

Access in Runtime: Read and write

### Syntax

Object.**ValueAxisShowGridLines**(i)[=BOOLEAN]

### Object

Required An object of the "ScreenItem" type with the format "OnlineTrendControl" or "FunctionTrendControl".

### BOOLEAN

Optional TRUE, if the trend window is shown with grid lines that run parallel to the y axis.

## Comments

The distance between two grid lines can be altered with the "ValueAxisGridLineInterval(i)" property.

## See also

OnlineTrendControl (Page 4045)

FunctionTrendControl (Page 4004)

## ValueAxisShowLargeIncrements(i)

### Description

Specifies whether the value axis is scaled with long marking lengths.

Access in Runtime: Read and write

### Syntax

Object.ValueAxisShowLargeIncrements(i)[=BOOLEAN]

#### Object

Required An object of the "ScreenItem" with the format "OnlineTrendControl" or "FunctionTrendControl".

#### BOOLEAN

Optional TRUE, if the value axis is scaled with long marking lengths.

### Comments

The distance of two long marking lines can be altered with the "ValueAxisLargeIncrementSize(i)" property.

## See also

OnlineTrendControl (Page 4045)

FunctionTrendControl (Page 4004)

## ValueAxisShowSmallIncrements(i)

### Description

Specifies whether the value axis is scaled with short marking lengths.

Access in Runtime: Read and write

### Syntax

Object.ValueAxisShowSmallIncrements(i)[=BOOLEAN]



**Object**

Required An object of the "ScreenItem" type with the format "OnlineTrendControl" or "FunctionTrendControl".

**BOOLEAN**

Optional TRUE, if the value axis is scaled with short marking lengths.

**Comments**

The distance between two short marking lines can be altered with the "ValueAxisSmallIncrementSize(i)" property.

**See also**

OnlineTrendControl (Page 4045)

FunctionTrendControl (Page 4004)

**ValueAxisSmallIncrementSize(i)**

**Description**

Specifies the distance between two short marking lengths of the scale. Whether the information is evaluated depends on the properties ""ValueAxisShowSmallIncrements(i)"" and ""TimeAxisShowSmallIncrements(i)"".

Access in Runtime: Read and write

**Syntax**

Object.**ValueAxisSmallIncrementSize(i)**[=Double]

**Object**

Required An object of the "ScreenItem" type with the format "OnlineTrendControl" or "FunctionTrendControl".

**Double**

Optional A value or a constant that specifies the distance between two short marking lengths of the scale.

**See also**

OnlineTrendControl (Page 4045)

FunctionTrendControl (Page 4004)

## ValueColumnAlignment(i)

### Description

Specifies the alignment of the tag values of this column pair. The parameter *i* indicates the number of the column pair.

Access in Runtime: Read and write

### Syntax

Object.**ValueColumnAlignment**(i)[=AlignmentHorizontal]

#### Object

Required A "ScreenItem" object with the format "OnlineTableControl".

#### AlignmentHorizontal

hmiAlignmentLeft ( 0): The text is shown left justified.

hmiAlignmentCentered ( 1): The text is shown centered.

hmiAlignmentRight ( 2): The text is shown right justified.

### See also

OnlineTableControl (Page 4037)

## ValueColumnPrecision(i)

### Description

Specifies the number of decimal places that are shown in this value column. The parameter *i* indicates the number of the column pair. A maximum of 16 decimal places can be shown.

Access in Runtime: Read and write

### Syntax

Object.**ValueColumnPrecision**(i)[=Int]

#### Object

Required A "ScreenItem" object with the format "OnlineTableControl".

#### Int

Optional A value or a constant that specifies the number of decimal places that are shown in this value column.

## See also

OnlineTableControl (Page 4037)

## VerticalAlignment

### Description

Specifies the vertical alignment of the text within the selected object.

Access in Runtime: Read and write

### Syntax

Object.**VerticalAlignment**[=AlignmentVertical]

#### Object

Required An object of the "ScreenItem" type with the format "TextField", "IOField", "SymbolicIOField", "DateTimeField", "Button", "Switch", "Checkbox" or "OptionGroup".

#### AlignmentVertical

A value that specifies the vertical alignment.

hmiAlignmentTop ( 0): The text will be shown in the upper margin.

hmiAlignmentMiddle ( 1): The text will be shown in the middle.

hmiAlignmentBottom ( 2): The Text will be shown in the lower margin.

## See also

TextField (Page 4107)

IOField (Page 4021)

SymbolicIOField (Page 4093)

Button (Page 3968)

Switch (Page 4089)

OptionGroup (Page 4054)

DateTimeField (Page 3989)

RoundButton (Page 4074)

## VerticalAlignment

### Description

Determines the vertical alignment of the text within the given object.

Access during runtime: Read and Write

## Syntax

Object.VerticalAlignment [= THmiVerticalAlignment]

### Object

Required An object of the "ScreenItem" type with the characteristics "TextField", "IOField", "SymbolicIOField", "Button" or "Switch".

### THmiVerticalAlignment

Optional A value or constant which determines the vertical alignment of the text.

hmiAlignmentTop (0): The text is aligned at the top of the object.

hmiAlignmentMiddle (1): The text is centered vertically in the object.

hmiAlignmentBottom (2): The text is aligned at the bottom in the object.

## See also

ProjectName (Page 4062)

## VerticalGridLines

### Description

Enables the display of vertical dividers.

Access in Runtime: Read and write

### Syntax

Object.VerticalGridLines[=BOOLEAN]

### Object

Required An object of the "ScreenItem" type with the format "AlarmControl", "OnlineTableControl", "UserArchiveControl", "TrendRulerControl".

### BOOLEAN

TRUE: Vertical grid lines are displayed.

FALSE: Vertical grid lines are not displayed.

## See also

UserArchiveControl (Page 4130)

TrendRulerControl (Page 4110)

OnlineTableControl (Page 4037)

AlarmControl (Page 3947)

## VerticalScrollbarPosition

### Description

Specifies the vertical positioning of the scroll bar in a picture window with slider, or returns its value.

The picture is displayed in the picture window by positioning the horizontal and vertical scroll bars. If you wish to display the picture as a cutout where the scroll bars are located at the left and upper edge of the picture, use the properties "OffsetLeft" and "OffsetTop" as the origin of this cutout.

### See also

ScreenWindow (Page 4078)

## ViewOnly

### Description

Specifies whether the Sm@rtClient display will be used for remote monitoring or remote maintenance.

Remote maintenance means that settings can be changed on the monitored device.

Remote monitoring means that settings of the monitored device cannot be changed.

Access in Runtime: Read and write

### Syntax

Object.**ViewOnly**[=BOOLEAN]

#### Object

Required A "ScreenItem" object with the format "SmartClientView".

#### BOOLEAN

Optional TRUE, if the Sm@rtClient display is to be used only for remote monitoring.

### See also

SmartClientView (Page 4085)

## Visible

### Description

Specifies whether the selected object is visible.

Access during runtime: Read and write

## Syntax

Object.**Visible**[=BOOLEAN]

### Object

Necessary. An object of the type "ScreenItem".

### BOOLEAN

Optional TRUE, if the object is visible.

### Used for the following object types:

Rectangle

## See also

Line (Page 4025)  
Polyline (Page 4060)  
Ellipse (Page 3993)  
Circle (Page 3977)  
EllipseSegment (Page 3995)  
CircleSegment (Page 3979)  
EllipticalArc (Page 3998)  
CircularArc (Page 3982)  
Rectangle (Page 4072)  
Polygon (Page 4057)  
TextField (Page 4107)  
IOField (Page 4021)  
SymbolicIOField (Page 4093)  
Button (Page 3968)  
Switch (Page 4089)  
GraphicView (Page 4014)  
GraphicIOField (Page 4011)  
Bar (Page 3961)  
Clock (Page 3984)  
Gauge (Page 4008)  
Slider (Page 4082)  
SymbolLibrary (Page 4098)  
OnlineTrendControl (Page 4045)  
FunctionTrendControl (Page 4004)  
OnlineTableControl (Page 4037)  
AlarmControl (Page 3947)  
HTMLBrowser (Page 4019)  
CheckBox (Page 3974)  
OptionGroup (Page 4054)  
WindowSlider (Page 4139)  
Connector (Page 3986)  
ScreenWindow (Page 4078)  
DiskSpaceView (Page 3991)  
ChannelDiagnose (Page 3972)  
ScriptDiagnostics (Page 4080)  
Group (Page 4017)  
DateTimeField (Page 3989)  
UIView (Page 4137)  
TubeTeeObject (Page 4128)  
TubePolyline (Page 4125)

## Warning

### Description

Specifies the limit for the storage space display as of which a warning will be reported.

Access in Runtime: Read and write

### Syntax

Object.**Warning**[=Int]

#### Object

Required A "ScreenItem" object with the format "DiskSpaceView".

#### Int

Optional A value or a constant that specifies the limit for the storage space display as of which a warning will be reported.

### See also

DiskSpaceView (Page 3991)

## WarningColor

### Description

Specifies the color in which the bar of the storage space display will be shown as soon as the warning area is reached.

Access in Runtime: Read and write

### Syntax

Object.**WarningColor**[=Color]

#### Object

Required A "ScreenItem" object with the format "DiskSpaceView".

#### Color

Optional A value or a constant that specifies the color in which the bar of the storage space display will be shown as soon as the warning area is exceeded.

### See also

DiskSpaceView (Page 3991)



## WarningHigh

### Description

Defines or returns the upper limit value for "Warning High".  
In order that the limit value is monitored, the "CheckWarningHigh" property must be set to TRUE.  
The display on reaching the limit value and the type of evaluation are defined by means of the "ColorWarningHigh" and "TypeWarningHigh" properties.

## WarningLow

### Description

Defines or returns the lower limit value for "Warning Low".  
In order that the limit value is monitored, the "CheckWarningLow" property must be set to TRUE.  
The display on reaching the limit value and the type of evaluation are defined by means of the "ColorWarningLow" and "TypeWarningLow" properties.

## WarningLowerLimit

### Description

Specifies the lower limit for "WarningLowerLimit".  
The ""WarningLowerLimitEnable" property must have the value TRUE so that the limit is monitored.  
Access in Runtime: Read and write

### Syntax

Object.**WarningLowerLimit**[=Double]

#### Object

Required A "ScreenItem" object with the format "Bar".

#### Double

Optional A value or a constant that specifies the lower limit for "WarningLowerLimit".

### Comments

The following values will be specified with the properties "WarningLowerLimitColor" and "WarningLowerLimitRelative":

Representation upon reaching the limit

Type of evaluation

## See also

Bar (Page 3961)

## WarningLowerLimitColor

### Description

Specifies the color for the lower limit ""WarningLowerLimit".

The ""WarningLowerLimitEnable" property must have the value TRUE if the bar color is to change once the limit has been reached.

Access in Runtime: Read and write

### Syntax

Object.**WarningLowerLimitColor**[=Color]

#### Object

Required A "ScreenItem" object with the format "Bar".

#### Color

Optional A value or a constant that specifies the color for the lower limit "WarningLowerLimit".

### Comments

The following values are specified by the "WarningUpperLimit", "WarningUpperLimitColor" and "WarningUpperLimitRelative" properties:

- Limit
- Representation upon reaching the limit
- Type of evaluation

## See also

Bar (Page 3961)

## WarningLowerLimitEnabled

### Description

Specifies whether the limit ""WarningLowerLimit" is to be monitored.

Access in Runtime: Read and write

## Syntax

Object.**WarningLowerLimitEnabled**[=BOOLEAN]

### Object

Required A "ScreenItem" object with the format "Bar".

### BOOLEAN

Optional TRUE, if the "WarningLowerLimit" limit is to be monitored.

## Comments

The following values will be specified with the properties "WarningLowerLimit", "WarningLowerLimitColor" and "WarningLowerLimitRelative":

Limit

Representation upon reaching the limit

Type of evaluation

## See also

Bar (Page 3961)

## WarningLowerLimitRelative

### Description

Determines whether the lower limit "WarningLowerLimit" is to be evaluated as a percentage or as an absolute value.

Access in Runtime: Read and write

### Syntax

Object.**WarningLowerLimitRelative**[=BOOLEAN]

#### Object

Required A ""ScreenItem" object with the format "Bar".

#### BOOLEAN

Optional TRUE, if the lower limit ""WarningLowerLimit" is to be evaluated as a percentage.

## See also

Bar (Page 3961)

## WarningRangeColor

### Description

Specifies the color of the warning range on the scale of the "Gauge" object.

The "WarningRangeVisible" property must have the value TRUE so that the warning range is displayed.

Access in Runtime: Read and write

### Syntax

Object.**WarningRangeColor**[= Color]

#### Object

Required A "ScreenItem" object with the format "Gauge".

#### Color

Optional A value or a constant that specifies the color of the warning range.

### Comments

Use the "RGB" function to establish the colors in RGB format (red, green blue). To do this, enter the appropriate decimal value for each of the three RGB values (range from 0 to 255). For example, the color "red" is shown as such: RGB(255, 0, 0). You can also use the VBS color constants like vbRed or vbGreen.

### See also

Gauge (Page 4008)

## WarningRangeStart

### Description

Specifies at which scale value the warning range of the "Gauge" object will start.

The "WarningRangeVisible" property must have the value TRUE so that the warning range is displayed.

Access in Runtime: Read and write

### Syntax

Object.**WarningRangeStart**[= DOUBLE]

#### Object

Required A "ScreenItem" object with the format "Gauge".

## **DOUBLE**

Optional A value or a constant that contains the scale value for the start of the warning range.

### **Comments**

The range extends from the value "Warning" through to the value "Danger". If no range is activated for "Danger", then the range for "Warning" extends to the end of the scale.

### **See also**

Gauge (Page 4008)

## **WarningRangeVisible**

### **Description**

Specifies whether the warning range in the scale of the "Gauge" object will be displayed.

Access in Runtime: Read and write

### **Syntax**

Object.**WarningRangeVisible**[= BOOLEAN]

#### **Object**

Required A "ScreenItem" object with the format "Gauge".

#### **BOOLEAN**

Optional TRUE, if the warning range will be displayed in the scale.

### **Comments**

Specifies the color of the warning range with the ""WarningRangeColor" property.

Specifies the start of the warning range with the "WarningRangeStart"" property.

### **See also**

Gauge (Page 4008)

WarningRangeColor (Page 4708)

WarningRangeStart (Page 4708)

## WarningUpperLimit

### Description

Specifies the upper limit for "WarningUpperLimit".

The "WarningUpperLimitEnable" property must have the value TRUE so that the limit is monitored.

Access in Runtime: Read and write

### Syntax

Object.**WarningUpperLimit**[=Double]

#### Object

Required A "ScreenItem" object with the format "Bar".

#### Double

Optional A value or a constant that specifies the upper limit for "WarningUpperLimit".

### Comments

The following values will be specified with the properties "WarningUpperLimitColor" and "WarningUpperLimitRelative":

- Representation upon reaching the limit
- Type of evaluation

### See also

Bar (Page 3961)

## WarningUpperLimitColor

### Description

Specifies the color for the upper limit "WarningUpperLimit".

The "WarningUpperLimitEnable" property must have the value TRUE if the bar color is to change once the limit has been reached.

Access in Runtime: Read and write

### Syntax

Object.**WarningUpperLimitColor**[=Color]

**Object**

Required A "ScreenItem" object with the format "Bar".

**Color**

Optional A value or a constant that specifies the color for the upper limit "WarningUpperLimit".

**See also**

Bar (Page 3961)

**WarningUpperLimitEnabled**

**Description**

Specifies whether the limit ""WarningUpperLimit" is to be monitored.

Access in Runtime: Read and write

**Syntax**

Object.**WarningUpperLimitEnabled**[=BOOLEAN]

**Object**

Required A "ScreenItem" object with the format "Bar".

**BOOLEAN**

Optional TRUE, if the "WarningUpperLimit" limit is to be monitored.

**See also**

Bar (Page 3961)

**WarningUpperLimitRelative**

**Description**

Determines whether the lower limit "WarningUpperLimit" is to be evaluated as a percentage or as an absolute value.

Access in Runtime: Read and write

**Syntax**

Object.**WarningUpperLimitRelative**[=BOOLEAN]

**Object**

Required A "ScreenItem" object with the format "Bar".

### **BOOLEAN**

Optional TRUE, if the lower limit "WarningUpperLimit" is to be evaluated as a percentage.

### **See also**

Bar (Page 3961)

### **Width**

### **Description**

Specifies the width of the selected objects "Ellipse", "Circle" and "Rectangle".

Access in Runtime: Read and write.

The other objects only have read access to the property.

### **Syntax**

Object.**Width**[=LONG]

#### **Object**

Required A "Screen" object or an object of type "ScreenItem". This property is a standard property of the ScreenItem-object and is therefore available for all formats.

#### **LONG**

Optional A value or a constant that specifies the width in pixels. This parameter can only be set for the objects "Ellipse", Circle" and "Rectangle".



## See also

Line (Page 4025)  
Polyline (Page 4060)  
Ellipse (Page 3993)  
Circle (Page 3977)  
EllipseSegment (Page 3995)  
CircleSegment (Page 3979)  
EllipticalArc (Page 3998)  
CircularArc (Page 3982)  
Rectangle (Page 4072)  
Polygon (Page 4057)  
TextField (Page 4107)  
IOField (Page 4021)  
SymbolicIOField (Page 4093)  
Button (Page 3968)  
Switch (Page 4089)  
GraphicView (Page 4014)  
GraphicIOField (Page 4011)  
Bar (Page 3961)  
Clock (Page 3984)  
Gauge (Page 4008)  
Slider (Page 4082)  
SymbolLibrary (Page 4098)  
OnlineTrendControl (Page 4045)  
FunctionTrendControl (Page 4004)  
OnlineTableControl (Page 4037)  
AlarmControl (Page 3947)  
HTMLBrowser (Page 4019)  
CheckBox (Page 3974)  
OptionGroup (Page 4054)  
WindowSlider (Page 4139)  
Connector (Page 3986)  
ScreenWindow (Page 4078)  
DiskSpaceView (Page 3991)  
ChannelDiagnose (Page 3972)  
ScriptDiagnostics (Page 4080)  
Group (Page 4017)  
ForeignControl (Page 4000)  
DateTimeField (Page 3989)  
ProtectedAreaName (Page 4064)  
UserView (Page 4137)

## WinCCStyle

### Description

Defines the style in which the object is displayed.

User Defined	Shows the object according to the respective settings.
Global	Shows the object in a globally defined design.
Windows Style	Shows the object in Windows style.

## WindowBorder

### Description

TRUE, when the window is displayed with borders in Runtime. Read only access.

## WindowCloseEnabled

### Description

Specifies whether the window can be closed in Runtime.

Access in Runtime: Read and write

### Syntax

Object.**WindowCloseEnabled**[=BOOLEAN]

#### Object

Required A "ScreenItem" object with the formats "OnlineTrend", "FunctionTrendView" or "TableView".

#### BOOLEAN

Optional TRUE, if the window can be closed in Runtime.

### See also

OnlineTrendControl (Page 4045)

FunctionTrendControl (Page 4004)

OnlineTableControl (Page 4037)

## WindowMaximizeenabled

### Description

TRUE, when the object can be maximized in Runtime. Read only access.

### See also

ScreenWindow (Page 4078)  
ScriptDiagnostics (Page 4080)

## WindowMovingEnabled

### Description

TRUE, when the object can be moved in Runtime. Read only access.

### See also

ScreenWindow (Page 4078)  
ScriptDiagnostics (Page 4080)

## WindowOnTop

### Description

TRUE, when the object should remain in the foreground in Runtime. Read only access.

### See also

ScreenWindow (Page 4078)  
ScriptDiagnostics (Page 4080)

## WindowsContents

### Description

Supplies the content of the application window Read only access.

### See also

ScriptDiagnostics (Page 4080)

## WindowSizingEnabled

### Description

Specifies whether the size of the specified object can be changed in Runtime.

Access in Runtime: Read and write

### Syntax

Object.**WindowSizingEnabled**[=BOOLEAN]

#### Object

Required A "ScreenItem" object with the formats "OnlineTrend", "FunctionTrendView" or "TableView".

#### BOOLEAN

Optional. TRUE, if the size of the selected object can be changed in Runtime.

### See also

OnlineTrendControl (Page 4045)

FunctionTrendControl (Page 4004)

OnlineTableControl (Page 4037)

## WindowsStyle

### Description

Specifies whether the object will be displayed in the general Windows style.

Access in Runtime: Read and write

### Syntax

Object.**WindowsStyle**[=BOOLEAN]

#### Object

Required A "ScreenItem" object with the formats "Button" or "WindowSlider".

#### BOOLEAN

Optional TRUE, if the object will be displayed in the general Windows style.

**See also**

Button (Page 3968)

WindowSlider (Page 4139)

**Properties X-Z****XAxisAdd****Description**

Creates a new X axis.

**Syntax**

Object.**XAxisAdd**

**Object**

Required A "ScreenItem" object with the format "FunctionTrendControl".

**See also**

FunctionTrendControl (Page 4004)

**XAxisAlign****Description**

Defines the alignment mode for a selected axis.

**Syntax**

Object.**XAxisAlign**[=Alignement]

**Object**

Required A "ScreenItem" object with the format "FunctionTrendControl".

**Alignment**

Value	Description	Description
0	Bottom	The X axis selected is displayed below the trend.
1	Top	The X axis selected is displayed above the trend.

## XAxisAutoPrecisions

### Description

Enables automatic setting of the decimal precision.

Access in Runtime: Read and write

### Syntax

Object.XAxisAutoPrecisions[=BOOLEAN]

#### Object

Required A "ScreenItem" object with the format "FunctionTrendControl".

#### BOOLEAN

TRUE: The number of decimal places is specified automatically.

FALSE: The value configured under "Properties > X axis > Format > Decimal places" is effective.

### See also

FunctionTrendControl (Page 4004)

## XAxisAutorange(i)

### Description

Specifies whether the value range of the X axis is determined automatically or via the attributes "XAxisBegin(i)" and "XAxisEnd(i)".

Access in Runtime: Read and write

### Syntax

Object.XAxisAutorange(i)[=BOOLEAN]

#### Object

Required A "ScreenItem" object with the format "FunctionTrendView".

#### BOOLEAN

Optional TRUE, if the value range of the X axis is determined automatically or via the values "XAxisBegin(i)" and "XAxisEnd(i)".

### See also

FunctionTrendControl (Page 4004)

## XAxisBegin(i)

### Description

Specifies the lower limit of the X axis of a trend that has been referenced with the property "CurrentCurveIndex". Whether the information is evaluated depends on the properties "XAxisAutorange(i)" and "ShareXAxis".

Access in Runtime: Read and write

### Syntax

Object.XAxisBegin(i)[=String]

#### Object

Required A ""ScreenItem" object with the format ""FunctionTrendView".

#### String

Optional A value or a constant that specifies the lower limit of the X axis of a trend that has been referenced with the property "CurrentCurveIndex".

### See also

FunctionTrendControl (Page 4004)

## XAxisBeginValue

### Description

Specifies the lower range of values of the axis selected. To configure the value, deactivate the "Automatic" option in "Value range".

### See also

FunctionTrendControl (Page 4004)

## XAxisColor

### Description

Use this attribute to define the color for the common X-axis.

Access in Runtime: Read and write

### Syntax

Object.XAxisColor[=COLOR]

**Object**

Required An object of the "ScreenItem" type with the format "FunctionTrendControl" or "OnlineTrendControl" (Runtime Professional) or "HMITrendView" (Runtime Advanced).

**Color**

The color is defined as an RGB value.

**See also**

FunctionTrendControl (Page 4004)

**XAxisCount**

**Description**

Defines the number of X axes configured.

**Syntax**

Object.**XAxisCount**

Object

Required An object of the "ScreenItem" type with the format "FunctionTrendControl"..

**See also**

FunctionTrendControl (Page 4004)

**XAxisDecimalPrecision(i)**

**Description**

Specifies the number of decimal places with which the scaling value of the X axis will be displayed.

Access in Runtime: Read and write

**Syntax**

Object.**XAxisDecimalPrecision(i)**[=Int]

**Object**

Required A "ScreenItem" object with the format "FunctionTrendView".



**Int**

Optional A value or a constant that specifies the number of decimal places with which the scaling value for the X axis will be displayed.

**See also**

FunctionTrendControl (Page 4004)

**XAxisEnd(i)**

**Description**

Specifies the lower limit of the X axis of a trend that has been referenced with the property "CurrentCurveIndex". Whether the information is evaluated depends on the properties "XAxisAutorange(i)" and "ShareXAxis".

Access in Runtime: Read and write

**Syntax**

Object.XAxisEnd(i)[=String]

**Object**

Required A "ScreenItem" object with the format "FunctionTrendView".

**String**

Optional A value or a constant that specifies the upper limit of the X axis of a trend that has been referenced with the property "CurrentCurveIndex".

**See also**

FunctionTrendControl (Page 4004)

**XAxisEndValue**

**Description**

Specifies the upper range of values of the axis selected. To configure the value, deactivate the "Automatic" option in "Value range".

**See also**

FunctionTrendControl (Page 4004)

## XAxisExponentialFormat

### Description

Enables the exponential notation for visualization of a selected axis.

Access in Runtime: Read and write

### Syntax

Object.XAxisExponentialFormat [=BOOLEAN]

#### Object

Required A "ScreenItem" object with the format "FunctionTrendControl".

#### BOOLEAN

TRUE: The values are displayed in exponential format.

FALSE: The values are displayed in exponential format.

### See also

FunctionTrendControl (Page 4004)

## XAxisGridLineInterval(i)

### Description

Specifies the distance between two grid lines of the X axis. Whether the information is evaluated depends on the value of the property ""XAxisShowGridLines(i)".

Access in Runtime: Read and write

### Syntax

Object.XAxisGridLineInterval(i)[=Double]

#### Object

Required A "ScreenItem" object with the format "FunctionTrendView".

#### Double

Optional A value or a constant that specifies the distance between two grid lines of the X axis.

### See also

FunctionTrendControl (Page 4004)

## XAxisIndex

### Description

References a configured X axis. You can assign the values of other properties to a specific X axis by using the property.

Valid values for "Index" are between 0 and "XAxisCount" minus 1. The "ToolBarButtonCount" property specifies the number of configured X axes.

### See also

FunctionTrendControl (Page 4004)

## XAxisInTrendColor

### Description

Enables the display of an axis selected in the trend color. The color of the first trend is activated if several trends are displayed in the trend window. The order of the trends is determined in the "Trends" properties.

Access in Runtime: Read and write

### Syntax

Object.XAxisInTrendColor[=BOOLEAN]

#### Object

Required An object of the "ScreenItem" type with the format "FunctionTrendControl".

#### BOOLEAN

TRUE: The selected axis is displayed in the trend color. The setting in the "Color" field is disabled.

FALSE: The selected axis is displayed in the color which is set in the "Color" field.

### See also

FunctionTrendControl (Page 4004)

## XAxisLabel(i)

### Description

Specifies the labeling of the X axis of a trend that has been referenced with the property "CurrentCurveIndex", dependent upon the value of "XAxisMode(i)".

Access in Runtime: Read and write

## Syntax

Object.XAxisLabel(i)[=String]

### Object

Required A "ScreenItem" object with the format "FunctionTrendView".

### String

Optional A value or a constant that specifies the labeling of the X axis of a trend that has been referenced with the property "CurrentCurveIndex".

## See also

FunctionTrendControl (Page 4004)

## XAxisLargeIncrementSize(i)

### Description

Specifies the distance of two long marking lengths of the X axis. Whether the information is evaluated depends on the property "XAxisShowLargeIncrements(i)".

Access in Runtime: Read and write

## Syntax

Object.XAxisLargeIncrementSize(i)[=Double]

### Object

Required A "ScreenItem" object with the format "FunctionTrendView".

### Double

Optional A value or a constant that specifies the distance of two long marking lengths of the scaling of the X axis.

## See also

FunctionTrendControl (Page 4004)

## XAxisMode(i)

### Description

Specifies whether a mutual time axis will be used in the trend window for all trends.

Specifies time units used by tag logging controls.

Access in Runtime: Read and write

## Syntax

Object.**XAxisMode**(i)[=TrendViewTimeAxisMode]

### Object

Required A "ScreenItem" object with the format "FunctionTrendControl".

### TrendViewTimeAxisMode

( 1): The time axis will be scaled.

( 2): No time range has been specified. Only a random sample will be displayed.

( 3): The time range will be established via tags.

( 4): The time range will be defined by constant values.

## Comments

Specifies whether a mutual X axis will be used in the trend window for all trends.

## See also

FunctionTrendControl (Page 4004)

## XAxisName

### Description

Specifies the name of a selected axis.

## Syntax

Object.**XAxisName**

### Object

Required A "ScreenItem" object with the format "FunctionTrendControl".

## See also

FunctionTrendControl (Page 4004)

## XAxisPrecisions

### Description

Specifies the decimal precision for displaying the axis selected. To configure the value, deactivate the "Automatic" option in "Format".

**See also**

FunctionTrendControl (Page 4004)

**XAxisRemove**

**Description**

Removes the selected axis from the list.

**Syntax**

Object.XAxisRemove

**Object**

Required A "ScreenItem" object with the format "FunctionTrendControl".

**See also**

FunctionTrendControl (Page 4004)

**XAxisRepos**

**Description**

Changes the sorting order of the axes. "Up" and "Down" move the axis selected up or down in the list. The order in the list determines the position of the axis in the trend view in Runtime. If the alignment is identical and the axis is further up in the list, it is shown at a position further away from the trend.

**Syntax**

Object.XAxisRepos

**Object**

Required A "ScreenItem" object with the format "FunctionTrendControl".

**See also**

FunctionTrendControl (Page 4004)

## XAxisScalingType(i)

### Description

Specifies the type of scaling for the X axis. Whether the information is evaluated depends on the value of the property "XAxisMode(i)".

Access in Runtime: Read and write

### Syntax

Object.XAxisScalingType(i)[=AxisScalingType]

#### Object

Required A "ScreenItem" object with the format "FunctionTrendView".

#### AxisScalingType

hmiBarScalingLinear ( 0): Linear axis scaling.

hmiBarScalingLogarithmic ( 1): Logarithmic axis scaling

hmiBarScalingNegativeLogarithmic ( 2): Negative logarithmic axis scaling

### Comments

The parameter i indicates the number of the trend.

### See also

FunctionTrendControl (Page 4004)

## XAxisShowGridLines(i)

### Description

Specifies whether the trend window is shown with grid lines that run parallel to the X axis. The distance between two grid lines can be altered with the ""XAxisGridLineInterval(i)" property.

Access in Runtime: Read and write

### Syntax

Object.XAxisShowGridLines(i)[=BOOLEAN]

#### Object

Required A "ScreenItem" object with the format "FunctionTrendView".

#### BOOLEAN

Optional TRUE, if the trend window is shown with grid lines that run parallel to the X axis.

## See also

FunctionTrendControl (Page 4004)

## XAxisShowLargeIncrements(i)

### Description

Specifies whether the X axis is scaled with long marking lengths. The distance of two long marking lines can be altered with the "XAxisLargeIncrementSize(i)" property.

Access in Runtime: Read and write

### Syntax

Object.XAxisShowLargeIncrements(i)[=BOOLEAN]

#### Object

Required A "ScreenItem" object with the format "FunctionTrendView".

#### BOOLEAN

Optional TRUE, if the X axis is scaled with long marking lengths.

## See also

FunctionTrendControl (Page 4004)

## XAxisShowSmallIncrements(i)

### Description

Specifies whether the X axis is scaled with short marking lengths. The distance of two short marking lines can be altered with the "XAxisSmallIncrementSize(i)" property.

Access in Runtime: Read and write

### Syntax

Object.XAxisShowSmallIncrements(i)[=BOOLEAN]

#### Object

Required A "ScreenItem" object with the format "FunctionTrendView".

#### BOOLEAN

Optional TRUE, if the X axis is scaled with short marking lengths.



## See also

FunctionTrendControl (Page 4004)

## XAxisSmallIncrementSize(i)

### Description

Specifies the distance of two short marking lengths of the X axis. Whether the information is evaluated depends on the property "XAxisShowSmallIncrements(i)".

Access in Runtime: Read and write

### Syntax

Object.XAxisSmallIncrementSize(i)[=Double]

#### Object

Required A "ScreenItem" object with the format "FunctionTrendView".

#### Double

Optional A value or a constant that specifies the distance of two short marking lengths of the X axis scaling.

## See also

FunctionTrendControl (Page 4004)

## XAxisTrendWindow

### Description

Specifies in which trend view the selected axis is used. The available trend views are specified in the properties in "Trends".

Access in Runtime: Read and write

### Syntax

Object.XAxisTrendWindow

#### Object

Required A "ScreenItem" object with the format "FunctionTrendControl".

## See also

FunctionTrendControl (Page 4004)

## XAxisVisible

### Description

The list shows all axes you created.

Activate the axes which are to be displayed in the trend views in the list.

Click an axis in the list to adapt the properties and to assign the axis to a trend view.

### See also

FunctionTrendControl (Page 4004)

## XDataLogTag(i)

### Description

Specifies the tag that will be shown along the X axis. The property "TagProviderType(i)" must have the value -1.

Access in Runtime: Read and write

### Syntax

Object.XDataLogTag(i)[=HmiLoggingTag]

#### Object

Required A ""ScreenItem" object with the format "FunctionTrendView".

#### HmiLoggingTag

Optional A value or a constant that specifies which tag will be shown along the X axis.

### Comments

If "XOnlineTag(i)" is changed, illegal combinations with different attributes for the data connection could arise. This means you have to prevent immediate acceptance of the change with "FreezeProviderConnections" before changing "XOnlineTag(i)".

### See also

FunctionTrendControl (Page 4004)

## XOnlineTag(i)

### Description

Specifies the tag that will be shown along the X axis. The property "TagProviderType(i)" must have the value -1.

Access in Runtime: Read and write

### Syntax

Object.XOnlineTag(i)[=HmiTag]

#### Object

Required A "ScreenItem" object with the format "FunctionTrendView".

#### HmiTag

Optional A value or a constant that specifies which tag will be shown along the X axis.

### Comments

The parameter i indicates the number of the trend.

If "XOnlineTag(i)" is changed, illegal combinations with different attributes for the data connection could arise. This means you have to prevent an immediate acceptance of the change with "FreezeProviderConnections" before changing "XOnlineTag(i)".

### See also

FunctionTrendControl (Page 4004)

## YAxisAdd

### Description

Creates a new X axis.

### Syntax

Object.YAxisAdd

#### Object

Required A "ScreenItem" object with the format "FunctionTrendControl".

### See also

FunctionTrendControl (Page 4004)

## YAxisAlign

### Description

Specifies how the selected axis is aligned.

### Syntax

Object.YAxisAlign[=Alignment]

#### Object

Required A "ScreenItem" object with the format "FunctionTrendControl".

#### Alignment

Value	Description	Explanation
0	Left	The X axis selected is displayed on left side of the trend.
1	Right	The selected Y axis is displayed to the right of the trend.

## YAxisAutoPrecisions

### Description

Enables automatic setting of the decimal precision.

Access in Runtime: Read and write

### Syntax

Object.YAxisAutoPrecisions[=BOOLEAN]

#### Object

Required A "ScreenItem" object with the format "FunctionTrendControl".

#### BOOLEAN

TRUE: The number of decimal places is specified automatically.

FALSE: The value configured under "Properties > Y axis > Format > Decimal places" is effective.

### See also

FunctionTrendControl (Page 4004)

## YAxisAutoRange

### Value range automatic - X/YAxisAutoRange

Enables automatic calculation of the value range of the axis selected.

Value	Description
TRUE	The range of values is calculated automatically.
FALSE	The range of values is calculated based in the values configured in the "from" and "to" fields.

The X axis attribute can be assigned dynamic properties by means of the name **XAxisAutoRange**.

The Y axis attribute can be assigned dynamic properties by means of the name **YAxisAutoRange**.

### See also

FunctionTrendControl (Page 4004)

## YAxisBeginValue

### Description

Specifies the lower value range of the selected axis. To configure the value, deactivate the "Automatic" option in "Value range".

### See also

FunctionTrendControl (Page 4004)

## YAxisColor

### Description

Specifies the color of the axis selected. Open the "Color selection" dialog by clicking the button. . The setting is only active if the "Use trend color" field is disabled.

### Syntax

Object.YAxisColor[=COLOR]

### Object

Required An object of the "ScreenItem" type with the format "FunctionTrendControl" or "OnlineTrendControl" (Runtime Professional) or "HMITrendView" (Runtime Advanced).

**Color**

The color is defined as an RGB value.

**See also**

FunctionTrendControl (Page 4004)

**YAxisCount**

**Description**

Defines the number of Y axes configured.

**Syntax**

Object.YAxisCount

Object

Required A "ScreenItem" object with the format "FunctionTrendControl".

**See also**

FunctionTrendControl (Page 4004)

**YAxisEndValue**

**Description**

Specifies the upper value range of the selected axis. To configure the value, deactivate the "Automatic" option in "Value range".

**See also**

FunctionTrendControl (Page 4004)

**YAxisExponentialFormat**

**Description**

Enables the exponential notation for visualization of a selected axis.

Access in Runtime: Read and write

## Syntax

Object.YAxisExponentialFormat [=BOOLEAN]

### Object

Required A "ScreenItem" object with the format "FunctionTrendControl".

### BOOLEAN

TRUE: The values are displayed in exponential format.

FALSE: The values are displayed in exponential format.

## See also

FunctionTrendControl (Page 4004)

## YAxisIndex

### Description

References a configured Y axis. You can assign the values of other properties to a specific Y axis by using the property.

Valid values for "Index" are between 0 and "YAxisCount" minus 1. The "ToolbarButtonCount" property specifies the number of configured Y axes.

## See also

FunctionTrendControl (Page 4004)

## YAxisInTrendColor

### Description

Enables the display of an axis selected in the trend color. The color of the first trend is activated if several trends are displayed in the trend window. The order of the trends is determined in the "Trends" properties.

Access in Runtime: Read and write

## Syntax

Object.YAxisInTrendColor[=BOOLEAN]

### Object

Required An object of the "ScreenItem" type with the format "FunctionTrendControl".

### **BOOLEAN**

TRUE: The selected axis is displayed in the trend color. The setting in the "Color" field is disabled.

FALSE: The selected axis is displayed in the color which is set in the "Color" field.

### **See also**

FunctionTrendControl (Page 4004)

### **YAxisLabel**

#### **Description**

Defines the label text for a selected axis.

### **See also**

FunctionTrendControl (Page 4004)

### **YAxisName**

#### **Description**

Specifies the name of the selected axis.

#### **Syntax**

Object.**XAxisName**

#### **Object**

Required A "ScreenItem" object with the format "FunctionTrendControl".

### **See also**

FunctionTrendControl (Page 4004)

### **YAxisPrecisions**

#### **Description**

Specifies the decimal precision for displaying the axis selected. To configure the value, deactivate the "Automatic" option in "Format".



## See also

FunctionTrendControl (Page 4004)

## YAxisRename

### Description

Changes the name of the Y axis which is referenced by the "YAxisIndex" property.

### Syntax

Object.YAxisRename

#### Object

Required An object of the "ScreenItem" type with the format "FunctionTrendControl".

## YAxisRemove

### Description

Removes the selected axis from the list.

### Syntax

Object.YAxisRemove

#### Object

Required A "ScreenItem" object with the format "FunctionTrendControl".

## See also

FunctionTrendControl (Page 4004)

## YAxisRepos

### Description

Changes the order of the axes. "Up" and "Down" move the selected axis up or down in the list.

The order in the list determines the position of the axis in the trend view in Runtime. The axis output position is moved away from the trend if the axis is moved further up in the list and the orientation is the same.

## Syntax

Object.YAxisRepos

### Object

Required A "ScreenItem" object with the format "FunctionTrendControl".

## See also

FunctionTrendControl (Page 4004)

## YAxisScalingType

### Scaling - X/YAxisScalingType

Defines the scaling mode for a selected axis.

The following settings are available:

Value	Description
0	Linear
1	Logarithmic
2	Logarithmically negated

The X axis attribute can be assigned dynamic properties by means of the name **XAxisScalingType**.

The Y axis attribute can be assigned dynamic properties by means of the name **YAxisScalingType**.

## See also

FunctionTrendControl (Page 4004)

## YAxisTrendWindow

### Description

Specifies in which trend view the selected axis is used. The available trend views are specified in the properties in "Trends".

Access in Runtime: Read and write

### Syntax

Object.YAxisTrendWindow

### Object

Required A "ScreenItem" object with the format "FunctionTrendControl".

### See also

FunctionTrendControl (Page 4004)

### YAxisVisible

### Description

The list shows all axes you created.

Activate the axes which are to be displayed in the trend views in the list.

Click an axis in the list to adapt the properties and to assign the axis to a trend view.

### See also

FunctionTrendControl (Page 4004)

### YDataLogTag(i)

### Description

Specifies the tag that will be shown along the Y axis. The property "TagProviderType(i)" must have the value -1.

Access in Runtime: Read and write

### Syntax

Object.YDataLogTag(i)[=HmiLoggingTag]

### Object

Required A "ScreenItem" object with the format "FunctionTrendView".

### HmiLoggingTag

Optional A value or a constant that specifies which tag will be shown along the Y axis.

### Comments

If "YOnlineTag(i)" is changed, illegal combinations with different attributes for the data connection could arise. This means you have to prevent immediate acceptance of the change with "FreezeProviderConnections" before changing "YOnlineTag(i)".

## See also

FunctionTrendControl (Page 4004)

## YOnlineTag(i)

### Description

Specifies the tag that will be shown along the Y axis. The property "TagProviderType(i)" must have the value -1.

Access in Runtime: Read and write

### Syntax

Object.YOnlineTag(i)[=HmiTag]

#### Object

Required A "ScreenItem" object with the format "FunctionTrendView".

#### HmiTag

Optional A value or a constant that specifies which tag will be shown along the Y axis.

### Comments

The parameter i indicates the number of the trend.

If "YOnlineTag(i)" is changed, illegal combinations with different attributes for the data connection could arise. This means you have to prevent immediate acceptance of the change with "FreezeProviderConnections" before changing "YOnlineTag(i)".

## See also

FunctionTrendControl (Page 4004)

## ZeroPoint

### Description

Specifies the position of the zero point as a percentage of the bar height. The zero point can also be located outside of the displayed area.

The "ScalingType" property must be set to "Auto".

The "ShowScale" property must be set to "TRUE".

Access in Runtime: Read and write

## Syntax

Object.**ZeroPoint**[=Int]

### Object

Required A ""ScreenItem" object with the format ""Bar".

### Int

Optional A value or a constant that specifies the position of the zero point as a percentage of the bar height.

## See also

Bar (Page 3961)

## ZeroPointValue

### Description

Defines the value of the zero point of the scale indicator.

Defines or returns the absolute value for the zero point.

## Zoom/Zoomfactor

### Description

Sets or reads the zoom factor of a screen or screen window.

If the indicated zoom factor is smaller than the minimum value, the zoom factor is automatically set to the minimum value. If the indicated zoom factor is larger than the minimum value, the zoom factor is automatically set to the maximum value.

The minimum value of the zoom factor is at 2%, the maximum value at 800%.

With the Screen Object the zoom factor is indicated as a numeric value and with a picture window object, it is indicated in percent.

Zoom: Zoom factor of picture

Zoomfactor: Zoom factor of picture window

## Example

The following example doubles the zoom factor of the current picture:

```
'VBS97
HMIRuntime.ActiveScreen.Zoom = HMIRuntime.ActiveScreen.Zoom * 2
```

## See also

ScreenWindow (Page 4078)

## Zoomable

## Description

Specifies whether the DXF screen display supports the zoom functions in Runtime mode.

Access in Runtime: Read and write

## Syntax

Object.**Zoomable**[=BOOLEAN]

### Object

Required A "ScreenItem" object with the format "DXFView".

### BOOLEAN

Optional TRUE, if the DXF screen display supports the zoom functions in Runtime mode.

## Methods

## Methods A-G

## Activate

## Description

Activates the permanent window or the root screen.

To activate a not selected screen, use the "BaseScreenName" property.

It only makes sense to use the activate method with the following operable screen objects. An error message is output at screen objects which cannot be operated, for example rectangles.

- I/O field
- Switch
- Symbol library
- Trend view
- f(x) trend view
- HTML browser
- Slider
- Graphic I/O field

- Symbolic I/O field
- Button
- Alarm view
- User view
- Recipe view
- Sm@rtClient View
- Status/Force

## Syntax

Expression.Activate

### Expression

Necessary. An output which returns an object of the "Screen" or "ScreenItem" type.

## Parameters

--

## See also

ScreenItem (Page 3932)  
Screen (Page 3930)  
ChannelDiagnose (Page 3972)  
CheckBox (Page 3974)  
Circle (Page 3977)  
CircleSegment (Page 3979)  
CircularArc (Page 3982)  
Clock (Page 3984)  
Connector (Page 3986)  
DateTimeField (Page 3989)  
DiskSpaceView (Page 3991)  
Ellipse (Page 3993)  
EllipseSegment (Page 3995)  
EllipticalArc (Page 3998)  
Gauge (Page 4008)  
GraphicIOField (Page 4011)  
GraphicView (Page 4014)  
HTMLBrowser (Page 4019)  
IOField (Page 4021)  
Rectangle (Page 4072)  
ScriptDiagnostics (Page 4080)  
Switch (Page 4089)  
SymbolicIOField (Page 4093)  
SymbolLibrary (Page 4098)  
TextField (Page 4107)  
TrendView (Page 4118)  
TubeArcObject (Page 4121)  
TubeDoubleTeeObject (Page 4123)  
TubePolyline (Page 4125)  
TubeTeeObject (Page 4128)  
UserView (Page 4137)  
WindowSlider (Page 4139)  
StatusForce (Page 4087)  
SmartClientView (Page 4085)  
Slider (Page 4082)  
ScreenWindow (Page 4078)  
RoundButton (Page 4074)  
Polyline (Page 4060)  
Polygon (Page 4057)  
OptionGroup (Page 4054)



## ActivateDynamic

### Description

Dynamically activates a trigger and the specified cycle for a property at runtime. This requires a VB script at the property as well as a trigger set to "On demand". Every time the trigger is activated a different activation cycle can be used.

### Syntax

```
Expression.ActivateDynamic (ByVal bstrPropertyName As String, ByVal  
bstrCycleName As String)
```

### Expression

Necessary. An expression that returns an object of the "ScreenItem" type.

### Parameters

Parameter	Description
bstrPropertyName	Name of property to which trigger relates.
bstrCycleName	Name of activation cycle, e.g. "CycleTime1s".

## See also

ChannelDiagnose (Page 3972)  
CheckBox (Page 3974)  
Circle (Page 3977)  
CircleSegment (Page 3979)  
CircularArc (Page 3982)  
Clock (Page 3984)  
Connector (Page 3986)  
DiskSpaceView (Page 3991)  
Ellipse (Page 3993)  
EllipseSegment (Page 3995)  
EllipticalArc (Page 3998)  
Gauge (Page 4008)  
GraphicIOField (Page 4011)  
GraphicView (Page 4014)  
HTMLBrowser (Page 4019)  
IOField (Page 4021)  
Rectangle (Page 4072)  
ScriptDiagnostics (Page 4080)  
SymbolicIOField (Page 4093)  
SymbolLibrary (Page 4098)  
TextField (Page 4107)  
TubeArcObject (Page 4121)  
TubeDoubleTeeObject (Page 4123)  
TubePolyline (Page 4125)  
TubeTeeObject (Page 4128)  
UserView (Page 4137)  
WindowSlider (Page 4139)  
Slider (Page 4082)  
ScreenWindow (Page 4078)  
RoundButton (Page 4074)  
Polyline (Page 4060)  
Polygon (Page 4057)  
OptionGroup (Page 4054)  
MultiLineEdit (Page 4032)  
MediaPlayer (Page 4030)  
Listbox (Page 4027)  
Line (Page 4025)  
Bar (Page 3961)  
Button (Page 3968)  
OnlineTrendControl (Page 4045)

## Add

### Description of TagSet Object

Adds a tag to the list. A tag may be added to the tag object by using name or reference.

### syntax

```
Expression.Add [Tag]
```

#### Expression

Necessary. An expression which returns an object of type "TagSet".

### Parameters

VARIANT

Parameters	Description
Tag	Name of a WinCC tag or reference to a tag object to be added to the list.

### Example:

In the following example, a TagSet object is generated and a tag is added.

```
'VBS170
Dim group
Set group = HMIRuntime.Tags.CreateTagSet
group.Add "Motor1"
```

Tag objects may also be added as follows.

```
'VBS171
Dim Tag
Set Tag = HMIRuntime.Tags("Motor2")
Dim group2
Set group2 = HMIRuntime.Tags.CreateTagSet
group2.Add Tag
```

## Description of DataSet Object

Adds a value or object reference to the list.

---

### Note

The Data Set Object does not support classes.

Objects of type Screen, Screens, ScreenItem, ScreenItems, Tag and TagSet cannot be included in the DataSet list.

For object references it must be ascertained that objects are multiread-enabled.

---

## syntax

```
Expression.Add [vtName], [vtUserData]
```

### Expression

Necessary. An expression which returns an object of type "DataSet".

## Parameters

VARIANT

Parameters	Description
vtName	Name by which value or tag are to be added to list.
vtUserData	Value to be added to list.

## Example:

In this example, a value is included in the DataSet list.

```
'VBS172  
HMIRuntime.DataSet.Add "Motor1",23
```

## See also

[DataSet \(list\) \(Page 3919\)](#)

[OnlineTrendControl \(Page 4045\)](#)

## AttachDB method

### Description

Executes the "Connect backup" key function of the control.

## Syntax

```
Ausdruck.AttachDB()
```

### Expression

Required An expression that returns an object of the "ScreenItem" type.

## Parameters

--

## See also

[OnlineTrendControl \(Page 4045\)](#)

[OnlineTableControl \(Page 4037\)](#)

[FunctionTrendControl \(Page 4004\)](#)

[AlarmControl \(Page 3947\)](#)

## CalculateStatistic

### Description

Executes the "calculate statistics" key function of the f(t) trend view.

### Syntax

```
Ausdruck.CalculateStatistic()
```

### Expression

Required An expression that returns an object of the "ScreenItem" type.

## Parameters

--

## See also

[OnlineTrendControl \(Page 4045\)](#)

[OnlineTableControl \(Page 4037\)](#)

## CopyRows

### Description

Executes the "Copy lines" key function of the control.

### Syntax

Ausdruck.CopyRows ( )

#### Expression

Required An expression that returns an object of the "ScreenItem" type.

### Parameters

--

### See also

[OnlineTrendControl \(Page 4045\)](#)

[OnlineTableControl \(Page 4037\)](#)

[UserArchiveControl \(Page 4130\)](#)

[AlarmControl \(Page 3947\)](#)

### Create

### Description

Creates a new Alarm object.

### Syntax

Expression.Create (VARIANT vtApplication)

#### Expression

Required An expression which returns an object of type "Alarm".

### Parameters

VARIANT

Parameters	Description
vtApplication	Name of alarm object (optional)

### See also

[OnlineTrendControl \(Page 4045\)](#)

## CreateTagSet

### Description

Creates a new TagSet object. This object may be used for optimized multi-tag access.

### syntax

```
Expression.CreateTagSet()
```

#### Expression

Necessary. An expression which returns an object of type "TagSet".

### Parameters

VARIANT

### Example:

The following example shows how to create a TagSet object.

```
'VBS168  
'Build a Reference to the TagSet Object  
Dim group  
Set group = HMIRuntime.Tags.CreateTagSet
```

### See also

[OnlineTrendControl \(Page 4045\)](#)

## CutRows

### Description

Executes the "Cut rows" key function of the recipe view.

### Syntax

```
Ausdruck.CutRows()
```

#### Expression

Necessary. An expression that returns an object of the "ScreenItem" type.

## Parameters

--

## See also

OnlineTrendControl (Page 4045)

UserArchiveControl (Page 4130)

## DeactivateDynamic

### Description

Deactivates the trigger of the "ActivateDynamic" method used for the specified property in/ during runtime.

### Syntax

```
Ausdruck.DeactivateDynamic(ByVal bstrPropertyName As String)
```

### Expression

Necessary. An expression that returns an object of the "ScreenItem" type.

## Parameters

String

Parameters	Description
bstrPropertyName	Name of property to which trigger relates.



## See also

ChannelDiagnose (Page 3972)  
CheckBox (Page 3974)  
Circle (Page 3977)  
CircleSegment (Page 3979)  
CircularArc (Page 3982)  
Clock (Page 3984)  
Connector (Page 3986)  
DiskSpaceView (Page 3991)  
Ellipse (Page 3993)  
EllipseSegment (Page 3995)  
EllipticalArc (Page 3998)  
Gauge (Page 4008)  
GraphicIOField (Page 4011)  
GraphicView (Page 4014)  
HTMLBrowser (Page 4019)  
IOField (Page 4021)  
Rectangle (Page 4072)  
ScriptDiagnostics (Page 4080)  
SymbolicIOField (Page 4093)  
SymbolLibrary (Page 4098)  
TextField (Page 4107)  
TubeArcObject (Page 4121)  
TubeDoubleTeeObject (Page 4123)  
TubePolyline (Page 4125)  
TubeTeeObject (Page 4128)  
UserView (Page 4137)  
WindowSlider (Page 4139)  
Slider (Page 4082)  
ScreenWindow (Page 4078)  
RoundButton (Page 4074)  
Polyline (Page 4060)  
Polygon (Page 4057)  
OptionGroup (Page 4054)  
MultiLineEdit (Page 4032)  
MediaPlayer (Page 4030)  
Listbox (Page 4027)  
Line (Page 4025)  
Bar (Page 3961)  
Button (Page 3968)  
OnlineTrendControl (Page 4045)

## DeleteRows

### Description

Executes the "Delete rows" key function of the recipe view.

### Syntax

```
Ausdruck.DeleteRows ()
```

#### Expression

Necessary. An expression that returns an object of the "ScreenItem" type.

### Parameters

--

### See also

OnlineTrendControl (Page 4045)

UserArchiveControl (Page 4130)

## DetachDB

### Description

Executes the "Disconnect backup" key function of the control.

### Syntax

```
Ausdruck.DetachDB ()
```

#### Expression

Required An expression that returns an object of the "ScreenItem" type.

### Parameters

--

### See also

OnlineTrendControl (Page 4045)

OnlineTableControl (Page 4037)

FunctionTrendControl (Page 4004)

AlarmControl (Page 3947)

## Edit

### Description

Executes the "Edit" key function of the table view.

### Syntax

```
Ausdruck.Edit()
```

#### Expression

Necessary. An expression that returns an object of the "ScreenItem" type.

### Parameters

--

### See also

[OnlineTrendControl \(Page 4045\)](#)

[OnlineTableControl \(Page 4037\)](#)

[AlarmControl \(Page 3947\)](#)

## Export

### Description

Executes the "Export archive" or "Export data" key function of the control.

### Syntax

```
Ausdruck.Export()
```

#### Expression

Required An expression that returns an object of the "ScreenItem" type.

### Parameters

VARIANT

### See also

- OnlineTrendControl (Page 4045)
- OnlineTableControl (Page 4037)
- TrendRulerControl (Page 4110)
- UserArchiveControl (Page 4130)
- FunctionTrendControl (Page 4004)
- AlarmControl (Page 3947)

### GetColumn

#### Description

Returns the column object of the recipe view designated by name or index as "ICCAxUAColumn" type.

#### Syntax

```
Ausdruck.GetColumn(ByVal vIndex As Variant)
```

#### Expression

Necessary. An expression that returns an object of the "ScreenItem" type.

#### Parameters

VARIANT

Parameters	Description
vIndex	Index or name of the column of the recipe view

#### Example

```
'VBS312  
Dim ctrl  
Dim objColumn  
Set ctrl = ScreenItems("RecipeControl")  
Set objColumn = ctrl.GetColumn("Field1")  
objColumn.Length = 30  
Set objColumn = ctrl.GetColumn(3)  
objColumn.Align = 2
```

---

**Note**

When you use the "Get..." methods to access properties from the Control object list rather than with the Control object, you have to omit the prefix of the property with the name of the list.

For the "Column" listing, for example, you write "objColumn.Align" instead of "objColumn.ColumnAlign".

---

**See also**

OnlineTrendControl (Page 4045)

UserArchiveControl (Page 4130)

**GetColumnCollection**

**Description**

Returns the list of all column objects of the recipe view as "ICCAxCollection" type.

**Syntax**

```
Ausdruck.GetColumnCollection()
```

**Expression**

Necessary. An expression that returns an object of the "ScreenItem" type.

**Parameters**

--

**Features and functions of the ICCAxCollection**

The following properties are available for the ICCAxCollection:

- Count
- Item

The following functions are available for the ICCAxCollection:

- AddItem(vName) As Object
- RemoveItem(vIndex)

## Example

```
'VBS313
Dim ctrl
Dim coll
Dim field
Set ctrl = ScreenItems("RecipeControl")
Set coll = ctrl.GetColumnCollection
HMIRuntime.Trace "Number of fields:" & coll.Count & vbCrLf
For Each field In coll
  HMIRuntime.Trace field.Name & vbCrLf
  HMIRuntime.Trace field.Type & vbCrLf
  HMIRuntime.Trace field.Length & vbCrLf
  HMIRuntime.Trace field.Caption & vbCrLf
Next
```

## See also

[OnlineTrendControl \(Page 4045\)](#)

[UserArchiveControl \(Page 4130\)](#)

## GetHitlistColumnCollection

### Description

Returns the list of all column objects of the message view hit list as "ICCAxCollection" type.

### Syntax

```
Expression.GetHitlistColumnCollection()
```

#### Expression

Necessary. An expression that returns an object of the "ScreenItem" type.

### Parameters

--

## Features and functions of the ICCAxCollection

The following properties are available for the ICCAxCollection:

- Count
- Item

The following functions are available for the ICCAxCollection:

- AddItem(vName) As Object
- RemoveItem(vIndex)

## Example

```
'VBS315
Dim ctrl
Dim coll
Dim hitlistcol
Set ctrl = ScreenItems("AlarmControl")
Set coll = ctrl.GetHitlistColumnCollection
HMIRuntime.Trace "Number of hitlist columns:" & coll.Count & vbCrLf
For Each hitlistcol In coll
  HMIRuntime.Trace hitlistcol.Index & vbCrLf
  HMIRuntime.Trace hitlistcol.Name & vbCrLf
  HMIRuntime.Trace hitlistcol.Sort & vbCrLf
  HMIRuntime.Trace hitlistcol.SortIndex & vbCrLf
Next
```

## See also

[OnlineTrendControl \(Page 4045\)](#)

[AlarmControl \(Page 3947\)](#)

## GetHitlistColumn

### Description

Returns the column object of the message view hit list designated by name or index as "ICCAxMessageColumn" type.

### Syntax

```
Expression.GetHitlistColumn(ByVal vIndex As Variant)
```

#### Expression

Necessary. An expression that returns an object of the "ScreenItem" type.

### Parameters

VARIANT

Parameters	Description
vIndex	Index or name of hitlist column

## Example

```
'VBS314
Dim ctrl
Dim objHitlistColumn
Set ctrl = ScreenItems("AlarmControl")
Set objHitlistColumn = ctrl.GetHitlistColumn("Date")
objHitlistColumn.Sort = 2
Set objHitlistColumn = ctrl.GetHitlistColumn("AverageComeGo")
objHitlistColumn.Visible = FALSE
```

---

### Note

When you use the "Get..." methods to access properties from the Control object list rather than with the Control object, you have to omit the prefix of the property with the name of the list.

For the "HitlistColumn" listing, for example, you write "objHitlistColumn.Visible" instead of "objHitlistColumn.HitlistColumnVisible".

---

## See also

[OnlineTrendControl \(Page 4045\)](#)

[AlarmControl \(Page 3947\)](#)

## GetMessageBlock

### Description

Returns the message block of the message view designated by name or index as "ICCAxMessageBlock" type.

### Syntax

```
Expression.GetMessageBlock(ByVal vIndex As Variant)
```

### Expression

Necessary. An expression that returns an object of the "ScreenItem" type.



## Parameters

VARIANT

Parameters	Description
vIndex	Index or name of message block.

## Example

```
'VBS316
Dim ctrl
Dim objMsgBlock
Set ctrl = ScreenItems("AlarmControl")
Set objMsgBlock = ctrl.GetMessageBlock("Date")
objMsgBlock.Align = 2
Set objMsgBlock = ctrl.GetMessageBlock("Number")
objMsgBlock.LeadingZeros = 4
```

### Note

When you use the "Get..." methods to access properties from the Control object list rather than with the Control object, you have to omit the prefix of the property with the name of the list.

For the "MessageBlock" listing, for example, you write "objMsgBlock.Align" instead of "objMsgBlock.MessageBlockAlign".

## See also

OnlineTrendControl (Page 4045)

AlarmControl (Page 3947)

## GetMessageBlockCollection

### Description

Returns the list of all message block objects of the message view as "ICCAxCollection" type.

### Syntax

```
Expression.GetMessageBlockCollection()
```

### Expression

Necessary. An expression that returns an object of the "ScreenItem" type.

## Parameters

--

## Features and functions of the ICCAxCollection

The following properties are available for the ICCAxCollection:

- Count
- Item

The following functions are available for the ICCAxCollection:

- AddItem(vName) As Object
- RemoveItem(vIndex)

## Example

```
'VBS317
Dim ctrl
Dim coll
Dim msgblock
Set ctrl = ScreenItems("AlarmControl")
Set coll = ctrl.GetMessageBlockCollection
For Each msgblock In coll
  msgblock.Align = 1
  msgblock.Length = 12
  msgblock.Selected = TRUE
Next
```

---

### Note

When you use the "Get..." methods to access properties from the Control object list rather than with the Control object, you have to omit the prefix of the property with the name of the list.

For the "MessageBlock" listing, for example, you write "msgblock.Align" instead of "msgblock.MessageBlockAlign".

---

## See also

[OnlineTrendControl \(Page 4045\)](#)

[AlarmControl \(Page 3947\)](#)

## GetMessageColumn

### Description

Returns the column object of the message view designated by name or index as "ICCAxMessageColumn" type.

### Syntax

```
Expression.GetMessageColumn(ByVal vIndex As Variant)
```

#### Expression

Necessary. An expression that returns an object of the "ScreenItem" type.

### Parameters

VARIANT

Parameters	Description
vIndex	Index or name of column in message list.

### Example

```
'VBS318
Dim ctrl
Dim objMessColumn
Set ctrl = ScreenItems("AlarmControl")
Set objMessColumn = ctrl.GetMessageColumn("Date")
objMessColumn.Visible = FALSE
Set objMessColumn = ctrl.GetMessageColumn("Number")
objMessColumn.Sort = 1
```

#### Note

When you use the "Get..." methods to access properties from the Control object list rather than with the Control object, you have to omit the prefix of the property with the name of the list.

For the "MessageColumn" listing, for example, you write "objMessColumn.Visible" instead of "objMessColumn.MessageColumnVisible".

## See also

OnlineTrendControl (Page 4045)

AlarmControl (Page 3947)

## GetOperatorMessage

### Description

Returns the operator message object of the message view designated by name or index as "ICCAxOperatorMessage" type.

### Syntax

```
Expression.GetOperatorMessage(ByVal vIndex As Variant)
```

### Expression

Necessary. An expression that returns an object of the "ScreenItem" type.

### Parameters

VARIANT

Parameters	Description
vIndex	Index or name of operator message

### Example

```
'VBS320
Dim ctrl
Dim objOpMess
Set ctrl = ScreenItems("AlarmControl")
Set objOpMess = ctrl.GetOperatorMessage(0)
objOpMess.Source1 = "Number"
objOpMess.SourceType1 = 1
```

---

### Note

When you use the "Get..." methods to access properties from the Control object list rather than with the Control object, you have to omit the prefix of the property with the name of the list.

For the "OperatorMessage" listing, for example, you write "objOpMess.Source1" instead of "objOpMess.OperatorMessageSource1".

---

**See also**

OnlineTrendControl (Page 4045)

AlarmControl (Page 3947)

**GetMessageColumnCollection****Description**

Returns the list of all column objects of the message view as "ICCAxCollection" type.

**Syntax**

```
Expression.GetMessageColumnCollection()
```

**Expression**

Necessary. An expression that returns an object of the "ScreenItem" type.

**Parameters**

--

**Features and functions of the ICCAxCollection**

The following properties are available for the ICCAxCollection:

- Count
- Item

The following functions are available for the ICCAxCollection:

- AddItem(vName) As Object
- RemoveItem(vIndex)

**Example**

```
'VBS319
Dim ctrl
Dim coll
Dim msgcol
Set ctrl = ScreenItems("AlarmControl")
Set coll = ctrl.GetMessageColumnCollection
HMIRuntime.Trace "Number of message columns:" & coll.Count & vbCrLf
For Each msgcol In coll
  HMIRuntime.Trace msgcol.Index & vbCrLf
  HMIRuntime.Trace msgcol.Name & vbCrLf
  HMIRuntime.Trace msgcol.Sort & vbCrLf
  HMIRuntime.Trace msgcol.SortIndex & vbCrLf
```

Next

## See also

OnlineTrendControl (Page 4045)

AlarmControl (Page 3947)

## GetOperatorMessageCollection

### Description

Returns the list of all operator message objects of the message view as "ICCAxCollection" type.

### Syntax

```
Expression.GetOperatorMessageCollection()
```

#### Expression

Necessary. An expression that returns an object of the "ScreenItem" type.

### Parameters

--

## Features and functions of the ICCAxCollection

The following properties are available for the ICCAxCollection:

- Count
- Item

The following functions are available for the ICCAxCollection:

- AddItem(vName) As Object
- RemoveItem(vIndex)

## Example

```
'VBS321
Dim ctrl
Dim coll
Dim opmsg
Set ctrl = ScreenItems("AlarmControl")
Set coll = ctrl.GetOperatorMessageCollection
```

```

For Each opmsg In coll
  HMIRuntime.Trace opmsg.Index & vbCrLf
  HMIRuntime.Trace opmsg.Name & vbCrLf
  HMIRuntime.Trace opmsg.Number & vbCrLf
  HMIRuntime.Trace opmsg.Selected & vbCrLf
Next

```

## See also

OnlineTrendControl (Page 4045)

AlarmControl (Page 3947)

## GetRow

### Description

Returns the row object defined by its row number in the table-based controls as "ICCAxDataRow" type.

### Syntax

```
Expression.GetRow(ByVal IRow As Long)
```

#### Expression

Required An expression that returns an object of the "ScreenItem" type.

### Parameters

Long

Parameters	Description
IRow	Number of the desired line of the control.

## Example

```

'VBS356
Dim coll
Dim ctrl
Dim lIndex
Dim lCellIndex
Set ctrl = ScreenItems("UAControl")
Set coll = ctrl.GetRowCollection
'enumerate and trace out row numbers
For lIndex = 1 To coll.Count
  HMIRuntime.trace "Row: " & (ctrl.GetRow(lIndex).RowNumber) & " "

```

## 10.8 Working with system functions and Runtime scripting

```
'enumerate and trace out column titles and cell texts
For lCellIndex = 1 To ctrl.GetRow(lIndex).CellCount
  HMIRuntime.trace ctrl.GetRow(0).CellText(lCellIndex) & " "
  HMIRuntime.trace ctrl.GetRow(lIndex).CellText(lCellIndex) & " "
Next
HMIRuntime.trace vbNewLine
Next
```

---

### Note

When you use the "Get..." methods to access properties from the control object list rather than with the control object, you have to omit the prefix of the property with the name of the list.

For the "Row" listing, for example, you write "objRow.CellCount" instead of "objRow.RowCellCount".

---

### See also

[OnlineTrendControl \(Page 4045\)](#)  
[OnlineTableControl \(Page 4037\)](#)  
[TrendRulerControl \(Page 4110\)](#)  
[UserArchiveControl \(Page 4130\)](#)  
[AlarmControl \(Page 3947\)](#)

## GetRowCollection

### Description

Returns the list of all row objects of the table-based controls type "ICCAxDataRowCollection".

### Syntax

```
Expression.GetRowCollection()
```

#### Expression

Necessary. An expression that returns an object of the "ScreenItem" type.

### Parameters

--



## Properties of the ICCAxDataRowCollection

The ICCAxDataRowCollection refers to runtime data. The data is read-only. It is not possible to add and edit the data.

The following properties are available for the ICCAxDataRowCollection:

- Count - Determines the number of rows in the collection.
- Item - Access to an individual row within the collection via the row number. Numbering runs from 1 to Count. A Row object is returned.

## Example

```
'VBS357
Dim ctrl
Dim coll
Dim lIndex
Dim lCellIndex
Set ctrl = ScreenItems("AlarmControl")
Set coll = ctrl.GetRowCollection
HMIRuntime.Trace "Number of message rows:" & coll.Count & vbCrLf
'enumerate and trace out row numbers
For lIndex = 1 To coll.Count
  HMIRuntime.Trace "Row: " & (ctrl.GetRow(lIndex).RowNumber) & " "
  'enumerate and trace out column titles and cell texts
  For lCellIndex = 1 To ctrl.GetRow(lIndex).CellCount
    HMIRuntime.Trace ctrl.GetMessageColumn(lCellIndex -1).Name & " "
    HMIRuntime.Trace ctrl.GetRow(lIndex).CellText(lCellIndex) & " "
  Next
  HMIRuntime.Trace vbCrLf
Next
```

## See also

[OnlineTrendControl \(Page 4045\)](#)

[OnlineTableControl \(Page 4037\)](#)

[TrendRulerControl \(Page 4110\)](#)

[UserArchiveControl \(Page 4130\)](#)

[AlarmControl \(Page 3947\)](#)

## GetRulerBlock

### Description

Returns the block object of the evaluation table designated by name or index as "ICCAxRulerBlock" type.

## Syntax

```
Expression.GetRulerBlock(ByVal vIndex As Variant)
```

### Expression

Necessary. An expression that returns an object of the "ScreenItem" type.

## Parameters

VARIANT

Parameters	Description
vIndex	Index or name of the block in the evaluation table

## Example

```
'VBS322
Dim ctrl
Dim objRulerBlock
Set ctrl = ScreenItems("RulerControl")
Set objRulerBlock = ctrl.GetRulerBlock(0)
objRulerBlock.Caption = "RulerBlock1"
Set objRulerBlock = ctrl.GetRulerBlock("Name")
objRulerBlock.Length = 10
```

---

### Note

When you use the "Get..." methods to access properties from the Control object list rather than with the Control object, you have to omit the prefix of the property with the name of the list.

For the "RulerBlock" listing, for example, you write "objRulerBlock.Caption" instead of "objRulerBlock.BlockCaption".

---

## See also

[OnlineTrendControl \(Page 4045\)](#)

[TrendRulerControl \(Page 4110\)](#)

## GetRulerBlockCollection

### Description

Returns the list of all block objects of the evaluation table as "ICCAxCollection" type.

## Syntax

```
Expression.GetRulerBlockCollection()
```

### Expression

Necessary. An expression that returns an object of the "ScreenItem" type.

## Parameters

--

## Features and functions of the ICCAxCollection

The following properties are available for the ICCAxCollection:

- Count
- Item

The following functions are available for the ICCAxCollection:

- AddItem(vName) As Object
- RemoveItem(vIndex)

## Example

```
'VBS323
Dim ctrl
Dim coll
Dim rulerblock
Set ctrl = ScreenItems("RulerControl")
Set coll = ctrl.GetRulerBlockCollection
For Each rulerblock In coll
    rulerblock.Align = 1
    rulerblock.Length = 12
Next
```

---

### Note

When you use the "Get..." methods to access properties from the Control object list rather than with the Control object, you have to omit the prefix of the property with the name of the list.

For the "RulerBlock" listing, for example, you write "rulerblock.Align" instead of "rulerblock.RulerBlockAlign".

---

**See also**

OnlineTrendControl (Page 4045)

TrendRulerControl (Page 4110)

**GetRulerColumn**

**Description**

Returns the column object of the evaluation table designated by name or index as "ICCAxRulerColumn" type.

**Syntax**

```
Expression.GetRulerColumn(ByVal vIndex As Variant)
```

**Expression**

Necessary. An expression that returns an object of the "ScreenItem" type.

**Parameters**

VARIANT

Parameters	Description
vIndex	Index or name of the column of the evaluation

**Example**

```
'VBS324
Dim ctrl
Dim objRulercol
Set ctrl = ScreenItems("RulerControl")
Set objRulercol = ctrl.GetRulerColumn("Name")
objRulercol.Sort = 0
Set objRulercol = ctrl.GetRulerColumn("ValueY")
objRulercol.Visible = FALSE
```

---

**Note**

When you use the "Get..." methods to access properties from the Control object list rather than with the Control object, you have to omit the prefix of the property with the name of the list.

For the "RulerColumn" listing, for example, you write "objRulercol.Visible" instead of "objRulercol.ColumnVisible".

---

**See also**

OnlineTrendControl (Page 4045)

TrendRulerControl (Page 4110)

**GetRulerColumnCollection****Description**

Returns the list of all column objects of the evaluation table as "ICCAxCollection" type.

**Syntax**

```
Expression.GetRulerColumnCollection()
```

**Expression**

Necessary. An expression that returns an object of the "ScreenItem" type.

**Parameters**

--

**Features and functions of the ICCAxCollection**

The following properties are available for the ICCAxCollection:

- Count
- Item

The following functions are available for the ICCAxCollection:

- AddItem(vName) As Object
- RemoveItem(vIndex)

**Example**

```
'VBS325
Dim ctrl
Dim coll
Dim rulercol
Set ctrl = ScreenItems("RulerControl")
Set coll = ctrl.GetRulerColumnCollection
HMIRuntime.Trace "Number of ruler columns:" & coll.Count & vbCrLf
For Each rulercol In coll
```

```
HMIRuntime.Trace rulercol.Index & vbCrLf
HMIRuntime.Trace rulercol.Name & vbCrLf
HMIRuntime.Trace rulercol.Sort & vbCrLf
HMIRuntime.Trace rulercol.SortIndex & vbCrLf
Next
```

## See also

[OnlineTrendControl \(Page 4045\)](#)

[TrendRulerControl \(Page 4110\)](#)

## GetRulerData

### Description

Returns the value of the called trend at the ruler position.

### Syntax

```
Expression.GetRulerData (ByVal RulerIndex As Long, pvValue As Variant, Optional pvTimeStamp As Variant, Optional pvFlags As Varian) Long
```

### Expression

Necessary. An expression which returns an object of the "Trend" type.

### Parameters

Parameters	Description
RulerIndex	0 =Ruler
pvValue	Value of X axis
pvTimeStamp	Time or value of the Y axis
pvFlags	Qualitycode

### Example

```
'VBS326
Dim ctrl
Dim objTrend
Dim objIOField1
Dim objIOField2
Dim rulvalue
Dim rultime
```

```
Set ctrl = ScreenItems( "Control1" )
Set objTrend = ctrl.GetTrend( "Trend 1" )
Set objIOField1 = ScreenItems( "I/O Field1" )
Set objIOField2 = ScreenItems( "I/O Field2" )
objTrend.GetRulerData 0, rulvalue, runtime
objIOField1.OutputValue = rulvalue
objIOField2.OutputValue = runtime
```

## See also

OnlineTrendControl (Page 4045)

## GetSelectedRow

### Description

Returns the selected row object of a table-based control as "ICCAxDataRow" type.

### Syntax

```
Expression.GetSelectedRow()
```

#### Expression

Necessary. An expression that returns an object of the "ScreenItem" type.

### Parameters

--

## Example

```
'VBS358
Dim ctrl
Dim lCellIndex
Dim lCellCount
Dim headingRow
Dim selectedRow
Set ctrl = ScreenItems("TableControl")
Set headingRow = ctrl.GetRow(0)
Set selectedRow = ctrl.GetSelectedRow
lCellCount = headingRow.CellCount
'enumerate and trace out column titles and cell texts
For lCellIndex = 1 To lCellCount
  HMIRuntime.trace headingRow.CellText(lCellIndex) & ": "
  HMIRuntime.trace selectedRow.CellText(lCellIndex)
  HMIRuntime.trace vbNewLine
Next
```

---

**Note**

When you use the "Get..." methods to access properties from the control object list rather than with the control object, you have to omit the prefix of the property with the name of the list.

For the "Row" listing, for example, you write "objRow.CellCount" instead of "objRow.RowCellCount".

---

**See also**

OnlineTrendControl (Page 4045)  
OnlineTableControl (Page 4037)  
TrendRulerControl (Page 4110)  
UserArchiveControl (Page 4130)  
AlarmControl (Page 3947)

**GetSelectedRows**

**Description**

Returns the selected row objects of a table-based control as type "ICCAxDataRow" for multiple selection.

**Syntax**

Expression.GetSelectedRows()

**Expression**

Necessary. An expression that returns an object of the "ScreenItem" type.

**Parameters**

--

**Example**

```
'VBS359  
Dim ctrl  
Dim lCellIndex  
Dim lCellCount  
Dim lRowIndex
```



```
Dim lRowCount
Dim headingRow
Dim selectedRow
Dim selectedRows
Set ctrl = ScreenItems("TableControl")
Set headingRow = ctrl.GetRow(0)
Set selectedRows = ctrl.GetSelectedRows
lCellCount = headingRow.CellCount
lRowCount = selectedRows.Count
'enumerate selected rows
For lRowIndex = 1 To lRowCount
  Set selectedRow = selectedRows(lRowIndex)
  HMIRuntime.Trace "Row number: " & CStr(lRowIndex) & vbNewLine
  'enumerate and trace out column titles and cell texts
  For lCellIndex = 1 To lCellCount
    HMIRuntime.trace headingRow.CellText(lCellIndex) & ": "
    HMIRuntime.trace selectedRow.CellText(lCellIndex)
    HMIRuntime.trace vbNewLine
  Next
Next
Next
```

---

**Note**

When you use the "Get..." methods to access properties from the control object list rather than with the control object, you have to omit the prefix of the property with the name of the list.

For the "Row" listing, for example, you write "objRow.CellCount" instead of "objRow.RowCellCount".

---

**See also**

[OnlineTrendControl \(Page 4045\)](#)  
[OnlineTableControl \(Page 4037\)](#)  
[TrendRulerControl \(Page 4110\)](#)  
[UserArchiveControl \(Page 4130\)](#)  
[AlarmControl \(Page 3947\)](#)

**GetStatisticAreaColumn****Description**

Returns the column object of the statistic area window of the evaluation window designated by name or index as "ICCAxRulerColumn" type.

## Syntax

```
Ausdruck.GetStatisticAreaColumn(ByVal vIndex As Variant)
```

## Expression

Necessary. An expression that returns an object of the "ScreenItem" type.

## Parameters

VARIANT

Parameters	Description
vIndex	Index or name of column of statistics area window.

## Example

```
'VBS327  
Dim ctrl  
Dim objStatAreaCol  
Set ctrl = ScreenItems("RulerControl")  
Set objStatAreaCol = ctrl.GetStatisticAreaColumn("DatasourceY")  
objStatAreaCol.Visible = FALSE  
Set objStatAreaCol = ctrl.GetStatisticAreaColumn("ValueY(LL)")  
objStatAreaCol.Sort = 1
```

---

### Note

When you use the "Get..." methods to access properties from the Control object list rather than with the Control object, you have to omit the prefix of the property with the name of the list.

For the "StatisticAreaColumn" listing, for example, you write "objStatAreaCol.Visible" instead of "objStatAreaCol.ColumnVisible".

---

## See also

[OnlineTrendControl \(Page 4045\)](#)

[TrendRulerControl \(Page 4110\)](#)

## GetStatisticAreaColumnCollection

### Description

Returns the list of all column objects of the statistic area window of the evaluation table as "ICCAxCollection" type.

### Syntax

```
Ausdruck.GetStatisticAreaColumnCollection()
```

#### Expression

Necessary. An expression that returns an object of the "ScreenItem" type.

### Parameters

--

### Features and functions of the ICCAxCollection

The following properties are available for the ICCAxCollection:

- Count
- Item

The following functions are available for the ICCAxCollection:

- AddItem(vName) As Object
- RemoveItem(vIndex)

### Example

```
'VBS328
Dim ctrl
Dim coll
Dim statcol
Set ctrl = ScreenItems("RulerControl")
Set coll = ctrl.GetStatisticAreaColumnCollection
HMIRuntime.Trace "Number of statistic Area columns:" & coll.Count & vbCrLf
For Each statcol In coll
  HMIRuntime.Trace statcol.Index & vbCrLf
  HMIRuntime.Trace statcol.Name & vbCrLf
  HMIRuntime.Trace statcol.Sort & vbCrLf
  HMIRuntime.Trace statcol.SortIndex & vbCrLf
Next
```

**See also**

OnlineTrendControl (Page 4045)

TrendRulerControl (Page 4110)

**GetStatisticResultColumn**

**Description**

Returns the column object of the statistic window of the evaluation window designated by name or index as "ICCAxRulerColumn" type.

**Syntax**

```
Ausdruck.GetStatisticResultColumn(ByVal vIndex As Variant)
```

**Expression**

Necessary. An expression that returns an object of the "ScreenItem" type.

**Parameters**

VARIANT

Parameters	Description
vIndex	Index or name of column of statistics window.

**Example**

```
'VBS329
Dim ctrl
Dim objStatResCol
Set ctrl = ScreenItems("RulerControl")
Set objStatResCol = ctrl.GetStatisticResultColumn("MaxValue")
objStatResCol.Visible = FALSE
Set objStatResCol = ctrl.GetStatisticResultColumn("Average")
objStatResCol.Sort = 2
```

---

**Note**

When you use the "Get..." methods to access properties from the Control object list rather than with the Control object, you have to omit the prefix of the property with the name of the list.

For the "StatisticResultColumn" listing, for example, you write "objStatResCol.Visible" instead of "objStatResCol.ColumnVisible".

---

**See also**

OnlineTrendControl (Page 4045)

TrendRulerControl (Page 4110)

**GetStatisticResultColumnCollection****Description**

Returns the list of all column objects of the statistic window of the evaluation table as "ICCAxCollection" type.

**Syntax**

```
Ausdruck.GetStatisticResultColumnCollection()
```

**Expression**

Necessary. An expression that returns an object of the "ScreenItem" type.

**Parameters**

--

**Features and functions of the ICCAxCollection**

The following properties are available for the ICCAxCollection:

- Count
- Item

The following functions are available for the ICCAxCollection:

- AddItem(vName) As Object
- RemoveItem(vIndex)

**Example**

```
'VBS330
Dim ctrl
Dim coll
Dim statcol
Set ctrl = ScreenItems("RulerControl")
Set coll = ctrl.GetStatisticResultColumnCollection
HMIRuntime.Trace "Number of statistic result columns:" & coll.Count & vbCrLf
For Each statcol In coll
  HMIRuntime.Trace statcol.Index & vbCrLf
  HMIRuntime.Trace statcol.Name & vbCrLf
  HMIRuntime.Trace statcol.Sort & vbCrLf
```

```
HMIRuntime.Trace statcol.SortIndex & vbCrLf  
Next
```

## See also

OnlineTrendControl (Page 4045)

TrendRulerControl (Page 4110)

## GetStatusbarElement

### Description

Returns the element of the control status bar designated as name or index as type "ICCAxStatusbarElement".

### Syntax

```
Ausdruck.GetStatusbarElement(ByVal vIndex As Variant)
```

### Expression

Required An expression that returns an object of the "ScreenItem" type.

### Parameters

VARIANT

Parameters	Description
vIndex	Index or name of status bar element.

### Example

```
'VBS331  
Dim ctrl  
Dim objStatusbar  
Set ctrl = ScreenItems( "Control1" )  
Set objStatusbar = ctrl.GetStatusbarElement(1)  
objStatusbar.Visible = FALSE  
Set objStatusbar = ctrl.GetStatusbarElement(3)  
objStatusbar.Width = 10
```

---

### Note

When you use the "Get..." methods to access properties from the Control object list rather than with the Control object, you have to omit the prefix of the property with the name of the list.

For the "StatusBarElement" listing, for example, you write "objStatusBar.Visible" instead of "objStatusBar.StatusbarElementVisible".

---

### See also

OnlineTrendControl (Page 4045)

OnlineTableControl (Page 4037)

TrendRulerControl (Page 4110)

UserArchiveControl (Page 4130)

FunctionTrendControl (Page 4004)

AlarmControl (Page 3947)

## GetStatusBarElementCollection

### Description

Returns the list of all status bar elements of the control as type "ICCAxCollection".

### Syntax

```
Ausdruck.GetStatusBarElementCollection()
```

### Expression

Required An expression that returns an object of the "ScreenItem" type.

### Parameters

--

## Features and functions of the ICCAxCollection

The following properties are available for the ICCAxCollection:

- Count
- Item

The following functions are available for the ICCAxCollection:

- AddItem(vName) As Object
- RemoveItem(vIndex)

## Example

```
'VBS332
Dim ctrl
Dim coll
Dim statelement
Set ctrl = ScreenItems.Item("Controll")
Set coll = ctrl.GetStatusBarElementCollection
HMIRuntime.Trace "Number of statusbar elements:" & coll.Count & vbCrLf
For Each statelement In coll
  HMIRuntime.Trace statelement.Name & vbCrLf
  HMIRuntime.Trace statelement.Width & vbCrLf
  HMIRuntime.Trace statelement.Text & vbCrLf
Next
```

---

### Note

When you use the "Get..." methods to access properties from the Control object list rather than with the Control object, you have to omit the prefix of the property with the name of the list.

For the "StatusBarElement" listing, for example, you write "statelement.Name" instead of "statelement.StatusBarElementName".

---

## See also

[OnlineTrendControl \(Page 4045\)](#)  
[OnlineTableControl \(Page 4037\)](#)  
[TrendRulerControl \(Page 4110\)](#)  
[UserArchiveControl \(Page 4130\)](#)  
[FunctionTrendControl \(Page 4004\)](#)  
[AlarmControl \(Page 3947\)](#)

## GetTimeAxis

### Description

Returns the time object that is specified by name or index for the f(t) trend view as "ICCAxTimeAxis" type.



## Syntax

```
Expression.GetTimeAxis(ByVal vIndex As Variant)
```

### Expression

Necessary. Expression that returns an object of the "ScreenItem" type.

## Parameters

VARIANT

Parameters	Description
vIndex	Index or name of time axis.

## Example

```
'VBS333
Dim ctrl
Dim objTimeAxis
Set ctrl = ScreenItems("OnlineTrendControl")
Set objTimeAxis = ctrl.GetTimeAxis(1)
objTimeAxis.Visible = FALSE
Set objTimeAxis = ctrl.GetTimeAxis("axis 2")
objTimeAxis.Label = "Time axis 2"
objTimeAxis.DateFormat = "dd.MM.yy"
objTimeAxis.TimeFormat = "HH:mm:ss.ms"
objTimeAxis.RangeType = 2
'The format to be used for date and time entries depends on the
'regional settings and language options in the operating system.
objTimeAxis.BeginTime = "06.04.2010 9:33:18"
'objTimeAxis.BeginTime = "04/06/2010 9:33:18"
objTimeAxis.MeasurePoints = 100
```

### Note

When you use the "Get..." methods to access properties from the control object list rather than with the control object, you have to omit the prefix of the property with the name of the list.

For the "TimeAxis" listing, for example, you write "objTimeAx.Visible" instead of "objTimeAx.TimeAxisVisible".

## See also

OnlineTrendControl (Page 4045)

## GetTimeAxisCollection

### Description

Returns a list of all time objects of the f(t) trend view as "ICCAxCollection" type.

### Syntax

```
Expression.GetTimeAxisCollection()
```

### Expression

Necessary. Expression that returns an object of the "ScreenItem" type.

### Parameters

--

## Features and functions of the ICCAxCollection

The following properties are available for ICCAxCollection:

- Count
- Item

The following functions are available for ICCAxCollection:

- AddItem(vName) As Object
- RemoveItem(vIndex)

## Example

```
'VBS334
Dim ctrl
Dim objTrendWnd
Dim objTimeAxis1
Dim objTimeAxis2
Dim objTrend
Set ctrl = ScreenItems("OnlineTrendControl")
Set objTrendWnd = ctrl.GetTrendWindowCollection.AddItem("myWindow")
Set objTimeAxis1 = ctrl.GetTimeAxisCollection.AddItem("TimeAxis2010")
Set objTimeAxis2 = ctrl.GetTimeAxisCollection.AddItem("TimeAxis2011")
objTimeAxis1.TrendWindow = objTrendWnd.Name
objTimeAxis1.Label = "2010"
objTimeAxis1.RangeType = 1
'The format to be used for date and time entries depends on the
'regional settings and language options in the operating system.
objTimeAxis1.BeginTime = "01.01.2010 0:00:00"
'objTimeAxis1.BeginTime = "01/01/2010 0:00:00"
objTimeAxis1.EndTime = "31.12.2010 11:59:59"
```

```
'objTimeAxis1.EndTime = "12/31/2010 11:59:59"
objTimeAxis2.TrendWindow = objTrendWnd.Name
objTimeAxis2.Label = "2011"
objTimeAxis2.RangeType = 1
objTimeAxis2.BeginTime = "01.01.2011 0:00:00"
'objTimeAxis2.BeginTime = "01/01/2011 0:00:00"
objTimeAxis2.EndTime = "31.12.2011 11:59:59"
'objTimeAxis2.EndTime = "12/31/2011 11:59:59"
Set objTrend = ctrl.GetTrendCollection.AddItem("myTrend1")
objTrend.TrendWindow = objTrendWnd.Name
objTrend.TimeAxis = objTimeAxis1.Name
Set objTrend = ctrl.GetTrendCollection.AddItem("myTrend2")
objTrend.TrendWindow = objTrendWnd.Name
objTrend.TimeAxis = objTimeAxis2.Name
```

---

### Note

When you use the "Get..." methods to access properties from the control object list rather than with the control object, you have to omit the prefix of the property with the name of the list.

For the "TimeAxis" listing, for example, you write "objTimeAxis1.Label" instead of "objTimeAxis1.TimeAxisLabel".

---

### See also

[OnlineTrendControl \(Page 4045\)](#)

### GetTimeColumn

#### Description

Returns the time column object of the table view designated by name or index as "ICCAxTime Column" type.

#### Syntax

```
Ausdruck.GetTimeColumn(ByVal vIndex As Variant)
```

#### Expression

Necessary. An expression that returns an object of the "ScreenItem" type.

## Parameters

VARIANT

Parameters	Description
vIndex	Index or name of time column.

## Example

```
'VBS335
Dim ctrl
Dim objTimeCol
Set ctrl = ScreenItems("TableControl")
Set objTimeCol = ctrl.GetTimeColumn("Timecolumn1")
objTimeCol.ShowDate = FALSE
Set objTimeCol = ctrl.GetTimeColumn("Timecolumn2")
objTimeCol.Visible = FALSE
```

---

### Note

When you use the "Get..." methods to access properties from the Control object list rather than with the Control object, you have to omit the prefix of the property with the name of the list.

For the "TimeColumn" listing, for example, you write "objTimeColumn.ShowDate" instead of "objTimeColumn.TimeColumnShowDate".

---

## See also

[OnlineTrendControl \(Page 4045\)](#)

[OnlineTableControl \(Page 4037\)](#)

## GetTimeColumnCollection

### Description

Returns the list of all time column objects of the table view as "ICCAxCollection" type.

### Syntax

```
Expression.GetTimeColumnCollection()
```

### Expression

Necessary. Expression that returns an object of the "ScreenItem" type.

## Parameters

--

## Features and functions of the ICCAxCollection

The following properties are available for ICCAxCollection:

- Count
- Item

The following functions are available for ICCAxCollection:

- AddItem(vName) As Object
- RemoveItem(vIndex)

## Example

```
'VBS336
Dim ctrl
Dim objTimeCol1
Dim objTimeCol2
Dim coll
Dim timecol
Set ctrl = ScreenItems("TableControl")
Set objTimeCol1 = ctrl.GetTimeColumnCollection.AddItem("TimeColumn2010")
Set objTimeCol2 = ctrl.GetTimeColumnCollection.AddItem("TimeColumn2011")
objTimeCol1.Caption = "2010"
objTimeCol1.RangeType = 1
'The format to be used for date and time entries depends on the
'regional settings and language options in the operating system.
objTimeCol1.BeginTime = "01.01.2010 0:00:00"
'objTimeCol1.BeginTime = "01/01/2010 0:00:00"
objTimeCol1.EndTime = "31.12.2010 11:59:59"
'objTimeCol1.EndTime = "12/31/2010 11:59:59"
objTimeCol2.Caption = "2011"
objTimeCol2.RangeType = 0
objTimeCol2.BeginTime = "01.01.2011 0:00:00"
'objTimeCol2.BeginTime = "01/01/2011 0:00:00"
objTimeCol2.TimeRangeFactor = 1
objTimeCol2.TimeRangeBase = 3600000
Set coll = ctrl.GetTimeColumnCollection
For Each timecol In coll
    timecol.Align = 1
    timecol.Length = 12
    timecol.BackColor = RGB(240,240,0)
    timecol.ForeColor = RGB(130,160,255)
Next
```

**See also**

OnlineTrendControl (Page 4045)

OnlineTableControl (Page 4037)

**GetToolBarButton**

**Description**

Returns the button function designated by name or index on the control toolbar as "ICCAxToolBarButton" type.

**Syntax**

```
Ausdruck.GetToolBarButton(ByVal vIndex As Variant)
```

**Expression**

Necessary. An expression that returns an object of the "ScreenItem" type.

**Parameters**

VARIANT

Parameters	Description
vIndex	Index or name of toolbar button function.

**Example**

```
'VBS337
Dim ctrl
Set ctrl = ScreenItems( "Control1" )
Dim toolbu
Set toolbu = ctrl.GetToolBarButton ("ShowHelp")
HMIRuntime.Trace "Name: " & toolbu.Name & vbCrLf
HMIRuntime.Trace "Index: " & toolbu.Index & vbCrLf
HMIRuntime.Trace "Hotkey: " & toolbu.HotKey & vbCrLf
```

---

**Note**

When you use the "Get..." methods to access properties from the control object list rather than with the control object, you have to omit the prefix of the property with the name of the list.

For the "ToolBarButton" listing, for example, you write "toolbu.Index" instead of "toolbu.ToolBarButtonIndex".

---

## See also

OnlineTrendControl (Page 4045)  
OnlineTableControl (Page 4037)  
TrendRulerControl (Page 4110)  
UserArchiveControl (Page 4130)  
FunctionTrendControl (Page 4004)  
AlarmControl (Page 3947)

## GetToolBarButtonCollection

### Description

Returns the list of all button functions of the control toolbar as "ICCAxCollection" type.

### Syntax

```
Ausdruck.GetToolBarButtonCollection()
```

#### Expression

Necessary. An expression that returns an object of the "ScreenItem" type.

### Parameters

--

## Features and functions of the ICCAxCollection

The following properties are available for the ICCAxCollection:

- Count
- Item

The following methods are available for the ICCAxCollection:

- AddItem(vName) As Object
- RemoveItem(vIndex)

## Example

```
'VBS338  
Dim ctrl  
Dim coll  
Dim toolbu  
Set ctrl = ScreenItems( "Control1" )
```

```
Set coll = ctrl.GetToolBarButtonCollection
HMIRuntime.Trace "Number of toolbar buttons:" & coll.Count & vbCrLf
For Each toolbu In coll
  HMIRuntime.Trace toolbu.Name & vbCrLf
  HMIRuntime.Trace "Hotkey: " & toolbu.HotKey & vbCrLf
  HMIRuntime.Trace "Authorization: " & toolbu.PasswordLevel & vbCrLf
Next
```

### See also

- OnlineTrendControl (Page 4045)
- OnlineTableControl (Page 4037)
- TrendRulerControl (Page 4110)
- UserArchiveControl (Page 4130)
- FunctionTrendControl (Page 4004)
- AlarmControl (Page 3947)

### GetTrend

#### Description

Returns the f(t) or f(x) trend view designated by name or index as "ICCAxTrend" or "ICCAxFunctionTrend" type.

#### Syntax

```
Ausdruck.GetTrend(ByVal vIndex As Variant)
```

#### Expression

Necessary. An expression that returns an object of the "ScreenItem" type.

#### Parameters

VARIANT

Parameters	Description
vIndex	Index or name of curve.

### Example for Runtime Professional

```
'VBS339
Dim ctrl
```



```
Dim objTrend
Set ctrl = ScreenItems("OnlineTrendControl")
Set objTrend = ctrl.GetTrend( "Trend 1" )
objTrend.PointStyle = 1
objTrend.LineWidth = 4
Set objTrend = ctrl.GetTrend(2)
objTrend.Provider = 1
objTrend.TagName = "Archive\ArchiveTag2"
```

---

**Note**

When you use the "Get..." methods to access properties from the control object list rather than with the control object, you have to omit the prefix of the property with the name of the list.

For the "Trend" listing, for example, you write "objTrend.PointStyle" instead of "objTrend.TrendPointStyle".

---

**See also**

[OnlineTrendControl \(Page 4045\)](#)

[FunctionTrendControl \(Page 4004\)](#)

**GetTrendCollection****Description**

Returns the list of all trends of the f(t) or f(x) trend view as "ICCAxCollection" type.

**Syntax**

```
Ausdruck.GetTrendCollection()
```

**Expression**

Necessary. An expression that returns an object of the "ScreenItem" type.

**Parameters**

--

## Features and functions of the ICCAxCollection

The following properties are available for the ICCAxCollection:

- Count
- Item

The following functions are available for the ICCAxCollection:

- AddItem(vName) As Object
- RemoveItem(vIndex)

## Example for Runtime Professional

```
'VBS340
Dim ctrl
Dim objTrendWnd
Dim objTimeAxis
Dim objValAxis
Dim objTrend
Set ctrl = ScreenItems("OnlineTrendControl")
Set objTrendWnd = ctrl.GetTrendWindowCollection.AddItem("myWindow")
Set objTimeAxis = ctrl.GetTimeAxisCollection.AddItem("myTimeAxis")
Set objValAxis = ctrl.GetValueAxisCollection.AddItem("myValueAxis")
objTimeAxis.TrendWindow = objTrendWnd.Name
objValAxis.TrendWindow = objTrendWnd.Name
Set objTrend = ctrl.GetTrendCollection.AddItem("myTrend1")
objTrend.Provider = 1
objTrend.TagName = "Archive\ArchiveTag1"
objTrend.TrendWindow = objTrendWnd.Name
objTrend.TimeAxis = objTimeAxis.Name
objTrend.ValueAxis = objValAxis.Name
```

---

### Note

When you use the "Get..." methods to access properties from the control object list rather than with the control object, you have to omit the prefix of the property with the name of the list.

For the "Trend" listing, for example, you write "objTrend.TagName" instead of "objTrend.TrendTagName".

---

## See also

[OnlineTrendControl \(Page 4045\)](#)

[FunctionTrendControl \(Page 4004\)](#)

## GetTrendWindow

### Description

Returns the trend view object of the f(t) trend view or the f(x) trend view designated by name or index as "ICCAxTrendWindow" type.

### Syntax

```
Ausdruck.GetTrendWindow(ByVal vIndex As Variant)
```

### Expression

Required An expression that returns an object of the "ScreenItem" type.

### Parameters

VARIANT

Parameters	Description
vIndex	Index or name of curve window.

### Example for Runtime Professional

```
'VBS341
Dim ctrl
Dim objTrendWnd
Set ctrl = ScreenItems("OnlineTrendControl")
Set objTrendWnd = ctrl.GetTrendWindow(1)
objTrendWnd.Visible = FALSE
Set objTrendWnd = ctrl.GetTrendWindow("trend window 2")
objTrendWnd.VerticalGrid = TRUE
objTrendWnd.FineGrid = TRUE
```

#### Note

When you use the "Get..." methods to access properties from the Control object list rather than with the Control object, you have to omit the prefix of the property with the name of the list.

For the "TrendWindow" listing, for example, you write "objTrendWnd.Visible" instead of "objTrendWnd.TrendWindowVisible".

## See also

OnlineTrendControl (Page 4045)

FunctionTrendControl (Page 4004)

## GetTrendWindowCollection

### Description

Returns the list of all trend window objects of the f(t) trend display or the f(x) trend display as "ICCAxCollection" type.

### Syntax

```
Ausdruck.GetTrendWindowCollection()
```

#### Expression

Required. An expression that returns an object of the "ScreenItem" type.

### Parameters

--

## Features and functions of the ICCAxCollection

The following properties are available for the ICCAxCollection:

- Count
- Item

The following functions are available for the ICCAxCollection:

- AddItem(vName) As Object
- RemoveItem(vIndex)

## Example for Runtime Professional

```
'VBS342
Dim ctrl
Dim objTrendWnd
Dim objTimeAxis
Dim objValAxis
Set ctrl = ScreenItems("OnlineTrendControl")
Set objTrendWnd = ctrl.GetTrendWindowCollection.AddItem("myWindow")
Set objTimeAxis = ctrl.GetTimeAxisCollection.AddItem("myTimeAxis")
Set objValAxis = ctrl.GetValueAxisCollection.AddItem("myValueAxis")
objTimeAxis.TrendWindow = objTrendWnd.Name
```

```
objValAxis.TrendWindow = objTrendWnd.Name
```

## See also

OnlineTrendControl (Page 4045)

FunctionTrendControl (Page 4004)

## GetValueAxis

### Description

Returns the value axis object of the f(t) trend view designated by name or index as "ICCAxValueAxis" type.

### Syntax

```
Ausdruck.GetValueAxis(ByVal vIndex As Variant)
```

### Expression

Necessary. An expression that returns an object of the "ScreenItem" type.

### Parameters

VARIANT

Parameters	Description
vIndex	Index or name of the value axis

### Example

```
'VBS343
Dim ctrl
Dim objValAxis
Set ctrl = ScreenItems("OnlineTrendControl")
Set objValAxis = ctrl.GetValueAxis(1)
objValAxis.Visible = FALSE
Set objValAxis = ctrl.GetValueAxis("axis 2")
objValAxis.Label = "Value axis 2"
objValAxis.ScalingType = 0
objValAxis.Precisions = 2
objValAxis.AutoRange = TRUE
```

---

**Note**

When you use the "Get..." methods to access properties from the Control object list rather than with the Control object, you have to omit the prefix of the property with the name of the list.

For the "ValueAxis" listing, for example, you write "objValueAx.Visible" instead of "objValueAx.ValueAxisVisible".

---

**See also**

OnlineTrendControl (Page 4045)

**GetValueAxisCollection**

**Description**

Returns the list of all value axis objects of the f(t) trend view as "ICCAxCollection" type.

**Syntax**

```
Ausdruck.GetValueAxisCollection()
```

**Expression**

Necessary. An expression that returns an object of the "ScreenItem" type.

**Parameters**

--

**Features and functions of the ICCAxCollection**

The following properties are available for the ICCAxCollection:

- Count
- Item

The following functions are available for the ICCAxCollection:

- AddItem(vName) As Object
- RemoveItem(vIndex)

## Example

```
'VBS344
Dim ctrl
Dim objTrendWnd
Dim objValAxis1
Dim objValAxis2
Dim objTrend
Set ctrl = ScreenItems("OnlineTrendControl")
Set objTrendWnd = ctrl.GetTrendWindowCollection.AddItem("myWindow")
Set objValAxis1 = ctrl.GetValueAxisCollection.AddItem("myValueAxis1")
Set objValAxis2 = ctrl.GetValueAxisCollection.AddItem("myValueAxis2")
objValAxis1.TrendWindow = objTrendWnd.Name
objValAxis1.Label = "Value1"
objValAxis2.TrendWindow = objTrendWnd.Name
objValAxis2.inTrendColor = TRUE
Set objTrend = ctrl.GetTrendCollection.AddItem("myTrend1")
objTrend.TrendWindow = objTrendWnd.Name
objTrend.ValueAxis = objValAxis1.Name
Set objTrend = ctrl.GetTrendCollection.AddItem("myTrend2")
objTrend.TrendWindow = objTrendWnd.Name
objTrend.ValueAxis = objValAxis2.Name
```

---

### Note

When you use the "Get..." methods to access properties from the Control object list rather than with the Control object, you have to omit the prefix of the property with the name of the list.

For the "ValueAxis" listing, for example, you write "objValueAxis1.Label" instead of "objValueAxis1.ValueAxisLabel".

---

## See also

[OnlineTrendControl \(Page 4045\)](#)

## GetValueColumn

### Description

Returns the value column object defined by name or index for the tabular view as "ICCAxValueColumn" type.

### Syntax

```
Expression.GetValueColumn(ByVal vIndex As Variant)
```

### Expression

Necessary. Expression that returns an object of the "ScreenItem" type.

### Parameters

VARIANT

Parameters	Description
vIndex	Index or name of the value column of the f(t) trend view.

### Example

```
'VBS345
Dim ctrl
Dim objValueColumn
Set ctrl = ScreenItems("TableControl")
Set objValueColumn = ctrl.GetValueColumn("Valuecolumn1")
objValueColumn.Precisions = 4
Set objValueColumn = ctrl.GetValueColumn(2)
objValueColumn.ExponentialFormat = TRUE
```

---

### Note

When you use the "Get..." methods to access properties from the control object list rather than with the control object, you have to omit the prefix of the property with the name of the list.

For the "ValueColumn" listing, for example, you write "objValueColumn.Precisions" instead of "objValueColumn.ValueColumnPrecisions".

---

### See also

[OnlineTrendControl \(Page 4045\)](#)

[OnlineTableControl \(Page 4037\)](#)

### GetValueColumnCollection

### Description

Returns the list of all value column objects of the f(t) trend view as "ICCAxCollection" type.



## Syntax

```
Ausdruck.GetValueColulmnCollection()
```

### Expression

Necessary. An expression that returns an object of the "ScreenItem" type.

## Parameters

--

## Features and functions of the ICCAxCollection

The following properties are available for the ICCAxCollection:

- Count
- Item

The following functions are available for the ICCAxCollection:

- AddItem(vName) As Object
- RemoveItem(vIndex)

## Example

```
'VBS346
Dim ctrl
Dim objValCol1
Dim objValCol2
Dim coll
Dim valcol
Set ctrl = ScreenItems("TableControl")
Set objValCol1 = ctrl.GetValueColumnCollection.AddItem("ValueColumn1")
Set objValCol2 = ctrl.GetValueColumnCollection.AddItem("ValueColumn2")
objValCol1.Caption = "Value Archive"
objValCol1.Provider = 1
objValCol1.TagName = "ProcessValueArchive\arch1"
objValCol1.TimeColumn = "TimeColumn1"
objValCol2.Caption = "Value Tag"
objValCol2.Provider = 2
objValCol2.TagName = "tagxx"
objValCol2.TimeColumn = "TimeColumn2"
Set coll = ctrl.GetValueColumnCollection
For Each valcol In coll
    valcol.Align = 2
    valcol.Length = 10
    valcol.AutoPrecisions = TRUE
Next
```

**See also**

OnlineTrendControl (Page 4045)

OnlineTableControl (Page 4037)

**GetXAxis**

**Description**

Returns the X axis object of the f(x) trend view designated by name or index as "ICCAxValueAxis" type.

**Syntax**

Ausdruck.GetXAxis (ByVal vIndex As Variant)

**Expression**

Necessary. An expression that returns an object of the "ScreenItem" type.

**Parameters**

VARIANT

Parameters	Description
vIndex	Index or name of X axis.

**Example**

```
'VBS347
Dim ctrl
Dim objXAx
Set ctrl = ScreenItems("FunctionTrendControl")
Set objXAx = ctrl.GetXAxis(1)
objXAx.Visible = FALSE
Set objXAx = ctrl.GetXAxis("axis 2")
objXAx.Label = "X axis 2"
objXAx.ScalingType = 0
objXAx.Precisions = 2
objXAx.Color = RGB(109,109,109)
```

---

**Note**

When you use the "Get..." methods to access properties from the Control object list rather than with the Control object, you have to omit the prefix of the property with the name of the list.

For the "XAxis" listing, for example, you write "objXAx.Visible" instead of "objXAx.XAxisVisible".

---

**See also**

OnlineTrendControl (Page 4045)

FunctionTrendControl (Page 4004)

**GetXAxisCollection**

**Description**

Returns the list of all X axis objects of the f(x) trend view as "ICCAxCollection" type.

**Syntax**

```
Ausdruck.GetXAxisCollection()
```

**Expression**

Necessary. An expression that returns an object of the "ScreenItem" type.

**Parameters**

--

**Features and functions of the ICCAxCollection**

The following properties are available for the ICCAxCollection:

- Count
- Item

The following functions are available for the ICCAxCollection:

- AddItem(vName) As Object
- RemoveItem(vIndex)

## Example

```
'VBS348
Dim ctrl
Dim objXAxis1
Dim objXAxis2
Dim coll
Dim axes
Set ctrl = ScreenItems("FunctionTrendControl")
Set objXAxis1 = ctrl.GetXAxisCollection.AddItem("myXAxis1")
objXAxis1.Label = "temperature"
Set objXAxis2 = ctrl.GetXAxisCollection.AddItem("myXAxis2")
objXAxis2.Label = "pressure"
Set coll = ctrl.GetXAxisCollection
HMIRuntime.Trace "Number of XAxis:" & coll.Count & vbCrLf
For Each axes In coll
    HMIRuntime.Trace axes.Name & vbCrLf
    HMIRuntime.Trace axes.Label & vbCrLf
Next
```

---

### Note

When you use the "Get..." methods to access properties from the Control object list rather than with the Control object, you have to omit the prefix of the property with the name of the list.

For the "XAxis" listing, for example, you write "objXAxis1.Label" instead of "objXAxis1.XAxisLabel".

---

## See also

[OnlineTrendControl \(Page 4045\)](#)

[FunctionTrendControl \(Page 4004\)](#)

## GetYAxis

### Description

Returns the Y axis object of the f(x) trend view designated by name or index as "ICCAxValueAxis" type.

### Syntax

```
Ausdruck.GetYAxis(ByVal vIndex As Variant)
```

**Expression**

Necessary. An expression that returns an object of the "ScreenItem" type.

**Parameters**

VARIANT

Parameters	Description
vIndex	Index or name of Y axis.

**Example**

```
'VBS349
Dim ctrl
Dim objYAx
Set ctrl = ScreenItems("FunctionTrendControl")
Set objYAx = ctrl.GetYAxis(1)
objYAx.Visible = FALSE
Set objYAx = ctrl.GetYAxis("axis 2")
objYAx.Label = "Y axis 2"
objYAx.Align = 0
objYAx.Precisions = 3
objYAx.EndValue = 90.000
objYAx.BeginValue = 10.000
```

**Note**

When you use the "Get..." methods to access properties from the Control object list rather than with the Control object, you have to omit the prefix of the property with the name of the list.

For the "YAxis" listing, for example, you write "objYAx.Visible" instead of "objYAx.YAxisVisible".

**See also**

[OnlineTrendControl \(Page 4045\)](#)

[FunctionTrendControl \(Page 4004\)](#)

**GetYAxisCollection****Description**

Returns the list of all Y axis objects of the f(x) trend view as "ICCAxCollection" type.

## Syntax

```
Ausdruck.GetYAxisCollection()
```

### Expression

Necessary. An expression that returns an object of the "ScreenItem" type.

## Parameters

--

## Features and functions of the ICCAxCollection

The following properties are available for the ICCAxCollection:

- Count
- Item

The following functions are available for the ICCAxCollection:

- AddItem(vName) As Object
- RemoveItem(vIndex)

## Example

```
'VBS350
Dim ctrl
Dim objYAxis1
Dim objYAxis2
Dim coll
Dim axes
Set ctrl = ScreenItems("FunctionTrendControl")
Set objYAxis1 = ctrl.GetXAxisCollection.AddItem("myYAxis1")
objYAxis1.Label = "temperature"
Set objYAxis2 = ctrl.GetXAxisCollection.AddItem("myYAxis2")
objYAxis2.Label = "pressure"
Set coll = ctrl.GetYAxisCollection
HMIRuntime.Trace "Number of YAxis:" & coll.Count & vbCrLf
For Each axes In coll
  HMIRuntime.Trace axes.Name & vbCrLf
  HMIRuntime.Trace axes.Label & vbCrLf
Next
```

---

**Note**

When you use the "Get..." methods to access properties from the Control object list rather than with the Control object, you have to omit the prefix of the property with the name of the list.

For the "YAxis" listing, for example, you write "objYAxis1.Label" instead of "objYAxis1.YAxisLabel".

---

**See also**

OnlineTrendControl (Page 4045)

FunctionTrendControl (Page 4004)

**Methods H-R**

**HideAlarm**

**Description**

Executes the "Hide alarm" button function of the alarm view.

**Syntax**

`Expression.HideAlarm()`

**Expression**

Necessary. An expression that returns an object of the "ScreenItem" type.

**Parameter**

--

**See also**

AlarmControl (Page 3947)

**InsertData**

**Description**

Adds data to the called trend.

## Syntax

Expression.InsertData(dblAxisX As Variant, dblAxisY As Variant)

### Expression

Necessary. An expression which returns an object of the "Trend" type.

## Parameters

Parameters	Description
dblAxisX	Value of X axis
dblAxisY	Value of Y axis

## Example

```
'VBS300
Dim lngFactor
Dim dblAxisX
Dim dblAxisY
Dim objTrendControl
Dim objTrend
Set objTrendControl = ScreenItems("Control1")
Set objTrend = objTrendControl.GetTrend("Trend 1")
For lngFactor = -100 To 100
dblAxisX = CDb1(lngFactor * 0.02)
dblAxisY = CDb1(dblAxisX * dblAxisX + 2 * dblAxisX + 1)
objTrend.InsertData dblAxisX, dblAxisY
Next
```

## Item

### Description

Returns an element from a list.

### Syntax

Expression.Item(Index)

### Expression

Necessary. An expression which returns a list.



## Parameters

### Index

The name or the index number of an element of the list:

- ScreenItems-Listing: Use an object name, e.g. "HmiRuntime.Screens(1).ScreenItems("Circle")", or the index number.
- Screens-Listing: Use either the name or the index number.
- SmartTags-Listing: You can only use the tag name as index in the SmartTags list. A counting of all tags is not possible.

If the transferred value does not correspond with an element in the list, an error occurs. The return value has the value "Nothing".

```
On Error Resume Next
Dim screen
Set screen = HmiRuntime.Screens("Screen_1")
If (screen is Nothing)
then...
Else...
End If
```

Best practice for optimizing auto-completion support is to use combined addressing by means of screen name and object name, e.g.

```
"HmiRuntime.Screens("Screen").ScreenItems("Circle")".
```

## Example

The item method is the default method for lists. Therefore, the results are the same for the following two examples:

```
'VBS_Example_Item
HMIRuntime.Screens.Item(1)
HMIRuntime.Screens(1)
```

Both instructions reference the respective base screen.

## See also

[ScreenItems \(list\) \(Page 3934\)](#)

[ScreenItem \(Page 3932\)](#)

## LockAlarm

### Description

Executes the "Disable alarm" button function of the alarm view.

### Syntax

```
Expression.LockAlarm()
```

#### Expression

Necessary. An expression that returns an object of the "ScreenItem" type.

### Parameter

--

### See also

AlarmControl (Page 3947)

## LoopInAlarm

### Description

Executes the "Loop in alarm" button function of the alarm view.

### Syntax

```
Expression.LoopInAlarm()
```

#### Expression

Necessary. An expression that returns an object of the "ScreenItem" type.

### Parameter

--

### See also

AlarmControl (Page 3947)

## MoveAxis

### Description

Executes the "Move axes area" button function of the f(t) and f(x) trend views.

### Syntax

```
Expression.MoveAxis()
```

#### Expression

Necessary. An expression that returns an object of the "ScreenItem" type.

### Parameter

--

### See also

OnlineTrendControl (Page 4045)

FunctionTrendControl (Page 4004)

## MoveToFirst

### Description

Executes the "First line" button function of the control.

### Syntax

```
Expression.MoveToFirst()
```

#### Expression

Necessary. An expression that returns an object of the "ScreenItem" type.

### Parameters

--

### See also

OnlineTrendControl (Page 4045)

OnlineTableControl (Page 4037)

UserArchiveControl (Page 4130)

## MoveToFirstLine

### Description

Executes the "First alarm" button function of the alarm view.

### Syntax

```
Ausdruck.MoveToFirstLine()
```

### Expression

Necessary. An expression that returns an object of the "ScreenItem" type.

### Parameter

--

### See also

AlarmControl (Page 3947)

## MoveToFirstPage

### Description

Executes the "First page" button function of the alarm view.

### Syntax

```
Ausdruck.MoveToFirstPage()
```

### Expression

Necessary. An expression that returns an object of the "ScreenItem" type.

### Parameter

--

### See also

AlarmControl (Page 3947)

## MoveToLast

### Description

Executes the "last data record" button function of the control.

### Syntax

```
Ausdruck.MoveToLast()
```

#### Expression

Necessary. An expression that returns an object of the "ScreenItem" type.

### Parameters

--

### See also

OnlineTrendControl (Page 4045)

OnlineTableControl (Page 4037)

UserArchiveControl (Page 4130)

## MoveToLastLine

### Description

Executes the "Last alarm" button function of the alarm view.

### Syntax

```
Ausdruck.MoveToLastLine()
```

#### Expression

Necessary. An expression that returns an object of the "ScreenItem" type.

### Parameters

--

### See also

AlarmControl (Page 3947)

## MoveToLastPage

### Description

Executes the "Last page" button function of the alarm view.

### Syntax

```
Ausdruck.MoveToLastPage ()
```

### Expression

Necessary. An expression that returns an object of the "ScreenItem" type.

### Parameter

--

### See also

AlarmControl (Page 3947)

## MoveToNext

### Description

Executes the "next data record" button function of the control.

### Syntax

```
Ausdruck.MoveToNext ()
```

### Expression

Necessary. An expression that returns an object of the "ScreenItem" type.

### Parameters

--

### See also

OnlineTrendControl (Page 4045)

OnlineTableControl (Page 4037)

UserArchiveControl (Page 4130)

## MoveToNextLine

### Description

Executes the "Next alarm" button function of the alarm view.

### Syntax

```
Ausdruck.MoveToNextLine()
```

#### Expression

Necessary. An expression that returns an object of the "ScreenItem" type.

### Parameter

--

### See also

AlarmControl (Page 3947)

## MoveToNextPage

### Description

Executes the "Next page" button function of the alarm view.

### Syntax

```
Ausdruck.MoveToNextPage()
```

#### Expression

Necessary. An expression that returns an object of the "ScreenItem" type.

### Parameter

--

### See also

AlarmControl (Page 3947)

## MoveToPrevious

### Description

Executes the "previous data record" button function of the control.

### Syntax

```
Ausdruck.MoveToPrevious()
```

### Expression

Necessary. An expression that returns an object of the "ScreenItem" type.

### Parameters

--

### See also

[OnlineTrendControl \(Page 4045\)](#)

[OnlineTableControl \(Page 4037\)](#)

[UserArchiveControl \(Page 4130\)](#)

## MoveToPreviousLine

### Description

Executes the "Previous alarm" button function of the alarm view.

### Syntax

```
Ausdruck.MoveToPreviousLine()
```

### Expression

Necessary. An expression that returns an object of the "ScreenItem" type.

### Parameter

--

### See also

[AlarmControl \(Page 3947\)](#)



## MoveToPreviousPage

### Description

Executes the "Previous page" button function of the alarm view.

### syntax

```
Ausdruck.MoveToPreviousPage()
```

### Expression

Necessary. An expression that returns an object of the "ScreenItem" type.

### Parameter

--

### See also

AlarmControl (Page 3947)

## NextColumn

### Description

Executes the "Next column" button function of the table view.

### Syntax

```
Ausdruck.NextColumn()
```

### Expression

Necessary. An expression that returns an object of the "ScreenItem" type.

### Parameter

--

### See also

OnlineTableControl (Page 4037)

## NextTrend

### Description

Executes the "Next trend" button function of the f(t) and f(x) trend views.

### Syntax

```
Ausdruck.NextTrend()
```

#### Expression

Necessary. An expression that returns an object of the "ScreenItem" type.

### Parameters

--

### See also

OnlineTrendControl (Page 4045)

FunctionTrendControl (Page 4004)

## OneToOneView

### Description

Executes the "Original view" button function of the f(t) and f(x) trend views.

### Syntax

```
Ausdruck.OneToOneView()
```

#### Expression

Necessary. An expression that returns an object of the "ScreenItem" type.

### Parameters

VARIANT

### See also

OnlineTrendControl (Page 4045)

FunctionTrendControl (Page 4004)

## PasteRows

### Description

Executes the "Insert rows" button function of the recipe view.

### Syntax

```
Expression.PasteRows()
```

#### Expression

Necessary. An expression that returns an object of the "ScreenItem" type.

### Parameter

--

### See also

UserArchiveControl (Page 4130)

## PreviousColumn

### Description

Executes the "Previous column" button function of the table view.

### Syntax

```
Ausdruck.PreviousColumn()
```

#### Expression

Necessary. An expression that returns an object of the "ScreenItem" type.

### Parameter

--

### See also

OnlineTableControl (Page 4037)

## PreviousTrend

### Description

Executes the "Previous trend" button function of the f(t) and f(x) trend views.

### Syntax

```
Ausdruck.PreviousTrend()
```

#### Expression

Necessary. An expression that returns an object of the "ScreenItem" type.

### Parameters

--

### See also

OnlineTrendControl (Page 4045)

FunctionTrendControl (Page 4004)

## Print

### Description

Executes the "Print" button function of the control.

### Syntax

```
Ausdruck.Print()
```

#### Expression

Necessary. An expression that returns an object of the "ScreenItem" type.

### Parameters

--

## See also

OnlineTrendControl (Page 4045)  
OnlineTableControl (Page 4037)  
TrendRulerControl (Page 4110)  
UserArchiveControl (Page 4130)  
FunctionTrendControl (Page 4004)  
AlarmControl (Page 3947)

## QuitHorn

### Description

Executes the "Acknowledge central alarm generator" button function of the alarm view.

### Syntax

```
Ausdruck.QuitHorn()
```

#### Expression

Necessary. An expression that returns an object of the "ScreenItem" type.

### Parameter

--

## See also

AlarmControl (Page 3947)

## QuitSelected

### Description

Executes the "Single acknowledgment" button function of the alarm view.

### Syntax

```
Ausdruck.QuitSelected()
```

#### Expression

Necessary. An expression that returns an object of the "ScreenItem" type.

**Parameter**

--

**See also**

AlarmControl (Page 3947)

**QuitVisible**

**Description**

Executes the "Group acknowledgment" button function of the alarm view.

**Syntax**

```
Ausdruck.QuitVisible()
```

**Expression**

Necessary. An expression that returns an object of the "ScreenItem" type.

**Parameter**

--

**See also**

AlarmControl (Page 3947)

**ReadTags**

**Description**

Executes the "Read tags" button function of the recipe view.

**Syntax**

```
Ausdruck.ReadTags()
```

**Expression**

Necessary. An expression that returns an object of the "ScreenItem" type.

**Parameter**

--

**See also**

UserArchiveControl (Page 4130)

**Read****Description of Tag Object**

Reads out the status of a tag (tag object) shortly after the moment it was called. At the same time, the tag object is provided with the values read. Upon reading a tag, its value, quality code and time stamp are determined. The "LastError" property can be used to determine whether the call was successful.

The "Name" and "Tagprefix" properties are not changed by this.

If the value of the tag is read successfully, the properties of the tag object are assigned the following values:

Property	Allocation
Value	Tag values
Name	Tag name (unchanged)
QualityCode	Quality level
Timestamp	Current tag time stamp
LastError	0
ErrorDescription	" "

If the value of the tag is not read successfully, the properties of the tag object are assigned the following values:

Property	Allocation
Value	VT_Empty
Name	Tag name (unchanged)
QualityCode	Bad Out of Service
Timestamp	0
LastError	Read operation error codes
ErrorDescription	Error description on LastError

**syntax**

```
Expression.Read([Readmode])
```

**Expression**

Necessary. An expression which returns a tag object. The return value of the Read method is the value of the tag read out.

## Parameters

The optional "Readmode" parameter enables the distinction between two types of reading:

Parameters	Description
0	The tag value is read from the process image (cache). 0 is the default value.
1	The value of a tag is read directly from AS or channel (direct).

If the "Readmode" parameter is omitted, the value is read from the process image by default. The return value of the Read method is the tag value read out as VARIANT.

## Reading From the Process Image

When reading from the process image, the tag is logged on and, from that moment, polled cyclically from the PLC. The login cycle is dependent on the configured trigger. The value is read from the tag image by WinCC. For Close Picture, the tag actions are ended again. The call is characterized by the following:

- The value is read by WinCC from the tag image.
- The call is faster in comparison to direct reading (except with the first call: The first call basically takes longer because the value from the PLC must be read out and logged on.)
- The duration of the call is not dependent on the bus load or AS.

### Behavior in actions with a tag trigger

All of the tags contained in the tag trigger are already known with Open Picture and are registered with the defined monitoring time. Since all tags are requested at once, the best possible optimization can be targeted from the channel. If a tag, contained in the trigger, is requested with Read during an action, the value already exists and is transferred directly to the call. If a tag is requested which is not contained in the trigger, the behavior is the same as with a standard trigger.

### Behavior in actions with a cyclic trigger

tags are registered with half of the cycle time with the first call. For every other call, the value is present.

### Behavior in event-driven actions

The tag is registered in the "upon change" mode with the first call. Process tags that are registered in the "upon change" mode correspond with a cyclic read job with a cycle time of 1s.

If an event (e.g. mouse click) requests a value asynchronously, the tag is transferred to the tag image. The tag is requested cyclically from the AS as of this point in time and therefore increases the basic load. To bypass this increase in the basic load, the value can also be read synchronously. The synchronous call causes a one-off increase in the communication load but the tag is not transferred to the tag image.



## Direct reading

In the case of direct reading, the current value is returned. The tag is not registered cyclically, the value is requested from the AS one time only. Direct reading has the following properties:

- The value is read explicitly from the AS.
- The call takes longer compared to reading from the process image.
- The duration of the call is dependent on the bus load and AS, amongst other things.

## Example

### Reading a tag directly from AS or channel

```
'VBS100
Dim objTag
Dim vntValue
Set objTag = HMIRuntime.Tags("Tagname")
vntValue = objTag.Read(1)      'Read direct
MsgBox vntValue
```

### Reading a tag from the process image

```
'VBS101
Dim objTag
Dim vntValue
Set objTag = HMIRuntime.Tags("Tagname")
vntValue = objTag.Read      'Read from cache
MsgBox vntValue
```

## Description of TagSet Object

The TagSet object offers the option of reading several tags in one call.

Functionality here is mostly identical with that of a tag object. In the following, only deviations thereof are described.

### Expression

Necessary. An expression which returns an object of type "TagSet".

## Reading From the Process Image

The TagSet object offers the advantage of requesting several tags in one read command. The tags are registered in the process image as a group, improving performance in the process.

## Direct reading

Since one call may process several read commands, performance is enhanced in comparison to single calls.

## Example

The following example shows how tags are included in the TagSet list, how tag values are imported and subsequently read.

```
'VBS174
Dim group
Set group = HMIRuntime.Tags.CreateTagSet
group.Add "Motor1"
group.Add "Motor2"
group.Read
HMIRuntime.Trace "Motor1: " & group("Motor1").Value & vbNewLine
HMIRuntime.Trace "Motor2: " & group("Motor2").Value & vbNewLine
```

If the optional parameter "Readmode" is set to 1, the process tags are not registered but read directly from AS or channel.

```
group.Read 1
```

## Refresh

### Description

Drawing all visible pictures again.

### syntax

```
Expression.Refresh
```

#### Expression

Necessary. An expression which returns a "Screens" or "Screen" type object.

### Parameter

--

## Examples

The first example forces all visible pictures to be drawn again:

```
'VBS149  
HMIRuntime.Screens.Refresh
```

The second example forces the basic picture to be immediately redrawn:

```
'VBS150  
HMIRuntime.Screens(1).Refresh
```

## See also

Screen (Page 3930)

HMIRuntime (Page 3922)

## Remove

### Description of TagSet Object

Removes a tag from the TagSet list. The tag may be removed by name or reference to a tag object.

### Syntax

```
Expression.Remove [Tag]
```

#### Expression

Required An expression that returns an object of type "TagSet".

### Parameters

VARIANT

Parameters	Description
Tag	Name of a WinCC tag or reference to a tag object to be removed from the list.

### Example

The following example shows how several tags are included in the TagSet list, and how to remove a tag again.

```
'VBS175
Dim group
Set group = HMIRuntime.Tags.CreateTagSet
group.Add "Motor1"
group.Add "Motor2"
group.Remove "Motor1"
```

### Description of DataSet Object

Deletes the element specified in parameter "Name" from a list.

### Syntax

Expression.Remove [Name]

#### Expression

Required An expression which returns an object of type "DataSet".

### Parameters

VARIANT

Parameters	Description
Name	Name of the object to be removed from the list.

### Example

The example shows how to remove the object "motor1" from the list.

```
'VBS166
HMIRuntime.DataSet.Remove("motor1")
```

### Description of objects Logging, AlarmLogs, DataLogs

The method deletes previously swapped-in log segments from the Runtime project.

Log segments that were deleted using the "Remove" method are removed from the "Common logging" folder of the project.

The call may require a somewhat longer time period, depending on the log data. This may block the processing of subsequent scripts. Blockage of actions within the picture may be

avoided if you start the call in a Global Scripting action, such as starting the action through a trigger tag.

The process of disconnecting and clearing logs creates a CPU load. This will affect performance.

---

**Note**

Calling up the "Remove" method is presently only possible at the server. There is an example, however, which shows how the method may be started by the client from a server.

---

## Syntax

### Objects Logging, AlarmLogs

```
Expression.Remove [TimeFrom] [TimeTo] [TimeOut] [ServerPrefix]
```

#### Expression

Required An expression that returns an object of type "Logging" or "AlarmLogs".

## Object DataLogs

```
Expression.Remove [TimeFrom] [TimeTo] [TimeOut] [Type] [ServerPrefix]
```

#### Expression

Required An expression that returns an object of type "DataLogs".

## Parameters

### TimeFrom

Point in time, from which the logs are to be cleared.

When specifying the time information, a short form is also possible. This is described in the "Time format" section.

### TimeTo

Time up to which log segments are to be cleared.

When specifying the time information, a short form is also possible. This is described in the "Time Format" section.

### Timeout

Timeout in milliseconds.

If you enter "-1" as a value, the wait will be infinite. If you enter a value of "0", there will be no wait.

### Type

Type of log.

The parameter can (optionally) be used only to delete log segments of the tag logging.

The following values can be entered:

Assigned value	Type	Description
1	hmiDataLogFast	Tag Logging Fast data
2	hmiDataLogSlow	Tag Logging Slow data
3	hmiDataLogAll	Tag Logging Fast and Slow data

**ServerPrefix**

Reserved for future versions.

**Return value**

If an error occurred during deletion of the log segments, the method will return an error alarm. Additional information may be found under the subject heading "Error alarms from database area".

**Time format**

The format for specifying time information is defined as follows: YYYY-MM-DD hh:mm:ss, where YYYY represents the year, MM the month, DD the day, hh the hour, mm the minute and ss the second. For example, the time of 2 minutes and one second past 11 o'clock on July 26, 2004 is displayed as follows: 2004-07-26 11:02:01.

For parameters "TimeFrom" and "TimeTo" the statement of data and time is also possible in short form. Not all format fields must be filled in this case. The short form means that the information on date and time may be lacking one or several parameters, beginning with the value for seconds. For example, the time may be specified in the "YYYY-MM" or "YYYY-MM-DD hh" format. Using the statement "TimeFrom" = "2004-09" and "TimeTo" = "2004-10-04" all log segments between September 2004 up to and including October 4.

**Example**

In the following example, log segments within a certain time period that were swapped in (again) after the fact are removed and the return value is output as a trace.

```
'VBS182
HMIRuntime.Trace "Ret: " & HMIRuntime.Logging.Remove("2004-08-22","2004-09-22",-1) &
vbNewLine
```

In the following example, all log segments that were swapped-in (again) after the fact are removed and the return value is output as a trace.

```
'VBS183
HMIRuntime.Trace "Ret: " & HMIRuntime.Logging.Remove("", "", -1) & vbNewLine
```

## See also

Logging (Page 3927)  
DataSet (list) (Page 3919)  
DataLogs (list) (Page 3918)  
AlarmLogs (list) (Page 3915)

## RemoveAll

### Description of TagSet Object

Deletes all tags from a TagSet list.

### syntax

```
Expression.RemoveAll
```

#### Expression

Necessary. An expression which returns an object of type "TagSet".

### Parameters

--

### Example:

The following example shows how several tags are included in the TagSet list, and how to remove all tags again.

```
'VBS176  
Dim group  
Set group = HMIRuntime.Tags.CreateTagSet  
group.Add "Motor1"  
group.Add "Motor2"  
group.RemoveAll
```

### Description of DataSet Object

Deletes all values or object references from a DataSet list.

### syntax

```
Expression.RemoveAll
```

### Expression

Necessary. An expression which returns an object of type "DataSet".

### Parameters

--

### Example:

The example shows how all objects are removed from the list.

```
'\VBS167  
HMIRuntime.DataSet.RemoveAll
```

### See also

[DataSet \(list\) \(Page 3919\)](#)

### Restore

#### Description of objects Logging, AlarmLogs, DataLogs

The method adds swapped-out log segments to the Runtime project.

Upon swapping-in, the log segments are copied to the "Common logging" folder of the project. Therefore the appropriate storage capacity must be available.

The call may require a somewhat longer time period, depending on the log data. This may block the processing of subsequent scripts. Blockage of actions within the picture may be avoided if you start the call in a Global Scripting action, such as starting the action through a trigger tag.

The connecting/copying of the logs generates a CPU load because the SQL server experiences additional load, especially if signature checking is activated. Copying of log segments will slow down hard disk access.

If signature checking is activated, an error message is returned if an unsigned or modified log is to be swapped in. There is always only one error alarm returned, even if several errors occurred during a swap-in process. Additionally, a WinCC system alarm is generated for each log segment. An entry is added to the Windows event viewer in the "Application" section. This provides the opportunity to check which log segments are creating the error.



- With an unsigned log, the return value "0x8004720F" is returned. The event viewer contains the entry "Validation of database <db\_name> failed! No signature found!". The log is swapped in.
- With a changed log, the return value "0x80047207" is returned. The event viewer contains the entry "Validation of database <db\_name> failed!". The log is not swapped in.

---

**Note**

Calling up the "Restore" method is presently only possible at the server. There is an example, however, which shows how the method may be started by the client from a server.

---

## Syntax

### Objects Logging, AlarmLogs

```
Expression.Restore [SourcePath] [TimeFrom] [TimeTo] [TimeOut]  
[ServerPrefix]
```

#### Expression

Required An expression that returns an object of type "Logging" or "AlarmLogs".

## Object DataLogs

```
Expression.Restore [SourcePath] [TimeFrom] [TimeTo] [TimeOut] [Type]  
[ServerPrefix]
```

#### Expression

Required An expression that returns an object of type "DataLogs".

## Parameters

### SourcePath

Path to log data.

### TimeFrom

Point in time, from which the logs are to be swapped in.

When specifying the time information, a short form is also possible. This is described in the "Time format" section.

### TimeTo

Time up to which log segments are to be swapped in.

When specifying the time information, a short form is also possible. This is described in the "Time Format" section.

**Timeout**

Timeout in milliseconds.

If you enter "-1" as a value, the wait will be infinite. If you enter a value of "0", there will be no wait.

**Type**

Type of log.

The parameter can (optionally) be used only to store log segments of the tag logging.

The following values can be entered:

Assigned value	Type	Description
1	hmiDataLogFast	Tag Logging Fast data
2	hmiDataLogSlow	Tag Logging Slow data
3	hmiDataLogAll	Tag Logging Fast and Slow data

**ServerPrefix**

Reserved for future versions.

**Return value**

If an error occurred while swapping in log segments, the method will return an error message. Additional information may be found under the subject heading "Error alarms from database area".

**Time format**

The format for specifying time information is defined as follows: YYYY-MM-DD hh:mm:ss, where YYYY represents the year, MM the month, DD the day, hh the hour, mm the minute and ss the second. For example, the time of 2 minutes and one second past 11 o'clock on July 26, 2004 is displayed as follows: 2004-07-26 11:02:01.

For parameters "TimeFrom" and "TimeTo" the statement of data and time is also possible in short form. Not all format fields must be filled in this case. The short form means that the information on date and time may be lacking one or several parameters, beginning with the value for seconds. For example, the statement may be in the form of "YYYY-MM" or "YYYY-MM-DD hh". Using the statement "TimeFrom" = "2004-09" and "TimeTo" = "2004-10-04" all log segments between September 2004 up to and including October 4.

**Example**

In the following example, all log segments since the start of the specified time period are swapped in again, and the return value is output as a trace.

```
'VBS184
HMIRuntime.Trace "Ret: " & HMIRuntime.Logging.Restore("D:\Folder","2004-09-14","", -1) &
vbNewLine
```

In the following example, all Tag Logging Slow log segments in the specified time period are swapped in again, and the return value is output as a trace.

```
'VBS185
HMIRuntime.Trace "Ret: " & HMIRuntime.Logging.DataLogs.Restore("D:\Folder", "2004-09-14
12:30:05", "2004-09-20 18:30", -1, 2) & vbNewLine
```

In the following example, all Alarm Logging log segments up to the specified time period are swapped in again, and the return value is output as a trace.

```
'VBS186
HMIRuntime.Trace "Ret: " & HMIRuntime.Logging.AlarmLogs.Remove("", "2004-09-20", -1) &
vbNewLine
```

## See also

Logging (Page 3927)  
DataLogs (list) (Page 3918)  
AlarmLogs (list) (Page 3915)

## Methods S-Z

### SelectAll

#### Description

Selects all rows in a table-based control.

#### Syntax

```
Expression.SelectAll()
```

#### Expression

Necessary. An expression that returns an object of the "ScreenItem" type.

#### Parameters

--

## See also

OnlineTableControl (Page 4037)

TrendRulerControl (Page 4110)

UserArchiveControl (Page 4130)

AlarmControl (Page 3947)

## SelectedStatisticArea

### Description

Executes the "Set statistics range" button function of the table view.

### Syntax

```
Ausdruck.SelectedStatisticArea()
```

#### Expression

Necessary. An expression that returns an object of the "ScreenItem" type.

### Parameter

--

## See also

OnlineTableControl (Page 4037)

## SelectRow

### Description

Selects a specific row in a table-based control.

### Syntax

```
Expression.SelectRow(ByVal IRow As Long, Optional bExtendSelection  
As Boolean)
```

#### Expression

Necessary. An expression that returns an object of the "ScreenItem" type.

## Parameters

Parameters	Description
IRow	Number of the row to be selected.
bExtendSelection	Indicates as an option whether the current selection will be extended. Is only relevant if multiple selections are possible.

## Example

- Row 1 is currently selected. If `SelectRow( 2, True )` is called, then row 1 and row 2 will be selected.
- Row 1 is currently selected. If `SelectRow( 2, False )` or `SelectRow( 2 )` is called without an optional parameter, then only row 2 will be selected.

## See also

[OnlineTableControl \(Page 4037\)](#)

[TrendRulerControl \(Page 4110\)](#)

[UserArchiveControl \(Page 4130\)](#)

[AlarmControl \(Page 3947\)](#)

## ServerExport

### Description

Executes the "Export log" button function of the recipe view.

### Syntax

```
Ausdruck.ServerExport()
```

### Expression

Necessary. An expression that returns an object of the "ScreenItem" type.

### Parameter

--

## See also

[UserArchiveControl \(Page 4130\)](#)

## ServerImport

### Description

Executes the "Import log" button function of the recipe view.

### Syntax

```
Ausdruck.ServerImport()
```

#### Expression

Necessary. An expression that returns an object of the "ScreenItem" type.

### Parameter

--

### See also

UserArchiveControl (Page 4130)

## ShowColumnSelection

### Description

Executes the "Select columns" button function of the table view.

### Syntax

```
Ausdruck.ShowColumnSelection()
```

#### Expression

Necessary. An expression that returns an object of the "ScreenItem" type.

### Parameter

--

### See also

OnlineTableControl (Page 4037)

## ShowComment

### Description

Executes the "Comment dialog" button function of the alarm view.

### Syntax

```
Ausdruck.ShowComment()
```

#### Expression

Necessary. An expression that returns an object of the "ScreenItem" type.

### Parameters

--

### See also

AlarmControl (Page 3947)

## ShowDisplayOptionsDialog

### Description

Executes the "Display options dialog" button function of the alarm view.

### Syntax

```
Ausdruck.ShowDisplayOptionsDialog()
```

#### Expression

Necessary. An expression that returns an object of the "ScreenItem" type.

### Parameter

--

### See also

AlarmControl (Page 3947)

## ShowEmergencyQuitDialog

### Description

Executes the "Single acknowledgment" button function of the alarm view.

### Syntax

```
Ausdruck.ShowEmergencyQuitDialog()
```

#### Expression

Necessary. An expression that returns an object of the "ScreenItem" type.

### Parameter

--

### See also

AlarmControl (Page 3947)

## ShowHelp

### Description

Executes the "Help" button function of the control.

### Syntax

```
Ausdruck.ShowHelp()
```

#### Expression

Necessary. An expression that returns an object of the "ScreenItem" type.

### Parameters

VARIANT



## See also

OnlineTrendControl (Page 4045)  
OnlineTableControl (Page 4037)  
TrendRulerControl (Page 4110)  
UserArchiveControl (Page 4130)  
FunctionTrendControl (Page 4004)  
AlarmControl (Page 3947)

## ShowHideList

### Description

Executes the "List of alarm to hide" button function of the alarm view.

### Syntax

```
Ausdruck.ShowHideList()
```

#### Expression

Necessary. An expression that returns an object of the "ScreenItem" type.

### Parameter

--

## See also

AlarmControl (Page 3947)

## ShowHitList

### Description

Executes the "Hitlist" button function of the alarm view.

### Syntax

```
Ausdruck.ShowHitList()
```

#### Expression

Necessary. An expression that returns an object of the "ScreenItem" type.

**Parameter**

--

**See also**

AlarmControl (Page 3947)

**ShowInfoText**

**Description**

Executes the "About dialog" button function of the alarm view.

**Syntax**

```
Ausdruck.ShowInfoText ()
```

**Expression**

Necessary. An expression that returns an object of the "ScreenItem" type.

**Parameter**

--

**See also**

AlarmControl (Page 3947)

**ShowLockDialog**

**Description**

Executes the "Lock dialog" button function of the alarm view.

**Syntax**

```
Ausdruck.ShowLockDialog ()
```

**Expression**

Necessary. An expression that returns an object of the "ScreenItem" type.

**Parameter**

--

**See also**

AlarmControl (Page 3947)

**ShowLockList**

**Description**

Executes the "Lock list" button function of the alarm view.

**Syntax**

```
Ausdruck.ShowLockList()
```

**Expression**

Necessary. An expression that returns an object of the "ScreenItem" type.

**Parameter**

--

**See also**

AlarmControl (Page 3947)

**ShowLongTermArchiveList**

**Description**

Executes the "Historical alarm list (long-term)" button function of the alarm view.

**Syntax**

```
Ausdruck.ShowLongTermArchiveList()
```

**Expression**

Necessary. An expression that returns an object of the "ScreenItem" type.

**Parameter**

--

**See also**

AlarmControl (Page 3947)

## ShowMessageList

### Description

Executes the "Alarm list" button function of the alarm view.

### Syntax

```
Ausdruck.ShowMessageList()
```

### Expression

Necessary. An expression that returns an object of the "ScreenItem" type.

### Parameter

--

### See also

AlarmControl (Page 3947)

## ShowPercentageAxis

### Description

Executes the "Relative axis" button function of the f(t) trend view.

### Syntax

```
Ausdruck.ShowPercentageAxis()
```

### Expression

Necessary. An expression that returns an object of the "ScreenItem" type.

### Parameter

--

### See also

OnlineTrendControl (Page 4045)

## ShowPropertyDialog

### Description

Executes the "Configuration dialog" button function of the control.

### Syntax

```
Ausdruck.ShowPropertyDialog()
```

#### Expression

Necessary. An expression that returns an object of the "ScreenItem" type.

### Parameters

VARIANT

### See also

[OnlineTrendControl \(Page 4045\)](#)

[OnlineTableControl \(Page 4037\)](#)

[TrendRulerControl \(Page 4110\)](#)

[UserArchiveControl \(Page 4130\)](#)

[FunctionTrendControl \(Page 4004\)](#)

[AlarmControl \(Page 3947\)](#)

## ShowSelectArchive

### Description

Executes the "Select data connection" button function of the recipe view.

### Syntax

```
Ausdruck.ShowSelectArchive()
```

#### Expression

Necessary. An expression that returns an object of the "ScreenItem" type.

### Parameter

--

**See also**

UserArchiveControl (Page 4130)

**ShowSelection**

**Description**

Executes the "Selection dialog" button function of the recipe view.

**Syntax**

```
Ausdruck.ShowSelection ()
```

**Expression**

Necessary. An expression that returns an object of the "ScreenItem" type.

**Parameter**

--

**See also**

UserArchiveControl (Page 4130)

**ShowSelectionDialog**

**Description**

Executes the "Selection dialog" button function of the alarm view.

**Syntax**

```
Ausdruck.ShowSelectionDialog()
```

**Expression**

Necessary. An expression that returns an object of the "ScreenItem" type.

**Parameter**

--

**See also**

AlarmControl (Page 3947)

## ShowSelectTimeBase

### Description

Executes the "Timebase dialog" button function of the recipe view.

### Syntax

```
Ausdruck.ShowSelectTimeBase()
```

#### Expression

Necessary. An expression that returns an object of the "ScreenItem" type.

### Parameter

--

### See also

UserArchiveControl (Page 4130)

## ShowShortTermArchiveList

### Description

Executes the "Historical alarm list (short-term)" button function of the alarm view.

### Syntax

```
Ausdruck.ShowShortTermArchiveList()
```

#### Expression

Necessary. An expression that returns an object of the "ScreenItem" type.

### Parameter

--

### See also

AlarmControl (Page 3947)

## ShowSort

### Description

Executes the "Sorting dialog" button function of the recipe view.

### Syntax

```
Ausdruck.ShowSort()
```

#### Expression

Necessary. An expression that returns an object of the "ScreenItem" type.

### Parameter

--

### See also

UserArchiveControl (Page 4130)

## ShowSortDialog

### Description

Executes the "Sorting dialog" button function of the alarm view.

### Syntax

```
Ausdruck.ShowSortDialog()
```

#### Expression

Necessary. An expression that returns an object of the "ScreenItem" type.

### Parameter

--

### See also

AlarmControl (Page 3947)



## ShowTagSelection

### Description

Executes the "Select data connection" button function of the control.

### Syntax

```
Ausdruck.ShowTagSelection()
```

#### Expression

Necessary. An expression that returns an object of the "ScreenItem" type.

### Parameters

--

### See also

OnlineTrendControl (Page 4045)

OnlineTableControl (Page 4037)

FunctionTrendControl (Page 4004)

## ShowTimebaseDialog

### Description

Executes the "Timebase dialog" button function of the alarm view.

### Syntax

```
Ausdruck.ShowTimebaseDialog()
```

#### Expression

Necessary. An expression that returns an object of the "ScreenItem" type.

### Parameter

--

### See also

AlarmControl (Page 3947)

## ShowTimeSelection

### Description

Executes the "Select time range" button function of the control.

### Syntax

```
Ausdruck.ShowTimeSelection()
```

### Expression

Necessary. An expression that returns an object of the "ScreenItem" type.

### Parameters

--

### See also

OnlineTrendControl (Page 4045)

OnlineTableControl (Page 4037)

FunctionTrendControl (Page 4004)

## ShowTrendSelection

### Description

Executes the "Select trends" button function of the f(t) and f(x) trend views.

### Syntax

```
Ausdruck.ShowTrendSelection()
```

### Expression

Necessary. An expression that returns an object of the "ScreenItem" type.

### Parameters

---

### See also

OnlineTrendControl (Page 4045)

OnlineTableControl (Page 4037)

FunctionTrendControl (Page 4004)

## StartStopUpdate

### Description

Executes the "Start" or "Stop" button function of the control.

### Syntax

```
Ausdruck.StartStopUpdate()
```

#### Expression

Necessary. An expression that returns an object of the "ScreenItem" type.

### Parameters

--

### See also

[OnlineTrendControl \(Page 4045\)](#)

[OnlineTableControl \(Page 4037\)](#)

[FunctionTrendControl \(Page 4004\)](#)

## Stop

### Description

Closes WinCC Runtime.

### Syntax

```
Expression.Stop
```

#### Expression

Required An expression which returns an "HMIRuntime" type object.

### Parameters

--

### See also

[HMIRuntime \(Page 3922\)](#)

## Trace

### Description

Returns a user-defined text through the operating system channel for debug alarms.

The methods HMIRuntime.Trace works only in a PC-based environment. The text transferred as parameter can be displayed using the diagnostics tools "GSC Diagnostics" or "ApDiag". You can use the "ShowSystemAlarm" system function if you need to run a trace without using external tools.

### Syntax

Expression.Trace"STRING"

#### Expression

Required An expression which returns an "HMIRuntime" type object.

### Parameters

#### STRING

The text which is issued as a debug alarm. The transferred text can be displayed using the diagnostics tools "GSC Diagnostics" or "ApDiag". You can use the "ShowSystemAlarm" system function if you need to run a trace without using external tools.

### Example

In the following example a debug alarm is issued:

```
'VBS example trace
HMIRuntime.Trace "Customized error message"
```

### See also

HMIRuntime (Page 3922)

## UnhideAlarm

### Description

Executes the "Unhide alarm" button function of the alarm view.

### Syntax

Ausdruck.UnhideAlarm()

**Expression**

Necessary. An expression that returns an object of the "ScreenItem" type.

**Parameter**

--

**See also**

AlarmControl (Page 3947)

**UnlockAlarm**

**Description**

Executes the "Unlock alarm" button function of the alarm view.

**Syntax**

```
Ausdruck.UnlockAlarm()
```

**Expression**

Necessary. An expression that returns an object of the "ScreenItem" type.

**Parameter**

--

**See also**

AlarmControl (Page 3947)

**UnselectAll**

**Description**

Removes all selections from the cells of a table-based control.

**Syntax**

```
Expression.UnselectAll()
```

**Expression**

Necessary. An expression that returns an object of the "ScreenItem" type.

## Parameters

--

## See also

[OnlineTableControl \(Page 4037\)](#)

[TrendRulerControl \(Page 4110\)](#)

[UserArchiveControl \(Page 4130\)](#)

[AlarmControl \(Page 3947\)](#)

## UnselectRow

### Description

Removes the selections from a specific cell of a table-based control.

### Syntax

```
Expression.UnselectRow(ByVal IRow As Long)
```

### Expression

Necessary. An expression that returns an object of the "ScreenItem" type.

## Parameters

Long

Parameters	Description
IRow	Number of the row to be selected.

## See also

[OnlineTableControl \(Page 4037\)](#)

[TrendRulerControl \(Page 4110\)](#)

[UserArchiveControl \(Page 4130\)](#)

[AlarmControl \(Page 3947\)](#)

## Write

### Description of Tag Object

Writes a value to a tag. The "LastError" property can be used to determine whether the call was successful.

If the value of the tag is set successfully, the properties of the tag object are assigned the following values:

Property	Allocation
Value	Tag values set by the user (unchanged)
Name	Tag name (unchanged)
QualityCode	Bad Out of Service
Timestamp	0
LastError	0
ErrorDescription	" "

If the value of the tag is not set successfully, the properties of the tag object are assigned the following values:

Property	Allocation
Value	Tag values set by the user (unchanged)
Name	Tag name (unchanged)
QualityCode	Bad Out of Service
Timestamp	0
LastError	Write operation error codes
ErrorDescription	Error description on LastError

### syntax

```
Expression.Write [Value],[Writemode]
```

#### Expression

Necessary. An expression which returns a tag object.

### Parameters

The value to be written can be transferred directly to the method as a parameter. If the parameter is not specified, the value in the "Value" property is used. The "Writemode" option parameter can be used to select whether the tag value should be written synchronously or asynchronously. If the "Writemode" parameter is not used, writing is performed asynchronously as its default value.

During the writing process, no information is supplied on the status of the tags.

The "Value" property contains the value which was set before or during the writing operation, therefore it may not correspond to the real current value of the tag. If the data on the tag should be updated, use the Read method.

Parameters	Description
Value (optional)	The tag value is specified. The specified value overwrites the value in the "Value" property in the tag object. The tag value is not specified. The tag receives the current value from the "Value" property of the tag object.
Writemode (optional)	0 or empty: The tag value is written asynchronously. 0 is the default value. 1: The tag value is written synchronously.

On asynchronous writing, it is written immediately into the tag image. The user does not receive any feedback if the value has been written in the programmable controller, too.

In the case of synchronous writing (direct to the PLC), the writing operation actually occurs when the PLC is ready to operate. The user receives a check-back message if the writing operation was not successful.

## Example

### Asynchronous writing

```
'VBS104
Dim objTag
Set objTag = HMIRuntime.Tags("Var1")
objTag.Value = 5
objTag.Write
MsgBox objTag.Value
```

or

```
'VBS105
Dim objTag
Set objTag = HMIRuntime.Tags("Var1")
objTag.Write 5
MsgBox objTag.Value
```

### Synchronous writing

```
'VBS106
Dim objTag
Set objTag = HMIRuntime.Tags("Var1")
objTag.Value = 5
objTag.Write ,1
MsgBox objTag.Value
```



or

```
'VBS107
Dim objTag
Set objTag = HMIRuntime.Tags("Var1")
objTag.Write 5, 1
MsgBox objTag.Value
```

## Description of TagSet Object

The TagSet object offers the option of writing several tags in one call.

Functionality here is mostly identical with that of a tag object. In the following, only deviations thereof are described.

### Expression

Necessary. An expression which returns an object of type "TagSet".

## Parameters

In order to write different values, the "Value" property of individual tag objects must be set, and write must be called thereafter without the "Value" parameter. Since the write commands are grouped into one call, it results in improved performance compared to single calls.

In a TagSet object, it is not possible to pass on a value using the "Write" method. Individual values must be set using the "Value" property of the individual tag objects.

## Example

The following example shows how tags are included in the TagSet list, how tag values are set and subsequently written.

```
'VBS173
Dim group
Set group = HMIRuntime.Tags.CreateTagSet
group.Add "Wert1"
group.Add "Wert2"
group("Wert1").Value = 3
group("Wert2").Value = 9
group.Write
```

If you set the optional parameter "Writemode" equal to 1, the process tags are written synchronously (directly to AS).

```
group.Write 1
```

## WriteTags

### Description

Executes the "Write tags" button function of the recipe view.

### Syntax

```
Expression.WriteTags ()
```

#### Expression

Necessary. An expression that returns an object of the "ScreenItem" type.

### Parameter

--

### See also

UserArchiveControl (Page 4130)

## ZoomArea

### Description

Executes the "Zoom area" button function of the f(t) and f(x) trend views.

### Syntax

```
Ausdruck.ZoomArea ()
```

#### Expression

Necessary. An expression that returns an object of the "ScreenItem" type.

### Parameters

--

### See also

OnlineTrendControl (Page 4045)

FunctionTrendControl (Page 4004)

## ZoomInOut

### Description

Executes the "Zoom +/-" button function of the f(t) and f(x) trend views.

### Syntax

```
Ausdruck.ZoomInOut()
```

#### Expression

Necessary. An expression that returns an object of the "ScreenItem" type.

### Parameters

--

### See also

OnlineTrendControl (Page 4045)

FunctionTrendControl (Page 4004)

## ZoomInOutTime

### Description

Executes the "Zoom time axis +/-" button function of the f(t) trend view.

### Syntax

```
Ausdruck.ZoomInOutTime()
```

#### Expression

Necessary. An expression that returns an object of the "ScreenItem" type.

### Parameter

--

### See also

OnlineTrendControl (Page 4045)

## ZoomInOutValues

### Description

Executes the "Zoom value axis +/-" button function of the f(t) trend view.

### Syntax

```
Ausdruck.ZoomInOutValues()
```

#### Expression

Necessary. An expression that returns an object of the "ScreenItem" type.

### Parameter

--

### See also

OnlineTrendControl (Page 4045)

## ZoomInOutX

### Description

Executes the "Zoom X axis +/-" button function of the f(x) trend view.

### Syntax

```
Ausdruck.ZoomInOutX()
```

#### Expression

Necessary. An expression that returns an object of the "ScreenItem" type.

### Parameters

--

### See also

FunctionTrendControl (Page 4004)

## ZoomInOutY

### Description

Executes the "Zoom Y axis +/-" button function of the f(x) trend view.

### Syntax

```
Ausdruck.ZoomInOutY()
```

#### Expression

Necessary. An expression that returns an object of the "ScreenItem" type.

### Parameters

--

### See also

FunctionTrendControl (Page 4004)

## ZoomMove

### Description

Executes the "Move trend area" button function of the f(t) and f(x) trend views.

### Syntax

```
Ausdruck.ZoomMove()
```

#### Expression

Necessary. An expression that returns an object of the "ScreenItem" type.

### Parameters

--

### See also

OnlineTrendControl (Page 4045)

FunctionTrendControl (Page 4004)

## 10.9 Mobile Wireless

### 10.9.1 Field of application of the Mobile Panel Wireless

#### Introduction

The Mobile Panel Wireless enables you to move through the plant without restrictions and with or without security technology. You can operate and monitor moving machine parts or the entire plant depending on the situation. You can plan, configure, simulate and extend wireless networks quickly and reliably.

The Mobile Panels Wireless are based on standardized WLAN technology and are specially tailored to the requirements of automation.

#### WLAN area

A WLAN area is the area of the plant in which the HMI device communicates with the PLC over a wireless local area network. The wireless coverage of the network has a sufficient signal strength in this area.

The WLAN of a plant is formed by the radio area of one or more Access Points.

#### Access Point

The Access Point serves as a gateway between the wireless and hard-wired network. The HMI device communicates with an Access Point via WLAN. You can operate the different machines or plants without annoying cables. The HMI device is connected to a network in which it communicates with a PLC via the access point.

#### Effective range

Safety-related operator input is only possible in a limited part of a WLAN area upstream of a machine or plant known as the effective range. One exception to this rule is the emergency stop, which works in the entire WLAN area.

The configured effective ranges are stored in the HMI device. The HMI device can only log on to a machine within the effective range. This also requires there no other HMI device is logged on in the same effective range.

To ensure clear logon and machine operator inputs, one effective range must not overlap another effective range.

#### Tags

Effective ranges are formed by the spatial assignment of tags to a machine or plant. Tags create a geometrical space which is relevant for logon to a machine. After logon you operate the machine using acknowledgement buttons.

A distinction is made between two types of tags:

- Transponder
- RFID tag

## Transponder

After successful logon to a machine, the spanned geometrical area will be monitored. The distance between the HMI device and the transponder can only be measured if the two devices are in the reception range of each other. When you leave the effective range, safety-related operator input of the machine with acknowledgment buttons is prevented.

## Zones in the transponder system

Zones are configurable objects within a transponder system. A zone is defined by the maximum distance from one or more transponders. In a hard-wired Mobile Panel, the length of the connection cable defines a zone around a connection box.

Zones are operating areas in which safety-related operator input is not possible. To enter a zone, you have to configure a screen change to the correct process picture.

## RFID tag

After successful logon to a machine, the spanned geometrical area is not monitored. Monitoring therefore calls for an additional organizational measure, for example: a light barrier or a protective fence. The protection area is separated from the plant by a security system. The protection area is the area in the plant in which you operate one or more machines in fail-safe operation. One or more RFID Tags are distributed within protection zones. The protection area is not a configurable object.

## 10.9.2 How does the transponder system work?

### Overview

To give a basic understanding of all this, the following section describes the interaction between:

- HMI device
- Zone
- Effective range
- Transponder

---

#### Note

You should always assign administrator rights or set up encryption to protect the project containing a Mobile Panel Wireless for fail-safe operation against unauthorized access.

---

### Principle of operation in the transponder system

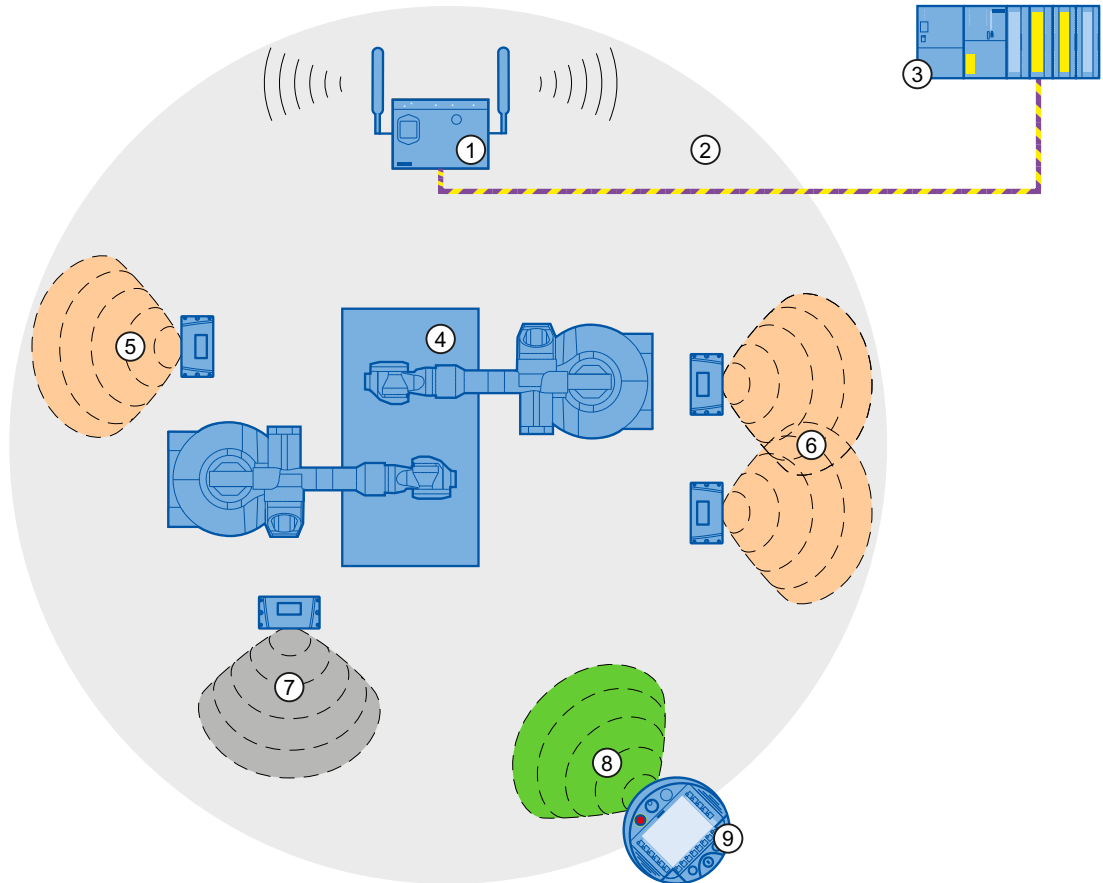

- 1 Access Point
- 2 WLAN of the Access Point
- 3 PLC
- 4 Plant
- 5 Effective range "Robot 1" with a transponder
- 6 Effective range "Robot 2" with two transponders
- 7 Zone "Zone 1" with a transponder
- 8 Radio area of the HMI device
- 9 HMI device

#### Example:

- A screen change is configured for "Zone 1".
- Transponder1 is assigned to the "Robot 2" effective range.
- The operator enters the radio cone of the transponder to receive the transponder ID.



- To log onto the machine "Robot 2", the operator presses the object "Effective range - Name".
- The "Effective range - Logon" dialog box opens. The operator enters the effective range ID and confirms with "OK". The dialog is closed.
- If the logon was successful, then the acknowledgement buttons will be active.
- The HMI device measures the distance from the transponder which is less than the configured distance of the effective range.

**Result:**

The operator is logged onto the machine "Robot 2". The operating element "Effective range - Name" is green and shows the name of the effective range "Robot 2".

If the HMI device is logged onto the effective range, then the following will apply:

- The operator may not leave the effective range without logging off. If the operator leaves the effective range without logging off for more than 30 seconds, a local rampdown will occur.
- No other HMI device can log onto the machine.

To log off from the machine, the operator presses the operating element "Effective range - Name". A logoff dialog is displayed. The operator confirms the dialog.

After successful logoff, another operator can log on to the machine "Robot2".

When the operator enters "Zone 1", a screen change will take place.

### 10.9.3 How does the RFID system work?

**Overview**

RFID stands for radio frequency identification. RFID allows wireless identification of objects without contact or visual sighting.

For a basic understanding, the following section describes the interaction between:

- HMI device
- Effective range (RFID)
- RFID tag

---

**Note****RFID Tags in the plant area**

You may only affix RFID Tags in restricted plant areas that are protected by additional protective measures, for example, protective railings.

---

### Principle of operation in the RFID system

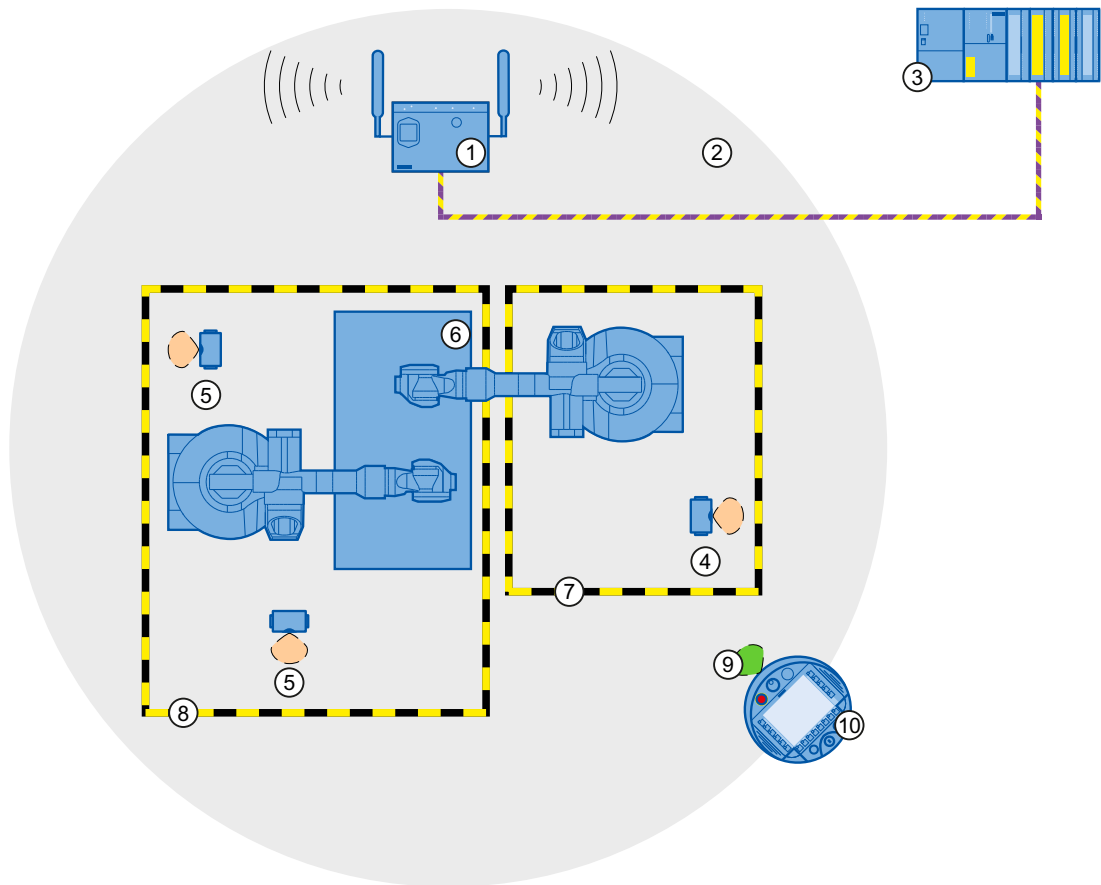

- ① Access Point
- ② WLAN of the Access Point
- ③ PLC
- ④ RFID tag with effective range (RFID) for logon to "Robot 1"
- ⑤ RFID tag with effective range (RFID) for logon to "Robot 2"
- ⑥ Plant
- ⑦ Protective area limit of the machine "Robot1"
- ⑧ Protective area limit of the machine "Robot2"
- ⑨ Radio area of the HMI device
- ⑩ HMI device

### Example:

- "RFID Tag1" is assigned to the effective range (RFID) "Robot1".
- An operator enters the restricted plant area. The operator manually switches to the screen with the configured operating element "Effective range - Name (RFID)".

- At "RFID Tag1", he presses the "Scan" button.  
During the logon operation, the button is yellow and displays the text "Scanning...".
- The "Effective range - Logon" dialog box opens. The operator enters the effective range (RFID) ID and confirms it with "OK". The dialog is closed.
- The "Confirmation of logon" dialog box opens. The operator confirms logon with the acknowledgment button.
- If logon was successful, the acknowledgement buttons are active.

### Result:

The operator is logged on to the machine "Robot 1" and operates the machine within the protection area in fail-safe operation. The operating element "Effective range - Name (RFID)" is green and shows the name of the effective range (RFID) "Robot1".

If the HMI device is logged on to the machine, the following applies:

- The user may not leave the protection area without logging off from the machine. If the operator leaves the protection area without logging off, a local rampdown occurs.
- No other HMI device can log on to this machine.

To log off from the machine, the operator presses the operating element "Effective range - Name (RFID)". A logoff dialog is displayed. The operator confirms the dialog.

After successful logoff, another operator can log on to the machine "Robot 1".

## 10.9.4 Configuring the Mobile Panel V2 for fail-safe operation

### 10.9.4.1 Configuration overview

#### Introduction

Additional steps in the TIA Portal are necessary before the configuration of the Mobile Panels V2 for fail-safe operation. This affects the following HMI devices:

- Mobile Panel 277F IWLAN V2
- Mobile Panel 277F IWLAN (RFID Tag)

#### Procedures overview

1. Creating PLC for fail-safe operation
2. Installing a general station description (GSD)
3. Creating a module from the GSD file
4. Creating a connection between a module from the GSD file and the PLC
5. Creating Mobile Panel V2 for fail-safe operation

## See also

- Creating Mobile Panel (Page 4875)
- Creating a module from the GSD file (Page 4871)
- Installing a general station description (GSD) (Page 4871)
- Creating PLC for fail-safe operation (Page 4870)
- Creating a connection between a module and the PLC (Page 4874)

### 10.9.4.2 Creating PLC for fail-safe operation

#### Requirement

A project is open

#### Procedure

1. Click "Add new device" in the project navigation.
2. Click "PLC" in the "Add new device" dialog.
3. Select a PLC for fail-safe operation, for example, CPU-315F-2PN/DP. The "Devices & Networks" editor opens.
4. Open the device view.
5. Select the device and click on "Device overview".
6. Select the device.
7. Click "Properties > PROFINET interface [X2] > Ethernet addresses > Interface connected with > Add new subnet" in the inspector window.
8. Enter the IP address under "IP protocol > Set IP address in the project".
9. Enter a time for "Properties > PROFINET interface [X2] > F parameter > Set default F monitoring time for F I/O of this interface".
10. Specify the properties for fail-safe operation in "Properties > Fail-safe"
  - "F-capability activated"
  - "Basis for PROFIsafe addresses"
11. Specify further properties for fail-safe operation as usual, for example, protection level.

#### Result

You have created a PLC in the project and made the settings for fail-safe operation.

## See also

- Configuration overview (Page 4867)

### 10.9.4.3 Installing a general station description (GSD)

#### Introduction

A GSD file (device master data file) contains all the IO device properties. The language used to describe the GSD files is GSDML (Generic Station Description Markup Language). Install a GSD file to expand the hardware catalog.

#### Requirement

- The "Devices & Networks" editor is open.
- The "Network view" is open.
- The GSD file is available on your PC.

The GSD file can be found online:

GSD file of Mobile Panel V2 for fail-safe operation (<http://support.automation.siemens.com/WW/view/de/19241467>)

#### Procedure

1. Click "Options > Install general station description (GSD)".
2. In the "Install general station description" dialog, choose the directory in which the GSD files are located.
3. Select the GSD file from the list.
4. Click the "Install" button.
5. To create a log file for the installation, click on the "Save log file" button.

#### Result

You have installed the GSD file. You can find the new devices installed by means of the GSD files in the hardware catalog under "Additional field devices > PROFINET". Any problems that occur during the installation can be traced using the log file.

#### See also

Configuration overview (Page 4867)

### 10.9.4.4 Creating a module from the GSD file

#### Requirements

- A PLC for fail-safe operation is created in the project e.g. CPU-315F-2PN/DP.
- The GSD file is installed.
- The "Network view" is opened in the "Devices & Networks" editor.

## Procedure

1. Open the hardware catalog.
2. Open the directory "Additional field devices > PROFINET-IO > HMI > Siemens AG > SIMATIC HMI > 277".
3. Now open the folder of the Mobile Panel V2 for fail-safe operation whose device type you also have as hardware:
  - Mobile Panel 277F IWLAN V2 or
  - Mobile Panel 277F IWLAN V2 (RFID tag)
4. For Mobile Panel 277F IWLAN V2, select the module with the order number 6AV6645-0EC01-0AX1.

- For Mobile Panel 277F IWLAN V2 (RFID tag), select the module with the order number 6AV6645-0EF01-0AX1.

### Note

The order number of the module in the GSD file has to match the order number of the Mobile Panel V2 in the software.

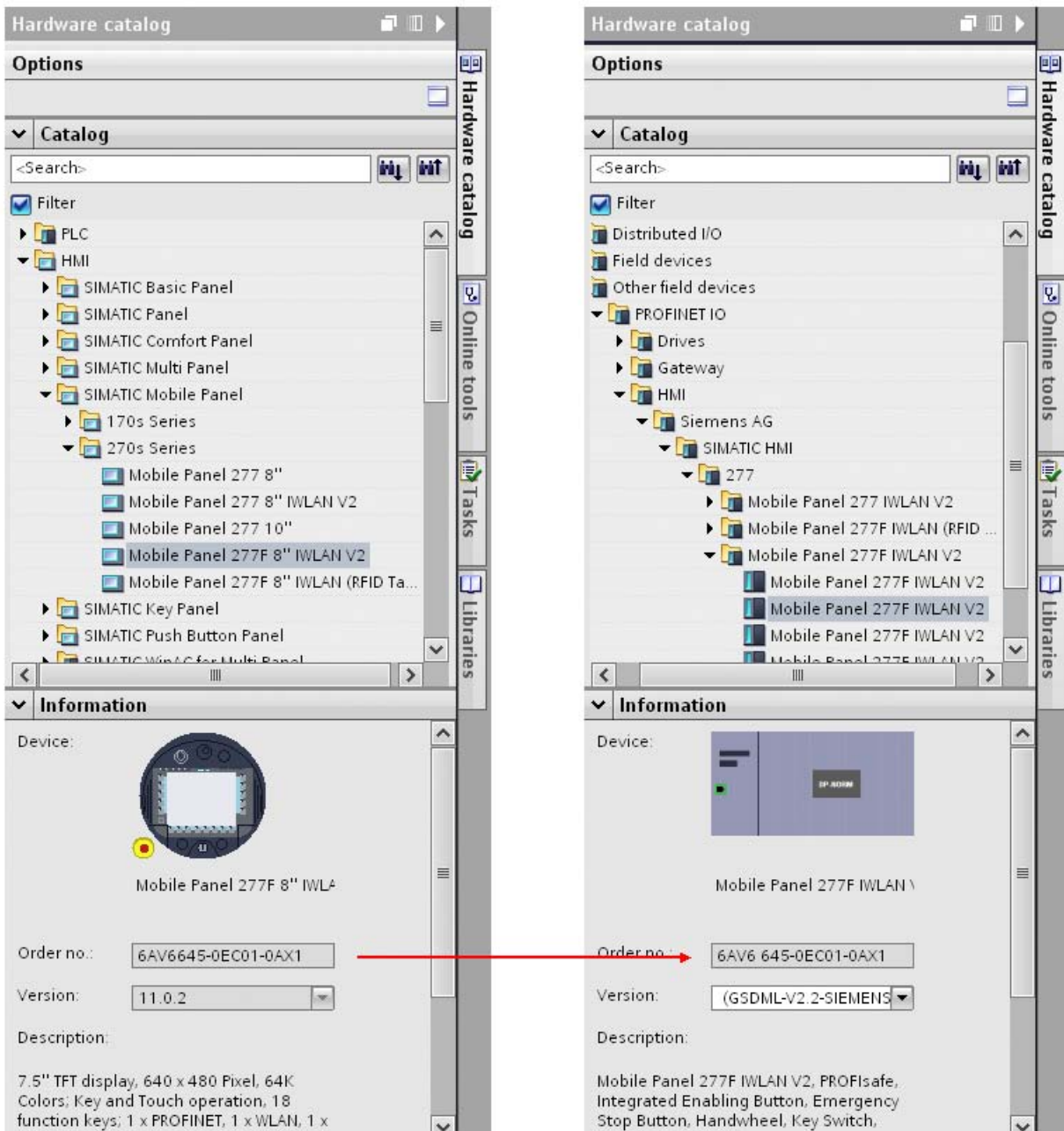

Figure 10-2 Left: Mobile Panel in the software. Right: Module in the GSD file

- Drag-and-drop the desired module into the network view.

## Result

You have created a module from the GSD file in your project.

## See also

PROFIsafe address (Page 4891)

Configuration overview (Page 4867)

### 10.9.4.5 Creating a connection between a module and the PLC

#### Requirements

- A PLC for fail-safe operation is created in the project e.g. CPU-315F-2PN/DP.
- The GSD file is installed.
- A module from the GSD file has been created.
- The "Devices & Networks" editor is open.

#### Procedure

1. Open the "Network view".
2. Select the module and right-click on "Not assigned". The shortcut menu is opened.
3. Select "Assign new IO controller". A dialog box opens.
4. Select the IO controller and confirm with OK. A connection is established.
5. Open the device view
6. Click on "Mobile277Failsafe\_IO\_1" in the device overview.
7. Specify the properties for fail-safe operation in the inspector window under "Properties > PROFIsafe":
  - "F-block ID"
  - "F-Source-Add"
  - "F-Dest-Add"
8. Click on the module in the device view.
9. Assign a name under "Properties > General > Name" in the inspector window.
10. Assign an IP address under "PROFINET interface [X1] > Ethernet addresses > IP protocol > Set IP address in the project".

## Result

The module from the GSD file is connected to the PLC. The module adopts the settings made in the PLC for PROFIsafe and PROFINET.



## See also

Configuration overview (Page 4867)

### 10.9.4.6 Creating Mobile Panel

#### Requirement

- The inspector window is open.
- A PLC for fail-safe operation is created in the project, for example, CPU-315F-2PN/DP.
- The GSD device is created in the project.

#### Inserting Mobile Panel into the project.

1. Click "Add new device" in the project navigation.
2. Click on "HMI" in the "Add new device" dialog.
3. Select a Mobile Panel V2 for fail-safe operation, for example, Mobile Panel 277F IWLAN V2. The device is inserted into the project.

---

#### Note

Select the corresponding Mobile Panel for the module already installed from the GSD file.

---

#### Defining properties

1. Open the "Devices and Networks" editor.
2. Open the "Device view".
3. Select the Mobile Panel in the work area.
4. Open "Properties > General" in the inspector window.
5. To facilitate assignment in the project, enter the name of the associated module under "Name".
6. Enter the same IP address as in the module under "Set IP address in the project".
7. Activate "Set IP address using a different method".

#### Result

Entering the same IP address as in the device enables error-free communication. Alternatively, you can set the IP address on the Mobile Panel after loading the project.

## See also

Configuration overview (Page 4867)

## 10.9.5 Basics

### 10.9.5.1 Zones

#### Introduction

The following section applies only to the Mobile Panels Wireless, e.g. Mobile Panel 277 IWLAN V2 and Mobile Panel 277F IWLAN V2. The "Zones" work area is only visible for these HMI devices.

---

#### Note

For more information refer to the operating instructions for the HMI device:

Complete documentation for Mobile Wireless (<http://support.automation.siemens.com/WW/view/en/26268960>)

---

#### Open

Depending on the HMI device selected, open the work area in the project window by double-clicking on "Zones" or "Zones and effective ranges".

#### Work area

The "Zones" work area displays the zones that have been set up and the transponders assigned to them.

#### Inspector window

When a zone is selected, you can edit the names, display names and the limits of the zone under the "General" category. The zone has the "On entry" and "On exit" zones. Assign the "ActivateScreen" system function to the events.

### 10.9.5.2 Zones working area

#### Introduction



The "Zones" work area displays the zones and the transponders assigned to them in table format. You create a list of transponders and assign certain transponders to a zone. The limit of the zone is defined by the maximum distance from the transponders.

## Principle

The work area consists of the "Zones" and "Transponders" tables.

Zones					
	Id	Name	Display name	Limit	Comment
	1	MixingPlant	MixingPlant	8	
	<Add new>				

Transponder (MixingPlant)					
	<input type="checkbox"/> Enable all	Id	Name	Zone	Comment
	<input checked="" type="checkbox"/>	1	Transponder 1	MixingPlant	
	<input checked="" type="checkbox"/>	2	Transponder 2	MixingPlant	
	<Add new>				

If you select a zone in the "Zones" table, the "Transponder" table displays the following:

- Transponder enabled: The transponder is assigned to the selected zone.
- Transponder deactivated: The transponder is not yet assigned to any zone.
- Transponder not available: The transponder has already been assigned to another zone. To undo the assignment, switch to the relevant zone and deactivate the transponder.

The zone and transponder IDs are initially assigned automatically. They can be changed, however.

Please note the following:

- A maximum of 254 zones may be configured.
- The zone ID must be unique and fall within the range from 1 - 254.
- You can initially configure transponders without assigning them to a zone.
- There may be no more than 255 transponders assigned to a zone.
- The transponder ID must be unique and fall within the range from 1 - 65534.

The transponder IDs are set on the transponder.

### 10.9.5.3 Effective ranges

#### Introduction

The following section applies only to the Mobile Panels Wireless that support fail-safe operation, e.g. Mobile Panel 277F IWLAN V2. The "Effective ranges" work area is only visible for these HMI devices.

You set up effective ranges in order to control safety related operations. An effective range is defined by the maximum distance from one or more transponders.

---

**Note**

For more information refer to the operating instructions for the HMI device:

Complete documentation for Mobile Wireless (<http://support.automation.siemens.com/WW/view/en/26268960>)

---

## Open

Open the work area in the project window by double-clicking on "Zones & effective ranges". Click the "Effective ranges" tab.

## Work area

The "Effective ranges" work area displays the effective ranges that have been set up and the transponders assigned to them.

## Inspector window

When an effective range is selected, you can edit the names, display names and the limits of the effective range under the "General" category.

When you select a transponder, you can see both the effective range and the zone that are assigned to that transponder. You can only assign a transponder to one effective range so that the effective ranges do not overlap.

### 10.9.5.4 Effective ranges working area

#### Introduction

The "Effective ranges" work area displays the effective ranges and their transponders in table format. You create a list of transponders and assign certain transponders to an effective range. The limit of the effective range is defined by the maximum distance from the transponders.

## Principle

The work area consists of the "Effective ranges" and "Transponders" tables.

Effective ranges					
Checksum:		0			
Id	Name	Display name	Limit	Comment	
1	MixingAxisControl	MixingAxisControl	5		
<Add new>					
Transponder (MixingAxisControl)					
<input type="checkbox"/>	Enable all	Id	Name	Effective range	Comment
<input checked="" type="checkbox"/>		1	Transponder 1	MixingAxisControl	
<Add new>					

The HMI device calculates a checksum from the local data so that the configured effective ranges and transponders reliably match those locally on the machine. The project cannot be started on the HMI device unless the local checksum agrees with the checksum stored in the "Effective ranges" editor.

When you select an effective range from the "Effective ranges" table, the "Transponder" table displays the following:

- Transponder enabled: The transponder is assigned to the selected effective range.
- Transponder deactivated: The transponder is not yet assigned to any effective range.
- Transponder not available: The transponder has already been assigned to another effective range. To undo the assignment, switch to the relevant effective range and deactivate the transponder.
- The zone assigned to the transponder is displayed in addition to the effective range.

The effective range and transponder IDs are initially assigned automatically. They can be changed, however.

Please note the following:

- A maximum of 127 effective ranges may be configured.
- The effective range ID must be unique and fall within the range from 1 - 127.
- The display name of an effective range must not be the same as its ID.
- You can initially configure transponders without assigning them to an effective range.
- There may be no more than 127 transponders assigned to an effective range.
- The transponder ID must be unique and fall within the range from 1 - 65534.

The transponder IDs are set on the transponder.

## Effective range in Runtime

To log on to the effective range in Runtime, only the display name of the effective range appears to the operator in the Runtime language. The operator reads the effective range ID in the plant and enters it on the HMI device. This ensures that the right machine operated. The acknowledgment buttons are activated after successful logon.

### 10.9.5.5 Effective ranges (RFID)

#### Introduction

The following section only applies to the Mobile Panel 277F IWLAN (RFID tag) which supports fail-safe operation with RFID. The "Effective ranges (RFID)" work area is only visible with these HMI devices.

To monitor safety-related operator inputs, you set up effective ranges (RFID).

---

#### Note

For more information, refer to the operating instructions of the HMI device:

Complete documentation for Mobile Wireless (<http://support.automation.siemens.com/WW/view/en/26268960>)

---

#### Open

Open the work area in the project window by double-clicking on "Effective ranges (RFID)".

#### Work area

The "Effective ranges (RFID)" work area displays the effective ranges that have been set up and the RFID Tags assigned to them.

#### Inspector window

When an effective range (RFID) is selected, you can edit the name, display name and ID of the effective range under the "General" category.

### 10.9.5.6 Work area for effective ranges (RFID)

#### Introduction

The "Effective ranges (RFID)" work area displays the effective ranges (RFID) and their RFID Tags in table format. You create a list of RFID Tags and assign specific RFID Tags to an effective range.

## Principle

The work area consists of the "Effective ranges (RFID)" and "RFID Tags" tables.

Effective ranges (RFID)				
Checksum:		<input type="text" value="0"/>	<input type="checkbox"/>	<input type="checkbox"/>
Id	Name	Display name ▲	Comment	
1	MixingAxisControl	MixingAxisControl		
<Add new>				
RFID tags (MixingAxisControl)				
<input type="checkbox"/>	Enable all	Id	Name	Effective range (RFID)
<input checked="" type="checkbox"/>		1	RFID Tag_1	MixingAxisControl
<Add new>				

The HMI device calculates a checksum from the local data so that the configured effective ranges (RFID) and RFID Tags reliably match those locally on the machine. The project cannot be started on the HMI device unless the local checksum agrees with the checksum stored in the "Effective ranges (RFID)" editor.

When you select an effective range (RFID) in the "Effective ranges (RFID)" table, the "RFID Tags" table displays the following:

- RFID Tag enabled: The RFID Tag is assigned to the selected effective range (RFID).
- RFID Tag disabled: The RFID Tag is not yet assigned to any effective range (RFID).
- RFID Tag not available: The RFID Tag has already been assigned to another effective range (RFID). To undo the assignment, switch to the relevant effective range (RFID) and deactivate the RFID Tag.

The IDs of the effective ranges (RFID) and RFID Tags are initially assigned automatically. They can be changed, however.

Please note the following:

- A maximum of 127 effective ranges (RFID) may be configured.
- The effective range (RFID) ID must be unique and fall within the range from 1 - 127.
- The display name of an effective range (RFID) must not be the same as its ID.
- You can initially configure RFID Tags without assigning them to an effective range (RFID).
- A maximum of 127 RFID Tags is available to assign to an effective range (RFID).
- The RFID Tag ID must be unique and fall within the range 1-65534.

The RFID Tag ID is written to the RFID Tag by the HMI device.

## Effective range in Runtime

To log on to the effective range (RFID) in Runtime, only the display name of the effective range (RFID) is displayed to the operator in the Runtime language. The operator reads the effective range (RFID) ID in the plant and enters it on the HMI device. This ensures that the right machine operated. The acknowledgment buttons are activated after successful logon.

## 10.9.6 Working with zones

### 10.9.6.1 Configuring a zone

#### Validity

The next section applies to all Mobile Panels Wireless, e.g. Mobile Panel 277 IWLAN.

#### Introduction

You will have to set up a zone in order to carry out plant-specific operator control and monitoring tasks.

#### Requirements

- A suitable editing language, e.g. English, must have been set in the "Project languages" editor.
- The "Zones" work area is open.

#### Procedure

1. Double-click "Add..." in the "Zones" table.
2. Enter the "MixingPlant" zone in the "Name" field.
3. Enter "MixingSystem" as the "Display name" for the zone at runtime. Enter zone "1" in the "ID" field.
4. Enter "8" meters as the zone "Limit".
5. Double-click "Add..." in the "Transponders" table.
6. Enter "Transponder 1" as the "Name" of the transponder.
7. Enter transponder "1" in the "ID" field.  
Then set transponder IDs on the transponder.
8. Enable the assignment of "Transponder 1".  
"Transponder 1" is assigned to the "MixingPlant" zone.
9. Repeat steps 6 to -9 accordingly for "Transponder 2".  
"Transponder 2" is assigned to the "MixingPlant" zone.



## Result

The "MixingPlant" zone is configured as two conical areas arranged at a distance of 8 meters, regardless of the effective ranges: one area around "Transponder 1" and one around "Transponder 2".

The screenshot shows two tables from the WinCC configuration interface. The top table, titled 'Zones', has columns for Id, Name, Display name, Limit, and Comment. It contains one entry for 'MixingPlant' with Id 1 and a Limit of 8. The bottom table, titled 'Transponder (MixingPlant)', has columns for Enable all, Id, Name, Zone, and Comment. It contains two entries: 'Transponder 1' with Id 1 and 'Transponder 2' with Id 2, both associated with the 'MixingPlant' zone. Both transponders have their 'Enable all' checkboxes checked.

Zones				
Id	Name	Display name	Limit	Comment
1	MixingPlant	MixingPlant	8	
<Add new>				

Transponder (MixingPlant)				
Enable all	Id	Name	Zone	Comment
<input checked="" type="checkbox"/>	1	Transponder 1	MixingPlant	
<input checked="" type="checkbox"/>	2	Transponder 2	MixingPlant	
<Add new>				

The display name designates the zone in the set editing language. An overview of the display names can be found in the "Project texts" editor.

### 10.9.6.2 Displaying the screen on entering a zone

#### Introduction

Configure a screen change when entering and leaving the zone.

#### Requirements

- A Mobile Panel which supports zones has been created, for example, Mobile Panel 277 IWLAN.
- The "MixingPlant" zone is configured.
- The "Plant\_1" screen has been created and opened.
- The "MixingPlant\_1" screen has been created and opened.
- The "Zones" work area is open.

#### Procedure

1. Select the "MixingPlant" zone from the "Zones" table.
2. Click "Properties> Events" in the Inspector window.
3. Click the event "On entry".

4. Select the "ActivateScreen" system function in the "function list".
5. Select "MixingPlant\_1" as the "Screen name".
6. Click the event "On exit".
7. Select the "ActivateScreen" system function in the function list.
8. Select "Plant\_1" as the "Screen name".

## Result

The "MixingPlant\_1" screen is displayed on the HMI device when you enter the "MixingPlant" zone. When you exit the zone, the "Plant\_1" screen appears once more.

### 10.9.6.3 Displaying an object in relation to the zone

## Validity

The following example is independent of the WLAN and applies to all Mobile Panels.

## Introduction

You configure an I/O field that is only visible within a specific zone.

## Requirements

- A Mobile Panel which supports zones has been created, for example, Mobile Panel 277 IWLAN.
- The "Zone\_id" variable of the "Int" data type has been created.
- A "Plant\_1\_Overview" screen has been created.

## Procedure

1. Open the "Runtime Settings > General" editor.
2. Select the "Zone\_id" tag as the "ID Zone/ Effective range".
3. Open the screen "Plant\_1\_Overview".
4. Drag and drop the "I/O box" object from the toolbox into the screen.
5. Click "Properties > Animations" in the Inspector window.
6. Click "Layout > Visibility."
7. Select "Zone\_id" as the "tag".
8. Select "from" 1 "to" 1 as the "Range".
9. Enable "Visible".

## Result

The IO field is only visible at runtime under the following conditions:

- The hard-wired Mobile Panel is connected to a connection box with ID = 1.
- The Mobile Panel Wireless is located in a zone with ID = 1, for example, the "MixingPlant" zone.

## 10.9.7 Working with effective ranges

### 10.9.7.1 Overview

#### Introduction

The following configuration guide describes the steps needed to set up an effective range for fail-safe operation on a Mobile Panel Wireless.

#### Procedures overview

1. Configuring the effective range:  
You configure the "MixingAxisControl" effective range as a conical area around "Transponder1 " at a distance of 5 meters.
2. Configuring the name of the effective range:  
To ensure logon to the effective range, configure the object "Effective range - Name".
3. Configuring additional effective range objects:  
Configure additional objects for displaying the position and signal strength within an effective range.
4. Set parameters for loading:
  - PROFIsafe communication
  - WLAN network
  - Power management
  - Interface
5. Configure the data channel
6. Configure network operation
7. Set the transponder
8. Commissioning effective ranges
9. Switching on and Testing the HMI device
10. Start loading manually
11. Acknowledging the effective range at the plant:  
You acknowledge the effective ranges and their transponders.

12. Determine the checksum
13. Load the project once again with checksum:  
Enter the checksum you have determined in the project and load the project once again.
14. Test effective range

---

**Note**

For detailed information on items 5 to 14, refer to the operating instructions of the HMI device.

Complete documentation for Mobile Wireless (<http://support.automation.siemens.com/WW/view/en/26268960>)

---

## 10.9.7.2 Configure effective range

### Introduction

You set up an effective range in order to control safety related operator input upstream of a machine or plant.

### Requirements

- A suitable editing language, e.g. English, must have been set in the "Project languages" editor.
- The "Effective ranges" work area is open.

### Procedure

1. Double-click "Add..." in the "Effective Ranges" table.
2. Enter "MixingAxisControl" as the "Name" of the effective range.
3. Enter "Mixing\_axis\_PLC" as the "Display name" for the effective range at runtime.
4. Enter effective range "1" in the "ID" field.  
Make sure that the effective range ID matches the ID on the machine.
5. Enter "5" meters as the "Limit" of the effective range.
6. Double-click "Add..." in the "Transponders" table.
7. Enter "Transponder 1" as the "Name" of the transponder.
8. Enter transponder "1" in the "ID" field.  
Then set transponder IDs on the transponder.
9. Enable the assignment of "Transponder 1".  
"Transponder 1" is assigned to the "MixingAxisControl" effective range.

## Result

You configure the "MixingAxisControl" effective range as a conical area around "Transponder 1" at a distance of 5 meters, regardless of the zones.

Id	Name	Display name	Limit	Comment
1	MixingAxisControl	MixingAxisControl	5	
<Add new>				

Enable all	Id	Name	Effective range	Comment
<input checked="" type="checkbox"/>	1	Transponder 1	MixingAxisControl	
<Add new>				

The display name designates the effective range in the set editing language. An overview of the display names can be found in the "Project texts" editor.

### 10.9.7.3 Configuring the effective range name

#### Introduction

Configure at least the "Effective range - Name" object so that an operator can log on and off a machine using an effective range. If you do not configure an effective range object for a Mobile Panel Wireless for fail-safe operation, a warning appears during generation.

#### Requirements

A screen has been created and opened.

#### Procedure

1. Select the "Effective range - Name" object from the "Advanced objects" category in the toolbox.
2. Drag and drop the "Effective range - Name" object from the toolbox into the screen.

## Result

If the operator clicks an object during runtime, he initiates logon or logoff of the HMI device to a machine that is assigned to an effective range.

## See also

Effective range name (Page 3152)

### 10.9.7.4 Configuring additional Mobile Wireless objects

#### Introduction

You will need to configure other objects in order to display further information about the effective range during testing, for example.

#### Requirements

A screen has been created and opened.

#### Procedure

1. Select the "Effective range - Signal" object from the "Elements" category in the toolbox.
2. Drag and drop the "Effective range - Signal" object from the toolbox into the screen.
3. Repeat steps 1 and 2 with the "WLAN - Reception" object.

#### Result

The "Effective range - Signal" object indicates how accurately the Mobile Panel Wireless is within an effective range. The "WLAN - Reception Quality" object displays the signal strength of the WLAN wireless connection.

## See also

Effective range signal (Page 3156)

WLAN reception (Page 3157)

### 10.9.8 Working with effective ranges (RFID)

#### 10.9.8.1 Overview

#### Validity

The next section applies only to Mobile Panels Wireless with RFID, for example, Mobile Panel 277F IWLAN (RFID Tag).

## Introduction

The following configuration guide describes the steps required to set up an effective range (RFID) for fail-safe operation on a Mobile Panel Wireless with RFID.

## Procedures overview

1. Configure effective range (RFID):  
You configure the effective range (RFID) "MixingAxisControl".
2. Configuring the name of the effective range (RFID):  
To ensure logon to the effective range, configure the object "Effective range - Name (RFID)".
3. Set parameters for loading
4. Configure the data channel
5. Configure network operation
6. Install RFID Tag in the plant
7. Turn on the HMI device and enable loading mode
8. Loading a project
9. Write the suitable IDs to the RFID Tags in the plant
10. Determine the checksum
11. Load the project once again with checksum:  
Enter the checksum you have determined in the project and load the project once again.
12. Test effective range (RFID)

---

### Note

For detailed information on items 4 to 12, refer to the operating instructions of the HMI device.

Complete documentation for Mobile Wireless (<http://support.automation.siemens.com/WW/view/en/26268960>)

---

## 10.9.8.2 Configuring effective range (RFID)

### Introduction

You set up an effective range (RFID) to control safety-related operator input upstream of a machine or plant.

### Requirements

- A suitable editing language, e.g. English, must have been set in the "Project languages" editor.
- The "Effective ranges (RFID)" work area is open.

### Procedure

1. Double-click "Add..." in the "Effective Ranges (RFID)" table.
2. Enter "MixingAxisControl" as the "Name" of the effective range (RFID).
3. Enter "MixingAxisControl" in the "Display name" field of the effective range (RFID).
4. Enter "1" in the "ID" field of the effective range (RFID).  
Make sure that the effective range (RFID)-ID matches the ID on the machine.
5. Double-click "Add..." in the "RFID Tag table.
6. Enter "RFID Tag 1" as the "Name" of the RFID Tag.
7. Enter "1" as the "ID" of the RFID Tag. Then set the RFID Tag-ID for the RFID Tag.
8. Enable the assignment of "RFID Tag 1".  
"RFID Tag 1" is assigned to the effective range (RFID) "MixingAxisControl".

### Result

The effective range (RFID) "MixingAxisControl" is configured.

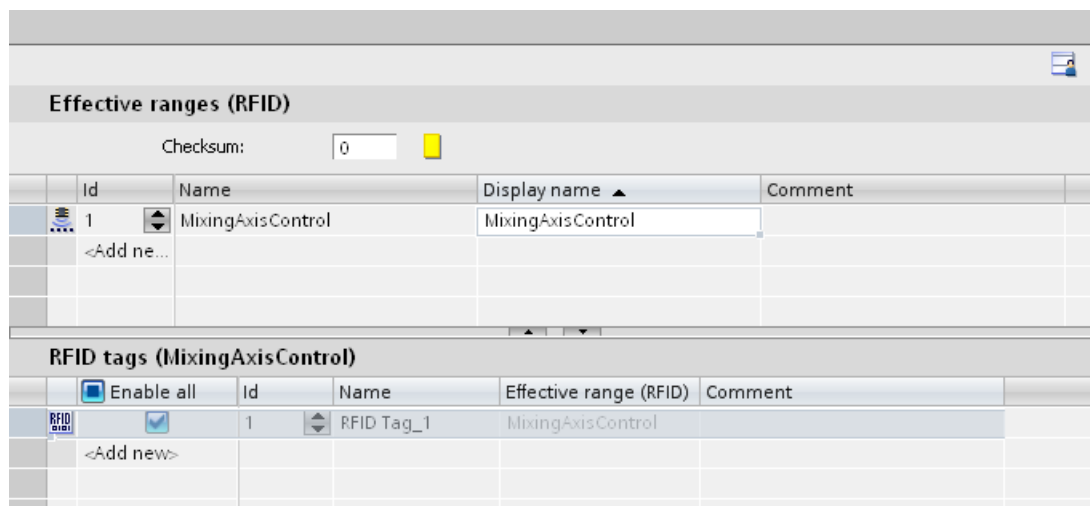

The display name describes the effective range (RFID) in the set editing language. An overview of the display names can be found in the "Project texts" editor.

#### 10.9.8.3 Configuring the effective range name (RFID)

##### Introduction

Configure the "Effective range - Name" object so that an operator can log on and off a machine using an effective range (RFID). If you do not configure the "Effective range-Name" object for a Mobile Panel Wireless RFID with (RFID), a warning will appear during generation.



## Requirements

A screen has been created and opened.

## Procedure

1. Select the "Effective range - Name (RFID)" object from "<Elements" in the toolbox.
2. Drag and drop the "Effective range - Name (RFID)" object from the toolbox into the screen.

## Result

If the operator clicks an object during runtime, he will initiate logon or logoff of the HMI device to a machine which has been assigned to an effective range (RFID).

## See also

Effective range name (RFID) (Page 3154)

## 10.9.9 Reference

### 10.9.9.1 PROFIsafe address

## Validity

The PROFIsafe address is only available for fail-safe operation for the Mobile Panel Wireless.

---

### Note

Additional information on fail-safe operation can be found in the operating instructions for the HMI device:

Complete documentation for Mobile Wireless (<http://support.automation.siemens.com/WW/view/en/26268960>)

---

## PROFIsafe address

The PROFIsafe address used for fail-safe I/Os in PROFIsafe communication is unique on the entire network and on all stations. On the Mobile Panel Wireless, you create a default value in the project and load it to the HMI device. You can also store a PROFIsafe address on the HMI device.

The PROFIsafe address fall within the range from 1 to 65534. The two PROFIsafe addresses (in the Engineering System and on the HMI device) are checked for formal validity.

The PROFIsafe address is loaded as follows at the start of Runtime:

## 10.9 Mobile Wireless

- You programmed a valid PROFIsafe address in the Control Panel.  
The HMI loads the PROFIsafe address set in the Control Panel.
- You did not program a valid PROFIsafe address in the Control Panel.  
The HMI loads the PROFIsafe address set in the project.

---

### Note

The invalid address 65.535 is programmed by default in the Control Panel of the HMI device. The HMI loads the address set in the project.

---

### See also

Power Management (Page 4892)

Zone ID / connection point ID (Page 4893)

### 10.9.9.2 Power Management

#### Validity

In the "Runtime Settings > Power Management" editor, configure the energy-saving mode of a Mobile Panel.

#### Power Management

The Mobile Panel Wireless can save energy in the following ways:

- Reduce brightness - minimal saving
- Switch off display - significant saving

You can also indicate after how long without operator input the power management function is enabled. The communication link is maintained. The time for "Switch monitor off" is longer than the time for "Reduce brightness".

### See also

PROFIsafe address (Page 4889)

### 10.9.9.3 Zone ID / connection point ID

#### Validity

In the "Runtime Settings > General" configure an internal tag which, depending on the value, shows specific information on the display of the HMI device.

---

#### Note

##### Mobile Panels Wireless with RFID

For Mobile Panels Wireless with RFID, the area "Zone ID / Connection point ID" is not available.

---

#### Zone ID / connection point ID

This field is used to configure an internal tag that contains the following value at runtime in relation to the type of HMI device:

- The ID of the connection box or effective range to which the hard-wired Mobile Panel is connected.
- The ID of the zone in which the Mobile Panel Wireless is located. If the value is set to 255, then the HMI device is not in any zone.

#### See also

PROFIsafe address (Page 4889)

## 10.10 Planning tasks

### 10.10.1 Field of application of the Scheduler

#### Definition

You can use the Scheduler to configure tasks to run independent of the screen in the background. You create tasks by linking system functions or scripts to a trigger. The linked functions will be called when the triggering event occurs.

#### Example of an application

The Scheduler is used to execute event-controlled tasks automatically. For example, you use a task to automate the following:

- Regular swap out of log data
- Printout of an alarm report when an alarm buffer overflow occurs
- Printout of a report at shift end
- Monitoring a tag
- Monitoring of a user change

---

#### Note

The availability of the listed examples is determined by the HMI device.

---

#### See also

Work area of the "Scheduler" editor (Page 4896)

## 10.10.2 Working with tasks and triggers

### Introduction

A task consists of a trigger and a task type.

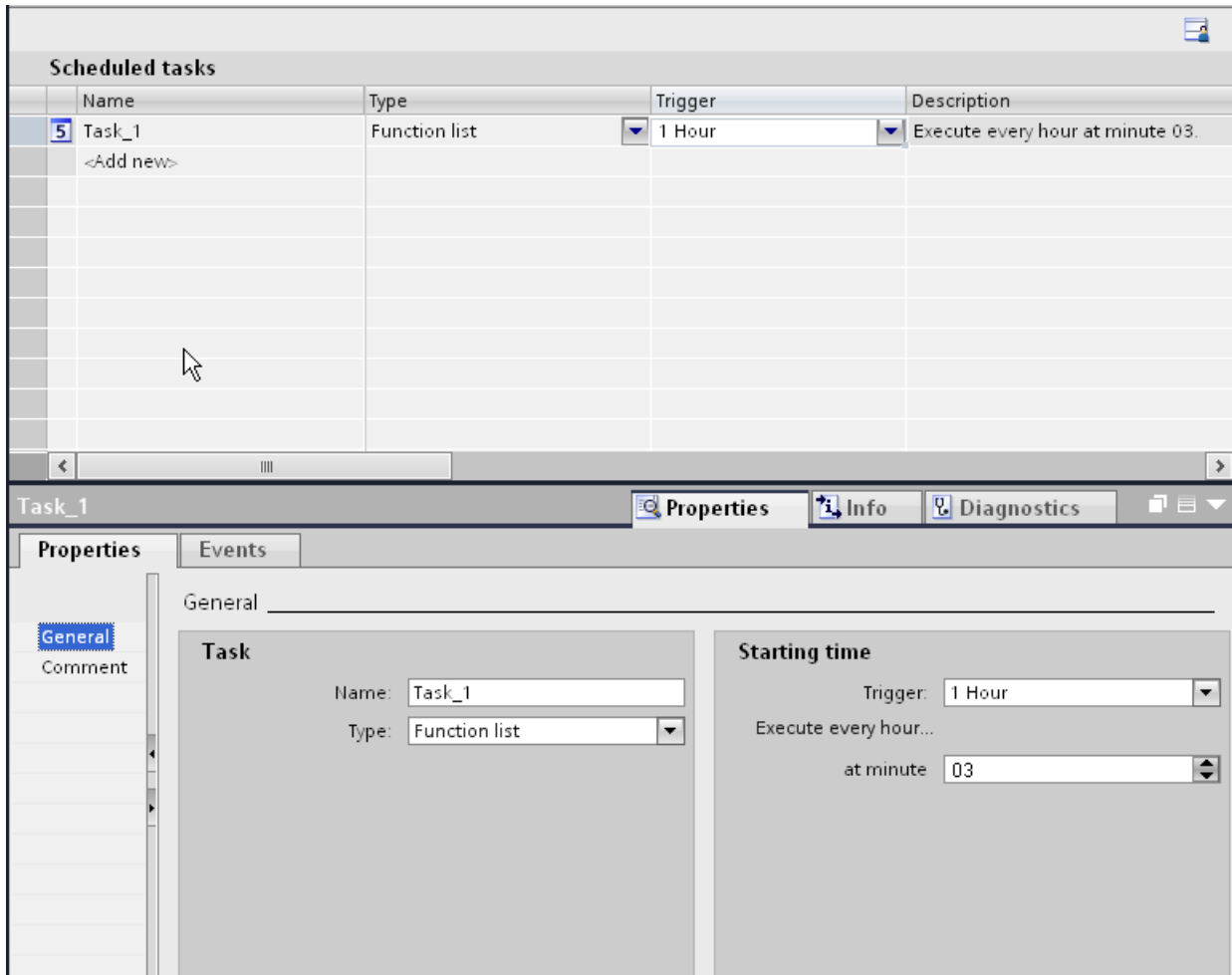

### Starting a task

Controlled by a trigger, the Scheduler starts the task linked to the trigger.

### 10.10.3 Basics

#### 10.10.3.1 Work area of the "Scheduler" editor

##### Introduction

Double-click on "Scheduler" to open it in the project view. The work area shows the scheduled tasks, which consist of the trigger and the task type, for example, the function list.

##### Structure

The work area consists of the table of jobs.

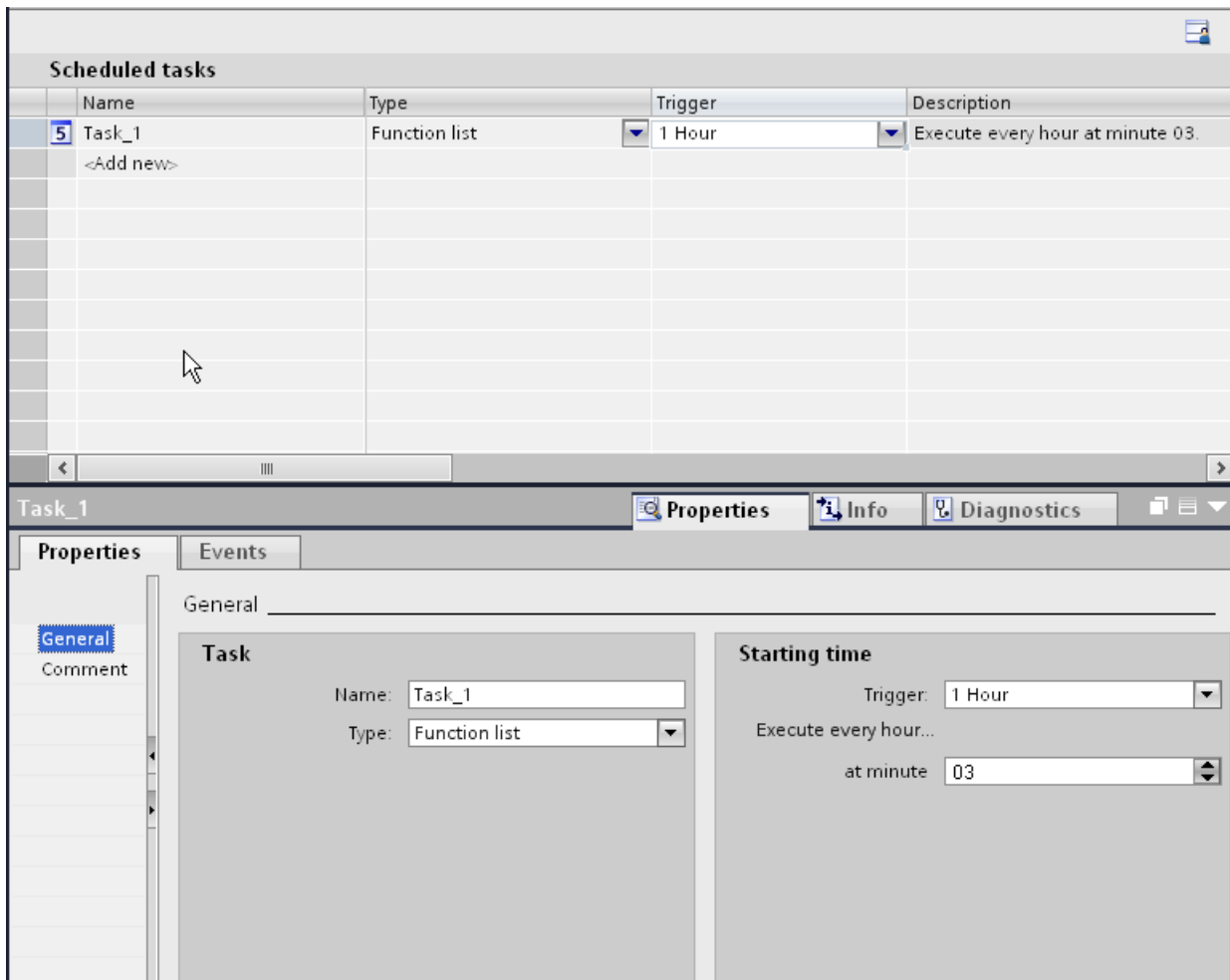

The table of tasks shows specified tasks with their properties, such as triggers. You select a task type and a trigger. You assign a name and a comment to the task. The description provides a written summary of the task including the timing for the task.

## Inspector window

The "Properties" tab of the Inspector window is split into two parts.

The "Job" area lists the name of the job and the job type. The "Starting time" area shows the trigger. The area is different depending on the trigger selected.

In the "Events" tab use the function list with system functions that will be executed in the task.

---

### Note

You can obtain more detailed information about the elements of the user interface using the tooltips. To do so, move the mouse pointer to the relevant object or press <F1> if the object has already been selected.

---

## See also

Field of application of the Scheduler (Page 4892)

Triggers (Page 4898)

### 10.10.3.2 Function list

#### Function list

A trigger starts the function list. The function list is executed line by line. Each line contains a system function. You can configure exactly one function list for each task.

---

### Note

The choice of configurable system functions in a function list depends on the selected trigger and the HMI device.

---

### 10.10.3.3 Function list

#### Function list

A trigger starts the function list. The function list is executed line by line. Each line contains a system function or a local script. You can configure exactly one function list for each task.

---

### Note

The choice of configurable system functions in a function list depends on the selected trigger and the HMI device.

---

## Processing of system functions and scripts

System functions and scripts in a function list are processed in Runtime sequentially from top to bottom.

Auto-Hotspot

Use a script with loops, conditional statements and abort conditions to program non-sequential and conditional procedures.

### 10.10.3.4 Triggers

## Triggers

### Introduction

A trigger is linked to a task and forms the triggering event which will call this task. The task is executed when the trigger occurs.

### Event trigger

When a task is linked to a system event, the task will be triggered by the event. System events include, for example, Runtime stop, screen change, user change, etc.

Each system event can only be configured once for each HMI device.

### Deactivating job

If you do not need a certain job temporarily, deactivate the job in the Engineering System. You also use the trigger "Deactivated" to make a previously configured system event available once again.

Example: Task "A" is planned with the system event "Shutdown". This system event is then no longer available for another task "B". Select "Disabled" as the trigger for task "A" to make the "Runtime stop" system event available again.

---

#### Note

The available triggers depend on the HMI device.

---

### See also

Work area of the "Scheduler" editor (Page 4894)



## Triggers

### Introduction

A trigger is linked to a task and forms the triggering event which will call this task. The task is executed when the trigger occurs.

### Types of triggers

The Scheduler recognizes different types of triggers:

#### Acyclic triggers

They consist of a specification for the date and time of day. Tasks with an acyclic trigger are performed once by the Scheduler on the specified date and at the specified time.

#### Cyclic triggers

Tasks linked to a cyclic trigger occur regularly at a specific point in time.

- **Standard cycle:** With a standard cycle, the beginning of the first interval coincides with the start of Runtime. The length of the interval is determined by the cycle.
- **Trigger with defined starting time:** You specify a start time and a time interval. You can use cyclic triggers to perform tasks on a daily or weekly basis, for example. For example, you can select a "Weekly" trigger to specify a week as the interval. You specify the beginning of the interval with the day of the week and the time of day.

---

#### Note

##### User-defined cycles

You have defined your own cycles. You can only use cycles in the Scheduler whose maximum value amounts to one hour.

---

### Event trigger

When a task is linked to a system event, the task will be triggered by the event. In contrast to cyclic triggers, system events usually occur acyclically. A Runtime stop is a system event, for example.

Each system event can only be configured once for each HMI device.

### Deactivating job

If you do not need a certain job temporarily, deactivate the job in the Engineering System. You also use the trigger "Deactivated" to make a previously configured system event available once again.

## 10.10 Planning tasks

Example: Task "A" is planned with the "User change" system event. This system event is then no longer available for another task "B". Select "Disabled" as the trigger for task "A" to make the "User change" system event available again.

---

### Note

The available triggers depend on the HMI device.

---

## Timers for cyclic triggers

### Timers for cyclic and acyclic triggers

You have the option to change the start time of a task dynamically in Runtime. You can select an HMI variable as the timer. The value of the tag determines the start time for the task during Runtime.

---

### Note

An HMI tag must be of the type "DateTime". A PLC tag must be of the type "Date and Time" or "DTL".

---

As long as the operator does not change the tag after Runtime starts, the start time configured in the task is valid. As soon as the operator enters a change to the tag, the current value of the tag is always the start time. To reset the configured time as the start time, the operator has to enter the configured time again.

## 10.10.4 Planning jobs

### 10.10.4.1 Planning tasks with acyclic triggers

#### Introduction

You are planning a one-time Runtime stop for maintenance work. The task starts a function which requires Runtime to stop.

#### Requirements

- The "Scheduler" editor is open.
- The Inspector window is open.

## Procedure

1. Click "Add..." in the table of the task area.
2. Enter "Maintenance at end of year" as the "Name."
3. Select "Once" as the "Trigger."
4. Select "31.12.2008" in the "Properties > Properties > General > on" field of the Inspector window.
5. Enter the time "18:00" in the "at" field.
6. Click "Properties > Events" in the Inspector window.
7. Select the "StopRuntime" system function in the function list.
8. Select "Runtime" as the "Mode".

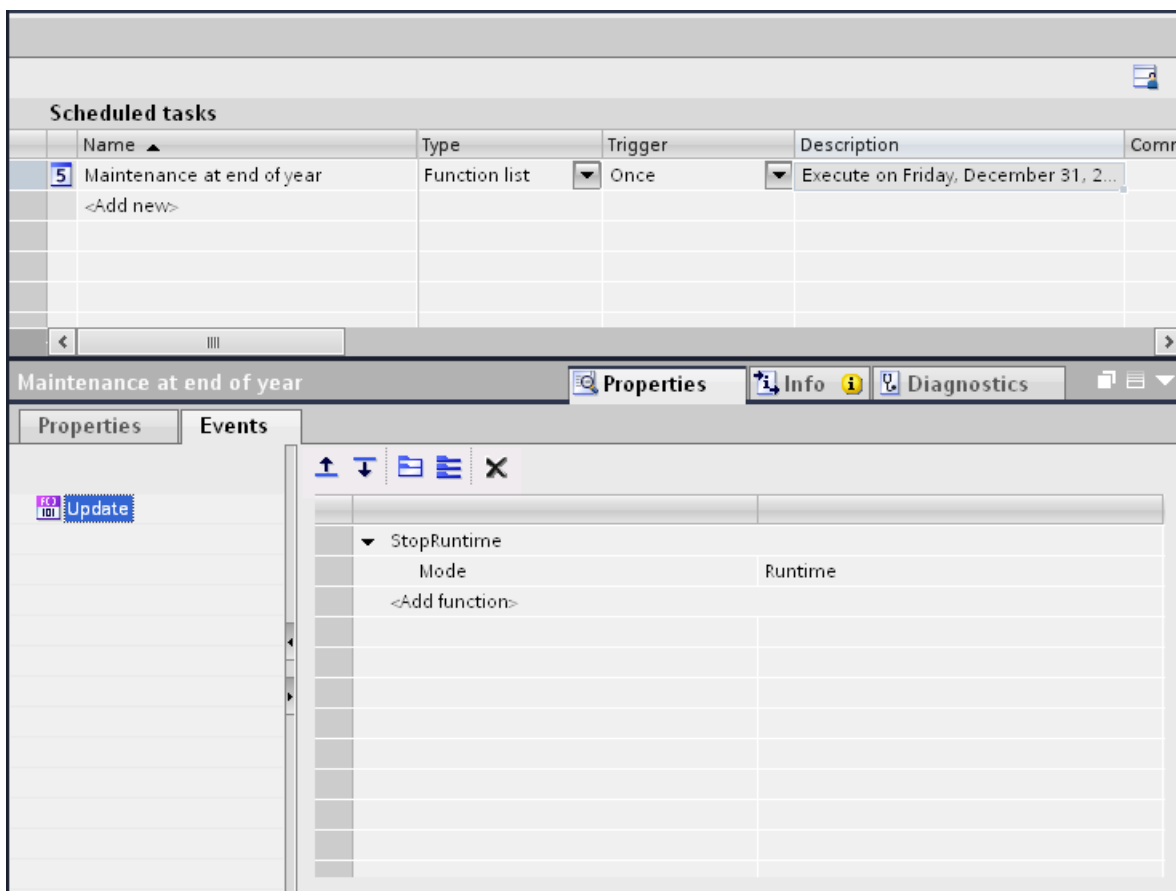

## Result

The task is executed once. Runtime will be stopped at 18:00 on December 31, 2008.

---

### Note

#### "StopRuntime" event on RT Professional

Please note that the "StopRuntime" event means runtime is in the process of ending and that some functionalities are therefore no longer available.

---

## 10.10.4.2 Planning tasks with cyclic triggers

### Introduction

You plan a job that provides a weekly printout of a report.

### Requirements

- A "Weekly report" report has been created.
- The "Scheduler" editor is open.
- The Inspector window is open.

### Procedure

1. Click "Add..." in the table of the task area.
2. Enter "Weekly report printout for end of shift" as the "Name."
3. Select "Weekly" as the "Event".
4. Open the "Properties" tab in the Inspector window.
5. Select "Friday" in the "on day" field of the "Starting point" area.
6. Enter the time "18:00" in the "at" field in the "Starting point" area.
7. Click in the "Events" tab of the "Function list" on the entry "No function."
8. Select "Print/PrintReport" as the function.
9. Select "Weekly report" report.

## Result

The task is executed weekly. The report "Weekly report" will be printed every Friday at 18:00 hours.

### 10.10.4.3 Planning tasks with event triggers

#### Introduction

You plan a task that generates a screen change when the user changes.

#### Requirements

- The "Scheduler" work area is open.
- You have created the "Start" screen.

#### Procedure

1. Click "Add..." in the table of the task area.
2. Enter "Screen change at user change" as the "Name."
3. Select "User change" as the "Trigger."
4. In the Inspector window, select "Properties > Events".
5. Select the "Screen/ActivateScreen" system function in the function list.
6. Select the "Start" screen in the screen name field.

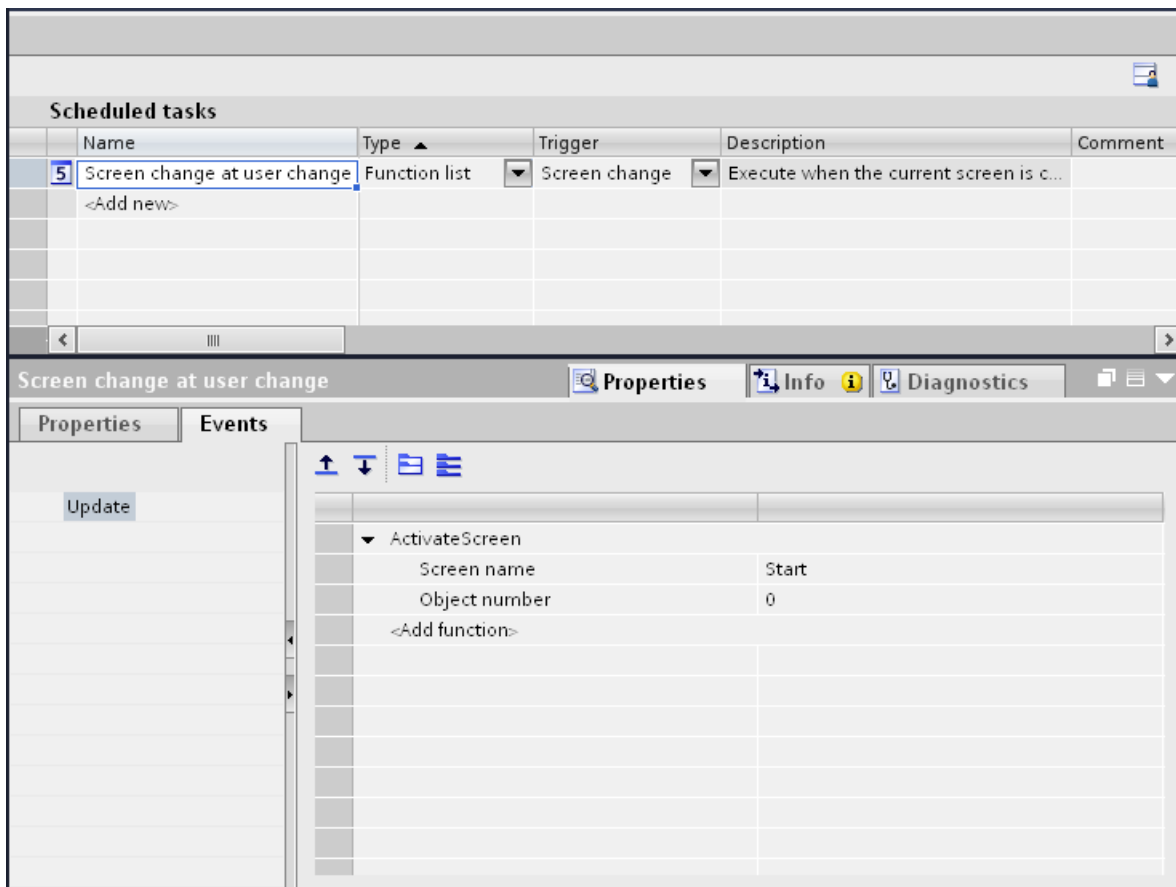

## Result

The task is executed with the "User change" event. When a new user logs on successfully, the "Start" screen is called up.

### 10.10.4.4 Administer task

#### Changing the designation

1. In the work area, double-click the field in the "Name" column.
2. Change the name of the task.
3. Confirm your entry with <Return>.

As an alternative, you can change the designation in the "Job > Name" box of the Inspector window.

#### Changing triggers

1. In the work area, mark the field in the "Trigger" column.
2. Open the drop-down list using the  button and select the trigger you require.

You can alternatively change the trigger in the "Starting time" area of the Inspector window.

#### Deleting a task

1. Select one or more lines for the tasks to be deleted.
2. Open the shortcut menu with the right button and select the menu command "Delete".

As an alternative, delete one or more tasks by using the <Del> button.

### 10.10.5 Examples

#### 10.10.5.1 Example: Terminating Runtime every day

##### Task

You plan a job that terminates Runtime every day at the end of work.

## Requirements

- The "Scheduler" work area is open.

## Procedure

1. Click "Add..." in the table of the task area.
2. Enter "Runtime stop at end of work" as the "Name."
3. Select "Daily" as the "Event."
4. Open the "Properties" tab in the Inspector window.
5. Enter the time "21:00" in the "at" field in the "Starting point" area.
6. Open the "Events" tab in the Inspector window.
7. Click the "No function" entry in the "Function list".
8. Select "System functions/System/StopRuntime" as the function.

## Result

Runtime is terminated every day at 21:00.

### 10.10.5.2 Example: Update user following change of user

## Task

Configure an I/O field which displays the logged on user. Configure a task which updates the I/O field when the logged on user changes.

## Requirements

- A "CurrentUser" tag of the "String" type is created.
- A screen has been created and opened.
- An I/O field is created in the screen.

## Procedure

1. Click on the "I/O field" object.
2. In the Inspector window, select "Properties > Properties > General":
  - Select "String" as the "Display format."
  - Select "CurrentUser" as the "Variable."
  - Select "Output" as the mode.
3. Change to the work area of the Scheduler.
4. Click "Add..." in the table of the task area.

10.10 Planning tasks

5. Enter "CurrentUser" as the "Name".
6. Select "User change" as the "Trigger."
7. In the Inspector window, select "Properties > Events".
8. Select the system function "ReadUserName" from the "User Management" group in the function list.
9. Select "CurrentUser" as the "Variable."

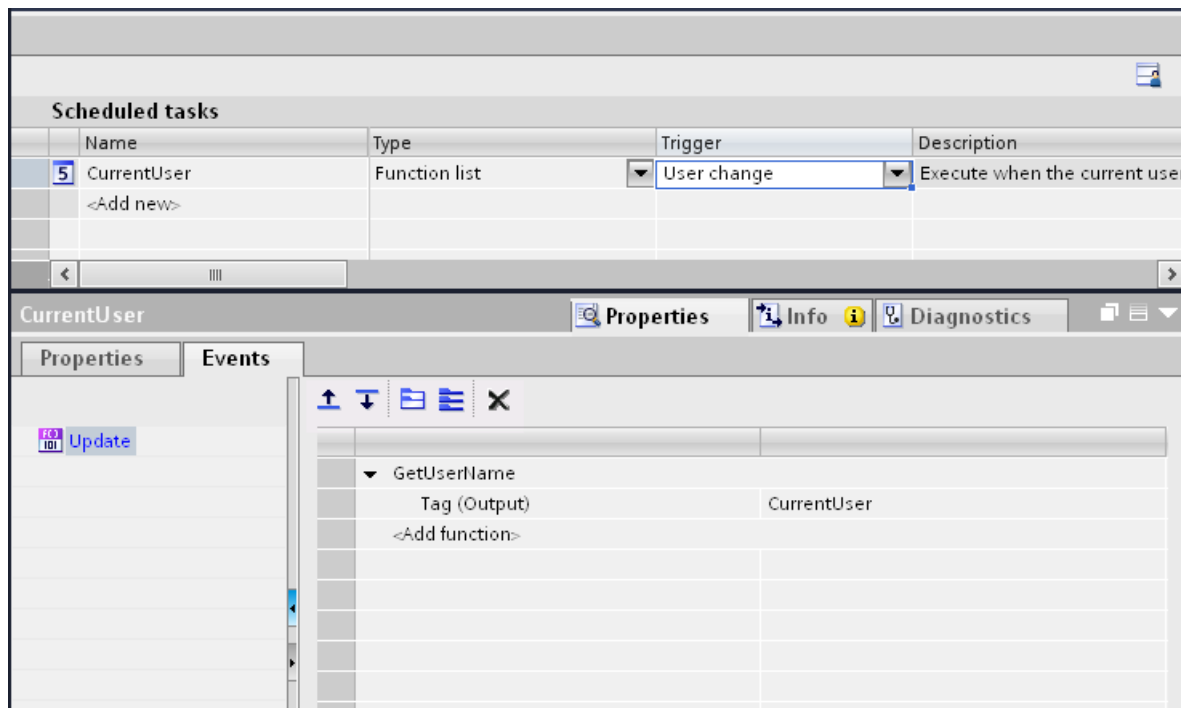

**Result**

When a new user logs on successfully, the "ReadUserName" function is called up. The "CurrentUser" tag is updated and displayed in the I/O field of the newly logged on user.

If a user does not log on successfully, the logged on user is logged off. The I/O field continues to display the user previously logged on until a new user logs on successfully.

**10.10.5.3 Example: Changing the starting point of a job in Runtime**

**Example: Changing the starting point of a task in Runtime**

**Introduction**

A cyclic trigger, for example "Starting daily at 18:00," is configured in the Engineering System. The time "18:00" is fixed as a constant. To change the start time in Runtime, select a tag as the "Timer." The value of the tag determines the start time of the task during Runtime.



## Task

You plan a task that swaps out log data daily and has the "LogTime" tag as the timer. You configure a "LogTime" tag in an input field.

## Requirements

- The "DataLogSource" source log has been created as a data log.
- The "DataLogDestination" destination log has been created as a data log.
- A "ChangeLogTime" screen has been created.

## Procedures overview

1. Creating a timer tag: You create a tag with which you change the starting point of the log data swap in Runtime.
2. Configuring a Date/time field: The operator changes the starting point of the task by using the Date/Time field in Runtime.
3. Configure the task with a timer tag: You create a task whose start time can be changed dynamically in Runtime.

## Result

If nothing is entered in the "LogDataTimeField" input field, then the task starts daily at 18:00 by default. The log data are swapped out. If an operator enters 19:00 in the "LogDataTimeField" input field, then the log data are swapped out at 19:00. Provided the value of the tag is not changed again before the task starts.

## See also

Example: 2. Configuring a Date/time field (Page 4908)

## Example: 1. Configuring a tag for Runtime

### Task

In the following example you configure the "LogTime" variable.

### Procedure

1. Open the "HMI tags" editor.
2. Click "Add..." in the table of the task area.
3. Enter "LogTime" as the "Name" of the variable.
4. Select "Internal variable" in the "Connection" column.
5. Select "DateTime" in the "Date type" column.

## Result

A variable of the "DateTime" type has been created.

## Example: 2. Configuring a Date/time field

### Task

In the following example you configure a Date/time field. To change the starting point of the task in Runtime, link the "LogTime" variable to the Date/time field.

### Requirements

- The "LogTime" variable of the "DateTime" type has been created.
- The "ChangeLogTime" screen is open.

### Procedure

1. In the toolbox view, drag-and-drop a "Date/time field" from the "Basic objects" category to the screen.
2. In the Inspector window, click "Properties > Properties > General".
3. Disable the "System time."
4. Click "Variable" and select "LogTime."
5. Disable "Display date" and enable "Display time."
6. Select "Input/output" as the "Mode."
7. Click "Properties > Miscellaneous."
8. Enter "LogDateTimeField" as the "Name".

## Result

The operator enters a time using the created date/time field.

## See also

Example: Changing the starting point of a task in Runtime (Page 4904)

## Example: 3. Configuring a swap to archive with a timer variable

### Task

In the following example you configure a task with a timer tag with which you change the starting point of the task in Runtime.

## Requirements

- The "LogTime" tag has been created.
- The "DataLogSource" source log has been created as a data log.
- The "DataLogDestination" destination log has been created as a data log.
- The Scheduler work area is open.

## Procedure

1. Click "Add..." in the table of the task area.
2. Enter "Swap out log daily at a tag time" as the "Name".
3. Select "Daily" as the "Trigger".
4. In the Inspector window "Properties > Properties > General > at" enter the time "18:00".
5. Select the "LogTime" tag as the "Standard timer".
6. In the Inspector window, open "Properties > Events".
7. Select the "System functions/Logs/CopyLog" system function in the function list.
8. Select these settings:
  - Select "Data log" as the "Log type".
  - Select "DataLogDestination" as the "Destination log".
  - Select "DataLogSource" as the "Source log".
  - Select "Overwrite" as the "Mode".
  - Select "Yes" for "Delete source log".

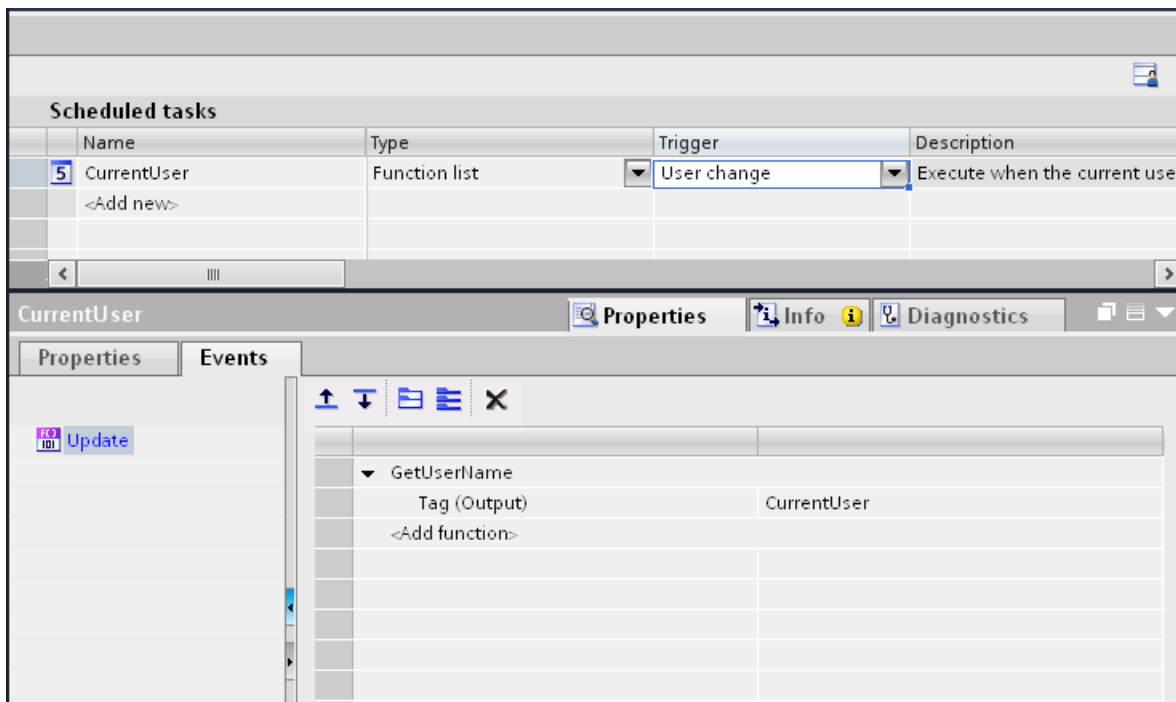

## **Result**

If nothing is entered in the "LogDataTimeField" input field, then the task starts daily at 18:00 by default. The log data are swapped out. If an operator enters 19:00 in the "LogDataTimeField" input field, then the log data are swapped out at 19:00. Provided the value of the tag is not changed again before the task starts.

## 10.11 Communicating with PLCs

### 10.11.1 Basics of communication

#### 10.11.1.1 Communication between devices

##### Communication

The data exchange between two devices is known as communication. The devices can be interconnected directly or via a network. The interconnected devices in communication are referred to as communication partners.

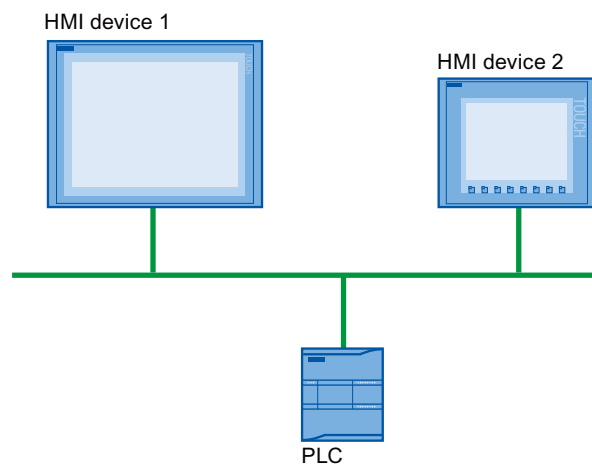

Data transferred between the communication partners may serve different purposes:

- Display processes
- Operate processes
- Output alarms
- Archive process values and alarms
- Document process values and alarms
- Administer process parameters and machine parameters

##### Communication partners

Communication between the following devices is described in more detail in this section:

- PLC  
The PLC controls a process by means of a user program.
- HMI device  
You use the HMI device to operate and monitor the process.

### Basic information for all communication

The basis for all types of communication is a network configuration. In a network configuration, you specify the connection that exists between the configured devices.

With the network configuration, you also ensure the necessary prerequisites for communication, in other words:

- Every device in a network is assigned a unique address.
- The devices carry out communication with consistent transmission characteristics.

### Automation system

The following characteristics describe an automation system:

- The PLC and HMI device are interconnected
- The network between the PLC and HMI device is configured

### Communication between HMI devices

The HTTP protocol is available for communication between HMI devices.

For more detailed information, refer to the documentation on the SIMATIC HMI HTTP protocol.

### Communication via a uniform and vendor-neutral interface

With OPC (Openness Productivity Collaboration), WinCC has a uniform and manufacturer-neutral software interface. This interface enables standardized data exchange between industrial, office, and manufacturing applications.

For more detailed information, refer to the documentation for OPC.

## 10.11.1.2 Devices and networks in the automation system

### Introduction

To set up an automation system, you must configure, parameterize, and interconnect the individual devices.

You insert PLCs and HMI devices into the project in the same way. Likewise, you configure the two devices in the same way.

Automation system setup:

1. Insert PLC into the project.
2. Insert HMI device into the project.
3. Network the devices together.
4. Interconnect the devices.

## **Inserting devices**

If you have created a project, you can add a device in the portal view or project view.

- Portal view

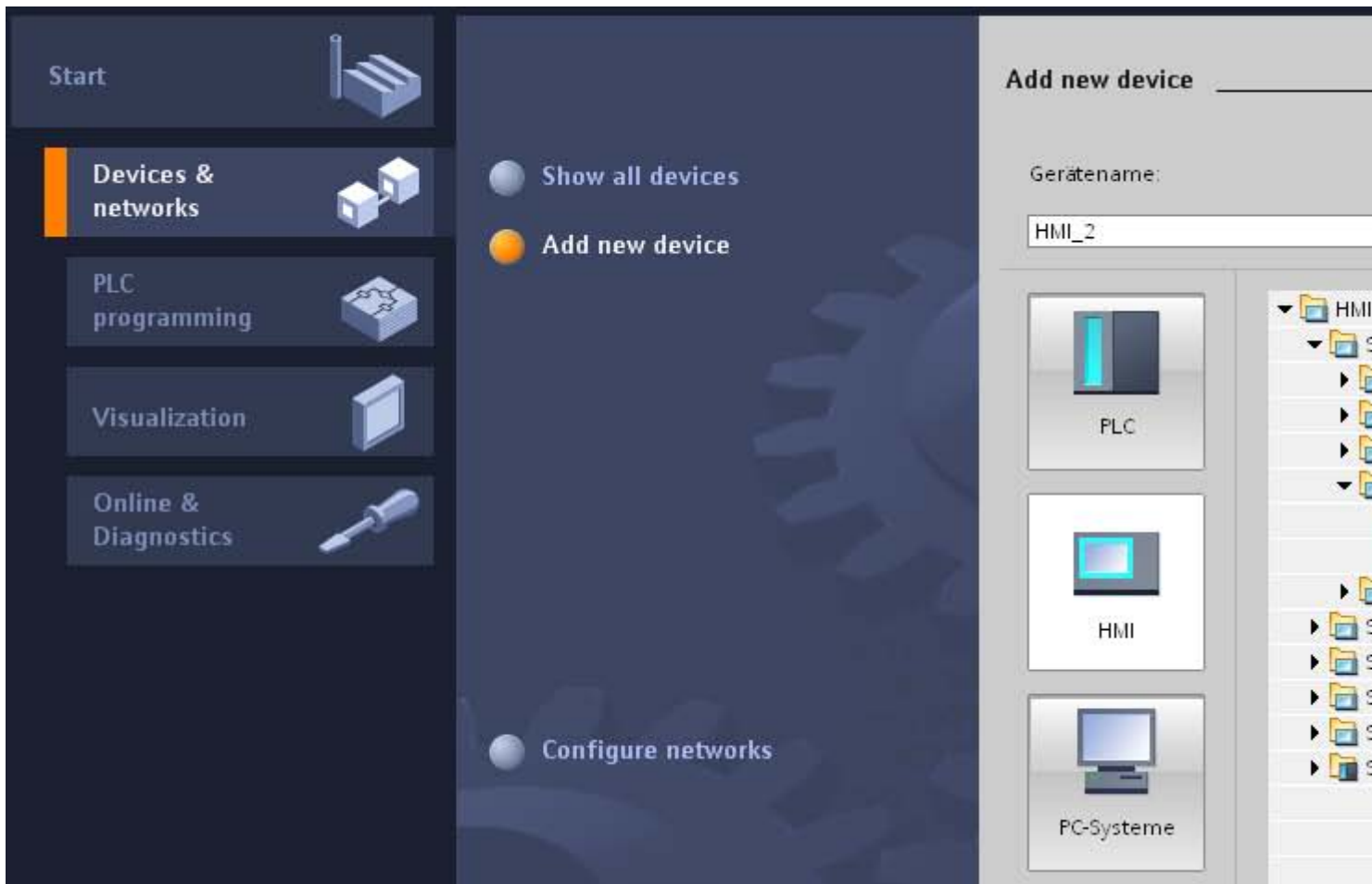

- Project view



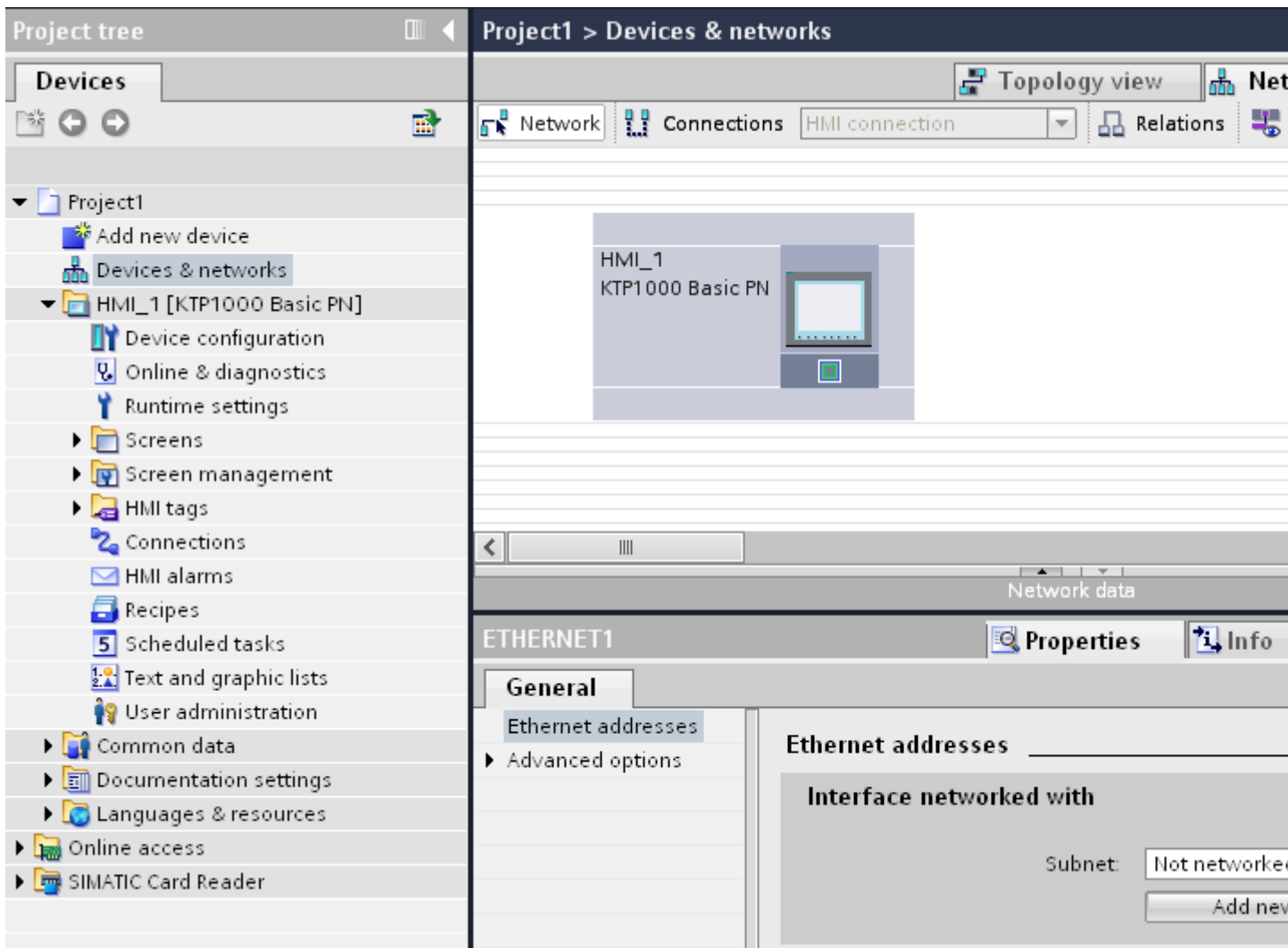

## Networking devices

You can network the interfaces of the communication-capable devices conveniently in the "Devices & Networks" editor. In the networking step, you configure the physical device connections.

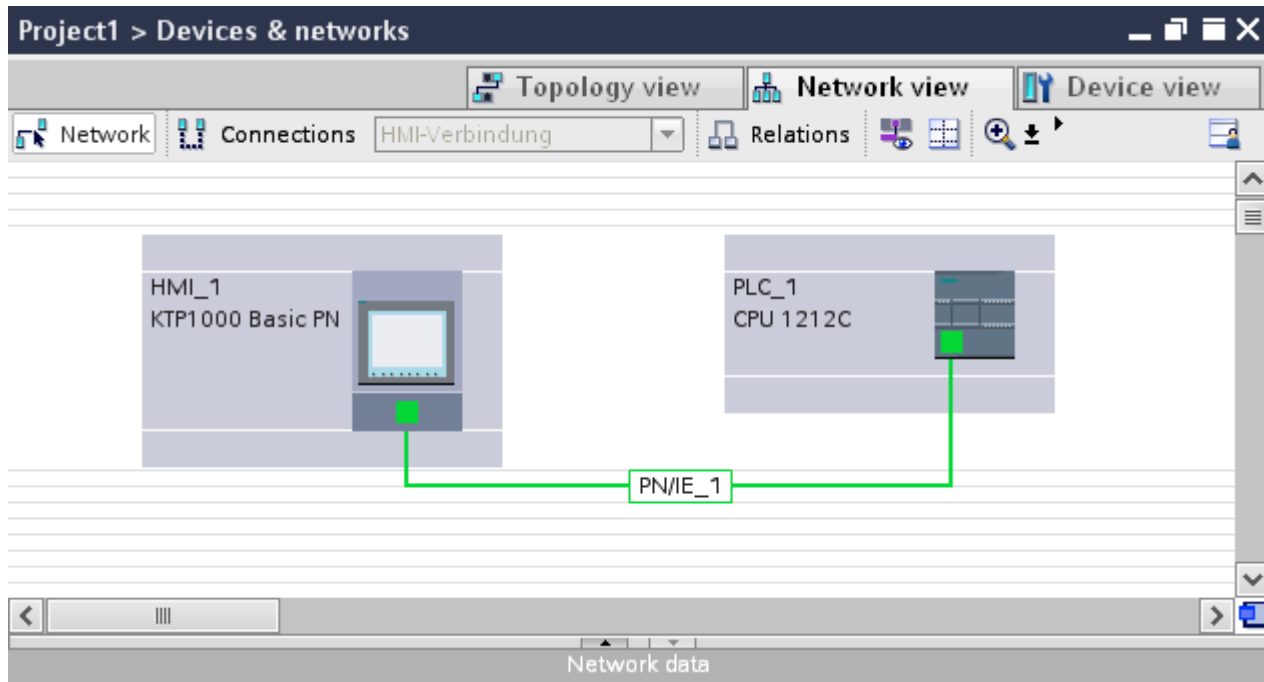

The tabular network overview supplements the graphical network view with the following additional functions:

- You obtain detailed information on the structure and parameter settings of the devices.
- Using the "Subnet" column, you can connect communication-capable components to subnets that have been created.

## Connecting devices

After you network the devices together, you configure the connection. You configure the "HMI connection" connection type for communication with the HMI device.

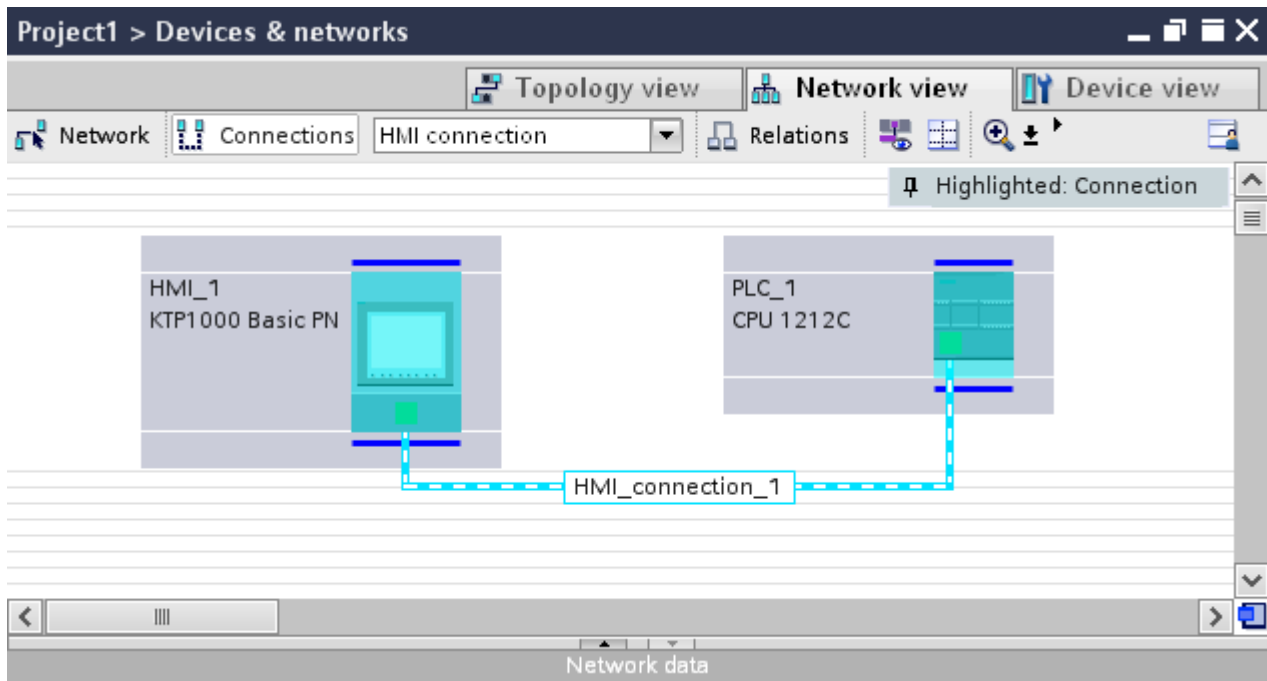

### 10.11.1.3 Data exchange using tags

#### Communication using tags

Process values are forwarded in runtime using tags. Process values are data which is stored in the memory of one of the connected automation systems. They represent the status of a plant in the form of temperatures, fill levels or switching states, for example. Define external tags for processing the process values in WinCC.

WinCC works with two types of tag:

- External tags
- Internal tags

#### Working with tags

See the chapter "Working with tags" for further information about configuring tags.

#### 10.11.1.4 Data exchange using area pointers

##### Communication using area pointers

Area pointers are parameter fields. WinCC receives information from these parameter fields in Runtime during the course of the project. This information contains data on the location and size of data areas in the PLC.

During communication, the PLC and the HMI device alternately access these data areas for read and write operations.

Based on the evaluation of data stored in the data areas, the PLC and HMI device initiate mutually defined actions.

The area pointers are managed centrally in the "Connections" editor. Area pointers are used to exchange data from specific user data areas.

You use the following area pointers in WinCC:

- Data record
- Date/time
- Coordination
- Job mailbox
- Date/time PLC
- Project ID
- Screen number

The availability of the various area pointers is determined by the HMI device used.

#### 10.11.1.5 Communication drivers

##### Communication drivers

A communication driver is a software component that establishes a connection between a PLC and an HMI device. The communication driver thus enables the assignment of process values to HMI tags.

The interface as well as the profile and transmission speed can be chosen, depending on the HMI device used and the connected communication partner.

## 10.11.2 Editors for communication

### 10.11.2.1 "Devices & networks" editor

#### Function of the hardware and network editor

The "Devices & networks" editor is the development environment for networking, configuring and assigning parameters to devices and modules.

#### Configuration

The "Devices & networks" editor consists of the following components:

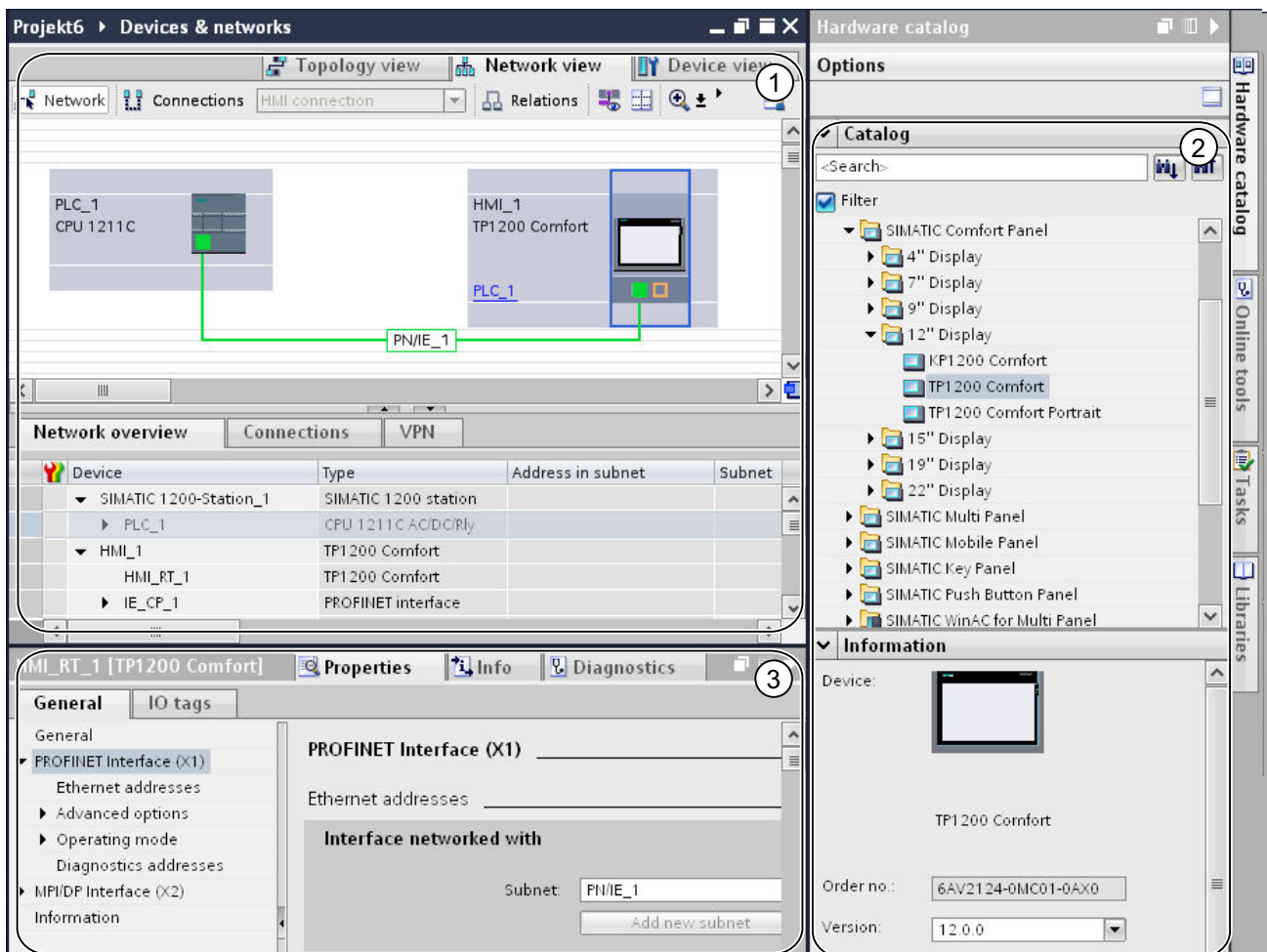

- 1 Device view, network view, topology view
- 2 Hardware catalog
- 3 Inspector window

The "Devices & networks" editor provides you with three different views of your project. You can switch between these three views at any time depending on whether you want to produce and edit individual devices and modules, entire networks and device configurations or the topological structure of your project.

The inspector window contains information on the object currently marked. Here you can change the settings for the object marked.

Drag the devices and modules you need for your automation system from the hardware catalog to the network, device or topology view.

### **10.11.2.2 Network view**

#### **Introduction**

The network view is a working area of the hardware and network editor.

You undertake the following tasks in network view:

- Configuring and assign device parameters
- Networking devices with one another

## Structure

The following diagram shows the components of the network view:

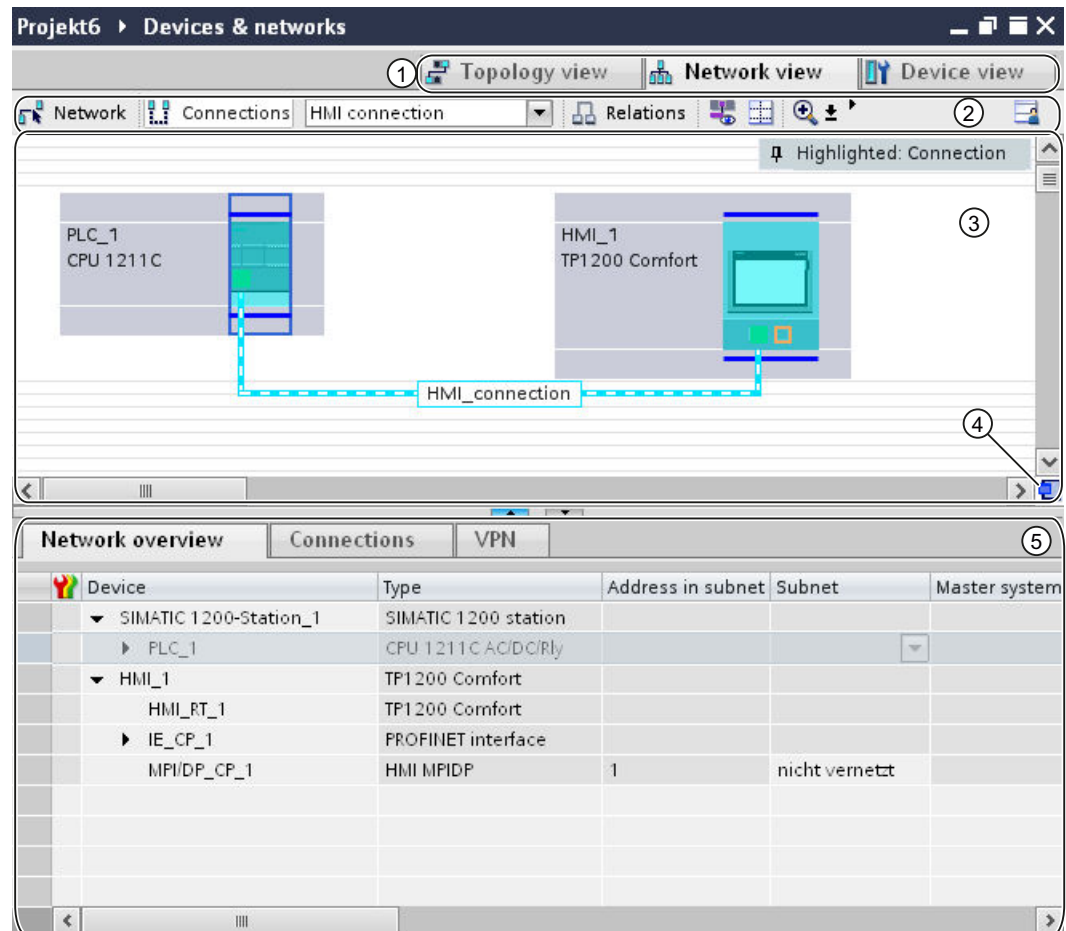

- ① Changeover switch: device view / network view / topology view
- ② Toolbar of network view
- ③ Graphic area of network view
- ④ Overview navigation
- ⑤ Table area of network view







You can use your mouse to change the spacing between the graphic and table areas of the network view.

To do this, click on the upper edge of the table view and expand or contract this by moving the mouse with the mouse button held down.

You can use the two small arrow keys to minimize, maximize or select the latest table structure of the table view with just one click.

## Toolbar

The toolbar provides the following functions:

Icon	Meaning
	Mode to network devices.
	Mode to create connections. You can define the connection type using the drop-down list.
	Mode to create relations.
	Show interface addresses.
	Adjust the zoom setting. You can select the zoom setting or enter it directly in the drop-down list. You can also zoom in or zoom out the view in steps using the zoom symbol or draw a frame around an area to be zoomed in.
	Show page breaks Enables page break preview. Dotted lines will be displayed at the positions where the pages will break when printed.
	Remember layout Saves the current table view. The layout, width and visibility of columns in the table view is stored.

## Graphic area

The graphic area of the network view displays any network-related devices, networks, connections and relations. In this area, you add devices from the hardware catalog, connect them with each other via their interfaces and configure the communication settings.

## Overview navigation

Click in the overview navigation to obtain an overview of the created objects in the graphic area. By holding down the mouse button, you can quickly navigate to the desired objects and display them in the graphic area.

## Table area

The table area of the network view includes various tables for the devices, connections and communication settings present:

- Network overview
- Connections
- I/O communication

You can use the shortcut menu of the title bar of the table to adjust the tabular display.



### 10.11.2.3 Network data

#### Introduction

The "Network view" editor also gives you a tabular view of the "Network data" in addition to the graphic network view.

You have the following selections in the "Network data" editor:

- Network overview
- Connections
- VPN
- I/O communication

You open the "Network data" below the graphic network overview.

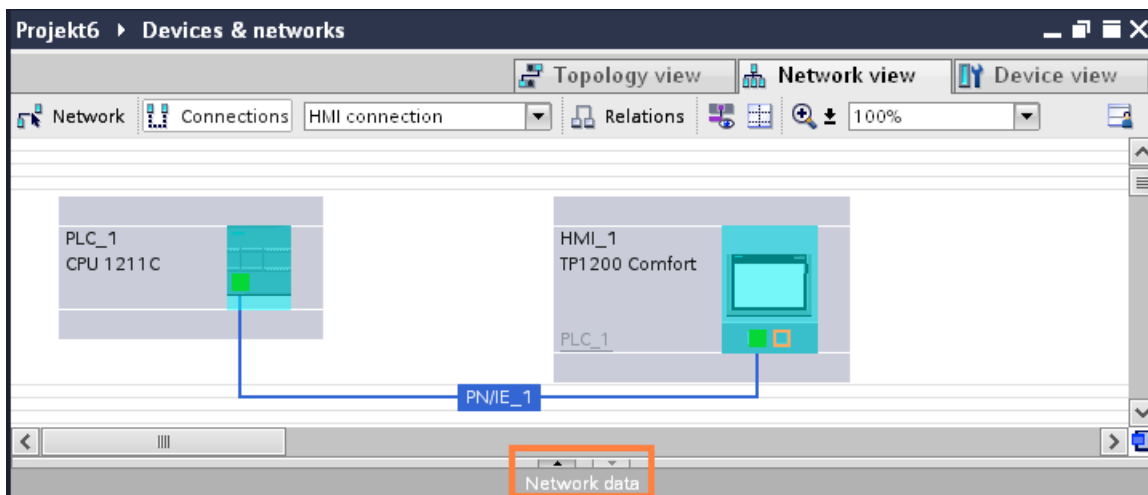

#### Basic functions

The network data are displayed in tabular form and support the following basic functions for editing a table:

- Displaying and hiding table columns  
Note: The columns of relevance to configuration cannot be hidden.
- Optimizing column width
- Sorting table
- Displaying the meaning of a column, a row or cell using tooltips.

### Network overview

The tabular network overview adds the following functions to the graphic network view:

- You obtain detailed information on the structure and parameter settings of the devices.
- Using the "Subnet" column, you can connect components capable of communication with created subnets.

The

Network overview		Connections	VPN			
Device	Type	Address in subnet	Subnet	Master system		
▼ SIMATIC 1200-Station_1	SIMATIC 1200 station					
▶ PLC_1	CPU 1211C AC/DC/Rly					
▼ HMI_1	TP1200 Comfort					
HMI_RT_1	TP1200 Comfort					
▶ IE_CP_1	PROFINET interface					
MPI/DP_CP_1	HMI MPIDP	1	nicht vernetzt			

### Connections

You will find additional network data under "Connections".

Network overview		Connections	VPN						
Local connection name	Local end point	Local ID (hex)	Partner ID (hex)	Partner	Connection type				
<div style="border: 1px solid gray; padding: 5px;">           Show/hide columns ▶            Optimize column width            Optimize width of all columns         </div>		<div style="border: 1px solid gray; padding: 5px;"> <input checked="" type="checkbox"/> Local connection name  <input checked="" type="checkbox"/> Local end point  <input checked="" type="checkbox"/> Local ID (hex)  <input checked="" type="checkbox"/> Partner ID (hex)  <input checked="" type="checkbox"/> Partner  <input checked="" type="checkbox"/> Connection type  <input type="checkbox"/> One-way  <input type="checkbox"/> Connection establishment  <input type="checkbox"/> Local subnet  <input type="checkbox"/> Partner subnet  <input type="checkbox"/> Local interface  <input type="checkbox"/> Partner interface  <input type="checkbox"/> Local address  <input type="checkbox"/> Partner address  <input type="checkbox"/> Local TSAP  <input type="checkbox"/> Partner TSAP  <input type="checkbox"/> Local port  <input type="checkbox"/> Partner port  <input type="checkbox"/> Local LSAP  <input type="checkbox"/> Partner LSAP  <input type="checkbox"/> Protocol         </div>							

### 10.11.2.4 Diagnostics of online connections

#### Diagnostics of online connections

You can read out the diagnostics data of existing connections in the TIA Portal.

The "Diagnostics" function shows the connection data in tabular form in the Inspector window.

#### Requirements

- Devices must be in "Online" mode.

#### Device information

The diagnostics data of all devices in "Online" mode is displayed in the "Diagnostics > Device information" Inspector window.

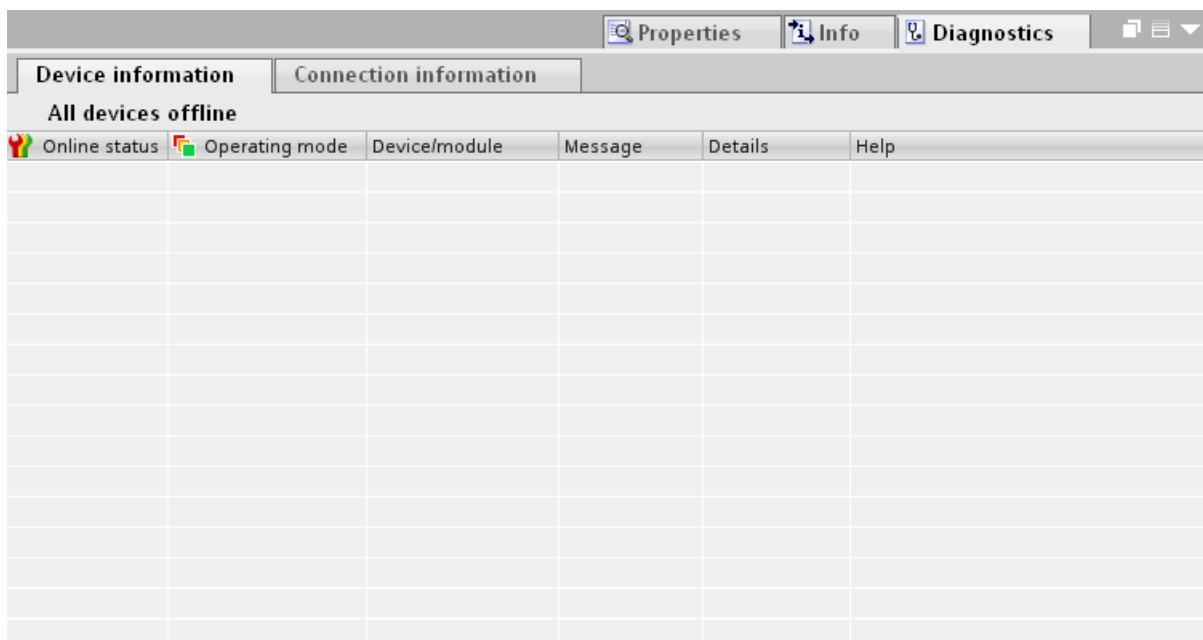

Online status	Operating mode	Device/module	Message	Details	Help
All devices offline					

The following data is displayed:

- Online status
- Operating mode
- Device / module
- Alarm
- Details
- Help

## Connection information

Use the "Connection information" function to display the diagnostics data of the connection selected in the "Devices&Networks" editor.

A graphic displays the communication partners of the connection and by which communication driver they are connected with each other.

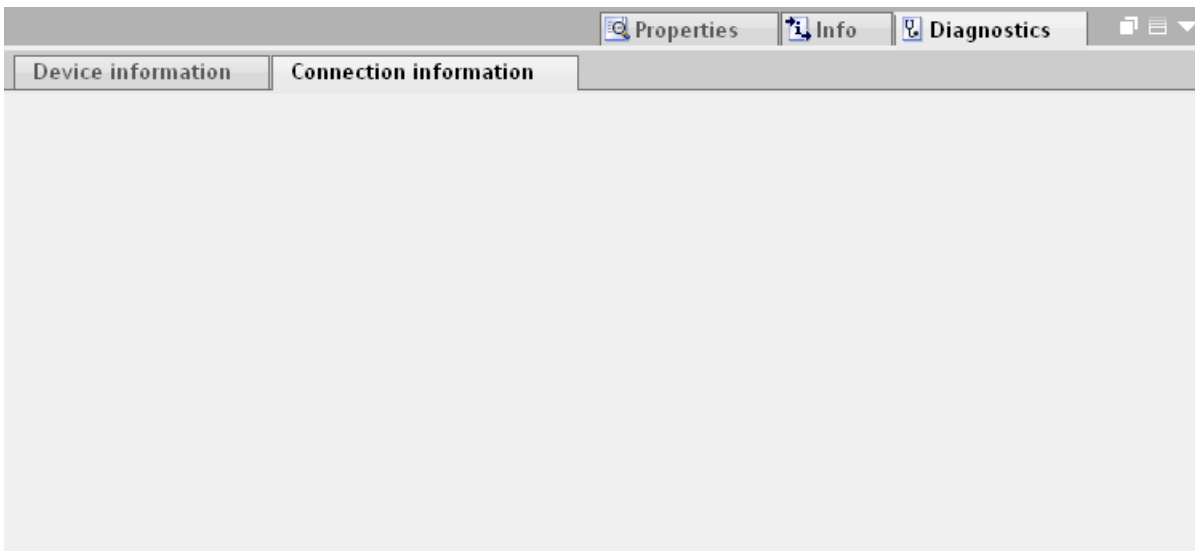

The following data is displayed:

- End point
- Interface
- Subnet
- Address
- TSAP
- Number of HMI resources

### 10.11.2.5 Device view

#### Introduction

The device view is a working area of the hardware and network editor.

You undertake the following tasks in device view:

- Configuring and assign device parameters
- Configuring and assign module parameters

## Structure

The following diagram shows the components of the device view:

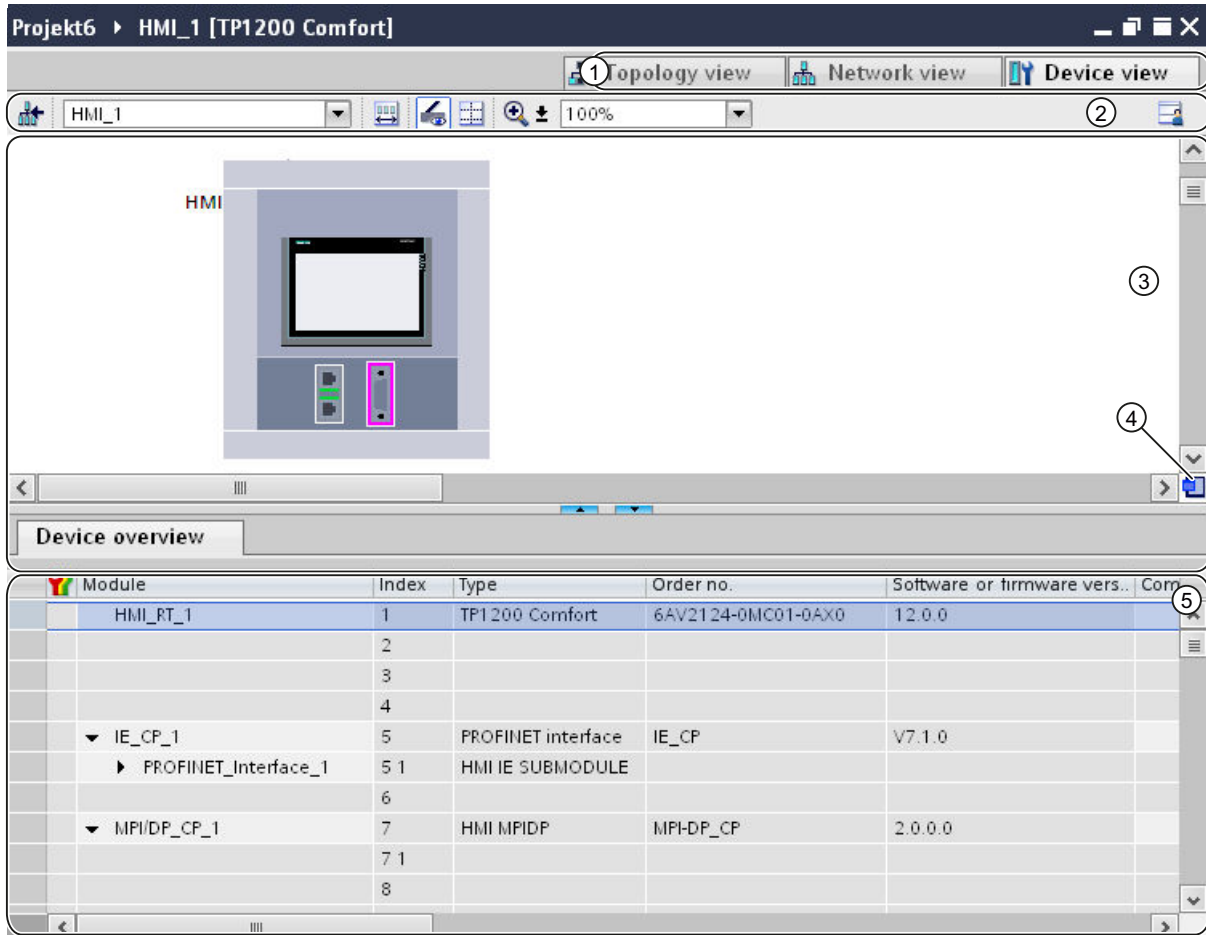







- ① Changeover switch: device view / network view / topology view
- ② Toolbar of device view
- ③ Graphic area of the device view
- ④ Overview navigation
- ⑤ Table area of device view

You can use your mouse to change the spacing between the graphic and table areas of the device view.

To do this, click on the upper edge of the table view and expand or contract this by moving the mouse with the mouse button held down. You can use the two small arrow keys to minimize, maximize or select the latest table structure of the table view with just one click.

## Toolbar

The toolbar provides the following functions:

Icon	Meaning
	Switches to the network view. Note: The device view can switch between the existing devices using the drop-down list.
	Show the area of unplugged modules.
	Show module labels.
	Adjust the zoom setting. Select the zoom setting or enter it directly in the drop-down list. You can use the Zoom symbol to zoom in or out incrementally or to drag a frame around an area to be enlarged. With signal modules, you can recognize the address labels from a zoom level of 200% or higher.
	Show page breaks Enables page break preview. Dotted lines will be displayed at the positions where the pages will break when printed.
	Remember layout Saves the current table view. The layout, width and visibility of columns in the table view is stored.

## Graphic area

The graphic area of the device view displays hardware components and if necessary the associated modules that are assigned to each other via one or more racks. In the case of devices with racks, you have the option of installing additional hardware objects from the hardware catalog into the slots on the racks.

## Overview navigation

Click in the overview navigation to obtain an overview of the created objects in the graphic area. By holding down the mouse button, you can quickly navigate to the desired objects and display them in the graphic area.

## Table area

The table area of the device view gives you an overview of the modules used and the most important technical and organizational data.

You can use the shortcut menu of the title bar of the table to adjust the tabular display.

### 10.11.2.6 Topology view

## Introduction

The topology view is a working area of the hardware and network editor.

You undertake the following tasks in topology view:

- Displaying the Ethernet topology
- Configuring the Ethernet topology
- Identify and minimize differences between the desired and actual topology

## Structure

The following figure provides an overview of the topology view.

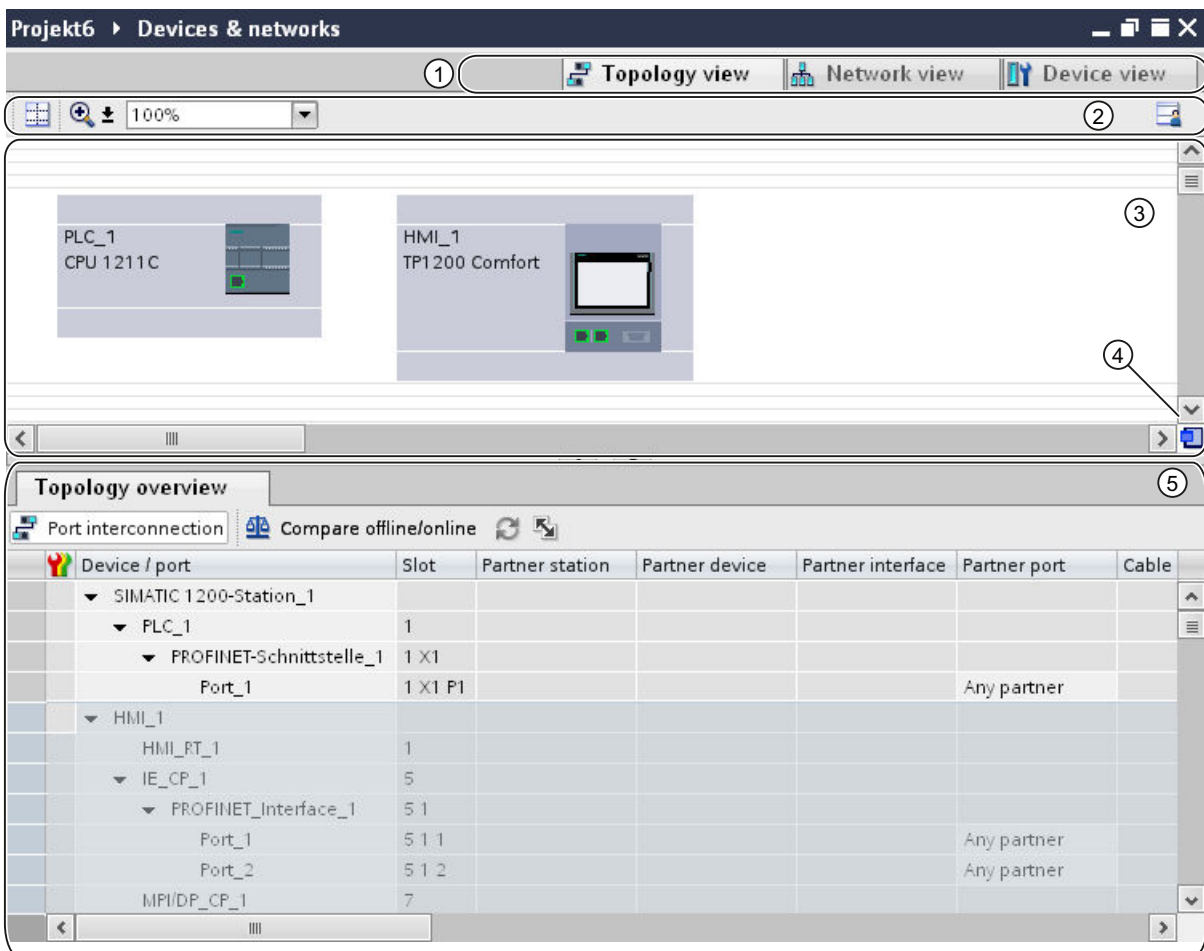



- ① Changeover switch: device view / network view / topology view
- ② Topology view toolbar
- ③ Graphic area of the topology view
- ④ Overview navigation
- ⑤ Table area of the topology view

You can use your mouse to change the spacing between the graphic and table areas of the topology view.

To do this, click on the upper edge of the table view and expand or contract this by moving the mouse with the mouse button held down. You can use the two small arrow keys to minimize, maximize or select the latest table structure of the table view with just one click.

## Toolbar

The toolbar provides the following functions:

Icon	Meaning
	Adjusting the zoom setting. You can select the zoom setting via the drop-down list or enter it directly. You can also zoom in or zoom out the view in steps using the zoom symbol or draw a frame around an area to be zoomed in.
	Show page breaks Enables page break preview. Dotted lines will be displayed at the positions where the pages will break when printed.
	Remember layout Saves the current table view. The layout, width and visibility of columns in the table view is stored.

## Graphic area

The graphic area of the topology view displays Ethernet modules with their appropriate ports and port connections. Here you can add additional hardware objects with Ethernet interfaces.

## Overview navigation

Click in the overview navigation to obtain an overview of the created objects in the graphic area. By holding down the mouse button, you can quickly navigate to the desired objects and display them in the graphic area.

## Table area

This displays the Ethernet or PROFINET modules with their appropriate ports and port connections in a table. This table corresponds to the network overview table in the network view.

You can use the shortcut menu of the title bar of the table to adjust the tabular display.

### 10.11.2.7 Inspector window

The properties and parameters shown for the object selected can be edited in the inspector window.



## Structure

The inspector window consists of the following components:

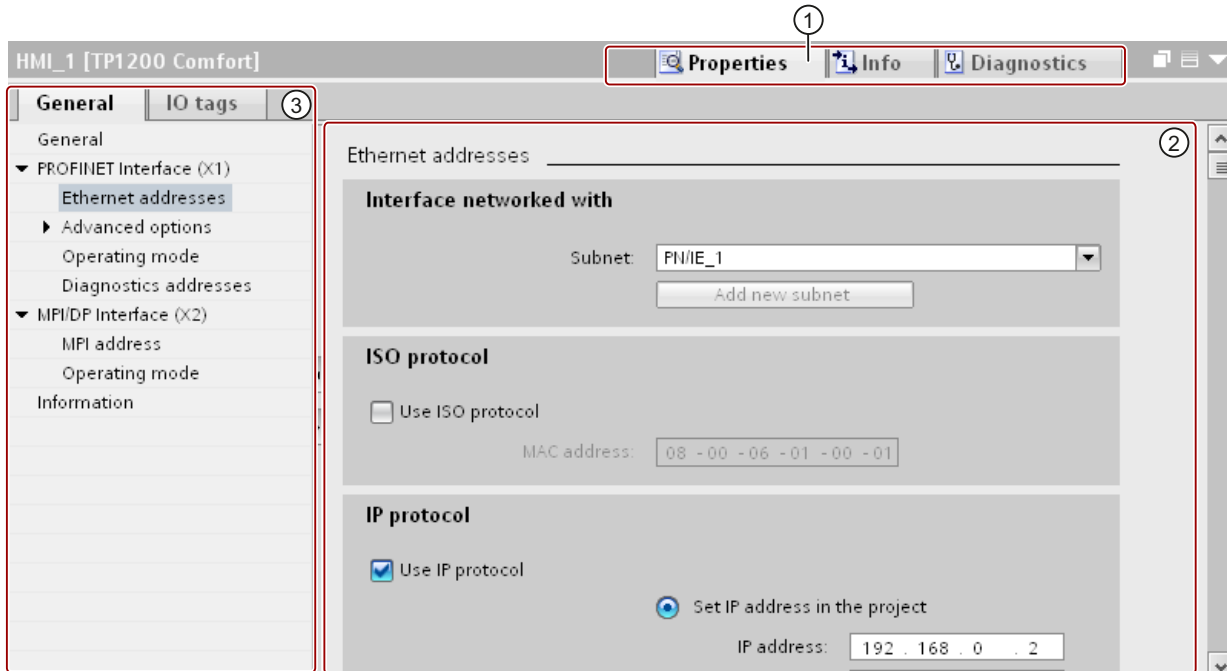

- ① Switch between various information and work areas
- ② Navigation between various pieces of information and parameters
- ③ Display showing the selected information and parameters

## Function

The information and parameters in the inspector window are split into different types of information:

- Properties
- Info
- Diagnostics

To display the corresponding information and parameters, click in the area you want. The "Properties" area is the most important one for configuring an automation system. This area is displayed by default.

The left pane of the inspector window is used for area navigation. Information and parameters are arranged there in groups. If you click on the arrow symbol to the left of the group name, you can expand the group if sub-groups are available. If you select a group or sub-group, the corresponding information and parameters are displayed in the right pane of the inspector window and can be edited there too.

### **10.11.2.8 Hardware catalog**

The "Hardware catalog" task card gives you easy access to a wide range of hardware components.

## Structure

The "Hardware catalog" task card consists of the following panes:

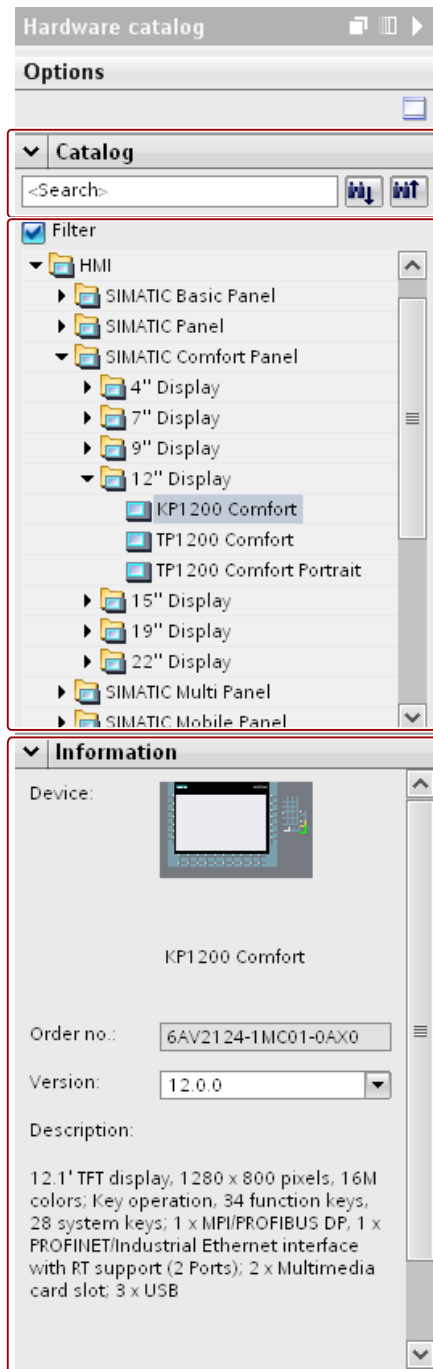

- ① "Catalog" pane, search and filter function
- ② "Catalog" pane, component selection
- ③ "Information" pane

## Search and filter function

The search and filter functions of the "Catalog" pane make it easy to search for particular hardware components. You can limit the display of the hardware components to certain criteria using the filter function. For example, you can limit the display to objects that you can also place within the current context or which contain certain functions.

Objects that can be used in the current context include, for example, interconnectable objects in the network view or only modules compatible with the device in the device view.

## Component selection

The component selection in the "Catalog" pane contains the installed hardware components in a tree structure. You can move the devices or modules you want from the catalog to the graphic work area of the device or network view.

Installed hardware components without a license are grayed out. You cannot use non-licensed hardware components.

Hardware components belonging to various components groups thematically are partially implemented as linked objects. When you click on such linked hardware components, a catalog tree opens in which you can find the appropriate hardware components.

## Information

The "Information" pane contains detailed information on the object selected from the catalog:

- Schematic representation
- Name
- Order number
- Version number
- Description

### 10.11.2.9 Information on hardware components

In the hardware catalog, you can display information on selected hardware components in the "Information" pane. You can also display further information on the selected hardware components using the shortcut menu.

## Access to further information

If you select a hardware object in the hardware catalog and open the shortcut menu, you not only have the "Copy" function available but also three options for accessing information on Service & Support:

- Information regarding product support
- FAQs
- Manuals

The required information is displayed in the work area of the hardware and network editor.

---

**Note**

You can only access Service & Support when you are connected to the Internet and the function is enabled. By default, the function is disabled.

To enable the function, refer to the instructions in the section "Enabling product support".

---

### Information regarding product support

Here, you have access to general information on hardware and software components. The order number of the selected hardware object is entered automatically in the search mask. You can, however, also search for other hardware and software components.

### FAQs

Here, you have access to "Frequently Asked Questions" (FAQs). You can view various entries on hardware and software questions. Using a detailed search mask, you can filter the required topics.

### Manuals

Here, you have access to the manuals of the various hardware components. This is particularly useful if the configuration, addressing or parameter assignment you are planning requires more detailed knowledge of the hardware you are using.

## 10.11.3 Networks and connections

### 10.11.3.1 SIMATIC communication networks

#### Communication networks

##### Overview

Communication networks are a central component of modern automation solutions. Industrial networks have to fulfill special requirements, for example:

- Coupling of automation systems as well as simple sensors, actuators, and computers.
- The information has to be correct and has to be transferred at the right moment.
- Robust against electromagnetic disturbances, mechanical stresses and soiling
- Flexible adaptation to the production requirements

Industrial networks belong to the LANs (Local Area Networks) and allow communication within a limited area.

Industrial networks fulfill the following communication functions:

- Process and field communication of the automation systems including sensors and actuators
- Data communication between automation systems
- IT communication for integrating the modern information technology

## Overview of the networks

This section examines the following networks:

- **Industrial Ethernet**  
The industrial network standard for all levels
- **PROFINET**  
The open Industrial Ethernet standard for automation
- **PROFIBUS**  
The international standard for the field area and market leader at the field busses
- **MPI**  
The integrated interface of the SIMATIC products
- **PPI**  
The integrated interface specially for the S7-200

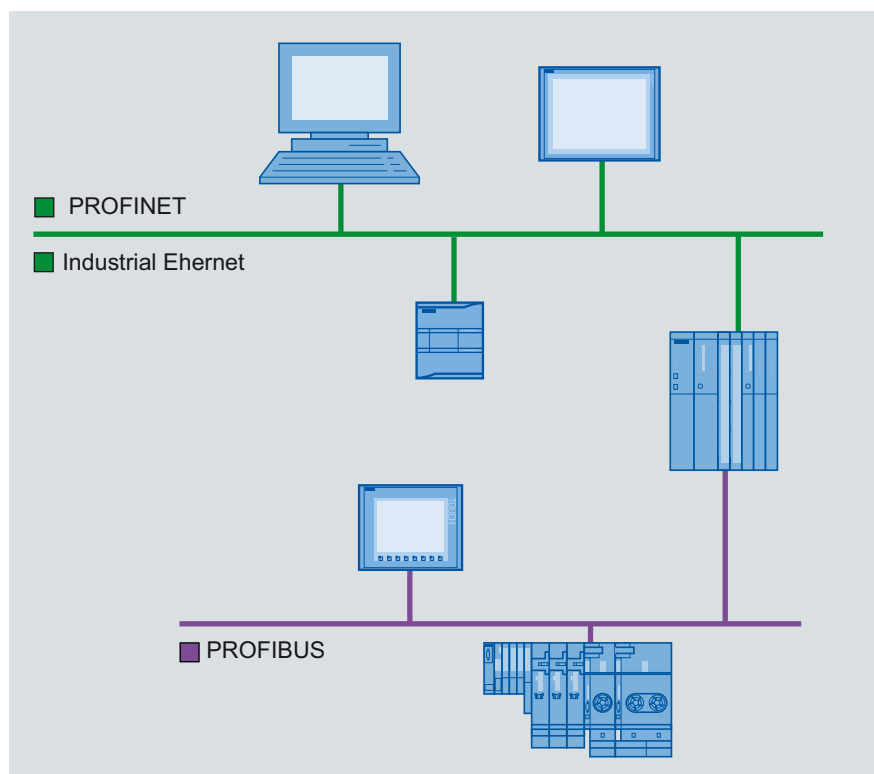

## PROFINET and Ethernet

### Industrial Ethernet

Industrial Ethernet, which is based on IEEE 802.3, enables you to connect your automation system to your office networks. Industrial Ethernet provides IT services that you can use to access production data from the office environment.

### Ethernet network

An Ethernet network allows you to interconnect all devices that are connected to the network via an integrated Ethernet interface or a communication module. This enables connection of multiple HMI devices to one SIMATIC S7 PLC and multiple SIMATIC S7 PLCs to one HMI device. The maximum number of communication partners that you can connect to an HMI device is dependent on the HMI device used. Additional information is available in the documentation for the respective HMI device.

### PROFINET

PROFINET is an open standard for industrial automation defined by IEEE 61158 and based on Industrial Ethernet. PROFINET makes use of IT standards all the way to the field level and enables plant-wide engineering.

With PROFINET, you can realize high-performance automation solutions for applications with stringent real-time requirements.

### PROFIBUS

#### PROFIBUS DP

PROFIBUS DP (distributed I/O) is used to connect the following devices:

- PLCs, PCs, HMI devices
- Distributed I/O devices, e.g., SIMATIC ET 200
- Valves
- Drives

PROFIBUS DP's fast response times make it ideally suited for the manufacturing industry.

Its basic functionality includes cyclic exchange of process data between the master and PROFIBUS DP slaves, as well as diagnostics.

#### PROFIBUS network

You can connect an HMI device within the PROFIBUS network to any SIMATIC S7 module that has an integrated PROFIBUS or PROFIBUS DP interface. You can thereby connect multiple HMI devices to one SIMATIC S7 PLC and multiple SIMATIC S7 PLCs to one HMI device.

The maximum number of communication partners that you can connect to an HMI device is dependent on the HMI device used. Additional information is available in the documentation for the respective HMI device.

You configure the SIMATIC S7-200 PLC as a passive device in the network. You connect the SIMATIC S7-200 using the DP connector or a PROFIBUS communication module.

## MPI

## MPI

MPI (Multi-Point Interface) is the integrated interface for SIMATIC products:

- PLCs
- HMI devices
- Programming device/PC

Small subnets with the following characteristics are set up with MPI:

- Short distances
- Few devices
- Small data quantities

## MPI network

You connect the HMI device to the MPI interface of the SIMATIC S7 PLC. This enables connection of multiple HMI devices to one SIMATIC S7 PLC and multiple SIMATIC S7 PLCs to one HMI device. The maximum number of communication partners that you can connect to an HMI device is dependent on the HMI device used. Additional information is available in the documentation for the respective HMI device.

## Network architectures

MPI is based on the PROFIBUS standard (IEC 61158 and EN 50170) and supports the following bus topologies:

- Line
- Star
- Tree

An MPI subnet contains a maximum of 127 devices and consists of multiple segments. Each segment contains a maximum of 32 devices and is limited by terminating resistors. Repeaters are used to connect segments. The maximum cable length without a repeater is 50 m.



## PPI

### Introduction

PPI (point-to-point interface) is an integrated interface that was developed specially for the SIMATIC S7-200. A PPI network typically connects S7-200 PLCs. However, other SIMATIC PLCs (e.g., S7-300 and S7-400) or HMI devices can communicate with a SIMATIC S7-200 in the PPI network.

### PPI network

A PPI connection is a point-to-point connection. The HMI device is the master. The SIMATIC S7-200 is the slave.

You can connect a maximum of one SIMATIC S7-200 to an HMI device. You use the serial connector of the CPU to connect the HMI device. You can connect multiple HMI devices to one SIMATIC S7-200. From the perspective of the SIMATIC S7-200, only one connection at a time is possible.

---

#### Note

The PPI network can contain a maximum of four masters in addition to the HMI device. For performance reasons, do not configure more than four devices at a time as a master in the PPI network.

---

### Network architectures

PPI is based on the PROFIBUS standard (IEC 61158 and EN 50170) and supports the following bus topologies:

- Line
- Star

Multi-master networks with a maximum of 32 masters are set up with PPI:

- An unlimited number of masters can communicate with each slave.
- A slave can be assigned to multiple masters.

The RS 485 repeater can be used to extend the PPI network. Modems can also be connected to the PPI network.

### 10.11.3.2 Configuring networks and connections

#### Networking devices

##### Introduction

The "Devices & Networks" editor is provided for configuring connections. You can network devices in the editor. You can also configure and assign parameters to devices and interfaces. You then configure the required connections between the networked devices.

In the "Devices & Networks" editor you configure HMI connections with the PLCs:

- SIMATIC S7 1500
- SIMATIC S7 1200
- SIMATIC S7 300
- SIMATIC S7 400

You configure the HMI connections to other PLCs in the "Connections" editor of the respective HMI device.

#### Networking devices

The network view of the "Devices & Networks" editor includes a graphical area and a tabular area. You can use the graphical area to network the devices in the project with drag-and-drop. The tabular area provides an overview of the devices and their components.

You can network the following PLCs together with HMI devices in the "Devices & Networks" area.

- SIMATIC S7 1500
- SIMATIC S7 1200
- SIMATIC S7 300
- SIMATIC S7 400

All other PLCs are available in the TIA-Portal and are configured "not integrated". You configure "not integrated" connections in the "Connections" editor of the HMI device.

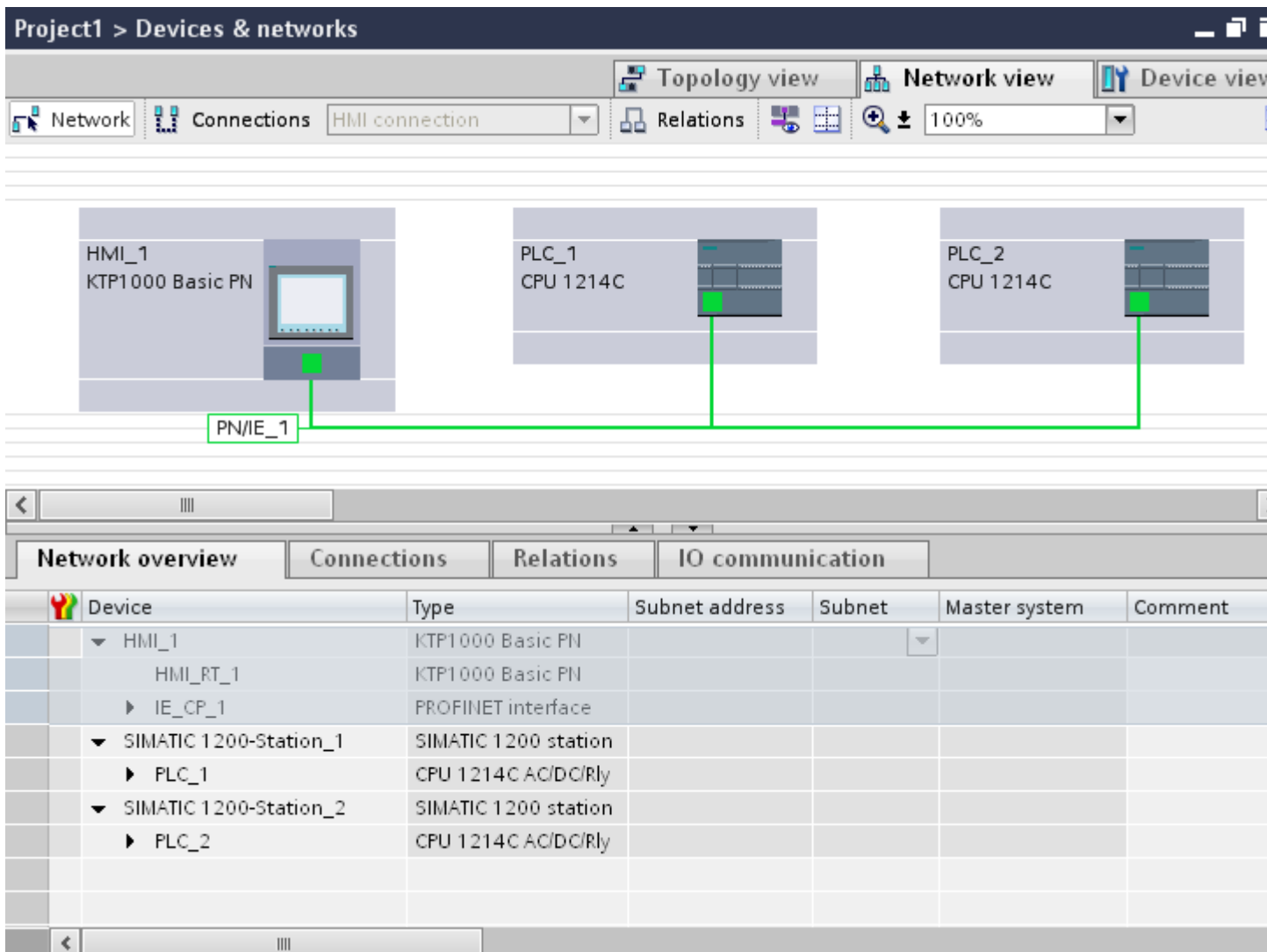

With the networking step, you configure the physical connection of the communication partners. The networking of devices is depicted by lines that are colored according to the interface.

## Configuring an integrated connection in the "Devices & Networks" editor

### Introduction

You configure an HMI connection between the HMI device and a SIMATIC S7 PLC in the "Devices & Networks" editor. This HMI connection is the direct connection between the communication partners that you have created in a project.

## Integrated connections

Connections of devices within a project are referred to as integrated connections. In the case of integrated connections, you can directly configure addresses of PLC tags.

### Note

An HMI connection can be configured in the "Devices & Networks" editor for the following PLCs only:

- SIMATIC S7 1500
- SIMATIC S7 1200
- SIMATIC S7 300
- SIMATIC S7 400

You configure the HMI connections to all other PLCs in the "Connections" editor of the HMI device.

## Configuring an HMI connection in the "Devices & Networks" editor

1. Insert an HMI device and a SIMATIC S7 PLC in your project.

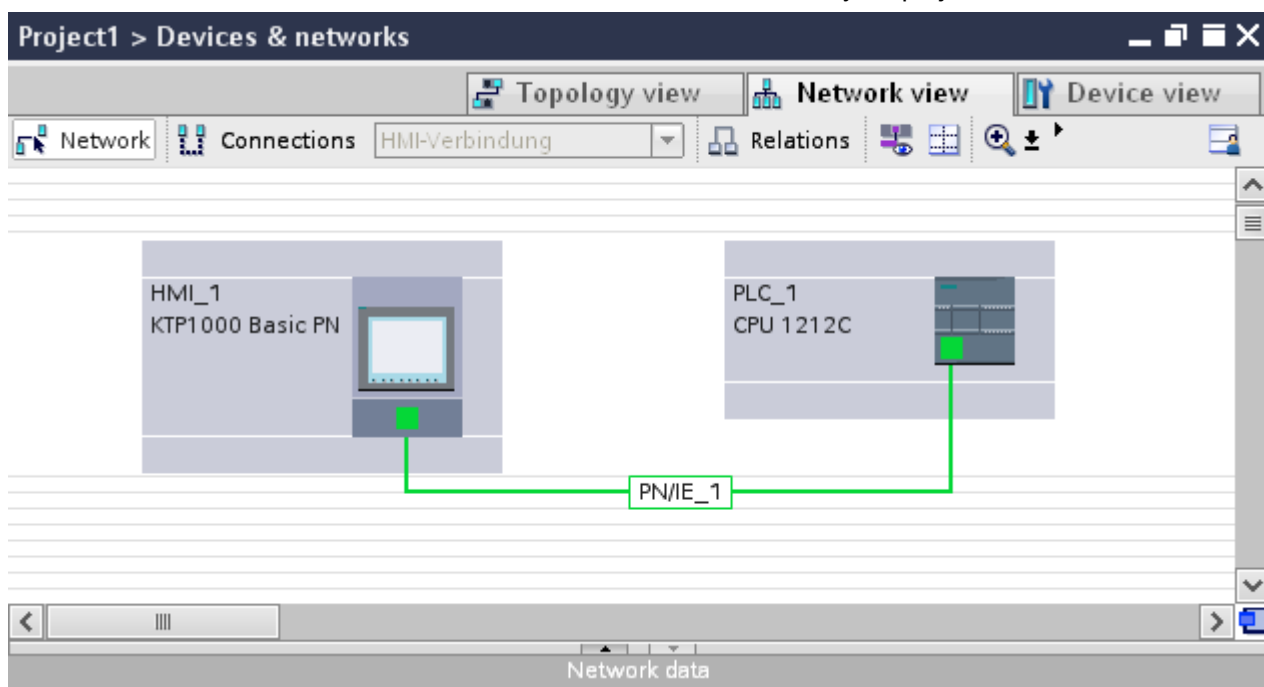

2. Switch to "Connections" mode.
3. Select the "HMI connection" connection type.

4. Use a drag-and-drop operation to interconnect the two PROFINET interfaces.

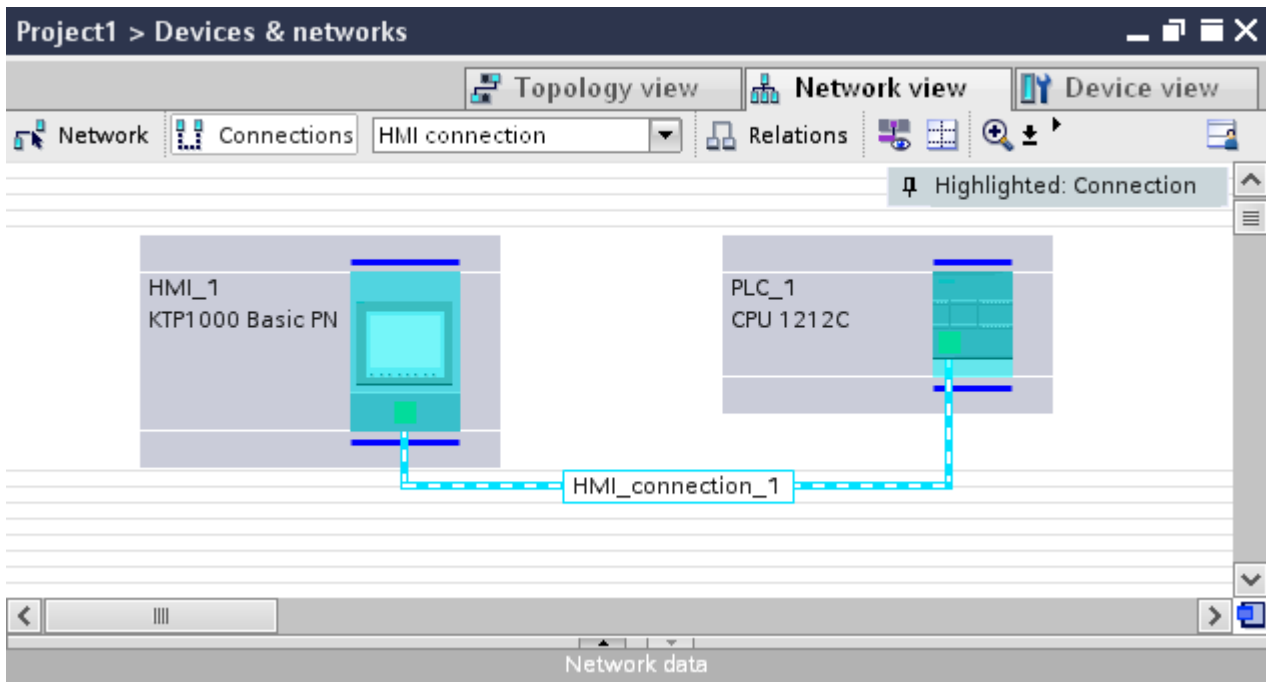

5. Change the IP address and subnet mask address parameters according to the requirements of your project.

## Special considerations of the "Devices & Networks" editor

### Introduction

If you are configuring or have already configured networks or HMI connections, the "Devices & Networks" editor supports you with the following functions:

- Highlighting of communication partners
- Highlighting of HMI connections
- Automatic creation of subnets

### Highlighting of communication partners

All communication partners for which an HMI connection is possible are highlighted in turquoise if you have selected the "HMI connection" type.

Starting from the interface of a device create an HMI connection to the device of another device using a drag-and-drop operation. During the drag-and-drop operation all potential communication partners are highlighted in turquoise.

Use the ESC key to stop connecting interfaces using a drag-and-drop operation.

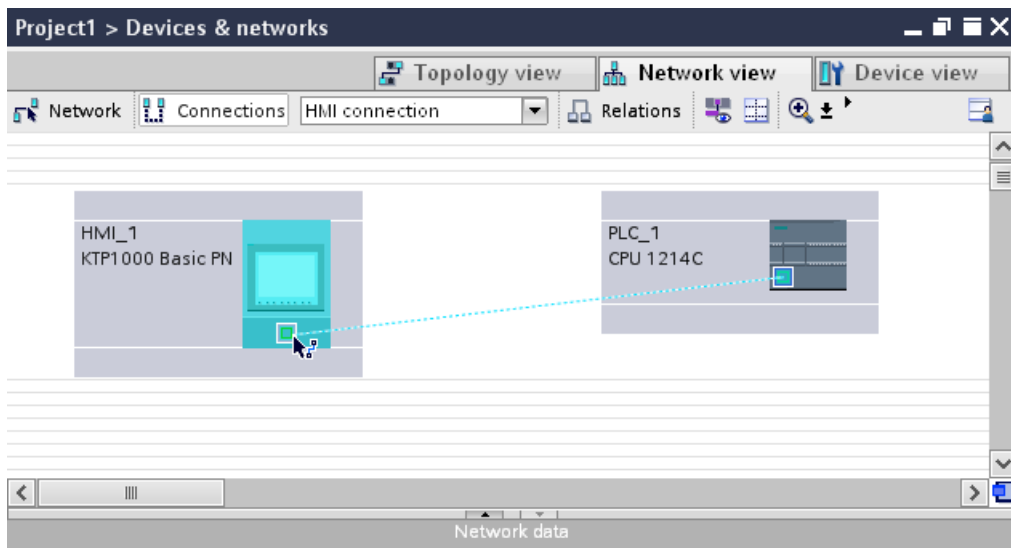

When the mouse pointer is moved over the interface of a device, the following icons indicate whether a connection is possible:



A connection is possible.



A connection is not possible.

## Highlighting of HMI connections

A turquoise highlighting of the connection indicates that a HMI connection was created. If several HMI connections are created, you can select one of the already created HMI connections in a dialog.

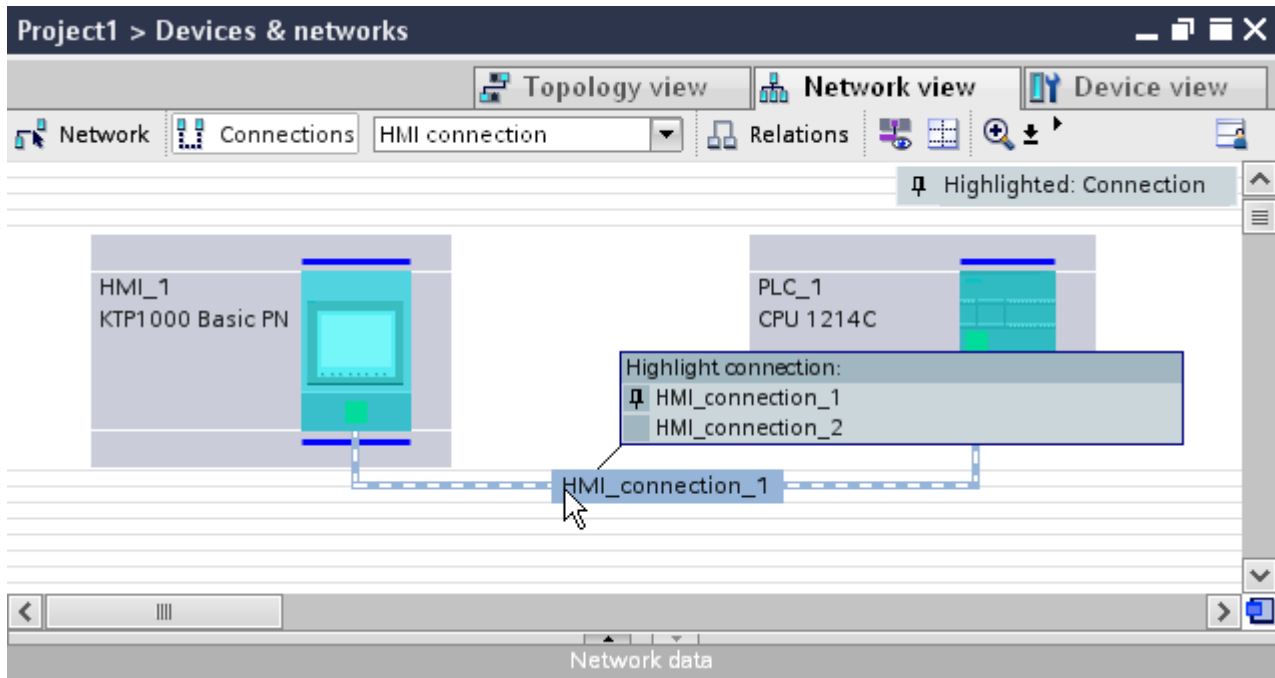

Then you can configure the parameters of the selected HMI connection and the communication partners in the inspector window.

## Subnets

Subnetworks are automatically created and used under the following conditions:

- If both communication partners are not already interconnected in different networks
- If a free interface is available to both communication partners.
- If a subnetwork already exists then that subnetwork is automatically used for the HMI connection.

## Configuring a non-integrated connection in the "Connections" editor

### Introduction

You use the "Connections" editor of the HMI device to configure a connection between an HMI device and a PLC that cannot be configured in the "Devices & Networks" editor.

These connections are referred to as non-integrated connections.

## Requirements

- A project is open.
- An HMI device has been created.

## Configuring a connection in the "Connections" editor

1. Open the "Connections" editor of the HMI device.
2. Create a new connection.

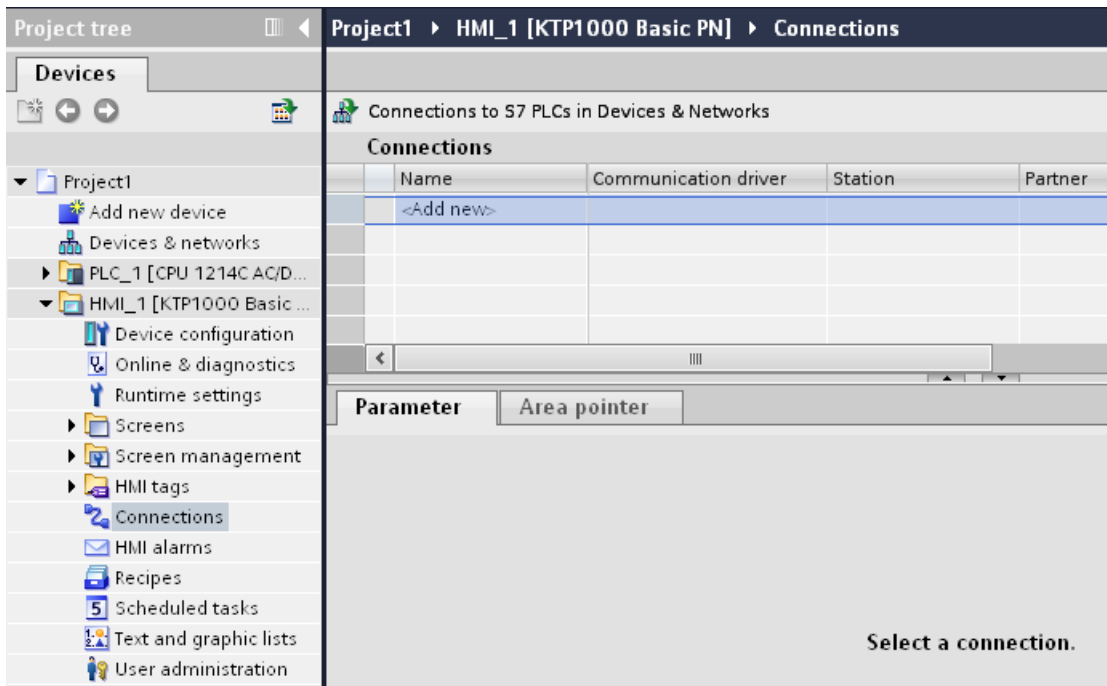



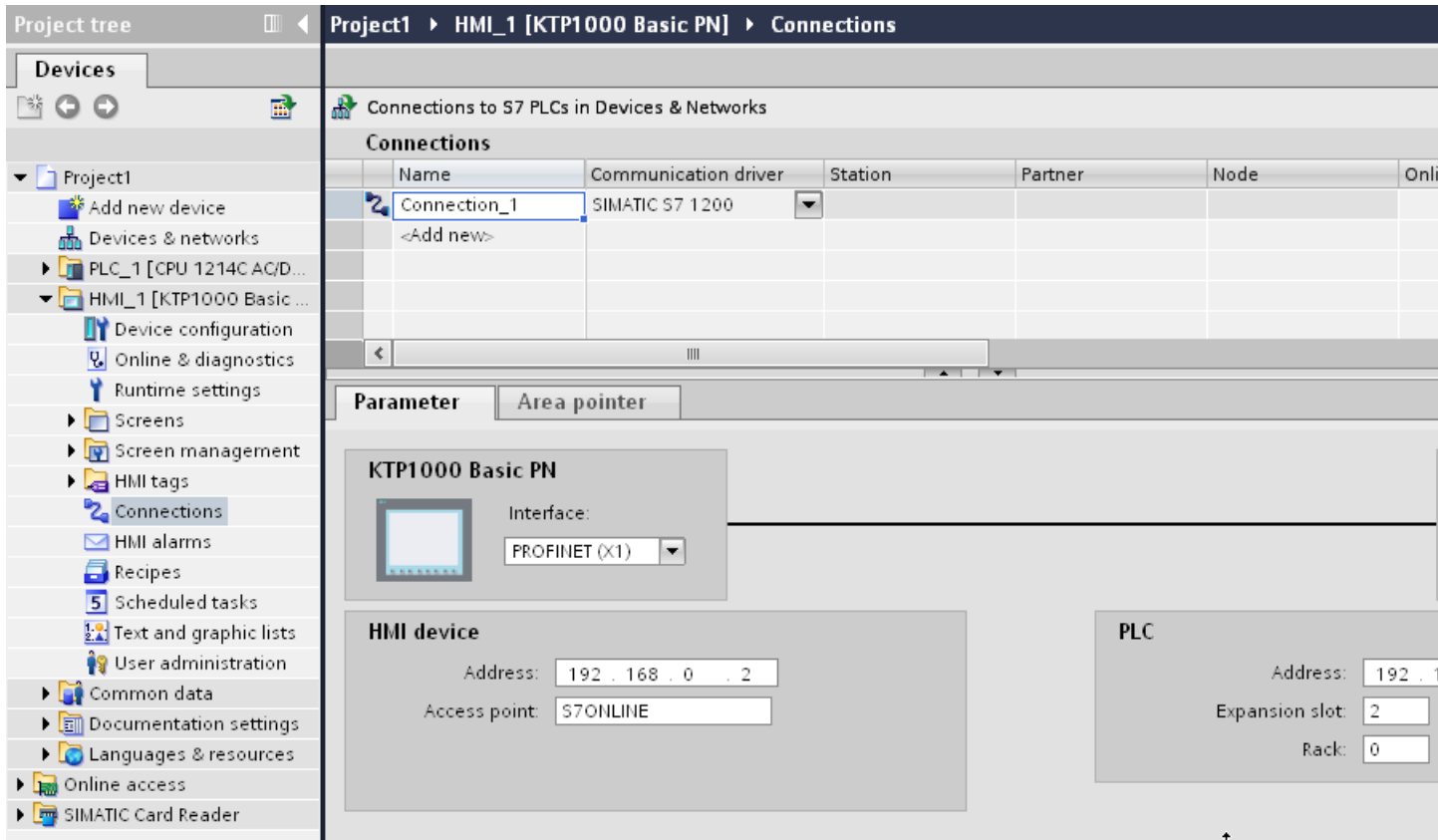

3. Select the communication driver.
4. Set the connection parameters.





### Integrated connections in the "Connections" editor

If you have already configured the integrated connections of the HMI device in the "Devices & Networks" editor, they are also displayed in the "Connections" editor.

Connexions						
	Nom	Pilote de communication	Station	Partenaire	Noeud	En ligne
	Connexion_1	SIMATIC S7 1200				<input checked="" type="checkbox"/>
	Liaison_HMI_1	SIMATIC S7 1200	SIMATIC 1200-Station	PLC_1	CPU 1214C AC/DC/R...	<input checked="" type="checkbox"/>
	<ajouter>					

Meaning of the icons used:

-  Integrated connection
-  Non-integrated connection

## 10.11.4 Data exchange

### 10.11.4.1 Data exchange using tags

#### Basics of tags

##### Introduction

Process values are forwarded in runtime using tags. Process values are data which is stored in the memory of one of the connected automation systems. They represent the status of a plant in the form of temperatures, fill levels or switching states, for example. Define external tags for processing the process values in WinCC.

WinCC works with two types of tag:

- External tags
- Internal tags

The external tags form the link between WinCC and the automation systems. The values of external tags correspond to the process values from the memory of an automation system. The value of an external tag is determined by reading the process value from the memory of the automation system. It is also possible to rewrite a process value in the memory of the automation system.

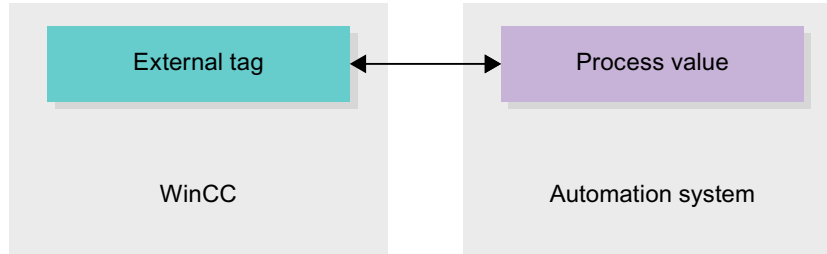

Internal tags do not have a process link and only convey values within the WinCC. The tag values are only available as long as runtime is running.

#### Tags in WinCC

For external tags, the properties of the tag are used to define the connection that the WinCC uses to communicate with the automation system and form of data exchange.

Tags that are not supplied with values by the process - the internal tags - are not connected to the automation system. In the tag's "Connection" property, this is identified by the "Internal tag" entry.

You can create tags in different tag tables for greater clarity. You then directly access the individual tag tables in the "HMI tags" node in the project tree. The tags from all tag tables can be displayed with the help of the table "Show all tags".

With structures you bundle a number of different tags that form one logical unit. Structures are project-associated data and are available for all HMI devices of the project. You use the "Types" editor in the project library to create and edit a structure.

## Overview of HMI tag tables

### Introduction

HMI tag tables contain the definitions of the HMI tags that apply across all devices. A tag table is created automatically for each HMI device created in the project.

In the project tree there is an "HMI tags" folder for each HMI device. The following tables can be contained in this folder:

- Default tag table
- User-defined tag tables
- Table of all tags

In the project tree you can create additional tag tables in the HMI tags folder and use these to sort and group tags and constants. You can move tags to a different tag table using a drag-and-drop operation or with the help of the "Tag table" field. Activate the "Tags table" field using the shortcut menu of the column headings.

### Default tag table

There is one default tag table for each HMI device of the project. It cannot be deleted or moved. The default tag table contains HMI tags and, depending on the HMI device, also system tags. You can declare all HMI tags in the standard tags table or, as necessary, additional user-defined tables of tags.

### User-defined tag tables

You can create multiple user-defined tag tables for each HMI device in order to group tags according to your requirements. You can rename, gather into groups, or delete user-defined tag tables. To group tag tables, create additional subfolders in the HMI tags folder.

### All tags

The "All tags" table shows an overview of all HMI tags and system tags of the HMI device in question. This table cannot be deleted, renamed or moved. This table also contains the "Tags table" column, which indicates the tag table of where a tag is included. Using the "Tags table" field, the assignment of a tag to a tags table can be changed.

With devices for Runtime Professional, the table "All tags" contain an additional tab "System tags". The system tags are created by the system and used for internal management of the project. The names of the system tags begin with the "@" character. System tags cannot be deleted or renamed. You can evaluate the value of a system tag, but cannot modify it.

## Additional tables

The following tables are also available in an HMI tag table:

- Discrete alarms
- Analog alarms
- Logging tags

With the help of these tables you configure alarms and logging tags for the currently selected HMI tag.

## Discrete alarms table

In the "Discrete alarms" table, you configure discrete alarms to the HMI tag selected in the HMI tag table. When you configure a discrete alarm, multiple selection in the HMI tag table is not possible. You configure the discrete alarms for each HMI tag separately.

## Analog alarms table

In the "Analog alarms" table, you configure analog alarms to the HMI tag selected in the HMI tag table. When you configure an analog alarm, multiple selection in the HMI tag table is not possible. You configure the analog alarms for each HMI tag separately.

## Logging tags table

In the "Logging tags" table, you configure logging tags to the HMI tag selected in the HMI tag table. When you configure a logging tag, multiple selection in the HMI tag table is not possible. You configure the logging tags for each HMI tag separately. The "Logging tags" table is only available if the HMI device used supports logging.

If WinCC Runtime Professional is used, you can also assign several log tags to a tag. With the other HMI devices, you can only assign one log tag to a tag.

## External tags

### Introduction

External tags allow communication (exchange of data) between the components of an automation system, such as between the HMI device and the PLC.

### Principle

An external tag is the image of a defined memory location in the PLC. You have read and write access to this storage location from both the HMI device and from the PLC.

Since external tags are the image of a storage location in the PLC, the applicable data types depend on the PLC which is connected to the HMI device.

In STEP 7, if you write a PLC control program, the PLC tags created in the control program will be added to the PLC tag table. If you want to connect an external tag to a PLC tag, access the PLC tags directly via the PLC tag table and connect them to the external tag.

## Data types

All the data types which are available at the connected PLC are available at an external tag in WinCC. Information about data types which are available for connection to other PLCs can be found in the documentation about the respective communication drivers.

See "Communication between devices (Page 4909)" for additional information.

---

### Note

As well as external tags, area pointers are also available for communication between the HMI device and PLC. You can set up and enable the area indicators in the "Connections" editor.

---

## Update of tag values

For external tags, the current tag values are transmitted in runtime via the communication connection between WinCC and the connected automation systems and then saved in the runtime memory. Next, the tag value will be updated to the set cycle time. For use in the runtime project, WinCC accesses tag values in the runtime memory that were read from the PLC at the previous cycle time. As a result, the value in the PLC can already change whilst the value from the runtime memory is being processed.

## See also

Communication between devices (Page 4909)



## Addressing external tags

### Introduction

The options for addressing external tags depend on the type of connection between WinCC and the PLC in question. A distinction must be made between the following connection types:

- **Integrated connection**  
Connections of devices which are within a project and were created with the "Devices & Networks" editor are referred to as integrated connections.
- **Non-integrated connection**  
Connections of devices which were created with the "Connections" editor are referred to as non-integrated connections. It is not necessary that all of the devices be within a single project.

The connection type can also be recognized by its icon.

	Integrated connection
	Non-integrated connection

You can find additional information in the section "Basics of communication (Page 4909)".

## Addressing with integrated connections

An integrated connection offers the advantage that you can address a tag both symbolically and absolutely.

For symbolic addressing, you select the PLC tag via its name and connect it to the HMI tag. The valid data type for the HMI tag is automatically selected by the system. You have to distinguish between the following cases when you address elements in data blocks:

### Symbolic addressing of data blocks with optimized access and standard access:

During the symbolic addressing of a data block with optimized access and standard access, the address of an element in the data block is dynamically assigned and is automatically adopted in the HMI tag in the event of a change. You do not need to compile the connected data block or the WinCC project for this step.

For data blocks with optimized access, only symbolic addressing is available.

For symbolic addressing of elements in a data block, you only need to recompile and reload the WinCC project in case of the following changes:

- If the name or the data type of the linked data block element or global PLC tag has changed.
- If the name or the data type of the higher level structure node of a linked element in the data block element or global PLC tag has changed.
- If the name of the connected data block has changed.

Symbolic addressing is currently available with the following PLCs:

- SIMATIC S7 1200
- SIMATIC S7 1500

Symbolic addressing is also available if you have an integrated link.

---

### Note

Symbolic addressing is not possible if you are using the "Date/Time" area pointer.

---

You can also use absolute addressing with an integrated connection. You have to use absolute addressing for PLC tags from a SIMATIC S7 300/400 PLC. If you have connected an HMI tag with a PLC tag and the address of the PLC tag changes, you only have to recompile the control program to update the new address in WinCC. Then you recompile the WinCC project and load it onto the HMI device.

In WinCC, symbolic addressing is the default method. To change the default setting, select the menu command "Options > Settings". Select "Visualization > Tags" in the "Settings" dialog. If required, disable the "Symbolic access" option.

The availability of an integrated connection depends on the PLC used. The following table shows the availability:

PLC	Integrated connection	Comments
S7 300/400	Yes	The linking of tags is not checked in Runtime. If the tag address changes in the PLC and the HMI device is not compiled again and loaded, the change is not registered in runtime.
S7 1200	Yes	A validity check of the tag connection is performed in runtime during symbolic addressing. If an address is changed in the PLC, the change is registered and an error message is issued. In the case of absolute addressing, the following behavior applies to the S7 300/400.
S7 1500	Yes	A validity check of the tag connection is performed in runtime during symbolic addressing. If an address is changed in the PLC, the change is registered and an error message is issued. In the case of absolute addressing, the following behavior applies to the S7 300/400.

Create an integrated connection in the "Devices & Networks" editor. If the PLC is contained in the project and integrated connections are supported, you can then also have the connection created automatically. To do this, when configuring the HMI tag, simply select an existing PLC tag to which you want to connect the HMI tag. The integrated connection is then automatically created by the system.

### Addressing with non-integrated connections

In the case of a project with a non-integrated connection, you always configure a tag connection with absolute addressing. Select the valid data type yourself. If the address of a PLC tag changes in a project with a non-integrated connection during the course of the project, you also have to make the change in WinCC. The tag connection cannot be checked for validity in Runtime, an error message is not issued.

A non-integrated connection is available for all supported PLCs.

Symbolic addressing is not available in a non-integrated connection.

With a non-integrated connection, the control program does not need to be part of the WinCC project. You can perform the configuration of the PLC and the WinCC project independently of each other. For configuration in WinCC, only the addresses used in the PLC and their function have to be known.

### See also

Basics of communication (Page 4909)

### Internal Tags

#### Introduction

Internal tags do not have any connection to the PLC. Internal tags transport values within the HMI device. The tag values are only available as long as runtime is running.

## Principle

Internal tags are stored in the memory of the HMI device. Therefore, only this HMI device has read and write access to the internal tags. You can create internal tags to perform local calculations, for example.

You can use the HMI data types for internal tags. Availability depends on the HMI device being used.

The following HMI data types are available:

HMI data type	Data format
ARRAY	One-dimensional array
BOOL	Binary tag
DATETIME	Date/time format
DINT	Signed 32-bit value
INT	Signed 16-bit value
LREAL	Floating-point number 64-bit IEEE 754
REAL	Floating-point number 32-bit IEEE 754
SINT	Signed 8-bit value
UDINT	Unsigned 32-bit value
UINT	Unsigned 16-bit value
USINT	Unsigned 8-bit value
WSTRING	Text tag, 16-bit character set

### 10.11.4.2 Data exchange using area pointers

#### Basic information on area pointers

##### Introduction

You use an area pointer to access a data area in the PLC. During communication, the PLC and the HMI device alternately access these data areas for read and write operations. The PLC and the HMI device trigger defined interactions based on the evaluation of stored data.

For example, area pointers are required for the following data:

- Recipes
- Job mailboxes
- Sign-of-life monitoring

##### Area pointers

The following area pointers are supported:



## Area pointer

Area pointers can be configured for connections.

- Data record
- Date/time
- Coordination
- Job mailbox

## Global area pointers of the HMI device

Global area pointers can be configured for separate connections.

- Screen number
- Date/time PLC
- Project ID

## Area pointers for connections

### Introduction

Using the "Area pointer" tab of the "Connections" editor, you can configure the usage of the available area pointers.

To configure the area pointers, open the "Connections" editor and open the "Area pointer" tab.

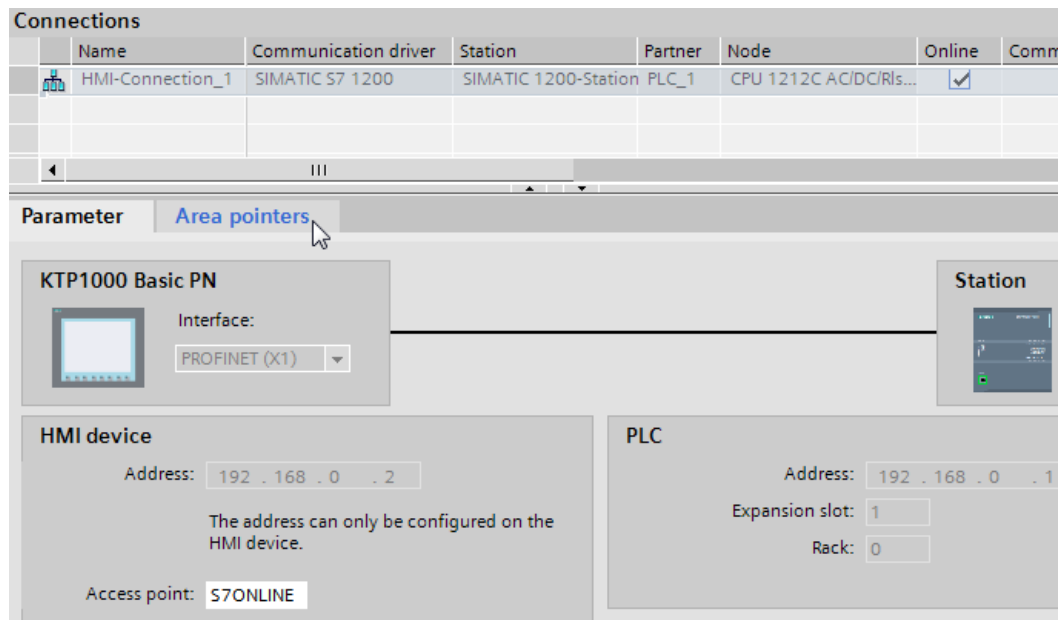

### Structure

The "Area pointer" tab contains two tables of area pointers. The top part of the table contains the area pointers you can create and enable separately for each available connection.

The "Global area pointers of HMI device" table contains the area pointers which are created only once in the project and can be used for only one connection.

Parameter		Area pointer							
Active	Display name	PLC tag	Access mode	Address	Length	Acquisition mode	Acquisition cycle	Comment	
<input type="checkbox"/>	Coordination	<Undefined>	<symbolic access>		1	Cyclic continuous	<Undefined>		
<input type="checkbox"/>	Date/time	<Undefined>	<symbolic access>		6	Cyclic continuous	<Undefined>		
<input type="checkbox"/>	Job mailbox	<Undefined>	<symbolic access>		4	Cyclic continuous	<Undefined>		
<input type="checkbox"/>	Data record	<Undefined>	<symbolic access>		5	Cyclic continuous	<Undefined>		
Global area pointer of HMI device									
Connection	Display name	PLC tag	Access mode	Address	Length	Acquisition mode	Acquisition cycle	Comment	
<Undefined>	Project ID	<Undefined>	<symbolic access>		1	Cyclic continuous	<Undefined>		
<Undefined>	Screen number	<Undefined>	<symbolic access>		5	Cyclic continuous	<Undefined>		
<Undefined>	Date/time PLC	<Undefined>	<symbolic access>		6	Cyclic continuous	<Undefined>		

### Use of area pointers

#### "Area pointer" tab

Before you use an area pointer, you enable it under "Connections > Area pointer". You then assign the area pointer parameters.

You assign the following parameters in the "Area pointer" tab:

Parameter		Area pointer							
Active	Display name	PLC tag	Access mode	Address	Length	Acquisition mode	Acquisition cycle	Comment	
<input type="checkbox"/>	Coordination	<Undefined>	<symbolic access>		1	Cyclic continuous	<Undefined>		
<input type="checkbox"/>	Date/time	<Undefined>	<symbolic access>		6	Cyclic continuous	<Undefined>		
<input type="checkbox"/>	Job mailbox	<Undefined>	<symbolic access>		4	Cyclic continuous	<Undefined>		
<input type="checkbox"/>	Data record	<Undefined>	<symbolic access>		5	Cyclic continuous	<Undefined>		
Global area pointer of HMI device									
Connection	Display name	PLC tag	Access mode	Address	Length	Acquisition mode	Acquisition cycle	Comment	
<Undefined>	Project ID	<Undefined>	<symbolic access>		1	Cyclic continuous	<Undefined>		
<Undefined>	Screen number	<Undefined>	<symbolic access>		5	Cyclic continuous	<Undefined>		
<Undefined>	Date/time PLC	<Undefined>	<symbolic access>		6	Cyclic continuous	<Undefined>		

- **Active**  
Enables the area pointer.
- **Pointer name**  
Name of the area pointer specified by WinCC.
- **PLC tag**  
Here you select the PLC tag or the tag array that you have configured as the data area for the area pointer.
- **Access mode**  
Here you can select from the following access modes:
  - Symbolic access
  - Absolute access
- **Address**  
If you selected "Symbolic access", no address is entered in this field.  
If you selected "Absolute access", enter the address of a tag in the "Address" field.
- **Length**  
WinCC specifies the length of the area pointer.
- **Acquisition cycle**  
You specify the acquisition cycle in this field for area pointers that are read by the HMI device. Note that a very short acquisition time may have a negative impact on HMI device performance.
- **Comment**  
Enter a comment, for example, to describe the purpose of the area pointer.

## Accessing data areas

### Accessing data areas

The following table shows how HMI devices and PLCs access individual data areas for read (R) or write (W) operations.

Data area	Required for	HMI device	PLC
Screen number	Evaluation by the PLC in order to determine the active screen.	W	R
Data record	Transfer of data records with synchronization	R/W	R/W
Date/time	Transfer of the date and time from the HMI device to the PLC	W	R
Date/time PLC	Transfer of the date and time from the PLC to the HMI device	R	W
Coordination	Requesting the HMI device status in the PLC program	W	R
Project ID	Runtime checks for consistency between the WinCC project ID and the project in the PLC	R	W
Job mailbox	Triggering of HMI device functions by the PLC program	R/W	R/W

## Configuring area pointers

### Configuration of area pointers

#### Introduction

You use an area pointer to access a data area in the PLC. The data area is stored in the PLC.

#### Prior to configuring area pointers

Before you use the area pointer, you must enable and parameterize it under "Connections > Area Pointer".

#### Global data block

To access the data area in the PLC, you have to create a global data block in the PLC program. The following example shows the use of a data block.

#### Length of area pointers

For area pointers with a length  $\geq 1$ , you set up the data area as a tag array in a global data block or instance data block.

You also have the option to use a PLC tag for area pointers with a length = 1.

The configuration of the tags in a data block is dependent on the length of the area pointer you want to use. The unit for the length of an area pointer is a 16-bit word.

If, for example, you want to use an area pointer with a length of "5", you must create an array with 5 array elements of the data type UINT in the data block.

#### Alternative procedure

Alternatively, you can also use the absolute access mode to access area pointers. Absolute access mode only works on standard PLC data blocks.

### Parameterizing a global data block

#### Introduction

To access the data area in the PLC, a global data block for the area pointer must be parameterized in the PLC program.

## Requirements

- A PLC is created in the project.
- A connection is configured between the PLC and the HMI device.
- The PLC program contains a global data block.

## Procedure

1. Open "PLC > Program blocks" in the project tree.
2. Double-click the global data block you created previously.  
The data block opens.

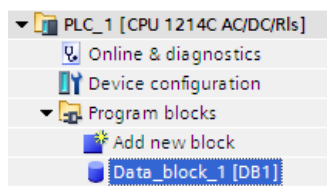

3. Enter a tag name in the "Name" column.
4. Select "Array[lo .. hi] of type" as the data type in the "Data type" column.
5. Replace the "lo" entry by the low value for the dimension of the array.
6. Replace the "hi" entry by the high value for the dimension of the array.  
Example: If you configure an area pointer with the length "4", enter the value "0" for "lo" and the value "3" for "hi" inside the brackets.
7. Replace the "type" designation with the "word" data type.  
The full data type for an array of 4 tags appears as follows: "Array[0 .. 3] of word".  
The tag array is created after the entry is confirmed.
8. Click "Compile".  
The project is compiled.

Data_block_1						
	Name	Data type	Default value	Initial value	Retain	Comment
1	Static				<input type="checkbox"/>	
2	Job_mailbox	Array [0 .. 3] of word			<input type="checkbox"/>	
3	Job_mailbox[0]	Word	W#16#0000	W#16#0000	<input type="checkbox"/>	
4	Job_mailbox[1]	Word	W#16#0000	W#16#0000	<input type="checkbox"/>	
5	Job_mailbox[2]	Word	W#16#0000	W#16#0000	<input type="checkbox"/>	
6	Job_mailbox[3]	Word	W#16#0000	W#16#0000	<input type="checkbox"/>	

## Configuring an area pointer for a connection

### Introduction

After you have parameterized the global data block, you now create the area pointer for the connection.

## Requirements

- The global data block has been parameterized in the PLC program.

## Procedure

- Open "HMI >Connections" in the project tree.
- Click the "Area pointer" tab.
- Enable the required area pointer.  
You enable a global area pointer by selecting the connection in the "Connection" field.
- Click the navigation button in the "PLC tag" field.  
The object list opens.
- Navigate to the data block in the object list, and select the tag in the right window.  
You do not need an array tag to configure an area pointer with the length of "1".

Parameter		Area pointers				
Active	Display name	PLC tag	Address	Length	Acquisition mode	
<input type="checkbox"/>	Data record			5	Cyclic continuous	
<input type="checkbox"/>	Datetime			6	Cyclic continuous	
<input type="checkbox"/>	Coordination			1	Cyclic continuous	
<input checked="" type="checkbox"/>	Job mailbox	Data_block_1_Job_mailbox ...	<symbolic access>	4	Cyclic continuous	

Global area pointer of HMI device						
Connection	Display name	PLC tag	Address	Length	Acquisition mode	Acquisition cycle
<Undefined> ...	Screen number			5	Cyclic continuous	<Undefined>
<Undefined>	Datetime PLC			6	Cyclic continuous	<Undefined>
<Undefined>	Project ID			1	Cyclic continuous	<Undefined>

- Select the "Word" data type when creating the tag in the data block.  
If required, set additional parameters, such as the acquisition cycle, during configuration.

## Result

The area pointer is enabled and connected to the PLC tag in the global data block.

### 10.11.5 Device dependency

#### 10.11.5.1 Basic Panel

#### Communication drivers for Basic Panels

#### Device dependency of the Basic Panels

The following table shows which communication drivers you can configure with the various Basic Panels.

## Communication drivers

HMI devices	SIMA TIC S7 1500	SIMA TIC S7 1200	SIMA TIC S7 300/400	SIMA TIC S7 200	SIMA TIC LOGO!	SIMA TIC HTTP protocol	OPC	Allen-Bradley EtherNet/IP	Allen-Bradley DF1	Mitsubishi MC TCP/IP	Mitsubishi FX	Modicon Modbus TCP/IP	Modicon Modbus RTU	Omron Host Link
KP300 Basic	Yes	Yes	Yes	Yes	Yes	No	No	Yes	No	Yes	No	Yes	No	No
KP400 Basic	Yes	Yes	Yes	Yes	Yes	No	No	Yes	No	Yes	No	Yes	No	No
KTP400 Basic PN	Yes	Yes	Yes	Yes	Yes	No	No	Yes	No	Yes	No	Yes	No	No
KTP600 Basic DP	Yes	Yes	Yes	Yes	Yes	No	No	No	Yes <sup>2)</sup>	No	Yes	No	Yes <sup>1)</sup>	Yes
KTP600 Basic PN	Yes	Yes	Yes	Yes	Yes	No	No	Yes	No	Yes	No	Yes	No	No
KTP1000 Basic DP	Yes	Yes	Yes	Yes	Yes	No	No	No	Yes <sup>2)</sup>	No	Yes	No	Yes <sup>1)</sup>	Yes
KTP1000 Basic PN	Yes	Yes	Yes	Yes	Yes	No	No	Yes	No	Yes	No	Yes	No	No
TP1500 Basic PN	Yes	Yes	Yes	Yes	Yes	No	No	Yes	No	Yes	No	Yes	No	No

<sup>1)</sup> only with RS 422-RS232 converter

Order number: 6AV6 671-8XE00-0AX0

<sup>2)</sup> Direct communication with PLC 5 or KF2 module, otherwise only approved with RS422-RS232 converter (option).

Order number: 6AV6 671-8XE00-0AX0

## Interfaces of the Basic Panels

### Device dependency of the Basic Panels

The following table shows which HMI device interfaces are available for the communication driver protocols.

Table 10-149 Basic Panels

	KP300 Basic KP400 Basic KTP400 Basic PN KTP600 Basic PN KTP1000 Basic PN TP1500 Basic PN	KTP600 Basic DP KTP1000 Basic DP
SIMATIC S7 - PPI <sup>1)</sup>	—	MPI/DP (X2)
SIMATIC S7 - MPI	—	MPI/DP (X2)
SIMATIC S7 - PROFIBUS	—	MPI/DP (X2)
SIMATIC S7 - PROFINET	PROFINET (X1)	—
SIMATIC HMI HTTP protocol	—	—
OPC	—	—
Allen-Bradley EtherNet/IP	PROFINET (X1)	—
Allen-Bradley DF1	—	MPI/DP (X2) <sup>2)</sup>
Mitsubishi TCP/IP	PROFINET (X1)	—
Mitsubishi FX	—	MPI/DP (X2) (RS422)
Modicon Modbus TCP	PROFINET (X1)	—
Modicon Modbus RTU	—	MPI/DP (X2) <sup>3)</sup>
Omron Host Link	—	MPI/DP (X2) (RS422)

<sup>1)</sup> For SIMATIC S7-200 only

<sup>2)</sup> Direct communication with PLC5 or KF2 module, otherwise only approved with RS422-RS232 converter (option).

Order number: 6AV6 671-8XE00-0AX0

<sup>3)</sup> only approved with RS 422-RS232 converter

Order number: 6AV6 671-8XE00-0AX0

## Area pointers for Basic Panels

### Introduction

Area pointers are parameter fields from which the HMI device obtains information about the location and size of data areas in the PLC. During communication, the PLC and the HMI device



alternately access these data areas for read and write operations. Based on the evaluation of data stored in the data areas, the PLC and HMI device initiate mutually defined actions.

WinCC uses the following area pointers:

- Job mailbox
- Project ID
- Screen number
- Data record
- Date/time
- Date/time PLC
- Coordination

### Availability of the area pointers

The following table shows the availability of the area pointers on the HMI devices. Note that the area pointers can be used only for available communication drivers.

#### Area pointer

	KP300 Basic	KTP400 Basic PN	KTP600 Basic PN	KTP600 Basic DP	KTP1000 Basic PN	KTP1000 Basic DP	TP1500 Basic PN
Screen number	Yes	Yes	Yes	Yes	Yes	Yes	Yes
Data record	Yes	Yes	Yes	Yes	Yes	Yes	Yes
Date/time	Yes	Yes	Yes	Yes	Yes	Yes	Yes
Date/time PLC	Yes	Yes	Yes	Yes	Yes	Yes	Yes
Coordination	Yes	Yes	Yes	Yes	Yes	Yes	Yes
Project ID	Yes	Yes	Yes	Yes	Yes	Yes	Yes
Job mailbox	Yes	Yes	Yes	Yes	Yes	Yes	Yes

### 10.11.5.2 Panel

#### Communication drivers for Panels

#### Device dependency of Panels

The following table shows which communication drivers you can configure with the various Panels.

Communication drivers

HMI devices	SIMATIC	SIMA TIC S71500	SIMA TIC S7300	SIMA TIC S7200	SIMA TIC LOGO!	SIMA TIC HTTP protocol	OPC	Allen-Bradley EtherNet/IP	Allen-Bradley DF1	Mitsubishi MC TCP/IP	Mitsubishi FX	Modicon Plus TCP/IP	Modicon Plus RTU	Omron Host Link
OP 73	No	No	Yes	Yes	No	No	No	No	No	No	No	No	No	No
OP 77A	No	Yes	Yes	Yes	No	No	No	No	Yes <sup>2)</sup> Yes <sup>3)</sup>	No	Yes	No	Yes <sup>1)</sup>	Yes <sup>3)</sup>
OP 77B	No	Yes	Yes	Yes	No	No	No	No	Yes <sup>2)</sup> Yes <sup>3)</sup>	No	Yes	No	Yes	Yes <sup>3)</sup>
TP 177A	No	Yes	Yes	Yes	No	No	No	No	Yes <sup>2)</sup> Yes <sup>3)</sup>	No	Yes	No	Yes <sup>1)</sup>	Yes <sup>3)</sup>
TP 177A Portrait	No	Yes	Yes	Yes	No	No	No	No	Yes <sup>2)</sup> Yes <sup>3)</sup>	No	Yes	No	Yes <sup>1)</sup>	Yes <sup>3)</sup>
TP 177B 4"	No	Yes	Yes	Yes	Yes	Yes	No	Yes	Yes <sup>2)</sup> Yes <sup>3)</sup>	Yes	Yes	Yes	Yes <sup>1)</sup> Yes <sup>3)</sup>	Yes <sup>3)</sup>
TP 177B 6" mono	No	Yes	Yes	Yes	Yes	No	No	No	Yes <sup>2)</sup> Yes <sup>3)</sup>	No	Yes	No	Yes <sup>1)</sup> Yes <sup>3)</sup>	Yes <sup>3)</sup>
TP 177B 6"	No	Yes	Yes	Yes	Yes	Yes	No	Yes	Yes <sup>2)</sup> Yes <sup>3)</sup>	Yes	Yes	Yes	Yes <sup>1)</sup> Yes <sup>3)</sup>	Yes <sup>3)</sup>
OP 177B 6" mono	No	Yes	Yes	Yes	Yes	No	No	No	Yes <sup>2)</sup> Yes <sup>3)</sup>	No	Yes	No	Yes <sup>1)</sup> Yes <sup>3)</sup>	Yes <sup>3)</sup>
OP 177B 6"	No	Yes	Yes	Yes	Yes	Yes	No	Yes	Yes <sup>2)</sup> Yes <sup>3)</sup>	Yes	Yes	Yes	Yes <sup>1)</sup> Yes <sup>3)</sup>	Yes <sup>3)</sup>
TP 277 6"	No	Yes	Yes	Yes	Yes	Yes	No	Yes	Yes <sup>2)</sup> Yes <sup>3)</sup>	Yes	Yes	Yes	Yes <sup>1)</sup> Yes <sup>3)</sup>	Yes <sup>3)</sup>
OP 277 6"	No	Yes	Yes	Yes	Yes	Yes	No	Yes	Yes <sup>2)</sup> Yes <sup>3)</sup>	Yes	Yes	Yes	Yes <sup>1)</sup> Yes <sup>3)</sup>	Yes <sup>3)</sup>

- 1) only approved with RS 422-RS232 converter  
Order number: 6AV6 671-8XE00-0AX0
- 2) Direct communication with PLC 5 or KF2 module, otherwise only approved with RS422-RS232 converter (option).  
Order number: 6AV6 671-8XE00-0AX0
- 3) "PROFINET IO Enabled" must be disabled.

## Interfaces of Panels

### Device dependency of Panels

The following table shows which HMI device interfaces are available for the communication driver protocols.

Table 10-150 Panels

	OP 73	OP 77A	OP 77B <sup>3)</sup>	TP 177A	TP 177B <sup>3)</sup> OP 177B <sup>3)</sup>	TP 277 <sup>3)</sup> OP 277 <sup>3)</sup>
SIMATIC S7 - PPI <sup>1)</sup>	IF1B	IF1B	IF1B	IF1B	IF1B	IF1B
SIMATIC S7 - MPI	IF1B	IF1B	IF1B	IF1B	IF1B	IF1B
SIMATIC S7 - PROFIBUS	IF1B	IF1B	IF1B	IF1B	IF1B	IF1B
SIMATIC S7 - PROFINET	—	—	—	—	ETHERNE T <sup>2)</sup>	ETHERNE T <sup>2)</sup>
SIMATIC HMI HTTP protocol	—	—	—	—	ETHERNE T <sup>2)</sup>	ETHERNE T
OPC	—	—	—	—	—	—
Allen-Bradley Ethernet IP	—	—	—	—	ETHERNE T <sup>2)</sup>	ETHERNE T
Allen-Bradley DF1	—	IF1B <sup>5)</sup>	IF1A <sup>3)</sup> , IF1B <sup>3)4)</sup>	IF1B <sup>5)</sup>	IF1B <sup>3) 5) 8)</sup>	IF1B <sup>3) 5) 8)</sup>
Mitsubishi MC TCP/IP	—	—	—	—	ETHERNE T <sup>2)</sup>	ETHERNE T
Mitsubishi FX	—	IF1B	IF1A <sup>3)</sup> , IF1B <sup>3)</sup>	IF1B	IF1B <sup>3) 8)</sup>	IF1B <sup>3) 8)</sup>
Modicon Modbus TCP	—	—	—	—	ETHERNE T <sup>2)</sup>	ETHERNE T
Modicon Modbus RTU	—	IF1B <sup>7)</sup>	IF1A <sup>3)</sup> , IF1B <sup>3)6)</sup>	IF1B <sup>7)</sup>	IF1B <sup>7) 3) 8)</sup>	IF1B <sup>7) 3) 8)</sup>
Omron Host Link	—	IF1B	IF1A <sup>3)</sup> , IF1B <sup>3)</sup>	IF1B	IF1B <sup>3) 8)</sup>	IF1B <sup>3) 8)</sup>

- 1) For SIMATIC S7-200 only
- 2) Not approved for TP 177B DP, OP 177B DP.
- 3) For serial communication, deselect "Remote Control" of "Channel 1" in the "File > Transfer > Options" menu.
- 4) Only with PLC5 or KF2 module.
- 5) Direct communication with PLC5 or KF2 module, otherwise only approved with RS422-RS232 converter 6AV6 671-8XE00-0AX0 (option)
- 6) Can be selected and used, but not approved.
- 7) Only with RS 422-RS 232 converter 6AV6 671-8XE00-0AX0 (option)
- 8) "PROFINET IO Enabled" must be disabled.

## Area pointers for Panels

### Introduction

Area pointers are parameter fields from which the HMI device obtains information about the location and size of data areas in the PLC. During communication, the PLC and the HMI device alternately access these data areas for read and write operations. Based on the evaluation of data stored in the data areas, the PLC and HMI device initiate mutually defined actions.

WinCC uses the following area pointers:

- Job mailbox
- Project ID
- Screen number
- Data record
- Date/time
- Date/time PLC
- Coordination

### Availability of the area pointers

The following table shows the availability of the area pointers on the HMI devices. Note that the area pointers can be used only for available communication drivers.

### Area pointers

	OP 73	OP 77A	OP 77B	TP 177A	TP 177B OP 177B	TP 277 OP 277
Screen number	Yes	Yes	Yes	Yes	Yes	Yes
Data record	No	Yes	Yes	Yes	Yes	Yes
Date/time	Yes	Yes	Yes	Yes	Yes	Yes
Date/time PLC	Yes	Yes	Yes	Yes	Yes	Yes
Coordination	Yes	Yes	Yes	Yes	Yes	Yes
Project ID	Yes	Yes	Yes	Yes	Yes	Yes
Job mailbox	Yes	Yes	Yes	Yes	Yes	Yes

### 10.11.5.3 Comfort Panel

#### Communication drivers for Comfort Panels

#### Device dependency of Comfort Panels

The following table shows which communication drivers you can configure with the various Comfort Panels.

#### Communication drivers

HMI devices	SIMATIC S7 1500	SIMATIC S7 300/400	SIMATIC S7 300/400	SIMATIC S7 300/400	SIMATIC S7 300/400	SIMATIC S7 300/400	OPC <sup>1)</sup>	Allen-Bradley EtherNet/IP	Allen-Bradley DF1	Mitsubishi MC TCP/IP	Mitsubishi FX	Modbus TCP/IP	Modbus RTU	Omron Host Link
KP400 Comfort	Yes	Yes	Yes	Yes	Yes	Yes	Yes	Yes	Yes <sup>2)</sup> Yes <sup>3)</sup>	Yes	Yes <sup>3)</sup>	Yes	yes <sup>3)4)</sup>	Yes <sup>3)</sup>
KTP400 Comfort	Yes	Yes	Yes	Yes	Yes	Yes	Yes	Yes	Yes <sup>2)</sup> Yes <sup>3)</sup>	Yes	Yes <sup>3)</sup>	Yes	yes <sup>3)4)</sup>	Yes <sup>3)</sup>
KTP400 Comfort Portrait	Yes	Yes	Yes	Yes	Yes	Yes	Yes	Yes	Yes <sup>2)</sup> Yes <sup>3)</sup>	Yes	Yes <sup>3)</sup>	Yes	yes <sup>3)4)</sup>	Yes <sup>3)</sup>
KP700 Comfort	Yes	Yes	Yes	Yes	Yes	Yes	Yes	Yes	Yes <sup>2)</sup> Yes <sup>3)</sup>	Yes	Yes <sup>3)</sup>	Yes	yes <sup>3)4)</sup>	Yes <sup>3)</sup>
TP700 Comfort	Yes	Yes	Yes	Yes	Yes	Yes	Yes	Yes	Yes <sup>2)</sup> Yes <sup>3)</sup>	Yes	Yes <sup>3)</sup>	Yes	yes <sup>3)4)</sup>	Yes <sup>3)</sup>
TP700 Comfort Portrait	Yes	Yes	Yes	Yes	Yes	Yes	Yes	Yes	Yes <sup>2)</sup> Yes <sup>3)</sup>	Yes	Yes <sup>3)</sup>	Yes	yes <sup>3)4)</sup>	Yes <sup>3)</sup>
KP900 Comfort	Yes	Yes	Yes	Yes	Yes	Yes	Yes	Yes	Yes <sup>2)</sup> Yes <sup>3)</sup>	Yes	Yes <sup>3)</sup>	Yes	yes <sup>3)4)</sup>	Yes <sup>3)</sup>
TP900 Comfort	Yes	Yes	Yes	Yes	Yes	Yes	Yes	Yes	Yes <sup>2)</sup> Yes <sup>3)</sup>	Yes	Yes <sup>3)</sup>	Yes	yes <sup>3)4)</sup>	Yes <sup>3)</sup>
TP900 Comfort Portrait	Yes	Yes	Yes	Yes	Yes	Yes	Yes	Yes	Yes <sup>2)</sup> Yes <sup>3)</sup>	Yes	Yes <sup>3)</sup>	Yes	yes <sup>3)4)</sup>	Yes <sup>3)</sup>
KP1200 Comfort	Yes	Yes	Yes	Yes	Yes	Yes	Yes	Yes	Yes <sup>2)</sup> Yes <sup>3)</sup>	Yes	Yes <sup>3)</sup>	Yes	yes <sup>3)4)</sup>	Yes <sup>3)</sup>
TP1200 Comfort	Yes	Yes	Yes	Yes	Yes	Yes	Yes	Yes	Yes <sup>2)</sup> Yes <sup>3)</sup>	Yes	Yes <sup>3)</sup>	Yes	yes <sup>3)4)</sup>	Yes <sup>3)</sup>
TP1200 Comfort Portrait	Yes	Yes	Yes	Yes	Yes	Yes	Yes	Yes	Yes <sup>2)</sup> Yes <sup>3)</sup>	Yes	Yes <sup>3)</sup>	Yes	yes <sup>3)4)</sup>	Yes <sup>3)</sup>
KP1500 Comfort	Yes	Yes	Yes	Yes	Yes	Yes	Yes	Yes	Yes <sup>2)</sup> Yes <sup>3)</sup>	Yes	Yes <sup>3)</sup>	Yes	yes <sup>3)4)</sup>	Yes <sup>3)</sup>

10.11 Communicating with PLCs

HMI devices	SIMATIC S7 1500	SIMATIC S7 300	SIMATIC S7 400	SIMATIC S7 1200	SIMATIC S7 1500	SIMATIC S7 300	OPC <sup>1)</sup>	Allen-Bradley EtherNet/IP	Allen-Bradley DF1	Mitsubishi MC TCP/IP	Mitsubishi FX	Modicon Modbus TCP/IP	Modicon Modbus RTU	Omron Host Link
TP1500 Comfort	Yes	Yes	Yes	Yes	Yes	Yes	Yes	Yes	Yes <sup>2)</sup> <sup>3)</sup>	Yes	Yes <sup>3)</sup>	Yes	yes <sup>3)4)</sup>	Yes <sup>3)</sup>
TP1500 Comfort Portrait	Yes	Yes	Yes	Yes	Yes	Yes	Yes	Yes	Yes <sup>2)</sup> <sup>3)</sup>	Yes	Yes <sup>3)</sup>	Yes	yes <sup>3)4)</sup>	Yes <sup>3)</sup>
TP1900 Comfort	Yes	Yes	Yes	Yes	Yes	Yes	Yes	Yes	Yes <sup>2)</sup> <sup>3)</sup>	Yes	Yes <sup>3)</sup>	Yes	yes <sup>3)4)</sup>	Yes <sup>3)</sup>
TP1900 Comfort Portrait	Yes	Yes	Yes	Yes	Yes	Yes	Yes	Yes	Yes <sup>2)</sup> <sup>3)</sup>	Yes	Yes <sup>3)</sup>	Yes	yes <sup>3)4)</sup>	Yes <sup>3)</sup>
TP2200 Comfort	Yes	Yes	Yes	Yes	Yes	Yes	Yes	Yes	Yes <sup>2)</sup> <sup>3)</sup>	Yes	Yes <sup>3)</sup>	Yes	yes <sup>3)4)</sup>	Yes <sup>3)</sup>
TP2200 Comfort Portrait	Yes	Yes	Yes	Yes	Yes	Yes	Yes	Yes	Yes <sup>2)</sup> <sup>3)</sup>	Yes	Yes <sup>3)</sup>	Yes	yes <sup>3)4)</sup>	Yes <sup>3)</sup>

- 1) OPC-UA (DA only) Client  
OPC-XML DA Server
- 2) Direct communication with PLC 5 or KF2 module, otherwise only approved with RS422-RS232 converter (option).  
Order number: 6AV6 671-8XE00-0AX0
- 3) "PROFINET IO Enabled" must be disabled.
- 4) Only approved with RS 422-RS232 converter  
Order number: 6AV6 671-8XE00-0AX0

Interfaces of Comfort Panels

Device dependency of Comfort Panels

The following table shows which HMI device interfaces are available for the communication driver protocols.

Table 10-151 Comfort Panels

	KP400 Comfort	KTP400 Comfort	KP700 Comfort	TP700 Comfort	KP900 Comfort	TP900 Comfort	KP120 Comfort	TP120 Comfort	KP150 Comfort	TP150 Comfort	TP190 Comfort	TP2200 Comfort
SIMATIC S7 - PPI <sup>1)</sup>	IF1B	IF1B	IF1B	IF1B	IF1B	IF1B	IF1B	IF1B	IF1B	IF1B	IF1B	IF1B
SIMATIC S7 - MPI	IF1B	IF1B	IF1B	IF1B	IF1B	IF1B	IF1B	IF1B	IF1B	IF1B	IF1B	IF1B

	KP400 Comfort	KTP400 Comfort	KP700 Comfort	TP700 Comfort	KP900 Comfort	TP900 Comfort	KP1200 Comfort	TP1200 Comfort	KP1500 Comfort	TP1500 Comfort	TP1900 Comfort	TP2200 Comfort
SIMATIC S7 - PROFIBUS	IF1B	IF1B	IF1B	IF1B	IF1B	IF1B	IF1B	IF1B	IF1B	IF1B	IF1B	IF1B
SIMATIC S7 - PROFINET	ETHERNET	ETHERNET	ETHERNET	ETHERNET	ETHERNET	ETHERNET	ETHERNET	ETHERNET	ETHERNET	ETHERNET	ETHERNET	ETHERNET
SIMATIC HMI HTTP protocol	ETHERNET	ETHERNET	ETHERNET	ETHERNET	ETHERNET	ETHERNET	ETHERNET	ETHERNET	ETHERNET	ETHERNET	ETHERNET	ETHERNET
OPC	ETHERNET	ETHERNET	ETHERNET	ETHERNET	ETHERNET	ETHERNET	ETHERNET	ETHERNET	ETHERNET	ETHERNET	ETHERNET	ETHERNET
Allen-Bradley EtherNet/IP	ETHERNET	ETHERNET	ETHERNET	ETHERNET	ETHERNET	ETHERNET	ETHERNET	ETHERNET	ETHERNET	ETHERNET	ETHERNET	ETHERNET
Allen-Bradley DF1	IF1B <sup>1)3)4)</sup>	IF1B <sup>1)3)4)</sup>	IF1B <sup>1)3)4)</sup>	IF1B <sup>1)3)4)</sup>	IF1B <sup>1)3)4)</sup>	IF1B <sup>1)3)4)</sup>	IF1B <sup>1)3)4)</sup>	IF1B <sup>1)3)4)</sup>	IF1B <sup>1)3)4)</sup>	IF1B <sup>1)3)4)</sup>	IF1B <sup>1)3)4)</sup>	IF1B <sup>1)3)4)</sup>
Mitsubishi i MC TCP/IP	ETHERNET	ETHERNET	ETHERNET	ETHERNET	ETHERNET	ETHERNET	ETHERNET	ETHERNET	ETHERNET	ETHERNET	ETHERNET	ETHERNET
Mitsubishi i FX	IF1B <sup>3)4)</sup>	IF1B <sup>3)4)</sup>	IF1B <sup>3)4)</sup>	IF1B <sup>3)4)</sup>	IF1B <sup>3)4)</sup>	IF1B <sup>3)4)</sup>	IF1B <sup>3)4)</sup>	IF1B <sup>3)4)</sup>	IF1B <sup>3)4)</sup>	IF1B <sup>3)4)</sup>	IF1B <sup>3)4)</sup>	IF1B <sup>3)4)</sup>
Modicon Modbus TCP/	ETHERNET	ETHERNET	ETHERNET	ETHERNET	ETHERNET	ETHERNET	ETHERNET	ETHERNET	ETHERNET	ETHERNET	ETHERNET	ETHERNET
Modicon Modbus RTU	IF1B <sup>2)3)4)</sup>	IF1B <sup>2)3)4)</sup>	IF1B <sup>2)3)4)</sup>	IF1B <sup>2)3)4)</sup>	IF1B <sup>2)3)4)</sup>	IF1B <sup>2)3)4)</sup>	IF1B <sup>2)3)4)</sup>	IF1B <sup>2)3)4)</sup>	IF1B <sup>2)3)4)</sup>	IF1B <sup>2)3)4)</sup>	IF1B <sup>2)3)4)</sup>	IF1B <sup>2)3)4)</sup>
Omron Host Link	IF1B <sup>3)4)</sup>	IF1B <sup>3)4)</sup>	IF1B <sup>3)4)</sup>	IF1B <sup>3)4)</sup>	IF1B <sup>3)4)</sup>	IF1B <sup>3)4)</sup>	IF1B <sup>3)4)</sup>	IF1B <sup>3)4)</sup>	IF1B <sup>3)4)</sup>	IF1B <sup>3)4)</sup>	IF1B <sup>3)4)</sup>	IF1B <sup>3)4)</sup>

- 1) Direct communication with PLC5 or KF2 module, otherwise only with RS422-RS232 converter.  
Order number: 6AV6 671-8XE00-0AX0
- 2) only with RS422-RS232 converter (option)  
Order number: 6AV6 671-8XE00-0AX0
- 3) For serial communication, deselect "Remote Control" of "Channel 1" in the "File > Transfer > Options" menu.
- 4) "PROFINET IO Enabled" must be disabled.

## Area pointers for Comfort Panel

### Introduction

Area pointers are parameter fields from which the HMI device obtains information about the location and size of data areas in the PLC. During communication, the PLC and the HMI device alternately access these data areas for read and write operations. Based on the evaluation of data stored in the data areas, the PLC and HMI device initiate mutually defined actions.

WinCC uses the following area pointers:

- Job mailbox
- Project ID
- Screen number
- Data record
- Date/time
- Date/time PLC
- Coordination

### Availability of the area pointers

The following table shows the availability of the area pointers on the HMI devices. Note that the area pointers can be used only for available communication drivers.

### Area pointer

	KP40 0 Comfo rt	KTP4 00 Comfo rt	KP70 0 Comfo rt	TP700 Comfo rt	KP90 0 Comfo rt	TP900 Comfo rt	KP12 00 Comfo rt	TP120 0 Comfo rt	KP15 00 Comfo rt	TP150 0 Comfo rt	TP190 0 Comfo rt	TP220 0 Comfo rt
Screen number	Yes	Yes	Yes	Yes	Yes	Yes	Yes	Yes	Yes	Yes	Yes	Yes
Data record	Yes	Yes	Yes	Yes	Yes	Yes	Yes	Yes	Yes	Yes	Yes	Yes
Date/time	Yes	Yes	Yes	Yes	Yes	Yes	Yes	Yes	Yes	Yes	Yes	Yes
Date/time PLC	Yes	Yes	Yes	Yes	Yes	Yes	Yes	Yes	Yes	Yes	Yes	Yes
Coordination	Yes	Yes	Yes	Yes	Yes	Yes	Yes	Yes	Yes	Yes	Yes	Yes
Project ID	Yes	Yes	Yes	Yes	Yes	Yes	Yes	Yes	Yes	Yes	Yes	Yes
Job mailbox	Yes	Yes	Yes	Yes	Yes	Yes	Yes	Yes	Yes	Yes	Yes	Yes



### 10.11.5.4 Multi Panel

#### Communication drivers for Multi Panels

#### Device dependency of Multi Panels

The following table shows which communication drivers you can configure with the various Multi Panels.

#### Communication drivers

HMI devices	SIMATIC S7 1500	SIMATIC S7 300/400	SIMATIC S7 200	SIMATIC S7 1200	SIMATIC S7 LOGO!	SIMATIC S7 HTTP protocol	OPC <sup>1)</sup>	Allen-Bradley EtherNet/IP	Allen-Bradley DF1	Mitsubishi MC TCP/IP	Mitsubishi FX	Modicon Modbus TCP/IP	Modicon Modbus RTU	Omron Host Link
MP 177 6" Touch	Yes	Yes	Yes	Yes	Yes	Yes	No	Yes	yes <sup>3)4)</sup>	Yes	Yes <sup>4)</sup>	Yes	yes <sup>2)4)</sup>	Yes <sup>4)</sup>
MP 277 8" Key	Yes	Yes	Yes	Yes	Yes	Yes	Yes	Yes	yes <sup>3)4)</sup>	Yes	Yes <sup>4)</sup>	Yes	yes <sup>2)4)</sup>	Yes <sup>4)</sup>
MP 277 10" Key	Yes	Yes	Yes	Yes	Yes	Yes	Yes	Yes	yes <sup>3)4)</sup>	Yes	Yes <sup>4)</sup>	Yes	yes <sup>2)4)</sup>	Yes <sup>4)</sup>
MP 277 10" Touch	Yes	Yes	Yes	Yes	Yes	Yes	Yes	Yes	yes <sup>3)4)</sup>	Yes	Yes <sup>4)</sup>	Yes	yes <sup>2)4)</sup>	Yes <sup>4)</sup>
MP 377 12" Key	Yes	Yes	Yes	Yes	Yes	Yes	Yes	Yes	yes <sup>3)4)</sup>	Yes	Yes <sup>4)</sup>	Yes	yes <sup>2)4)</sup>	Yes <sup>4)</sup>
MP 377 12" Touch	Yes	Yes	Yes	Yes	Yes	Yes	Yes	Yes	yes <sup>3)4)</sup>	Yes	Yes <sup>4)</sup>	Yes	yes <sup>2)4)</sup>	Yes <sup>4)</sup>
MP 377 15" Touch	Yes	Yes	Yes	Yes	Yes	Yes	Yes	Yes	yes <sup>3)4)</sup>	Yes	Yes <sup>4)</sup>	Yes	yes <sup>2)4)</sup>	Yes <sup>4)</sup>
MP 377 19" Touch	Yes	Yes	Yes	Yes	Yes	Yes	Yes	Yes	yes <sup>3)4)</sup>	Yes	Yes <sup>4)</sup>	Yes	yes <sup>2)4)</sup>	Yes <sup>4)</sup>

1) OPC-XML DA Server  
OPC-DA Client (Inproc)

2) only approved with RS 422-RS232 converter  
Order number: 6AV6 671-8XE00-0AX0

3) Direct communication with PLC 5 or KF2 module, otherwise only with RS422-RS232 converter (option).

Order number: 6AV6 671-8XE00-0AX0

4) "PROFINET IO Enabled" must be disabled.

## Interfaces of Multi Panels

### Device dependency of Multi Panels

The following table shows which HMI device interfaces are available for the communication driver protocols.

Table 10-152 Multi Panels

	MP 177 <sup>3)</sup>	MP 277 <sup>3)</sup>	MP 377 <sup>3)</sup>
SIMATIC S7 - PPI <sup>1)</sup>	IF1B	IF1B	IF1B
SIMATIC S7 - MPI	IF1B	IF1B	IF1B
SIMATIC S7 - PROFIBUS	IF1B	IF1B	IF1B
SIMATIC S7 - PROFINET	ETHERNET	ETHERNET	ETHERNET
SIMATIC HMI HTTP protocol	ETHERNET	ETHERNET	ETHERNET
OPC	-	ETHERNET	ETHERNET
Allen-Bradley EtherNet/IP	ETHERNET	ETHERNET	ETHERNET
Allen-Bradley DF1	IF1B <sup>3) 4) 5)</sup>	IF1B <sup>3) 4) 5)</sup>	IF1B <sup>3) 4) 5)</sup>
Mitsubishi MC TCP/IP	ETHERNET	ETHERNET	ETHERNET
Mitsubishi FX	IF1B <sup>3)5)</sup>	IF1B <sup>3)5)</sup>	IF1B <sup>3)5)</sup>
Modicon Modbus TCP	ETHERNET	ETHERNET	ETHERNET
Modicon Modbus RTU	IF1B <sup>2) 3) 5)</sup>	IF1B <sup>2) 3) 5)</sup>	IF1B <sup>2) 3) 5)</sup>
Omron Host Link	IF1B <sup>3)5)</sup>	IF1B <sup>3)5)</sup>	IF1B <sup>3)5)</sup>

1) For SIMATIC S7-200 only

2) only with RS 422-RS232 converter (option)  
Order number: 6AV6 671-8XE00-0AX0

3) For serial communication, deselect "Remote Control" of "Channel 1" in the "File > Transfer >Options" menu.

4) Direct communication with PLC5 or KF2 module, otherwise only approved with RS422-RS232 converter (option).  
Order number: 6AV6 671-8XE00-0AX0

5) "PROFINET IO Enabled" must be disabled.

## Area pointers for Multi Panel

### Introduction

Area pointers are parameter fields from which the HMI device obtains information about the location and size of data areas in the PLC. During communication, the PLC and the HMI device alternately access these data areas for read and write operations. Based on the evaluation of data stored in the data areas, the PLC and HMI device initiate mutually defined actions.

WinCC uses the following area pointers:

- Job mailbox
- Project ID
- Screen number
- Data record
- Date/time
- Date/time PLC
- Coordination

### Availability of the area pointers

The following table shows the availability of the area pointers on the HMI devices. Note that the area pointers can be used only for available communication drivers.

### Area pointers

	<b>MP 177</b>	<b>MP 277</b>	<b>MP 377</b>
Screen number	Yes	Yes	Yes
Data record	Yes	Yes	Yes
Date/time	Yes	Yes	Yes
Date/time PLC	Yes	Yes	Yes
Coordination	Yes	Yes	Yes
Project ID	Yes	Yes	Yes
Job mailbox	Yes	Yes	Yes

### 10.11.5.5 Mobile Panel

#### Communication drivers for Mobile Panels

#### Device dependency of Mobile Panels

The following table shows which communication drivers you can configure with the various Mobile Panels.

Communication drivers

HMI devices	SIMATIC S7 1500	SIMATIC S7 1200	SIMATIC S7 300/400	SIMATIC S7 200	SIMATIC LOGO!	SIMATIC HTP protocol	OPC	Allen-Bradley EtherNet/IP	Allen-Bradley DF1	Mitsubishi MC TCP/IP	Mitsubishi FX	Modicon Modbus TCP/IP	Modicon Modbus RTU	Omron Host Link
Mobile Panel 177 6" DP	Yes <sup>2)</sup>	Yes	Yes	Yes	No	No	No	No	Yes <sup>1)</sup>	No	Yes <sup>1)</sup>	No	Yes <sup>1)</sup>	Yes <sup>1)</sup>
Mobile Panel 177 6" PN	Yes <sup>2)</sup>	Yes	Yes	Yes	Yes	Yes	No	Yes	No	Yes	No	Yes	No	No
Mobile Panel 277 8"	Yes	Yes	Yes	Yes	Yes	Yes	No	Yes	Yes <sup>1)</sup>	Yes	Yes <sup>1)</sup>	Yes	Yes <sup>1)</sup>	Yes <sup>1)</sup>
Mobile Panel 277 8" IWLAN V2	Yes	Yes	Yes	Yes	Yes	Yes	No	Yes	No	Yes	No	Yes	No	No
Mobile Panel 277F 8" IWLAN V2	Yes	Yes	Yes	Yes	Yes	Yes	No	Yes	No	No	No	No	No	No
Mobile Panel 277F 8" IWLAN V2 (RFID tag)	Yes	Yes	Yes	Yes	Yes	Yes	No	Yes	No	No	No	No	No	No
Mobile Panel 277 10"	Yes	Yes	Yes	Yes	Yes	Yes	No	Yes	Yes <sup>1)</sup>	Yes	Yes <sup>1)</sup>	Yes	Yes <sup>1)</sup>	Yes <sup>1)</sup>

1) "PROFINET IO Enabled" must be disabled.

2) You must activate "Access via PUT/GET communication" for communication with the SIMATIC S7 1500 PLC.

Activate PUT/GET communication in the PLC properties at:

"General > Security > Enable PUT/GET communication with remote partner (PLC, HMI, OPC, ...)"

## Interfaces of Mobile Panels

### Device dependency of Mobile Panels

The following table shows which HMI device interfaces are available for the communication driver protocols.

Table 10-153 Mobile Panels

	Mobile Panel 177 DP <sup>3)</sup>	Mobile Panel 177 PN	Mobile Panel 277 <sup>2)3)</sup>	Mobile Panel 277 IWLAN V2	Mobile Panel 277F V2 IWLAN	Mobile Panel 277F IWLAN V2 (RFID tag)
SIMATIC S7 - PPI <sup>1)</sup>	IF1B	—	IF1B	—	—	—
SIMATIC S7 - MPI	IF1B	—	IF1B	—	—	—
SIMATIC S7 - PROFIBUS	IF1B	—	IF1B	—	—	—
SIMATIC S7 - PROFINET	—	ETHERNET	ETHERNET	ETHERNET	ETHERNET	ETHERNET
SIMATIC HMI HTTP protocol	—	ETHERNET	ETHERNET	ETHERNET	ETHERNET	ETHERNET
OPC	—	—	—	ETHERNET	ETHERNET	ETHERNET
Allen-Bradley DF1	IF1A <sup>3)</sup> , IF1B <sup>3)</sup> <sup>4) 6)</sup> (terminal box)	—	IF1A <sup>3)</sup> , IF1B <sup>3)</sup> <sup>4) 6)</sup> (terminal box)	—	—	—
Allen-Bradley EtherNet/IP	---	ETHERNET	ETHERNET	ETHERNET	ETHERNET	ETHERNET
Mitsubishi MC TCP/ IP	--	ETHERNET	ETHERNET	ETHERNET	—	—
Mitsubishi FX	IF1A <sup>3)</sup> , IF1B <sup>3)</sup> <sup>6)</sup> (terminal box)	—	IF1A <sup>3)</sup> , IF1B <sup>3)</sup> <sup>6)</sup> (terminal box)	—	—	—
Modicon Modbus RTU	IF1A <sup>3)</sup> , IF1B <sup>3)</sup> <sup>5) 6)</sup> (terminal box)	—	IF1A <sup>3)</sup> , IF1B <sup>3)</sup> <sup>5) 6)</sup> (terminal box)	—	—	—
Modicon Modbus TCP/IP	—	ETHERNET	ETHERNET	ETHERNET	—	—
Omron Host Link	IF1A <sup>3)</sup> , IF1B <sup>3)</sup> <sup>6)</sup> (terminal box)	—	IF1A <sup>3)</sup> , IF1B <sup>3)6)</sup> (terminal box)	—	—	—

<sup>1)</sup> For SIMATIC S7-200 only

<sup>2)</sup> Depending on the terminal box used

<sup>3)</sup> For serial communication, deselect "Remote Control" of "Channel 1" in the "File > Transfer > Options" menu.

<sup>4)</sup> With PLC5 and KF2 module only

<sup>5)</sup> Can be selected and used, but not approved.

<sup>6)</sup> "PROFINET IO Enabled" must be disabled.

## Area pointers for Mobile Panel

### Introduction

Area pointers are parameter fields from which the HMI device obtains information about the location and size of data areas in the PLC. During communication, the PLC and the HMI device alternately access these data areas for read and write operations. Based on the evaluation of data stored in the data areas, the PLC and HMI device initiate mutually defined actions.

WinCC uses the following area pointers:

- Job mailbox
- Project ID
- Screen number
- Data record
- Date/time
- Date/time PLC
- Coordination

### Availability of the area pointers

The following table shows the availability of the area pointers on the HMI devices. Note that the area pointers can be used only for available communication drivers.

### Area pointer

	Mobile Panel 177	Mobile Panel 277	Mobile Panel 277 IWLAN V2	Mobile Panel 277F IWLAN V2	Mobile Panel 277F IWLAN V2 (RFID tag)	Mobile Panel 277
Screen number	Yes	Yes	Yes	Yes	Yes	Yes
Data record	Yes	Yes	Yes	Yes	Yes	Yes
Date/time	Yes	Yes	Yes	Yes	Yes	Yes
Date/time PLC	Yes	Yes	Yes	Yes	Yes	Yes
Coordination	Yes	Yes	Yes	Yes	Yes	Yes
Project ID	Yes	Yes	Yes	Yes	Yes	Yes
Job mailbox	Yes	Yes	Yes	Yes	Yes	Yes

### 10.11.5.6 PC systems

#### Communication drivers for PC systems

##### Device dependency

The following table shows which communication drivers you can configure with the various Runtimes on a PC.

##### Communication drivers

HMI device	SIMATIC S	SIMATIC S	SIMATIC S7	SIMATIC S7-200	SIMATIC LOGO!	SIMATIC HTTP protocol	OPC	Allen-Bradley EtherNet/IP	Allen-Bradley DF1	Mitsubishi MC TCP/IP	Mitsubishi FX	Modicon Modbus TCP/IP	Modicon Modbus RTU	Omron Host Link
WinCC RT Advanced	Yes	Yes	Yes	Yes	Yes	Yes	Yes <sup>1)</sup>	Yes	Yes	Yes	Yes	Yes	Yes	Yes
WinCC RT Professional	Yes	Yes	Yes	No	No	No	Yes <sup>2)</sup>	Yes	No	Yes	No	Yes	No	No

<sup>1)</sup> OPC-DA-Client, OPC-XML-DA-Client, OPC-UA(DA only) Client and OPC-DA-Server

<sup>2)</sup> OPC-DA-Client, OPC-XML-DA-Client and OPC-DA-Server, OPC-XML-DA-Server (optional), OPC-HDA-Server (optional), OPC-AE-Server (optional) , OPC-UA(DA only)-Server

#### Interfaces for PC systems

##### Device dependency

The following table shows which HMI device interfaces are available for the communication driver protocols.

	WinCC RT Advanced	WinCC RT Professional
SIMATIC S7 - PPI	MPI/DP <sup>2)</sup>	--
SIMATIC S7 - MPI	MPI/DP <sup>2)</sup>	MPI/DP <sup>2)</sup>
SIMATIC S7 - PROFIBUS	MPI/DP <sup>2)</sup>	MPI/DP <sup>2)</sup>
SIMATIC S7 - PROFINET	ETHERNET	ETHERNET
SIMATIC HMI HTTP protocol	ETHERNET	ETHERNET

	WinCC RT Advanced	WinCC RT Professional
OPC	ETHERNET	ETHERNET
Allen-Bradley EtherNet/IP	ETHERNET	ETHERNET
Allen-Bradley DF1	COM1 to COM4 <sup>1)</sup>	--
Mitsubishi MC TCP/IP	ETHERNET	ETHERNET
Mitsubishi FX	COM1 to COM4 <sup>1)</sup>	--
Modicon Modbus TCP/IP	ETHERNET	ETHERNET
Modicon Modbus RTU	COM1 to COM4 <sup>1)</sup>	--
Omron Host Link	COM1 to COM4 <sup>1)</sup>	--

- 1) COM2 is blocked for Panel PC 477
- 2)
  - in SIMATIC PC via integrated interface
  - in Standard PC e.g. SIMATIC NET CP 5611 A2

## Area pointers for PC systems

### Introduction

Area pointers are parameter fields from which WinCC RT Advanced obtains information about the location and size of data areas in the PLC. During communication, the PLC and the HMI device alternately access these data areas for read and write operations. Based on the evaluation of data stored in the data areas, the PLC and HMI device initiate mutually defined actions.

WinCC uses the following area pointers:

- Job mailbox
- Project ID
- Screen number
- Data record
- Date/time
- Date/time PLC
- Coordination

### Availability of the area pointers

The following table shows the availability of the area pointers on the HMI devices. Note that the area pointers can be used only for available communication drivers.

Table 10-154 WinCC RT Advanced

	WinCC RT Advanced
Screen number	Yes
Data record	Yes



WinCC RT Advanced	
Date/time	Yes
Date/time PLC	Yes
Coordination	Yes
Project ID	Yes
Job mailbox	Yes

### 10.11.5.7 Parallel communication

#### Parallel communication of communication drivers

The following table shows an overview of which communication drivers you can use simultaneously on one HMI device.

#### Note

Parallel communication is not approved for Basic Panels.

#### Parallel communication over Ethernet interfaces

The approved combinations can be operated via the same Ethernet interface. Several Ethernet interfaces are not required.

Parallel communication only concerns the Ethernet-based communication drivers.

	Allen-Bradley EtherNet/IP	Mitsubishi MC TCP/IP	Modicon Modbus TCP/IP	OPC (DA/ XML DA)	OPC UA (DA)	SIMATIC LOGO!	SIMATIC S7 200	SIMATIC S7 300/400	SIMATIC S7 1200	SIMATIC S7 1500	SIMATIC C HTTP protocol	Sinumerik NC
Allen-Bradley	--	No	No	Yes	Yes	Yes	Yes	Yes	Yes	Yes	Yes	Yes
EtherNet/IP												
Mitsubishi MC TCP/IP	No	--	No	Yes	Yes	No	No	No	No	No	Yes	No
Modicon Modbus TCP/IP	No	No	--	Yes	Yes	No	No	No	No	No	Yes	No
OPC (DA/XML/DA)	Yes	Yes	Yes	--	Yes	Yes	Yes	Yes	Yes	Yes	Yes	Yes

	Allen-Bradley EtherNet/IP	Mitsubishi MC TCP/IP	Modicon Modbus TCPIP	OPC (DA/ XML DA)	OPC UA (DA)	SIMATIC LOGO!	SIMATIC S7 200	SIMATIC S7 300/400	SIMATIC S7 1200	SIMATIC S7 1500	SIMATIC C HTTP protocol	Sinumerik NC
OPC UA (DA)	Yes	Yes	Yes	Yes	--	Yes	Yes	Yes	Yes	Yes	Yes	Yes
SIMATIC LOGO!	Yes	No	No	Yes	Yes	--	Yes	Yes	Yes	Yes	Yes	Yes
SIMATIC S7 200	Yes	No	No	Yes	Yes	Yes	--	Yes	Yes	Yes	Yes	Yes
SIMATIC S7 300/400	Yes	No	No	Yes	Yes	Yes	Yes	--	Yes	Yes	Yes	Yes
SIMATIC S7 1200	Yes	No	No	Yes	Yes	Yes	Yes	Yes	--	Yes	Yes	Yes
SIMATIC S7 1500	Yes	No	No	Yes	Yes	Yes	Yes	Yes	Yes	--	Yes	Yes
SIMATIC C HTTP protocol	Yes	Yes	Yes	Yes	Yes	Yes	Yes	Yes	Yes	Yes	--	Yes
Sinumerik NC	Yes	No	No	Yes	Yes	Yes	Yes	Yes	Yes	Yes	Yes	--

### Parallel communication over serial interfaces

The following applies for parallel communication over serial interfaces:

- One communication driver per interface.
- One interface per communication driver.

## 10.11.6 Communicating with SIMATIC S7 1500

### 10.11.6.1 Communication with SIMATIC S7 1500

#### Introduction

This section describes the communication between an HMI device and the SIMATIC S7 1500 PLC.

You can configure the following communication channels for the SIMATIC S7 1500 PLC:

- PROFINET
- PROFIBUS

## HMI connection for communication

Configure connections between the HMI device and a SIMATIC S7 1500 in the "Devices & Networks" Editor.

### 10.11.6.2 Communication via PROFINET

#### Configuring an HMI connection

#### Communication via PROFINET

#### HMI connections via PROFINET

If you have inserted an HMI device and a SIMATIC S7 1500 into the project, interconnect the two PROFINET interfaces in the "Devices & Networks" editor.



You can also connect multiple HMI devices to a single SIMATIC S7 1500 and multiple SIMATIC S7 1500 to a single HMI device.

The maximum number of communication partners that you can connect to an HMI device is dependent on the HMI device used.

Additional information is available in the documentation for the respective HMI device.

## HMI connection in the "Devices & Networks" editor

You configure the HMI connection between the PLC and the HMI device via PROFINET in the "Devices & Networks" editor.

## Connection in the "Connections" editor

Alternatively, you configure the connection between the PLC and HMI device via PROFINET in the "Connections" editor of the HMI device.

## Configuring an HMI connection via PROFINET

### Introduction

You configure an HMI connection between HMI devices and a SIMATIC S7 1500 via PROFINET or Ethernet in the "Devices & Networks" editor.



#### CAUTION

##### Communication via Ethernet

In Ethernet-based communication, the end user is responsible for the security of his data network.

Targeted attacks can overload the device and interfere with proper functioning.

### Requirements

The following communication partners are created in the "Devices & Networks" editor:

- HMI device with PROFINET or Ethernet interface
- SIMATIC S7 1500 with PROFINET interface

### Procedure

1. Double-click the "Devices & Networks" item in the project tree.  
The available communication partners in the project are displayed graphically in the network view.
2. Click the "Connections" button and select "HMI connection" for the connection type.  
The devices available for connection are highlighted in color.

- Click the PROFINET interface of the PLC and use a drag-and-drop operation to draw a connection to the PROFINET or Ethernet interface of the HMI device.

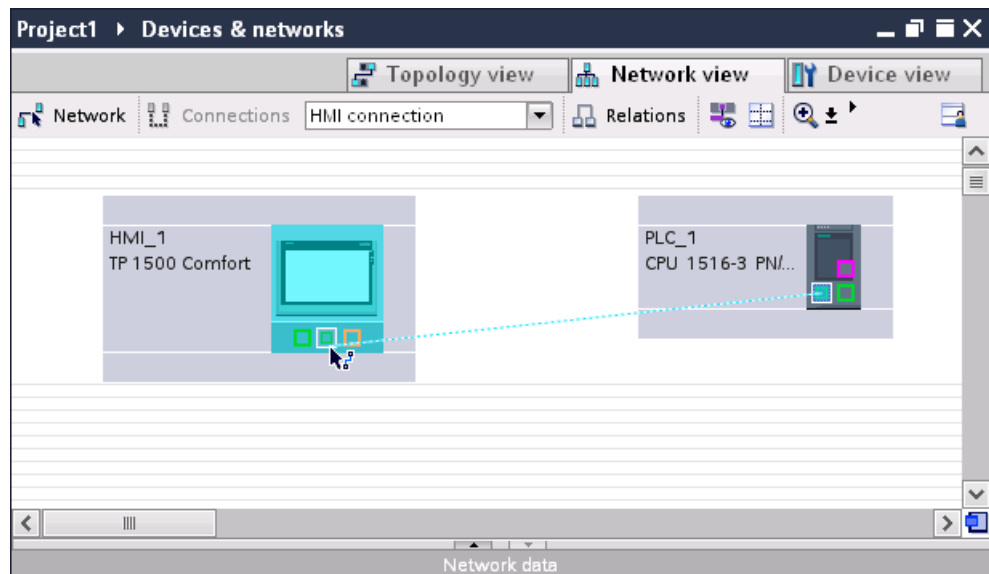

- Click the connecting line.
- Click "Highlight HMI connection" and select the HMI connection. The connection is displayed graphically in the Inspector window.
- Click the communication partners in the "Network view" and change the PROFINET parameters in the Inspector window according to the requirements of your project. See the chapter "PROFINET parameters (Page 4989)" for additional details.

---

#### Note

The created HMI connection is also shown in the tabular area of the editor on the "Connections" tab. You check the connection parameters in the table.

You can change the local name for the connection only in the table.

---

## Result

You have created a connection between an HMI device and a SIMATIC S7 1500. The IP address and subnet mask connection parameters are configured.

## Configuring an HMI connection

## Communication via PROFINET

## Communication via PROFINET

This chapter describes communication over PROFINET between a WinCC Runtime and the SIMATIC S7 1500 PLC.

You can use the following WinCC Runtimes as an HMI device:

- WinCC RT Advanced

### WinCC Runtime as HMI device

Configure the HMI connections between a WinCC Runtime and SIMATIC S7 1500 in the "Devices & Networks" editor.

If you want to use a WinCC Runtime as an HMI device, you have the following options:

1. You create a SIMATIC PC and configure a WinCC Runtime on this SIMATIC PC. In this way you use the SIMATIC PC with a WinCC Runtime as an HMI device.

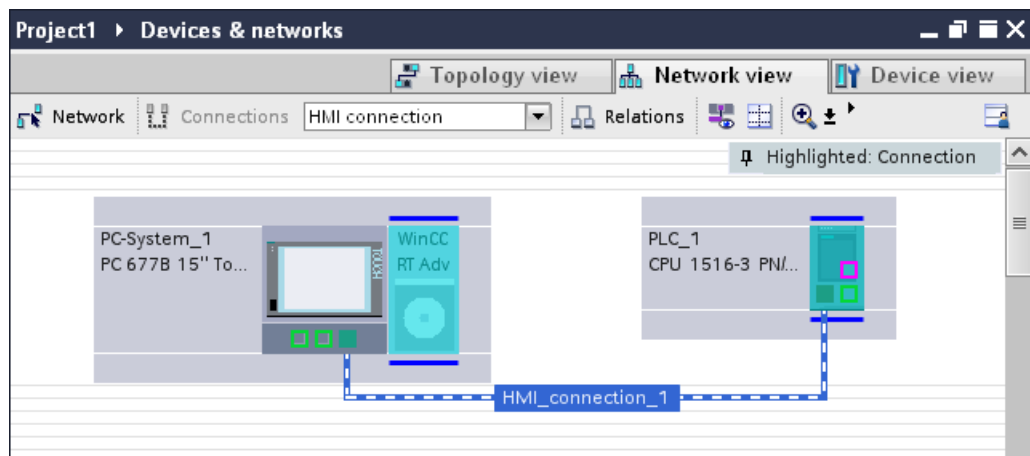

2. You create a WinCC Runtime and configure a communication processor to the Runtime. In this way you use your configuration PC with a WinCC Runtime as an HMI device.

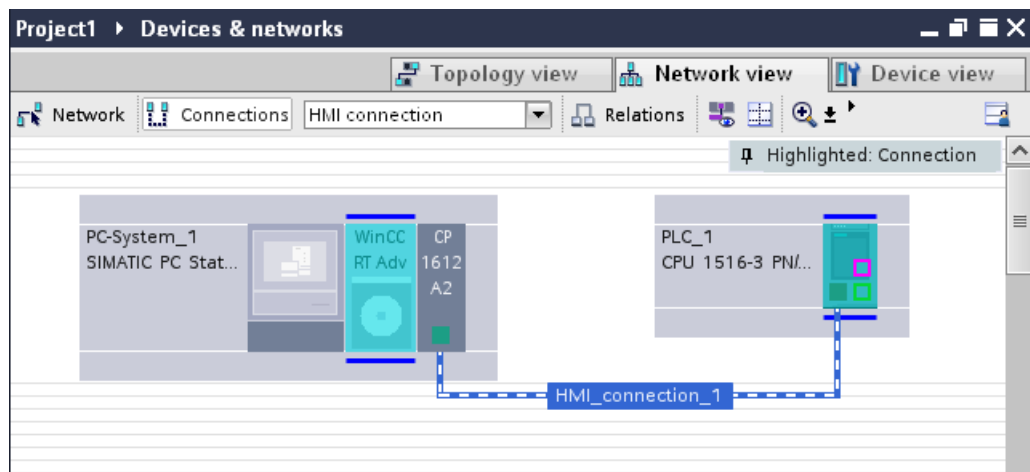

You can also connect multiple HMI devices to a single SIMATIC S7 1500 and multiple SIMATIC S7 1500 to a single HMI device.

The maximum number of communication partners that you can connect to an HMI device is dependent on the HMI device used.

Additional information is available in the documentation for the respective HMI device.

## HMI connection in the "Devices & Networks" editor

You configure the HMI connection between the PLC and the HMI device via PROFINET in the "Devices & Networks" editor.

## Connection in the "Connections" editor

Alternatively, you configure the connection between the PLC and HMI device via PROFINET in the "Connections" editor of the HMI device.

## Configuring an HMI connection via PROFINET with a PC

### Introduction

You configure an HMI connection over PROFINET or Ethernet between HMI devices and a SIMATIC S7 1500 in the "Devices & Networks" editor.

 <b>CAUTION</b>
<b>Communication via Ethernet</b>
In Ethernet-based communication, the end user is responsible for the security of his data network.
Targeted attacks can overload the device and interfere with proper functioning.

### Requirements

The following communication partners are created in the "Devices & Networks" editor:

- SIMATIC S7 1500 with PROFINET interface
- PC station with WinCC RT Advanced

### Procedure

1. Double-click the "Devices & Networks" item in the project navigation.  
The available communication partners in the project are displayed in the network view.
2. Use a drag-and-drop operation to move a PROFINET-capable communication processor from the hardware catalog to the WinCC Runtime.

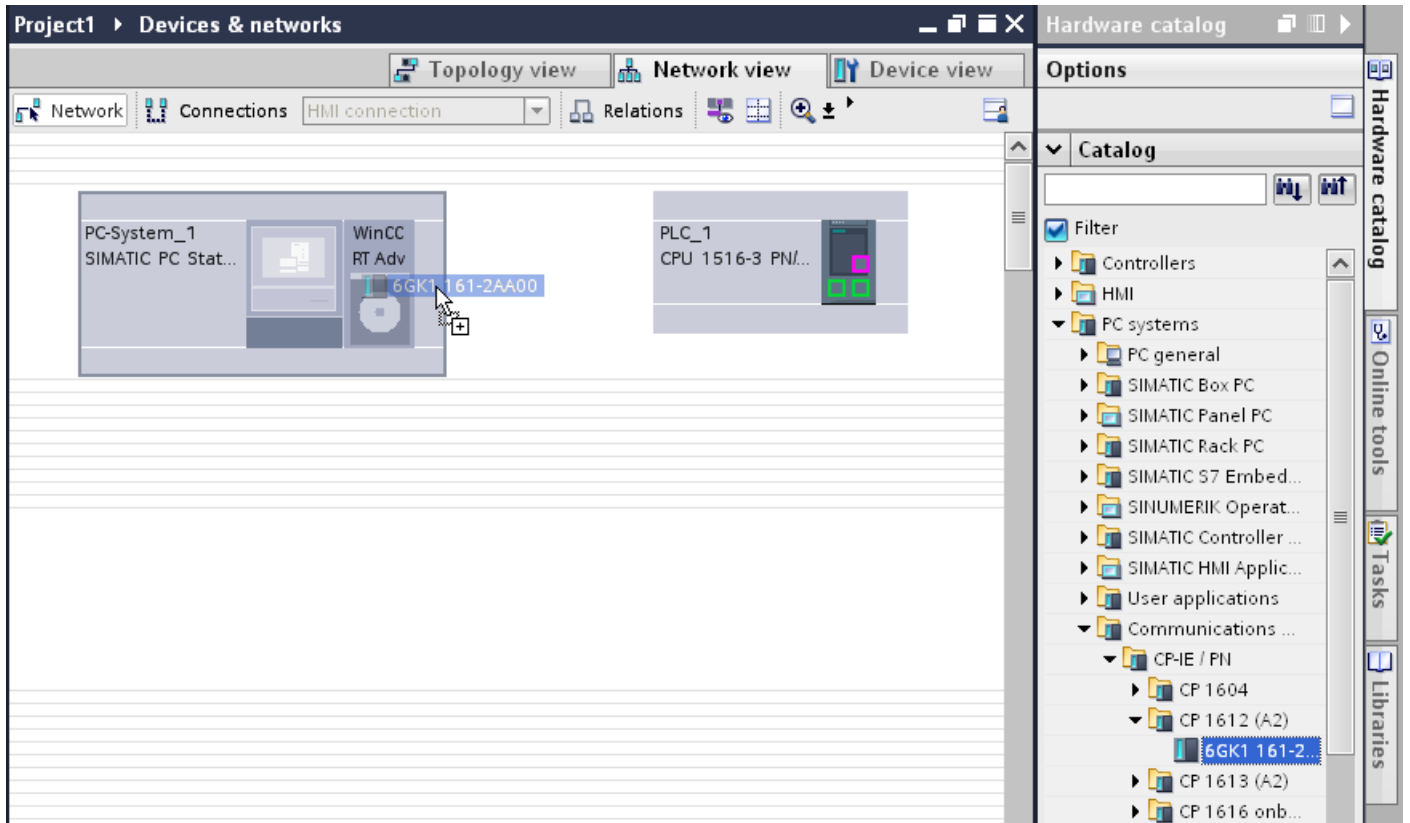

3. Click the "Connections" button and select "HMI connection" for the connection type.  
The devices available for connection are highlighted in color.



- Click the PROFINET interface of the PLC and use a drag-and-drop operation to draw a connection to the PROFINET interface of the communication processor.

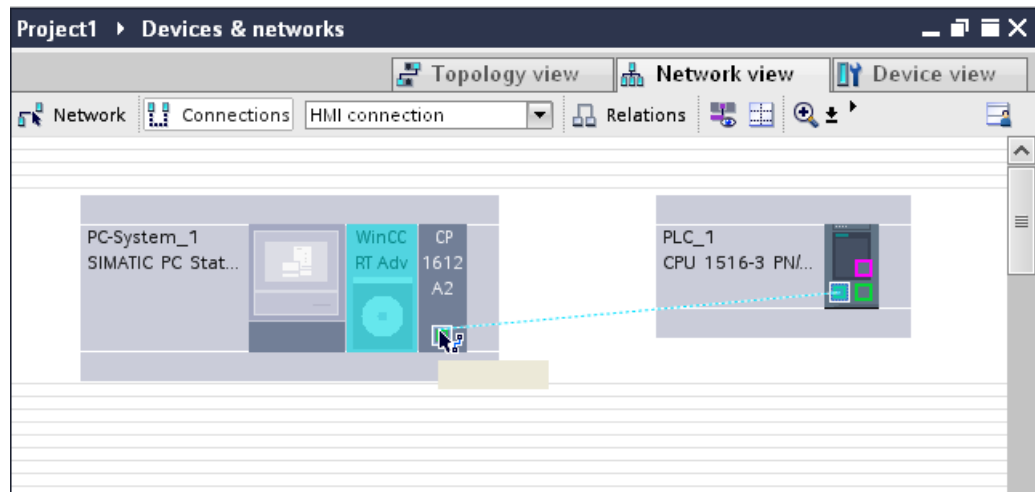

- Click the connecting line.  
The connection is displayed graphically in the Inspector window.
- Click "Highlight HMI connection" and select the HMI connection.  
The connection is displayed graphically in the Inspector window.
- Click the communication partners in the "Network view" and change the PROFINET parameters in the Inspector window according to the requirements of your project. See the chapter "PROFINET parameters (Page 4989)" for additional details.

#### Note

The created HMI connection is also shown in the tabular area of the editor on the "Connections" tab. You check the connection parameters in the table.

You can change the local name for the connection only in the table.

## Result

You have created a connection between an HMI device and a SIMATIC S7 1500. The IP address and subnet mask connection parameters are configured.

## Configuring an HMI connection via PROFINET with a SIMATIC PC

### Introduction

You configure an HMI connection over PROFINET or Ethernet between HMI devices and SIMATIC S7 1500 in the "Devices & Networks" editor.

#### CAUTION

##### Communication via Ethernet

In Ethernet-based communication, the end user is responsible for the security of his data network.

Targeted attacks can overload the device and interfere with proper functioning.

### Requirements

The following communication partners are created in the "Devices & Networks" editor:

- SIMATIC S7 1500 with PROFINET interface
- SIMATIC PC with PROFINET interface

### Procedure

1. Double-click the "Devices & Networks" item in the project navigation.  
The available communication partners in the project are displayed in the network view.
2. Use a drag-and-drop operation to move a WinCC Runtime from the hardware catalog to the PC.

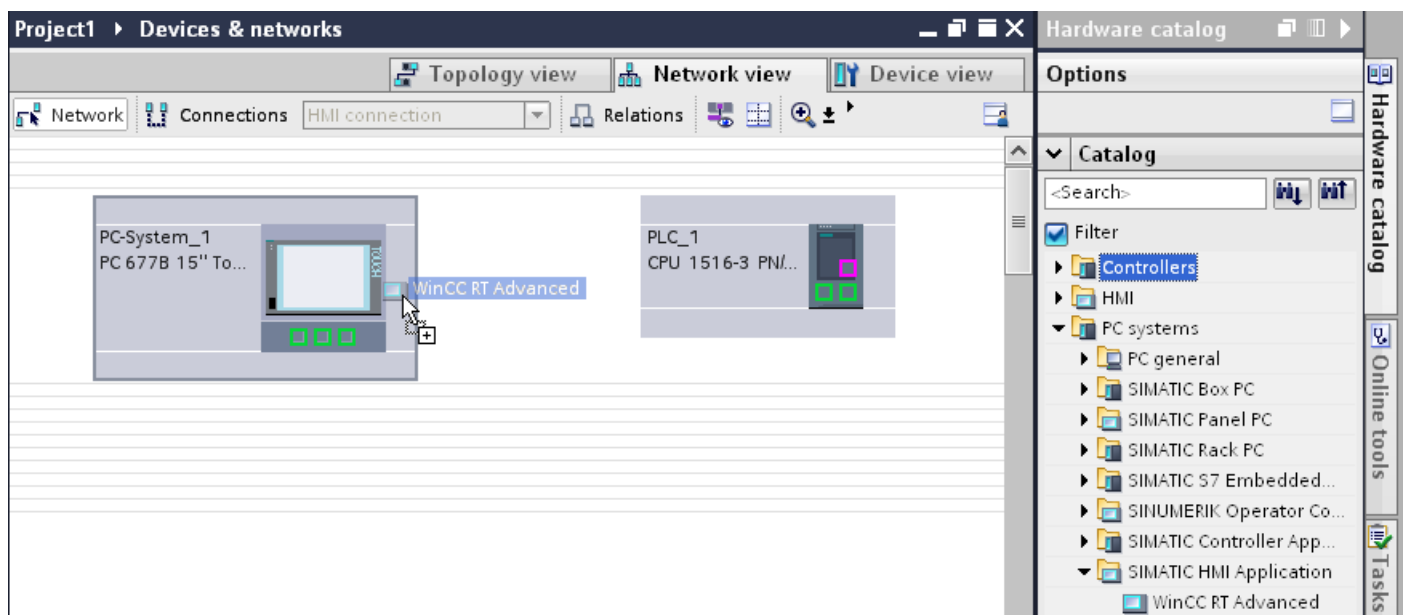

3. Click the "Connections" button and select "HMI connection" for the connection type. The devices available for connection are highlighted in color.
4. Click the PROFINET interface of the PLC and use a drag-and-drop operation to draw a connection to the PROFINET or Ethernet interface of the PC.

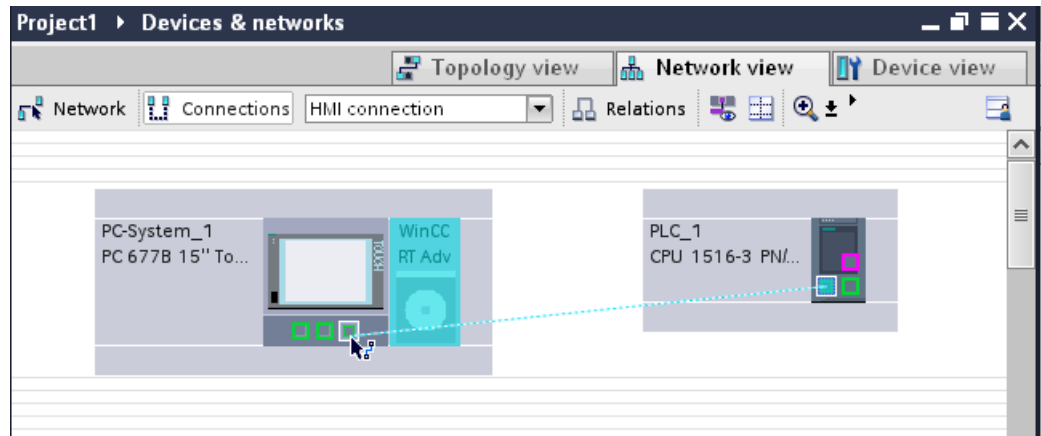

5. Click the connecting line.
6. Click "Highlight HMI connection" and select the HMI connection. The connection is displayed graphically in the Inspector window.
7. Click the communication partners in the "Network view" and change the PROFINET parameters in the Inspector window according to the requirements of your project. See the chapter "PROFINET parameters (Page 4989)" for additional details.

---

#### Note

The created HMI connection is also shown in the tabular area of the editor on the "Connections" tab. You check the connection parameters in the table.

You can change the local name for the connection only in the table.

---

## Result

You have created a connection between an HMI device and a SIMATIC S7 1500. The IP address and subnet mask connection parameters are configured.

## PROFINET parameters

### PROFINET parameters for the HMI connection

### PROFINET parameters for the HMI connection

An overview of the configured HMI connection parameters can be found in the properties for the HMI connection.

Only limited changes are possible in this Inspector window.

### Displaying and changing the HMI connection parameters

1. Click the HMI connection in the "Devices & Networks" editor.
2. Change the parameters of the HMI connection in the Inspector window under "Properties > General > General".

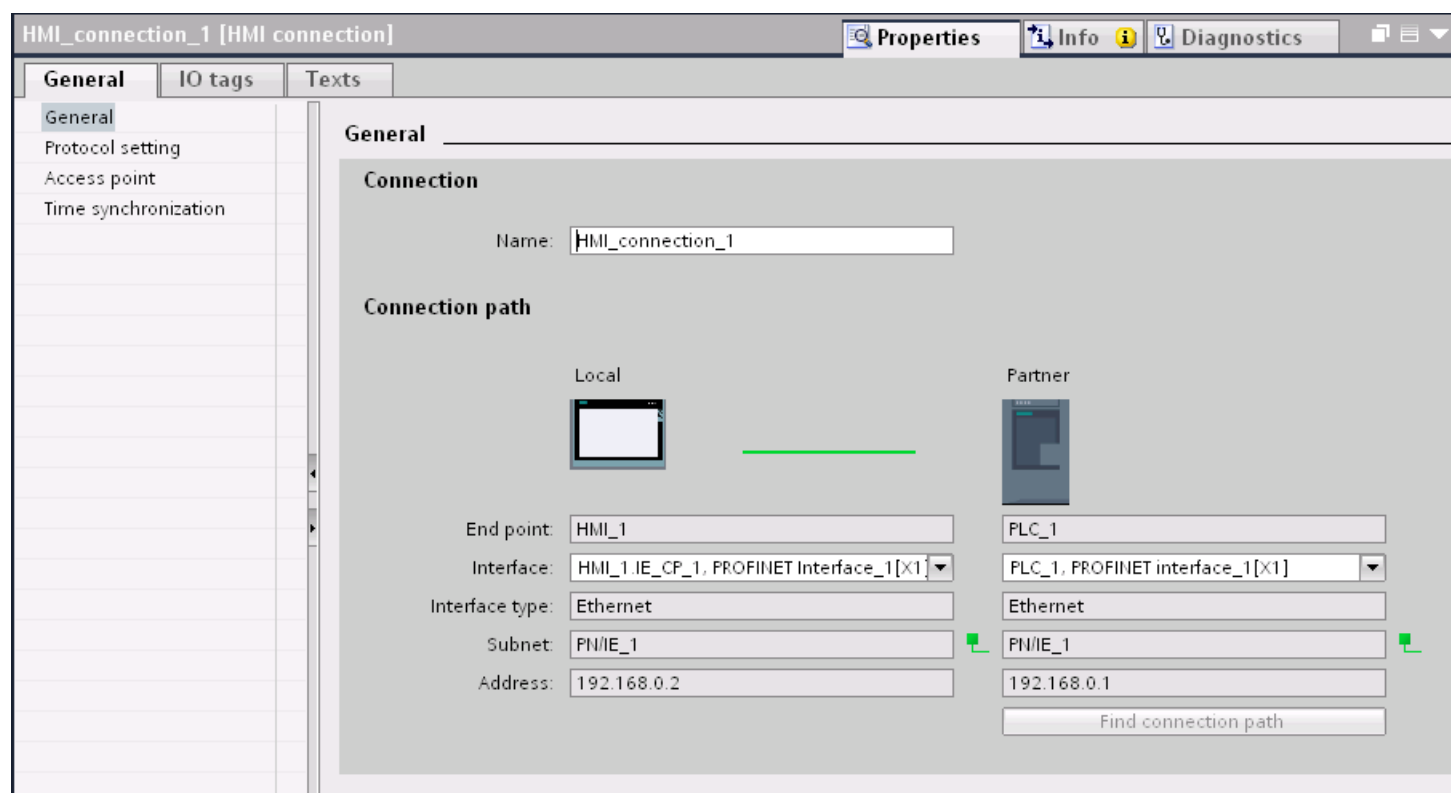

#### "Connection"

Shows the name of the HMI connection.

#### "Connection path"

The communication partners of the selected HMI connection and the associated PROFINET parameters are displayed in the "Connection path" area. Some of the areas displayed cannot be edited in this dialog.

- "End point"  
Displays the device name. This area cannot be edited.
- "Interface"  
Displays the selected interface of the device. You can choose between several interfaces, depending on the device.
- "Interface type"  
Displays the selected interface type. This area cannot be edited.
- "Subnet"  
Displays the selected subnet. This area cannot be edited.

- "Address"  
Displays the selected IP address of the device. This area cannot be edited.
- "Find connection path" button  
Enables the subsequent specification of connections.

## PROFINET parameters for the HMI device

## PROFINET parameters for the HMI device

An overview of the configured HMI device parameters can be found in the properties for the HMI device.

## Displaying and changing PROFINET parameters of the HMI device

1. Click the HMI device in the "Devices & Networks" editor.
2. Change the parameters of the HMI device in the Inspector window under "Properties > General".

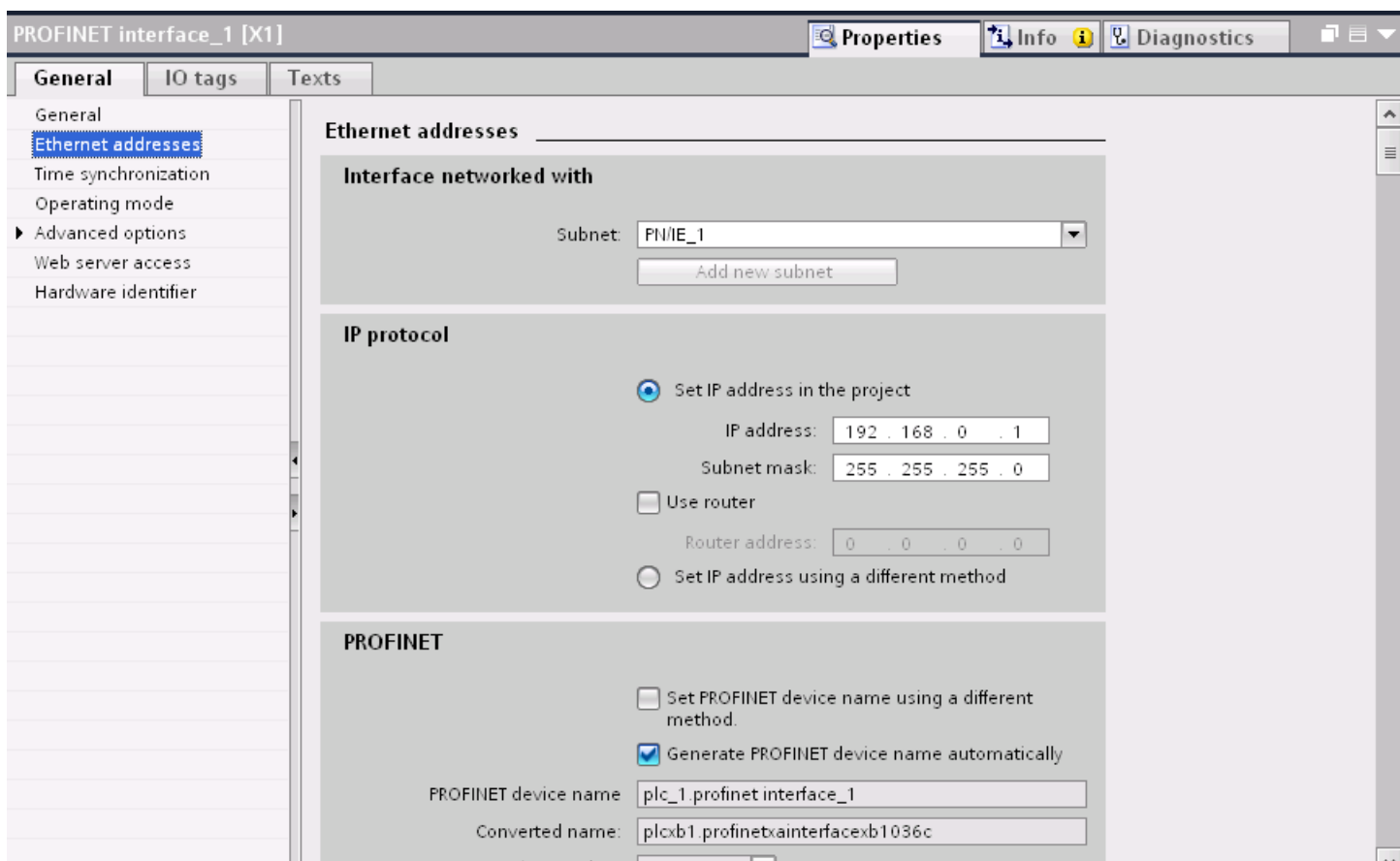

### "Interface networked with"

In the "Interface networked with" area, select the subnet of the HMI connection via which the HMI device is connected to the network. You use the "Add new subnet" button to create a new subnet.

### "IP protocol"

- "Set IP address in the project"  
When you transfer the WinCC project to the HMI device, this IP address is set up directly in the HMI device.

---

#### Note

The device is automatically restarted in the case of HMI devices with the Windows CE 3.0 operating system.

HMI devices with Windows CE 3.0:

- Mobile Panel 177 PN
  - Mobile Panel 177 DP
- 
- "Subnet mask"  
You assign data of the subnet mask in the "Subnet mask" area.
  - "Use IP router"  
If you are using an IP router, select "Use IP router" and enter the router address in the "Router address" field.
  - "Set IP address using a different method"  
If the function "Set IP address using a different method" is activated, the IP address is not taken from the project. You have to enter the IP address directly in the Control Panel of the HMI device.

### PROFINET parameters for the PLC

### PROFINET parameters for the PLC

An overview of the configured parameters can be found in the properties for the PLC.

## Displaying and changing PROFINET parameters of the PLC

1. Click the PLC in the "Devices & Networks" editor.
2. Change the parameters of the PLC in the Inspector window under "Properties > General > General".

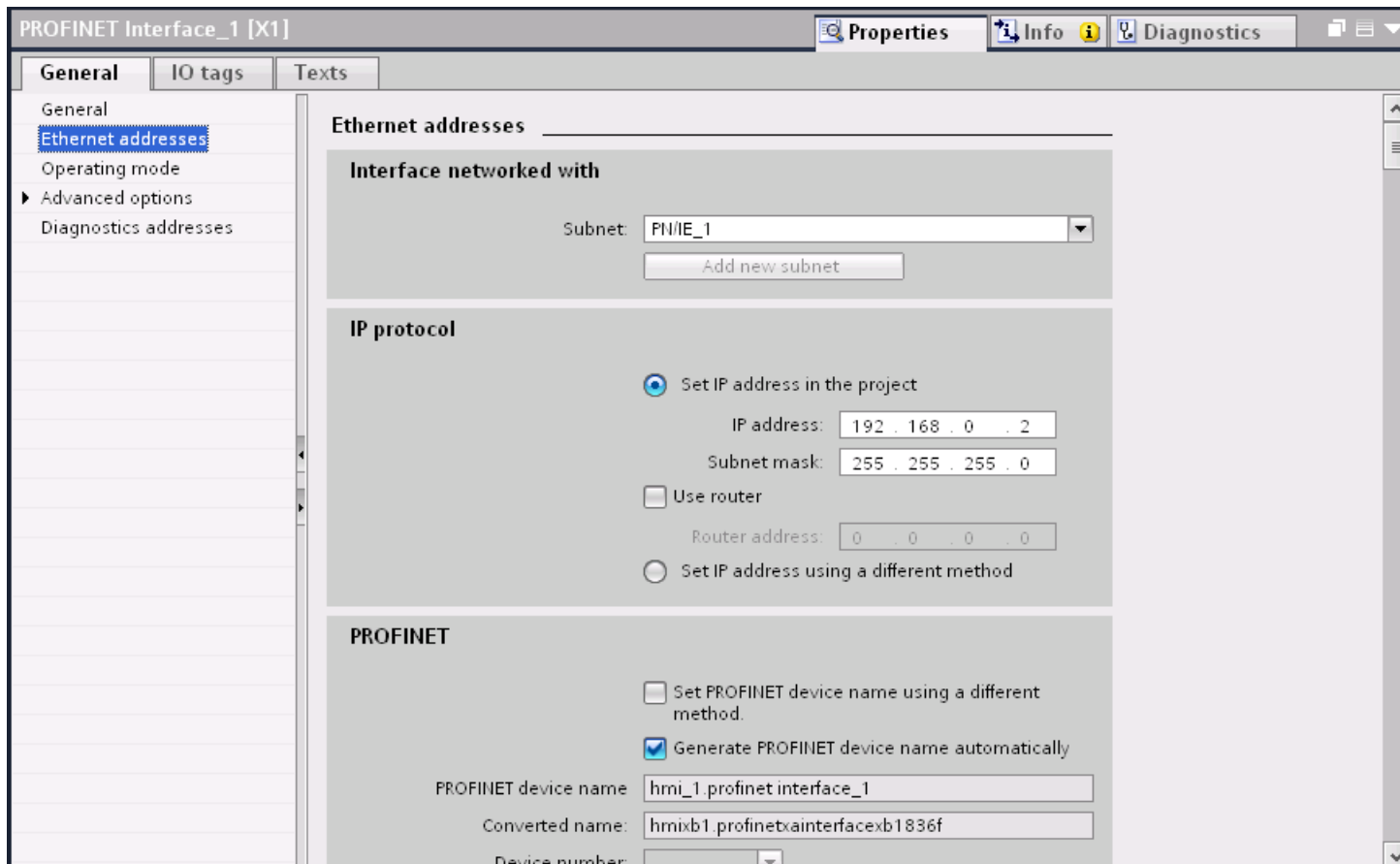

### "Interface networked with"

In the "Subnet" area, select the subnet of the HMI connection via which the PLC is connected to the network. You use the "Add new subnet" button to create a new subnet.

### "IP protocol"

- "Interface type"  
Depending on the HMI device type, you have various interfaces to choose from.
- "IP address"  
You assign the IP address of the HMI device in the "IP address" area.
- "Subnet mask"  
You assign data of the subnet mask in the "Subnet mask" area.  
If you are using an IP router, select "Use IP router" and enter the router address in the field.

## Protection of communication

### Security levels

You can assign communication security levels to protect PLC and HMI device communication.

For an S7-1500 CPU, you can enter multiple passwords and thereby set up different access rights for various user groups.

The passwords are entered in a table, so that each password is assigned to exactly one protection level.

The effect of the password is given in the "Protection" column.

### Example

Select the "Complete protection" security level for a standard CPU (in other words, not an F-CPU) and enter a separate password for each security level in the table.

For users who do not know any of the passwords, the CPU is completely protected. Not even HMI access is possible.

For users who know one of the assigned passwords, the effect depends on the table row in which the password occurs:

- The password in row 1 (no protection) allows access as if the CPU were completely unprotected. Users who know this password have unrestricted access to the CPU.
- The password in row 2 (write protection) allows access as if the CPU were write-protected. Despite knowing the password, users who know this password only have read access to the CPU.
- The password in row 3 (read/write protection) allows access as if the CPU were read-protected and write-protected, so that only HMI access is possible for users who know this password.

## Access password for the HMI connection

### Introduction

Communication with a PLC with the "Complete protection" protection level is protected by a password. The password is stored in the properties of the PLC.

Enter the password from the PLC in the "Access password" area.

Communication to the PLC is denied if an incorrect or no password is entered.



## Entering the access password

Enter the access password for the HMI connection in the "Connections" editor.

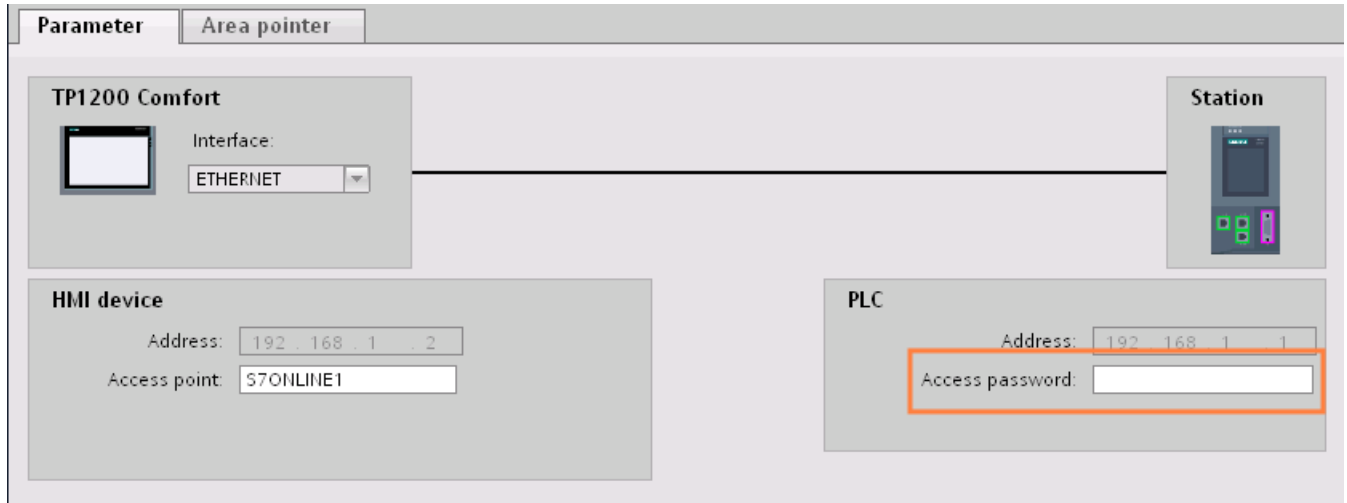

## Setting port options

## Setting the port options

## Changing connection settings for the PROFINET IO port

You can change the network settings for the PROFINET IO port as required. By default, the settings are made automatically. In normal situations, this guarantees problem-free communication.

### Possible settings for transmission rate / duplex

Depending on the selected device, you can make the following settings for "Transmission rate / duplex":

- Automatic setting  
Recommended default setting of the port. The transmission settings are automatically "negotiated" with the peer port. The "Enable autonegotiation" option is also enabled as a default, in other words, you can use cross cables or patch cables for the connection.
- TP/ITP at x Mbps full duplex (half duplex)  
Setting of the transmission rate and the full duplex/half duplex mode. The effectiveness depends on the "Enable autonegotiation" setting:
  - Autonegotiation enabled  
You can use both cross cable and patch cable.
  - Autonegotiation disabled  
Make sure that you use the correct cable (patch cable or cross cable)! The port is also monitored with this setting.
- Deactivated  
Depending on the module type, the drop down list box can contain the "- Disabled -" option. This option, for example, allows you to prevent access to an unused port for security reasons. With this setting, diagnostic events are not generated.

### "Monitor" option

This option enables or disables port diagnostics. Examples of port diagnostics: The link status is monitored, in other words, the diagnostics are generated during link-down and the system reserve is monitored in the case of fiber optic ports.

### Option "Enable autonegotiation "

The autonegotiation setting can only be changed if a concrete medium (for example, TP 100 Mbps full duplex) is selected. Whether or not a concrete medium can be set depends on the properties of the module.

If autonegotiation is disabled, this causes the port to be permanently specified, as for example, is necessary for a prioritized startup of the IO device.

You must make sure the partner port has the same settings because with this option the operating parameters of the connected network are not detected and the data transmission rate and transmission mode can accordingly not be optimally set.

---

#### Note

When a local port is connected, STEP 7 makes the setting for the partner port if the partner port supports the setting. If the partner port does not accept the setting, an error message is generated.

---

## Wiring rules for disabled autonegotiation

### Requirements

You have made the following settings for the port in question, for example, to accelerate the startup time of the IO device:

- Fixed transmission rate
- Autonegotiation incl. autocrossing disabled

The time for negotiating the transmission rate during startup has been saved.

If you have disabled autonegotiation, you must observe the wiring rules.

### Wiring rules for disabled autonegotiation

PROFINET devices have the following two types of ports:

Type of port	PROFINET devices	Note
Switch port with crossed pin assignment	For IO devices: Port 2 For S7 CPUs with 2 ports: Ports 1 and 2	Crossed pin assignment means that the pin assignment for the ports for sending and receiving between the respective PROFINET devices is exchanged internally.
End device port with uncrossed pin assignment	For IO devices: Port 1 For S7 CPUs with one port: Port 1	-

### Validity of the wiring rules

The cabling rules described in the following paragraph apply exclusively for the situation in which you have specified a fixed port setting.

## Rules for cabling

You can connect several IO devices in line using a single cable type (patch cable). To do this, you connect port 2 of the IO device (distributed I/O) with port 1 of the next IO device. The following graphic gives an example with two IO devices.

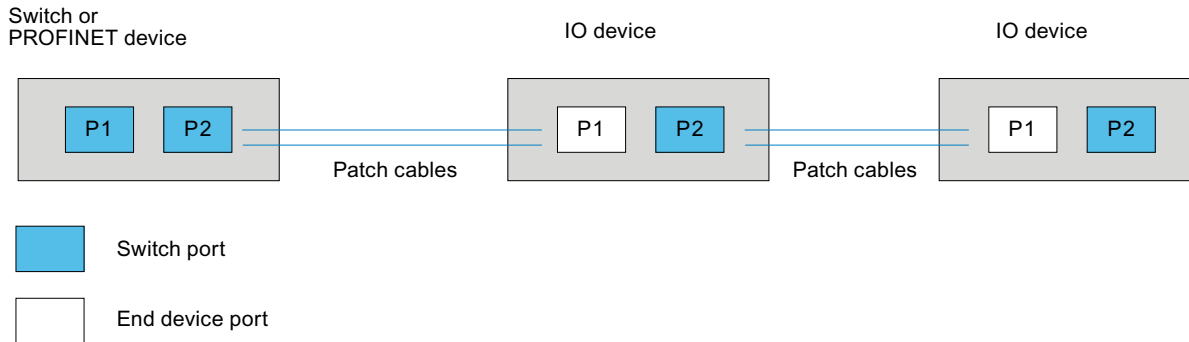

## Boundaries at the port

### Requirements

To use boundaries, the respective device must have more than one port. If the PROFINET does not support boundary settings, they are not shown.

### Enable boundaries

"Boundaries" are limits for transmission of certain Ethernet frames. The following boundaries can be set at a port:

- "End of discovery of accessible devices"  
No forwarding of DCP frames to identify accessible devices. Devices downstream from this port cannot be reached by the project tree under "Accessible devices". Devices downstream from this port cannot be reached by the CPU.
- "End of topology discovery"  
LLDP frames (Link Layer Discovery Protocol) are not forwarded for topology detection.
- "End of sync domain"  
No forwarding of sync frames transmitted to synchronize nodes within a sync domain. If you operate, for example, a PROFINET device with more than two ports in a ring, you should prevent the sync frame from being fed into the ring by setting a sync boundary (at the ports not inside the ring).  
Additional example: If you want to use several sync domains, configure a sync domain boundary for the port connected to a PROFINET device from the other sync domain.

## Restrictions

The following restrictions must be observed:

- The individual check boxes can only be used if the port supports the function in question.
- If a partner port has been determined for the port, the following check boxes cannot be used:
  - "End of discovery of accessible devices"
  - "End of topology discovery"
- If autonegotiation is disabled, none of the check boxes can be used.

### 10.11.6.3 Communication via PROFIBUS

#### Configuring an HMI connection

#### Communication via PROFIBUS

#### HMI connections via PROFIBUS

If you have inserted an HMI device and a SIMATIC S7 1500 into the project, interconnect the two PROFIBUS interfaces in the "Devices & Networks" editor.

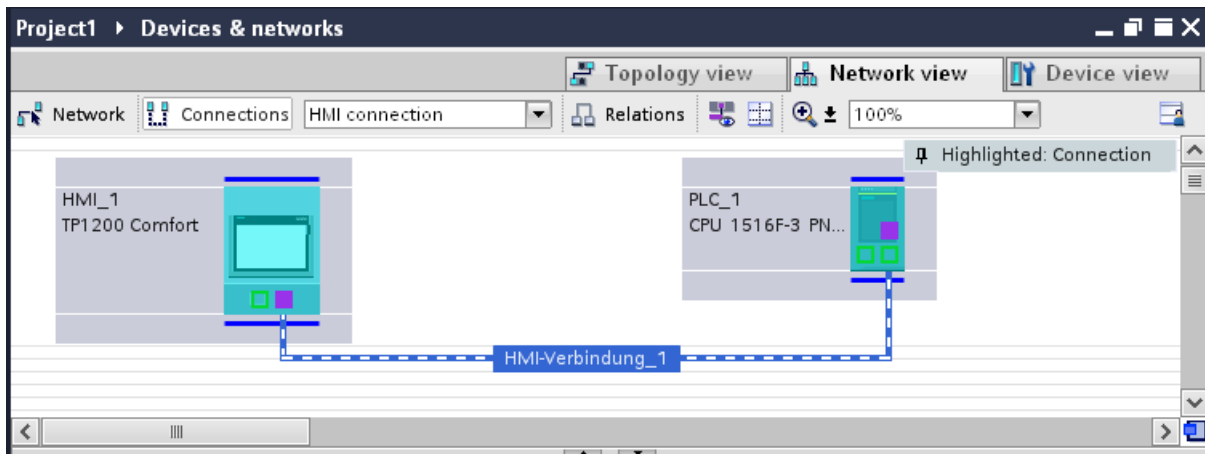

#### HMI connection in the "Devices & Networks" editor

You configure the HMI connection between the PLC and the HMI device via PROFIBUS in the "Devices & Networks" editor.

#### Connection in the "Connections" editor

Alternatively, you configure the connection between the PLC and HMI device in the "Connections" editor of the HMI device.

## Configuring an HMI connection via PROFIBUS

### Introduction

You configure an HMI connection over PROFIBUS between HMI devices and a SIMATIC S7 1500 in the "Devices & Networks" editor.

### Requirements

The following communication partners are created in the "Devices & Networks" editor:

- HMI device with MPI/DP interface
- SIMATIC S7 1500 with PROFIBUS interface

### Procedure

1. Double-click the "Devices & Networks" item in the project tree.  
The available communication partners in the project are displayed graphically in the network view.

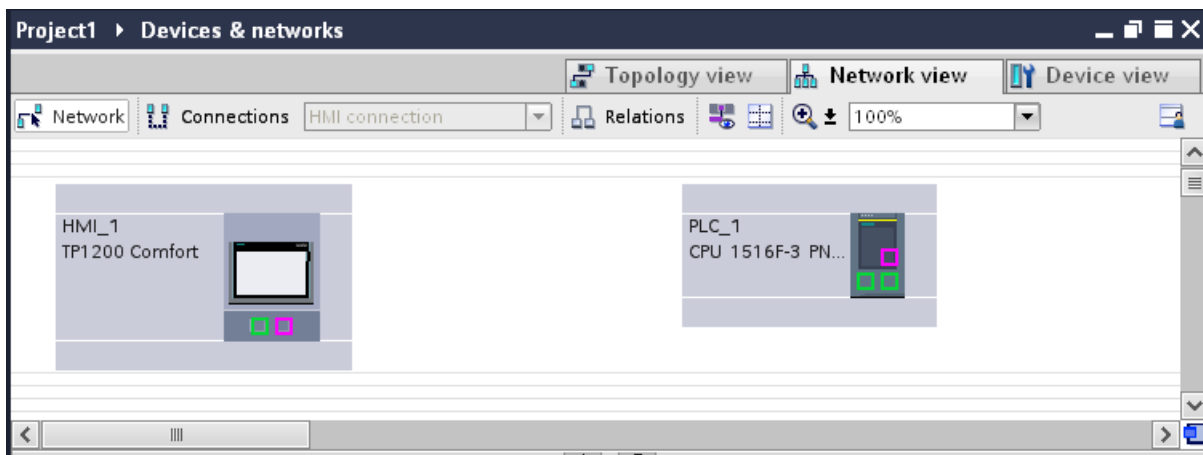

2. Click the "Connections" button.  
The devices available for connection are highlighted in color.
3. Click the HMI device interface.
4. Select the "PROFIBUS" interface type in the Inspector window under "Properties > General > HMI MPIDP > Parameters".

- Click the interface of the PLC and use a drag-and-drop operation to draw a connection to the HMI device.

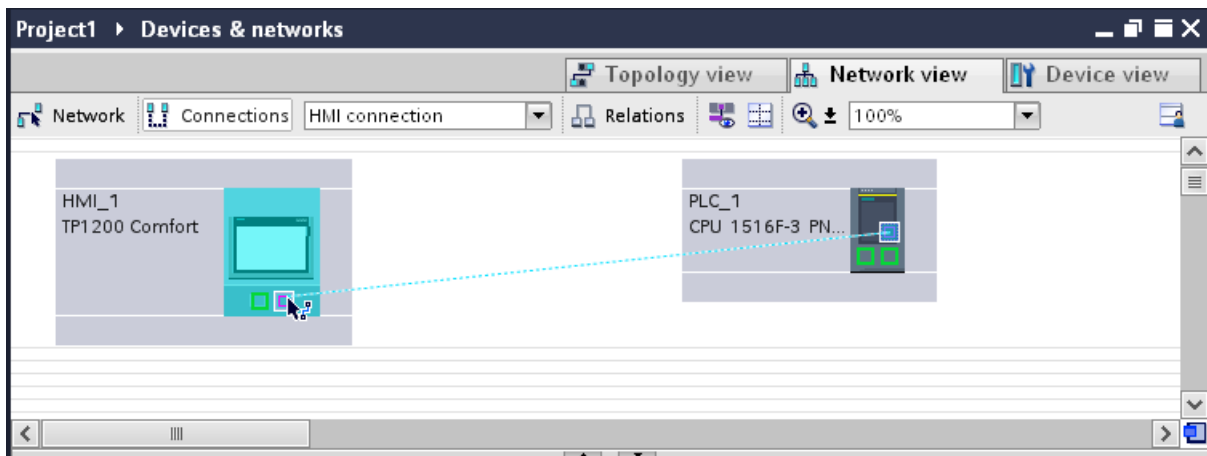

- Click the connecting line.
- Click "Highlight HMI connection" and select the HMI connection. The connection is displayed graphically in the Inspector window.
- Click the communication partners in the "Network view" and change the PROFINET parameters in the Inspector window according to the requirements of your project. See the chapter "PROFIBUS parameters (Page 5006)" for additional details.

---

#### Note

The created HMI connection is also shown in the tabular area of the editor on the "Connections" tab. You check the connection parameters in the table.

You can change the local name for the connection only in the table.

---

## Result

You have created an HMI connection over PROFIBUS between an HMI device and a SIMATIC S7 1500.

## Configuring an HMI connection

## Communication via PROFIBUS

### Communication via PROFIBUS

This chapter describes communication over PROFIBUS between a WinCC Runtime and the SIMATIC S7 1500 PLC.

You can use the following WinCC Runtimes as an HMI device:

- WinCC RT Advanced
- WinCC RT Professional

## WinCC Runtime as HMI device

Configure the HMI connections between WinCC Runtime and SIMATIC S7 1500 in the "Devices & Networks" editor.

If you want to use a WinCC Runtime as an HMI device, you have the following options:

1. You create a SIMATIC PC and configure a WinCC Runtime on this SIMATIC PC. In this way you use the SIMATIC PC with a WinCC Runtime as an HMI device.

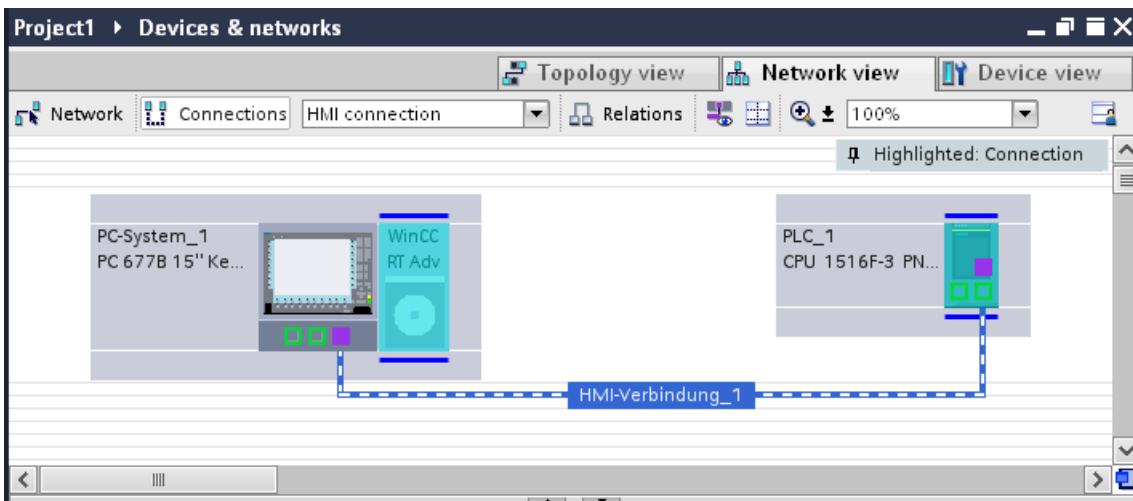

2. You create a WinCC Runtime and configure a communication processor to the Runtime. In this way you use your configuration PC with a WinCC Runtime as an HMI device.

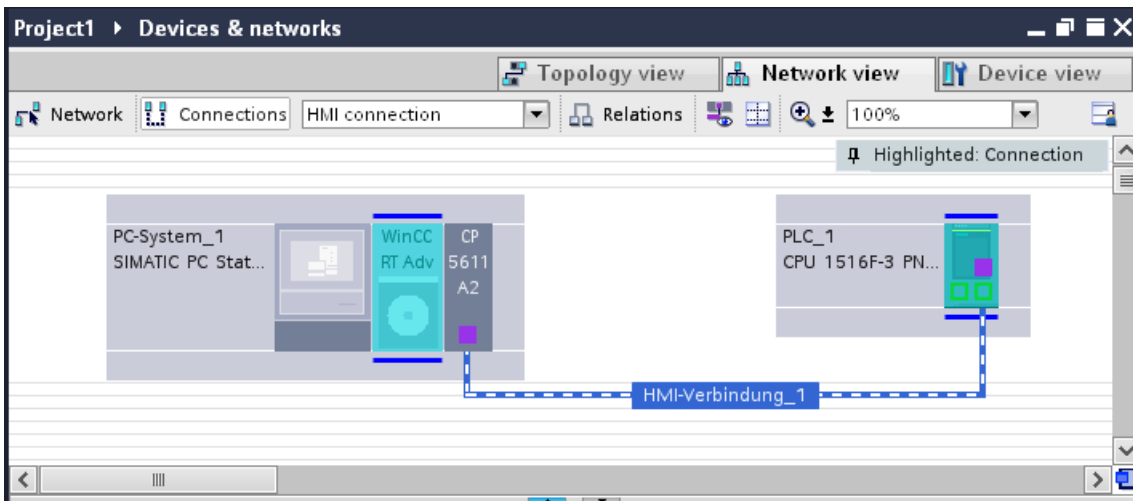

You can also connect multiple HMI devices to a single SIMATIC S7 1500 and multiple SIMATIC S7 1500 to a single HMI device. The maximum number of communication partners that you can connect to an HMI device is dependent on the HMI device used.

Additional information is available in the documentation for the respective HMI device.



## HMI connection in the "Devices & Networks" editor

You configure the HMI connection between the PLC and the HMI device via PROFIBUS in the "Devices & Networks" editor.

## Connection in the "Connections" editor

Alternatively, you configure the connection between the PLC and HMI device via PROFIBUS in the "Connections" editor of the HMI device.

## Configuring an HMI connection via PROFIBUS with a PC

### Introduction

You configure an HMI connection over PROFIBUS between the HMI device and SIMATIC S7 1500 in the "Devices & Networks" editor.

### Requirements

The following communication partners are created in the "Devices & Networks" editor:

- SIMATIC S7 1500 with PROFIBUS interface
- PC station with WinCC RT Advanced or WinCC RT Professional

### Procedure

1. Double-click the "Devices & Networks" item in the project navigation.  
The available communication partners in the project are displayed in the network view.
2. Use a drag-and-drop operation to move a PROFIBUS-capable communication processor from the hardware catalog to the WinCC Runtime.

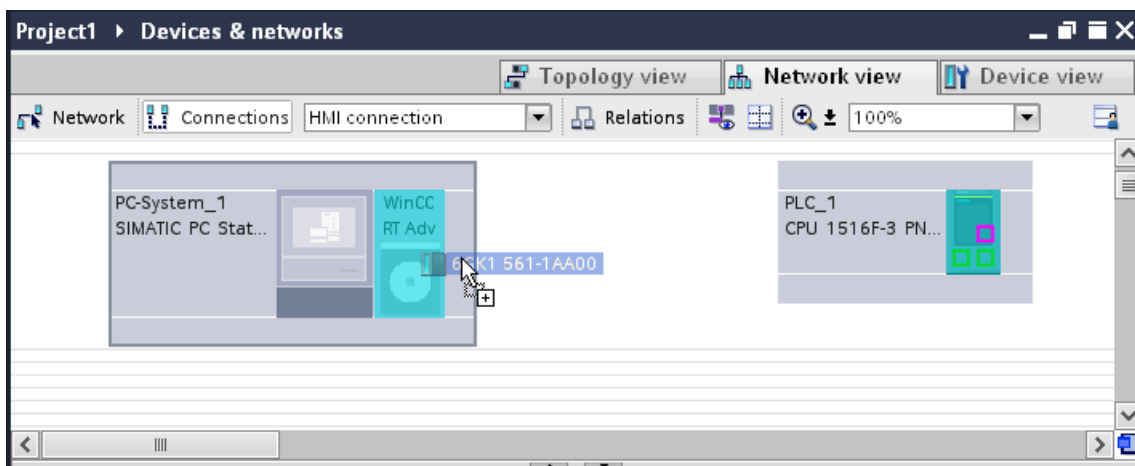

3. Click the "Connections" button and select "HMI connection" for the connection type.  
The devices available for connection are highlighted in color.

4. Click the PROFIBUS interface of the PLC and use a drag-and-drop operation to draw a connection to the PROFIBUS interface of the communication processor.

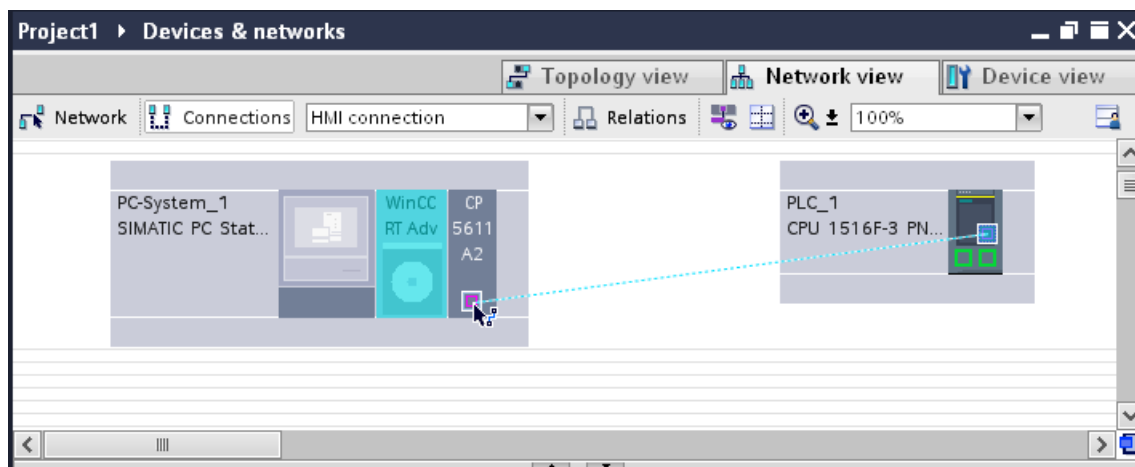

5. Click the connecting line.
6. Click "Highlight HMI connection" and select the HMI connection. The connection is displayed graphically in the Inspector window.
7. Click the communication partners in the "Network view" and change the PROFIBUS parameters in the Inspector window according to the requirements of your project. See the chapter "PROFIBUS parameters (Page 5006)" for additional details.

---

**Note**

The created HMI connection is also shown in the tabular area of the editor on the "Connections" tab. You check the connection parameters in the table.

You can change the local name for the connection only in the table.

---

**Result**

You have created an HMI connection over PROFIBUS between an HMI device and a SIMATIC S7 1500.

**Configuring an HMI connection via PROFIBUS with a SIMATIC PC**

**Introduction**

You configure an HMI connection over PROFIBUS between HMI devices and a SIMATIC S7 1500 in the "Devices & Networks" editor.

**Requirements**

The following communication partners are created in the "Devices & Networks" editor:

- SIMATIC S7 1500 with PROFIBUS interface
- SIMATIC PC with PROFIBUS interface

## Procedure

1. Double-click the "Devices & Networks" item in the project navigation.  
The available communication partners in the project are displayed in the network view.
2. Click the MPI interface of the PC and select "PROFIBUS" for the interface type in the Inspector window.
3. Use a drag-and-drop operation to move a WinCC Runtime from the hardware catalog to the PC.

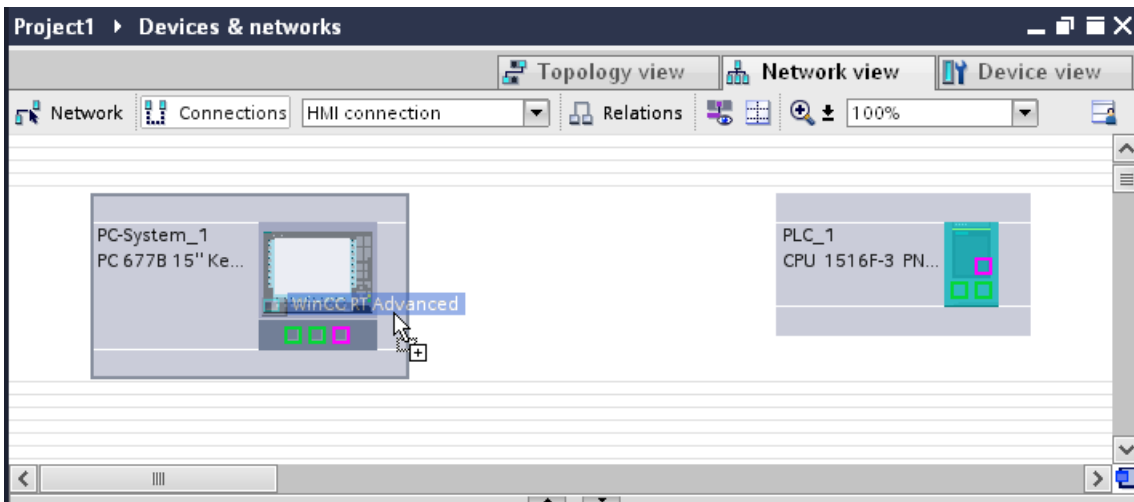

4. Click the "Connections" button and select "HMI connection" for the connection type.  
The devices available for connection are highlighted in color.
5. Click the PROFIBUS interface of the PLC and use a drag-and-drop operation to draw a connection to the PROFIBUS interface of the PC.

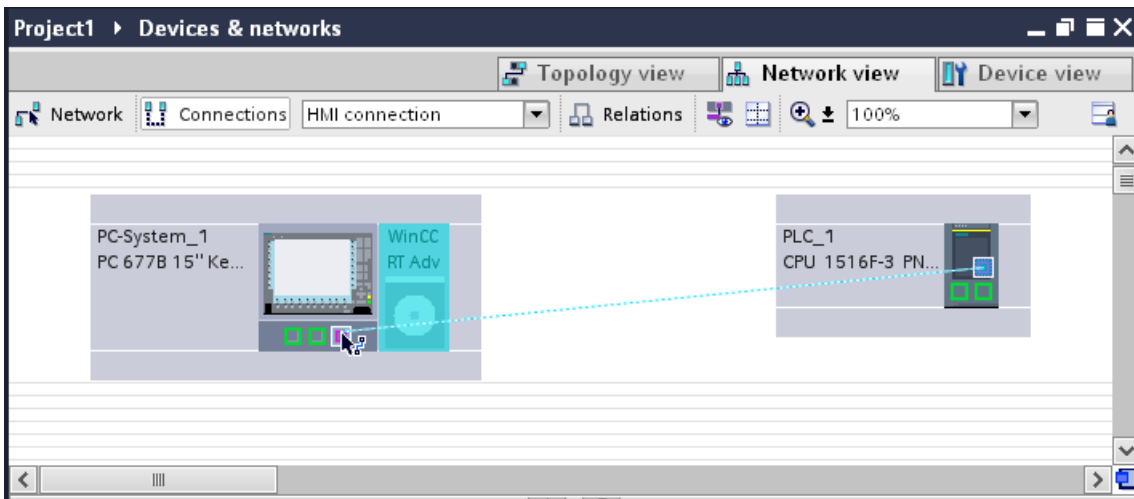

6. Click the connecting line.

7. Click "Highlight HMI connection" and select the HMI connection.  
The connection is displayed graphically in the Inspector window.
8. Click the communication partners in the "Network view" and change the PROFIBUS parameters in the Inspector window according to the requirements of your project.  
See the chapter "PROFIBUS parameters (Page 5006)" for additional details.

---

**Note**

The created HMI connection is also shown in the tabular area of the editor on the "Connections" tab. You check the connection parameters in the table.

You can change the local name for the connection only in the table.

---

**Result**

You have created an HMI connection over PROFIBUS between an HMI device and a SIMATIC S7 1500.

**PROFIBUS parameters**

**PROFIBUS parameters for the HMI connection**

**PROFIBUS parameters for the HMI connection**

An overview of the configured HMI connection parameters can be found in the properties for the HMI connection.

Only limited changes are possible in this Inspector window.

## Displaying and changing the HMI connection parameters

1. Click the HMI connection in the "Devices & Networks" editor.
2. Change the parameters of the HMI connection in the Inspector window under "Properties > General > General".

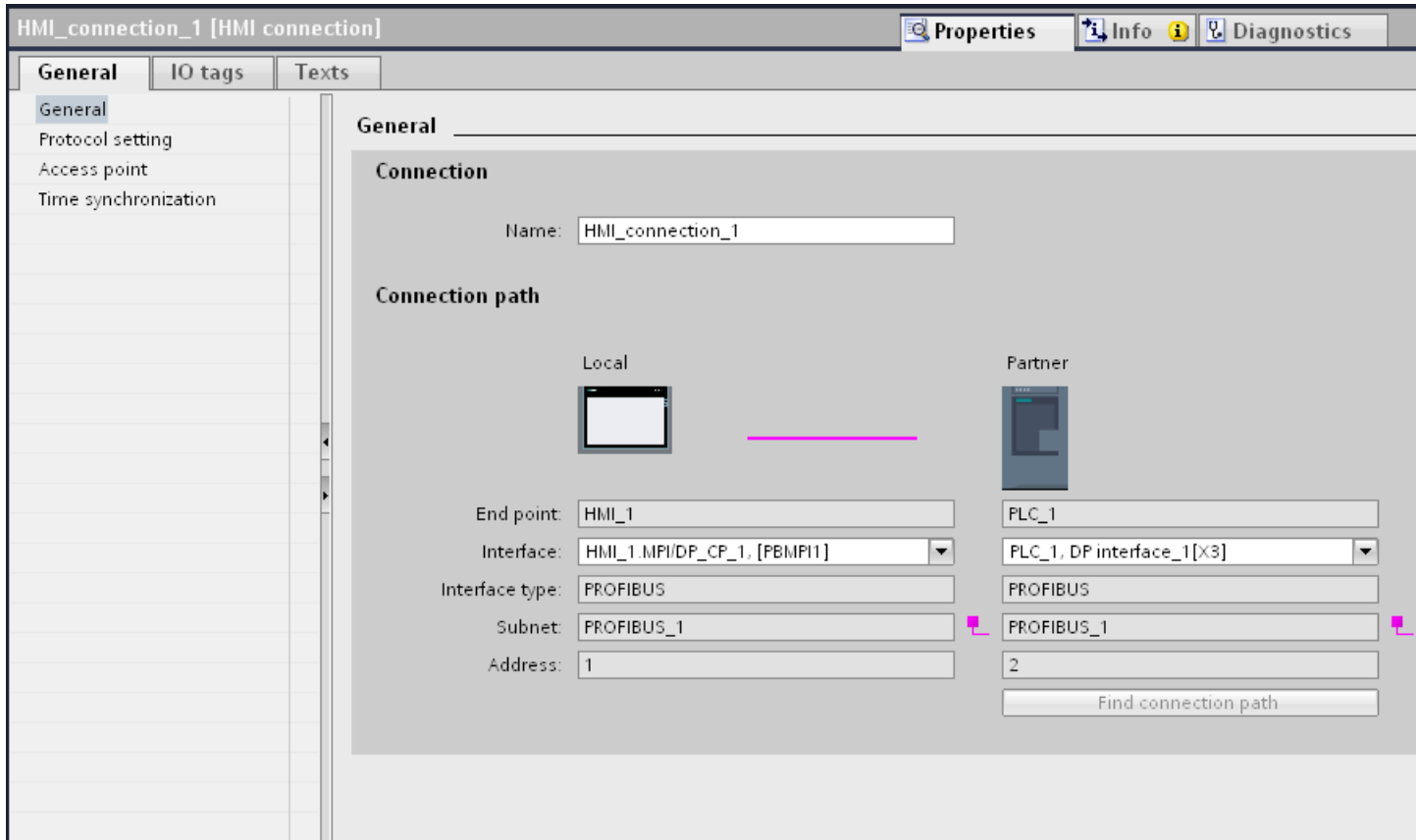

### "Connection"

Displays whether the devices are networked together.

- displayed if the devices are networked together.
- displayed if the devices are not networked together.

### "Connection path"

The communication partners of the selected HMI connection and the associated PROFIBUS parameters are displayed in the "Connection path" area. Some of the areas displayed cannot be edited in this dialog.

- "End point"  
Displays the device name. This area cannot be edited.
- "Interface"  
Displays the selected interface of the device. You can choose between several interfaces, depending on the device.

- "Interface type"  
Displays the selected interface type. This area cannot be edited.
- "Subnet"  
Displays the selected subnet. This area cannot be edited.
- "Address"  
Displays the PROFIBUS address of the device. This area cannot be edited.
- "Find connection path" button  
Enables the subsequent specification of connections.

## PROFIBUS parameters for the HMI device

### PROFIBUS parameters for the HMI device

An overview of the configured HMI device parameters can be found in the properties for the HMI device.

### Displaying and changing PROFINET parameters of the HMI device

1. Click the HMI device in the "Devices & Networks" editor.
2. Change the parameters of the HMI device in the Inspector window under "Properties > General > General".

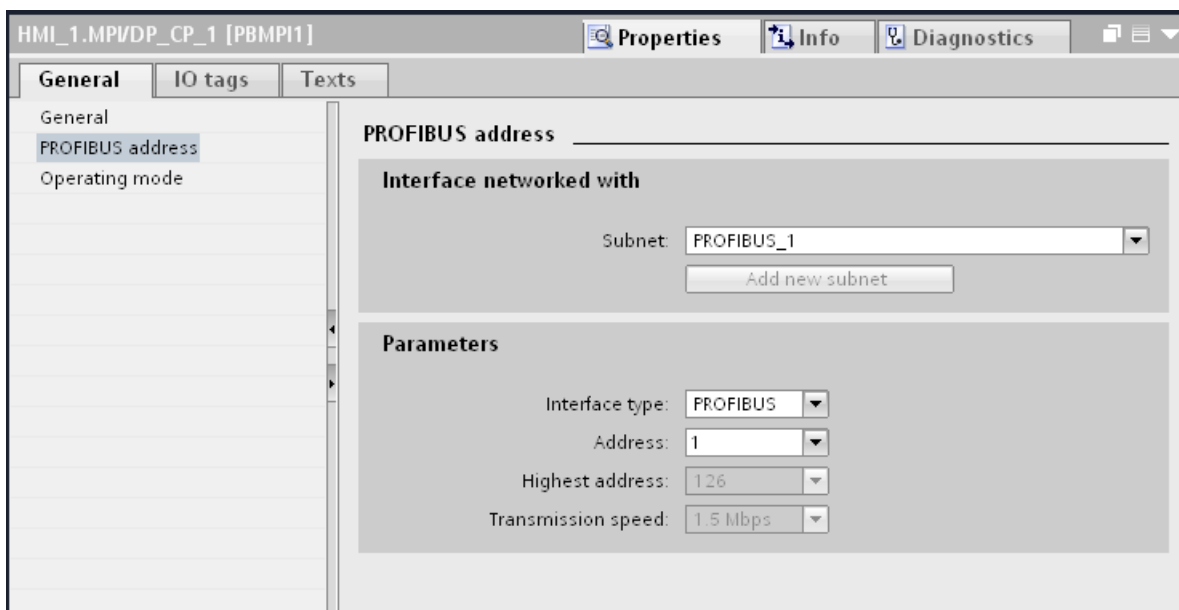

### "Interface networked with"

In the "Interface networked with" area, select the subnet of the HMI connection via which the HMI device is connected to the network. You use the "Add new subnet" button to create a new subnet.

## "Parameters"

- "Interface type"  
You assign the interface type in the "Interface type" area. Depending on the HMI device type, you have various interfaces to choose from.
- "Address"  
You assign the PROFIBUS address of the HMI device in the "Address" area. The PROFIBUS address must be unique throughout the PROFIBUS network.
- "Highest address"  
The "Highest address" area displays the highest address of the PROFIBUS network.
- "Transmission speed"  
The "Transmission speed" is determined by the slowest device connected to the network. The setting is identical throughout the network.

## PROFIBUS parameters for the PLC

## PROFIBUS parameters for the PLC

An overview of the configured parameters can be found in the properties for the PLC.

## Displaying and changing PROFIBUS parameters of the PLC

1. Click the PLC in the "Devices & Networks" editor.
2. Change the parameters of the PLC in the Inspector window under "Properties > General > General".

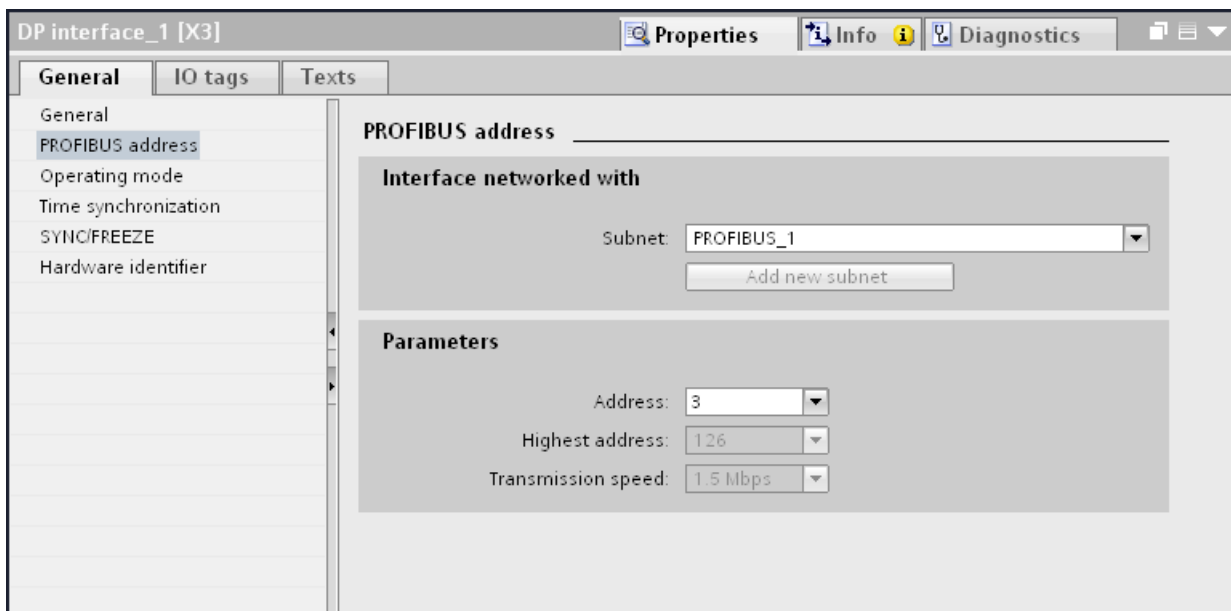

### "Interface networked with"

In the "Subnet" area, select the subnet of the HMI connection via which the PLC is connected to the network. You use the "Add new subnet" button to create a new subnet.

### "Parameters"

- "Interface type"  
Depending on the HMI device type, you have various interfaces to choose from.
- "Address"  
You assign the PROFIBUS address of the HMI device in the "Address" area. The PROFIBUS address must be unique throughout the PROFIBUS network.
- "Highest address"  
The "Highest address" area displays the highest address of the PROFIBUS network.
- "Transmission speed"  
The "Transmission speed" is determined by the slowest device connected to the network. The setting is identical throughout the network.

### Protection of communication

#### Security levels

You can assign communication security levels to protect PLC and HMI device communication.

For an S7-1500 CPU, you can enter multiple passwords and thereby set up different access rights for various user groups.

The passwords are entered in a table, so that each password is assigned to exactly one protection level.

The effect of the password is given in the "Protection" column.

#### Example

Select the "Complete protection" security level for a standard CPU (in other words, not an F-CPU) and enter a separate password for each security level in the table.

For users who do not know any of the passwords, the CPU is completely protected. Not even HMI access is possible.

For users who know one of the assigned passwords, the effect depends on the table row in which the password occurs:

- The password in row 1 (no protection) allows access as if the CPU were completely unprotected. Users who know this password have unrestricted access to the CPU.
- The password in row 2 (write protection) allows access as if the CPU were write-protected. Despite knowing the password, users who know this password only have read access to the CPU.
- The password in row 3 (read/write protection) allows access as if the CPU were read-protected and write-protected, so that only HMI access is possible for users who know this password.



## Access password for the HMI connection

### Introduction

Secure access to a PLC by assigning a password.

Assign the password when configuring the connection.

Input of the password of the PLC is mandatory as of "Complete protection" security level.

Communication to the PLC is denied if an incorrect password or no password is entered.

### Assigning password

Enter the access password for the HMI connection in the "Connections" editor.

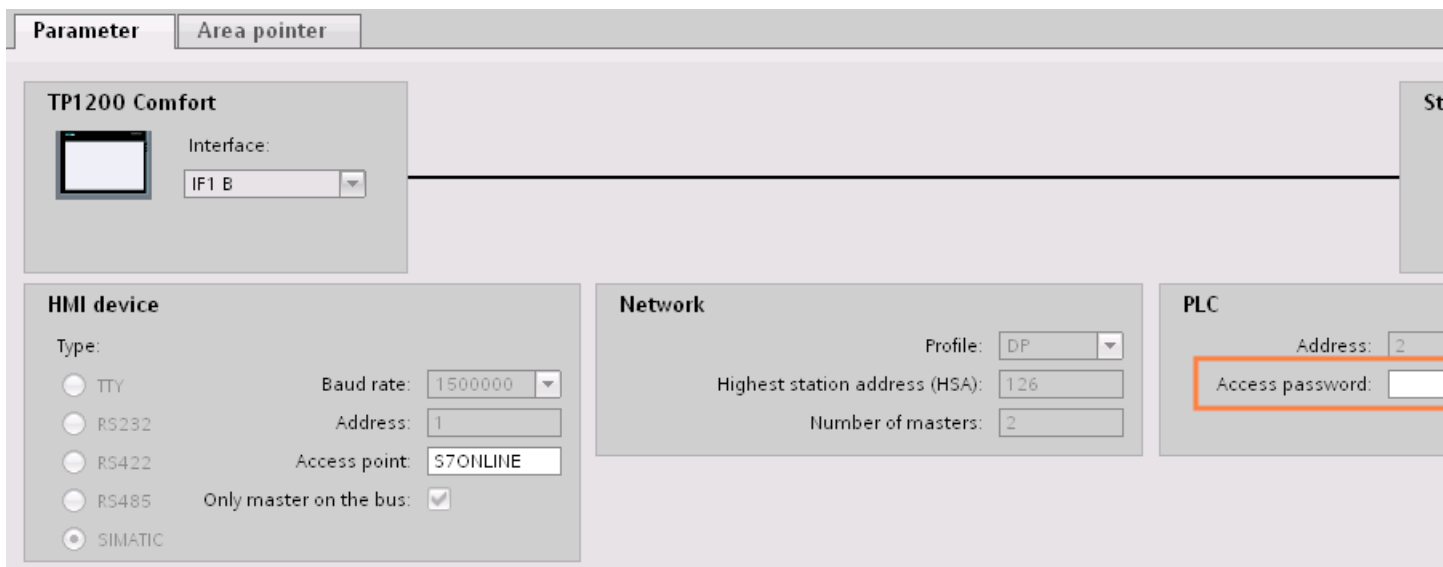

#### 10.11.6.4 Data exchange

### Data exchange using area pointers

### General information on area pointers

#### Introduction

You use an area pointer to access a data area in the PLC. During communication, the PLC and the HMI device alternately access these data areas for read and write operations.

The PLC and the HMI device trigger defined interactions based on the evaluation of stored data.

### Configuration of area pointers

Before you use an area pointer, you enable it under "Connections > Area pointer". You then assign the area pointer parameters.

You can find more detailed information on configuring area pointers in:

Data exchange using area pointers (Page 4916)

### Restrictions

You can only configure the following data types for communication with SIMATIC S7 1500 for data exchange using area pointers:

- UInt and array of UInt
- Word and array of Word
- Int and array of Int
- "Array[0..15] of Bool" for area pointer "Coordination"
- Date\_And\_Time
- DTL and LDT

### "Screen number" area pointer

#### Function

The HMI device saves information about the screen called on the HMI device to the "Screen number" area pointer.

This allows the transfer of the current screen contents from the HMI device to the PLC. The PLC can trigger specific reactions such as the call of a different screen.

#### Use

Configure and enable the area pointer in "Communication > Connections" before you put it into use. You can create only **one** instance of the "Screen number" area pointer and only on **one** PLC.

The screen number is always transferred to the PLC when a new screen is activated or when the focus within a screen changes from one screen object to another.

#### Structure

The area pointer is a data area in the memory of the PLC with a fixed length of 5 words.

	15	14	13	12	11	10	9	8	7	6	5	4	3	2	1	0
1st word	Current screen type															
2nd word	Current screen number															

	15	14	13	12	11	10	9	8	7	6	5	4	3	2	1	0
3rd word	Reserved															
4th word	Current field number															
5th word	Reserved															

- Current screen type  
"1" for root screen or  
"4" for permanent window
- Current screen number  
1 to 32767
- Current field number  
1 to 32767

### "Date/time" area pointer

#### Function

This area pointer is used to transfer the date and time from the HMI device to the PLC.

The PLC writes control job "41" or "40" to the job mailbox.

When it evaluates the control job, the HMI device writes its current date and the time in the data area configured in the "Date/time" area pointer. All definitions are coded in BCD format.

---

#### Note

You cannot use the "Date/Time PLC" area pointer if you have configured the "Date/Time" area pointer.

---

#### Note

Symbolic addressing is not possible if you are using the "Date/Time" area pointer.

---

The "Date/Time" area pointer when used in a project which contains multiple connections must be enabled for each configured connection.

The date/time data area has the following structure:

Data word	Most significant byte								Least significant byte								
	7							0	7							0	
n+0	Reserved								Hour (0 to 23)								Time
n+1	Minute (0 to 59)								Second (0 to 59)								
n+2	Reserved								Reserved								
n+3	Reserved								Weekday (1 to 7, 1=Sunday)								Date
n+4	Day (1 to 31)								Month (1 to 12)								
n+5	Year (80 to 99/0 to 29)								Reserved								

---

**Note**

When making entries in the "Year" data area, you should note that values 80 to 99 result in years 1980 through 1999, while the values 0 to 29 result in the years 2000 through 2029.

---

## Using data types

The data types "Date\_And\_Time, DTL" and "LDT" can only be used with the "Date/time" and "Date/time PLC" area pointers.

The data format of the "Date/time" area pointer depends on job mailbox 40/41.

If there are no control tags linked to the area pointer, or a control tag is linked with the data type "Array[0..5] of UInt/Word/Int", the following applies:

The configuration of the "Date/time" area pointer is only used for job mailbox 41.

If job mailbox 40 is used, the data format "DATE\_AND\_TIME (BCD-encoded)" is used (shown in the next section).

If the "Date/time" and "Date/time PLC" area pointers are linked to a control tag with the data type "DATE\_AND\_TIME", "DTL" or "LDT", the associated data format is used in the corresponding area pointer.

## "Date/time PLC" area pointer

### Function

This area pointer is used to transfer the date and time from the PLC to the HMI device. Use this area pointer if the PLC is the time master.

The PLC loads the data area of the area pointer. All definitions are coded in BCD format.

The HMI device reads the data cyclically within the configured acquisition cycle and synchronizes itself.

---

**Note**

Set an acquisition cycle of sufficient length for the Date/time area pointer in order to avoid any negative impact on HMI device performance.

Recommended: Acquisition cycle of 1 minute, if the process allows this.

---

"Date/Time PLC" is a global area pointer and may be configured only once per project.

---

**Note**

You cannot use the "Date/Time" area pointer if you have configured the "Date/Time PLC" area pointer.

---

The date/time data area has the following structure:

**DATE\_AND\_TIME format (in BCD code)**

Data word	Most significant byte			Least significant byte		
	7	.....	0	7	.....	0
n+0	Year (80 to 99/0 to 29)			Month (1 to 12)		
n+1	Day (1 to 31)			Hour (0 to 23)		
n+2	Minute (0 to 59)			Second (0 to 59)		
n+3	Reserved			Reserved	Weekday (1 to 7, 1=Sunday)	
n+4 <sup>1)</sup>	Reserved			Reserved		
n+5 <sup>1)</sup>	Reserved			Reserved		

- 1) The two data words must exist in the data area to ensure that the data format matches WinCC flexible and to avoid reading false information.

**Note**

When making entries in the "Year" data area, you should note that values 80 to 99 result in years 1980 through 1999, while the values 0 to 29 result in the years 2000 through 2029.

**Using data types**

The data types "Date\_And\_Time, DTL" and "LDT" can only be used with the "Date/time" and "Date/time PLC" area pointers.

The data format of the "Date/time" area pointer depends on job mailbox 40/41.

If there are no control tags linked to the area pointer, or a control tag is linked with the data type "Array[0..5] of UInt/Word/Int", the following applies:

The configuration of the "Date/time" area pointer is only used for job mailbox 41.

If job mailbox 40 is used, the data format "DATE\_AND\_TIME (BCD-encoded)" is used (shown in the next section).

If the "Date/time" and "Date/time PLC" area pointers are linked to a control tag with the data type "DATE\_AND\_TIME", "DTL" or "LDT", the associated data format is used in the corresponding area pointer.

## "Coordination" area pointer

### Function

The "Coordination" area pointer is used to implement the following functions:

- Detecting the startup of the HMI device in the control program
- Detecting the current operating mode of the HMI device in the control program
- Detecting whether the HMI device is ready to communicate in the control program

By default, the "Coordination" area pointer has the length of one word and cannot be changed.

### Usage

#### Note

The HMI device always writes the entire coordination area when updating the area pointer. The control program can for this reason not make changes to the coordination area.

### Assignment of the bits in the "Coordination" area pointer

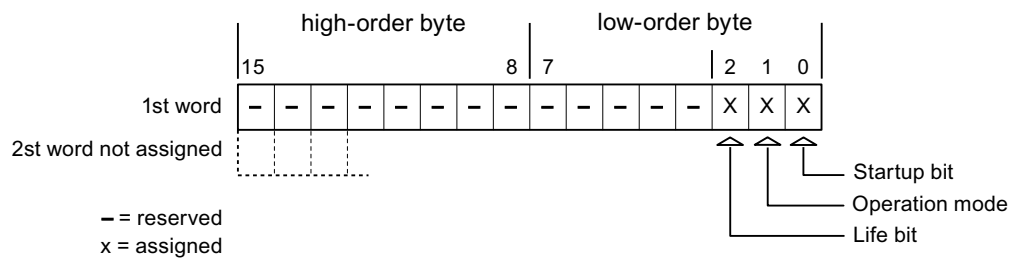

### Startup bit

The startup bit is set briefly to "0" by the HMI device during startup. It sets the bit permanently to "1" when startup is completed.

### Operating mode

The operating mode bit is set to 1 as soon as the user switches the HMI device offline. The status of the operating mode bit is "0" during normal operation of the HMI device. You can determine the current operating mode of the HMI device by reading this bit in the control program.

### Life bit

The HMI device inverts the life bit at intervals of approximately one second. You can check whether or not there is still a connection to the HMI device by querying this bit in the control program.

## "Project ID" area pointer

### Function

When Runtime starts it can check to see if the HMI device is connected to the correct PLC. This check is important when operating with several HMI devices.

For this, the HMI device compares a value stored on the PLC with the value specified in configuration. This ensures compatibility of the configuration data with the PLC program. If there is no concordance, a system event is given on the HMI device and Runtime is stopped.

### Use

To use this area pointer, set up the following during the configuration:

- Define the version of configuration. Values between 1 and 255 are possible.  
You enter the version in the editor "Runtime settings > General" in the "Identification" area.
- Data address of the value for the version that is stored in the PLC:  
You enter the data address in the editor "Communication > Connections" under "Address".

### Connection failure

A connection failure to a device on which the "project ID" area pointer is configured results in all the other connections of the device being switched to "offline".

This behavior has the following requirements:

- You have configured several connections in a project.
- You are using the "project ID" area pointer in at least one connection.

Causes which may set connections "offline":

- The PLC is not available.
- The connection has been switched offline in the engineering system.

## "Job mailbox" area pointer

### Function

The PLC can use the job mailbox to transfer jobs to the HMI device to trigger corresponding actions on the HMI device. These functions include, for example:

- Display screen
- Set date and time

### Data structure

The first word of the job mailbox contains the job number. Depending on the job mailbox, up to three parameters can be transferred.

Word	Most significant byte	Least significant byte
n+0	0	Job number
n+1	Parameter 1	
n+2	Parameter 2	
n+3	Parameter 3	

The HMI device evaluates the job mailbox if the first word of this job is not equal to zero. This means that the parameters must be entered in the job mailbox first, followed by the job number.

When the HMI device accepts the job mailbox, the first word is set to 0 again. The execution of the job mailbox is generally not completed at this point in time.

### Job mailboxes

All job mailboxes and their parameters are listed below. The "No." column contains the job number of the job mailbox. Job mailboxes can only be triggered by the PLC when the HMI device is online.

No.	Function	
<b>14</b>	<b>Set time (BCD-coded)</b>	
	Parameter 1	Left byte: - Right byte: hours (0-23)
	Parameter 2	Left byte: minutes (0-59) Right byte: seconds (0-59)
	Parameter 3	-
<b>15</b>	<b>Setting the date (BCD coded)</b> <sup>3) 4)</sup>	
	Parameter 1	Left byte: - Right byte: weekday (1-7: Sunday-Saturday)
	Parameter 2	Left byte: day (1-31) Right byte: month (1-12)
	Parameter 3	Left byte: year
<b>23</b>	<b>User logon</b>	
	Logs the user on with the name "PLC user" at the HMI device with the group number transferred in Parameter 1. The logon is possible only when the transferred group number exists in the project.	
	Parameter 1	Group number 1 to 255
	Parameter 2, 3	-
<b>24</b>	<b>User logoff</b>	
	Logs off the current user. (The function corresponds to the "logoff" system function)	
	Parameter 1, 2, 3	-
<b>40</b>	<b>Transfer date/time to PLC</b>	



No	Function	
<b>14</b>	<b>Set time (BCD-coded)</b>	
	(in the S7 format DATE_AND_TIME) An interval of at least 5 seconds must be maintained between two successive jobs to prevent overload of the HMI device.	
	Parameter 1, 2, 3	-
<b>41</b>	<b>Transfer date/time to PLC</b>	
	(In OP/MP format) An interval of at least 5 seconds must be maintained between successive jobs to prevent overload of the HMI device.	
	Parameter 1, 2, 3	-
<b>46</b>	<b>Update tag</b>	
	Causes the HMI device to read the current value of the tags from the PLC whose update ID matches the value transferred in Parameter 1. (Function corresponds to the "UpdateTag" system function.)	
	Parameter 1	1 - 100
<b>49</b>	<b>Delete alarm buffer</b>	
	Deletes all analog alarms and discrete alarms of the "Warnings" class from the alarm buffer.	
	Parameter 1, 2, 3	-
<b>50</b>	<b>Delete alarm buffer</b>	
	Deletes all analog alarms and discrete alarms of the "Errors" class from the alarm buffer.	
	Parameter 1, 2, 3	-
<b>51</b>	<b>Screen selection <sup>2)</sup></b>	
	Parameter 1	Screen number
	Parameter 2	-
	Parameter 3	Field number
<b>69</b>	<b>Reading data record from PLC <sup>1)</sup></b>	
	Parameter 1	Recipe number (1-999)
	Parameter 2	Data record number (1-65535)
	Parameter 3	0: Do not overwrite existing data record 1: Overwrite existing data record
<b>70</b>	<b>Writing data record to PLC <sup>1)</sup></b>	
	Parameter 1	Recipe number (1-999)
	Parameter 2	Data record number (1-65535)
	Parameter 3	-

<sup>1)</sup>	Only for devices supporting recipes.
<sup>2)</sup>	OP 73, OP 77A and TP 177A HMI devices also execute the "Screen selection" job mailbox if the on-screen keyboard is active.
<sup>3)</sup>	The weekday is ignored on HMI device KTP 600 BASIC PN.
<sup>4)</sup>	The weekday is ignored when you configure the "Date/Time PLC" area pointer.

## "Data record" area pointer

## "Data record" area pointer

### Function

When data records are transferred between the HMI device and PLC, both partners access common communications areas on the PLC.

### Data transfer types

There are two ways of transferring data records between the HMI device and PLC:

- Transfer without synchronization
- Transfer with synchronization via the data mailbox

Data records are always transferred directly, which means that the tag values are read straight from an address or written straight to an address configured for this tag without being redirected via an interim memory.

### Initiating the transfer of data records

There are three ways of triggering the transfer:

- Operator input in the recipe view
- Job mailboxes  
The transfer of data records can also be triggered by the PLC.
- Triggering by configured functions

If the transfer of data records is triggered by a configured function or by a job mailbox, the recipe view on the HMI device remains operable. The data records are transferred in the background.

Simultaneous processing of several transfer requests is, however, not possible. In this case, the HMI device rejects the other transfer requests with a system alarm.

### Transfer without synchronization

If you select asynchronous transfer of data records between the HMI device and PLC, there is no coordination over the common data areas. It is therefore unnecessary to set up a data area during configuration.

Asynchronous data record transfer can be a useful alternative, for example when:

- The system is capable of excluding the risk of uncontrolled overwriting of data by the communication peer.
- The PLC does not require information about the recipe number and data record number.
- The transfer of data records is triggered by the operator of the HMI device.

## Reading values

When a read job is triggered, the values are read from the PLC addresses and transferred to the HMI device.

- Triggering by the operator in the recipe view:  
The values are downloaded to the HMI device. You can then, for example, process, edit, or save these values in the HMI device.
- Triggering by a function or job mailbox:  
The values are saved immediately to the data volume.

## Writing values

When a write job is triggered, the values are written to the PLC addresses.

- Triggering by the operator in the recipe view:  
The current values are written to the PLC.
- Triggering by a function or job mailbox:  
The current values are written to the PLC from the data medium.

## Transfer with synchronization

If you select synchronous transfer, both communication partners set status bits in the common data area. You can use this mechanism to prevent uncontrolled overwriting of data in either direction in your control program.

## Application

Synchronous data record transfer can be a useful solution, for example, when:

- The PLC is the "active partner" in the transfer of data records.
- The PLC evaluates the information about the recipe number and data record number.
- The transfer of data records is triggered by means of a Job mailbox.

## Requirements

In order to synchronize transfer of data records between the HMI device and the PLC, the following requirements must be met during configuration:

- An area pointer has been set up: "Communication > Connections" editor in "Area pointer".
- The PLC with which the HMI device synchronizes transfer of data records is specified in the recipe:  
"Recipes" editor in the inspector window the option "Coordinated transfer of data records" under "General > Synchronization > Settings"

### Structure of the data area

The data area has a fixed length of 5 words. Structure of the data area:

	<b>15</b>		<b>0</b>
1. Word	Current recipe number (1 - 999)		
2. Word	Current data record number (0 - 65535)		
3. Word	Reserved		
4. Word	Status (0, 2, 4, 12)		
5. Word	Reserved		

- Status

The status word (word 4) can adopt the following values:

Value		Meaning
Decimal	Binary	
0	0000 0000	Transfer permitted, data mailbox free
2	0000 0010	Transferring
4	0000 0100	Transfer completed without error
12	0000 1100	Transfer completed with error

### Sequence of a transfer triggered by a job mailbox

The transfer of data records between the HMI device and the PLC can be initiated by either one of these stations.

The two job mailboxes No. 69 and No. 70 are available for this type of transfer.

### No. 69: Read data record from PLC ("PLC → DAT")

Job mailbox no. 69 transfers data records from the PLC to the HMI device. The job mailbox is structured as follows:

	Left byte (LB)	Right byte (RB)
Word 1	0	69
Word 2	Recipe number (1-999)	
Word 3	Data record number (1 to 65535)	
Word 4	Do not overwrite existing data record: 0 Overwrite existing data record: 1	

**No. 70: Write data record to PLC ("DAT → PLC")**

Job mailbox No. 70 transfers data records from the HMI device to the PLC. The job mailbox is structured as follows:

	Left byte (LB)	Right byte (RB)
Word 1	0	70
Word 2	Recipe number (1-999)	
Word 3	Data record number (1-65,535)	
Word 4	—	

**Sequence when reading from the PLC with job mailbox "PLC → DAT" (no. 69)**

Step	Action	
1	Check: Status word = 0?	
	Yes	No
2	The HMI device enters the recipe and data record number specified in the job and the status "Transferring" in the data record.	Abort without return message.
3	The HMI device reads the values from the PLC and saves these to the data record defined in the job mailbox.	
4	<ul style="list-style-type: none"> <li>If "Overwrite" was selected in the job, an existing data record is overwritten without any prompt for confirmation. The HMI device sets the status "Transfer completed."</li> <li>If "Do not overwrite" was selected in the job, and the data record already exists, the HMI device aborts the job and enters 0000 1100 in the status word of the data mailbox.</li> </ul>	
5	The control program must reset the status word to zero in order to enable further transfers.	

**Sequence of writing to the PLC with job mailbox "DAT → PLC" (no. 70)**

Step	Action	
1	Check: Status word = 0?	
	Yes	No
2	The HMI device enters the recipe and data record number specified in the job and the status "Transferring" in the data mailbox.	Abort without return message.
3	The HMI device fetches the values of the data record specified in the function from the data medium and writes the values to the PLC.	
4	The HMI device sets the status "Transfer completed."	
5	The control program can now evaluate the transferred data. The control program must reset the status word to zero in order to enable further transfers.	

### Sequence of the transfer when triggered by a configured function

#### Reading from the PLC using a configured function

Step	Action	
1	Check: Status word = 0?	
	Yes	No
2	The HMI device enters the recipe and data record number specified in the function and the status "Transferring" in the data mailbox.	Abort with system event.
3	The HMI device reads the values from the PLC and stores them in the data record specified in the function.	
4	<ul style="list-style-type: none"> <li>• If "Yes" was selected for the "Overwrite" function, an existing data record is overwritten without any prompt for confirmation. The HMI device sets the status "Transfer completed."</li> <li>• If "No" was selected for the "Overwrite" function and the data record already exists, the HMI device aborts the job and enters 0000 1100 in the status word of the data mailbox.</li> </ul>	
5	The control program must reset the status word to zero in order to enable further transfers.	

#### Writing to the PLC by means of configured function

Step	Action	
1	Check: Status word = 0?	
	Yes	No
2	The HMI device enters the recipe and data record number specified in the function and the status "Transferring" in the data mailbox.	Abort with system event.
3	The HMI device fetches the values of the data record specified in the function from the data medium and transfers the values to the PLC.	
4	The HMI device sets the status "Transfer completed."	
5	The control program can now evaluate the transferred data. The control program must reset the status word to zero in order to enable further transfers.	

### Possible causes of error when transferring data records

#### Possible causes of error

The section below shows possible error causes which lead to the cancellation of data record transfer:

- Tag address not set up on the PLC
- Overwriting data records not possible

- Recipe number does not exist
- Data record number does not exist

---

**Note**

The status word may only be set by the HMI device. The PLC may only reset the status word to zero.

---

**Note**

The PLC may only evaluate the recipe and data record numbers when data inconsistency is detected if one of the conditions outlined below has been met:

- The data mailbox status is set to "Transfer completed".
  - The data mailbox status is set to "Transfer completed with error".
- 

### Reaction to an aborted transfer due to errors

If the transfer of data records is aborted due to errors, the HMI device reacts as follows:

- Triggering by the operator in the recipe view  
Information in the status bar of the recipe view and output of system alarms
- Triggered by function  
Output of system alarms
- Triggering by job mailbox  
No return message on the HMI device

You can nonetheless evaluate the status of the transfer by querying the status word in the data record.

## Trends

### General information on trends

#### Trends

A trend is the graphical representation of one or more values from the PLC. The value is read out either time- or bit-triggered, depending on the configuration.

For additional information see:

Displaying tags with Runtime Advanced and Panels (Page 3237)

---

**Note**

The value is read out time-triggered for Basic Panels.

---

### Time-triggered trends

The HMI device reads in the trend values cyclically at an interval specified in the configuration. Time-triggered trends are suitable for continuous curves, such as the operating temperature of a motor.

### Bit-triggered trends

Through a trigger bit set in the trend request tag, the HMI device either reads in a trend value or an entire trend buffer. This setting is defined in the configuration. Bit-triggered trends are normally used to represent fast changing values. One example might be the injection pressure in the production of plastic parts.

To trigger bit-triggered trends, appropriate external tags must be created in the "HMI tags" editor and connected to trend areas during configuration. The HMI device and PLC then communicate with each other via these trend areas.

The following areas are available for trends:

- Trend request area
- Trend transfer area 1
- Trend transfer area 2 (required only with switch buffers)

### Trend request and trend transfer

#### Trend request area

The HMI device sets corresponding bits in the trend request area when you open a screen which contains one or more trends on the HMI device. After closing the screen, the HMI device resets the relevant bits in the trend request area.

The trend request area can be used for evaluation purposes in the PLC to determine which trend is currently being displayed on the HMI device. Trends can also be triggered without evaluation of the trend request area.

#### Trend transfer area 1

This area is used to trigger trends. You must set the bit assigned to the trend in the trend transfer area and set the trend group bit in your control program. The trend group bit is the last bit in the trend transfer area.

The HMI device detects the trigger. The HMI device reads either a value or the entire buffer from the PLC. It then resets the trend bit and the trend group bit.

The following picture shows the structure of a trend transfer area.



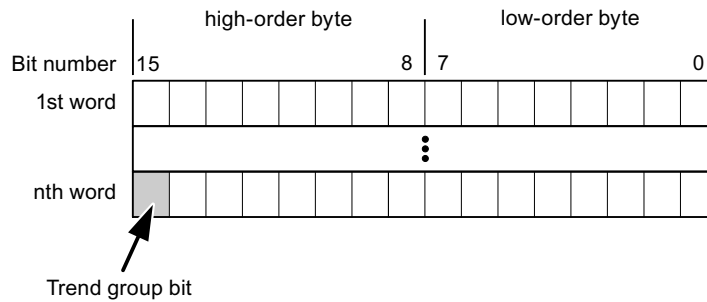

The trend transfer area must not be modified by the PLC program until the trend group bit has been reset.

## Trend transfer area 2

Trend transfer area 2 is required for trends configured with a switch buffer. The trend transfer areas 1 and 2 have a similar structure.

## Switch buffer

The switch buffer is a second buffer for the same trend that can be set up during configuration.

The PLC writes to Buffer 2 while the HMI device reads values from Buffer 1, and writes to Buffer 1 when the HMI device is reading Buffer 2. This prevents the PLC from overwriting trend values while the trend is being read by the HMI device.

## Permitted data types for trends

### For SIMATIC S7

You assign one bit to each trend during configuration. Tags and array tags of the "Word" or "Int" data type are permitted.

## Alarms

### Configuring alarms

#### Configure alarms

Several steps are needed to configure alarms, such as operational messages, error alarms, and acknowledgement.

- Step 1: Create tags
- Step 2: Configure alarms
- Step 3: Configure acknowledgment

You can find additional information in the section:

Configuring Alarms (Page 3261)

**Distinctive features when configuring alarms**

If you are configuring connections of HMI devices to PLCs of other manufacturers, note the following distinctive features when configuring:

- Data types of the tags
- Addressing of tags
- How the bit positions are counted

**Data types**

For connections with a SIMATIC communication driver, the following data types are supported:

PLC	Permitted data types	
	Discrete alarms	Analog alarms
SIMATIC S7 PLCs	WORD, INT	BYTE, CHAR, WORD, INT, DWORD, DINT, REAL, TIMER

**How the bit positions are counted**

For connections with a SIMATIC communication driver, the following counting method applies:

How the bit positions are counted	Byte 0								Byte 1								
	Most significant byte								Least significant byte								
In SIMATIC S7 PLCs	7							0	7								0
In WinCC you configure:	15							8	7								0

**Acknowledgment of alarms**

**Procedure**

Create suitable tags on the PLC to acknowledge an error alarm. You assign these tags to an alarm in the "Bit messages" editor. You make the assignment in "Properties > Acknowledgment".

Distinction in terms of acknowledgment:

- Acknowledgment by the PLC
- Acknowledgment on the HMI device

## Acknowledgment by the PLC

In "PLC acknowledgment tag", configure the tag or array tag and the bit number that the HMI device uses to identify a PLC acknowledgment.

A bit set in the tag triggers acknowledgment of the assigned error alarm bit at the HMI device. This tag bit returns a function similar to acknowledgment on the HMI device which is triggered by pressing the "ACK" button, for example.

The acknowledgment bit must be located in the same tag as the bit for the error alarm.

Reset the acknowledgment bit before setting the bit in the alarm area again. The figure below shows the pulse diagram.

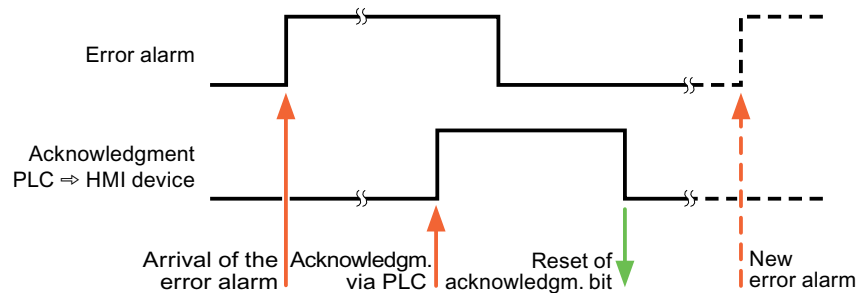

## Acknowledgment on the HMI device

In the "HMI acknowledgment tag" area, configure the tag or array tag as well as the bit number that the HMI device writes to the PLC after acknowledgment. Make sure when you use an array tag that it is not longer than 6 words.

To always create a signal change when setting an assigned acknowledgment bit of a discrete alarm that must be acknowledged, the HMI device will reset the acknowledgment bit assigned to the alarm as soon as it detects an alarm subject to acknowledgment and write the acknowledgment tag in the PLC. There will be a certain delay between detecting the message and writing the acknowledgment tag in the PLC because the HMI device has to process the operations.

If a discrete alarm subject to acknowledgment is acknowledged by the HMI device, then the corresponding bit in the assigned acknowledgment tag will be set. The entire acknowledgment tag is then written to the PLC by the HMI device. This allows the PLC to recognize that a certain alarm message has been acknowledged at the HMI device.

---

### Note

All alarm bits acknowledged since the last Runtime start will remain in the acknowledgment tag until a new incoming of the respective discrete alarms is detected.

This area should only be read by the PLC because the entire section of the HMI device will be overwritten once the next acknowledgment tag is written.

---

The figure below shows the pulse diagram.

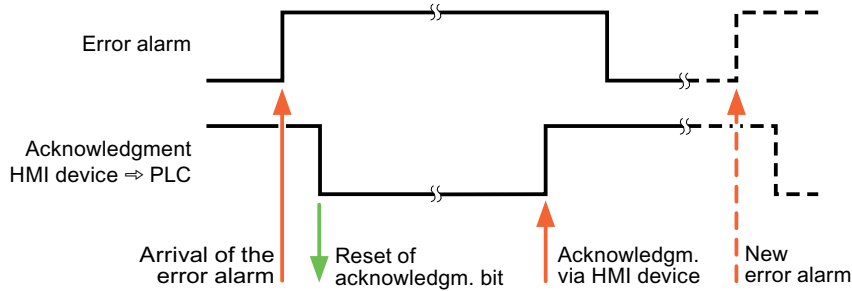

## LED mapping

### Function

Keyboard devices have LEDs in the function keys. These LEDs can be activated from the PLC. Thus, it is possible, for example, to signal to the user which key he should press in a given situation by lighting up an LED.

#### Note

The LED function cannot be configured for Basic Panels.

### Requirements

In order to activate an LED, an LED tag or an array tag must be set up in the PLC and specified as an LED tag during configuration.

### LED assignment

The assignment of the individual LEDs to the bits in the LED tags is specified when the function keys are configured. In this process, the "LED tag" and the assigned "Bit" are specified for each function key in the "General" group of the properties window.

The "Bit" bit number designates the first of two consecutive bits that control the following LED statuses.

Bit n+ 1	Bit n	LED function	
		All Mobile Panels, all Operator Panels, all Multi Panels	Panel PCs:
0	0	Off	Off
0	1	Rapid flashing	Flashing
1	0	Slow flashing	Flashing
1	1	On permanently	On permanently

### 10.11.6.5 Performance features of communication

#### S7-1500 device dependency

##### Device dependency

If you use devices from an earlier version of the TIA Portal with TIA Portal V12 SP1, it may not be possible to configure connections to certain HMI devices.

You can configure the SIMATIC S7-1500 controller with version V1.0 in the following scenarios:

TIA Portal	Basic Panels	Panels	Comfort Panels	RT Advanced
V11	No	No	Yes	No
V12	Yes	Yes	Yes	Yes

#### Valid data types for SIMATIC S7 1500

##### Valid data types for connections with SIMATIC S7 1500

The table lists the data types that can be used when configuring tags and area pointers.

Data type	Length
BOOL	1 bit
BYTE	1 byte
WORD	2 bytes
DWORD	4 bytes
CHAR	1 byte
INT	2 bytes
DINT	4 bytes
REAL	4 bytes
TIME	4 bytes
DATE	2 bytes
TIME_OF_DAY	4 bytes
S5TIME	2 bytes
COUNTER	2 bytes
TIMER	2 bytes
DATE_AND_TIME	8 bytes
STRING	(2+n) bytes, n = 0 to 254
DTL	12 bytes
LDT	8 bytes
LINT	8 bytes
LREAL	8 bytes
LTIME	8 bytes

Data type	Length
LTIME_OF_DAY	8 bytes
SINT	1 byte
UDINT	4 bytes
UINT	2 bytes
ULINT	8 bytes
USINT	1 byte

### 10.11.6.6 Configuring connections in the "Connections" editor

#### Creating a PROFINET connection

##### Requirements

- A project is open.
- An HMI device with a PROFINET interface has been created.

##### Procedure

1. Open the "Connections" editor of the HMI device.
2. Double-click "<Add>".

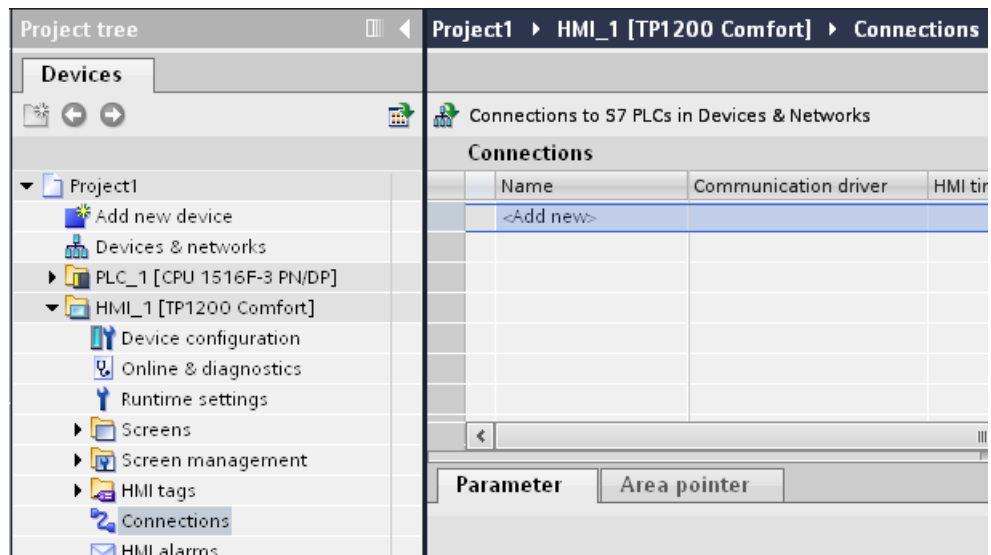

3. Select the driver in the "Communication driver" column.

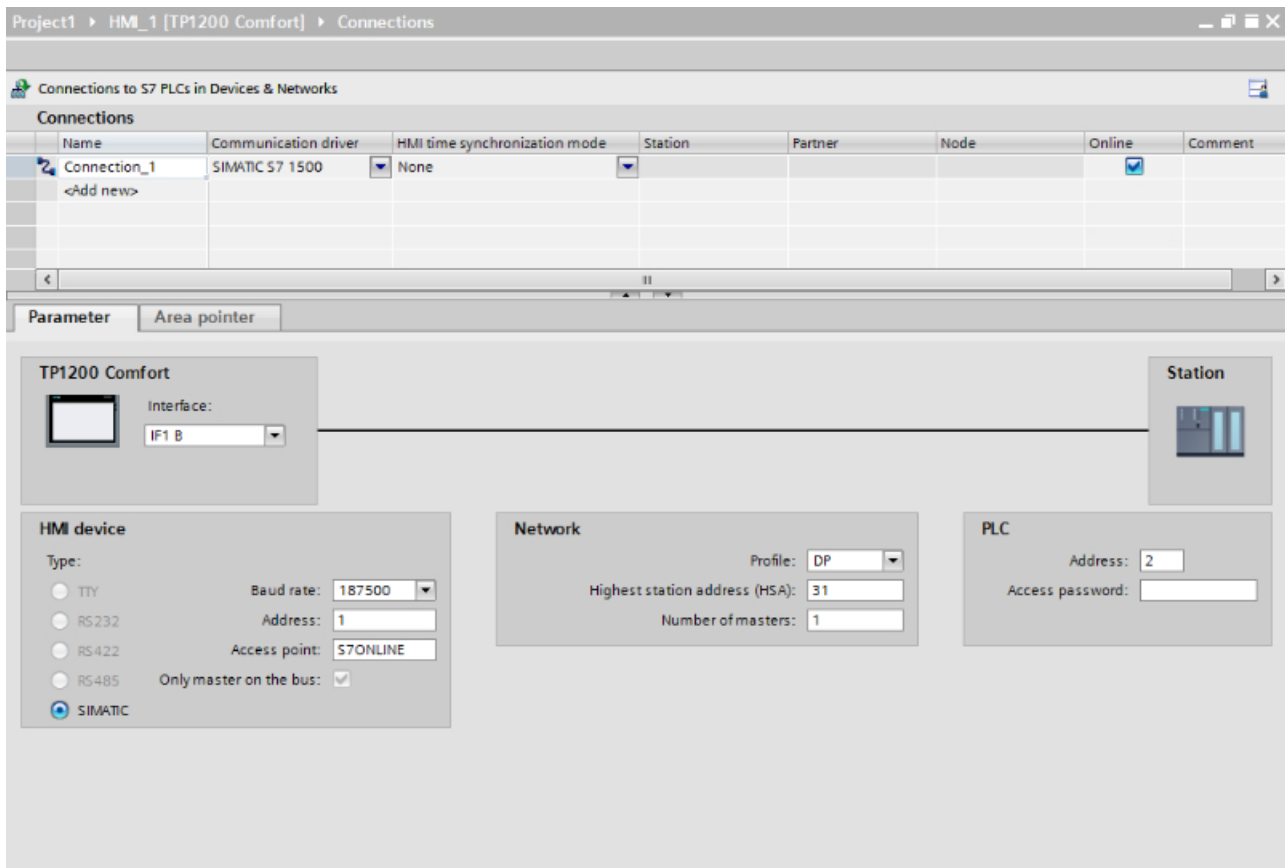

4. Click the name of the connection.
5. Select a PROFINET interface of the HMI device in the Inspector window under "Parameters > Interface".
6. Set the IP addresses of the communication partners in the Inspector window:
  - HMI device: "Parameters > HMI device > Address"
  - PLC: "Parameters > PLC > Address"

## Creating a PROFIBUS connection

### Requirements

- A project is open.
- An HMI device with a PROFIBUS interface has been created.

### Procedure

1. Open the "Connections" editor of the HMI device.
2. Double-click "<Add>".

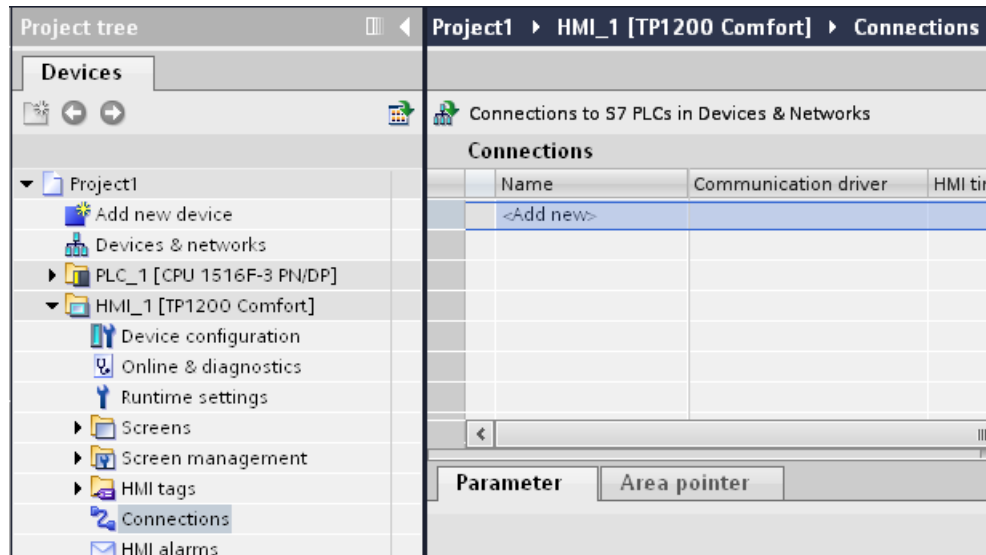

3. Select the driver in the "Communication driver" column.
4. Click the name of the connection.
5. Select the "IF 1 B" interface from "Parameters > interface" in the Inspector window.



6. Select the "DP" profile in the Inspector window under "Parameters > Network".

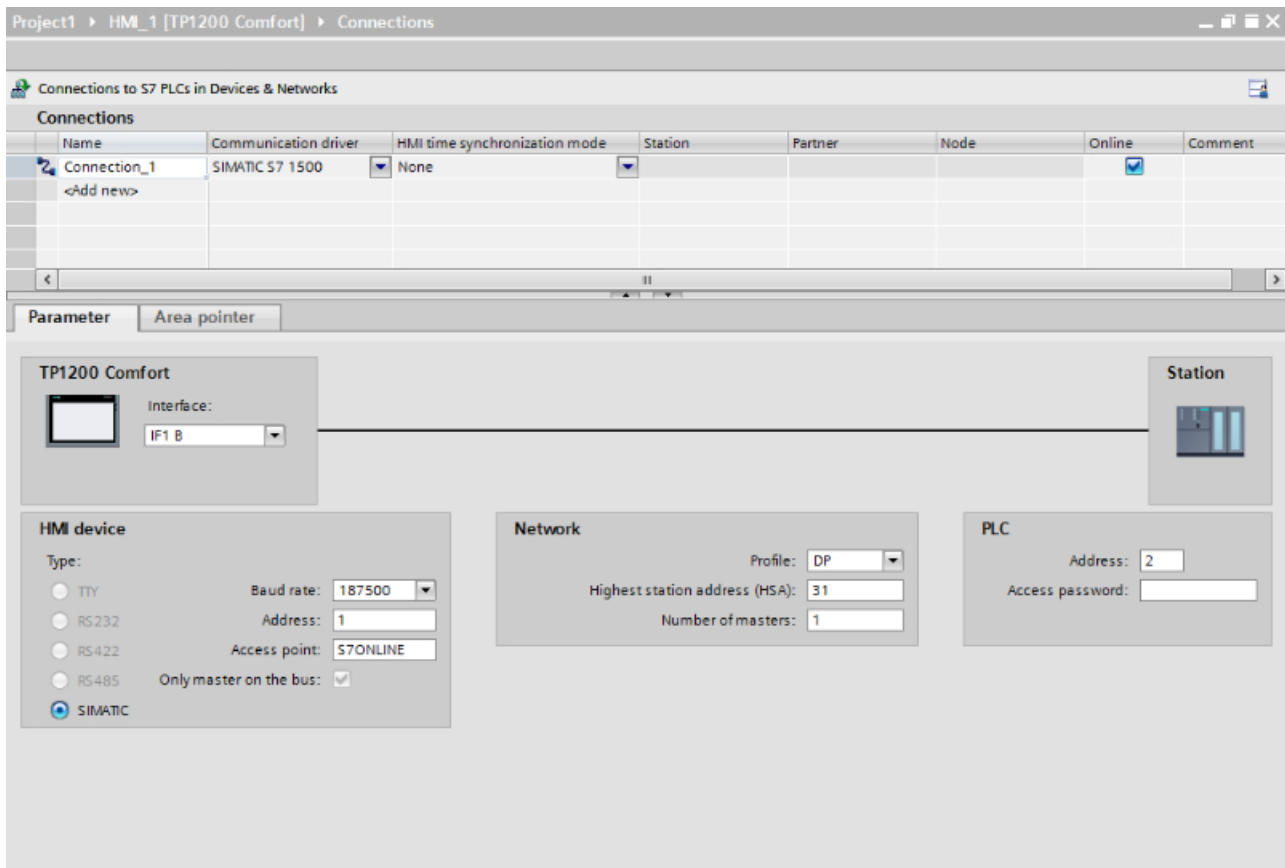

7. Set the addresses of the communication partners in the inspector window:

- HMI device: "Parameters > HMI device > Address"
- PLC: "Parameters > PLC > Address"

## Connection parameters

## Connection parameters

### Parameters to be set

To set the connection parameters, such as addresses and profiles, click the connection that you have created in the "Connections" editor.

The communication partners are displayed schematically in the Inspector window under "Parameters". The "HMI device", "Network", and "PLC" areas are available for assigning parameters according to the interface used.

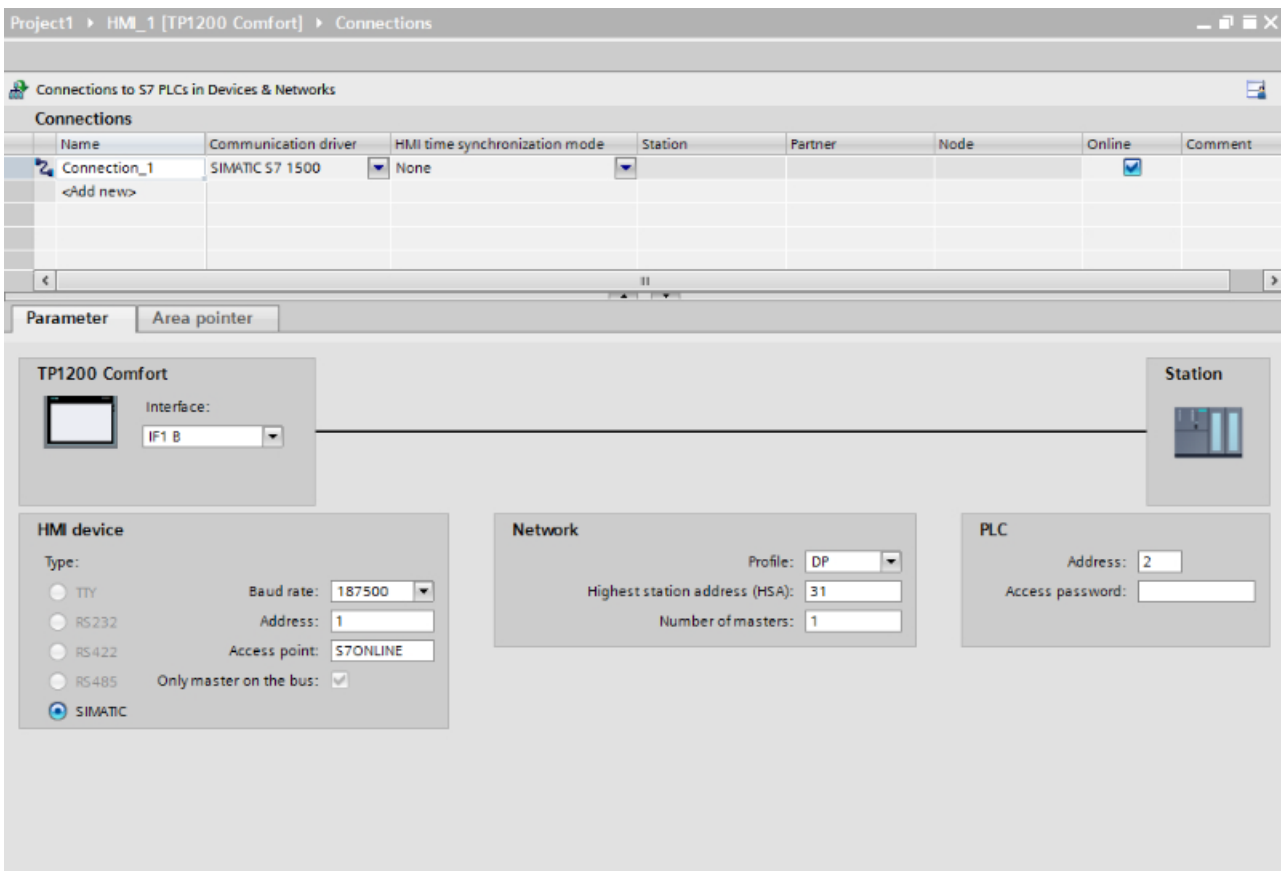

## PROFIBUS parameters

### Parameters for the HMI device

You assign the parameters for the HMI device in the network once under "HMI device". The change applies to each communication partner.

- "Type"  
Specifies the physical connection used.
- "Interface"  
For "Interface", you select the HMI device interface via which the HMI device is connected to the PROFIBUS network.
- "Baud rate"  
For "Baud rate", you set the transmission speed of the data in the network. The baud rate is determined by the slowest HMI device connected to the network. The setting must be identical throughout the network.

---

#### Note

If you set a baud rate of 1.5 Mbaud for OP 73 or OP 77A, the highest station address must be less than or equal to 63.

---

- "Address"  
You set the PROFIBUS address of the HMI device under "Address". The PROFIBUS address must be unique in the PROFIBUS network.
- "Sole master on bus"  
Disables an additional safety feature against bus faults when the HMI device is connected to the network. A passive station (slave) can only send data if it is requested to do so by an active station (master).  
In S7 200, you must set an HMI device as the master.
- "Access point"  
The access point defines a logical device name through which the communication partner can be reached.

### Parameters for the network

Under "Network", you set the parameters for the PROFIBUS network to which the HMI device is linked.

- "Profile"  
For "Profile", you select the network profile that is used in the network. In "Profile", set "DP", "Universal", or "Standard". The setting must be identical throughout the network.
- "Highest address"  
For "Highest station address", set the highest station address. The highest station address must be greater than or equal to the highest actual PROFIBUS address. The setting must be identical throughout the network.

---

#### Note

If you set a baud rate of 1.5 Mbaud in the OP 73 or the OP 77A, the highest station address must be less than or equal 63.

---

- "Number of masters"  
For "Number of masters", set the number of masters in the PROFIBUS network. This information is necessary to correctly calculate the bus parameters.

## Parameters for the PLC

Under "PLC", you address the S7 module with which the HMI device will exchange data. Assign a name for the connection for each communication partner.

- "Address"  
For "Address", set the PROFIBUS address of the S7 module (CPU, FM, or CP) to which the HMI device is connected.
- "Access password"  
Enter a password in the "Access password" field. This password must match the one you saved to the PLC.

---

### Note

You only need a password if you have set "Complete protection" at the PLC.

No connection is set up to the PLC if the "Complete protection" security level is stored on the PLC and you do not enter a password.

---

## Ethernet parameters

### Parameters for the HMI device

You set the parameters for the HMI device in the network under "HMI device".. The changes are not transferred automatically to the HMI device. You must change the settings in the Control Panel of the HMI device.

- "Interface"  
If you are directly connected to the HMI device during configuration, you can set up the IP address of the HMI device in WinCC.

---

### Note

The IP address in the Control Panel will be overwritten upon subsequent loading if you have already set up the IP address in the HMI device control panel.

The IP address already set up in the Control Panel will be retained upon subsequent loading if you activate "Set IP address using a different method".

---

The IP address is transferred to the HMI device during project transfer.

To set up the IP address of the HMI device:

- Click the HMI device.
- Open the "Device configuration" editor.
- Click the Ethernet interface.
- Assign the IP address in the inspector window under:

"General > PROFINET interface > Ethernet addresses"

- "Address"  
You assign the IP address of the HMI device in the "Address" area.  
When you transfer the WinCC project to the HMI device, this IP address is set up directly in the HMI device.
- "Access point"  
Specifies the access point for the PG/PC interface that can be used to reach the communication partner.

### Parameters for the PLC

Under "PLC", you address the S7 module with which the HMI device will exchange data. Assign a name for the connection for each communication partner.

- "Address"  
Under "Address", set the IP address of the S7 module to which the HMI device is connected.
- "Access password"  
Enter a password in the "Access password" field. This password must match the one you saved to the PLC.

---

#### Note

You only need a password if you have set "Complete protection" at the PLC.

No connection is set up to the PLC if the "Complete protection" security level is stored on the PLC and you do not enter a password.

---

### 10.11.6.7 Configuring connections in the "Connections" editor

#### Creating a connection

#### Requirements

- A project is open.
- WinCC RT Advanced is created.

## Procedure

1. Open the "Connections" editor of the HMI device.
2. Double-click "<Add>".

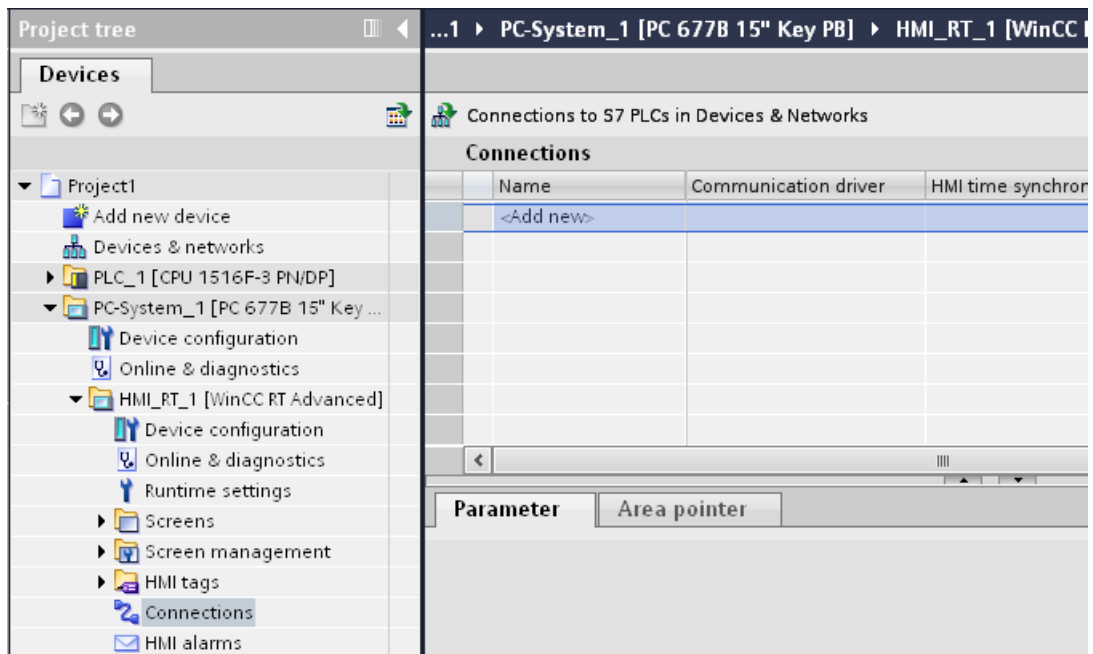

3. Select the driver in the "Communication driver" column.
4. Click the name of the connection.
5. Select an interface of the HMI device in the Inspector window under "Parameters > Interface".
6. Set the parameters for the connection in the Inspector window.

## Interfaces

Select one of the following interfaces in the Inspector window under "Parameters > WinCC RT Advanced > Interfaces".:

- Industrial Ethernet
- MPI
- PROFIBUS
- PLC slot
- Soft PLC
- TCP/IP

For additional information on the parameters of the interfaces see:

Connection parameters (Page 5041)

## Connection parameters

### ETHERNET

#### Introduction

You assign the parameters for the HMI device and the controller in the network under "Parameters".

The parameters described in the following apply to the following interfaces:

- TCP/IP

The screenshot displays the 'Connections' configuration window in WinCC RT Advanced. The window title is 'Project1 > PC-System\_1 [SIMATIC PC station] > HMI\_RT\_2 [WinCC RT Advanced] > Connections'. The main area shows a table of connections to S7 PLCs. The table has columns for Name, Communication driver, HMI time synchronization mode, Station, Partner, and Node. One connection is listed: 'Connection\_2' with a 'SIMATIC S7 1500' driver and 'None' synchronization mode. Below the table, there are tabs for 'Parameter' and 'Area pointer'. The 'Parameter' tab is active, showing configuration for 'WinCC RT Advanced' (Interface: ETHERNET), 'HMI device' (Address: 192.168.0.2, Access point: S7ONLINE), and 'PLC' (Address: 192.168.0.1, Access password: empty). A 'Station' icon is also visible.

Name	Communication driver	HMI time synchronization mode	Station	Partner	Node
Connection_2	SIMATIC S7 1500	None			
<Add new>					

Parameter | Area pointer

WinCC RT Advanced  
Interface: ETHERNET

Station

HMI device  
Address: 192.168.0.2  
Access point: S7ONLINE

PLC  
Address: 192.168.0.1  
Access password:

#### HMI device

- "Address"  
Enter the IP address of the HMI device under "Address".
- "Access point"  
Specifies the access point for the PG/PC interface that can be used to reach the communication partner.

## Controller

- "Address"  
Enter the IP address of the controller under "Address".
- "Access password"  
Enter a password in the "Access password" field. This password must match the one you saved to the controller.

---

### Note

You only need a password if you have set the "Complete protection" protection level at the controller.

No connection to the controller is established if the "Complete protection" protection level is stored on the controller and you do not enter a password.

---

## MPI/DP

### Introduction

You assign the parameters for the HMI device and the controller in the network under "Parameters".

The parameters described in the following apply to the following interfaces:



- PROFIBUS

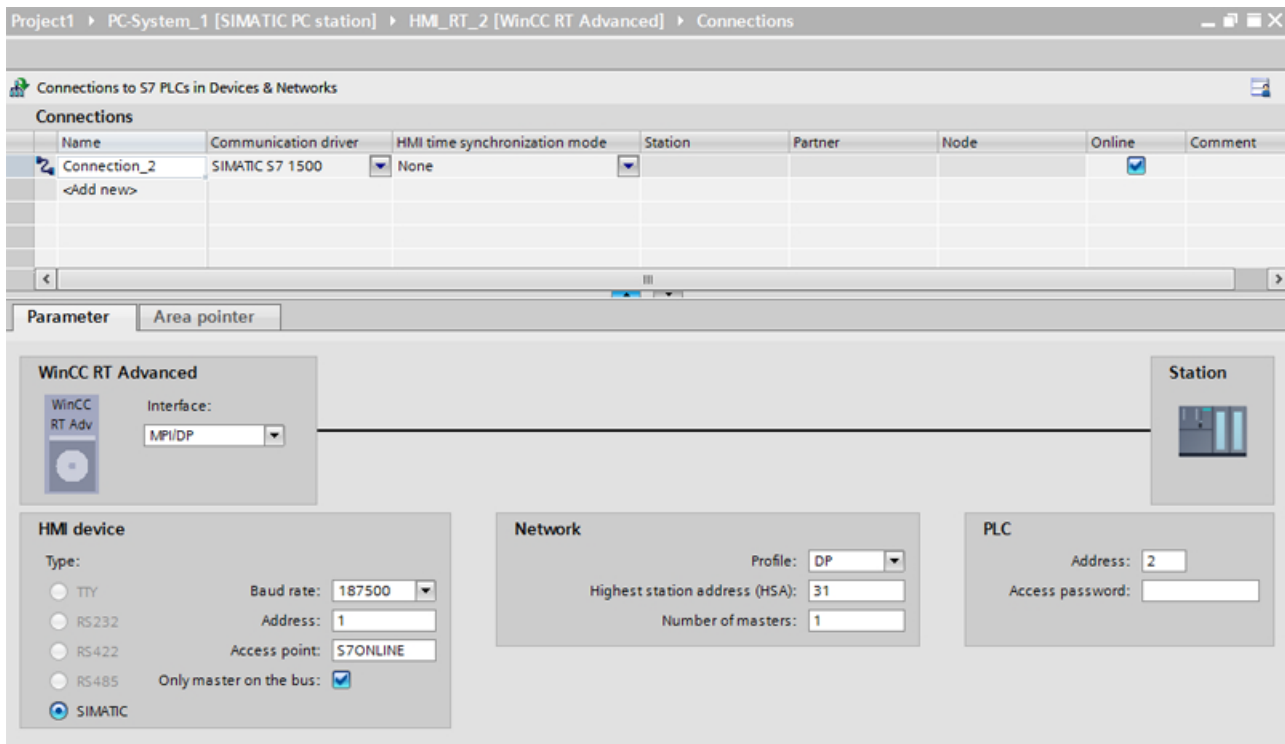

### HMI device

- "Baud rate"  
Select the baud rate of the HMI device under "Baud rate".
- "Address"  
Enter the address of the HMI device under "Address".
- "Access point"  
Enter the logical device name under "Access point".

### Controller

- "Address"  
Enter the address of the controller under "Address".
- "Access password"  
If you have configured the degree of protection "Complete protection" for the controller, enter the password for the controller under "Access password".

### 10.11.6.8 Configuring time synchronization

#### Time synchronization

##### Introduction

To have the same time of day throughout the plant, you can synchronize the time on various plant components using time synchronization. WinCC time synchronization is operated as a master-slave system.

One system component must be a clock for all components of a plant to work with identical time. The component functioning as the clock is referred to as the time master. The components that receive the time are time slaves.

##### Properties of time synchronization

- The HMI device can define the time as master or can accept the time of the PLC as slave.
- In "master mode", the time is synchronized at each connection setup.
- In "slave mode", the time is synchronized at each connection setup and then at cyclic intervals of 10 minutes.
- The first time synchronization is performed on the HMI device immediately after the start of runtime.
- Time synchronization is only performed on the HMI device during operation of runtime.

##### Time synchronization restrictions

##### Approved HMI devices

You can configure the time synchronization between a SIMATIC S7 1200 or SIMATIC S7 1500 and an HMI device with the following HMI devices:

Device	Operating system
Basic Panels	-
TP177 4"	Windows CE 5.0
Multi Panel 177	Windows CE 5.0
Multi Panel 277	Windows CE 5.0
Multi Panel 377	Windows CE 5.0
Mobile Panel 277	Windows CE 5.0
Mobile 277 IWLAN V2	Windows CE 5.0
Comfort Panels	Windows CE 6.0
PC systems with WinCC RT Advanced	Microsoft Windows XP Microsoft Windows 7

## Configuration restrictions

- If an HMI device has several connections to SIMATIC S7 1200 or SIMATIC S7 1500, you can only configure one connection as "slave".
- If you have enabled time synchronization for the HMI device as "slave", you can no longer use the global area pointer "Date/time PLC".
- An HMI device can only request the time from a PLC with "Complete protection" security type configuration if the correct "Access password" is configured.  
Configure the "Access password" for communication with a PLC with "Complete protection" security type in the "Connections" editor of the HMI device.  
This "Access password" must match the password configured on the PLC. The PLC password is assigned in the PLC properties at: "General > Security"
- Basic Panels can only be configured as "Slave".
- If you use Basic Panels for the configuration, it is not possible to use time synchronization via NTP and the "Date/time PLC" area pointer simultaneously.

## Configuring time synchronization for integrated connections

### Introduction

You configure time synchronization for an integrated connection in the "Devices & Networks" editor.

### Requirements

- An HMI connection between an HMI device and a SIMATIC S7 1200 or SIMATIC S7 1500 has been configured.
- The HMI device must support the "time synchronization" function.
- The "Devices & Networks" editor is open.

## Procedure

1. Click the line of the HMI connection in the "Devices & networks" editor.
2. Select the following in the inspector window under "General > Time synchronization > Settings":
  - None: No time synchronization is used.
  - Master: The HMI device sets the time.
  - Slave: The PLC sets the time.

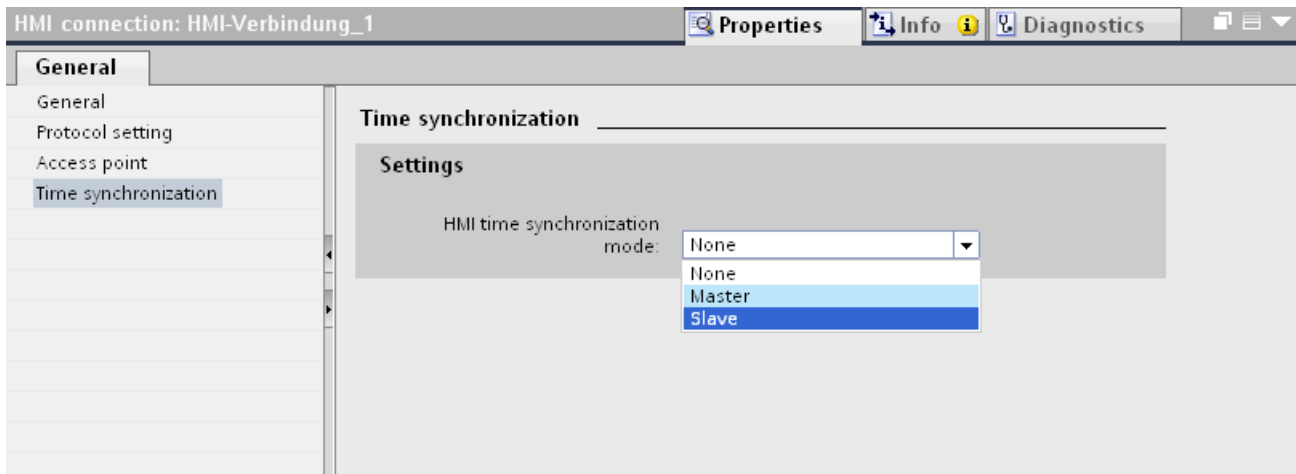

## Configuring time synchronization for non-integrated connections

### Introduction

You configure time synchronization for a non-integrated connection in the "Connections" editor.

### Requirements

- An HMI device which supports the "time synchronization" function has been created.
- "Connections" editor is open.

## Procedure

1. Double-click "<Add>".
2. In the "Communication drivers" column, select the "SIMATIC S7 1200" PLC.
3. Select the following in the "HMI time synchronization mode" column:
  - None: No time synchronization is used.
  - Master: The HMI device sets the time.
  - Slave: The PLC sets the time.

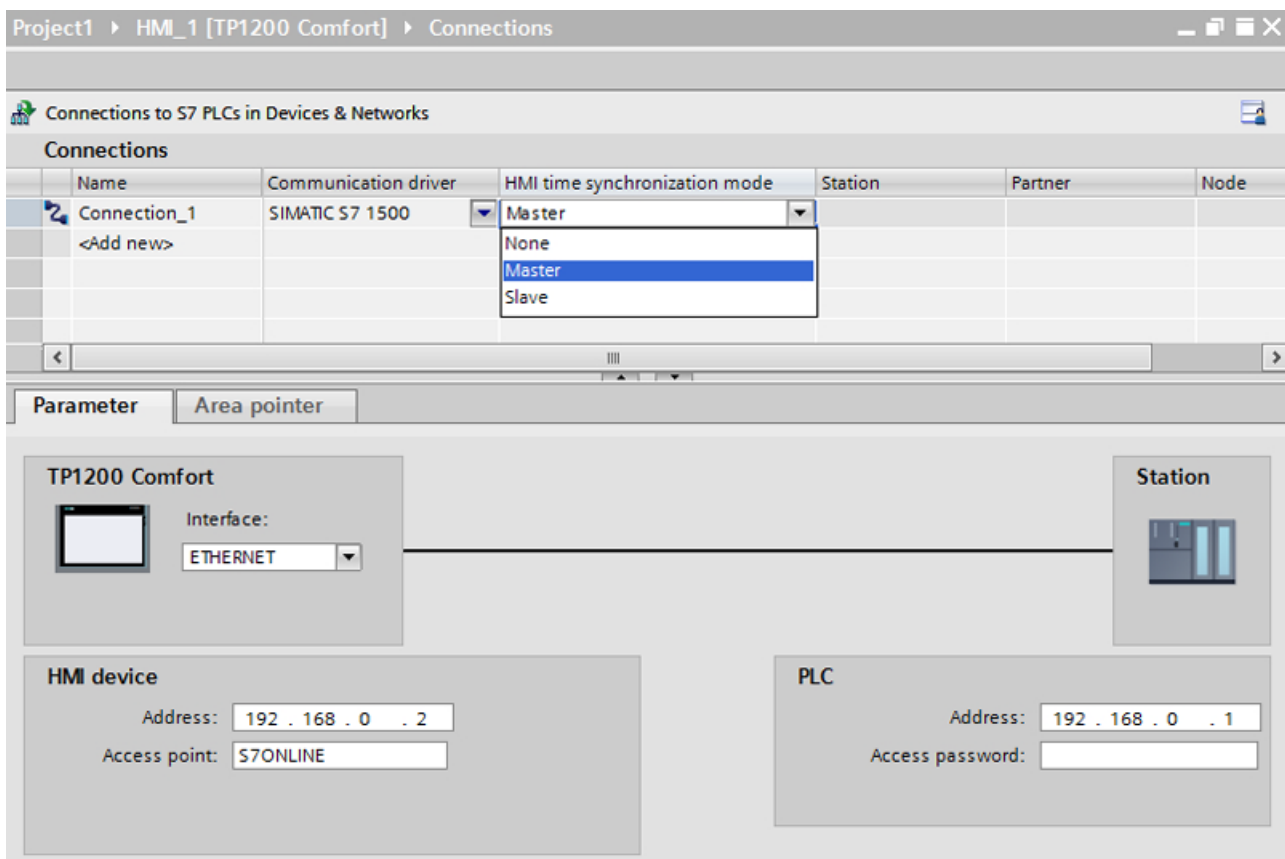

## 10.11.7 Communicating with SIMATIC S7 1200

### 10.11.7.1 Communication with SIMATIC S7 1200

#### Introduction

This section describes the communication between an HMI device and the SIMATIC S7 1200 PLC.

You can configure the following communication channels for the SIMATIC S7 1200 PLC:

- PROFINET
- PROFIBUS

### HMI connection for communication

You configure connections between the HMI device and a SIMATIC S7 1200 in the "Devices & Networks" editor. If you have configured a HMI device with a serial port, you must configure a PROFIBUS-capable communication module to the SIMATIC S7 1200.

#### 10.11.7.2 Communication via PROFINET

##### Configuring an HMI connection

##### Communication via PROFINET

##### HMI connections via PROFINET

If you have inserted an HMI device and a SIMATIC S7 1200 into the project, you interconnect the two PROFINET interfaces in the "Devices & Networks" editor.

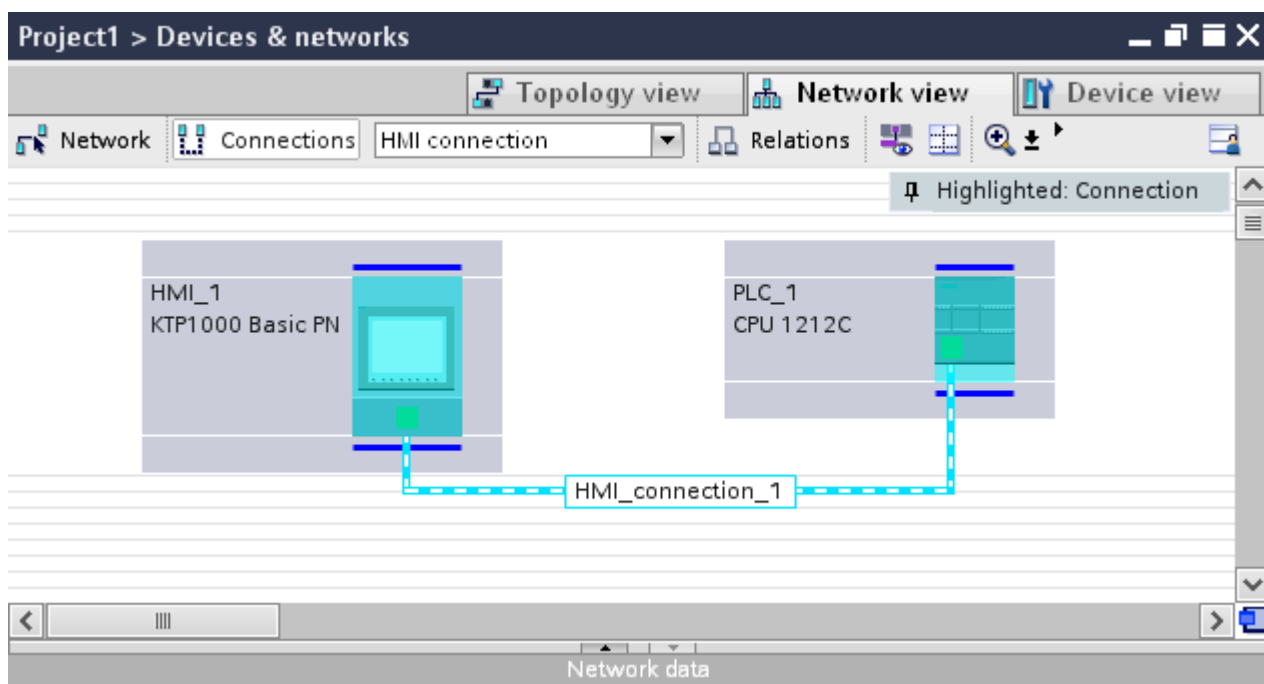

You can also connect multiple HMI devices to one SIMATIC S7 1200 and multiple SIMATIC S7 1200s to one HMI device. The maximum number of communication partners that you can connect to an HMI device is dependent on the HMI device used.

Additional information is available in the documentation for the respective HMI device.

## HMI connection in the "Devices & Networks" editor

You configure the HMI connection between the PLC and the HMI device via PROFINET in the "Devices & Networks" editor.

## Connection in the "Connections" editor

Alternatively, you configure the connection between the PLC and HMI device via PROFINET in the "Connections" editor of the HMI device.

## Configuring an HMI connection via PROFINET

### Introduction

You configure an HMI connection between HMI devices and a SIMATIC S7 1200 via PROFINET or Ethernet in the "Devices & Networks" editor.



### CAUTION

#### Communication via Ethernet

In Ethernet-based communication, the end user is responsible for the security of his data network.

Targeted attacks can overload the device and interfere with proper functioning.

## Requirements

The following communication partners are created in the "Devices & Networks" editor:

- SIMATIC S7 1200
- HMI device with PROFINET or Ethernet interface

## Procedure

1. Double-click the "Devices & Networks" item in the project tree.  
The available communication partners in the project are displayed graphically in the network view.
2. Click the "Connections" button and select "HMI connection" for the connection type.  
The devices available for connection are highlighted in color.

3. Click the PROFINET interface of the PLC and use a drag-and-drop operation to draw a connection to the PROFINET or Ethernet interface of the HMI device.

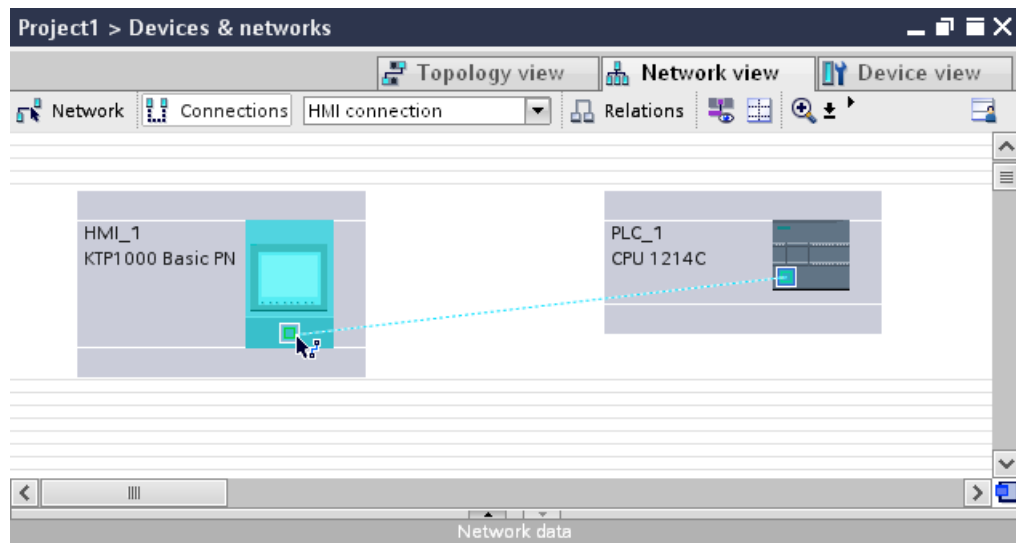

4. Click the connecting line.
5. Click "Highlight HMI connection" and select the HMI connection.

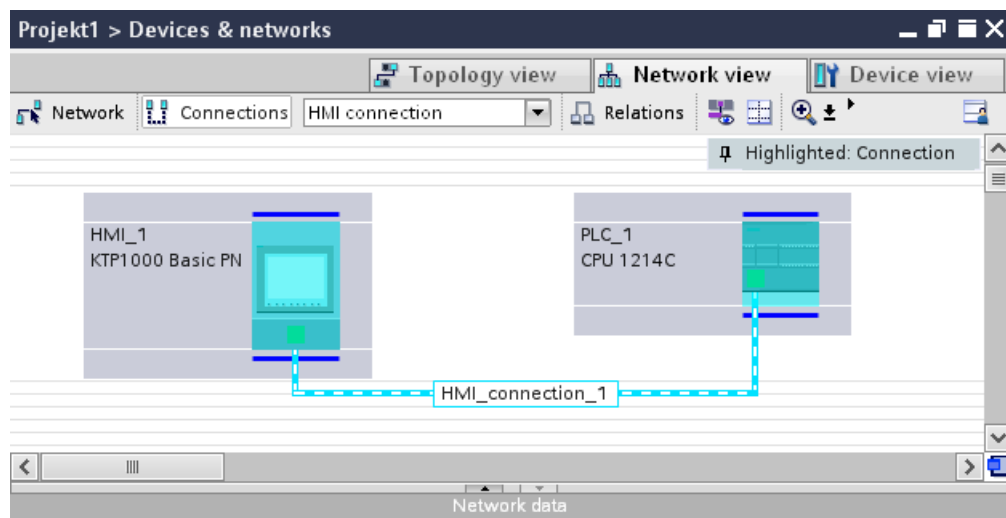

The connection is displayed graphically in the Inspector window.

6. Click the communication partners in the "Network view" and change the PROFINET parameters in the Inspector window according to the requirements of your project. See the chapter "PROFINET parameters (Page 5057)" for additional details.

#### Note

The created HMI connection is also shown in the tabular area of the editor on the "Connections" tab. You check the connection parameters in the table.

You can change the local name for the connection only in the table.



## **Result**

You have created a connection between an HMI device and a SIMATIC S7 1200. The IP address and subnet mask connection parameters are configured.

## **Configuring an HMI connection**

### **Communication via PROFINET**

### **Communication via PROFINET**

This section describes the communication between a WinCC Runtime and the SIMATIC S7 1200 PLC via PROFINET.

You can use the following WinCC Runtimes as an HMI device:

- WinCC RT Advanced

### **WinCC Runtime as HMI device**

You configure the HMI connections between WinCC Runtime and SIMATIC S7 1200 in the "Devices & Networks" editor.

If you want to use a WinCC Runtime as an HMI device, you have the following options:

1. You create a SIMATIC PC and configure a WinCC Runtime on this SIMATIC PC. In this way you use the SIMATIC PC with a WinCC Runtime as an HMI device.

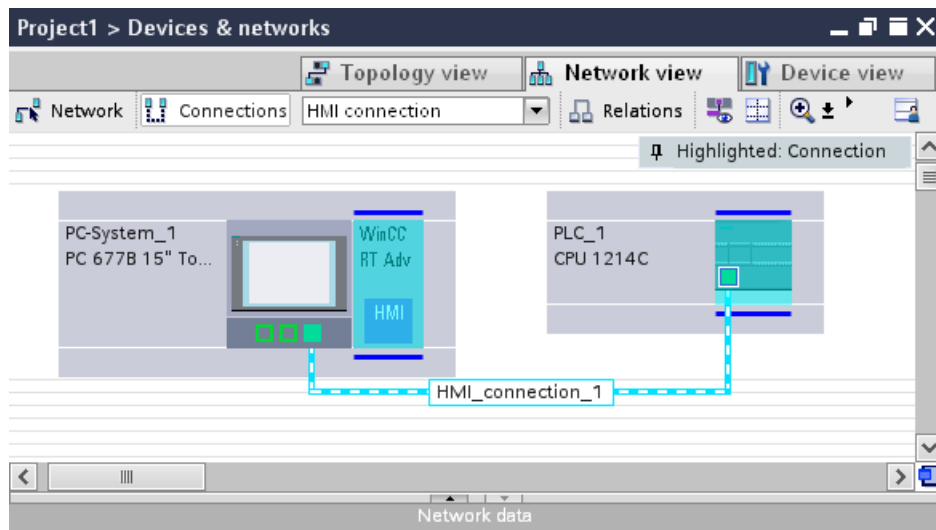

2. You create a Runtime and configure a communication processor to the Runtime. In this way you use your configuration PC as an HMI device.

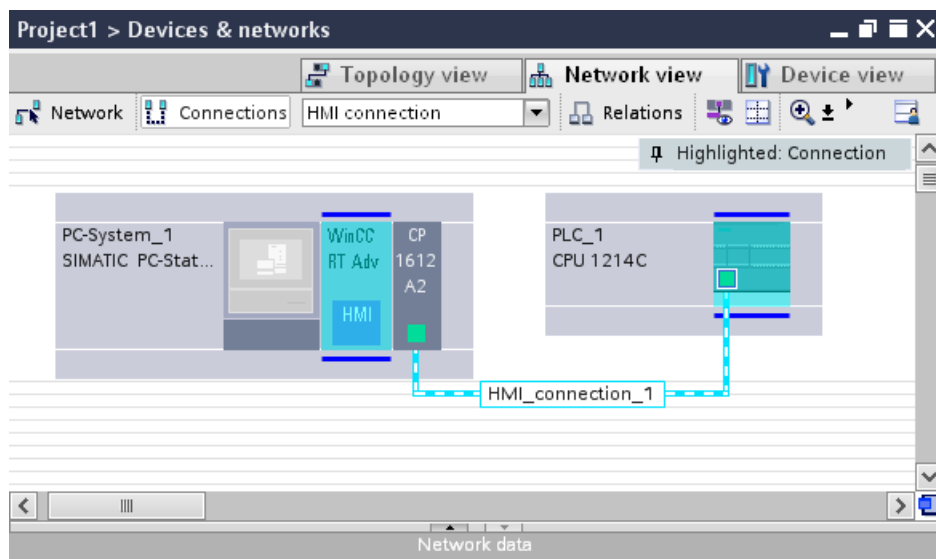

You can also connect multiple HMI devices to one SIMATIC S7 1200 and multiple SIMATIC S7 1200s to one HMI device. The maximum number of communication partners that you can connect to an HMI device is dependent on the HMI device used.

Additional information is available in the documentation for the respective HMI device.

### HMI connection in the "Devices & Networks" editor

You configure the HMI connection between the PLC and the HMI device via PROFINET in the "Devices & Networks" editor.

## Connection in the "Connections" editor

Alternatively, you configure the connection between the PLC and HMI device via PROFINET in the "Connections" editor of the HMI device.

## Configuring an HMI connection via PROFINET with a SIMATIC PC

### Introduction

You configure an HMI connection between HMI devices and a SIMATIC S7 1200 via PROFINET or Ethernet in the "Devices & Networks" editor.

 **CAUTION**

**Communication via Ethernet**

In Ethernet-based communication, the end user is responsible for the security of his data network.

Targeted attacks can overload the device and interfere with proper functioning.

### Requirements

The following communication partners are created in the "Devices & Networks" editor:

- SIMATIC S7 1200
- SIMATIC PC with PROFINET interface

### Procedure

1. Double-click the "Devices & Networks" item in the project tree.  
The available communication partners in the project are displayed in the network view.
2. Use a drag-and-drop operation to move a WinCC Runtime from the hardware catalog to the PC.

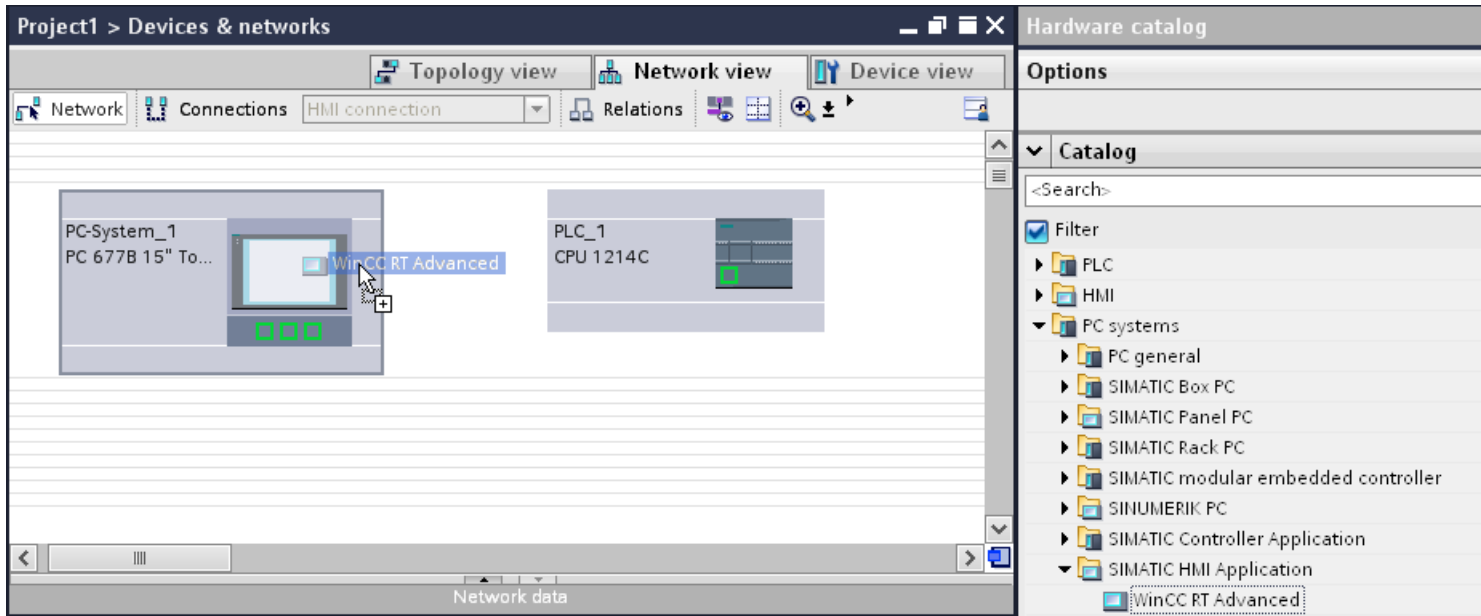

3. Click the "Connections" button and select "HMI connection" for the connection type.  
The devices available for connection are highlighted in color.
4. Click the PROFINET interface of the PLC and use a drag-and-drop operation to draw a connection to the PROFINET interface of the PC.

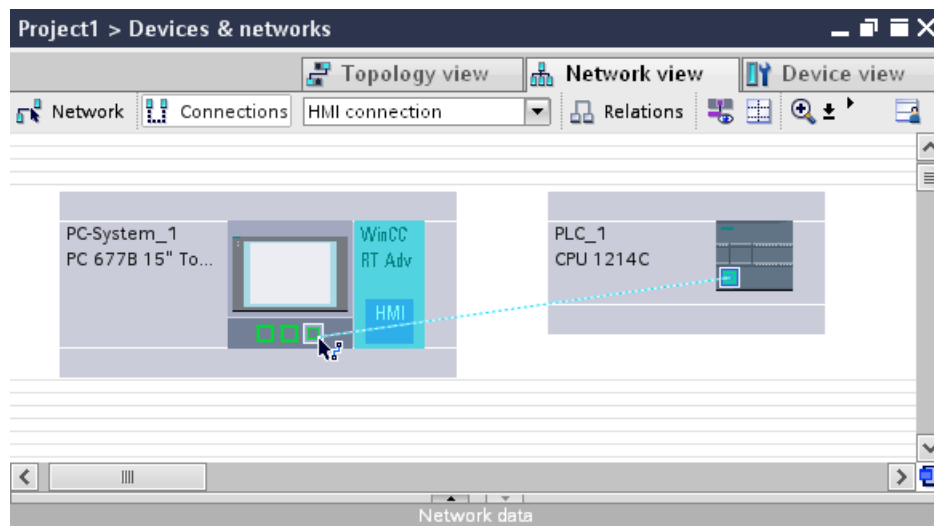

5. Click the connecting line.

6. Click "Highlight HMI connection" and select the HMI connection.  
The connection is displayed graphically in the Inspector window.
7. Click the communication partners in the "Network view" and change the PROFINET parameters in the Inspector window according to the requirements of your project.  
See the chapter "PROFINET parameters (Page 5057)" for additional details.

---

**Note**

The created HMI connection is also shown in the tabular area of the editor on the "Connections" tab. You check the connection parameters in the table.

You can change the local name for the connection only in the table.

---

## Result

You have created a connection between an HMI device and a SIMATIC S7 1200. The IP address and subnet mask connection parameters are configured.

## Configuring an HMI connection via PROFINET with a PC

### Introduction

You configure an HMI connection between HMI devices and a SIMATIC S7 1200 via PROFINET or Ethernet in the "Devices & Networks" editor.



**CAUTION**

**Communication via Ethernet**

In Ethernet-based communication, the end user is responsible for the security of his data network.

Targeted attacks can overload the device and interfere with proper functioning.

### Requirements

The following communication partners are created in the "Devices & Networks" editor:

- SIMATIC S7 1200
- PC station with WinCC RT Advanced

### Procedure

1. Double-click the "Devices & Networks" item in the project tree.  
The available communication partners in the project are displayed in the network view.
2. Use a drag-and-drop operation to move a communication processor from the hardware catalog to the WinCC Runtime.

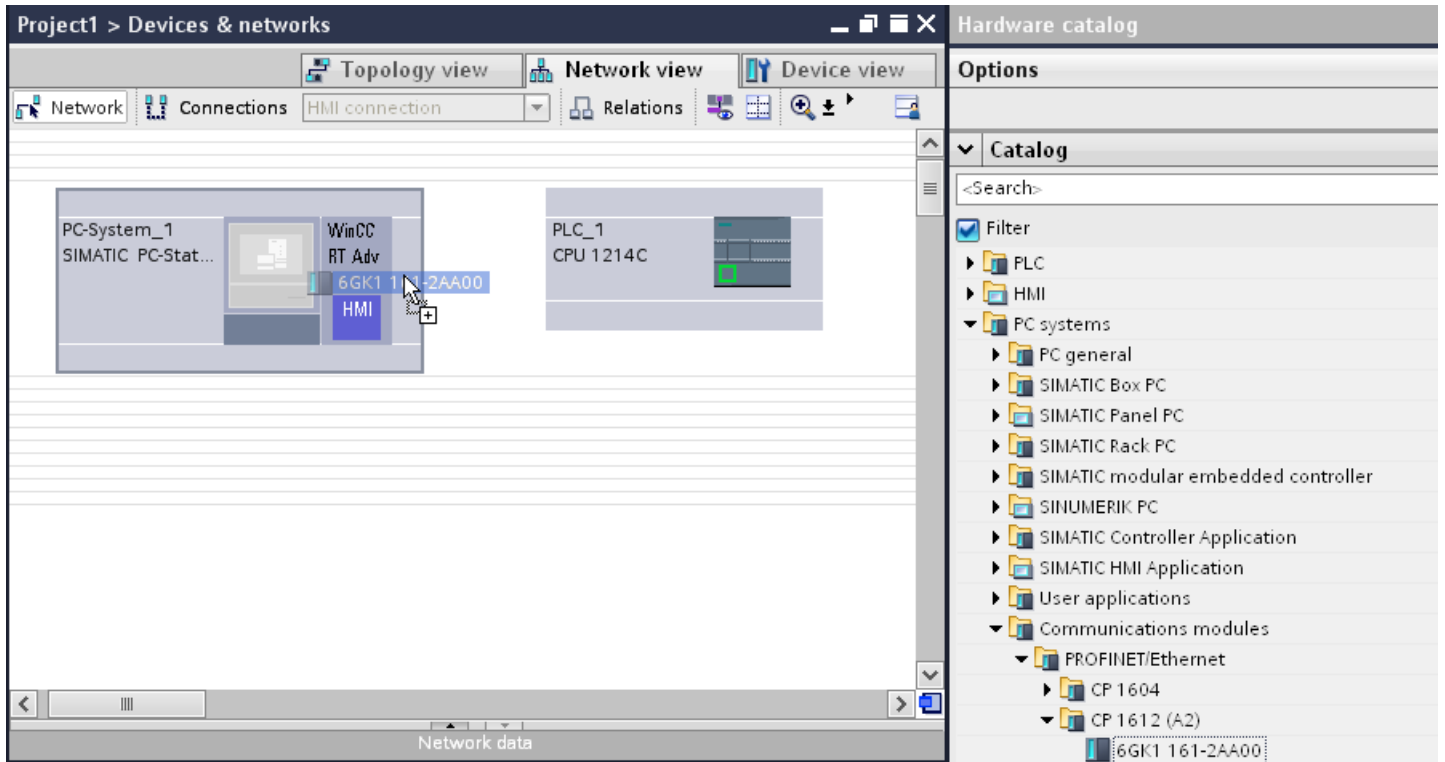

3. Click the "Connections" button and select "HMI connection" for the connection type.  
The devices available for connection are highlighted in color.

- Click the PROFINET interface of the PLC and use a drag-and-drop operation to draw a connection to the PROFINET interface of the communication processor.

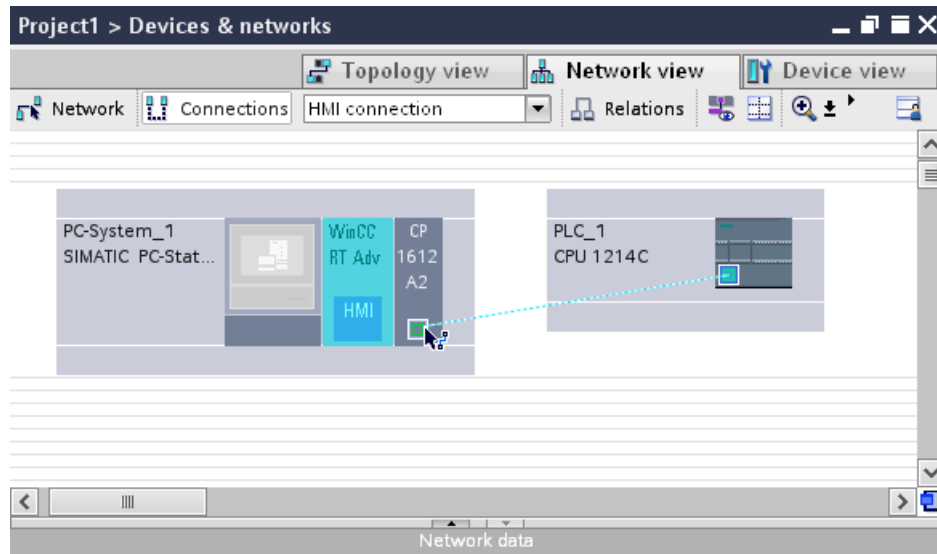

- Click the connecting line.
- Click "Highlight HMI connection" and select the HMI connection. The connection is displayed graphically in the Inspector window.
- Click the communication partners in the "Network view" and change the PROFINET parameters in the Inspector window according to the requirements of your project. See the chapter "PROFINET parameters (Page 5057)" for additional details.

#### Note

The created HMI connection is also shown in the tabular area of the editor on the "Connections" tab. You check the connection parameters in the table.

You can change the local name for the connection only in the table.

## Result

You have created a connection between an HMI device and a SIMATIC S7 1200. The IP address and subnet mask connection parameters are configured.

## PROFINET parameters

### PROFINET parameters for the HMI connection

### PROFINET parameters for the HMI connection

An overview of the configured HMI connection parameters can be found in the properties for the HMI connection.

Only limited changes are possible in this Inspector window.

## Displaying and editing HMI connection parameters

1. Click the HMI connection in the "Devices & Networks" editor.
2. Change the parameters of the HMI connection in the Inspector window under "Properties > General > General".

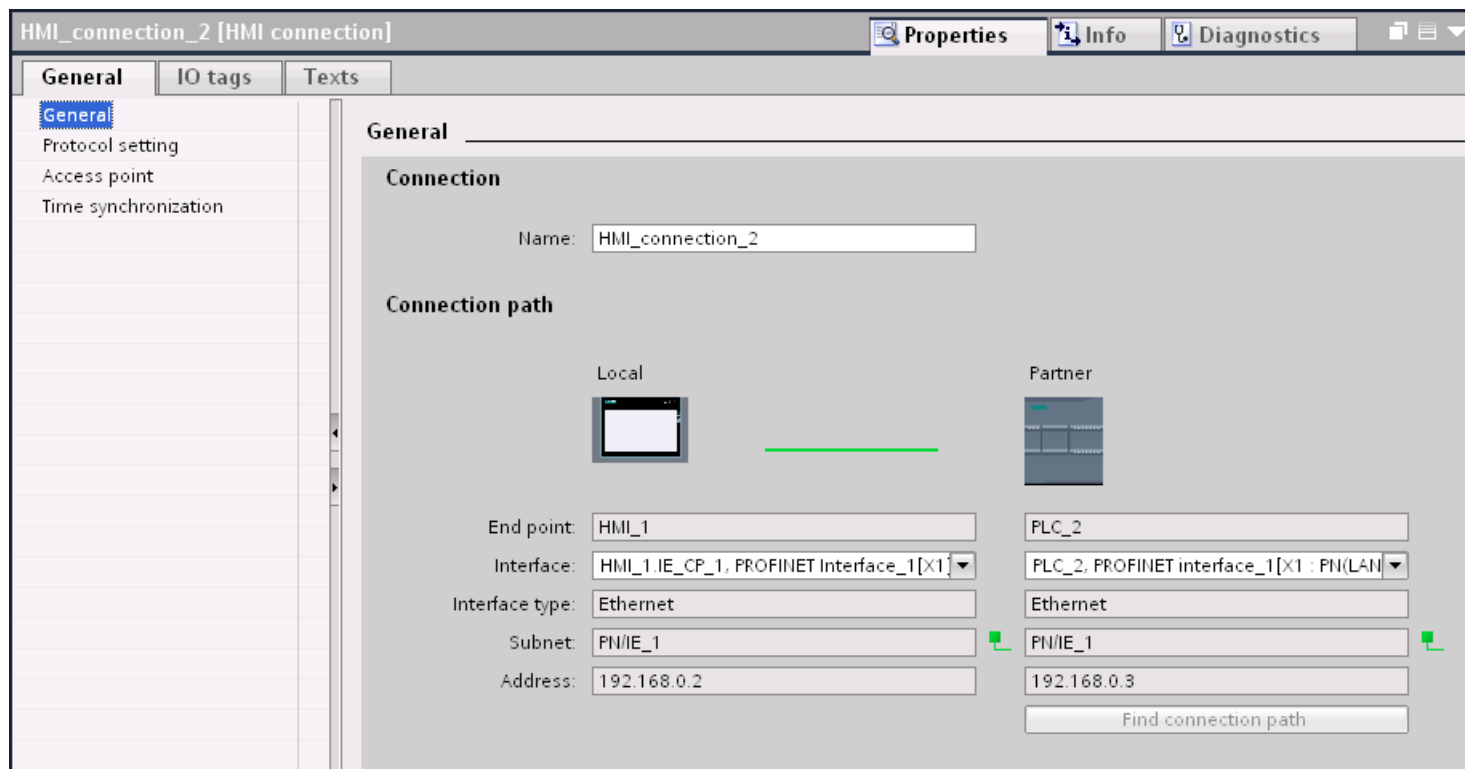

### Connection

The "Connection" area displays the HMI connection created for communication between the devices.

You can edit the name of the HMI connection in this area.

### "Connection path"

The communication partners of the selected HMI connection and the associated PROFINET parameters are displayed in the "Connection path" area. Some of the areas displayed cannot be edited in this dialog.

- "End point"  
Displays the device name. This area cannot be edited.
- "Interface"  
Displays the selected interface of the device. You can choose between several interfaces, depending on the device.
- "Interface type"  
Displays the selected interface type. This area cannot be edited.



- "Subnet"  
Displays the selected subnet. This area cannot be edited.
- "Address"  
Displays the selected IP address of the device. This area cannot be edited.
- "Find connection path" button  
Enables the subsequent specification of connections.

## PROFINET parameters for the HMI device

## PROFINET parameters for the HMI device

An overview of the configured HMI device parameters can be found in the properties for the HMI device.

## Displaying and changing PROFINET parameters of the HMI device

1. Click the HMI device in the "Devices & Networks" editor.
2. Change the parameters of the HMI device in the Inspector window under "Properties > General > General".

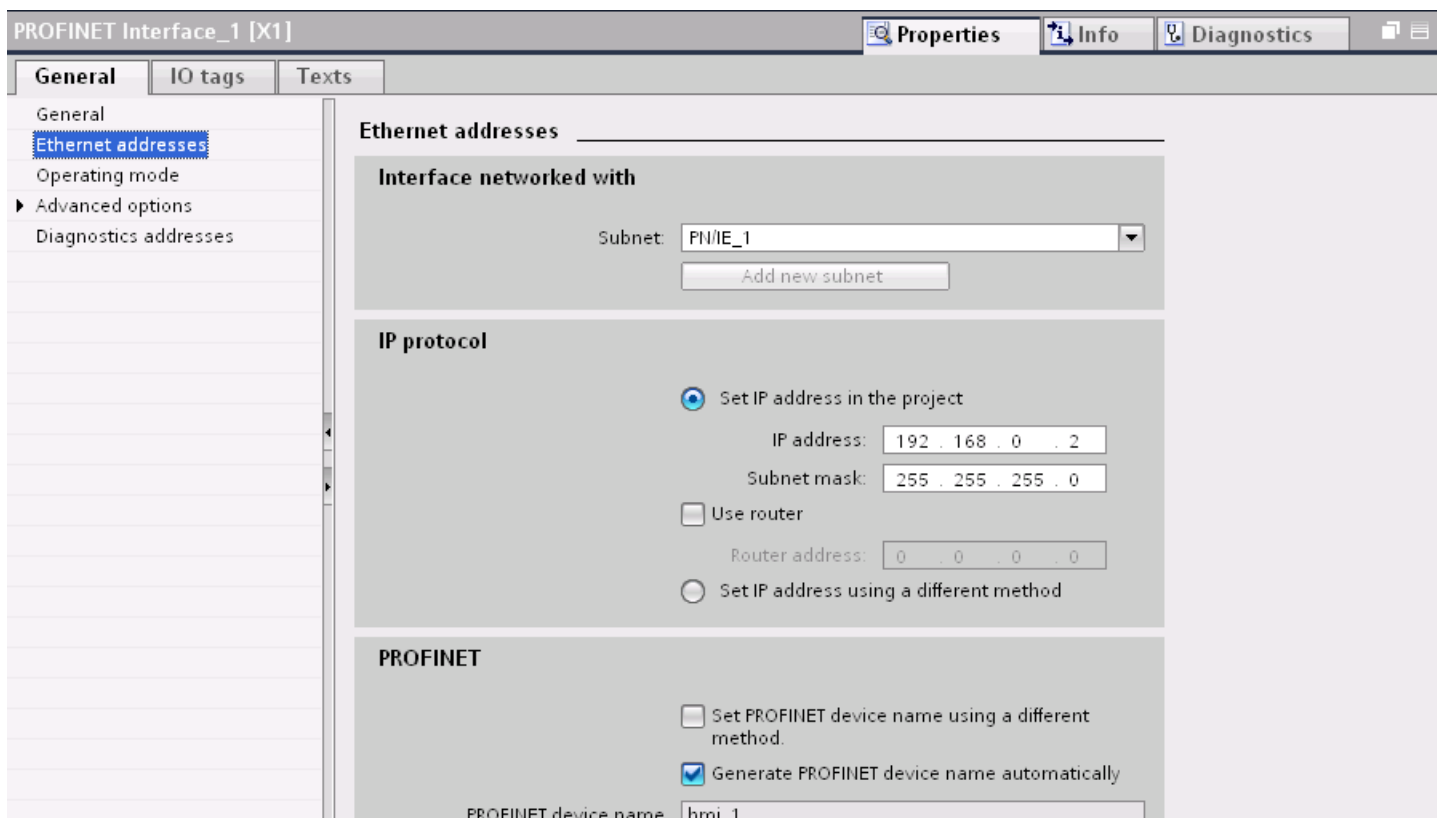

### "Interface networked with"

In the "Interface networked with" area, select the subnet of the HMI connection via which the HMI device is connected to the network. You use the "Add new subnet" button to create a new subnet.

### "IP protocol"

- "Set IP address in the project"  
When you transfer the WinCC project to the HMI device, this IP address is set up directly in the HMI device.

---

#### Note

The device is automatically restarted in the case of HMI devices with the Windows CE 3.0 operating system.

HMI devices with Windows CE 3.0:

- OP 77B
  - TP 177B color PN/DP
  - TP 177B mono DP
  - OP 177B color PN/DP
  - OP 177B mono DP
  - Mobile Panel 177 PN
  - Mobile Panel 177 DP
  - TP 277 6"
  - OP 277 6"
- 
- "Subnet mask"  
You assign data of the subnet mask in the "Subnet mask" area.
  - "Use IP router"  
If you are using an IP router, select "Use IP router" and enter the router address in the "Router address" field.
  - "Set IP address using a different method"  
If the function "Set IP address using a different method" is activated, the IP address is not taken from the project. You have to enter the IP address directly in the Control Panel of the HMI device.

### PROFINET parameters for the PLC

### PROFINET parameters for the PLC

An overview of the configured parameters can be found in the properties for the PLC.

## Displaying and changing PROFINET parameters of the PLC

1. Click the PLC in the "Devices & Networks" editor.
2. Change the parameters of the PLC in the Inspector window under "Properties > General > General".

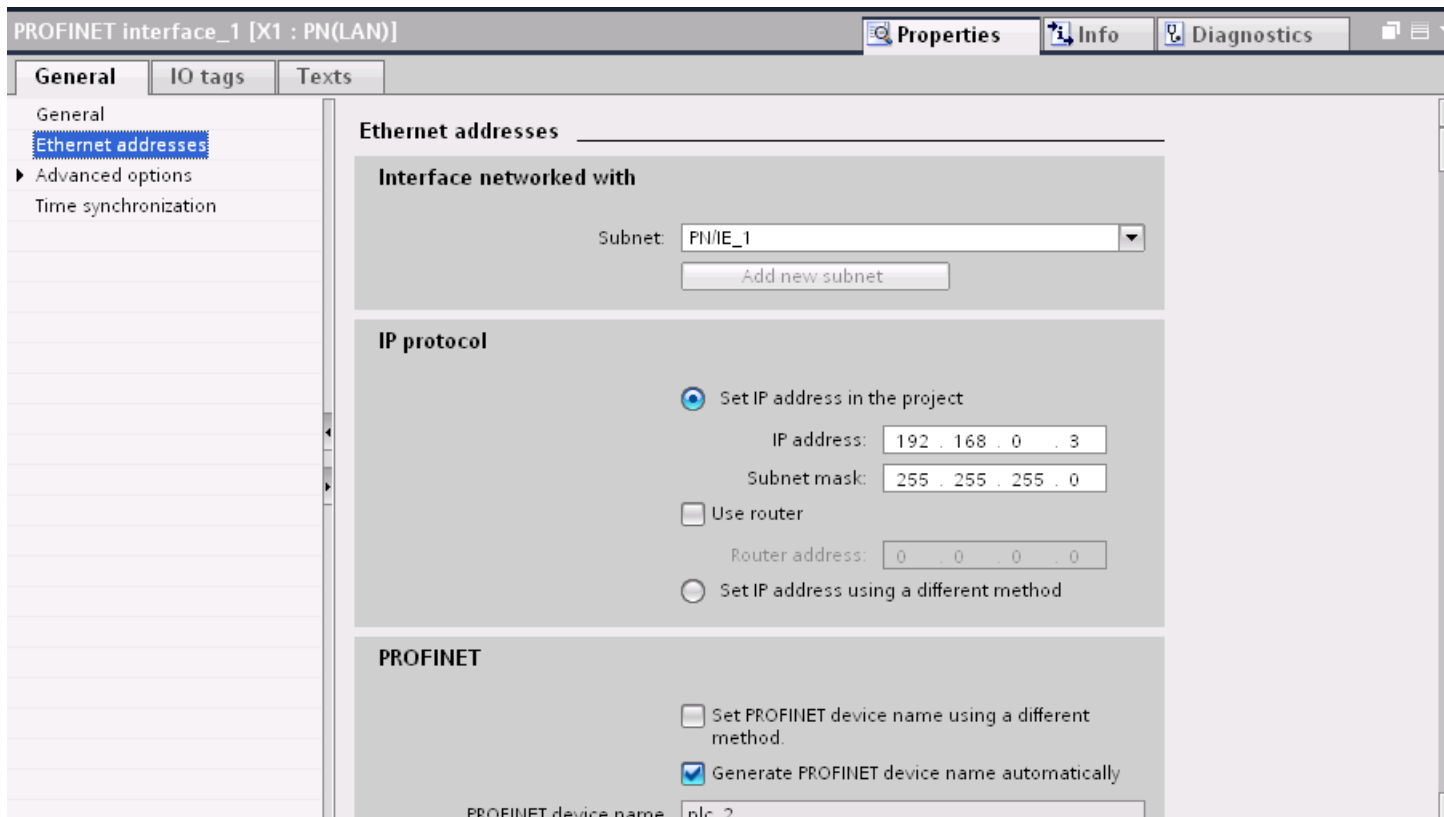

### "Interface networked with"

In the "Subnet" area, select the subnet of the HMI connection via which the PLC is connected to the network. You use the "Add new subnet" button to create a new subnet.

### "IP protocol"

- "Interface type"  
Depending on the HMI device type, you have various interfaces to choose from.
- "IP address"  
You assign the IP address of the HMI device in the "IP address" area.
- "Subnet mask"  
You assign data of the subnet mask in the "Subnet mask" area.  
If you are using an IP router, select "Use IP router" and enter the router address in the field.

## Configuring Industrial Ethernet

### Rules for the network configuration

The Ethernet interfaces of the devices have a default IP address that you can change.

### IP address

The IP parameters are visible if the communication-capable devices support the TCP/IP protocol.

The IP address consists of 4 decimal figures in the range of 0 to 255. The decimal figures are separated from one another by a dot.

Example: 140.80.0.2

The IP address consists of the following:

- The address of the (sub) net
- The address of the node (generally also called host or network node)

### Subnet mask

The subnet mask splits these two addresses. It determines which part of the IP address addresses the network and which part of the IP address addresses the node.

The set bits of the subnet mask determine the network part of the IP address.

Example:

Subnet mask: 255.255.0.0 = 11111111.11111111.00000000.00000000

In the example given for the above IP address, the subnet mask shown here has the following meaning:

The first 2 bytes of the IP address identify the subnet - i.e. 140.80. The last two bytes address the node, thus 0.2.

It is generally true that:

- The network address results from AND linking the IP address and subnet mask.
- The node address results from AND NOT linking the IP address and subnet mask.

### Relation between IP address and default subnet mask

An agreement exists relating to the assignment of IP address ranges and so-called "Default subnet masks". The first decimal number (from the left) in the IP address determines the structure of the default subnet mask. It determines the number of "1" values (binary) as follows:

IP address (decimal)	IP address (binary)	Address class	Default subnet mask
0 to 126	0xxxxxxx.xxxxxxxx...	A	255.0.0.0
128 to 191	10xxxxxx.xxxxxxxx...	B	255.255.0.0
192 to 223	110xxxxx.xxxxxxxx...	C	255.255.255.0

**Note****Range of values for the first decimal point**

A value of between 224 and 255 is also possible for the first decimal number of the IP address (address class D etc). This is, however, not recommended because there is no address check for these values.

**Masking other subnets**

You can use the subnet mask to add further structures and form "private" subnets for a subnet that is assigned one of the address classes A, B or C. This is done by setting other lower points of the subnet mask to "1". For each bit set to "1", the number of "private" networks doubles and the number of nodes they contain is halved. Externally, the network functions like an individual network as it did previously.

Example:

You have a subnet of address class B (e.g. IP address 129.80.xxx.xxx) and change the default subnet mask as follows:

Masks	Decimal	Binary
Default subnet mask	255.255.0.0	11111111.11111111.00000000.00000000
Subnet mask	255.255.128.0	11111111.11111111.10000000.00000000

Result:

All nodes with addresses between 129.80.001.xxx and 129.80.127.xxx are on one subnet, all nodes with addresses between 129.80.128.xxx and 129.80.255.xxx are on another subnet.

**Router**

The job of the routers is to connect the subnets. If an IP datagram is to be sent to another network, it first has to be conveyed to a router. To make this possible, in this case you have to enter the address of the router for each node in the subnet.

The IP address of a node in the subnet and the address of the router may only differ at the points at which there is a "0" in the subnet mask.

**Configuring time synchronization for integrated connections****Introduction**

You configure time synchronization for an integrated connection in the "Devices & Networks" editor.

## Requirements

- An HMI connection between an HMI device and a SIMATIC S7 1200 has been configured.
- The HMI device must support the "time synchronization" function.
- The "Devices & Networks" editor is open.

## Procedure

1. Click the line of the HMI connection in the "Devices & networks" editor.
2. Select the following in the inspector window under "General > Time synchronization > Settings":
  - None: No time synchronization is used.
  - Master: The HMI device sets the time.
  - Slave: The PLC sets the time.

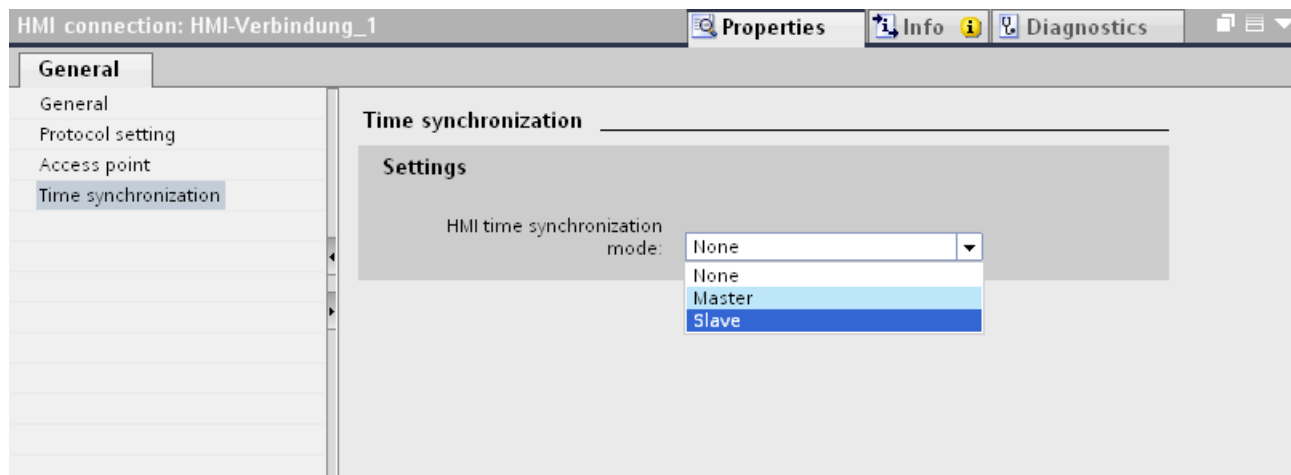

## Protection of communication

### Security levels

You can assign communication security levels to protect PLC and HMI device communication.

For an S7-1500 CPU, you can enter multiple passwords and thereby set up different access rights for various user groups.

The passwords are entered in a table, so that each password is assigned to exactly one protection level.

The effect of the password is given in the "Protection" column.

### Example

Select the "Complete protection" security level for a standard CPU (in other words, not an F-CPU) and enter a separate password for each security level in the table.

For users who do not know any of the passwords, the CPU is completely protected. Not even HMI access is possible.

For users who know one of the assigned passwords, the effect depends on the table row in which the password occurs:

- The password in row 1 (no protection) allows access as if the CPU were completely unprotected. Users who know this password have unrestricted access to the CPU.
- The password in row 2 (write protection) allows access as if the CPU were write-protected. Despite knowing the password, users who know this password only have read access to the CPU.
- The password in row 3 (read/write protection) allows access as if the CPU were read-protected and write-protected, so that only HMI access is possible for users who know this password.

## Access password for the HMI connection

### Introduction

Secure access to a PLC by assigning a password.

Assign the password when configuring the connection.

Input of the password of the PLC is mandatory as of "Complete protection" security level.

Communication to the PLC is denied if an incorrect password or no password is entered.

### Assigning password

Enter the access password for the HMI connection in the "Connections" editor.

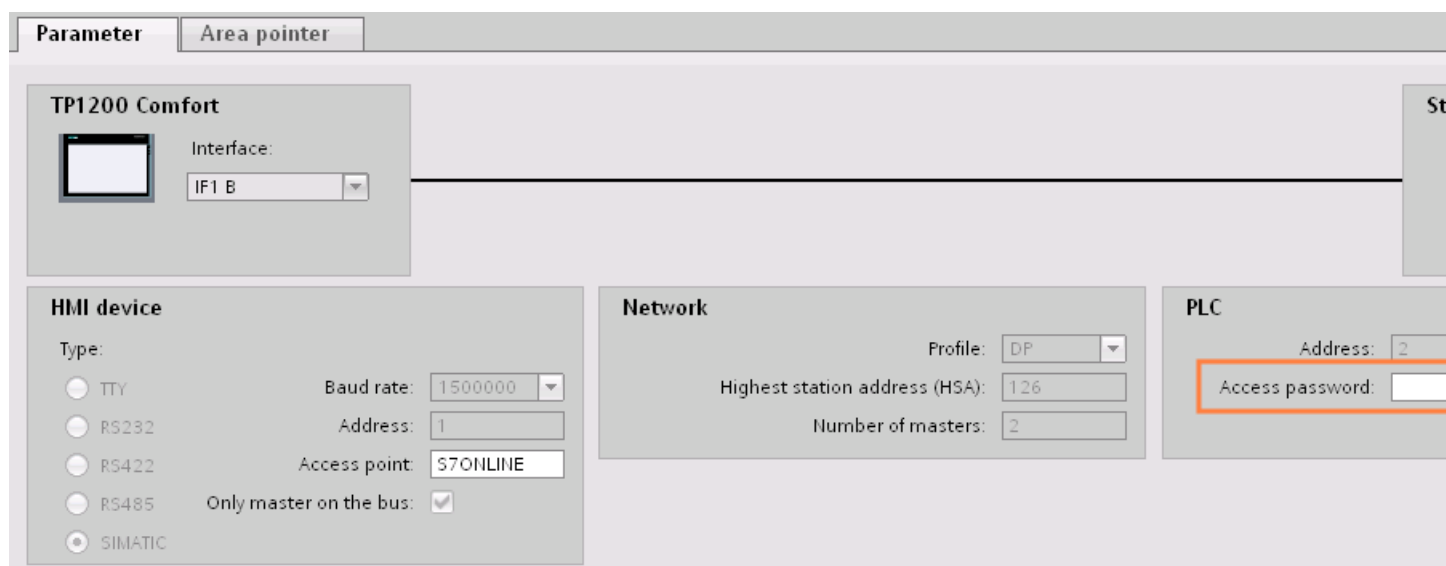

## Setting port options

### Setting the port options

#### Changing connection settings for the PROFINET IO port

You can change the network settings for the PROFINET IO port as required. By default, the settings are made automatically. In normal situations, this guarantees problem-free communication.

#### Possible settings for transmission rate / duplex

Depending on the selected device, you can make the following settings for "Transmission rate / duplex":

- Automatic setting  
Recommended default setting of the port. The transmission settings are automatically "negotiated" with the peer port. The "Enable autonegotiation" option is also enabled as a default, in other words, you can use cross cables or patch cables for the connection.
- TP/ITP at x Mbps full duplex (half duplex)  
Setting of the transmission rate and the full duplex/half duplex mode. The effectiveness depends on the "Enable autonegotiation" setting:
  - Autonegotiation enabled  
You can use both cross cable and patch cable.
  - Autonegotiation disabled  
Make sure that you use the correct cable (patch cable or cross cable)! The port is also monitored with this setting.
- Deactivated  
Depending on the module type, the drop down list box can contain the "- Disabled -" option. This option, for example, allows you to prevent access to an unused port for security reasons. With this setting, diagnostic events are not generated.

#### "Monitor" option

This option enables or disables port diagnostics. Examples of port diagnostics: The link status is monitored, in other words, the diagnostics are generated during link-down and the system reserve is monitored in the case of fiber optic ports.

#### Option "Enable autonegotiation "

The autonegotiation setting can only be changed if a concrete medium (for example, TP 100 Mbps full duplex) is selected. Whether or not a concrete medium can be set depends on the properties of the module.

If autonegotiation is disabled, this causes the port to be permanently specified, as for example, is necessary for a prioritized startup of the IO device.



You must make sure the partner port has the same settings because with this option the operating parameters of the connected network are not detected and the data transmission rate and transmission mode can accordingly not be optimally set.

---

#### Note

When a local port is connected, STEP 7 makes the setting for the partner port if the partner port supports the setting. If the partner port does not accept the setting, an error message is generated.

---

## Wiring rules for disabled autonegotiation

### Requirements

You have made the following settings for the port in question, for example, to accelerate the startup time of the IO device:

- Fixed transmission rate
- Autonegotiation incl. autocrossing disabled

The time for negotiating the transmission rate during startup has been saved.

If you have disabled autonegotiation, you must observe the wiring rules.

## Wiring rules for disabled autonegotiation

PROFINET devices have the following two types of ports:

Type of port	PROFINET devices	Note
Switch port with crossed pin assignment	For IO devices: Port 2 For S7 CPUs with 2 ports: Ports 1 and 2	Crossed pin assignment means that the pin assignment for the ports for sending and receiving between the respective PROFINET devices is exchanged internally.
End device port with uncrossed pin assignment	For IO devices: Port 1 For S7 CPUs with one port: Port 1	-

### Validity of the wiring rules

The cabling rules described in the following paragraph apply exclusively for the situation in which you have specified a fixed port setting.

### Rules for cabling

You can connect several IO devices in line using a single cable type (patch cable). To do this, you connect port 2 of the IO device (distributed I/O) with port 1 of the next IO device. The following graphic gives an example with two IO devices.

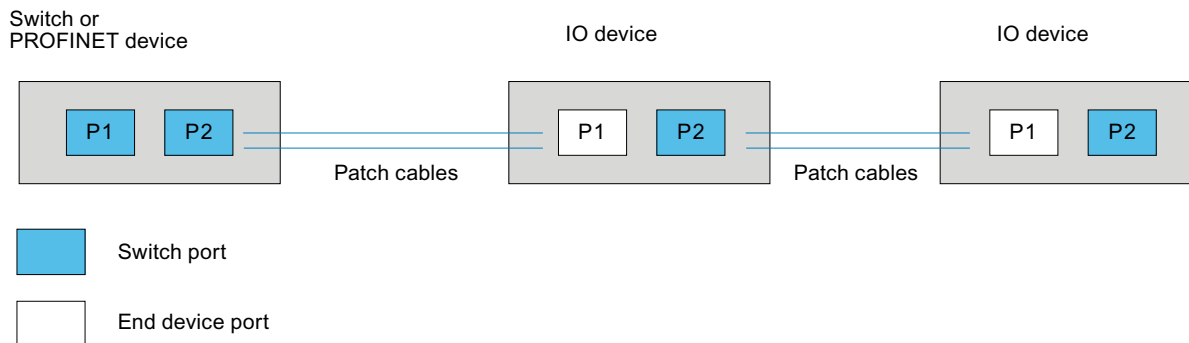

### Boundaries at the port

#### Requirements

To use boundaries, the respective device must have more than one port. If the PROFINET does not support boundary settings, they are not shown.

#### Enable boundaries

"Boundaries" are limits for transmission of certain Ethernet frames. The following boundaries can be set at a port:

- "End of discovery of accessible devices"  
No forwarding of DCP frames to identify accessible devices. Devices downstream from this port cannot be reached by the project tree under "Accessible devices". Devices downstream from this port cannot be reached by the CPU.
- "End of topology discovery"  
LLDP frames (Link Layer Discovery Protocol) are not forwarded for topology detection.
- "End of sync domain"  
No forwarding of sync frames transmitted to synchronize nodes within a sync domain. If you operate, for example, a PROFINET device with more than two ports in a ring, you should prevent the sync frame from being fed into the ring by setting a sync boundary (at the ports not inside the ring).  
Additional example: If you want to use several sync domains, configure a sync domain boundary for the port connected to a PROFINET device from the other sync domain.

## Restrictions

The following restrictions must be observed:

- The individual check boxes can only be used if the port supports the function in question.
- If a partner port has been determined for the port, the following check boxes cannot be used:
  - "End of discovery of accessible devices"
  - "End of topology discovery"
- If autonegotiation is disabled, none of the check boxes can be used.

### 10.11.7.3 Communication via PROFIBUS

#### Configuring an HMI connection

#### Communication via PROFIBUS

#### HMI connections via PROFIBUS

If you want to connect a SIMATIC S7 1200 to a HMI device via PROFIBUS, you must configure a PROFIBUS-capable communication module to a slot of the controller first.

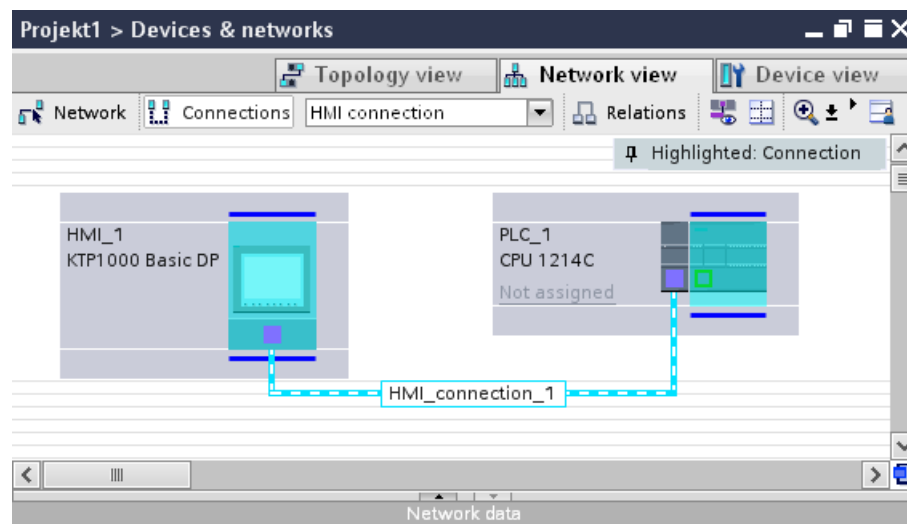

#### HMI connection in the "Devices & Networks" editor

You configure the HMI connection between the PLC and the HMI device via PROFIBUS in the "Devices & Networks" editor.

## Connection in the "Connections" editor

Alternatively, you configure the connection between the PLC and HMI device in the "Connections" editor of the HMI device.

## Configuring an HMI connection via PROFIBUS

### Introduction

You configure an HMI connection between HMI devices and a SIMATIC S7 1200 via PROFIBUS in the "Devices & Networks" editor.

### Requirements

The following communication partners are created in the "Devices & Networks" editor:

- HMI device with MPI/DP interface
- SIMATIC S7 1200

### Procedure

1. Double-click the "Devices & Networks" item in the project tree.  
The available communication partners in the project are displayed graphically in the network view.
2. Click the "Connections" button.  
The devices available for connection are highlighted in color.
3. Use a drag-and-drop operation to move a PROFIBUS-capable communication module from the hardware catalog to the PLC.

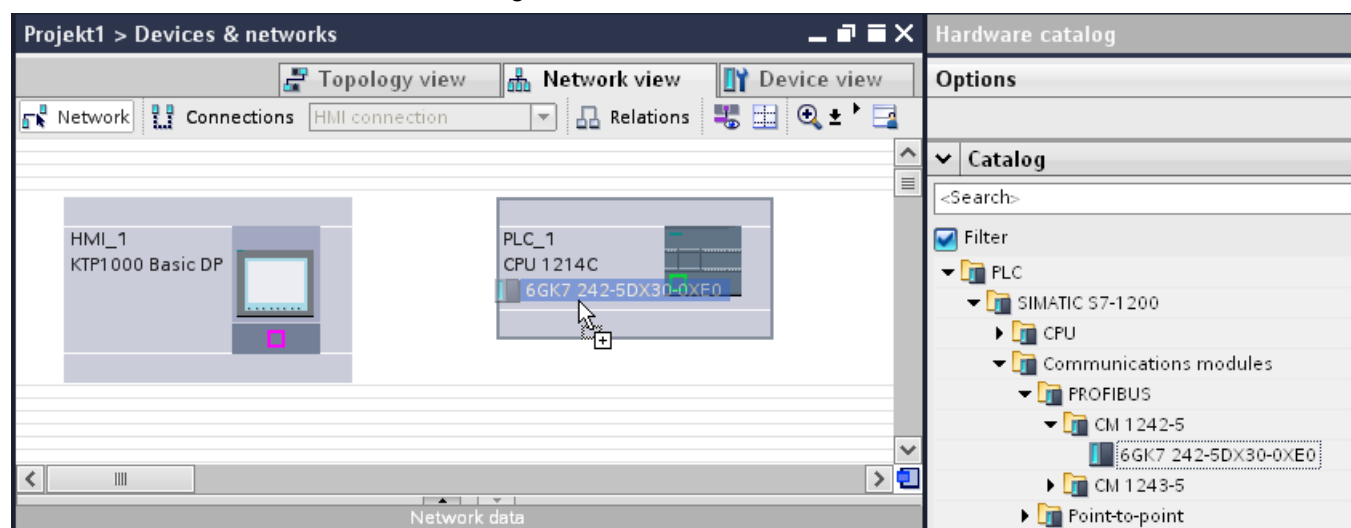

4. Click the HMI device interface.
5. Select the "PROFIBUS" interface type in the Inspector window under "Properties > General > PROFIBUS address/ MPI address > Parameters".

- Click the interface of the communication module and use a drag-and-drop operation to draw a connection to the HMI device.

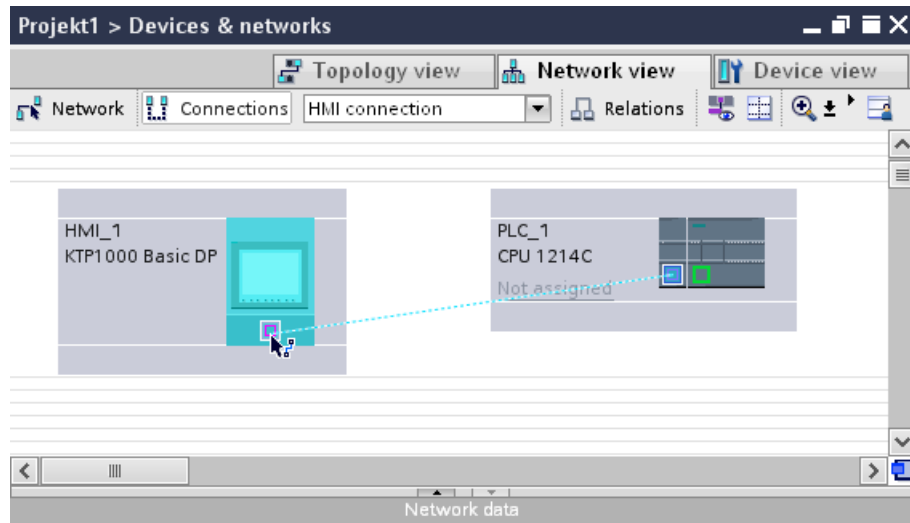

- Click the name of the connection.  
The connection is displayed graphically in the Inspector window.
- Click "Highlight HMI connection" and select the HMI connection.
- Click the communication partners in the "Network view" and change the PROFINET parameters in the Inspector window according to the requirements of your project. See the chapter "PROFIBUS parameters (Page 5077)" for additional details.

#### Note

The created HMI connection is also shown in the tabular area of the editor on the "Connections" tab. You check the connection parameters in the table.

You can change the local name for the connection only in the table.

## Result

You have created an HMI connection between an HMI device and a SIMATIC S7 1200 via PROFIBUS.

## Configuring an HMI connection

### Communication via PROFIBUS

### Communication via PROFIBUS

This section describes the communication between a WinCC Runtime and the SIMATIC S7 1200 PLC via PROFIBUS.

You can use the following WinCC Runtimes as an HMI device:

- WinCC RT Advanced

If you want to connect a SIMATIC S7 1200 to an HMI device via PROFIBUS, you must configure a PROFIBUS-capable communication module in a slot of the PLC.

### WinCC Runtime as HMI device

You configure the HMI connections between WinCC Runtime and SIMATIC S7 1200 in the "Devices & Networks" editor.

If you want to use a WinCC Runtime as an HMI device, you have the following options:

1. You create a SIMATIC PC and configure a WinCC Runtime on this SIMATIC PC. In this way you use the SIMATIC PC with a WinCC Runtime as an HMI device.

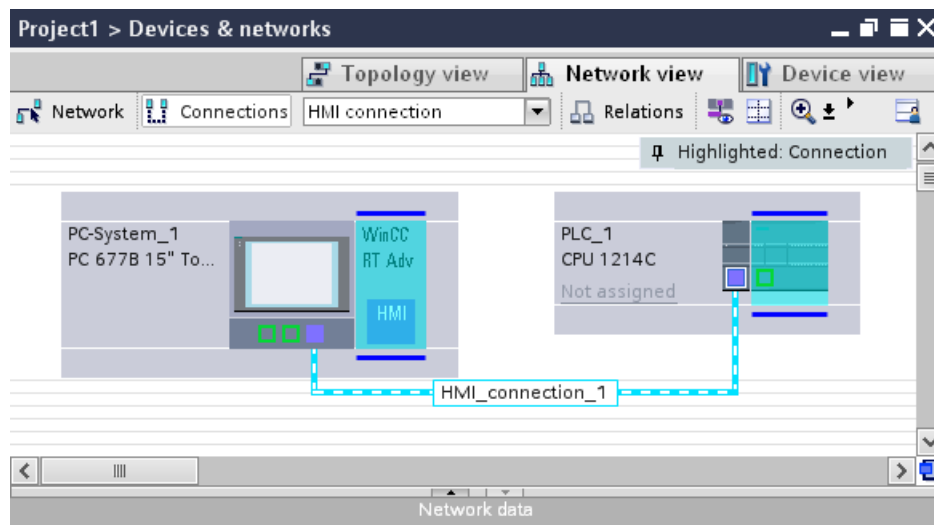

2. You create a WinCC Runtime and configure a communication processor to the Runtime. In this way you use your configuration PC with a WinCC Runtime as an HMI device.

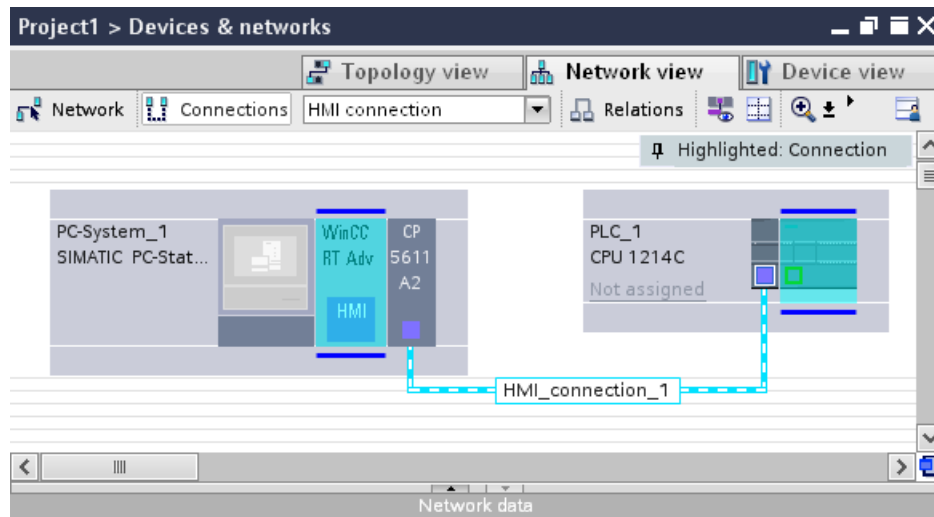

You can also connect multiple HMI devices to one SIMATIC S7 1200 and multiple SIMATIC S7 1200s to one HMI device. The maximum number of communication partners that you can connect to an HMI device is dependent on the HMI device used.

Additional information is available in the documentation for the respective HMI device.

### **HMI connection in the "Devices & Networks" editor**

You configure the HMI connection between the PLC and the HMI device via PROFIBUS in the "Devices & Networks" editor.

### **Connection in the "Connections" editor**

Alternatively, you configure the connection between the PLC and HMI device via PROFIBUS in the "Connections" editor of the HMI device.

## **Configuring an HMI connection via PROFIBUS with a SIMATIC PC**

### **Introduction**

You configure an HMI connection between HMI devices and a SIMATIC S7 1200 via PROFIBUS in the "Devices & Networks" editor.

### **Requirements**

The following communication partners are created in the "Devices & Networks" editor:

- SIMATIC S7 1200
- SIMATIC PC with PROFIBUS interface

### Procedure

1. Double-click the "Devices & Networks" item in the project tree.  
The available communication partners in the project are displayed in the network view.
2. Use a drag-and-drop operation to move a WinCC Runtime from the hardware catalog to the PC.

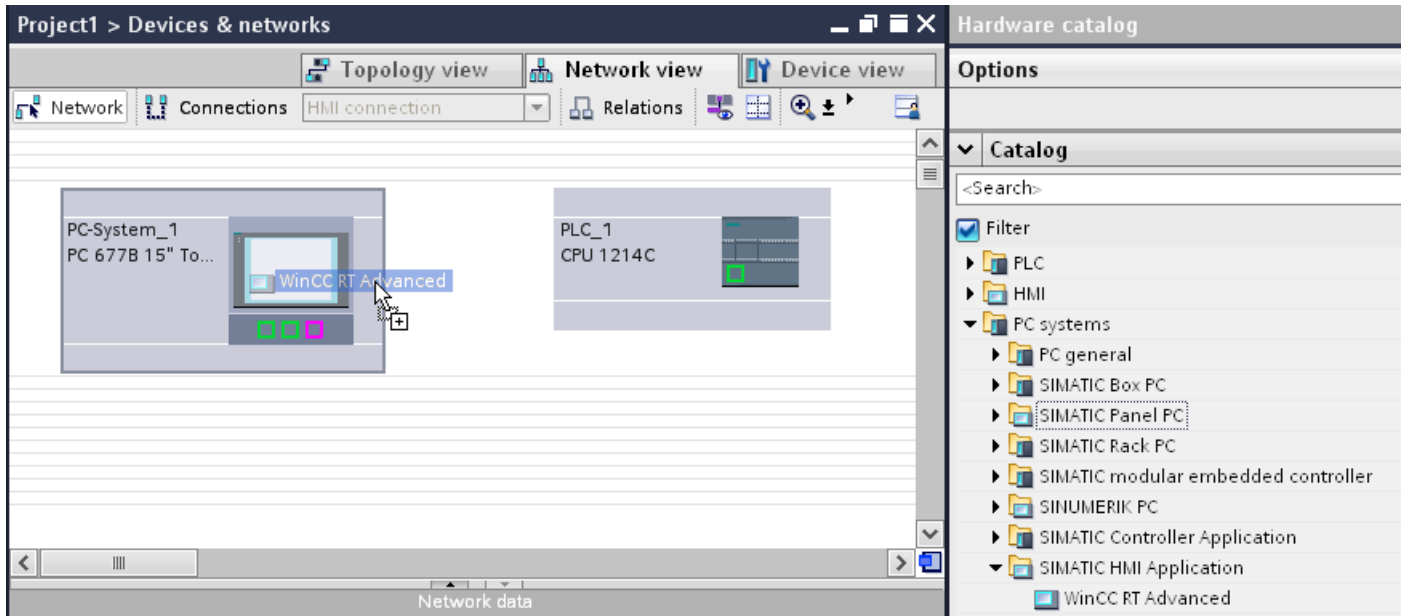

3. Use a drag-and-drop operation to move a PROFIBUS-capable communication module from the hardware catalog to the PLC.

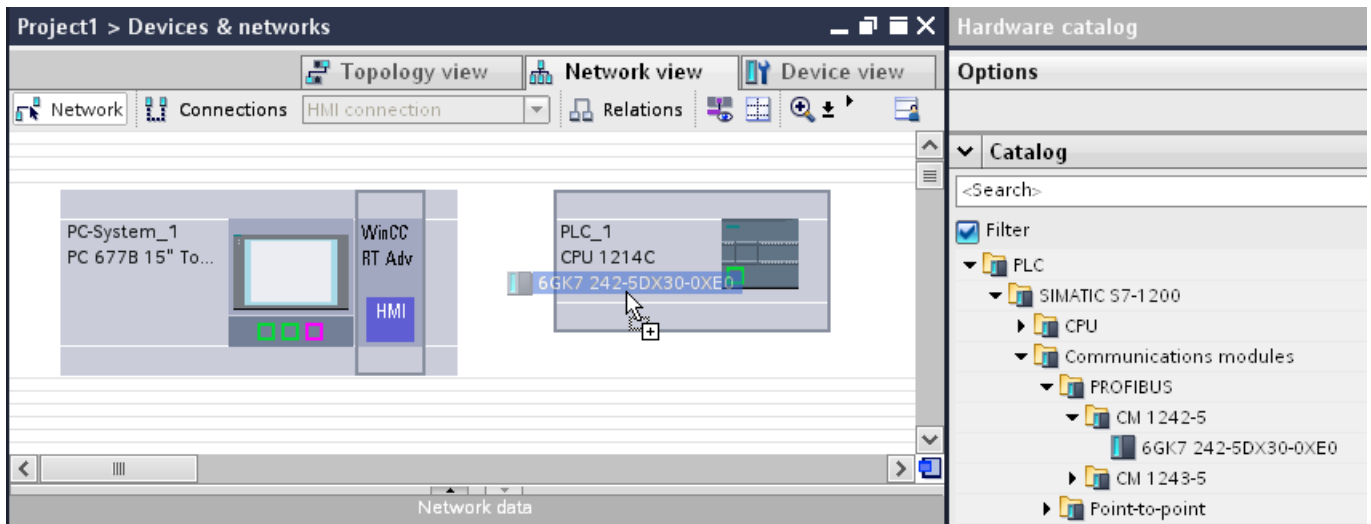

4. Click the "Connections" button and select "HMI connection" for the connection type.  
The devices available for connection are highlighted in color.



- Click the PROFIBUS interface of the communication module and use a drag-and-drop operation to draw a connection to the PROFIBUS interface of the PC.

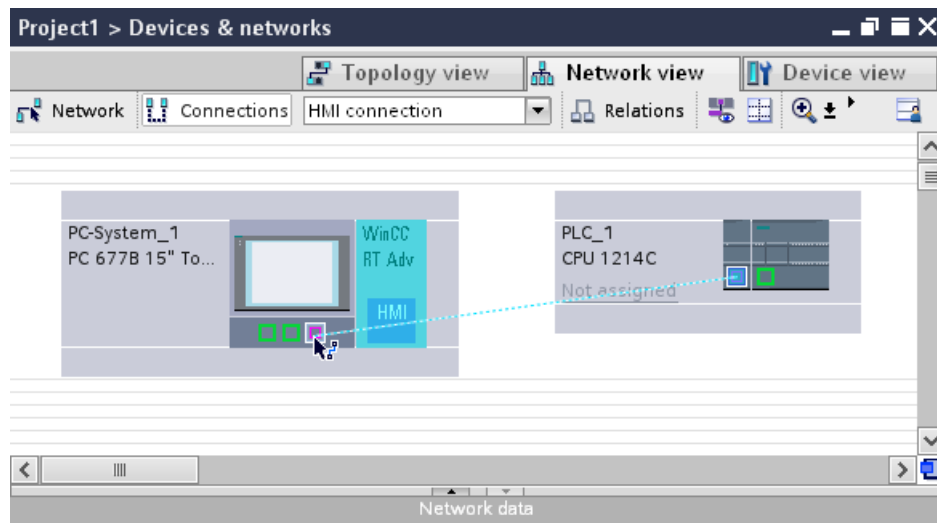

- Click the connecting line.
- Click "Highlight HMI connection" and select the HMI connection. The connection is displayed graphically in the Inspector window.
- Click the communication partners in the "Network view" and change the PROFINET parameters in the Inspector window according to the requirements of your project. See the chapter "PROFIBUS parameters (Page 5077)" for additional details.

#### Note

The created HMI connection is also shown in the tabular area of the editor on the "Connections" tab. You check the connection parameters in the table.

You can change the local name for the connection only in the table.

## Result

You have created an HMI connection between an HMI device and a SIMATIC S7 1200 via PROFIBUS.

## Configuring an HMI connection via PROFIBUS with a PC

### Introduction

You configure an HMI connection between HMI devices and a SIMATIC S7 1200 via PROFIBUS in the "Devices & Networks" editor.

## Requirements

The following communication partners are created in the "Devices & Networks" editor:

- SIMATIC S7 1200
- PC station with WinCC RT Advanced

## Procedure

1. Double-click the "Devices & Networks" item in the project tree.  
The available communication partners in the project are displayed in the network view.
2. Use a drag-and-drop operation to move a PROFIBUS-capable communication processor from the hardware catalog to the WinCC Runtime.
3. Use a drag-and-drop operation to move a PROFIBUS-capable communication module from the hardware catalog to the PLC.

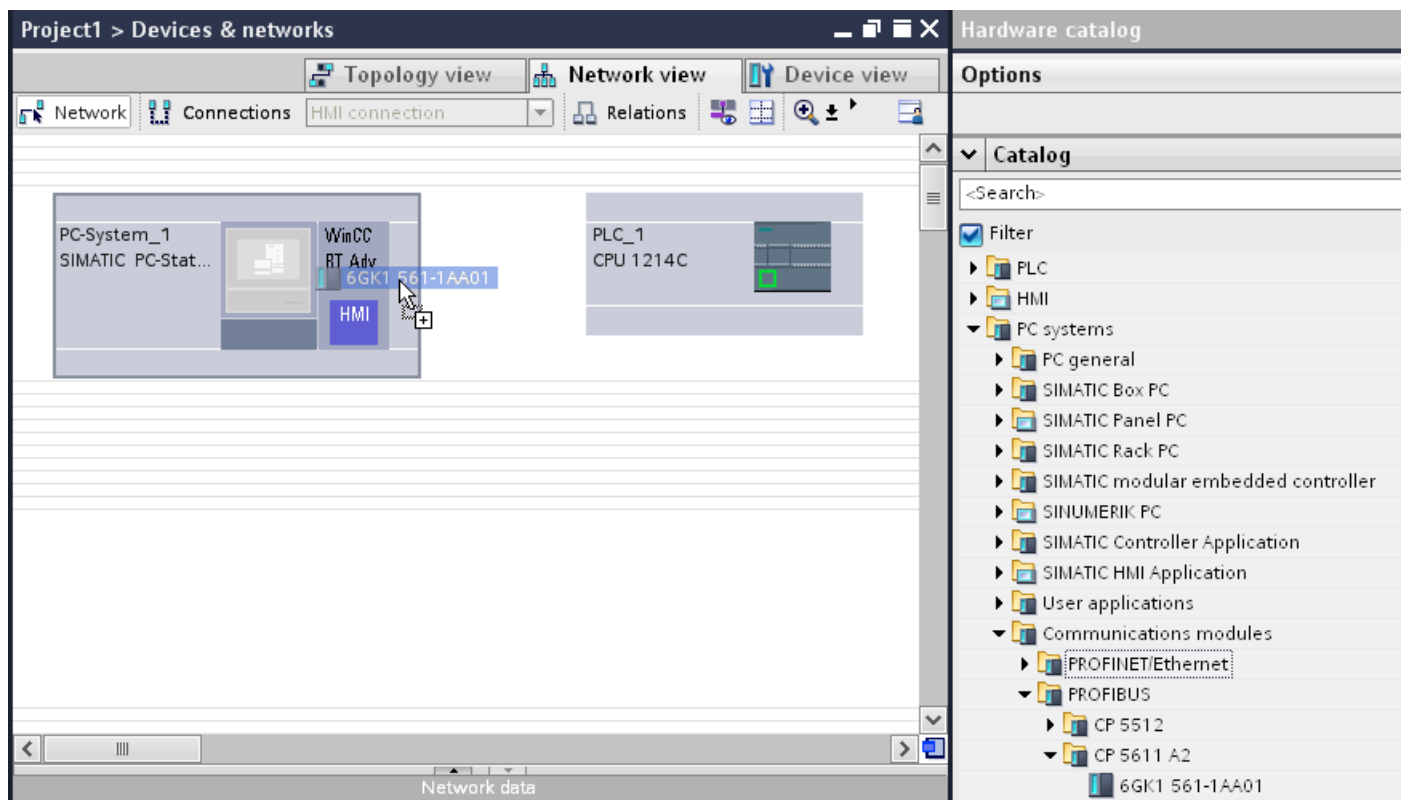

4. Click the "Connections" button and select "HMI connection" for the connection type.  
The devices available for connection are highlighted in color.

- Click the PROFIBUS interface of the communication module and use a drag-and-drop operation to draw a connection to the PROFIBUS interface of the communication processor.

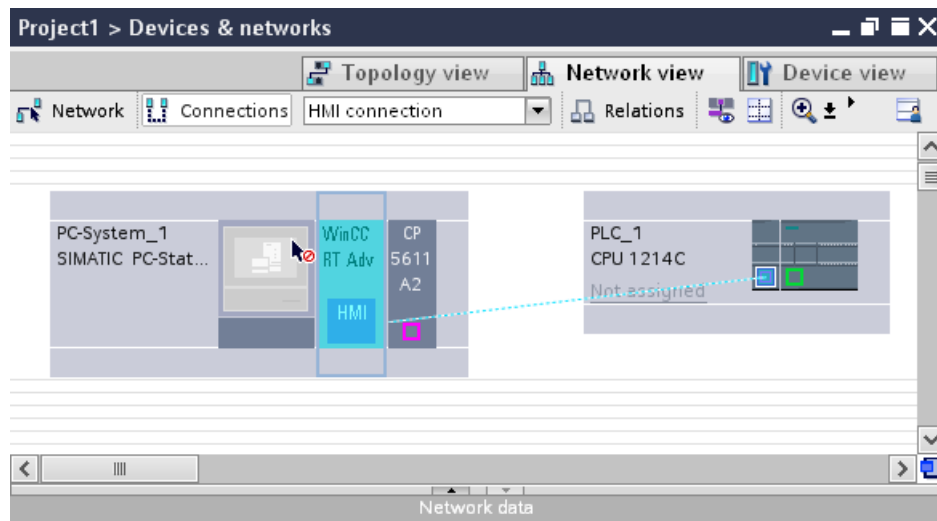

- Click the connecting line.
- Click "Highlight HMI connection" and select the HMI connection. The connection is displayed graphically in the Inspector window.
- Click the communication partners in the "Network view" and change the PROFIBUS parameters in the Inspector window according to the requirements of your project. See the chapter "PROFIBUS parameters (Page 5077)" for additional details.

---

#### Note

The created HMI connection is also shown in the tabular area of the editor on the "Connections" tab. You check the connection parameters in the table.

You can change the local name for the connection only in the table.

---

## Result

You have created an HMI connection between an HMI device and a SIMATIC S7 1200 via PROFIBUS.

## PROFIBUS parameters

### PROFIBUS parameters for the HMI connection

### PROFIBUS parameters for the HMI connection

An overview of the configured HMI connection parameters can be found in the properties for the HMI connection.

Only limited changes are possible in this Inspector window.

## Displaying and editing HMI connection parameters

1. Click the HMI connection in the "Devices & Networks" editor.
2. Change the parameters of the HMI connection in the Inspector window under "Properties > General > General".

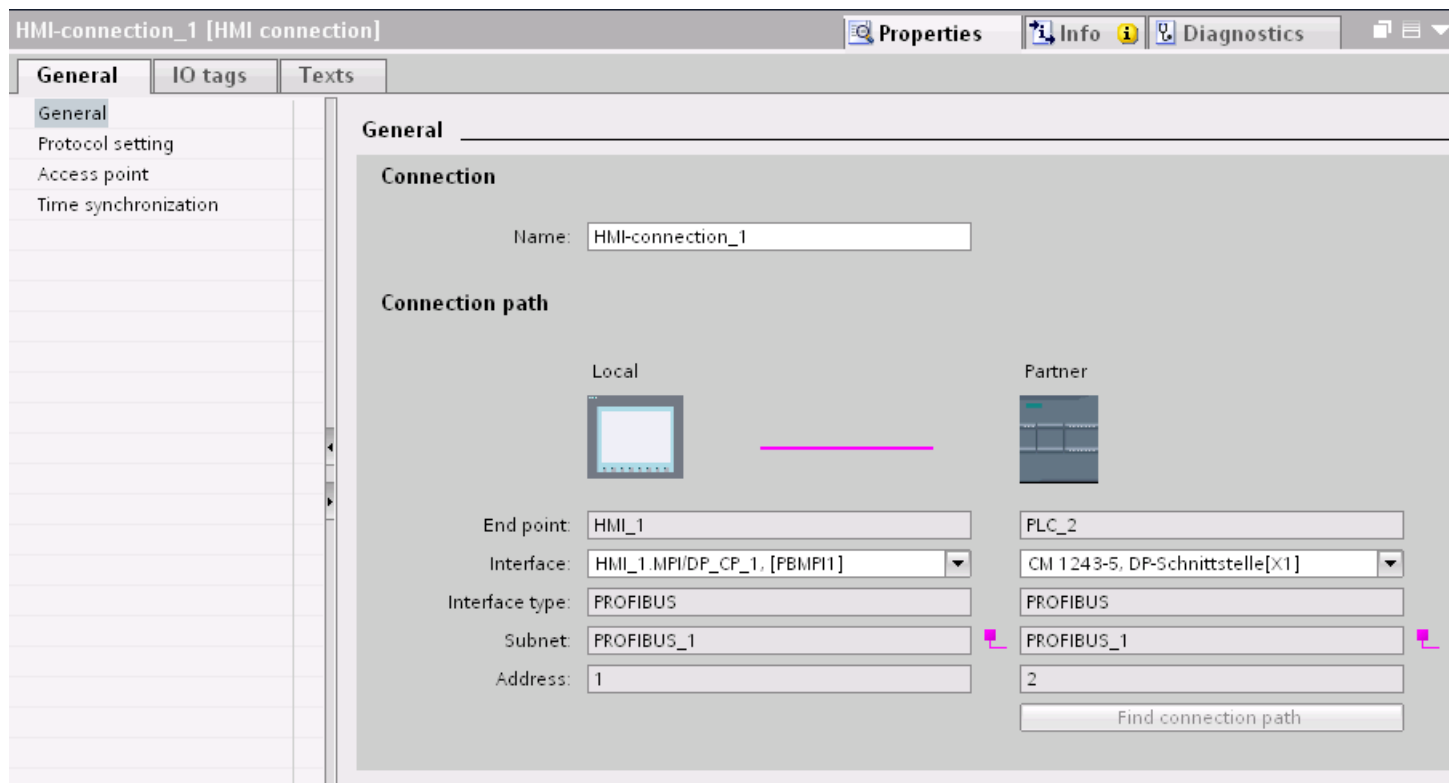

### "Connection"

The "Connection" area displays the HMI connection created for communication between the devices.

You can edit the name of the HMI connection in this area.

### "Connection path"

The communication partners of the selected HMI connection and the associated PROFIBUS parameters are displayed in the "Connection path" area. Some of the areas displayed cannot be edited in this dialog.

- "End point"  
Displays the device name. This area cannot be edited.
- "Interface"  
Displays the selected interface of the device. You can choose between several interfaces, depending on the device.
- "Interface type"  
Displays the selected interface type. This area cannot be edited.

Displays the selected interface type. This area cannot be edited.

- "Subnet"  
Displays the selected subnet. This area cannot be edited.
- "Address"  
Displays the PROFIBUS address of the device. This area cannot be edited.
- "Find connection path" button  
Enables the subsequent specification of connections.

## PROFIBUS parameters for the HMI device

## PROFIBUS parameters for the HMI device

An overview of the configured HMI device parameters can be found in the properties for the HMI device.

## Displaying and changing PROFIBUS parameters of the HMI device

1. Click the HMI device in the "Devices & Networks" editor.
2. Change the parameters of the HMI device in the Inspector window under "Properties > General > General".

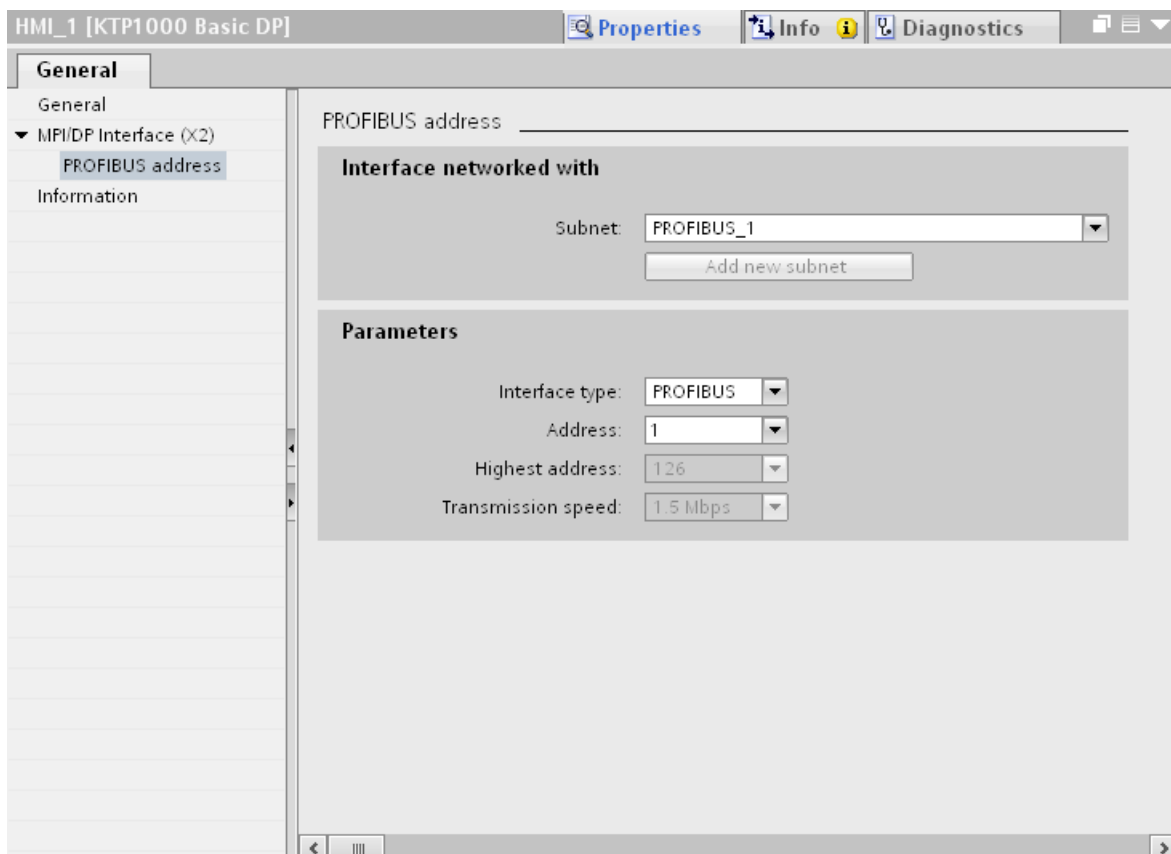

### "Interface networked with"

In the "Interface networked with" area, select the subnet of the HMI connection via which the HMI device is connected to the network. You use the "Add new subnet" button to create a new subnet.

### "Parameters"

- "Interface type"  
Depending on the HMI device type, you have various interfaces to choose from.
- "Address"  
You assign the PROFIBUS address of the HMI device in the "Address" area. The PROFIBUS address must be unique throughout the PROFIBUS network.
- "Highest address"  
The "Highest address" area displays the highest address of the PROFIBUS network.
- "Transmission speed"  
The "Transmission speed" is determined by the slowest device connected to the network. The setting is identical throughout the network.

### PROFIBUS parameters for the PLC

### PROFIBUS parameters for the PLC

An overview of the configured parameters can be found in the properties for the PLC.

## Displaying and changing PROFIBUS parameters of the PLC

1. Click the PLC in the "Devices & Networks" editor.
2. Change the parameters of the PLC in the Inspector window under "Properties > General > General".

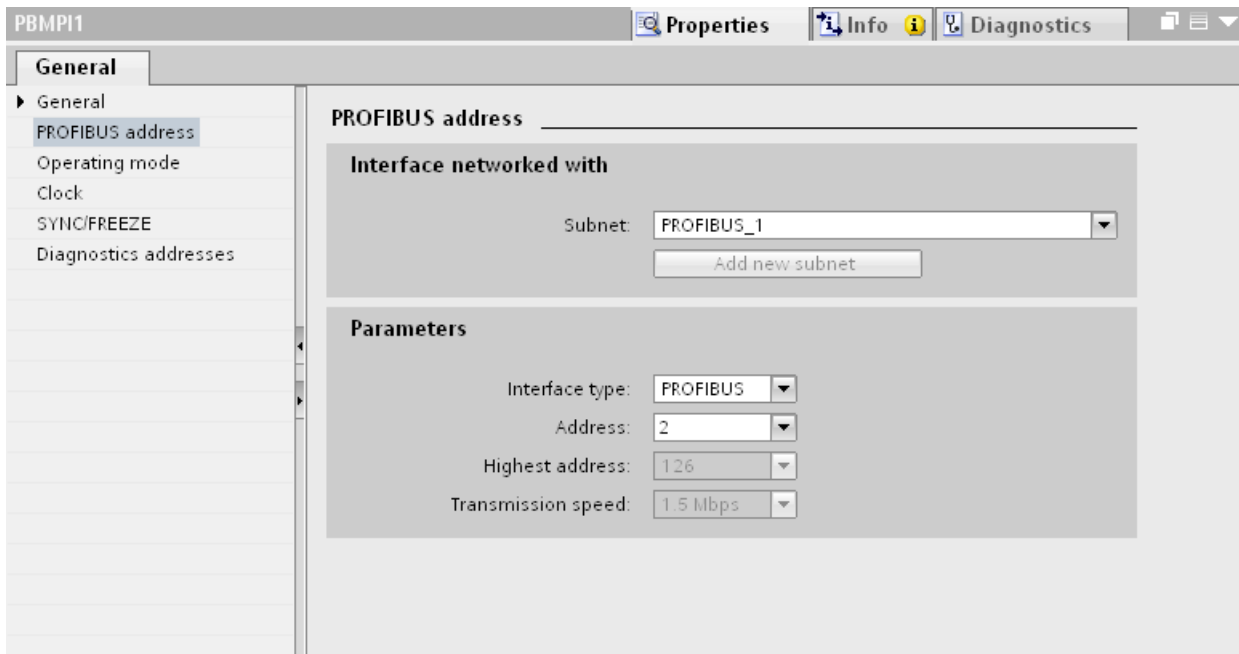

### "Interface networked with"

In the "Subnet" area, select the subnet of the HMI connection via which the PLC is connected to the network. You use the "Add new subnet" button to create a new subnet.

### "Parameters"

- "Interface type"  
Depending on the HMI device type, you have various interfaces to choose from.
- "Address"  
You assign the PROFIBUS address of the HMI device in the "Address" area. The PROFIBUS address must be unique throughout the PROFIBUS network.
- "Highest address"  
The "Highest address" area displays the highest address of the PROFIBUS network.
- "Transmission speed"  
The "Transmission speed" is determined by the slowest device connected to the network. The setting is identical throughout the network.

## Bus profiles with PROFIBUS

### Introduction

Depending on the device types connected and protocols used on the PROFIBUS, different profiles are available. The profiles differ in terms of the setting options and calculation of bus parameters. The profiles are explained below.

### Devices with different profiles on the same PROFIBUS subnet

The PROFIBUS subnet only functions without problem if the bus parameters of all devices have the same values.

### Profiles and transmission rates

Profiles	Supported transmission speeds in Kbits/s
DP	9,6 19,2 45,45 93,75 187,5 500 1500 3000 6000 12000
Standard	9,6 19,2 45,45 93,75 187,5 500 1500 3000 6000 12000
Universal	9,6 19,2 93,75 187,5 500 1500

### Meaning of profiles

Profile	Meaning
DP	<p>Select the "DP" bus profile when the only devices connected to the PROFIBUS subnet are those which satisfy the requirements of standard EN 50170 Volume 2/3, Part 8-2 PROFIBUS. The bus parameter setting is optimized on these devices.</p> <p>This includes devices with DP master and DP slave interfaces of the SIMATIC S7 and distributed I/Os of other manufacturers.</p>
Standard	<p>Compared to the "DP" profile, the "Standard" profile also offers scope for devices of another project or devices which have not been configured here to be taken into account when calculating the bus parameters. The bus parameters are then calculated following a simple, non-optimized algorithm.</p>
Universal	<p>Select the "Universal" bus profile when individual devices on the PROFIBUS subnet use the PROFIBUS-FMS service.</p> <p>This includes the following devices for example:</p> <ul style="list-style-type: none"> <li>• CP 343-5</li> <li>• PROFIBUS-FMS devices of other manufacturers</li> </ul> <p>As with the "Standard" profile, this profile allows you to take other devices into account when calculating the bus parameters.</p>



## Protection of communication

### Security levels

You can assign communication security levels to protect PLC and HMI device communication.

For an S7-1500 CPU, you can enter multiple passwords and thereby set up different access rights for various user groups.

The passwords are entered in a table, so that each password is assigned to exactly one protection level.

The effect of the password is given in the "Protection" column.

### Example

Select the "Complete protection" security level for a standard CPU (in other words, not an F-CPU) and enter a separate password for each security level in the table.

For users who do not know any of the passwords, the CPU is completely protected. Not even HMI access is possible.

For users who know one of the assigned passwords, the effect depends on the table row in which the password occurs:

- The password in row 1 (no protection) allows access as if the CPU were completely unprotected. Users who know this password have unrestricted access to the CPU.
- The password in row 2 (write protection) allows access as if the CPU were write-protected. Despite knowing the password, users who know this password only have read access to the CPU.
- The password in row 3 (read/write protection) allows access as if the CPU were read-protected and write-protected, so that only HMI access is possible for users who know this password.

## Access password for the HMI connection

### Introduction

Secure access to a PLC by assigning a password.

Assign the password when configuring the connection.

Input of the password of the PLC is mandatory as of "Complete protection" security level.

Communication to the PLC is denied if an incorrect password or no password is entered.

## Assigning password

Enter the access password for the HMI connection in the "Connections" editor.

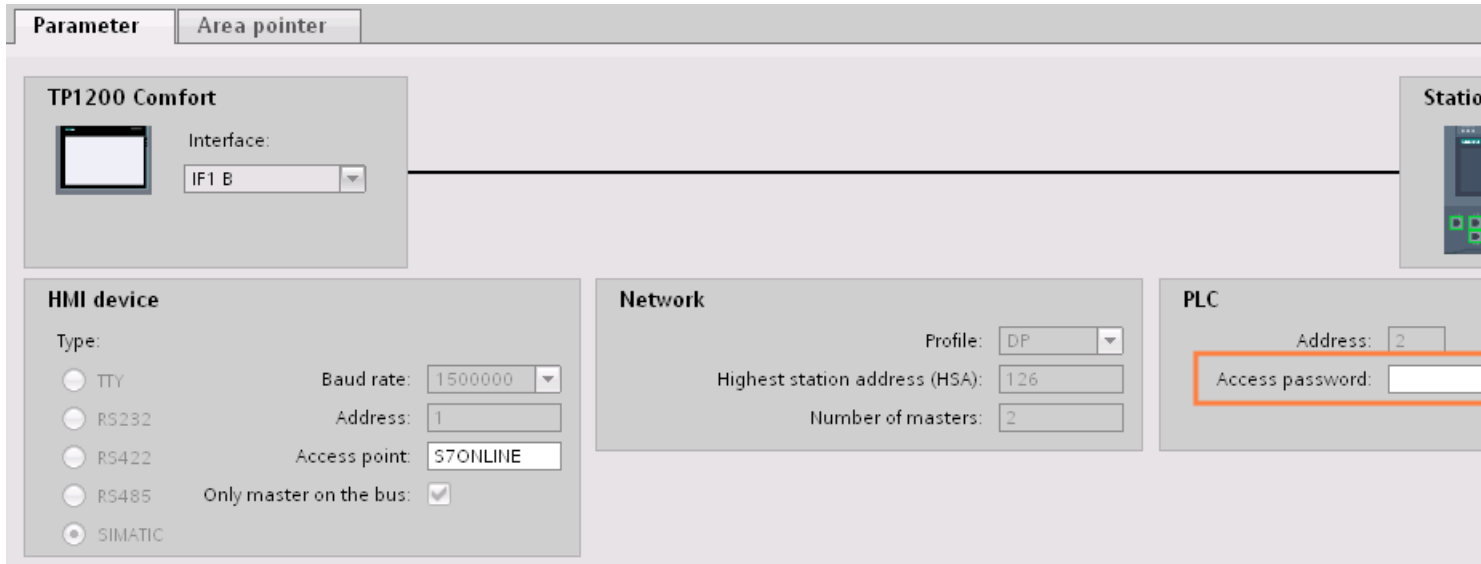

### 10.11.7.4 Data exchange

#### Data exchange using area pointers

#### General information on area pointers

#### Introduction

You use an area pointer to access a data area in the PLC. During communication, the PLC and the HMI device alternately access these data areas for read and write operations.

The PLC and the HMI device trigger defined interactions based on the evaluation of stored data.

#### Configuration of area pointers

Before you use an area pointer, you enable it under "Connections > Area pointer". You then assign the area pointer parameters.

You can find more detailed information on configuring area pointers in:

Configuring area pointers (Page 4956)

## Area pointer "Date/time"

### Function

This area pointer is used to transfer the date and time from the HMI device to the PLC.

The PLC writes control job "41" to the job mailbox.

When it evaluates the control job, the HMI device writes its current date and the time in the data area configured in the "Date/time" area pointer.

---

#### Note

You cannot use the "Date/Time PLC" area pointer if you have configured the "Date/Time" area pointer.

---

#### Note

Symbolic addressing is not possible if you are using the "Date/Time" area pointer.

---

The "Date/Time" area pointer when used in a project which contains multiple connections must be enabled for each configured connection.

The "Date/Time" area pointer when used in a project which contains multiple connections must be enabled for each configured connection.

The date/time data area has the following structure:

Data word	Most significant byte							Least significant byte							
	7						0	7						0	
n+0	Reserved							Hour (0 to 23)							Time
n+1	Minute (0 to 59)							Second (0 to 59)							
n+2	Reserved							Reserved							
n+3	Reserved							Weekday (1 to 7, 1=Sunday)							Date
n+4	Day (1 to 31)							Month (1 to 12)							
n+5	Year (80 to 99/0 to 29)							Reserved							

---

#### Note

When making entries in the "Year" data area, you should note that values 80 to 99 result in years 1980 through 1999, while the values 0 to 29 result in the years 2000 through 2029.

---

### Permitted data types

You can use the following data types when you configure the "Date/Time" area pointer.

- Word
- UInt
- DTL

### Use of the "DTL" data type

Use data type "DTL" with communication driver S7 1200. A tag of the "DTL" data type has a length of 12 bytes and saves information on date and time in a predefined structure.

The "DTL" data type has the following structure:

Byte	Component	Data type	Value range
0	Year	UINT	1970 to 2554
1			
2	Month	USINT	0 to 12
3	Day	USINT	1 to 31
4	Day of week	USINT	1(Sunday) to 7(Saturday) The weekday is not considered in the value entry.
5	Hour	USINT	0 to 23
6	Minute	USINT	0 to 59
7	Second	USINT	0 to 59
8	Nanoseconds	UDINT	0 to 999 999 999
9			
10			
11			

### "Date/time PLC" area pointer

#### Function

This area pointer is used to transfer the date and time from the PLC to the HMI device. Use this area pointer if the PLC is the time master.

The PLC loads the data area of the area pointer.

The HMI device reads the data cyclically within the configured acquisition cycle and synchronizes itself.

---

#### Note

Set an acquisition cycle of sufficient length for the date/time area pointer PLC to avoid any negative impact on HMI device performance.

Recommended: Acquisition cycle of 1 minute, if the process allows this.

---

"Date/Time PLC" is a global area pointer and may be configured only once per project.

---

#### Note

You cannot use the "Date/Time" area pointer if you have configured the "Date/Time PLC" area pointer.

---

The date/time data area has the following structure:

#### DATE\_AND\_TIME format (in BCD code)

Data word	Most significant byte			Least significant byte		
	7	.....	0	7	.....	0
n+0	Year (80 to 99/0 to 29)			Month (1 to 12)		
n+1	Day (1 to 31)			Hour (0 to 23)		
n+2	Minute (0 to 59)			Second (0 to 59)		
n+3	Reserved			Reserved	Weekday (1 to 7, 1=Sunday)	
n+4 <sup>1)</sup>	Reserved			Reserved		
n+5 <sup>1)</sup>	Reserved			Reserved		

- 1) The two data words must exist in the data area to ensure that the data format matches WinCC flexible and to avoid reading false information.

---

#### Note

When making entries in the "Year" data area, you should note that values 80 to 99 result in years 1980 through 1999, while the values 0 to 29 result in the years 2000 through 2029.

---

#### Permitted data types

You can use the following data types when you configure the "Date/Time PLC" area pointer:

- Word
- UInt
- DTL

#### Use of the "DTL" data type

Use data type "DTL" with communication driver S7 1200. A tag of the "DTL" data type has a length of 12 bytes and saves information on date and time in a predefined structure.

The "DTL" data type has the following structure:

Byte	Component	Data type	Value range
0	Year	UINT	1970 to 2554
1			
2	Month	USINT	0 to 12
3	Day	USINT	1 to 31
4	Day of week	USINT	1(Sunday) to 7(Saturday) The weekday is not considered in the value entry.
5	Hour	USINT	0 to 23
6	Minute	USINT	0 to 59
7	Second	USINT	0 to 59
8	Nanoseconds	UDINT	0 to 999 999 999
9			
10			
11			

The HMI devices do not support the use of nanoseconds. Values in the nanosecond range will be ignored during processing in Runtime.

## Area pointer "Coordination"

### Function

The "Coordination" area pointer is used to implement the following functions:

- Detecting the startup of the HMI device in the control program
- Detecting the current operating mode of the HMI device in the control program
- Detecting whether the HMI device is ready to communicate in the control program

By default, the "Coordination" area pointer has the length of one word and cannot be changed.

### Usage

---

#### Note

The HMI device always writes the entire coordination area when updating the area pointer. The control program can for this reason not make changes to the coordination area.

---

## Assignment of the bits in the "Coordination" area pointer

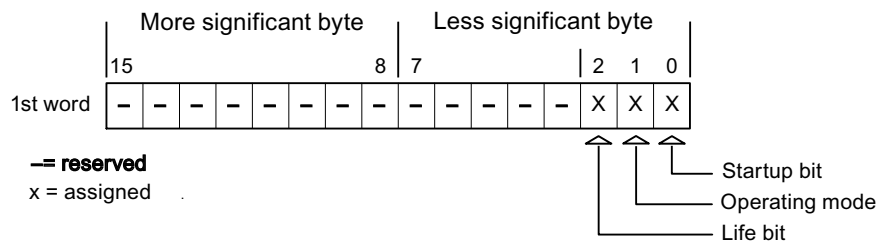

### Startup bit

The startup bit is set briefly to "0" by the HMI device during startup. It sets the bit permanently to "1" when startup is completed.

### Operating mode

The operating mode bit is set to 1 as soon as the user switches the HMI device offline. The status of the operating mode bit is "0" during normal operation of the HMI device. You can determine the current operating mode of the HMI device by reading this bit in the control program.

### Life bit

The HMI device inverts the life bit at intervals of approximately one second. You can check whether or not there is still a connection to the HMI device by querying this bit in the control program.

### Processing in the PLC

For a simpler evaluation in the PLC program, use a Bool array for this area pointer when using the SIMATIC S7 1200 communication driver. You will have to map the complete 16-bit word of the area pointer. Configure a tag of the data type "Array [0 .. 15] of bool" for this purpose.

### Permitted data types

You can use the following data types when you configure the "Coordination" area pointer.

- Word
- UInt
- Bool

## Area pointer "Screen number"

### Function

The HMI devices store information about the screen called up on the HMI device in the "Screen number" area pointer.

This allows the transfer of the current screen contents from the HMI device to the PLC. Certain reactions can be triggered in the PLC, such as the call of a different screen.

### Use

Before the "Screen number" area pointer can be used, it must be set up and activated by selecting "Communication ► Area pointer". You can create only **one** instance of the "Screen number" area pointer and only on **one** PLC.

The screen number is always transferred to the PLC when a new screen is activated or when the focus within a screen changes from one screen object to another.

### Structure

The area pointer is a data area in the memory of the PLC with a fixed length of 5 words.

	15	14	13	12	11	10	9	8	7	6	5	4	3	2	1	0
1. Word	Current screen type															
2. Word	Current screen number															
3. Word	Reserved															
4th word	Current field number															
5. Word	Reserved															

- Current screen type  
"1" for root screen or  
"4" for permanent window
- Current screen number  
1 to 32767
- Current field number  
1 to 32767

---

#### Note

##### Device dependency

Permanent windows are not available on Basic Panels.

---



### Permitted data types

You can use the following data types when you configure the "Screen number" area pointer.

- Word
- UInt

### Area pointer "Project ID"

#### Function

When Runtime starts it can check to see if the HMI device is connected to the correct PLC. This check is important when operating with several HMI devices.

For this, the HMI device compares a value stored on the PLC with the value specified in configuration. This ensures compatibility of the configuration data with the PLC program.

A missing compatibility results in a corresponding alarm and Runtime will not be started.

#### Use

To use this area pointer, set up the following during the configuration:

- Define the version of configuration. Values between 1 and 255 are possible. You enter the version in the editor "Runtime settings > General" in the "Identification" area.
- This is where you select the PLC tag or the tag array that you have configured as the data area for the area pointer.

#### Connection failure

A connection failure to a device on which the "project ID" area pointer is configured results in all the other connections of the device being switched to "offline".

This behavior has the following requirements:

- You have configured several connections in a project.
- You are using the "project ID" area pointer in at least one connection.

Causes which may set connections "offline":

- The PLC is not available.
- The connection has been switched offline in the engineering system.

### Permitted data types

You can use the following data types when you configure the "Project ID" area pointer.

- Word
- UInt

## Area pointer "Job mailbox"

### Function

The PLC can use the job mailbox to transfer jobs to the HMI device to trigger corresponding actions on the HMI device. These functions include, for example:

- Display screen
- Set date and time

### Data structure

The first word of the job mailbox contains the job number. Depending on the job mailbox, up to three parameters can be transferred.

Word	Most significant byte	Least significant byte
n+0	0	Job number
n+1	Parameter 1	
n+2	Parameter 2	
n+3	Parameter 3	

The HMI device evaluates the job mailbox if the first word of this job is not equal to zero. This means that the parameters must be entered in the job mailbox first, followed by the job number.

When the HMI device accepts the job mailbox, the first word is set to 0 again. The execution of the job mailbox is generally not completed at this point in time.

### Job mailboxes

All job mailboxes and their parameters are listed below. The "No." column contains the job number of the job mailbox. Job mailboxes can only be triggered by the PLC when the HMI device is online.

No.	Function	
<b>14</b>	<b>Set time (BCD-coded)</b>	
	Parameter 1	Left byte: - Right byte: hours (0-23)
	Parameter 2	Left byte: minutes (0-59) Right byte: seconds (0-59)
	Parameter 3	-
<b>15</b>	<b>Set date (BCD-coded)</b>	
	Parameter 1	Left byte: - Right byte: weekday (1-7: Sunday-Saturday)
	Parameter 2	Left byte: day (1-31) Right byte: month (1-12)
	Parameter 3	Left byte: year

No	Function	
<b>14</b>	<b>Set time (BCD-coded)</b>	
<b>23</b>	<b>User logon</b>	
	Logs the user on with the name "PLC user" at the HMI device with the group number transferred in Parameter 1. The logon is possible only when the transferred group number exists in the project.	
	Parameter 1	Group number 1 to 255
	Parameter 2, 3	-
<b>24</b>	<b>User logoff</b>	
	Logs off the current user. (The function corresponds to the "logoff" system function)	
	Parameter 1, 2, 3	-
<b>40</b>	<b>Transfer date/time to PLC</b>	
	An interval of at least 5 seconds must be maintained between two successive jobs to prevent overload of the HMI device.	
	Parameter 1, 2, 3	-
<b>41</b>	<b>Transfer date/time to PLC</b>	
	An interval of at least 5 seconds must be maintained between two successive jobs to prevent overload of the HMI device.	
	Parameter 1, 2, 3	-
<b>46</b>	<b>Update tag</b>	
	Causes the HMI device to read the current value of the tags from the PLC whose update ID matches the value transferred in Parameter 1. (Function corresponds to the "UpdateTag" system function.)	
	Parameter 1	1 - 100
<b>49</b>	<b>Clear event buffer</b>	
	Deletes all analog alarms and discrete alarms of the "Warnings" class from the alarm buffer.	
	Parameter 1, 2, 3	-
<b>50</b>	<b>Clear error alarm buffer</b>	
	Deletes all analog alarms and discrete alarms of the "Errors" class from the alarm buffer.	
	Parameter 1, 2, 3	-
<b>51</b>	<b>Display selection</b>	
	Parameter 1	Screen number
	Parameter 2	-
	Parameter 3	Field number
<b>69</b>	<b>Reading data record from PLC <sup>1)</sup></b>	
	Parameter 1	Recipe number (1-999)
	Parameter 2	Data record number (1-65535)
	Parameter 3	0: Do not overwrite existing data record 1: Overwrite existing data record
<b>70</b>	<b>Writing data record to PLC <sup>1)</sup></b>	
	Parameter 1	Recipe number (1-999)
	Parameter 2	Data record number (1-65535)
	Parameter 3	-

1)	Only devices supporting recipes
2)	OP 73, OP 77A and TP 177A HMI devices also execute the "Screen selection" job mailbox if the on-screen keyboard is active.
3)	The weekday is ignored on HMI device KTP 600 BASIC PN.

### Permitted data types

You can use the following data types when you configure the "Screen number" area pointer:

- Word
- UInt

### "Data record" area pointer

### "Data mailbox" area pointer

### Function

When data records are transferred between the HMI device and PLC, both partners access common communications areas on the PLC.

### Data transfer types

There are two ways of transferring data records between the HMI device and PLC:

- Transfer without synchronization
- Transfer with synchronization over the data mailbox

Data records are always transferred directly. That is, the tag values are read from an address or written to an address configured for this tag directly, without redirecting the values by means of interim memory.

### Initiating the transfer of data records

There are three ways of triggering the transfer:

- Operator input in the recipe view
- Job mailboxes  
The transfer of data records can also be triggered by the PLC.
- Triggering by configured functions

If the transfer of data records is triggered by a job mailbox, the data in the recipe view will be updated as well. Avoid operating the recipe view while job mailboxes for transfer of data records are being triggered. If you have already started editing a data record and a job mailbox is triggered for transfer of data records, then this job mailbox will be rejected.

## Permitted data types

You can use the following data types when you configure the "Data record" area pointer.

- Word
- UInt

## Transfer without synchronization

If you select asynchronous transfer of data records between the HMI device and PLC, there is no coordination over the common data areas. It is therefore unnecessary to set up a data area during configuration.

Asynchronous data record transfer can be a useful alternative, for example, when:

- The system is capable of excluding the risk of uncontrolled overwriting of data by the communication peer.
- The PLC does not require information about the recipe number and data record number.
- The transfer of data records is triggered by the operator of the HMI device.

## Reading values

When a read job is triggered, the values are read from the PLC addresses and transferred to the HMI device.

- Triggering by the operator in the recipe view:  
The values are downloaded to the HMI device. You can then process, edit, or save these values, for example.
- Triggering by a function or job mailbox:  
The values are saved immediately to the data volume.

## Writing values

When a write job is triggered, the values are written to the PLC addresses.

- Triggering by the operator in the recipe view:  
The current values are written to the PLC.
- Triggering by a function or job mailbox:  
The current values are written to the PLC from the data medium.

## Transfer with synchronization

If you select synchronous transfer, both communication partners set status bits in the common data area. Use this mechanism to prevent uncontrolled overwriting of data in either direction of your control program.

## Application

Synchronous data record transfer can be a useful solution, for example, when:

- The PLC is the "active partner" in the transfer of data records.
- The PLC evaluates the information about the recipe number and data record number.
- The transfer of data records is triggered by means of a Job mailbox.

## Requirements

In order to synchronize transfer of data records between the HMI device and the PLC, the following requirements must be met during configuration:

- An area pointer has been set up: "Connections ▶ Area pointer" editor.
- The PLC with which the HMI device synchronizes transfer of data records is specified in the recipe:  
"Recipes" editor in the inspector window the option "Coordinated transfer of data records" under "General > Synchronization > Settings"

## Structure of the data area

The data area has a fixed length of 5 words. Structure of the data area:

	<b>15</b>		<b>0</b>
1. Word	Current recipe number (1 - 999)		
2. Word	Current data record number (0 - 65535)		
3. Word	Reserved		
4. Word	Status (0, 2, 4, 12)		
5. Word	Reserved		

- Status  
The status word (word 4) can adopt the following values:

Value		Meaning
Decimal	Binary	
0	0000 0000	Transfer permitted, data record free
2	0000 0010	Transfer is busy
4	0000 0100	Transfer completed without error
12	0000 1100	Transfer completed with error

**Sequence of a transfer started by the operator in the recipe display****Reading from the PLC started by the operator in the recipe view**

Step	Action	
1	Check: Status word = 0?	
	Yes	No
2	The HMI device enters the recipe number to be read and the status "Transferring" in the data mailbox and sets the data record number to 0.	Abort with system alarm.
3	The HMI device reads the values from the PLC and displays them in the recipe view. If the recipes have synchronized tags, the values from the PLC are also written to the tags.	
4	The HMI device sets the status "Transfer completed."	
5	The control program must reset the status word to zero in order to enable further transfers.	

**Writing to the PLC started by the operator in the recipe view**

Step	Action	
1	Check: Status word = 0?	
	Yes	No
	The HMI device enters the recipe and data record number to be written and the status "Transferring" in the data mailbox.	Abort with system alarm.
2	The HMI device writes the current values to the PLC. If the recipes have synchronized tags, the changed values are synchronized between the recipe view and tags and then written to the PLC.	
3	The HMI device sets the status "Transfer completed."	
4	If required, the control program can now evaluate the transferred data.	
5	The control program must reset the status word to zero in order to enable further transfers.	

**Note**

The status word may only be set by the HMI device. The PLC may only reset the status word to zero.

**Note**

The PLC may only evaluate the recipe and data record numbers when data inconsistency is detected if one of the conditions outlined below has been met:

- The data mailbox status is set to "Transfer completed".
- The data mailbox status is set to "Transfer completed with error".

**Sequence of the transfer triggered by a job mailbox**

The transfer of data records between the HMI device and the PLC can be initiated by either one of these stations.

The two job mailboxes No. 69 and No. 70 are available for this type of transfer.

**No. 69: Read data record from PLC ("PLC → DAT")**

Job mailbox no. 69 transfers data mailboxes from the PLC to the HMI device. The job mailbox is structured as follows:

	Most significant byte	Least significant byte
Word 1	0	69
Word 2	Recipe number (1-999)	
Word 3	Data record number (1-65,535)	
Word 4	Do not overwrite existing data record: 0 Overwrite existing data record: 1	

**No. 70: Write data record to PLC ("DAT → PLC")**

Job mailbox no. 70 transfers data mailboxes from the HMI device to the PLC. The job mailbox is structured as follows:

	Most significant byte	Least significant byte
Word 1	0	70
Word 2	Recipe number (1-999)	
Word 3	Data record number (1-65,535)	
Word 4	—	

**Sequence when reading from the PLC with job mailbox "PLC → DAT" (no. 69)**

Step	Action	
1	Check: Status word = 0?	
	Yes	No
2	The HMI device enters the recipe and data record number specified in the job and the status "Transferring" in the data mailbox.	Abort without return message.



Step	Action
3	The HMI device reads the values and stores the values in the data record specified in the job mailbox.
4	<ul style="list-style-type: none"> <li>If "Overwrite" was selected in the job, an existing data record is overwritten without any prompt for confirmation. The HMI device sets the status "Transfer completed".</li> <li>If "Do not overwrite" was selected in the job, and the data record already exists, the HMI device aborts the job and enters 0000 1100 in the status word of the data mailbox.</li> </ul>
5	The control program must reset the status word to zero in order to enable further transfers.

### Sequence writing to the PLC with job mailbox "DAT → PLC" (no. 70)

Step	Action	
1	Check: Status word = 0?	
	<table border="1"> <tr> <td>Yes</td> <td>No</td> </tr> </table>	Yes
Yes	No	
2	The HMI device enters the recipe and data record number specified in the job and the status "Transferring" in the data mailbox. <span style="float: right;">Abort without return message.</span>	
3	The HMI device fetches the values of the data record specified in the job from the data medium and writes the values to the PLC.	
4	The HMI device sets the status "Transfer completed."	
5	The PLC program can now evaluate the transferred data. To allow further transfers, the PLC program must set the status word to 0 again.	

### Sequence of the transfer when triggered by a configured function

#### Reading from the PLC using a configured function

Step	Action	
1	Check: Status word = 0?	
	<table border="1"> <tr> <td>Yes</td> <td>No</td> </tr> </table>	Yes
Yes	No	
2	The HMI device enters the recipe and data record number specified in the function and the status "Transferring" in the data mailbox. <span style="float: right;">Abort with system alarm.</span>	
3	The HMI device reads the values from the PLC and stores them in the data record specified in the function.	
4	<ul style="list-style-type: none"> <li>If "Yes" was selected for the "Overwrite" function, an existing data record is overwritten without any prompt for confirmation. The HMI device sets the status "Transfer completed."</li> <li>If "No" was selected for the "Overwrite" function and the data record already exists, the HMI device aborts the job and enters 0000 1100 in the status word of the data mailbox.</li> </ul>	
5	The control program must reset the status word to zero in order to enable further transfers.	

### Writing to the PLC by means of configured function

Step	Action	
1	Check: Status word = 0?	
	Yes	No
2	The HMI device enters the recipe and data record number specified in the function and the status "Transferring" in the data mailbox.	Abort with system alarm.
3	The HMI device fetches the values of the data record specified in the function from the data medium and transfers the values to the PLC.	
4	The HMI device sets the status "Transfer completed."	
5	The control program can now evaluate the transferred data. The control program must reset the status word to zero in order to enable further transfers.	

### Possible causes of error when transferring data records

#### Possible causes of error

The section below shows possible error causes which lead to the cancellation of data record transfer:

- Tag address not set up on the PLC
- Overwriting data records not possible
- Recipe number does not exist
- Data record number does not exist

---

#### Note

The status word may only be set by the HMI device. The PLC may only reset the status word to zero.

---

#### Note

The PLC may only evaluate the recipe and data record numbers when data inconsistency is detected if one of the conditions outlined below has been met:

- The data mailbox status is set to "Transfer completed".
  - The data mailbox status is set to "Transfer completed with error".
-

## Reaction to an aborted transfer due to errors

If the transfer of data records is aborted due to errors, the HMI device reacts as follows:

- Triggering by the operator in the recipe view  
Information in the status bar of the recipe view and output of system alarms
- Triggered by function  
Output of system alarms
- Triggering by job mailbox  
No return message on the HMI device

You can nonetheless evaluate the status of the transfer by querying the status word in the data mailbox.

---

### Note

#### Availability for specific devices

Notes in the status bar of the recipe view are not available in Basic Panels.

---

## Trends

### General information on trends

#### Trends

A trend is the graphical representation of one or more values from the PLC. The value is read out either time- or bit-triggered, depending on the configuration.

For additional information see:

Displaying tags with Runtime Advanced and Panels (Page 3237)

---

### Note

The value is read out time-triggered for Basic Panels.

---

### Time-triggered trends

The HMI device reads in the trend values cyclically at an interval specified in the configuration. Time-triggered trends are suitable for continuous curves, such as the operating temperature of a motor.

### Bit-triggered trends

Through a trigger bit set in the trend request tag, the HMI device either reads in a trend value or an entire trend buffer. This setting is defined in the configuration. Bit-triggered trends are normally used to represent fast changing values. One example might be the injection pressure in the production of plastic parts.

To trigger bit-triggered trends, appropriate external tags must be created in the "HMI tags" editor and connected to trend areas during configuration. The HMI device and PLC then communicate with each other via these trend areas.

The following areas are available for trends:

- Trend request area
- Trend transfer area 1
- Trend transfer area 2 (required only with switch buffers)

**See also**

Trends (Page 3237)

**Trend request and trend transfer**

**Trend request area**

The HMI device sets corresponding bits in the trend request area when you open a screen which contains one or more trends on the HMI device. After closing the screen, the HMI device resets the relevant bits in the trend request area.

The trend request area can be used for evaluation purposes in the PLC to determine which trend is currently being displayed on the HMI device. Trends can also be triggered without evaluation of the trend request area.

**Trend transfer area 1**

This area is used to trigger trends. You must set the bit assigned to the trend in the trend transfer area and set the trend group bit in your control program. The trend group bit is the last bit in the trend transfer area.

The HMI device detects the trigger. The HMI device reads either a value or the entire buffer from the PLC. It then resets the trend bit and the trend group bit.

The following picture shows the structure of a trend transfer area.

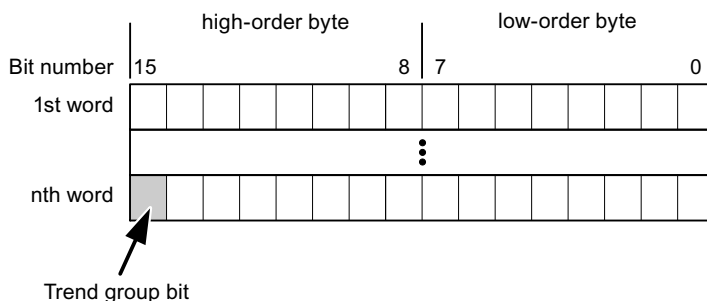

The trend transfer area must not be modified by the PLC program until the trend group bit has been reset.

## Trend transfer area 2

Trend transfer area 2 is required for trends configured with a switch buffer. The trend transfer areas 1 and 2 have a similar structure.

## Switch buffer

The switch buffer is a second buffer for the same trend that can be set up during configuration.

The PLC writes to Buffer 2 while the HMI device reads values from Buffer 1, and writes to Buffer 1 when the HMI device is reading Buffer 2. This prevents the PLC from overwriting trend values while the trend is being read by the HMI device.

## Permitted data types for trends

### For SIMATIC S7

You assign one bit to each trend during configuration. Tags and array tags of the "Word" or "Int" data type are permitted.

## Alarms

### Configuring alarms

#### Configure alarms

Several steps are needed to configure alarms, such as operational messages, error alarms, and acknowledgement.

- Step 1: Create tags
- Step 2: Configure alarms
- Step 3: Configure acknowledgment

You can find additional information in the section:

Working with Alarms (Page 3260)

#### Distinctive features when configuring alarms

If you are configuring connections of HMI devices to PLCs of other manufacturers, note the following distinctive features when configuring:

- Data types of the tags
- Addressing of tags
- How the bit positions are counted

## Data types

For connections with a SIMATIC communication driver, the following data types are supported:

PLC	Permitted data types	
	Discrete alarms	Analog alarms
SIMATIC S7 PLCs	WORD, INT	BYTE, CHAR, WORD, INT, DWORD, DINT, REAL, TIMER

## How the bit positions are counted

For connections with a SIMATIC communication driver, the following counting method applies:

How the bit positions are counted	Byte 0							Byte 1						
	Most significant byte							Least significant byte						
In SIMATIC S7 PLCs	7						0	7						0
In WinCC you configure:	15						8	7						0

## Acknowledgment of alarms

### Procedure

Create suitable tags on the PLC to acknowledge an error alarm. You assign these tags to an alarm in the "Bit messages" editor. You make the assignment in "Properties > Acknowledgment".

Distinction in terms of acknowledgment:

- Acknowledgment by the PLC
- Acknowledgment on the HMI device

### Acknowledgment by the PLC

In "PLC acknowledgment tag", configure the tag or array tag and the bit number that the HMI device uses to identify a PLC acknowledgment.

A bit set in the tag triggers acknowledgment of the assigned error alarm bit at the HMI device. This tag bit returns a function similar to acknowledgment on the HMI device which is triggered by pressing the "ACK" button, for example.

The acknowledgment bit must be located in the same tag as the bit for the error alarm.

Reset the acknowledgment bit before setting the bit in the alarm area again. The figure below shows the pulse diagram.

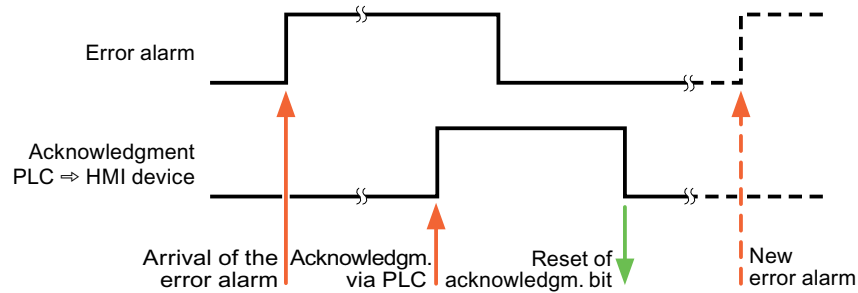

### Acknowledgment on the HMI device

In the "HMI acknowledgment tag" area, configure the tag or array tag as well as the bit number that the HMI device writes to the PLC after acknowledgment. Make sure when you use an array tag that it is not longer than 6 words.

To always create a signal change when setting an assigned acknowledgment bit of a discrete alarm that must be acknowledged, the HMI device will reset the acknowledgment bit assigned to the alarm as soon as it detects an alarm subject to acknowledgment and write the acknowledgment tag in the PLC. There will be a certain delay between detecting the message and writing the acknowledgment tag in the PLC because the HMI device has to process the operations.

If a discrete alarm subject to acknowledgment is acknowledged by the HMI device, then the corresponding bit in the assigned acknowledgment tag will be set. The entire acknowledgment tag is then written to the PLC by the HMI device. This allows the PLC to recognize that a certain alarm message has been acknowledged at the HMI device.

#### Note

All alarm bits acknowledged since the last Runtime start will remain in the acknowledgment tag until a new incoming of the respective discrete alarms is detected.

This area should only be read by the PLC because the entire section of the HMI device will be overwritten once the next acknowledgment tag is written.

The figure below shows the pulse diagram.

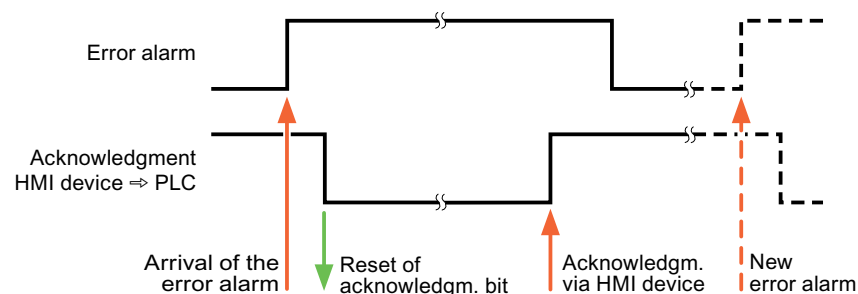

## LED mapping

### Function

Keyboard devices have LEDs in the function keys. These LEDs can be activated from the PLC. Thus, it is possible, for example, to signal to the user which key he should press in a given situation by lighting up an LED.

---

#### Note

The LED function cannot be configured for Basic Panels.

---

### Requirements

In order to activate an LED, an LED tag or an array tag must be set up in the PLC and specified as an LED tag during configuration.

### LED assignment

The assignment of the individual LEDs to the bits in the LED tags is specified when the function keys are configured. In this process, the "LED tag" and the assigned "Bit" are specified for each function key in the "General" group of the properties window.

The "Bit" bit number designates the first of two consecutive bits that control the following LED statuses.

Bit n+ 1	Bit n	LED function	
		All Mobile Panels, all Operator Panels, all Multi Panels	Panel PCs:
0	0	Off	Off
0	1	Rapid flashing	Flashing
1	0	Slow flashing	Flashing
1	1	On permanently	On permanently

#### 10.11.7.5 Performance features of communication

### S7-1200 device dependency

#### Communication with the SIMATIC S7-1200 controller

If you use devices from an earlier version of the TIA Portal with TIA Portal V12 SP1, it may not be possible to configure integrated connections to certain HMI devices.



**Version V1.0**

You can configure the SIMATIC S7-1200 controller with version V1.0 in the following scenarios:

TIA Portal	Basic Panels	Panels	Comfort Panels	RT Advanced
V11	Yes	Yes	No	No
V12	No	No	No	No

**Version V2.0**

You can configure the SIMATIC S7-1200 controller with version V2.0 in the following scenarios:

TIA Portal	Basic Panels	Panels	Comfort Panels	RT Advanced
V11	Yes	Yes	Yes	Yes
V12	Yes	Yes	Yes	Yes

**Version V3.0**

You can configure the SIMATIC S7-1200 controller with version V3.0 in the following scenarios:

TIA Portal	Basic Panels	Panels	Comfort Panels	RT Advanced
V11	Yes	Yes	Yes	Yes
V12	Yes	Yes	Yes	Yes

**Version V4.0**

You can configure the SIMATIC S7-1200 controller with version V4.0 in the following scenarios:

TIA Portal	Basic Panels	Panels	Comfort Panels	RT Advanced
V11	No	No	No	No
V12	Yes	Yes	Yes	Yes

**Permitted data types for SIMATIC S7 1200 - V2****Permitted data types for connections with SIMATIC S7 1200 (V2)**

The table lists the user data types that can be used when configuring tags and area pointers.

Data type	Length
BOOL	1-bit
SINT	1 byte
INT	2 bytes
DINT	4 bytes

Data type	Length
USINT	1 byte
UINT	2 bytes
UDINT	4 bytes
REAL	4 bytes
LREAL	8 bytes
TIME	4 bytes
DATE	2 bytes
DTL	12 bytes
TIME_OF_DAY, TOD	4 bytes
STRING	(2+n) bytes, n = 0 to 254
CHAR	1 byte
BYTE	1 byte
WORD	2 bytes
DWORD	4 bytes

### 10.11.7.6 Creating connections in the "Connections" editor

#### Creating a PROFINET connection

##### Requirements

- A project is open.
- An HMI device with a PROFINET interface has been created.

## Procedure

1. Open the "Connections" editor of the HMI device.
2. Double-click "<Add>".

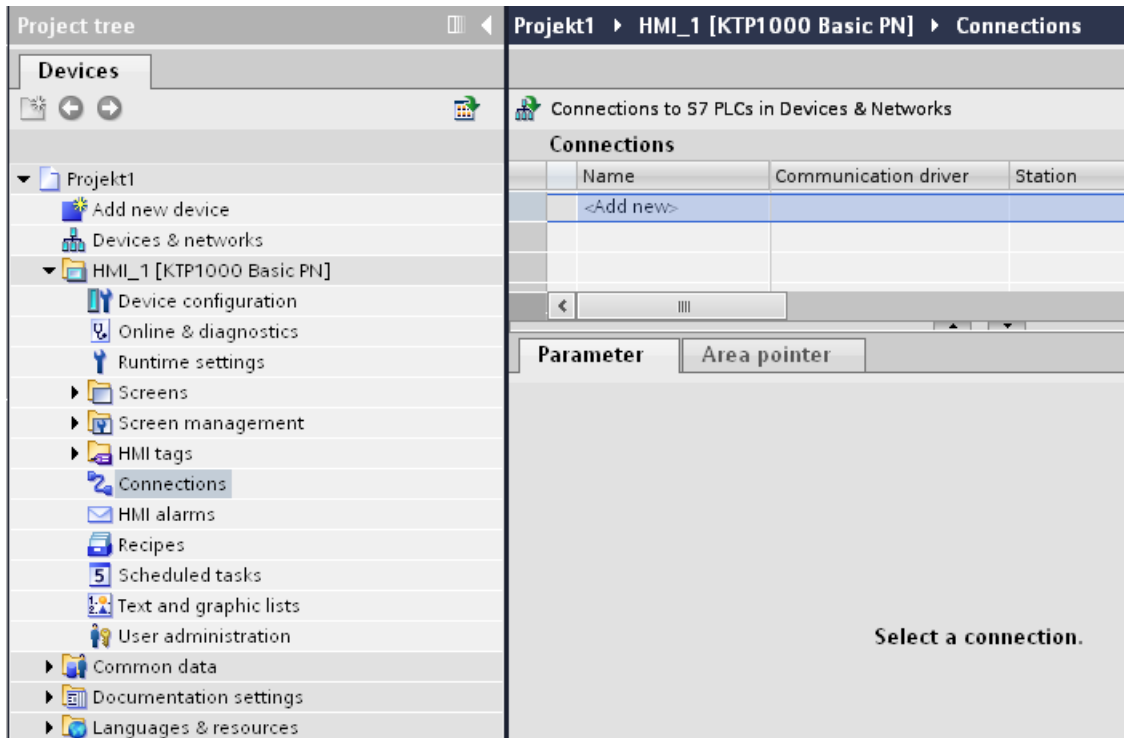

3. In the "Communication drivers" column, select the "SIMATIC S7 1200" driver.
4. Click the name of the connection.

5. Select a PROFINET interface of the HMI device in the Inspector window under "Parameters > Interface".

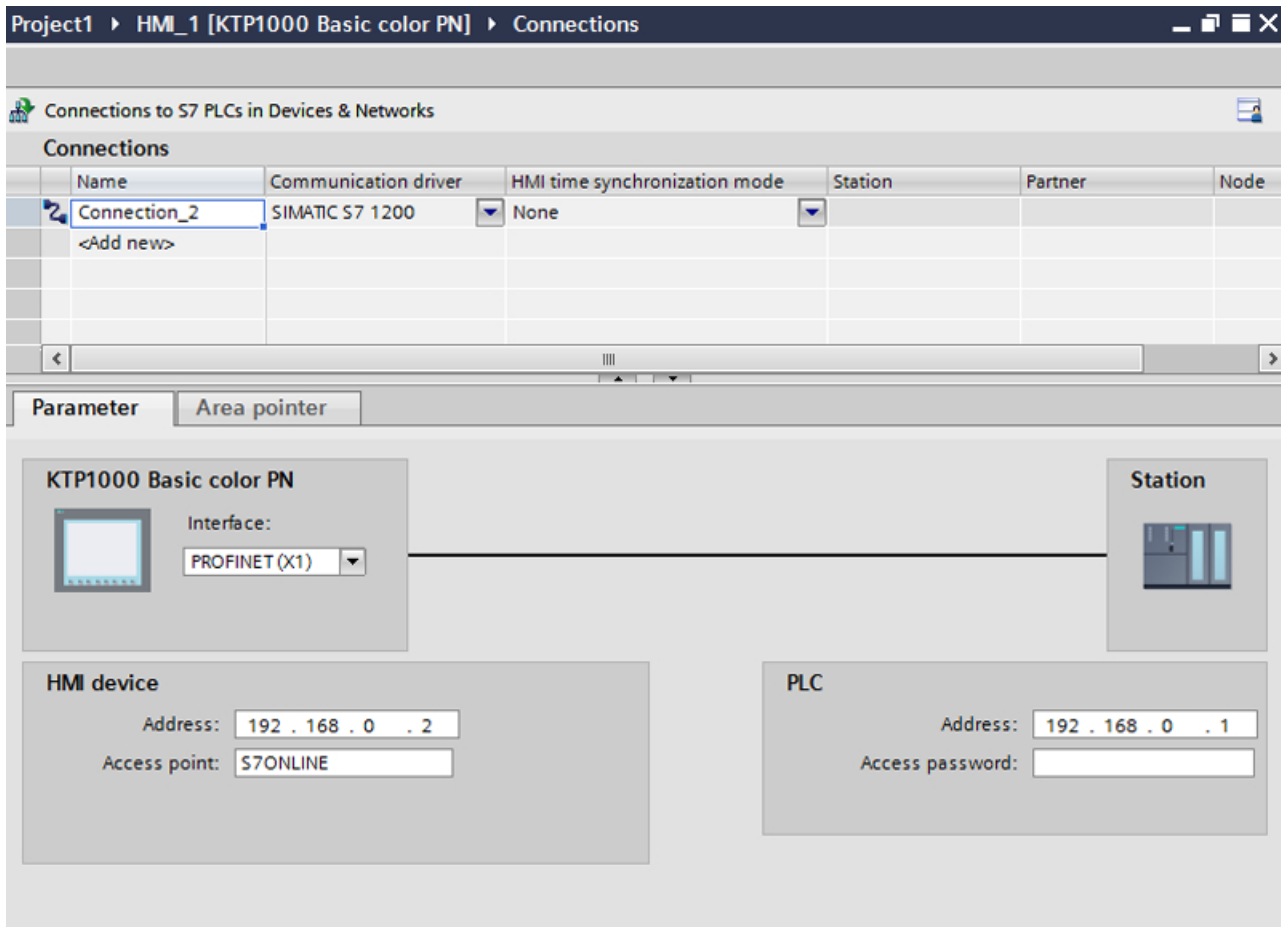

6. Set the IP addresses of the communication partners in the Inspector window:
  - HMI device: "Parameters > HMI device > Address"
  - PLC: "Parameters > PLC > Address"

## Creating a PROFIBUS DP connection

### Requirements

- A project is open.
- An HMI device with a PROFIBUS interface has been created.

## Procedure

1. Open the "Connections" editor of the HMI device.
2. Double-click "<Add>".

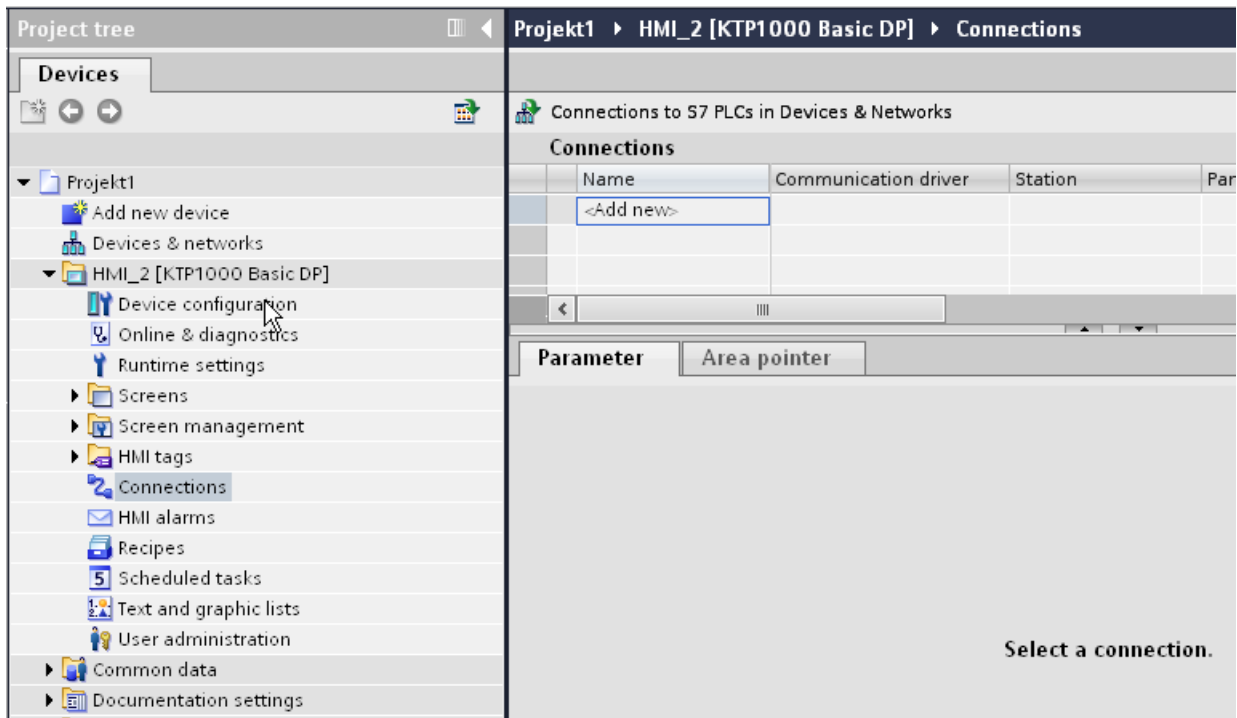

3. In the "Communication drivers" column, select the "SIMATIC S7 1200" driver.
4. Click the name of the connection.
5. Select the "MPI/DP" interface in the Inspector window under "Parameters".

6. Select the "DP" profile in the Inspector window under "Parameters > Network".

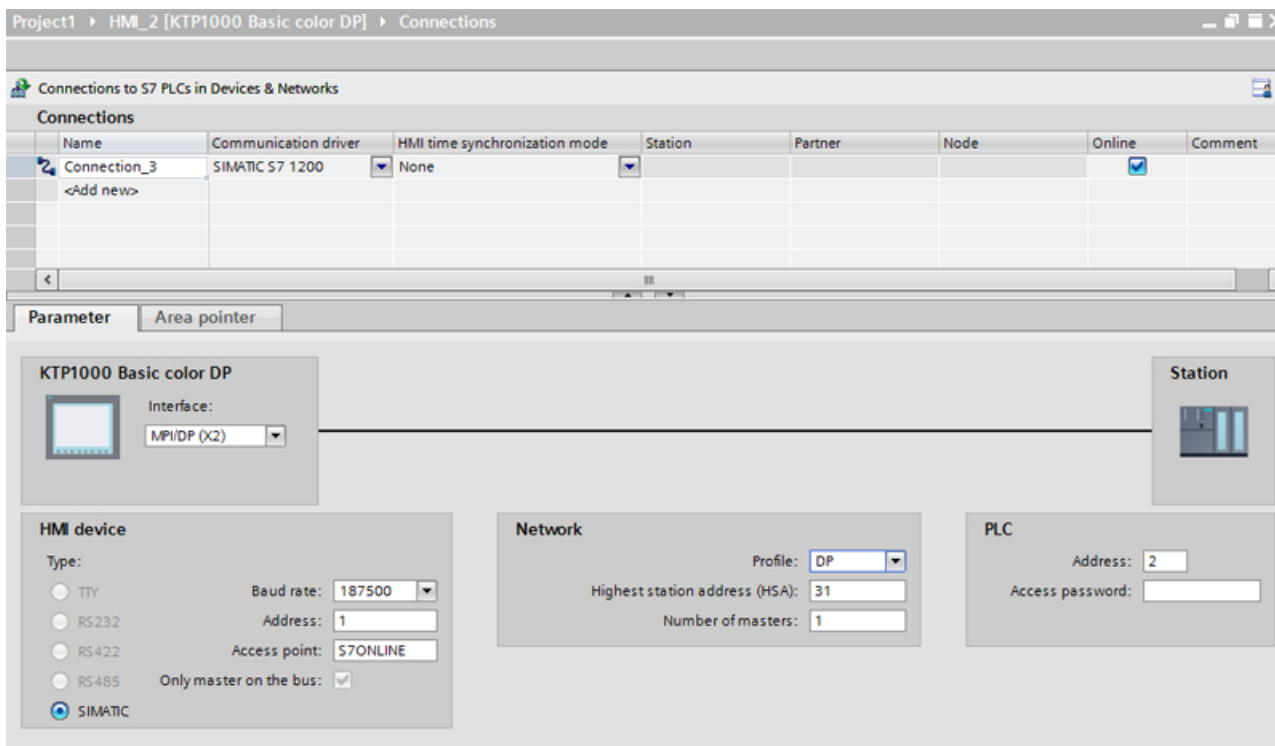

7. Set the addresses of the communication partners in the Inspector window:

- HMI device: "Parameters > HMI device > Address"
- PLC: "Parameters > PLC > Address"

### Parameters for the connection

### Parameters for the connection (SIMATIC S7 1200)

### Parameters to be set

To assign the connection parameters, such as addresses and profiles, click the connection that you have created in the "Connections" editor.

The communication partners are displayed schematically in the Inspector window under "Parameters". The "HMI device", "Network", and "PLC" areas are available for assigning parameters according to the interface used.

Project1 > HMI\_1 [KTP1000 Basic color PN] > Connections

Connections to S7 PLCs in Devices & Networks

**Connections**

Name	Communication driver	HMI time synchronization mode	Station	Partner	Node
Connection_2	SIMATIC S7 1200	None			
<Add new>					

Parameter | Area pointer

**KTP1000 Basic color PN**



Interface:

**Station**



---

**HMI device**

Address:

Access point:

**PLC**

Address:

Access password:

## Ethernet parameters

### Parameters for the HMI device

You set the parameters for the HMI device in the network under "HMI device".. The changes are not transferred automatically to the HMI device. You must change the settings in the Control Panel of the HMI device.

- "Interface"  
If you are directly connected to the HMI device during configuration, you can set up the IP address of the HMI device in WinCC.

---

#### Note

The IP address in the Control Panel will be overwritten upon subsequent loading if you have already set up the IP address in the HMI device control panel.

The IP address already set up in the Control Panel will be retained upon subsequent loading if you activate "Set IP address using a different method".

---

The IP address is transferred to the HMI device during project transfer.  
To set up the IP address of the HMI device:

- Click the HMI device.
- Open the "Device configuration" editor.
- Click the Ethernet interface.
- Assign the IP address in the inspector window under:  
"General > PROFINET interface > Ethernet addresses"
- "Address"  
You assign the IP address of the HMI device in the "Address" area.  
When you transfer the WinCC project to the HMI device, this IP address is set up directly in the HMI device.
- "Access point"  
Specifies the access point for the PG/PC interface that can be used to reach the communication partner.



## Parameters for the PLC

Under "PLC", you address the S7 module with which the HMI device will exchange data. Assign a name for the connection for each communication partner.

- "Address"  
Under "Address", set the IP address of the S7 module to which the HMI device is connected.
- "Access password"  
Enter a password in the "Access password" field. This password must match the one you saved to the PLC.

---

### Note

You only need a password if you have set "Complete protection" at the PLC.

No connection is set up to the PLC if the "Complete protection" security level is stored on the PLC and you do not enter a password.

---

## PROFIBUS parameters

### Parameters for the HMI device

You assign the parameters for the HMI device in the network once under "HMI device". The change applies to each communication partner.

- "Type"  
Specifies the physical connection used.
- "Interface"  
For "Interface", you select the HMI device interface via which the HMI device is connected to the PROFIBUS network.
- "Baud rate"  
For "Baud rate", you set the transmission speed of the data in the network. The baud rate is determined by the slowest HMI device connected to the network. The setting must be identical throughout the network.

---

### Note

If you set a baud rate of 1.5 Mbaud for OP 73 or OP 77A, the highest station address must be less than or equal to 63.

---

- "Address"  
You set the PROFIBUS address of the HMI device under "Address". The PROFIBUS address must be unique in the PROFIBUS network.

- "Sole master on bus"  
Disables an additional safety feature against bus faults when the HMI device is connected to the network. A passive station (slave) can only send data if it is requested to do so by an active station (master).  
In S7 200, you must set an HMI device as the master.
- "Access point"  
The access point defines a logical device name through which the communication partner can be reached.

### Parameters for the network

Under "Network", you set the parameters for the PROFIBUS network to which the HMI device is linked.

- "Profile"  
For "Profile", you select the network profile that is used in the network. In "Profile", set "DP", "Universal", or "Standard". The setting must be identical throughout the network.
- "Highest address"  
For "Highest station address", set the highest station address. The highest station address must be greater than or equal to the highest actual PROFIBUS address. The setting must be identical throughout the network.

---

#### Note

If you set a baud rate of 1.5 Mbaud in the OP 73 or the OP 77A, the highest station address must be less than or equal 63.

---

- "Number of masters"  
For "Number of masters", set the number of masters in the PROFIBUS network. This information is necessary to correctly calculate the bus parameters.

## Parameters for the PLC

Under "PLC", you address the S7 module with which the HMI device will exchange data. Assign a name for the connection for each communication partner.

- "Address"  
For "Address", set the PROFIBUS address of the S7 module (CPU, FM, or CP) to which the HMI device is connected.
- "Access password"  
Enter a password in the "Access password" field. This password must match the one you saved to the PLC.

---

### Note

You only need a password if you have set "Complete protection" at the PLC.

No connection is set up to the PLC if the "Complete protection" security level is stored on the PLC and you do not enter a password.

---

## 10.11.7.7 Time synchronization

### Time synchronization

#### Introduction

To have the same time of day throughout the plant, you can synchronize the time on various plant components using time synchronization. WinCC time synchronization is operated as a master-slave system.

One system component must be a clock for all components of a plant to work with identical time. The component functioning as the clock is referred to as the time master. The components that receive the time are time slaves.

#### Properties of time synchronization

- The HMI device can define the time as master or can accept the time of the PLC as slave.
- In "master mode", the time is synchronized at each connection setup.
- In "slave mode", the time is synchronized at each connection setup and then at cyclic intervals of 10 minutes.
- The first time synchronization is performed on the HMI device immediately after the start of runtime.
- Time synchronization is only performed on the HMI device during operation of runtime.

## Time synchronization restrictions

### Approved HMI devices

You can configure the time synchronization between a SIMATIC S7 1200 or SIMATIC S7 1500 and an HMI device with the following HMI devices:

Device	Operating system
Basic Panels	-
TP177 4"	Windows CE 5.0
Multi Panel 177	Windows CE 5.0
Multi Panel 277	Windows CE 5.0
Multi Panel 377	Windows CE 5.0
Mobile Panel 277	Windows CE 5.0
Mobile 277 IWLAN V2	Windows CE 5.0
Comfort Panels	Windows CE 6.0
PC systems with WinCC RT Advanced	Microsoft Windows XP Microsoft Windows 7

### Configuration restrictions

- If an HMI device has several connections to SIMATIC S7 1200 or SIMATIC S7 1500, you can only configure one connection as "slave".
- If you have enabled time synchronization for the HMI device as "slave", you can no longer use the global area pointer "Date/time PLC".
- An HMI device can only request the time from a PLC with "Complete protection" security type configuration if the correct "Access password" is configured. Configure the "Access password" for communication with a PLC with "Complete protection" security type in the "Connections" editor of the HMI device. This "Access password" must match the password configured on the PLC. The PLC password is assigned in the PLC properties at: "General > Security"
- Basic Panels can only be configured as "Slave".
- If you use Basic Panels for the configuration, it is not possible to use time synchronization via NTP and the "Date/time PLC" area pointer simultaneously.

## Configuring time synchronization for integrated connections

### Introduction

You configure time synchronization for an integrated connection in the "Devices & Networks" editor.

## Requirements

- An HMI connection between an HMI device and a SIMATIC S7 1200 has been configured.
- The HMI device must support the "time synchronization" function.
- The "Devices & Networks" editor is open.

## Procedure

1. Click the line of the HMI connection in the "Devices & networks" editor.
2. Select the following in the inspector window under "General > Time synchronization > Settings":
  - None: No time synchronization is used.
  - Master: The HMI device sets the time.
  - Slave: The PLC sets the time.

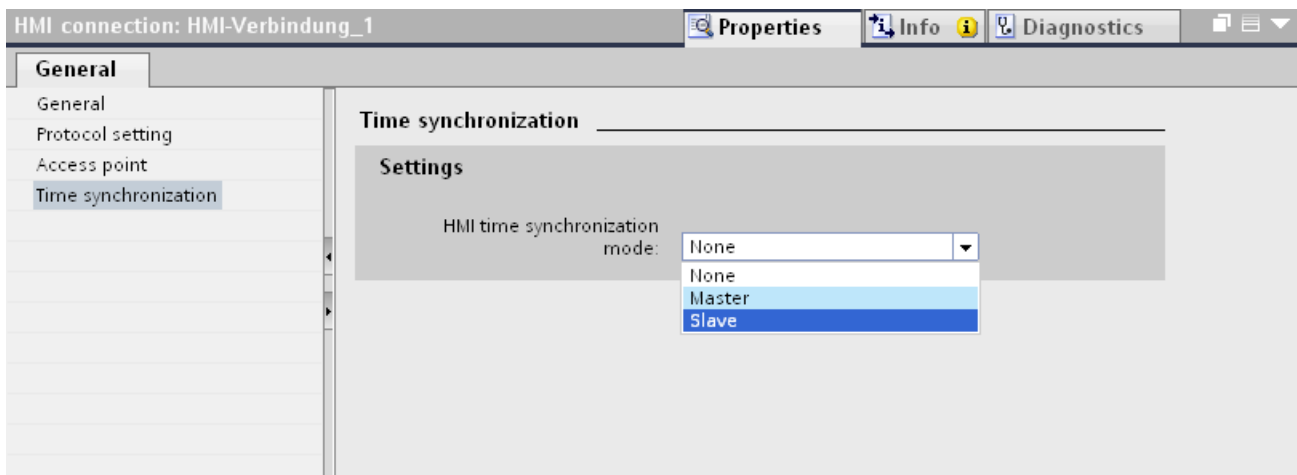

## Configuring time synchronization for non-integrated connections

### Introduction

You configure time synchronization for a non-integrated connection in the "Connections" editor.

### Requirements

- An HMI device which supports the "time synchronization" function has been created.
- "Connections" editor is open.

## Procedure

1. Double-click "<Add>".
2. In the "Communication drivers" column, select the "SIMATIC S7 1200" PLC.
3. Select the following in the "HMI time synchronization mode" column:
  - None: No time synchronization is used.
  - Master: The HMI device sets the time.
  - Slave: The PLC sets the time.

Name	Communication driver	HMI time synchronization mode	Station	Partner	Node
HMI-Verbindung_1	SIMATIC S7 1200	Master	SIMATIC 1200-Station	PLC_1	CPU 1214
<Add new>		None Master Slave			

**Parameter** | Area pointer

**TP1200 Comfort**  
Interface: ETHERNET

**HMI device**  
Address: 192.168.0.2  
Access point: S7ONLINE

**Stazione**

**PLC**  
Address: 192.168.0.1

## 10.11.8 Communicating with SIMATIC S7 300/400

### 10.11.8.1 Communication with SIMATIC S7 300/400

#### Introduction

This section describes the communication between an HMI device and the SIMATIC S7 300 and S7 400 PLCs. These two PLCs will be referred to jointly as SIMATIC S7 300/400.

You can configure the following communication channels for the SIMATIC S7 300/400 PLC:

- PROFINET
- PROFIBUS
- MPI

### HMI connection for communication

You configure connections between the HMI device and a SIMATIC S7 300/400 in the "Devices & Networks" editor.

#### 10.11.8.2 Communication via PROFINET

##### Configuring an HMI connection

##### Communication via PROFINET

##### HMI connections via PROFINET

If you have inserted an HMI device and a SIMATIC S7 300/400 into the project, you interconnect the two PROFINET interfaces in the "Devices & Networks" editor.

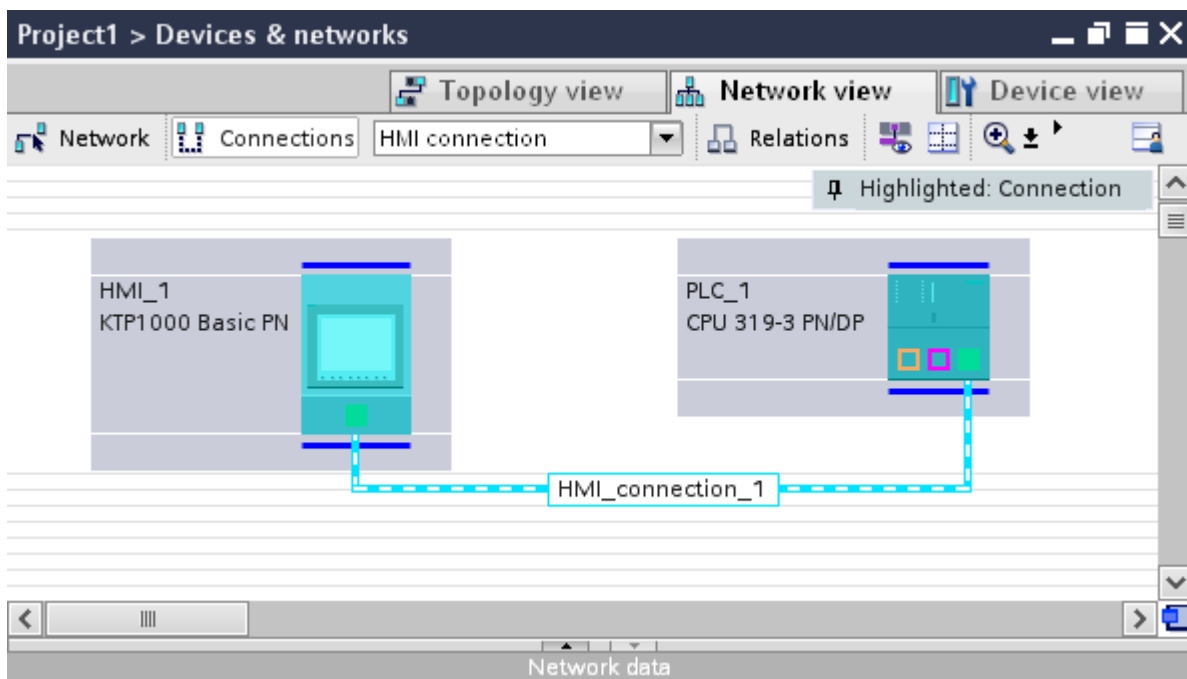

You can also connect multiple HMI devices to one SIMATIC S7 300/400 and multiple SIMATIC S7 300/400s to one HMI device. The maximum number of communication partners that you can connect to an HMI device is dependent on the HMI device used.

Additional information is available in the documentation for the respective HMI device.

### HMI connection in the "Devices & Networks" editor

You configure the HMI connection between the PLC and the HMI device via PROFINET in the "Devices & Networks" editor.

### Connection in the "Connections" editor

Alternatively, you configure the connection between the PLC and HMI device via PROFINET in the "Connections" editor of the HMI device.

## Configuring an HMI connection via PROFINET

### Introduction

You configure an HMI connection between HMI devices and a SIMATIC S7 300/400 via PROFINET or Ethernet in the "Devices & Networks" editor.



#### CAUTION

##### Communication via Ethernet

In Ethernet-based communication, the end user is responsible for the security of his data network.

Targeted attacks can overload the device and interfere with proper functioning.

### Requirements

The following communication partners are created in the "Devices & Networks" editor:

- HMI device with PROFINET or Ethernet interface
- SIMATIC S7 300/400 with PROFINET interface.

### Procedure

1. Double-click the "Devices & Networks" item in the project tree.  
The available communication partners in the project are displayed graphically in the network view.
2. Click the "Connections" button and select "HMI connection" for the connection type.  
The devices available for connection are highlighted in color.



- Click the PROFINET interface of the PLC and use a drag-and-drop operation to draw a connection to the PROFINET or Ethernet interface of the HMI device.

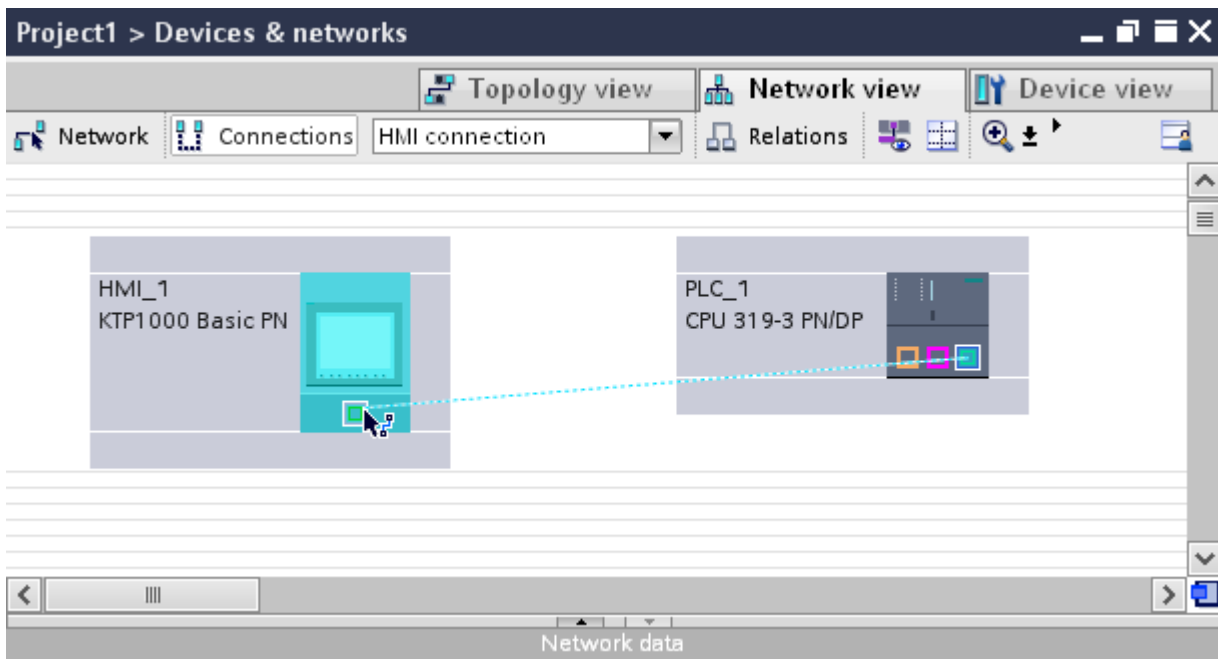

- Click the connecting line.
- Click "Highlight HMI connection" and select the HMI connection. The connection is displayed graphically in the Inspector window.
- Click the communication partners in the "Network view" and change the PROFINET parameters in the Inspector window according to the requirements of your project. See the chapter "PROFINET parameters (Page 5130)" for additional details.

#### Note

The created HMI connection is also shown in the tabular area of the editor on the "Connections" tab. You check the connection parameters in the table.

You can change the local name for the connection only in the table.

## Result

You have created a connection between an HMI device and a SIMATIC S7 300/400. The IP address and subnet mask connection parameters are configured.

## **Configuring an HMI connection**

### **Communication via PROFINET**

#### **Communication via PROFINET**

This section describes the communication between a WinCC Runtime and the SIMATIC S7 300/400 PLC via PROFINET.

You can use the following WinCC Runtimes as an HMI device:

- WinCC RT Advanced

#### **WinCC Runtime as HMI device**

You configure the HMI connections between WinCC Runtime and SIMATIC S7 300/400 in the "Devices & Networks" editor.

If you want to use a WinCC Runtime as an HMI device, you have the following options:

1. You create a SIMATIC PC and configure a WinCC Runtime on this SIMATIC PC. In this way you use the SIMATIC PC with a WinCC Runtime as an HMI device.

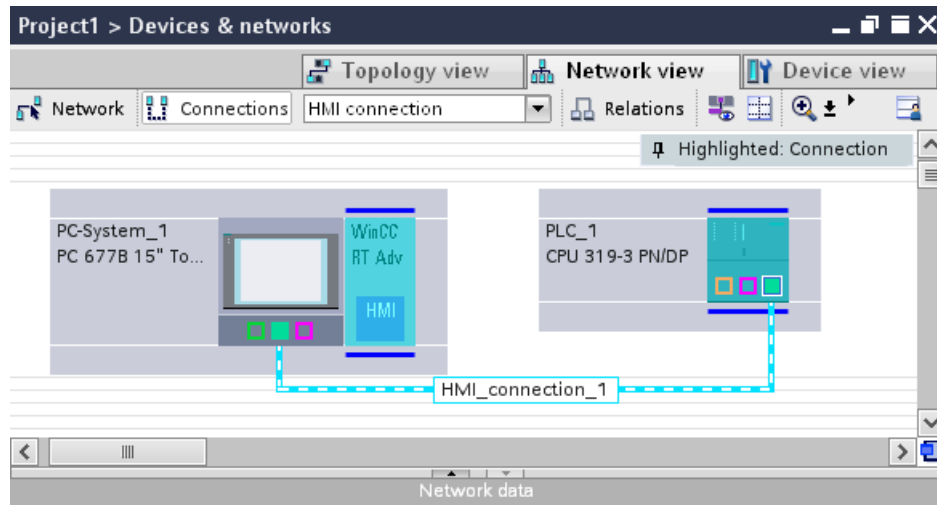

2. You create a WinCC Runtime and configure a communication processor to the Runtime. In this way you use your configuration PC with a WinCC Runtime as an HMI device.

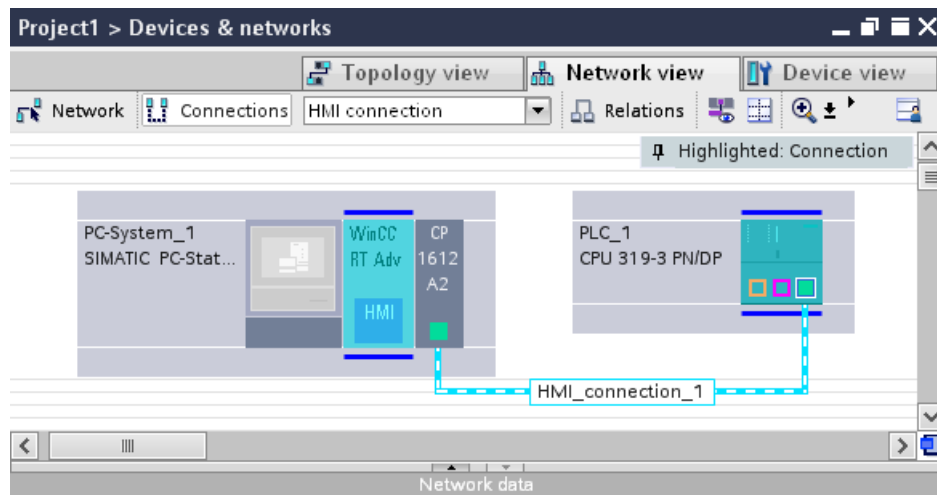

You can also connect multiple HMI devices to one SIMATIC S7 300/400 and multiple SIMATIC S7 300/400s to one HMI device. The maximum number of communication partners that you can connect to an HMI device is dependent on the HMI device used.

Additional information is available in the documentation for the respective HMI device.

### HMI connection in the "Devices & Networks" editor

You configure the HMI connection between the PLC and the HMI device via PROFINET in the "Devices & Networks" editor.

### Connection in the "Connections" editor

Alternatively, you configure the connection between the PLC and HMI device via PROFINET in the "Connections" editor of the HMI device.

## Configuring an HMI connection via PROFINET with a SIMATIC PC

### Introduction

You configure an HMI connection between HMI devices and a SIMATIC S7 300/400 via PROFINET or Ethernet in the "Devices & Networks" editor.

#### CAUTION

##### Communication via Ethernet

In Ethernet-based communication, the end user is responsible for the security of his data network.

Targeted attacks can overload the device and interfere with proper functioning.

### Requirements

The following communication partners are created in the "Devices & Networks" editor:

- SIMATIC S7 300/400 with PROFINET interface
- SIMATIC PC with PROFINET interface

### Procedure

1. Double-click the "Devices & Networks" item in the project tree.  
The available communication partners in the project are displayed in the network view.
2. Use a drag-and-drop operation to move a WinCC Runtime from the hardware catalog to the PC.

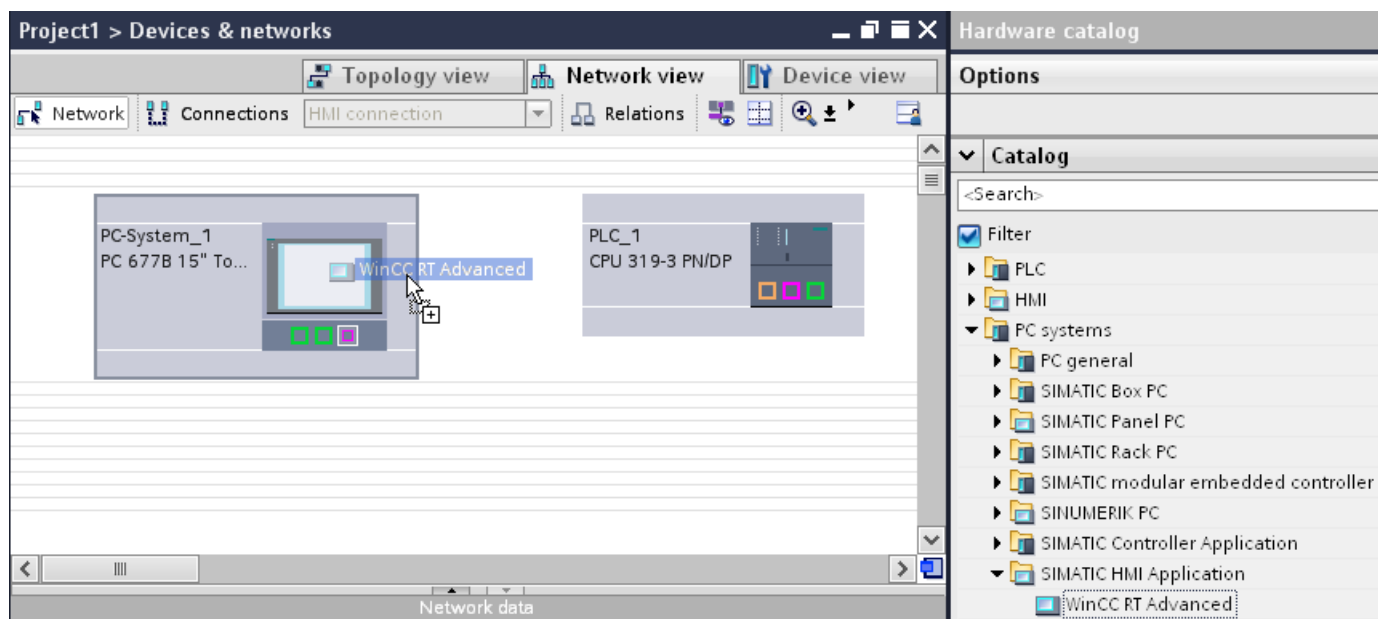

3. Click the "Connections" button and select "HMI connection" for the connection type. The devices available for connection are highlighted in color.
4. Click the PROFINET interface of the PLC and use a drag-and-drop operation to draw a connection to the PROFINET or Ethernet interface of the PC.

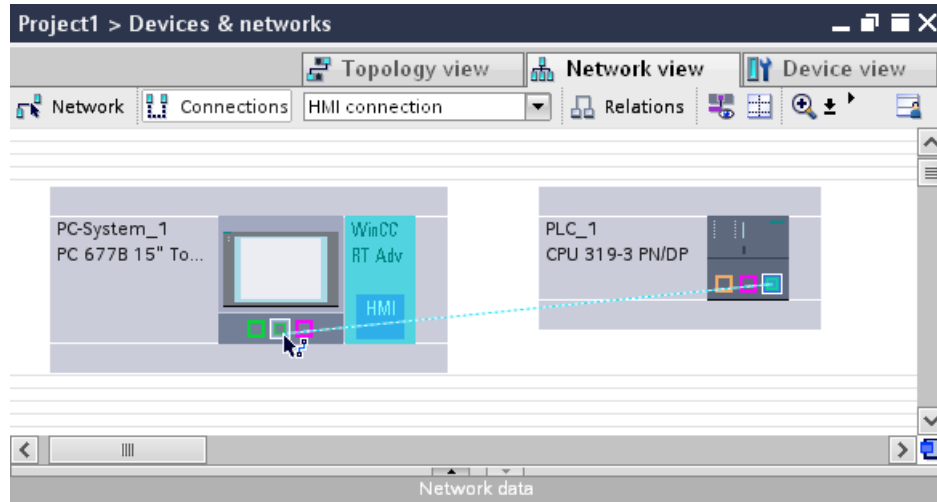

5. Click the connecting line.
6. Click "Highlight HMI connection" and select the HMI connection. The connection is displayed graphically in the Inspector window.
7. Click the communication partners in the "Network view" and change the PROFINET parameters in the Inspector window according to the requirements of your project. See the chapter "PROFINET parameters (Page 5130)" for additional details.

---

#### Note

The created HMI connection is also shown in the tabular area of the editor on the "Connections" tab. You check the connection parameters in the table.

You can change the local name for the connection only in the table.

---

## Result

You have created a connection between an HMI device and a SIMATIC S7 300/400. The IP address and subnet mask connection parameters are configured.

## Configuring an HMI connection via PROFINET with a PC

### Introduction

You configure an HMI connection between HMI devices and a SIMATIC S7 300/400 via PROFINET or Ethernet in the "Devices & Networks" editor.



#### CAUTION

##### Communication via Ethernet

In Ethernet-based communication, the end user is responsible for the security of his data network.

Targeted attacks can overload the device and interfere with proper functioning.

### Requirements

The following communication partners are created in the "Devices & Networks" editor:

- SIMATIC S7 300/400 with PROFINET interface
- PC station with WinCC RT Advanced

## Procedure

1. Double-click the "Devices & Networks" item in the project tree.  
The available communication partners in the project are displayed graphically in the network view.
2. Use a drag-and-drop operation to move a PROFINET-capable communication processor from the hardware catalog to the WinCC Runtime.

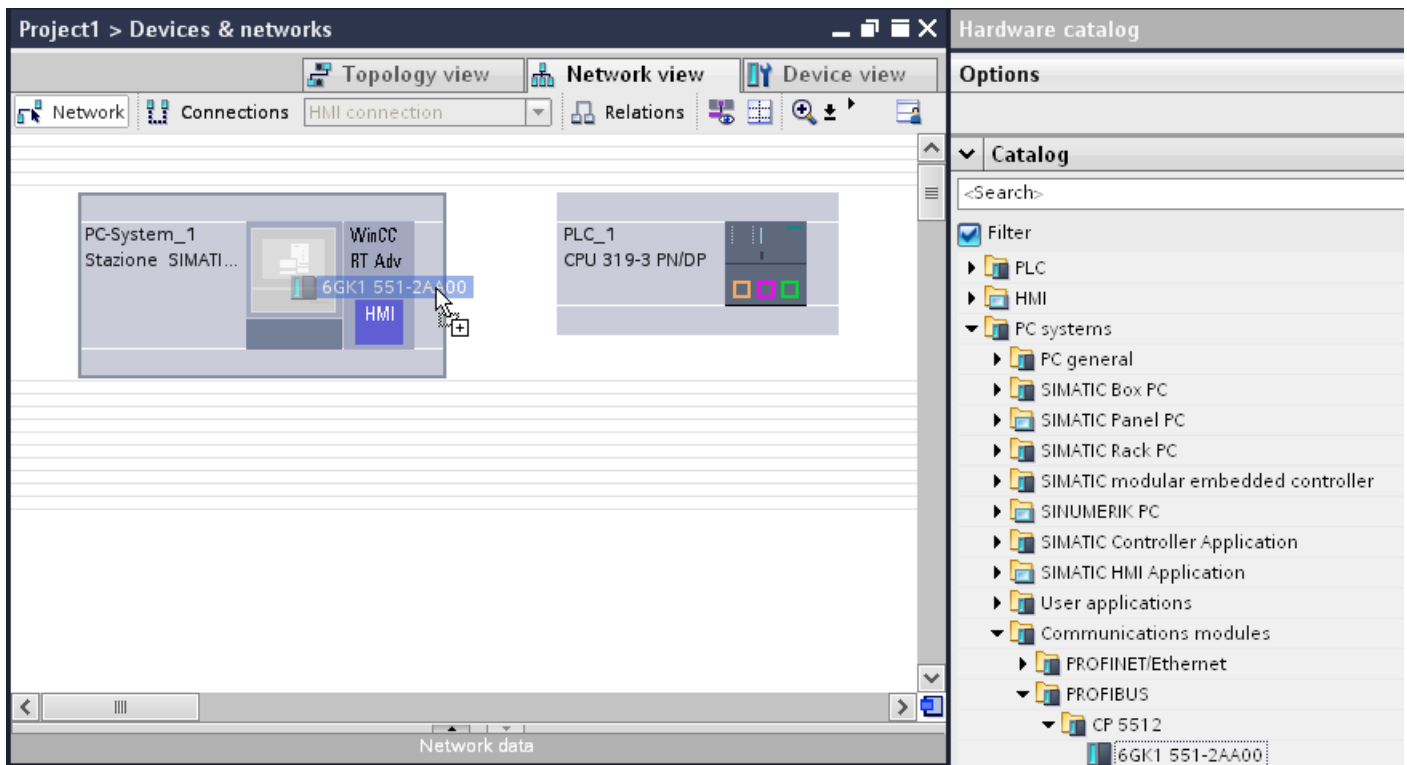

3. Click the "Connections" button and select "HMI connection" for the connection type.  
The devices available for connection are highlighted in color.
4. Click the PROFINET interface of the PLC and use a drag-and-drop operation to draw a connection to the PROFINET interface of the communication processor.

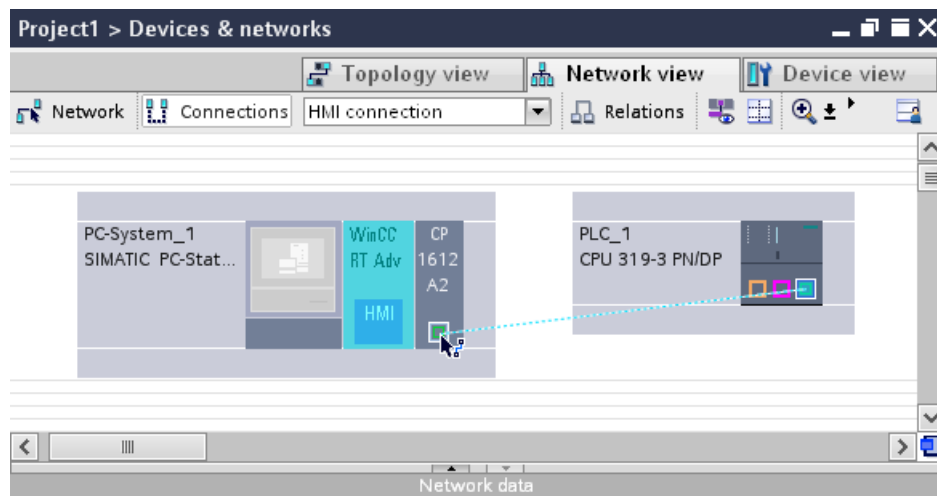

5. Click the connecting line.  
The connection is displayed graphically in the Inspector window.
6. Click "Highlight HMI connection" and select the HMI connection.  
The connection is displayed graphically in the Inspector window.
7. Click the communication partners in the "Network view" and change the PROFINET parameters in the Inspector window according to the requirements of your project.  
See the chapter "PROFINET parameters (Page 5130)" for additional details.

---

**Note**

The created HMI connection is also shown in the tabular area of the editor on the "Connections" tab. You check the connection parameters in the table.

You can change the local name for the connection only in the table.

---

**Result**

You have created a connection between an HMI device and a SIMATIC S7 300/400. The IP address and subnet mask connection parameters are configured.

**PROFINET parameters**

**PROFINET parameters for the HMI connection**

**PROFINET parameters for the HMI connection**

An overview of the configured HMI connection parameters can be found in the properties for the HMI connection.

Only limited changes are possible in this Inspector window.



## Displaying and changing the HMI connection parameters

1. Click the HMI connection in the "Devices & Networks" editor.
2. Change the parameters of the HMI connection in the Inspector window under "Properties > General > General".

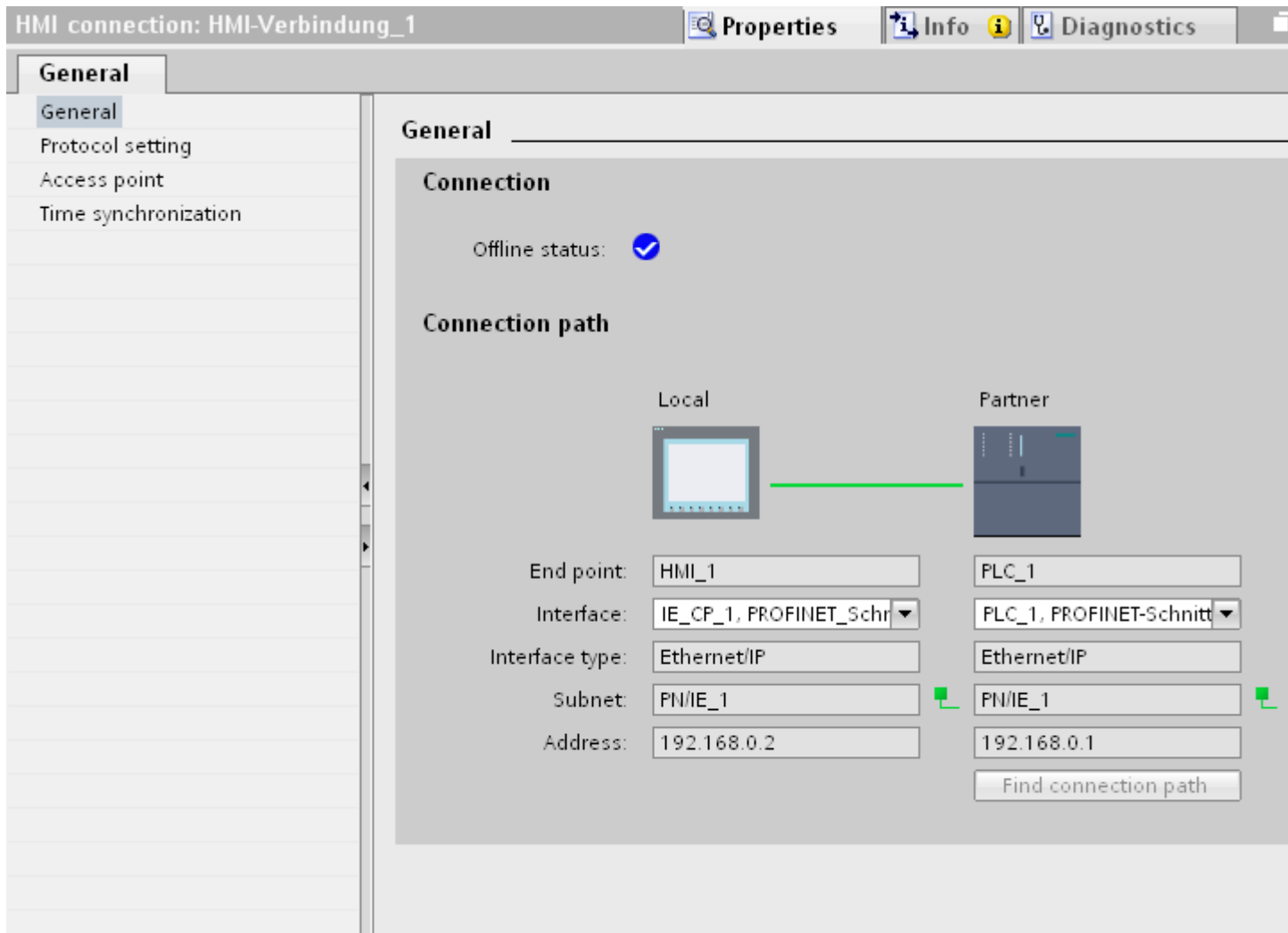

### "Connection"

Displays whether the devices are networked together.



- displayed if the devices are networked together.



- displayed if the devices are not networked together.

### "Connection path"

The communication partners of the selected HMI connection and the associated PROFINET parameters are displayed in the "Connection path" area. Some of the areas displayed cannot be edited in this dialog.

- "End point"  
Displays the device name. This area cannot be edited.
- "Interface"  
Displays the selected interface of the device. You can choose between several interfaces, depending on the device.
- "Interface type"  
Displays the selected interface type. This area cannot be edited.
- "Subnet"  
Displays the selected subnet. This area cannot be edited.
- "Address"  
Displays the selected IP address of the device. This area cannot be edited.
- "Find connection path" button  
Enables the subsequent specification of connections.

### PROFINET parameters for the HMI device

### PROFINET parameters for the HMI device

An overview of the configured HMI device parameters can be found in the properties for the HMI device.

## Displaying and changing PROFINET parameters of the HMI device

1. Click the HMI device in the "Devices & Networks" editor.
2. Change the parameters of the HMI device in the Inspector window under "Properties > General".

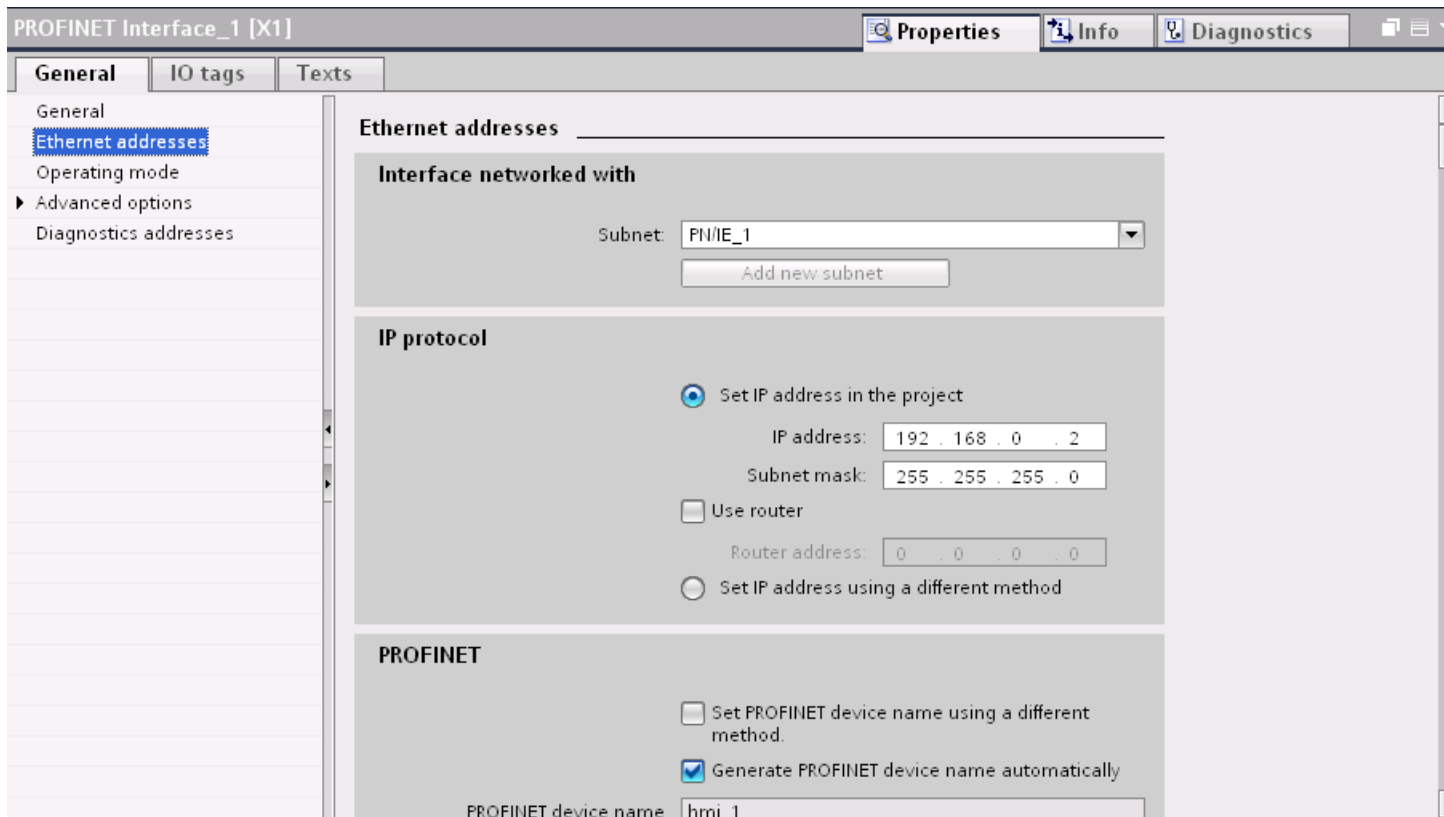

### "Interface networked with"

In the "Interface networked with" area, select the subnet of the HMI connection via which the HMI device is connected to the network. You use the "Add new subnet" button to create a new subnet.

## "IP protocol"

- "Set IP address in the project"  
When you transfer the WinCC project to the HMI device, this IP address is set up directly in the HMI device.

---

### Note

The device is automatically restarted in the case of HMI devices with the Windows CE 3.0 operating system.

HMI devices with Windows CE 3.0:

- OP 77B
  - TP 177B color PN/DP
  - TP 177B mono DP
  - OP 177B color PN/DP
  - OP 177B mono DP
  - Mobile Panel 177 PN
  - Mobile Panel 177 DP
  - TP 277 6"
  - OP 277 6"
- 
- "Subnet mask"  
You assign data of the subnet mask in the "Subnet mask" area.
  - "Use IP router"  
If you are using an IP router, select "Use IP router" and enter the router address in the "Router address" field.
  - "Set IP address using a different method"  
If the function "Set IP address using a different method" is activated, the IP address is not taken from the project. You have to enter the IP address directly in the Control Panel of the HMI device.

## PROFINET parameters for the PLC

### PROFINET parameters for the PLC

An overview of the configured parameters can be found in the properties for the PLC.

## Displaying and changing PROFINET parameters of the PLC

1. Click the PLC in the "Devices & Networks" editor.
2. Change the parameters of the PLC in the Inspector window under "Properties > General > General".

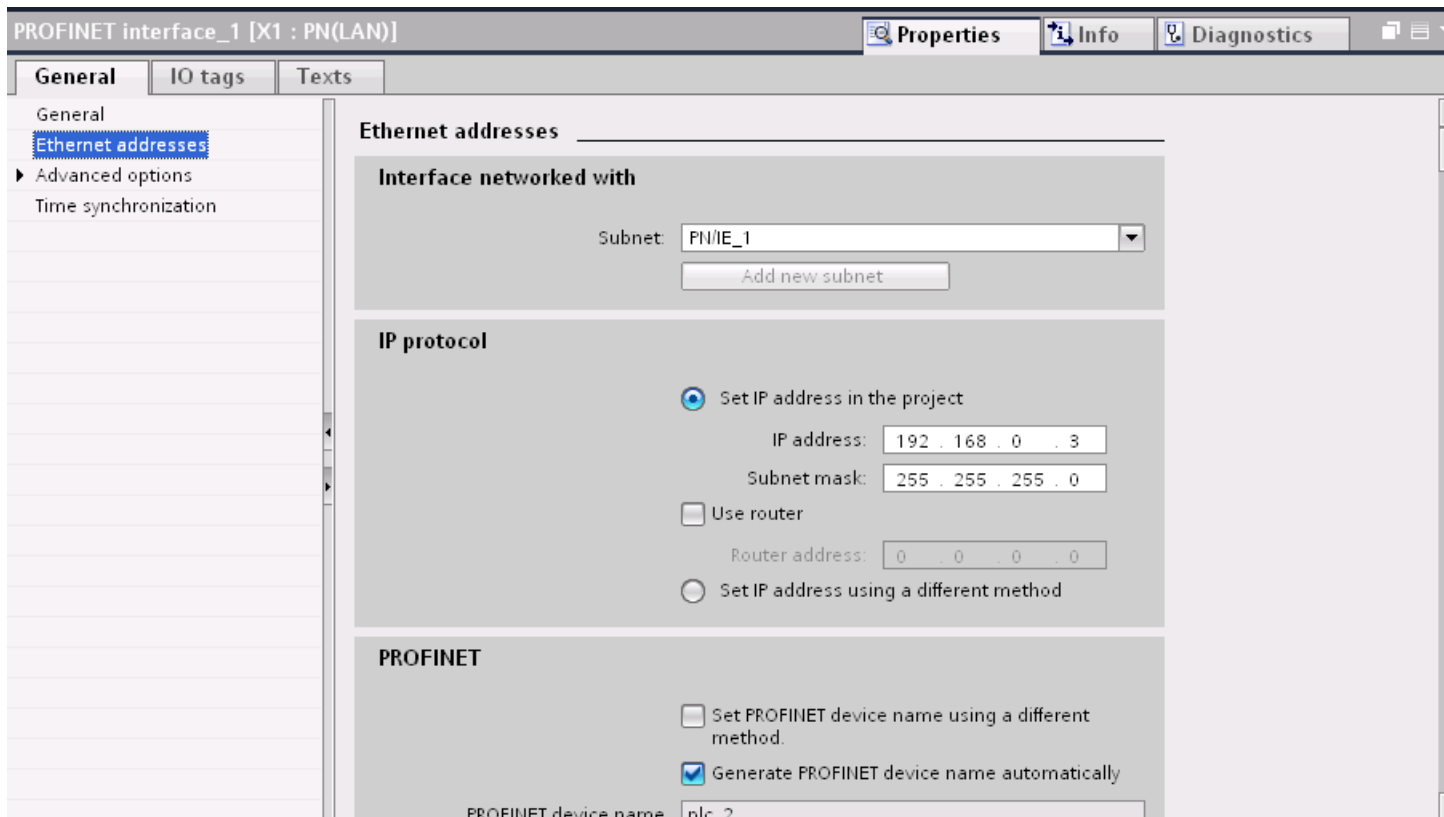

### "Interface networked with"

In the "Subnet" area, select the subnet of the HMI connection via which the PLC is connected to the network. You use the "Add new subnet" button to create a new subnet.

### "IP protocol"

- "Interface type"  
Depending on the HMI device type, you have various interfaces to choose from.
- "IP address"  
You assign the IP address of the HMI device in the "IP address" area.
- "Subnet mask"  
You assign data of the subnet mask in the "Subnet mask" area.  
If you are using an IP router, select "Use IP router" and enter the router address in the field.

## Configuring Industrial Ethernet

### Rules for the network configuration

The Ethernet interfaces of the devices have a default IP address that you can change.

### IP address

The IP parameters are visible if the communication-capable devices support the TCP/IP protocol.

The IP address consists of 4 decimal figures in the range of 0 to 255. The decimal figures are separated from one another by a dot.

Example: 140.80.0.2

The IP address consists of the following:

- The address of the (sub) net
- The address of the node (generally also called host or network node)

### Subnet mask

The subnet mask splits these two addresses. It determines which part of the IP address addresses the network and which part of the IP address addresses the node.

The set bits of the subnet mask determine the network part of the IP address.

Example:

Subnet mask: 255.255.0.0 = 11111111.11111111.00000000.00000000

In the example given for the above IP address, the subnet mask shown here has the following meaning:

The first 2 bytes of the IP address identify the subnet - i.e. 140.80. The last two bytes address the node, thus 0.2.

It is generally true that:

- The network address results from AND linking the IP address and subnet mask.
- The node address results from AND NOT linking the IP address and subnet mask.

### Relation between IP address and default subnet mask

An agreement exists relating to the assignment of IP address ranges and so-called "Default subnet masks". The first decimal number (from the left) in the IP address determines the structure of the default subnet mask. It determines the number of "1" values (binary) as follows:

IP address (decimal)	IP address (binary)	Address class	Default subnet mask
0 to 126	0xxxxxxx.xxxxxxxx...	A	255.0.0.0
128 to 191	10xxxxxx.xxxxxxxx...	B	255.255.0.0
192 to 223	110xxxxx.xxxxxxxx...	C	255.255.255.0

**Note****Range of values for the first decimal point**

A value of between 224 and 255 is also possible for the first decimal number of the IP address (address class D etc). This is, however, not recommended because there is no address check for these values.

**Masking other subnets**

You can use the subnet mask to add further structures and form "private" subnets for a subnet that is assigned one of the address classes A, B or C. This is done by setting other lower points of the subnet mask to "1". For each bit set to "1", the number of "private" networks doubles and the number of nodes they contain is halved. Externally, the network functions like an individual network as it did previously.

Example:

You have a subnet of address class B (e.g. IP address 129.80.xxx.xxx) and change the default subnet mask as follows:

Masks	Decimal	Binary
Default subnet mask	255.255.0.0	11111111.11111111.00000000.00000000
Subnet mask	255.255.128.0	11111111.11111111.10000000.00000000

Result:

All nodes with addresses between 129.80.001.xxx and 129.80.127.xxx are on one subnet, all nodes with addresses between 129.80.128.xxx and 129.80.255.xxx are on another subnet.

**Router**

The job of the routers is to connect the subnets. If an IP datagram is to be sent to another network, it first has to be conveyed to a router. To make this possible, in this case you have to enter the address of the router for each node in the subnet.

The IP address of a node in the subnet and the address of the router may only differ at the points at which there is a "0" in the subnet mask.

## Setting port options

### Setting the port options

#### Changing connection settings for the PROFINET IO port

You can change the network settings for the PROFINET IO port as required. By default, the settings are made automatically. In normal situations, this guarantees problem-free communication.

#### Possible settings for transmission rate / duplex

Depending on the selected device, you can make the following settings for "Transmission rate / duplex":

- **Automatic setting**  
Recommended default setting of the port. The transmission settings are automatically "negotiated" with the peer port. The "Enable autonegotiation" option is also enabled as a default, in other words, you can use cross cables or patch cables for the connection.
- **TP/ITP at x Mbps full duplex (half duplex)**  
Setting of the transmission rate and the full duplex/half duplex mode. The effectiveness depends on the "Enable autonegotiation" setting:
  - Autonegotiation enabled  
You can use both cross cable and patch cable.
  - Autonegotiation disabled  
Make sure that you use the correct cable (patch cable or cross cable)! The port is also monitored with this setting.
- **Deactivated**  
Depending on the module type, the drop down list box can contain the "- Disabled -" option. This option, for example, allows you to prevent access to an unused port for security reasons. With this setting, diagnostic events are not generated.

#### "Monitor" option

This option enables or disables port diagnostics. Examples of port diagnostics: The link status is monitored, in other words, the diagnostics are generated during link-down and the system reserve is monitored in the case of fiber optic ports.

#### Option "Enable autonegotiation "

The autonegotiation setting can only be changed if a concrete medium (for example, TP 100 Mbps full duplex) is selected. Whether or not a concrete medium can be set depends on the properties of the module.

If autonegotiation is disabled, this causes the port to be permanently specified, as for example, is necessary for a prioritized startup of the IO device.



You must make sure the partner port has the same settings because with this option the operating parameters of the connected network are not detected and the data transmission rate and transmission mode can accordingly not be optimally set.

---

#### Note

When a local port is connected, STEP 7 makes the setting for the partner port if the partner port supports the setting. If the partner port does not accept the setting, an error message is generated.

---

## Wiring rules for disabled autonegotiation

### Requirements

You have made the following settings for the port in question, for example, to accelerate the startup time of the IO device:

- Fixed transmission rate
- Autonegotiation incl. autocrossing disabled

The time for negotiating the transmission rate during startup has been saved.

If you have disabled autonegotiation, you must observe the wiring rules.

## Wiring rules for disabled autonegotiation

PROFINET devices have the following two types of ports:

Type of port	PROFINET devices	Note
Switch port with crossed pin assignment	For IO devices: Port 2 For S7 CPUs with 2 ports: Ports 1 and 2	Crossed pin assignment means that the pin assignment for the ports for sending and receiving between the respective PROFINET devices is exchanged internally.
End device port with uncrossed pin assignment	For IO devices: Port 1 For S7 CPUs with one port: Port 1	-

### Validity of the wiring rules

The cabling rules described in the following paragraph apply exclusively for the situation in which you have specified a fixed port setting.

## Rules for cabling

You can connect several IO devices in line using a single cable type (patch cable). To do this, you connect port 2 of the IO device (distributed I/O) with port 1 of the next IO device. The following graphic gives an example with two IO devices.

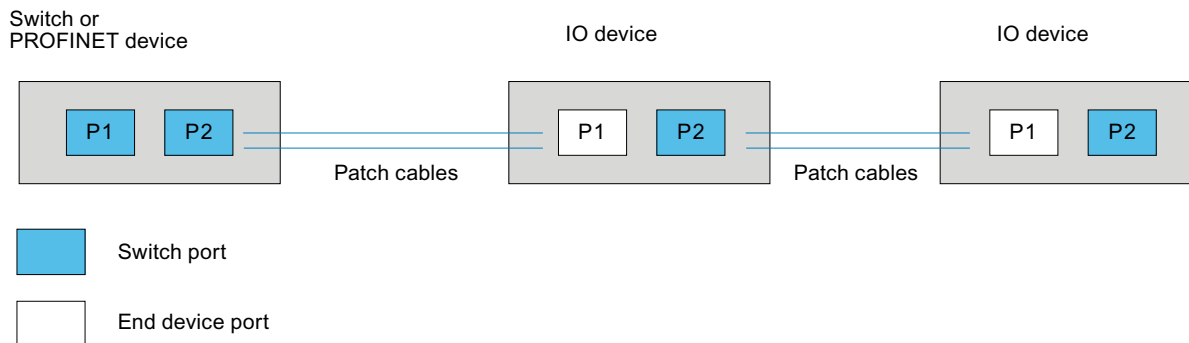

## Boundaries at the port

### Requirements

To use boundaries, the respective device must have more than one port. If the PROFINET does not support boundary settings, they are not shown.

### Enable boundaries

"Boundaries" are limits for transmission of certain Ethernet frames. The following boundaries can be set at a port:

- "End of discovery of accessible devices"  
No forwarding of DCP frames to identify accessible devices. Devices downstream from this port cannot be reached by the project tree under "Accessible devices". Devices downstream from this port cannot be reached by the CPU.
- "End of topology discovery"  
LLDP frames (Link Layer Discovery Protocol) are not forwarded for topology detection.
- "End of sync domain"  
No forwarding of sync frames transmitted to synchronize nodes within a sync domain. If you operate, for example, a PROFINET device with more than two ports in a ring, you should prevent the sync frame from being fed into the ring by setting a sync boundary (at the ports not inside the ring).  
Additional example: If you want to use several sync domains, configure a sync domain boundary for the port connected to a PROFINET device from the other sync domain.

## Restrictions

The following restrictions must be observed:

- The individual check boxes can only be used if the port supports the function in question.
- If a partner port has been determined for the port, the following check boxes cannot be used:
  - "End of discovery of accessible devices"
  - "End of topology discovery"
- If autonegotiation is disabled, none of the check boxes can be used.

### 10.11.8.3 Communication via PROFIBUS

#### Configuring an HMI connection

#### Communication via PROFIBUS

#### HMI connections via PROFIBUS

If you have inserted an HMI device and a SIMATIC S7 300/400 into the project, you interconnect the two PROFIBUS interfaces in the "Devices & Networks" editor.

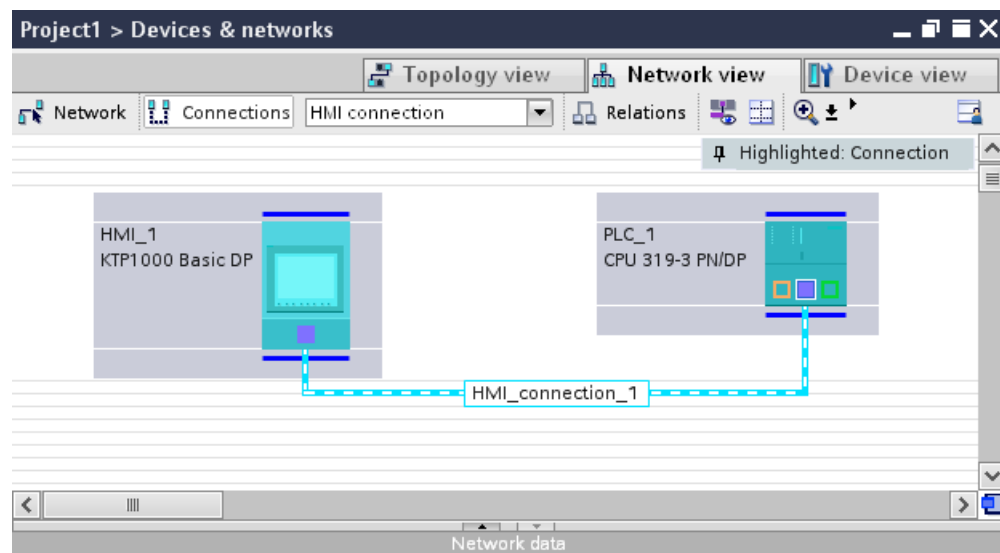

#### HMI connection in the "Devices & Networks" editor

You configure the HMI connection between the PLC and the HMI device via PROFIBUS in the "Devices & Networks" editor.

## Connection in the "Connections" editor

Alternatively, you configure the connection between the PLC and HMI device in the "Connections" editor of the HMI device.

## Configuring an HMI connection via PROFIBUS

### Introduction

You configure an HMI connection between HMI devices and a SIMATIC S7 300/400 via PROFIBUS in the "Devices & Networks" editor.

### Requirements

The following communication partners are created in the "Devices & Networks" editor:

- HMI device with MPI/DP interface
- SIMATIC S7 300/400 with PROFIBUS interface

### Procedure

1. Double-click the "Devices & Networks" item in the project tree.  
The available communication partners in the project are displayed graphically in the network view.

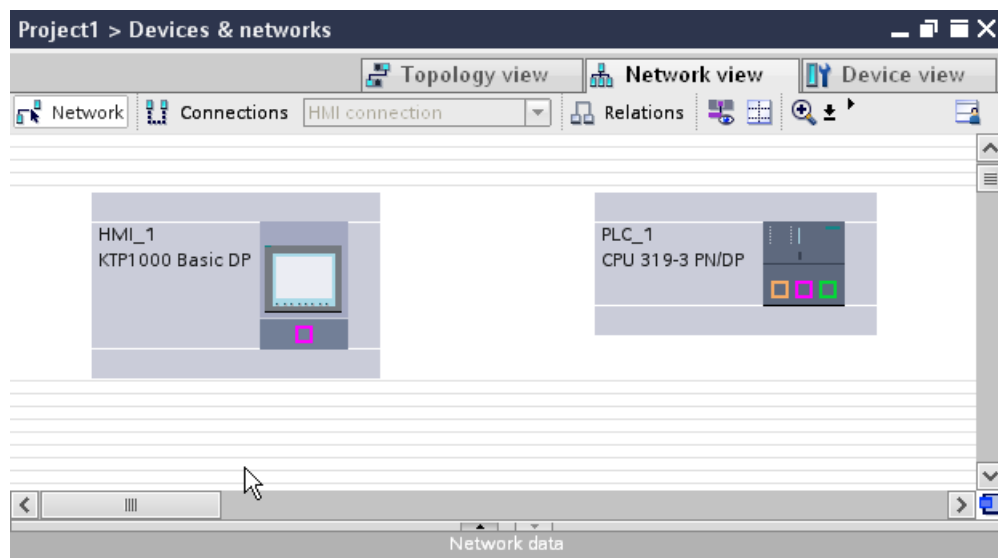

2. Click the "Connections" button.  
The devices available for connection are highlighted in color.
3. Click the HMI device interface.
4. Select the "PROFIBUS" interface type in the Inspector window under "Properties > General > HMI MPIDP > Parameters".

- Click the interface of the PLC and use a drag-and-drop operation to draw a connection to the HMI device.

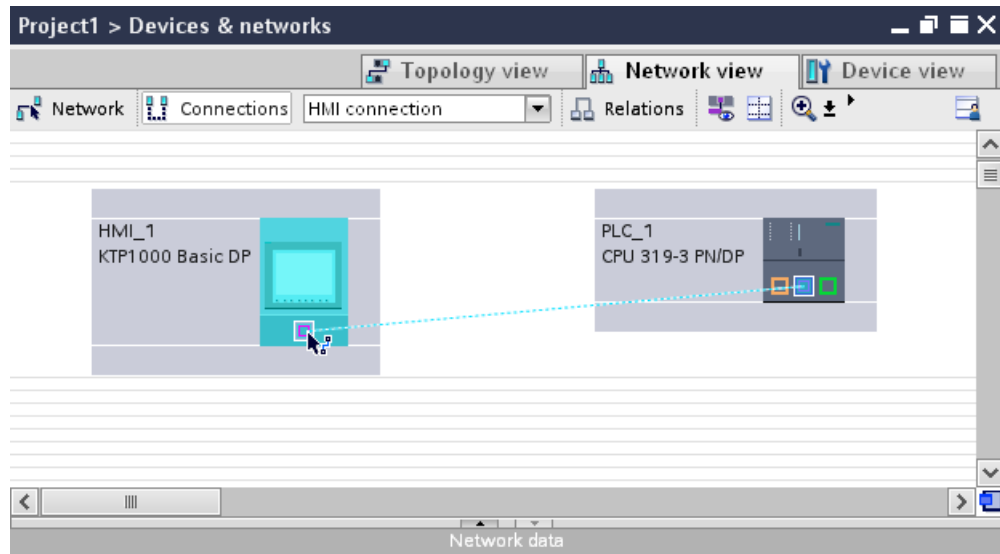

- Click the connecting line.
- Click "Highlight HMI connection" and select the HMI connection. The connection is displayed graphically in the Inspector window.
- Click the communication partners in the "Network view" and change the PROFINET parameters in the Inspector window according to the requirements of your project. See the chapter "PROFIBUS parameters (Page 5149)" for additional details.

---

#### Note

The created HMI connection is also shown in the tabular area of the editor on the "Connections" tab. You check the connection parameters in the table.

You can change the local name for the connection only in the table.

---

## Result

You have created an HMI connection between an HMI device and a SIMATIC S7 300/400 via PROFIBUS.

## Configuring an HMI connection

### Communication via PROFIBUS

### Communication via PROFIBUS

This section describes the communication between a WinCC Runtime and the SIMATIC S7 300/400 PLC via PROFIBUS.

You can use the following WinCC Runtimes as an HMI device:

- WinCC RT Advanced
- WinCC RT Professional

### WinCC Runtime as HMI device

You configure the HMI connections between WinCC Runtime and SIMATIC S7 300/400 in the "Devices & Networks" editor.

If you want to use a WinCC Runtime as an HMI device, you have the following options:

1. You create a SIMATIC PC and configure a WinCC Runtime on this SIMATIC PC. In this way you use the SIMATIC PC with a WinCC Runtime as an HMI device.

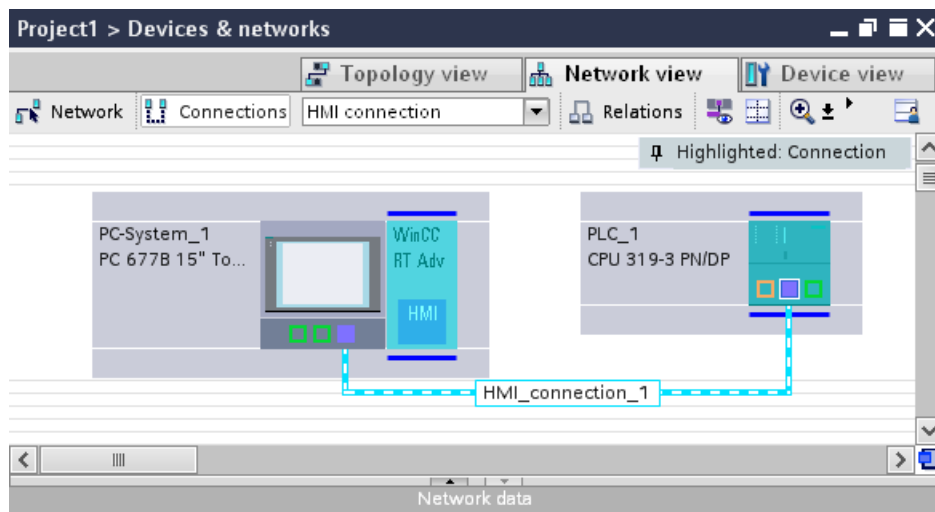

2. You create a WinCC Runtime and configure a communication processor to the Runtime. In this way you use your configuration PC with a WinCC Runtime as an HMI device.

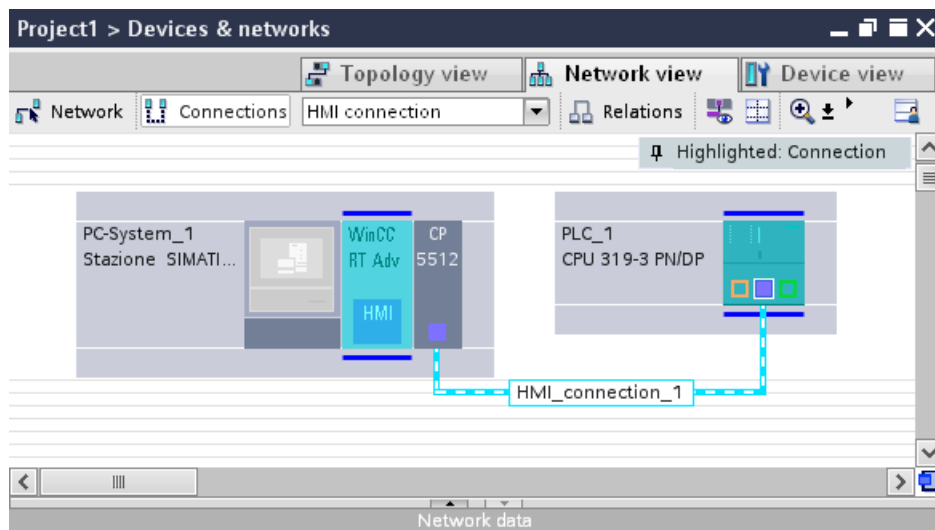

You can also connect multiple HMI devices to one SIMATIC S7 300/400 and multiple SIMATIC S7 300/400s to one HMI device. The maximum number of communication partners that you can connect to an HMI device is dependent on the HMI device used.

Additional information is available in the documentation for the respective HMI device.

### HMI connection in the "Devices & Networks" editor

You configure the HMI connection between the PLC and the HMI device via PROFIBUS in the "Devices & Networks" editor.

### Connection in the "Connections" editor

Alternatively, you configure the connection between the PLC and HMI device via PROFIBUS in the "Connections" editor of the HMI device.

## Configuring an HMI connection via PROFIBUS with a SIMATIC PC

### Introduction

You configure an HMI connection between HMI devices and a SIMATIC S7 300/400 via PROFIBUS in the "Devices & Networks" editor.

### Requirements

The following communication partners are created in the "Devices & Networks" editor:

- SIMATIC S7 300/400 with PROFIBUS interface
- SIMATIC PC with PROFIBUS interface

### Procedure

1. Double-click the "Devices & Networks" item in the project tree.  
The available communication partners in the project are displayed in the network view.
2. Click the MPI interface of the PC and select "PROFIBUS" for the interface type in the Inspector window.

3. Use a drag-and-drop operation to move a WinCC Runtime from the hardware catalog to the PC.

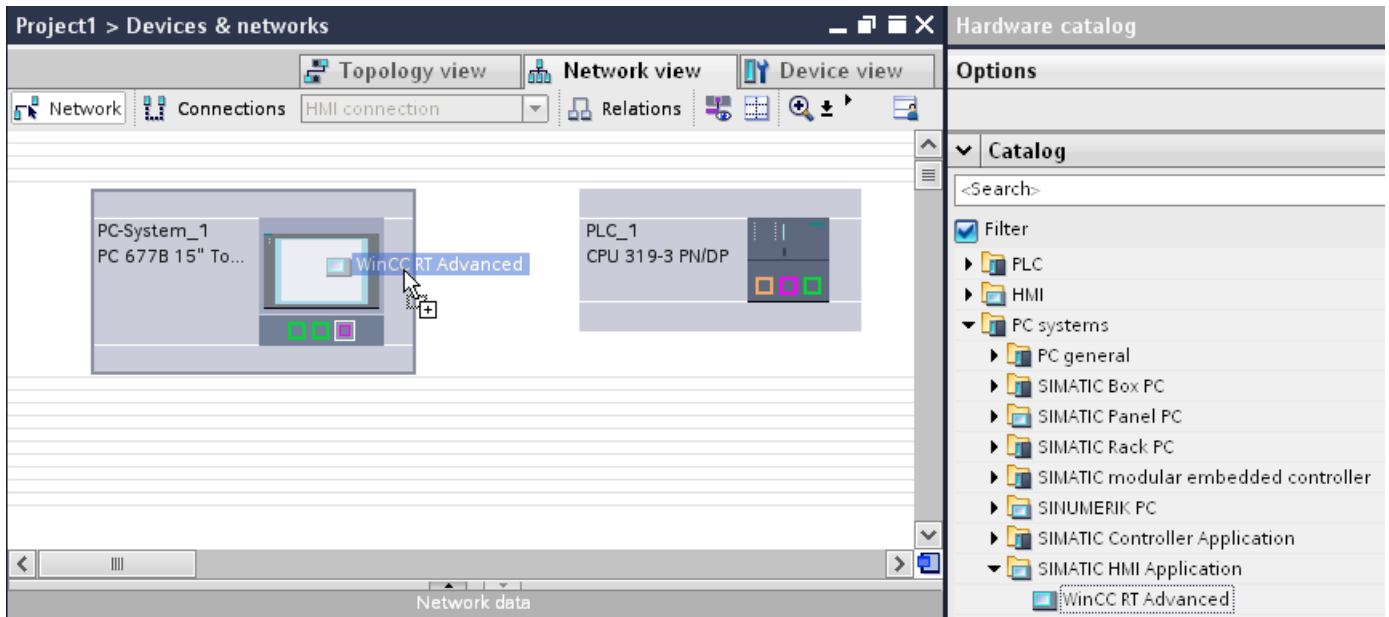

4. Click the "Connections" button and select "HMI connection" for the connection type. The devices available for connection are highlighted in color.
5. Click the PROFIBUS interface of the PLC and use a drag-and-drop operation to draw a connection to the PROFIBUS interface of the PC.

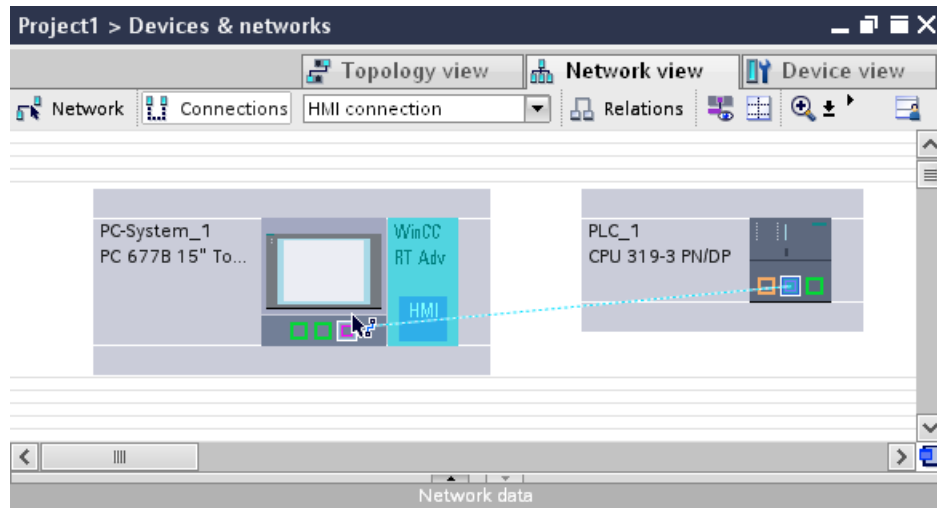

6. Click the connecting line.



7. Click "Highlight HMI connection" and select the HMI connection.  
The connection is displayed graphically in the Inspector window.
8. Click the communication partners in the "Network view" and change the PROFIBUS parameters in the Inspector window according to the requirements of your project.  
See the chapter "PROFIBUS parameters (Page 5149)" for additional details.

---

**Note**

The created HMI connection is also shown in the tabular area of the editor on the "Connections" tab. You check the connection parameters in the table.

You can change the local name for the connection only in the table.

---

## Result

You have created an HMI connection between an HMI device and a SIMATIC S7 300/400 via PROFIBUS.

## Configuring an HMI connection via PROFIBUS with a PC

### Introduction

You configure an HMI connection between HMI devices and a SIMATIC S7 300/400 via PROFIBUS in the "Devices & Networks" editor.

### Requirements

The following communication partners are created in the "Devices & Networks" editor:

- SIMATIC S7 300/400
- PC station with WinCC RT Advanced

**Procedure**

1. Double-click the "Devices & Networks" item in the project tree.  
The available communication partners in the project are displayed in the network view.
2. Use a drag-and-drop operation to move a PROFIBUS-capable communication processor from the hardware catalog to the WinCC Runtime.

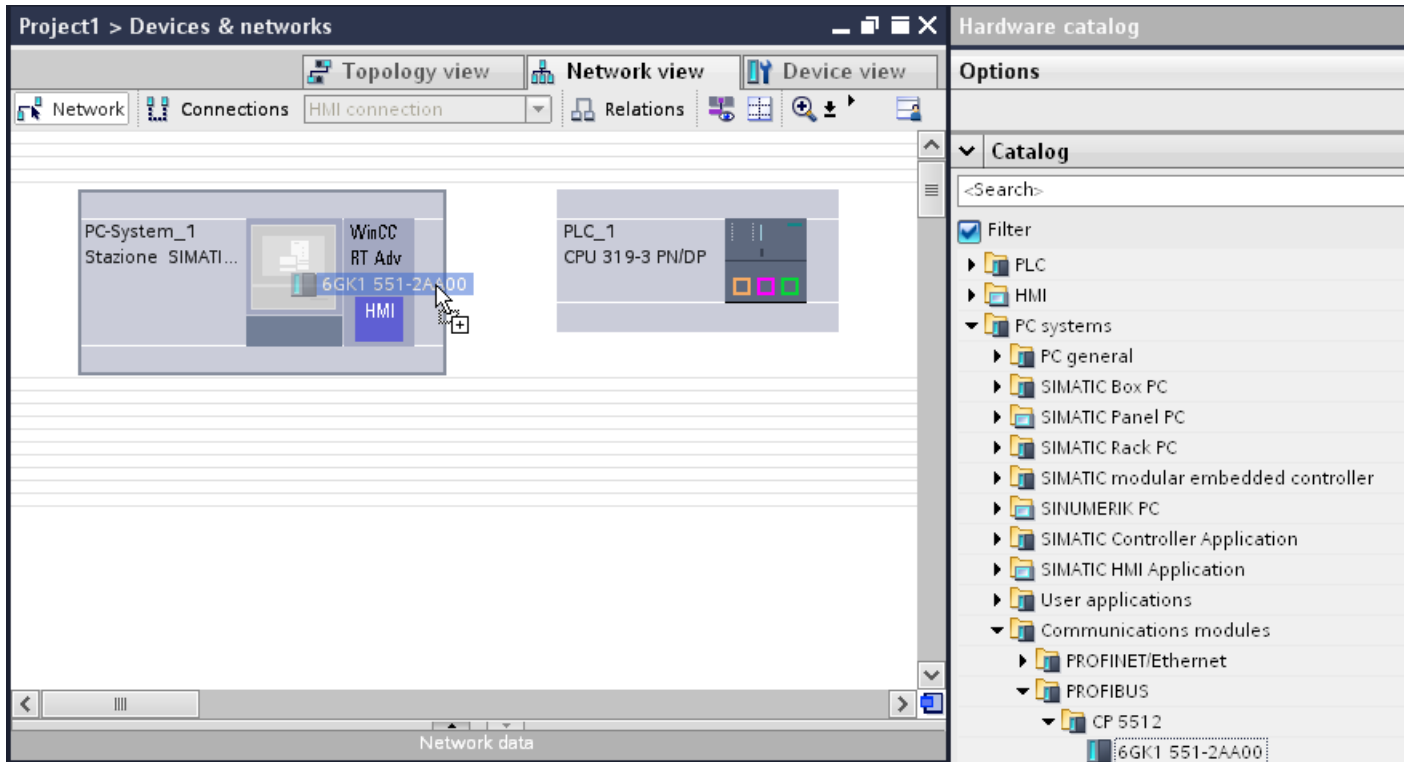

3. Click the "Connections" button and select "HMI connection" for the connection type.  
The devices available for connection are highlighted in color.
4. Click the PROFIBUS interface of the PLC and use a drag-and-drop operation to draw a connection to the PROFIBUS interface of the communication processor.

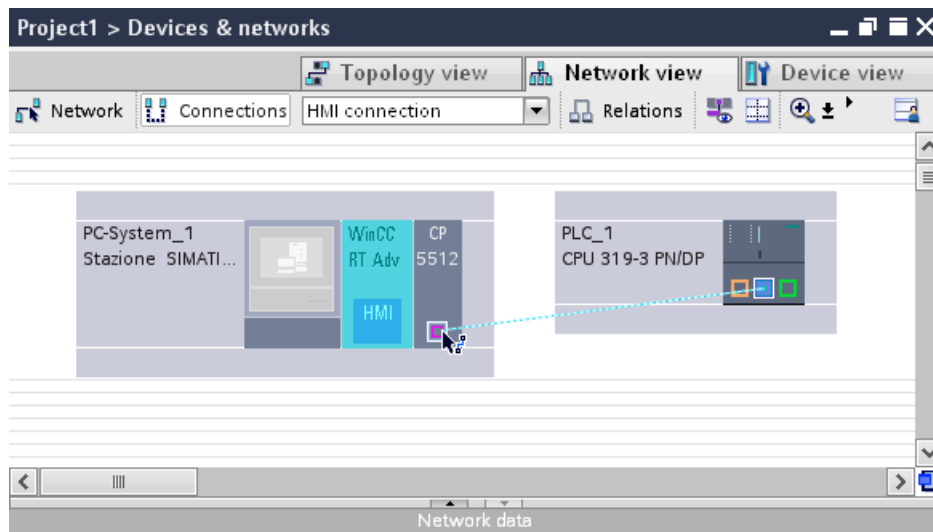

5. Click the connecting line.
6. Click "Highlight HMI connection" and select the HMI connection.  
The connection is displayed graphically in the Inspector window.
7. Click the communication partners in the "Network view" and change the PROFIBUS parameters in the Inspector window according to the requirements of your project.  
See the chapter "PROFIBUS parameters (Page 5149)" for additional details.

---

**Note**

The created HMI connection is also shown in the tabular area of the editor on the "Connections" tab. You check the connection parameters in the table.

You can change the local name for the connection only in the table.

---

**Result**

You have created an HMI connection between an HMI device and a SIMATIC S7 1200 via PROFIBUS.

**PROFIBUS parameters**

**PROFIBUS parameters for the HMI connection**

**PROFIBUS parameters for the HMI connection**

An overview of the configured HMI connection parameters can be found in the properties for the HMI connection.

Only limited changes are possible in this Inspector window.

## Displaying and changing the HMI connection parameters

1. Click the HMI connection in the "Devices & Networks" editor.
2. Change the parameters of the HMI connection in the Inspector window under "Properties > General > General".

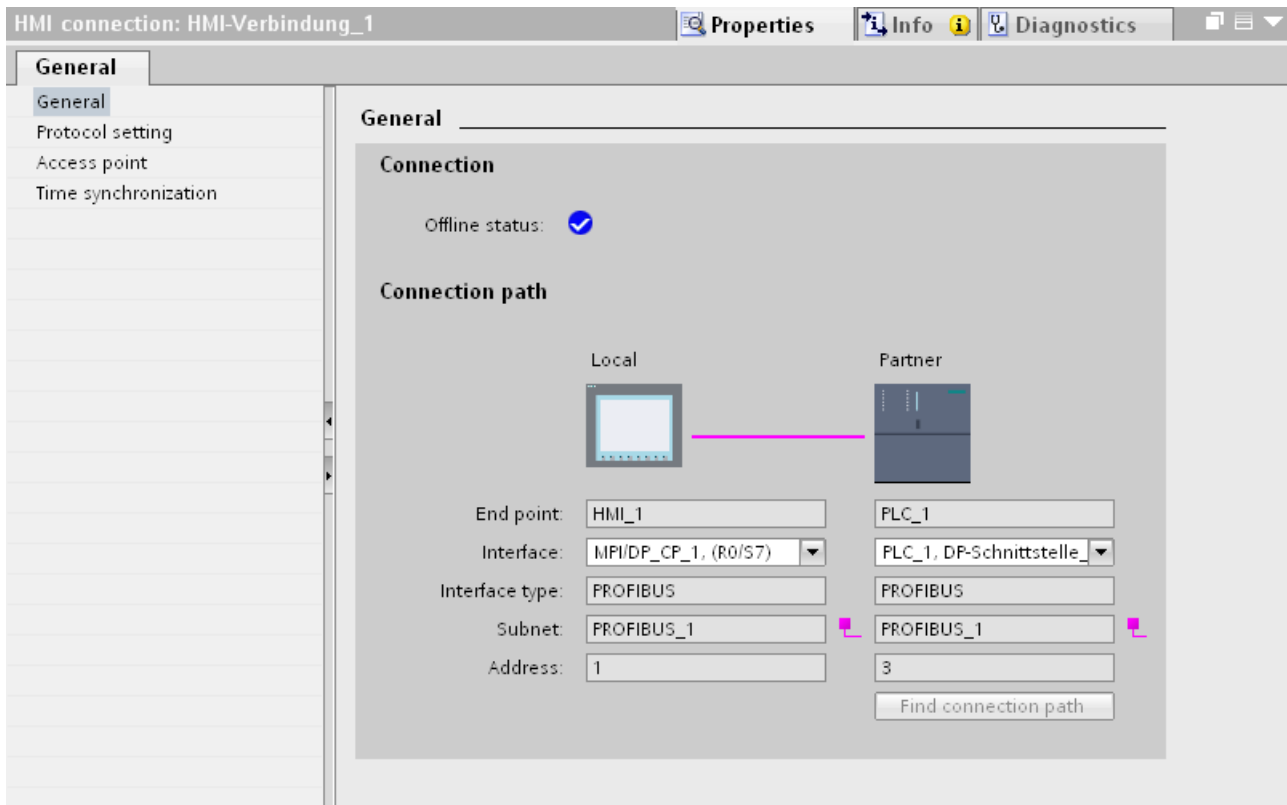

### "Connection"

Displays whether the devices are networked together.

- displayed if the devices are networked together.
- displayed if the devices are not networked together.

### "Connection path"

The communication partners of the selected HMI connection and the associated PROFIBUS parameters are displayed in the "Connection path" area. Some of the areas displayed cannot be edited in this dialog.

- "End point"  
Displays the device name. This area is not editable.
- "Interface"  
Displays the selected interface of the device. You can choose between several interfaces, depending on the device.

- "Interface type"  
Displays the selected interface type. This area is not editable.
- "Subnet"  
Displays the selected subnet. This area is not editable.
- "Address"  
Displays the PROFIBUS address of the device. This area is not editable.
- "Find connection path" button  
Enables the subsequent specification of connections.

## PROFIBUS parameters for the HMI device

## PROFIBUS parameters for the HMI device

An overview of the configured HMI device parameters can be found in the properties for the HMI device.

## Displaying and changing PROFINET parameters of the HMI device

1. Click the HMI device in the "Devices & Networks" editor.
2. Change the parameters of the HMI device in the Inspector window under "Properties > General > General".

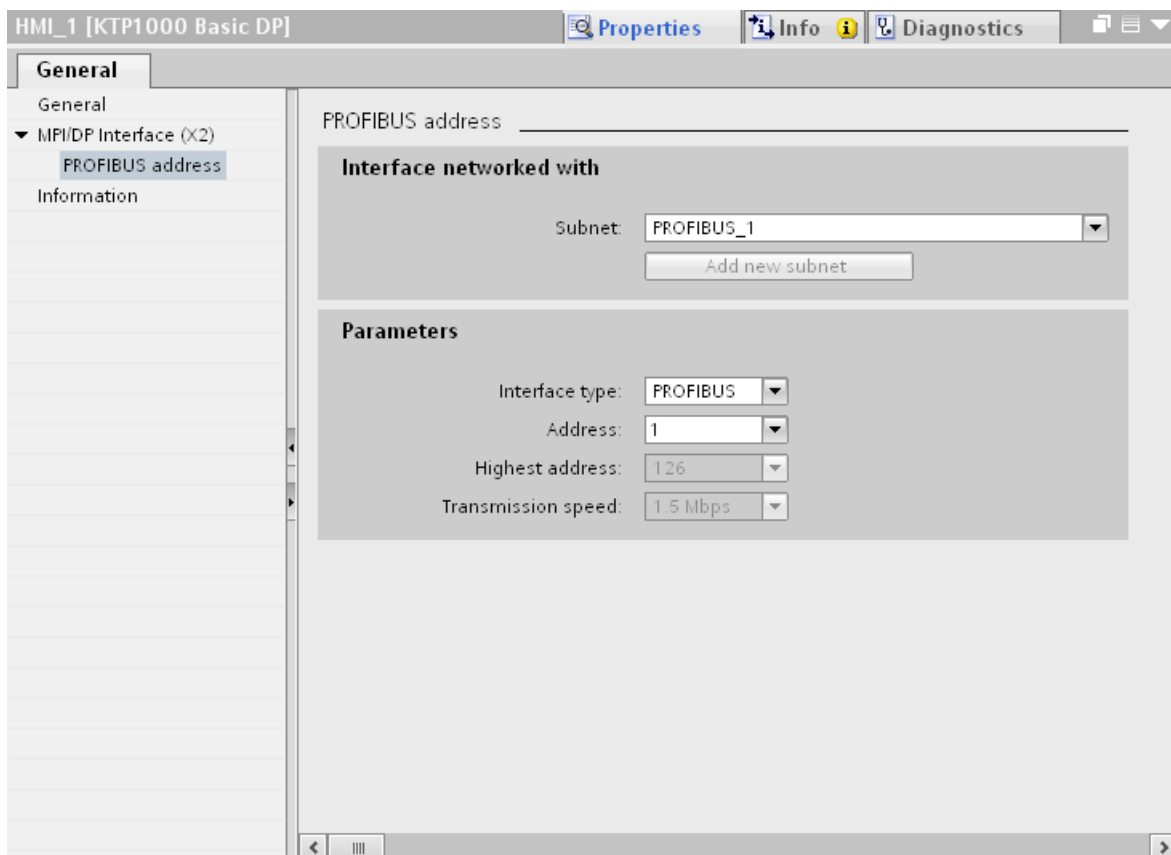

### "Interface networked with"

In the "Interface networked with" area, select the subnet of the HMI connection via which the HMI device is connected to the network. You use the "Add new subnet" button to create a new subnet.

### "Parameters"

- "Interface type"  
You assign the interface type in the "Interface type" area. Depending on the HMI device type, you have various interfaces to choose from.
- "Address"  
You assign the PROFIBUS address of the HMI device in the "Address" area. The PROFIBUS address must be unique throughout the PROFIBUS network.
- "Highest address"  
The "Highest address" area displays the highest address of the PROFIBUS network.
- "Transmission speed"  
The "Transmission speed" is determined by the slowest device connected to the network. The setting is identical throughout the network.

### PROFIBUS parameters for the PLC

### PROFIBUS parameters for the PLC

An overview of the configured parameters can be found in the properties for the PLC.

## Displaying and changing PROFIBUS parameters of the PLC

1. Click the PLC in the "Devices & Networks" editor.
2. Change the parameters of the PLC in the Inspector window under "Properties > General > General".

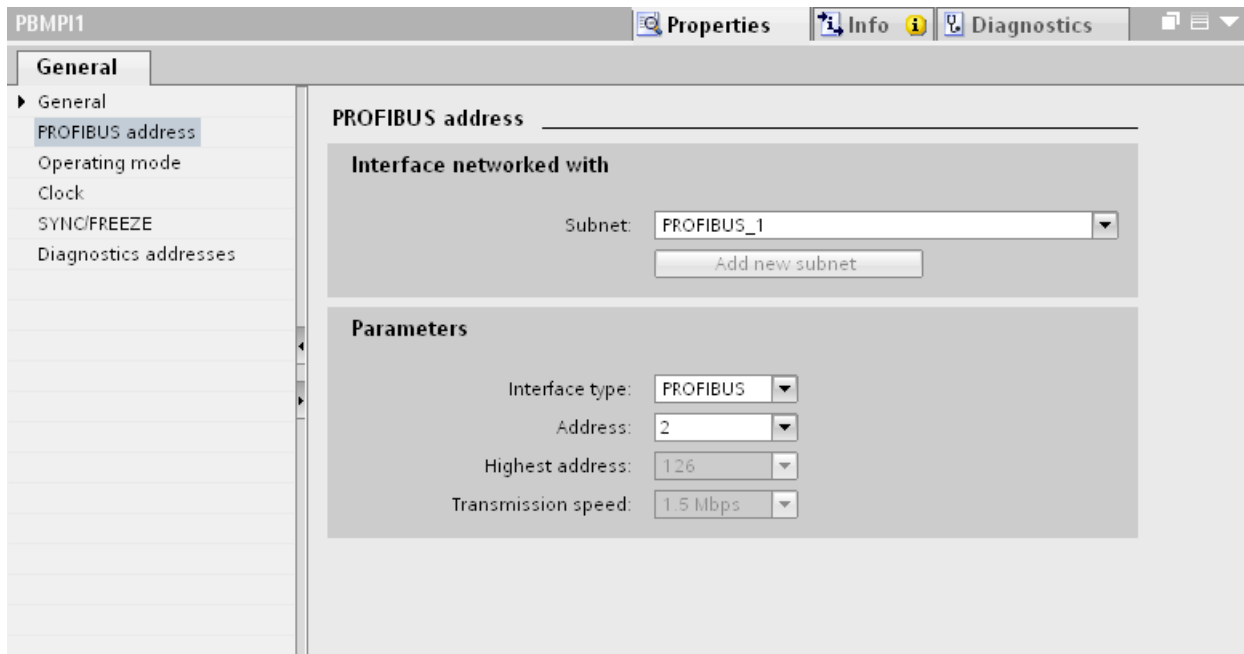

### "Interface networked with"

In the "Subnet" area, select the subnet of the HMI connection via which the PLC is connected to the network. You use the "Add new subnet" button to create a new subnet.

### "Parameters"

- "Interface type"  
Depending on the HMI device type, you have various interfaces to choose from.
- "Address"  
You assign the PROFIBUS address of the HMI device in the "Address" area. The PROFIBUS address must be unique throughout the PROFIBUS network.
- "Highest address"  
The "Highest address" area displays the highest address of the PROFIBUS network.
- "Transmission speed"  
The "Transmission speed" is determined by the slowest device connected to the network. The setting is identical throughout the network.

## Bus profiles with PROFIBUS

### Introduction

Depending on the device types connected and protocols used on the PROFIBUS, different profiles are available. The profiles differ in terms of the setting options and calculation of bus parameters. The profiles are explained below.

### Devices with different profiles on the same PROFIBUS subnet

The PROFIBUS subnet only functions without problem if the bus parameters of all devices have the same values.

### Profiles and transmission rates

Profiles	Supported transmission speeds in Kbits/s
DP	9,6 19,2 45,45 93,75 187,5 500 1500 3000 6000 12000
Standard	9,6 19,2 45,45 93,75 187,5 500 1500 3000 6000 12000
Universal	9,6 19,2 93,75 187,5 500 1500

### Meaning of profiles

Profile	Meaning
DP	<p>Select the "DP" bus profile when the only devices connected to the PROFIBUS subnet are those which satisfy the requirements of standard EN 50170 Volume 2/3, Part 8-2 PROFIBUS. The bus parameter setting is optimized on these devices.</p> <p>This includes devices with DP master and DP slave interfaces of the SIMATIC S7 and distributed I/Os of other manufacturers.</p>
Standard	<p>Compared to the "DP" profile, the "Standard" profile also offers scope for devices of another project or devices which have not been configured here to be taken into account when calculating the bus parameters. The bus parameters are then calculated following a simple, non-optimized algorithm.</p>
Universal	<p>Select the "Universal" bus profile when individual devices on the PROFIBUS subnet use the PROFIBUS-FMS service.</p> <p>This includes the following devices for example:</p> <ul style="list-style-type: none"> <li>• CP 343-5</li> <li>• PROFIBUS-FMS devices of other manufacturers</li> </ul> <p>As with the "Standard" profile, this profile allows you to take other devices into account when calculating the bus parameters.</p>



### 10.11.8.4 Communication via MPI

#### Configuring an HMI connection

#### Communication via MPI

#### HMI connections via MPI

If you have inserted an HMI device and a SIMATIC S7 300/400 into the project, you interconnect the two MPI interfaces in the "Devices & Networks" editor.

#### HMI connection in the "Devices & Networks" editor

You configure the HMI connection between the PLC and the HMI device via PROFIBUS in the "Devices & Networks" editor.

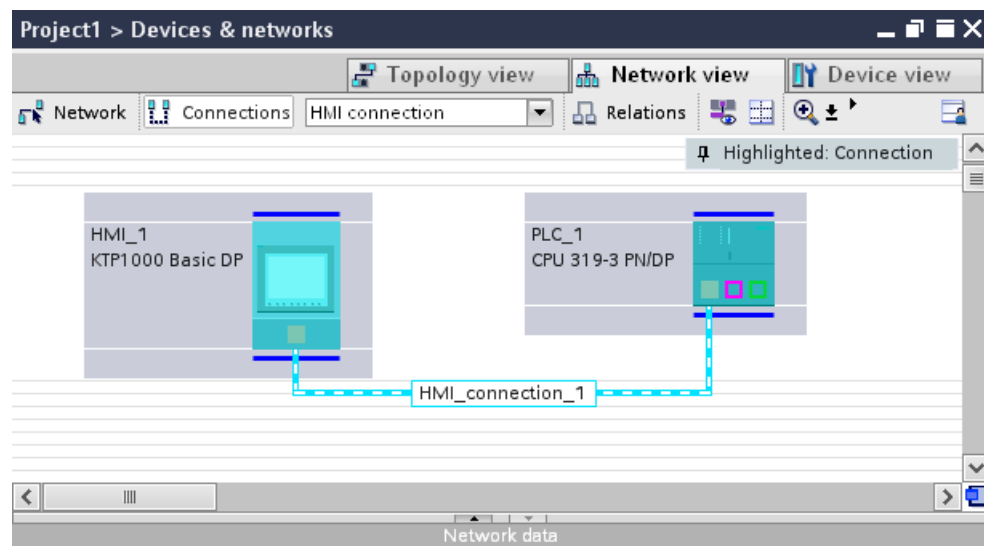

#### Connection in the "Connections" editor

Alternatively, you configure the connection between the PLC and HMI device in the "Connections" editor of the HMI device.

#### Configuring an HMI connection via MPI

#### Introduction

You configure an HMI connection between HMI devices and a SIMATIC S7 300/400 via MPI in the "Devices & Networks" editor.

## Requirements

The following communication partners are created in the "Devices & Networks" editor:

- HMI device with MPI/DP interface
- SIMATIC S7 300/400 with MPI/DP interface

## Procedure

1. Double-click the "Devices & Networks" item in the project tree.  
The available communication partners in the project are displayed graphically in the network view.

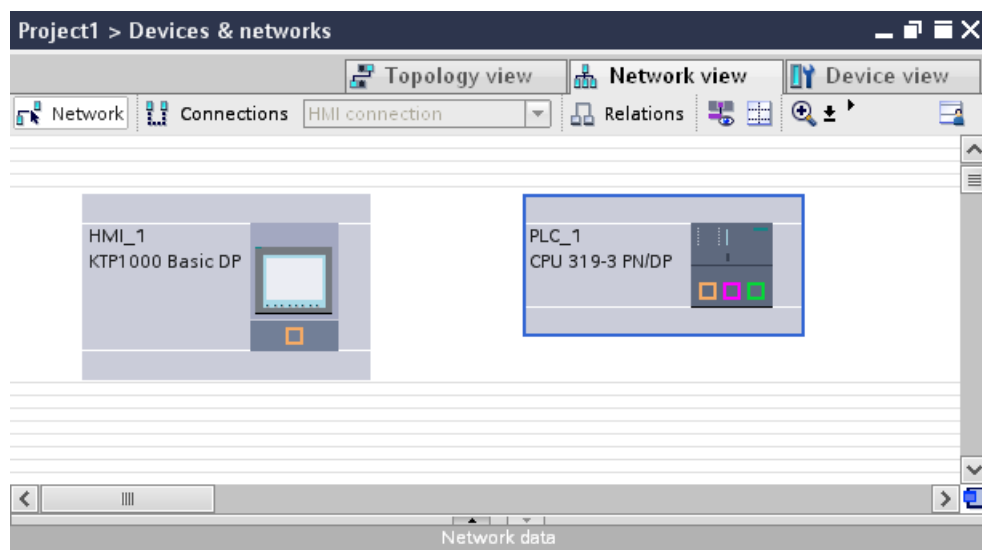

2. Click the "Connections" button.  
The devices available for connection are highlighted in color.
3. Click the interface of the PLC and use a drag-and-drop operation to draw a connection to the HMI device.

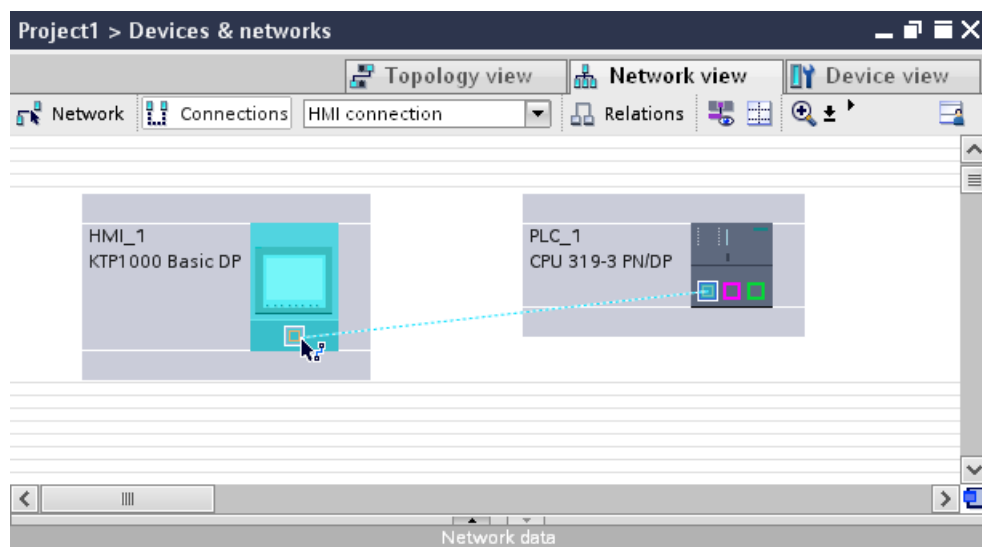

4. Click the connecting line.  
The connection is displayed graphically in the Inspector window.
5. Click "Highlight HMI connection" and select the HMI connection.
6. Click the communication partners in the "Network view" and change the MPI parameters in the Inspector window according to the requirements of your project.  
See the chapter "MPI parameters (Page 5162)" for additional details.

---

**Note**

The created HMI connection is also shown in the tabular area of the editor on the "Connections" tab. Use the table to monitor the connection parameters and change the connection partner. You can change the local name for the connection only in the table.

---

## Result

You have created an HMI connection between an HMI device and a SIMATIC S7 300/400 via MPI.

## Configuring an HMI connection

### Communication via MPI

### Communication via MPI

This section describes the communication between a WinCC Runtime and the SIMATIC S7 300/400 PLC via MPI.

You can use the following WinCC Runtimes as an HMI device:

- WinCC RT Advanced

### WinCC Runtime as HMI device

You configure the HMI connections between WinCC Runtime and SIMATIC S7 300/400 in the "Devices & Networks" editor.

If you want to use a WinCC Runtime as an HMI device, you have the following options:

1. You create a SIMATIC PC and configure a WinCC Runtime on this SIMATIC PC. In this way you use the SIMATIC PC with a WinCC Runtime as an HMI device.

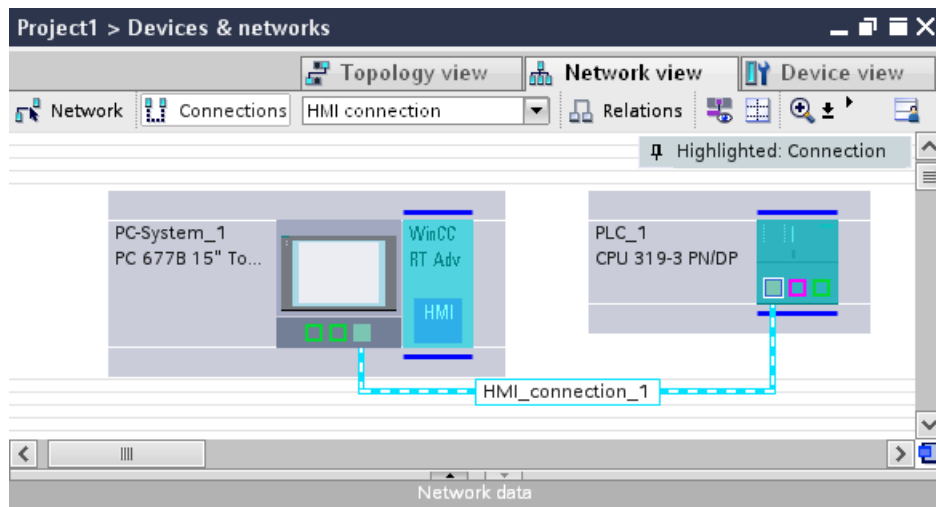

2. You create a WinCC Runtime and configure a communication processor to the Runtime. In this way you use your configuration PC with a WinCC Runtime as an HMI device.

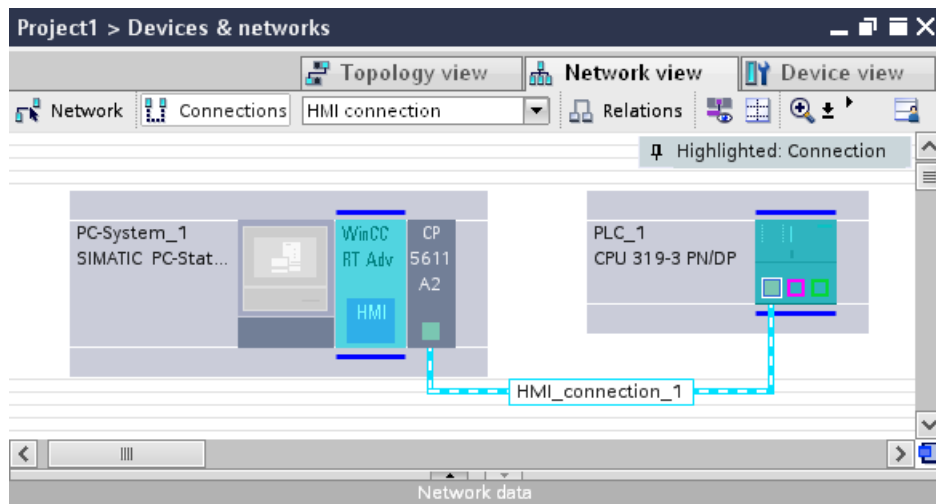

You can also connect multiple HMI devices to one SIMATIC S7 300/400 and multiple SIMATIC S7 300/400s to one HMI device. The maximum number of communication partners that you can connect to an HMI device is dependent on the HMI device used.

Additional information is available in the documentation for the respective HMI device.

### HMI connection in the "Devices & Networks" editor

You configure the HMI connection between the PLC and the HMI device via MPI in the "Devices & Networks" editor.

## Connection in the "Connections" editor

Alternatively, you configure the connection between the PLC and HMI device via MPI in the "Connections" editor of the HMI device.

## Configuring an HMI connection via MPI with a SIMATIC PC

### Introduction

You configure an HMI connection between HMI devices and a SIMATIC S7 300/400 via PROFIBUS in the "Devices & Networks" editor.

### Requirements

The following communication partners are created in the "Devices & Networks" editor:

- SIMATIC S7 300/400 with MPI interface
- SIMATIC PC with MPI interface

### Procedure

1. Double-click the "Devices & Networks" item in the project tree.  
The available communication partners in the project are displayed in the network view.
2. Use a drag-and-drop operation to move a WinCC Runtime from the hardware catalog to the PC.

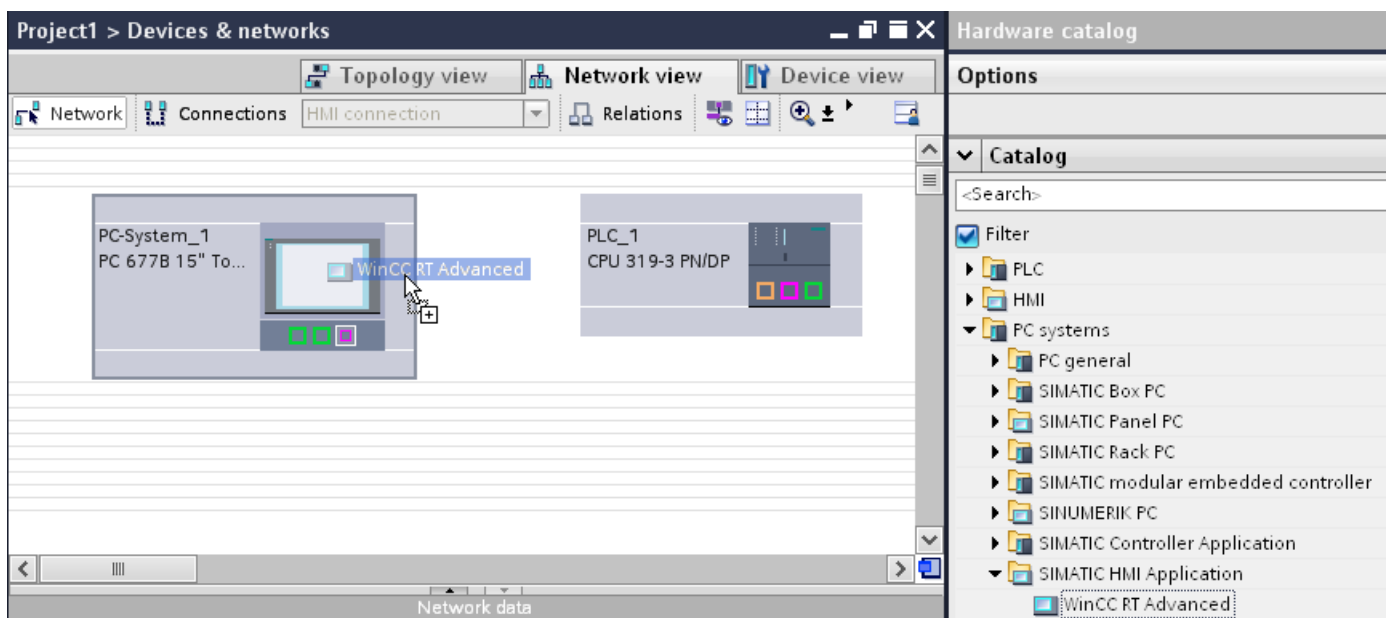

3. Click the "Connections" button and select "HMI connection" for the connection type.  
The devices available for connection are highlighted in color.

- Click the MPI interface of the PLC and use a drag-and-drop operation to draw a connection to the MPI interface of the PC.

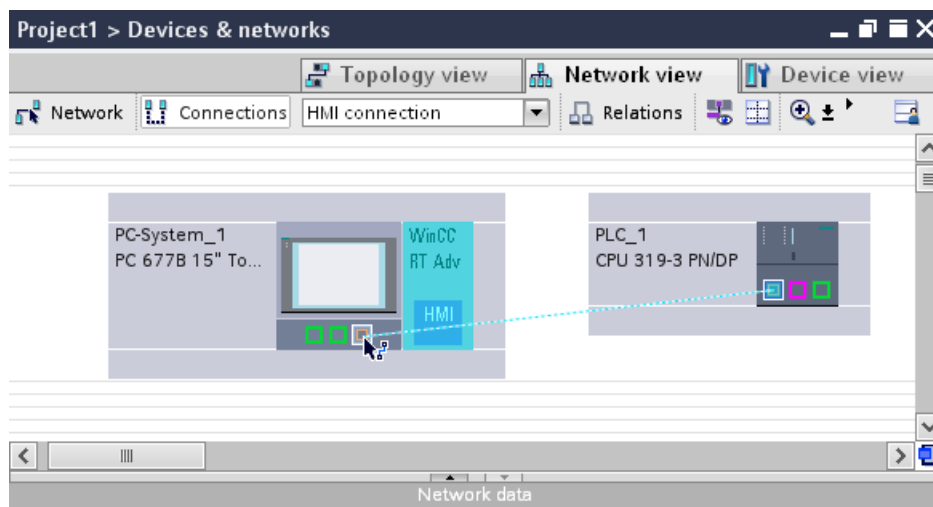

- Click the connecting line.
- Click "Highlight HMI connection" and select the HMI connection. The connection is displayed graphically in the Inspector window.
- Click the communication partners in the "Network view" and change the MPI parameters in the Inspector window according to the requirements of your project. See the chapter "MPI parameters (Page 5162)" for additional details.

**Note**

The created HMI connection is also shown in the tabular area of the editor on the "Connections" tab. You check the connection parameters in the table.

You can change the local name for the connection only in the table.

**Result**

You have created an HMI connection between an HMI device and a SIMATIC S7 300/400 via MPI.

**Configuring an HMI connection via MPI with a PC**

**Introduction**

You configure an HMI connection between HMI devices and a SIMATIC S7 300/400 via MPI in the "Devices & Networks" editor.

## Requirements

The following communication partners are created in the "Devices & Networks" editor:

- SIMATIC S7 300/400 with MPI interface
- PC station with WinCC RT Advanced

## Procedure

1. Double-click the "Devices & Networks" item in the project tree.  
The available communication partners in the project are displayed in the network view.
2. Use a drag-and-drop operation to move a PROFIBUS-capable communication processor from the hardware catalog to the WinCC Runtime.

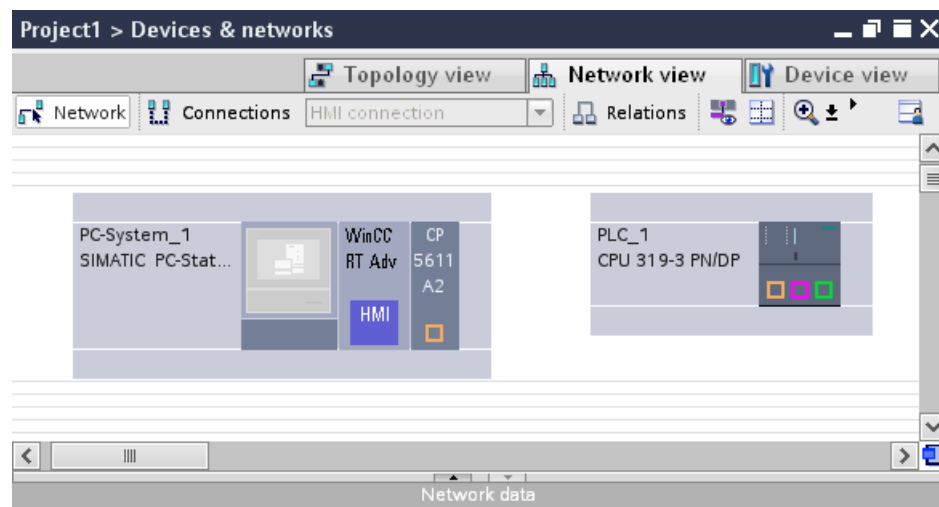

3. Click the PROFIBUS interface of the communication processor and change the interface to "MPI".
4. Click the "Connections" button and select "HMI connection" for the connection type.  
The devices available for connection are highlighted in color.

5. Click the MPI interface of the PLC and use a drag-and-drop operation to draw a connection to the MPI interface of the communication processor.

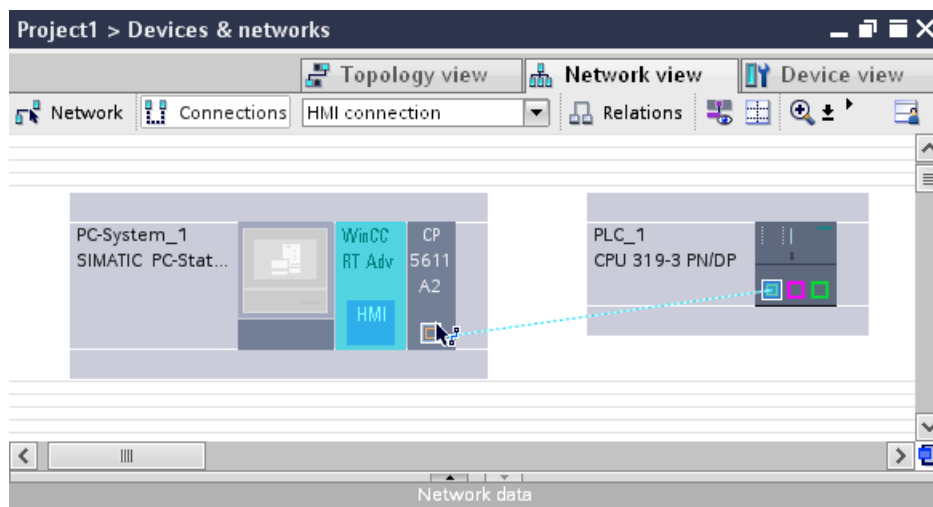

6. Click the connecting line.
7. Click "Highlight HMI connection" and select the HMI connection. The connection is displayed graphically in the Inspector window.
8. Click the communication partners in the "Network view" and change the MPI parameters in the Inspector window according to the requirements of your project. See the chapter "MPI parameters (Page 5162)" for additional details.

---

**Note**

The created HMI connection is also shown in the tabular area of the editor on the "Connections" tab. You check the connection parameters in the table.

You can change the local name for the connection only in the table.

---

**Result**

You have created an HMI connection between an HMI device and a SIMATIC S7 300/400 via MPI.

**MPI parameters**

**MPI parameters for the HMI connection**

**MPI parameters for the HMI connection**

An overview of the configured HMI connection parameters can be found in the properties for the HMI connection.

Only limited changes are possible in this Inspector window.



## Displaying and changing the HMI connection parameters

1. Click the HMI connection in the "Devices & Networks" editor.
2. Change the parameters of the HMI connection in the Inspector window under "Properties > General > General".

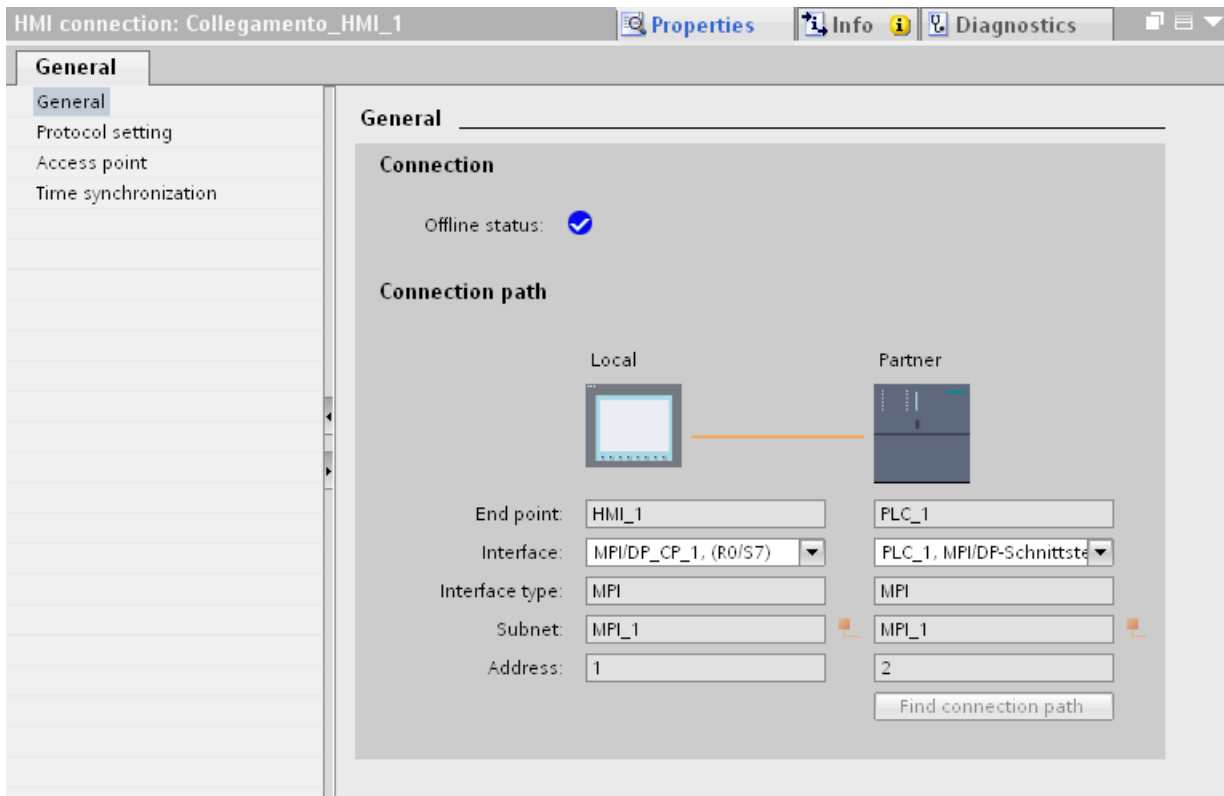

### "Connection"

Displays whether the devices are networked together.

- displayed if the devices are networked together.
- displayed if the devices are not networked together.

### "Connection path"

The communication partners of the selected HMI connection and the associated MPI parameters are displayed in the "Connection path" area. Some of the areas displayed cannot be edited in this dialog.

- "End point"  
Displays the name of the device. This area is not editable.
- "Interface"  
Displays the selected interface of the device. You can choose between several interfaces, depending on the device.

- "Interface type"  
Displays the selected interface type. This area is not editable.
- "Subnet"  
Displays the selected subnet. This area is not editable.
- "Address"  
Displays the MPI address of the device. This area is not editable.
- "Find connection path" button  
Enables the subsequent specification of connections.

## MPI parameters for the HMI device

## MPI parameters for the HMI device

An overview of the configured HMI device parameters can be found in the properties for the HMI device.

## Displaying and changing MPI parameters of the HMI device

1. Click the HMI device in the "Devices & Networks" editor.
2. Change the parameters of the HMI device in the Inspector window under "Properties > General > General".

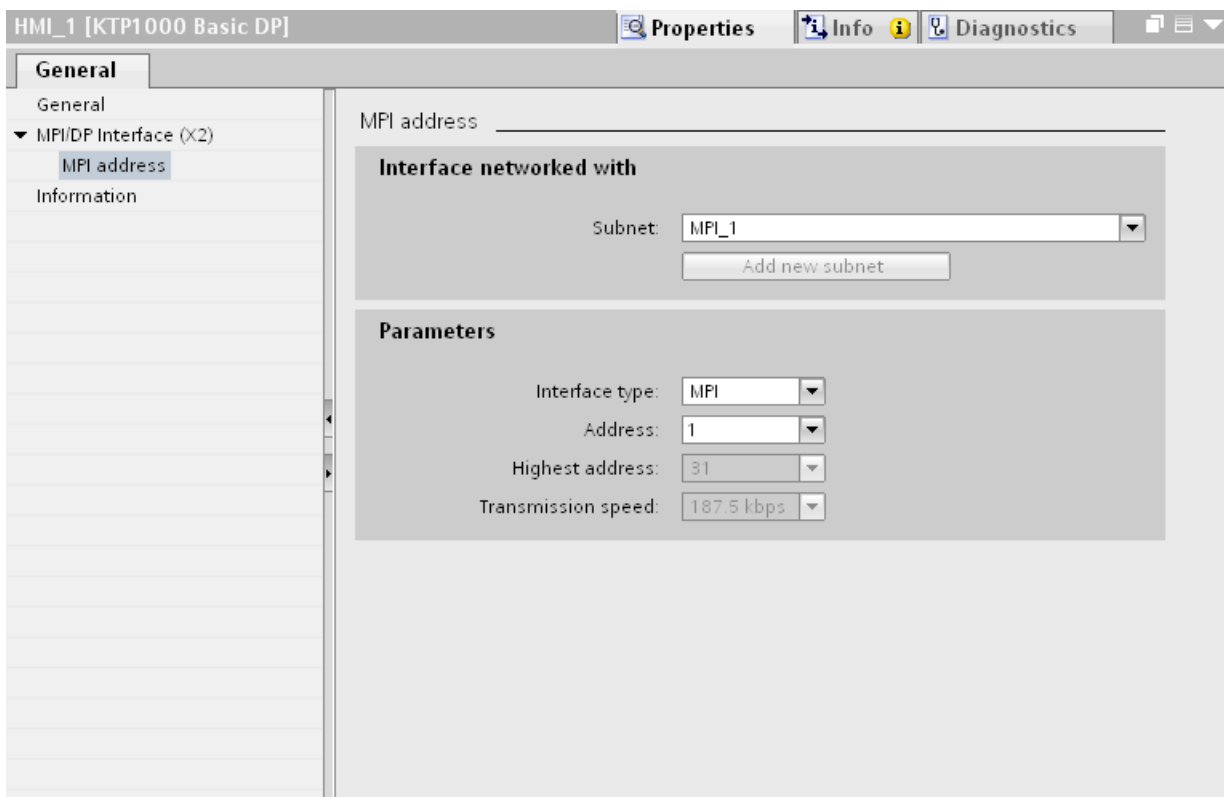

### "Interface networked with"

In the "Interface networked with" area, select the subnet of the HMI connection via which the HMI device is connected to the network. You use the "Add new subnet" button to create a new subnet.

### "Parameters"

- "Interface type"  
You assign the interface type in the "Interface type" area. Depending on the HMI device type, you have various interfaces to choose from.
- "Address"  
You assign the MPI address of the HMI device in the "Address" area. The MPI address must be unique throughout the MPI network.
- "Highest address"  
The "Highest address" area displays the highest address of the MPI network.
- "Transmission speed"  
The "Transmission speed" is determined by the slowest device connected to the network. The setting is identical throughout the network.

### MPI parameters for the PLC

### MPI parameters for the PLC

An overview of the configured parameters can be found in the properties for the PLC.

## Displaying and changing PROFIBUS parameters of the PLC

1. Click the PLC in the "Devices & Networks" editor.
2. Change the parameters of the PLC in the Inspector window under "Properties > General > General".

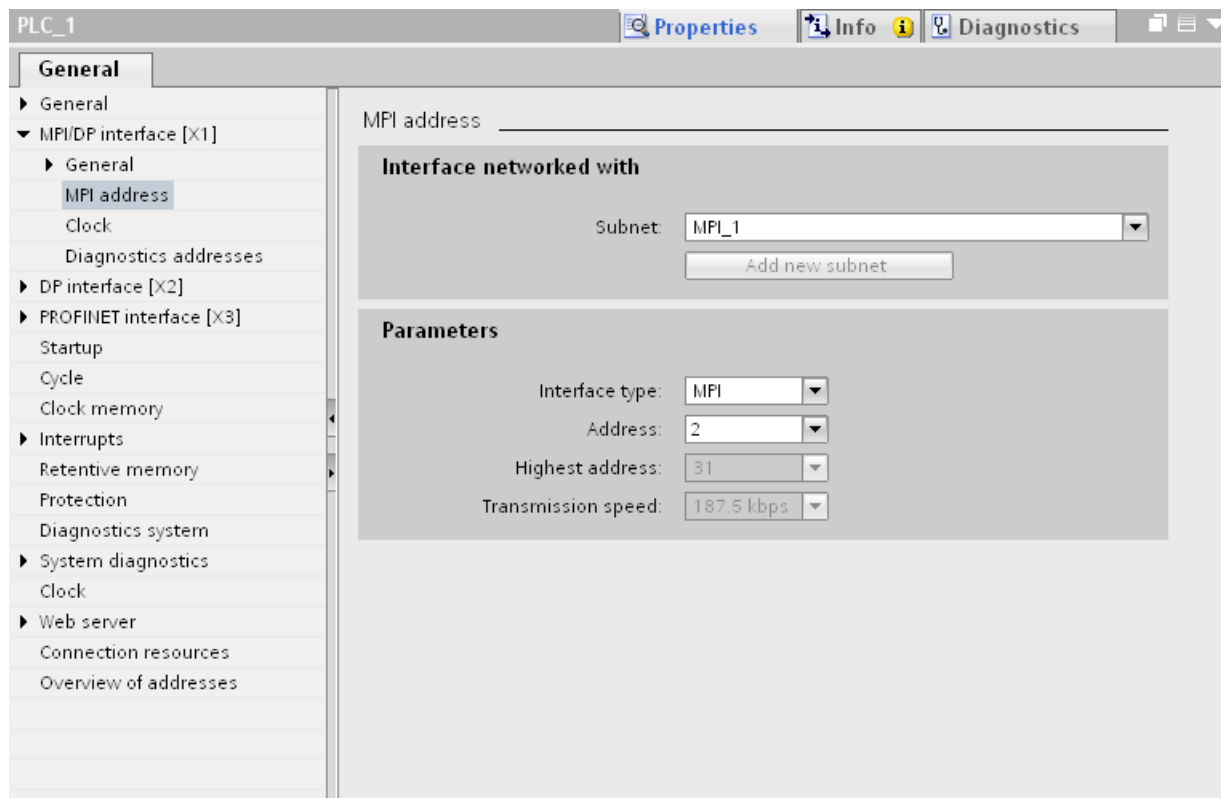

### "Interface networked with"

In the "Subnet" area, select the subnet of the HMI connection via which the HMI device is connected to the network. You use the "Add new subnet" button to create a new subnet.

### "Parameters"

- "Interface type"  
Depending on the HMI device type, you have various interfaces to choose from.
- "Address"  
You assign the MPI address of the HMI device in the "Address" area. The MPI address must be unique throughout the MPI network.
- "Highest address"  
The "Highest address" area displays the highest address of the MPI network.
- "Transmission speed"  
The "Transmission speed" is determined by the slowest device connected to the network. The setting is identical throughout the network.

## Addressing of the PLC via MPI

### Introduction

Each communication partner must be assigned an MPI network address.

Each S7 module which supports communication functions and is operated the SIMATIC S7-300/400 PLC is assigned a unique MPI address. Only one CPU may be used per rack.

---

#### Note

#### HMI devices cannot be operated with incorrect addressing

Always avoid redundant addressing on the MPI bus.

---

### MPI address of the communication partner of a SIMATIC S7-300

When assigning addresses, you have to distinguish between communication partners with and without separate MPI address.

- If the communications partner has its own MPI address, you only need to define the MPI address.
- If the communication partners do not have a separate MPI address, specify the MPI address of the communications partner used for the connection. In addition, define the slot and rack of a communication partner without its own MPI address.

### MPI address of the communication partner of a SIMATIC S7-400

Only S7 modules with an MPI connector are assigned an MPI address. Modules without an MPI connector are addressed indirectly:

- MPI address of the module to which the HMI is connected.
- The slot and the rack of the module with which the HMI device communicates.

#### 10.11.8.5 Data exchange

### Data exchange using area pointers

#### General information on area pointers

### Introduction

You use an area pointer to access a data area in the PLC. During communication, the PLC and the HMI device alternately access these data areas for read and write operations.

The PLC and the HMI device trigger defined interactions based on the evaluation of stored data.

### Configuration of area pointers

Before you use an area pointer, you enable it under "Connections > Area pointer". You then assign the area pointer parameters.

You can find more detailed information on configuring area pointers in:

Configuring area pointers (Page 4956)

### "Screen number" area pointer

#### Function

The HMI device saves information about the screen called on the HMI device to the "Screen number" area pointer.

This allows the transfer of the current screen contents from the HMI device to the PLC. The PLC can trigger specific reactions such as the call of a different screen.

#### Use

Configure and enable the area pointer in "Communication > Connections" before you put it into use. You can create only **one** instance of the "Screen number" area pointer and only on **one** PLC.

The screen number is always transferred to the PLC when a new screen is activated or when the focus within a screen changes from one screen object to another.

#### Structure

The area pointer is a data area in the memory of the PLC with a fixed length of 5 words.

	15	14	13	12	11	10	9	8	7	6	5	4	3	2	1	0
1st word	Current screen type															
2nd word	Current screen number															
3rd word	Reserved															
4th word	Current field number															
5th word	Reserved															

- Current screen type  
"1" for root screen or  
"4" for permanent window
- Current screen number  
1 to 32767
- Current field number  
1 to 32767

## "Date/time" area pointer

### Function

This area pointer is used to transfer the date and time from the HMI device to the PLC.

The PLC writes control job "41" or "40" to the job mailbox.

When it evaluates the control job, the HMI device writes its current date and the time in the data area configured in the "Date/time" area pointer. All definitions are coded in BCD format.

The "Date/Time" area pointer when used in a project which contains multiple connections must be enabled for each configured connection.

---

#### Note

You cannot use the "Date/Time PLC" area pointer if you have configured the "Date/Time" area pointer.

---

#### Note

Symbolic addressing is not possible if you are using the "Date/Time" area pointer.

---

The "Date/Time" area pointer when used in a project which contains multiple connections must be enabled for each configured connection.

The date/time data area has the following structure:

Data word	Most significant byte							Least significant byte							
	7						0	7						0	
n+0	Reserved							Hour (0 to 23)							Time
n+1	Minute (0 to 59)							Second (0 to 59)							
n+2	Reserved							Reserved							
n+3	Reserved							Weekday (1 to 7, 1=Sunday)							Date
n+4	Day (1 to 31)							Month (1 to 12)							
n+5	Year (80 to 99/0 to 29)							Reserved							

**Note**

When making entries in the "Year" data area, you should note that values 80 to 99 result in years 1980 through 1999, while the values 0 to 29 result in the years 2000 through 2029.

**"Date/time PLC" area pointer**

**Function**

This area pointer is used to transfer the date and time from the PLC to the HMI device. Use this area pointer if the PLC is the time master.

The PLC loads the data area of the area pointer. All definitions are coded in BCD format.

The HMI device reads the data cyclically within the configured acquisition cycle and synchronizes itself.

**Note**

Set an acquisition cycle of sufficient length for the Date/time area pointer in order to avoid any negative impact on HMI device performance.

Recommended: Acquisition cycle of 1 minute, if the process allows this.

You cannot use the "Date/Time" area pointer if you have configured the "Date/Time PLC" area pointer.

"Date/Time PLC" is a global area pointer and may be configured only once per project.

**Note**

You cannot use the "Date/Time" area pointer if you have configured the "Date/Time PLC" area pointer.

The date/time data area has the following structure:

**DATE\_AND\_TIME format (in BCD code)**

Data word	Most significant byte			Least significant byte		
	7	.....	0	7	.....	0
n+0	Year (80 to 99/0 to 29)			Month (1 to 12)		
n+1	Day (1 to 31)			Hour (0 to 23)		
n+2	Minute (0 to 59)			Second (0 to 59)		
n+3	Reserved			Reserved	Weekday (1 to 7, 1=Sunday)	



Data word	Most significant byte			Least significant byte		
	7	.....	0	7	.....	0
n+4 <sup>1)</sup>	Reserved			Reserved		
n+5 <sup>1)</sup>	Reserved			Reserved		

- 1) The two data words must exist in the data area to ensure that the data format matches WinCC flexible and to avoid reading false information.

**Note**

When making entries in the "Year" data area, you should note that values 80 to 99 result in years 1980 through 1999, while the values 0 to 29 result in the years 2000 through 2029.

**"Coordination" area pointer**

**Function**

The "Coordination" area pointer is used to implement the following functions:

- Detecting the startup of the HMI device in the control program
- Detecting the current operating mode of the HMI device in the control program
- Detecting whether the HMI device is ready to communicate in the control program

By default, the "Coordination" area pointer has the length of one word and cannot be changed.

**Application**

**Note**

The HMI device always writes the entire coordination area when updating the area pointer. The control program can for this reason not make changes to the coordination area.

**Assignment of bits in the "Coordination" area pointer**

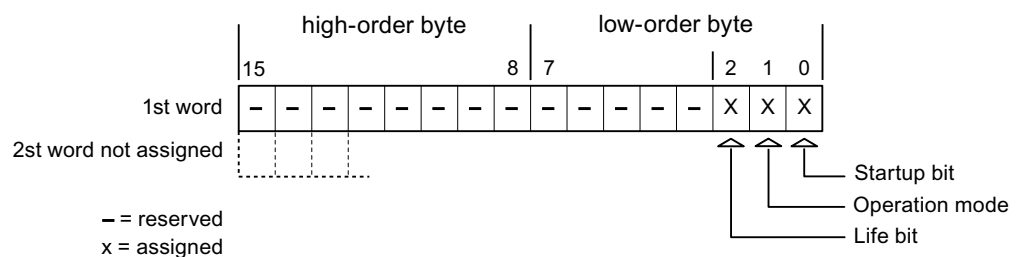

### Startup bit

The startup bit is set briefly to "0" by the HMI device during startup. It sets the bit permanently to "1" when startup is completed.

### Operating mode

The operating mode bit is set to 1 as soon as the user switches the HMI device offline. The status of the operating mode bit is "0" during normal operation of the HMI device. You can determine the current operating mode of the HMI device by reading this bit in the control program.

### Life bit

The HMI device inverts the life bit at intervals of approximately one second. You can check whether or not there is still a connection to the HMI device by querying this bit in the control program.

### "Project ID" area pointer

#### Function

When Runtime starts it can check to see if the HMI device is connected to the correct PLC. This check is important when operating with several HMI devices.

For this, the HMI device compares a value stored on the PLC with the value specified in configuration. This ensures compatibility of the configuration data with the PLC program. If there is no concordance, a system event is given on the HMI device and Runtime is stopped.

#### Use

To use this area pointer, set up the following during the configuration:

- Define the version of configuration. Values between 1 and 255 are possible.  
You enter the version in the editor "Runtime settings > General" in the "Identification" area.
- Data address of the value for the version that is stored in the PLC:  
You enter the data address in the editor "Communication > Connections" under "Address".

#### Connection failure

A connection failure to a device on which the "project ID" area pointer is configured results in all the other connections of the device being switched to "offline".

This behavior has the following requirements:

- You have configured several connections in a project.
- You are using the "project ID" area pointer in at least one connection.

Causes which may set connections "offline":

- The PLC is not available.
- The connection has been switched offline in the engineering system.

## "Job mailbox" area pointer

### Function

The PLC can use the job mailbox to transfer jobs to the HMI device to trigger corresponding actions on the HMI device. These functions include, for example:

- Display screen
- Set date and time

### Data structure

The first word of the job mailbox contains the job number. Depending on the job mailbox, up to three parameters can be transferred.

Word	Most significant byte	Least significant byte
n+0	0	Job number
n+1	Parameter 1	
n+2	Parameter 2	
n+3	Parameter 3	

The HMI device evaluates the job mailbox if the first word of this job is not equal to zero. This means that the parameters must be entered in the job mailbox first, followed by the job number.

When the HMI device accepts the job mailbox, the first word is set to 0 again. The execution of the job mailbox is generally not completed at this point in time.

### Job mailboxes

All job mailboxes and their parameters are listed below. The "No." column contains the job number of the job mailbox. Job mailboxes can only be triggered by the PLC when the HMI device is online.

No	Function	
14	<b>Set time (BCD-coded)</b>	
	Parameter 1	Left byte: - Right byte: hours (0-23)
	Parameter 2	Left byte: minutes (0-59) Right byte: seconds (0-59)
	Parameter 3	-
15	<b>Setting the date (BCD coded)</b> <sup>3) 4)</sup>	

No	Function	
<b>14</b>	<b>Set time (BCD-coded)</b>	
	Parameter 1	Left byte: - Right byte: weekday (1-7: Sunday-Saturday)
	Parameter 2	Left byte: day (1-31) Right byte: month (1-12)
	Parameter 3	Left byte: year
<b>23</b>	<b>User logon</b>	
	Logs the user on with the name "PLC user" at the HMI device with the group number transferred in Parameter 1. The logon is possible only when the transferred group number exists in the project.	
	Parameter 1	Group number 1 to 255
	Parameter 2, 3	-
<b>24</b>	<b>User logoff</b>	
	Logs off the current user. (The function corresponds to the "logoff" system function)	
	Parameter 1, 2, 3	-
<b>40</b>	<b>Transfer date/time to PLC</b>	
	(in the S7 format DATE_AND_TIME) An interval of at least 5 seconds must be maintained between two successive jobs to prevent overload of the HMI device.	
	Parameter 1, 2, 3	-
<b>41</b>	<b>Transfer date/time to PLC</b>	
	(In OP/MP format) An interval of at least 5 seconds must be maintained between successive jobs to prevent overload of the HMI device.	
	Parameter 1, 2, 3	-
<b>46</b>	<b>Update tag</b>	
	Causes the HMI device to read the current value of the tags from the PLC whose update ID matches the value transferred in Parameter 1. (Function corresponds to the "UpdateTag" system function.)	
	Parameter 1	1 - 100
<b>49</b>	<b>Delete alarm buffer</b>	
	Deletes all analog alarms and discrete alarms of the "Warnings" class from the alarm buffer.	
	Parameter 1, 2, 3	-
<b>50</b>	<b>Delete alarm buffer</b>	
	Deletes all analog alarms and discrete alarms of the "Errors" class from the alarm buffer.	
	Parameter 1, 2, 3	-
<b>51</b>	<b>Screen selection <sup>2)</sup></b>	
	Parameter 1	Screen number
	Parameter 2	-
	Parameter 3	Field number
<b>69</b>	<b>Reading data record from PLC <sup>1)</sup></b>	
	Parameter 1	Recipe number (1-999)
	Parameter 2	Data record number (1-65535)

No	Function	
14	<b>Set time (BCD-coded)</b>	
	Parameter 3	0: Do not overwrite existing data record 1: Overwrite existing data record
70	<b>Writing data record to PLC <sup>1)</sup></b>	
	Parameter 1	Recipe number (1-999)
	Parameter 2	Data record number (1-65535)
	Parameter 3	-

1)	Only for devices supporting recipes.
2)	OP 73, OP 77A and TP 177A HMI devices also execute the "Screen selection" job mailbox if the on-screen keyboard is active.
3)	The weekday is ignored on HMI device KTP 600 BASIC PN.
4)	The weekday is ignored when you configure the "Date/Time PLC" area pointer.

### "Data record" area pointer

### "Data record" area pointer

### Function

When data records are transferred between the HMI device and PLC, both partners access common communications areas on the PLC.

### Data transfer types

There are two ways of transferring data records between the HMI device and PLC:

- Transfer without synchronization
- Transfer with synchronization via the data mailbox

Data records are always transferred directly, which means that the tag values are read straight from an address or written straight to an address configured for this tag without being redirected via an interim memory.

### Initiating the transfer of data records

There are three ways of triggering the transfer:

- Operator input in the recipe view
- Job mailboxes  
The transfer of data records can also be triggered by the PLC.
- Triggering by configured functions

If the transfer of data records is triggered by a configured function or by a job mailbox, the recipe view on the HMI device remains operable. The data records are transferred in the background.

Simultaneous processing of several transfer requests is, however, not possible. In this case, the HMI device rejects the other transfer requests with a system alarm.

### Transfer without synchronization

If you select asynchronous transfer of data records between the HMI device and PLC, there is no coordination over the common data areas. It is therefore unnecessary to set up a data area during configuration.

Asynchronous data record transfer can be a useful alternative, for example when:

- The system is capable of excluding the risk of uncontrolled overwriting of data by the communication peer.
- The PLC does not require information about the recipe number and data record number.
- The transfer of data records is triggered by the operator of the HMI device.

### Reading values

When a read job is triggered, the values are read from the PLC addresses and transferred to the HMI device.

- Triggering by the operator in the recipe view:  
The values are downloaded to the HMI device. You can then, for example, process, edit, or save these values in the HMI device.
- Triggering by a function or job mailbox:  
The values are saved immediately to the data volume.

### Writing values

When a write job is triggered, the values are written to the PLC addresses.

- Triggering by the operator in the recipe view:  
The current values are written to the PLC.
- Triggering by a function or job mailbox:  
The current values are written to the PLC from the data medium.

### Transfer with synchronization

If you select synchronous transfer, both communication partners set status bits in the common data area. You can use this mechanism to prevent uncontrolled overwriting of data in either direction in your control program.

## Application

Synchronous data record transfer can be a useful solution, for example, when:

- The PLC is the "active partner" in the transfer of data records.
- The PLC evaluates the information about the recipe number and data record number.
- The transfer of data records is triggered by means of a Job mailbox.

## Requirements

In order to synchronize transfer of data records between the HMI device and the PLC, the following requirements must be met during configuration:

- An area pointer has been set up: "Communication > Connections" editor in "Area pointer".
- The PLC with which the HMI device synchronizes transfer of data records is specified in the recipe:  
"Recipes" editor in the inspector window the option "Coordinated transfer of data records" under "General > Synchronization > Settings"

## Structure of the data area

The data area has a fixed length of 5 words. Structure of the data area:

	15	0
1. Word	Current recipe number (1 - 999)	
2. Word	Current data record number (0 - 65535)	
3. Word	Reserved	
4. Word	Status (0, 2, 4, 12)	
5. Word	Reserved	

- Status  
The status word (word 4) can adopt the following values:

Value		Meaning
Decimal	Binary	
0	0000 0000	Transfer permitted, data mailbox free
2	0000 0010	Transferring
4	0000 0100	Transfer completed without error
12	0000 1100	Transfer completed with error

**Sequence of a transfer started by the operator in the recipe view**

**Reading from the PLC started by the operator in the recipe view**

Step	Action	
1	Check: Status word = 0?	
	Yes	No
2	The HMI device enters the recipe number to be read and the status "Transferring" in the data record and sets the data record number to 0.	Abort with system event.
3	The HMI device reads the values from the PLC and displays them in the recipe view. If the recipes have synchronized tags, the values from the PLC are also written to the tags.	
4	The HMI device sets the status "Transfer completed."	
5	The control program must reset the status word to zero in order to enable further transfers.	

**Writing to the PLC started by the operator in the recipe view**

Step	Action	
1	Check: Status word = 0?	
	Yes	No
	The HMI device enters the recipe and data record number to be written and the status "Transferring" in the data record.	Abort with system event.
2	The HMI device writes the current values to the PLC. If the recipes have synchronized tags, the changed values are synchronized between the recipe view and tags and then written to the PLC.	
3	The HMI device sets the status "Transfer completed."	
4	If required, the control program can now evaluate the transferred data.	
5	The control program must reset the status word to zero in order to enable further transfers.	

**Note**

The status word may only be set by the HMI device. The PLC may only reset the status word to zero.



**Note**

The PLC may only evaluate the recipe and data record numbers when data inconsistency is detected if one of the conditions outlined below has been met:

- The data mailbox status is set to "Transfer completed".
- The data mailbox status is set to "Transfer completed with error".

**Sequence of the transfer triggered by a job mailbox**

The transfer of data records between the HMI device and the PLC can be initiated by either one of these stations.

The two job mailboxes No. 69 and No. 70 are available for this type of transfer.

**No. 69: Read data record from PLC ("PLC → DAT")**

Job mailbox no. 69 transfers data records from the PLC to the HMI device. The job mailbox is structured as follows:

	Left byte (LB)	Right byte (RB)
Word 1	0	69
Word 2	Recipe number (1-999)	
Word 3	Data record number (1 to 65535)	
Word 4	Do not overwrite existing data record: 0 Overwrite existing data record: 1	

**No. 70: Write data record to PLC ("DAT → PLC")**

Job mailbox No. 70 transfers data records from the HMI device to the PLC. The job mailbox is structured as follows:

	Left byte (LB)	Right byte (RB)
Word 1	0	70
Word 2	Recipe number (1-999)	
Word 3	Data record number (1-65,535)	
Word 4	—	

**Sequence when reading from the PLC with job mailbox "PLC → DAT" (no. 69)**

Step	Action	
1	Check: Status word = 0?	
	Yes	No
2	The HMI device enters the recipe and data record number specified in the job and the status "Transferring" in the data record.	Abort without return message.

Step	Action
3	The HMI device reads the values from the PLC and saves these to the data record defined in the job mailbox.
4	<ul style="list-style-type: none"> <li>If "Overwrite" was selected in the job, an existing data record is overwritten without any prompt for confirmation. The HMI device sets the status "Transfer completed."</li> <li>If "Do not overwrite" was selected in the job, and the data record already exists, the HMI device aborts the job and enters 0000 1100 in the status word of the data mailbox.</li> </ul>
5	The control program must reset the status word to zero in order to enable further transfers.

**Sequence of writing to the PLC with job mailbox "DAT → PLC" (no. 70)**

Step	Action	
1	Check: Status word = 0?	
	<table border="1" style="width: 100%;"> <tr> <td style="width: 50%;">Yes</td> <td style="width: 50%;">No</td> </tr> </table>	Yes
Yes	No	
2	The HMI device enters the recipe and data record number specified in the job and the status "Transferring" in the data mailbox. <span style="float: right;">Abort without return message.</span>	
3	The HMI device fetches the values of the data record specified in the function from the data medium and writes the values to the PLC.	
4	The HMI device sets the status "Transfer completed."	
5	The control program can now evaluate the transferred data. The control program must reset the status word to zero in order to enable further transfers.	

**Sequence of the transfer when triggered by a configured function**

**Reading from the PLC using a configured function**

Step	Action	
1	Check: Status word = 0?	
	<table border="1" style="width: 100%;"> <tr> <td style="width: 50%;">Yes</td> <td style="width: 50%;">No</td> </tr> </table>	Yes
Yes	No	
2	The HMI device enters the recipe and data record number specified in the function and the status "Transferring" in the data mailbox. <span style="float: right;">Abort with system event.</span>	
3	The HMI device reads the values from the PLC and stores them in the data record specified in the function.	
4	<ul style="list-style-type: none"> <li>If "Yes" was selected for the "Overwrite" function, an existing data record is overwritten without any prompt for confirmation. The HMI device sets the status "Transfer completed."</li> <li>If "No" was selected for the "Overwrite" function and the data record already exists, the HMI device aborts the job and enters 0000 1100 in the status word of the data mailbox.</li> </ul>	
5	The control program must reset the status word to zero in order to enable further transfers.	

## Writing to the PLC by means of configured function

Step	Action	
1	Check: Status word = 0?	
	Yes	No
2	The HMI device enters the recipe and data record number specified in the function and the status "Transferring" in the data mailbox.	Abort with system event.
3	The HMI device fetches the values of the data record specified in the function from the data medium and transfers the values to the PLC.	
4	The HMI device sets the status "Transfer completed."	
5	The control program can now evaluate the transferred data. The control program must reset the status word to zero in order to enable further transfers.	

## Possible causes of error when transferring data records

### Possible causes of error

The section below shows possible error causes which lead to the cancellation of data record transfer:

- Tag address not set up on the PLC
- Overwriting data records not possible
- Recipe number does not exist
- Data record number does not exist

---

#### Note

The status word may only be set by the HMI device. The PLC may only reset the status word to zero.

---

#### Note

The PLC may only evaluate the recipe and data record numbers when data inconsistency is detected if one of the conditions outlined below has been met:

- The data mailbox status is set to "Transfer completed".
  - The data mailbox status is set to "Transfer completed with error".
-

### Reaction to an aborted transfer due to errors

If the transfer of data records is aborted due to errors, the HMI device reacts as follows:

- Triggering by the operator in the recipe view  
Information in the status bar of the recipe view and output of system alarms
- Triggered by function  
Output of system alarms
- Triggering by job mailbox  
No return message on the HMI device

You can nonetheless evaluate the status of the transfer by querying the status word in the data record.

### Trends

#### General information on trends

#### Trends

A trend is the graphical representation of one or more values from the PLC. The value is read out either time- or bit-triggered, depending on the configuration.

For additional information see:

Displaying tags with Runtime Advanced and Panels (Page 3237)

---

#### Note

The value is read out time-triggered for Basic Panels.

---

#### Time-triggered trends

The HMI device reads in the trend values cyclically at an interval specified in the configuration. Time-triggered trends are suitable for continuous curves, such as the operating temperature of a motor.

#### Bit-triggered trends

Through a trigger bit set in the trend request tag, the HMI device either reads in a trend value or an entire trend buffer. This setting is defined in the configuration. Bit-triggered trends are normally used to represent fast changing values. One example might be the injection pressure in the production of plastic parts.

To trigger bit-triggered trends, appropriate external tags must be created in the "HMI tags" editor and connected to trend areas during configuration. The HMI device and PLC then communicate with each other via these trend areas.

The following areas are available for trends:

- Trend request area
- Trend transfer area 1
- Trend transfer area 2 (required only with switch buffers)

## Trend request and trend transfer

### Trend request area

The HMI device sets corresponding bits in the trend request area when you open a screen which contains one or more trends on the HMI device. After closing the screen, the HMI device resets the relevant bits in the trend request area.

The trend request area can be used for evaluation purposes in the PLC to determine which trend is currently being displayed on the HMI device. Trends can also be triggered without evaluation of the trend request area.

### Trend transfer area 1

This area is used to trigger trends. You must set the bit assigned to the trend in the trend transfer area and set the trend group bit in your control program. The trend group bit is the last bit in the trend transfer area.

The HMI device detects the trigger. The HMI device reads either a value or the entire buffer from the PLC. It then resets the trend bit and the trend group bit.

The following picture shows the structure of a trend transfer area.

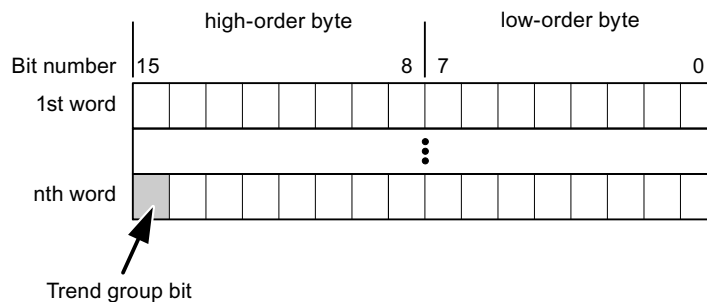

The trend transfer area must not be modified by the PLC program until the trend group bit has been reset.

### Trend transfer area 2

Trend transfer area 2 is required for trends configured with a switch buffer. The trend transfer areas 1 and 2 have a similar structure.

### Switch buffer

The switch buffer is a second buffer for the same trend that can be set up during configuration.

The PLC writes to Buffer 2 while the HMI device reads values from Buffer 1, and writes to Buffer 1 when the HMI device is reading Buffer 2. This prevents the PLC from overwriting trend values while the trend is being read by the HMI device.

## Permitted data types for trends

### For SIMATIC S7

You assign one bit to each trend during configuration. Tags and array tags of the "Word" or "Int" data type are permitted.

## Alarms

### Configuring alarms

#### Configure alarms

Several steps are needed to configure alarms, such as operational messages, error alarms, and acknowledgement.

- Step 1: Create tags
- Step 2: Configure alarms
- Step 3: Configure acknowledgment

You can find additional information in the section:

Working with Alarms (Page 3260)

### Distinctive features when configuring alarms

If you are configuring connections of HMI devices to PLCs of other manufacturers, note the following distinctive features when configuring:

- Data types of the tags
- Addressing of tags
- How the bit positions are counted

## Data types

For connections with a SIMATIC communication driver, the following data types are supported:

PLC	Permitted data types	
	Discrete alarms	Analog alarms
SIMATIC S7 300/400	WORD, INT	BYTE, CHAR, WORD, INT, DWORD, DINT, REAL, COUNTER, TIME

### How the bit positions are counted

For connections with a SIMATIC communication driver, the following counting method applies:

How the bit positions are counted	Byte 0								Byte 1								
	Most significant byte								Least significant byte								
In SIMATIC S7 PLCs	7							0	7								0
In WinCC you configure:	15							8	7								0

### Acknowledgment of alarms

#### Procedure

Create suitable tags on the PLC to acknowledge an error alarm. You assign these tags to an alarm in the "Bit messages" editor. You make the assignment in "Properties > Acknowledgment".

Distinction in terms of acknowledgment:

- Acknowledgment by the PLC
- Acknowledgment on the HMI device

#### Acknowledgment by the PLC

In "PLC acknowledgment tag", configure the tag or array tag and the bit number that the HMI device uses to identify a PLC acknowledgment.

A bit set in the tag triggers acknowledgment of the assigned error alarm bit at the HMI device. This tag bit returns a function similar to acknowledgment on the HMI device which is triggered by pressing the "ACK" button, for example.

The acknowledgment bit must be located in the same tag as the bit for the error alarm.

Reset the acknowledgment bit before setting the bit in the alarm area again. The figure below shows the pulse diagram.

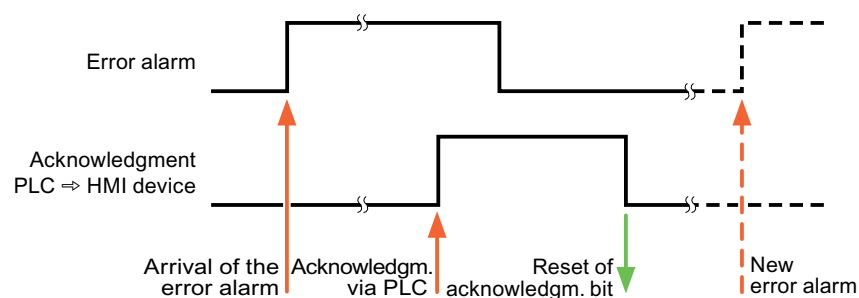

## Acknowledgment on the HMI device

In the "HMI acknowledgment tag" area, configure the tag or array tag as well as the bit number that the HMI device writes to the PLC after acknowledgment. Make sure when you use an array tag that it is not longer than 6 words.

To always create a signal change when setting an assigned acknowledgment bit of a discrete alarm that must be acknowledged, the HMI device will reset the acknowledgment bit assigned to the alarm as soon as it detects an alarm subject to acknowledgment and write the acknowledgment tag in the PLC. There will be a certain delay between detecting the message and writing the acknowledgment tag in the PLC because the HMI device has to process the operations.

If a discrete alarm subject to acknowledgment is acknowledged by the HMI device, then the corresponding bit in the assigned acknowledgment tag will be set. The entire acknowledgment tag is then written to the PLC by the HMI device. This allows the PLC to recognize that a certain alarm message has been acknowledged at the HMI device.

---

### Note

All alarm bits acknowledged since the last Runtime start will remain in the acknowledgment tag until a new incoming of the respective discrete alarms is detected.

This area should only be read by the PLC because the entire section of the HMI device will be overwritten once the next acknowledgment tag is written.

---

The figure below shows the pulse diagram.

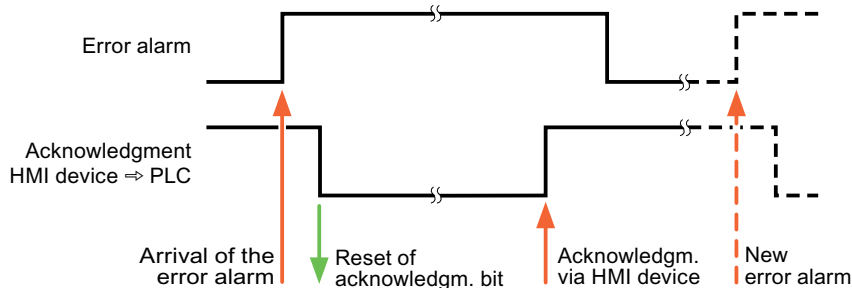

## LED mapping

### Function

Keyboard devices have LEDs in the function keys. These LEDs can be activated from the PLC. Thus, it is possible, for example, to signal to the user which key he should press in a given situation by lighting up an LED.

---

### Note

The LED function cannot be configured for Basic Panels.

---



## Requirements

In order to activate an LED, an LED tag or an array tag must be set up in the PLC and specified as an LED tag during configuration.

## LED assignment

The assignment of the individual LEDs to the bits in the LED tags is specified when the function keys are configured. In this process, the "LED tag" and the assigned "Bit" are specified for each function key in the "General" group of the properties window.

The "Bit" bit number designates the first of two consecutive bits that control the following LED statuses.

Bit n+ 1	Bit n	LED function	
		All Mobile Panels, all Operator Panels, all Multi Panels	Panel PCs:
0	0	Off	Off
0	1	Rapid flashing	Flashing
1	0	Slow flashing	Flashing
1	1	On permanently	On permanently

### 10.11.8.6 Performance features of communication

#### Permitted data types for SIMATIC S7 300/400

#### Permitted data types for connections with SIMATIC S7 300/400

The table lists the data types that can be used when configuring tags and area pointers.

Data type	Length
BOOL	1-bit
BYTE	1 byte
WORD	2 bytes
DWORD	4 bytes
CHAR	1 byte
INT	2 byte
DINT	4 bytes
REAL	4 bytes
TIME	4 bytes
DATE	2 bytes
TIME_OF_DAY, TOD	4 bytes
S5TIME	2 bytes
COUNTER	2 bytes

Data type	Length
TIMER	2 bytes
DATE_AND_TIME	8 bytes
STRING	(2+n) bytes, n = 0 to 254

### 10.11.8.7 Creating connections in the "Connections" editor

#### Creating a PROFINET connection

#### Requirements

- A project is open.
- An HMI device with a PROFINET interface has been created.

#### Procedure

1. Open the "Connections" editor of the HMI device.
2. Double-click "<Add>".

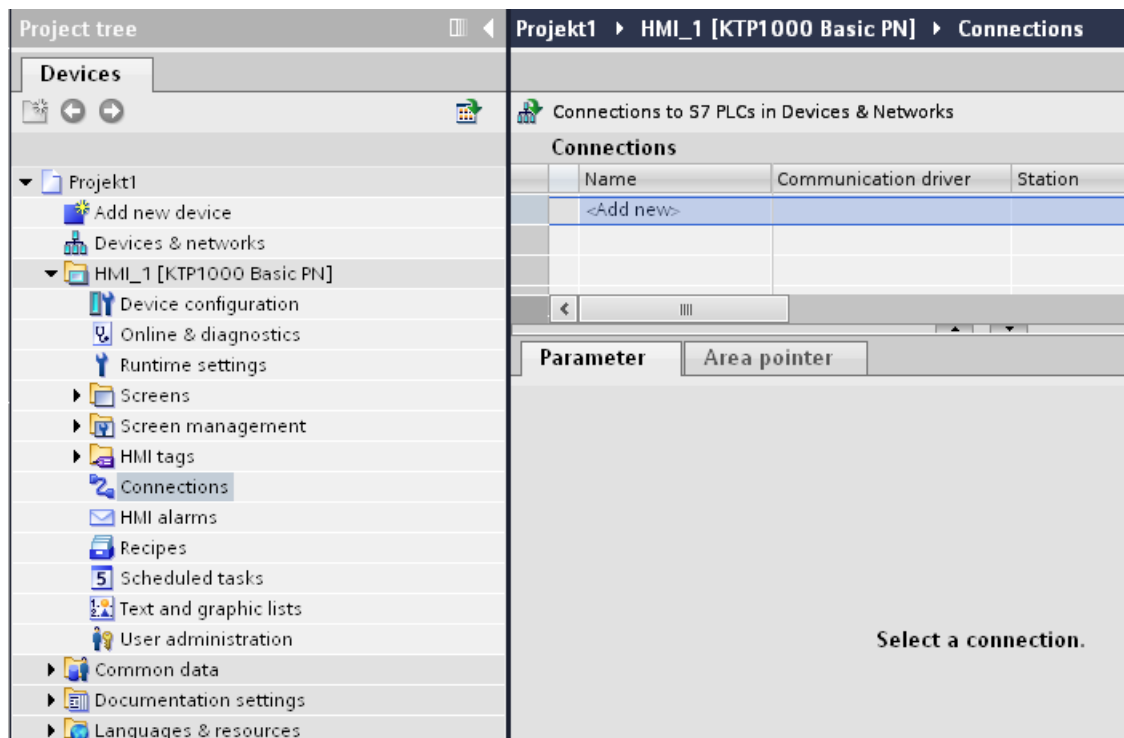

3. Select the driver in the "Communication driver" column.

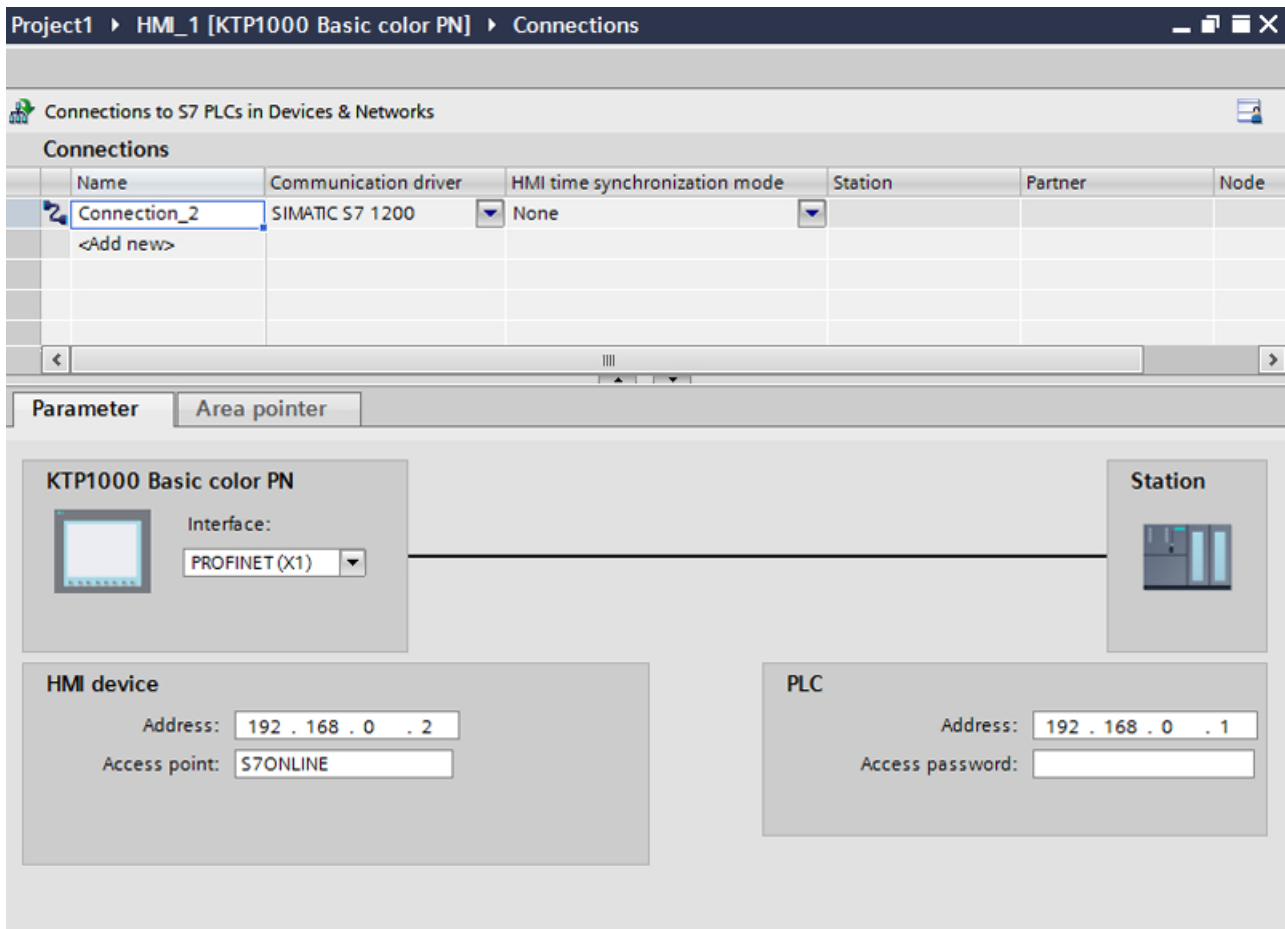

4. Click the name of the connection.
5. Select a PROFINET interface of the HMI device in the Inspector window under "Parameters > Interface".
6. Set the IP addresses of the communication partners in the Inspector window:
  - HMI device: "Parameters > HMI device > Address"
  - PLC: "Parameters > PLC > Address"

## Creating a PROFIBUS connection

### Requirements

- A project is open.
- An HMI device with a PROFIBUS interface has been created.

### Procedure

1. Open the "Connections" editor of the HMI device.
2. Double-click "<Add>".

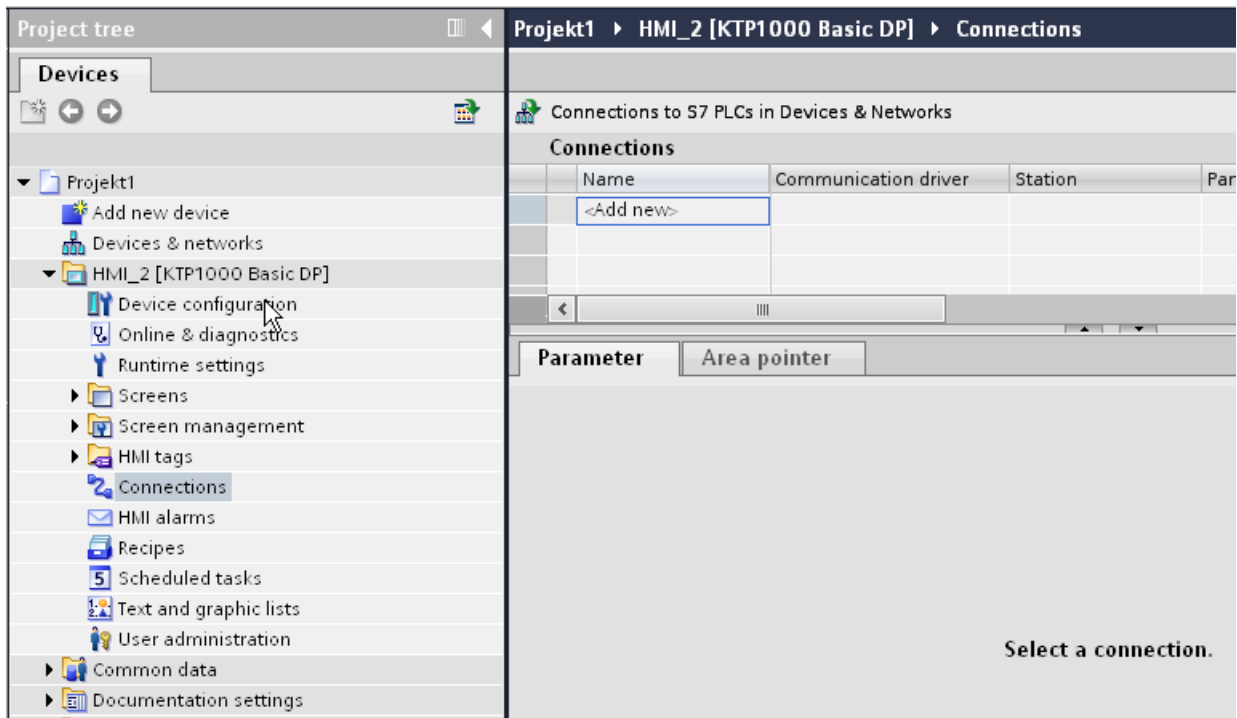

3. Select the driver in the "Communication driver" column.
4. Click the name of the connection.
5. Select the "MPI/DP" interface in the Inspector window under "Parameters > Interface".

6. Select the "DP" profile in the Inspector window under "Parameters > Network".

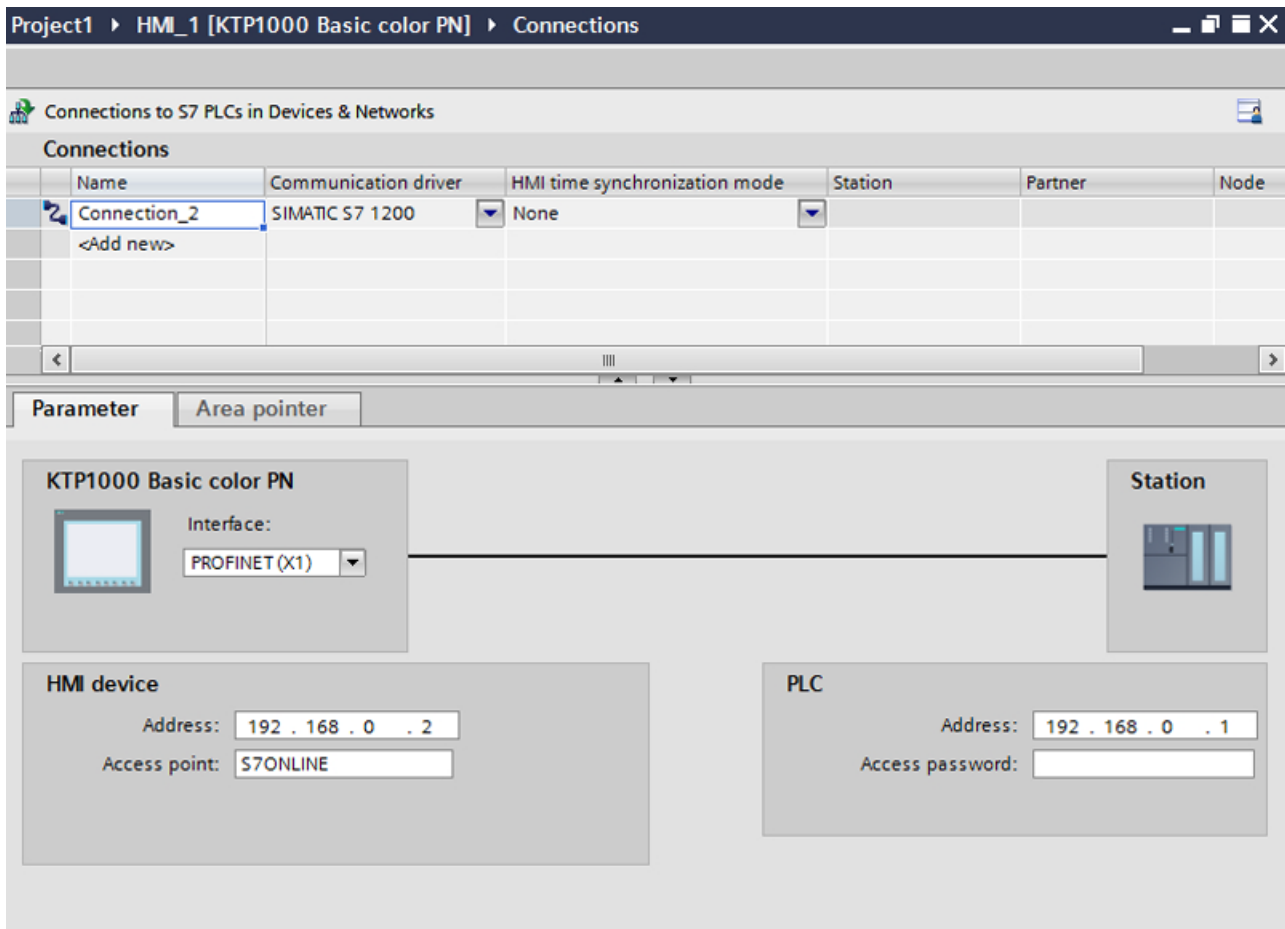

7. Set the addresses of the communication partners in the inspector window:

- HMI device: "Parameters > HMI device > Address"
- PLC: "Parameters > PLC > Address"

## Creating an MPI connection

### Requirements

- A project is open.
- An HMI device with an MPI interface has been created.

### Procedure

1. Open the "Connections" editor of the HMI device.
2. Double-click "<Add>".

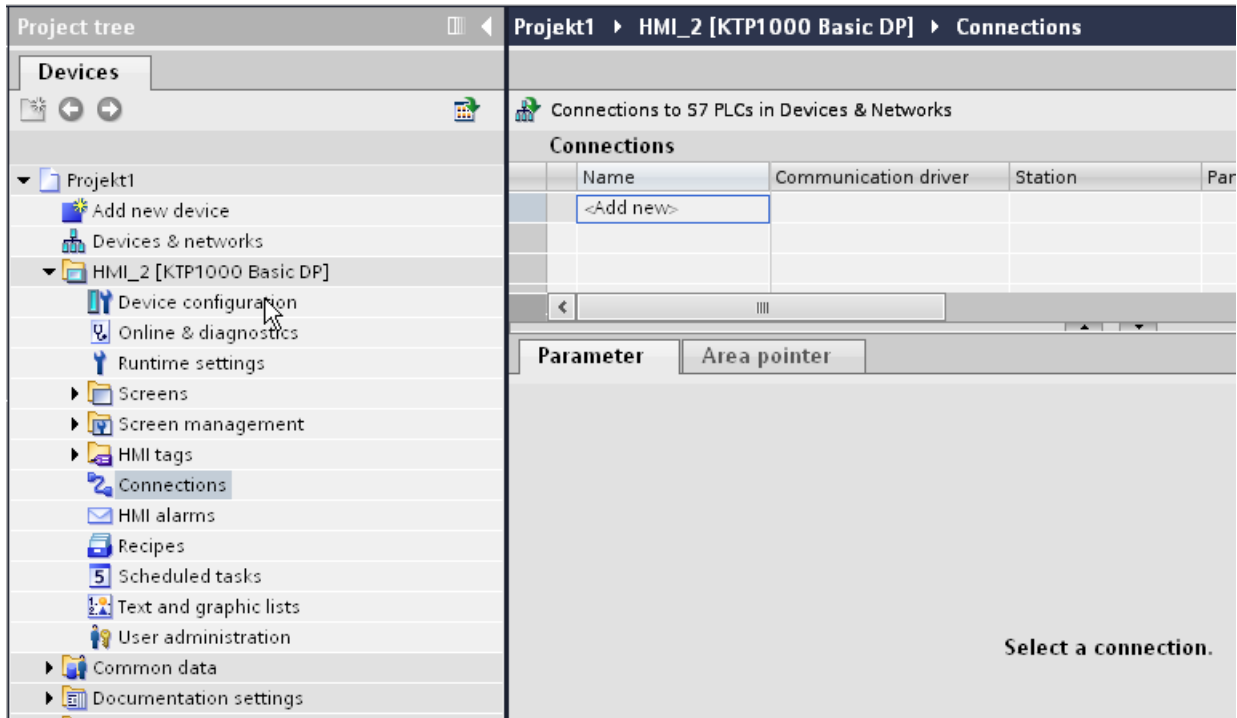

3. Select the driver in the "Communication driver" column.
4. Click the name of the connection.
5. Select the "MPI/DP" interface in the Inspector window under "Parameters > Interface".

6. Select the "MPI" profile in the Inspector window under "Parameters > Network".

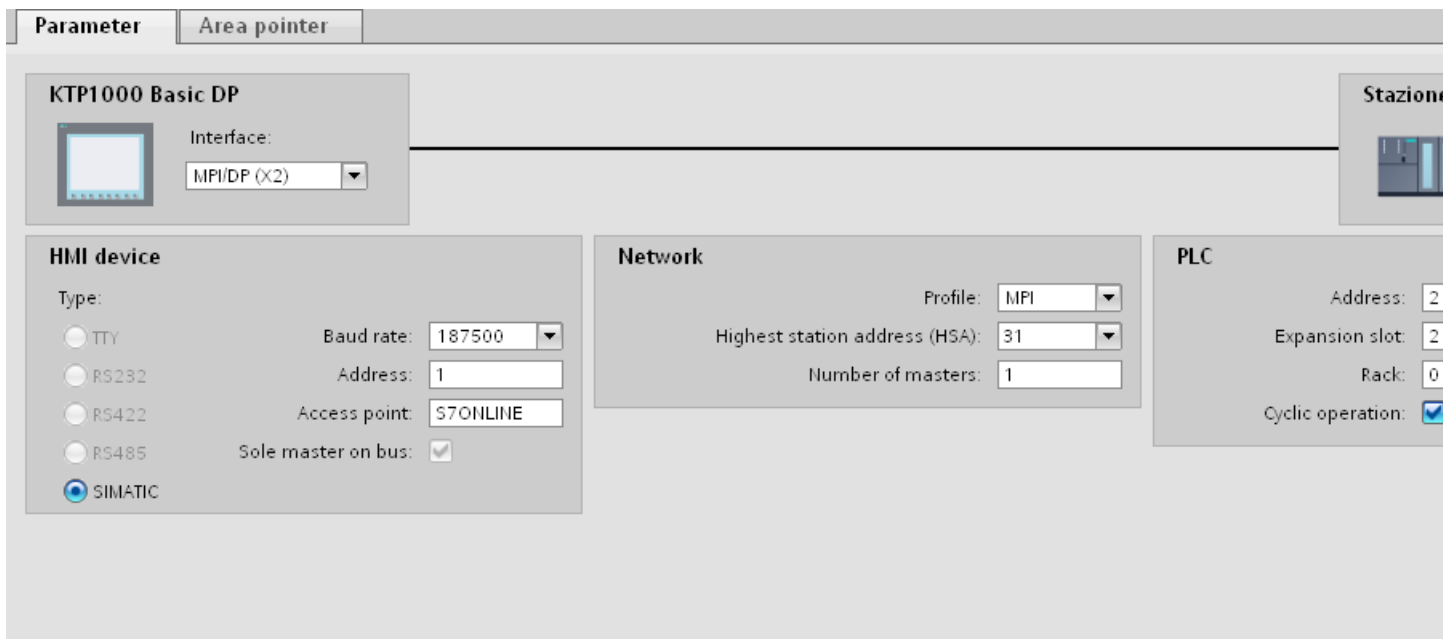

7. Set the addresses of the communication partners in the inspector window:

- HMI device: "Parameters > HMI device > Address"
- PLC: "Parameters > PLC > Address"

## Parameters for the connection

### Parameters for the connection (SIMATIC S7 300/400)

#### Parameters to be set

To set the connection parameters, such as addresses and profiles, click the connection that you have created in the "Connections" editor.

The communication partners are displayed schematically in the Inspector window under "Parameters". The "HMI device", "Network", and "PLC" areas are available for assigning parameters according to the interface used.

The screenshot shows the 'Connections' configuration window in WinCC. The window title is 'Project1 > HMI\_1 [KTP1000 Basic color PN] > Connections'. The main area is titled 'Connections to S7 PLCs in Devices & Networks' and contains a table with the following data:

Name	Communication driver	HMI time synchronization mode	Station	Partner	Node
Connection_2	SIMATIC S7 1200	None			
<Add new>					

Below the table, there are two tabs: 'Parameter' and 'Area pointer'. The 'Parameter' tab is active and shows a graphical representation of the connection between an HMI device and a PLC. On the left is the 'KTP1000 Basic color PN' HMI device, with an 'Interface' dropdown set to 'PROFINET (X1)'. On the right is the 'Station' representing the PLC. A horizontal line connects the HMI device to the PLC. Below these are two configuration panels:

- HMI device:** Address: 192 . 168 . 0 . 2, Access point: S7ONLINE
- PLC:** Address: 192 . 168 . 0 . 1, Access password: (empty field)



## Ethernet parameters

### Parameters for the HMI device

You set the parameters for the HMI device in the network under "HMI device".. The changes are not transferred automatically to the HMI device. You must change the settings in the Control Panel of the HMI device.

- "Interface"  
If you are directly connected to the HMI device during configuration, you can set up the IP address of the HMI device in WinCC.

---

#### Note

The IP address in the Control Panel will be overwritten upon subsequent loading if you have already set up the IP address in the HMI device control panel.

The IP address already set up in the Control Panel will be retained upon subsequent loading if you activate "Set IP address using a different method".

---

The IP address is transferred to the HMI device during project transfer.  
To set up the IP address of the HMI device:

- Click the HMI device.
- Open the "Device configuration" editor.
- Click the Ethernet interface.
- Assign the IP address in the inspector window under:  
"General > PROFINET interface > Ethernet addresses"
- "Address"  
You assign the IP address of the HMI device in the "Address" area.  
When you transfer the WinCC project to the HMI device, this IP address is set up directly in the HMI device.
- "Access point"  
The access point defines a logical device name through which the communication partner can be reached.

### Parameters for the PLC

Under "PLC", you address the S7 module with which the HMI device will exchange data. Assign a name for the connection for each communication partner.

- "Address"  
Under "Address", set the IP address of the S7 module to which the HMI device is connected.
- "Expansion slot"  
Defines the number of the expansion slot of the CPU to be addressed.

- "Rack"  
Defines the rack number of the CPU to be addressed.
- "Cyclic operation"

---

**Note**

The setting "Cyclic operation" cannot be configured for the SIMATIC S7 1200 PLC.

---

When cyclic operation is enabled, the PLC optimizes the data exchange between the HMI device and the PLC. This increases system performance.

Disable cyclic mode if you are operating several HMI devices in parallel.

## PROFIBUS parameters

### Parameters for the HMI device

You assign the parameters for the HMI device in the network once under "HMI device". The change applies to each communication partner.

- "Type"  
Specifies the physical connection used.
- "Interface"  
For "Interface", you select the HMI device interface via which the HMI device is connected to the PROFIBUS network.
- "Baud rate"  
For "Baud rate", you set the transmission speed of the data in the network. The baud rate is determined by the slowest HMI device connected to the network. The setting must be identical throughout the network.

---

**Note**

If you set a baud rate of 1.5 Mbaud for OP 73 or OP 77A, the highest station address must be less than or equal to 63.

---

- "Address"  
You set the PROFIBUS address of the HMI device under "Address". The PROFIBUS address must be unique in the PROFIBUS network.
- "Sole master on bus"  
Disables an additional safety feature against bus faults when the HMI device is connected to the network. A passive station (slave) can only send data if it is requested to do so by an active station (master).  
In S7 200, you must set an HMI device as the master.
- "Access point"  
The access point defines a logical device name through which the communication partner can be reached.

## Parameters for the network

Under "Network", you set the parameters for the PROFIBUS network to which the HMI device is linked.

- "Profile"  
For "Profile", you select the network profile that is used in the network. In "Profile", set "DP", "Universal", or "Standard". The setting must be identical throughout the network.
- "Highest address"  
For "Highest station address", set the highest station address. The highest station address must be greater than or equal to the highest actual PROFIBUS address. The setting must be identical throughout the network.

---

### Note

If you set a baud rate of 1.5 Mbaud in the OP 73 or the OP 77A, the highest station address must be less than or equal 63.

---

- "Number of masters"  
For "Number of masters", set the number of masters in the PROFIBUS network. This information is necessary to correctly calculate the bus parameters.

## Parameters for the PLC

Under "PLC", you address the S7 module with which the HMI device will exchange data. Assign a name for the connection for each communication partner.

- "Address"  
For "Address", set the PROFIBUS address of the S7 module (CPU, FM, or CP) to which the HMI device is connected.
- "Cyclic operation"

---

### Note

The setting "Cyclic operation" cannot be configured for the SIMATIC S7 1200 PLC.

---

When cyclic operation is enabled, the PLC optimizes the data exchange between the HMI device and the PLC. This increases system performance. Disable cyclic mode if you are operating several HMI devices in parallel. This setting is not required for SIMATIC S7-200 PLCs.

## MPI parameters

### Parameters for the HMI device

You assign the parameters for the HMI device in the network once under "HMI device". The change applies to each communication partner.

- "Type"  
Specifies the physical connection used.
- "Interface"  
For "Interface", you select the HMI device interface via which the HMI device is connected to the MPI network.
- "Baud rate"  
For "Baud rate", you set the transmission speed of the data in the network. The baud rate is determined by the slowest HMI device connected to the network. The setting must be identical throughout the network.

---

#### Note

If you set a baud rate of 1.5 Mbaud for OP 73 or OP 77A, the highest station address must be less than or equal to 63.

---

- "Address"  
For "Address", you set the MPI address of the HMI device. The MPI address must be unique throughout the MPI network.
- "Sole master on bus"  
Disables an additional safety feature against bus faults when the HMI device is connected to the network. A passive station (slave) can only send data if it is requested to do so by an active station (master). If you have connected only slaves to the HMI device, you must therefore disable the "Sole master on bus" safety feature.  
In S7 200, you must set an HMI device as the master.

### Parameters for the network

Under "Network", you set the parameters for the MPI network to which the HMI device is linked.

- "Profile"  
For "Profile", you select the network profile that is used in the network. In "Profile", set "MPI". The setting must be identical throughout the network.
- "Highest address"  
For "Highest station address", set the highest station address. The highest station address must be greater than or equal to the highest actual MPI address. The setting must be identical throughout the network.
- "Number of masters"  
This setting is not required for MPI.

## Parameters for the PLC

Under "PLC", you address the S7 module with which the HMI device will exchange data. Assign a name for the connection for each communication partner.

- "Address"  
For "Address", set the MPI address of the S7 module (CPU, FM, or CP) to which the HMI device is connected.
- "Cyclic mode"  
When cyclic mode is enabled, the PLC optimizes the data exchange between the HMI device and the PLC. This improves system performance. Disable cyclic mode if you are operating several HMI devices in parallel. This setting is not required for SIMATIC S7-200.

## Cyclic operation

### Handling the "Cyclic operation" selection

If "Cyclic operation" is enabled, the HMI device sends a message frame to the CPU at the beginning of communication indicating that certain tags are required on a recurring basis.

The CPU then always transmits the data at the same cyclic interval. This saves the HMI device from having to output new requests for the data.

If cyclic operation is disabled, the HMI device sends a request whenever information is required.

Additional properties:

- Cyclic operation reduces data transmission load at the HMI device. The PLC resources are used to relieve load on the HMI device.
- The PLC only supports a certain number of cyclic services. The HMI device handles the operation if the PLC cannot provide any further resources for cyclic services.
- The HMI device generates the cycle if the PLC does not support the cyclic mode.
- Screen tags are not integrated in cyclic operation.
- Cyclic mode is only set up at the restart of Runtime.
- The HMI device transfers several jobs to the PLC if cyclic mode is enabled, depending on the PLC.
- The HMI device only transfers one job to the PLC if cyclic mode is disabled.

## 10.11.9 Communicating with SIMATIC S7 200

### 10.11.9.1 Communication with SIMATIC S7 200

#### Introduction

This section describes the communication between an HMI device and the SIMATIC S7 200 PLC.

You can configure the following communication channels for the SIMATIC S7 200 PLC:

- PROFINET and Ethernet
- PROFIBUS
- MPI
- PPI

#### HMI connection for communication

You configure connections between the HMI device and a SIMATIC S7 200 in the "Connections" editor of the HMI device.

### 10.11.9.2 Creating a connection to SIMATIC S7 200

#### Introduction

You configure a connection to the SIMATIC S7 200 PLC in the "Connections" editor of the HMI device. The interfaces are named differently depending on the HMI device.

#### Requirements

- A project is open.
- An HMI device has been created.

#### Procedure

1. Double-click the HMI device under "Devices" in the project tree.
2. Double-click the "Connections" item.

3. Double-click "<Add>" in the "Connections" editor.

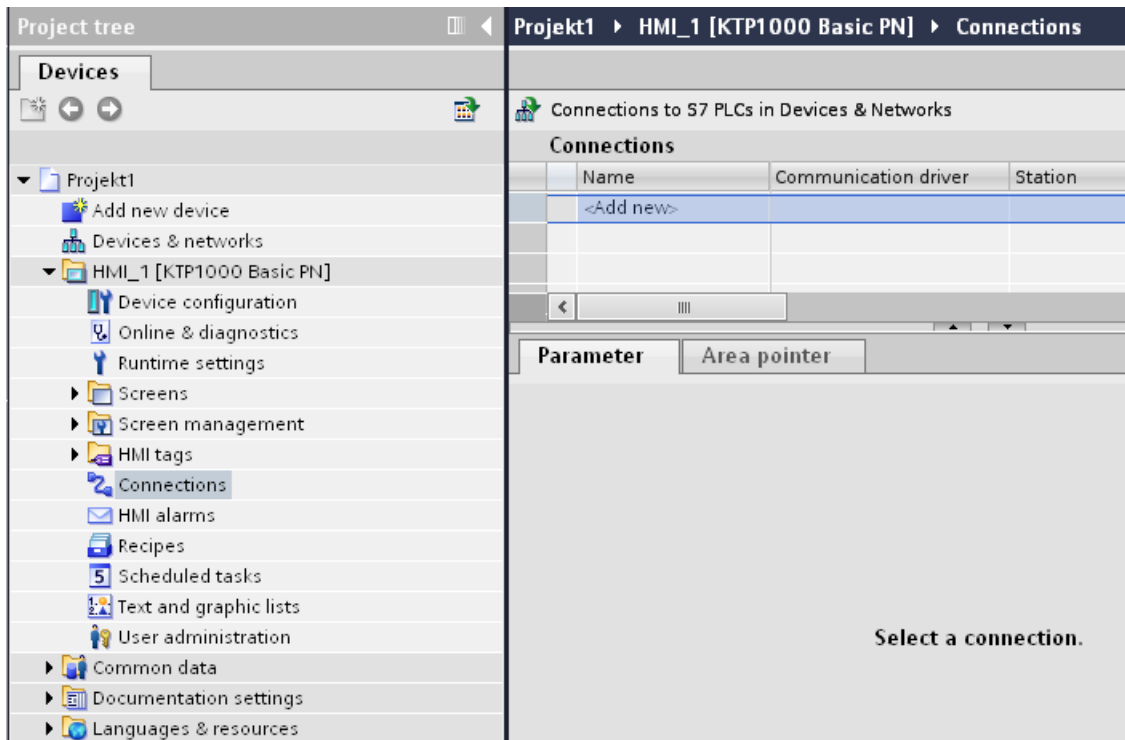

4. In the "Communication drivers" column, select the "SIMATIC S7 200" driver.
5. Select all necessary connection parameters for the interface in the Inspector window under "Parameters".

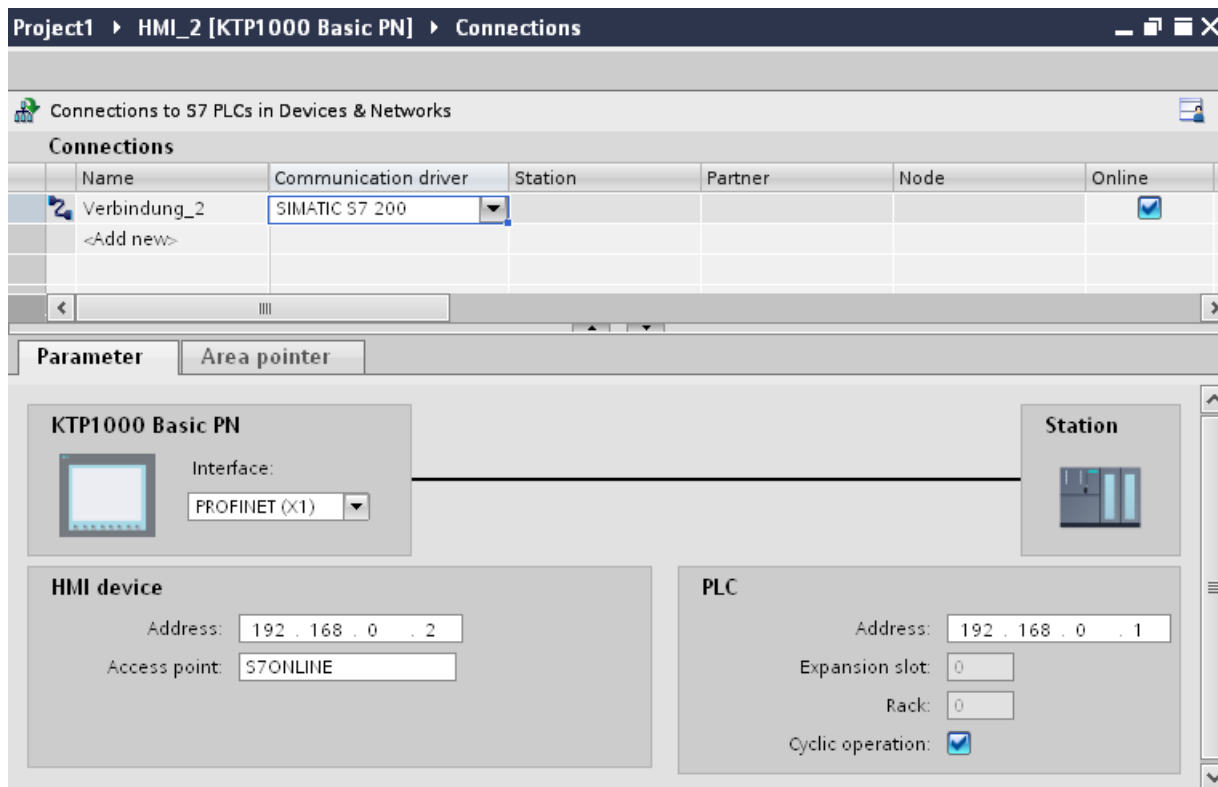

See the chapter "Parameters for the connection (Page 5202)" for additional details.

### 10.11.9.3 Parameters for the connection

#### Parameters for the connection (SIMATIC S7 200)

##### Parameters to be set

To set the connection parameters, such as addresses and profiles, click the connection that you have created in the "Connections" editor.

The communication partners are displayed schematically in the Inspector window under "Parameters". The "HMI device" and "PLC" areas are available for assigning parameters according to the interface used.



Project1 > HMI\_2 [KTP1000 Basic PN] > Connections

Connections to S7 PLCs in Devices & Networks

**Connections**

Name	Communication driver	Station	Partner	Node	Online
Verbindung_2	SIMATIC S7 200				<input checked="" type="checkbox"/>
<Add new>					

Parameter | Area pointer

**KTP1000 Basic PN**



Interface: PROFINET (X1)

**Station**



**HMI device**

Address: 192 . 168 . 0 . 2

Access point: S7ONLINE

**PLC**

Address: 192 . 168 . 0 . 1

Expansion slot: 0

Rack: 0

Cyclic operation:

## Ethernet parameters

### Parameters for the HMI device

You set the parameters for the HMI device in the network under "HMI device".. The changes are not transferred automatically to the HMI device. You must change the settings in the Control Panel of the HMI device.

- "Interface"  
If you are directly connected to the HMI device during configuration, you can set up the IP address of the HMI device in WinCC.

---

#### Note

The IP address in the Control Panel will be overwritten upon subsequent loading if you have already set up the IP address in the HMI device control panel.

The IP address already set up in the Control Panel will be retained upon subsequent loading if you activate "Set IP address using a different method".

---

The IP address is transferred to the HMI device during project transfer.  
To set up the IP address of the HMI device:

- Click the HMI device.
- Open the "Device configuration" editor.
- Click the Ethernet interface.
- Assign the IP address in the inspector window under:  
"General > PROFINET interface > Ethernet addresses"
- "Address"  
You assign the IP address of the HMI device in the "Address" area.  
When you transfer the WinCC project to the HMI device, this IP address is set up directly in the HMI device.
- "Access point"  
The access point defines a logical device name through which the communication partner can be reached.

### Parameters for the PLC

Under "PLC", you address the S7 module with which the HMI device will exchange data. Assign a name for the connection for each communication partner.

- "Address"  
Under "Address", set the IP address of the S7 module to which the HMI device is connected.
- "Expansion slot"  
Defines the number of the expansion slot of the CPU to be addressed.

- "Rack"  
Defines the rack number of the CPU to be addressed.
- "Cyclic operation"

---

**Note**

The setting "Cyclic operation" cannot be configured for the SIMATIC S7 1200 PLC.

---

When cyclic operation is enabled, the PLC optimizes the data exchange between the HMI device and the PLC. This increases system performance.

Disable cyclic mode if you are operating several HMI devices in parallel.

## PROFIBUS parameters

### Parameters for the HMI device

You assign the parameters for the HMI device in the network once under "HMI device". The change applies to each communication partner.

- "Type"  
Specifies the physical connection used.
- "Interface"  
For "Interface", you select the HMI device interface via which the HMI device is connected to the PROFIBUS network.
- "Baud rate"  
For "Baud rate", you set the transmission speed of the data in the network. The baud rate is determined by the slowest HMI device connected to the network. The setting must be identical throughout the network.

---

**Note**

If you set a baud rate of 1.5 Mbaud for OP 73 or OP 77A, the highest station address must be less than or equal to 63.

---

- "Address"  
You set the PROFIBUS address of the HMI device under "Address". The PROFIBUS address must be unique in the PROFIBUS network.
- "Sole master on bus"  
Disables an additional safety feature against bus faults when the HMI device is connected to the network. A passive station (slave) can only send data if it is requested to do so by an active station (master).  
In S7 200, you must set an HMI device as the master.
- "Access point"  
The access point defines a logical device name through which the communication partner can be reached.

### Parameters for the network

Under "Network", you set the parameters for the PROFIBUS network to which the HMI device is linked.

- "Profile"  
For "Profile", you select the network profile that is used in the network. In "Profile", set "DP", "Universal", or "Standard". The setting must be identical throughout the network.
- "Highest address"  
For "Highest station address", set the highest station address. The highest station address must be greater than or equal to the highest actual PROFIBUS address. The setting must be identical throughout the network.

---

#### Note

If you set a baud rate of 1.5 Mbaud in the OP 73 or the OP 77A, the highest station address must be less than or equal 63.

---

- "Number of masters"  
For "Number of masters", set the number of masters in the PROFIBUS network. This information is necessary to correctly calculate the bus parameters.

### Parameters for the PLC

Under "PLC", you address the S7 module with which the HMI device will exchange data. Assign a name for the connection for each communication partner.

- "Address"  
For "Address", set the PROFIBUS address of the S7 module (CPU, FM, or CP) to which the HMI device is connected.
- "Cyclic operation"

---

#### Note

The setting "Cyclic operation" cannot be configured for the SIMATIC S7 1200 PLC.

---

When cyclic operation is enabled, the PLC optimizes the data exchange between the HMI device and the PLC. This increases system performance. Disable cyclic mode if you are operating several HMI devices in parallel. This setting is not required for SIMATIC S7-200 PLCs.

## MPI parameters

### Parameters for the HMI device

You assign the parameters for the HMI device in the network once under "HMI device". The change applies to each communication partner.

- "Type"  
Specifies the physical connection used.
- "Interface"  
For "Interface", you select the HMI device interface via which the HMI device is connected to the MPI network.
- "Baud rate"  
For "Baud rate", you set the transmission speed of the data in the network. The baud rate is determined by the slowest HMI device connected to the network. The setting must be identical throughout the network.

---

**Note**

If you set a baud rate of 1.5 Mbaud for OP 73 or OP 77A, the highest station address must be less than or equal to 63.

---

- "Address"  
For "Address", you set the MPI address of the HMI device. The MPI address must be unique throughout the MPI network.
- "Sole master on bus"  
Disables an additional safety feature against bus faults when the HMI device is connected to the network. A passive station (slave) can only send data if it is requested to do so by an active station (master). If you have connected only slaves to the HMI device, you must therefore disable the "Sole master on bus" safety feature.  
In S7 200, you must set an HMI device as the master.

### Parameters for the network

Under "Network", you set the parameters for the MPI network to which the HMI device is linked.

- "Profile"  
For "Profile", you select the network profile that is used in the network. In "Profile", set "MPI". The setting must be identical throughout the network.
- "Highest address"  
For "Highest station address", set the highest station address. The highest station address must be greater than or equal to the highest actual MPI address. The setting must be identical throughout the network.
- "Number of masters"  
This setting is not required for MPI.

## Parameters for the PLC

Under "PLC", you address the S7 module with which the HMI device will exchange data. Assign a name for the connection for each communication partner.

- "Address"  
For "Address", set the MPI address of the S7 module (CPU, FM, or CP) to which the HMI device is connected.
- "Cyclic mode"  
When cyclic mode is enabled, the PLC optimizes the data exchange between the HMI device and the PLC. This improves system performance. Disable cyclic mode if you are operating several HMI devices in parallel. This setting is not required for SIMATIC S7-200.

## PPI parameters

### Parameters for the HMI device

You assign the parameters for the HMI device in the network once under "HMI device". The change applies to each communication partner.

- "Type"  
Specifies the physical connection used.
- "Interface"  
For "Interface", you select the HMI device interface via which the HMI device is connected to the PP network.
- "Baud rate"  
For "Baud rate", you set the transmission speed of the data in the network. The baud rate is determined by the slowest HMI device connected to the network. The setting must be identical throughout the network.

---

#### Note

If you set a baud rate of 1.5 Mbaud for OP 73 or OP 77A, the highest station address must be less than or equal to 63.

---

- "Address"  
For "Address", you set the PPI address of the HMI device. The PPI address must be unique throughout the PPI network.
- "Access point"  
For "Access point", you set the access point via which the communication partner is reached.
- "Sole master on bus"  
Disables an additional safety feature against bus faults when the HMI device is connected to the network. A passive station (slave) can only send data if it is requested to do so by an active station (master). If you have connected only slaves to the HMI device, you must therefore disable the "Sole master on bus" safety feature.  
In S7 200, you must set an HMI device as the master.

## Parameters for the network

Under "Network", you set the parameters for the network to which the HMI device is linked.

- "Profile"  
For "Profile", you select the network profile that is used in the network. In "Profile", set "PPI". The setting must be identical throughout the network.
- "Highest address"  
For "Highest station address", set the highest station address. The highest station address must be greater than or equal to the highest actual MPI address. The setting must be identical throughout the network.
- "Number of masters"  
Set the number of the master on the network to "1".

## Parameters for the PLC

Under "PLC", you address the S7 module with which the HMI device will exchange data. Assign a name for the connection for each communication partner.

- "Address"  
For "Address", set the PPI address of the S7 module to which the HMI device is connected.
- "Cyclic operation"  
This parameter is not required for communication via PPI.

## Cyclic operation

### Handling the "Cyclic operation" selection

If "Cyclic operation" is enabled, the HMI device sends a message frame to the CPU at the beginning of communication indicating that certain tags are required on a recurring basis.

The CPU then always transmits the data at the same cyclic interval. This saves the HMI device from having to output new requests for the data.

If cyclic operation is disabled, the HMI device sends a request whenever information is required.

Additional properties:

- Cyclic operation reduces data transmission load at the HMI device. The PLC resources are used to relieve load on the HMI device.
- The PLC only supports a certain number of cyclic services. The HMI device handles the operation if the PLC cannot provide any further resources for cyclic services.
- The HMI device generates the cycle if the PLC does not support the cyclic mode.
- Screen tags are not integrated in cyclic operation.
- Cyclic mode is only set up at the restart of Runtime.
- The HMI device transfers several jobs to the PLC if cyclic mode is enabled, depending on the PLC.
- The HMI device only transfers one job to the PLC if cyclic mode is disabled.

#### 10.11.9.4 Data exchange

##### Data exchange using area pointers

##### General information on area pointers

##### Introduction

You use an area pointer to access a data area in the PLC. During communication, the PLC and the HMI device alternately access these data areas for read and write operations.

The PLC and the HMI device trigger defined interactions based on the evaluation of stored data.

##### Configuration of area pointers

Before you use an area pointer, you enable it under "Connections > Area pointer". You then assign the area pointer parameters.

You can find more detailed information on configuring area pointers in:

Configuring area pointers (Page 4956)

##### See also

Data exchange using area pointers (Page 4952)

##### "Screen number" area pointer

##### Function

The HMI device saves information about the screen called on the HMI device to the "Screen number" area pointer.

This allows the transfer of the current screen contents from the HMI device to the PLC. The PLC can trigger specific reactions such as the call of a different screen.

##### Application

Configure and enable the area pointer in "Communication > Connections" before you put it into use. You can create only **one** instance of the "Screen number" area pointer and only on **one** PLC.

The screen number is always transferred to the PLC when a new screen is activated or when the focus within a screen changes from one screen object to another.



## Structure

The area pointer is a data area in the memory of the PLC with a fixed length of 5 words.

	15	14	13	12	11	10	9	8	7	6	5	4	3	2	1	0
1st word	Current screen type															
2nd word	Current screen number															
3rd word	Reserved															
4th word	Current field number															
5th word	Reserved															

- Current screen type  
"1" for root screen or  
"4" for permanent window
- Current screen number  
1 to 32767
- Current field number  
1 to 32767

## "Date/time" area pointer

### Function

This area pointer is used to transfer the date and time from the HMI device to the PLC.

The PLC writes control job "41" to the job mailbox.

When it evaluates the control job, the HMI device writes its current date and the time in the data area configured in the "Date/time" area pointer. All definitions are coded in BCD format.

The "Date/Time" area pointer when used in a project which contains multiple connections must be enabled for each configured connection.

---

#### Note

You cannot use the "Date/Time PLC" area pointer if you have configured the "Date/Time" area pointer.

---

#### Note

Symbolic addressing is not possible if you are using the "Date/Time" area pointer.

---

The "Date/Time" area pointer when used in a project which contains multiple connections must be enabled for each configured connection.

The date/time data area has the following structure:

Data word	Most significant byte					Least significant byte					
	7				0	7				0	
n+0	Reserved					Hour (0 to 23)					Time
n+1	Minute (0 to 59)					Second (0 to 59)					
n+2	Reserved					Reserved					
n+3	Reserved					Weekday (1 to 7, 1=Sunday)					Date
n+4	Day (1 to 31)					Month (1 to 12)					
n+5	Year (80 to 99/0 to 29)					Reserved					

**Note**

When making entries in the "Year" data area, you should note that values 80 to 99 result in years 1980 through 1999, while the values 0 to 29 result in the years 2000 through 2029.

**"Date/time PLC" area pointer**

**Function**

This area pointer is used to transfer the date and time from the PLC to the HMI device. Use this area pointer if the PLC is the time master.

The PLC loads the data area of the area pointer. All definitions are coded in BCD format.

The HMI device reads the data cyclically within the configured acquisition cycle and synchronizes itself.

**Note**

Set an acquisition cycle of sufficient length for the Date/time area pointer in order to avoid any negative impact on HMI device performance.  
Recommended: Acquisition cycle of 1 minute, if the process allows this.

"Date/Time PLC" is a global area pointer and may be configured only once per project.

**Note**

You cannot use the "Date/Time" area pointer if you have configured the "Date/Time PLC" area pointer.

The date/time data area has the following structure:

**DATE\_AND\_TIME format (in BCD code)**

Data word	Most significant byte			Least significant byte		
	7	.....	0	7	.....	0
n+0	Year (80 to 99/0 to 29)			Month (1 to 12)		
n+1	Day (1 to 31)			Hour (0 to 23)		
n+2	Minute (0 to 59)			Second (0 to 59)		
n+3	Reserved			Reserved	Weekday (1 to 7, 1=Sunday)	
n+4 <sup>1)</sup>	Reserved			Reserved		
n+5 <sup>1)</sup>	Reserved			Reserved		

- 1) The two data words must exist in the data area to ensure that the data format matches WinCC flexible and to avoid reading false information.

**Note**

When making entries in the "Year" data area, you should note that values 80 to 99 result in years 1980 through 1999, while the values 0 to 29 result in the years 2000 through 2029.

**"Coordination" area pointer****Function**

The "Coordination" area pointer is used to implement the following functions:

- Detecting the startup of the HMI device in the control program
- Detecting the current operating mode of the HMI device in the control program
- Detecting whether the HMI device is ready to communicate in the control program

By default, the "Coordination" area pointer has the length of one word and cannot be changed.

**Usage****Note**

The HMI device always writes the entire coordination area when updating the area pointer. The control program can for this reason not make changes to the coordination area.

### Assignment of the bits in the "Coordination" area pointer

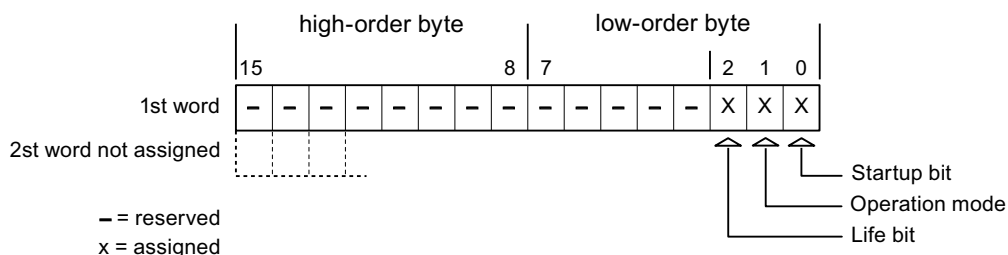

#### Startup bit

The startup bit is set briefly to "0" by the HMI device during startup. It sets the bit permanently to "1" when startup is completed.

#### Operating mode

The operating mode bit is set to 1 as soon as the user switches the HMI device offline. The status of the operating mode bit is "0" during normal operation of the HMI device. You can determine the current operating mode of the HMI device by reading this bit in the control program.

#### Life bit

The HMI device inverts the life bit at intervals of approximately one second. You can check whether or not there is still a connection to the HMI device by querying this bit in the control program.

### "Project ID" area pointer

#### Function

When Runtime starts it can check to see if the HMI device is connected to the correct PLC. This check is important when operating with several HMI devices.

For this, the HMI device compares a value stored on the PLC with the value specified in configuration. This ensures compatibility of the configuration data with the PLC program. If there is no concordance, a system event is given on the HMI device and Runtime is stopped.

#### Use

To use this area pointer, set up the following during the configuration:

- Define the version of configuration. Values between 1 and 255 are possible. You enter the version in the editor "Runtime settings > General" in the "Identification" area.
- Data address of the value for the version that is stored in the PLC: You enter the data address in the editor "Communication > Connections" under "Address".

## Connection failure

A connection failure to a device on which the "project ID" area pointer is configured results in all the other connections of the device being switched to "offline".

This behavior has the following requirements:

- You have configured several connections in a project.
- You are using the "project ID" area pointer in at least one connection.

Causes which may set connections "offline":

- The PLC is not available.
- The connection has been switched offline in the engineering system.

## "Job mailbox" area pointer

### Function

The PLC can use the job mailbox to transfer jobs to the HMI device to trigger corresponding actions on the HMI device. These functions include, for example:

- Display screen
- Set date and time

### Data structure

The first word of the job mailbox contains the job number. Depending on the job mailbox, up to three parameters can be transferred.

Word	Most significant byte	Least significant byte
n+0	0	Job number
n+1	Parameter 1	
n+2	Parameter 2	
n+3	Parameter 3	

The HMI device evaluates the job mailbox if the first word of this job is not equal to zero. This means that the parameters must be entered in the job mailbox first, followed by the job number.

When the HMI device accepts the job mailbox, the first word is set to 0 again. The execution of the job mailbox is generally not completed at this point in time.

### Job mailboxes

All job mailboxes and their parameters are listed below. The "No." column contains the job number of the job mailbox. Job mailboxes can only be triggered by the PLC when the HMI device is online.

#### Note

Please note that not all HMI devices support job mailboxes. TP 170A and Micro Panel do not support job mailboxes, for example.

No.	Function	
<b>14</b>	<b>Set time (BCD-coded)</b>	
	Parameter 1	Left byte: - Right byte: hours (0-23)
	Parameter 2	Left byte: minutes (0-59) Right byte: seconds (0-59)
	Parameter 3	-
<b>15</b>	<b>Setting the date (BCD coded)</b> <sup>3)</sup>	
	Parameter 1	Left byte: - Right byte: weekday (1-7: Sunday-Saturday)
	Parameter 2	Left byte: day (1-31) Right byte: month (1-12)
	Parameter 3	Left byte: year
<b>23</b>	<b>User logon</b>	
	Logs the user on with the name "PLC user" at the HMI device with the group number transferred in Parameter 1. The logon is possible only when the transferred group number exists in the project.	
	Parameter 1	Group number 1 to 255
	Parameter 2, 3	-
<b>24</b>	<b>User logoff</b>	
	Logs off the current user. (The function corresponds to the "logoff" system function)	
	Parameter 1, 2, 3	-
<b>40</b>	<b>Transfer date/time to PLC</b>	
	(in the S7 format DATE_AND_TIME) An interval of at least 5 seconds must be maintained between two successive jobs to prevent overload of the HMI device.	
	Parameter 1, 2, 3	-
<b>41</b>	<b>Transfer date/time to PLC</b>	
	(In OP/MP format) An interval of at least 5 seconds must be maintained between successive jobs to prevent overload of the HMI device.	
	Parameter 1, 2, 3	-
<b>46</b>	<b>Update tag</b>	

No	Function	
<b>14</b>	<b>Set time (BCD-coded)</b>	
	Causes the HMI device to read the current value of the tags from the PLC whose update ID matches the value transferred in Parameter 1. (Function corresponds to the "UpdateTag" system function.)	
	Parameter 1	1 - 100
<b>49</b>	<b>Delete alarm buffer</b>	
	Deletes all analog alarms and discrete alarms of the "Warnings" class from the alarm buffer.	
	Parameter 1, 2, 3	-
<b>50</b>	<b>Delete alarm buffer</b>	
	Deletes all analog alarms and discrete alarms of the "Errors" class from the alarm buffer.	
	Parameter 1, 2, 3	-
<b>51</b>	<b>Screen selection <sup>2)</sup></b>	
	Parameter 1	Screen number
	Parameter 2	-
	Parameter 3	Field number
<b>69</b>	<b>Reading data record from PLC <sup>1)</sup></b>	
	Parameter 1	Recipe number (1-999)
	Parameter 2	Data record number (1-65535)
	Parameter 3	0: Do not overwrite existing data record 1: Overwrite existing data record
<b>70</b>	<b>Writing data record to PLC <sup>1)</sup></b>	
	Parameter 1	Recipe number (1-999)
	Parameter 2	Data record number (1-65535)
	Parameter 3	-

<sup>1)</sup>	Only devices supporting recipes
<sup>2)</sup>	OP 73, OP 77A and TP 177A HMI devices also execute the "Screen selection" job mailbox if the on-screen keyboard is active.
<sup>3)</sup>	The weekday is ignored on HMI device KTP 600 BASIC PN.

## "Data record" area pointer

## "Data record" area pointer

### Function

When data records are transferred between the HMI device and PLC, both partners access common communications areas on the PLC.

### Data transfer types

There are two ways of transferring data records between the HMI device and PLC:

- Transfer without synchronization
- Transfer with synchronization over the data record

Data records are always transferred directly. That is, the tag values are read from an address or written to an address configured for this tag directly, without redirecting the values by means of interim memory.

### Initiating the transfer of data records

There are three ways of triggering the transfer:

- Operator input in the recipe view
- Job mailboxes  
The transfer of data records can also be triggered by the PLC.
- Triggering by configured functions

If the transfer of data records is triggered by a configured function or by a job mailbox, the recipe view on the HMI device remains operable. The data records are transferred in the background.

Simultaneous processing of several transfer requests is, however, not possible. In this case, the HMI device rejects the other transfer requests with a system event.

### Sequence of a transfer started by the operator in the recipe view

#### Reading from the PLC started by the operator in the recipe view

Step	Action	
1	Check: Status word = 0?	
	Yes	No
2	The HMI device enters the recipe number to be read and the status "Transferring" in the data record and sets the data record number to 0.	Abort with system event.
3	The HMI device reads the values from the PLC and displays them in the recipe view.  If the recipes have synchronized tags, the values from the PLC are also written to the tags.	
4	The HMI device sets the status "Transfer completed."	
5	The control program must reset the status word to zero in order to enable further transfers.	



**Writing to the PLC started by the operator in the recipe view**

Step	Action	
	Check: Status word = 0?	
1	Yes	No
	The HMI device enters the recipe and data record number to be written and the status "Transferring" in the data mailbox.	Abort with system event.
2	The HMI device writes the current values to the PLC. If the recipes have synchronized tags, the changed values are synchronized in the recipe view and tags and then written to the PLC.	
3	The HMI device sets the status "Transfer completed."	
4	If required, the control program can now evaluate the transferred data.	
5	The control program must reset the status word to zero in order to enable further transfers.	

**Note**

The status word may only be set by the HMI device. The PLC may only reset the status word to zero.

**Note**

The PLC may only evaluate the recipe and data record numbers when data inconsistency is detected if one of the conditions outlined below has been met:

- The data mailbox status is set to "Transfer completed".
- The data mailbox status is set to "Transfer completed with error".

**Sequence of the transfer triggered by a job mailbox**

The transfer of data records between the HMI device and the PLC can be initiated by the HMI device or by the PLC.

The two job mailboxes No. 69 and No. 70 are available for this type of transfer.

**No. 69: Read data record from PLC ("PLC → DAT")**

Job mailbox no. 69 transfers data records from the PLC to the HMI device. The job mailbox is structured as follows:

	Left byte (LB)	Right byte (RB)
Word 1	0	69
Word 2	Recipe number (1-999)	
Word 3	Data record number (1-65,535)	
Word 4	Do not overwrite existing data record: 0 Overwrite existing data record: 1	

**No. 70: Write data record to PLC ("DAT → PLC")**

Job mailbox No. 70 transfers data records from the HMI device to the PLC. The job mailbox is structured as follows:

	Left byte (LB)	Right byte (RB)
Word 1	0	70
Word 2	Recipe number (1-999)	
Word 3	Data record number (1-65,535)	
Word 4	—	

**Sequence when reading from the PLC with job mailbox "PLC → DAT" (no. 69)**

Step	Action	
1	Check: Status word = 0?	
	Yes	No
2	The HMI device enters the recipe and data record number specified in the job and the status "Transferring" in the data mailbox.	Abort without return message.
3	The HMI device reads the values from the PLC and saves these to the data record defined in the job mailbox.	
4	<ul style="list-style-type: none"> <li>If "Overwrite" was selected in the job, an existing data record is overwritten without any prompt for confirmation. The HMI device sets the status "Transfer completed."</li> <li>If "Do not overwrite" was selected in the job, and the data record already exists, the HMI device aborts the job and enters 0000 1100 in the status word of the data mailbox.</li> </ul>	
5	The control program must reset the status word to zero in order to enable further transfers.	

**Sequence of writing to the PLC using job mailbox "DAT → PLC" (no. 70)**

Step	Action	
1	Check: Status word = 0?	
	Yes	No
2	The HMI device enters the recipe and data record number specified in the job and the status "Transferring" in the data mailbox.	Abort without return message.
3	The HMI device fetches the values of the data record specified in the job from the data medium and writes the values to the PLC.	
4	The HMI device sets the status "Transfer completed."	
5	The control program can now evaluate the transferred data. The control program must reset the status word to zero in order to enable further transfers.	

## Sequence of the transfer when triggered by a configured function

### Reading from the PLC using a configured function

Step	Action	
1	Check: Status word = 0?	
	Yes	No
2	The HMI device enters the recipe and data record number specified in the function and the status "Transferring" in the data mailbox.	Abort with system event.
3	The HMI device reads the values from the PLC and stores them in the data record specified in the function.	
4	<ul style="list-style-type: none"> <li>• If "Yes" was selected for the "Overwrite" function, an existing data record is overwritten without any prompt for confirmation. The HMI device sets the status "Transfer completed."</li> <li>• If "No" was selected for the "Overwrite" function and the data record already exists, the HMI device aborts the job and enters 0000 1100 in the status word of the data mailbox.</li> </ul>	
5	The control program must reset the status word to zero in order to enable further transfers.	

### Writing to the PLC by means of configured function

Step	Action	
1	Check: Status word = 0?	
	Yes	No
2	The HMI device enters the recipe and data record number specified in the function and the status "Transferring" in the data mailbox.	Abort with system event.
3	The HMI device fetches the values of the data record specified in the function from the data medium and transfers the values to the PLC.	
4	The HMI device sets the status "Transfer completed."	
5	The control program can now evaluate the transferred data. The control program must reset the status word to zero in order to enable further transfers.	

### Possible causes of error when transferring data records

#### Possible causes of faults

The section below shows possible causes of errors which lead to a data record transfer being terminated with errors:

- Tag address not set up on the PLC
- Overwriting data records not possible

- Recipe number does not exist
- Data record number does not exist

---

**Note**

The status word may only be set by the HMI device. The PLC may only reset the status word to zero.

---

**Note**

The PLC may only evaluate the recipe and data record numbers when data inconsistency is detected if one of the conditions outlined below has been met:

- The data mailbox status is set to "Transfer completed".
  - The data mailbox status is set to "Transfer completed with error".
- 

### Reaction to an aborted transfer due to errors

If the transfer of data records is aborted due to errors, the HMI device reacts as follows:

- Triggering by the operator in the recipe view  
Information in the status bar of the recipe view and output of system events
- Triggered by function  
Output of system events
- Triggering by job mailbox  
No return message on the HMI device

You can nonetheless evaluate the status of the transfer by querying the status word in the data mailbox.

### Transfer without synchronization

If you select asynchronous transfer of data records between the HMI device and PLC, there is no coordination over the common data areas. It is therefore unnecessary to set up a data area during configuration.

Asynchronous data record transfer can be a useful alternative, for example, when:

- The system is capable of excluding the risk of uncontrolled overwriting of data by the communication peer.
- The PLC does not require information about the recipe number and data record number.
- The transfer of data records is triggered by the operator of the HMI device.

## Reading values

When a read job is triggered, the values are read from the PLC addresses and transferred to the HMI device.

- Triggering by the operator in the recipe view:  
The values are downloaded to the HMI device. You can then process, edit, or save these values, for example.
- Triggering by a function or job mailbox:  
The values are saved immediately to the data volume.

## Writing values

When a write job is triggered, the values are written to the PLC addresses.

- Triggering by the operator in the recipe view:  
The current values are written to the PLC.
- Triggering by a function or job mailbox:  
The current values are written to the PLC from the data medium.

## Transfer with synchronization

If you select synchronous transfer, both communication partners set status bits in the common data area. You can use this mechanism to prevent uncontrolled overwriting of data in either direction in your control program.

## Application

Synchronous data record transfer can be a useful solution, for example, when:

- The PLC is the "active partner" in the transfer of data records.
- The PLC evaluates the information about the recipe number and data record number.
- The transfer of data records is triggered by means of a Job mailbox.

## Requirements

In order to synchronize transfer of data records between the HMI device and the PLC, the following requirements must be met during configuration:

- An area pointer has been set up: "Communication > Connections" editor in "Area pointer".
- The PLC with which the HMI device synchronizes transfer of data records is specified in the recipe:  
"Recipes" editor in the Inspector window the "Coordinated transfer of data records" option under "General > Synchronization > Settings".

### Structure of the data area

The data area has a fixed length of 5 words. Structure of the data area:

	<b>15</b>		<b>0</b>
1. Word	Current recipe number (1 - 999)		
2. Word	Current data record number (0 - 65535)		
3. Word	Reserved		
4. Word	Status (0, 2, 4, 12)		
5. Word	Reserved		

- Status

The status word (word 4) can adopt the following values:

Value		Meaning
Decimal	Binary	
0	0000 0000	Transfer permitted, data record free
2	0000 0010	Transferring
4	0000 0100	Transfer completed without error
12	0000 1100	Transfer completed with error

### Trends

#### General information on trends

### Trends

A trend is the graphical representation of one or more values from the PLC. The value is read out either time- or bit-triggered, depending on the configuration.

For additional information see:

Displaying tags with Runtime Advanced and Panels (Page 3237)

---

#### Note

The value is read out time-triggered for Basic Panels.

---

### Time-triggered trends

The HMI device reads in the trend values cyclically at an interval specified in the configuration. Time-triggered trends are suitable for continuous curves, such as the operating temperature of a motor.

## Bit-triggered trends

Through a trigger bit set in the trend request tag, the HMI device either reads in a trend value or an entire trend buffer. This setting is defined in the configuration. Bit-triggered trends are normally used to represent fast changing values. One example might be the injection pressure in the production of plastic parts.

To trigger bit-triggered trends, appropriate external tags must be created in the "HMI tags" editor and connected to trend areas during configuration. The HMI device and PLC then communicate with each other via these trend areas.

The following areas are available for trends:

- Trend request area
- Trend transfer area 1
- Trend transfer area 2 (required only with switch buffers)

## Trend request and trend transfer

### Trend request area

The HMI device sets corresponding bits in the trend request area when you open a screen which contains one or more trends on the HMI device. After closing the screen, the HMI device resets the relevant bits in the trend request area.

The trend request area can be used for evaluation purposes in the PLC to determine which trend is currently being displayed on the HMI device. Trends can also be triggered without evaluation of the trend request area.

### Trend transfer area 1

This area is used to trigger trends. You must set the bit assigned to the trend in the trend transfer area and set the trend group bit in your control program. The trend group bit is the last bit in the trend transfer area.

The HMI device detects the trigger. The HMI device reads either a value or the entire buffer from the PLC. It then resets the trend bit and the trend group bit.

The following picture shows the structure of a trend transfer area.

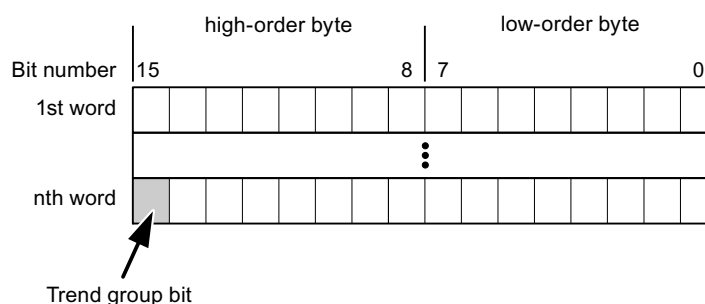

The trend transfer area must not be modified by the PLC program until the trend group bit has been reset.

## Trend transfer area 2

Trend transfer area 2 is required for trends configured with a switch buffer. The trend transfer areas 1 and 2 have a similar structure.

## Switch buffer

The switch buffer is a second buffer for the same trend that can be set up during configuration.

The PLC writes to Buffer 2 while the HMI device reads values from Buffer 1, and writes to Buffer 1 when the HMI device is reading Buffer 2. This prevents the PLC from overwriting trend values while the trend is being read by the HMI device.

## Permitted data types for trends

### For SIMATIC S7

You assign one bit to each trend during configuration. Tags and array tags of the "Word" or "Int" data type are permitted.

## Alarms

### Configuring alarms

#### Configure alarms

Several steps are needed to configure alarms, such as operational messages, error alarms, and acknowledgement.

- Step 1: Create tags
- Step 2: Configure alarms
- Step 3: Configure acknowledgment

You can find additional information in the section:

Working with Alarms (Page 3260)

#### Distinctive features when configuring alarms

If you are configuring connections of HMI devices to PLCs of other manufacturers, note the following distinctive features when configuring:

- Data types of the tags
- Addressing of tags
- How the bit positions are counted



## Data types

For connections with a SIMATIC communication driver, the following data types are supported:

PLC	Permitted data types	
	Discrete alarms	Analog alarms
SIMATIC S7 PLCs	WORD, INT	BYTE, CHAR, WORD, INT, DWORD, DINT, REAL, TIMER

## How the bit positions are counted

For connections with a SIMATIC communication driver, the following counting method applies:

How the bit positions are counted	Byte 0							Byte 1							
	Most significant byte							Least significant byte							
In SIMATIC S7 PLCs	7						0	7							0
In WinCC you configure:	15						8	7							0

## Acknowledgment of alarms

### Procedure

Create suitable tags on the PLC to acknowledge an error alarm. You assign these tags to an alarm in the "Bit messages" editor. You make the assignment in "Properties > Acknowledgment".

Distinction in terms of acknowledgment:

- Acknowledgment by the PLC
- Acknowledgment on the HMI device

### Acknowledgment by the PLC

In "PLC acknowledgment tag", configure the tag or array tag and the bit number that the HMI device uses to identify a PLC acknowledgment.

A bit set in the tag triggers acknowledgment of the assigned error alarm bit at the HMI device. This tag bit returns a function similar to acknowledgment on the HMI device which is triggered by pressing the "ACK" button, for example.

The acknowledgment bit must be located in the same tag as the bit for the error alarm.

Reset the acknowledgment bit before setting the bit in the alarm area again. The figure below shows the pulse diagram.

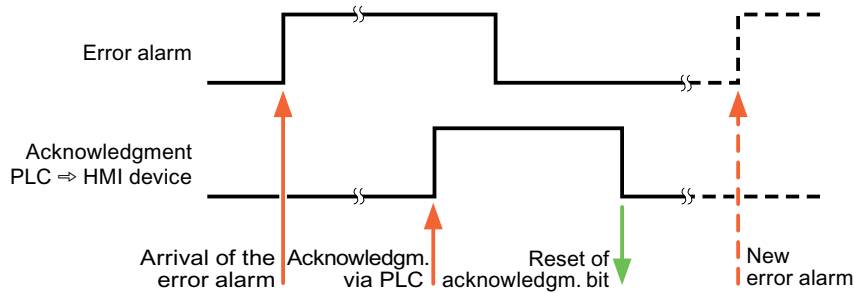

### Acknowledgment on the HMI device

In the "HMI acknowledgment tag" area, configure the tag or array tag as well as the bit number that the HMI device writes to the PLC after acknowledgment. Make sure when you use an array tag that it is not longer than 6 words.

To always create a signal change when setting an assigned acknowledgment bit of a discrete alarm that must be acknowledged, the HMI device will reset the acknowledgment bit assigned to the alarm as soon as it detects an alarm subject to acknowledgment and write the acknowledgment tag in the PLC. There will be a certain delay between detecting the message and writing the acknowledgment tag in the PLC because the HMI device has to process the operations.

If a discrete alarm subject to acknowledgment is acknowledged by the HMI device, then the corresponding bit in the assigned acknowledgment tag will be set. The entire acknowledgment tag is then written to the PLC by the HMI device. This allows the PLC to recognize that a certain alarm message has been acknowledged at the HMI device.

#### Note

All alarm bits acknowledged since the last Runtime start will remain in the acknowledgment tag until a new incoming of the respective discrete alarms is detected.

This area should only be read by the PLC because the entire section of the HMI device will be overwritten once the next acknowledgment tag is written.

The figure below shows the pulse diagram.

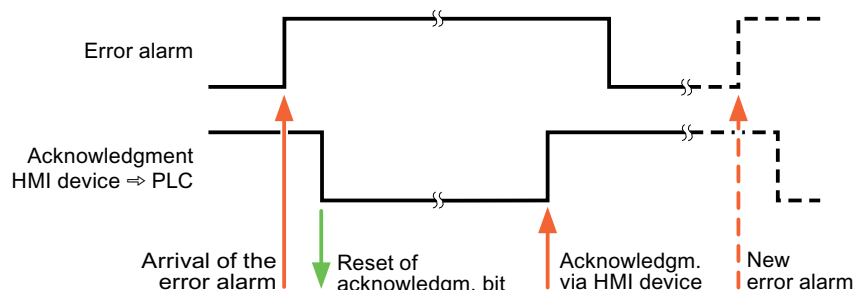

## LED mapping

### Function

Keyboard devices have LEDs in the function keys. These LEDs can be activated from the PLC. Thus, it is possible, for example, to signal to the user which key he should press in a given situation by lighting up an LED.

---

#### Note

The LED function cannot be configured for Basic Panels.

---

### Requirements

In order to activate an LED, an LED tag or an array tag must be set up in the PLC and specified as an LED tag during configuration.

### LED assignment

The assignment of the individual LEDs to the bits in the LED tags is specified when the function keys are configured. In this process, the "LED tag" and the assigned "Bit" are specified for each function key in the "General" group of the properties window.

The "Bit" bit number designates the first of two consecutive bits that control the following LED statuses.

Bit n+ 1	Bit n	LED function	
		All Mobile Panels, all Operator Panels, all Multi Panels	Panel PCs:
0	0	Off	Off
0	1	Rapid flashing	Flashing
1	0	Slow flashing	Flashing
1	1	On permanently	On permanently

#### 10.11.9.5 Performance features of communication

##### Permitted data types for SIMATIC S7 200

##### Permitted data types for connections with SIMATIC S7 200

The table lists the data types that can be used when configuring tags and area pointers.

Data type	Length
Bool	1 bit
Byte	1 byte

---

Data type	Length
Char	1 byte
Word	2 bytes
Int	2 bytes
DWord	4 bytes
DInt	4 bytes
Real	4 bytes
StringChar	--
Timer	2 bytes
Array	--

---

**Note**

**Disconnection with a PPI network**

If you are using arrays in the configuration, an array size of approximately 1000 bytes may cause an interruption of the connection.

Use smaller arrays in your configuration.

---

### 10.11.10 Communicating with SIMATIC LOGO!

#### 10.11.10. Communication with SIMATIC LOGO!

1

##### Introduction

This section describes the communication between an HMI device and the SIMATIC SIMATIC LOGO! controller.

You can configure the following communication channels for the SIMATIC LOGO! controller:

- PROFINET
- Ethernet

##### HMI connection for communication

You configure connections between the HMI device and SIMATIC LOGO! in the "Connections" editor of the HMI device.

##### Data exchange

Data exchange with the SIMATIC LOGO! control system is possible by means of tags.

Data cannot be exchanged using area pointers.

### 10.11.10. Creating a connection to SIMATIC LOGO!

2

#### Introduction

You configure a connection to the SIMATIC LOGO! controller in the "Connections" editor of the HMI device. The interfaces are named differently depending on the HMI device.

#### Requirements

- A project is open.
- An HMI device has been created.

#### Procedure

1. Double-click the HMI device under "Devices" in the project tree.
2. Double-click the "Connections" item.
3. Double-click "<Add>" in the "Connections" editor.

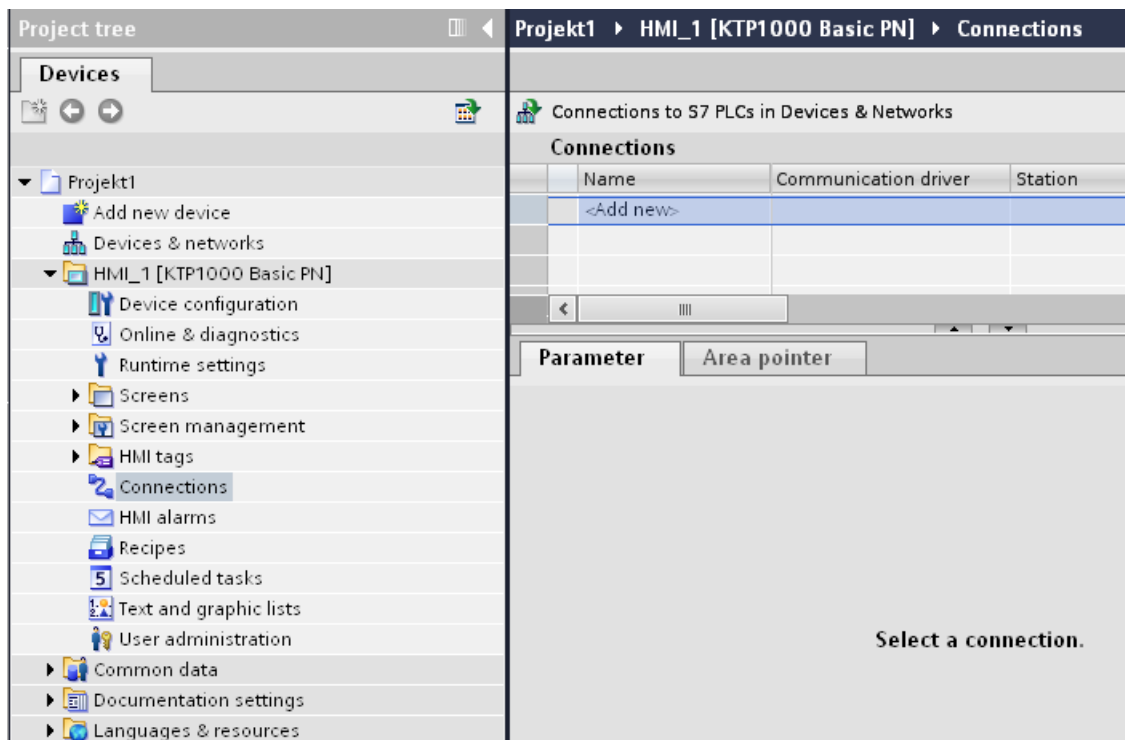

4. In the "Communication drivers" column, select the "SIMATIC LOGO!" driver.
5. Select all necessary connection parameters for the interface in the Inspector window under "Parameters".

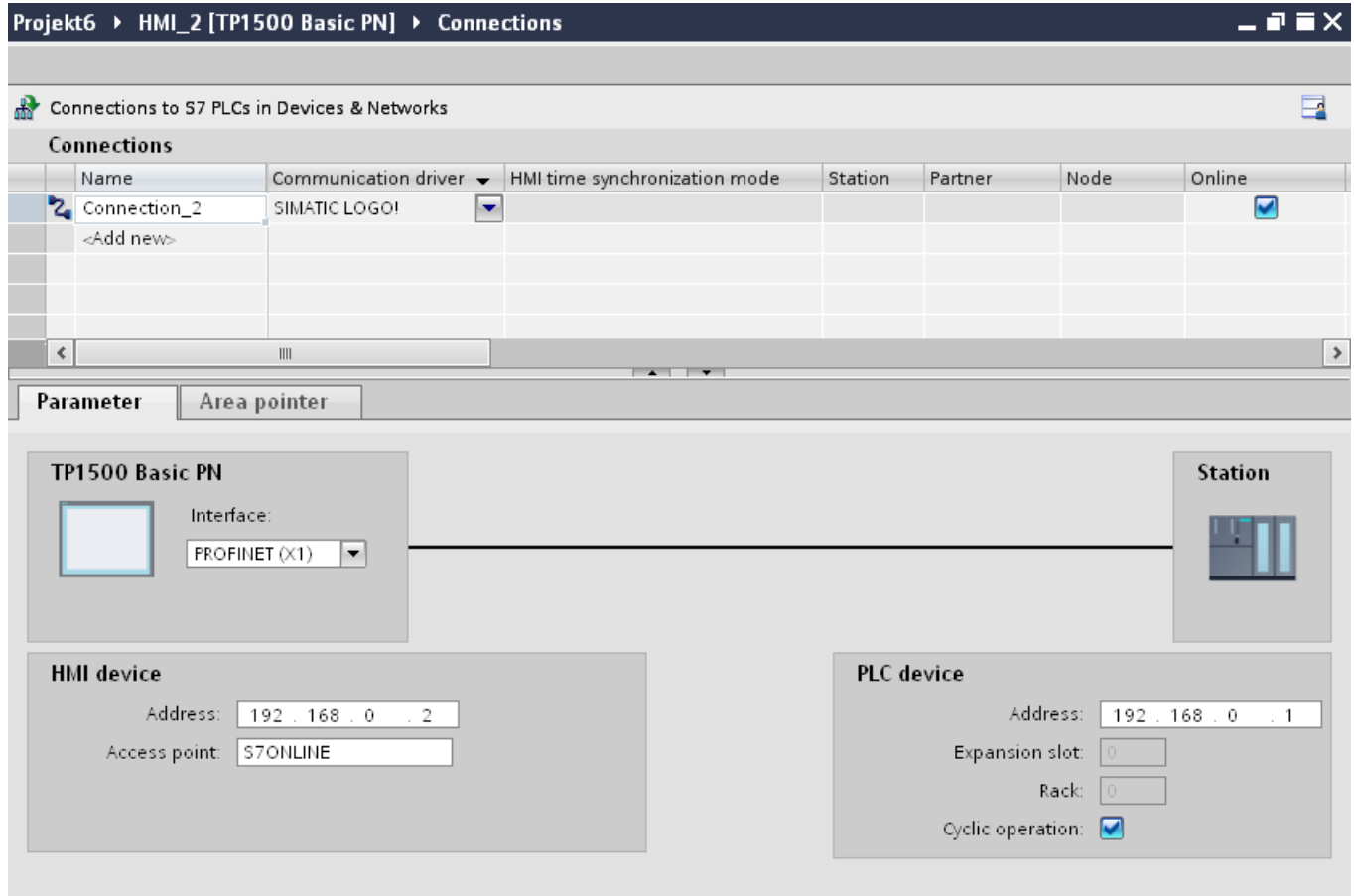

See the chapter "Connection parameters (Page 5232)" for additional details.

### 10.11.10. Connection parameters

3

#### Connection parameters

##### Parameters to be set

To set the connection parameters, such as addresses and profiles, click the connection that you have created in the "Connections" editor.

The communication partners are displayed schematically in the Inspector window under "Parameters". The "HMI device" and "PLC" areas are available for assigning parameters according to the interface used.

Projekt6 ▶ HMI\_2 [TP1500 Basic PN] ▶ Connections

Connections to S7 PLCs in Devices & Networks

**Connections**

Name	Communication driver	HMI time synchronization mode	Station	Partner	Node	Online
Connection_2	SIMATIC LOGON					<input checked="" type="checkbox"/>
<Add new>						

Parameter | Area pointer

**TP1500 Basic PN**

Interface: PROFINET (X1)

**Station**



---

**HMI device**

Address: 192 . 168 . 0 . 2

Access point: S7ONLINE

**PLC device**

Address: 192 . 168 . 0 . 1

Expansion slot: 0

Rack: 0

Cyclic operation:

## Ethernet parameters

### Parameters for the HMI device

You set the parameters for the HMI device in the network under "HMI device".. The changes are not transferred automatically to the HMI device. You must change the settings in the Control Panel of the HMI device.

- "Interface"  
If you are directly connected to the HMI device during configuration, you can set up the IP address of the HMI device in WinCC.

---

#### Note

The IP address in the Control Panel will be overwritten upon subsequent loading if you have already set up the IP address in the HMI device control panel.

The IP address already set up in the Control Panel will be retained upon subsequent loading if you activate "Set IP address using a different method".

---

The IP address is transferred to the HMI device during project transfer.  
To set up the IP address of the HMI device:

- Click the HMI device.
- Open the "Device configuration" editor.
- Click the Ethernet interface.
- Assign the IP address in the inspector window under:  
"General > PROFINET interface > Ethernet addresses"
- "Address"  
You assign the IP address of the HMI device in the "Address" area.  
When you transfer the WinCC project to the HMI device, this IP address is set up directly in the HMI device.
- "Access point"  
The access point defines a logical device name through which the communication partner can be reached.

### Parameters for the PLC

Under "PLC", you address the S7 module with which the HMI device will exchange data. Assign a name for the connection for each communication partner.

- "Address"  
Under "Address", set the IP address of the S7 module to which the HMI device is connected.
- "Expansion slot"  
Defines the number of the expansion slot of the CPU to be addressed.



- "Rack"  
Defines the rack number of the CPU to be addressed.
- "Cyclic operation"

---

**Note**

The setting "Cyclic operation" cannot be configured for the SIMATIC S7 1200 PLC.

---

When cyclic operation is enabled, the PLC optimizes the data exchange between the HMI device and the PLC. This increases system performance.

Disable cyclic mode if you are operating several HMI devices in parallel.

## Cyclic operation

### Handling the "Cyclic operation" selection

If "Cyclic operation" is enabled, the HMI device sends a message frame to the CPU at the beginning of communication indicating that certain tags are required on a recurring basis.

The CPU then always transmits the data at the same cyclic interval. This saves the HMI device from having to output new requests for the data.

If cyclic operation is disabled, the HMI device sends a request whenever information is required.

Additional properties:

- Cyclic operation reduces data transmission load at the HMI device. The PLC resources are used to relieve load on the HMI device.
- The PLC only supports a certain number of cyclic services. The HMI device handles the operation if the PLC cannot provide any further resources for cyclic services.
- The HMI device generates the cycle if the PLC does not support the cyclic mode.
- Screen tags are not integrated in cyclic operation.
- Cyclic mode is only set up at the restart of Runtime.
- The HMI device transfers several jobs to the PLC if cyclic mode is enabled, depending on the PLC.
- The HMI device only transfers one job to the PLC if cyclic mode is disabled.

### 10.11.10. Data exchange

#### 4

## Trends

### General information on trends

## Trends

A trend is the graphical representation of one or more values from the PLC. The value is read out either time- or bit-triggered, depending on the configuration.

For additional information see:

Auto-Hotspot

---

#### Note

The value is read out time-triggered for Basic Panels.

---

## Time-triggered trends

The HMI device reads in the trend values cyclically at an interval specified in the configuration. Time-triggered trends are suitable for continuous curves, such as the operating temperature of a motor.

## Bit-triggered trends

Through a trigger bit set in the trend request tag, the HMI device either reads in a trend value or an entire trend buffer. This setting is defined in the configuration. Bit-triggered trends are normally used to represent fast changing values. One example might be the injection pressure in the production of plastic parts.

To trigger bit-triggered trends, appropriate external tags must be created in the "HMI tags" editor and connected to trend areas during configuration. The HMI device and PLC then communicate with each other via these trend areas.

The following areas are available for trends:

- Trend request area
- Trend transfer area 1
- Trend transfer area 2 (required only with switch buffers)

## Trend request and trend transfer

### Trend request area

The HMI device sets corresponding bits in the trend request area when you open a screen which contains one or more trends on the HMI device. After closing the screen, the HMI device resets the relevant bits in the trend request area.

The trend request area can be used for evaluation purposes in the PLC to determine which trend is currently being displayed on the HMI device. Trends can also be triggered without evaluation of the trend request area.

### Trend transfer area 1

This area is used to trigger trends. You must set the bit assigned to the trend in the trend transfer area and set the trend group bit in your control program. The trend group bit is the last bit in the trend transfer area.

The HMI device detects the trigger. The HMI device reads either a value or the entire buffer from the PLC. It then resets the trend bit and the trend group bit.

The following picture shows the structure of a trend transfer area.

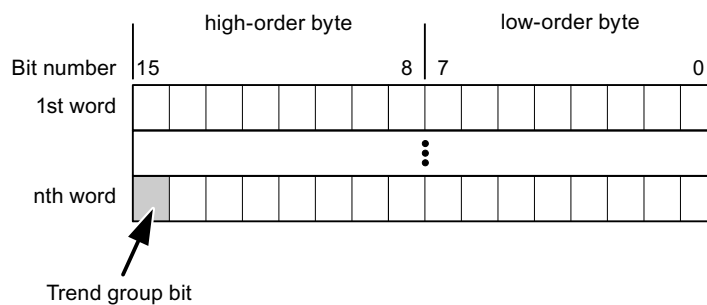

The trend transfer area must not be modified by the PLC program until the trend group bit has been reset.

### Trend transfer area 2

Trend transfer area 2 is required for trends configured with a switch buffer. The trend transfer areas 1 and 2 have a similar structure.

### Switch buffer

The switch buffer is a second buffer for the same trend that can be set up during configuration.

The PLC writes to Buffer 2 while the HMI device reads values from Buffer 1, and writes to Buffer 1 when the HMI device is reading Buffer 2. This prevents the PLC from overwriting trend values while the trend is being read by the HMI device.

## Permitted data types for trends

### For SIMATIC S7

You assign one bit to each trend during configuration. Tags and array tags of the "Word" or "Int" data type are permitted.

## Alarms

### Configuring alarms

#### Configure alarms

Several steps are needed to configure alarms, such as operational messages, error alarms, and acknowledgement.

- Step 1: Create tags
- Step 2: Configure alarms
- Step 3: Configure acknowledgment

You can find additional information in the section:

Auto-Hotspot

#### Distinctive features when configuring alarms

If you are configuring connections of HMI devices to PLCs of other manufacturers, note the following distinctive features when configuring:

- Data types of the tags
- Addressing of tags
- How the bit positions are counted

## Data types

For connections with a SIMATIC communication driver, the following data types are supported:

PLC	Permitted data types	
	Discrete alarms	Analog alarms
SIMATIC S7 PLCs	WORD, INT	BYTE, CHAR, WORD, INT, DWORD, DINT, REAL, TIMER

## How the bit positions are counted

For connections with a SIMATIC communication driver, the following counting method applies:

How the bit positions are counted	Byte 0							Byte 1						
	Most significant byte							Least significant byte						
In SIMATIC S7 PLCs	7						0	7						0
In WinCC you configure:	15						8	7						0

## Acknowledgment of alarms

### Procedure

Create suitable tags on the PLC to acknowledge an error alarm. You assign these tags to an alarm in the "Bit messages" editor. You make the assignment in "Properties > Acknowledgment".

Distinction in terms of acknowledgment:

- Acknowledgment by the PLC
- Acknowledgment on the HMI device

### Acknowledgment by the PLC

In "PLC acknowledgment tag", configure the tag or array tag and the bit number that the HMI device uses to identify a PLC acknowledgment.

A bit set in the tag triggers acknowledgment of the assigned error alarm bit at the HMI device. This tag bit returns a function similar to acknowledgment on the HMI device which is triggered by pressing the "ACK" button, for example.

The acknowledgment bit must be located in the same tag as the bit for the error alarm.

Reset the acknowledgment bit before setting the bit in the alarm area again. The figure below shows the pulse diagram.

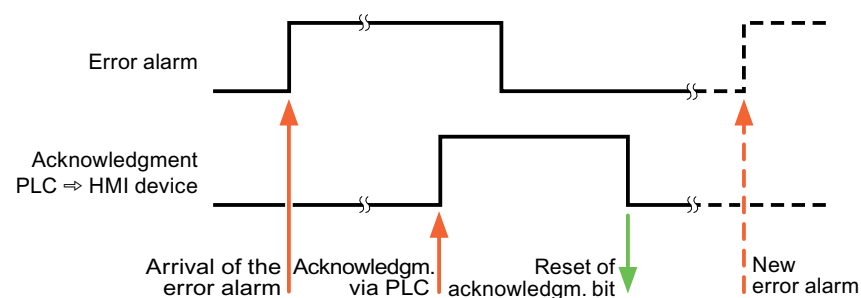

### Acknowledgment on the HMI device

In the "HMI acknowledgment tag" area, configure the tag or array tag as well as the bit number that the HMI device writes to the PLC after acknowledgment. Make sure when you use an array tag that it is not longer than 6 words.

To always create a signal change when setting an assigned acknowledgment bit of a discrete alarm that must be acknowledged, the HMI device will reset the acknowledgment bit assigned to the alarm as soon as it detects an alarm subject to acknowledgment and write the acknowledgment tag in the PLC. There will be a certain delay between detecting the message and writing the acknowledgment tag in the PLC because the HMI device has to process the operations.

If a discrete alarm subject to acknowledgment is acknowledged by the HMI device, then the corresponding bit in the assigned acknowledgment tag will be set. The entire acknowledgment tag is then written to the PLC by the HMI device. This allows the PLC to recognize that a certain alarm message has been acknowledged at the HMI device.

---

#### Note

All alarm bits acknowledged since the last Runtime start will remain in the acknowledgment tag until a new incoming of the respective discrete alarms is detected.

This area should only be read by the PLC because the entire section of the HMI device will be overwritten once the next acknowledgment tag is written.

---

The figure below shows the pulse diagram.

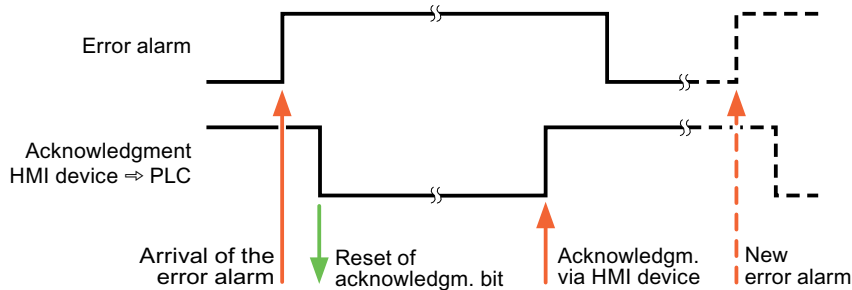

**10.11.10. Performance features of communication**

5

**Valid data types for SIMATIC LOGO!****Valid data types for connections with SIMATIC LOGO!**

The table lists the data types that can be used when configuring tags and area pointers.

<b>Data type</b>	<b>Length</b>
Bool	1 bit
Byte	1 byte
Int	2 bytes
DInt	4 bytes
Word	2 bytes
DWord	4 bytes
Array	--

**10.11.11 Configuring direct keys****10.11.11. Direct keys**

1

**Introduction**

In addition to their standard use, the F, K and S keys of an HMI device with key operation can be used as direct keys.

With HMI devices with touch operation, you configure the system function "Direct key" to a button

You can configure the following direct keys:

- PROFINET connection: PROFINET IO direct keys
- PROFIBUS connection: PROFIBUS DP direct keys

**Operating mode of HMI devices with direct keys**

Before accessing the PLC from the HMI device using the direct keys you have to change the operating mode of the HMI device.

### 10.11.11. Changing the operating mode of the HMI device

2

#### Changing the operating mode for a PROFINET connection

##### Requirements

The HMI device is networked with a PLC via PROFINET.

##### Procedure

1. Click the PROFINET interface of the HMI device in the "Devices & Networks" editor.
2. Click "Operating mode" under "Properties > General" in the Inspector window.
3. Select the function "IO device" in the "Operating mode" area.
4. Select the PLC which is networked with the HMI device under "Assigned IO controller".

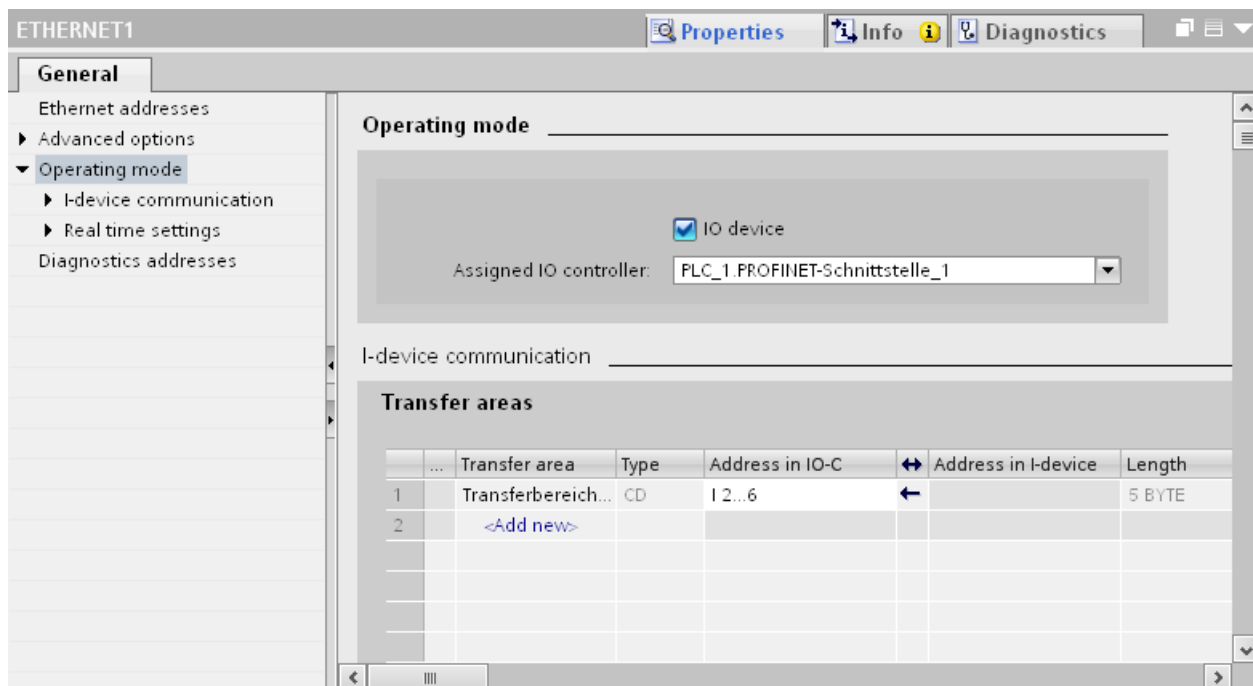

#### Changing the operating mode for a PROFIBUS connection

##### Requirements

The HMI device is networked with a PLC via PROFIBUS.



## Procedure

1. Click the PROFIBUS interface of the HMI device in the "Devices & Networks" editor.
2. Click "Operating mode" under "Properties > General" in the Inspector window.
3. Select the function "DP slave" in the "Operating mode" area.
4. Select the PLC which is networked with the HMI device under "Assigned DP master".

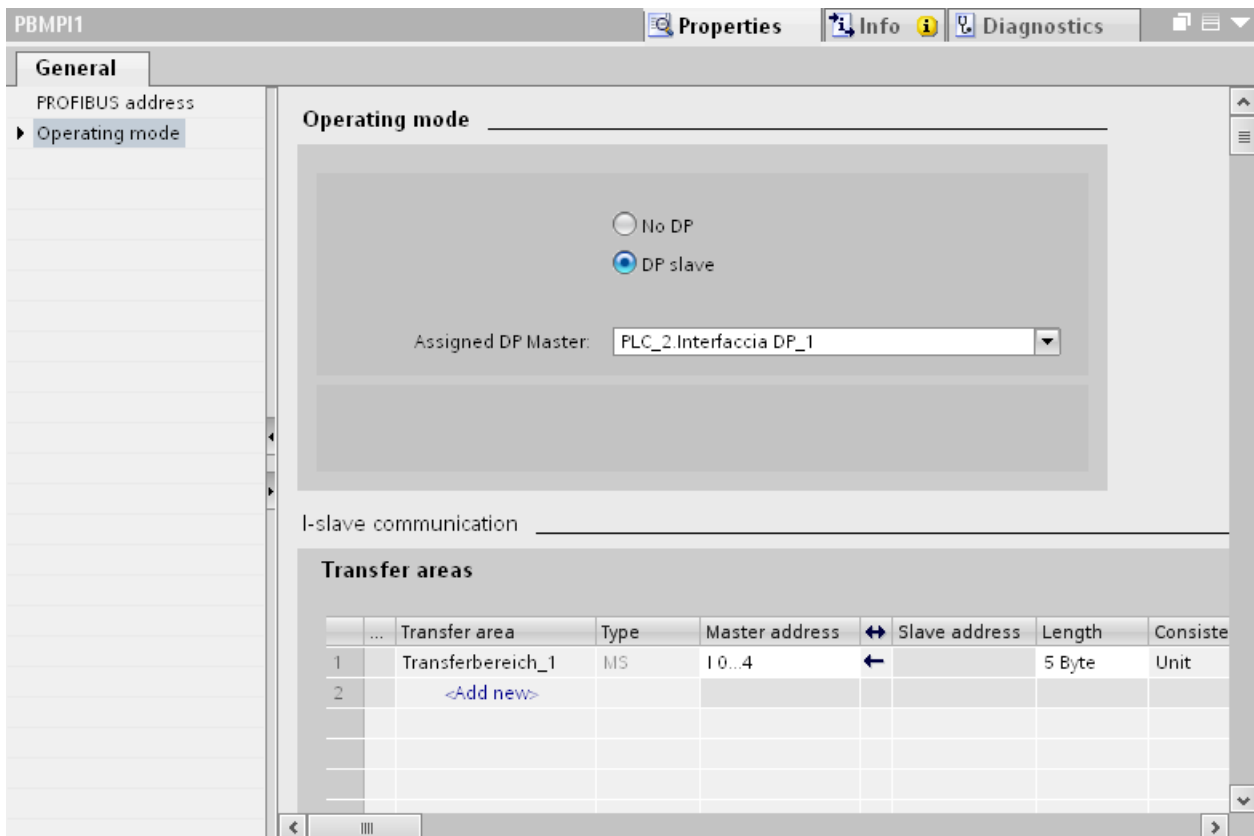

### 10.11.11. Configuring direct keys

3

#### Configuring direct keys for an HMI device with touch operation

#### Requirements

- An HMI device with key operation has been created.
- You have created an LED tag.

## Procedure

1. Create a new screen.
2. Drag-and-drop a button from the "Tools" task card into the screen.
3. Click the button.
4. In the Inspector window, click "Properties > Events > Press".
5. Click "<Add function>".
6. Select the "Direct key" system function.

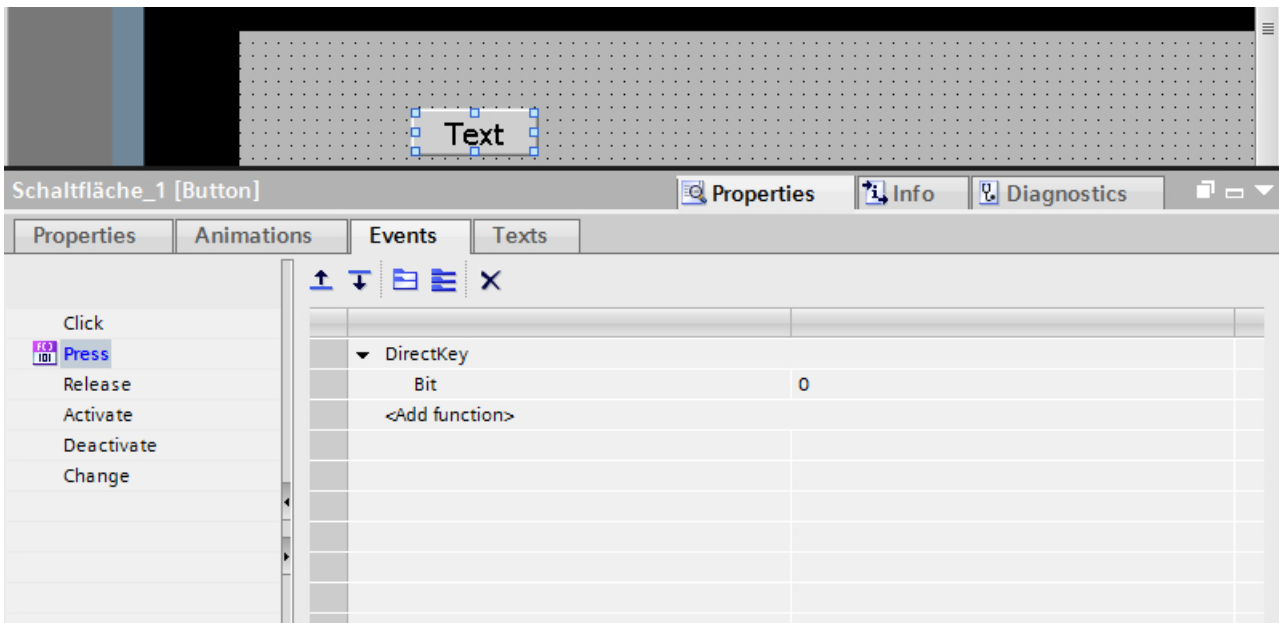

7. Under "Bit" enter the correct bit number.  
The correct bit number depends on the HMI device and the input and output assignments on the HMI device.

## Assignment of inputs and outputs

The exact assignment of inputs and outputs can be found under:

- PROFINET IO direct keys: Assignment of inputs and outputs (Page 5248)
- PROFIBUS DP direct keys: Assignment of inputs and outputs (Page 5265)

### 10.11.11. PROFINET IO direct keys

4

#### PROFINET IO direct keys

#### PROFINET IO direct keys

You configure the HMI device created in WinCC as an active communication partner in the automation network.

For the PROFINET IO direct keys, the HMI device can also be configured as a slave in the PROFINET IO network.

The following figure shows the basic configuration based on an automation network with an HMI device and a PLC.

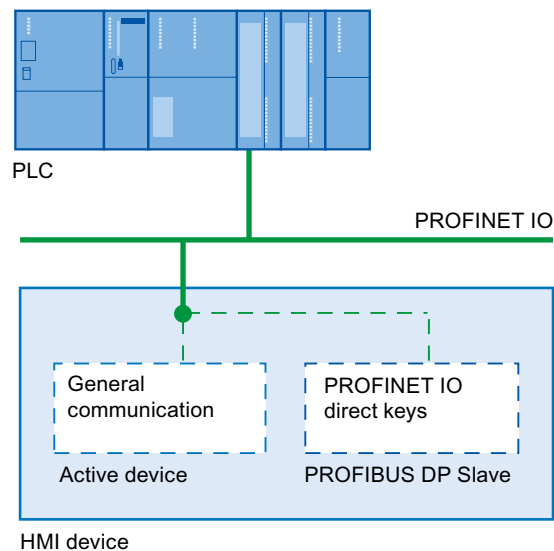

#### Mode of operation of the PROFINET IO direct keys

The cycle time of the Ethernet bus can be set between 8 ms and 512 ms.

Thus, the reaction time of the PROFINET IO direct keys can also be determined. For a typical configuration with a cycle time of 64 ms, the response time of the PROFINET IO direct keys is < 100 ms.

A response time of < 100 ms to the CPU is usually ensured when using the PROFINET IO direct keys. This time can be exceeded significantly in the following cases:

- Complex functions run in the background, e.g. transmitting recipes, printing reports.
- At the same time, multiple connections can be maintained to the CPU.

## HMI devices for the configuration of PROFINET IO direct keys

### HMI devices

You can configure PROFINET IO direct keys with the following HMI devices:

HMI device class	HMI device
Panel	OP 177B PN/DP
	OP 277 6"
	TP 177B 4" PN/DP
	TP 177B 6" PN/DP
	TP 277 6"
Mobile Panel	Mobile Panel 177 PN
	Mobile Panel 277 8"
	Mobile Panel 277 10"
	Mobile Panel 277 IWLAN V2
	Mobile Panel 277(F) IWLAN V2
	Mobile Panel 277(F) IWLAN V2 (RFID tags)
Multi Panel	Multi Panel 177 6" Touch
	Multi Panel 277 Key
	Multi Panel 277 Touch
	Multi Panel 377 Key
	Multi Panel 377 Touch
Comfort Panel	KTP400 Comfort
	KP400 Comfort
	KP700 Comfort
	TP700 Comfort
	KP900 Comfort
	TP900 Comfort
	KP1200 Comfort
	TP1200 Comfort
	KP1500 Comfort
	TP1500 Comfort
	TP1900 Comfort
TP2200 Comfort	

### Restrictions for PROFINET IO direct keys

**Note**

Direct keys are still active when the HMI device is in "offline" mode.

**Note**

If an external application such as Pocket Internet Explorer or Control Panel is started, it will run in the foreground and Runtime is placed in the background. The bit for the function "DirectKeyScreenNumber" is no longer set and the keys or buttons with the configured function "DirectKey" no longer trigger the associated bit in the PLC.

---

**Restrictions**

- It is not permitted to operate PROFIBUS IO direct keys and PROFINET DP direct keys simultaneously.
- Establish the following via the "PROFINET IO enabled" option in the control panel of the HMI device:
  - Option disabled = PROFIBUS DP direct keys enabled
  - Option enabled = PROFINET IO direct keys enabled
- If communication is enabled with PROFINET IO, you are not permitted to use the serial interface.
- You can operate direct keys only on local HMI devices. On the Sm@rtClient it is possible to operate the key / button for the direct key. However, No bit is set in the I/O area of the CPU.
- Direct keys which are assigned to a button are only triggered through touch operation. Triggering with a mouse click, for example with a connected USB mouse, is not possible.
- With touch operation, direct keys are triggered independent of any configured password protection.
- The buttons used as direct keys on HMI devices with touch screen functionality may not be modified as follows by means of scripting:
  - Moving
  - Resizing
  - Hiding
  - Disabling for operation
- The LEDs are addressed either via the PROFINET IO direct keys or the HMI Runtime application. Avoid concurrent addressing via the PROFINET IO direct keys and the HMI Runtime application. The LEDs "ACK", "A-Z I", "A-Z r" and "HELP" are reserved for system functions and cannot be configured. It is not advisable to control the "ACK", "A-Z I", "A-Z r" and "HELP" LEDs by means of PROFINET IO direct key functionality.

## Inputs and outputs of HMI devices

### Assignment of inputs and outputs

#### Assigning the inputs/outputs

The keys or buttons of the device are assigning bytes in the input area. The LEDs are assigning bytes in the output area. The number of bytes used depends on the HMI device.

The touch panels do not have any permanently assigned keys. They only have user-configurable buttons. Via the "DirectKey system function you can assign a bit to a button in the input area. The counting direction of the bit in the input direction is from right to left. In contrast to the operator panels which have permanently assigned keys, the touch panel buttons can be assigned freely.

#### Assigning direct keys to screen numbers (only for touch devices)

If a PROFINET IO direct key is using the same bit for different functions in different screens, the SIMATIC PLC must differentiate between the respective functionality by means of the screen number. You can use the "DirectKeyScreenNumber" system function to avoid the delayed updating of the screen number following a screen change.

Using the "DirectKeyScreenNumber" system function you can set within the input area any number of bits in order to identify the screen and simultaneously transfer the direct key bits to the PLC. This ensures unambiguous allocation of a control bit to screen number at all times.

#### See also

Panel (Page 5248)

Multi Panel (Page 5251)

Mobile Panel (Page 5254)

Comfort Panel (Page 5257)

#### Panel

#### OP 177

#### Direct keys OP 177B

Inputs	Outputs
9 bytes	4 bytes

Direct keys assignment								LED									
								Byte									
									7	6	5	4	3	2	1	0	
Membrane keys	7	6	5	4	3	2	1	0	n+0	F8	F7	F6	F5	F4	F3	F2	F1
									n+1	K2	K1						
									n+2	K10	K9	K8	K7	K6	K5	K4	K3
									n+3	K18	K17	K16	K15	K14	K13	K12	K11
								n+4									
Touch buttons	7	6	5	4	3	2	1	0	n+5								
	15	14	13	12	11	10	9	8	n+6								
	23	22	21	20	19	18	17	16	n+7								
	31	30	29	28	27	26	25	24	n+8								

TP 177

Direct keys TP 177B 4"

Inputs	Outputs
5 bytes	-

Direct key assignment								LED bits									
								Byte									
									7	6	5	4	3	2	1	0	
Membrane keys					F4	F3	F2	F1	n+0								
	7	6	5	4	3	2	1	0	n+1								
Touch buttons	15	14	13	12	11	10	9	8	n+2								
	23	22	21	20	19	18	17	16	n+3								
	31	30	29	28	27	26	25	24	n+4								

Direct keys TP 177B 6"

Inputs	Outputs
4 bytes	--

Direct keys assignment								LED															
								Byte															
								7	6	5	4	3	2	1	0	7	6	5	4	3	2	1	0
Touch buttons	7	6	5	4	3	2	1	0	n+0														
	15	14	13	12	11	10	9	8	n+1	No output area													
	23	22	21	20	19	18	17	16	n+2														
	31	30	29	28	27	26	25	24	n+3														

**OP 277**

**Direct keys OP 277 6"**

Inputs								Outputs															
4 bytes								4 bytes															
Direct keys assignment								LED															
								Byte															
								7	6	5	4	3	2	1	0	7	6	5	4	3	2	1	0
Keys	F8	F7	F6	F5	F4	F3	F2	F1	n+0	F8	F7	F6	F5	F4	F3	F2	F1						
	K2	K1	F14	F13	F12	F11	F10	F9	n+1	K2	K1												
	K10	K9	K8	K7	K6	K5	K4	K3	n+2	K10	K9	K8	K7	K6	K5	K4	K3						
	ACK	ALT	CTRL	SHIFT					n+3	ACK	A-Z left	A-Z right	HELP										

**TP 277**

**Direct keys TP 277 6"**

Inputs				Outputs			
4 bytes				-			



Direct keys assignment								Byte	LED	
	7	6	5	4	3	2	1	0		
Touch buttons	7	6	5	4	3	2	1	0	n+0	No output area
	15	14	13	12	11	10	9	8	n+1	
	23	22	21	20	19	18	17	16	n+2	
	31	30	29	28	27	26	25	24	n+3	

## Multi Panel

### Multi Panel 177

#### Direct keys Multi Panel 177 6" Touch

Inputs	Outputs
4 bytes	-

Direct keys assignment								Byte	LED	
	7	6	5	4	3	2	1	0		
Touch buttons	7	6	5	4	3	2	1	0	n+0	No output area
	15	14	13	12	11	10	9	8	n+1	
	23	22	21	20	19	18	17	16	n+2	
	31	30	29	28	27	26	25	24	n+3	

## Multi Panel 277

### Direct keys Multi Panel 277 8" Key

Inputs	Outputs
5 bytes	5 bytes

10.11 Communicating with PLCs

Direct keys assignment								LED									
								Byte	7	6	5	4	3	2	1	0	
Keys	7	6	5	4	3	2	1	0	n+0	F8	F7	F6	F5	F4	F3	F2	F1
									n+1							F10	F9
									n+2	K4	K3	K2	K1				
									n+3					K8	K7	K6	K5
									n+4	ACK	A-Z left	A-Z right	HELP				

Direct keys Multi Panel 277 10" Key

Inputs	Outputs
5 bytes	5 bytes

Direct keys assignment								LED									
								Byte	7	6	5	4	3	2	1	0	
Keys	7	6	5	4	3	2	1	0	n+0	F8	F7	F6	F5	F4	F3	F2	F1
									n+1					F12	F11	F10	F9
									n+2	K4	K3	K2	K1				
									n+3	K12	K11	K10	K9	K8	K7	K6	K5
									n+4	ACK	A-Z left	A-Z right	HELP	K16	K15	K14	K13

Direct keys Multi Panel 277 8" Touch

Inputs	Outputs
5 bytes	-

Direct keys assignment								Byte	LED	
	7	6	5	4	3	2	1	0		
Touch buttons	7	6	5	4	3	2	1	0	n+0	No output area
	15	14	13	12	11	10	9	8	n+1	
	23	22	21	20	19	18	17	16	n+2	
	31	30	29	28	27	26	25	24	n+3	
	39	38	37	36	35	34	33	32	n+4	

### Direct keys Multi Panel 277 10" Touch

Inputs	Outputs
5 bytes	-

Direct keys assignment								Byte	LED	
	7	6	5	4	3	2	1	0		
Touch buttons	7	6	5	4	3	2	1	0	n+0	No output area
	15	14	13	12	11	10	9	8	n+1	
	23	22	21	20	19	18	17	16	n+2	
	31	30	29	28	27	26	25	24	n+3	
	39	38	37	36	35	34	33	32	n+4	

### Multi Panel 377

#### Direct keys Multi Panel 377 Key

Inputs	Outputs
5 bytes	5 bytes

Direct keys assignment								LED									
								Byte									
									7	6	5	4	3	2	1	0	
Keys	7	6	5	4	3	2	1	0	n+0	S8	S7	S6	S5	S4	S3	S2	S1
									n+1	S16	S15	S14	S13	S12	S11	S10	S9
									n+2	F8	F7	F6	F5	F4	F3	F2	F1
									n+3	F16	F15	F14	F13	F12	F11	F10	F9
									n+4	ACK	ALT	CTRL	SHIFT	F20	F19	F18	F17

### Multi Panel 377 Touch

Inputs	Outputs
5 bytes	–

Direct keys assignment								LED									
								Byte									
									7	6	5	4	3	2	1	0	
Touch buttons	7	6	5	4	3	2	1	0	n+0								
									n+1								
									n+2								
									n+3								
									n+4								

No output area

### Mobile Panel

### Mobile Panel 177

### Direct keys Mobile Panel 177 PN

Inputs	Outputs
9 bytes	2 bytes

Direct keys assignment								LED-Bits									
	7	6	5	4	3	2	1	0	Byte	7	6	5	4	3	2	1	0
Membrane keys	F8	F7	F6	F5	F4	F3	F2	F1	n+0	F8	F7	F6	F5	F4	F3	F2	F1
			F14	F13	F12	F11	F10	F9	n+1								T1
optional operator controls						T1	S1	S0	n+2								
	I7	I6	I5	I4	I3	I2	I1	I0	n+3								
	D7	D6	D5	D4	D3	D2	D1	D0	n+4								
Touch buttons	7	6	5	4	3	2	1	0	n+5								
	15	14	13	12	11	10	9	8	n+6								
	23	22	21	20	19	18	17	16	n+7								
	31	30	29	28	27	26	25	24	n+8								

S0-S1: Key-operated switch  
T1: Illuminated pushbutton 1  
I0-I7: Handwheel pulses (forwards)  
D0-D7: Handwheel pulses (backwards)

**Mobile Panel 277**

**Direct keys Mobile Panel 277 8"**

HMI device	Inputs	Outputs
Mobile Panel 277 8"	10 bytes	4 bytes

Direct keys assignment								LED-Bits									
	7	6	5	4	3	2	1	0	Byte	7	6	5	4	3	2	1	0
Membrane keys	F8	F7	F6	F5	F4	F3	F2	F1	n+0	F8	F7	F6	F5	F4	F3	F2	F1
	F16	F15	F14	F13	F12	F11	F10	F9	n+1	F16	F15	F14	F13	F12	F11	F10	F9
optional operator controls							F18	F17	n+2							F18	F17
				T2		T1	S1	S0	n+3						T2	T1	
	I7	I6	I5	I4	I3	I2	I1	I0	n+4								
	D7	D6	D5	D4	D3	D2	D1	D0	n+5								
Touch buttons	7	6	5	4	3	2	1	0	n+6								
	15	14	13	12	11	10	9	8	n+7								
	23	22	21	20	19	18	17	16	n+8								
	31	30	29	28	27	26	25	24	n+9								

S0-S1: Key-operated switch  
 T1: Illuminated pushbutton 1  
 T2: Illuminated pushbutton 2  
 I0-I7: Handwheel pulses (forwards)  
 D0-D7: Handwheel pulses (backwards)

Direct keys Mobile Panel 277 10"

HMI device	Inputs	Outputs
Mobile Panel 277 10"	5 bytes	--

Direct keys assignment								LED									
	7	6	5	4	3	2	1	0	Byte	No output area							
Touch buttons	7	6	5	4	3	2	1	0	n+0								
	15	14	13	12	11	10	9	8	n+1								
	23	22	21	20	19	18	17	16	n+2								
	31	30	29	28	27	26	25	24	n+3								
	39	38	37	36	35	34	33	32	n+4								

## Mobile Panel 277 IWLAN V2

### Direct keys Mobile Panel 277 IWLAN V2

The assignment of the inputs and outputs of the direct keys applies to the following HMI devices:

- Mobile Panel 277 IWLAN V2
- Mobile Panel 277F IWLAN V2
- Mobile Panel 277 IWLAN V2 (RFID tags)

Inputs	Outputs
10 bytes	4 bytes

Direct keys assignment								LED-Bits									
	7	6	5	4	3	2	1	0	Byte	7	6	5	4	3	2	1	0
Membrane keys	F8	F7	F6	F5	F4	F3	F2	F1	n+0	F8	F7	F6	F5	F4	F3	F2	F1
	F16	F15	F14	F13	F12	F11	F10	F9	n+1	F16	F15	F14	F13	F12	F11	F10	F9
optional operator controls							F18	F17	n+2							F18	F17
				T2		T1	S1	S0	n+3						T2	T1	
Touch buttons	I7	I6	I5	I4	I3	I2	I1	I0	n+4								
	D7	D6	D5	D4	D3	D2	D1	D0	n+5								
	7	6	5	4	3	2	1	0	n+6								
	15	14	13	12	11	10	9	8	n+7								
	23	22	21	20	19	18	17	16	n+8								
	31	30	29	28	27	26	25	24	n+9								

S0-S1: Key-operated switch  
 T1: Illuminated pushbutton 1  
 T2: Illuminated pushbutton 2  
 I0-I7: Handwheel pulses (forwards)  
 D0-D7: Handwheel pulses (backwards)

## Comfort Panel

### KTP400 Comfort

#### Direct keys KTP400 Comfort

HMI device	Inputs	Outputs
Touch operation	4 bytes	-

10.11 Communicating with PLCs

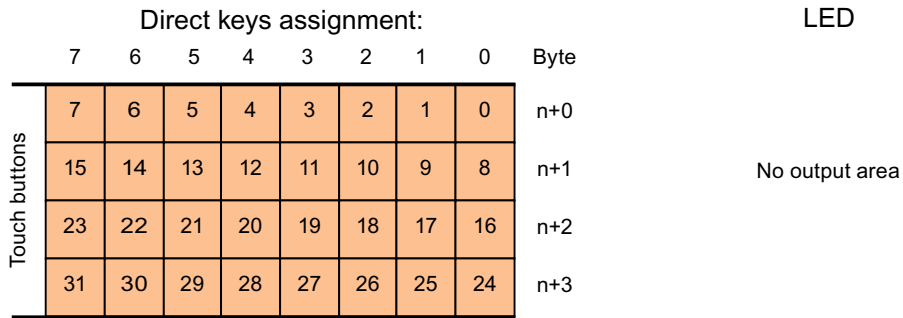

HMI device	Inputs	Outputs
Key operation	1 byte	1 byte

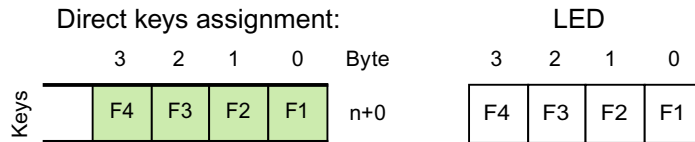

KP400 Comfort

Direct keys KP400 Comfort

Inputs	Outputs
1 byte	1 byte

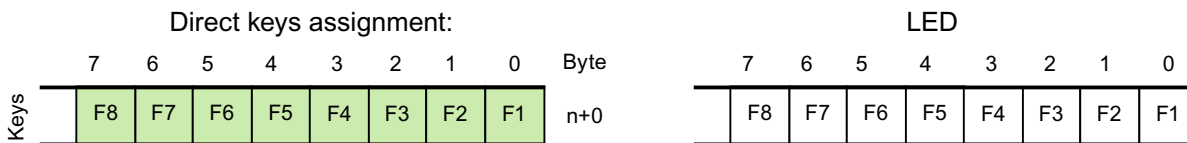



## KP700 Comfort

### Direct keys KP700 Comfort

Inputs	Outputs
3 bytes	3 bytes

Direct keys assignment:

	7	6	5	4	3	2	1	0	Byte
Keys	F8	F7	F6	F5	F4	F3	F2	F1	n+0
	F16	F15	F14	F13	F12	F11	F10	F9	n+1
	F24	F23	F22	F21	F20	F19	F18	F17	n+2

LED

	7	6	5	4	3	2	1	0
	F8	F7	F6	F5	F4	F3	F2	F1
	F16	F15	F14	F13	F12	F11	F10	F9
	F24	F23	F22	F21	F20	F19	F18	F17

## TP700 Comfort

### Direct keys TP700 Comfort

Inputs	Outputs
4 bytes	--

Direct keys assignment:

	7	6	5	4	3	2	1	0	Byte
Touch buttons	7	6	5	4	3	2	1	0	n+0
	15	14	13	12	11	10	9	8	n+1
	23	22	21	20	19	18	17	16	n+2
	31	30	29	28	27	26	25	24	n+3

LED

No output area

## KP900 Comfort

### Direct keys KP900 Comfort

Inputs	Outputs
4 bytes	4 bytes

10.11 Communicating with PLCs

Direct keys assignment:

	7	6	5	4	3	2	1	0	Byte
Keys	F8	F7	F6	F5	F4	F3	F2	F1	n+0
	F16	F15	F14	F13	F12	F11	F10	F9	n+1
	F24	F23	F22	F21	F20	F19	F18	F17	n+2
							F26	F25	n+3

LED

	7	6	5	4	3	2	1	0
	F8	F7	F6	F5	F4	F3	F2	F1
	F16	F15	F14	F13	F12	F11	F10	F9
	F24	F23	F22	F21	F20	F19	F18	F17
							F18	F17

TP900 Comfort

Direct keys TP900 Comfort

Inputs	Outputs
5 bytes	--

Direct keys assignment:										LED
	7	6	5	4	3	2	1	0	Byte	
Touch buttons	7	6	5	4	3	2	1	0	n+0	
	15	14	13	12	11	10	9	8	n+1	No output area
	23	22	21	20	19	18	17	16	n+2	
	31	30	29	28	27	26	25	24	n+3	
	39	38	37	36	35	34	33	32	n+4	

KP1200 Comfort

Direct keys KP1200 Comfort

Inputs	Outputs
5 bytes	5 bytes

**Direct keys assignment**

	7	6	5	4	3	2	1	0	Byte
Keys	F8	F7	F6	F5	F4	F3	F2	F1	n+0
	F16	F15	F14	F13	F12	F11	F10	F9	n+1
	F24	F23	F22	F21	F20	F19	F18	F17	n+2
	F32	F31	F30	F29	F28	F27	F26	F25	n+3
							F34	F33	n+4

**LED**

	7	6	5	4	3	2	1	0
	F8	F7	F6	F5	F4	F3	F2	F1
	F16	F15	F14	F13	F12	F11	F10	F9
	F24	F23	F22	F21	F20	F19	F18	F17
	F32	F31	F30	F29	F28	F27	F26	F25
							F34	F33

### TP1200 Comfort

#### Direct keys TP1200 Comfort

Inputs	Outputs
5 bytes	--

Direct keys assignment:									LED	
	7	6	5	4	3	2	1	0	Byte	
Touch buttons	7	6	5	4	3	2	1	0	n+0	No output area
	15	14	13	12	11	10	9	8	n+1	
	23	22	21	20	19	18	17	16	n+2	
	31	30	29	28	27	26	25	24	n+3	
	39	38	37	36	35	34	33	32	n+4	

### KP1500 Comfort

Inputs	Outputs
5 bytes	5 bytes

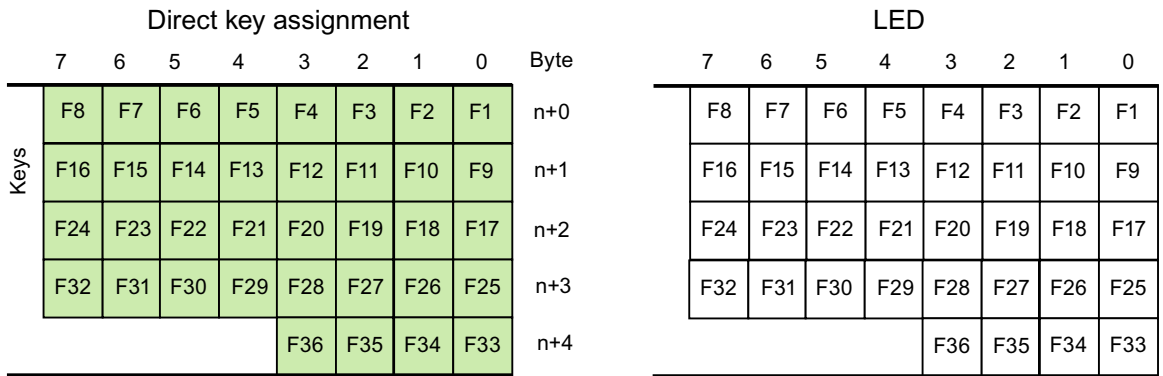

**TP1500, TP1900 and TP2200 Comfort**

Inputs	Outputs
5 bytes	--

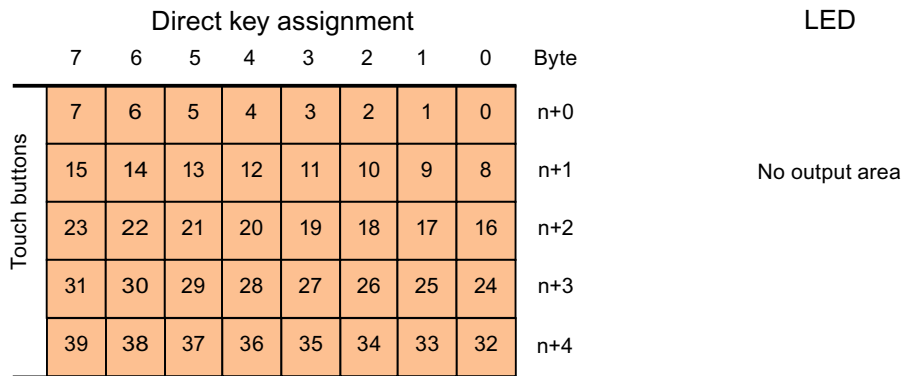

**10.11.11. PROFIBUS DP direct keys**  
5

**PROFIBUS DP direct keys**

**PROFIBUS DP direct keys**

You configure the HMI device created in WinCC as an active communication partner in the automation network.

For the PROFIBUS DP direct keys, also configure the HMI device as a slave in the PROFIBUS DP network.

The following figure shows the basic configuration based on an automation network with an HMI device and a PLC.

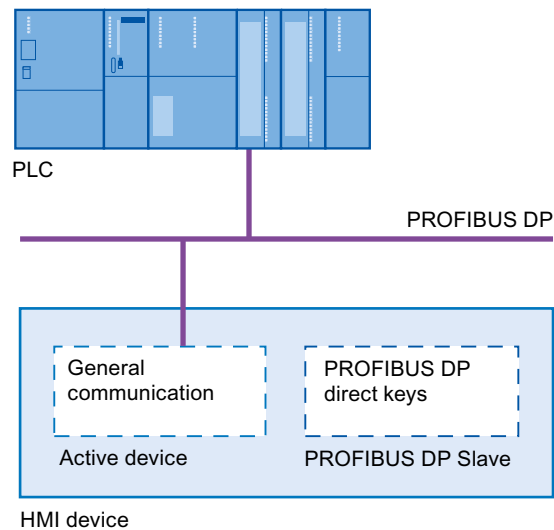

### Mode of operation of the PROFIBUS DP direct keys

With PROFIBUS DP direct keys, when the key or button is pressed, a bit is set in the I/O area of the CPU.

The cycle time of the PROFIBUS DP bus is calculated from the total of all configured inputs and outputs.

The number of configured inputs and outputs can influence the reaction time of the PROFIBUS DP direct key. For a typical configuration the response time of the PROFIBUS DP direct key is < 100 ms.

### HMI devices for the configuration of PROFIBUS DP direct keys

#### HMI devices

You can configure PROFIBUS DP direct keys with the following HMI devices:

HMI device class	HMI device
Panel	OP 77B
	OP 177B
	OP 277 6"
	TP 177B 4"
	TP 177B 6"
	TP 277 6"
Mobile Panel	Mobile Panel 177 DP
	Mobile Panel 277 8"
	Mobile Panel 277 10"

HMI device class	HMI device
Multi Panel	Multi Panel 177 6" Touch
	Multi Panel 277 Key
	Multi Panel 277 Touch
	Multi Panel 377 Key
	Multi Panel 377 Touch
Comfort Panel	KTP400 Comfort
	KP400 Comfort
	KP700 Comfort
	TP700 Comfort
	KP900 Comfort
	TP900 Comfort
	KP1200 Comfort
	TP1200 Comfort
	KP1500 Comfort
	TP1500 Comfort
	TP1900 Comfort
TP2200 Comfort	

## Restrictions for PROFIBUS DP direct keys

### Note

If an external application such as Pocket Internet Explorer or Control Panel is started, it will run in the foreground and Runtime is placed in the background. The bit for the function "DirectKeyScreenNumber" is no longer set and the keys or buttons with the configured function "DirectKey" no longer trigger the associated bit in the PLC.

## Restrictions

- It is not possible to operate PROFIBUS DP direct keys and PROFINET IO direct keys simultaneously.  
Establish the following via the "PROFINET IO enabled" option in the control panel of the HMI device:
  - Option disabled = PROFIBUS DP direct keys enabled
  - Option enabled = PROFINET IO direct keys enabled
- You can operate direct keys only on local HMI devices. On the Sm@rtClient it is possible to operate the key / button for the direct key. However, No bit is set in the I/O area of the CPU.

- The buttons used as direct keys on HMI devices with touch screen functionality may not be modified as follows by means of scripting:
  - Moving
  - Resizing
  - Hiding
  - Disabling for operation
- The LEDs are addressed either via the PROFIBUS DP direct keys or the HMI Runtime application. Avoid concurrent addressing via the PROFIBUS DP direct keys and the HMI Runtime application. The LEDs "ACK", "A-Z I", "A-Z r" and "HELP" are reserved for system functions and cannot be configured. We do not recommend addressing the LEDs "ACK", "A-Z I", "A-Z r" and "HELP" with the PROFIBUS DP direct keys.
- The PROFIBUS direct keys on an HMI device are triggered independent of any configured password protection.

## Inputs and outputs of HMI devices

### Assignment of inputs and outputs

#### Assigning the inputs/outputs

The keys or buttons of the device are assigning bytes in the input area. The LEDs occupy bytes in the DP output area. The following table shows the number of bytes used in the various HMI devices. The precise assignment is shown in the following screens.

The touch panels do not have any permanently assigned keys. They only have user-configurable buttons. Via the direct keys function you can assign to a button a bit in the input area. The counting direction of the bit in the input direction is from right to left. In contrast to the operator panels which have permanently assigned keys, the touch panel buttons can be assigned freely. For more detailed information, refer to the "WinCC flexible - Configuring WinCC Windows-based Systems" user manual.

#### Assigning direct keys to screen numbers (only for touch devices)

If a PROFIBUS DP direct key is using the same bit for different functions in different screens, the S7 must differentiate between the respective functionality by means of the screen number. To combat the delayed updating of the screen number in the PLC after a change of screen you use the "DirectKeyScreenNumber" screen function.

Using the "DirectKeyScreenNumber" you can set within the input area any number of bits in order to identify the screen and simultaneously transfer the direct key bits to the PLC. This ensures unambiguous allocation of a control bit to screen number at all times.

**See also**

- Panel (Page 5266)
- Multi Panel (Page 5269)
- Mobile Panel (Page 5272)
- Comfort Panel (Page 5275)

**Panel**

**OP 77**

**Direct keys OP 77B**

<b>Inputs</b>		<b>Outputs</b>	
4 bytes		4 bytes	

Direct keys assignment								LED									
								Byte	7	6	5	4	3	2	1	0	
Membrane keys					K4	K3	K2	K1	n+0					K4	K3	K2	K1
					F4	F3	F2	F1	n+1								
									n+2								
									n+3								

**OP 177**

**Direct keys OP 177B**

<b>Inputs</b>	<b>Outputs</b>
9 bytes	4 bytes



Direct keys assignment								LED									
								Byte									
									7	6	5	4	3	2	1	0	
Membrane keys	7	6	5	4	3	2	1	0	n+0	F8	F7	F6	F5	F4	F3	F2	F1
									n+1	K2	K1						
									n+2	K10	K9	K8	K7	K6	K5	K4	K3
									n+3	K18	K17	K16	K15	K14	K13	K12	K11
								n+4									
Touch buttons	7	6	5	4	3	2	1	0	n+5								
	15	14	13	12	11	10	9	8	n+6								
	23	22	21	20	19	18	17	16	n+7								
	31	30	29	28	27	26	25	24	n+8								

TP 177

Direct keys TP 177B 4"

Inputs	Outputs
5 bytes	-

Direct key assignment								LED bits									
								Byte									
									7	6	5	4	3	2	1	0	
Membrane keys					F4	F3	F2	F1	n+0								
	7	6	5	4	3	2	1	0	n+1								
Touch buttons	15	14	13	12	11	10	9	8	n+2								
	23	22	21	20	19	18	17	16	n+3								
	31	30	29	28	27	26	25	24	n+4								

Direct keys TP 177B 6"

Inputs	Outputs
4 bytes	--

Direct keys assignment								LED															
								Byte															
								7	6	5	4	3	2	1	0	7	6	5	4	3	2	1	0
Touch buttons	7	6	5	4	3	2	1	0	n+0														
	15	14	13	12	11	10	9	8	n+1	No output area													
	23	22	21	20	19	18	17	16	n+2														
	31	30	29	28	27	26	25	24	n+3														

**OP 277**

**Direct keys OP 277 6"**

Inputs								Outputs															
4 bytes								4 bytes															
Direct keys assignment								LED															
								Byte															
								7	6	5	4	3	2	1	0	7	6	5	4	3	2	1	0
Keys	F8	F7	F6	F5	F4	F3	F2	F1	n+0	F8	F7	F6	F5	F4	F3	F2	F1						
	K2	K1	F14	F13	F12	F11	F10	F9	n+1	K2	K1												
	K10	K9	K8	K7	K6	K5	K4	K3	n+2	K10	K9	K8	K7	K6	K5	K4	K3						
	ACK	ALT	CTRL	SHIFT					n+3	ACK	A-Z left	A-Z right	HELP										

**TP 277**

**Direct keys TP 277 6"**

Inputs				Outputs			
4 bytes				-			

Direct keys assignment								Byte	LED	
	7	6	5	4	3	2	1	0		
Touch buttons	7	6	5	4	3	2	1	0	n+0	No output area
	15	14	13	12	11	10	9	8	n+1	
	23	22	21	20	19	18	17	16	n+2	
	31	30	29	28	27	26	25	24	n+3	

## Multi Panel

### Multi Panel 177

#### Direct keys Multi Panel 177 6" Touch

Inputs	Outputs
4 bytes	-

Direct keys assignment								Byte	LED	
	7	6	5	4	3	2	1	0		
Touch buttons	7	6	5	4	3	2	1	0	n+0	No output area
	15	14	13	12	11	10	9	8	n+1	
	23	22	21	20	19	18	17	16	n+2	
	31	30	29	28	27	26	25	24	n+3	

## Multi Panel 277

#### Direct keys Multi Panel 277 8" Key

Inputs	Outputs
5 bytes	5 bytes

Direct keys assignment								LED									
								Byte	7	6	5	4	3	2	1	0	
Keys	7	6	5	4	3	2	1	0	n+0	F8	F7	F6	F5	F4	F3	F2	F1
									n+1							F10	F9
									n+2	K4	K3	K2	K1				
									n+3					K8	K7	K6	K5
									n+4	ACK	A-Z left	A-Z right	HELP				

### Direct keys Multi Panel 277 10" Key

Inputs	Outputs
5 bytes	5 bytes

Direct keys assignment								LED									
								Byte	7	6	5	4	3	2	1	0	
Keys	7	6	5	4	3	2	1	0	n+0	F8	F7	F6	F5	F4	F3	F2	F1
									n+1					F12	F11	F10	F9
									n+2	K4	K3	K2	K1				
									n+3	K12	K11	K10	K9	K8	K7	K6	K5
									n+4	ACK	A-Z left	A-Z right	HELP	K16	K15	K14	K13

### Direct keys Multi Panel 277 8" Touch

Inputs	Outputs
5 bytes	-

Direct keys assignment								Byte	LED	
	7	6	5	4	3	2	1	0		
Touch buttons	7	6	5	4	3	2	1	0	n+0	No output area
	15	14	13	12	11	10	9	8	n+1	
	23	22	21	20	19	18	17	16	n+2	
	31	30	29	28	27	26	25	24	n+3	
	39	38	37	36	35	34	33	32	n+4	

### Direct keys Multi Panel 277 10" Touch

Inputs	Outputs
5 bytes	-

Direct keys assignment								Byte	LED	
	7	6	5	4	3	2	1	0		
Touch buttons	7	6	5	4	3	2	1	0	n+0	No output area
	15	14	13	12	11	10	9	8	n+1	
	23	22	21	20	19	18	17	16	n+2	
	31	30	29	28	27	26	25	24	n+3	
	39	38	37	36	35	34	33	32	n+4	

### Multi Panel 377

#### Direct keys Multi Panel 377 Key

Inputs	Outputs
5 bytes	5 bytes

Direct keys assignment								LED									
								Byte									
									7	6	5	4	3	2	1	0	
Keys	7	6	5	4	3	2	1	0	n+0	S8	S7	S6	S5	S4	S3	S2	S1
									n+1	S16	S15	S14	S13	S12	S11	S10	S9
									n+2	F8	F7	F6	F5	F4	F3	F2	F1
									n+3	F16	F15	F14	F13	F12	F11	F10	F9
									n+4	ACK	ALT	CTRL	SHIFT	F20	F19	F18	F17

### Multi Panel 377 Touch

Inputs	Outputs
5 bytes	–

Direct keys assignment								LED									
								Byte									
									7	6	5	4	3	2	1	0	
Touch buttons	7	6	5	4	3	2	1	0	n+0								
									n+1								
									n+2								
									n+3								
									n+4								

No output area

### Mobile Panel

### Mobile Panel 177

### Direct keys Mobile Panel 177 DP

Inputs	Outputs
9 bytes	4 bytes

Direct keys assignment								LED-Bits									
	7	6	5	4	3	2	1	0	Byte	7	6	5	4	3	2	1	0
Membrane keys	F8	F7	F6	F5	F4	F3	F2	F1	n+0	F8	F7	F6	F5	F4	F3	F2	F1
			F14	F13	F12	F11	F10	F9	n+1								T1
optional operator controls						T1	S1	S0	n+2								
	I7	I6	I5	I4	I3	I2	I1	I0	n+3								
	D7	D6	D5	D4	D3	D2	D1	D0	n+4								
Touch buttons	7	6	5	4	3	2	1	0	n+5								
	15	14	13	12	11	10	9	8	n+6								
	23	22	21	20	19	18	17	16	n+7								
	31	30	29	28	27	26	25	24	n+8								

S0-S1: Key-operated switch  
T1: Illuminated pushbutton 1  
I0-I7: Handwheel pulses (forwards)  
D0-D7: Handwheel pulses (backwards)

Mobile Panel 277

Direct keys Mobile Panel 277 8"

HMI device	Inputs	Outputs
Mobile Panel 277 8"	10 bytes	4 bytes

Direct keys assignment								LED-Bits									
	7	6	5	4	3	2	1	0	Byte	7	6	5	4	3	2	1	0
Membrane keys	F8	F7	F6	F5	F4	F3	F2	F1	n+0	F8	F7	F6	F5	F4	F3	F2	F1
	F16	F15	F14	F13	F12	F11	F10	F9	n+1	F16	F15	F14	F13	F12	F11	F10	F9
optional operator controls							F18	F17	n+2							F18	F17
				T2		T1	S1	S0	n+3						T2	T1	
optional operator controls	I7	I6	I5	I4	I3	I2	I1	I0	n+4								
	D7	D6	D5	D4	D3	D2	D1	D0	n+5								
Touch buttons	7	6	5	4	3	2	1	0	n+6								
	15	14	13	12	11	10	9	8	n+7								
	23	22	21	20	19	18	17	16	n+8								
	31	30	29	28	27	26	25	24	n+9								

S0-S1: Key-operated switch  
 T1: Illuminated pushbutton 1  
 T2: Illuminated pushbutton 2  
 I0-I7: Handwheel pulses (forwards)  
 D0-D7: Handwheel pulses (backwards)

Direct keys Mobile Panel 277 10"

HMI device	Inputs	Outputs
Mobile Panel 277 10"	5 bytes	--

Direct keys assignment								LED									
	7	6	5	4	3	2	1	0	Byte	No output area							
Touch buttons	7	6	5	4	3	2	1	0	n+0								
	15	14	13	12	11	10	9	8	n+1								
	23	22	21	20	19	18	17	16	n+2								
	31	30	29	28	27	26	25	24	n+3								
	39	38	37	36	35	34	33	32	n+4								



## Mobile Panel 277 IWLAN V2

### Direct keys Mobile Panel 277 IWLAN V2

The assignment of the inputs and outputs of the direct keys applies to the following HMI devices:

- Mobile Panel 277 IWLAN V2
- Mobile Panel 277F IWLAN V2
- Mobile Panel 277 IWLAN V2 (RFID tags)

Inputs	Outputs
10 bytes	4 bytes

Direct keys assignment								LED-Bits									
	7	6	5	4	3	2	1	0	Byte	7	6	5	4	3	2	1	0
Membrane keys	F8	F7	F6	F5	F4	F3	F2	F1	n+0	F8	F7	F6	F5	F4	F3	F2	F1
	F16	F15	F14	F13	F12	F11	F10	F9	n+1	F16	F15	F14	F13	F12	F11	F10	F9
optional operator controls							F18	F17	n+2							F18	F17
				T2		T1	S1	S0	n+3						T2	T1	
Touch buttons	I7	I6	I5	I4	I3	I2	I1	I0	n+4								
	D7	D6	D5	D4	D3	D2	D1	D0	n+5								
	7	6	5	4	3	2	1	0	n+6								
	15	14	13	12	11	10	9	8	n+7								
	23	22	21	20	19	18	17	16	n+8								
	31	30	29	28	27	26	25	24	n+9								

S0-S1: Key-operated switch  
 T1: Illuminated pushbutton 1  
 T2: Illuminated pushbutton 2  
 I0-I7: Handwheel pulses (forwards)  
 D0-D7: Handwheel pulses (backwards)

## Comfort Panel

### KTP400 Comfort

#### Direct keys KTP400 Comfort

HMI device	Inputs	Outputs
Touch operation	4 bytes	-

10.11 Communicating with PLCs

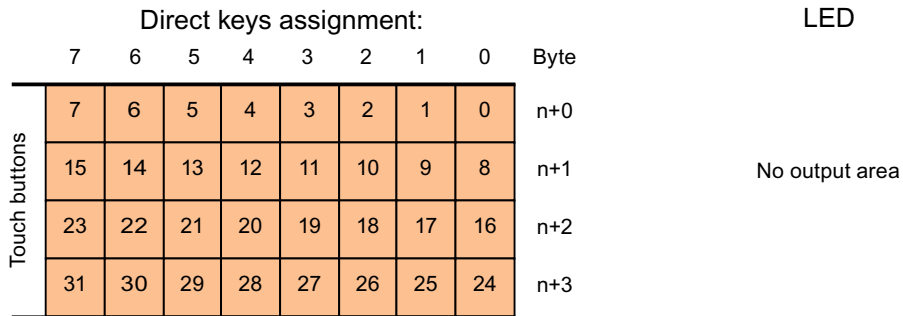

HMI device	Inputs	Outputs
Key operation	1 byte	1 byte

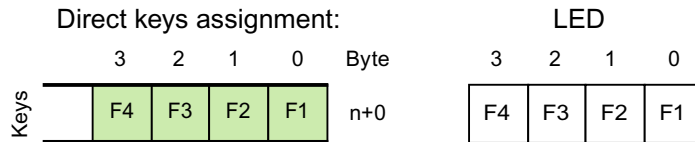

KP400 Comfort

Direct keys KP400 Comfort

Inputs	Outputs
1 byte	1 byte

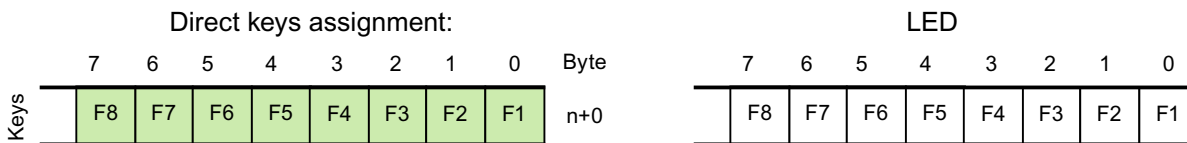

## KP700 Comfort

### Direct keys KP700 Comfort

Inputs	Outputs
3 bytes	3 bytes

#### Direct keys assignment:

	7	6	5	4	3	2	1	0	Byte
Keys	F8	F7	F6	F5	F4	F3	F2	F1	n+0
	F16	F15	F14	F13	F12	F11	F10	F9	n+1
	F24	F23	F22	F21	F20	F19	F18	F17	n+2

#### LED

	7	6	5	4	3	2	1	0
F8	F7	F6	F5	F4	F3	F2	F1	
F16	F15	F14	F13	F12	F11	F10	F9	
F24	F23	F22	F21	F20	F19	F18	F17	

## TP700 Comfort

### Direct keys TP700 Comfort

Inputs	Outputs
4 bytes	--

#### Direct keys assignment:

	7	6	5	4	3	2	1	0	Byte
Touch buttons	7	6	5	4	3	2	1	0	n+0
	15	14	13	12	11	10	9	8	n+1
	23	22	21	20	19	18	17	16	n+2
	31	30	29	28	27	26	25	24	n+3

#### LED

No output area

## KP900 Comfort

### Direct keys KP900 Comfort

Inputs	Outputs
4 bytes	4 bytes

10.11 Communicating with PLCs

Direct keys assignment:

		7	6	5	4	3	2	1	0	Byte
Keys		F8	F7	F6	F5	F4	F3	F2	F1	n+0
		F16	F15	F14	F13	F12	F11	F10	F9	n+1
		F24	F23	F22	F21	F20	F19	F18	F17	n+2
									F26	F25

LED

		7	6	5	4	3	2	1	0	
		F8	F7	F6	F5	F4	F3	F2	F1	
		F16	F15	F14	F13	F12	F11	F10	F9	
		F24	F23	F22	F21	F20	F19	F18	F17	
									F18	F17

TP900 Comfort

Direct keys TP900 Comfort

Inputs	Outputs
5 bytes	--

		Direct keys assignment:								LED		
		7	6	5	4	3	2	1	0	Byte		
Touch buttons		7	6	5	4	3	2	1	0	n+0		
		15	14	13	12	11	10	9	8	n+1	No output area	
		23	22	21	20	19	18	17	16	n+2		
		31	30	29	28	27	26	25	24	n+3		
		39	38	37	36	35	34	33	32	n+4		

KP1200 Comfort

Direct keys KP1200 Comfort

Inputs	Outputs
5 bytes	5 bytes

**Direct keys assignment**

		7	6	5	4	3	2	1	0	Byte
Keys		F8	F7	F6	F5	F4	F3	F2	F1	n+0
		F16	F15	F14	F13	F12	F11	F10	F9	n+1
		F24	F23	F22	F21	F20	F19	F18	F17	n+2
		F32	F31	F30	F29	F28	F27	F26	F25	n+3
								F34	F33	n+4

**LED**

		7	6	5	4	3	2	1	0
	F8	F7	F6	F5	F4	F3	F2	F1	
	F16	F15	F14	F13	F12	F11	F10	F9	
	F24	F23	F22	F21	F20	F19	F18	F17	
	F32	F31	F30	F29	F28	F27	F26	F25	
								F34	F33

### TP1200 Comfort

#### Direct keys TP1200 Comfort

Inputs	Outputs
5 bytes	--

		Direct keys assignment:								LED		
		7	6	5	4	3	2	1	0	Byte		
Touch buttons		7	6	5	4	3	2	1	0	n+0	No output area	
		15	14	13	12	11	10	9	8	n+1		
		23	22	21	20	19	18	17	16	n+2		
		31	30	29	28	27	26	25	24	n+3		
		39	38	37	36	35	34	33	32	n+4		

### KP1500 Comfort

Inputs	Outputs
5 bytes	5 bytes

10.11 Communicating with PLCs

Direct key assignment								LED										
	7	6	5	4	3	2	1	0	Byte		7	6	5	4	3	2	1	0
Keys	F8	F7	F6	F5	F4	F3	F2	F1	n+0	F8	F7	F6	F5	F4	F3	F2	F1	
	F16	F15	F14	F13	F12	F11	F10	F9	n+1	F16	F15	F14	F13	F12	F11	F10	F9	
	F24	F23	F22	F21	F20	F19	F18	F17	n+2	F24	F23	F22	F21	F20	F19	F18	F17	
	F32	F31	F30	F29	F28	F27	F26	F25	n+3	F32	F31	F30	F29	F28	F27	F26	F25	
				F36	F35	F34	F33	n+4					F36	F35	F34	F33		

TP1500, TP1900 and TP2200 Comfort

Inputs	Outputs
5 bytes	--

Direct key assignment								LED										
	7	6	5	4	3	2	1	0	Byte		7	6	5	4	3	2	1	0
Touch buttons	7	6	5	4	3	2	1	0	n+0									
	15	14	13	12	11	10	9	8	n+1	No output area								
	23	22	21	20	19	18	17	16	n+2									
	31	30	29	28	27	26	25	24	n+3									
	39	38	37	36	35	34	33	32	n+4									

10.11.12 Communication via SIMATIC HMI HTTP

10.11.12. Basic information on SIMATIC HMI HTTP

1

Introduction

You use the SIMATIC HMI HTTP Protocol for data exchange between HMI devices.  
 The SIMATIC HMI HTTP Protocol is not suited for exchange of bulk data.  
 Data exchange occurs according to the Request-Response method. The HTTP client sends its request to the HTTP server, which processes it and returns a response.  
 A device can be configured as an HTTP client and HTTP server simultaneously.  
 The client and server establish a connection via the Ethernet interface for data exchange.

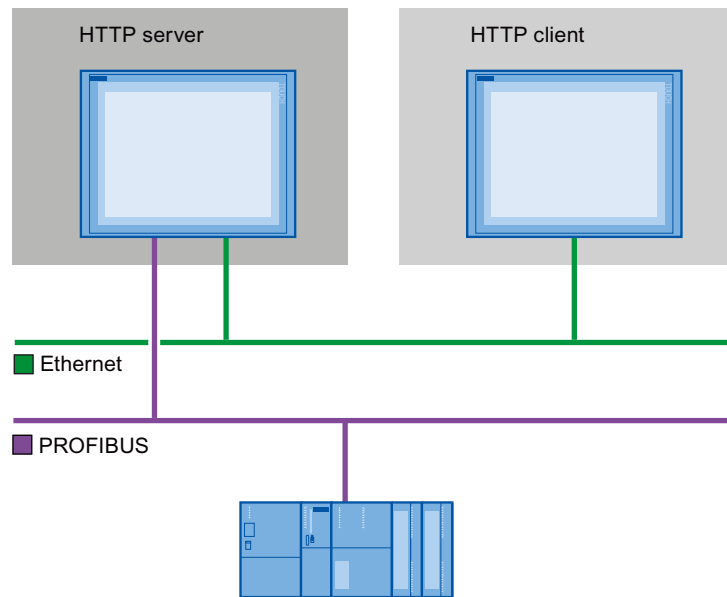

## HTTP components

The components of the SIMATIC HMI HTTP Protocol are transferred to the HMI device in "Load to device".

HTTP components are:

- HTTP server
- HTTP client

If you use a Standard-PC or SIMATIC IPC, you must install WinCC RT Advanced or WinCC RT Professional first.

## SMTP protocol

The SMTP protocol is not a requirement for communication via SIMATIC HMI HTTP Protocol .

## HTTP / HTTPS

The SIMATIC HMI HTTP Protocol offers two standards:

- HTTP  
Is implemented in local networks for a fast, uncoded transfer of uncritical data.
- HTTPS  
Enables a reliable HTTP connection between devices. Initially there is an exchange of secret keys. Then, in a further step, the respective public keys can be securely exchanged in the form of digital certificates. The public keys are used to encode the utility data in order to guarantee a bug-proof communication.

---

### Note

Due to the encryption, the HTTPS protocol has a lower transmission performance than the HTTP protocol.

---



### CAUTION

End users are responsible for the security of their own networks.

### 10.11.12. Configuring a connection via SIMATIC HMI HTTP

2

#### Configuring a connection via SIMATIC HMI HTTP

#### Communication between HMI devices via SIMATIC HMI HTTP protocol

Several steps are needed to configure communication between HMI devices via the SIMATIC HMI HTTP protocol:

1. Configure HMI device as a server.
2. Configure HMI device as a client.
3. Assign tag parameters in the client.
4. Commission connection.

#### Access to tags via SIMATIC HMI HTTP protocol

If access to tags via the SIMATIC HMI HTTP protocol is to be enabled, these tags must be defined for the relevant HMI devices and interconnected.



## Configuring an HMI device as a server

### Configuring a server

#### Requirements

- The HTTP communication channel must be set in the Control Panel of the HMI device.

#### Procedure

1. Double-click the HMI device under "Devices" in the project tree.
2. Double-click "Runtime settings".  
The "Runtime settings" editor opens.
3. Click "Services".
4. Select the "HTTP channel server" option.

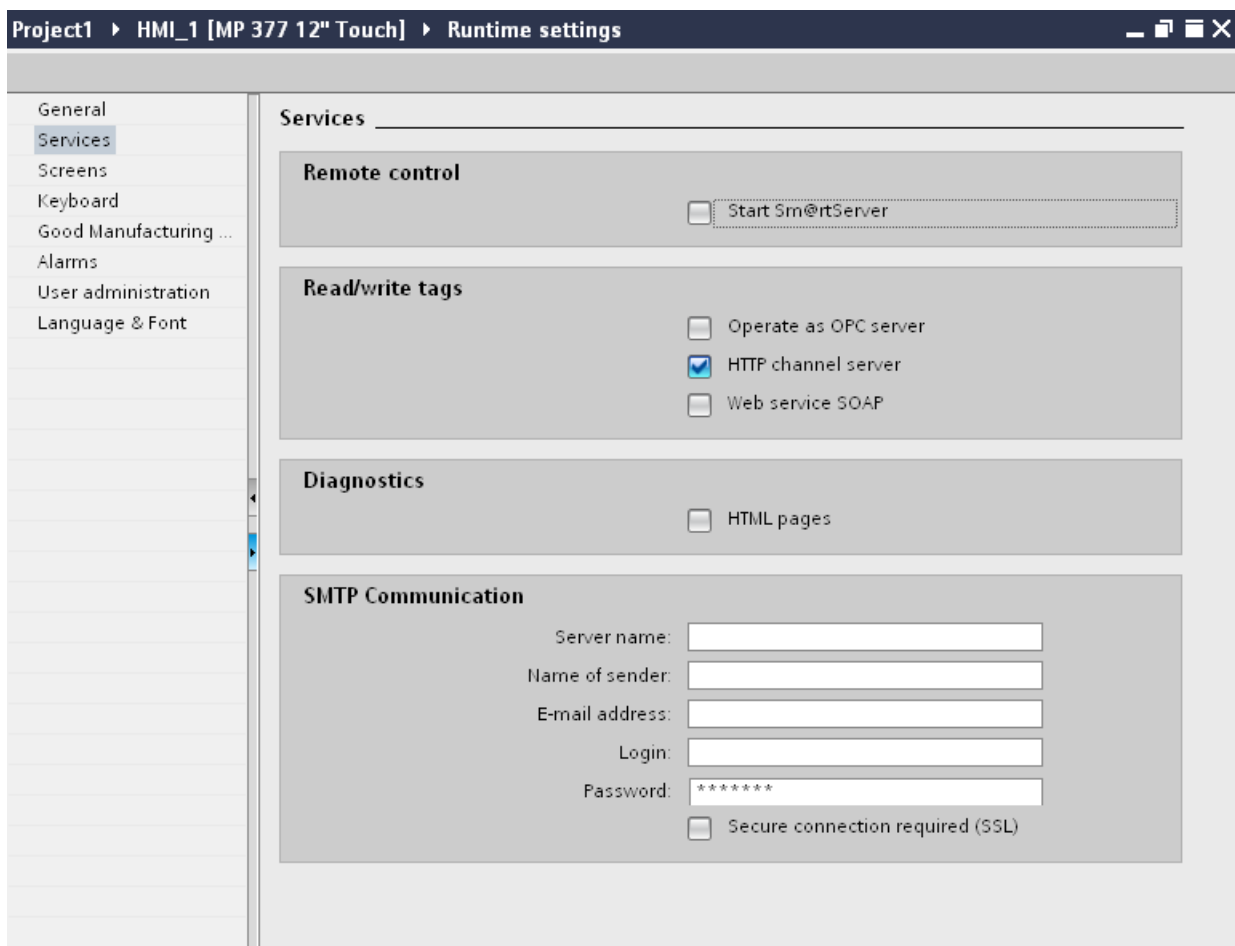

If you use the SMTP protocol, you assign the following values under "SMTP settings" according to your project specifications:

- Server name
- Login
- Password

## Result

The HMI device has been configured as a server.

## Tags in the server

## Tags used

The client can use the HTTP protocol for read and write access to tags configured on the server in runtime. This means that it is not necessary to configure additional tags for an HTTP communication.

However, the following aspects must be taken into account to ensure correct data exchange:

- The data type of the server tags must match the data type in the client.
- The tag name configured in the HTTP server must be identical to the name of the address tag of the HTTP client.

## Configuring an HMI device as a client

## Configuring a client

## Requirements

- The HTTP communication channel must be set in the Control Panel of the HMI device.
- An HMI device has been configured as a server.

## Procedure

1. Double-click the HMI device under "Devices" in the project tree.
2. Double-click the "Connections" item.
3. Double-click "<Add>" in the "Connections" editor.
4. In the "Communication drivers" column, select the "SIMATIC HMI HTTP Protocol" driver.

Connections						
	Name	Communication driver	HMI time synchronization mode	Station	Partner	Node
	Connection_2	SIMATIC HMI HTTP				
	<Add new>					

5. Select all necessary connection parameters for the interface in the Inspector window under "Parameters".
6. Set the parameters in the Property window.  
See "Setting parameters for the client" for more information about the parameters.

## Setting parameters for the client

### Requirements

- Connection has been created via SIMATIC HMI HTTP protocol.
- "Connections" editor is open.

### Procedure

1. Select "Ethernet" in the Inspector window under "Parameters > Interface".
2. Select protocol http:// or https://.
3. Enter the name of the server or its IP address.

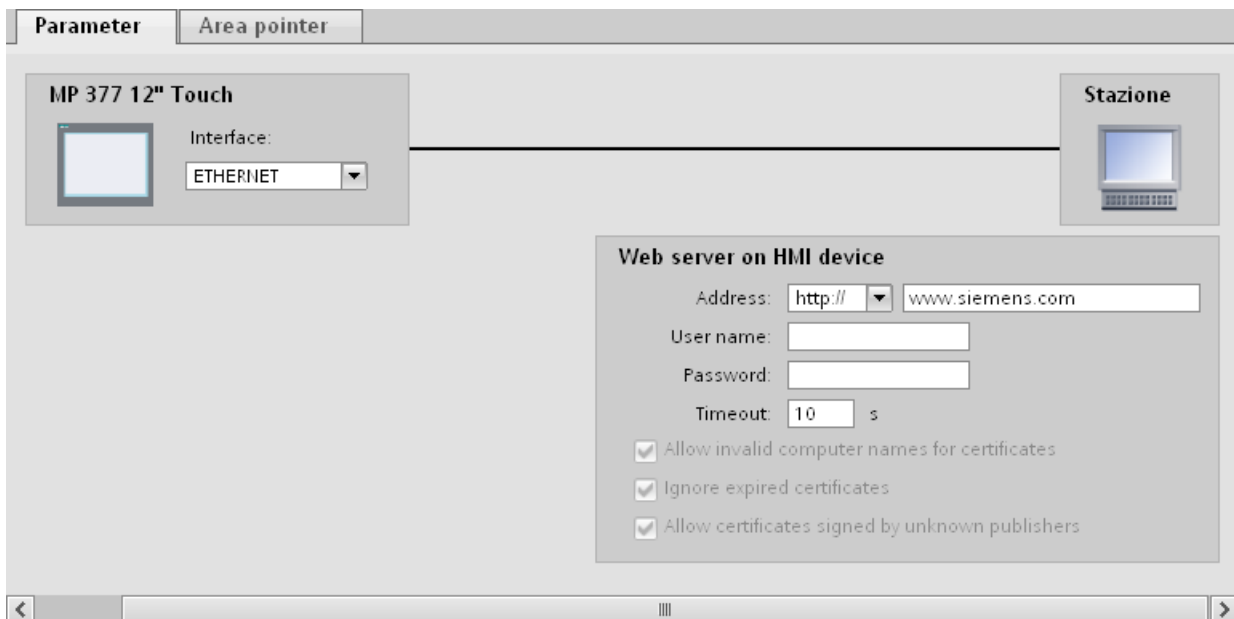

### User name and password

If the "Authentication required" check box was selected in the server in the "Control Panel > WinCC Internet Settings > Web Server" dialog, a user name and password must be entered here in the client.

### Timeout

Assign a time after which a connection break is recognized.

## HTTPS protocol

If the HTTPS protocol is selected, with the following settings you can establish how the HTTPS client should check the properties of the server certificate and how it should react in the event of error:

- "Allow invalid computer names for certificates"
- "Allow expired certificates"
- "Allow certificates signed by unknown publishers"

## Reading out an IP address

If the server has already been commissioned, you can read out the IP address on the server as well:

- For Panel  
Click "Start > Programs > Command Prompt" on the server and enter the "ipconfig" command using the screen keyboard. The IP address is displayed after pressing <Ret>.
- For PC / Panel PC  
Click "Start > Run" on the server, enter "Cmd", and press <Ret>: The command interpreter is displayed. Enter the "ipconfig" command. The IP address is displayed after pressing <Ret>.

## Assigning tag parameters in the client

## Assigning tag parameters in the client

### Introduction

In order to be able to access tags on the server, they must be configured in the client as tag addresses.

### Requirements

- Tags have been created in the "HMI tags" editor of the server.

### Procedure

1. Double-click the client under "Devices" in the project tree.
2. Double-click "HMI tags".
3. Create a new tag.
4. Select a data type.

5. Open the selection dialog in the "Addresses" column.

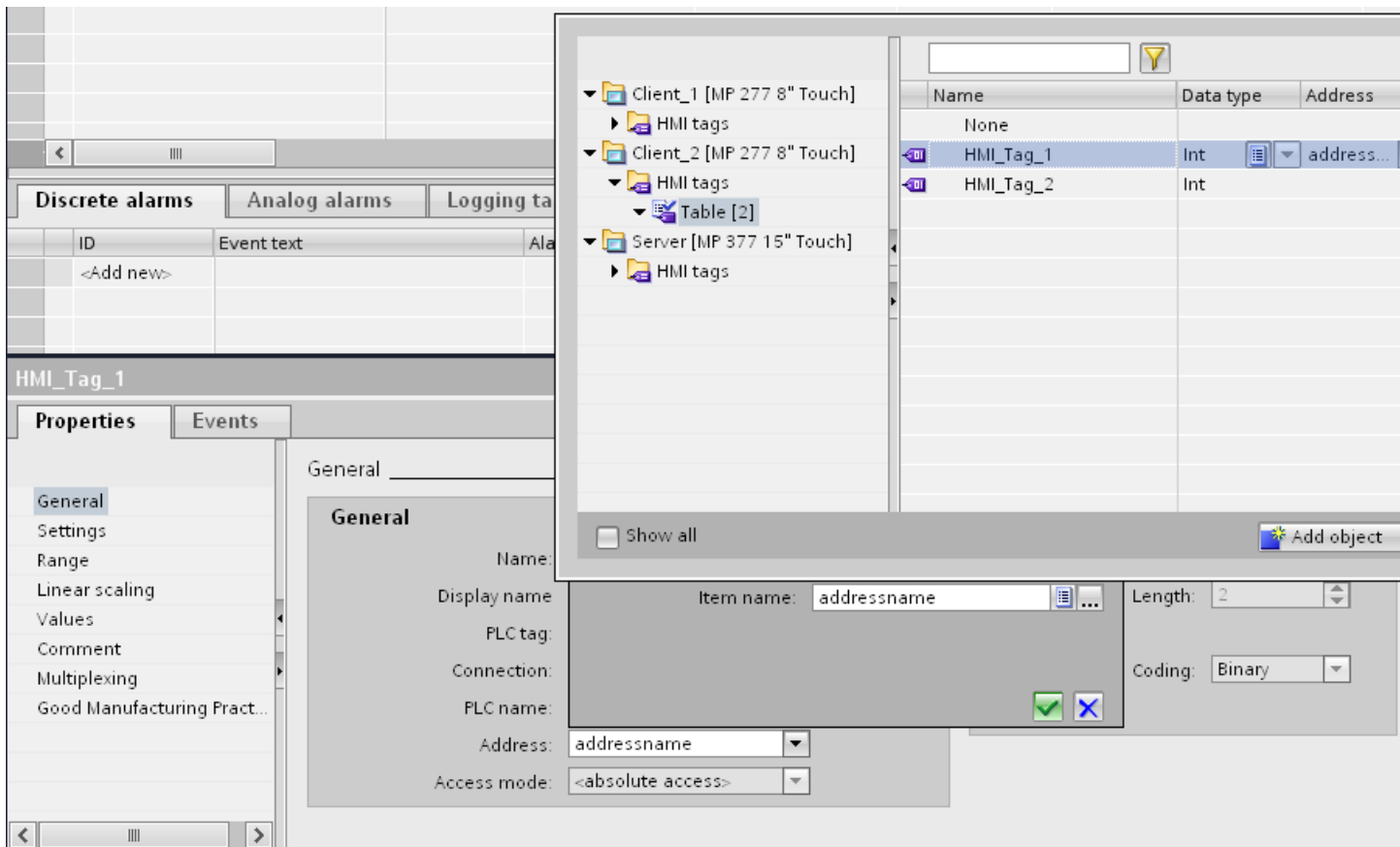

6. Define the parameters in the working area:  
See "Parameters for the client tags" for more information about the parameters.

## Parameters for the tags of the client

### Parameters for the tags

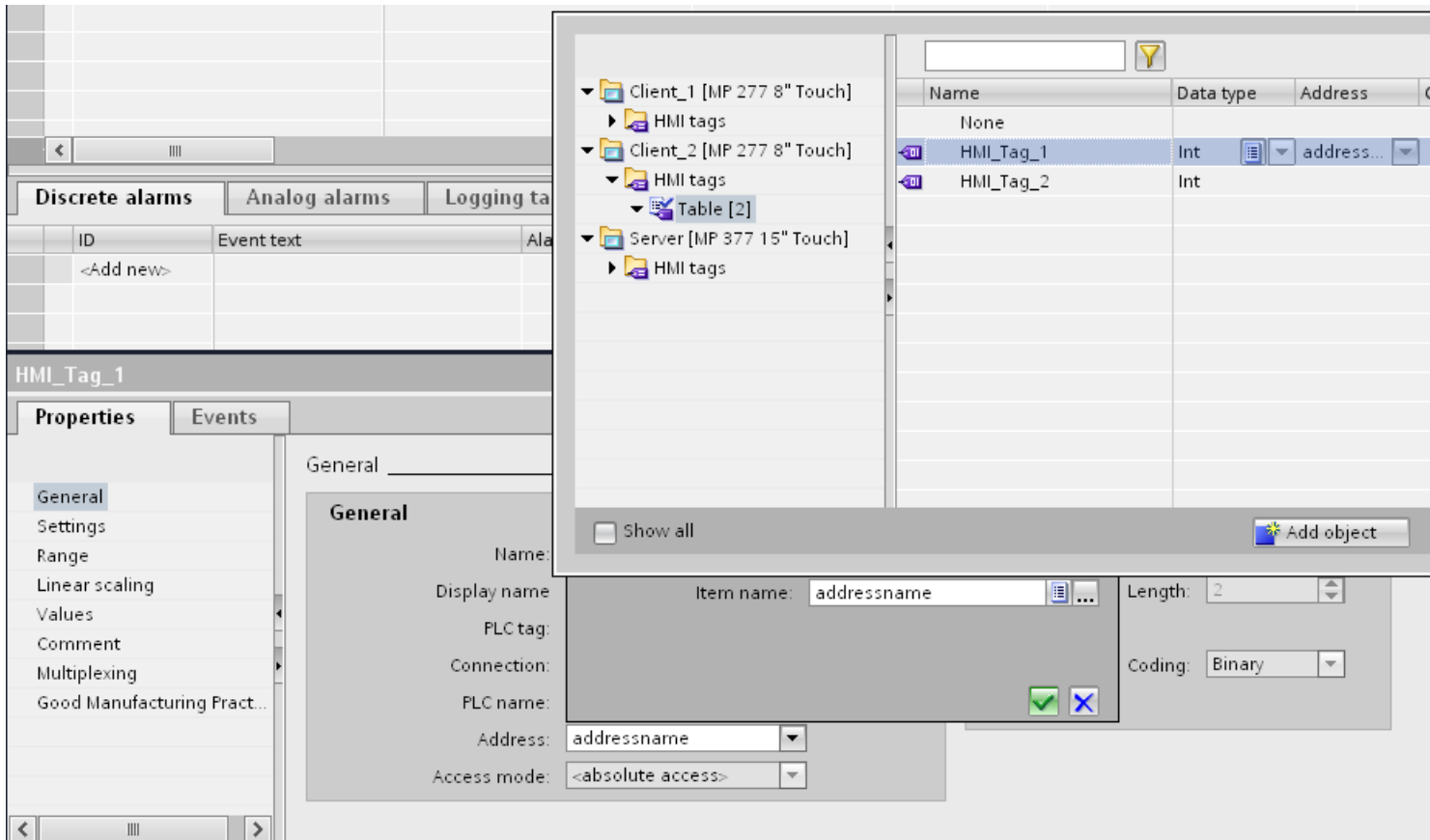

### Data type

- The client does not check the data type. Therefore, pay attention that the data type selected here matches the data type of the tags on the server.
- Array tags are not permitted.

### Addressing

If the server and client are not within the same project, note the following:

- Enter the exact name of the tag that is to be communicated with on the server.

## Commissioning a connection

### Setting the server's Internet Settings

#### Introduction

To commission an HTTP/HTTPS connection, the WinCC Internet Settings must be set up in the Control Panel of both the server and client, in addition to the configuration in WinCC.

The name and number of tabs contained in the "WinCC Internet Settings" dialog depend on the software installed.

Only the required tabs with the MP 277 HMI device as an example are shown below.

#### WinCC Internet Settings, Proxy tab

The valid network settings are specified by the network administrator.

Make the following settings:

- Internet settings for HMI devices with Windows CE
  - In this case, there are several options for calling the Control Panel:
    - In the startup phase, click on the "Control Panel" button in the Windows CE Loader menu.
    - Select "Start > Settings > Control Panel" in the toolbar.
    - During normal operation, pressing the key combination <CTRL + ESC> opens the toolbar. Start the Control Panel by selecting "Start > Settings > Control Panel".
    - Using the RT function "OpenControlPanel"

The language in the Windows CE based devices is always English.

#### WinCC Internet Settings, Web Server tab

Settings for using the integrated Web Server are made in this tab.

The "Web Server" tab is only available in the WinCC Internet Settings if the Web Server is installed on the HMI device.

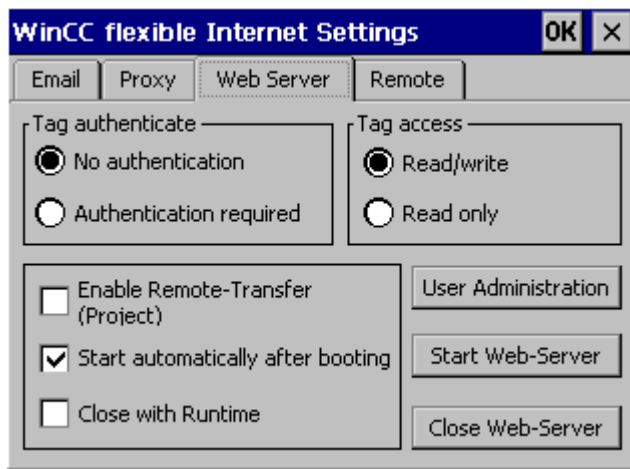

- Tag authenticate  
Controls authentication for tag access:
  - "No authentication": Authentication (user name password) is not required for access.
  - "Authentication required": Authentication (user name password) is required for access. The user name and password for the client are specified during configuration.
- Tag access  
Controls access to tags:
  - "Read/write": Tags can be read and rewritten.
  - "Read only": Tags can only be read.
- Group for defining operational performance  
The following check boxes are not selected in conjunction with tag exchange via the HTTP/HTTPS protocol:
  - Enable remote transfer (project)  
Select this check box to enable an HTTP transfer from the configuration computer to the HMI device.
  - Start automatically after booting  
Specifies when the HTTP server should be started:  
Enabled: The HTTP server starts immediately after the HMI device is booted, irrespective of the runtime software  
Disabled: The HTTP server starts at the same time as the runtime software.
  - Close with Runtime  
Enabling this check box causes the HTTP server to be closed at the same time as the runtime software.



- User Administration  
This button opens the "UserDatabase-Edit" dialog box.

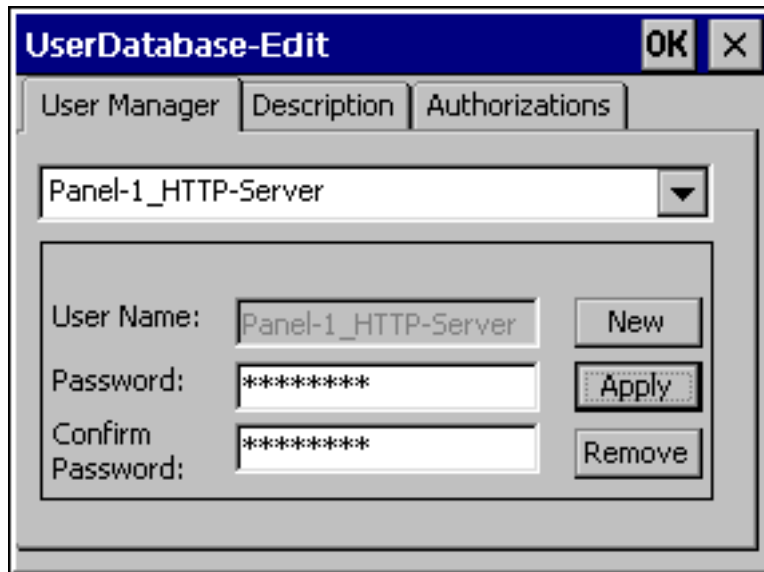

In the "User Manager" tab of this dialog box, you can select, delete, or create a new user. The "Description" and "Authorizations" tabs always apply to the user currently selected. (This example dialog box shows a user with the name 'Panel-1\_HTTP-Server'.)

- User Manager  
"Administrator" is the default user name, and "100" is the default password setting. If a user name and password have been entered for the HTTP server under "Connections" in your WinCC project, the same user name and password must be specified on the server.

- Description  
Enables input of a user description.
- Authorizations  
The newly set up user must be assigned the authorizations for "RT Communication on the "Authorizations" tab control.

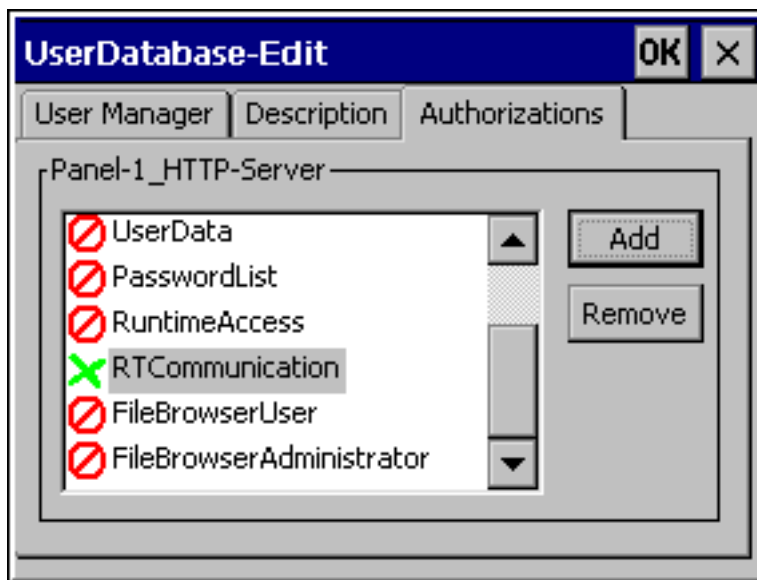

## Establishing an HTTP connection

### Introduction

To establish an HTTP connection, you must perform the following actions:

- In the "Connections" editor of WinCC, configure the connection as an "https://" protocol type and define how the HTTPS client should verify the properties of the server certificate and respond to errors.
- Install a valid certificate on the HTTPS client.  
Certificates are necessary for server authentication. Using certificates you can ensure that the server with which the connection is to be developed is actually the server for which it is outputting.

### Principle of an HTTPS connection

After runtime start, the HTTPS client establishes a connection to the HTTPS server. The HTTPS server presents its certificate, which the client verifies for authenticity. The session

code that can only be read by the HTTPS server is then transmitted. The session code is now available on both sides and enables a symmetrical data encryption.

#### Note

The certificate contains the current time. The current time can lead to problems if the time zones of the server and client are different. For example, a certificate generated on a server with an Asian time zone only becomes valid on a client with European time zone in the future (8 hours).

### Preparation for installing a certificate on the client

With the first HTTPS client access, the HTTPS server generates the certificate itself and then saves it in the "Cert.cer" memory. The file is stored in the following directory:

- On a PC/panel PC (with Windows XP) in the directory "..\\Siemens\\Automation\\WinCC Runtime Advanced\\SystemRoot\\SSL"
- On Windows CE-based devices in the directory "Flash\\Simatic\\SystemRoot\\SSL"  
The certificate must be stored on the HTTPS client on a storage medium from which it can be launched with a double click.

Server	Client	Possible file transfer
with Windows XP (PC, Panel PC)	with Windows XP (PC, Panel PC)	<ul style="list-style-type: none"> <li>• Disk</li> <li>• USB stick</li> <li>• LAN (Ethernet)</li> <li>• Internet Explorer (via TCP/IP, if Service is already running)</li> </ul>
With Windows CE (xP 270, xP 277, MP 370, MP 377, xP 177B, Mobile Panel 177 PN, Mobile Panel 277, Comfort Panels)	with Windows XP (PC, Panel PC)	<ul style="list-style-type: none"> <li>• Memory card</li> <li>• ActiveSync (serial)</li> </ul>
with Windows XP (PC, Panel PC)	With Windows CE (xP 270, xP 277, MP 370, MP 377, xP 177B, Mobile Panel 177 PN, Mobile Panel 277, Comfort Panels)	
With Windows CE (xP 270, xP 277, MP 370, MP 377, xP 177B, Mobile Panel 177 PN, Mobile Panel 277, Comfort Panels)	With Windows CE (xP 270, xP 277, MP 370, MP 377, xP 177B, Mobile Panel 177 PN, Mobile Panel 277, Comfort Panels)	<ul style="list-style-type: none"> <li>• Memory card</li> </ul>

### Installing a certificate on a client with Windows XP

Insert the storage medium on which you have saved the "Cert.cer" file into the HTTPS client or open the directory in which the file is located. Double click on the file and follow the instructions in the Windows dialog.

Tip: The Internet Explorer provides an easy way to install a certificate. Connect to this device via HTTPS (e.g.: `https://<my device>`). The browser establishes if a certificate has not yet been imported. In this case, the browser asks if you want to install the certificate. Any errors in the certificate will be displayed.

### Installing a certificate on a client with Windows CE

Insert the memory card on which you have saved the converted "Cert.cer" file into the HTTPS client. WinCC provides the "InstallCert.exe" tool for importing certificates with Windows CE.

You can implement the installation as follows:

- In Explorer:  
Double click the "Cert.cer" file to install the certificate.
- At the command prompt:  
Enter "InstallCert /[command parameter] [filename]".
  - command parameters:  
/r parameter must be specified because the certificate used in WinCC Runtime is a root certificate.  
A root certificate is the main certificate and is used to verify the authenticity of all other certificates transferred.
  - filename  
You must specify the certificate file with its complete path (e.g. "\\Storage Card\Cert.cer")

A status alarm is output when you completed the installation. Runtime has to be restarted after the installation of a certificate on Windows CE- HMI devices with HTTPS clients. It is necessary to restart Runtime so that an HTTPS connection can be established.

### The file "Cert.cer" cannot be opened.

The "Cert.cer" file generated at the HTTPS server cannot be opened on HMI devices based on Windows CE 5.0 by double-clicking the client.

1. Open the Control Panel.
2. Select "Certificates > My Certificates."
3. Click the "Import" button.  
A dialog box opens.
4. Select the "From a File" menu in the file browser and select the "Cert.cer" file.

## 10.11.12. Performance features of communication

## 3

## Permitted data types

## Permitted data types

When configuring tags, the data types listed below can be used.

Data type in the SIMATIC HMI HTTP protocol	Length	Sign	Range of values
Bool	0	No	true (-1) or false (0)
SInt	1 Byte	Yes	-128 to 127
USint	1 Byte	No	0 to 255
Int	2 Byte	Yes	-32768 to 32767
UInt	2 Byte	No	0 to 65535
DInt	4 Byte	Yes	-2,147,483,648 to 2,147,483,647
UDInt	4 Byte	No	0 to 4,294,967,295
Real	4 Byte	Yes	-3.402823E38 to -1.401298E-45 for negative values and 1.401298E-45 to 3.402823E38 for positive values
LReal	8 Byte	Yes	-1.79769313486231E308 to -4.94065645841247E-324 for negative values and 4.94065645841247E-324 to 1.79769313486232E308 for positive values
String	1 to 255 byte	—	
DateTime	8 Byte	—	1.1.1970 00:00:00 up to 31.12.2037 23:59:59

**Note****Data types for third-party PLCs**

Data types in third-party PLCs may differ from those in WinCC.

Note the the tag definition of the third-party PLC for the correct assignment.

**Note**

It is not possible to access array tags from an HTTP client.

Multiplex tags are not supported by the HTTP protocol. If you need a multiplex tag, you must configure it on the HTTP client. You will have to create the tags for the multiplex list on the server and the client and then connect them. You will then add these tags to the multiplex list on the client.

Address multiplex tags are not supported by the HTTP protocol.

### 10.11.13 Communication via OPC

#### 10.11.13. Communication via OPC

1

##### Introduction

This section describes the communication between an HMI device and a device via OPC.

In this case, the HMI device is the OPC client and the device is the OPC server.

For more detailed information on OPC and on configuring OPC servers, refer to Section "OPC (Page 5892)".

#### 10.11.13. Configuring a connection via OPC

2

##### Introduction

You configure a connection to a device via OPC in the "Connections" editor of the HMI device.

##### Requirements

- A project is open.
- An HMI device has been created.

##### Procedure

1. Double-click the HMI device under "Devices" in the project tree.
2. Double-click the "Connections" item.
3. Double-click "<Add>" in the "Connections" editor.
4. In the "Communication drivers" column, select the "OPC" driver.

5. Select the "OPC" interface for the HMI device under "Parameters > Interface".

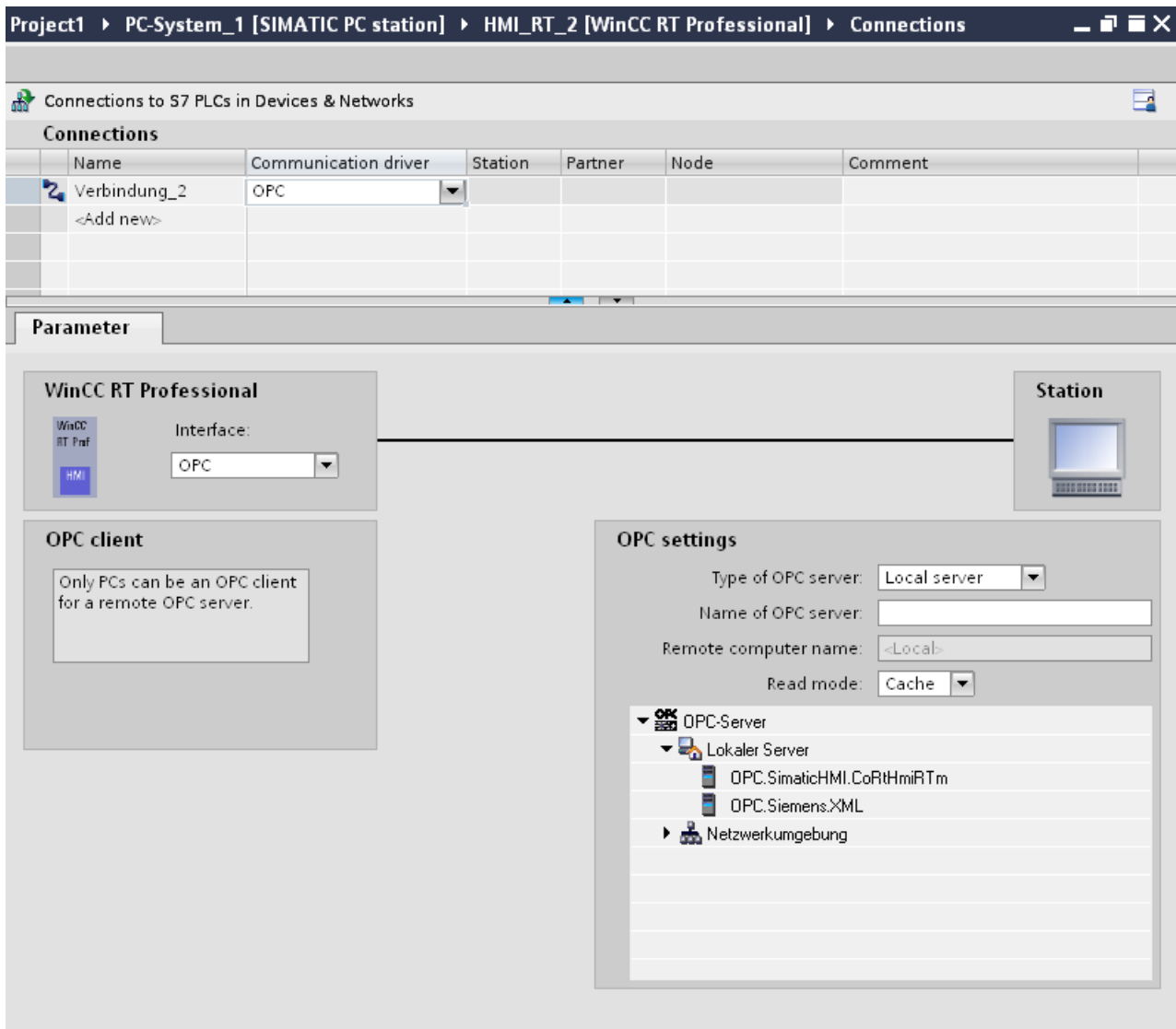

6. Select an OPC server from the tree view under "Parameters > OPC servers".  
The OPC server is entered in the "Name of OPC server" field.

### 10.11.13. Performance features of communication

3

#### Permitted data types for OPC DA

#### Permitted data types for connections with OPC DA

The table lists the user data types that can be used when configuring tags.

Data type	Length
VT_BOOL	1-bit
VT_I1	1 byte
VT_UI1	1 bytes
VT_I2	2 bytes
VT_UI2	2 bytes
VT_I4	4 bytes
VT_UI4	4 bytes
VT_R4	4 bytes
VT_R8	8 bytes
VT_BSTR	--
VT_DATE	8 bytes
VT_DATE VT_ARRAY	--
VT_I1 VT_ARRAY	--
VT_UI1 VT_ARRAY	--
VT_I2 VT_ARRAY	--
VT_UI2 VT_ARRAY	--
VT_I4 VT_ARRAY	--
VT_UI4 VT_ARRAY	--
VT_R4 VT_ARRAY	--
VT_R8 VT_ARRAY	--



## Permitted data types for OPC XML DA

### Permitted data types for connections with OPC DA XML

The table lists the user data types that can be used when configuring tags.

Data type	Length
boolean	1-bit
byte	1 byte
unsignedByte	1 byte
short	2 bytes
unsignedShort	2 bytes
int	4 bytes
unsignedInt	4 bytes
float	4 bytes
double	8 bytes
string	--
dateTime	--
time	--
date	--

## Permitted data types for OPC UA

### Permitted data types for connections with OPC UA

The table lists the user data types that can be used when configuring tags.

Data type	Length
Boolean	1-bit
SByte	1 byte
Byte	1 byte
Int16	2 bytes
UInt16	2 bytes
Int32	4 bytes
UInt32	4 bytes
Float	4 bytes
Double	8 bytes
String	--
DateTime	--

## 10.11.14 Communication via routing

### 10.11.14. Communication via routing

1

#### Introduction

If all stations in an automation system are not connected to the same subnet, these stations cannot be accessed directly online.

A connection between partners in different subnets is only possible via routing.

You configure the routing settings with the properties of the interfaces.

Communication from connection partners in various different subnets can be routed via the following links:

- PROFINET
- PROFIBUS
- MPI

#### Requirements for routing

To establish a connection to these devices, a router must be interposed. In this case, a SIMATIC station can also act as a router if it has appropriate interfaces with the different subnets.

Modules with communication capability (CPUs or CPs) used to establish gateways between the subnetworks must have routing capability.

A connection between partners in different subnets is only possible with IP routing. The routing settings can be edited in the corresponding interface properties.

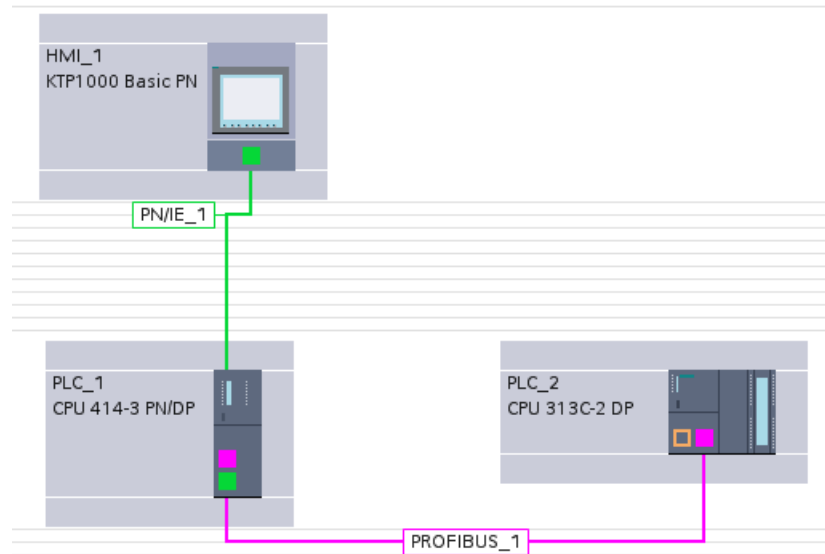

### Routing path

The routing path is determined in Runtime by the system and cannot be influenced by the user. During configuration, it is not possible to generate information about a faulty connection.

### HMI devices as routers

Only SIMATIC PCs or PC stations can be used as a router.

All other HMI devices from the "HMI" area cannot be used as a router.

### 10.11.14. Example for communication via routing

2

#### Communication via routing

Illustration of a hardware configuration with a routing connection

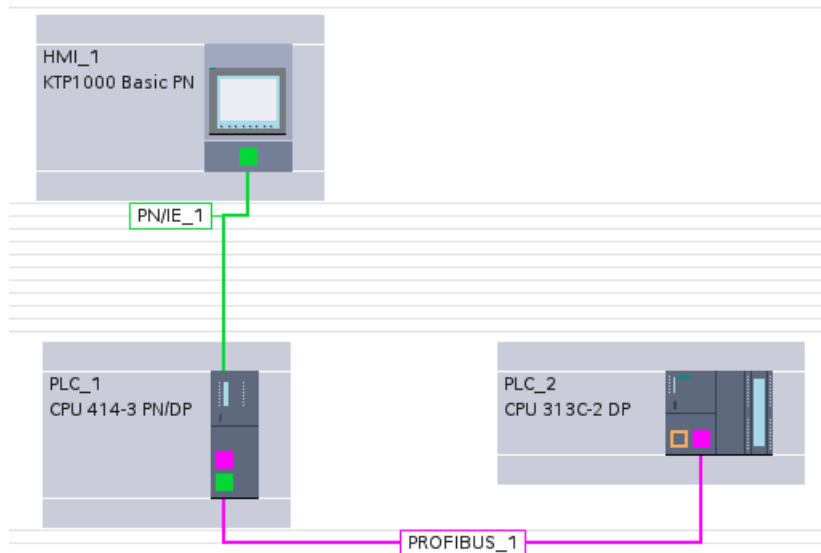

In the figure above, a routing connection has been established between an HMI device and the SIMATIC S7-300 controller.

The SIMATIC S7-400 automation device serves as a router.

A routing connection can be made directly in integrated projects. The communication partners are connected in the "Devices and Networks" editor.

You configure the parameters of the connection and interface in the Inspector window.

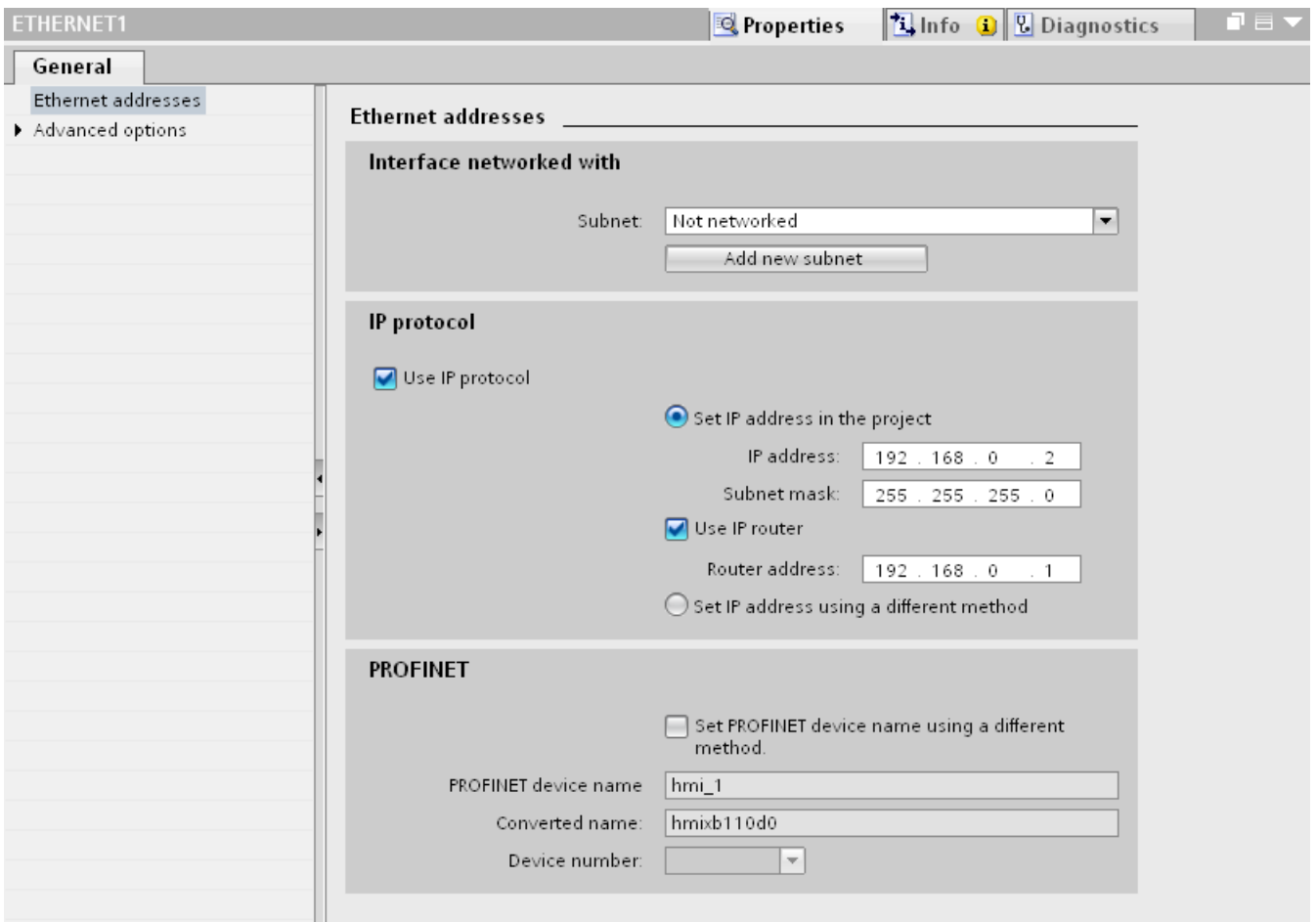

### 10.11.14. Configuring communication via routing

3

#### Introduction

The following configuration describes a network for the following communication partners:

- KTP1000 Basic PN
- SIMATIC S7-400 with PROFINET and PROFIBUS interface
- SIMATIC S7-300 with PROFIBUS interface

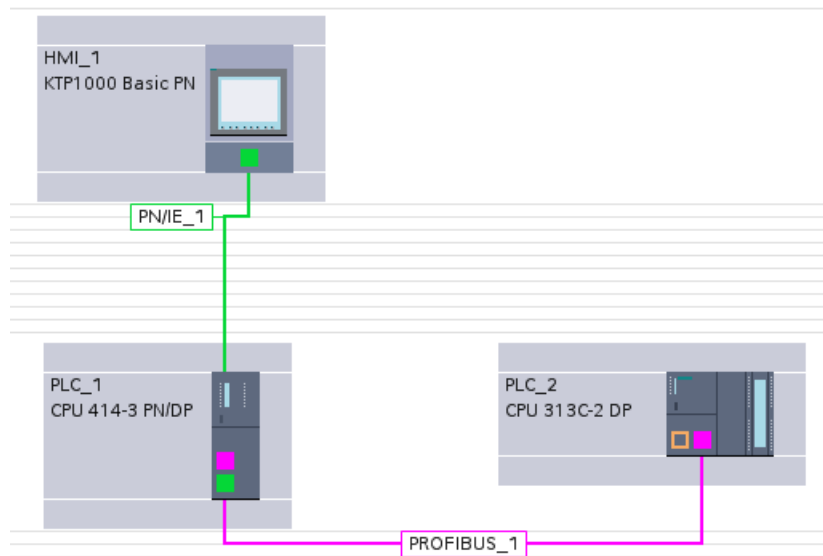

#### Requirements

- KTP1000 Basic PN is connected via PROFINET to the SIMATIC S7-400.
- SIMATIC S7-400 is connected via PROFIBUS to the SIMATIC S7-300.

#### Procedure

1. Click on the PROFINET interface of the HMI device.
2. In the Inspector window, click "Properties > General > Ethernet addresses".

3. Click "Use router" in the "IP protocol" area.
4. Enter the IP address of the router in the "Router address" field.

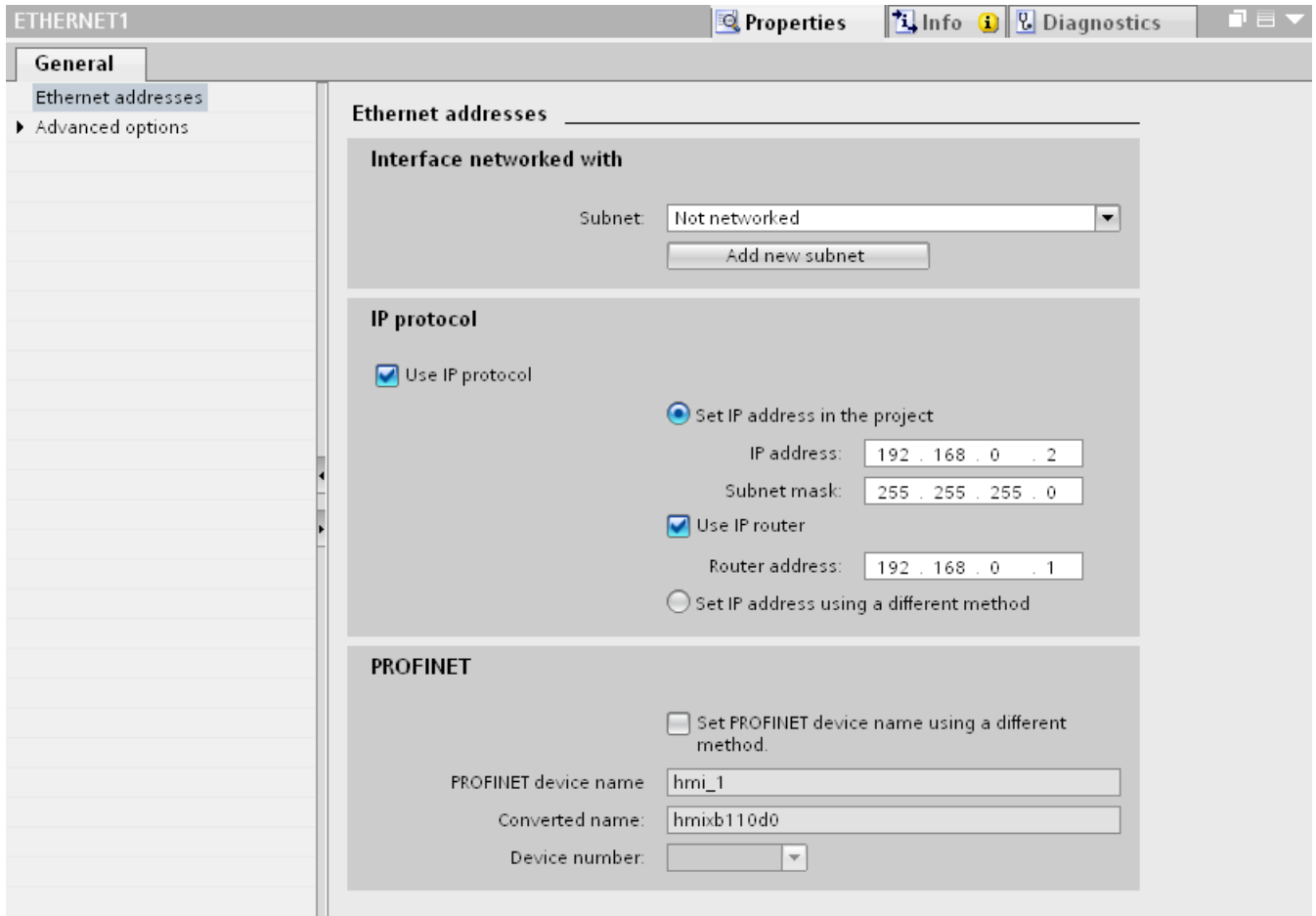

### 10.11.15 PROFINET IO and IRT

#### 10.11.15. PROFINET IO

1

#### What is PROFINET IO?

#### PROFINET IO

PROFINET is an Ethernet-based automation standard of PROFIBUS Nutzerorganisation e.V. (PNO) which defines a manufacturer-neutral communication, automation and engineering model.

## Objective

The objective of PROFINET is:

- Integrated communication via field bus and Ethernet
- Open, distributed automation
- Use of open standards

## Architecture

The PROFIBUS User Organisation e.V. (PNO) has designated the following aspects for PROFINET architecture:

- Communication between controllers as components within distributed systems.
- Communication between field devices, such as I/O devices and drives.

## Implementation by Siemens

The demand for "Communication between controllers as components within distributed systems" is implemented by "Component Based Automation" (CBA). Component Based Automation is used to create a distributed automation solution based on prefabricated components and partial solutions.

The demand for "Communication between field devices" is implemented by Siemens with "PROFINET IO". Just as with PROFIBUS DP, the complete configuration and programming of the components involved is possible using the Totally Integrated Automation Portal.

The following sections deal with the configuration of communication between field devices using PROFINET IO.

## PROFINET IO systems

### PROFINET IO system

A PROFINET IO system is comprised of a PROFINET IO controller and its assigned PROFINET IO devices.

- A PROFINET IO controller is a PLC that controls the automation task.  
Example: SIMATIC S7 1500 PLC
- A PROFINET IO device is a device that is controlled by an IO controller.  
Examples: HMI device TP 1200 Comfort, a head module of the distributed IO family ET 200S

As soon as you connect an IO controller to an IO device, a controller-device link is established.



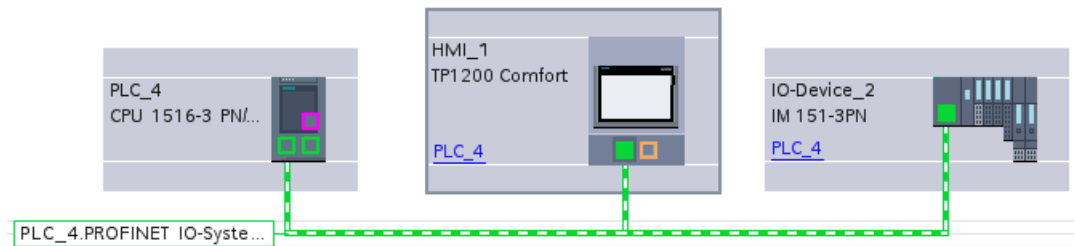

### 10.11.15. IRT communication

2

#### Overview of RT classes

##### RT classes in PROFINET IO

PROFINET IO is a scalable, real-time communication system based on Ethernet technology. The scalable approach is reflected in several real-time classes:

- **RT:** Transmission of data in prioritized, non-isochronous Ethernet frames. The required bandwidth is within the free bandwidth area for TCP/IP communication.
- **IRT:** Isochronous transmission of data with high stability for time-critical applications (for example, motion control). The required bandwidth is from the area of bandwidth reserved for cyclic data.

##### Device dependency

Depending on the device, not all real-time classes are supported.

You can find further information on device dependency here: Performance characteristics of PROFINET IO and IRT (Page 5313)

##### Introduction: Isochronous Realtime Ethernet

##### Introduction: Isochronous Realtime Ethernet

IRT is a transmission method by which PROFINET devices are synchronized with very high accuracy.

A sync master specifies the clock to which sync slaves are synchronized. An IO controller or an IO device can have the role of sync master.

Sync master and sync slaves are always devices in a sync domain. Bandwidth is reserved within the sync domain for IRT communication. Real-time and non-real-time communication (TCP/IP communication) is possible outside of the reserved bandwidth.

### Time ranges of communication cycles

The communication cycle is divided into three time ranges, which are represented in the following chart:

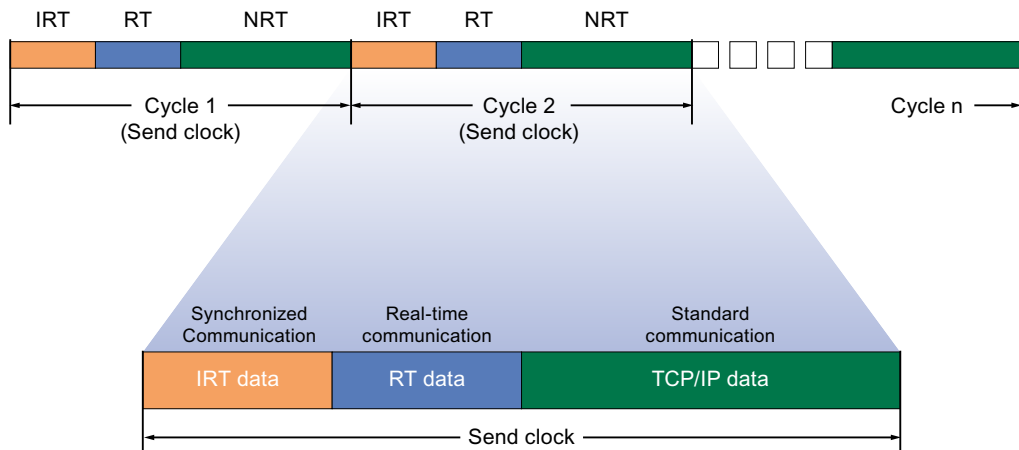

- **IRT data (synchronized communication)**  
This area can be reserved in specific steps, depending on the send clock. Within this time range the IRT data is transmitted.
- **RT data (real-time communication)**  
In this time range the cyclic RT data is transmitted. RT data has a higher priority than "normal" TCP/IP data. TCP/IP data or Ethernet frames can have a priority between 1 and 7. RT data has a priority of 6.
- **TCP/IP data (standard communication)**  
Standard communication (TCP/IP, etc.) is transmitted in the remaining interval of the communication cycle.

### Applications of IRT

PROFINET with IRT is especially suited for:

- High performance and deterministic for large quantity structures with regard to user data communications (productive data)
- High performance even with many devices in the line topology with regard to user data communications (productive data).
- Parallel transmission of production and TCP/IP data over wire, and securing the forwarding of production data when data volume is high by reserving transmission bandwidth.

## Basic procedures for configuring IRT

### Basic procedures for configuring IRT

If you want to upgrade equipment with PROFINET IO to IRT, follow these three steps:

1. Configure the PROFINET IO device. The PROFINET device must support IRT.
2. Set which device acts as the sync master and synchronizes the other devices. For this you must configure a sync domain with a sync master and at least one sync slave.
3. Download the configuration to all involved devices.

You can find further information on IRT configuration here: Auto-Hotspot

### Creating PROFINET IO configuration for IRT

As a prerequisite for IRT configuration, there must be an existing PROFINET IO configuration, i.e., one or more stations must be configured with an IO controller and IO devices.

You can read which components are suitable for IRT communication in the task card "Information", once you have selected the corresponding components in the hardware catalog.

The requirements for functioning IRT communication are met simply by configuring a PROFINET IO system with components that support IRT.

### Sync domain

### Sync domain

A sync domain is required for synchronization of PROFINET IO devices. The sync domain assures that all devices belonging to it communicate synchronously.

Prerequisite for IRT communication is a synchronization cycle to distribute a common time base for all PROFINET devices in a sync domain. With this base synchronization, a synchronous transmission cycle of PROFINET devices within a sync domain is achieved. The sync master (usually an IO controller) generates the common synchronization clock and specifies the time basis on which all other sync slaves (usually IO devices) are synchronized.

If the sync master fails, the communication between the IRT devices reverts to RT communication.

### Background processes during configuration of an IO system

If you configure an IO controller and network it with an Ethernet subnet, it will automatically be added to the default sync domain of the Ethernet subnet. The default sync domain is always available. The IO controller operates unsynchronized.

If you assign an additional IO device to the IO system of the IO controller, the IO device automatically assigns the IO controller's sync domain.

### 10.11.15. Configuring the HMI device as IO device

3

#### Introduction

An IO controller and at least one PROFINET IO device are necessary for a PROFINET IO system.

#### Requirements

- A SIMATIC S7 1200 or SIMATIC S7 1500 PLC has been created.
- An HMI device from the Comfort Panels device family has been created.
- The "Devices & Networks" editor is open.

#### Procedure

1. You network the PLC with the HMI device:
2. Click the HMI device in the "Devices & Networks" editor.
3. In the inspector window, you select the following:  
"General > PROFINET Interface (X1) > Operating mode"
4. Select the "IO device".

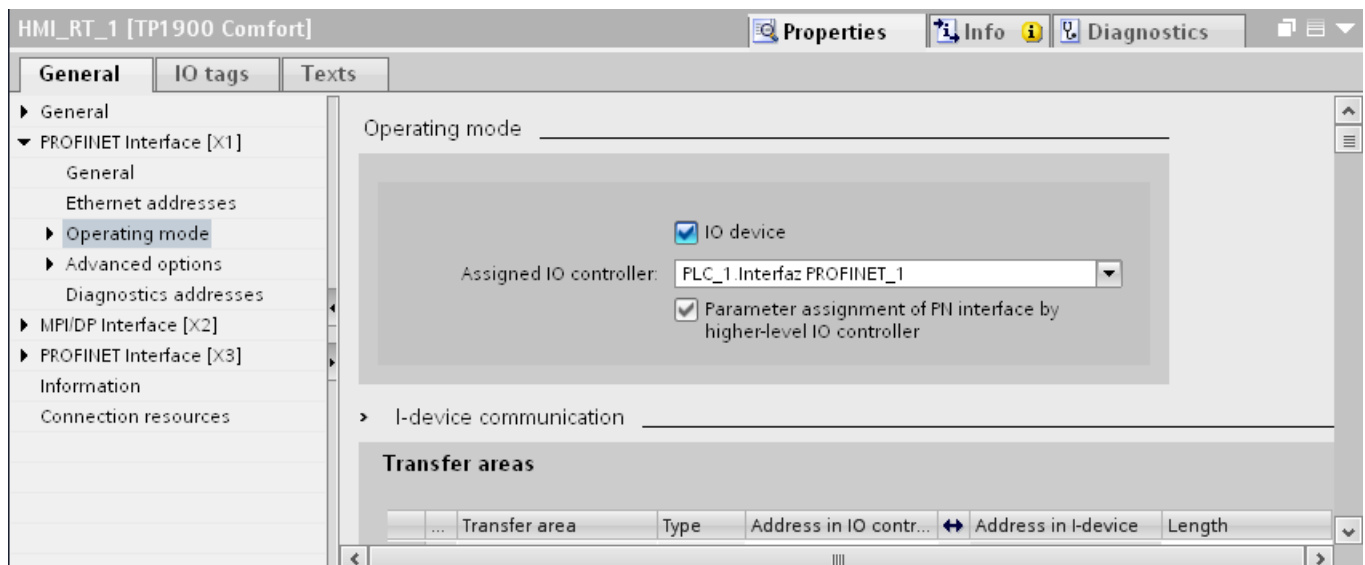

5. You assign the parameters required for your PROFINET IO system  
You can find further information on the parameters for PROFINET IO systems here:  
Parameters for PROFINET IO and IRT (Page 5311)

### 10.11.15. Parameters for PROFINET IO and IRT

#### 4

#### I-device communication

#### I-device

The "I-device" functionality (intelligent IO device) of a CPU allows data to be exchanged with an IO controller and therefore to use the CPU, for example, as an intelligent preprocessing unit of subprocesses. The I-device is linked as an IO device to a "higher-level" IO controller.

#### Parameters for I-device communication

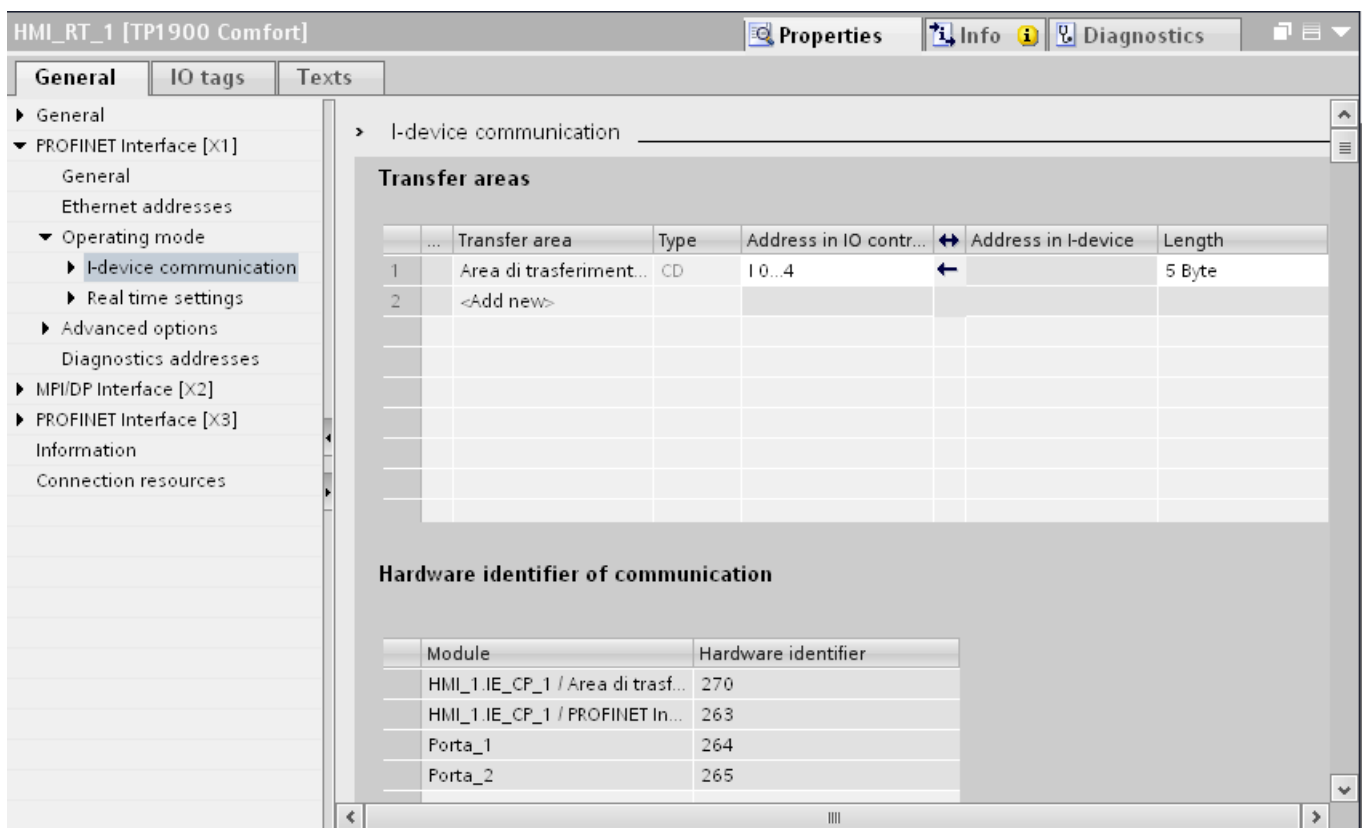

The screenshot shows the 'Properties' dialog box for 'HMI\_RT\_1 [TP1900 Comfort]'. The 'I-device communication' tab is active. The 'Transfer areas' table is as follows:

...	Transfer area	Type	Address in IO contr...	↔	Address in I-device	Length
1	Area di trasferiment...	CD	I 0...4	←		5 Byte
2	<Add new>					

Below the table is the 'Hardware identifier of communication' section with the following table:

Module	Hardware identifier
HMI_1.IE_CP_1 / Area di trasf...	270
HMI_1.IE_CP_1 / PROFINET In...	263
Porta_1	264
Porta_2	265

- Transfer areas  
Display transfer areas of the I-device communication
- Diagnostics address of communication  
Display of diagnostic data of the IO device

#### Configuring an I-device with a GSD file

If you use an I-device in another project, or if the I-device is used in another engineering system, then configure the higher-level IO controller and the I-device as described above.

However, click on the "Export" button after configuring the transfer areas in order to create a GSD file from the I-device. This GSD file represents the configured I-device in other projects.

The "Export" button is found in the "I-device communication" section of the inspector window.

The hardware configuration is compiled and the export dialog opened.

Assign a name for the I-device proxy as well as a description in the fields provided. Click the "Export" button to complete your process.

Finally, import the GSD file, for example, into another project.

## Real-time settings

### Parameters for real-time settings

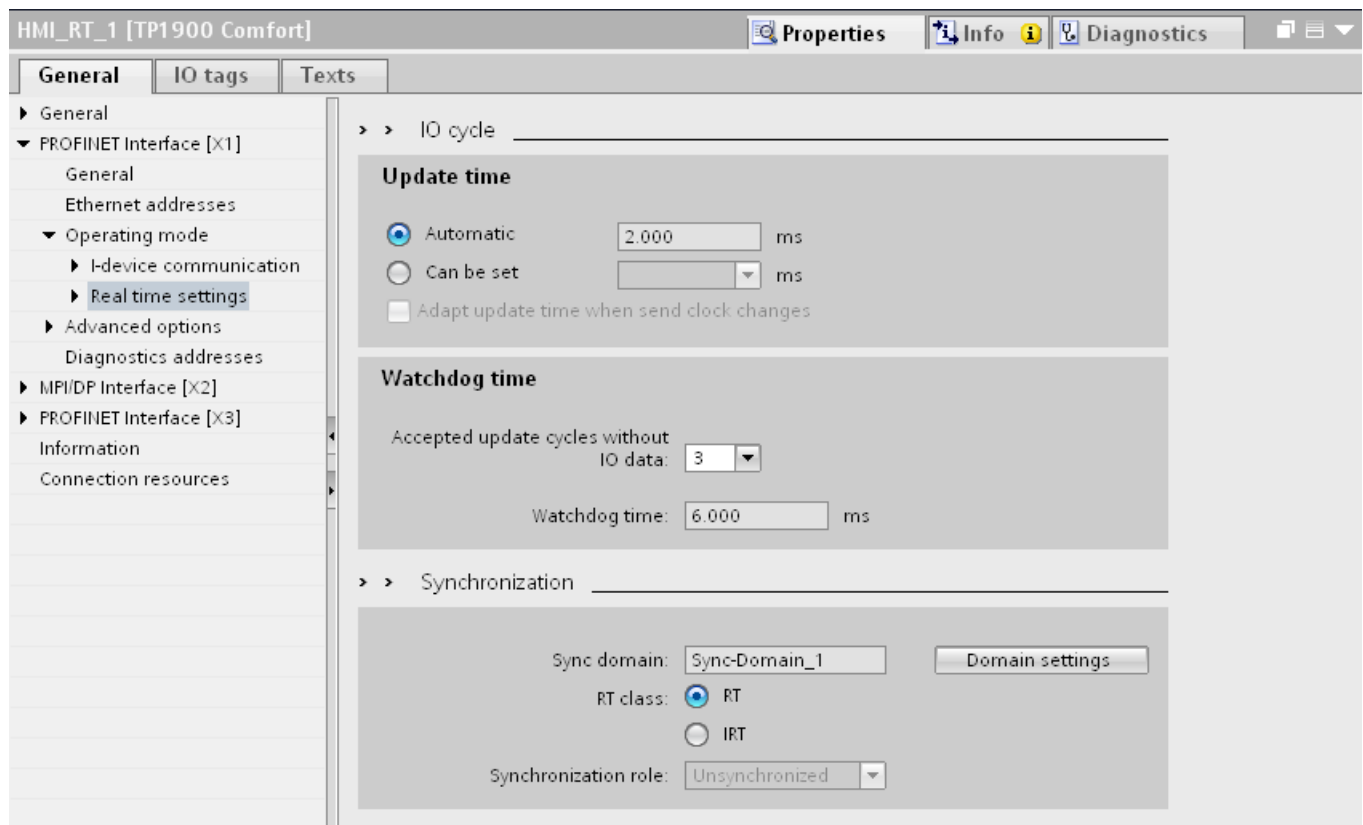

- Update time
  - Display of update time used in network.
  - Selection of update times available in network.
- Watchdog time
  - Selection of available update cycles.
  - Display of watchdog time used in network.
- Synchronization
  - Display of sync domain used
  - Selection of RT class.
  - Selection of role in the sync domain.

### 10.11.15. Performance characteristics of PROFINET IO and IRT

5

## Configuration of PROFINET and IRT

### Setting up PROFINET with IRT

Keep in mind the following rules for the set up and operation of a PROFINET IO system in IRT operation. They serve to insure an optimal operation of your PROFINET IO system.

- When using IRT, you must configure the topology. This will enable exact calculation of the update time, bandwidth, and additional parameters.
- If you would like to use multiple sync domains, configure a sync domain boundary for the port which is currently connected to the PROFINET device of another sync domain.
- In a sync domain you can only configure one sync master at a time.
- A PROFINET IO system may only be part of a single sync domain.
- If you configure a PROFINET device in a sync domain and want to synchronize with IRT, the PROFINET devices concerned must support IRT communication.
- Wherever possible, use the same PROFINET device as the PROFINET IO controller and sync master.
- If only some of the PROFINET devices in a PROFINET IO system are synchronized, please keep in mind the following: PROFINET devices which are not part of IRT communication are placed outside of the sync domain.

## Device dependency

### IRT communication

The following HMI devices support IRT communication:

- TP700 Comfort and KP700 Comfort
- TP900 Comfort and KP900 Comfort
- TP1200 Comfort and KP1200 Comfort
- TP1500 Comfort and KP1500 Comfort
- TP1900 Comfort
- TP2200 Comfort

### Communication options

The following configuration options are available for Comfort Panels:

- Comfort Panel with PROFINET Basis functionality without PROFINET IO
- Comfort Panel with PROFINET RT in an RT network networked with an RT controller
- Comfort Panel with PROFINET RT as end point in an IRT network networked with an RT controller
- Comfort Panel with PROFINET IRT in an IRT network networked with an IRT controller

## 10.11.16 Media redundancy

### 10.11.16. Restrictions with media redundancy

1

#### Diagnostic interrupts

If you have activated "Diagnostic interrupts", diagnostic interrupts pertaining to "Media redundancy" are only processed by PROFINET-compatible devices and displayed on the "IO Controller".

If you do not use a PROFINET-compatible device, the "Diagnostic interrupts" selection does not have any function.

Diagnostic interrupts are only detected by the IO controller. There is no separate diagnostic interrupts for HMI devices that are detected and displayed by HMI devices.



### 10.11.16. Media redundancy

2

#### Media redundancy options

To increase the network availability of an industrial Ethernet network with optical or electrical line topology, the following options are available:

- Meshing networks
- Parallel switching of transmission modes
- Consolidation of a line topology to a ring topology

#### Media redundancy in ring topologies

Devices in ring topologies can be the external switches and/or integrated switches of communication modules.

To set up a ring topology with media redundancy you must join both free ends of a line-shaped network topology to one device.

Consolidation of a line topology to a ring takes place over 2 ports (ring ports) in a device in the ring.

This device is the redundancy manager. All other devices in the ring are the redundancy clients.

The following figure shows the ring type interconnection:

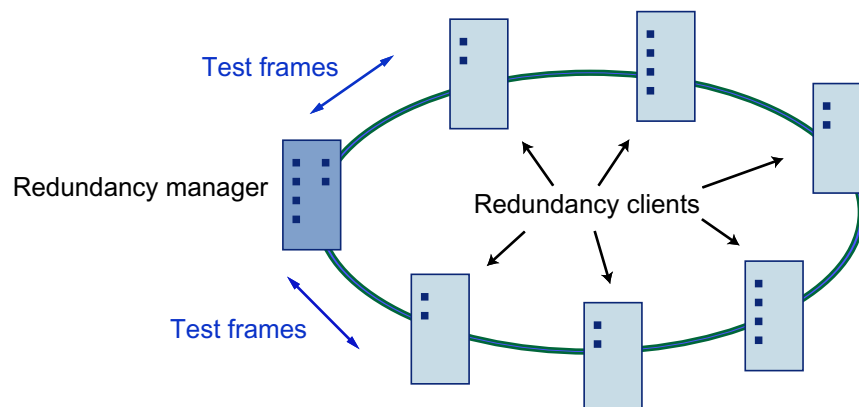

The two ring ports in a device are the ports which create the connection to both of its neighboring devices in a ring topology.

The selection and set up of the ring ports takes place during configuration of the respective device.

Download the configuration in the individual devices before physically connecting the ring.

#### Functions of media redundancy in a ring topology

If a part of the ring is disconnected, then the data paths between the individual devices is automatically reconfigured. After the reconfiguration the devices are once again accessible in the newly created topology.

### 10.11 Communicating with PLCs

In the redundancy manager, 2 ring ports will be separated from each other during interruption-free network operation, so that no data frames circulate.

The ring topology is a line when viewed from the standpoint of data transfer. The redundancy manager monitors the ring topology. To do so it sends a test frame not only from ring port 1 but also from ring port 2. The test frame passes through the ring in both directions until it arrives at the other ring port on the redundancy manager.

An interruption in the ring can occur from connection failure between two devices or device failure in the ring.

If the redundancy manager's test telegram does not reach the other ring port because of interruption in the ring, the redundancy manager connects via both ports.

With this alternate route a functioning connection is again created among all remaining devices in a line-shaped topology.

The time between ring interruption and re-establishment of a functional line topology is called the reconfiguration time.

As soon as the interruption is eliminated, the original transmission route is again created, both ring ports in the redundancy manager are separated from each other, and the redundancy clients are notified of the change.

The redundancy clients then use the new route to the other devices.

If the redundancy manager fails, then the ring is changed to a functional line.

#### 10.11.16. Media Redundancy Protocol (MRP)

3

#### Media Redundancy Protocol (MRP)

The MRP process works in conformity with Media Redundancy Protocol (MRP), which is specified in IEC 61158 Type 10 "PROFINET".

The reconfiguration time following an interruption of the ring amounts to a maximum of 0.2 seconds.

#### Requirements for trouble-free operation

Requirements for trouble-free operation with media redundancy process MRP are:

- MRP is supported in ring topologies of up to 50 devices. Exceeding the device limit can lead to data traffic failure.
- All devices must be connected to each other via their ring ports.
- "MRP" must be activated on all devices in the ring.
- The connection settings (transfer medium / duplex) must be set to full duplex and for at least 100 Mbit/s for all ring ports. Otherwise data traffic failure can occur.
- In STEP 7 configuration in the properties dialog for all ports in the ring, set the connection in the register "Options" to "Automatic settings".

## HMI devices for media redundancy

The following HMI devices support "Media Redundancy":

- KP700 Comfort
- TP700 Comfort
- KP900 Comfort
- TP900 Comfort
- KP1200 Comfort
- TP1200 Comfort
- KP1500 Comfort
- TP1500 Comfort
- TP1900 Comfort
- TP2200 Comfort

### 10.11.16. Configuring media redundancy for HMI devices

4

#### Requirements

- The participating components must support "media redundancy".
- IRT communication is not configured
- One device on the network must be configured as "Redundancy manager".
- A ring topology is set up by means of port interconnections.

### Procedure

1. Click on the PROFINET interface of an HMI device.
2. Select "General > Advanced settings > Media redundancy" in the properties.
3. Select "Client" in the "Media redundancy role" area.

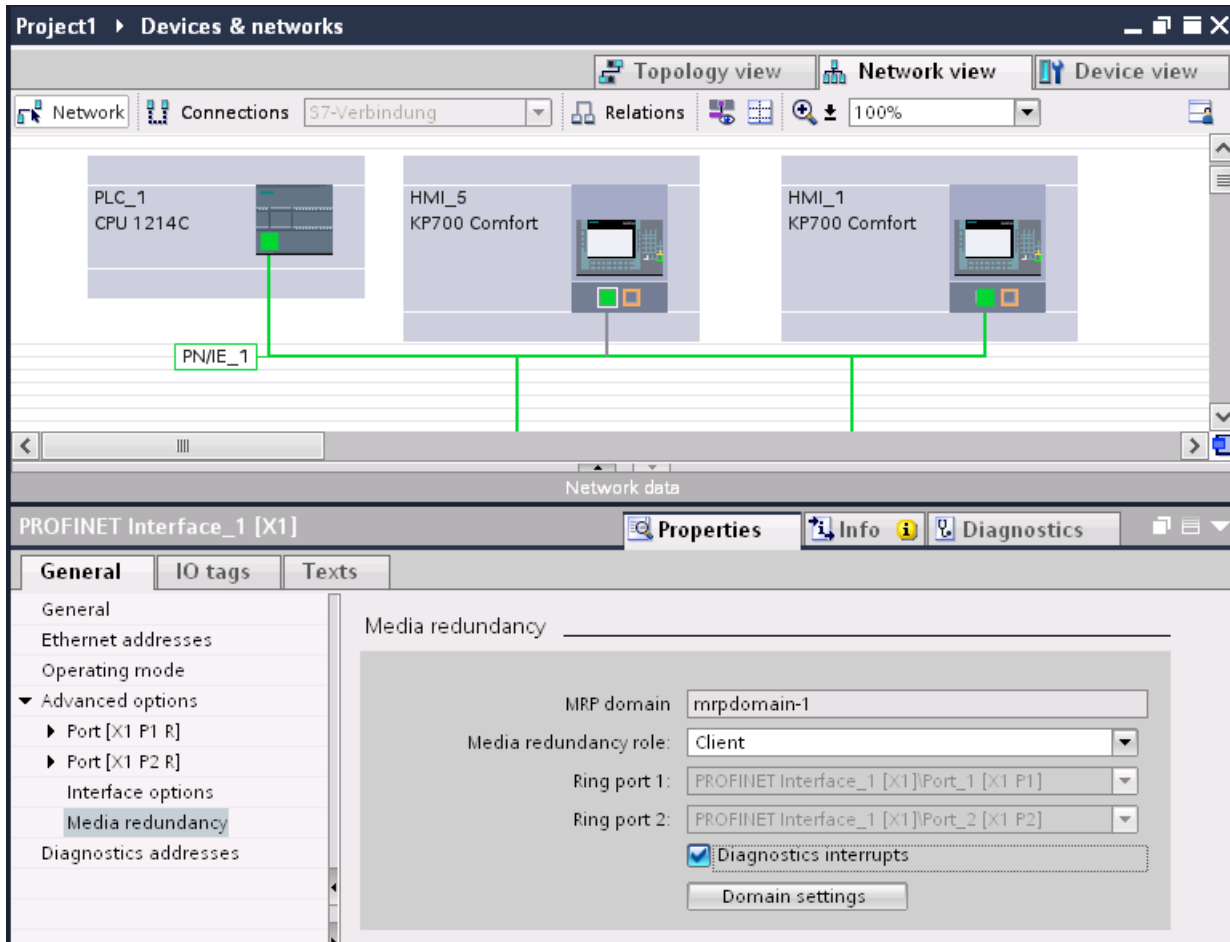

### Result

The HMI device is now operating as client on the MRP network.

The default ring ports will automatically be displayed in the subjacent fields.

### 10.11.16. Parameters for media redundancy

5

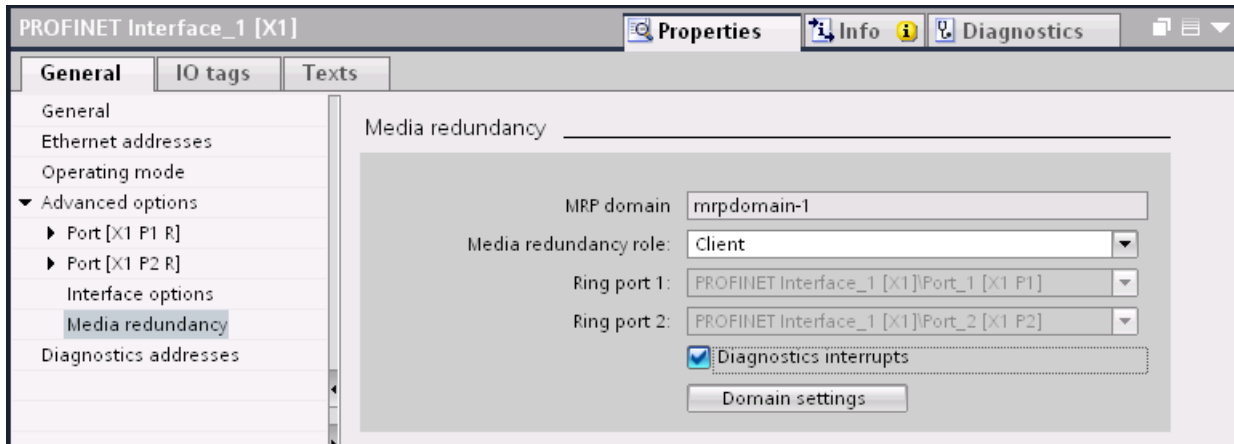

#### MRP domain

This area displays the MRP domain.

You can rename the MRP domain in the "Domain settings" dialog.

#### Domain settings

Click "Domain settings" to open the "Domain settings" editor.

You also manage the MRP domains in the MRP domain area of the "Domain settings" editor.

#### Media redundancy role

Assign the role of the HMI device in the "Media redundancy role" area.

You have the following options:

- Client  
The HIM device is operated as "Client" in an MRP domain.
- Not a node of the ring  
The HIM device is not operated within an MRP domain.

#### Ring port 1 and Ring port 2

Display of available ring ports

## Diagnostic interrupts

The following diagnostic interrupts can be generated if "Diagnostic interrupts" is activated:

- Wiring or port error  
Diagnostics interrupts will be generated for the following errors in the ring ports:
  - A neighbor of the ring port does not support MRP
  - A ring port is connected to a non-ring port

### 10.11.16. Managing MRP domains

6

You can monitor and adjust the media redundancy settings centrally.

## Requirements

The devices are configured and networked.

## Procedure

1. Select the PROFINET interface of the HMI device.
2. Select the "Advanced options > Media redundancy" area in the Inspector window.

3. Click the "Domain settings" button.
4. Navigate to the "Domain management > MRP domains" area in the Inspector window.

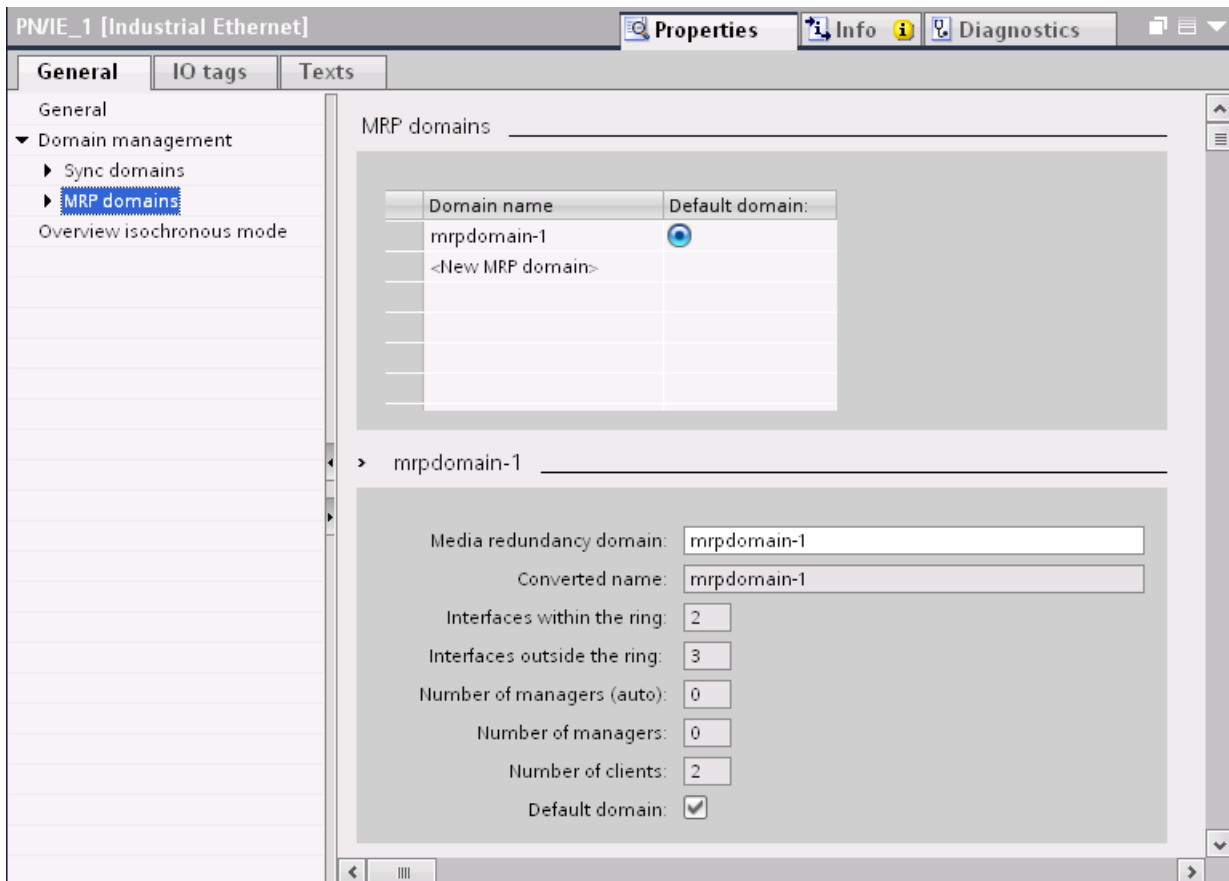

## MRP domains

You can specify the default MRP domain in the "MRP domains" area.

You can rename all domains and check the redundancy roles and ring ports.

For each MRP domain, you receive an overview of how many PROFINET interfaces are interconnected in the ring, how many PROFINET interfaces are located outside the ring, and the number of redundancy managers and redundancy clients.

You can have the devices in the ring, including device name, associated MRP domain, media redundancy role, and utilized ring ports, displayed in groups:

- IO systems  
The list shows you all configured devices of the selected IO system.
- Rings  
The list shows you all ring interconnections of the selected IO system. The identified rings are numbered consecutively. If all devices of this ring belong to one MRP domain, this is also displayed.
- MRP domain  
The list shows you the existing MRP domains of the selected IO system.

## 10.11.17 Communication with other PLCs

### 10.11.17. Communication with other PLCs

1

#### Introduction

Communication with other PLCs is communication with PLCs that are not in the SIMATIC family.

These PLCs have proprietary protocols for data exchange. The protocols are configured as communication drivers in WinCC.

#### Communication drivers

The following communication drivers are supported in WinCC and are already installed:

- Allen-Bradley
  - Allen-Bradley EtherNet/IP
  - Allen-Bradley DF1
- Mitsubishi
  - Mitsubishi MC TCP/IP
  - Mitsubishi FX
- Modicon Modbus
  - Modicon Modbus TCP/IP
  - Modicon Modbus RTU
- Omron
  - Omron Host Link

#### Communication drivers in WinCC RT Professional

The following communication drivers are supported for RT Professional:

- Allen-Bradley
  - Allen-Bradley EtherNet/IP
- Mitsubishi
  - Mitsubishi MC TCP/IP
- Modicon Modbus
  - Modicon Modbus TCP



## Connections between HMI devices and other PLCs

You configure the connections between HMI devices and other PLCs in the "Connections" editor of the HMI device. These connections are non-integrated connections.

### 10.11.17. Distinctive features when configuring

2

#### Distinctive features for data exchange

Distinctive features apply when configuring connections to other PLCs, compared to configuring integrated connections.

Note the following distinctive features when configuring:

- Addressing of tags
- Permitted data types
- Distinctive features when configuring area pointers
- Distinctive features when configuring alarms
- Distinctive features when configuring trends

For more detailed information on distinctive features when configuring, refer to Section "Data exchange" of the respective communication driver.

### 10.11.17. Parallel communication

3

#### Parallel communication of communication drivers

The following table shows an overview of which communication drivers you can use simultaneously on one HMI device.

---

**Note**

Parallel communication is not approved for Basic Panels.

---

#### Parallel communication over Ethernet interfaces

The approved combinations can be operated via the same Ethernet interface. Several Ethernet interfaces are not required.

Parallel communication only concerns the Ethernet-based communication drivers.

Visualizing processes (Comfort/Advanced)

10.11 Communicating with PLCs

	Allen-Bradley EtherNet/IP	Mitsubishi MC TCP/IP	Modicon Modbus TCP/IP	OPC (DA/ XML DA)	OPC UA (DA)	SIMATIC LOGO!	SIMATIC S7 200	SIMATIC S7 300/400	SIMATIC S7 1200	SIMATIC S7 1500	SIMATIC C HTTP protocol	Sinumerik NC
Allen-Bradley	--	No	No	Yes	Yes	Yes	Yes	Yes	Yes	Yes	Yes	Yes
EtherNet/IP												
Mitsubishi MC TCP/IP	No	--	No	Yes	Yes	No	No	No	No	No	Yes	No
Modicon Modbus TCP/IP	No	No	--	Yes	Yes	No	No	No	No	No	Yes	No
OPC (DA/ XML DA)	Yes	Yes	Yes	--	Yes	Yes	Yes	Yes	Yes	Yes	Yes	Yes
OPC UA (DA)	Yes	Yes	Yes	Yes	--	Yes	Yes	Yes	Yes	Yes	Yes	Yes
SIMATIC C LOGO!	Yes	No	No	Yes	Yes	--	Yes	Yes	Yes	Yes	Yes	Yes
SIMATIC S7 200	Yes	No	No	Yes	Yes	Yes	--	Yes	Yes	Yes	Yes	Yes
SIMATIC S7 300/400	Yes	No	No	Yes	Yes	Yes	Yes	--	Yes	Yes	Yes	Yes
SIMATIC S7 1200	Yes	No	No	Yes	Yes	Yes	Yes	Yes	--	Yes	Yes	Yes
SIMATIC S7 1500	Yes	No	No	Yes	Yes	Yes	Yes	Yes	Yes	--	Yes	Yes
SIMATIC C HTTP protocol	Yes	Yes	Yes	Yes	Yes	Yes	Yes	Yes	Yes	Yes	--	Yes
Sinumerik NC	Yes	No	No	Yes	Yes	Yes	Yes	Yes	Yes	Yes	Yes	--

## Parallel communication over serial interfaces

The following applies for parallel communication over serial interfaces:

- One communication driver per interface.
- One interface per communication driver.

### 10.11.17. Communication drivers

4

## Allen-Bradley

### Allen-Bradley communication drivers

#### Introduction

This section describes the communication between an HMI device and PLCs that use Allen-Bradley communication drivers.

The following communication drivers are supported:

- Allen-Bradley EtherNet/IP
- Allen-Bradley DF1

#### Data exchange

Data is exchanged by means of tags or area pointers.

- Tags  
The PLC and the HMI device use process values for data exchange. You create tags in the configuration that point to addresses in the PLC. The HMI device reads the value from the defined address, and then displays it. The operator may also enter values on the HMI device, which are then written to the address in the PLC.
- Area pointers  
Area pointers are used to exchange specific data and are only set up when these data are used.

## Allen-Bradley EtherNet/IP

### Configuring a connection via Allen-Bradley EtherNet/IP

#### Introduction

You configure a connection to a PLC with an Allen-Bradley EtherNet/IP communication driver in the "Connections" editor of the HMI device.

The Ethernet interfaces are named differently depending on the HMI device.

Example: PROFINET interface corresponds to the Ethernet interface

### Requirements

- A project is open.
- An HMI device has been created.

### Procedure

1. Double-click the HMI device under "Devices" in the project tree.
2. Double-click the "Connections" item.
3. Double-click "<Add>" in the "Connections" editor.

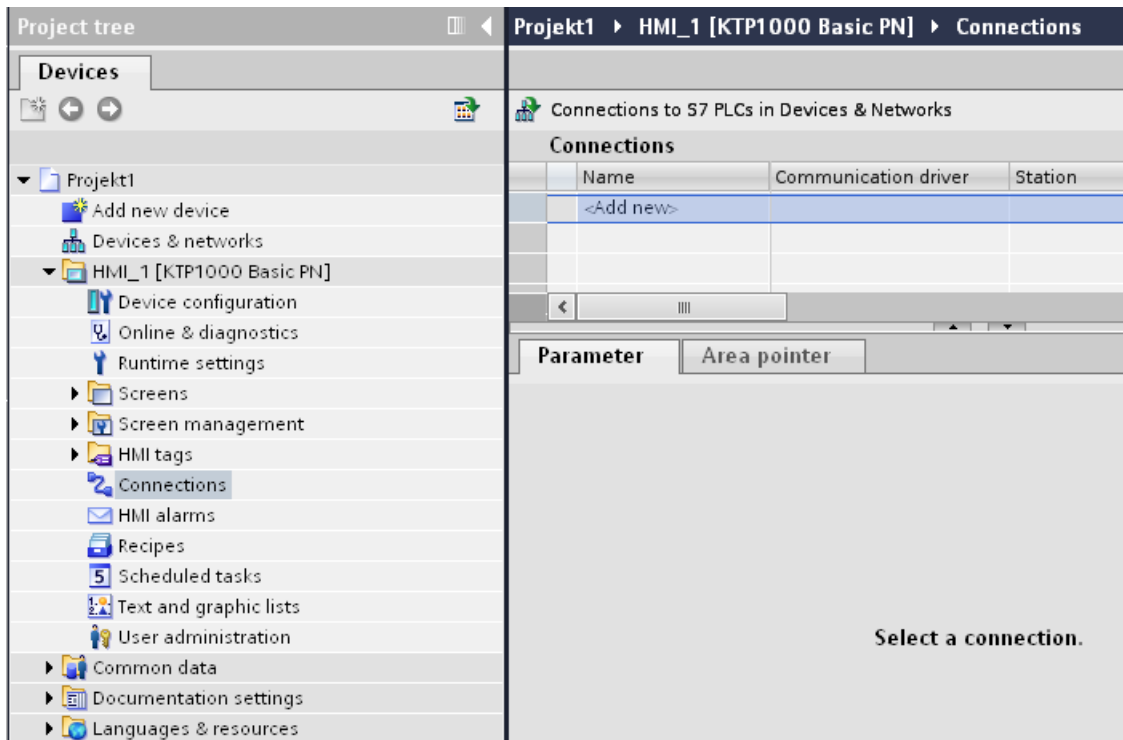

4. In the "Communication drivers" column, select the "Allen-Bradley EtherNet/IP" driver.

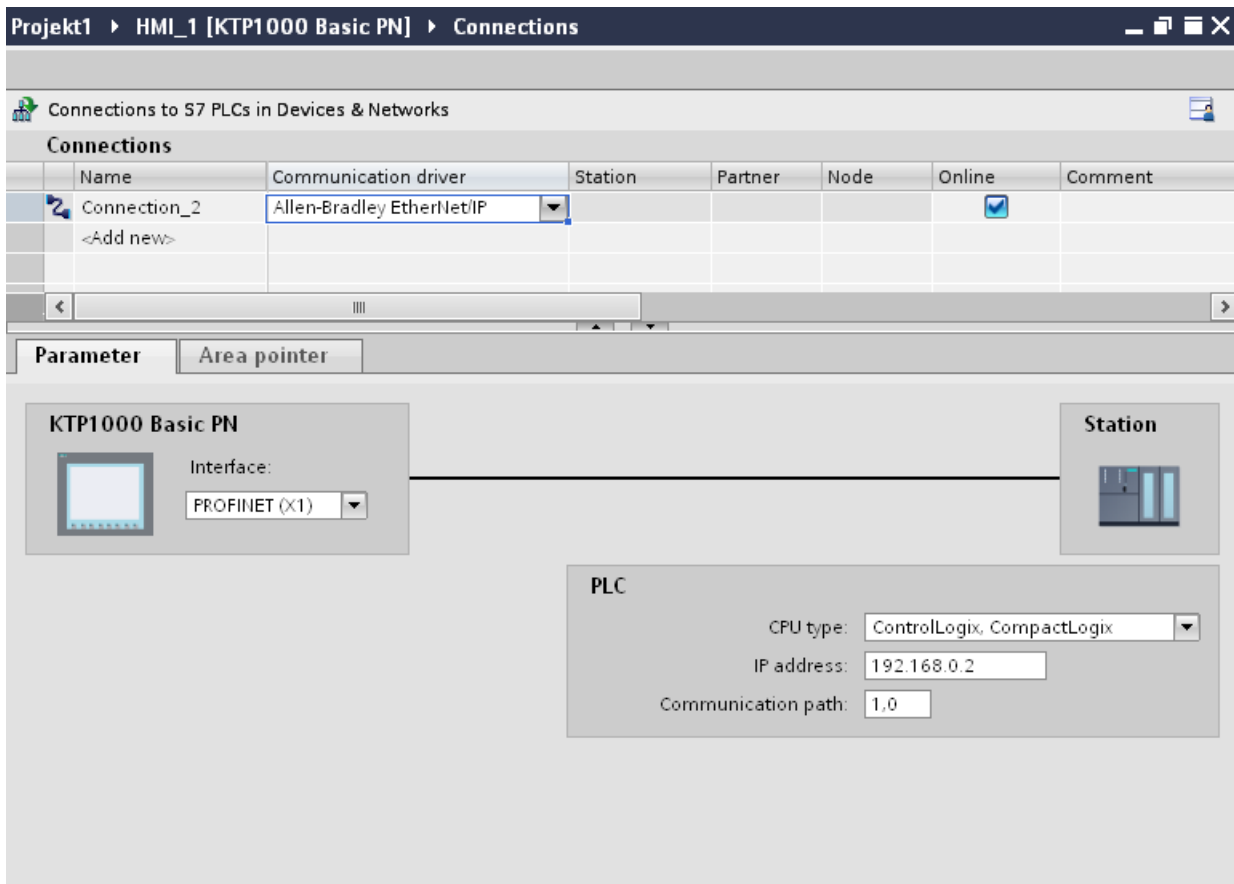

5. Select all necessary connection parameters for the interface in the Inspector window under "Parameters".

## Parameters for the connection (Allen-Bradley EtherNet/IP)

### Parameters to be set

To assign the connection parameters, such as addresses and profiles, click the connection that you have created in the "Connections" editor.

The communication partners are displayed schematically in the Inspector window under "Parameters". The "PLC" area is available for assigning parameters according to the interface used.

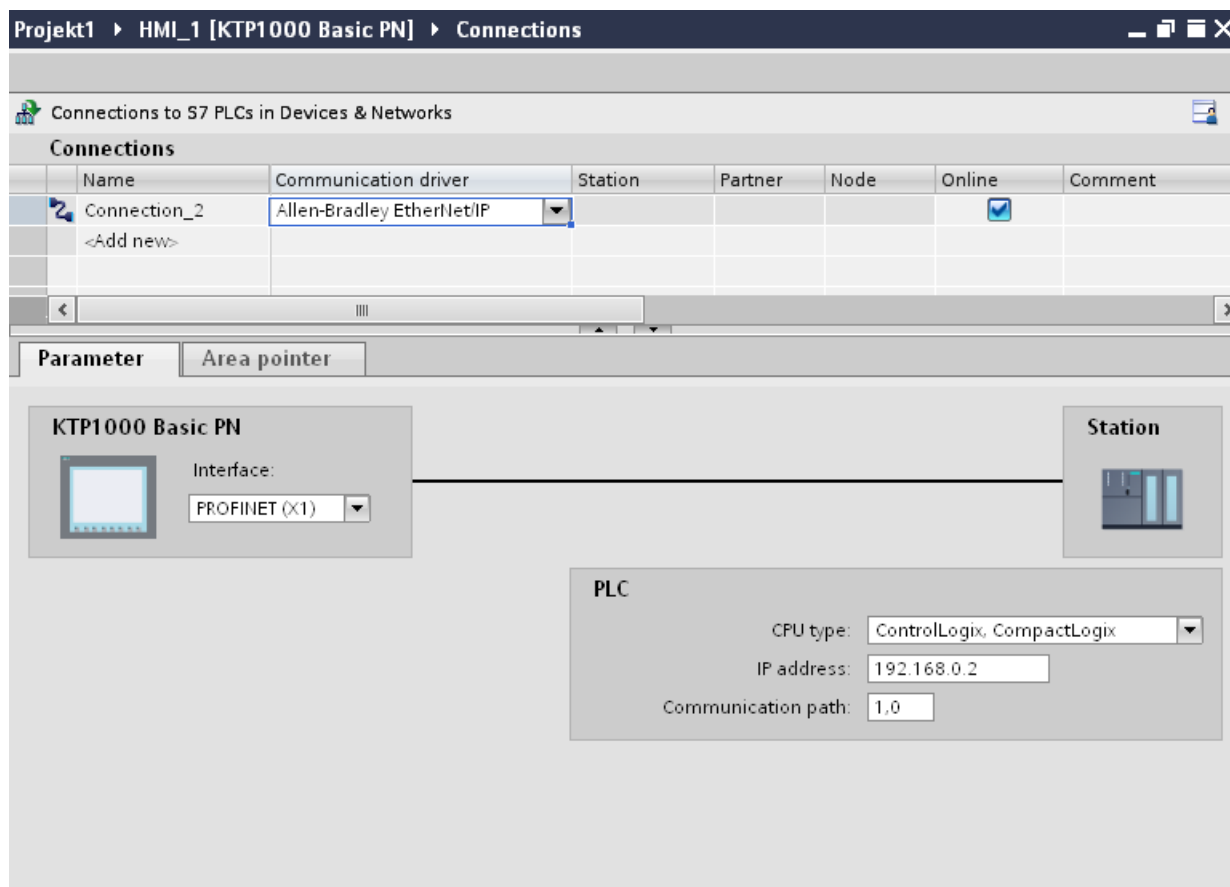

### Parameters for the HMI device

You can select only one interface for the HMI device in the Inspector window under "Parameters". Depending on the HMI device, there are several interfaces available.

If you are directly connected to the HMI device during configuration, you can set up the IP address of the HMI device in WinCC. The IP address is transferred to the HMI device upon subsequent loading.

---

#### Note

The IP address in the control panel will be overwritten upon subsequent loading if you have already set up the IP address in the HMI device control panel.

The IP address already set up in the control panel will be retained upon subsequent loading if you activate "Set IP address using a different method".

---

To set up the IP address of the HMI device:

1. Click on the HMI device.
2. Open the "Device configuration" editor.

3. Click the Ethernet interface.
4. Assign the IP address in the inspector window under:  
"General > PROFINET interface > Ethernet addresses"

### Parameters for the PLC

- CPU type  
For "CPU type", set the CPU type of the PLC used.
- IP address  
Set the IP address or host name of the Ethernet/IP module of the PLC. Only the IP address can be used on a Basic Panel.
- Communication path  
Set the CIP path from the Ethernet module to the PLC. This establishes a logical connection between the Ethernet module and PLC, even if both devices are located in different CIP networks.  
For additional information see: Examples: Communication path

### Connecting HMI device to PLC

#### Connections via Allen-Bradley EtherNet/IP

##### Connection

The HMI device can be connected to the Allen-Bradley PLC using the following components:

- Existing Ethernet network that also contains the PLCs
- Cross-over Ethernet cable connected directly to the Ethernet interface of the CPU or the communication module

The connection of the HMI device to an Allen-Bradley PLC is limited primarily to the physical connection of the HMI device. Special blocks for the connection are not required in the PLC.

##### Communication types

#### Approved communication types with Allen-Bradley EtherNet/IP

The following communication types are system-tested and approved:

- Point-to-point connection to the approved PLCs
- Multipoint connection from a HMI device (Allen-Bradley Ethernet/IP-Client) with up to 4 PLCs with the respectively approved PLCs. CPU types can be mixed.

## Connection

Connection with the following PLCs is approved with Allen-Bradley EtherNet/IP:

- CPU type: "ControlLogix, Compact Logix"
  - ControlLogix  
556x(1756-L6x) with Ethernet module 1756-ENBT
  - Guard Logix-System ControlLogix  
556xS(1756-L6xS) with Ethernet module 1756-ENBT
  - CompactLogix
    - 533xE(1769-L3xE) with Ethernet interface onboard
    - 532xE(1769-L2xE) with Ethernet interface onboard
    - 534x (1768-L4x) with Ethernet module 1768-ENBT
- CPU type: "SLC, MicroLogix"
  - MicroLogix 1100 (with Ethernet interface onboard)
  - MicroLogix 1400 (with Ethernet interface onboard)
  - SLC 5/05 (with Ethernet interface onboard)

## Performance features of communication

### Permitted data types for Allen-Bradley EtherNet/IP

#### Permitted data types

The table lists the data types that can be used when configuring tags and area pointers.

#### CPU type: ControlLogix, CompactLogix

Data type	Length
Bool	1 bit
DInt	4 bytes
Int	2 bytes
Real	4 bytes
SInt	1 byte
String	1 to 80 characters
UDInt	4 bytes
UInt	2 bytes
USInt	1 byte

Permitted data types arrays



Address	Permitted data types
Array	SInt, USInt, Int, UInt, DInt, UDInt, Real
Individual bits from the basic data types of the PLC SInt, USInt, Int, UInt, DInt, UDInt	Bool*

\* Any changed value of certain defined bits is written back to the PLC. There is no check to determine whether any other bits have changed. The PLC (or other PLCs) may only read access the value.

### CPU type: SLC, MicroLogix

Data type	Operand type	Length
ASCII	A	0 to 80 characters
Bool	N, R, C, T, B, S, I, O	1 bit
DInt	N	4 bytes
Int	N, R, C, T, S	2 bytes
Real	N, F	4 bytes
String	ST	1 to 80 characters
UDInt	N	4 bytes
UInt	N, R, C, T, B, I, O	2 bytes

#### Note

Strings in RSLogix 5000 have a default length of 82 characters. A maximum of 80 characters can be displayed in WinCC. Always use strings which do not exceed the maximum length of 80 characters.

Permitted data types arrays

Address	Permitted data types
Array	Int, UInt, DInt, UDInt, Real

### Distinctive features for connections with Allen-Bradley Ethernet/IP

With the communication driver Allen Bradley Ethernet/IP and the CPU type SLC, MicroLogix, you can only use array tags for discrete alarms and trends.

#### Note

I/O modules with 8 or 16 ports occupy one data word on the PLC.

I/O modules with 24 or 32 ports occupy two data words.

The HMI device does not output an error message if using non-existent bits.

You should always make sure that I/O modules with 8 or 24 ports only occupy the bits that are actually assigned to a port.

## Supported CPU types for Allen-Bradley EtherNet/IP

### CPU types

The following CPU types are supported for configuring the Allen-Bradley EtherNet/IP communication driver.

- CompactLogix
  - 1769-L2xE with Ethernet interface onboard
  - 1769-L3xE with Ethernet interface onboard
  - 1768-L4x with Ethernet module 1768-ENBT
- ControlLogix
  - 1756-L6x with Ethernet module 1756-ENBT
- GuardLogix
  - 1756-L61S with Ethernet module 1756-ENBT
  - 1756-L62S with Ethernet module 1756-ENBT
  - 1756-L63S with Ethernet module 1756-ENBT
- MicroLogix
  - MicroLogix 1100 / 1400
- SLC50x
  - SLC5/05

### Addressing in the C.Logix CPU type

#### Addressing

#### Addressing

A tag is uniquely referenced in WinCC by means of an address in the PLC. The address must correspond with the tag name in the PLC. The tag address is defined by a string with a length of up to 128 characters.

#### Using characters for addressing

Valid characters for tag addressing:

- Letters (a to z, A to Z)
- Numbers (0 to 9)
- Underscore ( \_ )

The tag address consists of tag name and other character strings used to specify the tag in the PLC.

Tag name properties:

- The tag name may begin but not end with an underscore character.
- Strings with successive underscore and space characters are invalid.
- The address may not exceed a length of 128 characters.

---

**Note**

The characters reserved for tag addressing may not be used in program/tag names or at any other address instance.

---

The reserved characters are listed below:

Reserved character	Function
.	Element delimiter
:	Definition of a program tag
,	Delimiter for addressing multi-dimensional arrays
/	Reserved for bit addressing.
[ ]	Addressing of array elements or arrays

## PLC and program tags

The Allen-Bradley EtherNet/IP communication driver supports addressing of PLC tags (global project tags) and/or program tags (global program tags).

A program tag is declared based on the program name in the PLC and actual tag name which are delimited by colon. PLC tags are simply addressed by their name.

---

**Note**

**Addressing errors**

Addressing errors occur when the tag name and data type are inconsistent.

Note that the tag name defined in the address field in WinCC must match the tag name in the PLC. Make sure that the data types of tags in WinCC match the data types in the PLC.

---

**Note**

Module-specific tags, e.g. for data on input and output modules, cannot be addressed directly. Instead, use an alias tag in the PLC.

Example: Local:3:O. Data cannot be addressed in WinCC.

If the alias "MyOut" is defined for Local:3:O in the PLC, you can address with WinCC via MyOut.Data.

---

## Addressing syntax

### Notation of addresses

The tables below define the notation for the individual addressing options for Allen-Bradley EtherNet/IP.

Table 10-155 Access to arrays, basic data types and structure elements

Data types	Type	Address
Basic data types	PLC tag	Tag name
	Program tag	Programname:tagname
Arrays	PLC tag	Array tag
	Program tag	Program name: array tag
Bits	PLC tag	Tagname/bitnumber
	Program tag	Programname:tagname/bitnumber
Structure elements	PLC tag	Structure tag. Structure element
	Program tag	Program name: structure tag. structure element

#### Note

Bit addressing with the data types Bool, Real and String is not permitted and will cause an addressing fault.

### Description of the syntax

Syntax description:

```
(Programname:) tagname ([x(, y) (, z)]) { .tagname ([x(, y) (, z)]) } (/bitnumber)
```

- The "(" defines an optional, single instance of an expression.
- The "{" defines an optional expression with multiple single instances.

The address string length may not exceed 128 characters.

### Addressing types

#### Arrays

An array is a data structure that includes a number of data of the same type. WinCC only supports one-dimensional arrays.

In the address column of the tag editor, enter the array name possibly by specifying a start element. The length is defined in the Array Elements input box of the tag editor. If array limits in the PLC are exceeded (due to faulty indexing), addressing errors result.

These arrays must be declared in the PLC as controller or program tags.

Two- or three-dimensional arrays in the PLC can only be addressed in WinCC if these can be mapped area-wise onto one-dimensional arrays .

---

**Note**

During all read accesses and all write accesses, all array elements of a tag are always read or written, respectively. The contents of an array tag which is interconnected with a PLC are always transferred whenever there is a change. The HMI device and the PLC cannot concurrently write data to the same array tag for this reason. Instead of writing data only to a single element, the program writes the entire array to the PLC.

---

### Array elements

Elements of one-dimensional, two-dimensional and three-dimensional arrays in the PLC are indexed by setting an index and the corresponding notation in the tag editor. Array addressing starts at element "0", with arrays of all basic types being valid for element addressing. Read/write operations are only carried out at the addressed element, and not for the entire array.

### Bits and bit tags

Bit access is allowed to all basic data types with the exception of Bool, Real and String. Bit addressing is also allowed at array/structure elements. The Bool data type is set in WinCC when bits and bit tags in the basic data types are addressed.

Single-digit bit numbers are addressed with "/x" or "/0x" (x = bit number). Bit numbers are defined by up to two digits.

---

**Note**

With the "Bool" data type in the data types SInt, Int and DInt, after changing the specified bit the complete tag is then written in the PLC again. In the meantime, no check is made as to whether other bits in the tag have since changed. Therefore, the PLC may have only read access to the specified tag.

---

### Structures

User-defined data types are created by means of structures. These structures group tags of different data types. Structures may consist of basic types, arrays and of other structures. In WinCC, only structure elements are addressed and not entire structures.

### Structure elements

Structure elements are addressed by means of the name of the structure and of the required structure element. This addressing is separated by point. In addition to basic data types, the

structure elements may represent arrays or other structures. Only one-dimensional arrays may be used as a structure element.

---

**Note**

The nesting depth of structures is only limited by the maximum length of 128 characters for the address.

---

## Address multiplexing

### Address multiplexing

Address multiplexing is possible with the CompactLogix, ControlLogix CPU type.

Address multiplexing requires two tags:

- "Tag\_1" of data type "String"; contains a logical address such as "HMI:Robot5.Block5" as value.  
The value may change to a second valid address, for example, "HMI:Robot4.Block3".
- "Tag\_2" is a tag in which the "Allen-Bradley EtherNet/IP" communication driver is set up as a connection.  
Enter a valid name of an HMI\_tag in square brackets as the address.
  - e.g.: "[Tag\_1]"
  - The tag must be of the String data type.
  - The square brackets indicate address multiplexing.
  - The address is derived from the actual value in "Tag\_1".

---

**Note**

You can only multiplex entire Allen-Bradley EtherNet/IP addresses. Multiplexing of address elements is not possible. "HMI:Robot[Tag\_1].Block5" is an invalid address.

You can optionally click the arrow right icon in the "Address" column. Replace the "Constant" with the "Multiplex" entry by clicking the arrow on the left edge of the next address dialog box. Now the tag selection list only returns tags of data type "String".

You can also configure a function triggered by a "change of value" event for multiplexed tags.

---

## Examples for addressing

### Example of a table for addressing

The table below defines the basic variants for addressing PLC tags. Other addressing variants are possible by means of combination.

Type	Type	Address
General	PLC tag	Tag name
	Program tag	Program:tagname
Array	Access to an element of a 2-dimensional array	Arraytag[Dim1,Dim2]
	Element of structure array (1-dimensional)	Arraytag[Dim1].structureelement
	Bit in element basic type array (2-dimensional)	Arraytag[Dim1,Dim2]/Bit
Structure	Array in structure	Structuretag.arraytag
	Bit in the element of an array in the substructure	Structuretag.structure2.arraytag [element]/bit

**Note**

Program tags are addressed by leading the address with the program name derived from the PLC with colon delimiter.

Example: Programname:arraytag[Dim1,Dim2]

**Access to array elements**

Type	Address
PLC tag	Arraytag[Dim1]
	Arraytag[Dim1,Dim2]
	Arraytag[Dim1,Dim2,Dim3]
Program tag	Programname:arraytag[Dim1]
	Programname:arraytag[Dim1,Dim2]
	Programname:arraytag[Dim1,Dim2,Dim3]

**Examples: Communication path****Example 1:**

Connection with a PLC in the same Allen-Bradley rack.

1,0

Number	Meaning
1	Stands for a backplane connection.
0	Stands for a CPU slot number.

**Example 2:**

Connection with a PLC in remote Allen-Bradley racks. Two Allen-Bradley racks are networked on Ethernet.

1,2,2,190.130.3.101,1,5

Number	Meaning
1	Backplane connection
2	Stands for the CPU slot number of the second Ethernet module.
2	Stands for an Ethernet connection.
190.130.3.101	IP address of a remote AB rack on the network – in particular the third Ethernet module
1	Backplane connection
5	Slot number of the CPU

**Commissioning components**

**Transferring a project to the HMI device**

1. Switch the HMI device to "transfer mode".
2. Set all necessary transfer parameters.
  - Interface
  - Transfer parameters
  - Target storage location
3. Start the project transfer.  
The project is compiled automatically.  
All compilation and transfer steps are logged to a message window.

---

**Note**

If running the CompactLogix PLC with firmware earlier than version 18, you will possibly have to restart the HMI device following the transfer of the PLC program.

You could also terminate the connection before transferring the PLC program and set up the connection again after having completed the transfer of the PLC program.

---

**Interconnecting the PLC with the HMI device**

1. Interconnect the PLC with the HMI device using a suitable cable.
2. The message "Connection to PLC .... is established" is output to the HMI device.



## Optimizing the configuration

### Acquisition cycle and update time

The acquisition cycles for the "Area pointers" and of the tags defined in the configuration software are decisive in terms of the update times which can actually be achieved.

The update time is equivalent to the acquisition cycle + transmission time + processing time.

Items to observe when optimizing the update times in configuration data:

- Optimize the maximum and minimum size of the data areas.
- Acquisition cycles which are too short lead to unnecessary load on overall performance. Set the acquisition cycle according to the rate of change of the process values. The rate of temperature changes at a furnace, for example, is significantly slower compared to the speed rate of an electrical drive. A time of approx. 1 second is a benchmark for the acquisition cycle.
- Avoid any gaps when entering the alarm or screen tags in a data area.
- Changes in the PLC can only be detected reliably if these are available at least within the actual acquisition cycle.

### Screens

The refresh rate of screens is determined by the type and volume of data to be visualized.

Only configure short acquisition cycles for objects which actually require shorter refresh cycles. This procedure reduces update times.

### Trends

The HMI device always updates all bit-triggered trends whose group bit is set in the "Trend transfer area". It resets the bits in the next cycle.

The group bit in the PLC program can only be set again after the HMI device has reset all bits.

### Job mailboxes

A high rate and volume of job mailboxes transferred may lead to overload in communication between the HMI device and the PLC.

The HMI device confirms acceptance of the job mailbox by entering the value zero in the first data word of the job mailbox. The HMI device now processes the job for which it requires a certain time slice. It may take the HMI device some time to process a new job mailbox which is transferred in immediate succession to the job mailbox. The next job mailbox is only accepted if sufficient computing resources are available.

## Allen-Bradley DF1

### Configuring a connection via Allen-Bradley DF1

#### Introduction

You configure a connection to a PLC with an Allen-Bradley DF1 communication driver in the "Connections" editor of the HMI device.

The interfaces are named differently depending on the HMI device.

#### Requirements

- A project is open.
- An HMI device has been created.

#### Procedure

1. Double-click the HMI device under "Devices" in the project tree.
2. Double-click the "Connections" item.
3. Double-click "<Add>" in the "Connections" editor.

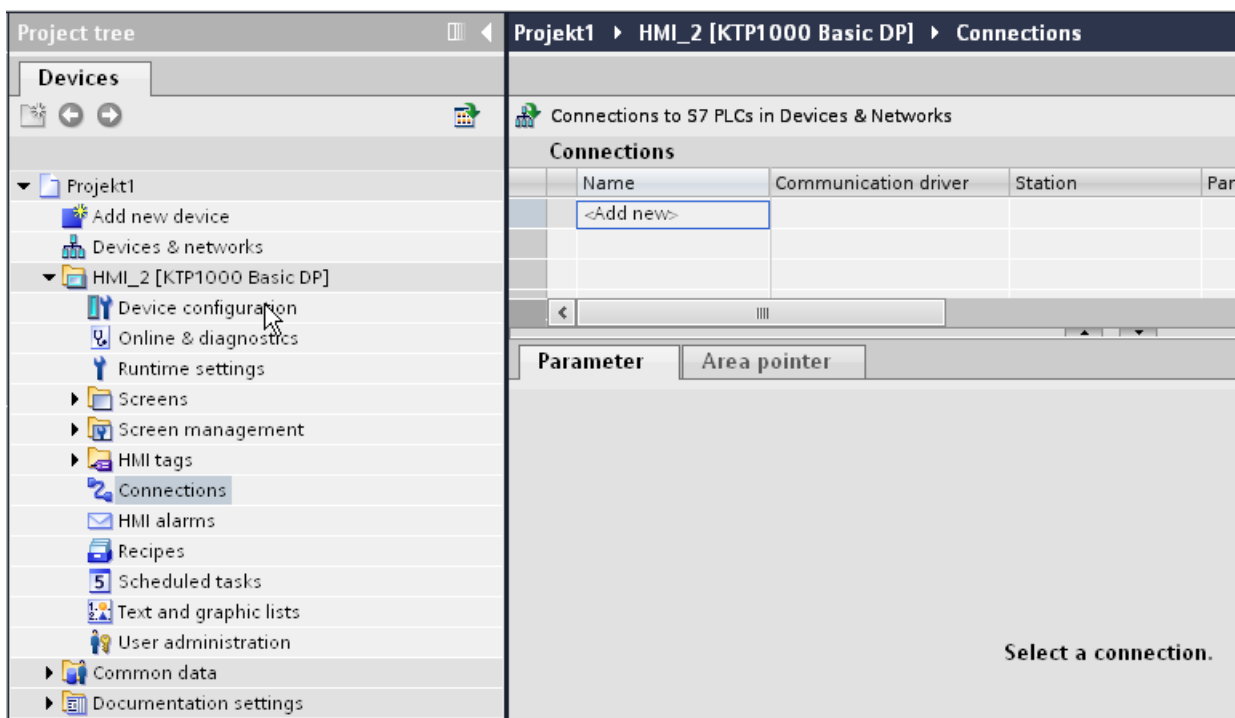

4. In the "Communication drivers" column, select the "Allen-Bradley DF1" driver.

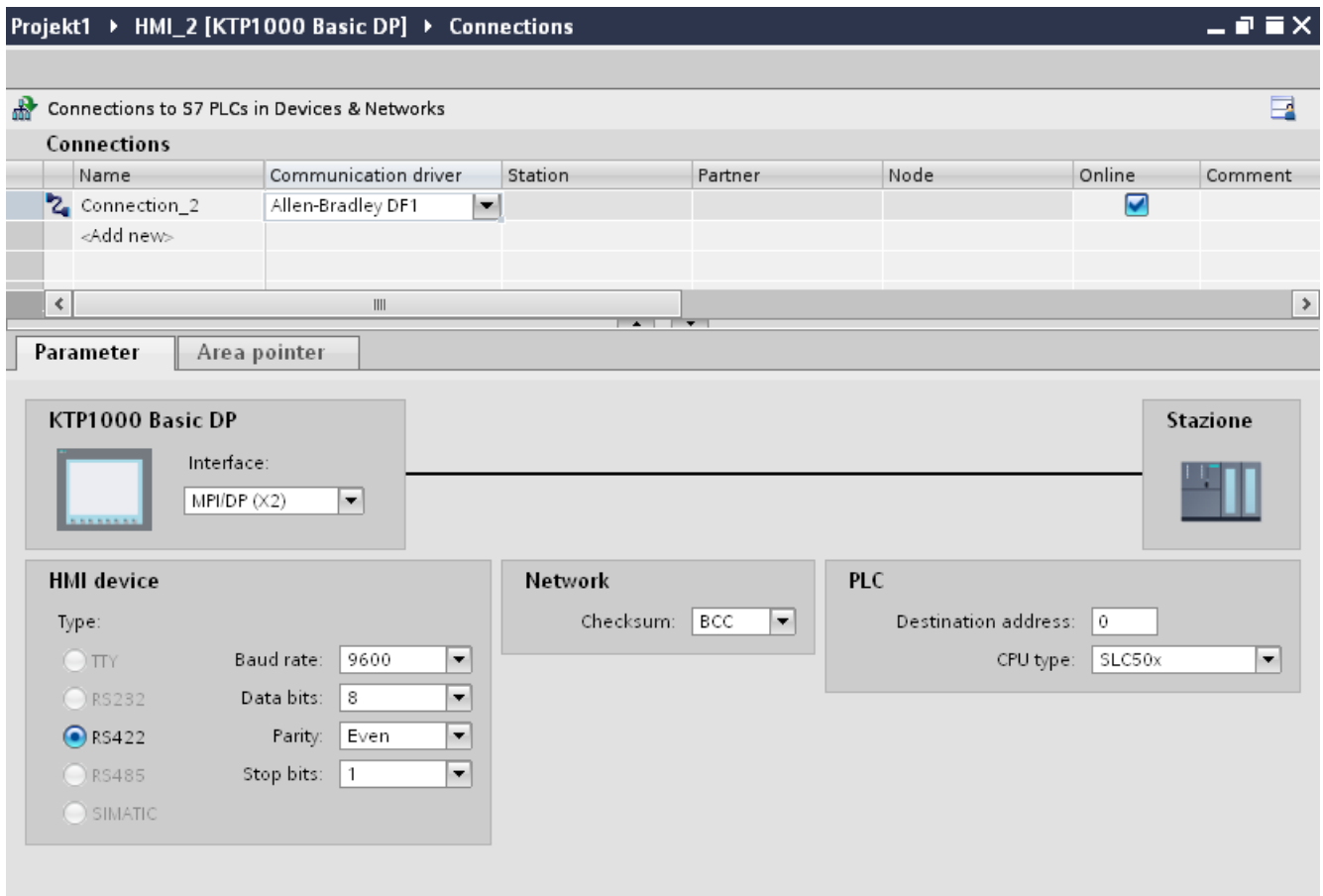

5. Select all necessary connection parameters for the interface in the Inspector window under "Parameters".

## Parameters for the connection (Allen-Bradley DF1)

### Parameters to be set

To set the connection parameters, such as addresses and profiles, click the connection that you have created in the "Connections" editor.

The communication partners are displayed schematically in the Inspector window under "Parameters". The "HMI device", "Network", and "PLC" areas are available for assigning parameters according to the interface used.

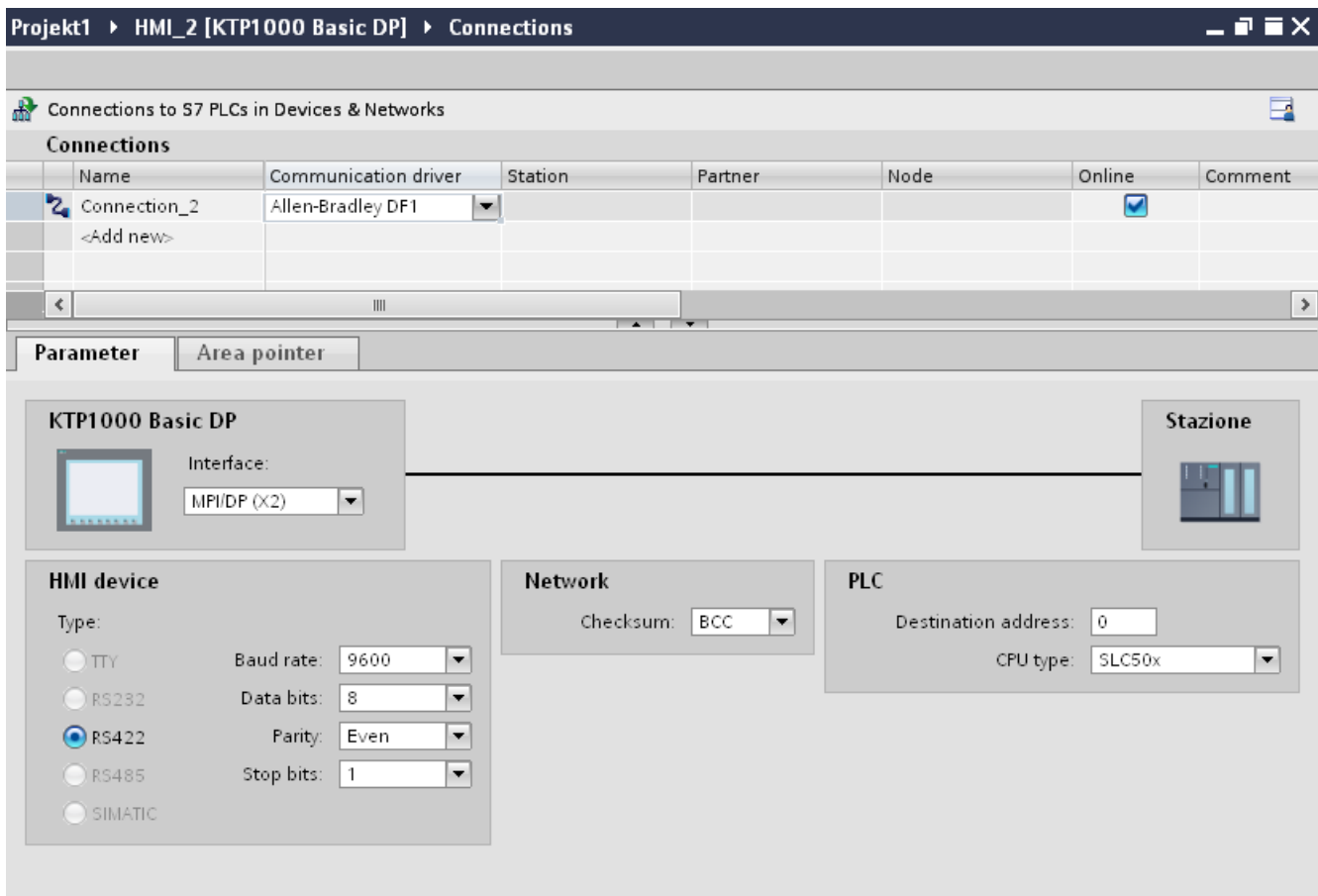

### Parameters for the HMI device

- **Interface**  
Under "Interface", you select the interface of the HMI device to which the PLC is connected. For additional information, refer to the device manual for the HMI device.
- **Type**  
Specifies the physical connection used.

---

#### Note

If you are using the IF1B interface, you must also reconnect the RS-485 receive data and the RTS signal to the rear of the HMI devices via 4 DIP switches.

---

- **Baud rate**  
For "Baud rate", select the transmission speed between the HMI device and PLC.
- **Data bits**  
For "Data bits", you can choose between "7 bits" and "8 bits".
- **Parity**  
For "Parity", you can choose from "None", "Even", and "Odd".
- **Stop bits**  
For "Stop bits", you can choose between 1 and 2 bits.

### Parameters for the network

- Checksum  
For "Checksum", choose the method for determining the error code: "BCC" or "CRC".

### Parameters for the PLC

- Destination address  
For "Destination address", choose the PLC address. If there is a point-to-point DF1 connection, you set the address "0".
- CPU type  
For "CPU type", set the CPU type of the PLC used.

---

#### Note

Assign the DF1 FULL-DUPLEX driver in the CPU as follows: "NO HANDSHAKING" for "Control Line" and "AUTO-DETECT" for "Embedded Responses".

---

## Connecting HMI device to PLC

### Connections via Allen-Bradley DF1

#### Connection

The connection is established when you have matched the parameters of the PLC and the HMI device. Special blocks for the connection are not required in the PLC.

---

#### Note

Rockwell offers a variety of communication adapters for integrating "DF1 devices" for the DH485, DH, and DH+ networks. Of these connections, the direct connection and the connection via KF2 and KF3 module are approved. None of the other connections have been system-tested by SIEMENS AG and are therefore not approved.

---

## Communication partners for Allen-Bradley DF1

### Connectable PLCs

The communication drivers listed below support Allen-Bradley PLCs :

PLC	DF1 (point-to-point)  RS-232	DF1 (point-to-point)  RS-422	DF1 (multipoint) over KF2 module to DH+ LAN RS-232/RS-422	DF1 (multipoint) over KF3 module to DH485 LAN RS-232
SLC500	–	–	–	X
SLC501	–	–	–	X
SLC502	–	–	–	X
SLC503	X	–	–	X
SLC504	X	–	X	X
SLC505	X	–	–	X
MicroLogix	X	–	–	X
PLC-5 <sup>1)</sup>	X	X	X	–

<sup>1)</sup> Processors released for PLC-5: PLC-5/11, PLC-5/20, PLC-5/30, PLC-5/40, PLC-5/60, and PLC-5/80.

### Communication types

#### PLCs with Allen-Bradley DF1 communication driver

The communication between the HMI device and the following Allen Bradley PLCs is described in this section:

- SLC500
- SLC501
- SLC502
- SLC503
- SLC504
- SLC505
- PLC5
- MicroLogix

In these PLCs the connection is made by the PLC-internal protocols Allen Bradley DF1, Allen Bradley DH485 and Allen Bradley DH+.

The Allen-Bradley DF1 communication driver is used here, the protocol of which is converted into one of the other two PLC-internal protocols in multipoint communication with the communication modules KF2 (Allen Bradley DH+) and KF3(Allen Bradley DH485).

## Enabled types of communication with Allen-Bradley DF1

The following communication types are system-tested and enabled:

- HMI (Allen Bradley DF1)  
Point-to-point connection
- HMI (Allen Bradley DF1)  
Via KF2 module to Allen Bradley DH+ (communication with up to 4 PLCs)
- HMI (Allen Bradley DF1)  
Via KF3 module to Allen Bradley DH485 (communication with up to 4 PLCs)

## Connectable PLCs

The Allen Bradley DF1 communication driver is available for the following Allen-Bradley PLCs:

PLC	DF1 (point-to-point)	DF1 (point-to-point)	DF1 (multipoint) via KF2 module to DH+ LAN RS 232/RS 422	DF1 (multipoint) via KF3 module to DH485 LAN RS 232 <sup>2)</sup>
	RS 232	RS 422		
SLC500	–	–	–	X
SLC501	–	–	–	X
SLC502	–	–	–	X
SLC503	X <sup>2)</sup>	–	–	X
SLC504	X <sup>2)</sup>	–	X	X
SLC505	X <sup>2)</sup>	–	–	X
MicroLogix	X <sup>2)</sup>	–	–	X
PLC-5 <sup>1)</sup>	X	X	X	–

<sup>1)</sup> Only the following processors are approved for PLC-5: PLC-5/11, PLC-5/20, PLC-5/30, PLC-5/40, PLC-5/60 und PLC-5/80.

<sup>2)</sup> For HMI devices which only have an RS 422/485 interface and the communication partner is an RS 232 interface, the RS 422/232 converter is tested and approved.  
Order number: 6AV6 671-8XE00-0AX0

## DF1 protocol with multi-point connection

### Point-to-point connection with DF1 protocol

Only point-to-point connections can be established with the DF1 protocol.

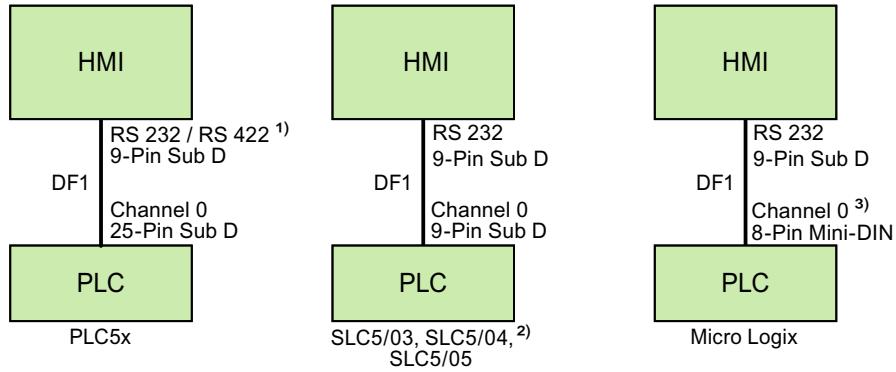

- 1) Only RS 232 is possible for Panel PC and PC.
- 2) A point-to-point connection to the SLC500, SLC501, and SLC502 PLCs via DF1 is not possible.
- 3) For MicroLogix ML1500 LRP, Channel 1 (9-pin Sub D) is also possible.

### Connecting cable

HMI panel interface used	For connection to PLC5x	For connection to SLC5/03, SLC5/04, SLC5/05	For connection to MicroLogix
RS 232 9-pin	Allen-Bradley cable 1784-CP10	Allen-Bradley cable 1747-CP3	Allen-Bradley cable 1761-CBL-PM02
RS 422 9-pin	Connecting cable 9-pin Sub D RS 422	—	—

Refer to the relevant device manual to determine which HMI device interface is to be used.

The cable pin assignments can be found in Section "Connecting cables for Allen-Bradley".



### DF1 protocol with multi-point connection via KF2 module

### DF1 protocol with multi-point connection via KF2 module to DH+ LAN

The use of a KF2 protocol interface module enables a connection to be made to PLCs in the DH+ LAN (Data Highway Plus Local Area Network).

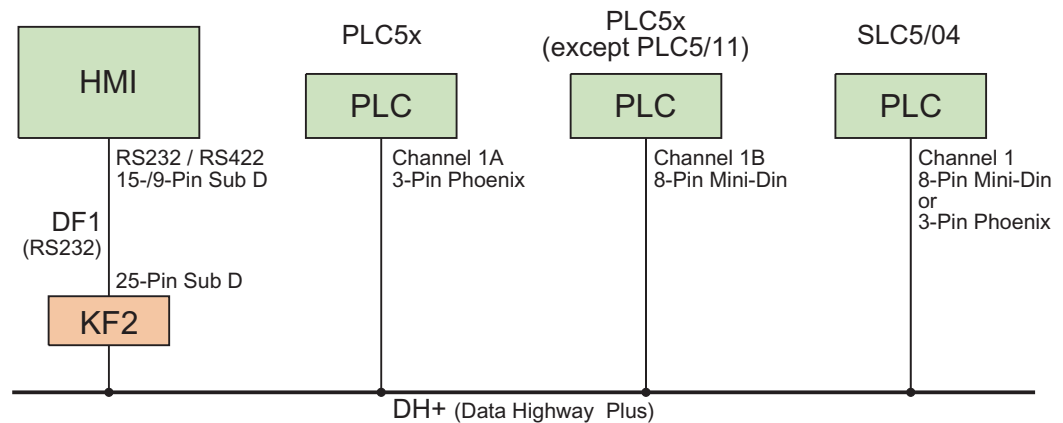

#### Connecting cable

HMI panel interface used	For connection to KF2 interface module
RS 232 9-pin	Allen-Bradley cable 1784-CP10 and 25-pin socket/socket adapter
RS 422 9-pin	9-pin Sub D RS 422 connecting cable and 25-pin female/female adapter

Refer to the Allen-Bradley documentation for the cable connection from the PLCs to the DH+ data bus.

Refer to the relevant device manual to determine which HMI device interface is to be used.

The cable pin assignments can be found in Section "Connecting cables for Allen-Bradley".

**DF1 protocol with multi-point connection via KF3 module**

**DF1 protocol with multi-point connection via KF3 module to DH485 LAN**

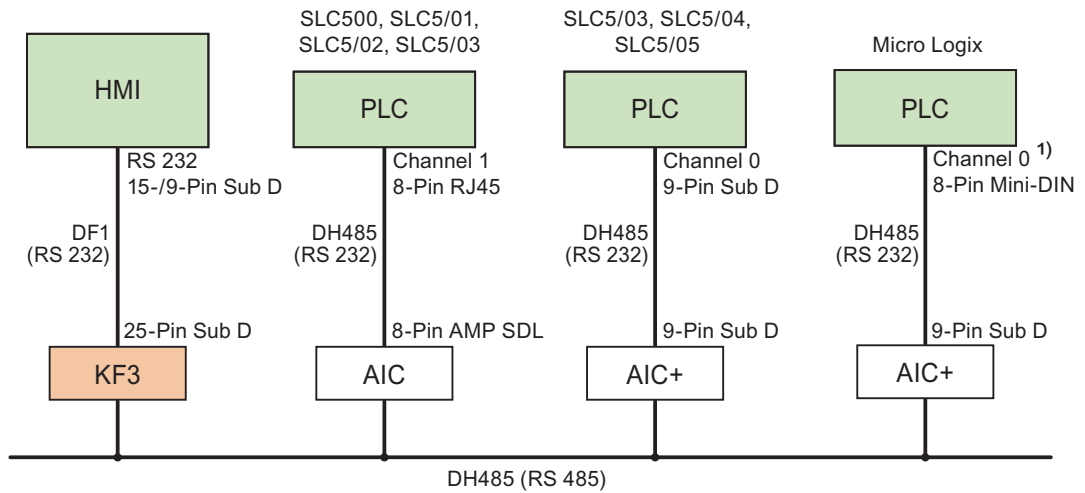

1) For MicroLogix ML1500 LRP, Channel 1 (9-pin Sub D) is also possible.

**Connecting cable**

HMI panel interface used	For connection to KF3 interface module
RS 232 9-pin	Allen-Bradley cable 1784-CP10 and 25-pin socket/socket adapter

Refer to the relevant device manual to determine which HMI device interface is to be used. The cable pin assignments can be found in Section "Connecting cables for Allen-Bradley".

**Connecting cables for Allen-Bradley DF1**

**Connecting cable 9-pin Sub D RS 422 for Allen-Bradley**

**Connecting cable 9-pin Sub D RS 422**

For interconnecting the HMI device (RS 422, 9-pin sub D) - PLC5x, KF2, KF3

You require an additional 25-pin, female / female adapter (gender changer) for interconnections with KF2 and KF3.

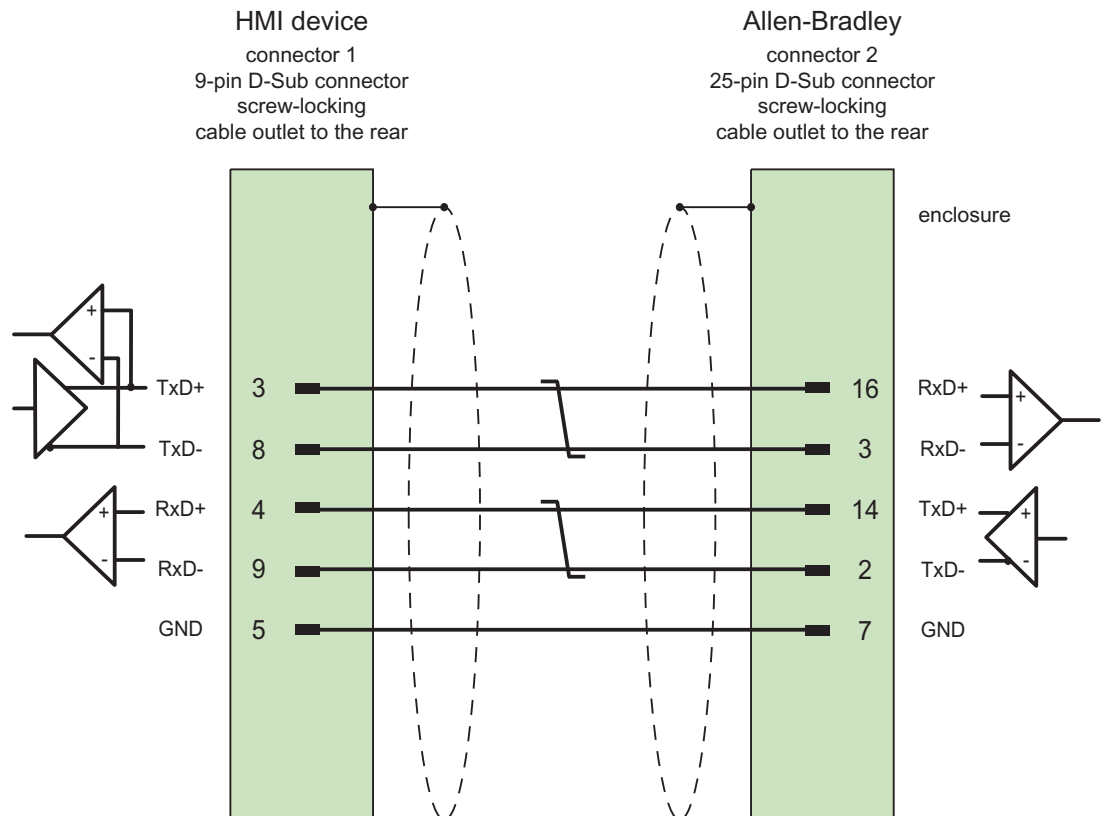

Shield with large-area contact to housing at both ends, interconnected shield contacts  
 Cable: 3 x 2 x 0.14 mm<sup>2</sup>, shielded,  
 max. length 60 m

### Connecting cable 1784-CP10, RS 232, for Allen-Bradley

#### Allen-Bradley cable 1784-CP10

For interconnecting the HMI device (RS 232, 9-pin sub D) - PLC5x, KF2, KF3

You require an additional 25-pin, female / female adapter (gender changer) for interconnections with KF2 and KF3.

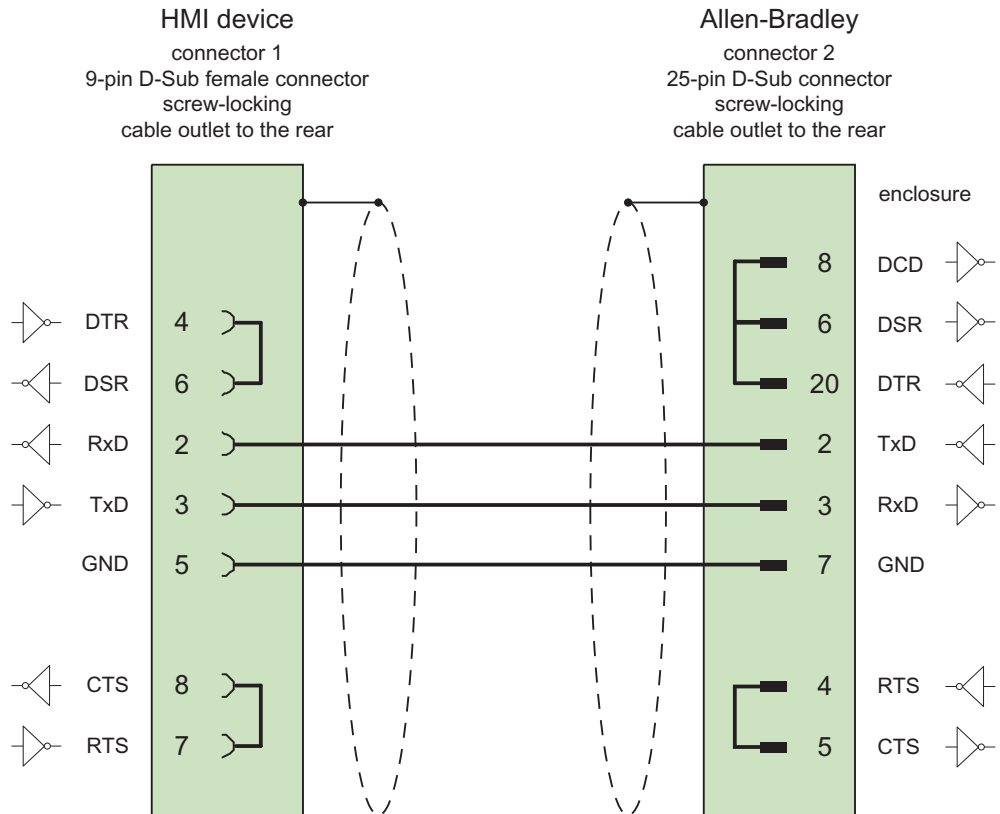

Screen connected with housing over large area on both sides  
max. length 15 m

### Connecting cable 1747-CP3, RS-232, for Allen-Bradley

#### Allen-Bradley cable 1747-CP3

For interconnecting the HMI device (RS 232, 9-pin sub D) - SLC503, SLC504, SLC505 (Channel 0), AIC+

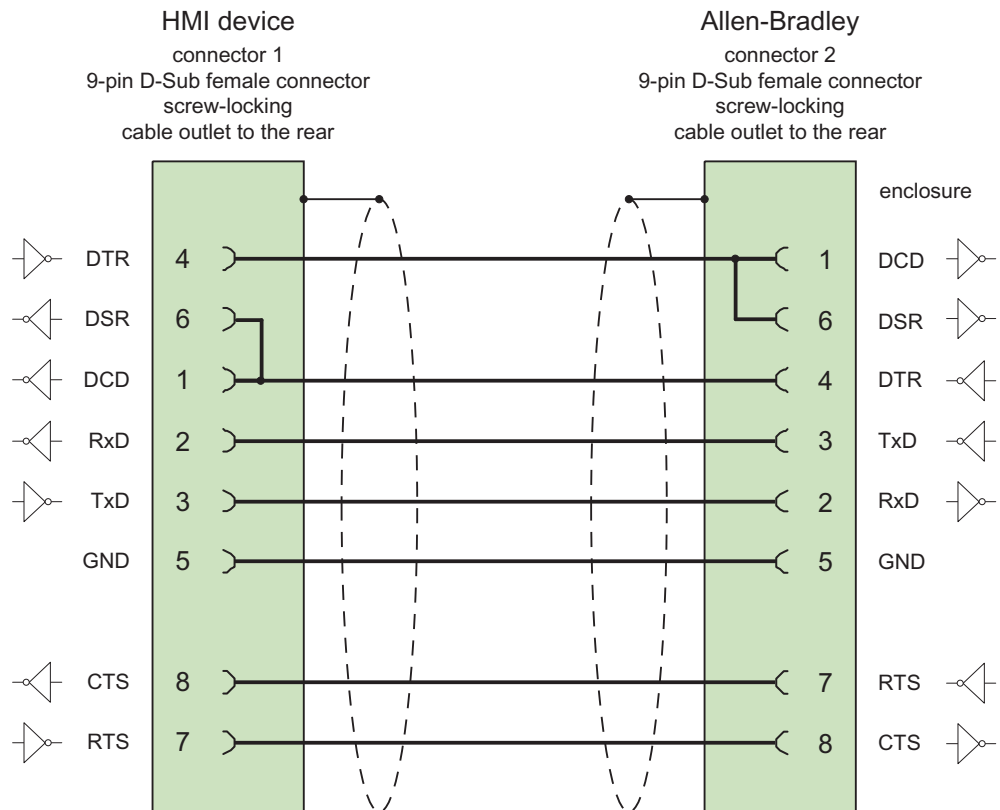

Screen connected with housing over large area on both sides  
max. length 3 m

### Connecting cable 1761-CBL-PM02, RS-232, for Allen-Bradley

#### Allen-Bradley cable 1761-CBL-PM02

For interconnecting the HMI device (RS 232, 9-pin sub D) - Micro Logix, AIC+

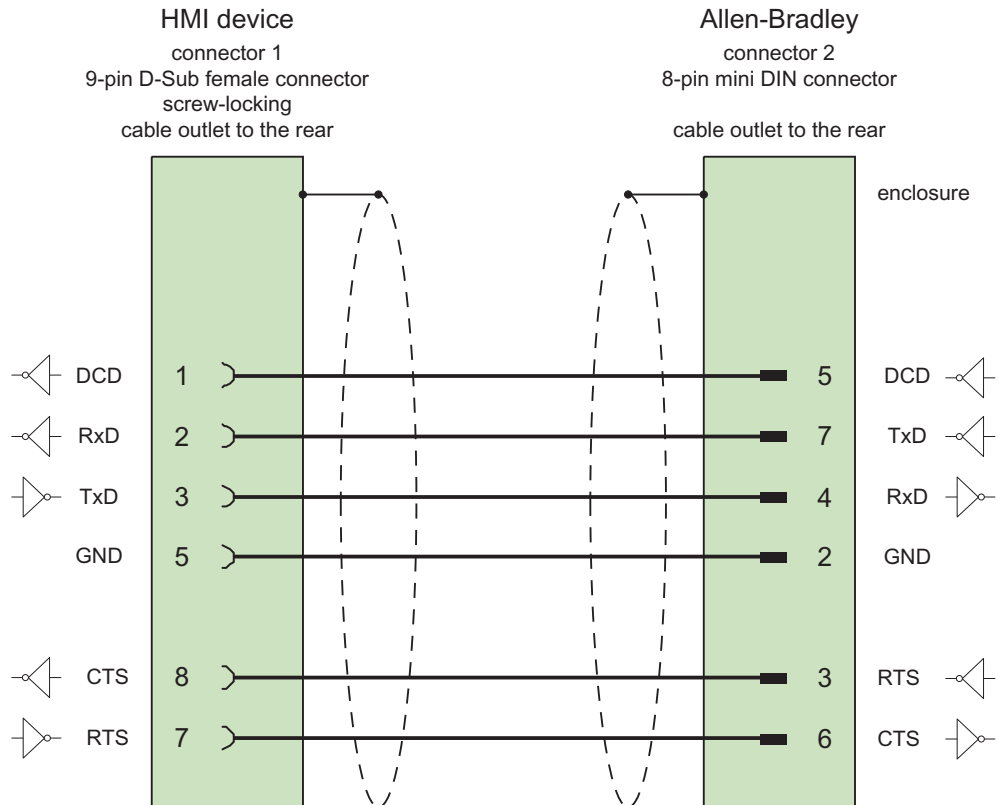

Screen connected with housing over large area on both sides  
max. length 15 m

### Performance features of communication

### Permitted data types for Allen-Bradley DF1

### Permitted data types for Allen-Bradley DF1

The table lists the user data types that can be used when configuring tags and area pointers.

Data type	Operand type	Length
ASCII	A <sup>1)</sup>	1 to 80 characters
Bool	N, R, C, T, B, S, I, O	1 bit
Int	N, R, C, T, S	2 bytes
DInt	N, D <sup>2)</sup>	4 bytes
UInt	N, R, C, T, B, I, O, D <sup>2)</sup>	2 bytes
UDInt	N, D <sup>2)</sup>	4 bytes
Real	N, F <sup>1)</sup>	4 bytes

- 1) Selectable depending on the selected CPU type.
- 2) Only for PLC5 CPU type

## Abbreviations

In WinCC, formats of the data types are abbreviated as follows:

- UNSIGNED INT = UInt
- UNSIGNED LONG = UInt
- SIGNED INT = Int
- SIGNED LONG = DInt

## Distinctive features for connections with Allen-Bradley DF1

With Allen Bradley DF1, array tags may only be used for discrete alarms and trends.

---

### Note

I/O modules with 8 or 16 ports occupy one data word on the PLC.

I/O modules with 24 or 32 ports occupy two data words.

The HMI device does not output an error message if using non-existent bits.

You should always make sure that I/O modules with 8 or 24 ports only occupy the bits that are actually assigned to a port.

---

## Supported CPU types for Allen-Bradley DF1

### CPU types

The following CPU types are supported for configuring the Allen-Bradley DF1 communication driver.

- SLC
  - SLC500
  - SLC501
  - SLC502
  - SLC503
  - SLC504
  - SLC505
- MicroLogix
  - MicroLogix 1x00
  - MicroLogix 1100 / 1400
- PLC 5
  - PLC-5/11
  - PLC-5/20
  - PLC-5/40
  - PLC-5/60
  - PLC-5/80

### Addressing

### Addressing

The addressing is entered in the following order in the Allen-Bradley DF1 communication driver:

- Operand type
- File number
- Element number



- Child element
- Bit number

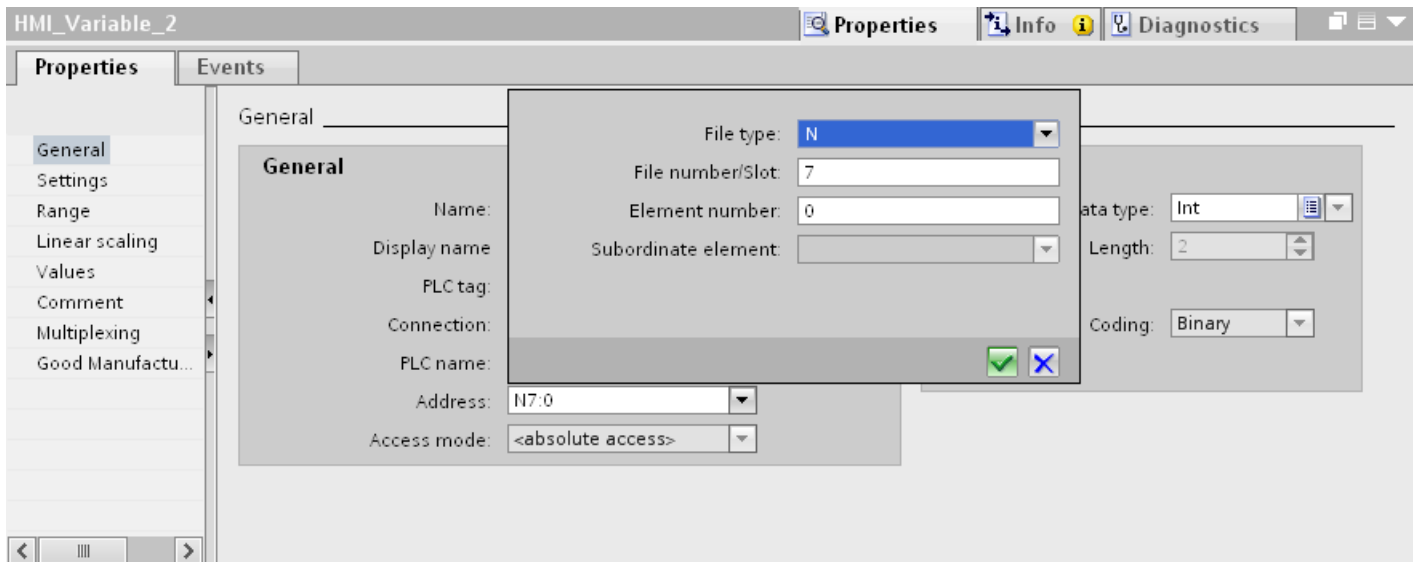

The address then appears in the following format without spaces:

- File type file number : Element number . Child element
- e.g. T8:2.ACC

## Operand type

You have the following options under operand type:

- I
- O
- S
- B
- T
- C
- R
- N
- A
- D only for PLC5 CPU type

## File number

Select the number between two limits under file number:

- Low limit
- High limit

The limit values depend on the selected file type.

### Child element

You can select a child element when you have selected one of the following data types:

- R
- C
- T

### Commissioning components

#### Transferring a project to the HMI device

1. Switch the HMI device to "transfer mode".
2. Set all necessary transfer parameters.
  - Interface
  - Transfer parameters
  - Target storage location
3. Start the project transfer.

The project is compiled automatically.  
All compilation and transfer steps are logged to a message window.

#### Interconnecting the PLC with the HMI device

1. Interconnect the PLC with the HMI device using a suitable cable.
2. The message "Connection to PLC .... is established" is output to the HMI device.

### Optimizing the configuration

#### Acquisition cycle and update time

The acquisition cycles for the "Area pointers" and of the tags defined in the configuration software are decisive in terms of the update times which can actually be achieved.

The update time is equivalent to the acquisition cycle + transmission time + processing time.

Items to observe when optimizing the update times in configuration data:

- Optimize the maximum and minimum size of the data areas.
- Acquisition cycles which are too short lead to unnecessary load on overall performance. Set the acquisition cycle according to the rate of change of the process values. The rate of temperature changes at a furnace, for example, is significantly slower compared to the speed rate of an electrical drive. A time of approx. 1 second is a benchmark for the acquisition cycle.

- Avoid any gaps when entering the alarm or screen tags in a data area.
- Changes in the PLC can only be detected reliably if these are available at least within the actual acquisition cycle.

## Screens

The refresh rate of screens is determined by the type and volume of data to be visualized.

Only configure short acquisition cycles for objects which actually require shorter refresh cycles. This procedure reduces update times.

## Trends

The HMI device always updates all bit-triggered trends whose group bit is set in the "Trend transfer area". It resets the bits in the next cycle.

The group bit in the PLC program can only be set again after the HMI device has reset all bits.

## Job mailboxes

A high rate and volume of job mailboxes transferred may lead to overload in communication between the HMI device and the PLC.

The HMI device confirms acceptance of the job mailbox by entering the value zero in the first data word of the job mailbox. The HMI device now processes the job for which it requires a certain time slice. It may take the HMI device some time to process a new job mailbox which is transferred in immediate succession to the job mailbox. The next job mailbox is only accepted if sufficient computing resources are available.

## Data exchange

### Area pointers for Allen-Bradley

#### Area pointers for connections using an Allen-Bradley communication driver

You use an area pointer to access a data area in the PLC.

For more detailed information on area pointers and their configuration, refer to Section "Data exchange using area pointers".

#### Distinctive features for connections via Allen-Bradley EtherNet/IP

You can configure the following area pointers

Area pointer	Allen-Bradley EtherNet/IP	Allen-Bradley DF1
Screen number	Yes	Yes
Date/time	Yes	Yes
Date/time PLC	Yes	Yes

Area pointer	Allen-Bradley EtherNet/IP	Allen-Bradley DF1
Coordination	Yes	Yes
Project ID	Yes	Yes
Job mailbox	Yes	Yes
Data record	Yes	Yes

### Restrictions Allen-Bradley Ethernet/IP

The following restrictions apply for configuring area pointers.

CPU type	Data types	File types
ControlLogix, CompactLogix	Int, UInt	--
SLC, MicroLogix	Int, UInt	N, B

### Restrictions Allen-Bradley DF1

The following restrictions apply for configuring area pointers.

CPU type	Data types	File types
MicroLogix	--	N, O, I, B
SLC50x	--	N, O, I, B
PLC5	--	N, O, I, B

### See also

Data exchange using area pointers (Page 5446)

### Trends

#### General information on trends

### Trends

A trend is the graphical representation of one or more values from the PLC. The value is read out either time- or bit-triggered, depending on the configuration.

For additional information see:

Displaying tags with Runtime Advanced and Panels (Page 3237)

#### Note

The value is read out time-triggered for Basic Panels.

## Time-triggered trends

The HMI device reads in the trend values cyclically at an interval specified in the configuration. Time-triggered trends are suitable for continuous curves, such as the operating temperature of a motor.

## Bit-triggered trends

Through a trigger bit set in the trend request tag, the HMI device either reads in a trend value or an entire trend buffer. This setting is defined in the configuration. Bit-triggered trends are normally used to represent fast changing values. One example might be the injection pressure in the production of plastic parts.

To trigger bit-triggered trends, appropriate external tags must be created in the "HMI tags" editor and connected to trend areas during configuration. The HMI device and PLC then communicate with each other via these trend areas.

The following areas are available for trends:

- Trend request area
- Trend transfer area 1
- Trend transfer area 2 (required only with switch buffers)

## Trend request and trend transfer

### Trend request area

The HMI device sets corresponding bits in the trend request area when you open a screen which contains one or more trends on the HMI device. After closing the screen, the HMI device resets the relevant bits in the trend request area.

The trend request area can be used for evaluation purposes in the PLC to determine which trend is currently being displayed on the HMI device. Trends can also be triggered without evaluation of the trend request area.

### Trend transfer area 1

This area is used to trigger trends. You must set the bit assigned to the trend in the trend transfer area and set the trend group bit in your control program. The trend group bit is the last bit in the trend transfer area.

The HMI device detects the trigger. The HMI device reads either a value or the entire buffer from the PLC. It then resets the trend bit and the trend group bit.

The following picture shows the structure of a trend transfer area.

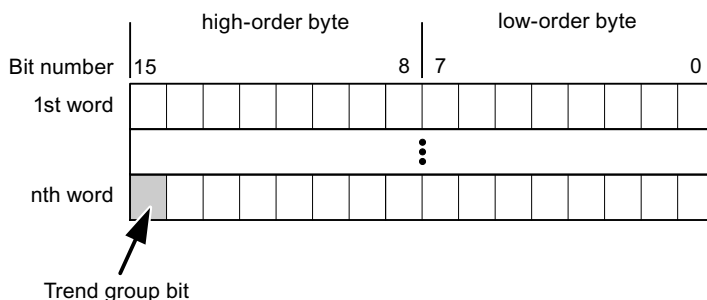

The trend transfer area must not be modified by the PLC program until the trend group bit has been reset.

### Trend transfer area 2

Trend transfer area 2 is required for trends configured with a switch buffer. The trend transfer areas 1 and 2 have a similar structure.

### Switch buffer

The switch buffer is a second buffer for the same trend that can be set up during configuration.

The PLC writes to Buffer 2 while the HMI device reads values from Buffer 1, and writes to Buffer 1 when the HMI device is reading Buffer 2. This prevents the PLC from overwriting trend values while the trend is being read by the HMI device.

### Restrictions to the trend control

#### For Allen-Bradley DF1 communication drivers

Tags of the following operand types are permitted:

- "N"
- "O"
- "I"
- "S"
- "B"

Permitted data types:

- "UInt"
- "Int"
- Array tag of "UInt"
- Array tag of "Int"

You assign a bit to a trend during configuration. This sets a defined bit assignment for all trend areas.

## For Allen-Bradley EtherNet/IP communication drivers

Tags of data type "Int" or an array tag of data type "Int" are permitted. You assign a bit to a trend during configuration. This sets a defined bit assignment for all trend areas.

## ControlLogix and CompactLogix

The following data types are possible for tags for the ControlLogix and CompactLogix CPU types:

- "UInt"
- "Int"
- Array tag of "UInt"
- Array tag of "Int"

## SLC and MicroLogix

The following operand types are permitted for tags of the SLC and MicroLogix CPU types:

- "N"
- "O"
- "I"
- "S"
- "B"

Permitted data types:

- "UInt"
- "Int"
- Array tag of "UInt"
- Array tag of "Int"

## Alarms

### Configuring alarms

#### Configuring alarms for non-integrated connections

Several steps are necessary to configure alarms such as warnings, error messages and acknowledgement.

- Step 1: Create tags
- Step 2: Configure alarms
- Step 3: Configure acknowledgment

You can find additional information in the section:

Working with Alarms (Page 3260)

### Distinctive features when configuring alarms

If you are configuring connections of HMI devices to PLCs of other manufacturers, note the following distinctive features when configuring:

- Data types of the tags
- Addressing of tags
- How the bit positions are counted

### Restrictions

Only tags whose "File type" is "N", "O", "I", "S" and "B" are allowed for use as a "trigger tag" for discrete alarms. These tags are only valid for the data types "Int" and "UInt".

### Data types

For connections with an Allen-Bradley communication driver, the following data types are supported:

Communication drivers	PLC	Permitted data types	
		Discrete alarms	Analog alarms
Allen-Bradley DF1	SLC500, SLC501, SLC502, SLC503, SLC504, SLC505, PLC5, MicroLogix	Int, UInt	Int, UInt, Long, ULong, Real
Allen-Bradley EtherNet/IP	ControlLogix, CompactLogix, SLC, Micrologix	Int, UInt	SInt, USInt, Int, UInt, DInt, UDIInt, Real

### How the bit positions are counted

For connections with an Allen-Bradley communication driver, the following counting method applies:

How the bit positions are counted	Left byte								Right byte								
In Allen-Bradley PLCs	15							8	7								0
In WinCC you configure:	15							8	7								0



## Acknowledgment of alarms

### Procedure

Create suitable tags on the PLC to acknowledge an error alarm. You assign these tags to an alarm in the "Bit messages" editor. You make the assignment in "Properties > Acknowledgment".

Distinction in terms of acknowledgment:

- Acknowledgment by the PLC
- Acknowledgment on the HMI device

### Acknowledgment by the PLC

In "PLC acknowledgment tag", configure the tag or array tag and the bit number that the HMI device uses to identify a PLC acknowledgment.

A bit set in the tag triggers acknowledgment of the assigned error alarm bit at the HMI device. This tag bit returns a function similar to acknowledgment on the HMI device which is triggered by pressing the "ACK" button, for example.

The acknowledgment bit must be located in the same tag as the bit for the error alarm.

Reset the acknowledgment bit before setting the bit in the alarm area again. The figure below shows the pulse diagram.

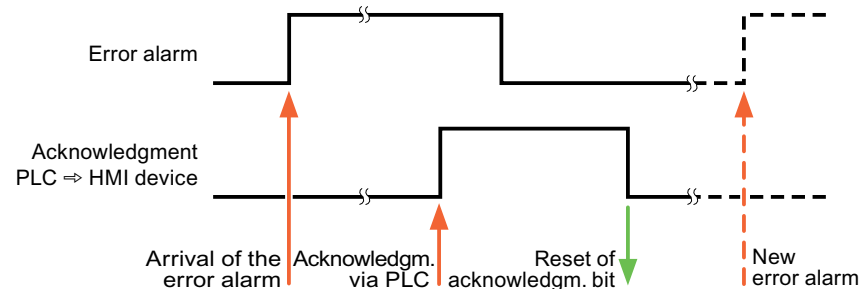

### Acknowledgment on the HMI device

In the "HMI acknowledgment tag" area, configure the tag or array tag as well as the bit number that the HMI device writes to the PLC after acknowledgment. Make sure when you use an array tag that it is not longer than 6 words.

To always create a signal change when setting an assigned acknowledgment bit of a discrete alarm that must be acknowledged, the HMI device will reset the acknowledgment bit assigned to the alarm as soon as it detects an alarm subject to acknowledgment and write the acknowledgment tag in the PLC. There will be a certain delay between detecting the message and writing the acknowledgment tag in the PLC because the HMI device has to process the operations.

If a discrete alarm subject to acknowledgment is acknowledged by the HMI device, then the corresponding bit in the assigned acknowledgment tag will be set. The entire acknowledgment

tag is then written to the PLC by the HMI device. This allows the PLC to recognize that a certain alarm message has been acknowledged at the HMI device.

---

**Note**

All alarm bits acknowledged since the last Runtime start will remain in the acknowledgment tag until a new incoming of the respective discrete alarms is detected.

This area should only be read by the PLC because the entire section of the HMI device will be overwritten once the next acknowledgment tag is written.

---

The figure below shows the pulse diagram.

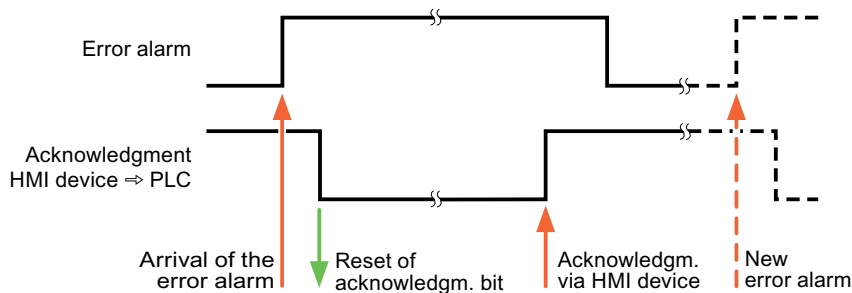

## LED mapping

### Function

Keyboard devices have LEDs in the function keys. These LEDs can be activated from the PLC. Thus, it is possible, for example, to signal to the user which key he should press in a given situation by lighting up an LED.

---

**Note**

The LED function cannot be configured for Basic Panels.

---

### Requirements

In order to activate an LED, an LED tag or an array tag must be set up in the PLC and specified as an LED tag during configuration.

### LED assignment

The assignment of the individual LEDs to the bits in the LED tags is specified when the function keys are configured. In this process, the "LED tag" and the assigned "Bit" are specified for each function key in the "General" group of the properties window.

The "Bit" bit number designates the first of two consecutive bits that control the following LED statuses.

Bit n+ 1	Bit n	LED function	
		All Mobile Panels, all Operator Panels, all Multi Panels	Panel PCs:
0	0	Off	Off
0	1	Rapid flashing	Flashing
1	0	Slow flashing	Flashing
1	1	On permanently	On permanently

## Mitsubishi

### Mitsubishi communication drivers

#### Introduction

This section describes the communication between an HMI device and PLCs that use Mitsubishi communication drivers.

The following communication drivers are supported:

- Mitsubishi MC TCP/IP
- Mitsubishi FX

#### Data exchange

Data is exchanged by means of tags or area pointers.

- Tags  
The PLC and the HMI device use process values for data exchange. You create tags in the configuration that point to addresses in the PLC. The HMI device reads the value from the defined address, and then displays it. The operator may also enter values on the HMI device, which are then written to the address in the PLC.
- Area pointers  
Area pointers are used to exchange specific data and are only set up when these data are used.

## Mitsubishi MC TCP/IP

### Configuring a connection via Mitsubishi MC TCP/IP

#### Introduction

You configure a connection to a PLC with a Mitsubishi MC TCP/IP communication driver in the "Connections" editor of the HMI device.

The Ethernet interfaces are named differently depending on the HMI device.

Example: PROFINET interface corresponds to the Ethernet interface

### Requirements

- A project is open.
- An HMI device has been created.

### Procedure

1. Double-click the HMI device under "Devices" in the project tree.
2. Double-click the "Connections" item.
3. Double-click "<Add>" in the "Connections" editor.

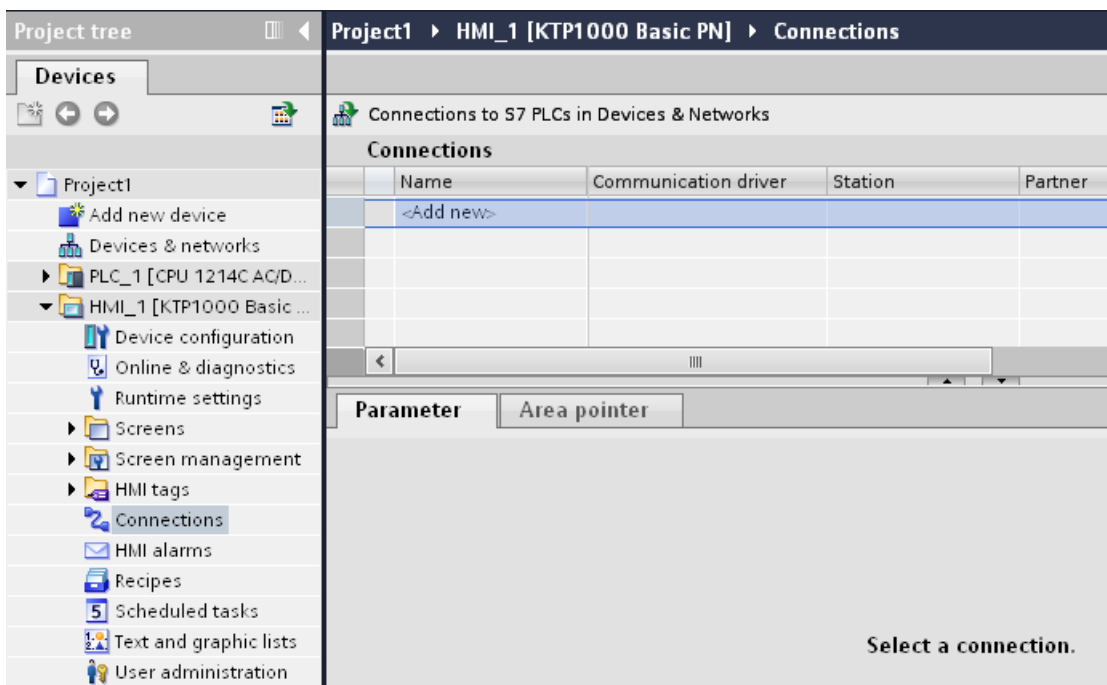

4. In the "Communication drivers" column, select the "Mitsubishi MC TCP/IP" driver.

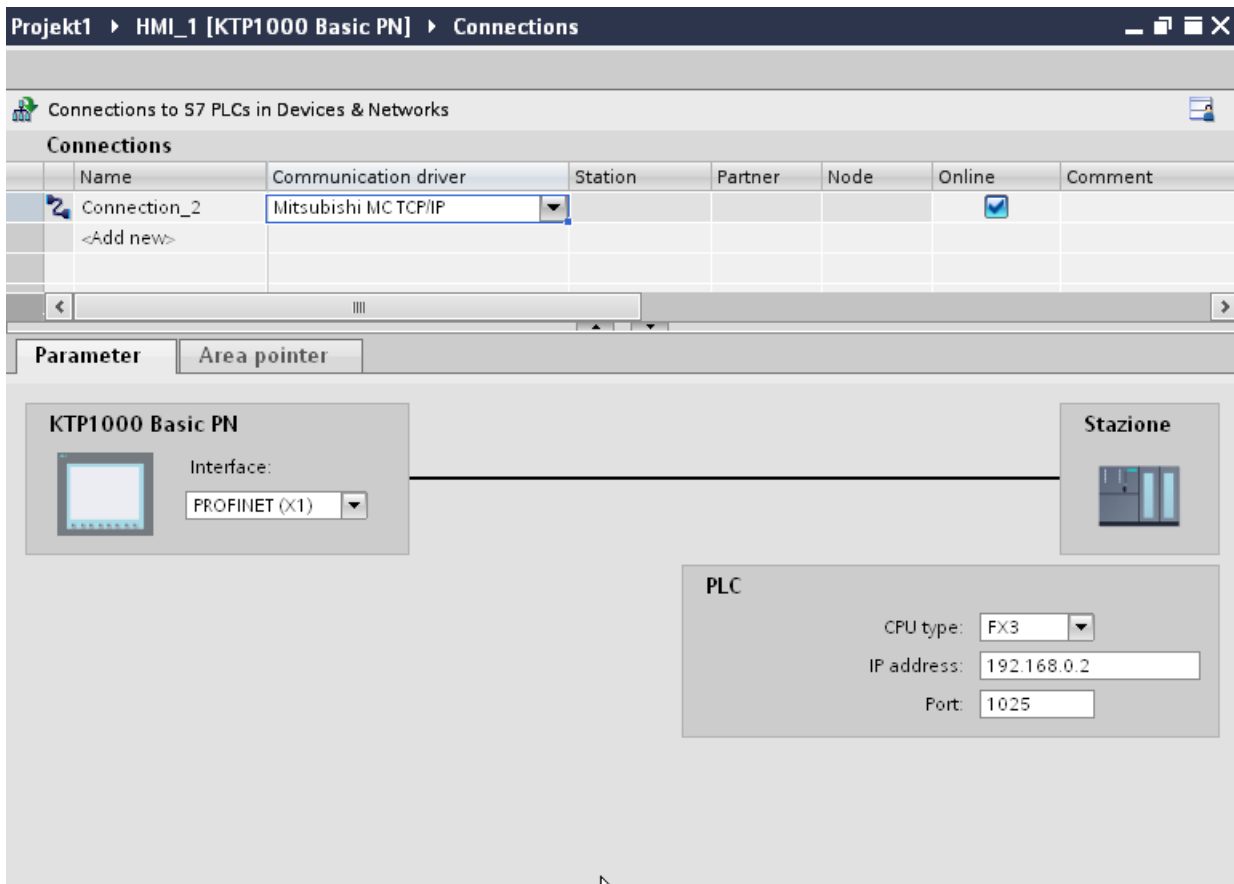

5. Select all necessary connection parameters for the interface in the Inspector window under "Parameters".

## Parameters for the connection (Mitsubishi MC TCP/IP)

### Parameters to be set

To set the connection parameters, such as addresses and profiles, click the connection that you have created in the "Connections" editor.

The communication partners are displayed schematically in the Inspector window under "Parameters". The "HMI device" and "PLC" areas are available for assigning parameters according to the interface used.

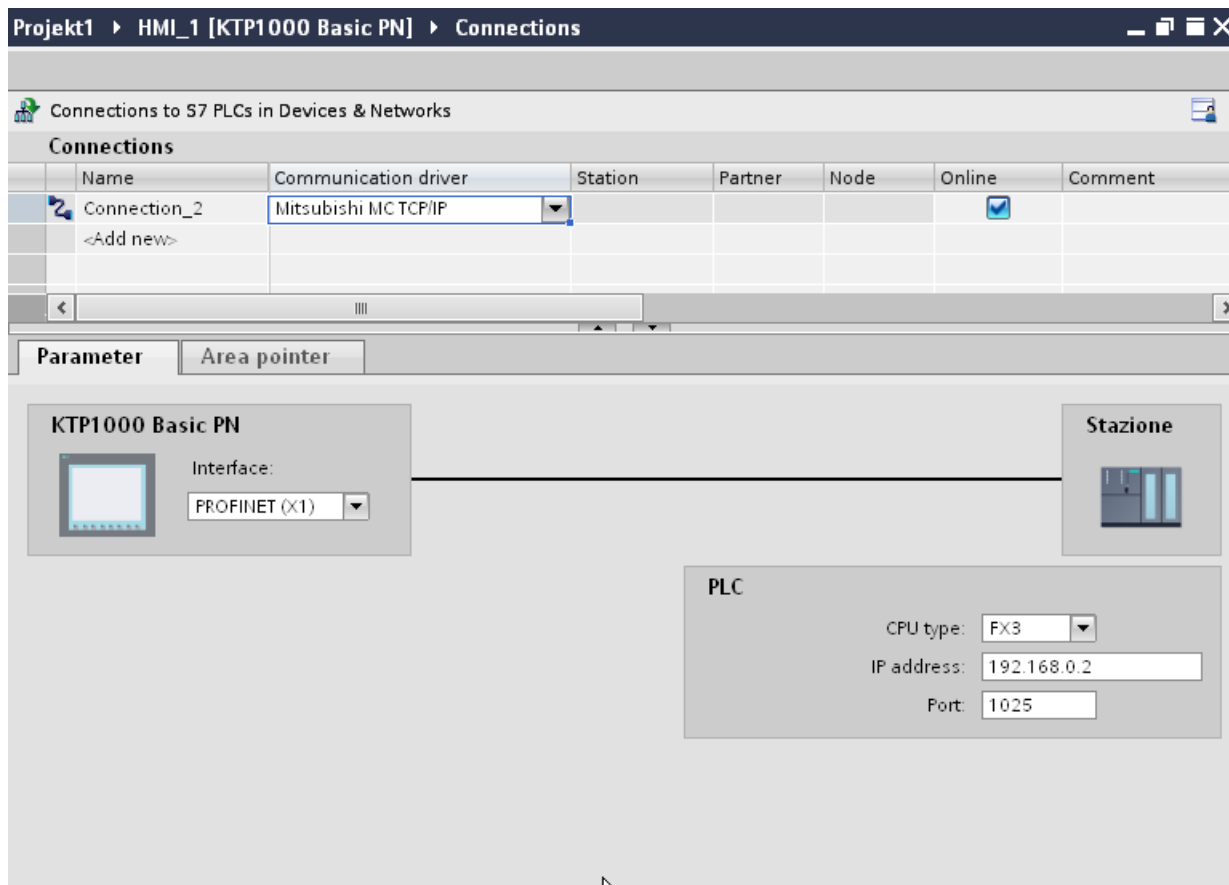

### Parameters for the HMI device

You can select only one interface for the HMI device in the Inspector window under "Parameters". Depending on the HMI device, there are several interfaces available.

If you are directly connected to the HMI device during configuration, you can set up the IP address of the HMI device in WinCC. The IP address is transferred to the HMI device during project transfer.

---

#### Note

The IP address in the control panel will be overwritten upon subsequent loading if you have already set up the IP address in the HMI device control panel.

The IP address already set up in the control panel will be retained upon subsequent loading if you activate "Set IP address using a different method".

---

To set up the IP address of the HMI device:

1. Click on the HMI device.
2. Open the "Device configuration" editor.

3. Click the Ethernet interface.
4. Assign the IP address in the inspector window under:  
"General > PROFINET interface > Ethernet addresses"

### Parameters for the PLC

- CPU type  
For "CPU type", you set the type of PLC to which the HMI device is connected.  
The following settings are possible:  
–FX3  
–Q  
If you select the FX3 CPU type, the Mitsubishi MC protocol "1E" is used and "3E" for the "Q" CPU type.  
The "Binary code" protocol variant is always used.

---

#### Note

If the CPU type is changed for a configured connection, tags with the following properties must be revised:

- Operands that do not exist for the new CPU type, such as "W", "B", "F".
  - Inputs and outputs with different addressing (hexadecimal/octal)
  - Addresses greater than the valid address area of the new CPU type
- 
- IP address  
Set the IP address or host name of the Ethernet/IP module of the PLC. Only the IP address can be used on a Basic Panel.
  - Port  
Set the port number of the module of the PLC.

### Connecting HMI device to PLC

#### Connections via Mitsubishi MC TCP/IP

##### Connection

The HMI device can be connected to the Mitsubishi PLC using the following components:

- Existing Ethernet network that also contains the PLCs
- Cross-over Ethernet cable connected directly to the Ethernet interface of the CPU or the communication module

The connection of the HMI device to a Mitsubishi PLC is limited primarily to the physical connection of the HMI device. Special blocks for the connection are not required in the PLC.

Connect the HMI device to one or several Q-series and/or FX3 PLCs. Connect the HMI device via the following interfaces:

- Communication interface OnBoard
  - Approved communication module suitable for the PLC
- 

**Note**

**Timeout response with TCP/IP (Ethernet)**

Due to the use of the TCP/IP protocol, the breakdown of a connection is detected at the earliest after approximately one minute. Communication failure cannot be reliably detected if no tags are requested, for example, no output tags in the current screen.

Configure area pointer coordination for each PLC. This setting ensures that a communication failure is recognized after approximately two minutes, even in the aforementioned scenario.

---

## Communication types

### Approved communication types

- Only applies for Mitsubishi FX(PG protocol):  
The point-to-point connection from a HMI device to an approved Mitsubishi FX-CPU via Mitsubishi FX is system-tested and approved by Siemens AG.
  - Only applies for Mitsubishi MC TCP/IP:  
The following communication types are system-tested and approved:
    - Point-to-point connection to the approved PLCs
    - Multipoint connection from a HMI device with up to 4 PLCs with the respectively approved PLCs. CPU types (FX3 and Q) can be mixed.
- 

**Note**

The HMI device is a client and the PLC must operate as a server.

---



## Connectable PLCs

Connections can be implemented for the following Mitsubishi PLCs:

PLC	Mitsubishi FX (PG protocol)	Mitsubishi MC TCP/IP
MELSEC FX1n, FX2n	Yes	No
MELSEC FX3U, FX3UC, FX3G with communication module FX3U-ENET	No	Yes
MELSEC System Q <ul style="list-style-type: none"> <li>• Q-series with the communication module QJ71E71-100</li> <li>• QnUDEH CPU with Ethernet interface onboard</li> </ul>	No	Yes

## Parameterization of the communications modules

### FX3 PLCs

#### Procedure

1. Start the FX-Configurator.
2. Select the module.
3. Assign the following settings in the "Operational settings" dialog:
  - Communication data code:  
Binary code
  - Initial timing:  
Always wait for OPEN
  - IP address:  
IP address
  - Send frame setting:  
Ethernet(V2.0)
  - TCP Existence confirmation setting:  
Use the Ping

### 10.11 Communicating with PLCs

4. Assign the following settings in the "Open Settings" dialog:

- Protocol:  
TCP
- Open system:  
Unpassive
- Fixed buffer:  
Receive
- Fixed buffer communication procedure:  
Procedure exist(MC)
- Pairing open  
Disable
- Existence confirmation  
No confirm
- Host station Port No. (DEC)  
Port number

---

**Note**

The port number chosen in the communication module must match the port number in WinCC. A connection with a port number must be assigned for each connected HMI device.

You must specify port numbers in decimal values.

---

5. Confirm the default settings of the other dialog boxes.

The network no. and station no. parameters are not relevant for the connection and can be chosen as required.

## Q PLCs

### Procedure

1. Click "Edit network parameters".
2. Select the network type:
  - Ethernet  
The network number and the group / station number are not evaluated and can be freely assigned

3. Assign the following settings in the "Operational settings" dialog:
  - Communication data code:  
Binary code
  - Initial timing:  
Always wait for OPEN
  - IP address:  
IP address
  - Send frame setting:  
Ethernet(V2.0)
  - Enable write operations during RUN
4. Assign the following settings in the "Open settings" dialog:
  - Protocol:  
TCP
  - Open system:  
Unpassive
  - Pairing open  
Disable
  - Existence confirmation  
No confirm
  - Host station Port No. (HEX)  
Port-Nummer

---

**Note**

The port number chosen in the communication module must match the port number in WinCC. A connection with a port number must be assigned for each connected HMI device.

You must specify port numbers in hexadecimal values.

---

## Internal Ethernet port of the Q0xUDEH CPU

### Procedure

1. Assign the following settings in the "Internal Ethernet Port" dialog:
  - IP address:  
IP address
  - Communication data code:  
Binary code
  - Enable online changes
2. Assign the following settings in the "Open settings" dialog:
  - Protocol:  
TCP
  - Open system:  
MC-Protocol
  - Host station Port No. (HEX)  
Port number

---

#### Note

The port number chosen in the communication module must match the port number in WinCC. A connection with a port number must be assigned for each connected HMI device.

---

### Performance features of communication

### Permitted data types for Mitsubishi MC TCPI/IP

#### Permitted data types

The table lists the data types that can be used when configuring tags and area pointers.

Data type	Operand type	Length
4-bit block	M, X, Y, B, F	1 byte
8-bit block	M, X, Y B, F	1 byte
12-bit block	M, X, Y B, F	2 bytes
16-bit block	M, X, Y B, F	2 bytes
20-bit block	M, X, Y B, F	4 bytes
24-bit block	M, X, Y B, F	4 bytes
28-bit block	M, X, Y B, F	4 bytes
32-bit block	M, X, Y B, F	4 bytes
Bool	M, D, X, Y B, F	1-bit

Data type	Operand type	Length
DInt	D, W	4 bytes
DWord	D, C, W	4 bytes
Int	D, W	2 bytes
Real 1)	D, W	4 bytes
String 1)	D	1 to 80 characters
Word	D, T, C, W	2 bytes

- 1) The "String" and "Real" data types are not available for all CPUs.
- 2) Operand types B, F and W are only available for CPU type "Q".

---

#### Note

Note the following for write accesses:

Tags can only be written if "Enable online changes" or "Enable write operations during RUN" was selected when parameterizing the Mitsubishi communication modules.

For data type "Bool" in operand type "D", the entire word is written back to the PLC following a change to the specified bit. There is no check to determine whether any other bits in the word have changed. As a result, the PLC only has read access to the specified word.

---

#### Note

Array elements in I/O fields cannot be used in communication with a Mitsubishi PLC.

---

## Supported CPU types for Mitsubishi MC TCP/IP

### CPU types

The following CPU types are supported for configuring the Mitsubishi MC TCP/IP communication driver.

- FX3 series
  - FX 3G / FX 3G with communication modul FX3U-ENET
  - FX 3U / FX 3U with communication modul FX3U-ENET
  - FX 3UC / FX 3UC with communication modul FX3U-ENET
- Q series
  - Q-Series with QJ71E71-100 communication module
- iQ series / QnUD
  - QnUDEHCPU with built in ethernet module

## Addresses for Mitsubishi MC TCP/IP

### Address areas for connections via Mitsubishi MC TCP/IP

The address area boundaries differ for the different series; refer to the Mitsubishi Computerlink manuals for this information.

Examples of address area boundaries dependent on the CPU and communication format:

Name	Operand type	Max. address FX3	Max. address Q-Series
Output/Input	Y/X	Octal X/Y 0 - 777	HEX X/Y 0 - 7FF
Bit memory	M	M0 - M3071 and M8000 - M8255	M/L/S 0 - 8191
Data register	D	D0 - 7999 D8000 - D8255	D0 - 8191 D9000 - D9255 becomes SD1000 - SD1255
Counter	C	C0 - 255	C0 - 1023
Timer	T	T0 - 255	T0 - 2047
Link register	W	--	Hex: W0 - FFF
Link flag	B	--	Hex: B0 - FFF
Error flag	F	--	F0 - 2047

### Address areas for Mitsubishi MC TCP/IP

#### FX0

Address areas	Data types												
	Bool	Word	DWord	Real	String	4-bit block	8-bit block	12-bit block	16-bit block	20-bit block	24-bit block	28-bit block	32-bit block
M	M0 - M9999	--	--	--	--	M0 - M999 6	M0 - M999 2	M0 - M998 8	M0 - M998 4	M0 - M9980	M0 - M9976	M0 - M9972	M0 - M9968
D	D0.0 - D999.1 5	D0 - D999	D0 - D998	D0 - D998	D0 - D998	--	--	--	--	--	--	--	--
T		T0 - T255	--	--	--	--	--	--	--	--	--	--	--
C-16-Bit	--	C-16-Bit 0 - C-16-Bit 199	--	--	--	--	--	--	--	--	--	--	--

Address areas	Data types												
	Bool	Word	DWord	Real	String	4-bit block	8-bit block	12-bit block	16-bit block	20-bit block	24-bit block	28-bit block	32-bit block
C-32-Bit	--	--	C-32-Bit 200 - C-32-Bit 255	--	--	--	--	--	--	--	--	--	--
X	X0 - X255	--	--	--	--	X0 - X252	X0 - X248	X0 - X244	X0 - X240	X0 - X236	X0 - X232	X0 - X228	X0 - X224
Y	Y0 - X255	--	--	--	--	Y0 - Y252	Y0 - Y248	Y0 - Y244	Y0 - Y240	Y0 - Y236	Y0 - Y232	Y0 - Y228	Y0 - Y224

## Commissioning components

### Transferring a project to the HMI device

1. Switch the HMI device to "transfer mode".
2. Set all necessary transfer parameters.
  - Interface
  - Transfer parameters
  - Target storage location
3. Start the project transfer.  
The project is compiled automatically.  
All compilation and transfer steps are logged to a message window.

### Interconnecting the PLC with the HMI device

1. Interconnect the PLC with the HMI device using a suitable cable.
2. The message "Connection to PLC .... is established" is output to the HMI device.

## Optimizing the configuration

### Acquisition cycle and update time

The acquisition cycles for the "Area pointers" and of the tags defined in the configuration software are decisive in terms of the update times which can actually be achieved.

The update time is equivalent to the acquisition cycle + transmission time + processing time.

Items to observe when optimizing the update times in configuration data:

- Optimize the maximum and minimum size of the data areas.
- Acquisition cycles which are too short lead to unnecessary load on overall performance. Set the acquisition cycle according to the rate of change of the process values. The rate of temperature changes at a furnace, for example, is significantly slower compared to the speed rate of an electrical drive. A time of approx. 1 second is a benchmark for the acquisition cycle.
- Avoid any gaps when entering the alarm or screen tags in a data area.
- Changes in the PLC can only be detected reliably if these are available at least within the actual acquisition cycle.

## Screens

The refresh rate of screens is determined by the type and volume of data to be visualized.

Only configure short acquisition cycles for objects which actually require shorter refresh cycles. This procedure reduces update times.

## Trends

The HMI device always updates all bit-triggered trends whose group bit is set in the "Trend transfer area". It resets the bits in the next cycle.

The group bit in the PLC program can only be set again after the HMI device has reset all bits.

## Job mailboxes

A high rate and volume of job mailboxes transferred may lead to overload in communication between the HMI device and the PLC.

The HMI device confirms acceptance of the job mailbox by entering the value zero in the first data word of the job mailbox. The HMI device now processes the job for which it requires a certain time slice. It may take the HMI device some time to process a new job mailbox which is transferred in immediate succession to the job mailbox. The next job mailbox is only accepted if sufficient computing resources are available.

## Mitsubishi FX

### Configuring a connection via Mitsubishi FX

#### Introduction

You configure a connection to a PLC with a Mitsubishi FX communication driver in the "Connections" editor of the HMI device.

The Mitsubishi FX protocol is also referred to as the Mitsubishi PG protocol.

The interfaces are named differently depending on the HMI device.



## Requirements

- A project is open.
- An HMI device has been created.

## Procedure

1. Double-click the HMI device under "Devices" in the project tree.
2. Double-click the "Connections" item.
3. Double-click "<Add>" in the "Connections" editor.

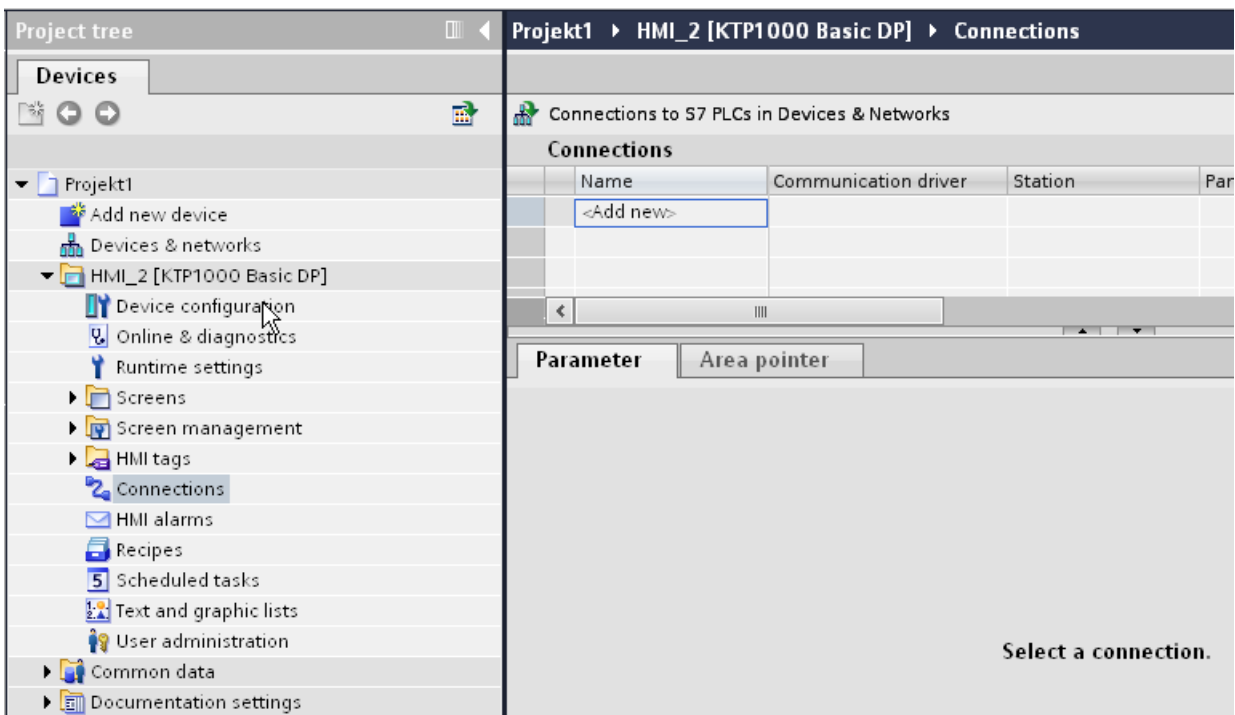

4. In the "Communication drivers" column, select the "Mitsubishi FX" driver.

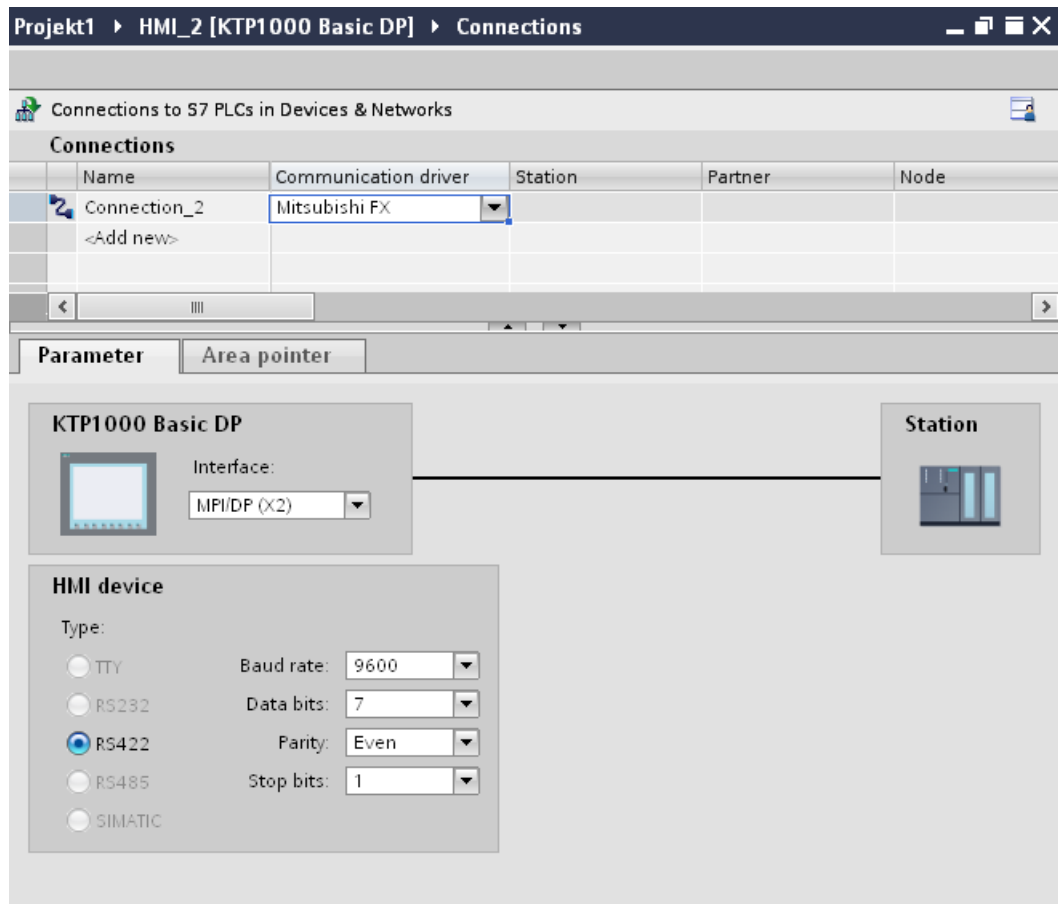

5. Select all necessary connection parameters for the interface in the Inspector window under "Parameters".

### Parameters for the connection (Mitsubishi FX)

#### Parameters to be set

To assign the connection parameters, such as addresses and profiles, click the connection that you have created in the "Connections" editor.

The communication partners are displayed schematically in the Inspector window under "Parameters". The "HMI device", "Network", and "PLC" areas are available for assigning parameters according to the interface used.

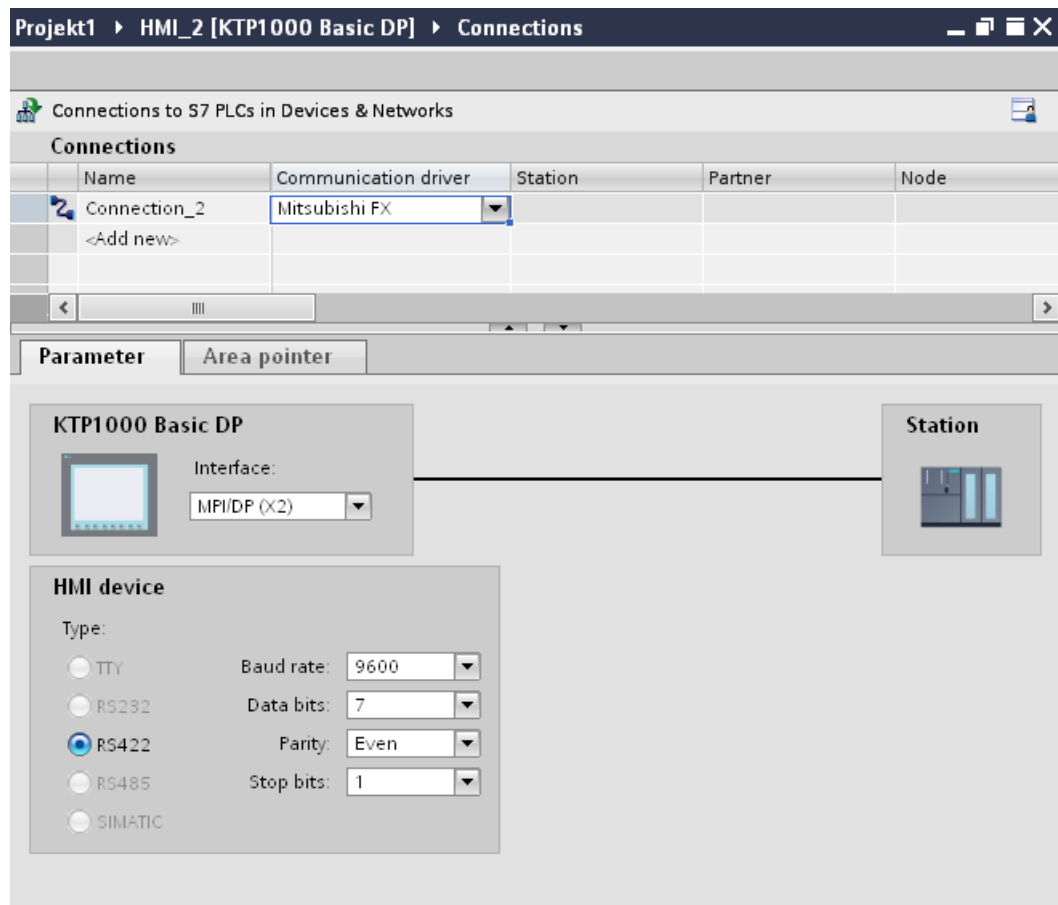

### Parameters for the HMI device

You can select an interface for the HMI device in the Inspector window under "Parameters". Depending on the HMI device, there are several interfaces available.

- "Type"  
Specifies the physical connection used.

#### Note

If you use the IF1B interface, you must switch over the RS422 receive data and the RTS signal additionally by 4 DIL-switches on the back of the HMI device.

### Parameters for the PLC

- Baud rate: For "Baud rate", select the transmission speed between the HMI device and PLC. Select the baud rate "9600".
- Data bits: Under "Data bits", select "7 bits".
- Parity: Under "Parity", select "Even".
- Stop bits: Under "Stop bits", select "1 bit".

## Connecting HMI device to PLC

### Connections via Mitsubishi FX

#### Connection

Connect the HMI device to the programming interface of the CPU (RS 422) (see documentation of the PLC).

The connection between the HMI device and the Mitsubishi PLC is basically restricted to setting the interface parameters. Special blocks for the connection are not required in the PLC.

#### Connecting cable

The following connecting cables are available to connect the HMI device to the PLC.

Interface to HMI device or adapter	Mitsubishi Electric PLC via FX protocol
	FX1n, Fx2n, Mini DIN, 8-pin
RS 232, 9-pin	Mitsubishi SC-09 <sup>1)</sup>
RS 422, 9-pin	Connecting cable RS422-2P

<sup>1)</sup> Since the Mitsubishi PLCs communicate via RS 422 as a standard, the Mitsubishi programming cable SC-09 with integrated RS 422/RS 232 adaptor is necessary for connecting a HMI device via RS 232.

---

#### Note

##### Applies only to RS 232:

Cable length is restricted to 0.32 m.

---

Refer to the relevant device manual to determine which HMI device interface is to be used.

The cable pin assignments can be found in Section "Connecting cables for Mitsubishi FX".

## Communication types

### Approved communication types

- Only applies for Mitsubishi FX(PG protocol):  
The point-to-point connection from a HMI device to an approved Mitsubishi FX-CPU via Mitsubishi FX (PG protocol := protocol for access to the program and memory elements of the FX series PC CPU version V1.21 and after) is system-tested and approved by Siemens AG.
- Only applies for Mitsubishi MC TCP/IP:  
The following communication types are system-tested and approved:
  - Point-to-point connection to the approved PLCs
  - Multipoint connection from a HMI device with up to 4 PLCs with the respectively approved PLCs. CPU types (FX3 and Q) can be mixed.

#### Note

The HMI device is a client and the PLC must operate as a server.

### Connectable PLCs

Connections can be implemented for the following Mitsubishi PLCs:

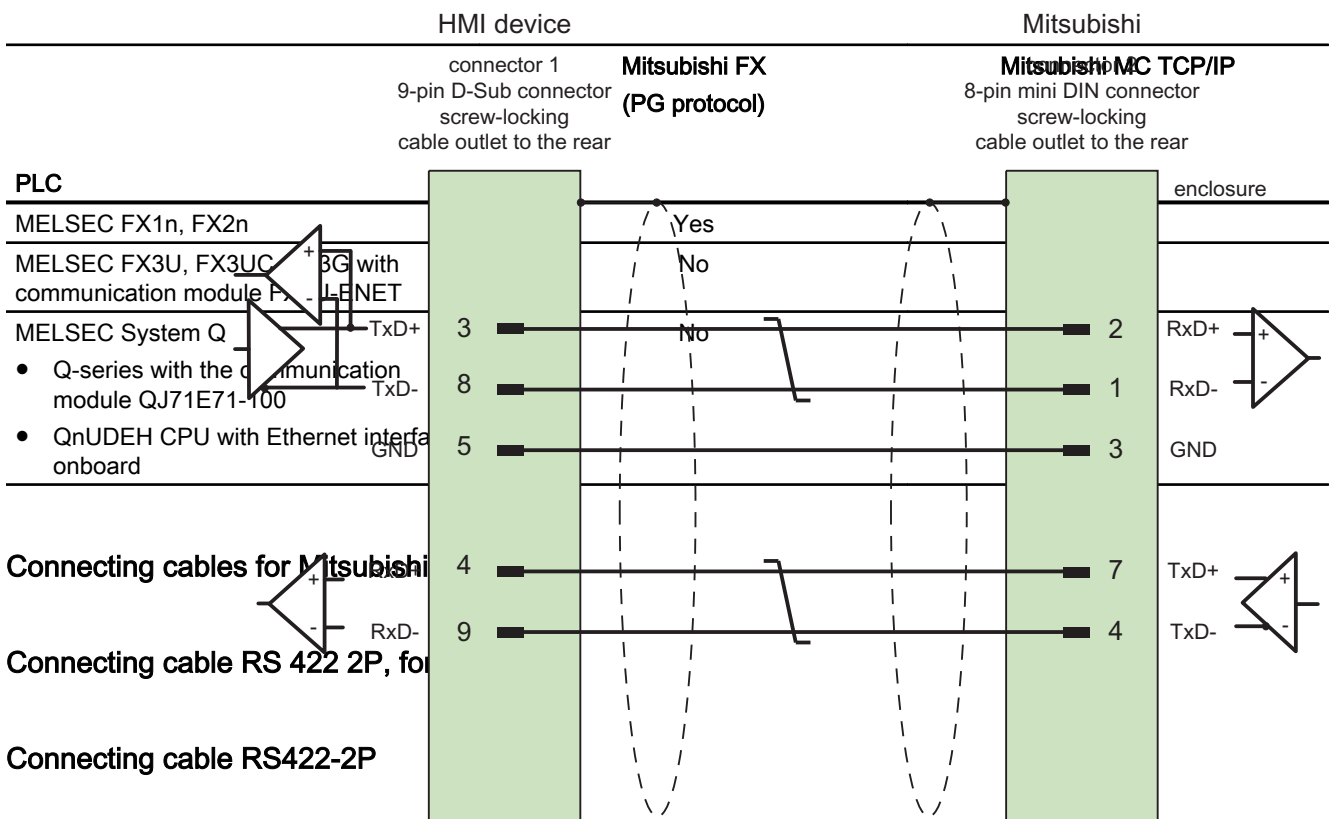

Shield with large-area contact to housing at both ends  
Cable: 3 x 2 x 0.14 mm<sup>2</sup>, shielded,  
max. length 500 m

## Performance features of communication

## Permitted data types for Mitsubishi FX

### Permitted data types

The table lists the data types that can be used when configuring tags and area pointers.

Data type	Operand type	Length
4-bit block	M, X, Y	1 byte
8-bit block	M, X, Y	1 byte
12-bit block	M, X, Y	2 bytes
16-bit block	M, X, Y	2 bytes
20-bit block	M, X, Y	4 bytes
24-bit block	M, X, Y	4 bytes
28-bit block	M, X, Y	4 bytes
32-bit block	M, X, Y	4 bytes
Bool	D, M, X, Y	1-bit
DWord	D, C-32 bit	4 bytes
Real	D	4 bytes
String	D	1 to 50 characters
Word	D, T, C-16 bit	2 bytes

### Note

Note the following for write accesses:

For data type "Bool" in operand type "D", the entire word is written back to the PLC following a change to the specified bit. There is no check to determine whether any other bits in the word have changed. As a result, the PLC only has read access to the specified word.

### Note

Array elements in I/O fields cannot be used in communication with a Mitsubishi PLC.

## Supported CPU types for Mitsubishi FX

### CPU types

The following CPU types are supported for configuring the Mitsubishi FX communication driver.

- FX1 series
  - FX1n
- FX2 series
  - FX2n

## Configurable address areas for Mitsubishi FX

### Permitted address areas

The following address areas can be configured for the "Mitsubishi FX" communication driver

X	Input	Octal 0- 377
Y	Output	Octal 0- 377
M	Bit memory	0...9999
D	Data register	0...999
C	Counter	0...199
T	Timer	0...25

## Address areas for Mitsubishi FX

### FX3

Address areas	Data types														
	Bool	Int	Word	DInt	DWord	Real	String	4-bit block	8-bit block	12-bit block	16-bit block	20-bit block	24-bit block	28-bit block	32-bit block
M	M0 - M9999	--	--	--	--	--	--	M0 - M9999	M0 - M9999	M0 - M9999	M0 - M9999	M0 - M9980	M0 - M9976	M0 - M9972	M0 - M9968
D	D0.0 - D9999.15	D0 - D9999	D0 - D9999	D0 - D9999	D0 - D9999	D0 - D9999	D0 - D9999	--	--	--	--	--	--	--	--
T	--	--	T0 - T9999	--	--	--	--	--	--	--	--	--	--	--	--

10.11 Communicating with PLCs

Address areas	Data types														
	Bool	Int	Word	DInt	DWord	Real	String	4-bit block	8-bit block	12-bit block	16-bit block	20-bit block	24-bit block	28-bit block	32-bit block
C	--	C0 - C999	C0 - C999	C0 - C998	C0 - C998	--	--	--	--	--	--	--	--	--	--
X	X0 - X777	--	--	--	--	--	--	X0 - X774	X0 - X770	X0 - X764	X0 - X760	X0 - X754	X0 - X750	X0 - X744	X0 - X740
Y	Y0 - Y777	--	--	--	--	--	--	Y0 - Y774	Y0 - Y770	Y0 - Y764	Y0 - Y760	Y0 - Y754	Y0 - Y750	Y0 - Y744	Y0 - Y740

Q

Address areas	Data types														
	Bool	Int	Word	DInt	DWord	Real	String	4-bit block	8-bit block	12-bit block	16-bit block	20-bit block	24-bit block	28-bit block	32-bit block
M	M0 - M999	--	--	--	--	--	--	M0 - M996	M0 - M992	M0 - M988	M0 - M984	M0 - M980	M0 - M976	M0 - M972	M0 - M968
F	F0 - F999	--	--	--	--	--	--	F0 - F996	F0 - F992	F0 - F988	F0 - F984	F0 - F980	F0 - F976	F0 - F972	F0 - F968
B	B0 - BFFF	--	--	--	--	--	--	B0 - BFC	B0 - BF8	B0 - BF4	B0 - BF0	B0 - BFE	B0 - BFE	B0 - BFE	B0 - BFE
D	D0.0 - D655.34.15	D0 - D655.34	D0 - D655.34	D0 - D655.33	D0 - D655.33	D0 - D655.33	D0 - D655.34	--	--	--	--	--	--	--	--
T	--	--	T0 - T2047	--	--	--	--	--	--	--	--	--	--	--	--
C	--	C0 - C2047	C0 - C2047	C0 - C2046	C0 - C2046	--	--	--	--	--	--	--	--	--	--
W	--	W0 - WFFF	W0 - WFFF	W0 - WFE	W0 - WFE	W0 - WFE	--	--	--	--	--	--	--	--	--
X	X0 - XFFF	--	--	--	--	--	--	X0 - XFC	X0 - XF8	X0 - XF4	X0 - XF0	X0 - XFE	X0 - XFE	X0 - XFE	X0 - XFE
Y	Y0 - YFFF	--	--	--	--	--	--	Y0 - YFC	Y0 - YF8	Y0 - YF4	Y0 - YF0	Y0 - YFE	Y0 - YFE	Y0 - YFE	Y0 - YFE



## FX0

Address areas	Data types												
	Bool	Word	DWord	Real	String	4-bit block	8-bit block	12-bit block	16-bit block	20-bit block	24-bit block	28-bit block	32-bit block
M	M0 - M9999					M0 - M999 6	M0 - M999 2	M0 - M998 8	M0 - M998 4	M0 - M9980	M0 - M9976	M0 - M9972	M0 - M9968
D	D0.0 - D999.1 5	D0 - D999	D0 - D998	D0 - D998	D0 - D998								
T		T0 - T255											
C-16- Bit		C-16- Bit 0 - C-16- Bit 199											
C-32- Bit			C-32- Bit 200 - C-32- Bit 255										
X	X0 - X255					X0 - X252	X0 - X248	X0 - X244	X0 - X240	X0 - X236	X0 - X232	X0 - X228	X0 - X224
Y	Y0 - X255					Y0 - Y252	Y0 - Y248	Y0 - Y244	Y0 - Y240	Y0 - Y236	Y0 - Y232	Y0 - Y228	Y0 - Y224

## Commissioning components

## Transferring a project to the HMI device

1. Switch the HMI device to "transfer mode".
2. Set all necessary transfer parameters.
  - Interface
  - Transfer parameters
  - Target storage location
3. Start the project transfer.  
The project is compiled automatically.  
All compilation and transfer steps are logged to a message window.

## Interconnecting the PLC with the HMI device

1. Interconnect the PLC with the HMI device using a suitable cable.
2. The message "Connection to PLC .... is established" is output to the HMI device.

## Optimizing the configuration

### Acquisition cycle and update time

The acquisition cycles for the "Area pointers" and of the tags defined in the configuration software are decisive in terms of the update times which can actually be achieved.

The update time is equivalent to the acquisition cycle + transmission time + processing time.

Items to observe when optimizing the update times in configuration data:

- Optimize the maximum and minimum size of the data areas.
- Acquisition cycles which are too short lead to unnecessary load on overall performance. Set the acquisition cycle according to the rate of change of the process values. The rate of temperature changes at a furnace, for example, is significantly slower compared to the speed rate of an electrical drive. A time of approx. 1 second is a benchmark for the acquisition cycle.
- Avoid any gaps when entering the alarm or screen tags in a data area.
- Changes in the PLC can only be detected reliably if these are available at least within the actual acquisition cycle.

### Screens

The refresh rate of screens is determined by the type and volume of data to be visualized.

Only configure short acquisition cycles for objects which actually require shorter refresh cycles. This procedure reduces update times.

### Trends

The HMI device always updates all bit-triggered trends whose group bit is set in the "Trend transfer area". It resets the bits in the next cycle.

The group bit in the PLC program can only be set again after the HMI device has reset all bits.

### Job mailboxes

A high rate and volume of job mailboxes transferred may lead to overload in communication between the HMI device and the PLC.

The HMI device confirms acceptance of the job mailbox by entering the value zero in the first data word of the job mailbox. The HMI device now processes the job for which it requires a certain time slice. It may take the HMI device some time to process a new job mailbox which is transferred in immediate succession to the job mailbox. The next job mailbox is only accepted if sufficient computing resources are available.

## Data exchange

### Area pointers for Mitsubishi

#### Area pointers for connections via Mitsubishi communication drivers

You use an area pointer to access a data area in the PLC.

For more detailed information on area pointers and their configuration, refer to Section "Data exchange using area pointers".

#### Special considerations for connections via Mitsubishi communication drivers

You can configure the following area pointers

Area pointers	Mitsubishi MC TCP/IP	Mitsubishi FX
Screen number	Yes	Yes
Date/time	Yes	Yes
Date/time PLC	Yes	Yes
Coordination	Yes	Yes
Project ID	Yes	Yes
Job mailbox	Yes	Yes
Data record	Yes	Yes

#### Restrictions Mitsubishi MC TCP/IP

The following restrictions apply for configuring area pointers.

CPU type	Data types	Operand type
FX3	Int, Word	D
Q	Int, Word	D

#### Mitsubishi FX restrictions

You cannot use the D operand type for configuring area pointers.

## Trends

### General information on trends

#### Trends

A trend is the graphical representation of one or more values from the PLC. The value is read out either time- or bit-triggered, depending on the configuration.

For additional information see:

Auto-Hotspot

---

**Note**

The value is read out time-triggered for Basic Panels.

---

### Time-triggered trends

The HMI device reads in the trend values cyclically at an interval specified in the configuration. Time-triggered trends are suitable for continuous curves, such as the operating temperature of a motor.

### Bit-triggered trends

Through a trigger bit set in the trend request tag, the HMI device either reads in a trend value or an entire trend buffer. This setting is defined in the configuration. Bit-triggered trends are normally used to represent fast changing values. One example might be the injection pressure in the production of plastic parts.

To trigger bit-triggered trends, appropriate external tags must be created in the "HMI tags" editor and connected to trend areas during configuration. The HMI device and PLC then communicate with each other via these trend areas.

The following areas are available for trends:

- Trend request area
- Trend transfer area 1
- Trend transfer area 2 (required only with switch buffers)

### See also

Displaying tags with Runtime Advanced and Panels (Page 3237)

### Trend request and trend transfer

#### Trend request area

The HMI device sets corresponding bits in the trend request area when you open a screen which contains one or more trends on the HMI device. After closing the screen, the HMI device resets the relevant bits in the trend request area.

The trend request area can be used for evaluation purposes in the PLC to determine which trend is currently being displayed on the HMI device. Trends can also be triggered without evaluation of the trend request area.

## Trend transfer area 1

This area is used to trigger trends. You must set the bit assigned to the trend in the trend transfer area and set the trend group bit in your control program. The trend group bit is the last bit in the trend transfer area.

The HMI device detects the trigger. The HMI device reads either a value or the entire buffer from the PLC. It then resets the trend bit and the trend group bit.

The following picture shows the structure of a trend transfer area.

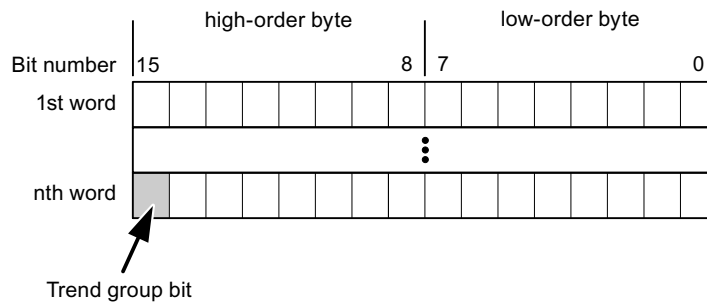

The trend transfer area must not be modified by the PLC program until the trend group bit has been reset.

## Trend transfer area 2

Trend transfer area 2 is required for trends configured with a switch buffer. The trend transfer areas 1 and 2 have a similar structure.

## Switch buffer

The switch buffer is a second buffer for the same trend that can be set up during configuration.

The PLC writes to Buffer 2 while the HMI device reads values from Buffer 1, and writes to Buffer 1 when the HMI device is reading Buffer 2. This prevents the PLC from overwriting trend values while the trend is being read by the HMI device.

## Restrictions to the trend control

### Data types for Mitsubishi MC TCPI/IP

For trend control you can create tags and array tags of the operand type "D" with the data type "Word" or "Int".

### Data types for Mitsubishi FX

For trend control you can create tags and array tags of the operand type "D" with the data type "Word".

## Alarms

### Configuring alarms

#### Configuring alarms for non-integrated connections

Several steps are necessary to configure alarms such as warnings, error messages and acknowledgement.

- Step 1: Create tags
- Step 2: Configure alarms
- Step 3: Configure acknowledgment

You can find additional information in the section:

Working with Alarms (Page 3260)

#### Distinctive features when configuring alarms

If you are configuring connections of HMI devices to PLCs of other manufacturers, note the following distinctive features when configuring:

- Data types of the tags
- Addressing of tags
- How the bit positions are counted

### Data types

For connections with a Mitsubishi communication driver, the following data types are supported:

PLC	Permitted data types	
	Discrete alarms	Analog alarms
FX1n, FX2n, FX3 series, Q-Series, iQ-Series	Word, Int <sup>1)</sup>	4-bit block, 8-bit block, 12-bit block, 16-bit block, 20-bit block, 24-bit block, 28-bit block, 32-bit block, Word, DWord, Int <sup>1)</sup> , DInt <sup>1)</sup> , Real,
<sup>1)</sup> Not for Mitsubishi FX communication driver		

## How the bit positions are counted

For connections with a Mitsubishi communication driver, the following counting method applies:

How the bit positions are counted	Left byte							Right byte						
In Mitsubishi PLCs	15						8	7						0
In WinCC you configure:	15						8	7						0

## Restrictions on alarms

- Mitsubishi MC TCP/IP  
Only tags of operand type "D" and data types "Word" and "Int" are permitted as trigger tags for discrete alarms. You can use array tags (operand type: "D"; data types: "ARRAY [x..y] of Word" or "ARRAY [x..y] of Int") for discrete alarms.
- Mitsubishi FX  
Only tags of operand type "D" and data type "Word" are permitted as trigger tags for discrete alarms. You can use array tags (operand type "D"; data type "ARRAY [x..y] of Word") for discrete alarms."

## Acknowledgment of alarms

### Procedure

Create suitable tags on the PLC to acknowledge an error alarm. You assign these tags to an alarm in the "Bit messages" editor. You make the assignment in "Properties > Acknowledgment".

Distinction in terms of acknowledgment:

- Acknowledgment by the PLC
- Acknowledgment on the HMI device

### Acknowledgment by the PLC

In "PLC acknowledgment tag", configure the tag or array tag and the bit number that the HMI device uses to identify a PLC acknowledgment.

A bit set in the tag triggers acknowledgment of the assigned error alarm bit at the HMI device. This tag bit returns a function similar to acknowledgment on the HMI device which is triggered by pressing the "ACK" button, for example.

The acknowledgment bit must be located in the same tag as the bit for the error alarm.

Reset the acknowledgment bit before setting the bit in the alarm area again. The figure below shows the pulse diagram.

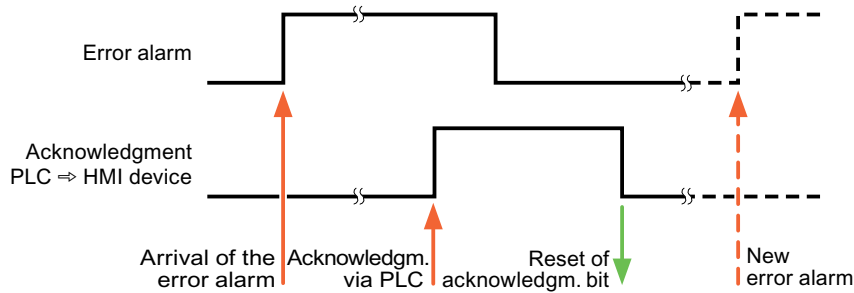

### Acknowledgment on the HMI device

In the "HMI acknowledgment tag" area, configure the tag or array tag as well as the bit number that the HMI device writes to the PLC after acknowledgment. Make sure when you use an array tag that it is not longer than 6 words.

To always create a signal change when setting an assigned acknowledgment bit of a discrete alarm that must be acknowledged, the HMI device will reset the acknowledgment bit assigned to the alarm as soon as it detects an alarm subject to acknowledgment and write the acknowledgment tag in the PLC. There will be a certain delay between detecting the message and writing the acknowledgment tag in the PLC because the HMI device has to process the operations.

If a discrete alarm subject to acknowledgment is acknowledged by the HMI device, then the corresponding bit in the assigned acknowledgment tag will be set. The entire acknowledgment tag is then written to the PLC by the HMI device. This allows the PLC to recognize that a certain alarm message has been acknowledged at the HMI device.

#### Note

All alarm bits acknowledged since the last Runtime start will remain in the acknowledgment tag until a new incoming of the respective discrete alarms is detected.

This area should only be read by the PLC because the entire section of the HMI device will be overwritten once the next acknowledgment tag is written.

The figure below shows the pulse diagram.

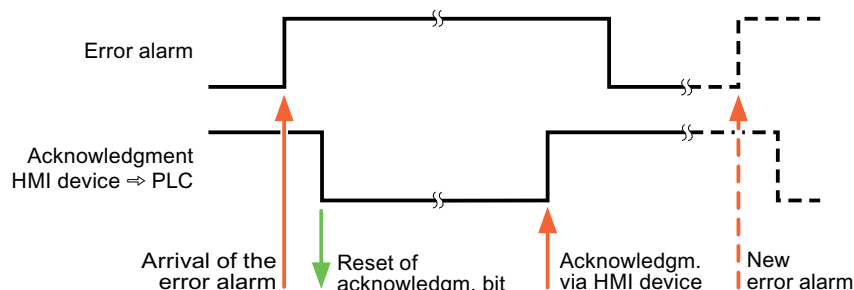



## LED mapping

### Function

Keyboard devices have LEDs in the function keys. These LEDs can be activated from the PLC. Thus, it is possible, for example, to signal to the user which key he should press in a given situation by lighting up an LED.

---

#### Note

The LED function cannot be configured for Basic Panels.

---

### Requirements

In order to activate an LED, an LED tag or an array tag must be set up in the PLC and specified as an LED tag during configuration.

### LED assignment

The assignment of the individual LEDs to the bits in the LED tags is specified when the function keys are configured. In this process, the "LED tag" and the assigned "Bit" are specified for each function key in the "General" group of the properties window.

The "Bit" bit number designates the first of two consecutive bits that control the following LED statuses.

Bit n+ 1	Bit n	LED function	
		All Mobile Panels, all Operator Panels, all Multi Panels	Panel PCs:
0	0	Off	Off
0	1	Rapid flashing	Flashing
1	0	Slow flashing	Flashing
1	1	On permanently	On permanently

## Modicon Modbus

### Modicon Modbus communication drivers

#### Introduction

This section describes the communication between an HMI device and PLCs that use Modicon Modbus communication drivers.

The following communication drivers are supported:

- Modicon Modbus TCP/IP
- Modicon Modbus RTU

## Data exchange

Data is exchanged by means of tags or area pointers.

- **Tags**  
The PLC and the HMI device use process values for data exchange. You create tags in the configuration that point to addresses in the PLC. The HMI device reads the value from the defined address, and then displays it. The operator may also enter values on the HMI device, which are then written to the address in the PLC.
- **Area pointers**  
Area pointers are used to exchange specific data and are only set up when these data are used.

## Modicon Modbus TCP/IP

### Configuring a connection via Modicon Modbus TCP/IP

#### Introduction

You configure a connection to one of the PLCs with Modicon Modbus TCP/IP communication driver in the "Connections" editor of the HMI device.

The Ethernet interfaces are named differently depending on the HMI device.

Example: PROFINET interface corresponds to the Ethernet interface

#### Requirements

- A project is open.
- An HMI device has been created.

#### Procedure

1. Double-click the HMI device under "Devices" in the project tree.
2. Double-click the "Connections" item.

3. Double-click "<Add>" in the "Connections" editor.

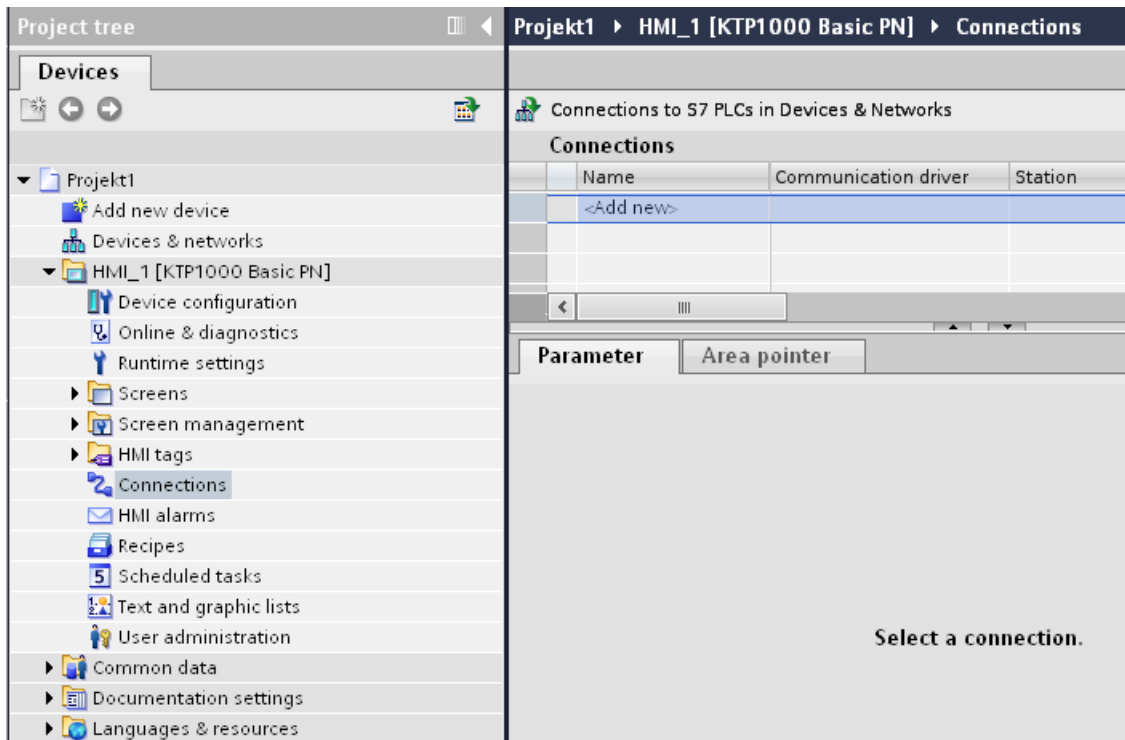

4. Select the "Modicon Modbus TCP" driver in the "Communication driver" column.

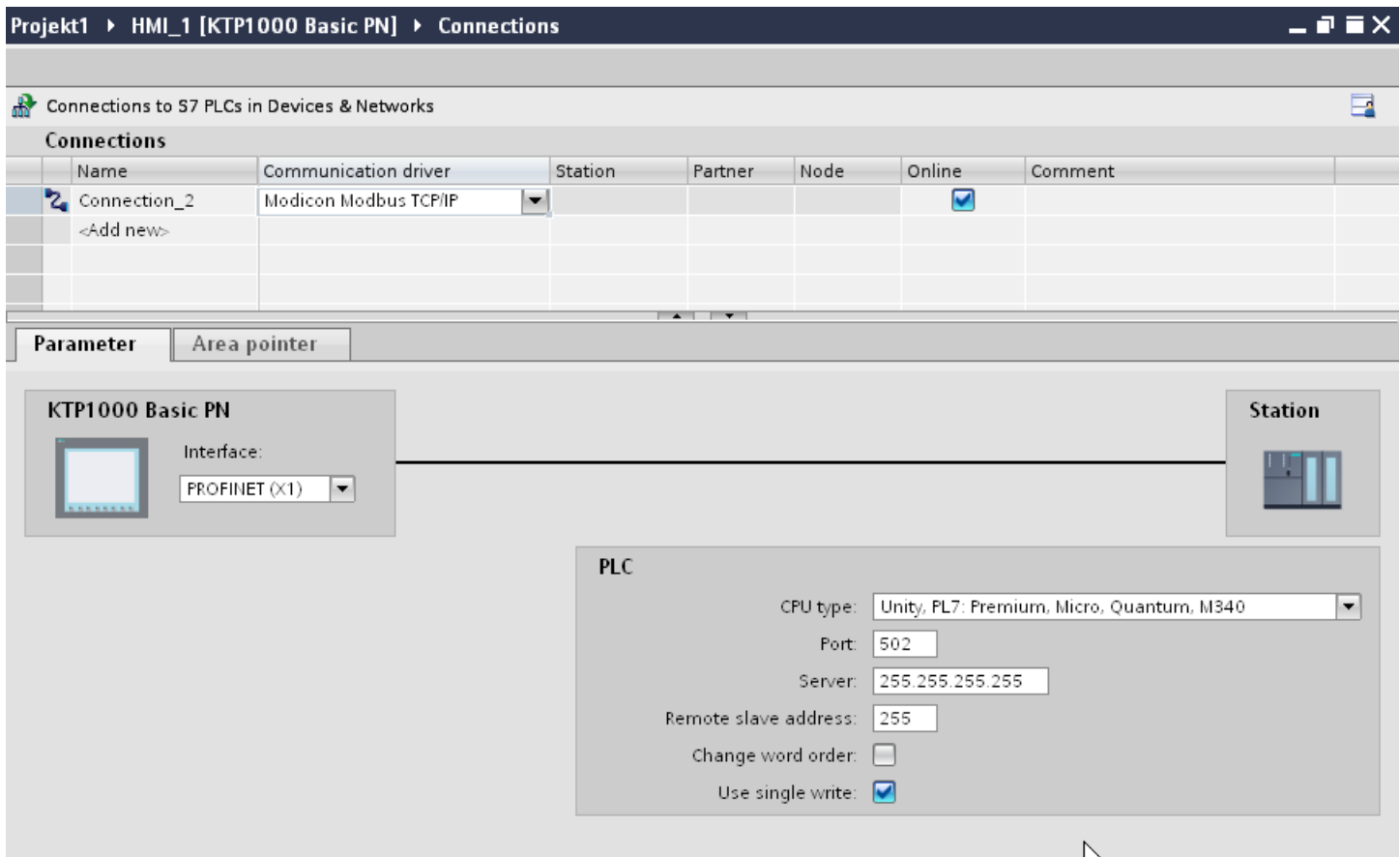

5. Select all necessary connection parameters for the interface in the Inspector window under "Parameters".

### Parameters for the connection (Modicon Modbus TCP/IP)

#### Parameters to be set

To set the connection parameters, such as addresses and profiles, click the connection that you have created in the "Connections" editor.

The communication partners are displayed schematically in the Inspector window under "Parameters". The "HMI device" and "PLC" areas are available for assigning parameters according to the interface used.

The screenshot shows the 'Connections' window in WinCC. At the top, the breadcrumb path is 'Projekt1 > HMI\_1 [KTP1000 Basic PN] > Connections'. Below this, there is a table of connections:

Name	Communication driver	Station	Partner	Node	Online	Comment
Connection_2	Modicon Modbus TCP/IP				<input checked="" type="checkbox"/>	
<Add new>						

Below the table, there are two tabs: 'Parameter' and 'Area pointer'. The 'Parameter' tab is active, showing a configuration for the 'KTP1000 Basic PN' HMI device. The 'Interface' is set to 'PROFINET (X1)'. A line connects this HMI device to a 'Station' (PLC). The PLC configuration is as follows:

- CPU type: Unity, PL7: Premium, Micro, Quantum, M340
- Port: 502
- Server: 255.255.255.255
- Remote slave address: 255
- Change word order:
- Use single write:

## Parameters for the HMI device

You can select only one interface for the HMI device in the Inspector window under "Parameters". Depending on the HMI device, there are several interfaces available.

If you are directly connected to the HMI device during configuration, you can set up the IP address of the HMI device in WinCC. The IP address is transferred to the HMI device during project transfer.

---

### Note

The IP address in the control panel will be overwritten upon subsequent loading if you have already set up the IP address in the HMI device control panel.

The IP address already set up in the control panel will be retained upon subsequent loading if you activate "Set IP address using a different method".

---

To set up the IP address of the HMI device:

1. Click the HMI device.
2. Open the "Device configuration" editor.

3. Click the Ethernet interface.
4. Assign the IP address in the inspector window under:  
"General > PROFINET interface > Ethernet addresses"

### Parameters for the PLC

- "CPU type"  
For "CPU type", you set the Modicon PLC to which the HMI device is connected.
- "Port"  
For "Port", you set the port that is used for the TCP/IP connection. The port used by the Modicon PLCs is 502.
- "Server"  
You set the IP address or host name of the PLC under "Server". Only the IP address can be used on a Basic Panel.
- "Remote Slave address"  
Under "Remote Slave address" you only set which slave address the remote PLC has when using a bridge.  
If no bridge is used, the default value 255 (or 0) must be retained.
- "Change word order"  
The "Change word order" parameter only affects the word order of the 32-bit values display. The setting pertains to the data types Double, Double+/-, and Float. The byte order cannot be changed.
  - "Change word order" not activated  
The most significant byte is sent first.  
For double words, the least significant word is sent before the most significant word.  
This setting has been system-tested for all approved PLCs.
  - "Change word order" activated  
The most significant byte is sent first.  
For double words, the most significant word is sent before the least significant word.

---

#### Note

This setting must be used for the SIEMENS SENTRON PAC3200 and PAC4200 multi-function meters and can be used for PLCs of other manufacturers.

---

- "Use single write"  
If you deselect this function, only function codes 15H and 16H are used for writing into the PLC.  
If this function remains selected, the function codes 05H, 06H 16H and 16H are used.

## Connecting HMI device to PLC

### Connections via Modicon Modbus TCP/IP

#### Connection

The HMI device can be connected to the Modicon Modbus PLC using the following components:

- Existing Ethernet network that also contains the PLCs
- Cross-over Ethernet cable connected directly to the Ethernet interface of the CPU or the communication module

The connection of the HMI device to a Modicon Modbus PLC is limited primarily to the physical connection of the HMI device. Special blocks for the connection are not required in the PLC.

---

#### Note

Timeout response with TCP/IP (Ethernet)

Due to the use of the TCP/IP protocol, the breakdown of a connection is detected at the earliest after approximately one minute. Communication failure cannot be reliably detected if no tags are requested, for example, no output tags in the current screen.

Configure area pointer coordination for each PLC. This setting ensures that a communication failure is recognized after approximately two minutes, even in the aforementioned scenario.

---

## Communication types

### Approved communication types

The following communication types are system-tested and approved:

- Point-to-point coupling:
- Multiple point coupling of a HMI device (Modbus TCP/IP Client) with up to 4 PLCs, each with different couplings. CPU types can be mixed.  
The following couplings are possible:
  - Coupling the Ethernet CPU interface of the TSX Unity Quantum.
  - Coupling via the communication modules for Ethernet 140 NOE 771 01 for the TSX Quantum and TSX Unity Quantum series
  - Coupling via the Ethernet interface of the 171 CCC 980 30 CPU adapter of the Momentum series
  - Coupling the Ethernet CPU interface of the TSX Unity Premium.
  - Coupling via the Ethernet TCP/IP connect module TSX ETY 110 for the TSX Premium and TSX Unity Premium series
  - Coupling via the Ethernet TCP/IP connect module TSX ETY 410 for the Micro series
  - Coupling via the Ethernet TCP/IP Modbus Plus Bridge 174 CEV 200 40 to the Modbus Plus interface of the Compact, the TSX Quantum and the TSX Unity Quantum series

Via the TCP/IP Modbus Plus Bridge, 174 CEV 200 40, the PLCs can be accessed at their Remote Slave Address via the Ethernet interface of this bridge.

---

#### Note

Integration of the HMI device in a Modbus network via a bridge is not possible. The HMI device is the Modbus master.

---

## Restrictions

The coupling of the HMI device to PLCs of other manufacturers who offer a Modbus TCP/IP interface is not system-tested and thus, not enabled.

However, if another PLC is to be used, observe the following instructions:

- Use the following CPU types, because these operate without address offset and in the usual bit count manner.
  - Unity, PL7: Premium, Micro, Quantum, M340
- The following function codes are used for the respective data areas:

Reading function codes		Address range	
01	ReadCoilStatus	0x / %M	DIGITAL_OUT
02	ReadInputStatus	1x / %I	DIGITAL_IN
03	ReadHoldingRegisters	4x / %MW	USERDATA



Reading function codes		Address range	
04	ReadInputRegisters	3x / %IW	ANALOG_IN
20 (14Hex)	ReadGeneralReference	6x / –	EXTENDEDMEMORY (not for all CPUs)

Writing function codes		Address range	
06 <sup>1)</sup>	PresetSingleRegister	4x / %MW	USERDATA Single
16 (10Hex)	PresetMultipleRegisters	4x / %MW	USERDATA Multiple
05 <sup>1)</sup>	ForceSingleCoil	0x / %M	DIGITAL_OUT with BIT
15 (0FHex)	ForceMultipleCoils	0x / %M	DIGITAL_OUT with 16 BIT GROUP
21 (15Hex)	WriteGeneralReference	6x / –	EXTENDEDMEMORY (not for all CPUs)

<sup>1)</sup> Select use with "Use single write".

## Connectable PLCs

Connections can be implemented for the following Modicon Modbus PLCs:

Modicon Modbus PLC	Supported protocol	
	Modicon Modbus RTU <sup>2)</sup>	Modicon Modbus TCP/IP
TSX Compact	x	x <sup>1)</sup>
TSX Quantum	x	x
Momentum	x	x
Premium	-	x
Micro	-	x
M340 20x0 (without 2010)	-	x

<sup>1)</sup> Only via Ethernet TCP/IP Modbus Plus Bridge

<sup>2)</sup> Communication via RS 232 is tested and enabled for the PLC. In the HMIs that only have a RS 422/485 interface, the RS 422/232 converter with the order number 6AV6 671-8XE00-0AX0 was tested and enabled.

## Performance features of communication

### Permissible data types for Modicon Modbus TCP/IP

#### Permitted data types

The table lists the data types that can be used when configuring tags and area pointers.

---

#### Note

If you change the Modicon Modbus RTU communication driver to Modicon Modbus TCP/IP, the string in the "String" data type may be different.

---

### Permitted data types for CPU type "Unity, PLC: Premium, Micro, Quantum M340"

---

Data type	Operand type	Length
+/- Double	%MW	4 bytes
+/- Int	%MW, %IW	2 bytes
16-bit group	%MW, %I	2 bytes
ASCII	%MW	0 to 80 characters
Bit	%MW, %IW, %M, %I	1-bit
Double	%MW	4 bytes
Float	%MW	4 bytes
Int	%MW, %IW	2 bytes

---

#### Note

The ranges "%I" and "%IW" are not supported for the following CPU types:

- Premium
  - Micro
  - M340
- 

### Permitted data types for CPU type "Concept, ProWORX: Compact, Quantum, Momentum"

---

Data type	Operand type	Length
+/- Double	4x, 6x	4 bytes
+/- Int	3x, 4x, 6x	2 bytes
16-bit group	0x, 1x	2 bytes
ASCII	4x, 6x	0 to 80 characters
Bit	0x, 1x, 3x, 4x, 6x	1-bit

---

Data type	Operand type	Length
Double	4x, 6x	4 bytes
Float	4x, 6x	4 bytes
Int	3x, 4x, 6x	2 bytes

### Bit counting method

The usual bit counting method "16 LSB - 1 MSB" in the following CPU types is only used in the "HMI tags" editor with the selected "Bit" data type:

- Concept, ProWORX: Compact, Quantum, Momentum

The following bit location assignment applies:

	Left byte								Right byte							
Counting with tags	1	2	3	4	5	6	7	8	9	10	11	12	13	14	15	16

### Format for "Signed"

The placeholder "+/-" stands for the data types "Signed Int" and "Signed Double".

### Supported CPU types for Modicon Modbus TCP/IP

#### CPU types

The following CPU types are supported for configuring the Modicon Modbus TCP/IP communication driver.

- Compact
- Momentum
- Quantum
  - Concept Quantum
  - Unity Quantum
- Micro
- Premium
- Modicon M340
  - 20x0 (except 2010)

Address areas for Modicon Modbus TCP/IP

Unity, PI7

Address areas	Data types							
	Bool	16 Bit Group	Int	+/- Int	DInt	+/- DInt	Float	ASCII
%I	%I0 - %I65535	%I65535 %I0 - %I65520	--	--	--	--	--	--
%M	%M0 - %M65535	%M65535 %M0 - %M65520	--	--	--	--	--	--
%IW	%IW0.0 - %IW65535. 15	--	%IW0 - %IW65535	%IW0 - %IW65535	--	--	--	--
%MW	%MW0.0 - %MW6553 5.15	--	%MW0 - %MW6553 5	%MW0 - %MW6553 5	%MW0 - %MW6553 4	%MW0 - %MW6553 4	%MW0 - %MW6553 4	%MW0 - %MW6553 5

Concept, ProWORX

Address areas	Data types							
	Bool	16 Bit Group	Int	+/- Int	DInt	+/- DInt	Float	ASCII
0x	0x1 - 0x65535	0x1 - 0x65520	--	--	--	--	--	--
1x	1x100001 - 1x165535	1x100001 - 1x165520	--	--	--	--	--	--
3x	3x300001.1 - 3x365535.1 6	--	3x300001 - 3x365535	3x300001 - 3x365535	--	--	--	--
4x	4x400001.1 - 4x465535.1 6	--	4x400001 - 4x465535	4x400001 - 4x465535	4x400001 - 4x465534	4x400001 - 4x465534	4x400001 - 4x465534	4x400001 - 4x465535
6x	6x60000.1: 1 - 6x69999.16 :10	--	6x60000:1 - 6x69999:10	6x60000:1 - 6x69999:10	6x60000:1 - 6x69998:10	6x60000:1 - 6x69998:10	6x60000:1 - 6x69998:10	6x60000:1 - 6x69999:10

## Commissioning components

### Transferring a project to the HMI device

1. Switch the HMI device to "transfer mode".
2. Set all necessary transfer parameters.
  - Interface
  - Transfer parameters
  - Target storage location
3. Start the project transfer.  
The project is compiled automatically.  
All compilation and transfer steps are logged to a message window.

### Interconnecting the PLC with the HMI device

1. Interconnect the PLC with the HMI device using a suitable cable.
2. The message "Connection to PLC .... is established" is output to the HMI device.

## Optimizing the configuration

### Acquisition cycle and update time

The acquisition cycles for the "Area pointers" and of the tags defined in the configuration software are decisive in terms of the update times which can actually be achieved.

The update time is equivalent to the acquisition cycle + transmission time + processing time.

Items to observe when optimizing the update times in configuration data:

- Optimize the maximum and minimum size of the data areas.
- Acquisition cycles which are too short lead to unnecessary load on overall performance. Set the acquisition cycle according to the rate of change of the process values. The rate of temperature changes at a furnace, for example, is significantly slower compared to the speed rate of an electrical drive. A time of approx. 1 second is a benchmark for the acquisition cycle.
- Avoid any gaps when entering the alarm or screen tags in a data area.
- Changes in the PLC can only be detected reliably if these are available at least within the actual acquisition cycle.

## Screens

The refresh rate of screens is determined by the type and volume of data to be visualized.

Only configure short acquisition cycles for objects which actually require shorter refresh cycles. This procedure reduces update times.

## Trends

The HMI device always updates all bit-triggered trends whose group bit is set in the "Trend transfer area". It resets the bits in the next cycle.

The group bit in the PLC program can only be set again after the HMI device has reset all bits.

## Job mailboxes

A high rate and volume of job mailboxes transferred may lead to overload in communication between the HMI device and the PLC.

The HMI device confirms acceptance of the job mailbox by entering the value zero in the first data word of the job mailbox. The HMI device now processes the job for which it requires a certain time slice. It may take the HMI device some time to process a new job mailbox which is transferred in immediate succession to the job mailbox. The next job mailbox is only accepted if sufficient computing resources are available.

## Modicon Modbus RTU

### Configuring a connection via Modicon Modbus RTU

#### Introduction

You configure a connection to a PLC with a Modicon Modbus RTU communication driver in the "Connections" editor of the HMI device.

The interfaces are named differently depending on the HMI device.

#### Requirements

- A project is open.
- An HMI device has been created.

#### Procedure

1. Double-click the HMI device under "Devices" in the project tree.
2. Double-click the "Connections" item.

3. Double-click "<Add>" in the "Connections" editor.

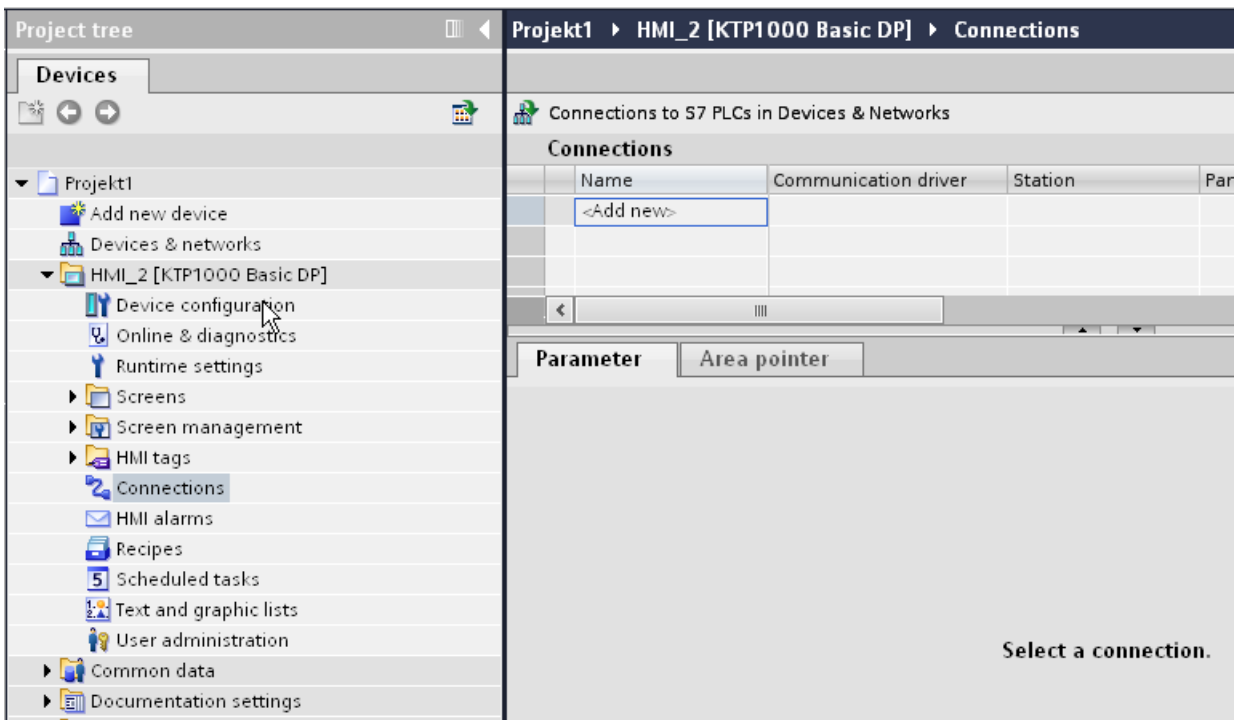

- In the "Communication drivers" column, select the "Modicon Modbus RTU" driver.

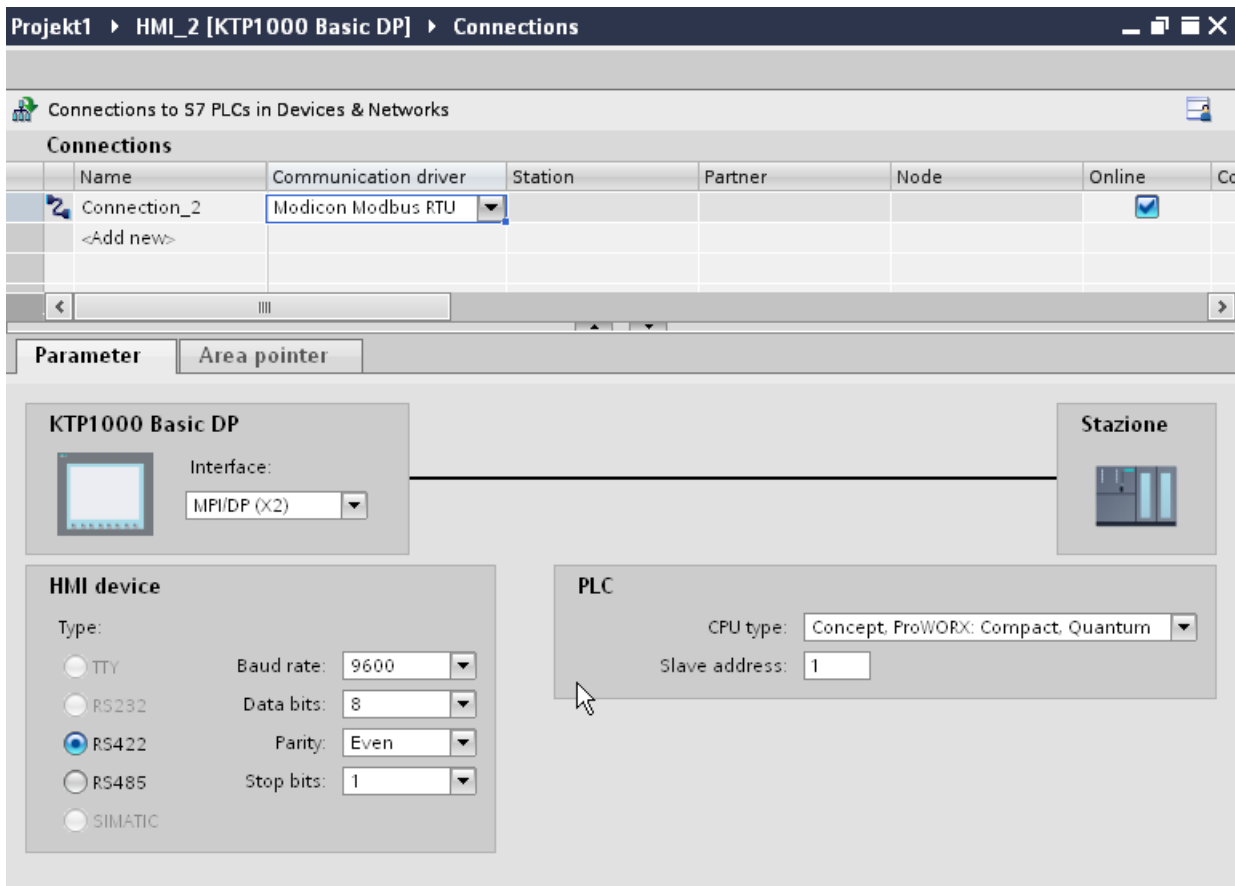

- Select all necessary connection parameters for the interface in the Inspector window under "Parameters".

## Parameters for the connection (Modicon Modbus RTU)

### Parameters to be set

To set the connection parameters, such as addresses and profiles, click the connection that you have created in the "Connections" editor.

The communication partners are displayed schematically in the Inspector window under "Parameters". The "HMI device" and "PLC" areas are available for assigning parameters according to the interface used.



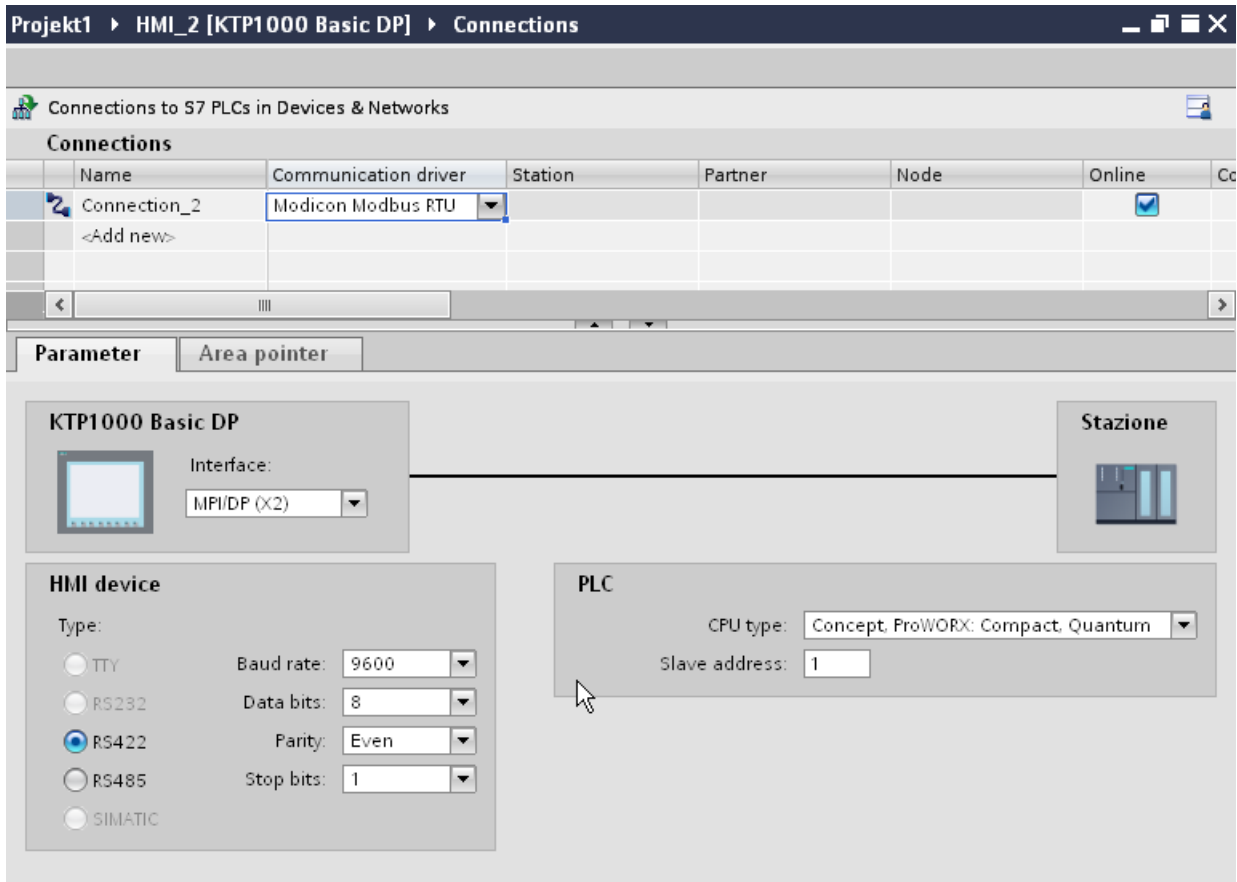

### Parameters for the HMI device

You can select an interface for the HMI device in the Inspector window under "Parameters". Depending on the HMI device, there are several interfaces available.

- Type  
Only RS 232 is system-tested.  
No warranty is given for RS 485.

---

#### Note

RS 422 is only approved in combination with the RS 422-RS 232 converter.

Order number: 6AV6 671-8XE00-0AX0

---

#### Note

If you use the IF1B interface, you must switch over the RS422 receive data additionally by 4 DIL-switches on the back of the HMI device.

---

- Baud rate  
For "Baud rate", select the transmission speed between the HMI device and Modicon PLC. A baud rate of 19200 or 9600 can be selected for the communication.  
A baud rate of 4800 can be selected for certain HMI devices.

10.11 Communicating with PLCs

- Data bits  
For "Data bits", only the value "8" can be selected.
- Parity  
For "Parity", you can choose from "None", "Even", and "Odd".
- Stop bits  
For "Stop bits", you can choose between 1 and 2 bits.

**Parameters for the PLC**

- CPU type  
For "CPU type", you set the Modicon PLC to which the HMI device is connected. You can select the following CPUs:
  - Concept, ProWORX: Compact, Quantum
- Slave address  
Under "Slave address" you set which slave address the CPU has.

**Connecting HMI device to PLC**

**Connections via Modicon Modbus RTU**

**Connection**

Connect the HMI device to the Modicon Modbus RTU interface of the Modicon Modbus RTU slave.

The connection of the HMI device to Modicon is limited primarily to the physical connection of the HMI device. Special blocks for the connection are not required in the PLC.

**Connection cable**

The following connecting cables are available to connect the HMI device to Modicon Modbus.

Interface to the HMI device	Modicon PLC		
	directly via Modbus interface (RS232) 9-pin Sub D male connector	Via MB Bridge (RS 232)	directly via Modbus interface (RS232) 8-pin RJ45 connector
RS 232, 9-pin	PP1	PP1	PP2

The cable pin assignments can be found in Section "Connecting cables for Modicon Modbus RTU".

## Communication types

### Approved communication types

The following communication types are system-tested and approved:

- Point-to-point connection only via the RS-232 interface.
- Multipoint connection from a HMI device (Modbus-Master) with up to 4 PLCs: The HMI device must be connected with a Modbus Plus Bridge or a Compact, Momentum CPU or TSX Quantum CPU which is configured as a Modbus Plus Bridge.
- You connect the other PLCs via the Modbus Plus connection on the first PLC. The PLCs can be reached under their address via the bridge functionality of the first PLC.

---

#### Note

It is not possible to integrate the HMI device into a Modbus network because the HMI device is Modbus-Master.

---

- Integration of the HMI device into a Modbus Plus network via the "bridge mode" of the Compact, Momentum or Quantum (logical point-to-point communication of the HMI device with a Compact, Momentum or Quantum).

## Restrictions

The connection of the HMI device to PLCs of other manufacturers which offer a Modicon Modbus interface is not system-tested and therefore not approved.

If you use another PLC nevertheless, observe the following information:

- These drivers only work for tags with the bit counting method typical for Modicon PLCs from left (bit1 = most significant bit) to right (bit16 = least significant bit in data type INT).
- The address offset displayed in the configuring is subtracted at protocol level in the message frame. E.g. in Holding Register 4x the offset "40001". The configured address "40006" therefore becomes address "5" in the message frame. The address (e.g. "5") transferred in the message frame is transformed to the PLC-specific address range in the different Non-Modicon PLCs.
- A reply message frame without "ExceptionCode" is expected within 500 ms.
- The following function codes are used for the respective data areas:

Reading function codes		Address range	
01	ReadCoilStatus	0x	DIGITAL_OUT
02	ReadInputStatus	1x	DIGITAL_IN
03	ReadHoldingRegisters	4x	USERDATA
04	ReadInputRegisters	3x	ANALOG_IN
20 (14Hex)	ReadGeneralReference	6x	EXTENDEDMEMORY (not for all CPUs)

Writing function codes		Address range	
06	PresetSingleRegister	4x	USERDATA Single
16 (10Hex)	PresetMultipleRegisters	4x	USERDATA Multiple
05	ForceSingleCoil	0x	DIGITAL_OUT with data type Bit
15 (0FHex)	ForceMultipleCoils	0x	DIGITAL_OUT with data type 16 bit group
21 (15Hex)	WriteGeneralReference	6x	EXTENDEDMEMORY (not for all CPUs)

## Connectable PLCs

Connections can be implemented for the following Modicon Modbus PLCs:

Modicon Modbus PLC	Supported protocol	
	Modicon Modbus RTU <sup>2)</sup>	Modicon Modbus TCP/IP
TSX Compact	x	x <sup>1)</sup>
TSX Quantum	x	x
Momentum	x	x
Premium	-	x
Micro	-	x
M340 20x0 (without 2010)	-	x

<sup>1)</sup> Only via Ethernet TCP/IP-Modbus Plus Bridge

<sup>2)</sup> Communication via RS 232 is tested and enabled for the PLC. In the HMI devices which only have an RS 422/485 interface, the RS 422/232 converter with the order number 6AV6 671-8XE00-0AX0 was tested and approved.

### Connecting cables for Modicon Modbus RTU

#### Connecting cable PP1, RS-232, for Modicon

#### Point-to-point cable 1: PLC > PC ...

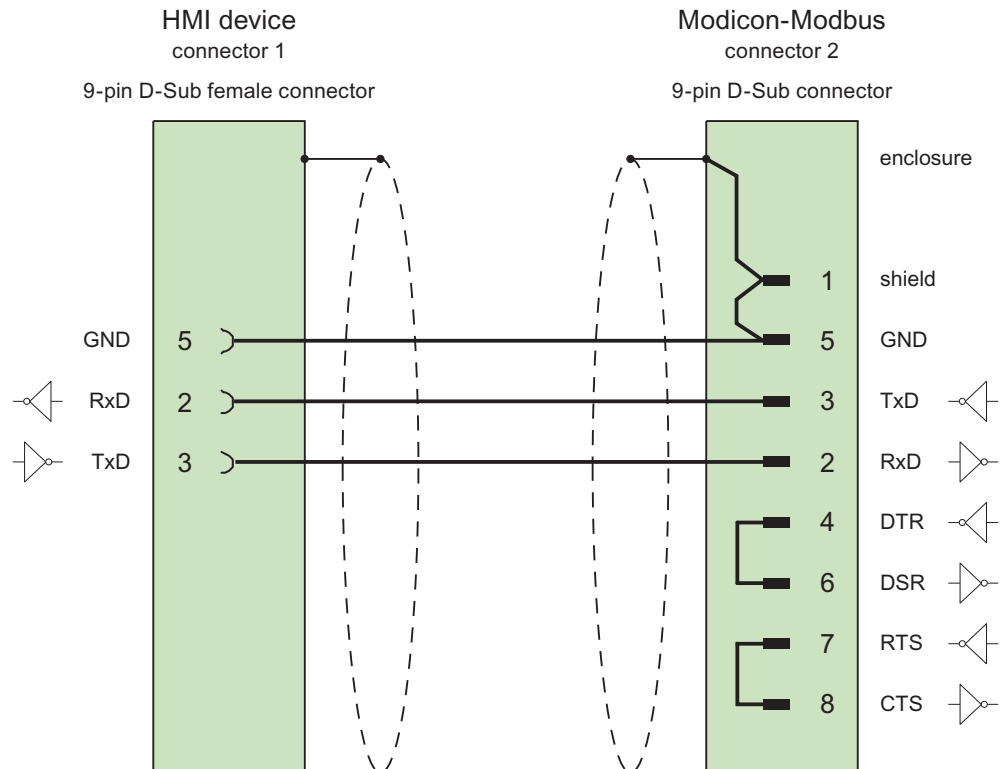

Cables: 3 x 0.14 mm<sup>2</sup>, shielded,  
max. length 15 m

### Connecting cable PP2, RS-232, for Modicon

#### Point-to-point cable 2: PLC (TSX Compact) > PC...

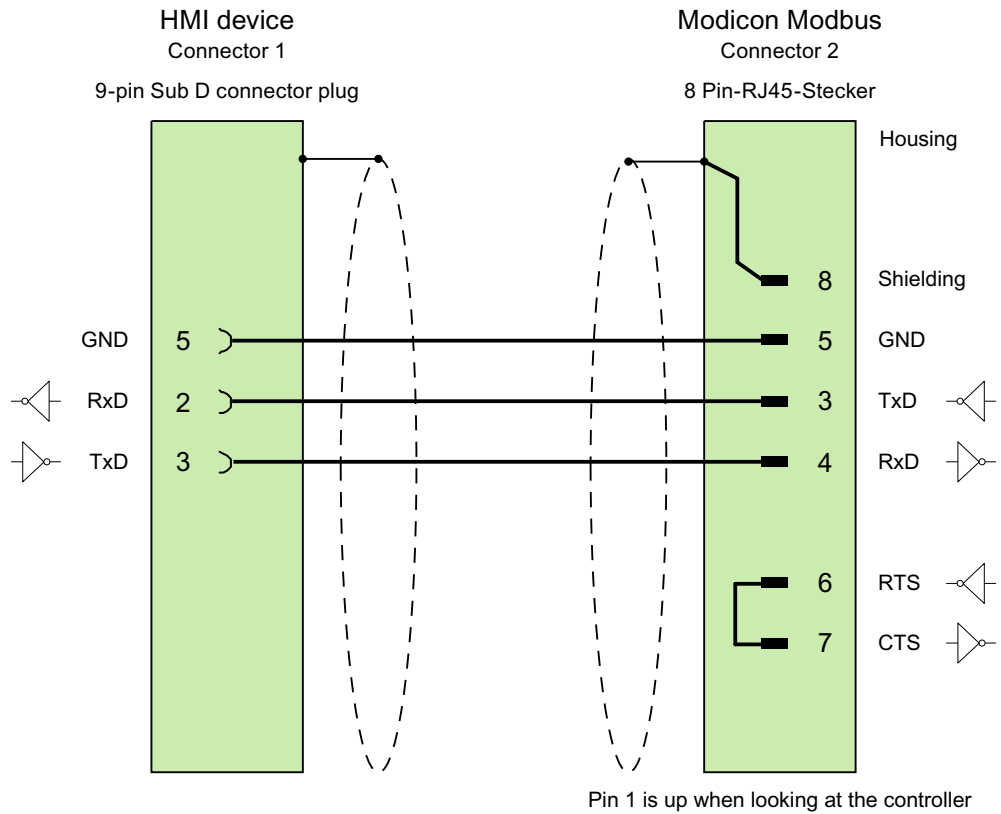

Cables: 3 x 0.14 mm<sup>2</sup>, shielded,  
max. length 15 m

## Performance features of communication

### Permitted data types for Modicon Modbus RTU

#### Permitted data types

The table lists the data types that can be used when configuring tags and area pointers.

Data type	Operand type	Length
+/- Double	4x, 6x	4 bytes
+/- Int	3x, 4x, 6x	2 bytes
16-bit group	0x, 1x	2 bytes
ASCII	4x, 6x	0 to 80 characters
Bit <sup>1)</sup>	0x, 1x, 3x, 4x, 6x	1-bit
Double	4x, 6x	4 bytes
Float	4x, 6x	4 bytes
Int	3x, 4x, 6x	2 bytes

<sup>1)</sup> Note the following for write accesses:

For data type "Bit" with the operand types "4x" and "6x", the entire word is written back to the PLC following a change to the specified bit. There is no check to determine whether any other bits in the word have changed. As a result, the PLC only has read access to the specified word.

The usual bit counting method (16 LSB - 1 MSB) in the following CPU types is only used in the "HMI tags" editor with the selected "Bit" data type:

- Concept ProWORX: Compact, Quantum

The following bit location assignment applies:

	Left byte								Right byte							
Counting with tags	1	2	3	4	5	6	7	8	9	10	11	12	13	14	15	16

#### Format for "Signed"

The placeholder "+/-" stands for the data types "Signed Int" and "Signed Double".

## Supported CPU types for Modicon Modbus RTU

### CPU types

The following CPU types are supported in the configuration of the Modicon Modbus RTU communication driver.

- Compact
- Momentum
- Quantum

## Address areas for Modicon Modbus RTU

### Concept, ProWORX

Address areas	Data types							
	Bool	16 Bit Group	Int	+/- Int	DInt	+/- DInt	Float	ASCII
0x	0x1 - 0x65535	0x1 - 0x65520	--	--	--	--	--	--
1x	1x100001 - 1x165535	1x100001 - 1x165520	--	--	--	--	--	--
3x	3x300001.1 - 3x365535.16	--	3x300001 - 3x365535	3x300001 - 3x365535	--	--	--	--
4x	4x400001.1 - 4x465535.16	--	4x400001 - 4x465535	4x400001 - 4x465535	4x400001 - 4x465534	4x400001 - 4x465534	4x400001 - 4x465534	4x400001 - 4x465535
6x	6x60000.1:1 - 6x69999.16:10	--	6x60000:1 - 6x69999:10	6x60000:1 - 6x69999:10	6x60000:1 - 6x69998:10	6x60000:1 - 6x69998:10	6x60000:1 - 6x69998:10	6x60000:1 - 6x69999:10



## Commissioning components

### Transferring a project to the HMI device

1. Switch the HMI device to "transfer mode".
2. Set all necessary transfer parameters.
  - Interface
  - Transfer parameters
  - Target storage location
3. Start the project transfer.  
The project is compiled automatically.  
All compilation and transfer steps are logged to a message window.

### Interconnecting the PLC with the HMI device

1. Interconnect the PLC with the HMI device using a suitable cable.
2. The message "Connection to PLC .... is established" is output to the HMI device.

## Optimizing the configuration

### Acquisition cycle and update time

The acquisition cycles for the "Area pointers" and of the tags defined in the configuration software are decisive in terms of the update times which can actually be achieved.

The update time is equivalent to the acquisition cycle + transmission time + processing time.

Items to observe when optimizing the update times in configuration data:

- Optimize the maximum and minimum size of the data areas.
- Acquisition cycles which are too short lead to unnecessary load on overall performance. Set the acquisition cycle according to the rate of change of the process values. The rate of temperature changes at a furnace, for example, is significantly slower compared to the speed rate of an electrical drive. A time of approx. 1 second is a benchmark for the acquisition cycle.
- Avoid any gaps when entering the alarm or screen tags in a data area.
- Changes in the PLC can only be detected reliably if these are available at least within the actual acquisition cycle.

## Screens

The refresh rate of screens is determined by the type and volume of data to be visualized.

Only configure short acquisition cycles for objects which actually require shorter refresh cycles. This procedure reduces update times.

## Trends

The HMI device always updates all bit-triggered trends whose group bit is set in the "Trend transfer area". It resets the bits in the next cycle.

The group bit in the PLC program can only be set again after the HMI device has reset all bits.

## Job mailboxes

A high rate and volume of job mailboxes transferred may lead to overload in communication between the HMI device and the PLC.

The HMI device confirms acceptance of the job mailbox by entering the value zero in the first data word of the job mailbox. The HMI device now processes the job for which it requires a certain time slice. It may take the HMI device some time to process a new job mailbox which is transferred in immediate succession to the job mailbox. The next job mailbox is only accepted if sufficient computing resources are available.

## Data exchange

### Area pointers for Modicon Modbus

#### Area pointers for connections via Modicon Modbus communication drivers

You use an area pointer to access a data area in the PLC.

For more detailed information on area pointers and their configuration, refer to Section "Data exchange using area pointers".

#### Special considerations for connections via Modicon communication drivers

You can configure the following area pointers

Area pointers	Modicon Modbus TCP/IP	Modicon Modbus RTU
Screen number	Yes	Yes
Date/time	Yes	Yes
Date/time PLC	Yes	Yes
Coordination	Yes	Yes
Project ID	Yes	Yes
Job mailbox	Yes	Yes
Data record	Yes	Yes

## Restrictions Modicon Modbus TCP/IP

The following restrictions apply for configuring area pointers.

CPU type	Data types	File types
Concept, ProWORX: Compact, Quantum, Momentum	+/- Int, Int	4x, 6x
Unity, PL7: Premium, Micro, Quantum, M340	+/- Int, Int	%MW

## Modicon Modbus RTU restrictions

The following restrictions apply for configuring area pointers.

CPU type	Data types	File types
Concept, ProWORX: Compact, Quantum, Momentum	+/- Int, Int	4x, 6x

## Trends

### General information on trends

### Trends

A trend is the graphical representation of one or more values from the PLC. The value is read out either time- or bit-triggered, depending on the configuration.

For additional information see:

Displaying tags with Runtime Advanced and Panels (Page 3237)

---

#### Note

The value is read out time-triggered for Basic Panels.

---

### Time-triggered trends

The HMI device reads in the trend values cyclically at an interval specified in the configuration. Time-triggered trends are suitable for continuous curves, such as the operating temperature of a motor.

### Bit-triggered trends

Through a trigger bit set in the trend request tag, the HMI device either reads in a trend value or an entire trend buffer. This setting is defined in the configuration. Bit-triggered trends are normally used to represent fast changing values. One example might be the injection pressure in the production of plastic parts.

To trigger bit-triggered trends, appropriate external tags must be created in the "HMI tags" editor and connected to trend areas during configuration. The HMI device and PLC then communicate with each other via these trend areas.

The following areas are available for trends:

- Trend request area
- Trend transfer area 1
- Trend transfer area 2 (required only with switch buffers)

## Trend request and trend transfer

### Trend request area

The HMI device sets corresponding bits in the trend request area when you open a screen which contains one or more trends on the HMI device. After closing the screen, the HMI device resets the relevant bits in the trend request area.

The trend request area can be used for evaluation purposes in the PLC to determine which trend is currently being displayed on the HMI device. Trends can also be triggered without evaluation of the trend request area.

### Trend transfer area 1

This area is used to trigger trends. You must set the bit assigned to the trend in the trend transfer area and set the trend group bit in your control program. The trend group bit is the last bit in the trend transfer area.

The HMI device detects the trigger. The HMI device reads either a value or the entire buffer from the PLC. It then resets the trend bit and the trend group bit.

The following picture shows the structure of a trend transfer area.

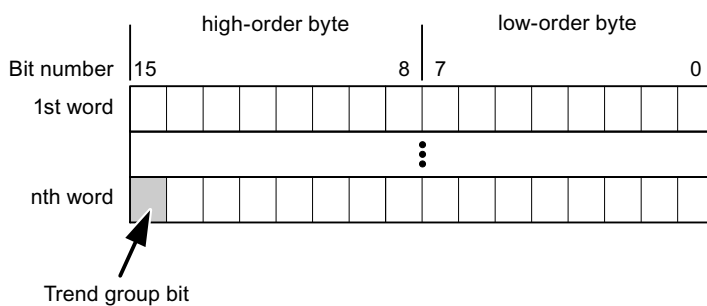

The trend transfer area must not be modified by the PLC program until the trend group bit has been reset.

### Trend transfer area 2

Trend transfer area 2 is required for trends configured with a switch buffer. The trend transfer areas 1 and 2 have a similar structure.

## Switch buffer

The switch buffer is a second buffer for the same trend that can be set up during configuration.

The PLC writes to Buffer 2 while the HMI device reads values from Buffer 1, and writes to Buffer 1 when the HMI device is reading Buffer 2. This prevents the PLC from overwriting trend values while the trend is being read by the HMI device.

## Permitted data types for trend control

### Modicon Modbus TCP/IP

Tags of the following operand types are permitted for CPU type "Concept, ProWORX: Compact, Quantum, Momentum".

- "4x"
- "6x"

Tags of the following operand types are permitted for CPU type "Unity, PL7: Premium, Micro, Quantum, M340".

- "%MW"

The tags for trend control must have data type "Int" or "+/- Int" or be an array tag with data type "Int" or "+/-Int".

You assign a bit to a trend during configuration. This sets a defined bit assignment for all areas.

### Modicon Modbus RTU

Tags of the following operand types are permitted for CPU type "Concept, ProWORX: Compact, Quantum".

- "4x"
- "6x"

The tags for trend control must have data type "Int" or "+/- Int" or be an array tag with data type "Int" or "+/-Int".

You assign a bit to a trend during configuration. This sets a defined bit assignment for all areas.

## Alarms

### Configuring alarms

#### Configuring alarms for non-integrated connections

Several steps are necessary to configure alarms such as warnings, error messages and acknowledgement.

- Step 1: Create tags
- Step 2: Configure alarms
- Step 3: Configure acknowledgment

You can find additional information in the section:

Working with Alarms (Page 3260)

#### Distinctive features when configuring alarms

If you are configuring connections of HMI devices to PLCs of other manufacturers, note the following distinctive features when configuring:

- Data types of the tags
- Addressing of tags
- How the bit positions are counted

### Data types

For connections with a Modicon Modbus communication driver, the following data types are supported:

PLC	Permitted data types	
	Discrete alarms	Analog alarms
All Modicon series	Int, +/-Int	16 Bit Group, Int, +/-Int, Double, +/-Double, Float

Arrays and array tags cannot be used for discrete alarms.

#### How the bit positions are counted

For connections with a Modicon Modbus communication driver, the following counting method applies:

How the bit positions are counted	Left byte								Right byte							
In WinCC you configure:	15	14	13	12	11	10	9	8	7	6	5	4	3	2	1	0

## Acknowledgment of alarms

### Procedure

Create suitable tags on the PLC to acknowledge an error alarm. You assign these tags to an alarm in the "Bit messages" editor. You make the assignment in "Properties > Acknowledgment".

Distinction in terms of acknowledgment:

- Acknowledgment by the PLC
- Acknowledgment on the HMI device

### Acknowledgment by the PLC

In "PLC acknowledgment tag", configure the tag or array tag and the bit number that the HMI device uses to identify a PLC acknowledgment.

A bit set in the tag triggers acknowledgment of the assigned error alarm bit at the HMI device. This tag bit returns a function similar to acknowledgment on the HMI device which is triggered by pressing the "ACK" button, for example.

The acknowledgment bit must be located in the same tag as the bit for the error alarm.

Reset the acknowledgment bit before setting the bit in the alarm area again. The figure below shows the pulse diagram.

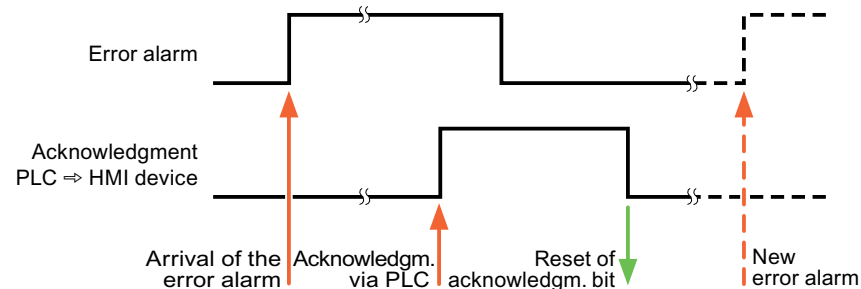

### Acknowledgment on the HMI device

In the "HMI acknowledgment tag" area, configure the tag or array tag as well as the bit number that the HMI device writes to the PLC after acknowledgment. Make sure when you use an array tag that it is not longer than 6 words.

To always create a signal change when setting an assigned acknowledgment bit of a discrete alarm that must be acknowledged, the HMI device will reset the acknowledgment bit assigned to the alarm as soon as it detects an alarm subject to acknowledgment and write the acknowledgment tag in the PLC. There will be a certain delay between detecting the message and writing the acknowledgment tag in the PLC because the HMI device has to process the operations.

If a discrete alarm subject to acknowledgment is acknowledged by the HMI device, then the corresponding bit in the assigned acknowledgment tag will be set. The entire acknowledgment

tag is then written to the PLC by the HMI device. This allows the PLC to recognize that a certain alarm message has been acknowledged at the HMI device.

---

**Note**

All alarm bits acknowledged since the last Runtime start will remain in the acknowledgment tag until a new incoming of the respective discrete alarms is detected.

This area should only be read by the PLC because the entire section of the HMI device will be overwritten once the next acknowledgment tag is written.

---

The figure below shows the pulse diagram.

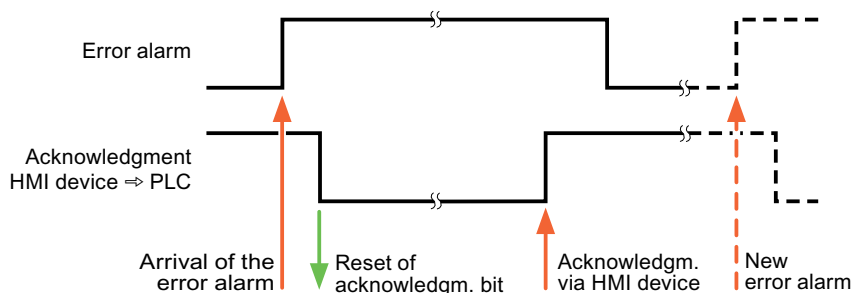

## LED mapping

### Function

Keyboard devices have LEDs in the function keys. These LEDs can be activated from the PLC. Thus, it is possible, for example, to signal to the user which key he should press in a given situation by lighting up an LED.

---

**Note**

The LED function cannot be configured for Basic Panels.

---

### Requirements

In order to activate an LED, an LED tag or an array tag must be set up in the PLC and specified as an LED tag during configuration.

### LED assignment

The assignment of the individual LEDs to the bits in the LED tags is specified when the function keys are configured. In this process, the "LED tag" and the assigned "Bit" are specified for each function key in the "General" group of the properties window.



The "Bit" bit number designates the first of two consecutive bits that control the following LED statuses.

Bit n+ 1	Bit n	LED function	
		All Mobile Panels, all Operator Panels, all Multi Panels	Panel PCs:
0	0	Off	Off
0	1	Rapid flashing	Flashing
1	0	Slow flashing	Flashing
1	1	On permanently	On permanently

## Omron

### Omron communication drivers

#### Introduction

This section describes the communication between an HMI device and PLCs that use Omron communication drivers.

The following communication drivers are supported:

- Omron Host Link

#### Data exchange

Data is exchanged by means of tags or area pointers.

- Tags  
The PLC and the HMI device use process values for data exchange. You create tags in the configuration that point to addresses in the PLC. The HMI device reads the value from the defined address, and then displays it. The operator may also enter values on the HMI device, which are then written to the address in the PLC.
- Area pointers  
Area pointers are used to exchange specific data and are only set up when these data are used.

## Omron Host Link

### Configuring a connection via Omron Host Link

#### Introduction

You configure a connection to a PLC with an Omron Host Link communication driver in the "Connections" editor of the HMI device.

---

#### Note

##### Connection with Omron Host Link

A connection will not automatically be established when runtime is started if you have configured a connection via Omron.

A tag which is in the valid PLC memory area must be configured in the runtime start screen.

The connection will otherwise only be established once a corresponding screen has been selected.

This tag will be accessed when runtime is started and a connection will then be established.

---

The interfaces are named differently depending on the HMI device.

#### Requirements

- A project is open.
- An HMI device has been created.

#### Procedure

1. Double-click the HMI device under "Devices" in the project tree.
2. Double-click the "Connections" item.

3. Double-click "<Add>" in the "Connections" editor.

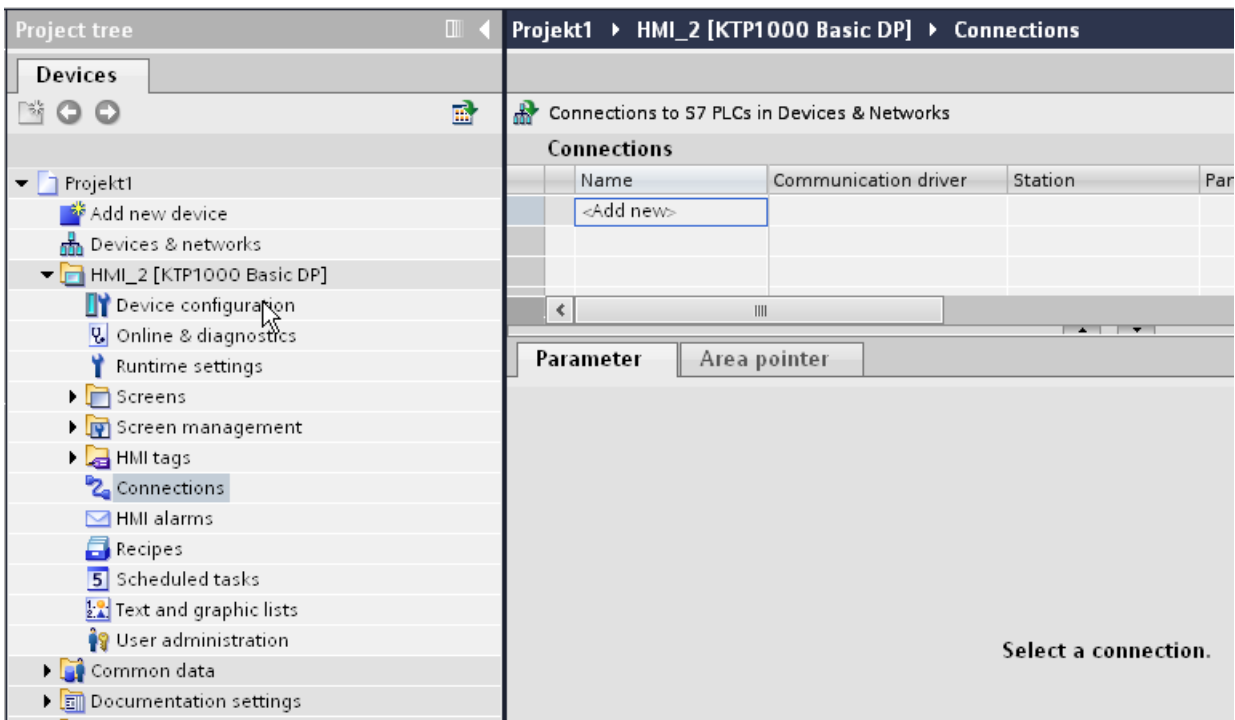

4. Select the "Omron Host Link" driver in the "Communication driver" column.

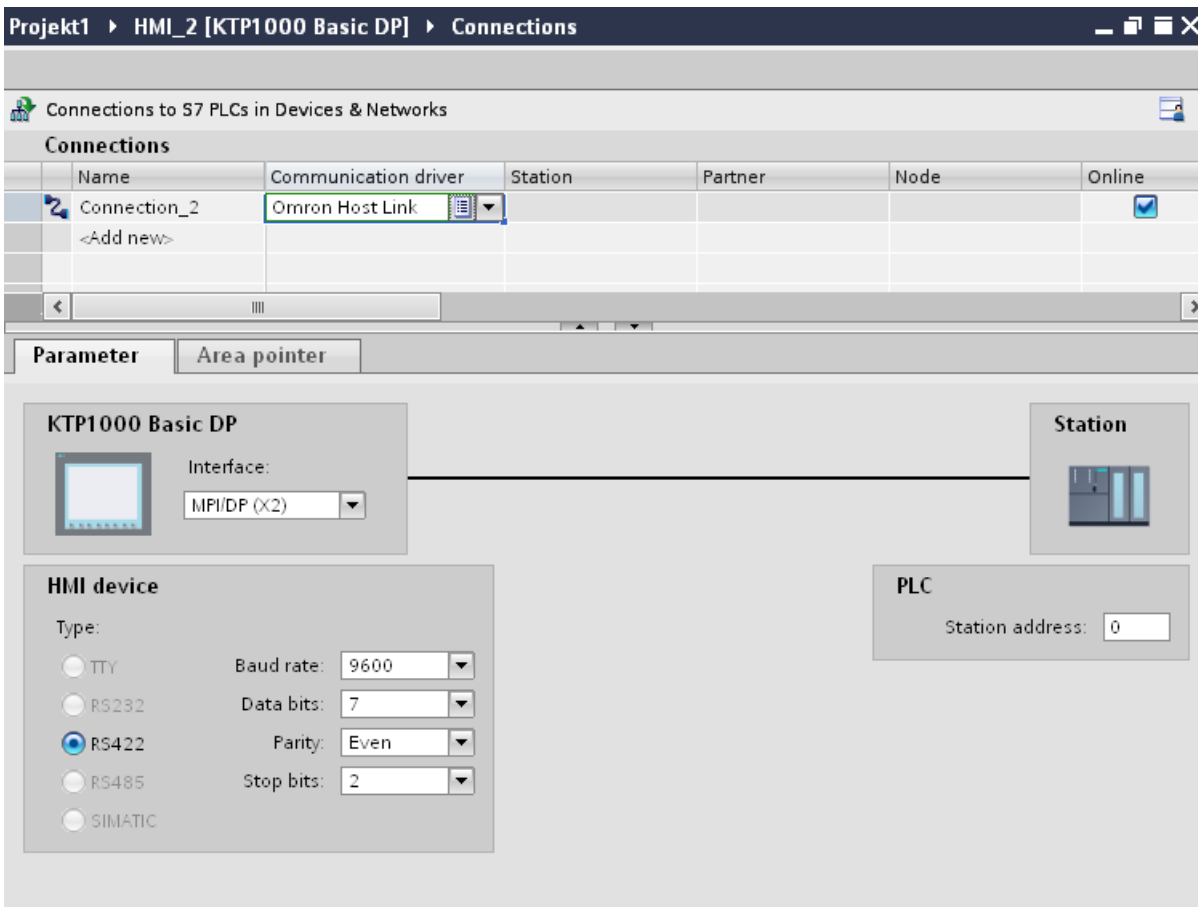

5. Select all necessary connection parameters for the interface in the inspector window under "Parameters".

### Parameters for the connection (Omron Hostlink)

#### Parameters to be set

To set the connection parameters, such as addresses and profiles, click the connection that you have created in the "Connections" editor.

The communication partners are displayed schematically in the Inspector window under "Parameters". The "HMI device" and "PLC" areas are available for assigning parameters according to the interface used.

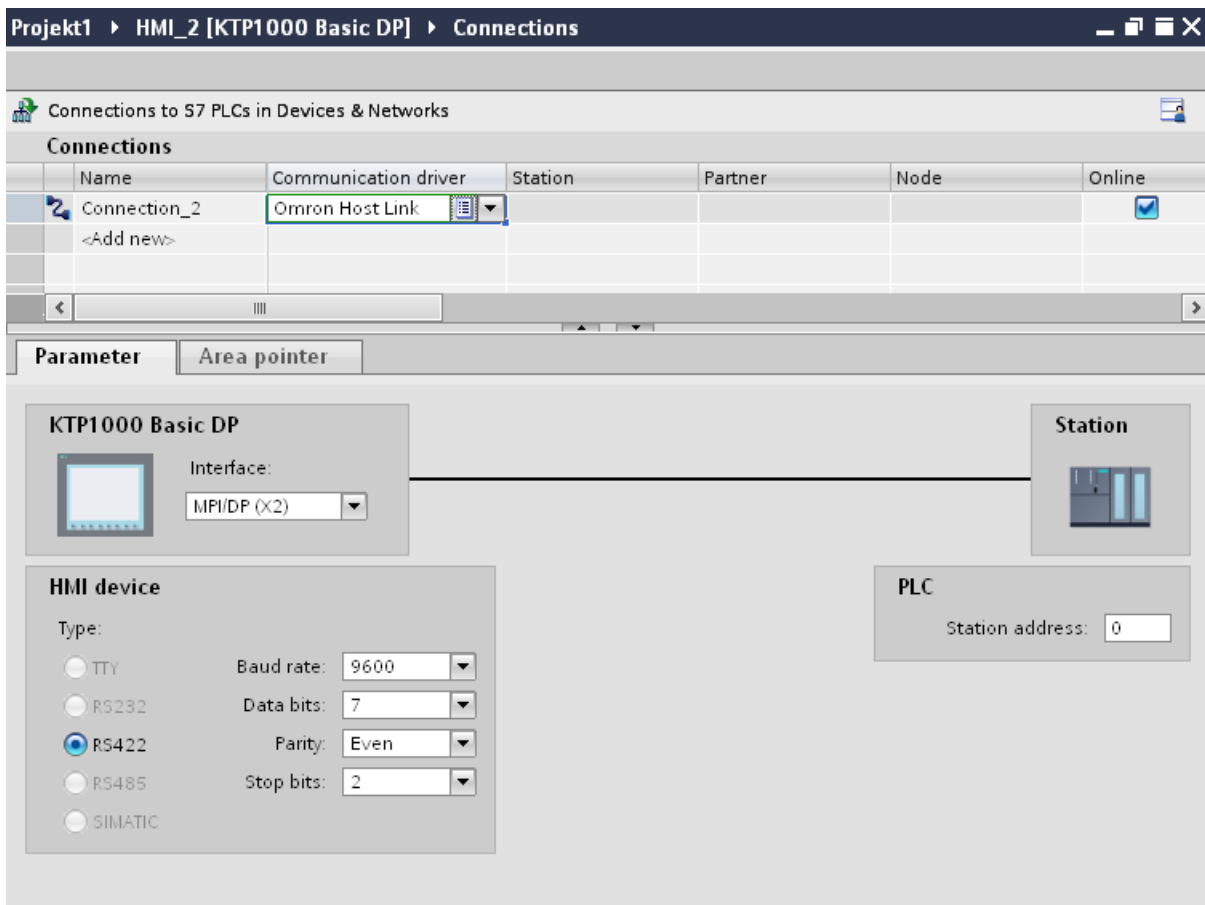

### Parameters for the HMI device

You can select an interface for the HMI device in the Inspector window under "Parameters". Depending on the HMI device, there are several interfaces available.

- **Type**  
Specifies the physical connection used.
- **Baud rate**  
For "Baud rate", you set the transmission speed of the HMI device to OMRON. A baud rate of 19200 or 9600 can be selected for the communication.
- **Data bits**  
For "Data bits", you can choose between "7 bits" and "8 bits".
- **Parity**  
For "Parity", you can choose from "None", "Even", and "Odd".
- **Stop bits**  
For "Stop bits", you can choose between 1 and 2 bits.

### Parameters for the PLC

- Station address  
For "Station address", set the station number of the connected PLC.

### Connecting HMI device to PLC

#### Connections via Omron Host Link

#### Connection

The connection of the HMI device to an OMRON PLC is limited primarily to the physical connection of the HMI device. Special blocks for the connection are not required in the PLC.

#### Connection cable

The following connecting cables are available to connect the HMI device to an Omron PLC.

Interface to the HMI device	Omron PLC			
	RS232, 9-pin	RS232 I/O port	RS422, 9-pin	RS422, terminals/pins
RS232, 9-pin	PP1	Programming cable (standard cable of Omron)	—	—
RS232 via converter	—	—	—	Multi-point cable 1
RS422, 9-pin	—	—	PP2	Multi-point cable 2

Refer to the relevant device manual to determine which HMI device interface is to be used.

### Communication types

#### Approved communication types

The connection from a HMI device to an OMRON-CPU with the Omron Host Link protocol via RS232 and via RS 422 is system-tested and approved by Siemens AG.

This concerns the following CPU types:

- CP1x (CP1L, CP1H, CP1E)
- CJ1x (CJ1M, CJ1H, CJ1G)
- CJ2H

- CS1x (CS1G, CS1H, CS1D)
- CPM2C

---

**Note**

Only the following CPU types have been tested and released for Basic Panels, TP 177A and OP 77A:

- CP1x (CP1L, CP1H, CP1E)
  - CJ1x (CJ1M, CJ1H, CJ1G)
- 

### Multipoint connection

A multipoint connection to the up to 4 approved OMRON PLCs in a RS422-four-wire connection can be implemented with communication modules on the PLCs and is system-tested and approved by Siemens AG.

---

**Note**

The HMI device can only be operated as a master. Exactly one master is possible in the RS422-four-wire-Multidrop connection.

---

### Connecting cables for Omron Host Link

#### Connecting cable MP1, RS-232, over converter, for Omron

#### Multipoint cable 1: MP/TP/PC > PLC

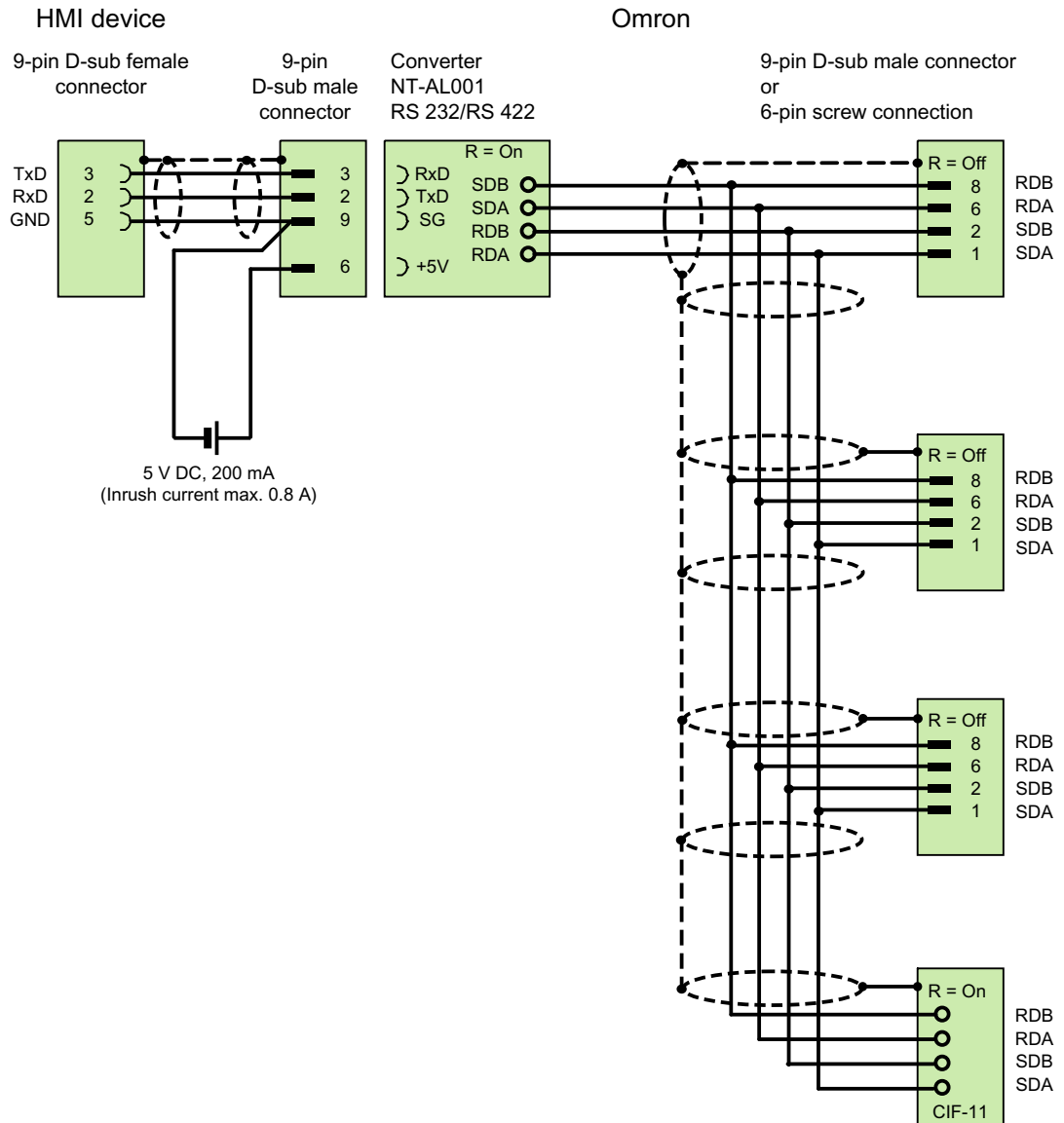

1) Inrush current max. 0.8 A  
shielded, max. length 500 m



Connecting cable MP2, RS-422, for Omron

Multipoint cable 2: RS422, MP/TP/PC > SPS\_

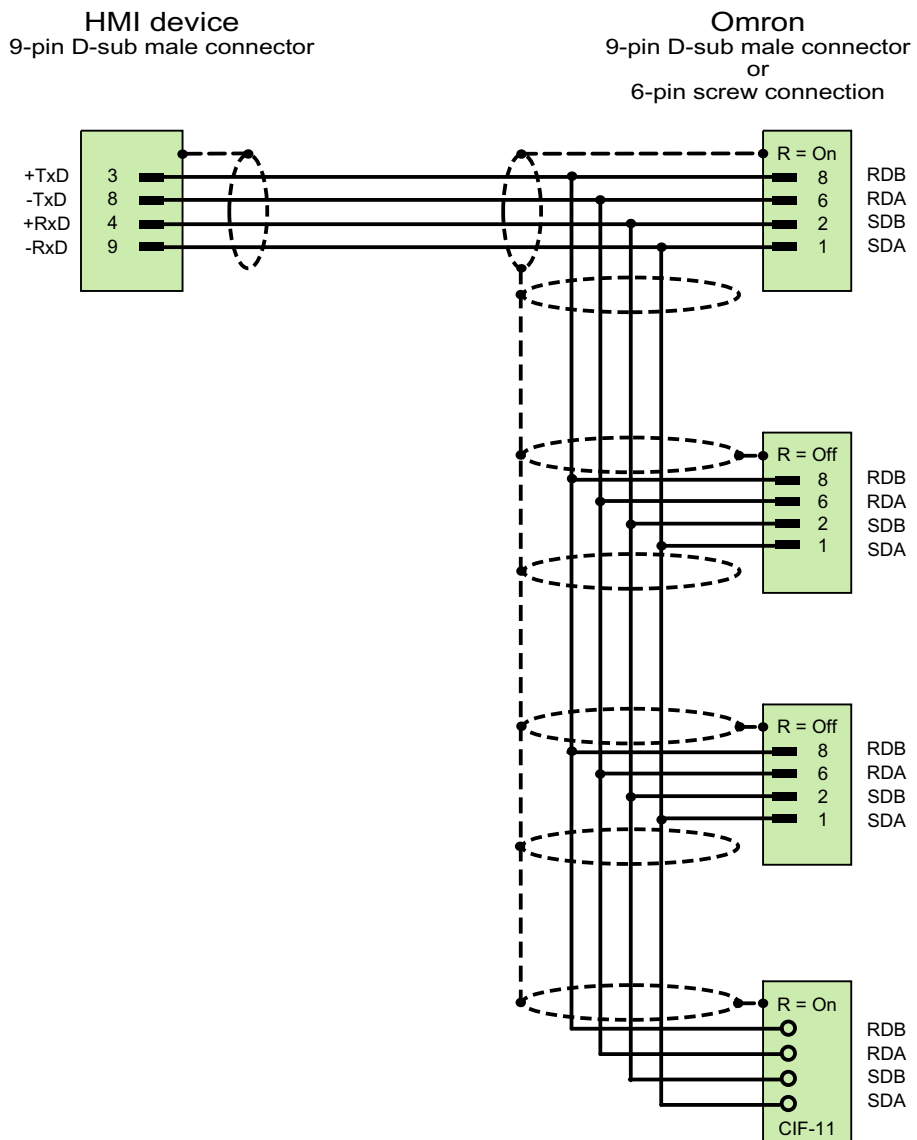

shielded, max. length 500 m

Connecting cable PP1, RS-232, for Omron

Point-to-point cable PP1, PC/TP/OP - PLC

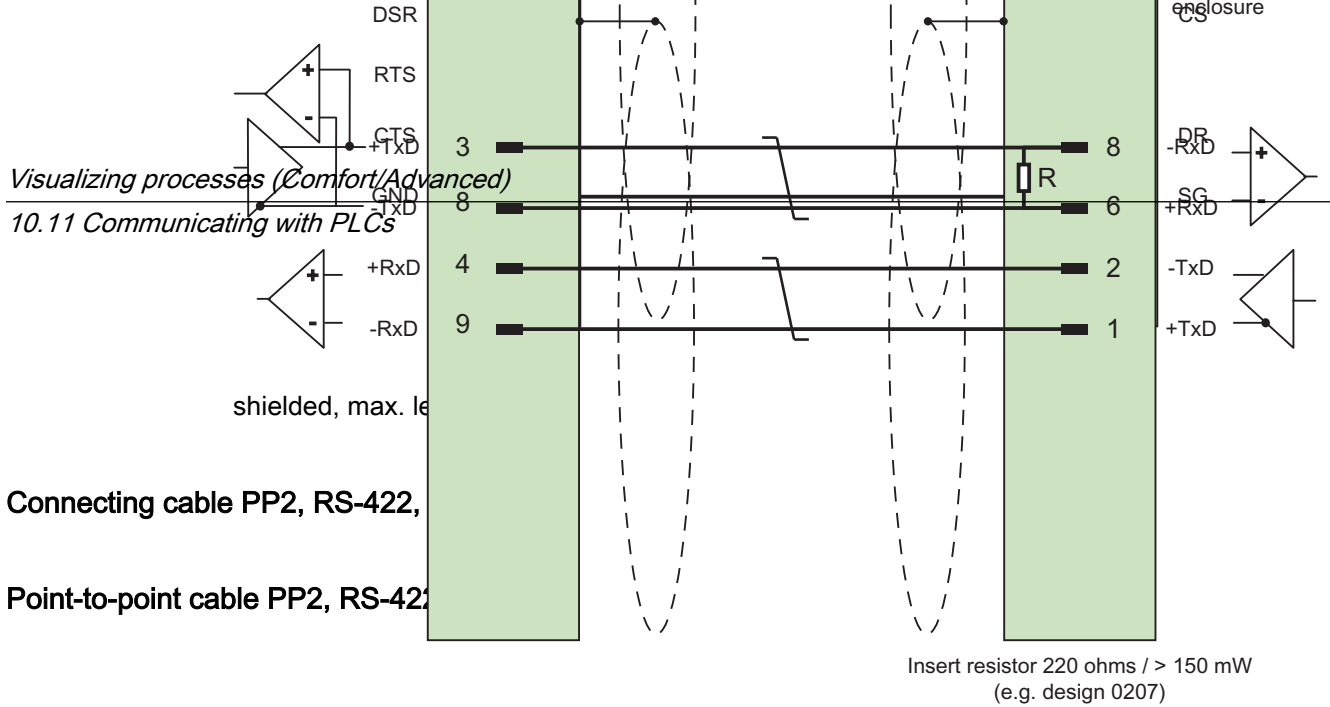

Connecting cable PP2, RS-422,  
Point-to-point cable PP2, RS-422

**Performance features of communication**

**Permissible data types for Omron Host Link**

**Permitted data types**

The table lists the data types that can be used when configuring tags and area pointers.

Data type	Operand type	Length
Bool	I/O, HR, AR, LR, DM, T/ C bit, CPU status	1-bit
Byte	CPU type	1 byte
DInt	HR, AR, LR, DM	4 bytes
Int	I/O, HR, AR, LR, DM, T/ C Val	2 bytes
Real	HR, DM	4 bytes
String	HR, AR, LR, DM	0 to 80 characters
UDInt	HR, AR, LR, DM	4 bytes
UInt	I/O, HR, AR, LR, DM, T/ C Val	2 bytes

**Note**

Read and write operations of all data areas in the OMRON PLC can only be reliably carried out in "STOP" or "MONITOR" mode.

"I/O" refers either to the IR/SR area or the CIO area depending on the PLC series. The operand types "LR", "HR" and "AR" are not available in all PLC series.

**Note**

Note the following for write accesses:

For the "Bool" data type with the operand types "I/O", "HR", "AR", "LR" and "DM", the entire word is written back into the PLC when the specified bit is changed. There is no check to determine whether any other bits in the word have changed. As a result, the PLC only has read access to the specified word.

Operand type old PLC	Operand type CS and CJ PLC
CPU Status	CPU Status
I/O	CIO
HR	H Range 0-511
AR	A
LR	n/a 1)
DM	D
T/C	T/C
CPU type	CPU type

- 1) You do not get an error message when you read or write the LR area in the following PLCs
- CS
  - CJ
  - CP

## Supported CPU types for Omron Host Link

### CPU types

The following CPU types are supported in the configuration of the Omron Host Link communication driver.

- CP1
  - CP1L
  - CP1H
  - CP1E
- CJ1
  - CJ1M
  - CJ1H
  - CJ1G

10.11 Communicating with PLCs

- CJ2
  - CJ2H
- CS1
  - CS1G
  - CS1H
  - CS1D
- CPM
  - CPM2C

Addressing in Omron Host Link

Addressing of PLCs in Omron Host Link

In PLCs of the series CS, CP and CJ, the timers 0-4095 are addressed with T/C 0-2047.

The counters 0-4095 must be addressed with an offset of 2048 (T/C 2048-4095 correspond to the counters 0-2047). Counters and timers with addresses > 2047 cannot be addressed via Host Link.

Counters and timers with addresses > 2047 cannot be addressed via Host Link.

Example:

If you want to address counter C20, you must address T/C 20+2048 = T/C 2068.

Address areas for Omron Hostlink

Omron

Address areas	Data types							
	Bool	Byte	UInt	Int	UDInt	DInt	Real	String
I/O	I/O 0.0 - I/O 9999.15	--	I/O 0 - I/O 9999	I/O 0 - I/O 9999	--	--	--	--
HR	HR 0.0 - HR 9999.15		HR 0 - HR 9999	HR 0 - HR 9999	HR 0 - HR 9998	HR 0 - HR 9998	HR 0 - HR 9999	HR 0 - HR 9999
AR	AR 0.0 - AR 9999.15		AR 0 - AR 9999	AR 0 - AR 9999	AR 0 - AR 9998	AR 0 - AR 9998		AR 0 - AR 9999
LR	LR 0.0 - LR 9999.15		LR 0 - LR 9999	LR 0 - LR 9999	LR 0 - LR 9998	LR 0 - LR 9998		LR 0 - LR 9999
DM	DM 0.0 - DM 9999.15		DM 0 - DM 9999	DM 0 - DM 9999	DM 0 - DM 9998	DM 0 - DM 9998	DM 0 - DM 9999	DM 0 - DM 9999
T/C Bit	T/C Bit 0 - T/C Bit 4095							

Address areas	Data types							
	Bool	Byte	UInt	Int	UDInt	DInt	Real	String
T/C Val			T/C Val 0 - T/C Val 4095	T/C Val 0 - T/C Val 4095				
CPU Status	RUN, MONITOR							
CPU type	CPU type							

## Commissioning components

### Transferring a project to the HMI device

1. Switch the HMI device to "transfer mode".
2. Set all necessary transfer parameters.
  - Interface
  - Transfer parameters
  - Target storage location
3. Start the project transfer.  
The project is compiled automatically.  
All compilation and transfer steps are logged to a message window.

### Interconnecting the PLC with the HMI device

1. Interconnect the PLC with the HMI device using a suitable cable.
2. The message "Connection to PLC .... is established" is output to the HMI device.

## Optimizing the configuration

### Acquisition cycle and update time

The acquisition cycles for the "Area pointers" and of the tags defined in the configuration software are decisive in terms of the update times which can actually be achieved.

The update time is equivalent to the acquisition cycle + transmission time + processing time.

Items to observe when optimizing the update times in configuration data:

- Optimize the maximum and minimum size of the data areas.
- Acquisition cycles which are too short lead to unnecessary load on overall performance. Set the acquisition cycle according to the rate of change of the process values. The rate of temperature changes at a furnace, for example, is significantly slower compared to the speed rate of an electrical drive. A time of approx. 1 second is a benchmark for the acquisition cycle.

- Avoid any gaps when entering the alarm or screen tags in a data area.
- Changes in the PLC can only be detected reliably if these are available at least within the actual acquisition cycle.

## Screens

The refresh rate of screens is determined by the type and volume of data to be visualized.

Only configure short acquisition cycles for objects which actually require shorter refresh cycles. This procedure reduces update times.

## Trends

The HMI device always updates all bit-triggered trends whose group bit is set in the "Trend transfer area". It resets the bits in the next cycle.

The group bit in the PLC program can only be set again after the HMI device has reset all bits.

## Job mailboxes

A high rate and volume of job mailboxes transferred may lead to overload in communication between the HMI device and the PLC.

The HMI device confirms acceptance of the job mailbox by entering the value zero in the first data word of the job mailbox. The HMI device now processes the job for which it requires a certain time slice. It may take the HMI device some time to process a new job mailbox which is transferred in immediate succession to the job mailbox. The next job mailbox is only accepted if sufficient computing resources are available.

## Data exchange

### Area pointers for Omron

#### Area pointers in connections via Omron communication drivers

You use an area pointer to access a data area in the PLC.

For more detailed information on area pointers and their configuration, refer to Section:

"Data exchange using area pointers".

#### Special features of connections via Omron Host Link

Area pointers can only be created in the following "File types": "DM", "I/O", "HR", "AR", and "LR".

## Trends

### General information on trends

#### Trends

A trend is the graphical representation of one or more values from the PLC. The value is read out either time- or bit-triggered, depending on the configuration.

For additional information see:

Displaying tags with Runtime Advanced and Panels (Page 3237)

---

#### Note

The value is read out time-triggered for Basic Panels.

---

#### Time-triggered trends

The HMI device reads in the trend values cyclically at an interval specified in the configuration. Time-triggered trends are suitable for continuous curves, such as the operating temperature of a motor.

#### Bit-triggered trends

Through a trigger bit set in the trend request tag, the HMI device either reads in a trend value or an entire trend buffer. This setting is defined in the configuration. Bit-triggered trends are normally used to represent fast changing values. One example might be the injection pressure in the production of plastic parts.

To trigger bit-triggered trends, appropriate external tags must be created in the "HMI tags" editor and connected to trend areas during configuration. The HMI device and PLC then communicate with each other via these trend areas.

The following areas are available for trends:

- Trend request area
- Trend transfer area 1
- Trend transfer area 2 (required only with switch buffers)

#### Trend request and trend transfer

##### Trend request area

The HMI device sets corresponding bits in the trend request area when you open a screen which contains one or more trends on the HMI device. After closing the screen, the HMI device resets the relevant bits in the trend request area.

The trend request area can be used for evaluation purposes in the PLC to determine which trend is currently being displayed on the HMI device. Trends can also be triggered without evaluation of the trend request area.

### Trend transfer area 1

This area is used to trigger trends. You must set the bit assigned to the trend in the trend transfer area and set the trend group bit in your control program. The trend group bit is the last bit in the trend transfer area.

The HMI device detects the trigger. The HMI device reads either a value or the entire buffer from the PLC. It then resets the trend bit and the trend group bit.

The following picture shows the structure of a trend transfer area.

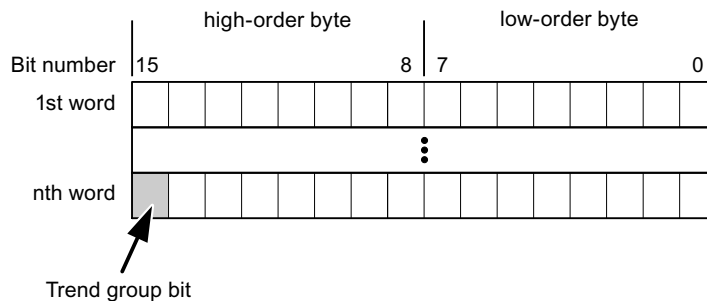

The trend transfer area must not be modified by the PLC program until the trend group bit has been reset.

### Trend transfer area 2

Trend transfer area 2 is required for trends configured with a switch buffer. The trend transfer areas 1 and 2 have a similar structure.

### Switch buffer

The switch buffer is a second buffer for the same trend that can be set up during configuration.

The PLC writes to Buffer 2 while the HMI device reads values from Buffer 1, and writes to Buffer 1 when the HMI device is reading Buffer 2. This prevents the PLC from overwriting trend values while the trend is being read by the HMI device.

### Restrictions to the trend control

#### For Omron Host Link communication drivers

Tags of "Operand type" "DM", "I/O", "HR", "AR" or "LR" are permitted.

They must be data type "UInt", "Int" or an array tag of data type "UInt", "Int". You assign a bit to a trend during configuration. This sets a defined bit assignment for all areas.



## Alarms

### Configuring alarms

#### Configuring alarms for non-integrated connections

Several steps are necessary to configure alarms such as warnings, error messages and acknowledgement.

- Step 1: Create tags
- Step 2: Configure alarms
- Step 3: Configure acknowledgment

You can find additional information in the section:

Working with Alarms (Page 3260)

#### Distinctive features when configuring alarms

If you are configuring connections of HMI devices to PLCs of other manufacturers, note the following distinctive features when configuring:

- Data types of the tags
- Addressing of tags
- How the bit positions are counted

### Data types

For connections with an Omron communication driver, the following data types are supported:

PLC	Permitted data types	
	Discrete alarms	Analog alarms
CP1, CJ1, CJ2, CS1, CPM	Uint, int	UInt, Int, UDInt, DInt

#### How the bit positions are counted

For connections with an Omron communication driver, the following counting method applies:

How the bit positions are counted	Left byte							Right byte								
	15	14	13	12	11	10	9	8	7	6	5	4	3	2	1	0
In Omron PLCs							8	7								0
In WinCC you configure:	15						8	7								0

Only tags for the "DM", "I/O", "HR", "AR", and "LR" file types are allowed for use as a trigger tag for discrete alarms.

## Configuring discrete alarms

Use arrays for discrete alarms and append each individual alarm to one bit of the array tags themselves and not to the individual subelements.

Only tags for the "DM", "I/O", "HR", "AR", LR" areas and the "Int" and "UInt" file types are permitted for discrete alarms and arrays.

## Acknowledgment of alarms

### Procedure

Create suitable tags on the PLC to acknowledge an error alarm. You assign these tags to an alarm in the "Bit messages" editor. You make the assignment in "Properties > Acknowledgment".

Distinction in terms of acknowledgment:

- Acknowledgment by the PLC
- Acknowledgment on the HMI device

### Acknowledgment by the PLC

In "PLC acknowledgment tag", configure the tag or array tag and the bit number that the HMI device uses to identify a PLC acknowledgment.

A bit set in the tag triggers acknowledgment of the assigned error alarm bit at the HMI device. This tag bit returns a function similar to acknowledgment on the HMI device which is triggered by pressing the "ACK" button, for example.

The acknowledgment bit must be located in the same tag as the bit for the error alarm.

Reset the acknowledgment bit before setting the bit in the alarm area again. The figure below shows the pulse diagram.

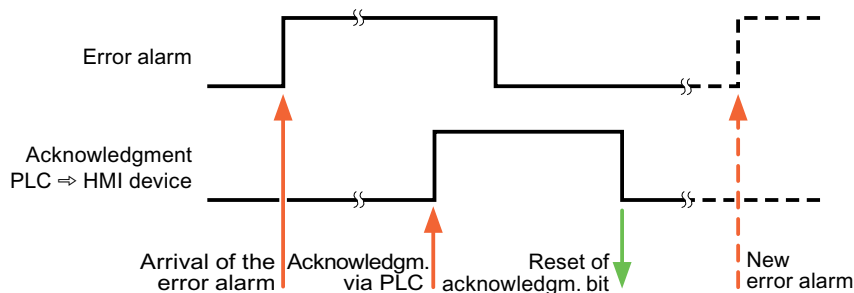

### Acknowledgment on the HMI device

In the "HMI acknowledgment tag" area, configure the tag or array tag as well as the bit number that the HMI device writes to the PLC after acknowledgment. Make sure when you use an array tag that it is not longer than 6 words.

To always create a signal change when setting an assigned acknowledgment bit of a discrete alarm that must be acknowledged, the HMI device will reset the acknowledgment bit assigned to the alarm as soon as it detects an alarm subject to acknowledgment and write the acknowledgment tag in the PLC. There will be a certain delay between detecting the message and writing the acknowledgment tag in the PLC because the HMI device has to process the operations.

If a discrete alarm subject to acknowledgment is acknowledged by the HMI device, then the corresponding bit in the assigned acknowledgment tag will be set. The entire acknowledgment tag is then written to the PLC by the HMI device. This allows the PLC to recognize that a certain alarm message has been acknowledged at the HMI device.

---

### Note

All alarm bits acknowledged since the last Runtime start will remain in the acknowledgment tag until a new incoming of the respective discrete alarms is detected.

This area should only be read by the PLC because the entire section of the HMI device will be overwritten once the next acknowledgment tag is written.

---

The figure below shows the pulse diagram.

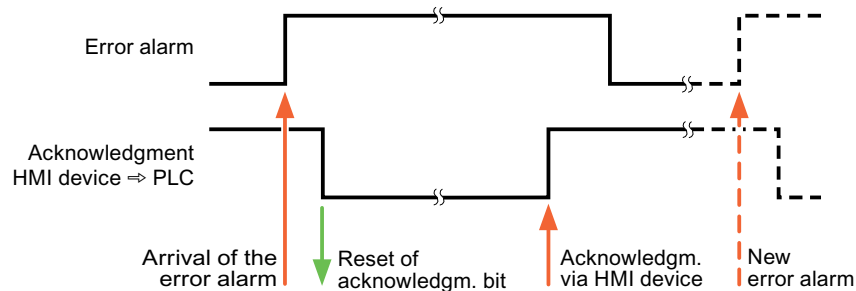

## LED mapping

### Function

Keyboard devices have LEDs in the function keys. These LEDs can be activated from the PLC. Thus, it is possible, for example, to signal to the user which key he should press in a given situation by lighting up an LED.

---

### Note

The LED function cannot be configured for Basic Panels.

---

## Requirements

In order to activate an LED, an LED tag or an array tag must be set up in the PLC and specified as an LED tag during configuration.

### LED assignment

The assignment of the individual LEDs to the bits in the LED tags is specified when the function keys are configured. In this process, the "LED tag" and the assigned "Bit" are specified for each function key in the "General" group of the properties window.

The "Bit" bit number designates the first of two consecutive bits that control the following LED statuses.

Bit n+ 1	Bit n	LED function	
		All Mobile Panels, all Operator Panels, all Multi Panels	Panel PCs:
0	0	Off	Off
0	1	Rapid flashing	Flashing
1	0	Slow flashing	Flashing
1	1	On permanently	On permanently

#### 10.11.17. Data exchange using area pointers

5

### General information on area pointers

#### Introduction

You use an area pointer to access a data area in the PLC. During communication, the PLC and the HMI device alternately access these data areas for read and write operations.

The PLC and the HMI device trigger defined interactions based on the evaluation of stored data.

## Configuration of area pointers

Before you use the area pointer, you enable it in "Connections ► Area pointers". You then assign the area pointer parameters.

Parameter	Area pointer							
Active	Display name	PLC tag	Access mode	Address	Length	Acquisition mode	Acquisition cycle	Comment
<input type="checkbox"/>	Coordination	<Undefined>	<symbolic access>		1	Cyclic continuous	<Undefined>	
<input type="checkbox"/>	Date/time	<Undefined>	<symbolic access>		6	Cyclic continuous	<Undefined>	
<input type="checkbox"/>	Job mailbox	<Undefined>	<symbolic access>		4	Cyclic continuous	<Undefined>	
<input type="checkbox"/>	Data record	<Undefined>	<symbolic access>		5	Cyclic continuous	<Undefined>	

Global area pointer of HMI device								
Connection	Display name	PLC tag	Access mode	Address	Length	Acquisition mode	Acquisition cycle	Comment
<Undefined>	Project ID	<Undefined>	<symbolic access>		1	Cyclic continuous	<Undefined>	
<Undefined>	Screen number	<Undefined>	<symbolic access>		5	Cyclic continuous	<Undefined>	
<Undefined>	Date/time PLC	<Undefined>	<symbolic access>		6	Cyclic continuous	<Undefined>	

- **Active**  
Enables the area pointer.
- **Pointer name**  
Name of the area pointer specified by WinCC.
- **PLC tag**  
Here you select the PLC tag or the tag array that you have configured as the data area for the area pointer.
- **Address**  
No address is entered into this field because of the symbolic access.
- **Length**  
WinCC specifies the length of the area pointer.
- **Acquisition cycle**  
You specify the acquisition cycle in this field for area pointers that are read by the HMI device. Note that a very short acquisition time may have a negative impact on HMI device performance.
- **Comment**  
Enter a comment, for example, to describe the purpose of the area pointer.

## Accessing data areas

### Accessing data areas

The following table shows how HMI devices and PLCs access individual data areas for read (R) or write (W) operations.

Data area	Required for	HMI device	PLC
Screen number	Evaluation by the PLC in order to determine the active screen.	W	R
Data record	Transfer of data records with synchronization	R/W	R/W
Date/time	Transfer of the date and time from the HMI device to the PLC	W	R
Date/time PLC	Transfer of the date and time from the PLC to the HMI device	R	W
Coordination	Requesting the HMI device status in the PLC program	W	R
Project ID	Runtime checks for consistency between the WinCC project ID and the project in the PLC	R	W
Job mailbox	Triggering of HMI device functions by the PLC program	R/W	R/W

### "Screen number" area pointer

#### Function

The HMI device saves information about the screen called on the HMI device to the "Screen number" area pointer.

This allows the transfer of the current screen contents from the HMI device to the PLC. The PLC can trigger specific reactions such as the call of a different screen.

#### Use

Configure and enable the area pointer in "Communication > Connections" before you put it into use. You can create only **one** instance of the "Screen number" area pointer and only on **one** PLC.

The screen number is always transferred to the PLC when a new screen is activated or when the focus within a screen changes from one screen object to another.

#### Structure

The area pointer is a data area in the memory of the PLC with a fixed length of 5 words.

	15	14	13	12	11	10	9	8	7	6	5	4	3	2	1	0
1. word	Current screen type															
2. word	Current screen number															
3. word	Reserved															
4th word	Current field number															
5. word	Reserved															

- Current screen type  
"1" for root screen or  
"4" for permanent window
- Current screen number  
1 to 32767
- Current field number  
1 to 32767

## "Date/time" area pointer

### Function

This area pointer is used to transfer the date and time from the HMI device to the PLC.

The PLC writes control job "41" to the job mailbox.

When it evaluates the control job, the HMI device writes its current date and the time in the data area configured in the "Date/time" area pointer. All definitions are coded in BCD format.

The "Date/Time" area pointer when used in a project which contains multiple connections must be enabled for each configured connection.

---

#### Note

You cannot use the "Date/Time PLC" area pointer if you have configured the "Date/Time" area pointer.

---

The date/time data area has the following structure:

Data word	Left byte							Right byte							
	15						8	7						0	
n+0	Reserved							Hour (0 to 23)							Time
n+1	Minute (0 to 59)							Second (0 to 59)							
n+2	Reserved							Reserved							
n+3	Reserved							Weekday (1 to 7, 1=Sunday)							Date
n+4	Day (1 to 31)							Month (1 to 12)							
n+5	Year (80 to 99/0 to 29)							Reserved							

---

#### Note

When making entries in the "Year" data area, you should note that values 80 to 99 result in years 1980 through 1999, while the values 0 to 29 result in the years 2000 through 2029.

---

## "Date/time PLC" area pointer

### Function

This area pointer is used to transfer the date and time from the PLC to the HMI device. Use this area pointer if the PLC is the time master.

The PLC loads the data area of the area pointer. All definitions are coded in BCD format.

The HMI device reads the data cyclically within the configured acquisition cycle and synchronizes itself.

---

#### Note

Set an acquisition cycle of sufficient length for the Date/time area pointer in order to avoid any negative impact on HMI device performance.

Recommended: Acquisition cycle of 1 minute if your process can handle it.

---

"Date/Time PLC" is a global area pointer and may be configured only once per project.

---

#### Note

You cannot use the "Date/Time" area pointer if you have configured the "Date/Time PLC" area pointer.

---

The "Date/time PLC" data area has the following structure:

Data word	Left byte			Right byte		
	15	.....	8	7	.....	0
n+0	Year (80 to 99/0 to 29)			Month (1 to 12)		
n+1	Day (1 to 31)			Hour (0 to 23)		
n+2	Minute (0 to 59)			Second (0 to 59)		
n+3	Reserved			Reserved	Weekday (1 to 7, 1=Sunday)	
n+4 <sup>1)</sup>	Reserved			Reserved		
n+5 <sup>1)</sup>	Reserved			Reserved		

- 1) The two data words must exist in the data area to ensure that the data format matches WinCC and to avoid reading false information.

---

#### Note

When making entries in the "Year" data area, you should note that values 80 to 99 result in years 1980 through 1999, while the values 0 to 29 result in the years 2000 through 2029.

---



## "Coordination" area pointer

### Function

The "Coordination" area pointer is used to implement the following functionality:

- Detecting the startup of the HMI device in the control program
- detection in the control program of the current HMI device operating mode
- detection in the control program of the HMI devices ready to communicate state

The "Coordination" area pointer has a length of one word.

### Use

---

#### Note

The HMI device always writes the entire coordination area when updating the area pointer. The control program may not make changes to the coordination area for this reason.

---

### Assignment of bits in the "Coordination" area pointer

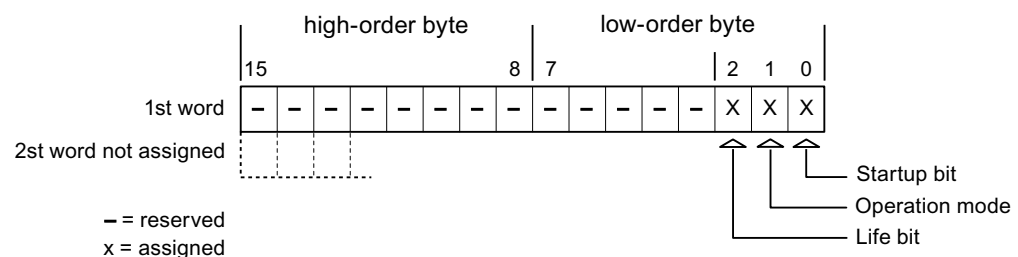

### Startup bit

The startup bit is set briefly to "0" by the HMI device during startup. It sets the bit permanently to "1" when startup is completed.

### Operating mode

The operating mode bit is set to 1 as soon as the user switches the HMI device offline. The state of the operating mode bit is "0" during normal operation of the HMI device. You can determine the current operating mode of the HMI device by reading this bit.

### Life bit

The HMI device inverts the life bit at intervals of approximately one second. You can check whether or not the connection to the HMI device is still up by querying this bit in the control program.

## "Project ID" area pointer

### Function

You can check whether the HMI device is connected to the correct PLC at the start of runtime. This check is important when operating with several HMI devices.

The HMI device compares a value stored on the PLC with the value specified in configuration. This ensures compatibility of configuration data with the control program. If discrepancy is detected, a system event is displayed on the HMI device and runtime is stopped.

### Use

To use this area pointer, set up the following during the configuration:

- Define the version of configuration. Possible values between 1 and 255.  
You enter the version in the editor "Runtime settings > General" in the "Identification" area.
- Data address of the value for the version that is stored in the PLC:  
You enter the data address in the editor "Communication > Connections".

### Connection failure

A connection failure to a device on which the "project ID" area pointer is configured results in all the other connections in the project being switched to "offline".

This behavior has the following prerequisites:

- You have configured several connections in a project.
- You are using the "project ID" area pointer in at least one connection.

Causes which may set connections "offline":

- The PLC is not available.
- The connection has been switched offline in the engineering system.

## "PLC job" area pointer

### Function

The PLC can use the job mailbox to transfer jobs to the HMI device to trigger corresponding actions on the HMI device. These functions include, for example:

- Display screen
- Set date and time

## Data structure

The first word of the job mailbox contains the job number. Depending on the job mailbox, up to three parameters can be transferred.

Word	Left byte	Right byte
n+0	0	Job number
n+1	Parameter 1	
n+2	Parameter 2	
n+3	Parameter 3	

The HMI device evaluates the job mailbox if the first word of this job is not equal to zero. This means that the parameters must be entered in the job mailbox first, followed by the job number.

When the HMI device accepts the job mailbox, the first word is set to 0 again. The execution of the job mailbox is generally not completed at this point in time.

## Job mailboxes

All job mailboxes and their parameters are listed below. The "No." column contains the job number of the job mailbox. Job mailboxes can only be triggered by the PLC when the HMI device is online.

### Note

Please note that not all HMI devices support job mailboxes.

No.	Function	
<b>14</b>	<b>Setting the time (BCD coded)</b>	
	Parameter 1	Left byte: - Right byte: hours (0-23)
	Parameter 2	Left byte: minutes (0-59) Right byte: seconds (0-59)
	Parameter 3	-
<b>15</b>	<b>Setting the date (BCD coded)</b>	
	Parameter 1	Left byte: - Right byte: weekday (1-7: Sunday-Saturday)
	Parameter 2	Left byte: day (1-31) Right byte: month (1-12)
	Parameter 3	Left byte: year
<b>23</b>	<b>User logon</b>	
	Logs the user on with the name "PLC user" at the HMI device with the group number transferred in Parameter 1. The logon is possible only when the transferred group number exists in the project.	
	Parameter 1	Group number 1 to 255
	Parameter 2, 3	-

No	Function	
<b>14</b>	<b>Setting the time (BCD coded)</b>	
<b>24</b>	<b>User logoff</b>	
	Logs off the current user. (The function corresponds to the "logoff" system function)	
	Parameter 1, 2, 3	-
<b>40</b>	<b>Transfer date/time to PLC</b>	
	(in the S7 format DATE_AND_TIME) An interval of at least 5 seconds must be maintained between two successive jobs to prevent overload of the HMI device.	
	Parameter 1, 2, 3	-
<b>41</b>	<b>Transfer date/time to PLC</b>	
	(In OP/MP format) An interval of at least 5 seconds must be maintained between successive jobs in order to prevent overload of the HMI device.	
	Parameter 1, 2, 3	-
<b>46</b>	<b>Update tags</b>	
	Causes the HMI device to read the current value of the tags from the PLC whose update ID matches the value transferred in parameter 1. (Function corresponds to the "UpdateTag" system function.)	
	Parameter 1	1 - 100
<b>49</b>	<b>Delete alarm buffer</b>	
	Deletes all analog alarms and discrete alarms of the "Warnings" class from the alarm buffer.	
	Parameter 1, 2, 3	-
<b>50</b>	<b>Delete alarm buffer</b>	
	Deletes all analog alarms and discrete alarms of the "Errors" class from the alarm buffer.	
	Parameter 1, 2, 3	-
<b>51</b>	<b>Screen selection <sup>1)</sup></b>	
	Parameter 1	Screen number
	Parameter 2	-
	Parameter 3	Field number
<b>69</b>	<b>Read data record from PLC</b>	
	Parameter 1	Recipe number (1-999)
	Parameter 2	Data record number (1-65535)
	Parameter 3	0: Do not overwrite existing data record 1: Overwrite existing data record
<b>70</b>	<b>Write data record to PLC</b>	
	Parameter 1	Recipe number (1-999)
	Parameter 2	Data record number (1-65535)
	Parameter 3	-

<sup>1)</sup> OP 73, OP 77A and TP 177A HMI devices also execute the "Screen selection" job mailbox if the on-screen keyboard is active.

"Data record" area pointer

"Data mailbox" area pointer

### Function

When data records are transferred between the HMI device and PLC, both partners access common communications areas on the PLC.

### Data transfer types

There are two ways of transferring data records between the HMI device and PLC:

- Transfer without synchronization
- Transfer with synchronization over the data record

Data records are always transferred directly. That is, the tag values are read from an address or written to an address configured for this tag directly, without redirecting the values by means of interim memory.

### Initiating the transfer of data records

There are three ways of triggering the transfer:

- Operator input in the recipe view
- Job mailboxes  
The transfer of data records can also be triggered by the PLC.
- Triggering by configured functions

If the transfer of data records is triggered by a configured function or by a job mailbox, the recipe view on the HMI device remains operable. The data records are transferred in the background.

Simultaneous processing of several transfer requests is, however, not possible. In this case, the HMI device rejects the other transfer requests with a system event.

### Transfer without synchronization

If you select asynchronous transfer of data records between the HMI device and PLC, there is no coordination over the common data areas. It is therefore unnecessary to set up a data area during configuration.

Asynchronous data record transfer can be a useful alternative, for example, when:

- The system is capable of excluding the risk of uncontrolled overwriting of data by the communication peer.
- The PLC does not require information about the recipe number and data record number.
- The transfer of data records is triggered by the operator of the HMI device.

## Reading values

When a read job is triggered, the values are read from the PLC addresses and transferred to the HMI device.

- Triggering by the operator in the recipe view:  
The values are downloaded to the HMI device. You can then process, edit, or save these values, for example.
- Triggering by a function or job mailbox:  
The values are saved immediately to the data volume.

## Writing values

When a write job is triggered, the values are written to the PLC addresses.

- Triggering by the operator in the recipe view:  
The current values are written to the PLC.
- Triggering by a function or job mailbox:  
The current values are written to the PLC from the data medium.

## Transfer with synchronization

If you select synchronous transfer, both communication partners set status bits in the common data area. You can use this mechanism to prevent uncontrolled overwriting of data in either direction in your control program.

## Application

Synchronous data record transfer can be a useful solution, for example, when:

- The PLC is the "active partner" in the transfer of data records.
- The PLC evaluates the information about the recipe number and data record number.
- The transfer of data records is triggered by means of a Job mailbox.

## Requirements

In order to synchronize transfer of data records between the HMI device and the PLC, the following requirements must be met during configuration:

- An area pointer has been set up: "Communication > Connections" editor in "Area pointer".
- The PLC with which the HMI device synchronizes transfer of data records is specified in the recipe:  
"Recipes" editor in the inspector window the option "Coordinated transfer of data records" under "General > Synchronization > Settings"

## Structure of the data area

The data area has a fixed length of 5 words. Structure of the data area:

	<b>15</b>		<b>0</b>
1. Word	Current recipe number (1 - 999)		
2. Word	Current data record number (0 - 65535)		
3. Word	Reserved		
4. Word	Status (0, 2, 4, 12)		
5. Word	Reserved		

- Status

The status word (word 4) can adopt the following values:

Value		Meaning
Decimal	Binary	
0	0000 0000	Transfer permitted, data record free
2	0000 0010	Transferring.
4	0000 0100	Transfer completed without error
12	0000 1100	Transfer completed with error

## Sequence of a transfer started by the operator in the recipe display

### Reading from the PLC started by the operator in the recipe view

Step	Action	
1	Check: Status word = 0?	
	Yes	No
2	The HMI device enters the recipe number to be read and the status "Transferring" in the data record and sets the data record number to 0.	Abort with system event.
3	The HMI device reads the values from the PLC and displays them in the recipe view. If the recipes have synchronized tags, the values from the PLC are also written to the tags.	
4	The HMI device sets the status "Transfer completed."	
5	The control program must reset the status word to zero in order to enable further transfers.	

**Writing to the PLC started by the operator in the recipe view**

Step	Action	
	Check: Status word = 0?	
1	Yes	No
	The HMI device enters the recipe and data record number to be written and the status "Transferring" in the data record.	Abort with system event.
2	The HMI device writes the current values to the PLC. If the recipes have synchronized tags, the changed values are synchronized between the recipe view and tags and then written to the PLC.	
3	The HMI device sets the status "Transfer completed."	
4	If required, the control program can now evaluate the transferred data.	
5	The control program must reset the status word to zero in order to enable further transfers.	

**Note**

The status word may only be set by the HMI device. The PLC may only reset the status word to zero.

**Note**

The PLC may only evaluate the recipe and data record numbers when data inconsistency is detected if one of the conditions outlined below has been met:

- The data mailbox status is set to "Transfer completed".
- The data mailbox status is set to "Transfer completed with error".

**Sequence of the transfer triggered by a PLC job**

The transfer of data records between the HMI device and the PLC can be initiated by either one of these stations.

The two job mailboxes No. 69 and No. 70 are available for this type of transfer.

**No. 69: Read data record from PLC ("PLC → DAT")**

Job mailbox no. 69 transfers data records from the PLC to the HMI device. The job mailbox is structured as follows:

	Left byte (LB)	Right byte (RB)
Word 1	0	69
Word 2	Recipe number (1-999)	
Word 3	Data record number (1 to 65535)	
Word 4	Do not overwrite existing data record: 0 Overwrite existing data record: 1	



**No. 70: Write data record to PLC ("DAT → PLC")**

Job mailbox No. 70 transfers data records from the HMI device to the PLC. The job mailbox is structured as follows:

	Left byte (LB)	Right byte (RB)
Word 1	0	70
Word 2	Recipe number (1-999)	
Word 3	Data record number (1 to 65535)	
Word 4	—	

**Sequence when reading from the PLC with job mailbox "PLC → DAT" (no. 69)**

Step	Action	
1	Check: Status word = 0?	
	Yes	No
2	The HMI device enters the recipe and data record number specified in the job and the status "Transferring" in the data record.	Abort without return message.
3	The HMI device reads the values from the PLC and saves these to the data record defined in the job mailbox.	
4	<ul style="list-style-type: none"> <li>If "Overwrite" was selected in the job, an existing data record is overwritten without any prompt for confirmation. The HMI device sets the status "Transfer completed."</li> <li>If "Do not overwrite" was selected in the job, and the data record already exists, the HMI device aborts the job and enters 0000 1100 in the status word of the data record.</li> </ul>	
5	The control program must reset the status word to zero in order to enable further transfers.	

**Sequence of writing to the PLC with job mailbox "DAT → PLC" (no. 70)**

Step	Action	
1	Check: Status word = 0?	
	Yes	No
2	The HMI device enters the recipe and data record number specified in the job and the status "Transferring" in the data record.	Abort without return message.
3	The HMI device fetches the values of the data record specified in the function from the data medium and writes the values to the PLC.	
4	The HMI device sets the status "Transfer completed."	
5	The control program can now evaluate the transferred data. The control program must reset the status word to zero in order to enable further transfers.	

### Sequence of the transfer when triggered by a configured function

#### Reading from the PLC using a configured function

Step	Action	
1	Check: Status word = 0?	
	Yes	No
2	The HMI device enters the recipe and data record number specified in the function and the status "Transferring" in the data record.	Abort with system event.
3	The HMI device reads the values from the PLC and stores them in the data record specified in the function.	
4	<ul style="list-style-type: none"> <li>If "Yes" was selected for the "Overwrite" function, an existing data record is overwritten without any prompt for confirmation. The HMI device sets the status "Transfer completed."</li> <li>If "No" was selected for the "Overwrite" function and the data record already exists, the HMI device aborts the job and enters 0000 1100 in the status word of the data record.</li> </ul>	
5	The control program must reset the status word to zero in order to enable further transfers.	

#### Writing to the PLC by means of configured function

Step	Action	
1	Check: Status word = 0?	
	Yes	No
2	The HMI device enters the recipe and data record number specified in the function and the status "Transferring" in the data record.	Abort with system event.
3	The HMI device fetches the values of the data record specified in the function from the data medium and transfers the values to the PLC.	
4	The HMI device sets the status "Transfer completed."	
5	The control program can now evaluate the transferred data. The control program must reset the status word to zero in order to enable further transfers.	

### Possible causes of error when transferring data records

#### Possible causes of error

The section below shows possible error causes which lead to the cancellation of data record transfer:

- Tag address not set up on the PLC
- Overwriting data records not possible

- Recipe number does not exist
- Data record number does not exist

---

**Note**

The status word may only be set by the HMI device. The PLC may only reset the status word to zero.

---

**Note**

The PLC may only evaluate the recipe and data record numbers when data inconsistency is detected if one of the conditions outlined below has been met:

- The data mailbox status is set to "Transfer completed".
  - The data mailbox status is set to "Transfer completed with error".
- 

### Reaction to an aborted transfer due to errors

If the transfer of data records is aborted due to errors, the HMI device reacts as follows:

- Triggering by the operator in the recipe view  
Information in the status bar of the recipe view and output of system alarms
- Triggered by function  
Output of system alarms
- Triggering by job mailbox  
No return message on the HMI device

You can nonetheless evaluate the status of the transfer by querying the status word in the data record.

## 10.11.18 Special features of WinAC MP

### 10.11.18. WinAC MP basics

1

#### WinAC MP basics

WinAC MP is a software package for HMI devices. WinAC MP integrates a software PLC compatible with SIMATIC S7 in WinCC Runtime.

Using WinAC MP you can execute STEP 7 programs on the HMI device.

The common use of WinAC MP and WinCC provides process control and visualization on one HMI device.

The communications driver for WinAC MP supports the following protocols for controlling the process components:

- Industrial Ethernet
- PROFIBUS DP

The following screen shows the principal connection of the process components on the PROFIBUS DP example.

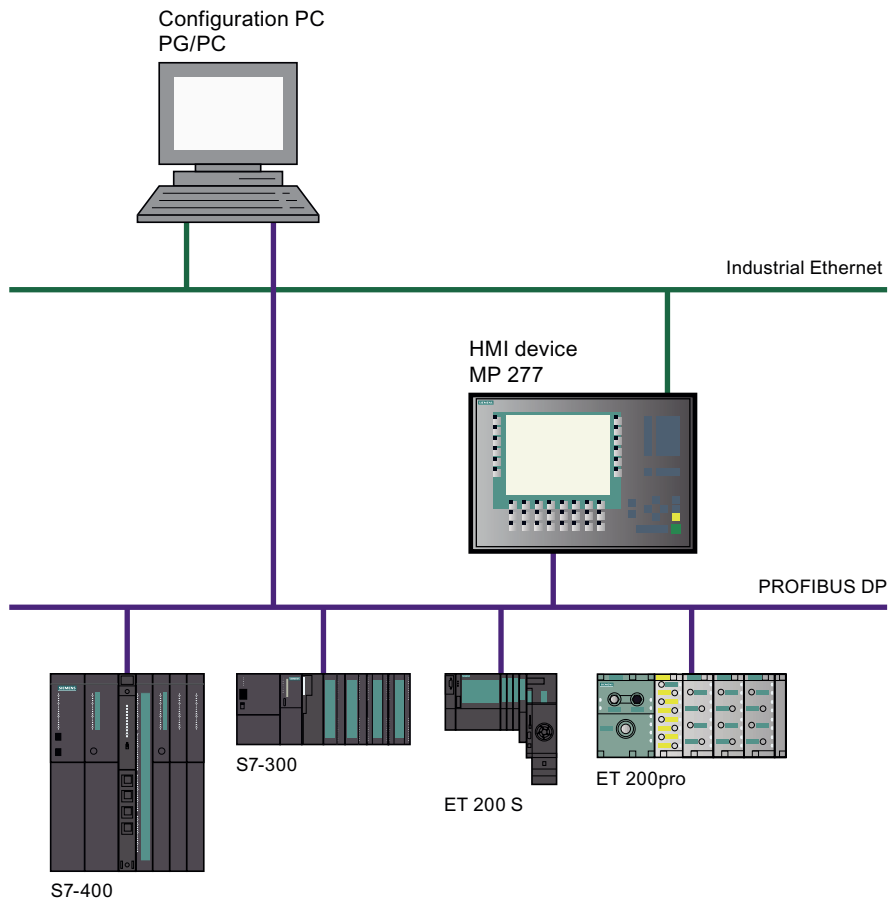

If you wish to control your process using an HMI device and WinAC MP, then you must install WinAC MP on your configuration PC. Then transfer WinAC MP and the project to your HMI device.

---

**Note**

**Notes about instructions**

The following describes how to install WinAC MP and transfer WinAC MP to an HMI device.

To transfer a STEP 7 project with a WinAC MP controller to an HMI device, you require experience with STEP 7.

---

### 10.11.18. Communication options with WinAC MP

2

#### Definition of "routing"

If there are stations in an automation system that are not connected to the same bus, these stations cannot be accessed directly online. To establish a connection to these devices, a router must be included between them.

An MP x77 HMI device with WinAC MP can function as the router. As a router, it connects the Ethernet and PROFIBUS networks.

You can use routing, for example, to do the following:

- Download STEP 7 user programs
- Download a hardware configuration
- Execute testing and diagnostics functions

#### Definition of "Softbus"

Virtual bus that allows data exchange between WinCC Runtime and WinAC MP. This bus is also installed when you install WinCC. After installing WinAC MP, S7 connections from WinCC Runtime to external stations on PROFIBUS or Ethernet are routed over Softbus.

#### Prior to installation of WinAC MP (without Softbus)

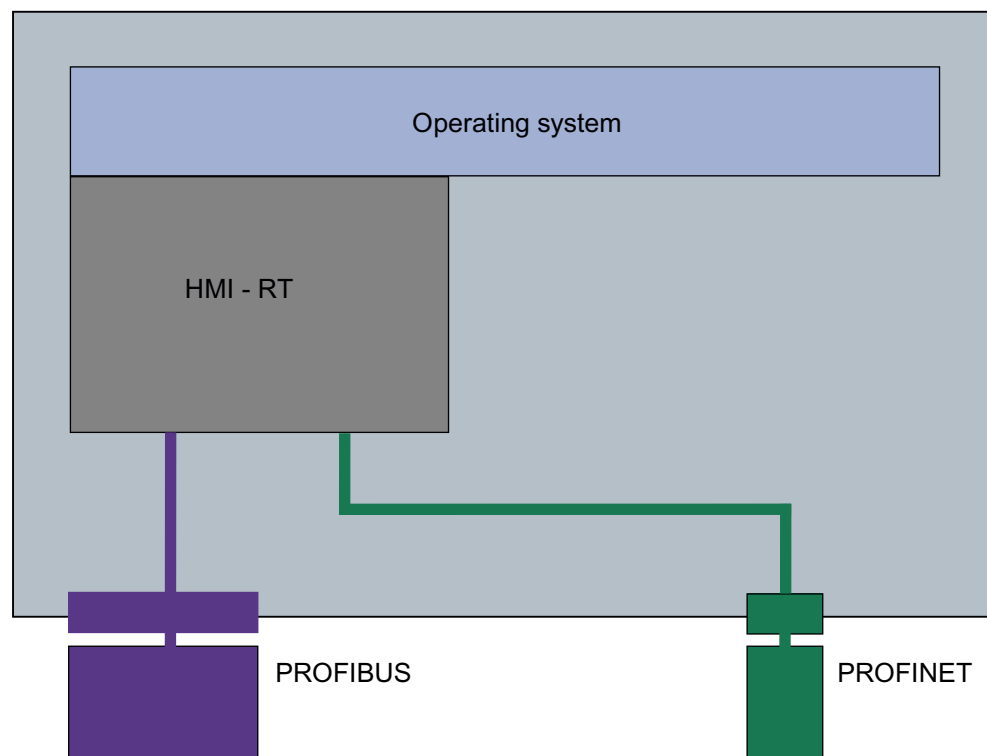

#### After installation of WinAC MP (with Softbus)

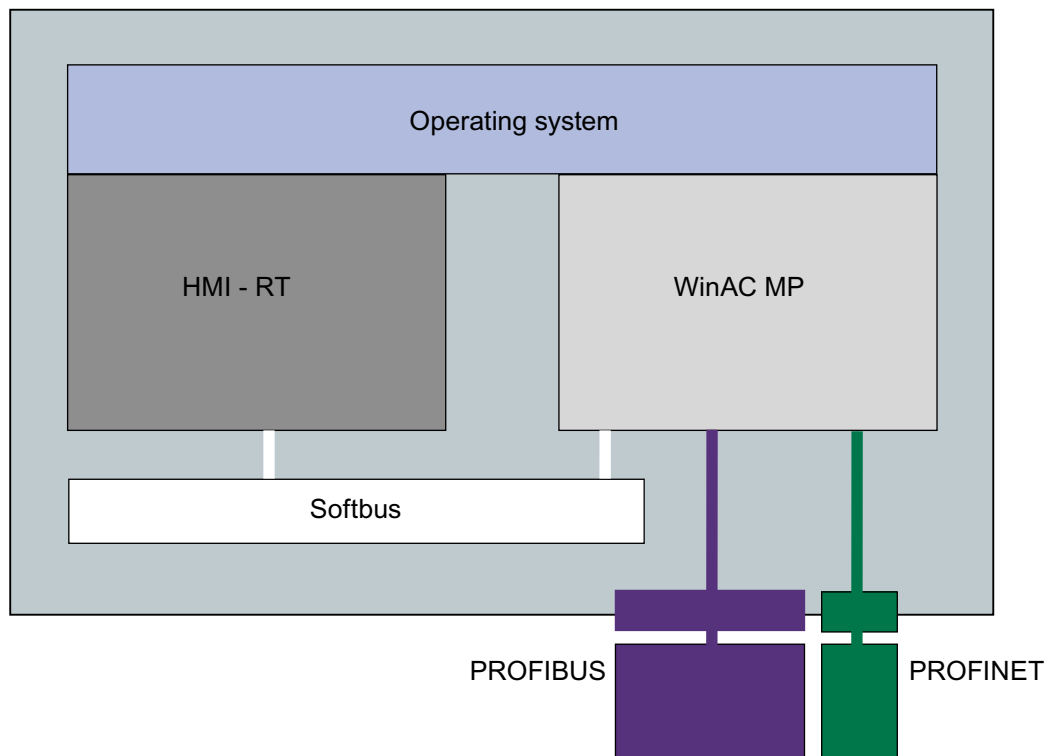

### Routing from Ethernet to PROFIBUS DP with WinAC MP

With STEP 7 on Industrial Ethernet, you can access all nodes on PROFIBUS DP from the HMI device. With WinCC, you can access the HMI device but not the nodes connected over PROFIBUS DP.

If the configuration PC is not connected directly to PROFIBUS DP, the nodes on PROFIBUS can nevertheless be reached because the MP x77 HMI device serves as a router.

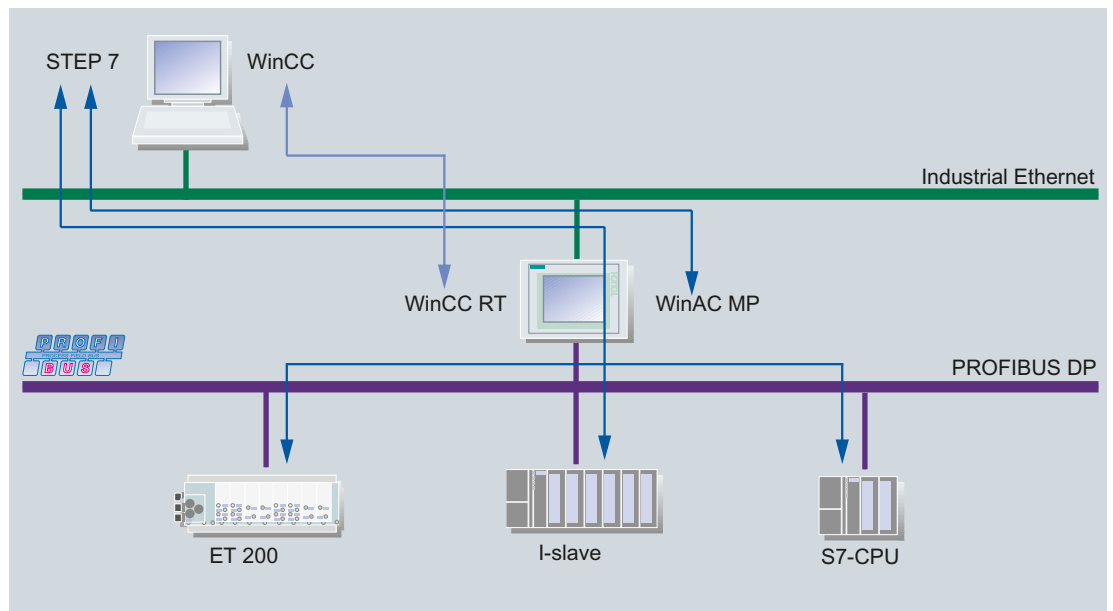

Figure 10-3 Routing from Ethernet to PROFIBUS DP with WinAC MP

### Routing from PROFIBUS DP to Ethernet with WinAC MP

With STEP 7 on PROFIBUS DP, you can access all nodes on Industrial Ethernet from the HMI device. With WinCC on PROFIBUS DP, you have access to the HMI device and to OPs connected over PROFIBUS DP.

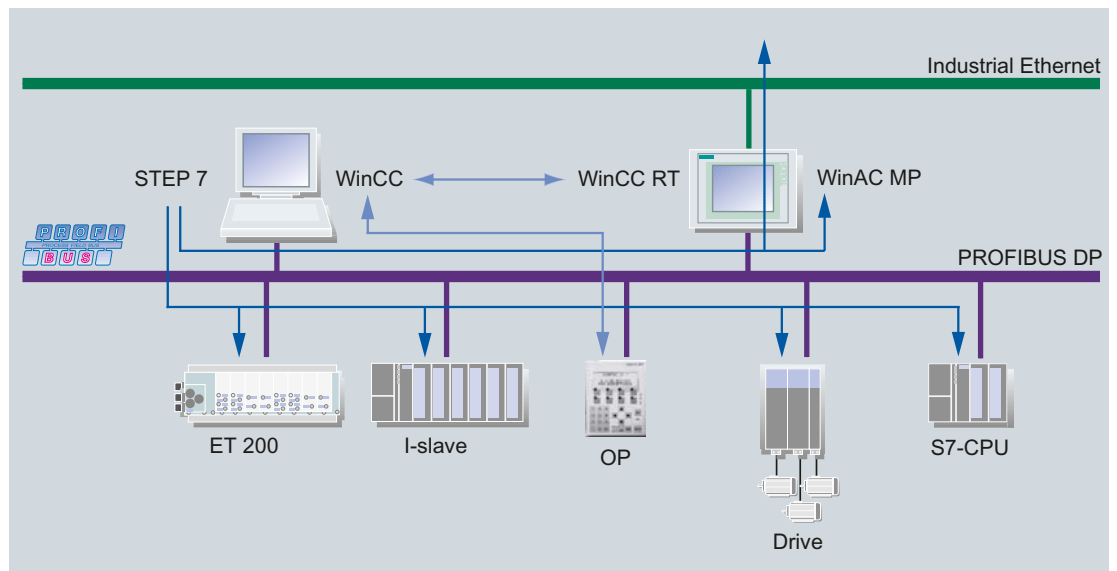

Figure 10-4 Routing with WinAC MP over PROFIBUS

### Visualization over WinAC MP

Visualization over the HMI device between Industrial Ethernet and PROFIBUS DP is possible with WinCC.

It is not necessary to program the communication links. A PC serves as the visualization platform.

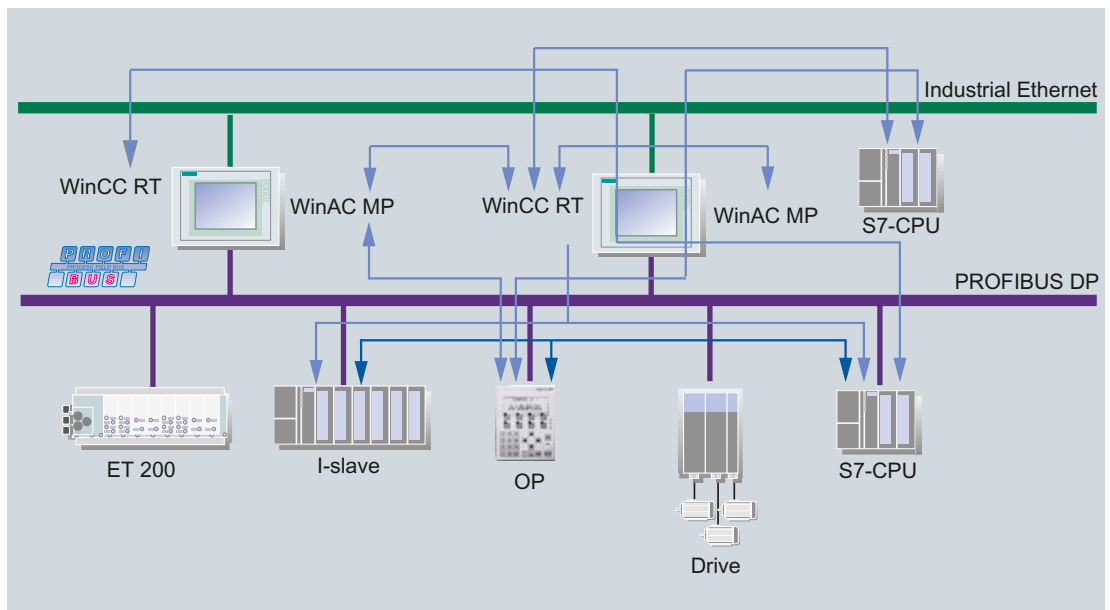

Figure 10-5 Visualization over WinAC MP



## CPU-CPU communication over WinAC MP

CPU-CPU communication is possible with the HMI device.

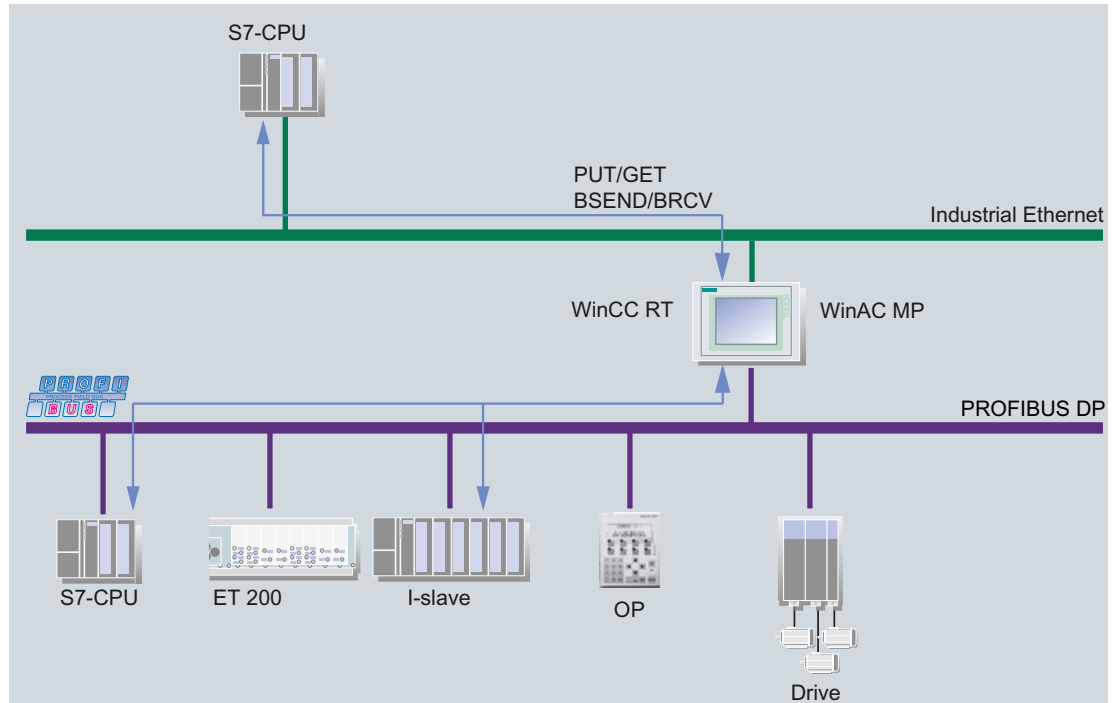

Figure 10-6 CPU-CPU communication over WinAC MP

### 10.11.18. Standard procedure for communication with WinAC MP

3

#### Overview

The section below shows how to configure WinAC MP in a SIMATIC HMI station using a configuration PC on which STEP 7 and WinCC are installed.

The configuration PC and WinAC MP in a SIMATIC HMI station are interconnected via PROFIBUS DP. Configuration via Ethernet is also possible. A description of the procedure can be found in the "WinAC MP" manual.

You can integrate DP slaves for WinAC MP in the STEP 7 project.

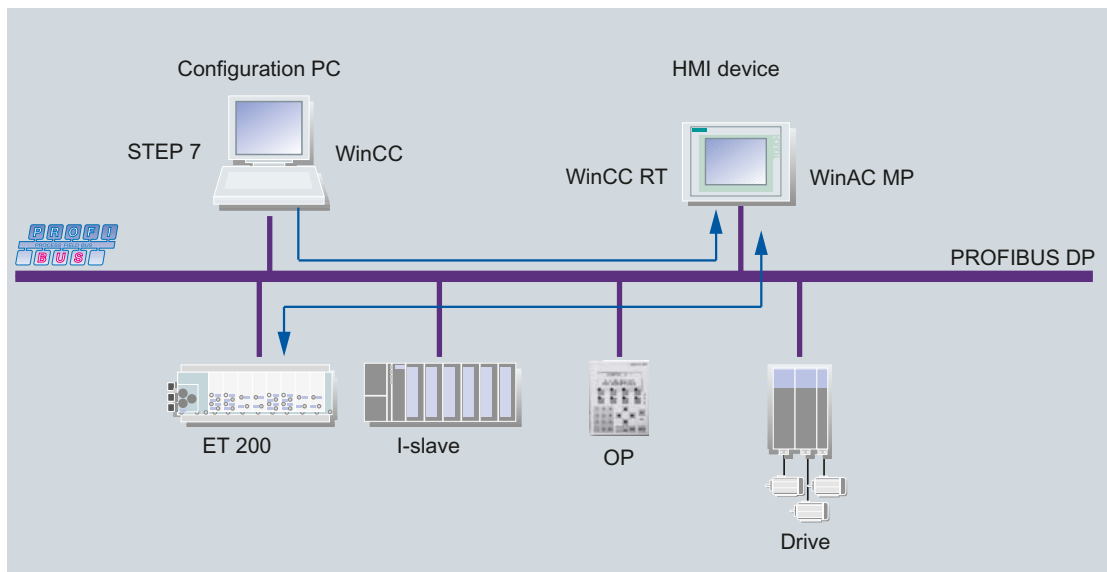

## Procedure

The basic steps are as follows:

1. Configure WinAC MP in STEP 7.
2. Create a connection between WinAC MP and WinCC Runtime.
3. In STEP 7, download the configuration to WinAC MP.
4. Configure (visualization) HMI objects with WinCC .
5. Download the (visualization) configuration (for example, visualization with histogram) from WinCC to the HMI device.

### 10.11.18. Configuring the WinAC MP communications driver

4

## Requirements for the use of WinAC MP

### Requirements

In order to use WinAC MP in the process control, you must perform the installation and development steps on your configuration PC. Transfer the necessary components to the HMI device.

## Basic procedure

The following steps are described in more detail in the following:

1. Check that your system meets the system requirements:
  - STEP 7 and the authorization are installed on the configuration PC.
  - WinCC and the authorization are installed on the configuration PC.  
WinCC Runtime and ProSave were installed along with WinCC.
2. When WinCC is installed, the WinAC MP option is also automatically installed. Authorization of the WinAC MP is carried out via separate licenses.  
The following components are installed alongside WinAC MP:
  - WinAC MP Runtime files
  - WinAC MP system library
3. Develop a STEP 7 project for controlling your process with WinAC MP on the HMI device.
4. Develop a WinCC project for operating and visualizing your controller.
5. Connect the process components via the PROFIBUS network and configure the hardware.
6. Transfer the WinAC MP Runtime files from the configuration PC to the HMI device.  
Use ProSave for this.
7. Transfer the WinAC MP authorization from its storage location to the HMI device.  
Use the Automation License Manager for this.
8. Transfer the STEP 7 project to the HMI device.
9. Transfer WinCC Runtime and the WinCC project to the HMI device.  
To do this, use the "Transfer" function.

## Changing the device type

### Introduction

There are different ways to create a SIMATIC HMI-station with an HMI device and a configured WinAC MP controller.

#### Procedure 1

Create an HMI device in a SIMATIC HMI-station in the device and network view. Then add the corresponding variant of WinAC MP.

The advantage of this procedure is that you can choose the device type (MP 177, MP 277 or MP 377) and the design of the device type (monitor size and touch or key) directly on selection in the hardware catalog.

#### Procedure 2

Insert the desired variant of WinAC MP directly in the device and network view.

This procedure creates, by default, the largest touch design of the selected HMI device in the device and network view.

## Changing the device type

Select a device. You can change the device type using the shortcut menu command "Change device". When the device type MP277 is changed to MP377 and MP 177 or vice versa with a configured WinAC MP controller in a SIMATIC HMI station, the WinAC MP controller is automatically moved to the storage location of the non slotted modules. It can therefore not be used in the new HMI device. If the the device type is changed, the WinAC MP-configuration must be created again.

## Connecting the configuration PC and HMI device

### Procedure for creating a connection via Ethernet or PROFIBUS DP

#### Basic procedure

WinAC MP supports the communication between the configuration PC and the HMI device via the following connections:

- Industrial Ethernet
- PROFIBUS DP
- USB

To achieve successful communication, follow these steps:

1. Connect the configuration PC to the HMI device.
2. Make the parameter settings for data transfer on the control panel.
3. Make the parameter settings for data transfer on the configuration PC.
4. Set the communications parameters in ProSave.  
With ProSave you can load the WinAC MP Runtime files in the HMI device. Therefore, you must set the communication parameters both in ProSave as well as on the HMI device.
5. Set the communications parameters in WinCC.  
Use WinCC to download your project to the HMI device using the "Download" function.

## Establishing a connection over Ethernet

### Connect the configuration PC to the HMI device (Ethernet)

In order to communicate via an Ethernet network you can either use a direct connection or a networked connection.

To connect a configuration PC to an HMI device via Ethernet, follow these steps:

1. Connect the interfaces of the configuration PC and the HMI device with an Ethernet cable.

---

**Note**

Use a crossover cable to create a direct connection between the configuration PC and the HMI device.

To connect the configuration PC and the HMI device to an Ethernet (LAN) use a 1 to 1 cable with RJ45 connector.

The interface to be used on the HMI device can be established from the operating instructions of your HMI device.

---

## Configuring the transmission settings in the Control Panel (Ethernet)

### Requirements

The configuration PC and HMI device are connected to each other over an Ethernet cable.

### Setting up an IP address on the control panel

The set up the IP address on the control panel, follow these steps:

1. Switch on the HMI device.  
Before the HMI device opens an existing project, the "Loader" selection field appears.
2. Select "Control Panel".

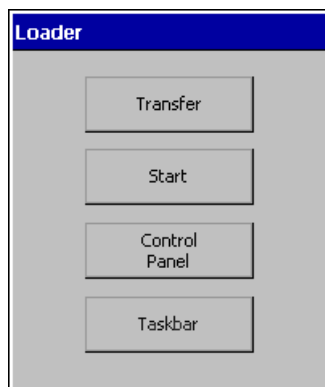

3. Double click on the "Network and Dial-up Connection" symbol.
4. Double-click on the LAN connection.
5. Select the "IP Adress" tab.

6. Select "Specify an IP address".

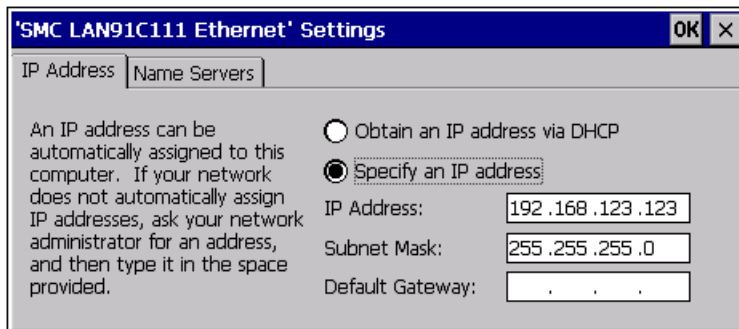

7. Enter the IP address and the subnet mask that you were given by your network administrator.
8. Confirm your entries with "OK".

### Entering transfer settings

To make the data transfer settings, follow these steps:

1. In the control panel, double click on the "Transfer" symbol.
2. Select the "Channel" tab.
3. Select the "Ethernet" option in the "Channel 2" area.
4. Enable "Enable Channel" and confirm your entries.

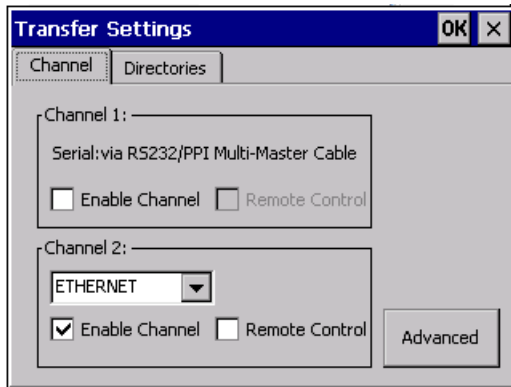

5. Click "OK" and end the dialog "Transfer Settings".

### The transmission settings are configured on the configuration PC

#### Requirement

- The configuration PC and HMI device are connected to each other over an Ethernet cable
- The data transfer settings have been made on the control panel

## Procedure

To make the data transfer settings on the configuration PC, follow these steps:

1. Open the network settings of your PC.
2. Select the "Internet Protocol (TCP/IP)".
3. Enable the "General" tab.
4. Select the "Use the following IP address" check box in the protocol properties.
5. Enter an "IP address".
6. Enter a "subnetwork mask".
7. Confirm your entries.

---

### Note

The IP addresses of the configuration PC and the HMI device must not be the same.  
The subnet mask must be the same for the configuration PC and the HMI device.

---

## Set the communication parameters (Ethernet)

### Requirement

- The configuration PC and HMI device are connected to each other over an Ethernet cable
- The data transfer settings have been made on the control panel
- The data transfer settings have been made on the configuration PC

### Procedure

To make the communications parameter settings in ProSave, follow these steps:

1. Make the transfer settings first.
2. To do this, select the desired component in the project tree.
3. Select the "Download to device > Software" command in the shortcut menu.
  - If you have not already established an online connection, the "Extended download to device" dialog will automatically open. In this case, set all the necessary parameters for the connection and click "Load".
  - If you have already defined an online connection, the project data will be compiled immediately and the "Load preview" dialog will open. This dialog displays messages and proposes actions necessary for uploading.
4. Select the "Options" command from the "Online > HMI device maintenance" menu to start ProSave .

5. Select an element under "Available options".
6. Click ">>".

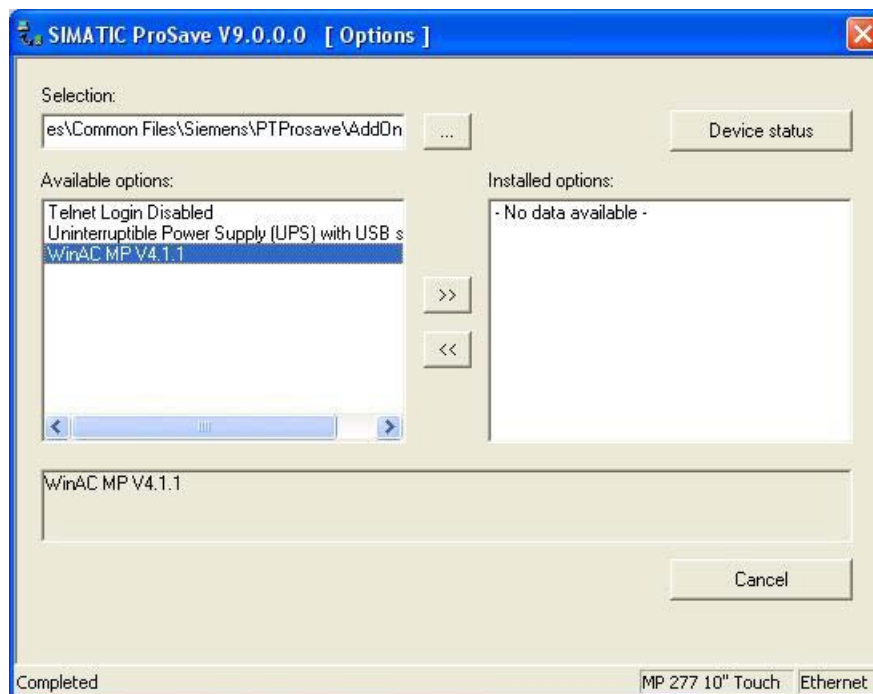

## Setting the communication parameters in WinCC (Ethernet)

### Requirement

- The configuration PC and HMI device are connected to each other over an Ethernet cable.
- The data transfer settings have been made on the control panel.
- The data transfer settings have been made on the configuration PC.

### Procedure

To make the connection settings in WinCC, follow these steps:

1. Open the transfer settings.
2. Select the desired HMI device in the project tree.
3. Select the "Download to device > Software" command in the shortcut menu.
  - If you have not already established an online connection, the "Extended download to device" dialog will automatically open. In this case, set all the necessary parameters for the connection and click "Load".
  - If you have already defined an online connection, the project data will be compiled immediately and the "Load preview" dialog will open. This dialog displays messages and proposes actions necessary for uploading.



4. Select the "Ethernet" mode.
5. Specify the IP address or the computer name of the HMI device.
6. Switch the HMI device to "transfer" mode.
7. Transfer the WinCC project to the HMI device.



**WARNING**

**Death, serious bodily harm and / or damage to property from unexpected process or machine behavior.**

If you use DHCP it is not guaranteed that every time the same IP address will be issued if a node is switched on.

Nodes could lose the connection in the Industrial Ethernet or be connected with incorrect nodes. Always enter a static IP address for the HMI device. Contact your network administrator for address allocations.

## Establishing a connection via PROFIBUS DP

### Connect the configuration PC to the HMI device (PROFIBUS DP)

1. Connect the interfaces from the configuration PC and the HMI device with an PROFIBUS DP cable.

---

#### Note

To communicate via an PROFIBUS DP network you must create a direct connection.

Check if your configuration PC has a suitable interface for connection to the PROFIBUS DP.

If this interface is missing, you must perform the following steps:

- Build a card into the configuration PC, e.g. CP 5611 for desktop PCs.
  - Install the respective drivers.
- 

### Configuring the transmission settings in the Control Panel (PROFIBUS DP)

#### Requirement

- The configuration PC and HMI device are linked with each other via a PROFIBUS DP cable.

#### Procedure

Perform the following steps on the HMI device:

1. Switch on the HMI device.  
Before the HMI device opens an existing project, the "Loader" selection field appears.
2. Select "Control Panel".

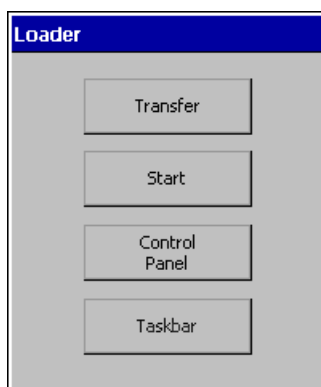

3. Double click on "Transfer".
4. Select the "MPI/PROFIBUS" option from the "Channel 2" selection list under the "Channel" tab.

5. Select "Enable Channel".

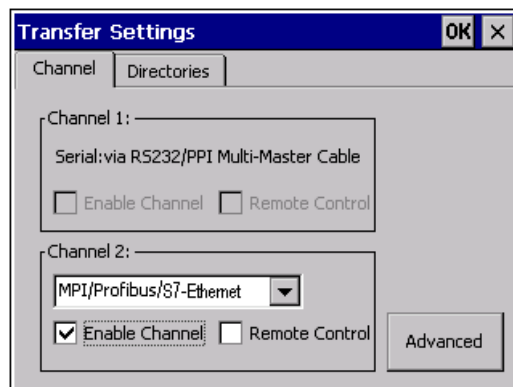

6. Confirm with "OK".
7. "Transfer Settings" End the dialog.

## Setting the communication parameters in ProSave (PROFIBUS DP)

### Requirement

The configuration PC and HMI device are linked with each other via a PROFIBUS DP cable.  
The data transfer settings have been made on the control panel.

### Procedure

To make the communications parameter settings in ProSave, follow these steps:

1. Make the transfer settings first.
2. To do this, select the desired component in the project tree.
3. Select the "Download to device > Software" command in the shortcut menu.
  - If you have not already established an online connection, the "Extended download to device" dialog will automatically open. In this case, set all the necessary parameters for the connection and click "Load".
  - If you have already defined an online connection, the project data will be compiled immediately and the "Load preview" dialog will open. This dialog displays messages and proposes actions necessary for uploading.
4. Select the "Options" command from the "Online > HMI device maintenance" menu to start ProSave .

5. Select an element under "Available options".
6. Click ">>".

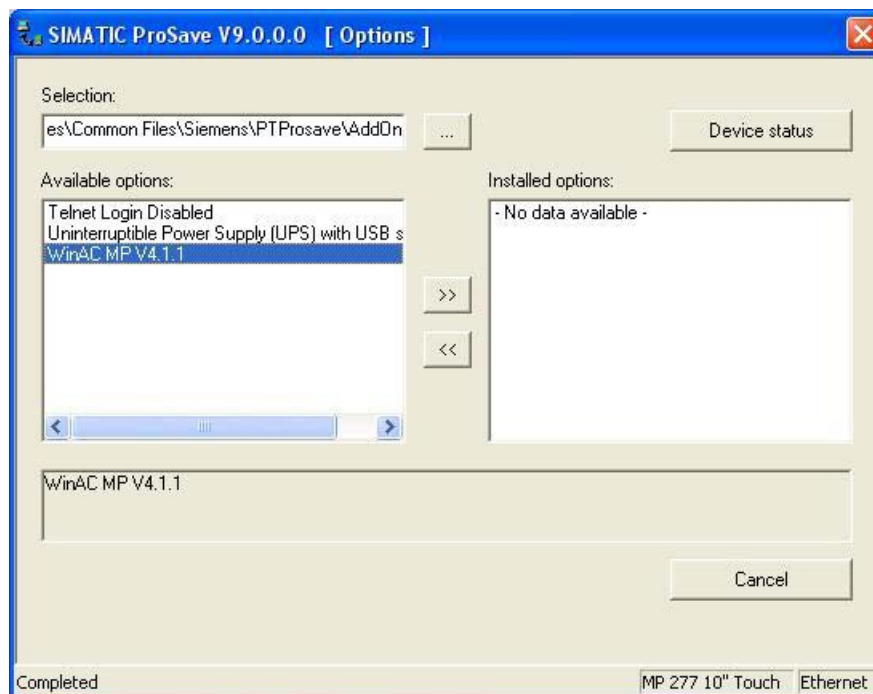

## Set the communication parameters in WinCC (PROFIBUS DP)

### Requirement

- The configuration PC and HMI device are linked with each other via a PROFIBUS DP cable.
- The data transfer settings have been made on the control panel.

### Procedure

To make the connection settings in WinCC, follow these steps:

1. Open the transfer settings.
2. Select the desired HMI device in the project tree.
3. Select the "Download to device > Software" command in the shortcut menu.
  - If you have not already established an online connection, the "Extended download to device" dialog will automatically open. In this case, set all the necessary parameters for the connection and click "Load".
  - If you have already defined an online connection, the project data will be compiled immediately and the "Load preview" dialog will open. This dialog displays messages and proposes actions necessary for uploading.
4. Select the "MPI / PROFIBUS DP" mode.

5. Specify the PROFIBUS address that is assigned to the HMI device.  
The PROFIBUS address is the station address and corresponds to the address configured for the WinAC MP controller.
6. Switch the HMI device to "transfer" mode.
7. Transfer the WinCC project to the HMI device.

---

**Note**

For PROFIBUS DP transmission the WinAC MP control must be started on the HMI device.

---

### 10.11.18. Transferring WinAC MP to the HMI device

5

#### Procedure for transferring WinAC MP

##### Introduction

If you want to execute WinAC MP on the HMI device you must transfer the WinAC MP Runtime files from the configuration PC to the HMI device. For the transfer there must be a data connection between the configuration PC and the HMI device. The following screen shows the arrangement using example Industrial Ethernet.

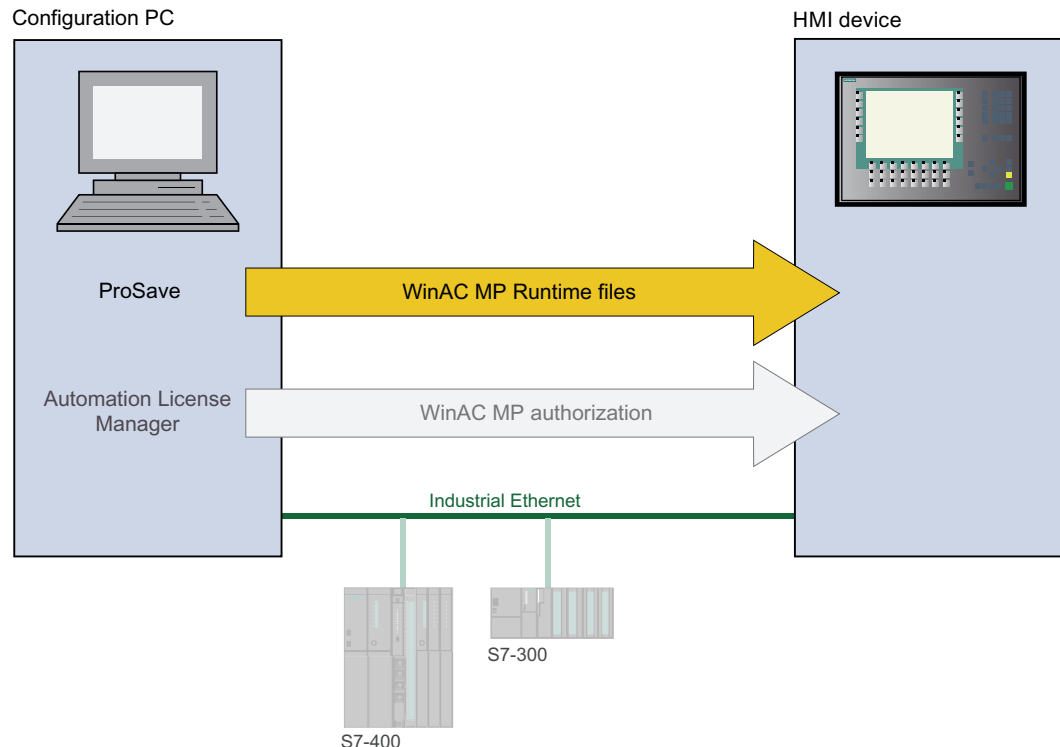

### Basic procedure

To transfer WinAC MP Runtime files to an HMI device, follow these steps:

1. Setting up the HMI device.
2. Configure the ProSave on the configuration PC.
3. Start transfer.

### Switch the HMI device to transfer mode

#### Procedure

For the transfer of data you must switch the HMI device to "Transfer":

1. Switch on the HMI device.  
Before the HMI device opens an existing project, the "Loader" selection field appears.
2. Click on the "Transfer" button.  
The dialog window displays the message "Connecting to host ...".

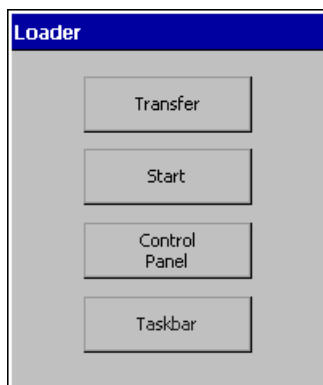

### Configuring ProSave on the configuration PC

#### Requirement

The HMI device was switched to transfer mode.

#### Procedure

To set up a configuration PC to transfer WinAC MP, proceed as follows:

1. Start ProSave.
2. Select the "General" tab.
3. Select the device type of your HMI device.

4. Select the "Ethernet" connection type.
5. Specify the IP address or the computer name of the HMI device.
6. Start the transfer of WinAC MP.

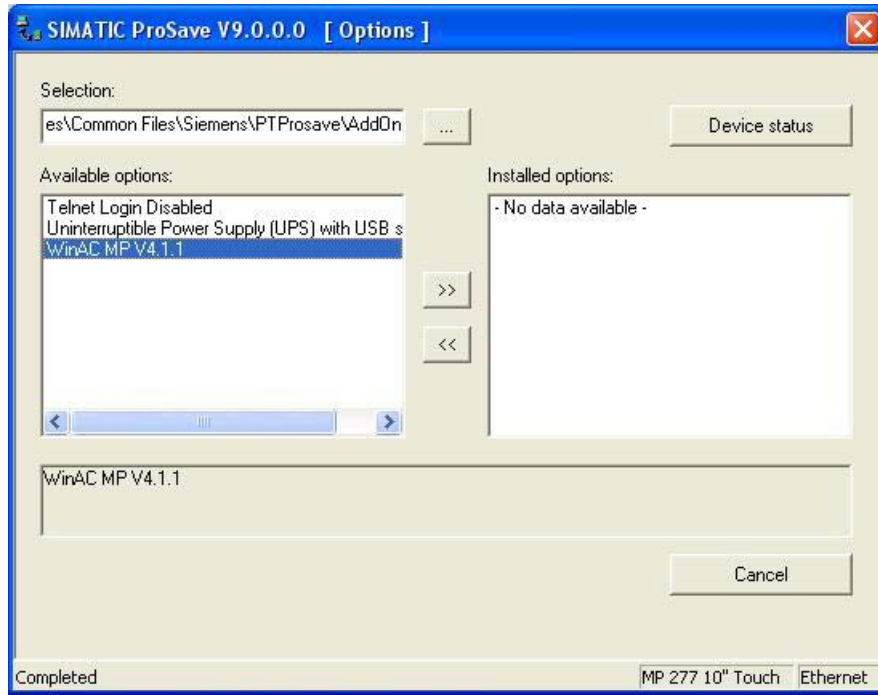

## Start transfer

## Requirement

- The HMI device was switched to transfer mode.
- ProSave is set up on the configuration PC.

## Procedure

To start the transfer of WinAC MP files, follow these steps:

1. Open the "Options" tab in transfer mode and click the "Device status" button. If no error message is shown then the communication connection is valid.

---

### Note

If there is a communication error, then you must check the following circumstances:

- The HMI device must be in Transfer mode.
  - Check the cable connections for a correct and firm connection.
  - The settings in ProSave and on the HMI device must be correctly defined for the connection.
- 

2. In the "Options" tab, select "WinAC MP" below "Available options".



3. To transfer WinAC MP to the HMI device, click the  button.

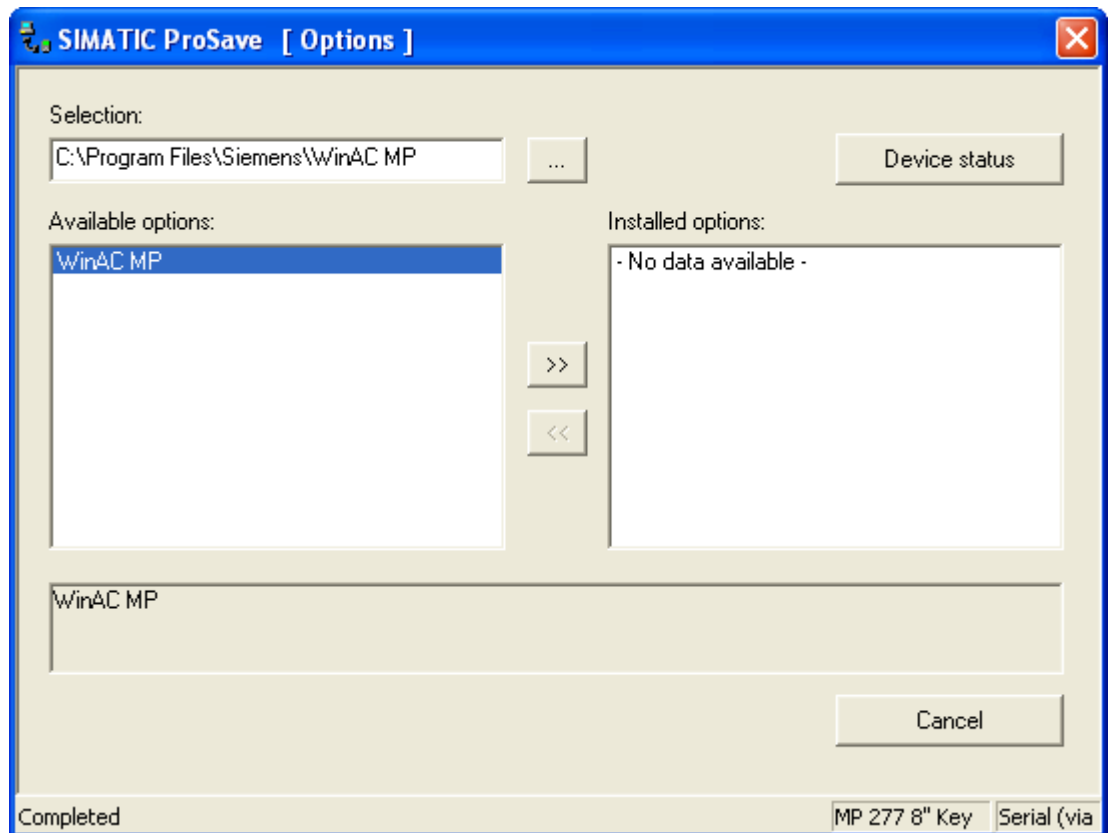

ProSave then starts to load the software of the WinAC MP control to the HMI device. While the files are being transferred the configuration PC shows the progress of the transfer. The following messages are displayed on the HMI device in the "Transfer" dialog box:

- Progress of the file receipt on the HMI device.
- Unzip data in the Flash file system.
- Save data in the Flash file system.

At the end of the transfer, a message confirms a successful transfer.

4. When transfer is complete, you will be asked to restart the device. Restart the device.

## Result

The WinAC MP control is now installed on the HMI device. Now, transfer the authorization for WinAC MP to the HMI device.

### 10.11.18. Transferring authorization to the HMI device

6

#### Introduction

You need a license key to operate WinAC MP. The license key is transferred with the Automation License Manager to the HMI device.

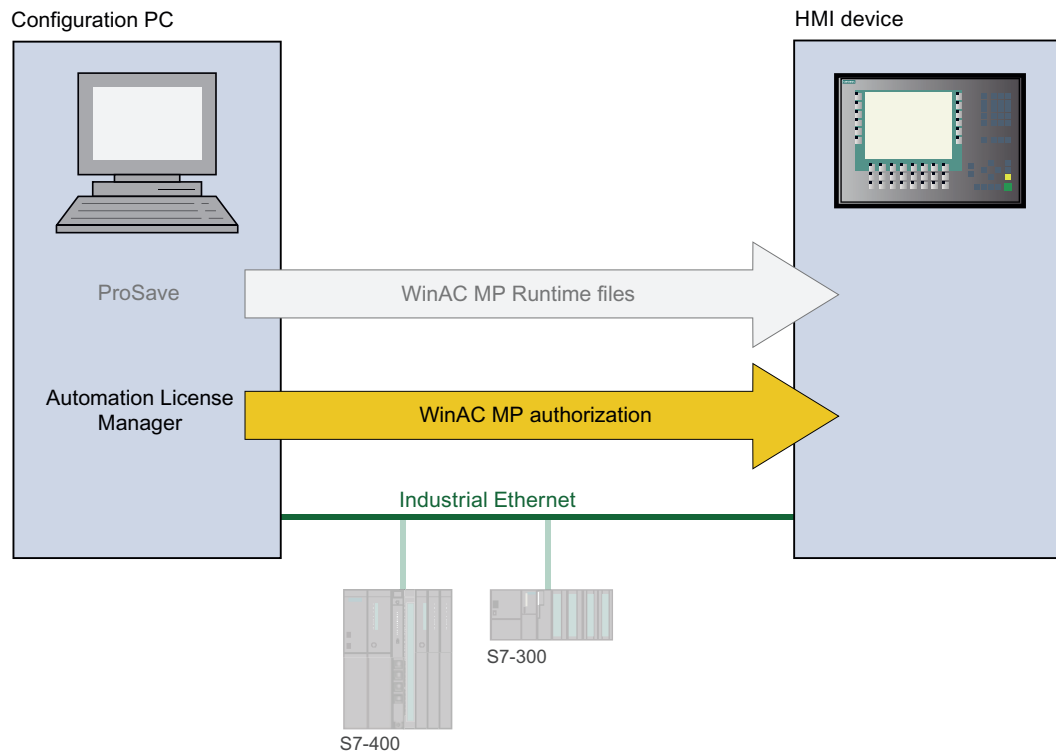

#### Requirements

The storage location of the license key can be called from the configuration PC.

#### Procedure

To transfer the WinAC MP authorization to an HMI device, follow these steps:

1. Select the "Authorize/License" command from the "Online > Device maintenance" menu to start WinAC MP authorization. Automation License Manager is launched.
2. Select the "Connect HMI device" menu command.
3. Select the device type of the HMI device.
4. Select the type of connection and set the parameters for the connection. The connection to the HMI device is established. The connected HMI device is displayed.
5. Select the source drive.

6. Drag one or more license keys to the HMI device.  
The license keys are then transferred to the HMI device.
7. Close the Automation License Manager after a successful transfer.

### 10.11.18. WinAC MP system library

7

#### Screens from the system library

The screens from the system library are optimized for a 6' display with a resolution of 320 x 240. If you use a display of a different size, you can adapt the screens for your display in WinCC.

#### Standard screens and tags

The WinAC MP-system library offers you the standard screens "WinAC\_MP\_Home" and "WinAC\_MP\_Tuning" and the tags "WinAC\_MP\_Tags". To use the standard screens, move them to the "Screens" folder in the project tree.

In addition to the standard screens, the tags must be copied separately. To do this, drag "WinAC\_MP\_Tags" from the WinAC MP-system library to the "HMI\_Tags" folder in the project tree.

## 10.12 Using global functions

### 10.12.1 HMI device wizard basics

#### Introduction

The HMI device wizard will automatically start when you create a new HMI device in your project.

#### HMI device wizard

The HMI device wizard will guide you through each dialog step by step and help you set up a device. You use the HMI device wizard to specify the basic settings for your HMI device, such as screen layout and the connection to your PLC.

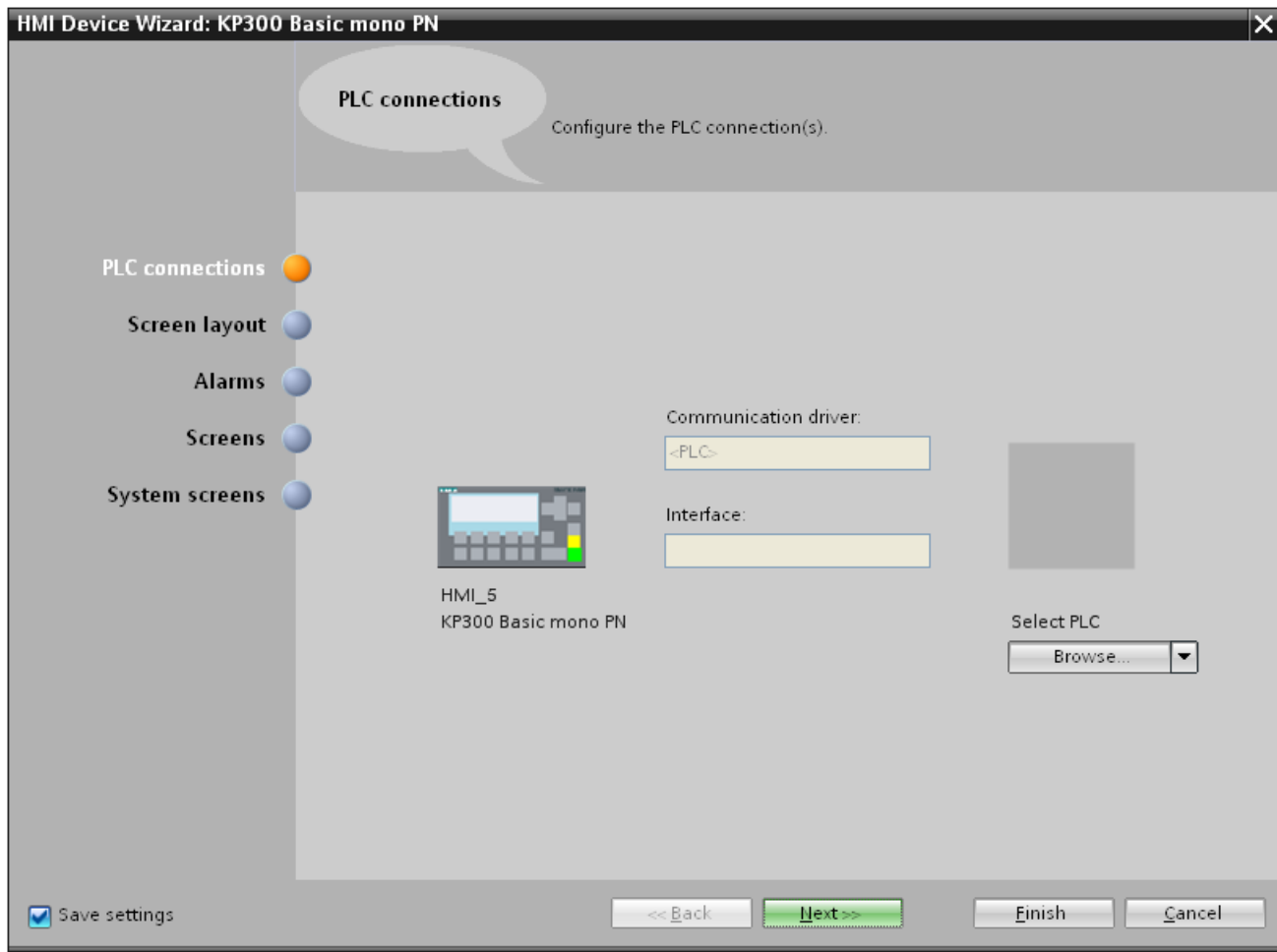

**See also**

HMI device wizard basics (Page 5487)

**10.12.2 HMI device wizard basics****Introduction**

The HMI device wizard will guide you through each dialog step by step and help you set up a device. You use the HMI device wizard to specify the basic settings for your HMI device, such as screen layout and the connection to your PLC.

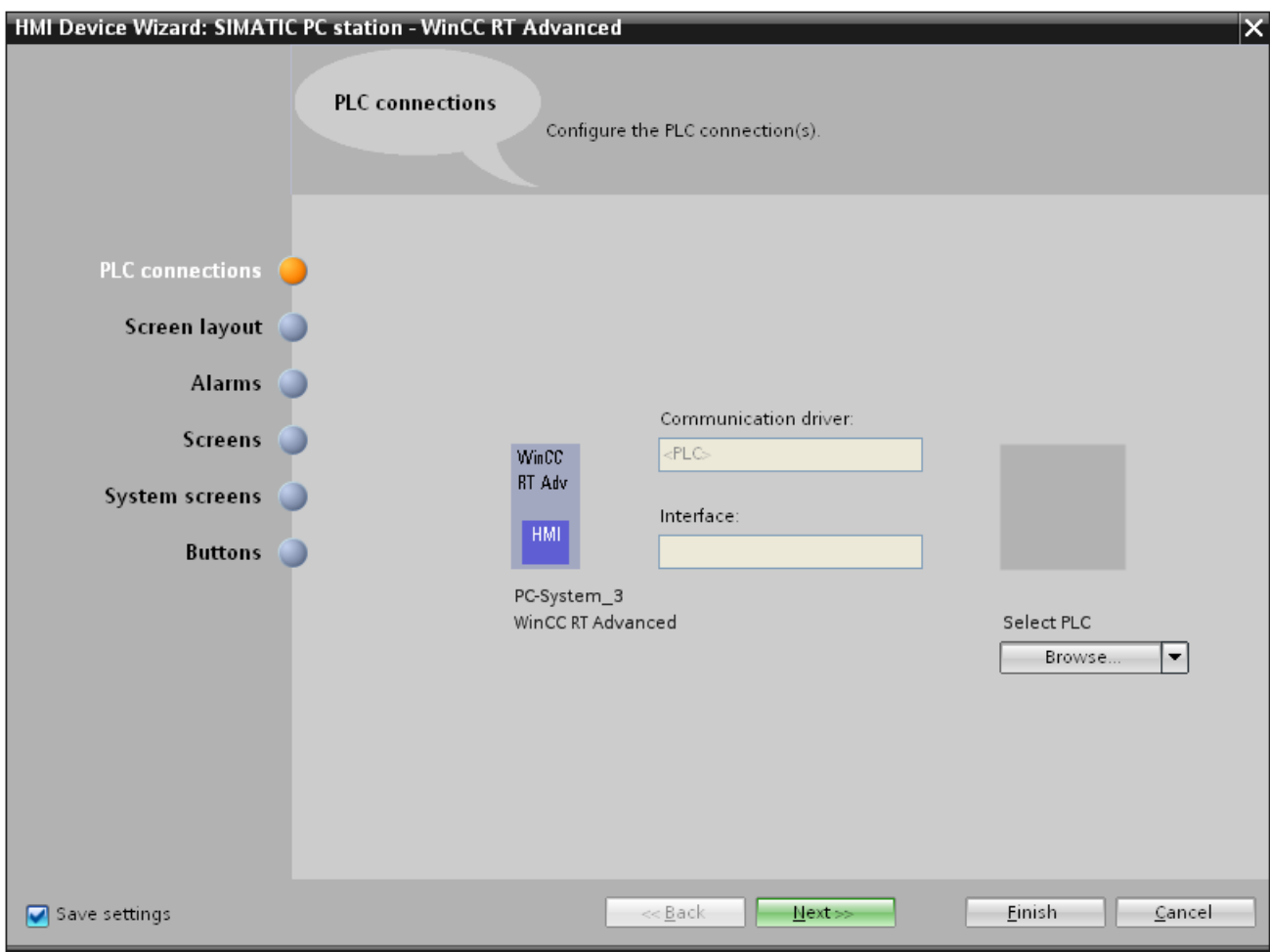

### Opening the HMI device wizard

1. Add a new device to your project, for example, RT Advanced.
2. Click on the device in the project tree.
3. Select "Start the HMI device wizard" in the shortcut menu. The "HMI device wizard" opens.

---

#### Note

If you make changes after adding the device, such as adding a new screen, the HMI device wizard will not open again.

---

### See also

HMI device wizard basics (Page 5484)

## 10.12.3 Working with libraries

### 10.12.3.1 Basics on libraries

#### Introduction

Store all objects you need frequently in the libraries. An object that is stored in the library only has to be configured once. It can then be used repeatedly as often as required. Library objects extend the number of available screen objects and increase the effectiveness during configuration through the multiple usage of ready-to-use objects.

Your WinCC software package is supplied with comprehensive libraries that contain, for example, "Motor" or "Valve" objects. You may, however, define your own library objects.

You manage libraries in the "Libraries" task card or library view. The following libraries are available:

- Project library
- Global libraries

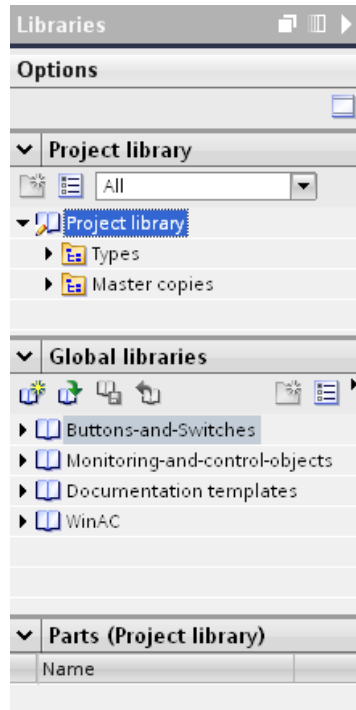

---

### Note

There is a symbol library in the "Tools" task card in the "Graphics" palette.

---

### Project library

There is one library for each project. Objects of the project library are stored alongside with the project data and are available only for the project in which the library was created. If the project is moved to another PC, any project library created in it is also moved.

To use the library object of the project library in other objects, move or copy the object into a global library.

### Global libraries

A global library is saved independently of the project data in its own file with the extension \*.al12.

A project can access several global libraries. A global library may be used concurrently in several projects.

When a library object is changed by a project, this library will be changed in all projects in which these libraries are open.

## **Library objects**

A library can contain all WinCC objects. Examples:

- Complete HMI device
- Screens
- Display and control objects including tags and functions
- Graphics
- Tags
- Alarms
- Text and graphics lists
- Faceplates
- User data types

## **See also**

Copy templates and types (Page 5492)

Screen basics (Page 2931)

### **10.12.3.2 Overview of the library view**

#### **Function of the library view**

The library view combines the functionality of the "Libraries" task card and the overview window. In the library view, the elements of a library are displayed in various views. In the details view, for example, you see additional properties of the individual elements. You can also edit and version the types in the library view.



## Layout of the library view

The following figure shows the components of the library view:

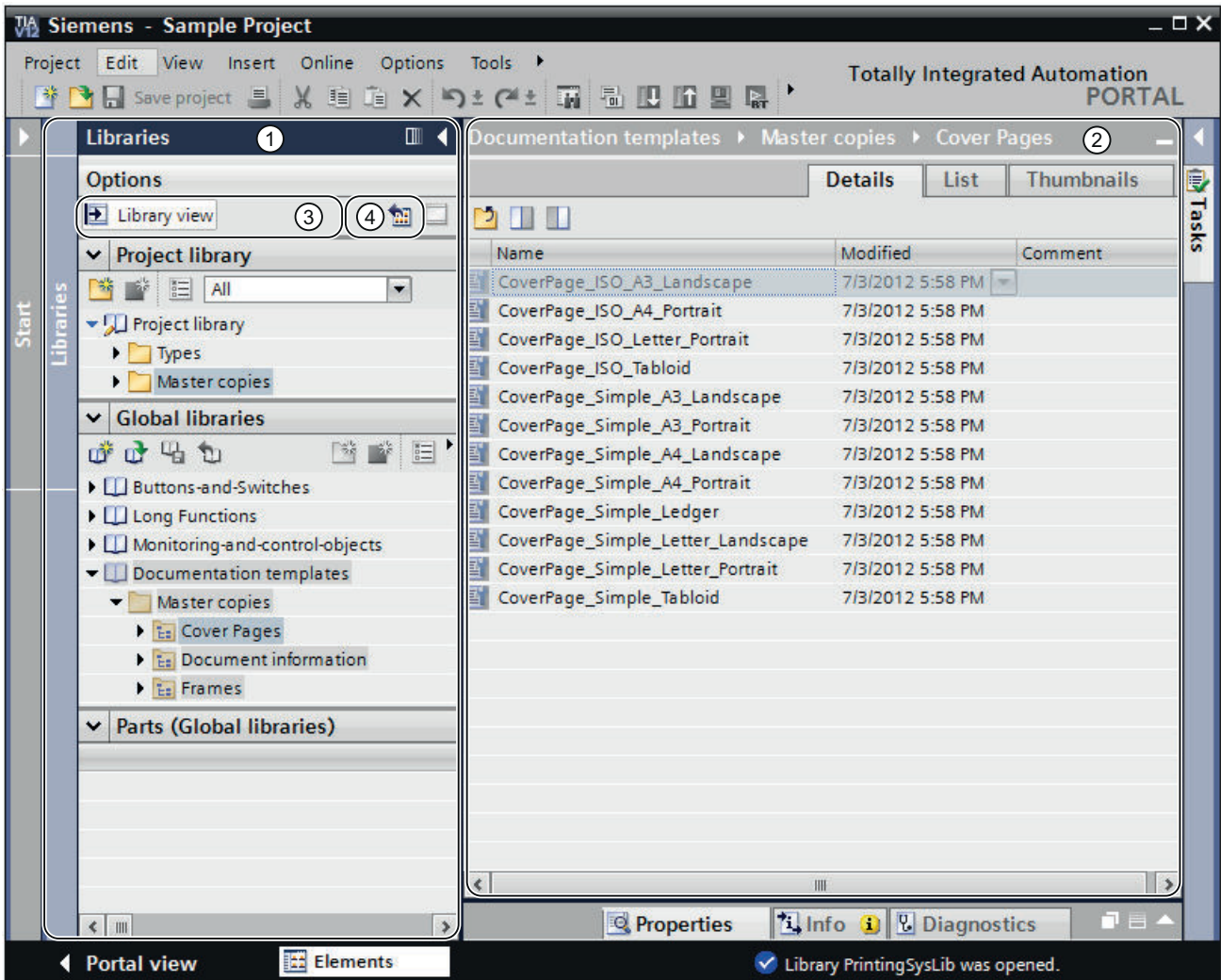

- 1 Library tree
- 2 Library overview
- 3 "Library view" button
- 4 "Open or close library overview" button

## Library tree

The library tree is similar to the "Libraries" task card, apart from a few minor differences. In contrast to the task card, there is no "Elements" palette, because the elements are displayed in the library overview. In addition, you can close the library view in the library tree, or open and close the library overview.

## Library overview

The library overview corresponds to the overview window and displays the elements of the currently selected object in the library tree. You can display the elements in three different views. You can also perform the following actions in the library overview, for example:

- Copying elements
- Moving elements
- Versioning types
- Editing faceplates and HMI user data types
- Editing type instances

### 10.12.3.3 Copy templates and types

#### Introduction

Both the "Project library" and the "Global library" contain the two folders "Master copies" and "Types". You can create or use the library objects either as a copy template or a type.

#### Master copies

Use copy templates to create independent copies of the library object.

#### Types

Create instances of objects of the "Types" folder and use these in your project. The instances are bound to their respective type.

#### Administration of the library objects

You can copy and move library objects to another library. You can only copy copy templates to the "Master copies" folder or any sub-folder of "Master copies". You can also only insert types in the "Types" folder or any sub-folder of "Types".

#### See also

Basics on libraries (Page 5486)

State of type versions (Page 5503)

### 10.12.3.4 Libraries in WinCC

#### Introduction

The WinCC software package includes extensive libraries. Sorted by topic into folders, they contain preassembled graphic objects which you can use in screens for operation and monitoring of your plant.

#### Global library "Buttons and Switches"

The libraries "Buttons and Switches" offer a wide selection of buttons and switches.

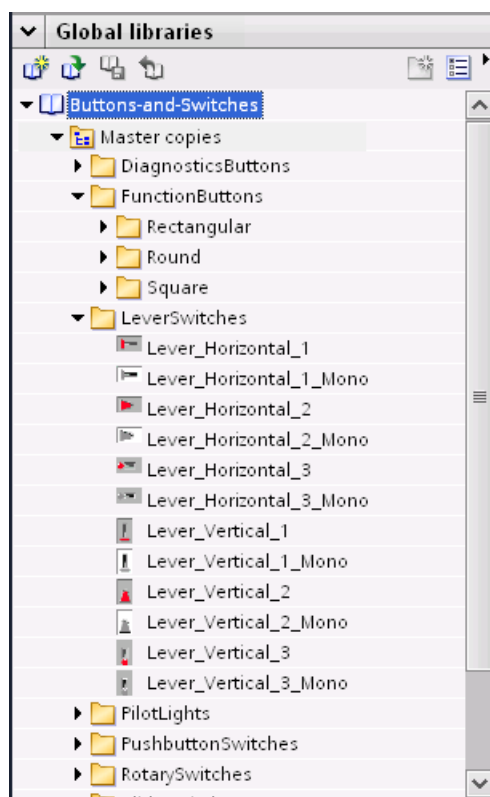

The folders divide switches and buttons into categories. The "DiagnosticsButtons" folder contains the object "System diagnostics indicator", for example. You use the "System diagnostics indicator" object for system diagnostics in your plant.

---

#### Note

You can only use the objects in the "DiagnosticsButtons" folder on Comfort Panels.

You cannot use objects which have "Switch" in the object name or in the associated folder name in Runtime Professional.

---

## Global library "Monitoring and Control objects"

The "Monitoring and Control objects" library offers more complex display and operating objects in several designs and corresponding control lights, buttons and switches.

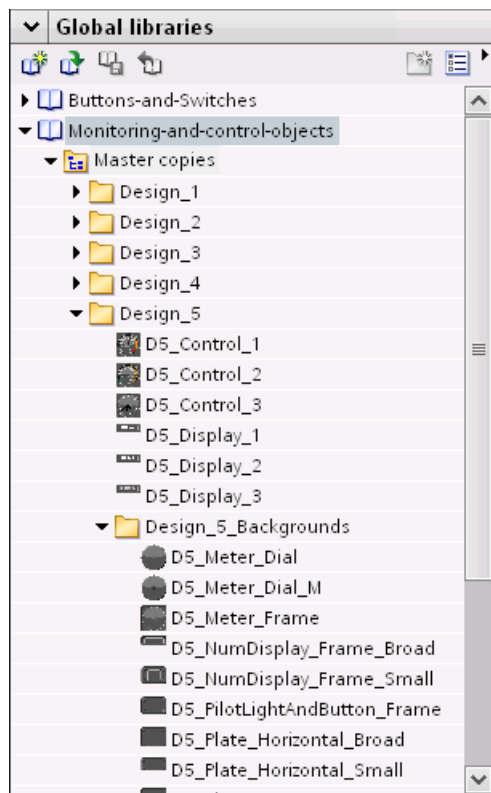

In addition, graphics views for the designs are stored in the "Design\_Backgrounds" folder; they can be used as object backgrounds for the custom extension of the scope of the library.

---

### Note

You cannot use objects which have "Switch" in the object name in Runtime Professional. The same applies for the object "D5\_Display\_3" with the date/time field it contains.

---

### 10.12.3.5 Managing libraries

#### Creating a global library

##### Introduction

In the libraries you store the configured objects that you want to use several times in your configuration. To use objects in several projects, create a global library.

## Requirement

- A project is open.
- The "Libraries" task card is displayed or the "Library view" is open.

## Procedure

1. Click the  icon under "Global library".  
The "Create new global library" dialog opens.

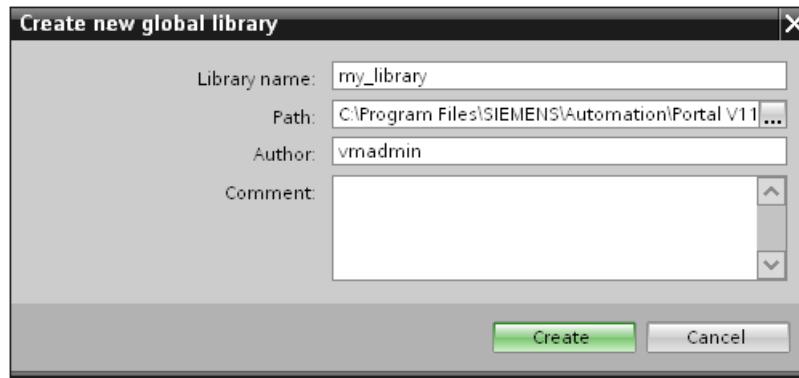

2. Enter a name.
3. Select the path where the new library is to be stored.
4. Click "Create".

## Result

The new library is shown in the "Global libraries" palette. The global library contains the "Types", "Master copies" and "Common data" folders. Under the "Common data" you can find reports for the global library.

A folder with the name of the global library is created in the file system at the storage location of the global library. This actual library file is given the file name extension ".al12".

## Saving a global library

### Introduction

A global library is stored in a separate file on your hard disk drive. The file contains the objects of the global library including the referenced objects. E.g. the reference of a tag which was configured on an I/O field is also saved in the library.

WinCC prompts you to save the global libraries when you close WinCC or your project without saving. You also can store the global library during configuration, without storing the entire project.

## Requirement

- You have opened a project which contains at least one library.
- The "Global libraries" palette is displayed or the library view is open.

## Procedure

1. Click the  icon in the "Global library" palette to save the library you want to save.

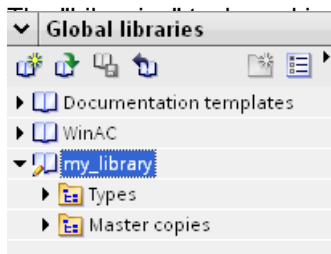

2. Click the  icon in the "Global library" palette.

You can alternatively select the "Save Library" command in the shortcut menu.

If you want to store the global library in a different folder, select "Save as" in the shortcut menu. Select the path in which you want to store the new library and enter a file name.

## Result

The global libraries are saved under their current file name or a file name you have specified.

## Opening a global library

### Introduction

In WinCC, the global libraries are stored in separate files. You can use a global library in every project.

## Requirement

- You have saved a global library.
- A project is open.
- The "Libraries" task card is displayed or the library view is open.

## Procedure

1. Click the  icon in the "Global library" palette. The "Open global library" dialog box is displayed.
2. Select the path in which the library is stored.
3. Click "Open".

---

### Note

To have the access to a global library from multiple projects, open the global library read-only. As soon as a global library is not opened read-only, access from other projects is blocked.

---

## Result

WinCC displays the opened global library in the "Global library" palette.

## Displaying logs of global libraries

Logs listing all changes made to the global library are created when global libraries are updated. The logs are stored together with the global library and are always available once you have opened the global library.

## Procedure

To open the logs of a global library, follow these steps:

1. Open the global library in the "Libraries" task card or in the library view.
2. Open "Common data > Logs" in the lower-level folder.
3. Double-click the required log.  
The log opens in the work area.

## Updating a project with the contents of a library

### Introduction

After you have edited several types in the project library, update all instances in the project to the most recent version of the types from the project library.

### Requirement

The "Libraries" task card or the library view is open.

### Procedure

1. Select the project library.
2. Select "Update > Project" from the shortcut menu. A dialog opens.
3. Select either the entire project or individual devices for the update.
4. Select the "Delete all unused versions of affected types" check box to delete all older versions of the updated types from the project library.
5. Click "OK" to confirm.

## Result

All instances of the types are updated in the project to the most recent version of the selected types in the project library.

You can find a log of the update process in the project tree under "Common data".

## Updating a library with the contents of another library

The following options are available for updating libraries:

- Updating a global library with types from another global library
- Updating the project library with types from a global library

Each of the following elements can be selected as source for the update:

- An entire library
- Individual folders within a library
- Individual types

## Requirement

To update a global library, open the library with write rights.

## Requirement

The "Libraries" task card or the library view is open.

## Procedure

To update a library with the contents of a different library, follow these steps:

1. Select the entire library or a folder within the library or individual types.
2. Right-click the source and select the "Update > Library" command from the shortcut menu. The "Update library" dialog box opens.
3. Select the type of library you want to update:
  - Select "Update the project library" to update the project library with types from a global library.
  - Select "Update a global library" if you want to update a global library.
4. Optional: Select the global library you want to update from the drop-down list.
5. Select the "Delete all unused versions of affected types" check box to delete all older versions of the updated types from the project library.
6. Click "OK" to confirm.



## Result

- Types not yet available in the target library are supplemented there with all their versions. More recent versions are added to the types that already exist in the target library. If a more recent version of a type already exists in the target library, the latest version is nevertheless copied and automatically assigned a newer version number.
- A log listing all performed changes to the target library is created for the update process. If you have updated the project library, you can find the log in the project tree under "Common data > Logs". If you have updated a global library, you can find the log in the "Common data > Logs" folder in the level below the global library.

### 10.12.3.6 Managing objects in a library

#### Displaying library objects

##### Introduction

The libraries are displayed as file folders in the corresponding palette. The elements contained in the library are displayed in the file folder and in the "Elements" palette.

##### Requirement

- At least one library object has been created in a library.
- The "Libraries" task card is opened.

### Procedure

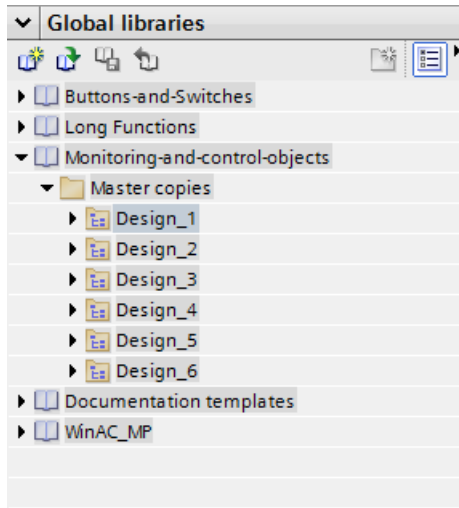

1. Select the library in the corresponding palette whose library objects you want to display.

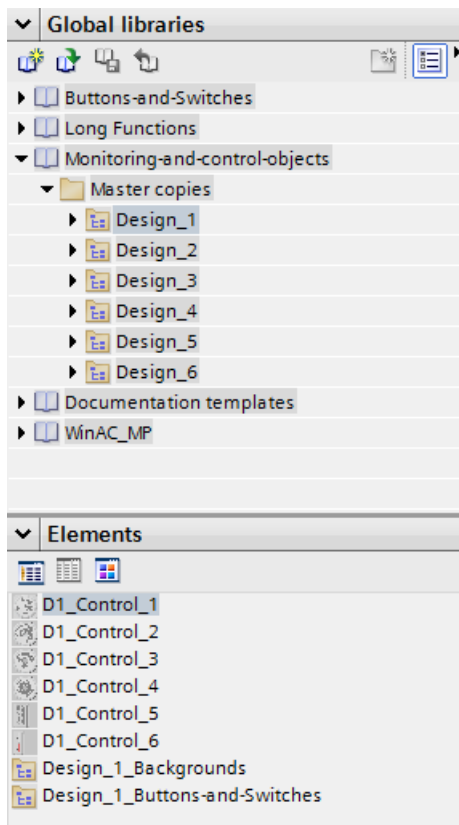

2. Click .  
The contained library objects are displayed in the "Elements" palette.



3. Click one of the following icons:

Icon	Description
	Element view in detailed mode
	Element view in list mode
	Element view in overview mode with icons

When several objects are assigned to the library with a multiple selection, only one of the objects is shown in the "Elements" palette. The individual components of this element are displayed in the "Parts" palette.

### Show parts of the library objects

1. Select the library in the corresponding palette from which you want to view the components of an element.
2. Click .
3. The contained library objects are displayed in the "Elements" palette.
4. Select the element.  
The "Parts" palette shows the objects of which the element consists.

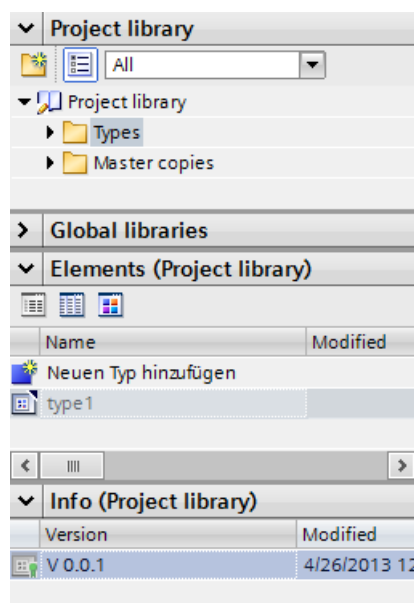

### Result

The library objects are displayed in accordance with the configuration. The components of the faceplates are displayed.

## Storing an object in a library

### Introduction

You can store all of WinCC objects, such as screens, tags, graphic objects or alarms in your libraries. You can use drag-and-drop to move the corresponding object from the work area, project window or detail view to the library. In a library you have divided into categories, you can directly add objects to a specific category.

### Requirement

- The "Screens" editor is open.
- A screen object has been created in the work area of the screen.
- The created libraries are displayed.

### Procedure

1. Select the object in the work area of the "Screens" editor.
2. Drag-and-drop the object from the work area to the desired library.  
The mouse pointer is transformed into a crosshair with an appended object icon.

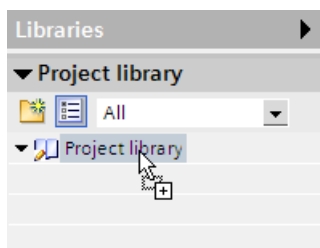

### Result

The object is saved to the library for further use in multiple instances of your configuration.

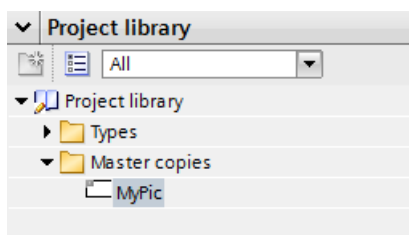

## Inserting a library object

### Introduction

The system always assigns the inserted library object a name which consists of the name of the object type and of a consecutive number.

If the inserted object already exists, you have the option of replacing the object or of saving it under a new name.

You cannot insert library objects that are not supported by the HMI device.

---

**Note**

If you insert a screen with interconnected template from the library, the template will also be inserted. Any existing matching template is not used.

---

**Requirement**

- The "Libraries" task card is opened.
- The editor in which you want to insert the library object is open.

**Procedure**

1. Select a library object from the library.
2. Drag-and-drop the library object to the position in the work area where you want to insert the object.  
The library object is inserted.

**Result**

If the object was contained in the "Copy templates" folder, you have inserted an independent copy of the library object in the editor.

If the object was contained in the "Types" folder, you have inserted an instance of the library object in the editor.

### 10.12.3.7 Using types and their versions

**State of type versions****Introduction**

Depending on the point of use, the version of a type has different statuses.

**Released version**

The "released version" status is available for all types, regardless of the point of use.

If you want to edit a released version, you must first create a new test version or an "in progress" version.

Released type versions of scripts and screens can be opened and viewed at their instance.

### "In progress" version

Only versions of faceplate types and user-data types have the "in progress" status.

When you create a new type or a new version of a released type, the type is assigned the status "in progress".

Types with the "in progress" status can be edited in the library view without the need for a reference to an instance in the project. Upon release, the compatibility of the type is tested by a consistency check.

### "In testing" version

Only versions of scripts and HMI screens have the "in testing" status.

When you create a new version of a type, the type is assigned the status "in testing".

A version with "in testing" status is linked to an instance in the project. You can set only one version to "in testing" for each type at a given time.

A version in testing may only be linked to a single instance in the project. Therefore, it is not possible to copy an instance to the clipboard, to duplicate it or to create an additional type from the instance as long as it has "in testing" status.

### See also

Generating a script as a type (Page 5504)

Generating a screen as a type (Page 5505)

Creating a faceplate type (Page 3054)

Create a new version of a type (Page 5506)

Copy templates and types (Page 5490)

### Generating a script as a type

#### Requirement

- A project is open.
- An HMI device has been created and opened.
- The project tree is open.
- The "Libraries" task card is opened.

#### Procedure

1. Open the "Scripts" editor in the project tree.
2. Create a new script.
3. Select the script in the project tree.
4. Drag-and-drop the script into a library in the "Libraries" task card. A dialog opens.

5. Enter a name.
6. Enter a comment.

## Result

You have created a type version of a script in the library. The created type is stored as a released version in the library. An instance of the type is used in the project.

To change the script create a new version of the script.

## See also

State of type versions (Page 5501)

## Generating a screen as a type

### Requirement

- A project is open.
- An HMI device has been created and opened.
- The project tree is open.
- The "Libraries" task card is opened.

### Procedure

1. Open the "Screens" editor in the project tree.
2. Create a new screen.
3. Select the screen in the project tree.
4. Drag-and-drop the screen into a library in the "Libraries" task card. A dialog opens.
5. Enter a name.
6. Enter a comment.

## Result

You have created a type of a screen in the library.

The created type is stored as a released version in the library. An instance of the type is used in the project.

To change the screen create a new version of the screen.

## See also

State of type versions (Page 5501)

## Create a new version of a type

### Principle

If you create a new version of a type, the point of use of the type determines the status of the newly created version.

### Requirement

The "Libraries" task card is opened.

A type has been created and released.

### Procedure

1. Select the released type.
2. Select "Edit type" in the shortcut menu.

### Result for faceplate types and user data types

A new version of the type is created.

The version has the status "in progress". The library view opens.

### Result for types of scripts and screens

A dialog opens.

After you have selected the settings in the dialog, the version is set to the status "in testing". The instance used in the project is set to the status "in testing". The library view opens.

### See also

State of type versions (Page 5501)

## 10.12.4 Importing and exporting project data

### 10.12.4.1 Importing and exporting project data

#### Introduction

WinCC gives you the option of exchanging project data between the projects or copying them to external applications.



## Exporting and importing between projects

You can export the following project data from a project and import them into another project.

- Recipe data records
- Alarms
- Tags
- Text lists
- Project texts

Exporting and importing reduces the workload. Instead of creating new data records, you use data already created in previous projects.

## Editing the export file

The following file formats are available for export and import depending on the editor:

- \*.xlsx for alarms, tags, project texts and text lists
- \*.csv for recipe data records

You can edit the import file in Excel, for example.

## XLSX file format

XLSX format is a file format for Excel tables based on the Open XML format. XLSX files are optimized for Microsoft Excel 2007.

You can sort the columns as required in the XLSX file.

## CSV file format

CSV stands for Comma Separated Value. In this format, the columns of the table that contain the names and the value of the entry are separated by semicolons. Each table row terminates with a line break. You can also open the CSV file for editing in Excel.

## Importing project data

When project data is imported, the objects in the project are created.

The syntax of the import file is checked during import. The accuracy of the values imported and dependencies between the imported values are not checked.

Any errors found in the imported data are reported when the project is compiled.

## Copying in Excel format

In all spreadsheet editors you can copy the content in Excel format into the buffer of your PC. Subsequently you insert the project data in Excel format directly into any application outside

the TIA Portal. To this purpose you use the corresponding command in the shortcut menu of the work area:

- If you select the command in the shortcut menu of the line header, the complete line is copied into the buffer.
- If you select the command in the shortcut menu of a cell, only the cell content is copied into the buffer.
- If you select several lines and select the command, all marked data are always copied into the buffer.

This data exchange is only possible as an export.

#### 10.12.4.2 Importing and exporting recipes

##### Exporting recipes

##### Introduction

WinCC features an export function for exporting data records from recipes.

##### Requirements

- The WinCC project for the export is open.
- Recipes have been created in a project.
- The "Recipes" editor is open.

## Exporting recipes

1. In the "Recipes" editor, select the recipe with the data records you want to export.
2. Click .  
The "Export" dialog box opens.

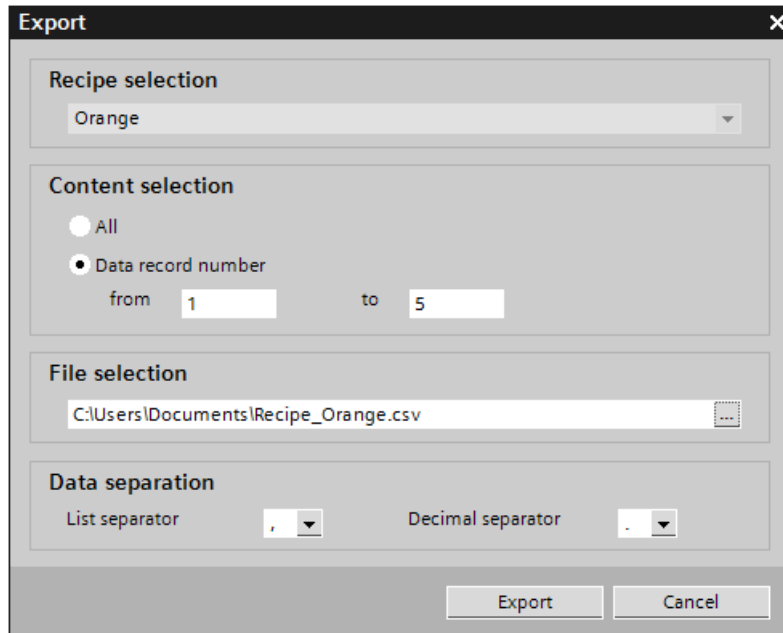

The selected recipe is shown under "Recipe selection".

3. Under "Content selection", specify if all or only selected data records are to be exported.
4. Under "File selection", specify the file in which the recipe data is to be stored.
5. Specify the list separator and decimal separator under "Data separation".
6. Click "Export."  
The export will start.

## Result

The exported data has been written to a CSV file. The CSV file will be stored in the specified directory.

## See also

- Exporting alarms (Page 5512)
- Exporting text lists (Page 5525)

## Importing recipes

### Introduction

Recipes are identified by their name. The recipe name must therefore be unique. Open the import file in a simple text editor to check that it has the correct data structure.

Specify whether or not existing data records should be overwritten by records with the same name during the import.

### Requirements

- A CSV file containing at least one recipe has been created.
- The WinCC project for the import is open.
- The "Recipes" editor is open with at least one recipe.

### Importing a recipe

1. In the "Recipes" editor, select the recipe with the data records you want to import.
2. Click .  
The "Import" dialog box opens.

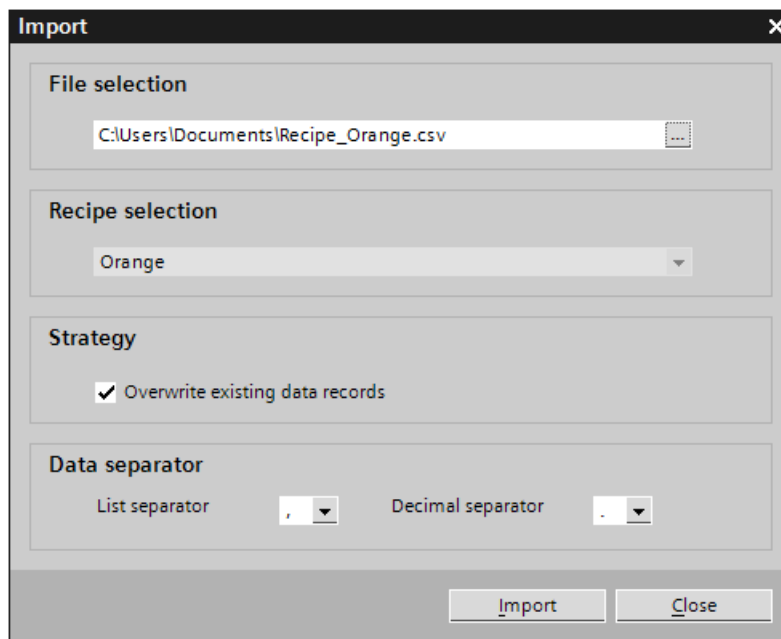

The selected recipe is shown under "Recipe selection".

3. Select the file you want to import under "File selection".
4. Under "Strategy", specify if existing data records should be overwritten by records of the same name.

5. Under "Data separation", select the list separator and the decimal separator to use in the CSV file.
6. Click "Import".  
The import will start.

## Result

The data records are created in the selected recipe. Depending on the setting for "Strategy", existing data records are overwritten by records with the same name from the CSV file.

Existing data records with the same name will also be imported from the CSV file if you deactivate the "Overwrite existing data records" option.

## Format of recipe data

### Introduction

This section describes the required format of the file for the import of recipes. The file containing the data of the recipes must be available in "\*.csv" format. :

### Structure of recipe data

The structure of the import file is fixed. The following example shows the structure of a recipe containing two recipe elements, each with two data records:

```
List separator=<List separator>Decimal symbol=<Decimal
separator><List separator><Line break>
<Name of the recipe><List separator><List separator><Line break>
LANGID_<ID of the language><List separator>
<Display name, recipe element 1><List separator>
<Display name, recipe element 2><Line break>
<Number recipe><List separator>
<Recipe data record number 1><List separator>
<Recipe data record number 2><Line break>
<Tag recipe element 1><List separator>
<Recipe data record 1 value 1><List separator>
<Recipe data record 2 value 1><Line break>
<Tag recipe element 2><List separator>
<Recipe data record 1 value 2><List separator>
<Recipe data record 2 value 2><Line break>
```

### ID of the language

Use the "Windows language ID" in decimal notation, e.g. "1033" for English. Additional information is available in the documentation for the Windows operating system.

### 10.12.4.3 Importing and exporting alarms

#### Exporting alarms

##### Introduction

WinCC has an export function for alarms.

##### Requirements

- The WinCC project for the export is open.
- Alarms have been created in the project.
- The "HMI alarms" editor is open.

##### Exporting alarms

1. Click the  button in "Discrete alarms" or "Analog alarms". The "Export" dialog box opens.



2. Click the "..." button and specify in which file the data are saved.
3. Specify whether you want to export "Discrete alarms" or "Analog alarms".
4. Click "Export". The export will start.

##### Result

The exported data has been written to an xlsx file. The xlsx file will be stored in the specified folder.

## See also

- Importing alarms (Page 5513)
- Format of the analog alarm data (Page 5514)
- Format of the discrete alarm data (Page 5517)
- Exporting recipes (Page 5506)
- Exporting text lists (Page 5525)
- Exporting tags (Page 5519)

## Importing alarms

### Introduction

Alarms are identified by their alarm number. The alarm numbers must be unique in the analog and discrete alarm types. Alarms with redundant alarm numbers will be overwritten. An alarm without an existing alarm number is created.

Any empty list entries for existing alarms contained in an xlsx file will be ignored for the purposes of the import. The entries of the existing alarms remain active and will not be replaced by empty ones.

### Requirements

- An xlsx file with alarms has been created.
- The structure of the xlsx file meets the requirements.
- The WinCC project for the import is open.
- The "HMI alarms" editor is open.

## Importing alarms

1. Click the  button in "Discrete alarms" or "Analog alarms". The "Import" dialog box opens.

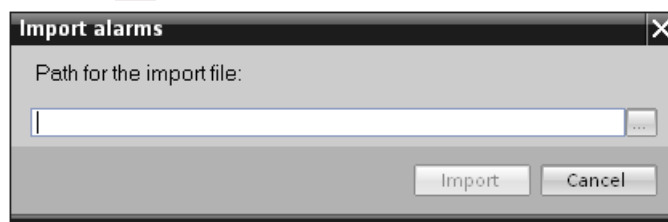

2. Click the "..." button and select the file that you want to import.
3. Click on the "Import" button. The import will start. A progress bar indicates the progress of the import operation.

## Result

The corresponding alarms including alarm texts are created in WinCC on the basis of the import data. Alarms relating to the import operation are displayed in the output window. A log file is saved in the source directory of the import files. The log file has the same name as the respective import file but with the ".xml" extension.

Check when importing the data whether there are any links to objects, for example, dynamic parameters such as tags.

- If an object with the same name already exists, the existing object is used.
- If no object of the same name yet exists, create an object with the relevant name or create a new link.

---

### Note

The syntax of the import file is checked during xlsx file import. The meaning of the properties or dependencies between the properties is not checked. It is possible to assign a trigger tag of an incorrect type, such as string, to an alarm. An error will be reported during compilation.

---

## See also

Exporting alarms (Page 5510)

Format of the discrete alarm data (Page 5517)

## Format of the analog alarm data

### Introduction

This chapter describes the required format of the file for the import of analog alarms. The file containing the analog alarm data must be in ".xlsx" format.

### Structure of the alarm data

The import file in Microsoft Excel consists of a number of worksheets:

- Analog alarms(Analog alarms)
- Limits (Limits)

Each alarm is assigned a separate row in the import file. The import file with the analog alarms must be formatted as follows:



Example of the worksheet "Analog alarms"

	A	B	C	D	E
1	ID	Name	Event text [en-US], Alarm text	FieldInfo [Alarm text]	Class
2	1	Analog_alarm_1	AA1 Error-AC with maximum text length: abcdefghijklmnopqrstuvwxyz		Errors
3	2	Analog_alarm_2	AA2 Warning-AC <b>this text should be bold</b>		Warnings
4	3	Analog_alarm_3	AA3 SDm-AC <i>this text should be italic</i>		SDm
5	4	Analog_alarm_4	AA4 SDo-AC <u>this text should be underlined</u>		SDo
6	5	Analog_alarm_5	AA5 SystemAcknowledgement-AC <blink>this text should be flashing<		System_Ackn
7	25	Analog_alarm_25	Internal AA23 switchDT: Deadband mode in case of violation - value HL		AA2T-Interna
8	26	Analog_alarm_26	Internal AA23 switchDT: Deadband mode in case of violation - percent		AA2T-Interna
9	31	Analog_alarm_31	Internal AA23 switchDT: Low limit violation static		AA2T-Interna
10	32	Analog_alarm_32	Internal AA23 switchDT: High limit violation static		AA2T-Interna
11	33	Analog_alarm_33	Internal AA23 switchDT: Low limit violation dynamic		AA2T-Interna
12	34	Analog_alarm_34	Internal AA23 switchDT: High limit violation dynamic		AA2T-Interna
13	35	Analog_alarm_35	Internal AA23 switchDT: delay 3 seconds High limit violation		AA2T-Interna
14	42	Analog_alarm_40	Internal AA23 switchDT: delay 3 seconds Low limit violation LLV		AA2T-Interna
15	23	Analog_alarm_41	AA23 DT in event text: <field ref="0" /> Bool, <field ref="1" /> Byte, <fi	<ref id = 0; type = AlarmTag; T	ACAT
16	24	Analog_alarm_42	AA24 DT in event text: <field ref="0" /> Timer, <field ref="1" /> Counte	<ref id = 0; type = AlarmTag; T	ACAT

Table 10-156 Meaning of the entries

List entry	Meaning
ID	The alarm number is used to reference an alarm. The alarm number is unique. Alarms with identical alarm numbers are overwritten during import. An alarm without an existing alarm number is created.
Name	Name of the analog alarm
Event text [de-DE], Alarm text	Displays the alarm text. The field designation contains a language ID. Alarm texts must be assigned a language ID for import.  An expression with a reference ID will be added to the alarm text if the text has a dynamic parameter. Example: text <field ref="0" />. Use the ID to assign dynamic parameters to alarm texts.
FeldInfo	Specifies whether the alarm text contains dynamic parameters. The settings are separated by a semicolon ";".  Example of dynamic parameters: Tag: <ref id = 0; type = AlarmTag; Tag = Tag1; DisplayType = Decimal; Length = 5;> Text list: <ref id = 1; type = CommonTextList; TextList = Textlist1; Tag = tag 2; Length = 5;>
Class	The class of an alarm determines whether or not the alarm must be acknowledged. It can also be used to determine how the alarm appears when it is displayed on the HMI device. The alarm class also determines whether and where the corresponding alarm will be logged.
Group	Indicates the allocation to an alarm group. If an alarm belongs to a group with other alarms, it can be acknowledged together with these alarms of the same group in a single operation.
Trigger tag	Specifies the tag monitored for limit value violation.
Delay time value	Specifies the delay time. The alarm is not triggered until the duration of the limit value violation equals the specified delay time.

List entry	Meaning
Delay time unit	Specifies the time unit for the delay.
Report	Enables reporting of the specific alarm on a printer. True or "1" = Reporting enabled. False or "0" = Reporting disabled. Reporting must also be globally enabled in the project.
Info text [de-DE], Info text	The tooltip is an optional property of an alarm. Tooltips can contain additional information about the alarm. A tooltip will be displayed in a separate window on the HMI device when the operator presses the <HELP> key. The field designation contains a language ID.

Example of the worksheet "Limits"

	A	B	C	D	E	F	G
1	Alarm ID	Limit type	Limit value	Limit mode	Deadband mo	Deadband valu	Deadband in percent
2	1	Constant	0	Upper limit	Off	0	False
3	2	Constant	1	Upper limit	Off	0	False
4	3	Constant	2	Upper limit	Off	0	False
5	4	Constant	3	Upper limit	Off	0	False
6	5	Constant	4	Upper limit	Off	0	False
7	25	Constant	50	Upper limit	On both	5	False
8	26	Constant	50	Upper limit	On both	10	True
9	31	Constant	50	Lower limit	Off	0	False
10	32	Constant	50	Upper limit	Off	0	False
11	33	Tag	AASDTdyn	Lower limit	Off	0	False
12	34	Tag	AASDT1dyn	Upper limit	Off	0	False
13	35	Constant	50	Upper limit	Off	0	False
14	36	Constant	50	Lower limit	On both	5	False

Table 10-157 Meaning of the entries

List entry	Meaning
Alarm ID	Alarm number The alarm number is used to reference an alarm. The alarm number is unique. Alarms with identical alarm numbers are overwritten during import. An alarm without an existing alarm number is created.
Limit mode	Trigger mode Indicates the method used for monitoring the limit value.
Limit type	Specifies the limit that will be monitored. Both a tag and a constant can be used as limit value.
Limit value	Limit value Indicates the tag or constant monitored for limit violation.

List entry	Meaning
Deadband mode	Hysteresis mode Specifies whether and in which cases hysteresis will be used. For "Outgoing" For "Incoming" For "Incoming" and "Outgoing"
Deadband in percent	0 = The value specified for "Hysteresis" is considered to be absolute. 1 = The value specified for "Hysteresis" is referred to as a percentage of the limit value.
Deadband mode	Hysteresis Specifies a constant as a value of the hysteresis.

**Note****"No value" in the table**

Entries in the table which have the value "No value" delete the corresponding values in an existing alarm of the same name.

**See also**

Exporting alarms (Page 5510)

Format of the discrete alarm data (Page 5517)

**Format of the discrete alarm data****Introduction**

This chapter describes the required format of the file for the import of discrete alarms. The file containing the discrete alarm data must be in "\*.xlsx" format.

**Structure of the alarm data**

The import file in Microsoft Excel consists of the worksheets "Discrete alarms" (discrete alarms). Each alarm is assigned a separate row in the import file. Structure of the import file containing the discrete alarms:

Example of the worksheet "Discrete alarms"

	A	B	C	D	E	F
1	ID	Name	Event text [en-US], Alarm text	FieldInfo [Alarm text]	Class	Trigger
2	1	Discrete_alarm_1	DA1 Error-AC with maximum text length: abcdefghijklmnopqrstuvwxyz äöü\na		Errors	HMI_AC
3	2	Discrete_alarm_2	DA2 Warning-AC <b>this text should be bold</b>		Warnings	HMI_AC
4	3	Discrete_alarm_3	DA3 SDm-AC <i>this text should be italic</i>		SDm	HMI_AC
5	4	Discrete_alarm_4	DA4 SDo-AC <u>this text should be underlined</u>		SDo	HMI_AC
6	5	Discrete_alarm_5	DA5 SystemAcknowledgement-AC <blink>this text should be flashing</blink>		System_Ackn	HMI_AC
7	6	Discrete_alarm_6	DA6 SystemNoAcknowledgement-AC mixed test: <b>Bold,</b> <i>Italic,</i> <		System_No_A	HMI_AC
8	7	Discrete_alarm_7	DA7 DT in event text: <field ref="0" /> Integer, <field ref="1" /> Real, <field re	<ref id = 0; type = AlarmTag; Tag = Pl	ACAT	HMI_Tri
9	8	Discrete_alarm_8	DA8 DT in event text: <field ref="0" /> S5Time, <field ref="1" /> Timer, <field r	<ref id = 0; type = AlarmTag; Tag = Pl	ACAT	HMI_Tri
10	11	Discrete_alarm_9	DA11 DT in event text: <field ref="0" /> Int, <field ref="1" /> Real, <field ref="	<ref id = 0; type = AlarmTag; Tag = In	ACAT	HMI_Tri
11	12	Discrete_alarm_10	DA12 DT in event text: <field ref="0" /> UDInt, <field ref="1" /> UInt,	<ref id = 0; type = AlarmTag; Tag = U	ACAT	HMI_Tri
12	13	Discrete_alarm_11	DA13 Textformat: Integer: <field ref="0" /> decimal, <field ref="1" /> binary, <	<ref id = 0; type = AlarmTag; Tag = H	ACAT	HMI_TF

Table 10-158 Meaning of the entries

List entry	Meaning
ID	The alarm number is used to reference an alarm. The alarm number is unique. Alarms with identical alarm numbers are overwritten during import. An alarm without an existing alarm number is created.
Name	Name of the analog alarm
Event text [de-DE], Alarm text	Displays the alarm text. The field designation contains a language ID. For import, a language ID must be assigned to alarm text. An expression with a reference ID will be added to the alarm text if the text has a dynamic parameter. Example: text <field ref="0" />. Use the ID to assign dynamic parameters to alarm texts.
FeldInfo	Specifies whether the alarm text contains dynamic parameters. The settings are separated by a semicolon ";". Example of dynamic parameters: Tag: <ref id = 0; type = AlarmTag; Tag = Tag1; DisplayType = Decimal; Length = 5;> Text list: <ref id = 1; type = CommonTextList; TextList = Textlist1; Tag = tag 2; Length = 5;>
Class	The class of an alarm determines whether or not the alarm must be acknowledged. It can also be used to determine how the alarm appears when it is displayed on the HMI device. The alarm class also determines whether and where the corresponding alarm will be logged.
Group	Indicates the allocation to an alarm group. If an alarm belongs to a group with other alarms, it can be acknowledged together with these alarms of the same group in a single operation.
Trigger tag	Specifies the tag containing the bit that triggers the alarm.
Trigger bit	Specifies the number of the bit that triggers the alarm.
Acknowledge tag	Specifies the tag containing the bit that is set by the operator upon acknowledgment. Only available if the selected alarm class requires alarm acknowledgment.
Acknowledgment bit	Specifies the number of the bit that is set when the operator acknowledges the alarm.

List entry	Meaning
PLC acknowledgement tag	Specifies the tag containing the bit that acknowledges the alarm of the control program. Only available if the selected alarm class requires alarm acknowledgment.
PLC acknowledgment bit	Specifies the number of the bit that acknowledges the alarm of the control program.
Delay time value	Specifies the delay time. The alarm is not triggered until the duration of the limit value violation equals the specified delay time.
Delay time unit	Specifies the time unit for the delay.
Report	Enables reporting of the specific alarm on a printer. True or "1" = Reporting enabled. False or "0" = Reporting disabled. Reporting must also be globally enabled in the project.
Info text [de-DE], Info text	The tooltip is an optional property of an alarm. Tooltips can contain additional information about the alarm. A tooltip will be displayed in a separate window on the HMI device when the operator presses the <HELP> key. The field designation contains a language ID.

**Note****"No value" in the table**

Entries in the table which have the value "No value" delete the corresponding values in an existing alarm of the same name.

**See also**

Exporting alarms (Page 5510)

Format of the analog alarm data (Page 5512)

Importing alarms (Page 5511)

**10.12.4.4 Importing and exporting tags****Exporting tags****Introduction**

WinCC has an export function for tags.

## Requirements

- The WinCC project for the export is open.
- Tags have been created in the project.
- The "HMI tags" editor is open.

## Exporting tags

1. Click on the  button in the "HMI Tags" tab. The "Export" dialog box opens.

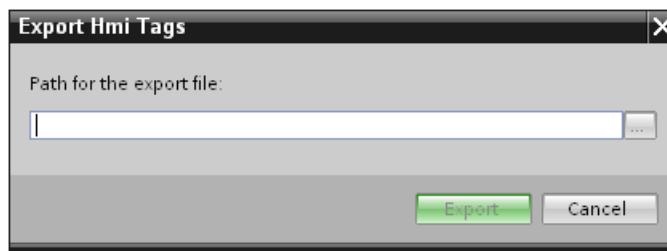

2. Click the "..." button and specify in which file the data are saved.
3. Click "Export". The export will start.

## Result

The exported data has been written to an xlsx file. The xlsx file will be stored in the specified folder.

## See also

- Importing tags (Page 5520)
- Format of the tag data (Page 5522)
- Exporting text lists (Page 5525)
- Exporting alarms (Page 5510)

## Importing tags

### Introduction

Tags are identified by the tag name. An existing tag will be overwritten with the data from the xlsx file if the tag name already exists in the project. A new tag is created if the tag does not yet exist.

## Requirements

- An xlsx file with tags has been created.
- The structure of the xlsx file meets the requirements.
- The WinCC project for the import is open.

## Importing tags

1. Click "HMI tags" in the project navigation.
2. Double-click "Show all tags". The "HMI tags" editor opens.
3. Click on the  button. The "Import" dialog box opens.

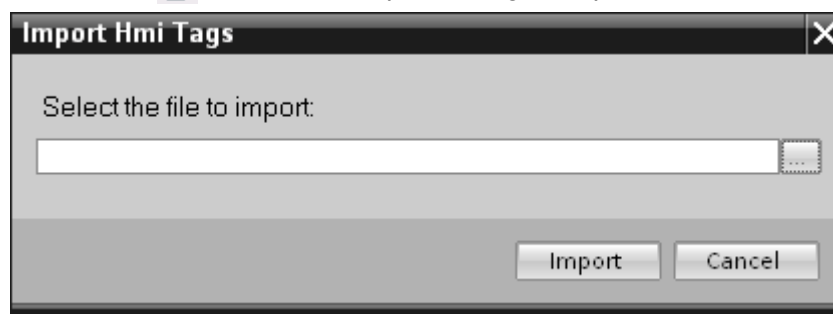

4. Click the "..." button and select the file that you want to import.
5. Click on the "Import" button. The import will start.

## Result

The relevant tags have been created in WinCC. Alarms relating to the import operation are displayed in the output window. A log file is saved in the source directory of the import files. The log file has the same name as the respective import file but with the "\*.xml" extension.

Check when importing the data whether there are any links to objects, for example, dynamic parameters such as tags.

- If an object with the same name already exists, the existing object is used.
- If no object of the same name yet exists, create an object with the relevant name or create a new link.

---

### Note

The syntax of the import file is checked during xlsx file import. The meaning of the properties or dependencies between the properties is not checked. It is possible to assign a tag a trigger tag of the wrong type, for example, string. An error will be reported during compilation.

---

**See also**

- Exporting tags (Page 5517)
- Format of the tag data (Page 5522)

**Format of the tag data**

**Introduction**

This section describes the format required for the file with tag data used for imports. The tag data file must be in "\*.xlsx" format.

**Tag data structure**

The import file in Microsoft Excel consists of a number of worksheets:

- HMI Tags (HMI tags)
- Multiplexing (multiplex tags)

Each tag is on a separate line in the import file. The import file with the tag data must have the following format:

**Example of the worksheet "HMI Tags"**

	A	B	C	D	E	F	G	H
1	Name	Path	Connection	PLC tag	DataType	Length	Address	Access Me
2	HMI_Int	Internal Tags	<No Value>	<No Value>	Int	2	<No Value>	<No Value>
3	Mux_Tag_1	Internal Tags	<No Value>	<No Value>	Int	2	<No Value>	<No Value>
4	Mux_Tag_2	Internal Tags	<No Value>	<No Value>	Int	2	<No Value>	<No Value>
5	Mux_11	Internal Tags	<No Value>	<No Value>	Int	2	<No Value>	<No Value>
6	Mux_21	Internal Tags	<No Value>	<No Value>	Int	2	<No Value>	<No Value>
7	Mux_13	Internal Tags	<No Value>	<No Value>	Int	2	<No Value>	<No Value>
8	Mux_12	Internal Tags	<No Value>	<No Value>	Int	2	<No Value>	<No Value>
9	Mux_23	Internal Tags	<No Value>	<No Value>	Int	2	<No Value>	<No Value>
10	Mux_22	Internal Tags	<No Value>	<No Value>	Int	2	<No Value>	<No Value>
11	Mux_Tag_1_Index	Internal Tags	<No Value>	<No Value>	UInt	2	<No Value>	<No Value>
12	Mux_Tag_12	Internal Tags	<No Value>	<No Value>	USInt	1	<No Value>	<No Value>
13	Mux_Tag_11	Internal Tags	<No Value>	<No Value>	USInt	1	<No Value>	<No Value>
14	Mux_Tag_13	Internal Tags	<No Value>	<No Value>	USInt	1	<No Value>	<No Value>
15	HMI_UDInt	Internal Tags	<No Value>	<No Value>	UDInt	4	<No Value>	<No Value>
16	Gauge_Process	Default tag table	<No Value>	<No Value>	Int	2	<No Value>	<No Value>
17	Button_Tag_4	Default tag table	<No Value>	<No Value>	Int	2	<No Value>	<No Value>
18	HMI_USInt	Internal Tags	<No Value>	<No Value>	USInt	1	<No Value>	<No Value>
19	Data_block_2_PLC_DateTime_2	Default tag table	HMI_connection_1	Data_block_2.PLC	Date_And_Time	8	%DB28.DBX598.C	<absolute



Table 10-159 Meaning of the entries

List entry	Meaning
Name	Indicates the configured name of an HMI tag.
Path	Specifies which folders in the project tree contain the tag. The folder structure is represented by "\" : "FolderName1\FolderName2\TagName".
PLC Tag	Indicates whether the tag is linked to a PLC tag.
Connection	Indicates the name of the connection to the PLC.
Data type	Specifies the data type of a tag. The data types allowed depend on the communication driver being used. See the "Communication" section of the documentation for additional information on the data types permitted for the various communication drivers.
Length	Specifies the length of the tag. This entry is only useful for data types with a dynamic length such as strings; it is left empty for all other data types.
Address	Specifies the tag address in the PLC. The tag address must exactly match the one used in WinCC, for example, "%DB1.DBW0". The tag address is empty for internal tags.
Multiplexing	Specifies whether multiplexing is used.
Index tag	Shows the name of the index tag for multiplexing. In Runtime, the system first reads the value of the index tag. It then accesses the tag in the corresponding place in the tag list.
StartValue	Specifies the start value of a tag.
ID tag	The update ID updates the value of a tag with the aid of a function or a PLC job. The update ID must be unique within an HMI device.
Coding	Shows the coding method.
Display Name [de_DE]	Shows the display name of an HMI tag. The field designation contains a language ID. The field designation contains a language ID. Display names must be assigned a language ID for import. Texts are imported to the corresponding project language.
Acquisition mode	Specifies the tag acquisition mode.
Acquisition cycle	Specifies the tag acquisition cycle. The acquisition cycle must correspond exactly to the one used in WinCC. The value is not language-dependent and should therefore be the same in every language. The default value is "1 s". The acquisition cycle is undefined if the tag acquisition mode is "on demand". User-defined acquisition cycles must be created beforehand as the file will otherwise not be imported.
High High Limit type	Indicates whether the limit value "High high" is monitored by a constant, a tag or not at all.
High High Limit	Displays the limit value "High High".
High Limit type	Indicates whether the limit value "High" is monitored by a constant, a tag or not at all.
High Limit	Displays the limit value "High".
Low Limit type	Indicates whether the limit value "Low" is monitored by a constant, a tag or not at all.
Low Limit	Displays the limit value "Low".
Low Low Limit type	Indicates whether the limit value "Low Low" is monitored by a constant, a tag or not at all.
Low Low Limit	Displays the limit value "Low Low".

List entry	Meaning
Linear scaling	Indicates whether linear scaling is enabled. This entry can only be used for external tags.
End value PLC	Specifies the end value of the PLC tag.
Start value PLC	Specifies the start value of the PLC tag.
End value HMI	Specifies the end value of the HMI tag.
Start value HMI	Specifies the start value of the HMI tag.

### Example of the worksheet "Multiplexing"

	A	B	C
1	HMI Tag name	Multiplex Tag	Index
2	Mux_Tag_1	Mux_11	0
3	Mux_Tag_1	Mux_12	1
4	Mux_Tag_1	Mux_13	2
5	Mux_Tag_2	Mux_21	0
6	Mux_Tag_2	Mux_22	1
7	Mux_Tag_2	Mux_23	2
8	Mux_Tag_12	HMI_Array_Mux2	-1
9	Mux_Tag_11	HMI_Array_Mux1	-1
10	Mux_Tag_13	HMI_Array_Mux3	-1

Table 10-160 Meaning of the entries

List entry	Meaning
Name	Indicates the configured name of an HMI tag which uses indirect addressing. The HMI tag must be available in the "HMI Tags" worksheet.
Index	Shows the value which governs which tag is selected.
Multiplex Tag	Displays the tag from the tag list corresponding to the index value.

#### Note

##### "No value" in the table

Entries in the table which have the value "No value" delete the corresponding values in an existing tag of the same name.

#### See also

Exporting tags (Page 5517)

Importing tags (Page 5518)

### 10.12.4.5 Importing and exporting text lists

#### Exporting text lists

##### Introduction

WinCC has an export function for text lists.

##### Requirements

- The WinCC project for the export is open.
- Text lists have been created in the project.
- The "Text & graphics lists" editor is open.

##### Exporting text lists

1. Click on the  button in the "TextLists" tab. The "Export" dialog box opens.

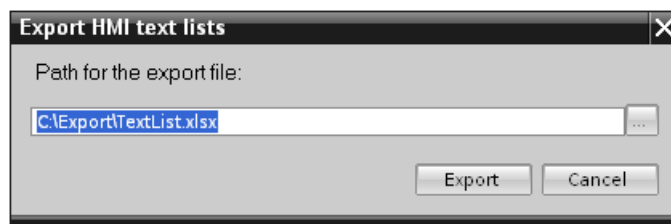

2. Click the "..." button and specify in which file the data are saved.
3. Click "Export". The export will start.

##### Result

The exported data has been written to an xlsx file. The xlsx file will be stored in the specified folder.

##### See also

- Exporting alarms (Page 5510)
- Exporting recipes (Page 5506)
- Exporting tags (Page 5517)

#### Importing text lists

##### Introduction

You then import text lists from an xlsx file to WinCC.

## Requirements

- An xlsx file with text lists has been created.
- The structure of the xlsx file meets the requirements.
- The WinCC project for the import is open.
- The "Text & graphics lists" editor is open.

## Importing text lists

1. Click on the  button in the "Text lists" tab. The "Import" dialog box opens.

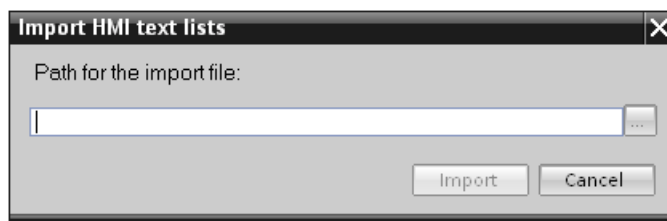

2. Select the file you want to import under "File selection".
3. Click on the "Import" button. The import will start.

## Result

You have now imported the text lists. The relevant text lists have been created in WinCC. Alarms relating to the import operation are displayed in the output window. A log file is saved in the source directory of the import files. The log file has the same name as the respective import file but with the ".xml" extension.

Check when importing the data whether there are any links to objects, for example, dynamic parameters such as tags.

- If an object with the same name already exists, the existing object is used.
- If no object of the same name yet exists, create an object with the relevant name or create a new link.

## Format of text list data

### Introduction

This section describes the format required for the file with the text lists used for imports. The text list data file must be in ".xlsx" format.

## Tag data structure

The import file in Microsoft Excel consists of two worksheets:

- TextList (Text lists)
- TextListEntry (Text list entry)

Each text list is assigned a separate line in the import file. The import file containing the data must be structured as follows:

### Example of the worksheet "TextList"

	A	B	C
1	Name	ListRange	Comment
2	TLValue/Range	Decimal	
3	TLBit	Bit	
4	TLBitnumber	Binary	
5	TLall_1	Decimal	
6	TLall_2	Decimal	

Table 10-161 Meaning of the entries

List entry	Meaning
Name	Shows the name of the text list.
ListRange	Shows the text list range: Number = Bit number (0-31) Range = value/range (...-...) Bit = Bit (0;1)
Comment	Any comments on the text list. You can use up to 500 characters

Example of the worksheet "TextListEntry"

	A	B	C	D	E	F
1	Name	Parent	DefaultEntry	Value	Text	FieldInfos
2	Text_list_entry_1	TLValue/Range	TRUE	0 - 1	Default entry TLValue/Range ->	
3	Text_list_entry_2	TLValue/Range		2 - 3	TLValue/Range = 2-3 ->	
4	Text_list_entry_3	TLValue/Range		1	TLValue Range - single value = 1 ->	
5	Text_list_entry_1	TLBit		0	TLBit = 0 ->	
6	Text_list_entry_2	TLBit		1	TLBit = 1 ->	
7	Text_list_entry_1	TLBitnumber	TRUE	0	Default entry TLBitnumber; ->	
8	Text_list_entry_2	TLBitnumber		0	TLBitnumber - Bitnumber 0 is set ->	
9	Text_list_entry_3	TLBitnumber		1	TLBitnumber - Bitnumber 1 is set ->	
10	Text_list_entry_4	TLBitnumber		2	TLBitnumber - Bitnumber 2 is set ->	
11	Text_list_entry_5	TLBitnumber		3	TLBitnumber - Bitnumber 3 is set ->	
12	Text_list_entry_1	TL1	TRUE	0 - 1	Default entry TL1	
13	Text_list_entry_2	TL1		1 - 3	TL1 Value between 1 - 3 ->	
14	Text_list_entry_3	TL1		4 - 6	TL1 Value between 4 - 6 ->	
15	Text_list_entry_4	TL1		7	TL1 Single value = 7 ->	
16	Text_list_entry_1	TL2	TRUE	0 - 1	<field ref="0" />->	<ref id = 0; type = CommonTextList; TextList = TL1; Tag = HMI_TL1control; Length = 1
17	Text_list_entry_2	TL2		1	TL2 Single value = 1 ->	
18	Text_list_entry_3	TL2		2 - 3	TL2 Range between 2 - 3 ->	
19	Text_list_entry_1	TLMultilined	TRUE	0 - 1	Default entry TLMultilined; last row	
20	Text_list_entry_2	TLMultilined		0 - 3	TLMultilined Value between 0-3\nwith test of"\n"	
21	Text_list_entry_1	TLall_1	TRUE	0 - 1	Default entry TLall_1	
22	Text_list_entry_1	TLall_2	TRUE	0 - 1	Default entry TLall_2	

Table 10-162 Meaning of the entries

List entry	Meaning
Name	Shows the name of the text list entry.
Parent	Specifies the name of the corresponding text list.
DefaultEntry	Indicates whether the text list entry is a default entry. The default entry is always displayed when the tag has an undefined value.
Value	Specifies the tag integer values or value ranges which are assigned to the text entries in the text list.
Text	Shows the text list entry. The field designation contains a language ID. Text list entries must be assigned a language ID for import. An expression with a reference ID will be added to the text if the text list entry has a dynamic parameter. Example: text <field ref="0" />. Use the ID to assign the dynamic parameter to a text list entry.
FeldInfo	Specifies whether the text list contains dynamic parameters. The settings are separated by a semicolon ";". Example of dynamic parameters: Tag: <ref id = 0; type = CommonTagDisplayFormat; Tag = tag 1; DisplayType = Decimal; DisplayFormat = 9;> Text list: <ref id = 1; type = CommonTextList; TextList = Textliste_1; Tag = tag 2; Length = 5;> PLC tag: <ref id = 0; type = CommonControlTagDisplayFormat; DisplayType = Decimal; DisplayFormat = 9;>

## 10.12.5 Using cross-references

### 10.12.5.1 General information about cross references

#### Introduction

The cross-reference list provides an overview of the use of objects within the project.

#### Uses of cross-references

The cross-reference list offers you the following advantages:

- When creating and changing a program, you retain an overview of the objects, tags, and alarms etc. you have used.
- From the cross-references, you can jump directly to the object location of use.
- You can learn the following when debugging:
  - The objects used in a specific screen.
  - The alarms and recipes shown in a specific display.
  - The tags used in a specific alarm or object.
- As part of the project documentation, the cross-references provide a comprehensive overview of all object, alarms, recipes, tags and screens.

### 10.12.5.2 Displaying the cross-reference list

#### Introduction

Details on the use of objects can be found in the cross-reference list. You can show cross-references for HMI devices, folders and all editors in the project tree. The detail view also lets you select individual objects of the editors.

#### Requirement

You have created a project.

Several objects have been created.

#### Procedure

1. Select the required entry in the project tree or detail view.
2. Select "Cross-references" in the shortcut menu. The cross-reference list is opened in the work area.
3. Open the "Used by" tab to display where the objects shown in the cross-reference list are used.
4. Open the "Used" tab to view the users of the objects displayed in the cross-reference list.

5. You can sort the entries in the "Object" column in ascending or descending order by clicking on the corresponding column header.
6. To go to the location of use for a specific object, click on the displayed link.

## Result

The cross-reference list for the selected object is displayed in the work area.

### 10.12.5.3 Structure of the cross-reference list

#### Views of the cross-reference list

There are two views of the cross-reference list. The difference between the two views is in the objects displayed in the first column:

- Used by:  
Display of the referenced objects. Here, you can see where the object is used.
- Used:  
Display of the referencing objects. The users of the object are shown here.

The assigned tool tips provide additional information about each object.

#### Structure of the cross-reference list

Column	Content/meaning
Object	Name of the object that uses the lower-level objects or that is being used by the lower-level objects.
Numbers	Number of uses
Location of use	Each location of use, for example, an object or event
Property	Function of the referenced objects, for example, tag for data record or process value
Connected to	PLC tag with which the object is connected.
Type	Type of object
Path	Path of object

Depending on the installed products, additional columns or different columns are displayed for the cross-references.



### Settings in the cross-reference list

You can make the following settings using the icons in the toolbar for the cross-reference list:

- Update cross-reference list  
Updates the current cross-reference list.
- Making settings for the cross-reference list  
Here, you specify whether all used, all unused, all defined or all undefined objects will be displayed. If the "Undefined objects" option is enabled, references to previously deleted objects are also displayed.
- Collapse entries  
Reduces the entries in the current cross-reference list by closing the lower-level objects.
- Expand entries  
Expands the entries in the current cross-reference list by opening the low-level objects.

### Sorting in the cross-reference list

You can sort the entries in the "Object" column in ascending or descending order. Click on the column header to do this.

#### 10.12.5.4 Displaying cross-references in the Inspector window

##### Introduction

The Inspector window displays cross-reference information about a selected object in the "Info > Cross-references" tab. The Inspector window displays the cross-reference information in tabular format.

##### Requirement

You have created a project.  
Several objects have been created.

**Procedure**

1. Select an object in a screen or a tabular editor.
2. Select "Cross-reference information" in the shortcut menu. The cross-references are opened in the Inspector window.

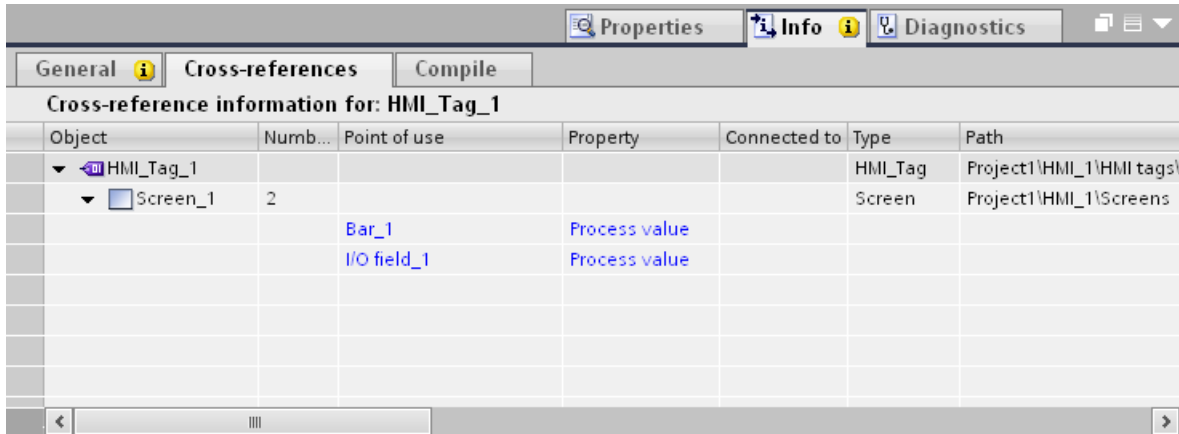

**Result**

The instances where and the other objects by which the selected object is being used are displayed.

The table below shows the additional information listed in the "About > Cross-reference" tab:

Column	Meaning
Object	Name of the object that uses the lower-level objects or that is being used by the lower-level objects.
Numbers	Number of uses
Location of use	Each location of use, for example an object or event
Property	Function of the referenced objects, for example tag for data record or process value
Connected to	PLC tag with which the object is connected.
Type	Type of object
Path	Path of object

Depending on the installed products, additional columns or different columns are displayed for the cross-references.

## 10.12.6 Managing languages

### 10.12.6.1 Languages in WinCC

#### User interface language and project languages

A distinction is drawn between two different language levels in WinCC:

- **User interface language**  
During configuration, the text in the WinCC menus and dialogs is displayed in the user interface language. The user interface language also affects the labeling of operating elements, the parameters of the system functions, the online help, etc.
- **Project languages**  
Project languages are all languages in which a project will later be used. Project languages are used to create a project in multiple languages.

The two language levels are completely independent of one another. For example, you can create English projects at any time using a German user interface and vice versa.

#### Project languages

The following languages are differentiated within the project languages:

- **Reference language**  
The reference language is the language that you use to configure the project initially. During configuration, you select one of the project languages as the reference language. You use the reference language as a template for translations. All of the texts for the project are first created in the reference language and then translated. While you are translating the texts, you can have them displayed simultaneously in the reference language.
- **Editing language**  
You produce translations of the texts in the editing language. Once you have created your project in the reference language, you can translate the texts into the remaining project languages. Select a project language respectively as an edit language and edit the texts for the appropriate language variant. You can change the editing language at any time.

---

#### Note

When switching the project languages, the assignment to the keys on the keyboard also changes. For some languages (for example, Spanish), the operating system does not allow you to switch to the corresponding keyboard assignment. In this case, the keyboard assignment is switched to English.

---

- **Runtime languages**  
Runtime languages are those project languages that are transferred to the HMI device. You decide which project languages to transfer to the HMI device depending on your project requirements. You must provide appropriate controls so that the operator can switch between languages in runtime.

## See also

- Language settings in the operating system (Page 5534)
- Operating system settings for Asian languages (Page 5535)
- Selecting the user interface language (Page 5536)
- "Graphics" editor (Page 5547)
- Languages in Runtime (Page 5551)
- Example: Configuring a button for language switching (Page 5558)

### 10.12.6.2 Language settings in the operating system

#### Introduction

The configuration PC operating system settings influence WinCC language management in the following areas:

- Selection of project languages
- Regional format of dates, times, currency, and numbers
- Displaying ASCII characters

#### Project language selection

A language is not available as a project language unless it is installed in the operating system.

#### Regional format of dates, times, currency, and numbers

WinCC specifies a fixed date and time format in the Date - Time field for the selected project language and runtime language.

In order for dates, times, and numbers to be presented correctly in the selected editing language, this language must be set in the Regional Options in the Control Panel.

#### Displaying ASCII characters

With text output fields, the display of ASCII characters as of 128 depends on the set language and the operating system being used.

If the same special characters are to be displayed on different PCs, the PCs must use the same operating system and regional settings.

## See also

- Languages in WinCC (Page 5531)
- Operating system settings for Asian languages (Page 5535)

### 10.12.6.3 Operating system settings for Asian languages

#### Settings on Western operating systems

If you want to enter Asian characters, you must activate the support for this language in the operating system.

The Input Method Editor (IME) is available in Windows for configuring Asian texts. Without this editor, you can display Asian text but not edit it. For more information on the Input Method Editor, refer to the documentation for Windows. To enter Asian characters when configuring, switch to the Asian entry method in the "Input Method Editor".

Switch the operating system to the appropriate language to have language-specific project texts, such as alarm texts, displayed in the simulator in Asian characters.

#### Settings on Asian operating systems

If you are configuring on an Asian operating system, you must switch to the English default input language to enter ASCII characters, for example, for object names. As the English default input language is included in the basic installation of the operating system, you do not need to install an additional input locale.

#### Enable language support

1. Open the system controller.
2. Select "Regional and Language Options".
3. On the "Languages" tab, activate the check box "Install files for East Asian languages".
4. Then click on "Details" under "Text Services and Input Languages". The dialog "Text Services and Input Languages" is opened.
5. On the "Settings" tab add the required default input language under the "Installed Services".
6. Select the language of the operating system in the "Language for non-Unicode programs" area in the "Advanced" tab.

#### See also

Languages in WinCC (Page 5531)

Language settings in the operating system (Page 5532)

#### 10.12.6.4 Setting project languages

##### Selecting the user interface language

###### Introduction

The user interface language is used for displaying menu entries, title bars, infotexts, dialog texts and other designations in the WinCC user interface.

You can switch between the installed user interface languages during configuration. The labeling of the operating elements remains in the language you set when you added the object even if you change the user interface language.

###### Procedure

1. Select "Options > Settings" in the menu.  
The "Settings" dialog box is opened.
2. Select the desired user interface language under "General > General settings".

###### Result

WinCC will use the selected language as user interface language.

###### See also

Enable project languages (Page 5536)

Selecting the reference language and editing language (Page 5537)

Languages in WinCC (Page 5531)

##### Enable project languages

###### Introduction

The project languages are set in the "Project languages" editor. You define which project language is to be the reference language and which the editing language.

## Enable project languages

1. Click on the arrow to the left of "Languages & resources" in the project tree.  
The lower-level elements will be displayed.
2. Double-click on "Project languages".  
The possible project languages will be displayed in the working area.
3. Enable the relevant project languages.

---

### Note

#### Copying multilingual objects

The copies of multilingual objects to a different project only include text objects in the project languages which are activated in the target project. Activate all project languages in the target project to include the corresponding text objects when transferring the copy.

---

## Disabling project languages

1. Disable the languages which are not relevant for the project.

<b>NOTICE</b>
If you disable a project language, all text and graphic objects you have already created in this language will be deleted from the current project.

## See also

Selecting the user interface language (Page 5534)

Selecting the reference language and editing language (Page 5537)

## Selecting the reference language and editing language

### Introduction

The project languages are set in the "Project languages" editor. You define which project language is to be the reference language and which the editing language. You can change the editing language at any time.

### Requirements

The "Project languages" editor is open.

Several project languages have been activated.

## Selecting the reference language and editing language

1. Click the arrow in the drop-down list in the "General > Editing language" section.
2. Click on the required language in the drop-down list, for example, German.

3. Click on the arrow in the drop-down list in the "General > Reference language" section.
4. Click on the required language in the drop-down list, for example, English.

The language selection is displayed in the list box.

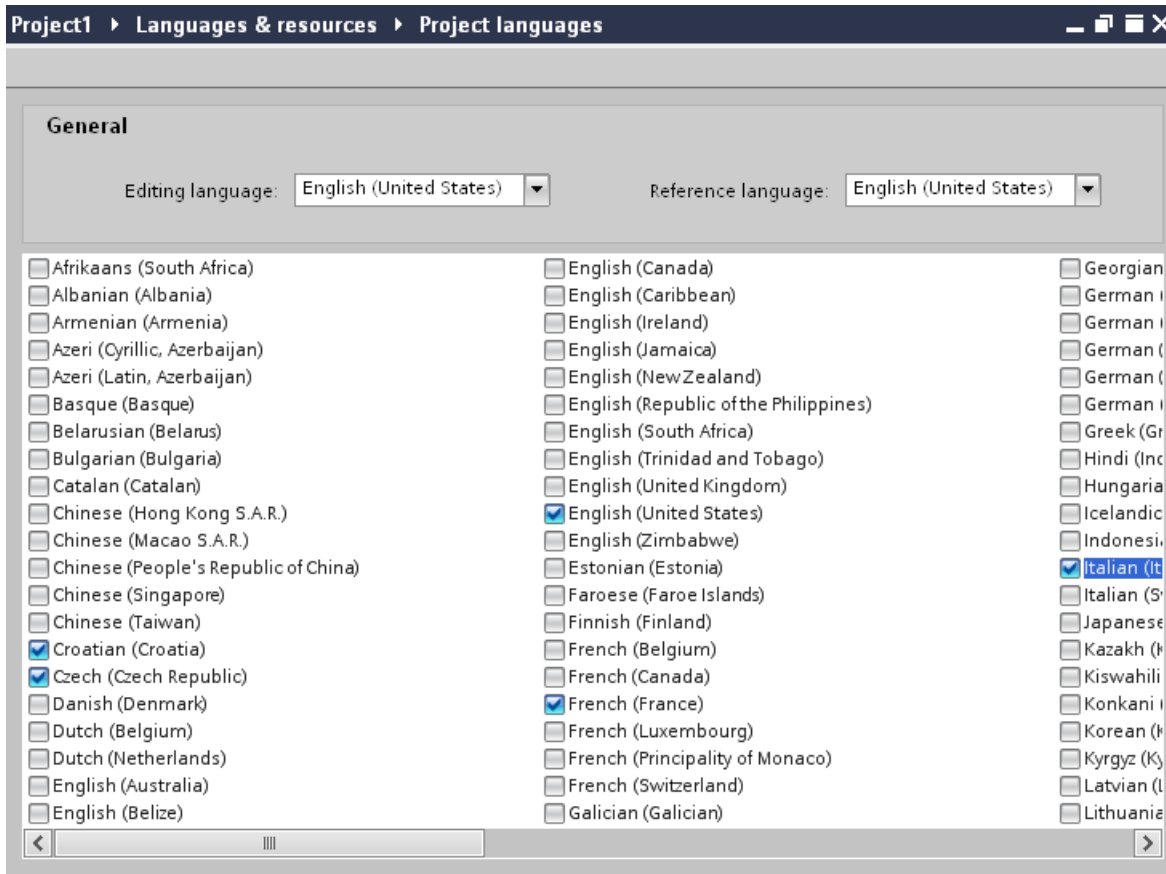

## Result

You have now selected the editing and reference languages.

If you change the editing language, all future text input will be stored in the new editing language.

## See also

Selecting the user interface language (Page 5534)

Enable project languages (Page 5534)



### 10.12.6.5 Creating one project in multiple languages

#### Working with multiple languages

#### Multilingual configuration in WinCC

You can configure your projects in multiple languages using WinCC. There are various grounds for creating a project in multiple languages:

- You would like to use a project in more than one country.  
You create the project in multiple languages but when the HMI device is commissioned, only the language spoken by the operators at the respective site will be transferred to the HMI device.
- The operators of a system speak a range of different languages.  
Example: An HMI device is used in China, but the service personnel understand only English.

#### Translating project texts

With WinCC, you can enter project texts directly in several languages in various different editors, for example, in the "Project texts" editor. WinCC also allows you to export and import your configuration for translation purposes. This is particularly advantageous if you configure projects containing a large amount of text and want to have it translated.

#### Language management and translation in WinCC

The following editors are used to manage languages and translate texts in WinCC:

Editor	Short description
Project languages	Selection of project languages, editing language and reference language.
Languages and fonts	Management of runtime languages and fonts used on the HMI device.
Project texts	Central management of configured texts in all project languages.
Graphics	Graphic library for managing graphics and their language-specific versions.

#### See also

Project text basics (Page 5540)

Translating texts directly (Page 5541)

Translating texts using reference texts (Page 5543)

Exporting project texts (Page 5544)

Importing project texts (Page 5546)

## Project text basics

### Texts in different languages in the project

Texts that are output on display devices during processing are typically entered in the language in which the automation solution is programmed. Comments and the names of objects are also entered in this language.

If operators do not understand this language, they require a translation of all operator-relevant texts into a language they understand. You can therefore translate all the texts into any language. In this way, you can ensure that anyone who is subsequently confronted with the texts in the project sees the texts in his/her language of choice.

### User texts and system texts

In the interests of clarity, a distinction is drawn between user texts and system texts:

- User texts are texts created by the user.
- System texts are texts created automatically and which are a product of configuration in the project.

The project texts are managed in the project text editor. This can be found in the project tree under "Languages & Resources > Project texts".

### Examples of multilingual project texts

You can, for example, manage the following types of text in more than one language:

- Display texts
- Alarm texts
- Comments in tables
- Labels of screen objects
- Text lists

### Translating texts

There are two ways of translating texts.

- Translating texts directly  
You can enter the translations for the individual project languages directly in the "Project texts" editor.
- Translating texts using reference texts  
You can change the editing language for shorter texts. You can enter the new texts in the editing language while the texts of the reference language are displayed.

## See also

- Working with multiple languages (Page 5537)
- Translating texts directly (Page 5541)
- Translating texts using reference texts (Page 5543)
- Exporting project texts (Page 5544)
- Importing project texts (Page 5546)

## Translating texts directly

### Translating texts

If you use several languages in your project, you can translate individual texts directly. As soon as you change the language of the software user interface, the translated texts are available in the selected language.

### Requirements

- You are in the project view.
- A project is open.
- You have selected at least two further project languages.

### Procedure

Proceed as follows to translate individual texts:

1. Click on the arrow to the left of "Languages & resources" in the project tree. The elements below this are displayed.
2. Double-click on "Project texts".  
A list with the texts in the project is displayed in the work area. There is a separate column for each project language.

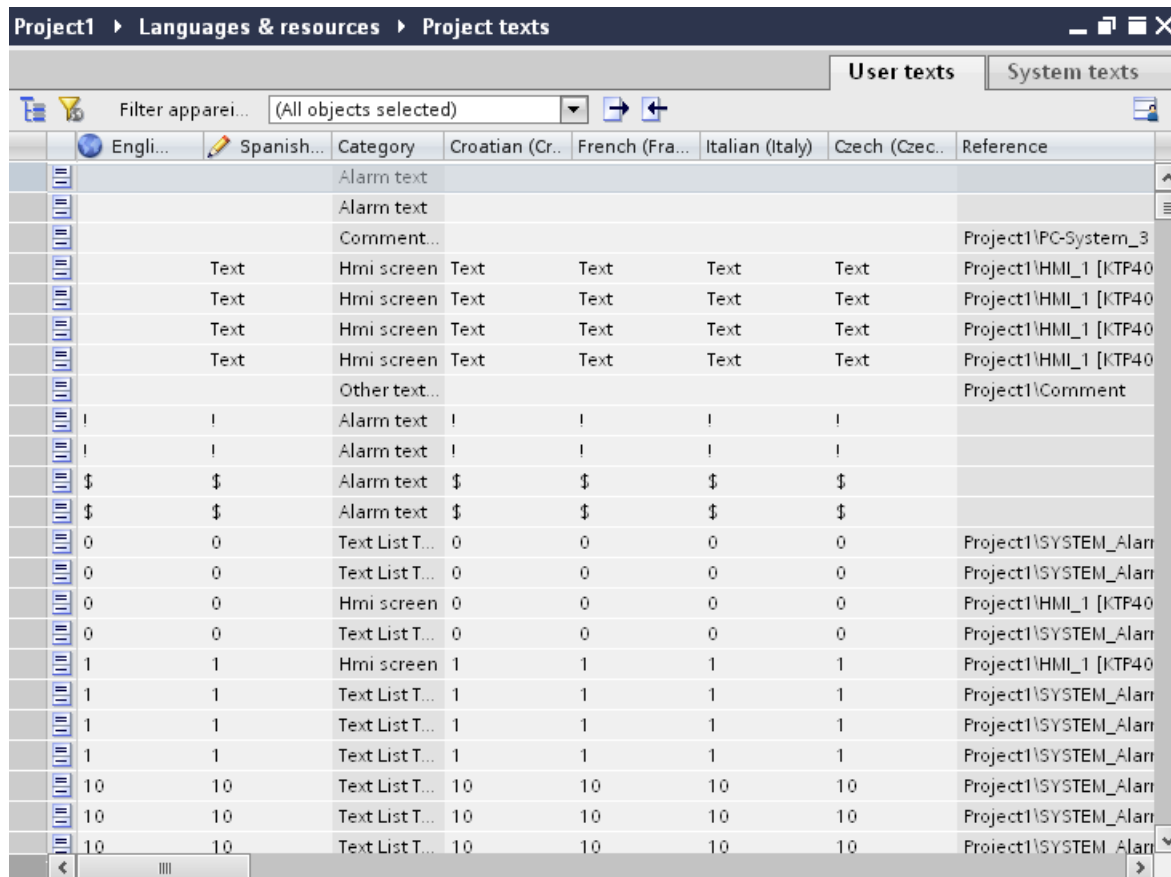

3. To group identical texts and translate them simultaneously, click on the "📁" button in the toolbar.
4. To hide texts that do not have a translation, click on the "🔍" button in the toolbar.
5. Click on an empty column and enter the translation.

### Result

You have translated individual texts in the "Project texts" editor. The texts will then be displayed in the runtime language.

## See also

Working with multiple languages (Page 5537)

Exporting project texts (Page 5544)

Project text basics (Page 5538)

Importing project texts (Page 5546)

## Translating texts using reference texts

### Introduction

After changing the editing language, all texts are shown in input boxes in the new editing language. If there is not yet a translation available for this language, the input boxes are empty or filled with default values.

If you enter text again in an input field, this is saved in the current editing language. Following this, the texts exist in two project languages for this input field, in the previous editing language and in the current editing language. This makes it possible to create texts in several project languages.

You can display existing translations for an input box in other project languages. These serve as a comparison for text input in the current editing language and they are known as the reference language.

### Requirement

There is at least one translation into a different project language for an input field.

### Procedure

To display the translation of an input cell in a reference language, follow these steps:

1. Select "Tasks > Languages & resources" in the task card.
2. Select a reference language from the "Reference language" drop-down list.

### Result

The reference language is preset. If you click in a text block, translations that already exist in other project languages are shown in the "Tasks > Reference text" task card.

## See also

Working with multiple languages (Page 5537)

Exporting project texts (Page 5544)

Project text basics (Page 5538)

Importing project texts (Page 5546)

### **Exporting project texts**

Project texts are exported for translation. Texts are exported to Office Open XML files ending in ".xlsx". These files can be edited in Microsoft Excel, for example.

You can exchange the file with the translators and import it back to the project as soon as it has been translated.

### **Requirements**

- At least two languages have been enabled in the "Project languages" editor, for example, Italian and French.

### **Exporting project texts**

To export individual project texts, proceed as follows:

1. Click on the arrow to the left of "Languages & resources" in the project tree. The child elements are displayed.
2. Double-click on "Project texts". The "Project texts" editor will open.
3. Select the texts you want to export.

- Click on the  button. The "Export" dialog opens.

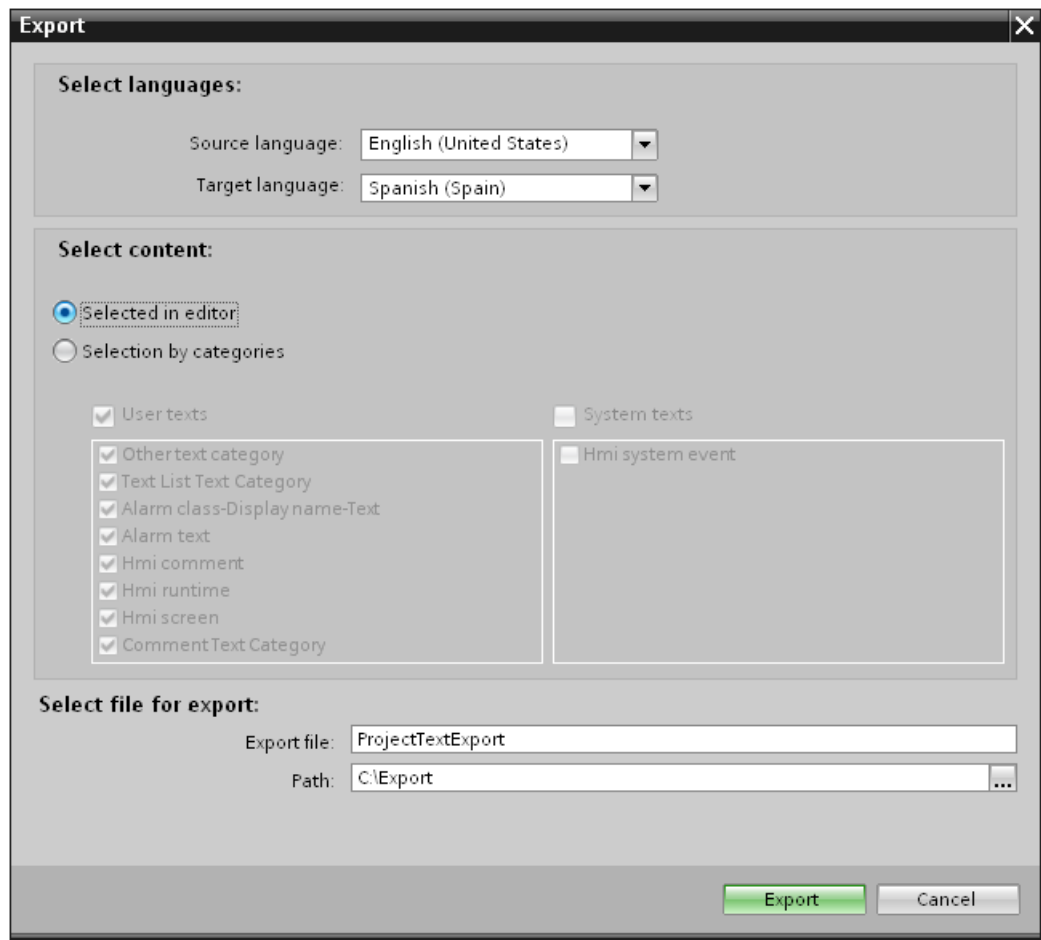

- From the "Source language" drop-down list, select the language from which you wish to translate, for example Italian.
- From the "Target language" drop-down list, select the language into which the texts are to be translated, for example, French.
- Enter a file path and a file name for the export file in the "Export file" input field.
- Click "Export".

## Result

The texts selected in the "Project texts" editor are written to an xlsx file. The xlsx file will be stored in the specified folder.

You can alternatively select and export all project texts from categories. Select "User texts" or "System texts" in the "Export" dialog in line with the type of texts you wish to export. In this case, export can additionally be limited by categories.

---

**Note**

Project texts in library objects cannot be exported.

---

**See also**

Working with multiple languages (Page 5537)

Translating texts using reference texts (Page 5541)

Translating texts directly (Page 5539)

Project text basics (Page 5538)

Importing project texts (Page 5546)

**Importing project texts**

Edit the xlsx file or send it to a translator. Import the texts once they have been translated. The foreign languages will be imported to the relevant object in the project.

**Requirements**

- At least two languages have been enabled in the "Project languages" editor, for example, Italian and French.

**Importing project texts**

To import a project text file, proceed as follows:

1. Click on the arrow to the left of "Languages & resources" in the project tree. The lower-level elements will be displayed.
2. Double-click on "Project texts". The "Project texts" editor will open.
3. Click on the  button. The "Import" dialog opens.
4. Select the path and file name of the import file from the "Import file" field.
5. Activate the "Import source language" check box if you have made changes to the source language in the export file and would like to overwrite the entries in the project with the changes.
6. Click on "Import".

**Result**

You have imported the project texts.



## See also

- Exporting project texts (Page 5542)
- Working with multiple languages (Page 5537)
- Project text basics (Page 5538)
- Translating texts directly (Page 5539)
- Translating texts using reference texts (Page 5541)

### 10.12.6.6 Using language-specific graphics

## "Graphics" editor

### Introduction

You use the "Graphics" editor to manage the configured graphic objects in different language versions. Multilingual projects sometimes also require language-specific versions of the graphics, for example, if

- the graphics contain text;
- cultural aspects play a role in the graphics.

### Opening the "Graphics" editor

Double-click on "Languages and resources" in the project tree.

### Work area

The work area displays all configured graphic objects in a table. There is a separate column in the table for each project language. Each column in the table contains the versions of the graphics for one particular language.

In addition, you can specify a default graphic for each graphic to be displayed whenever a language-specific graphic for a project language does not exist.

### Preview

The preview shows you how the graphics will look on various devices.

## See also

- Storing an external image in the graphics library (Page 5549)
- Storing an image in the graphics library (Page 5548)
- Languages in WinCC (Page 5531)

## Storing an image in the graphics library

### Introduction

You use the "Graphics" editor to import graphics you want to use in screens in the "Screens" editor. It also allows you to manage language-specific versions of graphics. A preview shows the graphic displays on various HMI devices.

### Requirement

- The language-dependent versions of a graphic are available.
- Multiple languages have been enabled in the "Project languages" editor.
- The "Graphics" editor is open.

### Inserting graphics

1. Click "Add" in the "Graphics library" table. A dialog box opens.
2. Select the required graphic file.
3. Click "Open" in the dialog box.  
The graphic will be imported to the project and displayed in all cells in this row in the "Graphics" editor.
4. Click in the corresponding cell of a language for which a language-dependent version of this graphic exists.
5. Select "Add graphic" from the shortcut menu. A dialog box opens.
6. Select the desired graphic file and click "Open."  
The language-dependent version is inserted in the table in place of the reference language graphic.
7. Then, in the "Default graphic" column, import a graphic to be displayed in runtime for those languages for which there is no language-specific graphic.

You can also drag&drop a graphic from Windows Explorer to the relevant position in the "Graphics library" table.

### Displaying graphics in the HMI device preview

1. Click on a graphic in the table.
2. Select the required HMI device under "Properties > Graphics settings > Device preview" in the Inspector window.  
The graphic will then be displayed as it will appear in runtime on the selected HMI device.

### Result

The graphics added are available in the "Graphics" editor. The graphic assigned to the respective editing language will be displayed during editing. The default screen will be displayed in all editing languages for which no screen has been imported.

The screens assigned to the respective runtime language are displayed during runtime. The default screen is displayed in all runtime languages for which a screen has not been imported.

---

**Note**

If you disable a project language, all of the graphic objects you have already created in this language will be deleted from the current project.

---

**See also**

"Graphics" editor (Page 5545)

**Storing an external image in the graphics library**

**Introduction**

To display graphics that have been created in an external graphics program in your screens, you will first have to store these graphics in the graphics browser of the WinCC project.

**Requirement**

- Multiple languages have been enabled in the "Project languages" editor.
- The "Graphics" editor is open.
- There is a graphic in the "Graphics" editor.

**Creating and adding a new graphic as an OLE object**

1. Click "Add" in the "Graphics library" table. A dialog box opens.
2. Navigate to the folder in which the graphic is stored.
3. Click "Open" in the dialog box.  
The graphic will be imported to the project and displayed in all cells in this row in the "Graphics" editor.
4. Click in the corresponding cell of a language for which a language-dependent version of this graphic exists.
5. Select "Insert object" from the shortcut menu. The "Insert object" dialog box opens.

---

**Note**

In addition, the dialog "External application running..." will open. The dialog will not close until you exit the external application.

---

6. Select "Insert object > Create new" and an object type in the dialog.

7. Click "OK." The associated graphic program is opened.
8. Close the graphics program once you have created the graphic.  
The graphic will be stored in the graphic programming software standard format and added to the graphic browser.

### Inserting created graphics in WinCC

1. Click in the corresponding cell of a language for which a language-dependent version of this graphic exists.
2. Select "Insert object" from the shortcut menu. The "Insert object" dialog box opens.

---

#### Note

In addition, the dialog "External application running..." will open. The dialog will not close until you exit the external application.

---

3. From the "Insert object" dialog box, select "Create from file."
4. Click the "Browse" button.
5. Navigate to the created graphic and select it.

---

#### Note

To import graphics files, note the following size restrictions:

\*.bmp, \*.tif, \*.emf, \*.wmf ≤4 MB

\*.jpg, \*.jpeg, \*.ico, \*.gif ≤1 MB

---

### Result

The OLE objects added are available in the "Graphics" editor.

Versions of the graphics for the current editing language are displayed in the "Screens" editor. The default graphic is displayed in all editing languages for which no screen has been imported.

The graphic is displayed in runtime in the set runtime language. The default graphic is displayed in all runtime languages for which no graphic has been imported.

You can double-click OLE objects in your library to open them for editing in the corresponding graphic editor.

### See also

"Graphics" editor (Page 5545)

### 10.12.6.7 Languages in runtime

## Languages in Runtime

### Using multiple runtime languages

You can decide which project languages are to be used in runtime on a particular HMI device. The number of runtime languages that can be available at one time on the HMI device depends on the device. To enable the operator to switch between languages during runtime, you must configure a corresponding operator control.

When runtime starts, the project is displayed according to the most recent language setting. When runtime starts the first time, the language with the lowest number in the "Order for language setting" is displayed.

### Setting runtime languages during configuration

In the "Languages and Fonts" editor you can specify:

- The project languages to be available as runtime languages for the respective HMI device.
- The order in which the languages are to be switched.

### See also

Methods for language switching (Page 5551)

Enabling the runtime language (Page 5552)

Setting the runtime language order for language switching (Page 5554)

Setting the default font for a runtime language (Page 5556)

Selecting the log language (Page 5557)

Languages in WinCC (Page 5531)

## Methods for language switching

### Introduction

You need to configure language switching if you want to have multiple runtime languages available on the HMI device. This is necessary to enable the operator to switch between the various Runtime languages.

## Methods for language switching

You can configure the following methods for language switching:

- Direct language selection  
Each language is set by means of a separate button. In this case, you create a button for each Runtime language.
- Language switching  
The operator switches the languages using a button.

Regardless of the method used, the button names must be translated into each of the languages used. You can also configure an output field that displays the current language setting.

## See also

Languages in Runtime (Page 5549)

Selecting the log language (Page 5557)

Enabling the runtime language (Page 5552)

Setting the runtime language order for language switching (Page 5554)

Setting the default font for a runtime language (Page 5556)

## Enabling the runtime language

### Introduction

The "Language & Font" editor shows all project languages available in the project. Here you select which project languages are to be available as runtime languages on the HMI device.

### Requirements

Multiple languages have been enabled in the "Project languages" editor.

## Procedure

1. Double-click on "Runtime settings" in the project tree.
2. Click on "Language & Font".
3. Select the following languages:
  - German
  - Chinese
  - French

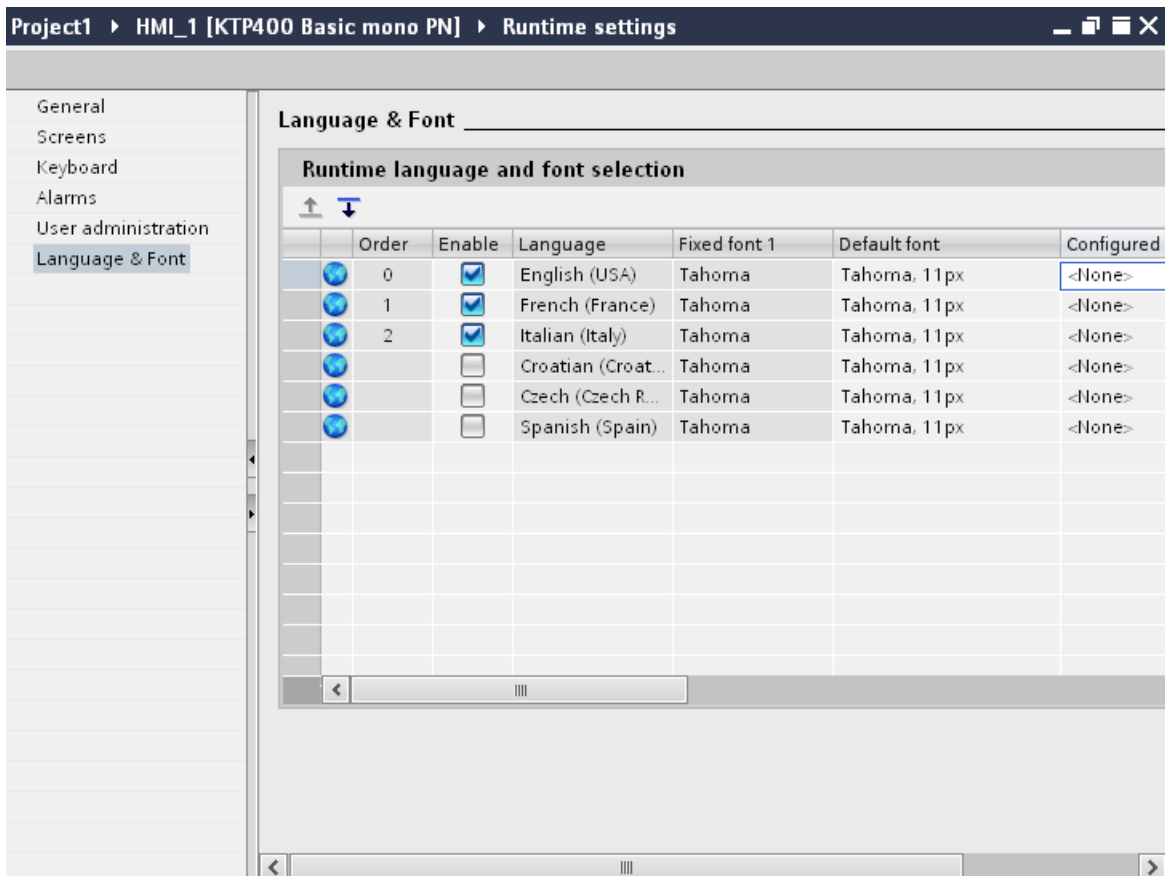

## Result

You have now set three runtime languages. A number is automatically assigned to each language in the "Order" column. The enabled runtime languages are transferred with the compiled project to the HMI device.

If the number of languages selected exceeds the number that can be transferred to the HMI device, the table background changes color.

## **See also**

Languages in Runtime (Page 5549)

Selecting the log language (Page 5557)

Setting the runtime language order for language switching (Page 5554)

Methods for language switching (Page 5549)

## **Setting the runtime language order for language switching**

### **Introduction**

You specify the language order for runtime language switching. The first time runtime starts, the project is displayed in the language with the lowest number in the "Order" column.

### **Requirements**

- Multiple languages have been enabled in the "Project languages" editor.
- "Language & Font" is open in the editor and three runtime languages have been set in the following order:
  1. German
  2. Chinese
  3. French



## Procedure

1. Select the runtime language "German".
2. Click the  button. The runtime language "German" will move down a place. The number will automatically be changed to "2" in the "Order" column.

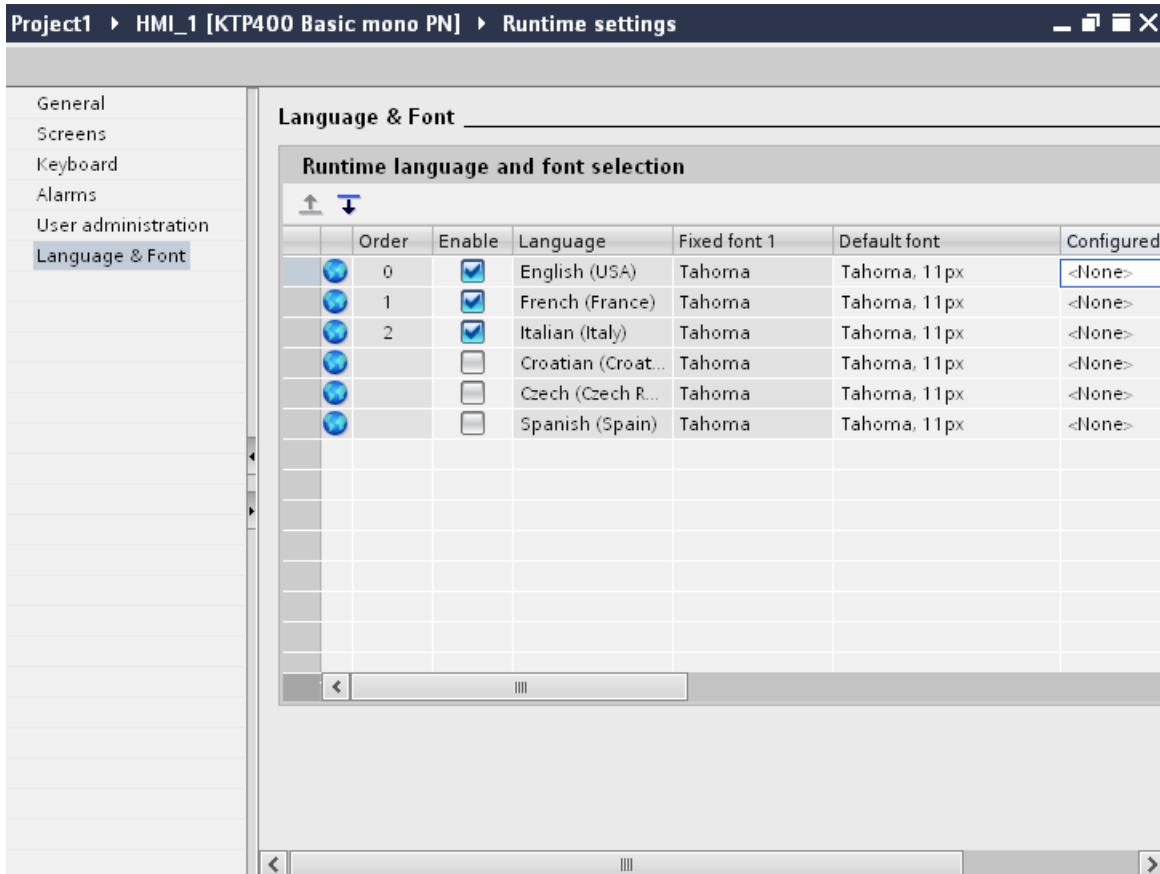

## Result

You have changed the order of runtime languages. The first time runtime starts, the project will be displayed in the language with the smallest number, in other words Chinese. If the language is switched, this will happen in numerical order.

## See also

- Languages in Runtime (Page 5549)
- Selecting the log language (Page 5557)
- Enabling the runtime language (Page 5550)
- Setting the default font for a runtime language (Page 5556)
- Methods for language switching (Page 5549)

## Setting the default font for a runtime language

### Introduction

You can specify the font used to display the texts for each runtime language on the HMI device in the "Language & Font" editor. The default font is used in all texts, such as dialog texts, for which you cannot define a specific font.

WinCC offers only fonts supported by the HMI device.

### Requirements

- Multiple languages have been enabled in the "Project languages" editor.
- Three runtime languages have been enabled in the "Language & Font" editor.
  1. Chinese
  2. German
  3. French

### Procedure

1. Double-click on "Runtime settings" in the project tree.
2. Click on "Language & Font". The table shows the runtime languages and fonts set.
3. Click in the "French" row in the "Default font" column.
4. Select the font to be used by default if a font cannot be selected for a given text.

### Result

The project texts for the runtime language "French" are displayed on the HMI device in the selected font.

These fonts are transferred to the HMI device during a transfer operation.

The default font is also used for the representation of dialogs in the operating system of the HMI device. Select a smaller font as default if the full length of the dialog texts or headers is not displayed.

### See also

Languages in Runtime (Page 5549)

Selecting the log language (Page 5557)

Setting the runtime language order for language switching (Page 5552)

Methods for language switching (Page 5549)

## Selecting the log language

### Introduction

In the "Runtime settings > General" editor, select the language to be used for writing to logs in runtime.

### Requirements

- The languages used in your project are activated in the "Project languages" editor, for example "German" and "English" .

### Procedure

1. Double-click on "Runtime settings" in the project tree.
2. Click on "Language & Font".
3. Activate the runtime languages, for example, "German" and "English".
4. Specify the "order":
  - 1 German
  - 2 English
5. Click on "Runtime settings > General".
6. Select "German" for "Logs > Log language".

### Result

After loading, the project will start in the runtime language "German". The logs are now written in German. During runtime, the operator switches the runtime language to English. The logs will still to be written in German.

### See also

Languages in Runtime (Page 5549)

Setting the default font for a runtime language (Page 5554)

Setting the runtime language order for language switching (Page 5552)

Methods for language switching (Page 5549)

Enabling the runtime language (Page 5550)

### 10.12.6.8 Example of multilingual configuration

#### Example: Configuring a button for language switching

##### Introduction

In this example, you configure a button that can be used to toggle between multiple runtime languages during runtime.

##### Requirements

- You have completed the "Configuring a button in multiple languages" example.
- The "Screen\_1" screen is open.
- The button on the screen has been selected.

##### Procedure

1. In the Inspector window, select "Properties > Events > Press".
2. Click on "Add function" in the table.
3. Select the "SetLanguage" system function.

##### Result

You have assigned the button the function "SetLanguage". Pressing the button during runtime will switch the runtime language. The runtime languages are switched in the order specified by the number sequence in the "Languages and fonts" editor.

##### See also

Example: Configuring a button in multiple languages (Page 5558)

Example: Configuring a button for language switching for each runtime language (Page 5559)

Languages in WinCC (Page 5531)

#### Example: Configuring a button in multiple languages

##### Introduction

In this example, you configure a "Sprache umschalten" button in German and "Switch language" button in English.

## Requirements

- The languages "German" and "English" have been enabled in the "Project languages" editor.
- German has been set as editing and reference language.
- You have created and opened the "Screen\_1" screen.
- The Inspector window is open.

## Procedure

1. Drag-and-drop a button from the "Tools" task card into the screen. The button will be added to the screen.
2. In the Inspector window, open "Properties > Properties > General".
3. Enter the text ""Sprache umschalten" under "Text > off".
4. Press <Enter> to confirm. The button is named.
5. Open the "Tasks" task card.
6. Select "English" under "Languages & Resources > Editing language".
7. Enter the label "Switch Language" under "Properties > Properties > General > Text > Off" in the Inspector window.

## Result

The button name is configured in German and English language. The button name corresponding with the current Runtime language is shown in Runtime.

## See also

Example: Configuring a button for language switching (Page 5556)

Example: Configuring a button for language switching for each runtime language (Page 5559)

## Example: Configuring a button for language switching for each runtime language

### Introduction

In this example, you configure a "Sprache umschalten" button in German and "Switch language" button in English.

## Requirements

- The following languages have been enabled in the "Project languages" editor
  - German
  - English
  - Italian
- All languages have been set as runtime languages in the "Runtime settings > Language & Font" editor.
- You have created and opened the "Screen\_1" screen.
- Three buttons have been created on the screen:
  - Button\_1 labelled "Deutsch"
  - Button\_2 labelled "English"
  - Button\_3 labelled "Italiano"
- The Inspector window is open.

## Procedure

1. Select "Button\_1".
2. In the Inspector window, select "Properties > Events > Press".
3. Click on <Add function> in the table.
4. Select the "SetLanguage" system function.
5. Click on the "Switch" field.
6. Click on the  button.
7. Select "Runtime language". The field will be highlighted in red.
8. Select "German" from the drop-down list.
9. Repeat steps 1 - 8 for the other two buttons and select the corresponding runtime language.

## Result

You have configured three buttons for switching language in runtime. Each button will switch to a different runtime language. For example, clicking on the "English" button during runtime will switch the runtime language to English.

## See also

Example: Configuring a button for language switching (Page 5556)

Example: Configuring a button in multiple languages (Page 5556)

## 10.12.7 Replacing devices

### 10.12.7.1 Basics

#### Introduction

You can use existing configurations for new devices and optimize these configurations with little manual effort.

All data configured by you is retained in the configuration data. This means you do not need to copy individual objects of one device and paste them to another.

#### Principle

The following applies when you replace devices:

- Only functions supported by the new device are available. Only configuration data supported by the new device are displayed.  
This affects
  - recipes,
  - objects available on the screens,
  - available system functions,
  - available communication logs, etc.
- The number of supported objects, such as screens or tags, may be limited on the new device. If the existing objects exceed the limitations on the new device, the objects are displayed in full. The objects are, however, highlighted in color in the individual editors. An error is generated when the project data is compiled.  
Manual post processing is required when switching to a device with fewer features.  
Example: Limited number of connections  
All connections will be highlighted in color as invalid if fewer connections are supported on the new device than have been configured. Delete any excess connections.

---

#### Note

If you replace a Panel and select a PC Station as your new device, for example, WinCC Runtime Advanced will automatically be moved below the PC Station in the project tree.

---

## See also

- Example: Replacing devices (Page 5574)
- Screen adjustment options (Page 5567)
- Key assignment when replacing devices (Page 5563)
- Device-specific functions (Page 5562)
- Engineering system (Page 5727)
- Basic Panel (Page 5729)
- Panel (Page 5732)
- Mobile Panel (Page 5736)
- Multi Panel (Page 5740)
- Comfort Panel (Page 5744)
- WinCC Runtime Advanced (Page 5749)

### 10.12.7.2 Device-specific functions

#### Device-specific functions

#### Functions dependent on the device

Functions dependent on the device are implemented as follows:

- Colors  
The color is changed automatically when you switch from a device with full color display to one with a smaller color range.  
If you change the color manually and then change back again to a device with a larger range of colors, the reduced range of colors will be retained.
- Fonts  
Any configured font not available on a device will be replaced by a similar one or by the configured default font. The default font depends on the device selected.
- Character sets with different font sizes  
Avoid using too many different font sizes when configuring the following devices:
  - OP 73
  - OP 77A
  - TP 177A

A character set is downloaded to the device for each font size. Check the Inspector window during compilation to see how much of the device memory is being used by the character sets.



- **Font size**  
Use small Windows fonts to display the text on devices. If you use large Windows fonts, then, depending on the size of the display, the text will not be displayed in full. Using font sizes of 28 pixels or more for the OP 77A and TP 177A devices will affect device performance.  
The character scope is much greater for Asian languages. The use of different font sizes therefore has serious implications on the memory requirements of all devices.  
Use the same font type for all large characters throughout the project to ensure effective and efficient configuration.
- **Screens and screen objects**  
If the new device supports a different resolution than the previous device when you replace a device, there are several ways to adjust the screens.  
Adjust the size of the screens to the new device in the menu under "Options > Settings > Visualization > Fit to size screen".

### See also

Example: Replacing devices (Page 5574)

Basics (Page 5559)

### Key assignment when replacing devices

#### Introduction

The devices available each have different function keys. The functions configured for these keys will be mapped to the available function keys of the new device if the device is replaced.

#### Function key mapping

The function keys to the left and right of the display are mapped from top to bottom to the new device. If the new device has fewer keys, the keys it does not have are not mapped. The function keys below the display are mapped from left to right to the new device. If the new device has fewer keys, the keys it does not have are not mapped.

#### Example: Exchange MP 377 with KP700 Comfort

You have configured a function on key S3 on the MP 377. This function is triggered by F5 if the panel is replaced with an KP700 Comfort.

If you use the S8 key on an MP 377, this function is no longer available when the panel is replaced with a KP700 Comfort.

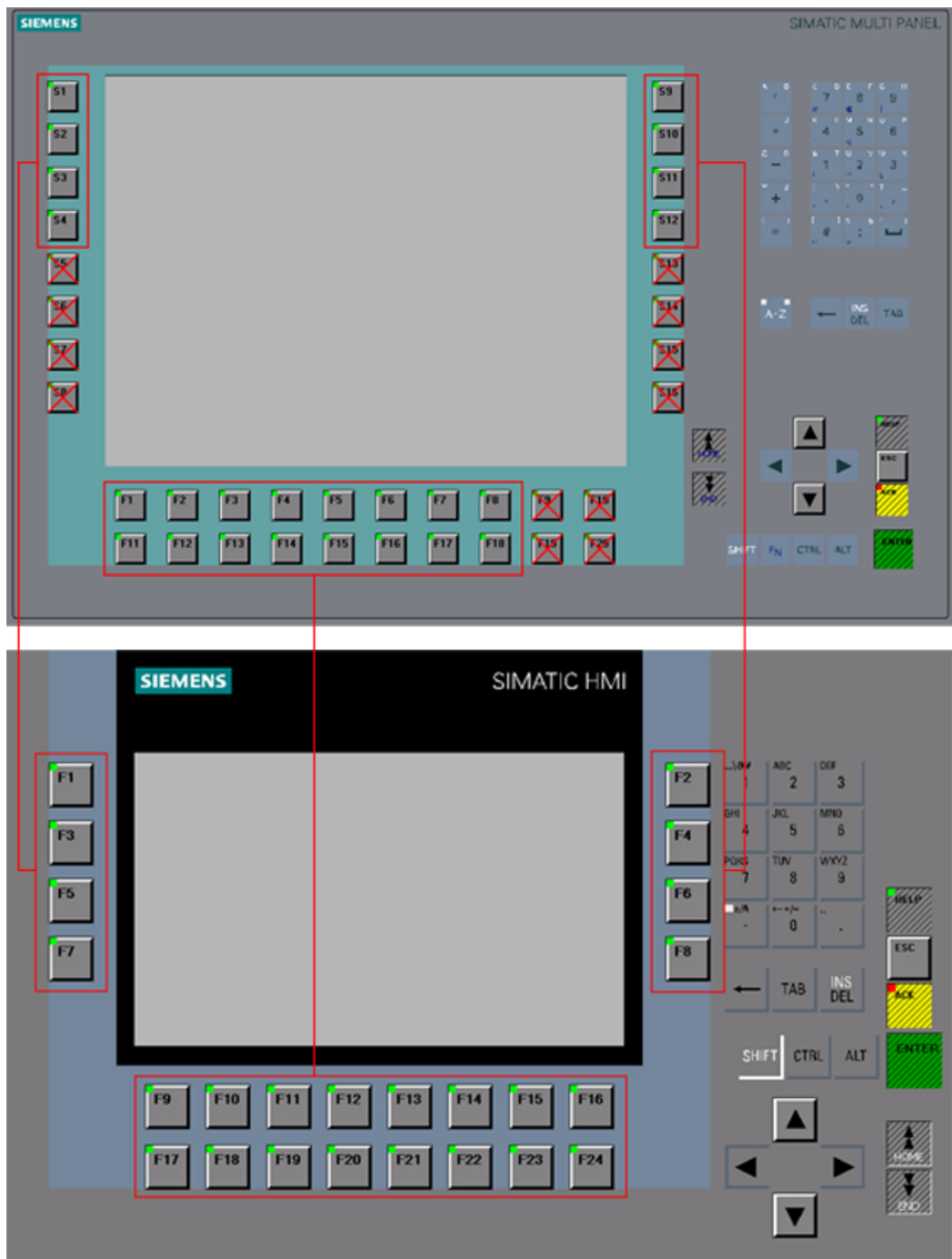

### Mapping K-keys

K-keys are only mapped to the same K-keys in the new device, e.g. K5 to K5.

If the new device has no K keys, configurations for the K keys are lost.



## Mapping of control keys and cursor keys

The following keys are mapped only to the same keys of the new device:

- HELP
- ESC
- ACK
- ENTER
- PAGE UP
- PAGE DOWN
- CURSOR UP
- CURSOR DOWN

## Exception

"HELP" is triggered by "SHIFT+ ESC" on OP 73.

## See also

Key assignment when replacing devices (Page 5565)

Basics (Page 5559)

Screen adjustment options (Page 5567)

## Key assignment when replacing devices

### Introduction

The devices available each have different function keys. The functions configured for these keys will be mapped to the available function keys of the new device if the device is replaced.

### Function key mapping

The function keys below the display are mapped from left to right to the new device. If the new device has fewer keys, the keys it does not have are not mapped.

### Example: Replacing a KTP1000 Basic with a KTP600 Basic

You have configured a function for F2 in KTP1000 Basic. This function is triggered by F2 following replacement with a KTP600 Basic.

If you have used F7 in a KTP1000 Basic, this function will no longer be available if the panel is replaced with a KTP600 Basic.

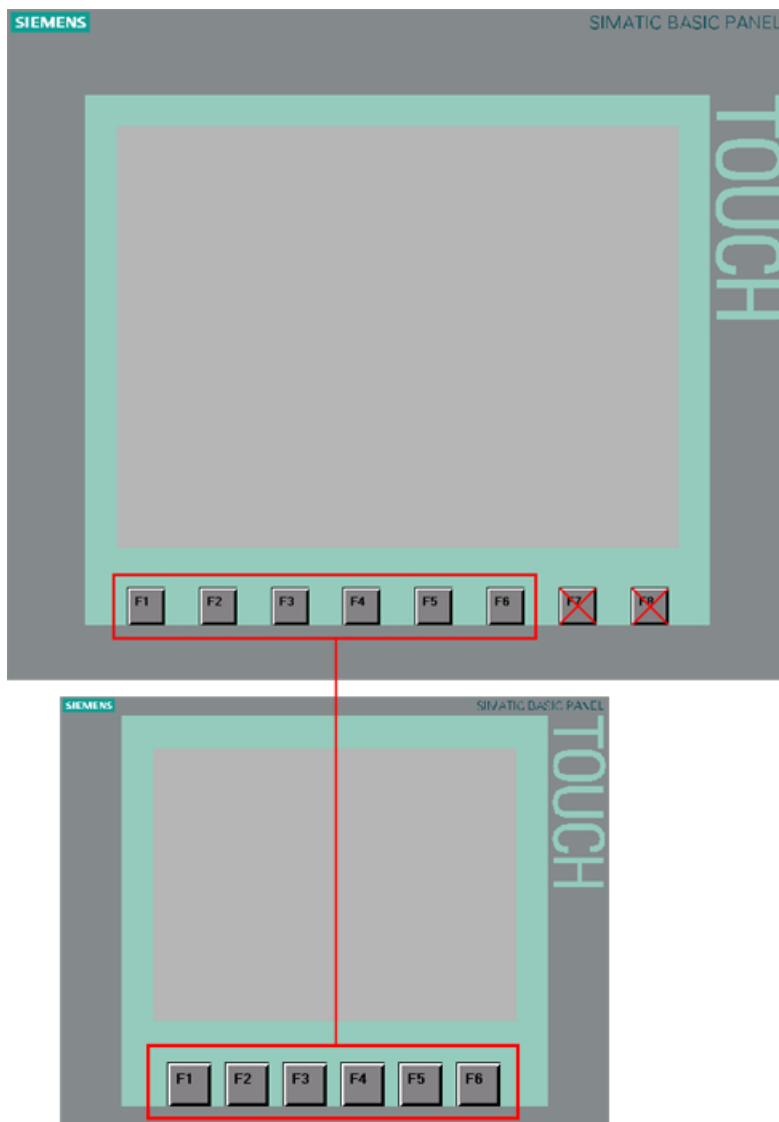

### Mapping of control keys and cursor keys

The following keys are mapped only to the same keys of the new device:

- HELP
- ESC
- ACK

- ENTER
- PAGE UP
- PAGE DOWN
- CURSOR UP
- CURSOR DOWN

### See also

Key assignment when replacing devices (Page 5561)

### 10.12.7.3 Adjust screens to the new device

#### Screen adjustment options

#### Introduction

Select fit to size for screens before you replace a device. Fit to size is particularly important when switching devices with different display resolutions.

Object adjustment to content can be prevented for objects such as graphic views or text fields.

---

#### Note

The objects are distorted if you replace a device with a landscape format display with a device with a portrait format display. The difference in display format can, for example, result in object labels being cut off and content not being fitted to the object. You must therefore adjust the screens to the new device once you have replaced devices.

---

## Screen adjustment when replacing devices

Adjust the size of the screens to the new device in the menu under "Options > Settings > Visualization > Fit to size screen".

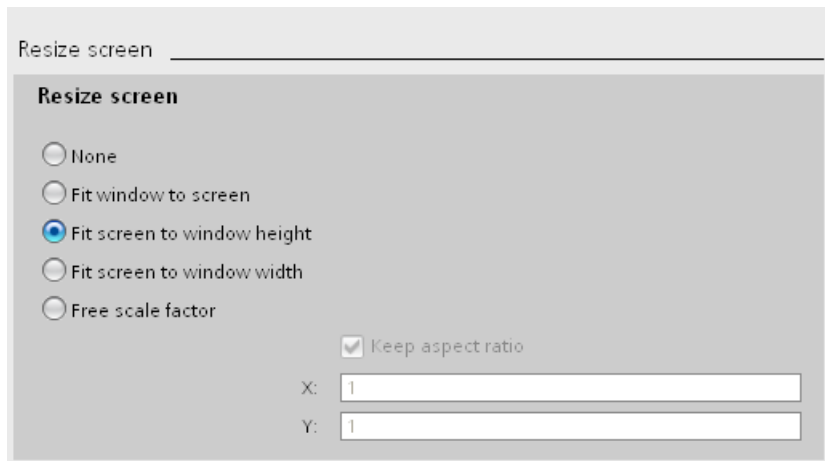

Select one of the following settings.

### None (default)

The screens are not scaled. The objects in the screen retain their position and size. Use this setting as first test for checking of a possible exchange result because there are no rounding losses during forth and back exchange.

This option may result in objects being outside the configurable area if the display of the new device is smaller than the old one.

### Adjusting the width and height to the new device

The position and object size are adjusted to the new display size. Adjustment takes place along the x-axis and the y-axis. Graphics and font size are adjusted accordingly.

### Fit screen to window height

The aspect ratio is maintained and the screens are adjusted to the height of the new device.

Use this option when you are replacing a device with display format 4:3, for example, with a device with widescreen.

### Fit screen to window width

The aspect ratio is maintained and the screens are adjusted to the width of the new device.

Use this option when you are replacing a device with widescreen, for example, with a device with display format 4:3.

## Free scale factor

You select a free scale factor for screen adjustment. You can specify a factor for the x-axis and the y-axis.

Using a free scale factor of  $< 1$  may distort the objects. Object labels may, for example, be cut off and the content may not be fitted to the object.

You must therefore adjust the screens to the new device once you have replaced devices.

---

### Note

The aspect ratio is not adjusted for objects with a fixed aspect ratio, for example, gauge, circle. The objects are displayed on the new device with the same aspect ratio as prior to the replacement of the device.

---

## See also

Example: Adjusting screens (Page 5573)

Specifying the position of screen objects (Page 5572)

Fit objects to contents (Page 5569)

Basics (Page 5559)

Key assignment when replacing devices (Page 5561)

## Fit objects to contents

### Introduction

For some objects, you can specify fit to respective content in the Inspector window, for example:

- Text field: fit to text content
- I/O field: fit to text content
- Symbolic I/O field: fit to text content or to text list
- Graphic view: fit to included graphic

### Fit to size for text and graphic objects

Disable automatic fit to size of the individual objects in the menu under "Options > Settings > Visualization > Resize screen and screen objects > Fit to content". This results in scaling of the objects as specified under "Options > Settings > Visualization > Resize screen and screen objects".

Select the objects which are not automatically fitted to size.

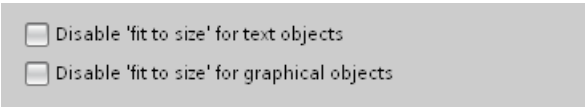
- 
- Disable 'fit to size' for text objects
  - Disable 'fit to size' for graphical objects

- If "Disable 'fit to size' for text objects" is activated, automatic fit to size is ignored in the text object properties.  
If you have activated "Fit screen to window height", the text field along with the other objects is scaled in accordance with the height of the new device.
- If "Disable 'fit to size' for graphic objects" is activated, automatic fit to size is ignored in the graphic object properties.  
If you have activated "Fit screen to window width", the graphics view along with the other objects is scaled in accordance with the width of the new device.

---

**Note**

The settings have no effect on screen objects whose size cannot be changed, such as alarm indicators or screen objects with a fixed aspect ratio.

---

"Disable 'fit to size' for text objects" and "Disable 'fit to size' for graphic objects" have no effect if:

- You have activated "Resize screen and screen objects > None".
- You have activated "Fit screen to window width and height" and the new device has the same resolution as the current device.
- You have activated "Fit screen to window height" and the new device has the same resolution as the current device.
- You have activated "Fit screen to window width" and the new device has the same resolution as the current device.

**Example**

The figure below shows the effects of automatic sizing using a graphic object with two buttons aligned as an example:



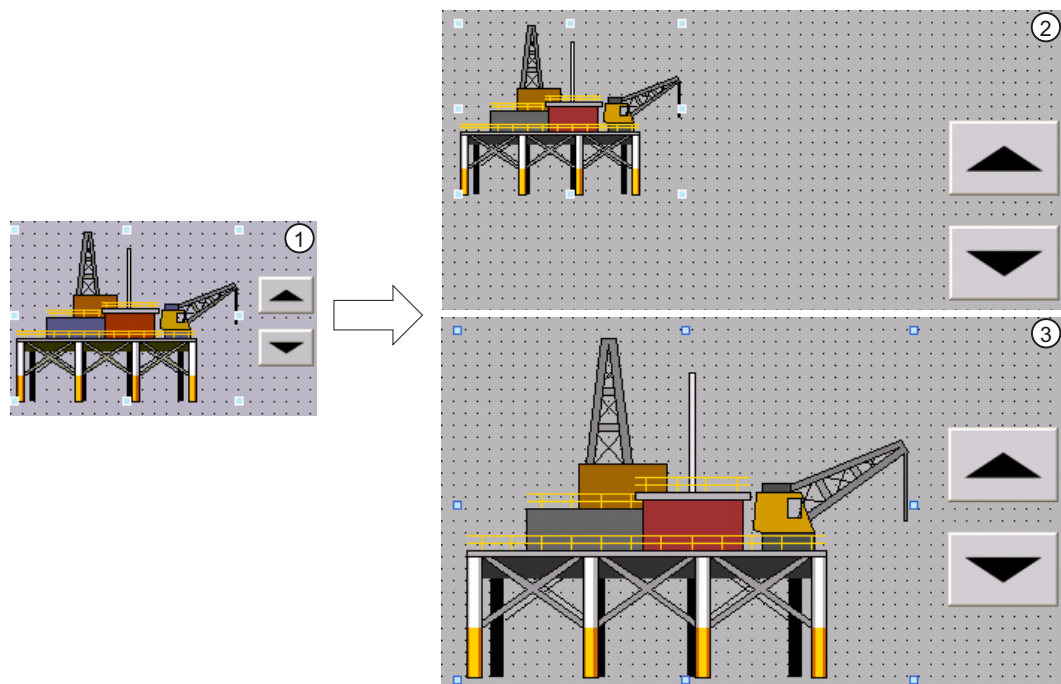

- ① Initial situation:
- Two buttons are aligned on a graphic object.
  - The option "Fit object size to graphic" or "Adjust object size to graphic" is activated in the object properties of the graphic object under "Display > Sizing".
- ② Option 1: The original properties of the graphic object are to be maintained after switching the HMI device.
- Deactivate the option "Disable 'fit to size' for graphical objects" in the settings under "Size adaptation of objects".
- Effect: The graphic object retains its original size after switching the HMI device. The alignment to the buttons is lost.
- ③ Option 2: The graphic object is to be placed relative to the new screen resolution after switching the HMI device.
- Activate the option "Disable 'fit to size' for graphical objects" in the settings under "Size adaptation of objects".
- The option "Fit graphic to object size" is activated automatically in the object properties of the graphic object. The two buttons are properly aligned on the graphic object even after switching the HMI device.

## See also

Specifying the position of screen objects (Page 5572)

Screen adjustment options (Page 5565)

Example: Adjusting screens (Page 5573)

## Specifying the position of screen objects

### Introduction

There are various ways to adjust the position of screen objects to the new device.

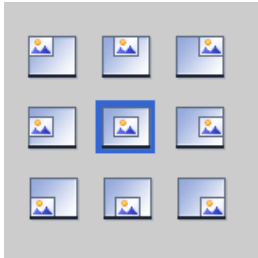

### Select position

Adjust the position of the screen objects to the new device in the menu under "Options > Settings > Visualization > Fit to size screen > Select position".

### Example

The following option aligns the objects with the top left edge.



The following object centers the objects in the middle of the screen.



### See also

Screen adjustment options (Page 5565)

Fit objects to contents (Page 5567)

Example: Adjusting screens (Page 5573)

#### 10.12.7.4 Example: Replacing devices

### Example: Procedures overview

### Introduction

In the following example you replace a TP177 B 6" PN/DP with a TP700 Comfort.

## Procedures overview

The procedure when replacing a device is as follows:

1. Adjust screens to the new device
2. Replacing devices

## See also

Example: Adjusting screens (Page 5573)

Example: Replacing devices (Page 5574)

## Example: Adjusting screens

### Introduction

Adapt the screen before you replace a device. Screen adaptation is required as the display formats are different.

The TP 177B format is 320 x 240 pixels while the format of the TP700 Comfort is 800 x 480 pixels.

### Requirements

- A project is open.
- The TP 177B 6" PN/DP device is used in the project.

### Adjusting screens

1. Open the "Options > Settings" menu.
2. Click on "Visualization > Fit screen to size".
3. Select "Fit screen to window height".

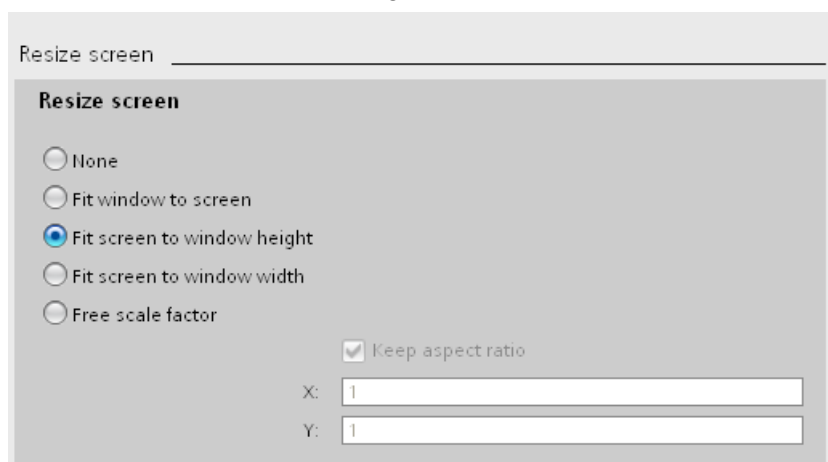

4. Select "Disable fit to size for text objects".
5. Select "Disable fit to size for graphical objects".

## Result

You have carried out screen adjustment in preparation for replacing devices.

## See also

Example: Replacing devices (Page 5574)

Screen adjustment options (Page 5565)

Specifying the position of screen objects (Page 5570)

Fit objects to contents (Page 5567)

Example: Procedures overview (Page 5570)

## Example: Replacing devices

### Introduction

The following example shows you how to replace a device.

### Requirements

- A project has been created and opened.
- The TP 177B 6" PN/DP device is used in the project.

### Procedure

1. Double-click on "Devices & Networks" in the project navigation. The editor opens.
2. Click on the "TP 177B" device.
3. Select "Change Device/Version" in the device shortcut menu. A dialog opens.
4. Select the TP700 Comfort device.

5. Select the matching image for the HMI device version that suits your configuration under "Version".

When you change the image, the new image is automatically transferred to the target system with the next download. All runtime files are deleted during this step.

Details of hardware differences can be found in the "Compatibility information".

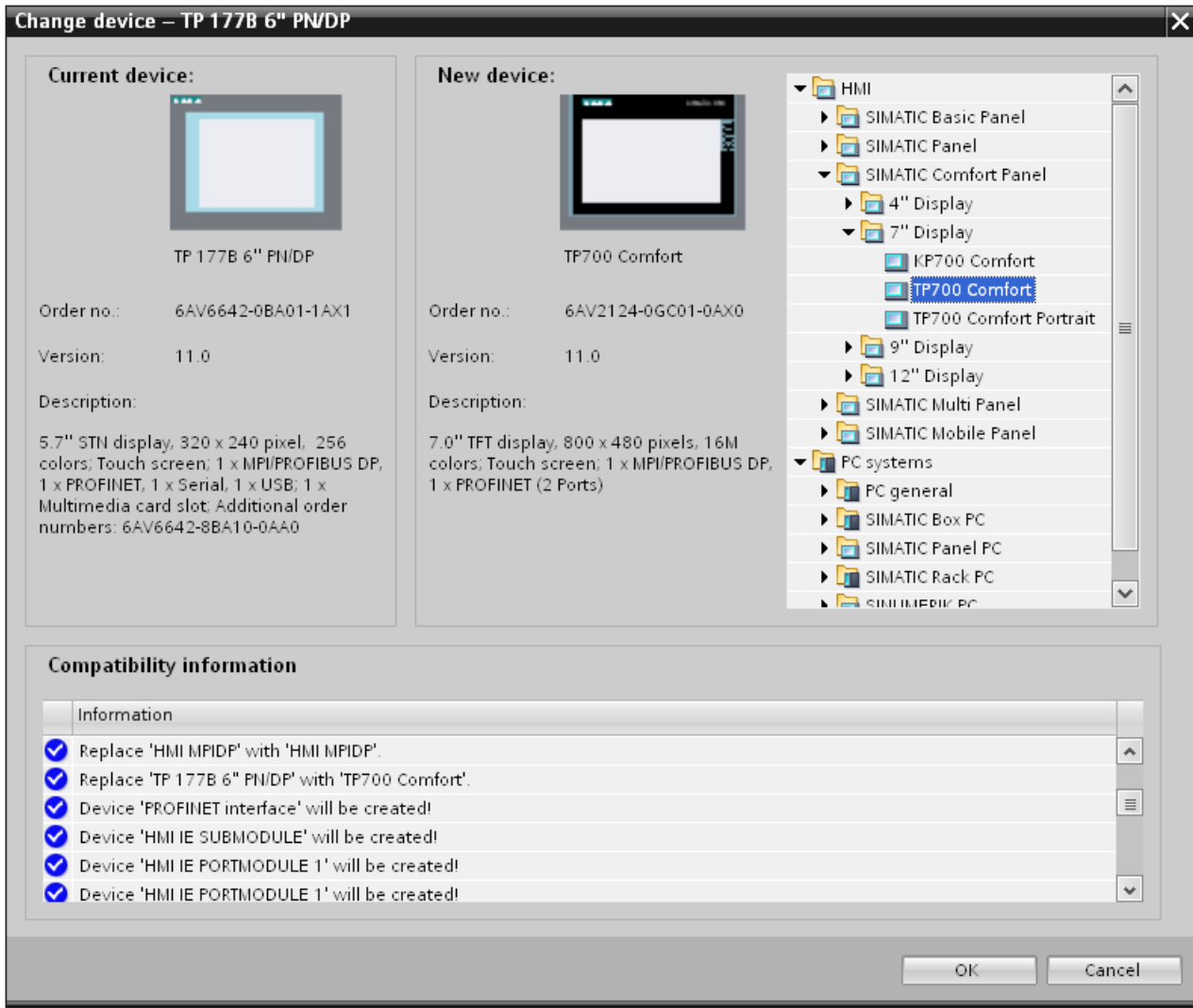

6. Click "OK". Device replacement is started.

## Result

You have replaced the TP 177B device used in the project. You now use the TP700 Comfort device.

## See also

Example: Adjusting screens (Page 5571)

Device-specific functions (Page 5560)

Basics (Page 5559)

Example: Procedures overview (Page 5570)

## 10.12.8 Copying between devices and editors

### 10.12.8.1 Basics

#### Basics

#### Copying and pasting within an HMI device

You can copy and paste objects, such as display objects, within an HMI device. If the object is already created in the editor, when the object name is inserted a number is automatically attached, in accordance with the following principle:

- "<Object\_name>\_1" is renamed to "<Object\_name>\_2".
- "<Object\_name>\_2" is renamed to "<Object\_name>\_3".

#### Copying and pasting between HMI devices

You can also copy and paste between HMI devices. If an object with the same name already exists, you have the following options:

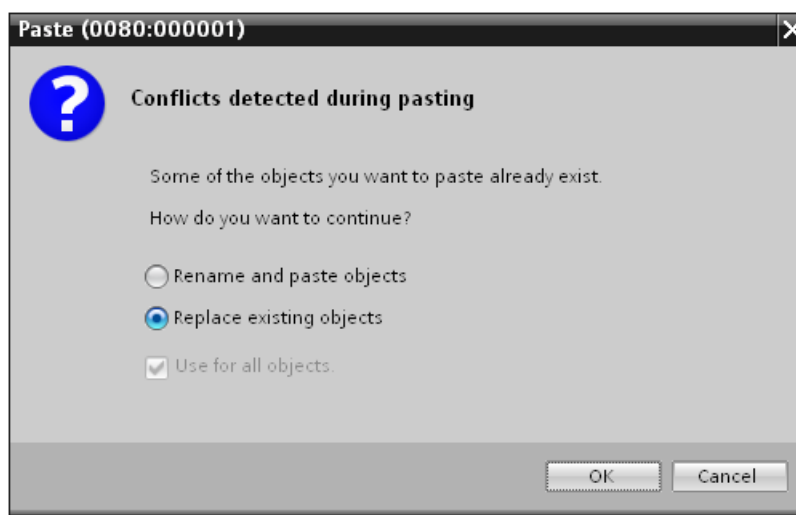

---

**Note**

**Exception to this basic rule**

Copying and pasting of an alarm class that has been generated from project-wide alarm class is handled differently than with this basic rule. When the copied alarm class already exists in the target HMI device within the same project, the "Paste" command is not performed.

---

## Copying user-defined folders

You can create user-defined folders for editors, for example, for HMI tags, screens, etc.

You can copy user-defined folders and paste them into another HMI device. The objects contained in a user-defined folder may exceed the limitations applying to the other HMI device, such as the number of supported screens. After they have been pasted, all the objects are displayed. An error is displayed when the project data is compiled.

System folders cannot be copied.

## See also

Unsupported objects and functionalities (Page 5578)

Copy and paste options (Page 5577)

## Copy and paste options

### Copy and paste options

Copy and pasting individual objects simplifies configuration.

WinCC offers a number of options for copying and pasting objects.

## Shortcut menu

To copy and paste objects using the shortcut menu, proceed as follows:

1. Select an object, for example a button.
2. Select "Copy" in the shortcut menu.
3. Move the mouse cursor to the place on the screen where you want to paste the button.
4. Select "Paste" in the shortcut menu.

The button will be pasted together with all properties already defined.

## Drag&drop

To drag-and-drop objects, proceed as follows:

1. Click on "Screens > Start" in the project tree of a device.
2. Drag-and-drop the "Start" screen into the "Screens" folder of another device.
3. A dialog will appear if the second device already contains a screen with the same name.
4. Choose whether to replace or rename the existing screen.

## See also

Basics (Page 5574)

## Unsupported objects and functionalities

### Introduction

When an object is copied, all its properties and settings are transferred to the target HMI device.

### Unsupported objects

Objects that are not supported in the target HMI device cannot be pasted.

---

#### Note

When you copy a screen containing objects which are not supported by the destination HMI device, the objects remain in the background. When you copy the screen again and the new device supports the objects, they are displayed again.

---

### Invalid objects

The following objects become invalid once they have been pasted into the target HMI device:

- Referenced objects that do not exist in the target HMI device.
- Objects with settings that are not supported in the target HMI device.
- System functions that were configured for objects and that are not supported in the target HMI device.

Invalid objects are highlighted by a color coding. Select a supported object or create a new one. If you retain an invalid object, an error will be displayed when the project data is compiled.

### Colors and fonts

Colors and fonts are supported to varying degrees by HMI devices. When unsupported colors and fonts are pasted, they are replaced by supported colors and fonts. When you paste the same object back into the source HMI device, the original settings become active again.



## See also

Basics (Page 5574)

### 10.12.8.2 Copy and paste

## Copying screens

### Introduction

You copy one or more screens from the "Screens" folder and paste them into the "Screens" folder of another device.

### Type and size of the displays

In the case of HMI devices with keys, the available keys are displayed automatically in the screen. When a screen is copied between HMI devices, the keys are either displayed or hidden; functions configured for function keys are not transferred.

If there is less space for the screen in the target HMI device than in the source HMI device, you can adjust the size of and the spacing between existing objects.

### Automatic fit to size for objects

1. Select "Options > Settings > Visualization > Resize screen and screen objects" in the menu.
2. Activate, for example, "Fit screen to window width and height".

## See also

Screen adjustment options (Page 5565)

Fit objects to contents (Page 5567)

Specifying the position of screen objects (Page 5570)

Copying recipes within an HMI device (Page 5579)

Copying objects with linked objects (Page 5580)

Linked objects copied automatically (Page 5581)

Linked objects copied automatically (Page 5581)

Drag & drop from the details view (Page 5582)

## Copying recipes within an HMI device

### "Recipes" Editor

You can copy recipes, recipe elements and recipe data records within each table. You copy a recipe element to another recipe.

Only WinCC Runtime Professional: You can copy a recipe view element to another recipe view. If a recipe view element of the same name already exists, a conflict dialog is displayed. You can select whether to replace or rename the recipe element. You can copy recipe elements to the first empty row of the "Recipe views" editor, "Elements" tab.

You can copy a recipe data record to another recipe, if the other recipe contains the same number of recipe elements. If the data types differ, the value will be copied to the target data record but it is assigned an error flag.

### "Tags" editor

You can drag-and-drop a tag to a recipe element in the "Tag" column. The tag is linked to the recipe element. If a tag is already linked, an error message will be generated.

### "Screens" editor

If you drag-and-drop a recipe to a screen, a new recipe display will be created and linked to the recipe.

### See also

Copying screens (Page 5577)

## Copying objects with linked objects

### Introduction

An object is linked to another object in the following situations, for example:

- You specify a tag for an alarm as a trigger tag.  
The alarm is the object. The tag is the linked object.
- You specify a connection for an external tag.  
The tag is the object. The connection is the linked object.

The object is always fully inserted during copying and pasting. Whether or not the linked object is pasted depends on the command used to insert it.

### Simple pasting

The linked object is not copied. The linked object is transferred and handled as follows in the target HMI device:

- If an object with the same name exists, the existing object with its settings is used.
- If no object with the same name exists, the name of the object will be displayed. The object becomes invalid.

For some objects, linked objects are pasted automatically during simple pasting.

**Extended pasting**

Select the "Extended paste" command in the shortcut menu to paste the linked objects as well. If objects of the same name exist in the target HMI device, you need to decide whether or not to overwrite each of these objects.

**See also**

Copying screens (Page 5577)

**Linked objects copied automatically****Copying linked objects**

The following table shows the objects for which linked objects are pasted automatically in simple pasting.

Object	Linked object
Screen	Template
Symbolic I/O field	Text list
Graphic I/O field	Graphics list
Graphic view	Graphic
Tag	Alarm
	Cycle
Recipe element	Text list
Scheduler	Triggers

**See also**

Copying screens (Page 5577)

**Linked objects copied automatically****Copying linked objects**

The following table shows the objects for which linked objects are pasted automatically in simple pasting.

Object	Linked object
Screen	Cycle
	Template
Symbolic I/O field	Text list
Graphic I/O field	Graphics list
Graphic view	Graphic

Object	Linked object
Tag	Alarm
	Logging tag
	Cycle
Log	Logging tag
Logging tag	Log type
Recipe element	Text list
Scheduler	Triggers

## See also

Copying screens (Page 5577)

## Drag & drop from the details view

### Introduction

You can improve configuration efficiency with just a few simple measures. Below are a few examples of efficient configuration.

### Pasting objects to a screen from the details view

You can drag objects in the details view from various different editors to other editors.

### Pasting a symbolic I/O field

1. Open a screen.
2. Click on the "Text and graphics lists" editor in the project tree. All existing text and graphics lists will be shown in the details view.
3. Click on a text list, for example, "Textlist1" in the Details view.
4. Drag-and-drop a text list from the Details view to a screen. A symbolic I/O field has been created and connected to the text list "Textlist1".

### Pasting a graphic I/O field

1. Open a screen.
2. Click on the "Text and graphics lists" editor in the project tree. All existing text and graphics lists will be shown in the details view.
3. Click on a graphics list in the Details view, for example "Graficlist1".
4. Drag-and-drop a graphics list from the Details view to a screen. A graphic I/O field has been created and connected to the graphics list "Graficlist1".

## Pasting an I/O field

1. Open a screen.
2. Click on the "HMI tags" editor in the project tree. All existing HMI tags will be shown in the Details view.
3. Click on an HMI tag in the Details view, for example "Tag1".
4. Drag-and-drop the HMI tag from the Details view to a screen. An I/O field has been created and connected to the HMI tag "Tag1".

## See also

Copying screens (Page 5577)

### 10.12.8.3 Copying between different RT and ES versions

#### Introduction

You can copy and paste project data such as screens, objects or tags between projects with different WinCC versions.

All configurations that are supported in the target version are retained when you copy data between projects of different WinCC versions. Configurations that are not supported by the target version are marked as invalid with a color code.

#### Copy of control between HMI devices from different device versions

WinCC supports all configurations of a previous WinCC version.

The following applies when copying within different ES versions:

- All the configurations that are also supported in the respective RT version are retained.
- Default settings are defined for configurations that are only supported in the WinCC version of the target project.

- Configurations that are not supported by the respective RT version are marked as invalid with a color code or they are not displayed. All properties and settings originally defined in the source HMI device are reactivated when you copy the object back to the source HMI device unchanged.

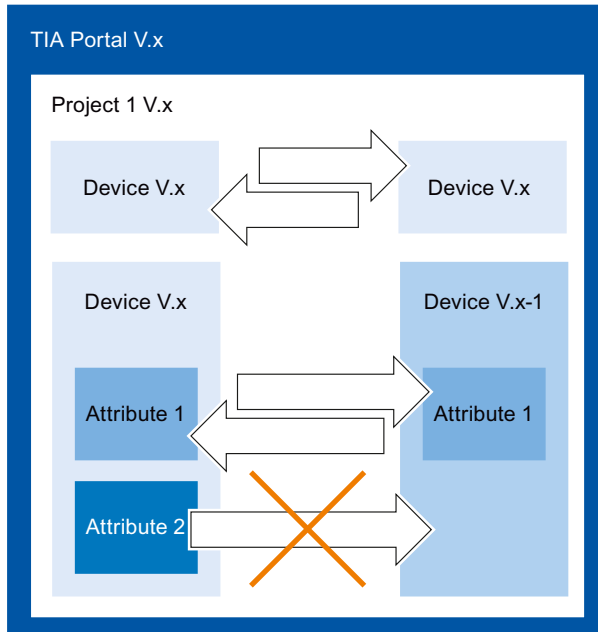

- The HMI device must be valid for the current Runtime version.

### Copying between different ES versions

Open a second instance of the TIA Portal to copy between two TIA projects. You can only copy between projects that have the same ES version. The ES version of a project is indicated by the file extension \*.ap<version\_number>.

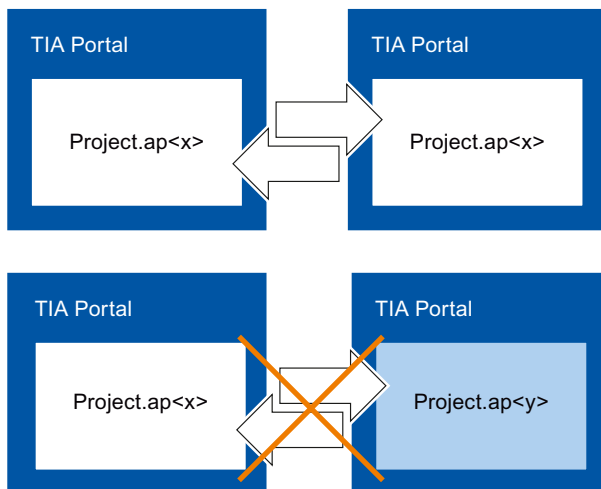

## 10.12.9 Using WinCC version compatibility

### 10.12.9.1 Basics on version compatibility

#### Introduction

Edit existing projects as follows with WinCC:

- You edit, compile and download existing projects with the range of functions of the previous version of WinCC. You can continue to edit these projects afterwards with the previous version of WinCC.
- You upgrade existing projects and use the functions of the current WinCC version.

---

#### Note

##### WinCC functions

While editing a project of a previous WinCC version, you can only access the functions and HMI devices of this previous WinCC version.

---

#### Versions in WinCC

In WinCC, you work with different version types:

- WinCC version  
The WinCC version installed on the configuration PC, for example, WinCC V12.
- Project version  
Projects are created using the WinCC version that is installed on the configuration PC. While you are editing a WinCC project from a previous version in the current WinCC version, the version ID is displayed behind the project name in the project tree.
- Runtime version  
You can configure HMI devices with different runtime versions in WinCC. You specify the runtime version once for an HMI device. The device version must match the Runtime version.
- Device versions  
Depending on the used HMI device, the image is a combination of the operating system and / or runtime software. For each HMI device, WinCC provides various images which can be loaded onto the HMI device, if necessary, according to the configuration. The device version corresponds to a specific image. The device version must match the configuration.

### Compatibility of WinCC versions, Runtime versions and device versions

The figure below shows the interaction of versions in the TIA Portal:

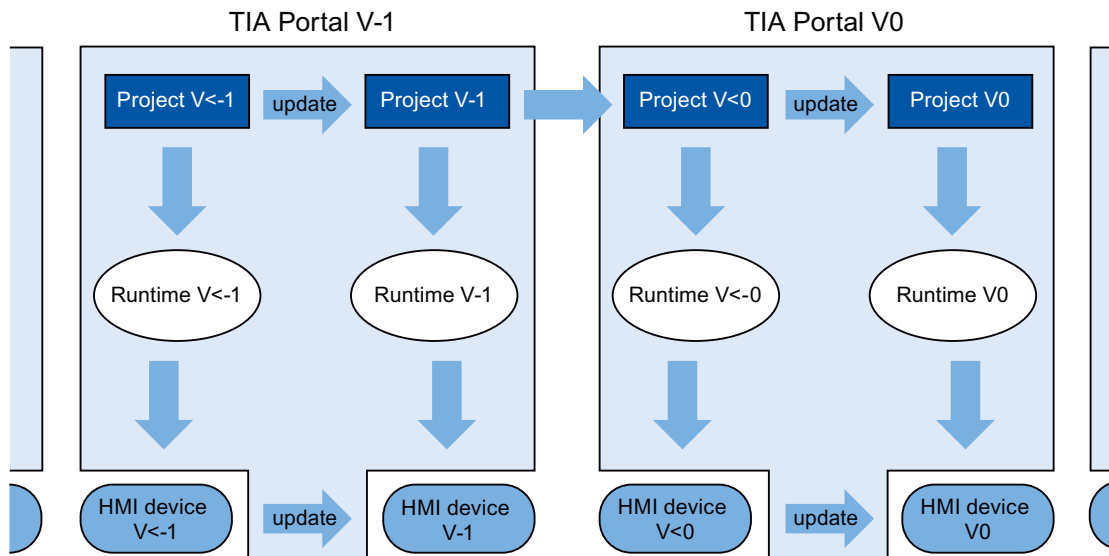

### Creating projects

After you create a new project in WinCC, open and edit it in the WinCC version in which you created it.

### Saving

To save a project of a predecessor WinCC version in this version again, save it in the usual way. If you manually upgrade the project to your WinCC version, please note that you will no longer be able to open the project in the previous WinCC version.

To save a project of the previous WinCC version in the current version, upgrade the project to your WinCC version. You can then no longer edit the project with a previous version of WinCC.

### Compiling, simulating and loading

If you are using a project of a previous WinCC version, you can use your current version to generate Runtime data for this previous version. This also allows you to load HMI devices that are no longer compatible with your WinCC version.

### Copying within projects with different WinCC versions

If objects and configurations are also available in the target version, copy these as required via the clipboard or using drag-and-drop.



## Opening, editing and saving projects of a previous WinCC version

You can open and edit projects of previous WinCC versions as required. In doing so, you only utilize the functions of the previous WinCC version. Once you have completed editing, you can once again save and edit the project in the previous WinCC version.

## Compiling, downloading and simulating projects of a previous WinCC version

You can compile, download and simulate projects of previous WinCC versions as required. Your current WinCC version will provide the Runtimes and device versions for the corresponding WinCC version.

### 10.12.9.2 Editing projects of a previous WinCC version

#### Introduction

WinCC provides the option of editing projects of a previous WinCC version. While editing a project of a previous WinCC version, you can only access the functions of this version. In order to use the functions of your current WinCC version for this project, upgrade the project to your WinCC version.

---

#### Note

If you upgrade a project to your WinCC version, please note that you will no longer be able to open and edit the project in the previous WinCC version.

---

#### Requirement

- A project of a previous WinCC version has been created.
- The current WinCC version is installed on the configuration PC.

#### Procedure

Proceed as follows to edit a project of a previous WinCC version:

1. Open the project.
2. Edit the project using the functions of the previous WinCC version.
3. Save the project.
4. Compile the project.
5. Download and simulate the project.
6. You can open the project in the previous WinCC version for further editing, if required.

## Result

The modified project data can be edited further on a different configuration PC with the previous WinCC version for further processing. The Runtime project was generated and downloaded in the corresponding Runtime version.

### 10.12.9.3 Upgrading projects

#### Introduction

If the project version is older than the WinCC version, the version ID is displayed in the project tree. Your WinCC version also contains the previous version that you can use to edit projects as required. In order to use the functions and options of your WinCC version in a project, upgrade the project to your WinCC version.

---

#### Note

##### WinCC version compatibility

If you upgrade a project to your WinCC version, please note that you will no longer be able to edit it with the previous WinCC version.

---

#### Requirements

- The project version is a predecessor of your WinCC version.
- You have write access to your project drive.
- The project drive provides sufficient storage capacity for another project of this size.

#### Procedure

Proceed as follows to upgrade a project to your WinCC version:

1. Select the project in the project tree.
2. Select the "Upgrade project" command from the shortcut menu of the project.  
A dialog opens.
3. Click "Confirm".  
The project closes and the progress bar is displayed.

A message is output when the project has been upgraded.

#### Result

- The project has been saved on the project drive in the previous WinCC version and with the corresponding file extension.
- The project is displayed on the project drive in the current WinCC version and with the corresponding file extension.
- The project is displayed without a WinCC version ID in the project tree.

### 10.12.9.4 Changing between device versions

#### Selection of the device version

When you configure a new HMI device, WinCC automatically selects the latest version of the device.

If you want to use a device version other than the one set in WinCC, transfer an image to the HMI device. WinCC provides the images required for the supported HMI devices.

Information on the device versions used in WinCC is available in the FAQs on the Internet, entry ID 21742389.

**NOTICE**

**Changing the device version deletes all data on the HMI device.**

Data is deleted on the target system if you change the device version. For this reason, you should save existing Runtime data before changing the device version.

#### HMI device configuration

The following figure shows the software components of an HMI device:

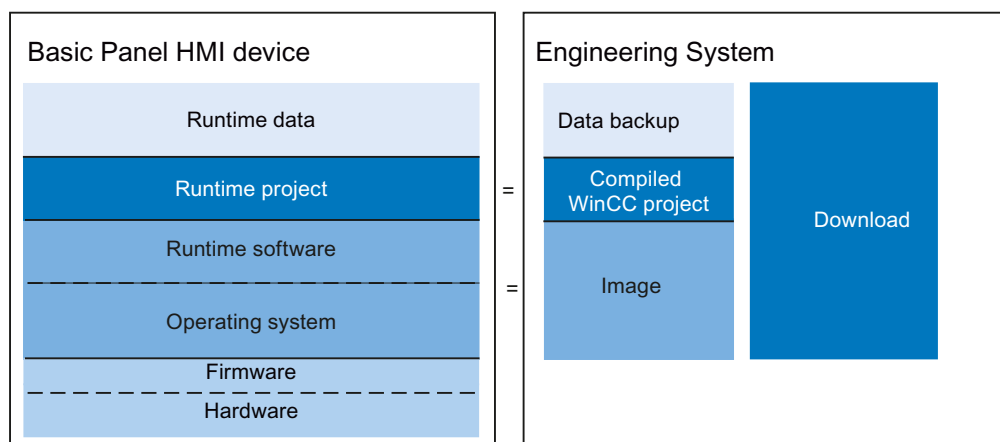

### 10.12.9.5 Changing the device version

#### Introduction

Depending on the required Runtime version, select the suitable device version for your configuration.

---

#### Note

##### Selection of device versions

The selection of available devices versions depends on the version of the project.

---

#### Requirements

- A project has been created and opened.
- The project contains an HMI device.

#### Procedure

To change the device version, follow these steps:

1. Double-click on "Devices & Networks" in the project tree.  
The editor opens.
2. Select the required HMI device from the device view.
3. Select "Change Device/Version" in the device shortcut menu of the HMI device.  
A dialog opens.
4. Select the required HMI device.
5. Select the required device version under "Version".
6. Confirm your selection with "OK".

#### Result

You have changed the device version in the WinCC project.

<b>NOTICE</b>
<b>Changing the device version deletes all data on the HMI device.</b>
All data is deleted from the HMI device when you change the device version and compile/download the project. You should therefore backup your Runtime data prior to the download.

## 10.12.10 Viewing memory card data

### 10.12.10. Basics

1

#### Introduction

WinCC provides you with the possibility of viewing data stored on your memory card. The function supports the use of memory cards of the HMI device and of the CPU.

You have the following options:

Viewing a backup (Page 5591)

Renaming and deleting backups (Page 5593)

Viewing HMI device images (Page 5594)

Deleting HMI device images (Page 5595)

Creating HMI device images on memory card (Page 5596)

#### See also

Viewing a backup (Page 5591)

Renaming and deleting backups (Page 5593)

Viewing HMI device images (Page 5594)

Deleting HMI device images (Page 5595)

Creating HMI device images on memory card (Page 5596)

### 10.12.10. Working with backups

2

#### Viewing a backup

#### Introduction

The backup of a Basic Panel that is stored on a memory card can also be viewed in the TIA Portal.

#### Requirements

- WinCC is installed.
- A memory card with a backup is available.
- The card reader is connected to the configuration PC.
- The project view is open.

### Backup on the memory card in the card reader

1. Insert the memory card into the card reader.
2. Open "SIMATIC Card Reader" in the project navigation.
3. Select the card reader drive.  
The "Online Card Data" folder is displayed.
4. Open the "Online Card Data" folder
5. Click the backup to open the shortcut menu.
6. Select "Properties".

### Backup on the memory card of the PLC

Proceed as follows if the backup is stored on the memory card of the PLC:

1. Connect the PLC with the configuration PC.
2. Click on the PLC in the project navigation.
3. Select "Connect online" from the shortcut menu.  
A connection to the PLC is established.  
Once the PLC is connected, the "Online Card Data" folder is displayed.
4. Open the "Online Card Data" folder.

---

#### Note

##### Accessing a password-protected PLC

When you attempt to access a PLC that is protected by a password, you will be prompted to enter the password.

You need at least read access rights in order to view the data that is stored on the memory card.

---

5. Click the backup to open the shortcut menu.
6. Select "Properties".

### Result

The backup properties are displayed in a separate dialog.

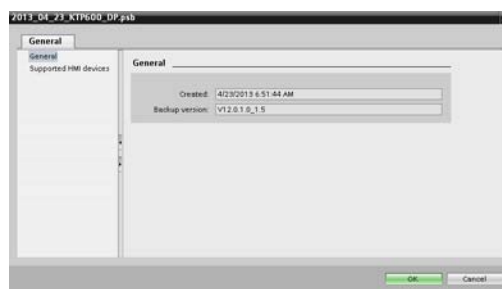

## See also

Renaming and deleting backups (Page 5593)

Basics (Page 5589)

## Renaming and deleting backups

### Introduction

You may rename and delete backups from a memory card in the project navigation of the TIA Portal.

### Requirements

- WinCC is installed.
- The card reader is connected to the configuration PC.  
The PLC is connected online with the configuration PC.
- A memory card with a backup is available.
- The project view is open.
- The backup is displayed in the project navigation.

---

#### Note

##### Accessing a password-protected PLC

When you attempt to access a PLC that is protected by a password, you will be prompted to enter the password.

You need write access rights to rename or delete memory card data.

---

### Procedure

1. Click on the backup in the project navigation.
2. Open the shortcut menu.
3. Select "Rename" to rename the file.
4. Enter a new name.
5. Select "Delete" to delete the file.

### Result

The backup file is now renamed or deleted.

## See also

Viewing a backup (Page 5589)

Basics (Page 5589)

### 10.12.10. Working with HMI device images

3

## Viewing HMI device images

### Introduction

The HMI device image of a Comfort Panel that is stored on a memory card can be viewed in the TIA Portal.

### Requirements

- WinCC is installed.
- The card reader is connected to the configuration PC.
- A memory card with the HMI device image is available.
- The project view is open.

### Procedure

1. Insert the memory card into the card reader.
2. Open "SIMATIC Card Reader" in the project navigation.
3. Select the card reader drive.  
The "Online Card Data" dialog is displayed.
4. Open the "Online Card Data" folder.  
The available images of the HMI device are displayed in additional folders.
5. Click the required HMI device image.
6. Select "Properties" in the shortcut menu.



## Result

The properties of the HMI device image are displayed in a separate dialog.

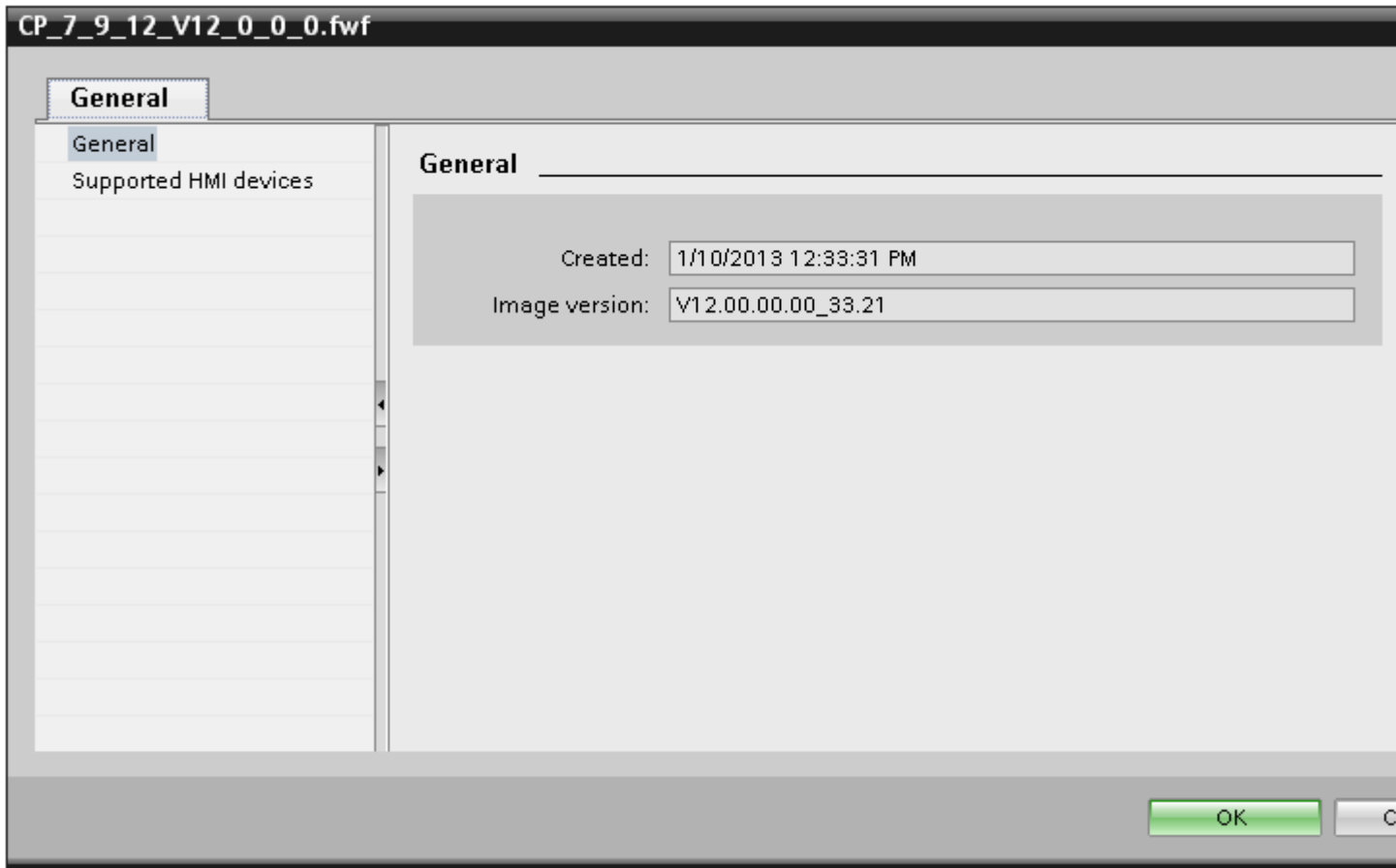

## See also

Deleting HMI device images (Page 5595)

Creating HMI device images on memory card (Page 5596)

Basics (Page 5589)

## Deleting HMI device images

### Introduction

You may delete the HMI device image of a Comfort Panel from a memory card in the project navigation of the TIA Portal.

## Requirements

- WinCC is installed.
- The card reader is connected to the configuration PC.
- A memory card with an HMI device image is available.
- The project view is open.
- The HMI device image is displayed in the project navigation.

## Procedure

1. Click the HMI device image in the project navigation.
2. Open the shortcut menu.
3. Select "Delete" to delete the file.

## Result

The HMI device image is deleted.

## See also

Viewing HMI device images (Page 5592)

Basics (Page 5589)

## Creating HMI device images on memory card

### Introduction

You may edit the HMI device image of a Comfort Panel without connecting the Comfort Panel to the configuration PC.

Simply create the HMI device image on an external memory card or USB stick and then transfer it from there to the Comfort Panel.

### Requirements

- WinCC is installed.
- The card reader is connected to the configuration PC.
- The project view is open.

### Procedure

1. Insert the memory card into the card reader.
2. Click on the memory card in the project navigation.
3. Open the shortcut menu.

4. Select "Create HMI OS image on memory card".  
A dialog opens.

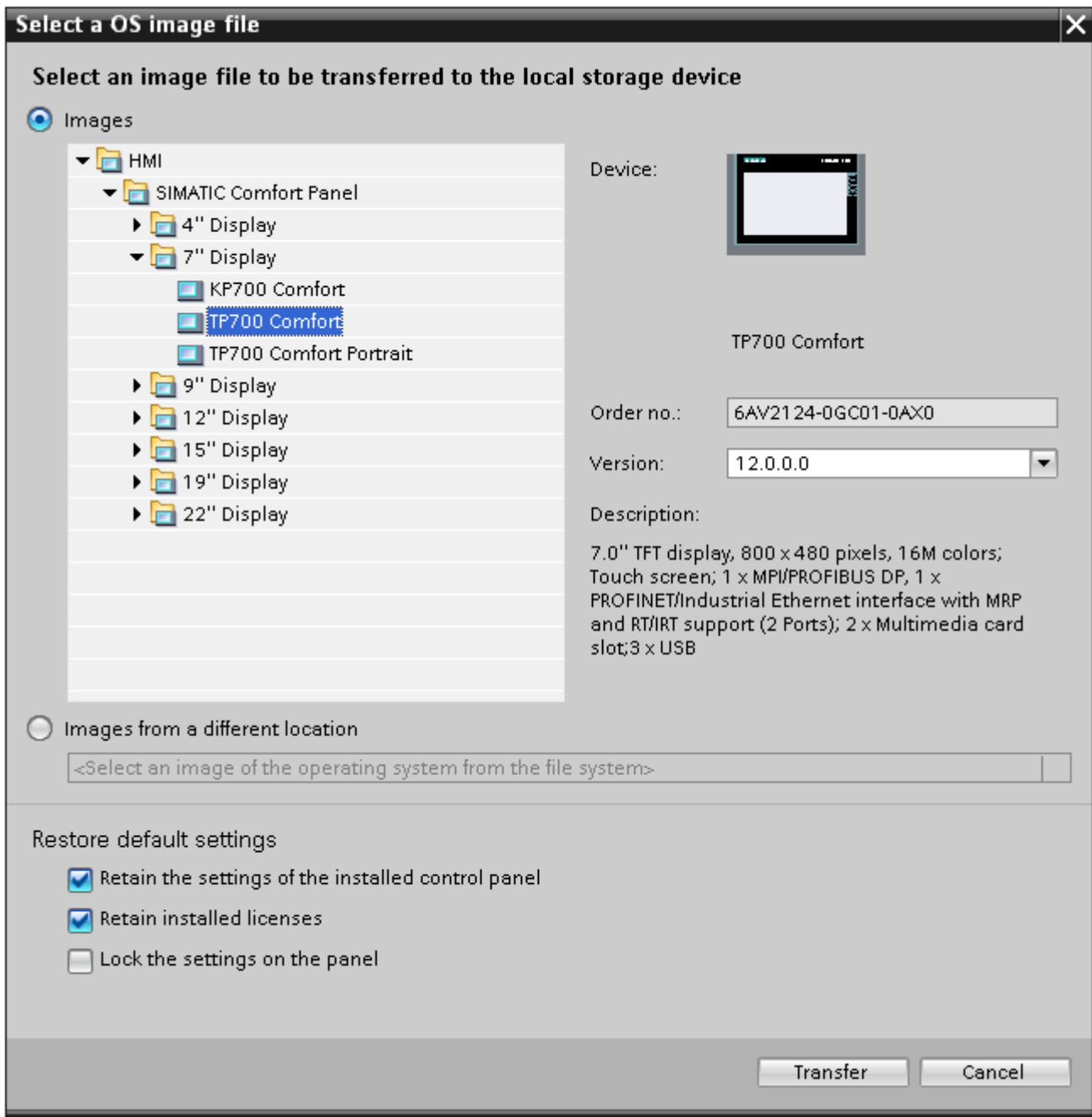

5. Select an HMI device image.
6. Select the settings for the restoration.
  - Activate "Retain installed settings of the Control Panel"  
The settings you have made on the Comfort Panel are retained.
  - Activate "Retain installed licenses":  
The licenses on the Panel are retained.
  - Activate "Lock settings on the Panel"  
You can no longer change the selected settings for "Retain installed settings of the Control Panel" and "Retain installed licenses" on the Comfort Panel.

## **Result**

You have created an HMI device images on memory card. You may use a USB stick instead of a memory card.

## **See also**

Viewing HMI device images (Page 5592)

Basics (Page 5589)

## 10.13 Compiling and loading

### 10.13.1 Compiling and loading projects

#### 10.13.1.1 Overview of compiling and loading projects

##### Overview

The project is compiled in the background even as you are configuring it in WinCC. This reduces the time for final compilation. When you start compilation, you create a file that can be run on the corresponding HMI device.

If an error occurs during compilation, WinCC provides support in locating and correcting it.

Once you have corrected any problems, you download the compiled project to the HMI devices on which the project is to run. If the configuration PC is not connected to the HMI device, save the compiled project on a data medium of your choice. The compiled project is then transferred from a PC connected to the HMI device to the HMI device.

If you are using HMI tags in your project that are connected to PLC tags, you should also compile all modified S7 blocks with the command "Compile > Software" in the shortcut menu before you compile the HMI device.

##### Project

The term "project" has two different meanings in the contexts of compilation and loading. "Project" is the WinCC project on the configuration PC. "Project" is also the Runtime project you create by compiling the configuration data of an HMI device and download to the HMI device.

- WinCC project: contains the configuration data of one or more HMI devices
- Runtime project: contains the compiled configuration data of an HMI device

The figure below illustrates the link between WinCC projects and Runtime projects using the example of the "Compile and load" process:

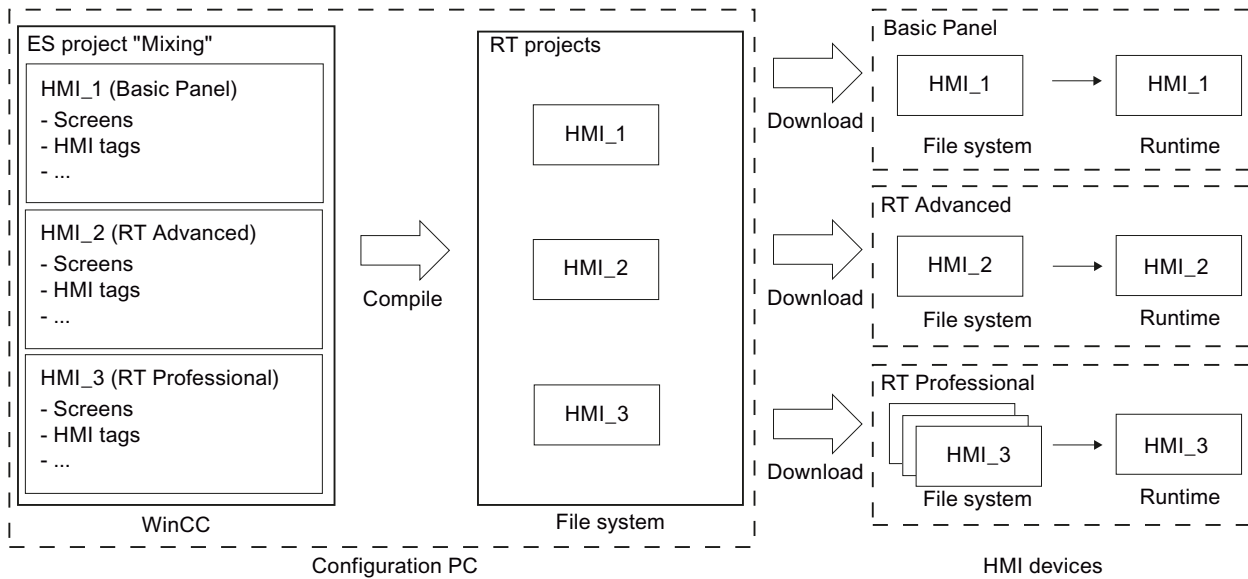

## Runtime

Runtime is the software for process visualization. In Runtime, you execute the project in process mode.

A distinction is made between two types of Runtime:

1. Runtime on a panel  
Before executing a Runtime project on a panel, you have to transfer the Runtime project to the panel before startup.
2. Runtime on a PC  
You can execute the Runtime project directly on the configuration PC if Runtime has been installed on the configuration PC.  
If you want to execute the Runtime project on a different PC, you have to transfer the Runtime project to the PC before startup.

## Runtime version

The Runtime version depends on the image of the configured HMI device. The Runtime version of the compiled project is displayed under "Info" in the Inspector window.

## Simulation

You test your configuration with a simulation. You can start a simulation without a link to the active process.

In a simulation, you test configured tags or screen changes, for example. During the simulation, the configured tags can be manipulated, activated and deactivated with the help of the tag simulator.

There are two types of simulation:

1. Simulating a panel  
If you created a panel in your project, the panel is displayed in the simulation. With the help of this type of simulation, you can test your configuration on the HMI device without transferring the project to the panel.
2. Simulating Runtime  
Simulating Runtime allows you to test the project directly on the configuration PC.

## See also

Generating a "Pack&Go" file (Page 5609)

Starting Runtime Advanced and Panels (Page 5616)

### 10.13.1.2 Compiling a project

#### Introduction

The changes made to the project are compiled in the background even as you are configuring a project in WinCC. Projects are compiled automatically when you load them. This ensures that the latest version of the project is loaded at all times.

WinCC checks consistency of the project during compilation. The error locations in the project are listed in the Inspector window. You can jump directly to the source of the error from the entry in the Inspector window. Check and correct errors found.

#### Scope of the compilation

Configuration data is compiled in the background as soon as you start configuring an HMI device. If you compile a project manually, only the changes in the configuration made since the last compilation process are compiled in the background.

You can start complete project compilation manually at any time; this may, for example, be done to test the consistency of the configured data.

#### Requirement

- A project is open.

#### Procedure

Proceed as follows to compile a project:

1. If you want to compile several HMI devices at the same time, select all the relevant HMI devices with multiple selection in the project navigation.
2. Compile the project:
  - For delta compilation of the project, select the "Compile > Software" command from the shortcut menu of the HMI device.
  - To compile all project data, select the "Compile > Software (compile all)" command from the shortcut menu.

## **Result**

The configuration data of all selected HMI devices is compiled. Any errors that occur during compilation are shown in the Inspector window.

### **10.13.1.3 Loading projects**

#### **Overview for loading of projects**

##### **Overview**

Delta data of the project is automatically compiled before you download it to one or several HMI devices. This always ensures that the latest version of the project is transferred.



## Loading a project to an HMI device

The following steps are completed prior to downloading:

1. The download settings are verified. The "Extended loading" dialog box is opened automatically during the initial download of a project to an HMI device. You use this dialog to define the protocol and interface or destination path for the project in accordance with the HMI device Runtime used.  
If, for example, the HMI device is part of a subnetwork, you also select the subnetwork and the 1st gateway.  
You can open the "Extended download" dialog at any time with the menu command "Online > Advanced download to device...".  
The "Load preview" dialog opens.
2. The project is compiled. Warnings and errors during compilation are displayed in the Inspector window and in the "Load preview" dialog.
3. The "Load preview" dialog shows you the following information for each HMI device:
  - The individual steps for loading
  - If the device version of the target HMI device does not match the configured device version, you are asked whether you wish to change the device version at this time.

### NOTICE

#### Changing the device version deletes all data on the HMI device.

Data is deleted on the target system if you change the device version. For this reason, you should first back up the following data:

- User administration
- Recipes

Resetting to factory settings also deletes the license keys. Back up the license keys before you reset the system to factory settings.

- Presettings that take effect at loading. You can change the default settings for this download process, if necessary.
- Warning events (optional). You can download a project while ignoring the "warnings". The functionality may be restricted in runtime.
- Error events (optional). You cannot load the project. Eliminate the errors and then reload the project.  
WinCC will open the invalid configuration in the corresponding editor if you double-click the error message in the Inspector window. Correct the errors and reload the project.

If you are using HMI tags in your project that are connected to PLC tags, you should also compile all modified S7 blocks with the command "Compile > Software" in the shortcut menu before you compile the HMI device.

### Loading a project without a connected HMI device

If you cannot establish a direct connection from the configuration PC to the HMI device, save the compiled project on a data medium of your choice. Additional steps depend on the Runtime used:

- Panel Runtime: Copy the compiled project to a PC connected to the HMI device, for example, via a network. Download the project from this PC to the HMI device ("Pack&Go").
- Runtime Advanced: Move the compiled project to the HMI device.

### Loading with S7 routing

Configure the S7 routing settings in the "Devices & Networks" editor in the relevant PLC. The settings depend on the device configured.

S7 routing supports the following protocols:

- MPI/PROFIBUS
- Ethernet

### See also

Loading a project (Page 5604)

Generating a "Pack&Go" file (Page 5609)

### Loading a project

#### Introduction

Before a project can run on an HMI device, you must first load it to the HMI device. During loading, you must most importantly specify whether existing data on the HMI device such as "user administration" and "recipe data" is to be overwritten.

If the HMI device supports PROFINET, the name of the HMI device registered in the project tree is used as the device name for the PROFINET communication. The name is written during download to the HMI device. If a device name for the PROFINET communication has already been entered in the HMI device, it will be overwritten.

As a general rule, only one project can be active in Runtime on an HMI device. An HMI device is generally configured to exit Runtime automatically when loading is started. If this is not the case, you will have to exit Runtime manually on the HMI device.

You can alternatively enable the "Remote" option in the transfer settings in the control panel of the HMI device. This will then allow you to load a project to the HMI device without first having to set the transfer mode manually on the HMI device.

---

If the device version of the target HMI device does not match the configured device version, you are asked whether you wish to change the device version at this time.

---

**Note**

If your HMI device is a PC, the device version of the target system is not automatically updated during the download.

Verify that the configured device version corresponds to the one of the target HMI device before you compile and download your project. If necessary, install the matching Runtime version on your HMI device or change the device version manually using the properties of the HMI device.

---

**NOTICE****Changing the device version deletes all data on the HMI device.**

Data is deleted on the target system if you change the device version. For this reason, you should first back up the following data:

- User administration
- Recipes

Resetting to factory settings also deletes the license keys. Back up the license keys before you reset the system to factory settings.

---

Please refer to the documentation for the HMI device used for more detailed information on transfer settings.

---

**Note****Closing Runtime automatically**

If automatic transfer is enabled on the HMI device and a transfer is started on the configuration PC, the running project is automatically stopped.

The HMI device then switches autonomously to "Transfer" mode.

After the commissioning phase, disable the automatic transfer function to prevent the HMI device from switching inadvertently to transfer mode.

Transfer mode can cause undesired reactions in the system.

To block access to the transfer settings and thus avoid unauthorized changes, assign a password in the Control Panel.

---

**Note****Transfer to an HMI device with WinAC MP**

The "PN/IE" channel is not approved for the project transfer on HMI devices with WinAC MP.

Use the "Ethernet" channel instead of "PN/IE" to transfer data to an HMI device that is running PLC WinAC MP.

---

## Requirement

- You have created an HMI device in the project.
- The HMI device is connected to the configuration PC.
- Transfer mode is set in the HMI device.

## Procedure

Proceed as follows to load a project:

1. To download a project simultaneously to several HMI devices, select the HMI devices by means of multiple selection in the project tree.
2. Select the "Download to device > Software" command from the shortcut menu of the HMI device.
3. If the "Extended loading" dialog is open, configure the "Settings for loading". Make sure that the "Settings for loading" correspond to the "Transfer settings in the HMI device".
  - Select the protocol used, for example, Ethernet or HTTP.
  - Configure the relevant interface parameters on the configuration PC.
  - Make any interface-specific or protocol-specific settings required in the HMI device.
  - Click "Download".

You can open the "Extended download" dialog at any time with the menu command "Online > Advanced download to device...".

The "Load preview" dialog opens. The project is compiled at the same time. The result is displayed in the "Load preview" dialog.

4. Check the displayed presettings and change them as necessary.
5. Click "Download".

## Result

The project is loaded to all selected HMI devices. If errors or warnings occur during the download, corresponding alarms are displayed under "Info > Load" in the Inspector window.

On completion of the successful download of the project, you can execute it on the HMI device.

## See also

Error messages during the download of projects (Page 5635)

Overview for loading of projects (Page 5600)

## Loading projects to a file

### Introduction

Load the Runtime project to the file system of your PC if that is your HMI device. Double-click the Runtime project to open it in runtime.

During loading, you must most importantly specify whether existing data on the HMI device such as "user administration" and "recipe data" is to be overwritten.

If the HMI device supports PROFINET, the name of the HMI device registered in the project tree is used as the device name for the PROFINET communication. The name is written during download to the HMI device. If a device name for the PROFINET communication has already been entered in the HMI device, it will be overwritten.

As a general rule, only one project can be active in Runtime on an HMI device. An HMI device is generally configured to exit Runtime automatically when loading is started. If this is not the case, you will have to exit Runtime manually on the HMI device.

You can alternatively enable the "Remote" option in the transfer settings in the control panel of the HMI device. This will then allow you to load a project to the HMI device without first having to set the transfer mode manually on the HMI device.

---

**Note****Device version**

If the device version of the target HMI device does not correspond to that of the configured device version, Runtime cannot be started after loading.

Verify that the device version of the target HMI device conforms to your configuration before you compile and download your project.

If necessary, change the device version manually via the properties of the HMI device.

**NOTICE****Changing the device version deletes all data on the HMI device.**

Data is deleted on the target system if you change the device version. It is therefore advisable to generate a backup copy of the Runtime data prior to such actions.

Please refer to the documentation for the HMI device used for more detailed information on transfer settings.

---

**Note****Closing Runtime automatically**

If automatic transfer is enabled on the HMI device and a transfer is started on the configuration PC, the running project is automatically stopped.

The HMI device then switches autonomously to "Transfer" mode.

After the commissioning phase, disable the automatic transfer function to prevent the HMI device from switching inadvertently to transfer mode.

Transfer mode can cause undesired reactions in the system.

To block access to the transfer settings and thus avoid unauthorized changes, assign a password in the Control Panel.

---

## Requirement

- You have created an HMI device in the project.
- The HMI device is a PC.
- The HMI device is connected to the configuration PC.
- Transfer mode is set in the HMI device.

## Procedure

Proceed as follows to load a project to a file:

1. Select the project in the project tree.
2. Select the "Download to device > Software" command from the shortcut menu of an HMI device.
3. If the "Extended loading" dialog is open, configure the "Settings for loading". Make sure that the "Settings for loading" correspond to the "Transfer settings in the HMI device".
  - Select the "Type of the PG/PC interface > File" dialog,
  - Select "PG/PC interface > File system" in the dialog,
  - Select the file system path under "destination path".
  - Click "Download".You can open the "Extended download" dialog at any time with the menu command "Online > Advanced download to device...".  
The "Load preview" dialog opens. The project is compiled at the same time. The result is displayed in the "Load preview" dialog.
4. Check the displayed presettings and change them as necessary.
5. Decide whether to overwrite user administration data and/or recipe data on the HMI device.
6. Click "Download".

## Result

The Runtime is loaded to the file system. If errors or warnings occur during the download, corresponding alarms are displayed under "Info > Load" in the Inspector window.

On completion of the successful download of the project, you can execute it on the HMI device.

Double-click the Runtime project file on the target system to launch the Runtime project.

## Generating a "Pack&Go" file

### Introduction

Create a "Pack&Go" file if you cannot connect the HMI device to the configuration PC. The "Pack&Go" file is a ZIP file containing the following data:

- The compiled project
- A program for transferring the project to the HMI device
- Image for the configured HMI device

Typical example of an application: An engineering company creates a project variant for a new HMI device. The project engineer of the engineering company does not have direct access to the plant. The project engineer therefore e-mails the "Pack&Go" file to his local contact. The contact unpacks the "Pack&Go" file on a PC connected to the HMI device via a network. He then transfers the project from the PC to the HMI device.

### Requirement

- You have created an HMI device in the project.

### Procedure

To create a "Pack&Go" file, follow these steps:

1. Select the HMI device in the project tree.
2. Select the "Pack&Go" command from the menu under "Online > HMI device maintenance".
3. The "Create Pack&Go file" opens.
4. Verify that the displayed device version corresponds with that of the target HMI device.
5. Select a protocol as transfer mode.
6. Select the storage location under "Pack&Go file" and enter the file name.
7. If necessary, specify if the "Pack&Go" file is split into several files.
8. Click "Create".

---

#### Note

To unzip a "Pack&Go" file which is distributed over several files, you need a compression program. The compression program integrated into the operating system is not adequate to unzip distributed files.

---

### Result

The "Pack&Go" file is created and saved to the specified folder in the file system. Now copy the "Pack&Go" file to the PC connected to the HMI device.

## See also

Downloading projects from a "Pack&Go" file to the HMI device (Page 5610)

## Downloading projects from a "Pack&Go" file to the HMI device

### Requirement

- .NET Framework with V2.0.50727
- The "Pack&Go" file has been stored in the file system of a PC.
- The PC is connected to the HMI device.
- The device version of the HMI device is consistent with the device version in the project

---

### Note

To unzip a "Pack&Go" file which is distributed over several files, you need a compression program. The compression program integrated into the operating system is not adequate to unzip distributed files.

---

### Procedure

To download the project from a "Pack&Go" file to an HMI device, follow these steps:

1. Unpack the "Pack&Go" file to a folder of your choice in the file system of the PC.
2. From the "PackNGo" subfolder of this directory, run "Siemens.Simatic.Hmi.PackNgo.exe". The "Pack'n Go" dialog opens. The settings for loading are set by default. Exception: You must select the target device if you are using an S7 USB connection.
3. Adjust the settings for loading appropriately if they differ from the interfaces or protocols available on the PC.
4. Specify whether or not to overwrite the user management and recipe data already stored on the HMI device.
5. If necessary, edit the "settings for loading".
6. Click "Transfer".

### Result

The connection to the HMI device is set up via the selected path. An alarm is output if the device version used in the project differs from that of HMI device.

If this is the case, update the operating system on the HMI device. To update the operating system on the HMI device, you need ProSave. A prompt for operating system update will appear automatically if ProSave has been installed and the selected connection supports the update of the operating system.



## See also

Generating a "Pack&Go" file (Page 5607)

Updating the operating system (Page 5629)

Updating the operating system on the HMI device (Page 5630)

## Loading via USB interface

### Introduction

When you load a project via a USB port, connect the configuration PC and the HMI device with a USB cable. You load projects in both directions.

### Requirements for transfer via USB

The following conditions must be met to ensure successful data transfer using a USB port:

- Use a USB host-to-host cable, USB 2.0 standard.
- You have installed the provided USB driver.  
You can find the driver on the WinCC product DVD under "Support\DeviceDriver\USB".
- The HMI device being used is based on Windows CE and has a USB port.

You can find more information on the cables used and the manufacturers/suppliers in the Internet at:

- <http://support.automation.siemens.com> (<http://support.automation.siemens.com/WWW/view/en/19142034>)

---

#### Note

##### Driver installation

To avoid problems when transferring projects, only use the USB driver provided on the WinCC product DVD.

---

#### Note

##### Comfort HMI devices

Use the mini USB port to load projects via USB with Comfort HMI devices. This driver is installed automatically.

---

## Restrictions

A project can always be transferred to an HMI device. The simultaneous transfer to several HMI devices is not possible.

## Installing a USB driver in Windows XP

### Introduction

To load a project via the USB port, install the USB drivers provided on the WinCC product DVD.

---

#### Note

##### Driver installation

To avoid problems when transferring projects, only use the USB driver provided on the WinCC product DVD.

---

#### Note

Comfort HMI devices

Use the mini USB port to load projects via USB with Comfort HMI devices. This driver is installed automatically.

---

### Requirement

- The WinCC product DVD is available.
- You are using a USB host-to-host cable, USB 2.0 standard.
- The HMI device has a USB port.

### Procedure

To install the USB driver under Windows XP, follow these steps:

1. Connect the USB host-to-host cable to the USB port of the configuration PC.  
The USB cable is automatically detected by the hardware detection under Windows XP.  
The driver installation wizard starts automatically.

---

#### Note

Connect the HMI device only when the driver has been completely installed on the PC.

---

2. If you are prompted with "Can Windows connect to Windows Update to search for software", select "No, not this time" and click "Next".
3. Select "Install software from a list or specific source" and click "Next".
4. Select "Search removable media".
5. Insert the WinCC product DVD into the DVD drive and click "Next".  
The system will search the WinCC product DVD for the corresponding driver for the USB host-to-host cable.  
The drivers available on the WinCC product DVD are displayed. The wizard highlights the appropriate driver for Windows XP.

6. Check the selection and click "Next".

---

**Note**

The "Hardware installation" dialog box indicates that the software found has not passed Windows Logo testing. The Logo test does not have any effects on the functioning of the USB driver. Continue with the installation.

---

7. Click "Hardware Installation > Continue installation".  
The driver is installed.
8. Click "Finish".  
The installation is complete.

## Result

The driver for the USB host-to-host cable has been installed. To load the project, connect the HMI device to the USB cable.

## Installing a USB driver in Windows 7

### Introduction

To load a project via the USB port, install the USB drivers provided on the WinCC product DVD.

---

**Note**

**Driver installation**

To avoid problems when transferring projects, only use the USB driver provided on the WinCC product DVD.

---

---

**Note**

**Comfort HMI devices**

Use the mini USB port to load projects via USB with Comfort HMI devices. This driver is installed automatically.

---

### Requirement

- The WinCC product DVD is available.
- You are using a USB host-to-host cable, USB 2.0 standard.
- The HMI device has a USB port.

## Procedure

To install the USB driver under Windows 7, follow these steps:

1. Connect the USB host-to-host cable to the PC's USB port.  
The USB cable is detected, but the wizard for the driver installation does not find the driver.

---

### Note

Connect the HMI device only when the driver has been completely installed on the PC.

---

2. Open the Device Manager in the Control Panel.
3. Select "Other devices > USB host-to-host cable".
4. Select "USB host-to-host cable" and then select "Update driver software..." in the shortcut menu.
5. When the "How do you want to search for driver software?" prompt appears, select "Search for driver software on the computer".
6. Click "Update driver software > Browse...".
7. Insert the WinCC product DVD as the source for driver installation.
8. Select "Include subfolders" and then click "Next".  
The system will search the WinCC product DVD for the corresponding driver for the USB host-to-host cable.  
The drivers available on the WinCC product DVD are displayed. The wizard highlights the appropriate driver for Windows 7.
9. Check the selection and click "Next".
10. To continue with the installation, click "Hardware Installation > Continue installation".  
The driver is installed.
11. Click "Finish".  
The installation is complete.

## Result

The driver required for the USB host-to-host cable has been installed. To load the project, now connect the HMI device to the USB cable.

### 10.13.1.4 Runtime start

## Starting Runtime on the configuration PC

### Introduction

You can start a project in Runtime on the configuration PC if Runtime has been installed. The project settings defined in the "Runtime settings" of the HMI device are activated when the project is started in Runtime.

---

#### Note

You can only simulate HMI devices with Runtime Panels on the configuration PC. Select the "Online > Start simulation" menu command.

---

#### Note

##### Ending Runtime automatically

If automatic transfer is activated on the HMI device and if a transfer is started on the configuration PC, the running project is automatically ended.

The HMI device then switches autonomously to the "Transfer" operating mode.

Deactivate automatic transfer after the commissioning phase so that the HMI device does not inadvertently go into transfer mode.

Transfer mode can cause undesired reactions in the system.

In order to restrict access to the transfer settings and thus avoid unauthorized changes, enter a password in the control panel.

---

### Requirement

- A project is open on the configuration PC.
- Runtime is installed on the configuration PC.
- There is no project in Runtime on the configuration PC.

### Procedure

To start runtime on the configuration PC, follow these steps:

1. Select the desired HMI device in the project navigation.
2. Select the "Online > Start Runtime" menu command.

### Result

Runtime is started and the project is displayed on the configuration PC.

## See also

Simulating a project (Page 5619)

## Starting Runtime Advanced and Panels

### Introduction

You can start the project in Runtime as soon as you have downloaded the project to the HMI device. The project is generally started automatically on the HMI device.

There may be several projects in the file system of the HMI device for HMI devices with Runtime Advanced. You can start one of these projects in Runtime.

The project settings defined in the "Runtime settings" of the HMI device are activated when the project is started in Runtime. Make sure when defining the Runtime settings "Lock task switching" and "Full screen" that you will be able to stop Runtime again. You can, for example, configure a button with the system function "StopRuntime".

---

### Note

#### Ending Runtime automatically

If automatic transfer is activated on the HMI device and if a transfer is started on the configuration PC, the running project is automatically ended.

The HMI device then switches autonomously to the "Transfer" operating mode.

Deactivate automatic transfer after the commissioning phase so that the HMI device does not inadvertently go into transfer mode.

Transfer mode can cause undesired reactions in the system.

In order to restrict access to the transfer settings and thus avoid unauthorized changes, enter a password in the control panel.

---

### Requirement

- WinCC Runtime Advanced or Panels is installed on the HMI device.
- The project was downloaded to the HMI device

## Starting Runtime on a PC

The compiled project is saved in the PC file system with the extension "\*.fwc" and is freely accessible.

1. To start the project once the HMI device has booted up, enter the automatic start of a project file under "Settings" in the "RT Loader" ("HmiLoad.exe").  
You can also create a link to the project file in the Windows Autostart directory.

## Starting Runtime on a panel

The project will be stored on a panel in a folder you specify in the HMI device transfer settings. The "RT Loader" application is started on a panel. The project loaded is started automatically after expiration of the configured delay.

If the project does not start automatically:

1. Click on "Start" to start the loaded project.

Refer to the documentation for the HMI device for additional information on startup of projects.

## Result

Runtime is started on the HMI device.

## See also

Overview of compiling and loading projects (Page 5597)

Loading a project (Page 5602)

Downloading projects from a "Pack&Go" file to the HMI device (Page 5608)

## 10.13.2 Simulating projects

### 10.13.2.1 Simulation basics

#### Introduction

You can use the simulator to test the performance of your configuration on the configuration PC. This allows you to quickly locate any logical configuration errors before productive operation.

You can start the simulator as follows:

- In the shortcut menu of the HMI device or in a screen: "Start simulation"
- Menu command "Online > Simulation > [Start|With tag simulator|With script debugger]"
- Under "Visualization > Simulate device" in the portal view.

## Requirement

The simulation/runtime component is installed on the configuration PC.

## Field of application

You can use the simulator to test the following functions of the HMI system, for example:

- Checking limit levels and alarm outputs
- Consistency of interrupts
- Configured interrupt simulation
- Configured warnings
- Configured error messages
- Check of status displays

## See also

Simulating a screen (Page 5621)

WinCC Runtime Advanced simulation (Page 5618)

Working with the tag simulator (Page 5621)

### 10.13.2.2 WinCC Runtime Advanced simulation

#### Introduction

There are two different simulation modes for Runtime Advanced simulation:

- Device simulation
- Tag simulation

Both types of simulation simulate the project without a direct process link to the configuration PC. Data such as logs or recipes generated during simulation are not deleted. This data is saved on the configuration PC in the paths configured in the project.

#### Device simulation

Use device simulation to simulate operator control of the HMI device. Device simulation is, for example, used to test screen switching.

#### Tag simulation

Use tag simulation to simulate the configured process tags. You can either have tag values generated automatically by a simulation table or define tag values yourself.



**See also**

- Simulation basics (Page 5615)
- Simulating a project (Page 5619)
- Start debugger (Page 5623)

**10.13.2.3 Simulating a project****Introduction**

You simulate your project with one of the following two methods:

- Without a connected PLC  
You change the value of area pointers and tags in a tag simulator that is read for the simulation of WinCC Runtime.
- With a connected PLC without a running process  
You simulate your project by running it directly in Runtime. The tags and area pointers become active. This allows you to create an authentic simulation of your configured HMI device in Runtime.

---

**Note****Simulation restrictions**

You cannot simulate the following system functions:

- CalibrateTouchScreen

You cannot simulate the Media Player. A static screen appears in the simulation window instead of the Media Player.

File access via scripts is not possible for HMI devices with Windows CE.

---

**Requirement**

- Simulation without a connected PLC: Tags have been created
- Simulation with a connected PLC but no active process: A project with tags and area pointers has been created

**Procedure**

To simulate a project using the tag simulator, follow these steps:

1. Open the project on the configuration PC.
2. Select the "Online > Simulation > With tag simulator" menu command.  
For initial project simulation, the simulator is started with a new, empty table. The project is opened simultaneously in Runtime.  
Toggle between the tag simulator and Runtime using the <Alt +Tab> key combination.
3. To simulate a process value, select the corresponding "tag" from the tag simulator.  
The table lists all configured tags. You can simulate up to 300 tags simultaneously.

10.13 Compiling and loading

4. Select the simulation mode in the "Simulation" column.
5. Change the value of tags and area pointers in the respective columns.
6. Activate the "Start" check box to start the simulation for this tag.
7. To save the simulation, select the menu command "File > Save" and enter a descriptive name, for example, "Mixing".  
The file name is assigned the extension "\*.cors".

**Result**

The process values are simulated in Runtime. The tag values are created at random, or incremented, depending on the simulation mode.

To specify tag values, change the simulation mode to "<Display" and enter a value at "Set value".

The following figure shows a tag simulator with four tags whose values can be determined at random in a range of values from 10 to 1000:

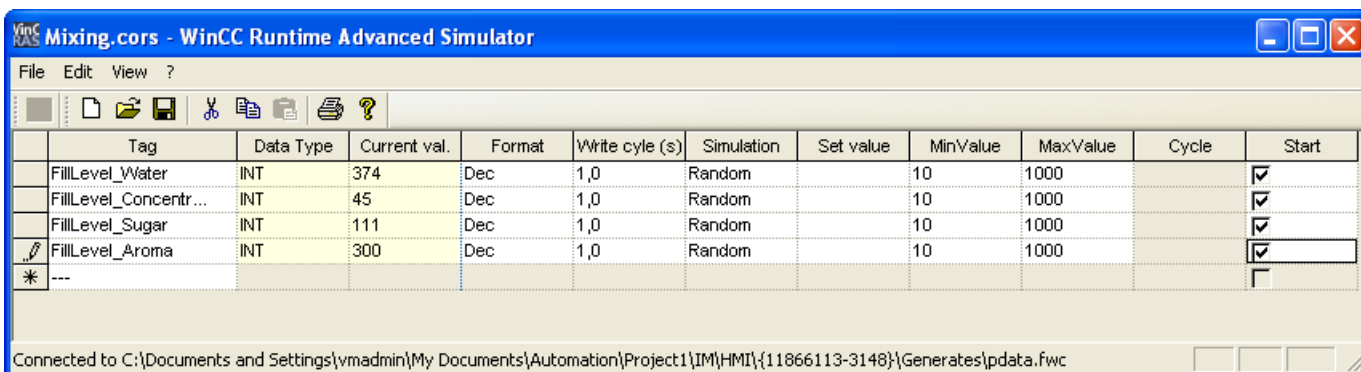

**Managing simulation data**

If you have saved data from a previous simulation, you can open the file at a later point in time and simulate your project again. The tags and area pointers listed in the tag simulator must still be available in the project.

Proceed as follows to open a simulation file:

1. Select the menu command "Online > Simulate Runtime > With tag simulator".
2. Select the menu command "File > Open" in the tag simulator.
3. Select the corresponding simulation file and click "Open".  
The simulator loads the stored data.

**Enabling and disabling tags**

Start and stop the simulation for each tag separately in order to facilitate the transition from offline to online engineering. Activate "Start" in the corresponding row.

If a tag is activated, the simulation values are calculated and transferred to the WinCC simulator.

## Deleting a tag

To delete a tag from the tag simulator, follow these steps:

1. Select the cell that contains the tag name.
2. Select the "Edit > Cut" menu command.  
The tag is removed from the table.

### 10.13.2.4 Simulating a screen

#### Introduction

If you have only made changes to one screen, you can temporarily specify this screen as the start screen for simulation. In this way, you can debug changes without having to modify the start screen, or opening the screen on the HMI device.

#### Requirements

You created a project that contains at least one screen.

#### Procedure

To define a screen as temporary start screen for simulation, follow these steps:

1. In the project navigation, select the image to display as the start screen in the simulation.
2. Select the "Start simulation" command from the shortcut menu of the screen.

#### Result

Project simulation is started. Instead of the configured start screen, the simulation window shows the screen you selected in the project navigation.

#### See also

Simulation basics (Page 5615)

### 10.13.2.5 Working with the tag simulator

#### About the tag simulator

The tag simulator has the following columns:

Column	Description
Tag	Specifies the tags for the simulation.
Data type	Shows the data type of the selected tag.
Current value	Shows the simulated value of the defined tags.

Column	Description
Format	Specifies the selected format in which the tag values are simulated: <ul style="list-style-type: none"> <li>• Decimal (1, 2, 3, 4, ...)</li> <li>• Hexadecimal (03CE, 01F3, ...)</li> <li>• Binary (0 and 1)</li> </ul>
Write cycle	Specifies the selected time interval at which the current tag values are simulated. If you enter "2", for example, the current value of the tag will be shown every 2 seconds.
Simulation	Shows the method by which the tag values are processed during simulation.
Set value	Sets the selected value for the respective tag. The simulation start with the specified value.
minValue maxValue	Specifies the value range of the tag. You set a minimum and maximum value for this range. The default values are -32768 for the minimum and 32767 for the maximum.
Period	Contains the period during which the value of the tag is repeated for the "Increment" and "Decrement" simulation modes.
Start	Starts simulation of the tag based on the previously entered information.

### Simulation modes

The simulator has six different simulation modes. The configured tags are supplied with nearly realistic values during the simulation.

Simulation mode	Description
Sinusoidal	Changes the tag value to form a sinusoidal curve. The value is visualized as a periodic, non-linear function.
Random	Provides randomly generated values. The tag value is changed by means of a random function.
Increment	Increases the value of the tag continuously up to a specified maximum value. Begins again at the minimum after the maximum has been reached. The value trend corresponds to a positive saw-tooth curve.
Decrement	Reduces the value of the tag continuously down to a specified minimum value. Begins again at the maximum after the minimum has been reached. The value curve corresponds to a negative saw-tooth curve.
Shift bit	Shifts a set bit continuously by one position. The previous position is always reset. This lets you test the alarms of an HMI device, for example.
<Display>	The current tag value is displayed statically.

### Example: Simulate tags with the "Shift bit" simulation mode

Proceed as follows to simulate tags with the "Shift bit" simulation mode:

1. Open the project you want to simulate.
2. Select the menu command "Online > Simulate Runtime > With tag simulator".  
The tag simulator opens.
3. In the "Tag" column, select a tag from your project.
4. Select "Bin" in the "Format" column.
5. Enter the value "1" in the "Write cycle" column.

6. Select the "Shift bit" simulation mode in the "Simulation" column.
7. Enter the value "1" in the "Set value" column.
8. Enable the tag with the "Start" check box.

## Result

The simulator tests the selected tag bit-by-bit as follows:

Simulation values	Byte for alarms
Set start value	00000001
1. Simulation value	00000010
2. Simulation value	00000100
3. Simulation value	00001000
....	...

In Runtime you see if the desired alarm is output at a given value.

### 10.13.2.6 Simulation restrictions

#### Alarms with dynamic parameters

If you use tags or text lists as external tags for alarm, the alarms are not displayed.

Only internal tags are enabled for the simulation of alarms in the tag simulator .

You can use PLCSim to simulate dynamic parameters.

### 10.13.2.7 Start debugger

#### Introduction

Select the "With script debugger" script mode to test scripts. The debugger allows you to set breakpoints in the code, for example, or implement a script step by step.

#### Requirements

- A debugger that supports VBS is installed on the Engineering Station, e.g. "MS Script Debugger".
- WinCC Runtime is installed on the Engineering Station.
- A project is open.

### Procedure

1. Select the "Online > Simulation > With script debugger" menu command.  
The Runtime software searches for debuggers installed on the Engineering Station.
2. If several debuggers are found, click on a selected.

### Result

The debugger is connected automatically with the runtime software.

## 10.13.3 Servicing the HMI device

### 10.13.3.1 Overview of HMI device maintenance (Basic Panels)

#### Configuration

The following figure shows the software components of an HMI device and their relation to the Engineering System.

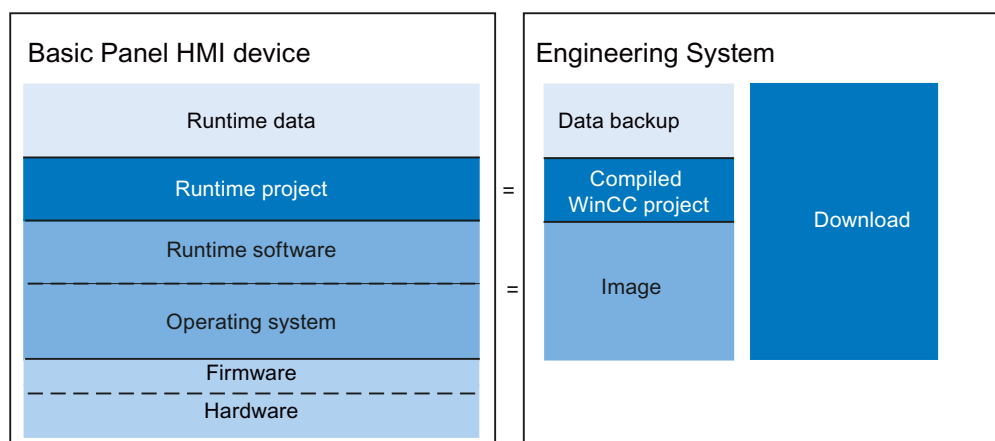

#### Runtime data

The runtime data is generated during operation of the plant and saved to the HMI device. This includes recipes and user administration data, for example. This data is overwritten during the download. If required, back up this data before you download a Runtime project.

#### Runtime project

The Runtime project contains the compiled configuration data for an HMI device. You download the Runtime project from WinCC to the HMI device.

## Runtime software and operating system

Together, the Runtime software and operating system of an HMI device form the image. Different images are available for the HMI device. All images of an HMI device are available in WinCC. Depending on the configuration, download the appropriate image along with the Runtime project to the HMI device as required.

## Firmware and hardware

The HMI device is delivered with preconfigured firmware and hardware.

### 10.13.3.2 Overview of HMI device maintenance tasks (Basic Panels)

#### Configuration

The following figure shows the software components of an HMI device and their relation to the Engineering System.

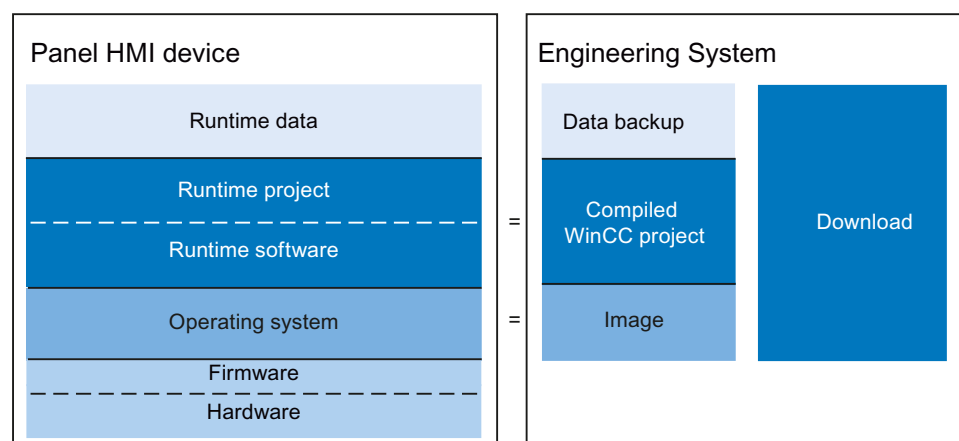

#### Runtime data

The runtime data is generated during operation of the plant and saved to the HMI device. This includes recipes and user administration data, for example. This data is overwritten during the download. If required, back up this data before you download a Runtime project.

#### Runtime project and Runtime software

The Runtime project contains the compiled configuration data for an HMI device. Download the Runtime project along with the Runtime software from WinCC to the HMI device.

#### Operating system

The HMI operating system is referred to as image. Different images are available for the HMI device. All images of an HMI device are available in WinCC. Depending on the configuration, download the appropriate image along with the Runtime project to the HMI device as required.

## Firmware and hardware

The HMI device is delivered with preconfigured firmware and hardware.

### 10.13.3.3 ProSave

#### Introduction

The "ProSave" service tool is installed by default when WinCC is installed. The ProSave functions are called in WinCC with the menu "Online > HMI device maintenance".

#### Functional scope

ProSave provides all of the functions you need to manage data on the HMI device:

- Data backup and restoration of backed-up data
- Operating system update for HMI devices with Windows CE or below
- Transferring License Keys
- Installing and uninstalling drivers and options as well as information on installed options and options that can be installed on an HMI device
- Communication settings (transferred from WinCC)

#### See also

Backup of HMI data (Page 5626)

Updating the operating system (Page 5629)

Transferring license keys (Page 5632)

Installing and uninstalling an option (Page 5634)

Overview of HMI device maintenance (Basic Panels) (Page 5622)

### 10.13.3.4 Backup of HMI data

#### Introduction

Regular backups of HMI device data keep downtimes to a minimum, for example, when you replace a device. You simply transfer the backup data to the HMI device, restoring the original status.

#### Data backup with WinCC

If an HMI device is connected to the configuration PC, you can back up and restore HMI device data from the configuration PC using WinCC.



## Scope of data backup

Which data is backed up and restored depends on the type of HMI device:

- Complete backup  
Depending on the HMI device: Runtime, firmware, operating system, configuration, recipes, user administration, settings

---

### Note

License Keys are only saved for 177, 277 and 377 series HMI devices.

The License Keys are not saved for the following HMI devices:

- all other Windows CE HMI devices
- TP 177A and OP 77A

- 
- Recipes only
  - User administration only

A backup file with the extension \*.psb is generated when you backup the data of an HMI device.

As a general rule, you can backup the data to any storage medium. If the HMI device is networked, you can also backup the data to a server.

---

### Note

#### Scope of data backup for Windows CE HMI devices

Data backup secures the contents of the flash memory. Alarm logs and process value logs are generally saved on the external storage medium. Alarm logs and process value logs are not backed up. If necessary, back up the contents of the memory card separately.

Please note the following when performing a complete data file backup and restore operation for Windows CE devices:

- A full backup includes all options installed. As a rule, the backup includes all options data that is still available after "POWER OFF".
- All data previously on the device, including License Keys and the operating system, will be permanently deleted when you carry out complete data restoration.
- If the data restoration was interrupted, execute the command "Reset to factory settings". Restart data restoration.

---

### Note

Use interfaces with high bandwidths, e.g. USB or Ethernet to backup and restore data.

---

### Note

For Windows CE devices, you can also backup the data directly to a CF or PC card, independent of ProSave and WinCC. For additional information, refer to the relevant operating instructions.

---

## See also

Backing up and restoring data of the HMI device (Page 5628)

Overview of HMI device maintenance (Basic Panels) (Page 5622)

### 10.13.3.5 Backing up and restoring data of the HMI device

---

#### Note

Use the restore function for project data only on operating devices which were configured using the same configuration software.

---

## Requirements

- The HMI device is connected to the configuration PC
- The HMI device is selected in the project navigation.
- If a server is used for data backup: The configuration PC has access to the server

## Backup of the data of the HMI device

Proceed as follows to backup the data of the HMI device:

1. Select the "Backup" command from the "Online > HMI device maintenance" menu. The "SIMATIC ProSave" dialog box opens.
2. Select the data to backup for the HMI device under "Data type".
3. Enter the name of the backup file under "Save as".
4. Click "Start Backup".

This starts the data backup. The backup operation takes some time, depending on the connection selected.

## Restoring the data of the HMI device

Proceed as follows to restore the data of the HMI device:

1. Select the "Restore" command from the "Online > HMI device maintenance" menu.
2. Enter the name of the backup file under "Save as". Information about the selected backup file is displayed under "Content".
3. Click "Start Restore".

This starts the restoration. This operation takes some time, depending on the connection selected.

## Backup/Restore from the "Backup/Restore" dialog in the control panel of the HMI device

The "Backup/Restore" function is enabled for MMC, SD memory cards and USB mass storage devices.

### See also

Backup of HMI data (Page 5624)

Overview of HMI device maintenance (Basic Panels) (Page 5622)

### 10.13.3.6 Updating the operating system

#### Introduction

Update the HMI device image if the version is incompatible with the configuration. The image version matches the device version. Update the operating system and Runtime software of the HMI device with the help of the device version. While loading the project, you may be prompted to run an automatic update of the device version, depending on the protocol used. Loading will then continue. Loading will otherwise be aborted. In this case, perform the update of the device version manually.

---

#### Note

A device version can only be updated on HMI devices that are not PC-based.

---

#### Updating the device version

Connect the HMI device to the configuration PC to update the device version. If possible, use the interface providing the highest bandwidth for this connection, e.g. Ethernet. An update of the device version via serial connection may take up to an hour.

---

#### Note

##### Transfer of operating systems for MP 377 via PROFIBUS

The size of the image and the baud rates available with PROFIBUS mean image transfer with an MP 377 via PROFIBUS can take up to an hour.

Updating the operating system via USB or Ethernet.

---

## "Reset to factory settings"

If the operating system on the HMI device is no longer operational, update the operating system and reset the HMI device to the factory settings.

---

### Note

#### Resetting to factory settings via Ethernet for Basic Panels

You will require the following to reset to the factory settings via Ethernet:

- the MAC address of the HMI device
- the available IP address
- the programming device/PC interface of the configuration PC set to Ethernet TCP/IP

The programming device/PC interface is configured using the control panel of the configuration PC. Select "S7ONLINE (STEP7) -> TCP/IP" in the "Access point of the application" field.

---

## See also

Updating the operating system on the HMI device (Page 5630)

Overview of HMI device maintenance (Basic Panels) (Page 5622)

### 10.13.3.7 Updating the operating system on the HMI device

If possible, you should use the interface with the highest bandwidth for this connection, such as Ethernet. Updating the operating system via a serial connection can take up to an hour. When you update the operating system, the Runtime software on the HMI device is also updated and the device version is changed.

NOTICE
<p><b>Updating the operating system deletes all data on the HMI device</b></p> <p>When you update the operating system you delete data on the target system. For this reason, you should first back up the following data:</p> <ul style="list-style-type: none"><li>• User administration</li><li>• Recipes</li></ul> <p>Resetting to factory settings also deletes the License Keys. Back up the License Keys before you reset the system to factory settings.</p>



## Requirement

- The HMI device is connected to the configuration PC.
- The HMI device is selected in the project tree.

## Updating the operating system

Proceed as follows to update the operating system:

1. Select the "Update operating system" command from the "Online > HMI device maintenance" menu.  
The "SIMATIC ProSave [OS-Update]" dialog opens. The path to the image is preset.
2. If required, you can select a different path for the image that you want to transfer to the HMI device.
3. Click "Update OS".

This starts the update. The update operation can take time, depending on the connection selected.

## Resetting the HMI device to factory settings

To reset the HMI device to factory settings, proceed as follows:

1. Switch off power to the HMI device.
2. Connect the HMI device to the Engineering Station.
3. Select the "Update operating system" command from the menu under "Online > HMI device maintenance" on the configuration PC in WinCC.  
The "SIMATIC ProSave [OS-Update]" dialog opens. The path to the image is preset.
4. If required, you can select a different path for the image that you want to transfer to the HMI device.
5. Activate "Reset to factory settings".
6. Click "Update OS".
7. To "Reset to factory settings", switch on power to the HMI device again.  
This operation can take time.

## Result

The operating system of the HMI device is operational and up-to-date.

## See also

Managing licenses (Page 5632)

Backing up and restoring data of the HMI device (Page 5626)

Updating the operating system (Page 5627)

Overview for loading of projects (Page 5600)

Overview of HMI device maintenance (Basic Panels) (Page 5622)

### 10.13.3.8 Transferring license keys

#### Introduction

You need a license for certain WinCC Runtime options you may want to install on an HMI device. Usually, the necessary licenses supplied as "License Keys" on a data medium, e.g. USB stick. The "License Keys" can also be made available on a license server.

Use "Automation License Manager" to transfer the "License Keys" to or from an HMI device. The "Automation License Manager" is included automatically when you install WinCC.

#### NOTICE

##### Backing up License Keys

In the following cases you have to backup the "License Keys" in order to prevent deletion of the "License Keys":

- Prior to the update of the operating system of a Windows CE HMI device
  - Prior to restoring the data from a full backup
- "License Keys" on an HMI device are backed up depending on the HMI device configuration. For more information, refer to the operating instructions of the corresponding HMI device.

#### See also

Managing licenses (Page 5632)

### 10.13.3.9 Managing licenses

#### Requirement

- The HMI device is connected to the configuration PC or the PC running the "Automation License Manager".
- If you are using the configuration PC: The HMI device is selected in the project navigation.

#### Procedure

To transfer license key, proceed as follows:

1. Open the "Automation License Manager". Go to the Windows Start menu and start "Automation License Manager" on a PC on which WinCC is not installed. The "Automation License Manager" starts.
2. Select the "Connect HMI device" command from the "Edit > Connect target system" menu. The "Connect target system" dialog opens.
3. Select the HMI device type in the "Device type" area.
4. Select the "Connection".

- Configure the "connection parameters" associated with the selected connection.

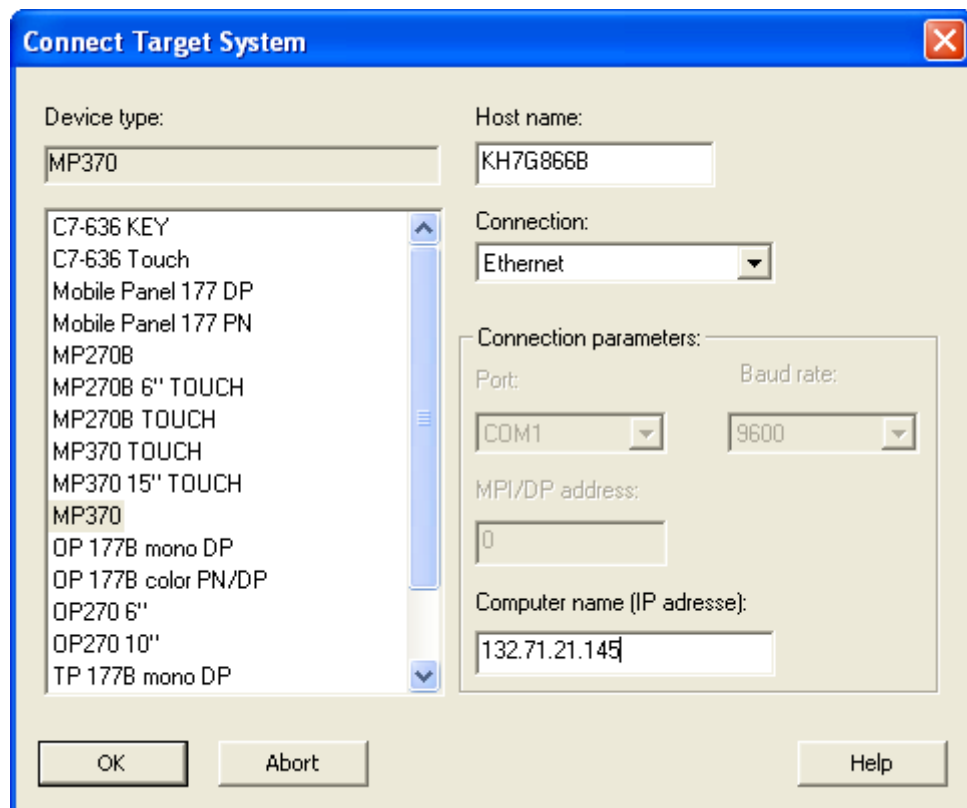

- Click "OK."
 

The connection to the HMI device is now set up. The connected HMI device is displayed in the left pane of "Automation License Manager".
- Transfer the "License Keys" to the HMI device:
  - In the left pane, select the drive on which the "License Keys" are located. The "License Keys" are displayed on the right pane.
  - Select the "License Keys"
  - Drag-and-drop the "License Keys" to the HMI device.

You can also remove License Keys from the HMI device using drag-and-drop.

### Alternative procedure

You can also start the "Automation License Manager" from WinCC on a PC with a WinCC installation: Select the "Authorize/License" command in the "Online > HMI device maintenance" menu.

### Result

The "License Keys" are transferred to the HMI device.

To backup the "License Keys" from the HMI device, drag-and-drop the "License Keys" from the HMI device to an available drive.

## See also

- Transferring license keys (Page 5630)
- Installing and uninstalling an option (Page 5634)

### 10.13.3.1 Installing and uninstalling an option 0

#### Introduction

You can install the following options on an HMI device:

- Additional options supplied with WinCC
- Options purchased in addition to WinCC

Which options you can install depends on the HMI device type.

#### Requirements

- The HMI device is connected to the Engineering Station, or to the PC with ProSave.
- The HMI device is selected in the project navigation.

#### Procedure

To install an option on the HMI device, proceed as follows:

1. Select the "Options" command from the "Online > HMI device maintenance" menu. All available options and the previously installed options are displayed.
2. To display the installed options on the HMI device, click "Device status".
3. Select the option to install on the HMI device and transfer it to the list of installed options with ">>".
4. Click "<<" to uninstall an option from an HMI device.
5. To start installation or deinstallation, click on "OK".

#### Result

The selected options were installed on the HMI device, or removed.

## See also

- Managing licenses (Page 5630)
- ProSave (Page 5624)



## 10.13.4 Reference

### 10.13.4.1 Error messages during the download of projects

#### Possible problems during the download

When a project is being downloaded to the HMI device, status messages regarding the download progress are displayed in the output window.

Usually, problems arising during the download of the project to the HMI device are caused by one of the following errors:

- Wrong operating system version on the HMI device
- Incorrect download settings on the HMI device
- Incorrect HMI device type in the project
- The HMI device is not connected to the configuration PC.

The most common download failures and possible causes and remedies are listed below.

#### The serial download is cancelled

Possible remedy: Select a lower baud rate.

#### The download is cancelled due to a compatibility conflict

Possible cause	Remedy
Conflict between versions of the configuration software and the operating system of the HMI device	<p>Synchronize the operating system of the HMI device with the version of the configuration software.</p> <p>To update the operating system on the HMI device, select the "Update operating system" command from the "Online &gt; HMI device maintenance" menu in WinCC. You can also use ProSave.</p> <p>For additional information, refer to the operating instructions for the HMI device.</p>
The configuration PC is connected to the wrong device, e.g. a controller.	<p>Check the cabling.</p> <p>Correct the communication parameters.</p>

### Project download fails

Possible cause	Remedy
Connection to the HMI device cannot be established (alarm in the output window)	Check the physical connection between the configuration PC and the HMI device. Check whether the HMI device is in transfer mode. Exception: Remote control
The default communication driver is not listed in the Windows Device Manager.	Check the device status of the COM connection in the properties window of the Device Manager.

### Download over MPI/DP interface fails

Possible cause	Remedy
"Configured mode" is set on the CP, for example, if you are using the SIMATIC NET CD.	Set the CP to "PG mode" using the "Set PC station" application. Check the "baud rate" and "MPI address" network parameters. Download the project from WinCC to the CP. Set the CP back to "configured mode".
On the programming device/PC panel, the "S7ONLINE" access point is not set to a hardware device such as CP5611 (MPI). This may be due to the installation of "SIMATIC NET CD".	Set the access point "S7ONLINE" on the selected device using the "PG/PC Panel" or "Set PC station" application. Check the "baud rate" and "MPI address" network parameters. Download the project from WinCC to the HMI device. Restore the "S7ONLINE" access point to the original device.

### The configuration is too complex

Possible cause	Remedy
The configuration contains too many different objects or options for the HMI device selected.	Remove all objects of a specific type, for example all HTML browsers. Alternatively, remove options such as Sm@rtServer or OPC server.

#### 10.13.4.2 Adapting the project for another HMI device

##### Introduction

When you download a WinCC project to an HMI device, WinCC checks whether this is compatible with the HMI device type used in the project. If the types of HMI device do not match, you will see a message before the download starts.

The download is aborted.

## Adapting the project for the HMI device

You need to adapt the project accordingly to be able to download the project to the connected HMI device.

- Add a new HMI device in the project tree. Select the correct type of HMI device from the HMI device selection.
- Copy the configured components from the previous to the new HMI device. Copy large amounts of components directly in the project navigation and details view. For example, copy the "Screens" folder to the screens folder of the new HMI device with the help of the shortcut menu.
- Use the detail view to copy entries in the project tree for which the "Copy" command is not available in the shortcut menu.
- Select the "Recipes" entry in the project tree, for example. The recipes are displayed in the detail view.
- Select the recipes in the detail view and drag them to the "Recipes" entry of the new HMI device. The recipes are copied. You can also select multiple objects in the detail view.
- Configure the components that cannot be copied, e.g. connections, area pointers, and alarms.
- Save the project at various points in time.
- Compile the full project.
- When the compilation is successfully completed, download the project to the HMI device.

## Linking references

References to linked objects are included in the copying. The references are linked again once the linked objects are copied.

Example:

You copy a screen in which objects are linked to tags. The tag names are entered at the individual objects after the screen is added to the new HMI device. The tag names are marked in red because the references are open. When you then copy the tags and insert them into the new HMI device, the open references are closed. The red marking for the tag names disappears.

For complete references to connected objects in the PLC, you first need to configure a connection to the PLC.

## Using the information area

When you compile the project for the HMI device, errors and warnings are displayed in the "Info" tab of the Inspector window. You can use the shortcut menu command "Go to" to go directly to the location where the error or warning can be corrected.

Work through the list of errors and warnings from top to bottom.

When the compilation is successfully completed, download the project to the HMI device.

## See also

Loading a project (Page 5602)

### 10.13.4.3 Establishing a connection to the HMI device

#### Introduction

To download a WinCC project to an HMI device, a properly configured connection must be set up between the configuration PC and HMI device. The connection cannot be set up, the download is cancelled.

#### Setting up a connection between the configuration PC and HMI device

1. Check the cable connection between the HMI device and configuration PC.
2. Open the "Devices & Networks" editor in WinCC and start the network view.
3. Select the subnet in the network view and check the settings for the subnet.
4. Select the interface of the HMI device in the network view or device view and check the connection parameters in the Inspector window.
5. Switch on the HMI device and press the "Control Panel" button in the loader.  
The Control Panel opens.
6. Press "Transfer" twice in the Control Panel.  
The "Transfer Settings" dialog box opens.
7. Check the settings and then press "Advanced".  
The [Protocol\*] Settings" dialog opens.  
\*: The title of the dialog depends on the protocol used, for example, "PROFIBUS Settings".
8. Check the advanced settings and close the dialog with "OK".

#### Important settings

Check the connection settings and in particular the following parameters:

- Network and station addresses
- Selected transmission rate
- Master on the bus; as a general rule, only one master is permitted.

If using a configurable adapter for the connection, check the adapter settings, for example, transmission rate, master on the bus.

## See also

Loading a project (Page 5602)

## 10.14 Operating in Runtime

### 10.14.1 Basics

#### 10.14.1.1 Overview

#### Configuration and process control phases

HMI devices are used to operate and monitor tasks in process and production automation. The plant screens on the HMI devices provide a clear overview of active processes. The HMI device project, which includes the plant screens, is created during the configuration phase.

Transfer the project to the HMI device for the process control phase. Another requirement for the process control phase is that the HMI device must be connected online to a PLC. The process control phase, operator control, and monitoring can then be carried out during an ongoing work process.

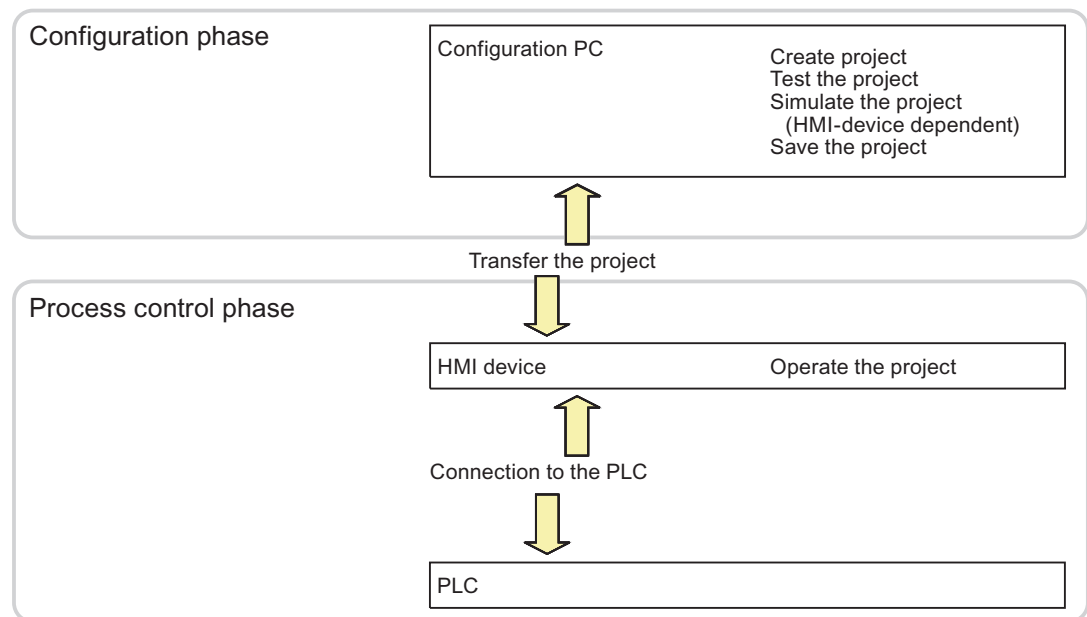

Figure 10-7 Configuration and process control phases

#### Downloading the project to the HMI device

The following procedures are available to download a project to an HMI device:

- Downloading from the configuration PC
- Restore the project from a PC using ProSave  
In this case, an archived project is downloaded from a PC to the HMI device. The configuration software need not be installed on this PC.

These procedures are available for commissioning and recommissioning a project.

## Commissioning and Recommissioning

- When the HMI device is commissioned there is no project at first. The HMI device is also in this state after the operating system has been updated.
- When recommissioning, any project on the HMI device is replaced.

### 10.14.1.2 System behavior

## System functions and scripts

### Use

System functions and user-defined functions are used in Runtime for the following purposes:

- To control the process.
- To utilize the properties of the HMI device.
- To configure system settings on the HMI device in online mode.

Each system function and user-defined function within WinCC is linked to an object and an event. As soon as the event occurs, the system function is triggered.

## System functions

These default system functions are used to implement many tasks in Runtime, such as:

- Calculations, e.g. increasing a tag value by a specific or variable amount.
- Logging functions, e.g. starting a process value log.
- Settings, e.g. PLC changes or setting a bit in the PLC.
- Alarms, e.g. after a different user logs on.

## User-defined functions

User-defined functions may also be included in the project for specific applications which may require additional functions. WinCC provides an interface to Microsoft Visual Basic Script (VBScript or VBS for short) for creating user-defined functions.

### Examples:

- Conversion of values, e.g. between different physical units (temperatures).
- Automation of production sequences  
The user-defined function controls a production sequence by transferring values to a PLC. The status is checked based on return values and corresponding measures are initiated.

## Events

The object and the selected function determine which events can be defined as triggers for executing a system function.

For example, the "Value change", "On exceeding" and "On falling below" events are associated with the "Tag" object. The "Loaded" and "Cleared" events are associated with the "Screen" object.

## Reports

### Overview

Logs are used to document process data and completed production cycles. The report content and layout are specified in the project, as is the event triggering the printout of the report.

For example, a report can be configured for output at the end of a shift to record downtimes. A log can also be configured for the purpose of the documentation of product testing or quality inspections (ISO 9000).

### Output

Reports are printed in Runtime either automatically, e.g. by means of a scheduler, or manually by means of a softkey.

### Printing reports

Reports are output to the printer in graphic mode. The use of a serial printer is not recommended because of the accumulated data volume.

For proper output, the printer must support the paper format and page layout of the report.

---

#### Note

The value of a tag in the report is read and output at the moment of printing. A substantial time may elapse between printing out the first and the last page of a report consisting of several pages. This may lead to the same tag on the last page being output with a different value from that on the first page.

---

## Logs

### Overview

Alarm events and process values can be saved to log files. Alarm events are, for example, the "Incoming", "Acknowledged" and "Outgoing" events contained in an alarm message.

Data logging can be used for the following purposes:

- Early detection of danger / fault states
- Increase of productivity
- Enhancement of product quality
- Optimization of maintenance cycles
- Documentation of processes
- Quality assurance

## Memory options

Depending on the configuration, the logs are written to a file or stored in a database set up for this purpose.

- Data logging to File – CSV(ASCII)  
In CSV format, table columns are separated by separators and the table rows are terminated by a line break. This allows you to evaluate or edit your log data, for example, using an external text editor or a spreadsheet program.

---

### Note

Double quotation marks or multiple characters cannot be used as list separators for the storage location "File - CSV (ASCII)". The setting for list separators can be found under "Start > Settings > Control Panel > Regional and Language Options".

---

- Data logging to File – TXT (Unicode)  
The data is saved in the Unicode format. This file format supports all characters than can be used in WinCC Runtime. For processing, you require a software that can save Unicode, such as Notepad.

---

### Note

To save Asian languages, use the storage location "File - TXT (Unicode)".

---

- Data logging to a File - RDB  
Log files of this format can only be read or visualized in WinCC Runtime Advanced. If you want to evaluate the logged data in a different manner, convert the data to the CSV format using the "CopyLog" system function.
- Data logging to a database  
Data is saved in a database for which ODBC access was set up by the PC administrator.

## Logging methods

Logging methods used in WinCC:

- Circular log
- Segmented circular log
- Log with level-dependent system alarms
- Log with level-dependent triggering of an event



## Alarm logs

Alarms in the project indicate fault states and operating states of a process. They are generally triggered by the controller. Alarms are output on the HMI device in form of screen objects. All the data associated with an alarm and configuration data are saved in an alarm log, for example, alarm class, time stamp and alarm text. All alarm classes can be logged separately. Alarms can be logged either automatically or by operator intervention. For additional information, refer to "Logging alarms".

## Data logs

In Runtime, the process values are logged, processed and, depending on the project, written either to files or to the log database.

Data logging is controlled by means of cyclic operations and events. Logging cycles are used to ensure continuous acquisition and storage of the process values. Data logging can also be triggered by events, for example, when a value has changed. For additional information, refer to "Logging tags".

## Storing logs on network drives

Close all logs with the system function "CloseAllLogs" before disconnecting the HMI device from the network.

End Runtime if an unexpected network failure occurs. The logs will be available again after restarting Runtime.

## Storing files on a Windows 2003 server

Log files and recipes can only be stored on a Windows 2003 server with Active Directory for the following HMI devices:

- MP 277
- MP 377
- Mobile Panel 277
- Mobile Panel 277 IWLAN

## Tags

### Definition

Tags correspond to defined memory areas on the HMI device, to which values are written and/or from which values are read. This action can be initiated by the PLC, or by the operator at the HMI device.

## 10.14.2 Commissioning projects

### 10.14.2.1 Runtime Advanced and Panels

#### Introduction

Modern automation concepts are extremely demanding on process visualization. Process control close to machines must in particular meet the demands for simple, high-performance control of the processes. The objective is to present quick, clear and comprehensible information to operators, for example, by means of a trend view. This increasingly requires process displays that simplify understanding of the actual process. There is an increasing demand for data logging functionality, e.g. for QC. This makes it necessary to log process data at machine level.

Runtime Advanced and Panels is designed for visualizing and operating machines and small-scale plants. The Runtime software has a window-based pixel-graphics user interface. Due to its short response times, the software features secure process operation, jogging at the machine and secure data acquisition.

#### Licensing

A License Key is required to install Runtime Advanced and Panels on a standard PC or on a Panel PC. Runtime Advanced and Panels only runs in demo mode if not licensed.

- PC: The license is included with your Runtime Advanced and Panels package.
- Panel PCs: The "Runtime Advanced and Panels" license is shipped with the device.

#### WinCC components

The WinCC configuration software is used to create your project data on a PC or PG that is operating on a Windows platform.

The Runtime software lets you visualize the process. You use Runtime to test and simulate the compiled project file on the configuration PC.

You can order several options with enhanced functions for Runtime Advanced and Panels.

### 10.14.2.2 Settings for Runtime Advanced and Panels

#### Settings in the Runtime software

Open the WinCC configuration software and make the following settings for the Runtime software:

#### Display on the PLC

In WinCC, configure the visual representation of the generated project in Runtime: Select the full-screen or window mode for the project. The window has a smaller size than the screen. In

full-screen mode, the project is zoomed to the full screen. There will be no window and operator control elements for this view.

Click "Screens" in the "Settings" editor to define activation of the full-screen at startup. Activate the "Full-screen mode" check box in the "Screen" field.

You can hide the taskbar in Windows as required. Select "Start > Settings > Taskbar" and then deactivate the "Always on Top" and "Auto hide" check boxes in the "Taskbar properties" dialog.

---

**Note****Truncated view**

If the HMI screen does not match the configured size (in pixels), the project opened in full-screen mode only appears on a part of the screen.

---

## Dialog fonts

The dialog text will be shown in the standard font. Define the default font by selecting "Languages and fonts" in the "Settings" editor.

## Disabling program switching

You lock program switching to prevent operators from calling other applications in Runtime.

Click "Screens" in the "Settings" editor and then activate the "Disable program switching" and "Full-screen mode" check boxes. Also hide the Windows taskbar.

---

**Note****Stop runtime**

If you lock program switching, always configure in your project the system function "StopRuntime" for an object, e.g. a softkey or button. Otherwise, you cannot close Runtime or Windows.

The <CTRL+ALT+DEL> key shortcut is not available if program switching is disabled. On a Windows 2000 operating system this effect prevents you from logging on to your device again after the screensaver was started. Windows 2000 allows you to disable the <CTRL+ALT+DEL> key shortcut required for logon. Open the "Control Panel > Users > Passwords > Advanced" tab and deactivate the "Press CTRL + ALT + DEL before logon" check box.

---

## Screen saver

A screensaver is no longer required for most modern screens and can, in fact, even cause damage. These monitors switch to hibernate mode as soon as the video signal has not

changed for a specified time. A conventional screensaver would prevent this and thus reduce the service life of your monitor.

---

**Note**

**Approved screensavers**

If you do want to use a screensaver, note that only the standard Windows screensavers are approved for use in Runtime.

---

Make sure that the correct time zone is set on the PC on which the runtime software is installed. To set the time zone in Windows, select Start > Settings > Control Panel > Date and Time.

## Additional operating options

### Print functions

Print functions available in online mode: :

- Hardcopy  
You can print the content of the currently displayed screen if you utilize the "Print screen" system function in your configuration.
- Printing alarms  
Each alarm event that occurs (incoming, outgoing, acknowledgment) is also sent to a printer.
- Printing reports

### LED control

The light-emitting diodes (LEDs) in the function keys of the HMI devices can be controlled from the PLC. For example, a lit or flashing LED can signal the operator to press a specific function key on the device.

### 10.14.2.3 Loading a project

#### Overview

Various scenarios are possible for loading the project:

- The Runtime software is installed on the same system as the configuration software.
- The Runtime software and the configuration software are installed on different systems. The project must be loaded from the configuration computer to the target system. The HMI devices must be connected to the configuration PC for the transfer. Another requirement is that the transfer mode must match on the HMI devices and in WinCC.

---

#### Note

Security prompts may appear during the loading process, depending on the configuration. The recipe data and password list on the HMI device are overwritten following a prompt.

---

#### The configuration software and the Runtime software are installed on the same system

If the configuration software and the Runtime software are installed on the same system, proceed as follows:

1. Create and compile your project.
2. Start Runtime directly from the active configuration software. Select the "Start Runtime" command from the "Online" menu.
3. You may test and operate the project online with the controller if you have configured the corresponding communication.

#### The configuration software and the Runtime software are installed on different systems

If the configuration software and the Runtime software are installed on different systems, proceed as follows:

1. Create and compile your project. For additional information, refer to "Compiling a project".
2. To download the file via cable:  
Connect the HMI device to the configuration computer using a standard cable to match the desired transfer mode and then switch on the HMI device.
3. Set the HMI device to transfer mode.  
To start transfer mode, press the "Transfer" button in the Loader. You can also assign the system function "SetDeviceMode" to an operator control.
4. Load the project from the configuration computer to your target device. For further information, refer to "Loading projects".

---

#### Note

If the HMI device is a PC, you can transfer the compiled file without using the loader, for example, via Ethernet. Double-click the corresponding file on your PC to start Runtime.

---

### 10.14.2.4 Testing a project

#### Introduction

You have the following options for testing a WinCC project:

#### Testing projects on the configuration computer.

- Simulator  
The Simulator is used to test WinCC projects with internal tags and process tags. For additional information, refer to "Simulating projects".  
Tests supported by the Simulator:
  - Offline testing of a configuration without connection to a PLC.
  - Online testing of a configuration with connection to a PLC and inactive process.
  - Implementation of a demo project.
- Script debugger  
The script debugger tests your scripts in Runtime to find logical programming errors. For additional information, refer to "Working with the Debugger".

#### Testing projects on the HMI device

- Offline testing of the project on the HMI device  
Offline testing means that communication between the HMI device and the PLC is down for the duration of the test. You can operate the HMI device, however, without being able to exchange data with the PLC. Set the "Offline" mode on the HMI device by assigning the system function "SetDeviceMode" to an operating element.
- Online testing of the project on the HMI device  
Online testing means that communication between the HMI device and the PLC is up for the duration of the test. You can use the HMI device to control the plant as configured. Set the "Online" mode on the HMI device by assigning the system function "SetDeviceMode" to an operating element.

#### Procedure

The following steps show the basic procedures for simulating a project offline on the configuration computer without PLC connection.

1. Start by creating a project as it is going to be run later with an interconnected PLC.
2. Save and compile the project.

3. Start the Simulator directly from the active configuration software. Select "Online > Simulate Runtime > With tag simulator".  
If simulating the project for the first time, the simulator is started with a new, empty simulation table. If you have already created a simulation table for your project, it will be opened.  
The simulation table "\*.six" contains all your settings for the simulation of tags and area pointers.
4. Make any changes to the tags and area pointers of your project in the simulation table. Toggle between the simulation table and Runtime using the <ALT+TAB> key shortcut. Save your simulation settings with "File > Save." Assign the file a meaningful name. The file name is automatically assigned the extension "\*.six".

### 10.14.2.5 Backup and restoring projects

#### Introduction

Backup and restore operations transfer the relevant data between flash memory on the HMI device and a configuration computer.

#### Requirement

- The HMI device is connected to a configuration computer.
- No project is open in WinCC.
- Relevant only for backup or for restore operations without reset to factory setting: The data channel is configured on the HMI device.

#### Project backup

Proceed as follows to backup the project:

1. Select "Project ► Transfer ► Communication Settings" in WinCC on the configuration computer.  
The "Communication Settings" dialog opens.
2. Select the HMI device type.
3. Select the type of connection between the HMI device and the configuration computer, then set the communication parameters.
4. Close the dialog with "OK".
5. In WinCC, select the menu command "Project ► Transfer ► Backup".  
The "Backup Settings" dialog opens.
6. Select the data to be backed up.
7. Select a destination folder and a file name for the \*.psb backup file.

### 10.14 Operating in Runtime

8. Set "Transfer" mode on the HMI device.  
If automatic transfer mode is enabled on the HMI device, the device automatically sets "Transfer" mode when a backup is initiated.
9. Start the backup operation in WinCC with "OK" on the configuration computer.  
Follow the instructions in WinCC flexible.  
A status view opens to indicate the progress of the operation.

#### Result

The system outputs a message when the backup is completed.

The relevant data is now backed up on the configuration computer.

#### Restoring projects

Proceed as follows to restore projects:

1. Select "Project ► Transfer ► Communication Settings" in WinCC on the configuration computer.  
The "Communication Settings" dialog opens.
2. Select the HMI device type.
3. Select the type of connection between the HMI device and the configuration computer, then set the communication parameters.
4. Close the dialog with "OK".
5. In WinCC, select the menu command "Project ► Transfer ► Backup".  
The "Restore Settings" dialog opens.
6. Select the \*.psb backup file to be restored from the "Open" dialog.  
The view shows from which HMI device the backup file originates and the type of data it contains.
7. Set "Transfer" mode on the HMI device.  
If automatic transfer mode is enabled on the HMI device, the device automatically sets "Transfer" mode when a restore operation is initiated.
8. Start the backup operation in WinCC with "OK" on the configuration computer.  
Follow the instructions in WinCC.  
A status view opens to indicate the progress of the operation.

#### Result

The transfer is completed when the backup data is restored from the configuration computer to the HMI device.



### 10.14.2.6 Starting the project

#### Project start modes

Options of starting a WinCC project on a Runtime PC:

- Running it from the Explorer  
You can run the project by double-clicking its file name in Windows Explorer.
- Starting together with Runtime  
If you enter a project file in the "HmiRT.ini" file, it will start as soon as WinCC Runtime is started from the Windows Start menu.
- Run from the command line  
To run your project, type in one command either at the MS-DOS prompt, or on the "Start > Run" command line in Windows, and then press <Enter>. Note that the following command line may diverge from its installation path:  
`c:\Programs\Siemens\SIMATIC WinCC flexible\WinCC flexible 2007 Runtime\HmiRTm.exe c:\project\myproject.fwx`
- Autostart
  - If your project is linked to the Autostart directory of the Windows start menu, it will be automatically upon system startup.
  - You can also make the settings for the automatic startup in the "Settings" dialog of the WinCC Runtime Loader.

---

**Note**

Start the loader from the Windows Start menu "SIMATIC\WinCC flexible Runtime > WinCC flexible Runtime Loader".

---

### 10.14.3 Operating projects

#### 10.14.3.1 Setting the project language

##### Introduction

The HMI device supports multilingual projects. You must have configured a corresponding operating element which lets you change the language setting on the HMI device during runtime.

The project always starts with the language set in the previous session.

##### Requirement

- The required language for the project must be available on the HMI device.
- The language switching function must be logically linked to a configured operating element such as a button.

### Selecting a language

You can change project languages at any time. Language-specific objects are immediately output to the screen in the new language when you switch languages.

The following options are available for switching the language:

- A configured operating element switches from one language to the next in a list.
- A configured operating element directly sets the desired language.

### 10.14.3.2 Operating recipes

#### Structure of a recipe

#### Recipes

The recipe collection for the production of a product family can be compared to a file cabinet. A recipe which is used to manufacture a product corresponds to a drawer in a file cabinet.

Example:

In a plant for producing fruit juice, recipes are required for different flavors. There is a recipe, for example, for the flavors orange, grape, apple and cherry.

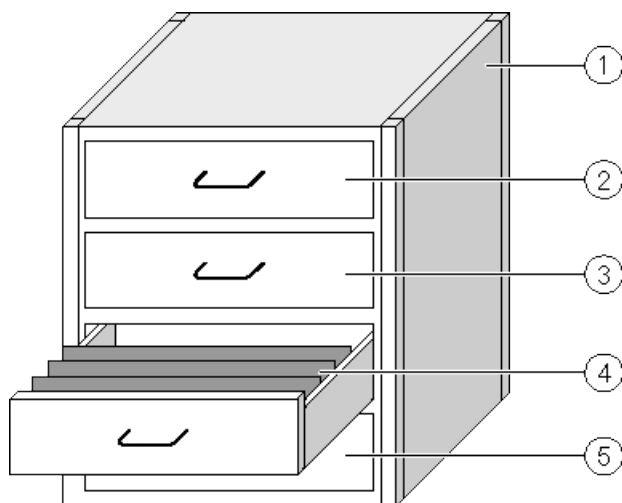

① File cabinet	Recipe collection	Recipes for a fruit juice plant
② Drawer	Recipe	Orange flavored drinks
③ Drawer	Recipe	Grape flavored drinks
④ Drawer	Recipe	Apple flavored drinks
⑤ Drawer	Recipe	Cherry flavored drinks

## Recipe data records

The drawers of the file cabinet are filled with suspension folders. The suspension folders in the drawers represent records required for manufacturing various product variants.

Example:

Product variants of the flavor apple might be a soft drink, a juice or nectar, for example.

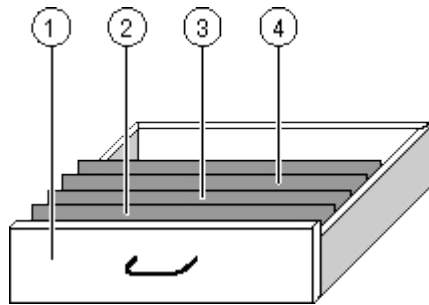

①	Drawer	Recipe	Product variants of apple flavored drinks
②	Suspension folder	Recipe data record	Apple drink
③	Suspension folder	Recipe data record	Apple nectar
④	Suspension folder	Recipe data record	Apple juice

## Elements

In the figure showing the file cabinet, each suspension folder contains the same number of sheets. Each sheet in the suspension folder corresponds to an element of the recipe data record. All the records of a recipe contain the same elements. The records differ, however, in the value of the individual elements.

Example:

All drinks contain the same components: water, concentrate, sugar and flavoring. The records for soft drink, fruit juice or nectar differ, however, in the quantity of sugar used in production.

## Recipes in the project

### Overview

If recipes are used in a project, the following components interact:

- HMI device recipe memory  
Recipes are saved in the form of data records in the HMI device recipe memory.
- Recipe view / recipe screen  
On the HMI device, recipes are displayed and edited in the recipe view or in a recipe screen.
  - The recipe data records from the internal memory of the HMI device are displayed and edited in the recipe view.
  - The values of the recipe tags are displayed and edited in the recipe screen.

#### Note

The same recipe tags can be configured in a variety of recipes. If you modify the value of a recipe tag, the synchronization changes the value of the recipe tag in all recipes.

- Recipe tags  
The recipe tags contain recipe data. When you edit recipes in a recipe screen, the recipe values are stored in recipe tags. The point at which the recipe tag values are exchanged with the PLC depends on the configuration.

### Data flow

The following figure shows the data flow in a project with recipes:

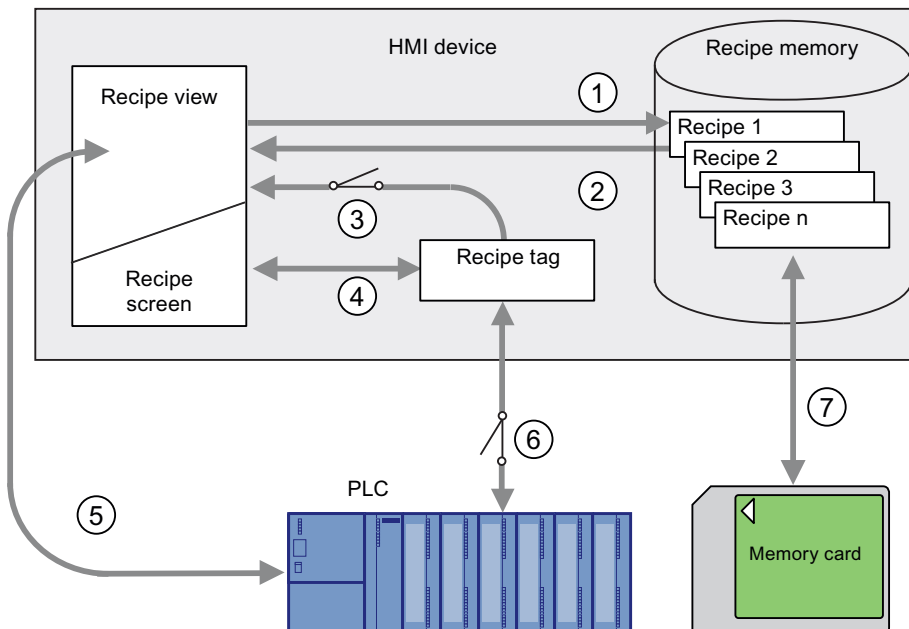

- ① Editing, saving or deleting a recipe data record
- ② Display recipe data record
- ③ Synchronize or do not synchronize recipe tags
- ④ Display and edit recipe tags in the recipe screen
- ⑤ Write records from the recipe view to the PLC or read records from the PLC and display them in the recipe view.
- ⑥ Recipe tags are to the PLC online or offline
- ⑦ Export or import recipe data record to memory card

## Displaying a Recipe

### Displaying Recipes

You can display and edit recipes on the HMI device with a recipe view or recipe screen.

### Recipe view

A recipe view is a screen object used to manage recipe data records. The recipe view shows recipe data records in tabular form.

Depending on the configuration, the recipe view is displayed as follows:

- As enhanced recipe view
- As simple recipe view

The configuration engineer also defines which operator controls are displayed in the recipe view. Only the simple recipe view can be configured on the TP 177A.

### Enhanced Recipe View

The figure below shows an example of the enhanced recipe view:

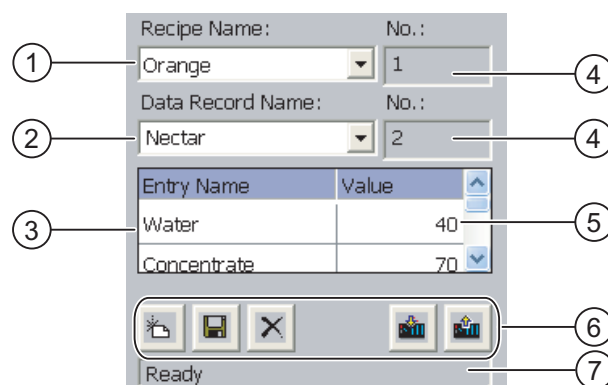

- ① Selection field for the recipe
- ② Selection field for the recipe data record

- ③ Element name  
The element name designates a specific element in the recipe data record.
- ④ Display field  
This show the number of the selected recipe or the selected recipe data record.
- ⑤ Value of the element
- ⑥ Buttons for editing a recipe data record
- ⑦ Status bar for display of the status messages

### Simple recipe view

The simple recipe view consists of three areas:

- Recipe list
- Data record list
- Element list

In the simple recipe view, each area is shown separately on the HMI device. Depending on the configuration, the simple recipe view starts with the recipe list or data record list.

The figure below shows an example of the data record list:

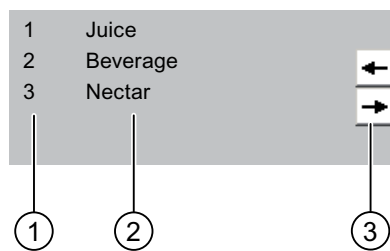

- ① Number of the recipe data record
- ② Recipe data records
- ③ Buttons for changing the displayed list and calling the menu

### Display of Values

#### Note

#### Changing the recipe data record in the background

Applies to the processing of a recipe data record:

If values of the corresponding recipe data record are changed by a PLC job, the recipe view is not updated automatically.

To update the recipe view, reactivate the respective recipe data record.

## Recipe screen

A recipe screen allows the correlation between the plant and the recipe data to be displayed in graphic form. The configuration engineer combines I/O fields and screen objects to form a custom input screen. The configuration engineer can distribute the I/O fields of a recipe over several recipe screens, thus allowing recipe elements to be arranged by subject. The recipe screen can be operated using buttons configured accordingly.

The figure below shows an example of the recipe screen:

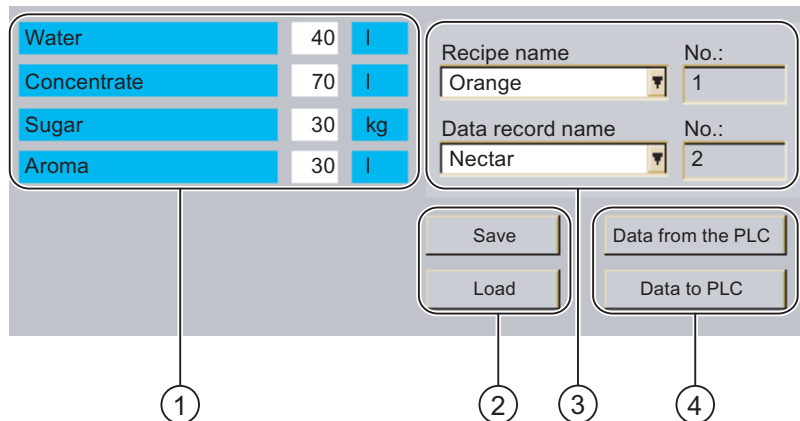

- ① Element names and corresponding values  
The element name designates a specific element in the recipe data record.
- ② Buttons for editing a recipe data record
- ③ Modified recipe view
- ④ Buttons for transferring recipe data

The values displayed or entered in the recipe screen are saved in recipe tags. The recipe values are exchanged with the PLC immediately or later via these tags.

A configured recipe view can itself be a component of a recipe screen. You must synchronize the tags in order to synchronize data between the tags of the recipe screen and the recipe data records displayed in the recipe view.

## Recipe Values in the HMI Device and the PLC

### Introduction

You can change the values of a recipe on the HMI device and therefore influence the manufacturing process or a machine.

Depending on the configuration, the recipe values are displayed, edited and saved in different ways.

- If you are editing recipes with a recipe view in your project, the values are saved in recipe data records.
- If you are editing recipes in a recipe screen in your project, the values are saved in recipe tags.

Differences may occur between the display values in the recipe view and the values saved in the associated tags in an ongoing project when you edit recipes with a recipe view and in a recipe screen. Synchronize the values of the recipe data records with the values of the recipe tags to prevent this effect.

## Synchronizing recipe tags

---

### Note

Recipe tags can only be synchronized in the advanced recipe view.

---

Synchronization of the recipe tags depends on the configuration of the enhanced recipe view:

- **Automatic synchronization:**  
The values of the recipe view are synchronized with the associated recipe tags. In this case, changes to values in the recipe view have an immediate effect on the values of the associated recipe tags. The values are only synchronized, when an operating element that is outside the recipe view is operated.
- **Synchronization by the user:**  
The values of the recipe view and the associated recipe tags are not synchronized automatically. The project engineer has assigned the same function to the  button or to a different operator control in the recipe view. The recipe tags and the recipe view are only synchronized when you operate the buttons or the appropriate operator control.

## Recipe Tags Online / Offline

The configuration engineer can configure a recipe so that changes to the values of the recipe tags do not have an immediate effect on the current process.

Synchronization of the recipe values between the HMI device and the PLC depends on whether the configuration engineer has selected the settings "Tags online" or the setting "Tags offline" for a recipe.

- **"Tags online":**  
This setting has the following effect:
  - When you change recipe values in the recipe screen, these changes are applied immediately by the PLC and immediately influence the process.
  - If recipe values are changed in the PLC, the changed values are displayed immediately in the recipe screen.
- **"Tags offline":**  
With this setting, changed recipe values are not synchronized immediately between the HMI device and the PLC.  
In this case, the configuration engineer must configure operating elements for transferring the values to the PLC or reading them from the PLC in a recipe screen. The recipe values are only synchronized between HMI device and PLC when you operate the appropriate operator control.



## Exporting a recipe data record

### Introduction

You can export one or more recipe data records to a CSV file, depending on the configuration. After export, the values in the recipe data record can be further processed in a spreadsheet program such as MS Excel. The degree to which you can influence the export depends on the configuration:

### Requirement

- A screen with a recipe view is displayed.
- An operating element with the function "Export record" has been configured.
- The following tags are configured equally in the recipe view and for the "Export record" operating element.
  - Recipe number
  - Data record number

### Procedure

Proceed as follows:

1. If the recipe view contains several recipes: Select the recipe which contains the relevant recipe data record.
2. Select the recipe data record you want to export.
3. Operate the operator control which was configured for export, for example the "Export data record" button.  
The data record is exported as a CSV file to an external data medium.

### Result

The recipe data record is exported.

## Importing a recipe data record

### Introduction

You can import values from a CSV file to a recipe data record, depending on the configuration.

### Requirement

- An operator control with the function "Import data record" has been configured, for example a button
- A screen with a recipe view is displayed.

## Procedure

Proceed as follows:

1. If the recipe view contains several recipes: Select the recipe which contains the recipe data record to be imported.
2. Operate the operator control with the function "Import data record".  
The record is imported from an external data medium as a CSV file and then displayed in the recipe view after import.

## Result

The imported recipe data record is saved on the HMI device.

## Deviating structure

If the structure of the CSV file differs from the structure of the recipe, deviations are handled as follows:

- Any additional values in the CSV file will be rejected
- The system applies the configured default value to the recipe data record if the CSV file contains an insufficient number of values
- If the CSV file contains values of the wrong data type, the configured default value is set in the recipe data record

Example:

The imported CSV file contains values that were entered as floating point numbers  
However, the corresponding tag expects an integer value. In this case, the system discards the imported value and uses the configured default

## Operating the recipe view

### Overview

### Use

The recipe view is used to display, edit and manage data records.

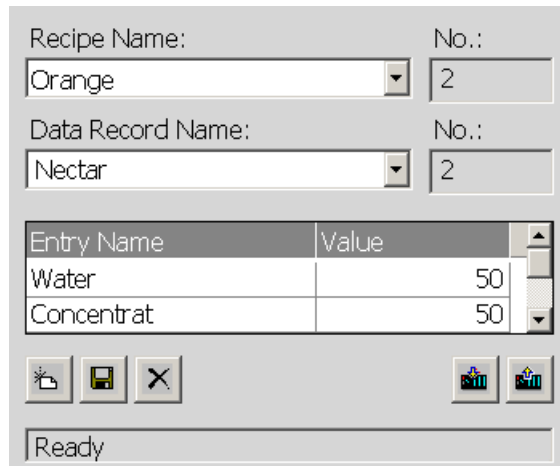

### Operation



Depending on the configuration you can:

- Creating, editing, copying or deleting recipe data records
- Synchronize recipe data records with the associated recipe tags
- Read recipe data records from or transfer to the PLC

### Operator controls

The following operating elements can be configured in the recipe view:

Button	Hotkey	Function
		The configured tooltip is displayed.
	CTRL +	Creates a new recipe data record. If a start value is configured, it is displayed in the input field.
	CTRL +	Saves the displayed values of the recipe data record. The storage location is predefined by the project.
	CTRL +	The recipe data record is saved under a different name regardless of the recipe view. A dialog box opens where you can enter the name.
	CTRL +	The displayed recipe data record is deleted.

Button	Hotkey	Function
	CTRL + =	The system always updates the current value of the recipe view with the latest recipe tag value. When the value shown in the recipe view is more recent than the current recipe tag value, the system writes this value to the recipe tag. "Synchronize tags" must be enabled in the recipe properties before you can use this function.
	CTRL + ▲	The values of the set recipe data record displayed in the recipe view are transferred to the PLC.
	CTRL + ▼	The recipe values from the PLC are displayed in the recipe view.

### Mouse control or touchscreen control of the recipe view

1. Select the recipe you want to use.  
The data records of the recipe are displayed.
2. Click on the data record you wish to edit.
3. Press the button whose function you wish to execute.

### Using the keyboard with the recipe view

1. Press the <Tab> key until the "Recipe name" or "Data record name" field is activated.
2. Press <Enter>.  
The selection list for the recipes or data records opens.
3. Select a recipe or a data record from the list. Toggle between the next or previous entry by using the cursor keys <Left>, <Right>, <Up> and <Down>.
4. Press the <Tab> key until the operating element you wish to use is selected. You can also operate the recipe view via hotkeys.

### Creating a recipe data record

#### Touch and key operation

#### Introduction



Create a new recipe data record by editing an existing data record. Save this data record under a new name.

#### Requirement

A screen with a recipe view is displayed.





## Procedure for touch operation

Proceed as follows:

1. If the recipe view contains several recipes: Select the recipe for which you want to create a new recipe data record.
2. Touch .  
A new recipe data record with the next available number is created.  
An existing data record is overwritten if you assign its number to a new data record.
3. Enter values for the data record elements.  
The data record elements can be assigned default values, depending on the configuration.
4. Touch the button .
5. Enter a name for the data record.  
The data record is saved under the new name.  
A dialog will open if the recipe data record already exists. In this dialog, define whether to overwrite the existing data record.

## Procedure for key operation

Proceed as follows:

1. If the recipe view contains several recipes: Select the recipe for which you want to create a new recipe data record.
2. Press  + .
3. Enter values for the data record elements.  
The data record elements can be assigned default values, depending on the configuration.
4. Press  + .
5. Enter a name for the data record.
6. Confirm your input.  
The data record is saved under the new name.  
A dialog will open if the recipe data record already exists. In this dialog, define whether to overwrite the existing data record.

## Result

The new recipe data records will be saved to the selected recipe.

## Mouse and keyboard operation

### Introduction



Create a new recipe data record by editing an existing data record. Save this data record under a new name.

## Requirement

A screen with a recipe view is displayed.

## Procedure for mouse operation

Proceed as follows:

1. If the recipe view contains several recipes: Select the recipe for which you want to create a new recipe data record.
2. Click the  button.  
A new recipe data record with the next available number is created.  
An existing data record is overwritten if you assign its number to a new data record.
3. Enter values for the data record elements.  
The data record elements can be assigned default values, depending on the configuration.
4. Click the  button.
5. Enter a name for the data record.  
The data record is saved under the new name.  
A dialog will open if the recipe data record already exists. In this dialog, define whether to overwrite the existing data record.

## Procedure for keyboard operation

Proceed as follows:

1. Press the <TAB> key until the recipe view is selected.
2. If the recipe view contains several recipes: Press the <TAB> key until the recipe for which you are going to create a new data record is selected.
3. Press the <CTRL+Space> key shortcut to create a new recipe data record with the next available number.  
An existing data record is overwritten if you assign its number to a new data record.
4. Enter values for the data record elements. The data record elements can be assigned default values, depending on the configuration.
5. Press the <CTRL+ENTER> key shortcut to save the recipe data record.
6. Enter a name for the data record. The data record is saved under the new name.  
A dialog will open if the recipe data record already exists. In this dialog, define whether to overwrite the existing data record.

## Result

The new recipe data records will be saved to the selected recipe.

## Editing recipe data records

### Touch and key operation

#### Introduction

Edit the values of the recipe data records and save them in a recipe view.

#### Synchronization with the PLC

If you want to display the current recipe values from the PLC in the recipe view, you first have to read the current values from the PLC with .



You must transfer the data record to the PLC by pressing the  button to activate the changes you have made in the recipe view.

#### Requirement

A screen with a recipe view is displayed.



#### Procedure for touch operation

Proceed as follows:

1. If the recipe list contains several recipes: Select the recipe which contains the recipe data record required.
2. Select the recipe data record you want to edit.
3. Edit the data record as required.
4. Press  to save the changes.  
Touch the  key to save the recipe data record under a different name.

#### Procedure for key operation

Proceed as follows:

1. If the recipe list contains several recipes: Press the <TAB> key until the recipe which contains the relevant data record is selected.
2. Press the <TAB> key until the desired recipe data record is selected.
3. Edit the data record.
4. Press  to save the changes.  
Touch the  key to save the recipe data record under a different name.

#### Result

The edited recipe data record is saved to the selected recipe.

## Mouse and keyboard operation

### Introduction

Edit the values of the recipe data records and save them to a recipe view.

### Synchronization with the PLC

You must read the current values from the PLC by pressing the  button or the <CTRL+UP> key shortcut to display the current recipe values from the PLC in the recipe view.



You must transfer the data record you have edited to the PLC to activate the changes you have made in the recipe view by pressing the  button or the <CTRL+DOWN> key shortcut.

### Requirement

A screen with a recipe view is displayed.

### Procedure for mouse operation

Proceed as follows:

1. If the recipe list contains several recipes: Select the recipe which contains the recipe data record required.
2. Select the recipe data record to be edited.
3. Edit the data record.
4. Click on  to save your changes.  
Click the  button to save the recipe data record under a different name.

### Procedure for keyboard operation

Proceed as follows:

1. If the recipe list contains several recipes: Press the <TAB> key until the recipe which contains the relevant data record is selected.
2. Press the <TAB> key until the desired recipe data record is selected.
3. Edit the data record.
4. Press the <CTRL+ENTER> key shortcut to save your changes.  
Use the <CTRL + \*> shortcut to save the recipe data record under a different name.

### Result

The edited recipe data record is saved to the selected recipe.



## Deleting recipe data records

### Touch and key operation

#### Introduction

You can delete all recipe data records which are not required.

#### Requirement

A screen with a recipe view is displayed.



#### Procedure using the touch screen

Proceed as follows:

1. If the recipe view contains several recipes: Select the recipe which contains the relevant recipe data record.
2. Select the recipe data record to be deleted.
3. Touch the button .

#### Procedure using the keys

Proceed as follows:

1. If the recipe view contains several recipes: Select the recipe which contains the relevant recipe data record.
2. Select the recipe data record to be deleted.
3. Press  + .

#### Result

The recipe data record is deleted.

### Mouse and keyboard operation

#### Introduction

You can delete all recipe data records which are not required.

#### Requirement

A screen with a recipe view is displayed.

### Procedure for mouse operation

Proceed as follows:

1. If the recipe view contains several recipes: Select the recipe which contains the relevant recipe data record.
2. Select the recipe data record to be deleted.
3. Touch the button .

### Procedure for keyboard operation

Proceed as follows:

1. Press the <TAB> key until the recipe view is selected.
2. If the recipe view contains several recipes: Press the <TAB> key until the recipe which contains the relevant data record is selected.
3. Select the recipe data record to be deleted.
4. Press the <CTRL+DEL> key shortcut to delete the data record.

### Result

The recipe data record is deleted.

### Synchronizing tags

### Touch and key operation

### Introduction

You can save the values of recipe elements to recipe tags, depending on your configuration. Differences may develop in your active project between the values displayed in the recipe view and the actual values of the tags. Synchronize the tags to compensate for such differences. Synchronization encompasses all tags of a recipe data record.

---

#### Note

##### Renamed tag

The tag and the value of the recipe data record cannot be associated if you have renamed the tag you want to synchronize. The tags in question are not synchronized.

---

#### Note

Recipe tags can only be synchronized in the advanced recipe view.

---

## Requirement

A screen with a recipe view is displayed.



## Procedure for touch operation

Proceed as follows:

1. If the recipe view contains several recipes: Select the recipe which contains the desired recipe data record.
2. Select the recipe data record to be synchronized.
3. Touch the button .

## Procedure for key operation

Proceed as follows:

1. If the recipe view contains several recipes: Select the recipe which contains the desired recipe data record.
2. Select the recipe data record to be synchronized.
3. Press  + .

## Result

The values of the recipe data record are synchronized with the tag values.

The most recently updated value is accepted if there is a difference between the values of the recipe view and the tag.

## Mouse and keyboard operation

### Introduction

You can save the values of recipe elements to recipe tags, depending on your configuration.

Differences may develop in your active project between the values displayed in the recipe view and the actual values of the tags. Synchronize the tags to compensate for such differences.

Synchronization encompasses all tags of a recipe data record.

---

#### Note

##### Renamed tag

The tag and the value of the recipe data record cannot be associated if you have renamed the tag you want to synchronize. The tags in question are not synchronized.

---

---

**Note**

Recipe tags can only be synchronized in the advanced recipe view.

---

**Requirement**

A screen with a recipe view is displayed.

**Procedure for mouse operation**

Proceed as follows:

1. If the recipe view contains several recipes: Select the recipe which contains the desired recipe data record.
2. Select the recipe data record to be synchronized.
3. Click the  button.

**Procedure for keyboard operation**

Proceed as follows:

1. Press the <TAB> key until the recipe view is selected.
2. Press <Enter>. The selection list opens. Select the recipe data record from the list.
3. Press the <TAB> key until the  button is selected. You could also use the <CTRL+=> key shortcut for synchronizing.

**Reading recipe data records from the PLC**

**Touch and key operation**

**Introduction**

You can edit values which were saved to the recipes in the HMI device directly at plant level within the active project; this may be the case if a valve in the plant opens more than is indicated in the recipe. Inconsistency could have developed between the values of the recipe data records stored in the HMI device and the values in the PLC.



Read the values from the PLC and output these to the recipe view to synchronize the recipe values.

**Requirement**

A screen with a recipe view is displayed.





### Procedure for touch operation

Proceed as follows:

1. If the recipe view contains several recipes: Select the recipe which contains the desired recipe data record.
2. Select the recipe data record which is to receive the values from the PLC.
3. Touch the button .  
The values are read from the PLC.
4. Touch the button  to store the displayed values in the HMI device.

### Procedure for key operation

Proceed as follows:

1. If the recipe view contains several recipes: Select the recipe which contains the desired recipe data record.
2. Select the recipe data record which is to receive the values from the PLC.
3. Press  + .
4. Press the  +  keys to store the displayed values in the HMI device.

### Result

The values were read from the PLC, are visible on the HMI device and were saved to the selected recipe data record.



### Mouse and keyboard operation

#### Requirement

A screen with a recipe view is displayed.

### Procedure for mouse operation

Proceed as follows:

1. If the recipe view contains several recipes: Select the recipe which contains the desired recipe data record.
2. Select the recipe data record which is to receive the values from the PLC.
3. Click the  button.  
The values are read from the PLC.
4. Click on  to store the displayed values in the HMI device.

### Procedure for keyboard operation

Proceed as follows:

1. Press the <TAB> key until the recipe view is selected.
2. Press <Enter>. The selection list opens. Select the recipe data record from the list.
3. Press the <TAB> key until the  button is selected. Press <Enter>. You could also use the <CTRL+Down> key shortcut.

### Result

The values were read from the PLC, are visible on the HMI device and were saved to the selected recipe data record.

### Transferring recipe data records to the PLC

#### Touch and key operation

#### Introduction

You must transfer the values to the PLC to activate a changed recipe data record for the process.

The values displayed in the recipe view are transferred to the PLC.

#### Requirement

A screen with a recipe view is displayed.



### Procedure for touch operation

Proceed as follows:

1. If the recipe view contains several recipes: Select the recipe which contains the desired recipe data record.
2. Select the recipe data record which contains the values to be transferred to the PLC.
3. Touch the button . The values are transferred to the PLC.

## Procedure for key operation

Proceed as follows:

1. If the recipe view contains several recipes: Select the recipe which contains the desired recipe data record.
  2. Select the recipe data record which contains the values to be transferred to the PLC.
  3. Press  + .
- The values are transferred to the PLC.

## Result

The values of the recipe data record were transferred to the PLC and are active in the process.

## Mouse and keyboard operation

### Requirement

A screen with a recipe view is displayed.

### Operation with the mouse

1. If the recipe view contains several recipes: Select the recipe which contains the desired recipe data record.
  2. Select the recipe data record which contains the values to be transferred to the PLC.
  3. Click the  button.
- The values are transferred to the PLC.

### Operation with the keyboard

1. Press the <TAB> key until the recipe view is selected.
  2. Press <Enter>. The selection list opens. Select the recipe data record from the list.
  3. Press the <TAB> key until the  button is selected. Press <Enter>. You could also use the <CTRL+Down> key shortcut.
- The values are transferred to the PLC.

## Result

The values of the recipe data record were transferred to the PLC and are active in the process.

## Using the simple recipe view

### Overview

### Layout

The simple recipe view consists of three areas:

- Recipe list
- Data record list
- Element list

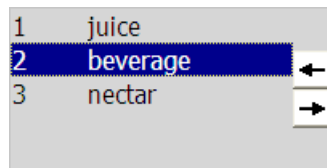

Figure 10-8 Simple recipe view - example with data record list

In the simple recipe view, each area is shown separately on the HMI device. You can use the shortcut menu to operate each of these display areas.

The simple recipe view always begins with the recipe list.

### Operation

You can use the simple recipe view as follows, depending on the configuration:

- Create, change, copy or delete recipe data records
- Read recipe data records from the PLC or transfer to the PLC

### Operator controls of the simple recipe view



Toggle between the display areas and the shortcut menus to operate the simple recipe views.

The table below shows the operation of the display area.



	Key	Function
Touching an entry		The next lowest display area is opened, i.e. the data record list or the element list.
		The previous display area opens.
		The shortcut menu of the display area opens.

The table below shows the operation of the shortcut menu:







	Key	Function
		The menu is closed. The display area opens.
Touching the menu command	Input of the number of the menu command	The menu command is executed.

### Shortcut menus of the simple recipe view







A shortcut menu can be called for each view area by pressing the  button or the  key. The shortcut menu lists the commands that are available in the active view area. A number is assigned to each command. You execute the command by entering its number. You can also use the system keys to execute certain commands.

The scope depends on the HMI device.

- Recipe list



No.	Menu command	Keys	Function
0	New	 + 	A new recipe data record is created for the selected recipe. If a start value is configured, it is displayed in the input field.
1	Displaying infotext		Displays the infotext configured for the simple recipe view.
2	Open		The record list of the selected recipe opens.

- Data record list



	Menu command	Keys	Function
	New	 + 	Creates a new recipe data record. If a start value is configured, it is displayed in the input field.
	Deleting		The displayed record is deleted.
	Save as		The selected data record is saved under a different name. A dialog box opens where you can enter the name.
	Rename		Renames the selected data record. A dialog box opens where you can enter the name.
	Open		The element list of the selected data record opens.
	Previous		The recipe list opens.
	To PLC		The displayed values of the selected data record are transferred from the HMI device to the PLC.
	From PLC		The recipe values from the PLC are displayed in the recipe view of the HMI device.
	Displaying infotext		Displays the infotext configured for the simple recipe view.

- Element list





	Menu command	Keys	Function
	Save		The selected record is renamed.
	To PLC		The displayed values of the selected data record are transferred from the HMI device to the PLC.

	Menu command	Keys	Function
	From PLC		The recipe values from the PLC are displayed in the recipe view of the HMI device.
	Save as		The data record is saved under a new name. A dialog box opens where you can enter the name.
	Displaying infotext		Displays the infotext configured for the simple recipe view.
	Rename		Renames the selected data record. A dialog box opens where you can enter the name.
	Previous		The data record list opens.

### Mouse control or touchscreen control of the simple recipe view

1. Select the desired recipe from the recipe view.
2. Click on the  button.  
The shortcut menu is opened.
3. Select the desired menu command.  
The menu command is executed.
4. Alternatively, open the desired recipe in the recipe view.  
The data record list is displayed.
5. Open the desired data record. You could also use the  button to open the shortcut menu and select a menu command.  
The menu command is executed.

### Using the keyboard with the simple recipe view

1. Press the  key as many times as required to select the simple recipe view.
2. Select the desired recipe with the cursor keys.
3. Press the  key.  
The shortcut menu is opened.
4. Press the  cursor key as many times as required to select the menu command.
5. Confirm the menu command by pressing the key .
6. Alternatively, press the number of the desired menu command.  
The menu command is executed.

### Creating a recipe data record

#### Introduction

Create a new recipe data record in the recipe list or in the record list. Then enter the values for the new record in the element list and save the record.

## Requirement

A screen with a simple recipe view is displayed.

## Procedure

Proceed as follows to create a recipe data record:

1. If the recipe list contains several recipes: Select the recipe for which you want to create a new recipe data record.
2. Open the recipe list menu.
3. Select the "0 new" menu command.  
Creates a new record.  
The element list of the new record opens.
4. Enter values for the data record elements.  
The tags of the record can be assigned default values depending on the configuration.
5. Open the menu of the element list and select the "0 Save" menu command.
6. Enter a name for the new record.
7. Confirm your entries.  
An existing data record is overwritten if you assign its number to a new data record.

## Result

The new recipe data record is saved to the selected recipe.

## Editing a recipe data record

### Introduction

Edit the values of the recipe data records and save them to a recipe view.

### Synchronization with the PLC

To display the current recipe values from the PLC in the simple recipe view, you first have to read the actual values in the element list from the PLC using menu command "2 From PLC".

Values changed in the recipe view are only activated after you transferred the modified data record to the PLC by means of menu command "1 To PLC".

## Requirement

A screen with a recipe view is displayed.

## Procedure

Proceed as follows to copy a recipe data record:

1. If the recipe list contains several recipes: Select the recipe which contains the relevant recipe data record.
2. Open the data record list.
3. Select the recipe data record you want to edit.
4. Open the element list.
5. Edit the element values as required.
6. Save your changes using menu command "0 Save".

## Result

The edited recipe data record is saved to the selected recipe.

## Deleting a recipe data record

### Introduction

You can delete all the data records which are not required.

### Requirement

A screen with a simple recipe view is displayed.

### Procedure for touch operation

Proceed as follows to delete a new recipe data record:

1. If the recipe list contains several recipes: Select the recipe which contains the relevant recipe data record.
2. Open the data record list.
3. Select the data record you want to delete.
4. Open the menu.
5. Select the menu command "1 Delete".

### Procedure for key operation

Proceed as follows to delete a new recipe data record:

1. If the recipe list contains several recipes: Select the recipe which contains the relevant recipe data record.
2. Open the data record list.

3. Select the data record you want to delete.
4. Press .

## Result

The data record is deleted.

## Transferring recipe data records to the PLC

### Introduction

You must transfer the values to the PLC to activate a changed recipe data record for the process.

The values displayed in the recipe view are transferred to the PLC.

### Requirement

A screen with a simple recipe view is displayed.

### Procedure

To transfer a recipe data record to the PLC, proceed as follows:

1. If the recipe list contains several recipes: Select the recipe which contains the relevant recipe data record.
2. Select the element list of the recipe data record whose values you want to transfer to the PLC.
3. Open the menu.
4. Select menu command "1 To PLC".

## Result

The values of the recipe data record were transferred to the PLC and are active in the process.

---

### Note

#### Basic Panels

With Basic Panels, the "To PLC" menu command can also be configured for the data record list: In this case, you can also select the "To PLC" menu command in the data record list.

---

## Reading a recipe data record from the PLC

### Introduction

The values of recipe elements are exchanged with the PLC via tags.

You can edit values which were saved to the recipes in the HMI device directly at plant level within the active project; this may be the case if a valve in the plant opens more than is indicated in the recipe. The values of the tags on the HMI device possibly no longer match the values in the PLC.

Read the values from the PLC and output these to the recipe view to synchronize the recipe values.

### Requirement

A screen with a simple recipe view is displayed.

### Procedure

To transfer a recipe data record to the PLC, proceed as follows:

1. If the recipe list contains several recipes: Select the recipe which contains the relevant recipe data record.
2. Select the element list of the recipe data record to which you want to apply the values from the PLC.
3. Open the menu.
4. Select menu command "2 From PLC".  
The values are read from the PLC.
5. Save the displayed values to the HMI device using menu command "0 Save".

### Result

The values were read from the PLC, are visible on the HMI device and were saved to the selected recipe data record.

---

#### Note

##### Basic Panels

With Basic Panels, the "From PLC" menu command can also be configured for the data record list: In this case, you can also select the "From PLC" menu command in the data record list.

---

### 10.14.3.3 Operating alarms

#### Overview

#### Alarms

Alarms indicate events and states on the HMI device which have occurred in the plant, in the process or on the HMI device itself. A status is reported when it is received.

An alarm could trigger one of the following alarm events:

- Incoming
- Outgoing
- Acknowledge

The configuration engineer defines which alarms must be acknowledged by the user.

An alarm may contain the following information:

- Date
- Time
- Alarm text
- Event text
- Location of fault
- Status
- Alarm class
- Alarm number
- Alarm group
- Supports diagnostics

#### Alarm classes

Alarms are assigned to various alarm classes. The selection depends on the HMI device.

- "Warnings"  
Alarms of this class usually indicate states of a plant such as "Motor switched on." Alarms in this class do not require acknowledgment.
- "Errors"  
Alarms in this class must always be acknowledged. Alarms normally indicate critical errors within the plant such as "Motor temperature too high".
- "System"  
System alarms indicate states or events which occur on the HMI device. System alarms provide information on occurrences such as operator errors or communication faults.
- "Diagnosis Events"  
SIMATIC diagnostic alarms show states and events in the SIMATIC S7 controllers.

---

**Note**

**Availability for specific devices**

Diagnostic alarms are not available for Basic Panels.

---

- STEP 7 alarm classes  
The alarm classes configured in STEP 7 are also available to the HMI device.
- 

**Note**

**Availability for specific devices**

STEP 7 alarm classes are not available for Basic Panels.

---

- Custom alarm classes  
The properties of this alarm class must be defined in the configuration.

### Alarm buffer

Alarm events are saved to an internal buffer. The size of this alarm buffer depends on the HMI device type.

### Alarm report

When alarm report is enabled in the project, alarm events are output directly to the connected printer.

You can set the reporting function separately for each alarm. The system outputs "Incoming" and "Outgoing" alarm events to the printer.

The output of alarms of the "System" alarm class to a printer must be initiated by means of the corresponding alarm buffer. This outputs the complete content of the alarm buffer to the printer. To be able to initiate this print function, you need to configure a corresponding control object in the project.

---

**Note**

**Availability for specific devices**

Alarm reports are not available for Basic Panels.

---

### Alarm log

Alarm events are stored in an alarm log, provided this log file is configured. The capacity of the log file is limited by the storage medium and system limits.

---

**Note**

**Availability for specific devices**

Alarm logs are not available for Basic Panels.

---



## Alarm view

The alarm view shows selected alarms or alarm events from the alarm buffer or alarm log. Whether alarms have to be acknowledged or not is specified in your configuration. By means of configuration, the display can be filtered in such a way that only alarms that contain a specific character string will be shown.

## Alarm window

If configured, an alarm window shows all pending alarms or alarms awaiting acknowledgment of a particular alarm class. The alarm window is displayed as soon as a new alarm occurs.

You can configure the order in which the alarms are displayed. Either the current alarm or the oldest alarm is displayed. The alarm window can also be set to indicate the exact location of the fault, including the date and time of the alarm event. By means of configuration, the display can be filtered in such a way that only alarms that contain a specific character string will be shown.

## Alarm indicator

The alarm indicator is a graphic icon that is displayed on the screen when an alarm of the specified alarm class is incoming.

The alarm indicator can assume one of two states:

- Flashing: At least one unacknowledged alarm is pending.
- Static: The alarms are acknowledged but at least one of them is not yet deactivated. The number displayed indicates the number of pending alarms.

## Detecting pending alarms

### Introduction

You can recognize the presence of alarms which must be acknowledged by the following:

- For an HMI device with keys: The LED of the key  is lit.
- Depending on the configuration: An alarm indicator is displayed on screen.

The configuration determines whether an alarm has to be acknowledged or not. This is also defined by the alarm class which an alarm belongs to.

### LED in the "ACK" key

An LED is integrated in the  key on HMI devices with keyboard. The LED is lit if there are alarms requiring acknowledgment which must still be acknowledged.

The LED goes out when you acknowledge all alarms requiring acknowledgment.

## Alarm indicator

The alarm indicator is a graphic symbol indicating pending alarms or alarms requiring acknowledgment, depending on the configuration.



Figure 10-9 Alarm indicator with three pending alarms

## Layout

The alarm indicator can assume one of two states:

- **Flashing:**  
The alarm indicator flashes as long as alarms are pending for acknowledgment. The number displayed indicates the number of pending alarms. The project engineer can configure specific functions to be executed by operating the alarm indicator.
- **Static:** The alarms are acknowledged but at least one of them is not yet deactivated.

## Displaying dialogs

The displayed alarm indicator view is covered, for example, by the logon dialog, help dialog or alarm text windows. The alarm indicator is visible once you close these dialogs.

## Viewing alarms

### Alarm view, alarm window

## Use



Alarms are displayed in the alarm view or in the alarm window on the HMI device. The layout and operation of the alarm window corresponds to that of the alarm view.

The alarm window is independent of the process screen. Depending on the configuration, the alarm window appears automatically as soon as a new, unacknowledged alarm has been received. The alarm window can be configured so that it only closes after all the alarms have been acknowledged.

No	Time	Date	Status	Text	
!	1	2:59:51 PM	4/18/2008	I	The value has exceeded the high limit.
!	2	2:59:50 PM	4/18/2008	I	The value exceeds the high limit warning.
!	3	2:59:42 PM	4/18/2008	IO	The value is less than the low warning limit.

## Control elements

The buttons have the following functions:

Button	Function
	Display tooltip for an alarm
	Edit alarms
	Acknowledge alarm

## Layout of the alarm classes

Depending on the configuration, in the alarm view different columns with information regarding an alarm or an alarm event are displayed. If a filter is configured, only alarms that contain a specific character string are displayed in the alarm text.

To differentiate between the different alarm classes, the first column in the alarm view contains an icon:

Icon	Alarm class
!	"Errors"
(empty)	"Warnings"
(depends on the configuration)	Custom alarm classes
\$	"System"
S7	"Diagnosis Events"

## Operation

Depending on the configuration you can:

- Change the column sequence
- Change the order in which the alarms are displayed

- Acknowledge alarms
- Edit alarms

## Runtime behavior

### Linked alarm windows for touch panels

When you configure the alarm window for a keyboard unit, select the property "Modal" under "Properties > Mode". This ensures that the alarm window does not lose its focus during screen changes. This is important, as the switching between the screen and different windows with <Ctrl+TAB> is not supported. If the linked alarm window has the focus, the buttons in the screen behind it cannot be operated. The functions configured on a function key are carried out.

### Changing the order of the displayed alarms

Click in the column to sort the alarms by date and time.

### Simple alarm view, alarm window

#### Use

The simple alarm view shows selected alarms or alarm events from the alarm buffer or alarm log. The layout and operation of the simple alarm window correspond to that of the simple alarm view.

---

#### Note

The "Single alarm view" object cannot be operated dynamically with a script.

In the Engineering System you can dynamically control the visibility of an object, for example, in the "Animations" tab of the Inspector window. In Runtime, the "Simple alarm view" does not support animations. If you have configured an animation and wish to perform a consistency check of the project, for example, then an error alarm is issued in the Output window.

---

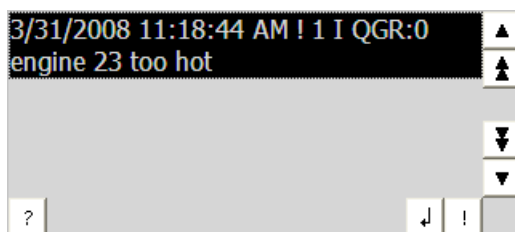

## Layout

Depending on the configuration, in the alarm view different columns with information regarding an alarm or an alarm event are displayed.

To differentiate between the different alarm classes, the first column in the alarm view contains an icon:

Icon	Alarm class
!	"Errors"
(empty)	"Warnings"
(depends on the configuration)	Custom alarm classes
\$	"System"









## Operation

Depending on the configuration you can:

- Acknowledge alarms
- Edit alarms

## Control elements

The buttons have the following functions:

Button	Function
	Acknowledge alarm
	Edit alarm
	Display tooltip for an alarm
	Shows the full text of the selected alarm in a separate window, the alarm text window. In the alarm text window, you can view alarm text that requires more space than is available in the alarm view. Close the alarm text window with  .
	Scrolls one alarm up
	Scrolls one page up in the alarm view
	Scrolls one page down in the alarm view
	Scrolls one alarm down

## Layout of the control elements

On the OP 73micro and TP 177micro HMI devices the simple alarm view has a button that displays the message text in a separate window. This button is not displayed during configuration of the simple alarm view in the Engineering System.



The layout of the buttons for operating the simple alarm view depends on the configured size. You should therefore check on the HMI device whether all required buttons are available.

## Display tooltip for alarm

### Touch and key operation



#### Procedure for touch operation

Proceed as follows to display the info text:

1. Touch the relevant alarm in the alarm view or in the alarm window.  
The alarm is selected.
2. Touch the  button in the simple alarm view or  in the advanced alarm view.  
If configured, the info text assigned to this alarm is displayed.
3. Close the screen for displaying the Info text by means of the  button.

#### Procedure for key operation

Proceed as follows to display the info text:

1. Select the desired alarm in the alarm view.
2. Press the key .
3. Close the info text by pressing the  key.



### Mouse and keyboard operation

#### Procedure for mouse operation

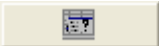
Proceed as follows:

1. Click on the alarm to be edited.
2. Click the  button in the simple alarm view or  in the advanced alarm view.

#### Procedure for keyboard operation

1. Press the <Tab> key until the list of displayed alarms is selected in the alarm view.
2. Click on the alarm to be edited. Use the <Home>, <END>, <Up> and <Down> keys accordingly.
3. Press the <TAB> key until the  button is selected in the simple alarm view or until  is selected in the advanced alarm view.
4. Press <ENTER>.

## Acknowledge alarm



### Touch and key operation

#### Requirement

The alarm to be acknowledged is displayed in the alarm window or the alarm view.

#### Procedure for touch operation







To acknowledge an alarm, proceed as follows:

1. Touch the relevant alarm in the alarm view or in the alarm window.  
The alarm is selected.
2. Touch the  button in the simple alarm view or  in the advanced alarm view.

#### Procedure for key operation

The alarm view and the alarm window have a tab sequence with which you can select operator controls and the last selected alarm using the keyboard.

To acknowledge an alarm, proceed as follows:

1. Select the desired alarm view or alarm window using the  key.
2. Select the desired alarm. Use the , ,  or  keys accordingly.
3. Press the key .

#### Alternative operation

Depending on the configuration, you can also acknowledge an alarm with a function key.

#### Result

The alarm is acknowledged. If the alarm belongs to an alarm group, all the alarms of the associated group are acknowledged.

### Mouse and keyboard operation



#### Procedure for mouse operation

Proceed as follows:

1. Click on the alarm to be edited.
2. Click the  button in the simple alarm view or  in the advanced alarm view.

### Procedure for keyboard operation

Proceed as follows:

1. Press the <Tab> key until the list of displayed alarms is selected in the alarm view.
2. Click on the alarm to be edited. Use the <Home>, <END>, <Up> and <Down> keys accordingly.
3. Press the <Tab> key until the  button is selected in the simple alarm view or until  is selected in the advanced alarm view.
4. Press <Enter>.

### Edit alarm

### Touch and key operation

### Introduction

The configuration engineer can assign additional functions to each alarm. These functions are executed when the alarm is processed.

---

#### Note

When you edit an unacknowledged alarm, it is acknowledged automatically.



---

### Requirement

The alarm to be edited is displayed in the alarm window or the alarm view.









### Procedure for touch operation

Proceed as follows to edit an alarm:

1. Touch the relevant alarm in the alarm view or in the alarm window. The alarm is selected.
2. Touch the  button in the simple alarm view or  in the enhanced alarm view.

### Procedure for key operation

Proceed as follows to edit an alarm:

1. Select the desired alarm view or alarm window with .
2. Select the desired alarm. Use the , ,  or  keys.
3. Continue to press the key  until the button  is selected in the simple alarm view or  in the extended alarm view.
4. Confirm your entry by pressing the key .





## Result

The system executes the additional functions of the alarm. Additional information on this topic may be available in your plant documentation.

## Mouse and keyboard operation



### Procedure for mouse operation

Proceed as follows:

1. Click on the alarm to be edited.
2. Click the  button in the simple alarm view or  in the advanced alarm view.

### Procedure for keyboard operation

Proceed as follows:

1. Press the <Tab> key until the list of displayed alarms is selected in the alarm view.
2. Click on the alarm to be edited. Use the <Home>, <END>, <Up> and <Down> keys accordingly.
3. Press the <Tab> key until the  button is selected in the simple alarm view or until  is selected in the advanced alarm view.
4. Press <Enter>.

## Alternative operation

Depending on the configuration, you can also operate the alarm view via the function keys.

### 10.14.3.4 Basics

## Overview

### Operation options

The hardware determines how you can operate the HMI device:

- Touch screen  
The operating elements shown in the dialogs are touch-sensitive. Touch objects are basically operated in the same way as mechanical keys. You activate operating elements by touching them with your finger. To double-click them, touch an operating element twice in succession.
- HMI device keyboard  
The operating elements shown in the screens are selected and operated using the keys of the HMI device.

- External keyboard
- External mouse

### Operation feedback from operating elements

The HMI device provides optical feedback as soon as it detects that an operating element has been selected. The operating element receives the focus and is selected. This selection is independent of any communication with the PLC. Therefore this selection does not indicate whether the relevant action is actually executed or not.

The configuration engineer can also configure the selection of an operating element so that it deviates from the standard.

### Optical feedback from operating elements

The type of optical feedback depends on the operating element:

- Buttons  
The HMI device outputs different views of the "Pressed" and "Unpressed" states, provided the configuration engineer has configured a 3D effect:

– "Pressed" state:

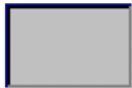

– "Unpressed" state:



The configuration engineer determines the appearance of a selected field, for example, line width and color for the focus.

- Invisible buttons  
By default, invisible buttons are not displayed as pressed when they are touched. No optical operation feedback is provided in this case.  
The configuration engineer may, however, configure invisible buttons so that their outline appears as lines when touched. This outline remains visible until you select another operating element.
- I/O fields  
When you select an I/O field, the content of the I/O field is displayed against a colored background. With touch operation, a screen keyboard is displayed for the entering of values.

### Direct keys

### Introduction

Direct keys on the HMI device are used to set bits in the I/O area of a SIMATIC S7.

Direct keys enable operations with short reaction times that are, for example, a jog mode requirement.

---

**Note**

Direct keys are still active when the HMI device is in "offline" mode.

---

**Note**

If you operate a function key with direct key functionality in a running project, the direct key function is always executed, independent of the current screen contents.

---

**Note**

You can only use direct keys when there is a connection via PROFIBUS DP or PROFINET IO. Direct keys result in additional basic load on the HMI device.

---

## Direct keys

The following objects can be configured as a direct key:

- Buttons
- Function keys

You can also define image numbers in the case of HMI devices with touch operation. In this way, the project engineer can configure the direct keys on an image-specific basis.

For additional information on configuring direct keys, refer to "WinCC Communication."

## Touch operation

### Overview

### Screen keyboard

When you touch an operating element requiring entry on the HMI device touch screen, a screen keyboard appears. The screen keyboard is displayed in the following cases:

- An I/O field is selected for input.
- A password must be entered for accessing a password-protected function.

The screen keyboard is automatically hidden again when input is complete.

Based on the configuration of the operating element, the system displays different screen keyboards for entering numerical or alphanumerical values.

---

**Note**

The screen keyboard display is independent of the configured project language.

---

## General procedure

The operating elements of a screen are operated by touching the touch screen.

Proceed as follows:

1. Touch the desired operating element within the screen.
2. Depending on the operating element, perform further actions. Detailed descriptions can be found under the respective operating element.

Examples:

- I/O field: Enter numerical, alphanumeric or symbolic values in the I/O field.
- Symbolic I/O field: Select an entry from the drop down list box.
- Slider control: Move the slider control.

## Procedure for input fields

Values are entered in the project input fields. Based on your configuration, the values are saved to tags and transferred, for example, to the PLC.

Proceed as follows:

1. Touch the desired input field within the screen.

The screen keyboard opens.

Depending on your configuration, you can enter values in the input field in the following manner:

- Numerical values, for example decimal numbers, hexadecimal numbers, binary values
- Alphanumerical values, for example digits and letters
- Date/time

2. Enter the value.

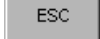
3. Confirm your entry with  or discard your entry using the button .

## Entering and editing numerical values

### Numerical screen keyboard

When you touch an operating element for numerical input on the HMI device touch screen, the numerical screen keyboard appears. This is the case, for example, for an input field. The screen keyboard is automatically hidden again when input is complete.

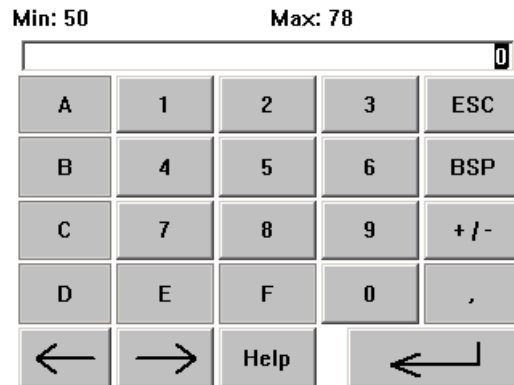

Figure 10-10 Numerical screen keyboard

---

#### Note

##### Opened screen keyboard

When the screen keyboard is open, PLC job 51, "Select Screen", has no effect.

---

## Display formats for numerical values

You can enter values of the following format type in numerical input fields:

- Decimal
- Hexadecimal
- Binary

## Limit test of numerical values

Tags can be assigned limits. The current limits are indicated in the numerical screen keyboard. If you enter a value that lies outside of this limit, it will not be accepted, for example, 80 with a limit value of 78. In this case the HMI device will deliver a system event, if an alarm window is configured. The original value is displayed again.

## Decimal places for numerical values







The configuration engineer can define the number of decimal places for a numerical input field. The number of decimal places is checked when you enter a value in this type of I/O field.

- Decimal places in excess of the limit are ignored.
- Empty decimal places are filled with "0".

## Procedure

Numerical and hexadecimal values can be entered character-by-character via the buttons on the numerical screen keyboard.

Proceed as follows:

1. Touch the desired operating element within the screen.  
The numerical screen keyboard opens. The existing value is displayed in the screen keyboard and is selected.
2. Enter the value.  
You can only operate keys that are required for entering values. The keys with letters cannot be used, for example, for entering a decimal value. Which keys can be operated can be seen from the appearance of the keys.  
You have the following options to enter a value:
  - The selected value is deleted when you enter the first character. Completely reenter the value.
  - Use the  and  keys to move the cursor within the current value. You can now edit characters of the current value or add characters.  
Use the  key to delete the next character to the left of the cursor. If the value is selected, use this key to delete the selected part of the value.
  - Change the sign of the value using the  key.
  - Use the  key to display the tooltip of the I/O field.  
This key is only enabled if a tooltip was configured for the input object or for the current screen.
3. Use the  key to confirm your entry or cancel it with . Either action closes the screen keyboard.

## Result

You have changed the numerical value or entered a new one.

## Entering and editing alphanumerical values

### Alphanumerical screen keyboard

When you touch an operating element for numerical input on the HMI device touch screen, the alphanumerical screen keyboard appears. This is the case, for example, for an input field. The screen keyboard is automatically hidden again when input is complete.

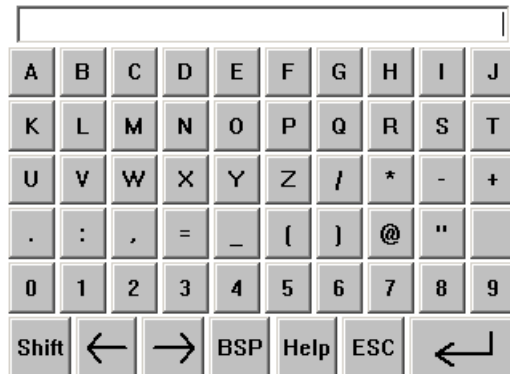

Figure 10-11 Alphanumerical screen keyboard, normal level

---

#### Note

##### Opened screen keyboard

When the screen keyboard is open, PLC job 51, "Select Screen", has no effect.

##### Language change

Language change in the project has no influence on the alphanumerical screen keyboard. The entry of Cyrillic or Asian characters is therefore not possible.

---

## Keyboard levels

The alphanumerical screen keyboard has various levels.







- Normal level
- Shift level

The key labels change when you change levels with the **Shift** key.

## Procedure

Alphanumerical values can be entered character-by-character via the buttons on the alphanumerical screen keyboard.

Proceed as follows:

1. Touch the desired operating element within the screen.  
The alphanumerical screen keyboard opens. The existing value is displayed in the screen keyboard and is selected.
2. Enter the value.  
You have the following options to enter a value:
  - The selected value is deleted when you enter the first character. Completely reenter the value.
  - Use the  and  keys to move the cursor within the current value. You can now edit characters of the current value or add characters.  
Use the  key to delete the next character to the left of the cursor. If the value is selected, use this key to delete the selected part of the value.
  - Use the  key to toggle between keyboard levels of the screen keyboard. On switchover, the key assignment of the screen keyboard changes.
  - Use the  key to display the tooltip of the I/O field.  
This key is only enabled if a tooltip was configured for the input object or for the current screen.
3. Use the  key to confirm your entry or cancel it with . Either action closes the screen keyboard.

## Result

You have changed the alphanumeric value or entered a new one.

## Display tooltip for touch control

### Purpose

The configuration engineer uses tooltips to provide additional information and operating instructions. The configuration engineer can configure tooltips for screens and operating elements.



The tooltip of an I/O field may, for example, contain information about the value to be entered.



Figure 10-12 Tooltip for an I/O field, example

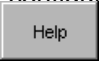

## Opening tooltips for operating elements

1. Touch the required operating element.  
The screen keyboard opens. The representation of the  key indicates whether a tooltip was configured for the operating element or for the current screen.
2. Touch the  key of the on-screen keyboard.  
The tooltip for the operating element is displayed. If there is no tooltip for the selected screen object, the tooltip for the current screen is displayed if it has been configured.  
You can scroll through the contents of long tooltips using the  and  buttons.

---

### Note

#### Switching between displayed tooltips

The configuration engineer can configure a tooltip for an I/O field and the associated screen. You can switch between two tooltips by touching the tooltip window.

---

3. Close the displayed tooltip by pressing .

## Alternative procedure

Depending on your configuration, tooltips can also be called via a configured operating element.

Additional information on this topic may be available in your plant documentation.

## Key operation

## Control keys

## Introduction

The following tables list the control keys available to operate the project. For detailed information, refer to the description of the individual operating elements.





---

### Note



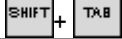









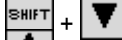

The availability of system keys is determined by the HMI device used.

---



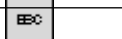

Selecting operating elements

Key	Function	Description
 	Tabulator	Selects the next or previous operating element based on the configured tab sequence.
   	Cursor keys	Selects the next operating element on the left, right, above or below the current screen object. Navigates in the operating element.

Operating operating elements

Key	Function	Description
   	Positioning cursor	Positions the cursor within an operating element, for example, in an I/O field.
	Scrolling back	Scrolls the list back by one page.
	Scroll to start	Scrolls to the start page of a list.
	Scrolling up	Scrolls the list up by one page.
	Scroll to end	Scrolls to the end of a list.
	ENTER key	<ul style="list-style-type: none"> <li>Controls buttons.</li> <li>Applies and ends an entry.</li> <li>Opens a selection list.</li> <li>Toggles between character mode and standard mode within an input field.</li> </ul> A single character is selected in character mode. In this mode, you can scroll within the character set using the cursor keys.
	Cancel	<ul style="list-style-type: none"> <li>Deletes the input characters of a value and restores the original value.</li> <li>Closes the active dialog.</li> </ul>
	Delete characters	Deletes the next character to the right of the current cursor position.
	Delete characters	Deletes the character to the left of the current cursor position.
	Open selection list	Opens a selection list.
	Accept value	Accepts the value selected in the selection list without closing the list.

## Enter hotkey

Key	Function	Purpose
	Toggle (numbers/letters)	<p>Toggles the assignment from numbers to letters.</p> <ul style="list-style-type: none"> <li>No LED is lit: The number assignment is enabled. Pressing the key once switches to letter assignment.</li> <li>An LED is lit: The left or right letter assignment is enabled.</li> </ul> <p>Each time the key is pressed, the system toggles between the left letter assignment, the right letter assignment and the number assignment.</p>
	Shift (upper/lower case)	Use in hotkeys, for example, for switching to uppercase letters.
	Toggle to additional keyboard layout	Some of the keys contain a blue special character on their bottom left corner, for example, the "%" character. To input these characters, press the relevant key in combination with the special character key shown on the left.
	General control function	Used in hotkeys, for example, for navigating trend views.
	General control function	Used in hotkeys, for example, for the "Status/Force" screen object.

## Acknowledge alarms

Key	Function	Purpose
	Acknowledge	<p>Acknowledges the currently displayed error alarm or all alarms of an alarm group (group acknowledgment).</p> <p>The LED is lit as long as an unacknowledged alarm is active.</p>

## Displaying infotext

Key	Function	Description
	Display tooltip	Opens the configured tooltip for the selected object, for example, alarm or I/O field. The LED is lit if a tooltip is available for the selected object.

## Function keys

### Function keys

Function key assignment is defined during configuration. The configuration engineer can assign function keys globally and locally.

### Function keys with global function assignment

A globally assigned function key always triggers the same action on the HMI device or in the PLC irrespective of the screen displayed. Such an action could be, for example, the activation of a screen or the closure of an alarm window.

### Function keys with local function assignment

A function key with local function assignment is screen-specific and is therefore only effective within the active screen.

The function assigned locally to a function key can vary from screen to screen.

The function key of a screen can be assigned one function only, either a global or local one. The local assignment function takes priority over the global setting.

The configuration engineer can assign function keys in such a way that you can operate operating elements with function keys, for example, the alarm view, trend view, recipe view or status / force.

## General procedures



### Introduction

The control keys and function keys of the HMI device are available for key operation.

### General procedure

The operating elements of a screen are operated using the control keys of the HMI device.

Proceed as follows:

1. Continue pressing the  key or the cursor keys until the required operating element is selected in the screen.
2. Depending on the operating element, perform further actions. Detailed descriptions can be found under the respective operating element.  
Examples:
  - I/O field: Enter numerical, alphanumeric or symbolic values in the I/O field.
  - Slider control: Move the slider control.
3. Confirm your entry with  or cancel it with .

## Entering and editing numerical values

### Display formats for numerical values

You can enter values of the following format type in numerical input fields:

- Decimal
- Hexadecimal
- Binary









### Limit test of numerical values

Tags can be assigned limits. If you enter a value that lies outside of this limit, it will not be accepted, for example, 80 with a limit value of 78. In this case the HMI device will deliver a system event, if an alarm window is configured. The original value is displayed again.

### Procedure

Numerical and hexadecimal values can be entered in character mode using the system keys.

Proceed as follows:

1. Select the input field within the screen using the  key.  
The existing value is selected in the input field.
2. Enter the value using the numerical keypad.  
You have the following options to enter a value:
  - The existing value is deleted when you enter the first character. Completely reenter the value.
  - Press  and a cursor key simultaneously. This step cancels the field content selection. Move the cursor in the existing value. You can now edit the characters of the current value or add characters.  
The  key deletes the next character to the right of the cursor. Use the  key to delete the next character to the left of the cursor.  
To enter the hexadecimal characters "A" to "F", switch the numerical keypad to alphabet mode using the  key.
  - The lit LED of the  key indicates that a tooltip is available for the selected object or the active screen.  
Use the key  to view the tooltip for the operating element or active screen.
3. Confirm your entry with the  key.

### Result









You have changed the numerical value or entered a new one.

## Entering and editing alphanumerical values

### Procedure

Alphanumerical values can be entered in character mode using the system keys.

Proceed as follows:





1. Select the input field within the screen using the  key.  
The existing value is selected in the input field.
2. Enter the value using the system keys.  
You have the following options to enter a value:
  - The existing value is deleted when you enter the first character. Completely reenter the value.
  - Press  and a cursor key simultaneously. This step cancels the field content selection. Move the cursor in the existing value. You can now edit the characters of the current value or add characters.  
The  key deletes the next character to the right of the cursor. Use the  key to delete the next character to the left of the cursor.  
Switch the numerical keypad to alphabet mode using the  key to enter letters.
  - The lit LED of the  key indicates that a tooltip is available for the selected object or the active screen.  
Use the key  to view the tooltip for the operating element or active screen.
3. Confirm your entry with the  key.

### Result



You have changed the alphanumeric value or entered a new one.

### Enter characters using the alphanumeric keyboard

Using the same keys of the alphanumeric keyboard you can enter up to six different characters. The entry result depends on the combination of the keys pressed.

The values "5", "m", "N", "M" and "%" are entered using the same key  of the keyboard. Use the keys ,  and  to select the key mode.

The following table shows the entry options using the key .

Key 	Key 	Key 	Result
No LED is lit.	Not relevant	Not pressed	5
Left LED is illuminated.	Not pressed	Not pressed	m
Left LED is illuminated.	Pressed	Not pressed	M
Right LED is illuminated.	Not pressed	Not pressed	n
Right LED is illuminated.	Pressed	Not pressed	N
Not relevant	Not relevant	Pressed	%

## Display tooltip for key operation

### Use

The configuration engineer uses tooltips to provide additional information and operating instructions. The configuration engineer can configure tooltips for screens and operating elements.

The tooltip of an I/O field may, for example, contain information about the value to be entered.





Figure 10-13 Tooltip for an I/O field, example

The lit LED of the  key indicates that a tooltip was configured for the selected screen object or for the active screen.

### Procedure

Proceed as follows:

1. Press the  key.  
The tooltip for the selected screen object is displayed. If there is no tooltip for the selected screen object, the tooltip for the current screen is displayed if it has been configured. You can scroll the contents of longer tooltips using the cursor keys  and .

---

#### Note

##### Switching between displayed infotext

The configuration engineer can configure a tooltip for an I/O field and the associated screen. You can switch between two tooltips by pressing the  key.

---

2. Close the tooltip by pressing the  key.

### Alternative procedure

Depending on your configuration, tooltips can also be opened with a function key or via an existing operating element.

Additional information on this topic may be available in your plant documentation.

## Mouse and keyboard operation

### Operation with the keyboard

The navigation options listed in the table can be used for keyboard operations in a screen.

Navigation	PC	SIMATIC Panel PC
Next field right/left	<Shift+Right> / <Shift+Left>	<Right> / <Left>
Next field up/down	<Shift+Down> / <Shift+Up>	<Down> / <Up>
To the right/left in the field	<Right> / <Left>	<Shift+Right> / <Shift+Left>

The other keys have identical functions on the PC and the SIMATIC Panel PC:

Key	Function
<Enter>	Applies a value (e.g. in unmarked input fields) or opens a selection list.  If the I/O field is marked (highlighted in color), WinCC Runtime will switch to the special editing mode. Only one character at any time is marked in the field.  Use the cursor keys <Up>/<Down> to scroll through a character table.  Use the cursor keys Right/Left to move the cursor to the next or previous entry position.  Press <Enter> or <Esc> to exit from the entry mode. The characters entered up to this point will be either applied or discarded.
<Esc>	Interrupts the input.
<Tab>	Selects the next available screen object in the configured tab sequence.
<Shift+Tab>	Selects the previously available screen object in the configured tab sequence.
<F1> -... <F12>, <Shift+F1>, ..., <Shift+F12>	On the PC: Triggers a function, e.g. screen selection.
<F1>, ... or <S1>, ... or <K1>, ...	On the SIMATIC Panel PC: triggers a global or local function.

#### CAUTION

If you press a function key after a screen change, the associated function in the new screen may be triggered before the new screen is fully displayed.



## Controlling Windows with the keyboard

You may also use the keyboard to control the operating system of your HMI device. See your Windows manual for detailed information. The most important key combinations for SIMATIC Panel PCs are listed in the following table.

Navigation	HMI device
Open start menu	<Ctrl+Esc>
Show the shortcut menu of the selected element	<Shift+F10>
Select all	<Ctrl+A>
Display properties of the selected element	<Ctrl+Enter>
Explorer:	
Change folder	<F4>
Change display areas	<F6>
Enable menu bar	<F10>
Dialogs:	
Go to next field	<Tab>
Back to previous field	<Shift+Tab>
Open next tab	<Ctrl+Tab>
Open previous tab	<Ctrl+Shift+Tab>

## Operation with the mouse

A lightning symbol attached to the mouse pointer indicates that the screen object, for example a switch, may be operated with the mouse.

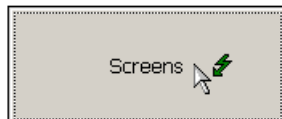

### Note

If a screen object is covered by another, e.g. a button from a rectangle with a transparent fill, it is not possible to operate with the mouse in runtime.

The screen object can be operated with the keyboard.



### 10.14.3.5 Project security

#### Overview

#### Design of the security system

The configuration engineer can protect the operation of a project by implementing a security system.

The security system is based on authorizations, user groups and users.

If you use an operator control with access protection, the HMI device first requests that you log on. A logon screen is displayed in which you enter your user name and password. After logging on, you can operate the operator controls for which you have the necessary authorizations.

The logon dialog can be set up by the configuration engineer via an individual operator control.

In the same way, the configuration engineer can set up an operator control to log off. After logging off, objects assigned access protection can no longer be operated; to do so, log on again.

#### User groups and authorizations

Project-specific user groups are created by the configuration engineer. The "Administrators" and "Users" groups are included in all projects by default. User groups are assigned authorizations. Authorization required for an operation is specifically defined for each individual object and function in the project.

#### Users and passwords

Each user is assigned to exactly one user group.

The following people are allowed to create users and assign them passwords:

- The configuration engineer during configuration
- The administrator on the HMI device
- A user with user administration authorization on the HMI device

Irrespective of the user group, each user is allowed to change his own password.

#### Logoff times

A logoff time is specified in the system for each user. If the time between any two user actions, such as entering a value or changing screens, exceeds this logoff time, the user is automatically logged off. The user must then log on again to continue to operate objects assigned access protection.

## Backup and restore

The user data is encrypted and saved on the HMI device to protect it from loss due to power failure.

The users, passwords, group assignments and logoff times set up on the HMI device can be backed up and restored. This prevents you having to enter all of the data again on another HMI device.

---

### Note

The currently valid user data is overwritten in the following cases:

- Depending on settings for a new download of the project.
  - Upon restore of a backed-up project
  - Upon import of the user administration via an operator control. The newly downloaded or restored user data and passwords take effect immediately.
- 

## Displaying users

### User view

### Use

The user view is used by the administrator to manage user accounts, group assignments and user passwords.

Users can change their passwords and logoff times.

User	Password	Group	Logoff time
Administrator	*****	Administrator gr...	5
PLC User	*****	Unauthorized	5
User_2	*****	Users	5

### Layout

The user view contains four columns for the user, password, group and logoff time. The passwords are encrypted by means of asterisks.

- All users on the HMI device are displayed in the User view to the administrator or to a user with administrator authorizations.
- When user administration authorization is lacking, only the personal user entry is displayed.

## Operation

Depending on the configuration you can:

- Manage users, e.g. create, delete.
- Change existing user data.
- Export or import user data.

---

### Note

On an HMI device the number is limited to 100 users and one PLC user. This restriction does not apply to PCs. On a PC, the maximum number of users is restricted by the physical memory.

---

## Runtime behavior

The user view on the HMI devices OP 73, OP 77A and TP 177A also displays the "PLC User" with administrator privileges who is logged on in Runtime.

## Changing existing user data

The following options are available for the changes that can be made:

- The administrator or a user with user administration authorization can change the data for all users on the HMI device system in the user view.
  - User name
  - Group assignment
  - Password
  - Logoff times
- A user without user administration authorization can only change their own user data:
  - Password
  - Logoff time

---

### Note

If you enter the value "0" in the logoff time, user is not logged off automatically.

---

## Export or import user data

A user view contains all users, passwords, group assignments and logoff times set up on the HMI device. To not have to enter all data again on another HMI device, you can export the

user view and then import it to another device. But you can only do this if this function has been configured.

---

**Note**

Do not export the password list immediately after changing it. Exit the "User view" object after making changes and wait until the changes have been written to the internal Flash memory before performing the export.

---

**Note**

The currently valid user data are overwritten during an import. The imported user data and passwords are valid immediately.

---

## Simple user view

### Use

On HMI devices with a small display, the simple user view is used to display users on the HMI device.

Administrator	Administrator group	▲
Foreman	Users	▲
Miller	Programmer	
PLC User	Unauthorized	
Smith	Users	
<New user >		
		▼
		▼

---

**Note**

The "Simple user view" object cannot be operated dynamically with a script.

---

## Layout

The appearance depends on the authorizations.

- All users on the HMI device are displayed in the User view to the administrator or to a user with administrator authorizations.
- When user administration authorization is lacking, only the personal user entry is displayed.

## Operation

Depending on the configuration you can:

- Manage users, e.g. create, delete.
- Change existing user data.
- Export or import user data.

---

### Note

On an HMI device the number is limited to 100 users and one PLC user. This restriction does not apply to PCs. On a PC, the maximum number of users is restricted by the physical memory.

---

## User logon

## Touch and key operation

## Logon dialog

Use the logon dialog to log on to the security system of the HMI device. Enter your user name and password in the logon dialog.

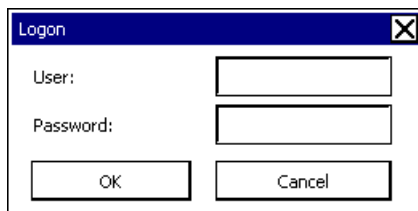

The logon dialog opens in the following cases:

- You use an operator control with access protection.
- You press an operator control that was configured for displaying the logon dialog.
- You enable the "<ENTER>" entry in the simple user view.
- You enable a blank entry in the extended user view.
- The logon dialog will be automatically displayed when the project is started, depending on the configuration.

## Requirement

The logon dialog is open.



### Procedure for touch operation

Proceed as follows:

1. Enter the user name and password.  
Touch the corresponding input field. The alphanumerical screen keyboard is displayed.
2. Select "OK" to confirm logon.

### Procedure for key operation

Proceed as follows:

1. Select the "User" input field within the logon dialog by pressing the  key.
2. Enter the user name using the system keys.  
Switch the numerical keypad to alphabet mode using the  key to enter letters.
3. Use the  key to select the "Password" input field.
4. Enter the password using the system keys.
5. Confirm your entries with "OK".

---

#### Note

The user name is not case sensitive.

The password is case sensitive.

---

### Result

After successful logon to the security system, you can execute functions on the HMI device which are access protected and for which you have authorization.

An alarm is output if an incorrect password has been entered and if an alarm view was configured.

### Mouse and keyboard operation

#### Requirement

The logon dialog is open.

#### Procedure for mouse operation

Proceed as follows:

1. Click in the input field. The alphanumerical on-screen keyboard is displayed.
2. Enter the user name and the password.
3. Click "OK" in the logon dialog.

### Procedure for keyboard operation

Proceed as follows:

1. Press the <Tab> key until the "Users" input field is selected.
2. Enter the user name and the password.
3. Confirm your entries with "ENTER."

---

#### Note

The user name is not case-sensitive.

The password is case-sensitive.

---

### Result

After successful logon to the security system, you can execute functions on the HMI device which are access protected and for which you have authorization.

An alarm is output if an incorrect password has been entered and if an alarm view was configured.

### User logoff

### Requirement

You have logged into the security system of the HMI device.

### Procedure

You have the following options for logging off:

- You press an operator control that was configured for logoff.
- You will be logged off automatically if you are not operating the project and if the logoff time has been exceeded.

You will also be automatically logged off if you enter an incorrect password.

### Result

You are no longer logged into the project. In order to use an operator control with access protection, you first have to log on again.



## Creating users

## Touch operation

## Requirement

- The user view is open.
- You are either authorized for user administration or you are an administrator.
- A user group has been created.

### Note

Runtime users must be assigned to a user group. The user group is created in the Engineering System. The designation of the user group is language-dependent.

### Note

The following characters cannot be used in passwords:

- Blanks
- Special characters \* ? . % / \ ' "

## Creating users in the simple user view

Proceed as follows:

1. Click the "<New user>" entry in the user view. A dialog opens.

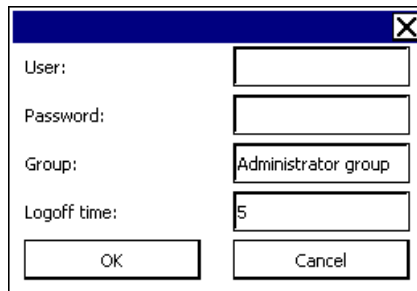

2. Enter the desired user name and password.  
Touch the corresponding text box. The alphanumerical on-screen keyboard is displayed.
3. Click on the text box of the group. A dialog opens.
4. Assign the user to a group. Select ▲ and ▼ to scroll the selection list.
5. Touch the required entry in the drop down list box.  
The selected entry is accepted as input.
6. Touch the text box "Logoff time". The on-screen keyboard is displayed.
7. Enter a logoff time between 0 and 60 minutes. The value 0 stands for "no automatic logoff."
8. Confirm your entries with "OK."

## Result

The new user is created.

## Key operation

## Requirement

- The user view is open.
- You are either authorized for user administration or you are an administrator.
- A user group has been created.

---

### Note

Runtime users must be assigned to a user group. The user group is set up in the Engineering System. The user group name is language-specific.

---



### Note

The following characters cannot be used in passwords:

- Blanks
  - Special characters \* ? . % / \ ' "
- 

## Creating users in the simple user view

Proceed as follows:

1. Select the user view using the key  or using the cursor keys.
2. Select the entry "<New user>" in the user view with the cursor keys and confirm with .

The following dialog opens:

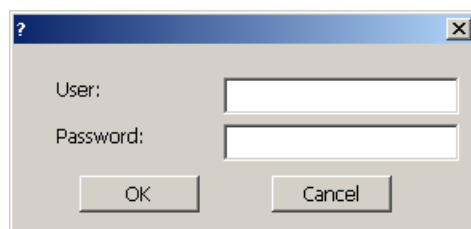

3. Enter the desired user name using the system keys.
4. Select the next text box with the  key and enter a password using the system keys.

5. Confirm your entries with "OK."

The following dialog opens:

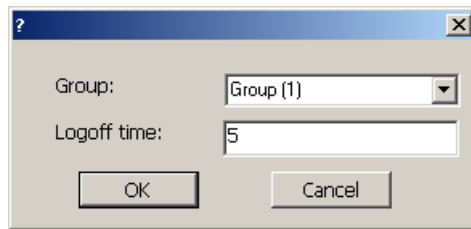

6. Select the "Group" selection box with .
7. Assign the user to a group.
  - Select to open the drop down list box. The drop down list box opens.
  - Select the required entry using or .
  - Confirm your entry by pressing the key .
8. Select the text box "Logoff time" with .
9. Enter the desired logoff time using the system keys.  
Enter a logoff time between 0 and 60 minutes. The value 0 stands for "no automatic logoff."
10. Confirm your entries with "OK."

## Creating users in the advanced user view

Proceed as follows:

1. Select the user view with the key via the configured tab order.
2. Select a blank line with the or keys.
3. Select the desired field in the blank line of the user view with the or keys.
4. Confirm your entry by pressing the key .
5. Enter the desired user data:
  - Enter the data using the system keyboard. To enter letters, switch the numerical keypad to letter assignment using the key .
  - Assign the user to one of the groups from the drop down list box. Open the drop down list box with the key and select the desired entry with the or keys.
  - Enter a logoff time between 0 and 60 minutes. The value 0 stands for "no automatic logoff."
6. Confirm your entry by pressing the key .

## Result

The new user is created.

## Operation with the mouse

### Requirement

- The user view is open.
- You are either authorized for user administration or you are an administrator.
- A user group has been created.

---

#### Note

Runtime users must be assigned to a user group. The user group is set up in the Engineering System. The user group name is language-specific.

---

#### Note

The following characters cannot be used in passwords:

- Blanks
  - Special characters \* ? . % / \ ' "
- 

## Creating users in the simple user view

Proceed as follows:

1. Click the "<New User>" entry in the user view.  
The following dialog opens:

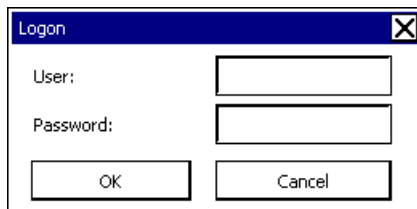

2. Enter the desired user name and password.  
Click in the corresponding input field. The alphanumerical on-screen keyboard is displayed.
3. Click "OK".  
The following dialog opens:

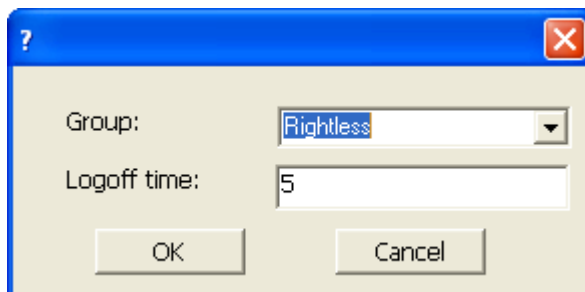

4. Assign the user to a group.
5. Click the required entry in the selection list.  
The selected entry is accepted as input.

6. Click in the "Logoff time" input field. The on-screen keyboard is displayed.
7. Enter a logoff time between 0 and 60 minutes. The value 0 stands for "no automatic logoff."
8. Confirm your entries with "OK."

### Creating users in the advanced user view

Proceed as follows:

1. Double-click the desired field in the blank line of the user view.  
The corresponding on-screen keyboard is displayed.
2. Enter the respective user data in the field:
  - Assign the user to one of the groups from the drop down list box.
  - Enter a logoff time between 0 and 60 minutes. The value 0 stands for "no automatic logoff."

### Result

The new user is created.

### Operation with the keyboard

### Requirement

- The user view is open.
- You are either authorized for user administration or you are an administrator.
- A user group has been created.

---

#### Note

Runtime users must be assigned to a user group. The user group is set up in the Engineering System. The user group name is language-specific.

---

#### Note

The following characters cannot be used in passwords:

- Blanks
  - Special characters \* ? . % / \ ' "
-

### Creating users in the simple user view

Proceed as follows:

1. Press the <TAB> key until the user view is selected.
2. Select the "<New user>" entry in the user view using the cursor keys and confirm it with <ENTER>.

The following dialog opens:

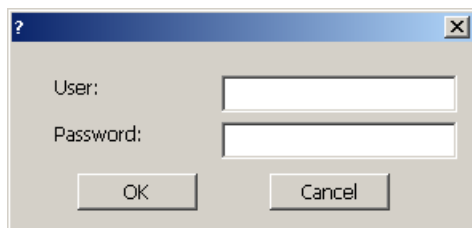

3. Enter the user name.
4. Press the <Tab> key to move to the next input field and enter a password.
5. Confirm your entries with <ENTER>.

The following dialog opens:

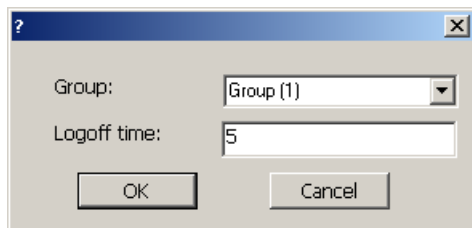

6. Select the "Group" selection list using the <TAB> key.
7. Assign the user to a group.
  - Press <ENTER> to open the selection list. The drop down list box opens.
  - Select the entry. Use the <Home>, <End>, <Up> and <Down> keys accordingly.
  - Confirm the selection with <ENTER>.
8. Change to the "Logoff time" input field using the <TAB> key.
9. Enter the desired logoff time.  
Enter a logoff time between 0 and 60 minutes. The value 0 stands for "no automatic logoff."
10. Confirm your entries with <ENTER>.

### Creating users in the advanced user view

Proceed as follows:

1. Press the <TAB> key until the user view is selected.
2. Select an empty line in the user view using the cursor keys.
3. Select the desired field in the empty line of the user view. Use the <Up> and <Down> keys accordingly.
4. Confirm the selection with <ENTER>.

5. Enter the desired user data:
  - Enter the user name and the password.
  - Assign the user to one of the groups from the drop down list box. Open the selection list by pressing <ENTER> and then select the entry using the <Up> and <Down> cursor keys.
  - Enter a logoff time between 0 and 60 minutes. The value 0 stands for "no automatic logoff."
6. Confirm your entries with <ENTER>.

## Result

The new user is created.

## Changing user data

## Key operation

## Requirement

The user view is open.

Your authorization level determines the data you can edit:

- You are an administrator or a user with user administration authorization. In these cases you are allowed to change the data for all the users on the HMI device in the user view:
  - User name
  - Group assignment
  - Password
  - Logoff time
- You are a user without user administration authorization. In this case you are only allowed to change your personal user data:
  - Password
  - Logoff time, if configured

---

**Note**

You can only change the logoff time and password for the "Admin" user.

You can only change the logoff time for the "PLC\_User". This user is used for logging on via the PLC.

---

**Note**



Changes in the user view are effective immediately in Runtime. Changes in Runtime are not updated in the Engineering System.

When the user management is downloaded to the HMI device, all changes in the user view are overwritten.

---



### Changing user data in the simple user view

Proceed as follows:

1. Confirm your entry by pressing the key .
2. In the user view, use the cursor keys to select the user whose user data you want to change. Confirm your entry by pressing the key .
3. When entering the data, use exactly the same procedure as for creating a user.

### Changing user data in the advanced user view

Proceed as follows:

1. Confirm your entry by pressing the key .
2. Use the cursor keys to select the field in which you want to change data. Confirm your entry by pressing the key .
3. When entering the data, use exactly the same procedure as for creating a user.

### Result

User data have been changed.



## Touch operation

### Requirement

The user view is open.

Your authorization level determines the data you can change:

- You are an administrator or a user with user administration authorization. In these cases you are allowed to change the data for all the users on the HMI device in the user view:
  - User name
  - Group assignment
  - Password
  - Logoff time
- You are a user without user management authorization. In this case you are only allowed to change your personal user data:
  - Password
  - Logoff time, if configured

---

#### Note

You can only change the logoff time and password for the "Admin" user.

You can only change the logoff time for the "PLC\_User". This user is used for logging on via the PLC.

---

#### Note

Changes in the user view are effective immediately in Runtime. Changes in Runtime are not updated in the Engineering System.

When the user management is downloaded to the HMI device, all changes in the user view are overwritten.

---

### Changing user data in the simple user view

Proceed as follows:

1. In the user view, touch the user whose user data you want to change.
2. When entering the data, use exactly the same procedure as for creating a user.

### Changing user data in the advanced user view

Proceed as follows:

1. In the user view, touch the user whose user data you want to change.
2. When entering the data, use exactly the same procedure as for creating a user.

## Result

User data have been changed.

## Mouse and keyboard operation

### Requirement

- The user view is open.
- You are either authorized for user administration or you are an administrator.

---

#### Note

Changes in the user view are effective immediately in Runtime. Changes in Runtime are not updated in the Engineering System.

When the user management is downloaded to the HMI device, all changes in the user view are overwritten.

---

### Procedure for mouse operation

Proceed as follows:

1. Click the user to be deleted in the user view.
2. Delete the user name.

### Procedure for keyboard operation

Proceed as follows:

1. Select the user view using the <TAB> key or the cursor keys.
2. Select the user in the user view by means of cursor keys.
3. Press <DEL> to delete the user.

## Result

The user has been deleted and may no longer log onto the project.

## Deleting users

### Touch and key operation

#### Requirement

- You have opened a screen that contains the user view.
- You must be logged on with administrator rights or be authorized for user management to delete users.

---

#### Note

Changes in the user view are effective immediately in Runtime. Changes in Runtime are not updated in the Engineering System.

When the user management is downloaded to the HMI device, all changes in the user view are overwritten.

---



#### Procedure for touch operation

Proceed as follows:

1. Touch the user to be deleted in the user view.
2. Delete the user name.

#### Procedure for key operation

Proceed as follows:

1. Select the user view using the  key or the cursor keys.
2. Select the user in the user view by means of cursor keys.
3. Press  to delete the user.

#### Result

The user has been deleted and may no longer log onto the project.

## Mouse and keyboard operation

### Requirement

- The user view is open.
- You are either authorized for user administration or you are an administrator.

---

#### Note

Changes in the user view are effective immediately in Runtime. Changes in Runtime are not updated in the Engineering System.

When the user management is downloaded to the HMI device, all changes in the user view are overwritten.

---

### Procedure for mouse operation

Proceed as follows:

1. Click the user to be deleted in the user view.
2. Delete the user name.

### Procedure for keyboard operation

Proceed as follows:

1. Select the user view using the <TAB> key or the cursor keys.
2. Select the user in the user view by means of cursor keys.
3. Press <DEL> to delete the user.

### Result

The user has been deleted and may no longer log onto the project.

## 10.15 Performance features

### 10.15.1 Engineering system

#### Engineering system

The following tables help you assess whether your project still meets the performance specifications of the Engineering System.

In addition to the specified limits, allowances must also be made for restrictions imposed by main memory resources. WinCC uses up to 2 GB of RAM, depending on the operating system. It is nonetheless useful to install more than 2 GB of main memory on the PC if running many applications with high memory requirements in parallel.

#### Project system limits

	WinCC
Number of HMI devices in the project	35
Number of HMI tags <sup>1)</sup>	80.000
Number of logging tags	8.000
Number of blocks (faceplates, user data types) <sup>3)</sup>	10.000
Number of screens	3.000
Number of screen objects per screen	3.000
Number of screen objects	320.000
Number of alarms <sup>2) 3)</sup>	20.000
Number of texts <sup>3)</sup>	300.000
Number of text lists and graphic lists <sup>3)</sup>	10.000
Number of entries per text list	3.000
Number of languages	32
Number of global libraries <sup>3)</sup>	20
Number of objects in the project library <sup>3)</sup>	300.000

1) Including logging tags.

2) With an average of 5 texts and a dynamic parameter

3) Including the objects configured in the "Program PLC" area

#### HMI device system limits

	WinCC
Number of HMI tags <sup>1)</sup>	80.000
Number of logging tags	8.000

	WinCC
Number of logs	500
Number of screens	1000
Number of screen objects per screen	3.000
Number of screen objects	320.000
Number of function lists	30.000
Number of animations and local scripts	50.000
Number of user-defined functions	1.000
Number of tasks	500
Number of alarms <sup>2)</sup>	20.000
Number of recipes	1.000
Number of recipe elements	10.000
Number of texts	100.000
Number of text lists and graphic lists	1.000
Number of entries per text list	3.000
Number of users	200
Number of reports	300

- 1) Including logging tags.
- 2) With an average of 5 texts and a dynamic parameter

### System limits during migration

You can migrate projects which are beyond the specified system limits in one or more areas.

An alarm will be output if migration creates a project whose limits are beyond the specified system limits. You must then adapt the project after migration to within the specified system limits to ensure safe operation in WinCC.

### See also

- Basic Panel (Page 5729)
- Panel (Page 5732)
- Mobile Panel (Page 5736)
- Multi Panel (Page 5740)
- Comfort Panel (Page 5744)
- WinCC Runtime Advanced (Page 5749)

## 10.15.2 Basic Panel

### Basic Panel

The following table helps you assess whether your project meets the performance features of the HMI device.

The specified maximum values are not additive. It cannot be guaranteed that configurations running on the devices at the full system limits will be functional.

In addition to the specified limits, allowances must be made for restrictions imposed by configuration memory resources.

### Tags

	KP300 Basic	KP400 Basic	KTP400 Basic	KTP600 Basic	KTP1000 Basic	TP1500 Basic
Number of tags in the project	250	500	250 (mono) 500 (color)	500	500	500
Number of PowerTags	--	--	--	--	--	--
Number of elements per array	100	100	100	100	100	100
Number of local tags	--	--	--	--	--	--

### Alarms

	KP300 Basic	KP400 Basic	KTP400 Basic	KTP600 Basic	KTP1000 Basic	TP1500 Basic
Number of alarm classes	32	32	32	32	32	32
Number of discrete alarms	200	200	200	200	200	200
Number of analog alarms	15	15	15	15	15	15
Length of an alarm in characters	80	80	80	80	80	80
Number of process values per alarm	8	8	8	8	8	8
Size of the alarm buffer	256	256	256	256	256	256
Number of queued alarm events	64	64	64	64	64	64

### Screens

	KP300 Basic	KP400 Basic	KTP400 Basic	KTP600 Basic	KTP1000 Basic	TP1500 Basic
Number of screens	50	50	50	50	50	50
Number of fields per screen	30	30	30	30	30	30
Number of tags per screen	30	30	30	30	30	30
Number of complex objects per screen <sup>1)</sup>	5	5	5	5	5	5
Number of array elements per screen <sup>2)</sup>	100	100	100	100	100	100

10.15 Performance features

- 1) Complex objects include: bars, sliders, symbol library, clock, and all objects from the Controls area.
- 2) Array elements contained in recipes are included in the count.

### Recipes

	KP300 Basic	KP400 Basic	KTP400 Basic	KTP600 Basic	KTP1000 Basic	TP1500 Basic
Number of recipes	5	5	5	5	5	5
Number of elements per recipe <sup>1)</sup>	20	20	20	20	20	20
User data length in bytes per data record	--	--	--	--	--	--
Number of data records per recipe	20	20	20	20	20	20
Reserved memory for data records in the internal Flash	40 KB	40 KB	40 KB	40 KB	40 KB	40 KB

- 1) If arrays are used, each array element counts as one recipe element

### Logs

	KP300 Basic	KP400 Basic	KTP400 Basic	KTP600 Basic	KTP1000 Basic	TP1500 Basic
Number of logs	--	--	--	--	--	--
Number of entries per log (including all log segments) <sup>1)</sup>	--	--	--	--	--	--
Number of log segments	--	--	--	--	--	--
Cyclic trigger for tag logging	--	--	--	--	--	--
Number of tags that can be logged per log	--	--	--	--	--	--

- 1) The number of entries for the "segmented circular log" logging method is the maximum number for all segmental circular logs. The product of the number of segmental circular logs and the number of data records per segmental circular log may not exceed the system limit.

### Trends

	KP300 Basic	KP400 Basic	KTP400 Basic	KTP600 Basic	KTP1000 Basic	TP1500 Basic
Number of trends	25	25	25	25	25	25



**Text lists and graphics lists**

	KP300 Basic	KP400 Basic	KTP400 Basic	KTP600 Basic	KTP1000 Basic	TP1500 Basic
Number of graphics lists	100	100	100	100	100	100
Number of text lists	150	150	150	150	150	150
Number of entries per text or graphics list	30	30	30	30	30	30
Number of graphic objects	500	500	500	500	500	500
Number of text elements	500	500	500	500	500	500

**Scripts**

	KP300 Basic	KP400 Basic	KTP400 Basic	KTP600 Basic	KTP1000 Basic	TP1500 Basic
Number of scripts	--	--	--	--	--	--

**Communication**

	KP300 Basic	KP400 Basic	KTP400 Basic	KTP600 Basic	KTP1000 Basic	TP1500 Basic
Number of connections	4	4	4	4	4	4
Number of connections based on "SIMATIC HMI HTTP"	--	--	--	--	--	--

For communication with S7-1200 PLCs, please note that no more than 200 tags should be configured per controller. If multiple HMI devices access one controller, this limit applies to all HMI devices.

A maximum of 4 HMI devices can access an S7-1200 at the same time. A maximum of 8 controllers can be addressed by a panel.

**Help system**

	KP300 Basic	KP400 Basic	KTP400 Basic	KTP600 Basic	KTP1000 Basic	TP1500 Basic
Number of characters in a help text	320	320	320	320	320	320

**Languages**

	KP300 Basic	KP400 Basic	KTP400 Basic	KTP600 Basic	KTP1000 Basic	TP1500 Basic
Number of runtime languages	5	5	5	5	5	5

## Scheduler

	KP300 Basic	KP400 Basic	KTP400 Basic	KTP600 Basic	KTP1000 Basic	TP1500 Basic
Time-triggered tasks <sup>1)</sup>	--	--	--	--	--	--

1) Event-triggered tasks are irrelevant for the system limits

## User administration

	KP300 Basic	KP400 Basic	KTP400 Basic	KTP600 Basic	KTP1000 Basic	TP1500 Basic
Number of user groups	50	50	50	50	50	50
Number of authorizations	32	32	32	32	32	32
Number of users	50	50	50	50	50	50

## Project

	KP300 Basic	KP400 Basic	KTP400 Basic	KTP600 Basic	KTP1000 Basic	TP1500 Basic
Size of the project file "*.srt"	512 kB	512 kB	512 kB	512 kB	1024 kB	1024 kB

## See also

Engineering system (Page 5725)

### 10.15.3 Panel

#### Introduction

The following tables of system limits help you assess whether your project conforms to the system limits of a given HMI device.

The specified maximum values are not additive. It cannot be guaranteed that configurations running on the devices at the full system limits will be functional.

In addition to the specified limits, allowances must be made for restrictions imposed by configuration memory resources.

**Tags**

	OP 73	OP 77A	OP 77B	TP 177A	TP 177B OP 177B	TP 277 OP 277
Number of tags in the project	1000	1000	1000	500	1000	2048
Number of PowerTags	--	--	--	--	-	--
Number of elements per array	50	100	1000	250	1000	1000
Number of local tags	--	--	500	--	500	1000

**Alarms**

	OP 73	OP 77A	OP 77B	TP 177A	TP 177B OP 177B	TP 277 OP 277
Number of alarm classes	32	32	32	32	32	32
Number of discrete alarms	500	1000	1000	1000	2000	4000
Number of analog alarms	3	5	50	15	50	200
Length of an alarm in characters	80	80	80	80	80	80
Number of process values per alarm	8	8	8	8	8	8
Size of the alarm buffer	150	256	256	256	256	512
Number of queued alarm events	50	64	64	64	64	250

**Screens**

	OP 73	OP 77A	OP 77B	TP 177A	TP 177B OP 177B	TP 277 OP 277
Number of screens	500	500	500	250	500	500
Number of fields per screen	20	30	30	30	50	200
Number of tags per screen	20	30	30	30	50	200
Number of complex objects per screen <sup>1)</sup>	5	5	5	5	5	10

- 1) Complex objects include: bars, sliders, symbol library, clock, and all objects from the Controls area.

**Recipes**

	OP 73	OP 77A	OP 77B	TP 177A	TP 177B OP 177B	TP 277 OP 277
Number of recipes	--	5	100	5	100	300
Number of elements per recipe <sup>1)</sup>	--	20	200	20	200	1000
User data length in bytes per data record	--	--	800	--	800	4000

10.15 Performance features

	OP 73	OP 77A	OP 77B	TP 177A	TP 177B OP 177B	TP 277 OP 277
Number of data records per recipe	--	20	200	20	200	500
Reserved memory for data records in the internal Flash	--	40 KB	32 KB	40 KB	32 KB	64 KB

- 1) If arrays are used, each array element counts as one recipe element

## Logs

	OP 73	OP 77A	OP 77B	TP 177A	TP 177B OP 177B	TP 277 OP 277
Number of logs	--	--	--	--	--	20
Number of entries per log (including all log segments) <sup>1)</sup>	--	--	--	--	--	10000
Number of log segments	--	--	--	--	--	400
Cyclic trigger for tag logging	--	--	--	--	--	1 s
Number of tags that can be logged per log	--	--	--	--	--	2048

- 1) The number of entries for the "segmented circular log" logging method is the total number for all sequential logs. The product of the number of sequential logs and the number of data records per sequential log may not exceed the system limit

## Trends

	OP 73	OP 77A	OP 77B	TP 177A	TP 177B OP 177B	TP 277 OP 277
Number of trends	--	--	--	25	50	300
Number of measured values per trend	--	--	--	999	999	999

## Text lists and graphics lists

	OP 73	OP 77A	OP 77B	TP 177A	TP 177B OP 177B	TP 277 OP 277
Number of graphics lists	--	--	--	100	100	400
Number of text lists	150	300	300	300	300	500
Number of entries per text or graphics list	30	30	30	30	30	256
Number of graphic objects	500	1000	1000	1000	1000	1000
Number of text elements	1000	1000	2500	1000	2500	10000

**Scripts**

	OP 73	OP 77A	OP 77B	TP 177A	TP 177B OP 177B	TP 277 OP 277
Number of scripts	--	--	--	--	--	50

**Communication**

	OP 73	OP 77A	OP 77B	TP 177A	TP 177B OP 177B	TP 277 OP 277
Number of connections	2	4	4	4	4	6
Number of connections based on "SIMATIC HMI HTTP"	--	--	--	--	4	8
Maximum number of connected Sm@rtClients (including a service client)	--	--	--	--	2	3

In the case of communication with S7-1200 PLCs, please note that a maximum of 200 tags should be configured per controller. When multiple HMI devices access one PLC, this limit applies to all HMI devices.

A maximum of 4 HMI devices can access an S7-1200 at the same time. A panel can address a maximum of 8 PLCs.

**Help system**

	OP 73	OP 77A	OP 77B	TP 177A	TP 177B OP 177B	TP 277 OP 277
Number of characters in a help text	320	320	320	320	320	320

**Languages**

	OP 73	OP 77A	OP 77B	TP 177A	TP 177B OP 177B	TP 277 OP 277
Number of runtime languages	5	5	5	5	5	16

**Scheduler**

	OP 73	OP 77A	OP 77B	TP 177A	TP 177B OP 177B	TP 277 OP 277
Time-triggered tasks <sup>1)</sup>	--	--	10	--	10	48

1) Event-triggered tasks are not relevant for the system limits

## User administration

	OP 73	OP 77A	OP 77B	TP 177A	TP 177B OP 177B	TP 277 OP 277
Number of user groups	25	50	50	50	50	50
Number of authorizations	32	32	32	32	32	32
Number of users	25	50	50	50	50	50

## Project

	OP 73	OP 77A	OP 77B	TP 177A	TP 177B OP 177B	TP 277 OP 277
Size of the project files "*.fwc", "*.srt"	256 KB	320 KB	1 MB	6":512 KB	2 MB	4 MB

## See also

Engineering system (Page 5725)

### 10.15.4 Mobile Panel

#### Mobile Panel

The following tables of system limits help you assess whether your project conforms to the system limits of a given HMI device.

The specified maximum values are not additive. It cannot be guaranteed that configurations running on the devices at the full system limits will be functional.

In addition to the specified limits, allowances must be made for restrictions imposed by configuration memory resources.

#### Tags

	Mobile Panel 177	Mobile Panel 277	Mobile Panel 277 IWLAN V2	Mobile Panel 277F IWLAN V2	Mobile Panel 277F IWLAN (RFID Tag)
Number of tags in the project	1000	2048	2048	2048	2048
Number of PowerTags	-	--	--	--	--
Number of elements per array	1000	1000	1000	1000	1000
Number of local tags	500	1000	1000	1000	1000

## Alarms

	Mobile Panel 177	Mobile Panel 277	Mobile Panel 277 IWLAN V2	Mobile Panel 277F IWLAN V2	Mobile Panel 277F IWLAN (RFID Tag)
Number of alarm classes	32	32	32	32	32
Number of discrete alarms	2000	4000	4000	4000	4000
Number of analog alarms	50	200	200	200	200
Length of an alarm in characters	80	80	80	80	80
Number of process values per alarm	8	8	8	8	8
Size of the alarm buffer	256	512	512	512	512
Number of queued alarm events	64	250	250	250	250

## Screens

	Mobile Panel 177	Mobile Panel 277	Mobile Panel 277 IWLAN V2	Mobile Panel 277F IWLAN V2	Mobile Panel 277F IWLAN (RFID Tag)
Number of screens	500	500	500	500	500
Number of fields per screen	50	200	200	200	200
Number of tags per screen	50	200	200	200	200
Number of complex objects per screen <sup>1)</sup>	5	10	10	10	10

- 1) Complex objects include: bars, sliders, symbol library, clock, and all objects from the Controls area.

## Recipes

	Mobile Panel 177	Mobile Panel 277	Mobile Panel 277 IWLAN V2	Mobile Panel 277F IWLAN V2	Mobile Panel 277F IWLAN (RFID Tag)
Number of recipes	100	300	300	300	300
Number of elements per recipe <sup>1)</sup>	200	1000	1000	1000	1000
User data length in bytes per data record	800	4000	4000	4000	4000
Number of data records per recipe	200	500	500	500	500
Reserved memory for data records in the internal Flash	32 KB	64 KB	64 KB	64 KB	64 KB

- 1) If arrays are used, each array element counts as one recipe element

## Logs

	Mobile Panel 177	Mobile Panel 277	Mobile Panel 277 IWLAN V2	Mobile Panel 277F IWLAN V2	Mobile Panel 277F IWLAN (RFID Tag)
Number of logs	--	20	20	20	20
Number of entries per log (including all log segments) <sup>1)</sup>	--	10000	10000	10000	10000
Number of log segments	--	400	400	400	400
Cyclic trigger for tag logging	--	1 s	1 s	1 s	1 s
Number of tags that can be logged per log	--	2048	2048	2048	2048

- 1) The number of entries for the "segmented circular log" logging method is the total number for all sequential logs. The product of the number of sequential logs and the number of data records per sequential log may not exceed the system limit

## Trends

	Mobile Panel 177	Mobile Panel 277	Mobile Panel 277 IWLAN V2	Mobile Panel 277F IWLAN V2	Mobile Panel 277F IWLAN (RFID Tag)
Number of trends	50	300	300	300	300

## Text lists and graphics lists

	Mobile Panel 177	Mobile Panel 277	Mobile Panel 277 IWLAN V2	Mobile Panel 277F IWLAN V2	Mobile Panel 277F IWLAN (RFID Tag)
Number of graphics lists	100	400	400	400	400
Number of text lists	300	500	500	500	500
Number of entries per text or graphics list	30	256	256	256	256
Number of graphic objects	1000	1000	1000	1000	1000
Number of text elements	2500	10000	10000	10000	10000

## Scripts

	Mobile Panel 177	Mobile Panel 277	Mobile Panel 277 IWLAN V2	Mobile Panel 277F IWLAN V2	Mobile Panel 277F IWLAN (RFID Tag)
Number of scripts	--	50	50	50	50



## Communication

	Mobile Panel 177	Mobile Panel 277	Mobile Panel 277 IWLAN V2	Mobile Panel 277F IWLAN V2	Mobile Panel 277F IWLAN (RFID Tag)
Number of connections	4	6	6	6	6
Number of connections based on "SIMATIC HMI HTTP"	4	8	8	8	8
Maximum number of connected Sm@rtClients (including a service client)	2	2	8": 3 10": 2	8": 3 10": 2	8": 3 10": 2

In the case of communication with S7-1200 PLCs, please note that a maximum of 200 tags should be configured per controller. When multiple HMI devices access one PLC, this limit applies to all HMI devices.

A maximum of 4 HMI devices can access an S7-1200 at the same time. A panel can address a maximum of 8 PLCs.

## Mobile Wireless

	Mobile Panel 177	Mobile Panel 277	Mobile Panel 277 IWLAN V2	Mobile Panel 277F IWLAN V2	Mobile Panel 277F IWLAN (RFID Tag)
Number of zones	--	--	254	254	--
Number of effective ranges	--	--	--	127	--
Number of assigned transponders - zones	--	--	255	255	--
Number of assigned transponders - effective ranges	--	--	--	127	--
Number of effective ranges (RFID)	--	--	--	--	127
Number of RFID tags that can be assigned to effective ranges (RFID) in a project	--	--	--	--	127

## Help system

	Mobile Panel 177	Mobile Panel 277	Mobile Panel 277 IWLAN V2	Mobile Panel 277F IWLAN V2	Mobile Panel 277F IWLAN (RFID Tag)
Number of characters in a help text	320	320	320	320	320

## Languages

	Mobile Panel 177	Mobile Panel 277	Mobile Panel 277 IWLAN V2	Mobile Panel 277F IWLAN V2	Mobile Panel 277F IWLAN (RFID Tag)
Number of runtime languages	5	16	16	16	16

## Scheduler

	Mobile Panel 177	Mobile Panel 277	Mobile Panel 277 IWLAN V2	Mobile Panel 277F IWLAN V2	Mobile Panel 277F IWLAN (RFID Tag)
Time-triggered tasks <sup>1)</sup>	10	48	48	48	48

- 1) Event-triggered tasks are not relevant for the system limits

## User administration

	Mobile Panel 177	Mobile Panel 277	Mobile Panel 277 IWLAN V2	Mobile Panel 277F IWLAN V2	Mobile Panel 277F IWLAN (RFID Tag)
Number of user groups	50	50	50	50	50
Number of authorizations	32	32	32	32	32
Number of users	50	50	50	50	50

## Project

	Mobile Panel 177	Mobile Panel 277	Mobile Panel 277 IWLAN V2	Mobile Panel 277F IWLAN V2	Mobile Panel 277F IWLAN (RFID Tag)
Size of the project file "*.fwc"	2 MB	6 MB	6 MB	6 MB	6 MB

## See also

Engineering system (Page 5725)

### 10.15.5 Multi Panel

#### Multi Panel

The following tables of system limits help you assess whether your project conforms to the system limits of a given HMI device.

The specified maximum values are not additive. It cannot be guaranteed that configurations running on the devices at the full system limits will be functional.

In addition to the specified limits, allowances must be made for restrictions imposed by configuration memory resources.

## Tags

	MP 177	MP 277	MP 377
Number of tags in the project	1000	2048	4096
Number of PowerTags	--	--	--
Number of elements per array	1000	1000	1000
Number of local tags	500	1000	2000

## Alarms

	MP 177	MP 277	MP 377
Number of alarm classes	32	32	32
Number of discrete alarms	2000	4000	4000
Number of analog alarms	50	200	200
Length of an alarm in characters	80	80	80
Number of process values per alarm	8	8	8
Size of the alarm buffer	256	512	1024
Number of queued alarm events	64	250	500

## Screens

	MP 177	MP 277	MP 377
Number of screens	500	500	500
Number of fields per screen	50	200	400
Number of tags per screen	50	200	400
Number of complex objects per screen <sup>1)</sup>	5	10	20

- 1) Complex objects include: bars, sliders, symbol library, clock and all objects from the Controls area.

## Recipes

	MP 177	MP 277	MP 377
Number of recipes	100	300	500
Number of elements per recipe <sup>1)</sup>	200	1000	1000
User data length in KB per data record	0,8	4	128

10.15 Performance features

	MP 177	MP 277	MP 377
Number of data records per recipe	200	500	1000
Reserved memory for data records in the internal Flash	32 KB	64 KB	128 KB

- 1) If arrays are used, each array element counts as one recipe element

**Logs**

	MP 177	MP 277	MP 377
Number of logs	--	20	50
Number of entries per log (including all log segments) <sup>1)</sup>	--	10000	50000
Number of log segments	--	400	400
Cyclic trigger for tag logging	--	1 s	1 s
Number of tags that can be logged per log	--	2048	2048

- 1) The number of entries for the "segmented circular log" logging method is the total number for all sequential logs. The product of the number of sequential logs and the number of data records per sequential log may not exceed the system limit

**Trends**

	MP 177	MP 277	MP 377
Number of trends	50	300	400

**Text lists and graphics lists**

	MP 177	MP 277	MP 377
Number of graphics lists	100	400	500
Number of text lists	300	500	500
Number of entries per text or graphics list	30	256	256
Number of graphic objects	1000	1000	2000
Number of text elements	2500	10000	30000

**Scripts**

	MP 177	MP 277	MP 377
Number of scripts	--	50	100

## Communication

	MP 177	MP 277	MP 377
Number of connections	4	6	6
Number of connections based on "SIMATIC HMI HTTP"	4	8	8
Maximum number of connected Sm@rtClients (including a service client)	2	6": max. 3 10": max. 2	12": max. 3 15": max. 2 19": max. 1

In the case of communication with S7-1200 PLCs, please note that a maximum of 200 tags should be configured per controller. When multiple HMI devices access one PLC, this limit applies to all HMI devices.

A maximum of 4 HMI devices can access an S7-1200 at the same time. A panel can address a maximum of 8 PLCs.

## Help system

	MP 177	MP 277	MP 377
Number of characters in a help text	320	320	320

## Languages

	MP 177	MP 277	MP 377
Number of runtime languages	5	16	16

## Scheduler

	MP 177	MP 277	MP 377
Time-triggered tasks <sup>1)</sup>	10	48	48

1) Event-triggered tasks are not relevant for the system limits

## User administration

	MP 177	MP 277	MP 377
Number of user groups	50	50	50
Number of authorizations	32	32	32
Number of users	50	50	50

## Project

	MP 177	MP 277	MP 377
Size of the project file ".fvc"	2 MB	6 MB	12 MB

## See also

Engineering system (Page 5725)

## 10.15.6 Comfort Panel

### Comfort Panel

The following tables of system limits help you assess whether your project conforms to the system limits of a given HMI device.

The specified maximum values are not additive. It cannot be guaranteed that configurations running on the devices at the full system limits will be functional.

In addition to the specified limits, allowances must be made for restrictions imposed by configuration memory resources.

---

#### Note

##### Graphic objects on Comfort Panels

The use of 32-bit graphic objects increases memory requirements for the project file on Comfort Panels.

The use of jpeg graphic objects reduces memory requirements for the project file on Comfort Panels.

---

## Tags

	KTP400 KP400	TP700, KP700 TP900, KP900 TP1200, KP1200	TP1500 KP1500	TP1900	TP2200
Number of tags in the project	1024	2048	4096	4096	4096
Number of PowerTags	--	--	--	--	--
Number of elements per array	1000	1000	1000	1000	1000
Number of local tags	500	1000	2000	2000	2000

**Alarms**

	KTP400 KP400	TP700, KP700 TP900, KP900 TP1200, KP1200	TP1500 KP1500	TP1900	TP2200
Number of alarm classes	32	32	32	32	32
Number of discrete alarms	2000	4000	6000	6000	6000
Number of analog alarms	50	200	200	200	200
Length of an alarm in characters	80	80	80	80	80
Number of process values per alarm	8	8	8	8	8
Size of the alarm buffer	256	1024	1024	1024	1024
Number of queued alarm events	64	500	500	600	500

**Screens**

	KTP400 KP400	TP700, KP700 TP900, KP900 TP1200, KP1200	TP1500 KP1500	TP1900	TP2200
Number of screens	500	500	750	750	750
Number of fields per screen	50	400	600	600	600
Number of tags per screen	50	400	400	400	400
Number of complex objects per screen <sup>1)</sup>	5	20	40	40	40

- 1) Complex objects include: bars, sliders, symbol library, clock and all objects from the Controls area.

**Recipes**

	KTP400 KP400	TP700, KP700 TP900, KP900 TP1200, KP1200	TP1500 KP1500	TP1900	TP2200
Number of recipes	100	300	500	500	500
Number of elements per recipe <sup>1)</sup>	200	1000	2000	2000	2000
User data length in KB per data record	32	256	512	512	512
Number of data records per recipe	200	500	1000	1000	1000
Reserved memory for data records in the internal Flash	512 KB	2 MB	4 MB	4 MB	4 MB

- 1) If arrays are used, each array element counts as one recipe element

### Logs

	KTP400 KP400	TP700, KP700 TP900, KP900 TP1200, KP1200	TP1500 KP1500	TP1900	TP2200
Number of logs	10	50	50	50	50
Number of entries per log (including all log segments) <sup>1)</sup>	10000	20000	20000	20000	20000
Number of log segments	400	400	400	400	400
Cyclic trigger for tag logging	1 s	1 s	1 s	1 s	1 s
Number of tags that can be logged per log	100	2048	2048	2048	2048

- 1) The number of entries for the "segmented circular log" logging method is the total number for all sequential logs. The product of the number of sequential logs and the number of data records per sequential log may not exceed the system limit

### Trends

	KTP400 KP400	TP700, KP700 TP900, KP900 TP1200, KP1200	TP1500 KP1500	TP1900	TP2200
Number of trends	50	300	400	400	400

### Text lists and graphics lists

	KTP400 KP400	TP700, KP700 TP900, KP900 TP1200, KP1200	TP1500 KP1500	TP1900	TP2200
Number of graphics lists	100	500	500	500	500
Number of text lists	300	500	500	500	500
Number of entries per text or graphics list	30	500	500	500	500
Number of graphic objects	1000	4000	4000	4000	4000
Number of text elements	2500	40000	40000	40000	40000



**Scripts**

	KTP400 KP400	TP700, KP700 TP900, KP900 TP1200, KP1200	TP1500 KP1500	TP1900	TP2200
Number of scripts	50	100	200	200	200

**Communication**

	KTP400 KP400	TP700, KP700 TP900, KP900 TP1200, KP1200	TP1500 KP1500	TP1900	TP2200
Number of connections	4	8	8	8	8
Number of OPC connections including OPC UA	4	8	8	8	8
Number of connections based on "SIMATIC HMI HTTP"	4	8	8	8	8
Maximum number of connected Sm@rtClients (including a service client)	2	3	3	2	1

In the case of communication with S7-1200 PLCs, please note that a maximum of 200 tags should be configured per controller. When multiple HMI devices access one PLC, this limit applies to all HMI devices.

A maximum of 4 HMI devices can access an S7-1200 at the same time. A panel can address a maximum of 8 PLCs.

**Help system**

	KTP400 KP400	TP700, KP700 TP900, KP900 TP1200, KP1200	TP1500 KP1500	TP1900	TP2200
Number of characters in a help text	320	320	320	320	320

## Languages

	KTP400 KP400	TP700, KP700 TP900, KP900 TP1200, KP1200	TP1500 KP1500	TP1900	TP2200
Number of runtime languages	32	32	32	32	32

## Scheduler

	KTP400 KP400	TP700, KP700 TP900, KP900 TP1200, KP1200	TP1500 KP1500	TP1900	TP2200
Time-triggered tasks <sup>1)</sup>	10	48	48	48	48

- 1) Event-triggered tasks are not relevant for the system limits

## User administration

	KTP400 KP400	TP700, KP700 TP900, KP900 TP1200, KP1200	TP1500 KP1500	TP1900	TP2200
Number of user groups	50	50	50	50	50
Number of authorizations	32	32	32	32	32
Number of users	50	50	50	50	50

## Project

	KTP400 KP400	TP700, KP700 TP900, KP900 TP1200, KP1200	TP1500 KP1500	TP1900	TP2200
Size of the project file "*.fwc"	4 MB	12 MB	24 MB	24 MB	12 MB

## See also

Engineering system (Page 5725)

## 10.15.7 WinCC Runtime Advanced

### WinCC Runtime Advanced

The following tables of system limits help you assess whether your project conforms to the system limits of a given HMI device.

The specified maximum values are not additive. It cannot be guaranteed that configurations running on the devices at the full system limits will be functional.

In addition to the specified limits, allowances must be made for restrictions imposed by configuration memory resources.

### Tags

	WinCC Runtime Advanced
Number of tags in the project	6144
Number of PowerTags	128 –4096
Number of elements per array	1600
Number of local tags	2048
Number of structures	999
Number of structure elements	400

### Alarms

	WinCC Runtime Advanced
Number of alarm classes	32
Number of discrete alarms	4000
Number of analog alarms	500
Length of an alarm in characters	80
Number of process values per alarm	8
Size of the alarm buffer	1024
Number of queued alarm events	500

### Screens

	WinCC Runtime Advanced
Number of screens	500
Number of fields per screen	400
Number of tags per screen	400
Number of complex objects per screen <sup>1)</sup>	40

10.15 Performance features

- 1) Complex objects include: bars, sliders, symbol library, clock, and all objects from the Controls area.

**Recipes**

	WinCC Runtime Advanced
Number of recipes	999
Number of elements per recipe <sup>1)</sup>	2000
User data length, in KB per data record	256
Number of data records per recipe	5000
Reserved memory for data records in the internal Flash	--

- 1) If arrays are used, each array element counts as one recipe element

**Logs**

	WinCC Runtime Advanced
Number of logs	100
Number of entries per log (including all log segments) <sup>1)</sup>	500000
Number of log segments	400
Cyclic trigger for tag logging	1 s
Number of tags that can be logged per log	6144

- 1) The number of entries for the "segmented circular log" logging method is the total number for all sequential logs. The product of the number of sequential logs and the number of data records per sequential log may not exceed the system limit

**Trends**

	WinCC Runtime Advanced
Number of trends	800

**Text lists and graphics lists**

	WinCC Runtime Advanced
Number of graphics lists	500
Number of text lists	500
Number of entries per text or graphics list	3500
Number of graphic objects	2000
Number of text elements	30000

## Scripts

	WinCC Runtime Advanced
Number of scripts	200

## Communication

	WinCC Runtime Advanced
Number of connections	8
Number of OPC connections including OPC UA	8
Number of connections based on "SIMATIC HMI HTTP"	16
Maximum number of connected Sm@rtClients (including a service client)	4 <sup>1)</sup>

In the case of communication with S7-1200 PLCs, please note that a maximum of 200 tags should be configured per controller. When multiple HMI devices access one PLC, this limit applies to all HMI devices.

A maximum of 4 HMI devices can access an S7-1200 at the same time. A Runtime Advanced can address a maximum of 8 controllers.

- 1) Only up to three Sm@rtClients can interconnect with the Sm@rtServer on Panel PC 477.

## Help system

	WinCC Runtime Advanced
Number of characters in a help text	320

## Languages

	WinCC Runtime Advanced
Number of runtime languages	32

## Scheduler

	WinCC Runtime Advanced
Time-triggered tasks <sup>1)</sup>	48

- 1) Event-triggered tasks are not relevant for the system limits

## User administration

---

	WinCC Runtime Advanced
Number of user groups	50
Number of authorizations	32
Number of users	100

---

## Project

---

	WinCC Runtime Advanced
Size of the project file "*.fwc"	No limiting

---

## See also

Engineering system (Page 5725)

## 10.15.8 General technical specifications

### 10.15.8.1 Recommended printers

#### Recommended printers

The current list of printers recommended for use with the HMI devices is available on the Internet at:

Link to the current printer list (<http://support.automation.siemens.com/WW/llisapi.dll?aktprim=0&lang=en&referer=%2fWW%2f&func=cslib.csinfo&siteid=csius&caller=view&extranet=standard&viewreg=WW&nodeid0=10805558&objaction=csopen>)

---

#### Note

All HMI devices except for a PC and Panel PC support only one printer at their USB port, even if several ports are available.

---

## See also

Printer list (<http://support.automation.siemens.com/WW/llisapi.dll?aktprim=0&lang=en&referer=%2fWW%2f&func=cslib.csinfo&siteid=csius&caller=view&extranet=standard&viewreg=WW&nodeid0=10805558&objaction=csopen>)

## 10.15.8.2 Printing via print server

### Introduction

Print servers enable access to network printers. Print jobs are routed to a corresponding printer via the print server.

---

#### Note

Printing takes place via the print server for the following HMI devices:

- xP 177, Mobile Panel 177
  - xP 277, Mobile Panel 277, Mobile Panel 277 IWLAN, Mobile Panel 277F IWLAN
  - Mobile Panel 277 IWLAN V2, Mobile Panel 277F IWLAN V2, Mobile Panel 277F IWLAN (RFID Tag)
  - MP 377
  - PC with WinCC Runtime Advanced
- 

### Requirements

- The print server deploys the "RAW" mode.

---

#### Note

For additional information on settings, refer to the relevant print server documentation.

---

- The device is interconnected via Ethernet with the print server or with a printer featuring an integrated print server.
- External print servers are interconnected with a printer via USB port.
- The IP address and port used are identical in the "Printer Properties" of the HMI device and on the print server.

### Procedure

1. Open the "Control Panel" on your HMI device.
2. Select "Printer". The "Printer Properties" dialog box opens.

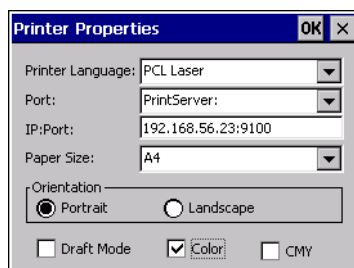

3. Select a printer from the "Printer Language" selection list.
4. Select the "PrintServer" entry from the "Port" selection list.

### 10.15 Performance features

5. Enter the IP address and the port used for communication with the printer in the "IP:Port" input field.

---

**Note**

Use the ":" character as delimiter between the IP address and the port number. For example: "192.168.56.23:9100".

---

6. Select any additional printer settings.

#### 10.15.8.3 Memory requirement of recipes

##### Introduction

The following calculation of memory requirements of recipes is only valid for Windows CE devices.

##### Calculation of memory requirements

The memory space required by each recipe (in KB) is derived from the sum of D1 + D2 + D3.

Valid is:

- $D1 = (\text{number of entries} \times 5 + M + 8):1024$   
Applies to M:  
M = Accumulated length of all tag names = sum of characters in all tag names (UTF8 coded, max. 255 bytes per tag name) used in the entries.
- $D2 = [(\text{number of data records} \times 12) + 4]:1024$
- $D3 = [\text{number of data records} \times (\text{data record length} + N) + 4]:1024$   
Applies to N:

The total length of the name of the corresponding data record in all languages (max. 255 bytes per language) + overhead per data record (1 byte + number of languages \* 3 bytes).

D1, D2 and D3 are rounded to the next higher number.

##### Memory requirements for using arrays

The memory required by each recipe (in KB) is derived from the sum of D1 + D2 + D3.

Valid is:



- $D1 = (\text{number of entries} \times 5 + M + 8) : 1024$   
Each element of the tag array used counts as a single entry.  
Applies to M:  
 $M = (\text{length of the array tag name} + K) \times \text{number of array elements}$   
Applies to K:  
K = 3: 2 to 9 elements in the array  
K = 4: 10 to 99 elements in the array  
K = 5: 100 to 999 elements in the array  
K = 6: 1000 to 9999 elements in the array  
K = 7: 10000 to 12000 elements in the array
- $D2 = [(\text{number of data records} \times 12) + 4] : 1024$
- $D3 = [\text{number of data records} \times (\text{data record length} + N) + 4] : 1024$   
Applies to N:

The total length of the name of the corresponding data record in all languages (max. 255 bytes per language) + overhead per data record (1 byte + number of languages \* 3 bytes).

D1, D2 and D3 are rounded to the next higher number.

---

#### Note

If you use both tags and arrays in a recipe, you have to add the results of both formulas to calculate the total memory required.

---

### 10.15.8.4 Memory requirements of recipes for Basic Panels, OP 77A, and TP 177A

#### Introduction

The following calculation of memory requirements of recipes is valid for Basic Panels, OP 77A, and TP 177A devices.

#### Restrictions

The HMI device provides 39 KB of memory space for recipes. This memory space may not be exceeded. The total memory space for recipes is calculated as follows: Total of all recipes + recipe with highest memory requirement.

Each recipe may not exceed a maximum memory space of 19 KB.

#### Calculation of memory requirements

The memory space requirement of each recipe (in KB) is calculated based on the three addends  $D1 + D2 + D3$ .

Valid is::

10.15 Performance features

- $D1 = \text{number of data records} \times M$

Rule for M (size of a data record):

$M = 1 \times \text{number of elements of a byte} + 2 \times \text{number of elements of 2 bytes} + 4 \times \text{number of elements of 4 bytes} + 8 \times \text{number of elements of 8 bytes} + K$

Rule for K (size of the string elements):

$K = \text{number of string elements} \times (\text{string length} + 1) \times 2$

- D2 - data record size

$D2 = 4 + \text{number of languages} \times 8 + \text{number of languages} \times (4 + 4 \times \text{number of data records} + (\text{length of the data record name} + 1) \times 2 \times \text{number of data records}) + 8 + 8 \times \text{number of data records}$

Or rewritten:

$D2 = 12 + 8 \times \text{number of data records} + \text{number of languages} \times (12 + \text{number of data records} \times (4 + (\text{length of the data record name} + 1) \times 2))$

- D3 - shared memory

$D3 = 14 + \text{number of elements}$

---

**Note**

Arrays and single elements can be calculated as described above.

---

## 10.16 Options

### 10.16.1 Following GMP with Audit

#### 10.16.1.1 Basics

#### GMP compliance

#### GMP compliant projects with WinCC

Traceability and therefore the documentation of production data is becoming increasingly important in many industrial sectors such as the pharmaceuticals industry, the food and beverage industry, and in the related mechanical engineering sector.

Storage of production data in electronic form offers many advantages compared to paper documents, such as simple acquisition and logging of data.

However, it is also important to ensure that data cannot be falsified and that it can be read at any time.

Industry-specific and general standards for electronic documentation of production data have been developed for this purpose.

The most important set of regulations is the FDA guideline 21 CFR Part 11 for electronic data records and electronic signatures issued by the FDA, the US Food and Drug Administration. The various EU regulations, such as EU 178/2002, also apply for particular industries.

Requirements for production systems in these industries have been developed on the basis of 21 CFR Part 11 and the corresponding layout to comply with GMP (Good Manufacturing Practice). They are also required for other industries.

The following primary requirements are derived from these directives and rules:

- Creation of an Audit Trail or operating trace in runtime  
This document can be used to trace a complete log of which user has run what control function on the machine at what time.
- Important process stages must also be traceable to a specific responsibility, for example with an electronic signature.

#### GMP-compliant configuration

##### Introduction

"GMP compliant configuration" means creating projects in accordance with "Good Manufacturing Practice". The requirements are set out in FDA rules "21 CFR Part 11". The FDA is the U.S. Food and Drug Administration.

GMP-compliant configuration means HMI devices have electronic production data documentation functionalities.

## GMP relevant and the audit trail

WinCC offers the "Audit" option for implementing GMP compliance. Using the audit option, the "GMP compliant configuration" function can be enabled.

Enable the "GMP compliant configuration" function directly in the runtime settings of the HMI device. GMP relevant functionalities are then added to WinCC. These functionalities are:

- Audit Trail
- Electronic signature
- Option to label tags as "GMP relevant".
- Option to label tags as "GMP relevant" for recipes.
- NotifyUserAction system function
- Logging of tags using checksum
- Logging of alarms using checksum
- Audit trail record for printing logged changes

A license is required to convert the GMP-relevant functions configured in WinCC in runtime.

Depending on the edition of WinCC, use one of the following licenses:

- WinCC Audit for RT Advanced
- WinCC Audit for SIMATIC Panel

If the labeled objects are executed or changed, then it is saved in a special log, the "Audit Trail".

## See also

Configuring a checksum for a log (Page 3228)

Evaluating the checksum of log data (Page 3229)

Configuring a checksum for a log (Page 3315)

## Audit option

### Advanced functions

The Audit option adds functions to WinCC to ensure that your project is GMP compliant.

The following functions are added:

- **Audit Trail**  
For every HMI device, you can create an Audit Trail .  
Operator actions and system processes that are relevant for the FDA-compliance of the process are recorded in an Audit Trail during runtime.
  - User actions such as changes in the values of GMP relevant tags or recipes or the acknowledgment of alarms.
  - Actions by the system, such as starting up runtime or rejection of logon attempts.
- **Electronic signature**  
You can set mandatory acknowledgement of important user actions in runtime, such as changing recipe data records or tag values.  
All Audit-relevant user actions must be protected by authorization in the user administration. The user will then only be able to run these actions if an electronic signature and, if configured appropriately, a comment have been input. The electronic signature and the comment are logged in the audit trail.

### Extension of the WinCC engineering system

For all HMI devices that support "GMP-compliant configuration", the WinCC engineering system is extended to include the following configuration options when GMP is enabled:

- The entry "AuditTrail" is added to the "Logs" editor.
- A "Good Manufacturing Practice Settings" entry is added to "HMI tags" editor in the inspector window of a "Properties > Properties" tag.
- A "Good Manufacturing Practice" entry is added to "Recipes" editor in the inspector window of a "Properties > Properties" recipe.
- "NotifyUserAction" system function

### Scope of logging

#### Introduction

It is important to ensure that audit-related processes are always logged in runtime in the audit trail in a project with the option "Audit".

## Scope of logging

The following operations are Audit-relevant and are automatically saved in the Audit Trail:

- Runtime sequence
  - Runtime start and runtime stop
  - Project information: Version and project name, of the configuration environment, device, and current runtime configuration
  - Failure of the voltage supply of an active Uninterruptible Power Supply (UPS).
- User administration
  - Logon and logoff of users
  - Invalid logon attempts
  - Import of user administration
  - Changes of user administration
- Alarm system
  - All alarms that are acknowledged by the user.
  - All acknowledgment attempts of the user

---

### Note

#### Logging alarm text

To log alarm texts, select the "Log alarm text in Audit Trail" option in the Audit Trail editor:

"Audit trail > Properties > Settings" in the "Settings" area

---

- Log operations
  - Starting, stopping and copying a log
  - Opening and closing all logs
  - Deleting a log
  - Starting a sequence log
  - Long-term logging of a log
- Running specific system functions depending on their functionality and the triggering event

The following audit processes are logged depending on the configuration of the recipes and the tags of the project:

- Change values of GMP-relevant tags by the user
- for GMP-relevant recipes:
  - Storing after changing and creating recipe data records
  - Transfer of recipe data records to the PLC and from the PLC
  - For recipe tags: Changing the setting for the synchronization of the tag values with the PLC ("offline"/"online")
- "NotifyUserAction" system function  
You use the system function "NotifyUserAction" to record user actions that are not automatically recorded by the audit trail.  
You can configure this system function for screen calls, for example You can also configure function lists containing system functions that do not require signature or acknowledgement.

### 10.16.1.2 Enabling GMP compliant configuration

#### Introduction

The Audit Trail and "Electronic Signature" functions are qualified as "GMP compliant configuration".

#### Requirements

- A project is created.
- A GMP compatible HMI device has been created.

#### Procedure

1. Double-click on the HMI device in the project tree.
2. Double-click "Runtime settings".

3. Click on "GMP".
4. Select "GMP compliant configuration".

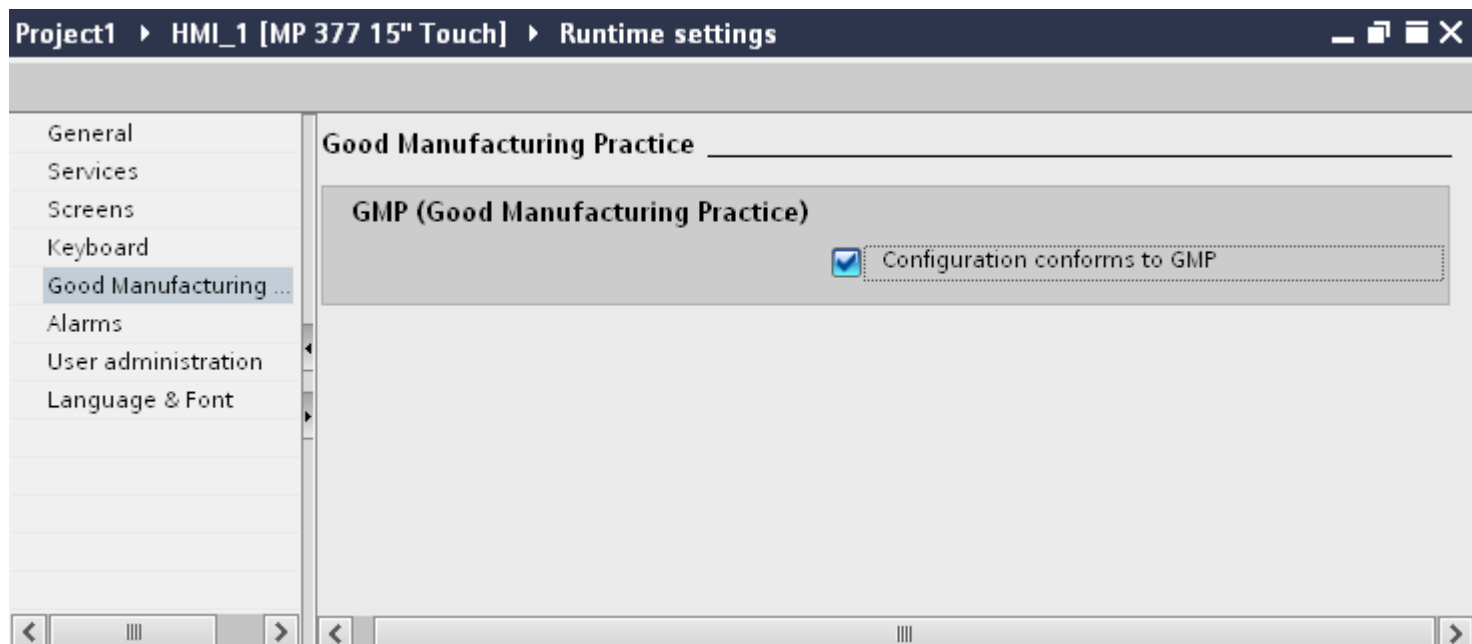

## Result

The Audit option is now enabled for the HMI device.

The following functions can now be configured:

- Audit Trail log
- "NotifyUserAction" system function
- GMP relevant tags
- GMP relevant recipes

## See also

Configuring a checksum for a log (Page 3228)

Evaluating the checksum of log data (Page 3229)

Configuring a checksum for a log (Page 3315)

Evaluating the checksum of log data (Page 3317)



### 10.16.1.3 Using the Audit trail

#### Audit Trail

#### Introduction

Configure a log in the settings for Audit Trail editor. This log is used to store changes in tag or recipe values made by the user and other user actions in runtime.

#### "Settings for audit trail" editor

1. In the project view, double-click "AuditTrail" in the "Log" group.
2. Click on the "Settings for audit trail" tab.
3. Change the properties of Audit Trail in the inspector window.

The screenshot displays the WinCC software interface. On the left is the 'Project tree' showing a hierarchy: Project1 > HMI\_1 [MP 377 15" Touch] > Historical data. The 'Historical data' folder is expanded, showing 'AuditTrail' selected. On the right, the 'Audit Trail' settings table is visible:

Name	Path	Storage location	Low limit	Enable at startup
AuditTrail	\St...	CSV file (AS...	1.0	<input checked="" type="checkbox"/>

Below the table, the 'AuditTrail' Properties inspector is open, showing the 'General' tab. The 'Name' field contains 'AuditTrail'. Under the 'Storage location' section, the 'Storage location' is set to 'CSV file (ASCII)', the 'Path' is '\Storage Card', and the 'Free storage space limit in MB' is set to '1.0'.

#### Audit trail work area

You define the settings for the Audit Trail in the "Properties > Properties" inspector window.

### *10.16 Options*

You set the name of the log and the storage location and decide whether logging will begin on startup. Also determine if "Forcing" is permitted.

"Forcing" is a function for administrators. It allows the administrator to continue the process even if the maximum log storage space has been exceeded.

Thus, the Audit Trail switches off and must be rebooted using the "StartLogging" system function.

## **Creating an audit trail**

### **Requirements**

"GMP compliant configuration" has been selected on the HMI device.

### **Procedure**

1. Double-click on the HMI device in the project tree.
2. Double-click "Logs".  
The "Logs" editor will open.

3. Change to the "Audit Trail" tab.  
An audit trail has been created.

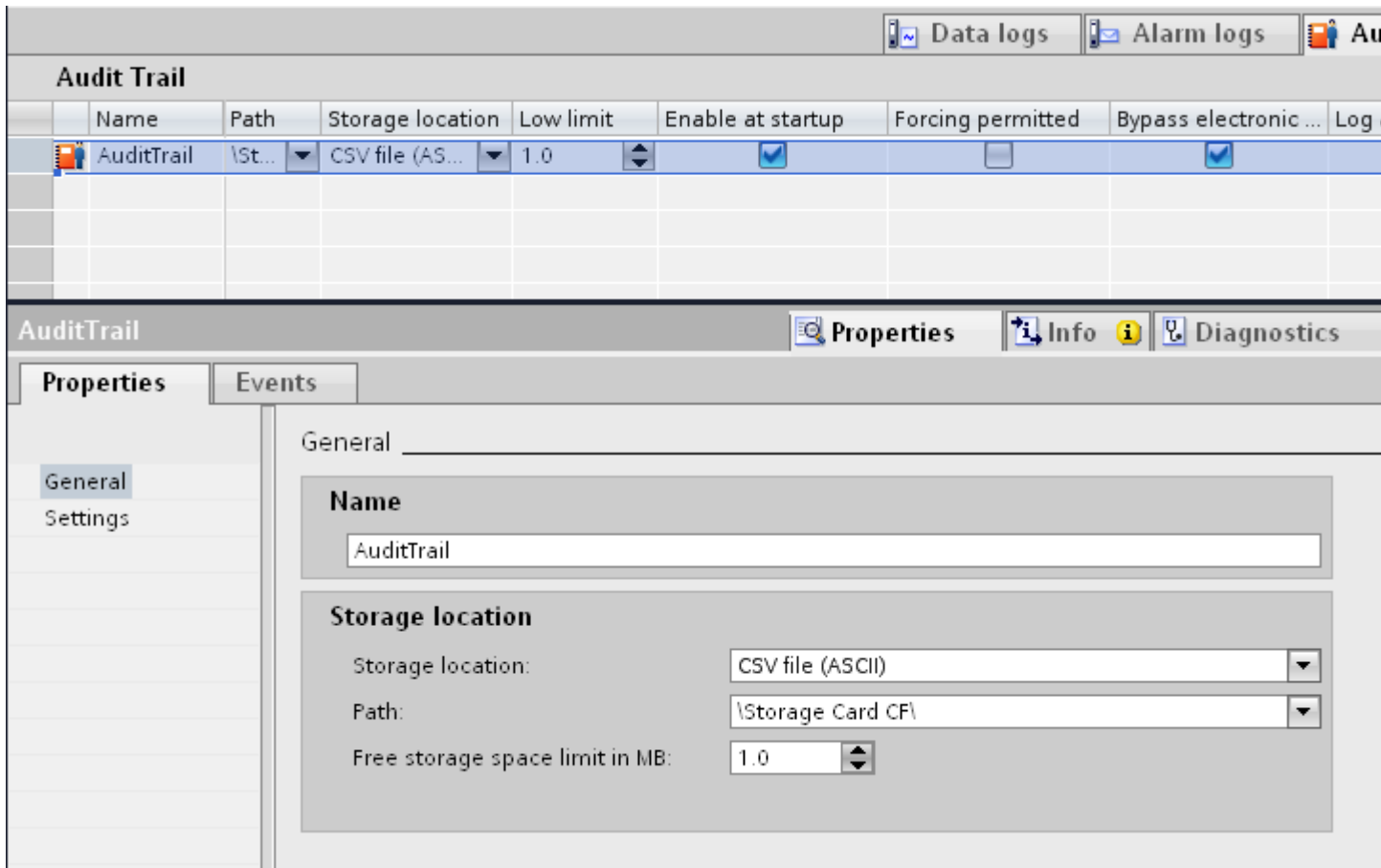

4. Define the following in the inspector window:
  - Name
  - Storage location
  - Logging with runtime start-up
  - Forcing

---

#### Note

No audit-related user actions are permitted in GMP relevant projects if there is insufficient storage space available for the audit trail.

If the check box "Forcing permitted" is activated and, because of the hardware, there is insufficient storage space in runtime, the administrator can interrupt audit trail logging. The administrator can prevent the process from stopping in this way.

If the administrator enables the "Forcing" function, the interruption of the audit trail by the administrator will be entered in the audit trail as the last entry.

At the end of "Forcing" restart the audit trail using the "StartLogging" system function.

---

### Configuring a function list

If necessary, configure a function list for the events "Low free storage space" and "Free space critically low".

The "Low free storage space" event is triggered if the amount of free storage space available for the audit trail in runtime is less than the amount configured in "Minimum storage space in MB".

The "Free space critically low" event is triggered if there is no longer sufficient free storage space for the audit trail in runtime. The value depends on the HMI device.

For more information refer to chapter: Configuring the "Low free storage space" event

### Result

Audit relevant user actions are entered in the configured audit trail in runtime.

### Parameters for the audit trail

#### Introduction

Configure Audit Trail in the "Logs" editor if you have enabled "GMP compliant configuration" in the runtime settings.

There are two ways of assigning parameters for the audit trail:

- "Settings for audit trail" editor
- "Audit Trail" inspector window

#### Editor "Audit Trail"

The "Audit Trail" editor is an overview of the Audit Trail created.

Only one Audit Trail can be created per HMI device.

Parameters that are assigned for the Audit Trail can be seen in the line. You can select or deselect the parameters displayed.

The parameters of an Audit Trail are also displayed and described in more detail in the inspector window.

### General inspector window

You can set the following parameters under "Audit trail > Properties > General":

The screenshot displays the 'Audit Trail' configuration window. At the top, there are tabs for 'Data logs', 'Alarm logs', and 'Audit Trail'. Below this is a table with the following columns: Name, Path, Storage location, Low limit, Enable at startup, Forcing permitted, Bypass electronic, and Log. The table contains one entry: 'AuditTrail' with a path of '\St...', storage location of 'CSV file (AS...', and a low limit of '1.0'. Below the table is the 'AuditTrail' properties window. It has tabs for 'Properties' and 'Events'. The 'Properties' tab is active, and the 'General' sub-tab is selected. The 'General' section contains the following fields:

- Name:** AuditTrail
- Storage location:** CSV file (ASCII)
- Path:** \Storage Card CF\
- Free storage space limit in MB:** 1.0

### Name

- Under "Name", assign a name for the Audit Trail .  
Special characters are not permitted when assigning the name.

### Storage location

- Storage location  
You can choose between:
  - a CSV file (ASCII)
  - a TXT file (Unicode)

---

**Note**

Use "TXT (Unicode)" as storage location for logging Asian languages.

---

- Path  
Depending on the HMI device, enter the storage location of the Audit Trail under "Path".
- Minimum space in MB  
Specify the size of remaining storage space that triggers the "Less free storage space" event.

### Inspector window settings

You can set the following parameters under "Audit trail > Properties > Properties > Settings":

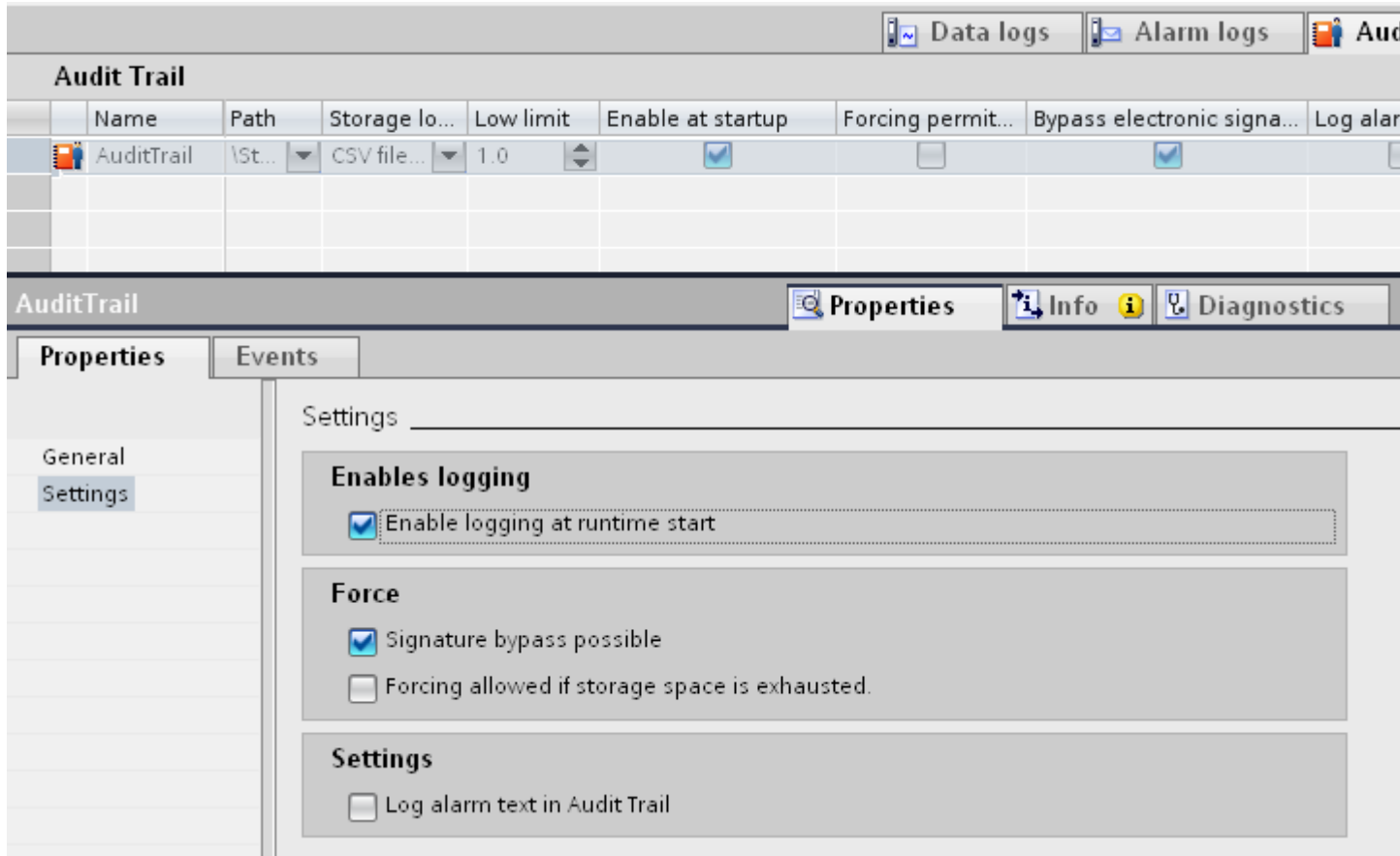

### Logging activation

- Enable logging at runtime start

### Forcing

- Bypass electronic signature  
Specifies whether the administrator is permitted to run operator actions without entering an electronic signature or comments.
- Forcing allowed if storage space is exhausted  
This function allows the administrator to interrupt audit trail logging in the following scenarios:
  - There is no free storage space available.
  - The storage medium is missing.
  - Access to required storage medium is not possible.

You can thus prevent the process from stopping.

After Forcing was carried out, the audit trail log switches off.

After the end of "Forcing", the audit trail must be restarted with the system function "StartLogging".

### Settings

- Logging alarm texts in the audit trail.

---

#### Note

Use "TXT (Unicode)" as storage location for logging Asian languages.

---

For further details on setting the logging language, refer to the following section:  
Setting the audit trail language

### Setting the audit trail language

#### Introduction

The logging language for an Audit Trail is set in the runtime settings.

#### Procedure

1. Double-click on the HMI device in the project tree.
2. Double-click "Runtime settings".



3. Click "General".
4. Select the logging language in the "Logs" area.

**Note**

If an Asian language was selected, use the "TXT (Unicode)" storage location in the "Audit trail" editor.

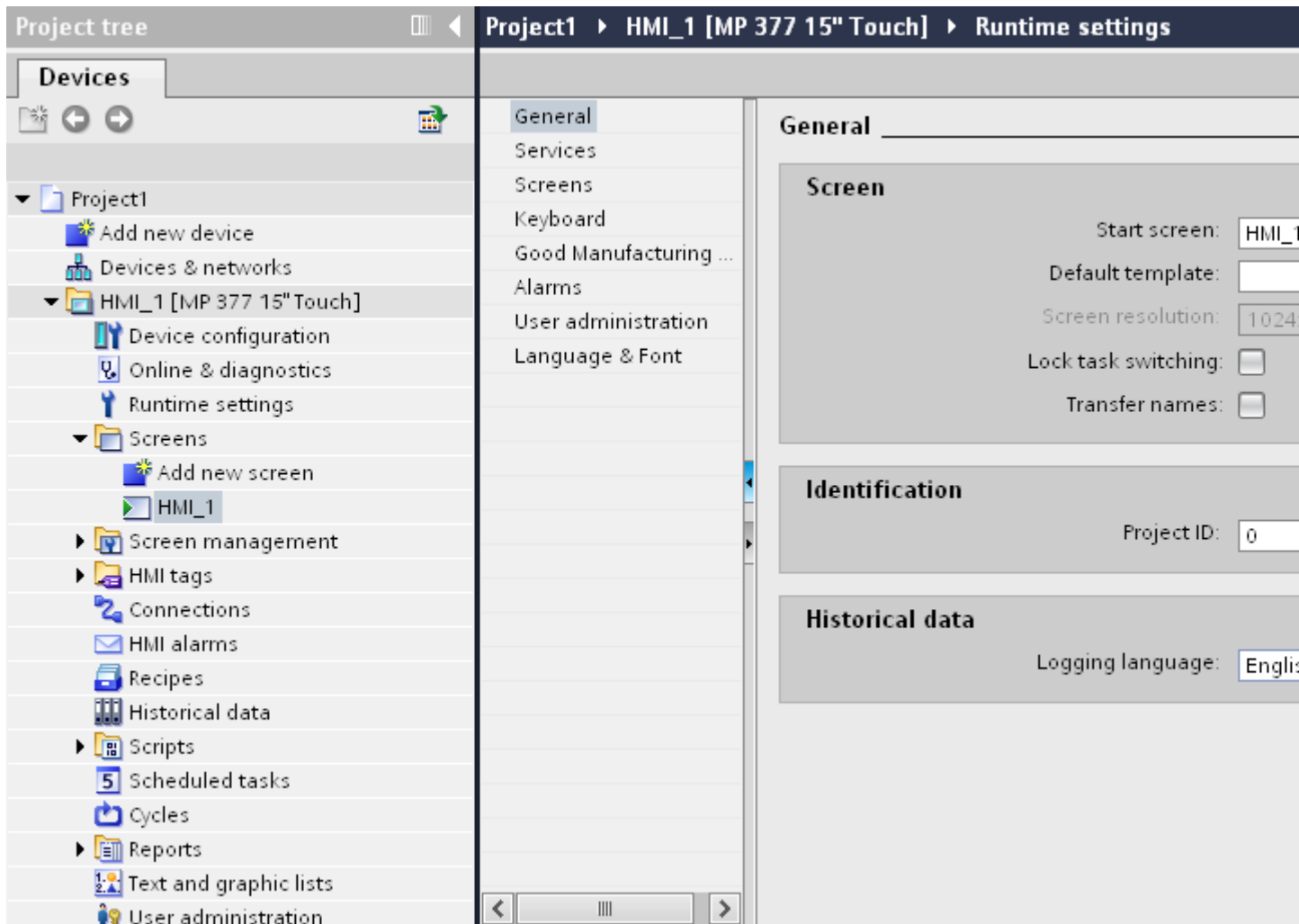
**Low free storage space****Low free storage space****Description**

This event is triggered if the storage space available on the medium to which the Audit Trail is less than the configured minimum.

## Free space critically low

### Description

This event is triggered if the storage medium to which an Audit Trail is saved provides insufficient storage space due to hardware restrictions.

## Configuring the "Low free storage space" event

### Requirements

- A GMP- compliant configuration is enabled
- An Audit Trail is created

### Procedure

1. Click on the Audit Trail in the "Audit Trail" editor.
2. In the Inspector window, click "Properties > General".
3. In the "Free storage space limit in MB" area, select a value that triggers the "Little free space" event.
4. Click on Events in the Inspector window.
5. Click on the "Low free storage space" event.
6. In the function list, specify a system function to execute when an "Overflow" event is triggered.

## Logging the audit trail

## Reporting an audit trail

### Introduction

You can print a report of the operations saved in an Audit Trail. All recorded actions are included in the printout.

### Requirements for reporting

The "Audit trail report" report object is available for the printout of an Audit Trail.

You can configure the report in the "Report" editor. The report object is only available if the "GMP-compliant configuration" option is set in the runtime settings of the HMI device.

If an Audit must be printed in runtime, initially the logging of Audit Trail must be stopped using the "StopLogging" system function.

Whilst an Audit Trail is being printed, no user actions are recorded. Ensure that no GMP-relevant user actions are executed whilst the logging is stopped.

After printing is complete without any errors, restart the audit trail using the "StartLogging" system function.

The header of the report is printed in the current runtime language. Change the runtime language to the logging language accordingly.

The logged data from Audit are printed in the configured runtime logging language.

In order to receive a complete report, the report object can also be used in a report in conjunction with the "Print alarm" and "Print recipe" report objects.

## Audit Trail reporting

### Introduction

You use the "Audit Trail" report object to configure a report for the output of Audit Trail contents to a printer.

Once the printout is started in runtime, all entries currently contained in the Audit Trail are printed out.

### Procedure

To create a report, proceed as follows:

1. Double-click on the "Reports" entry in the project tree.
2. Double-click "Add new report".  
A new report is created and opened in the "Report" editor.

3. Drag & drop the "Audit trail report" object under "Tools > Controls" to the report created.

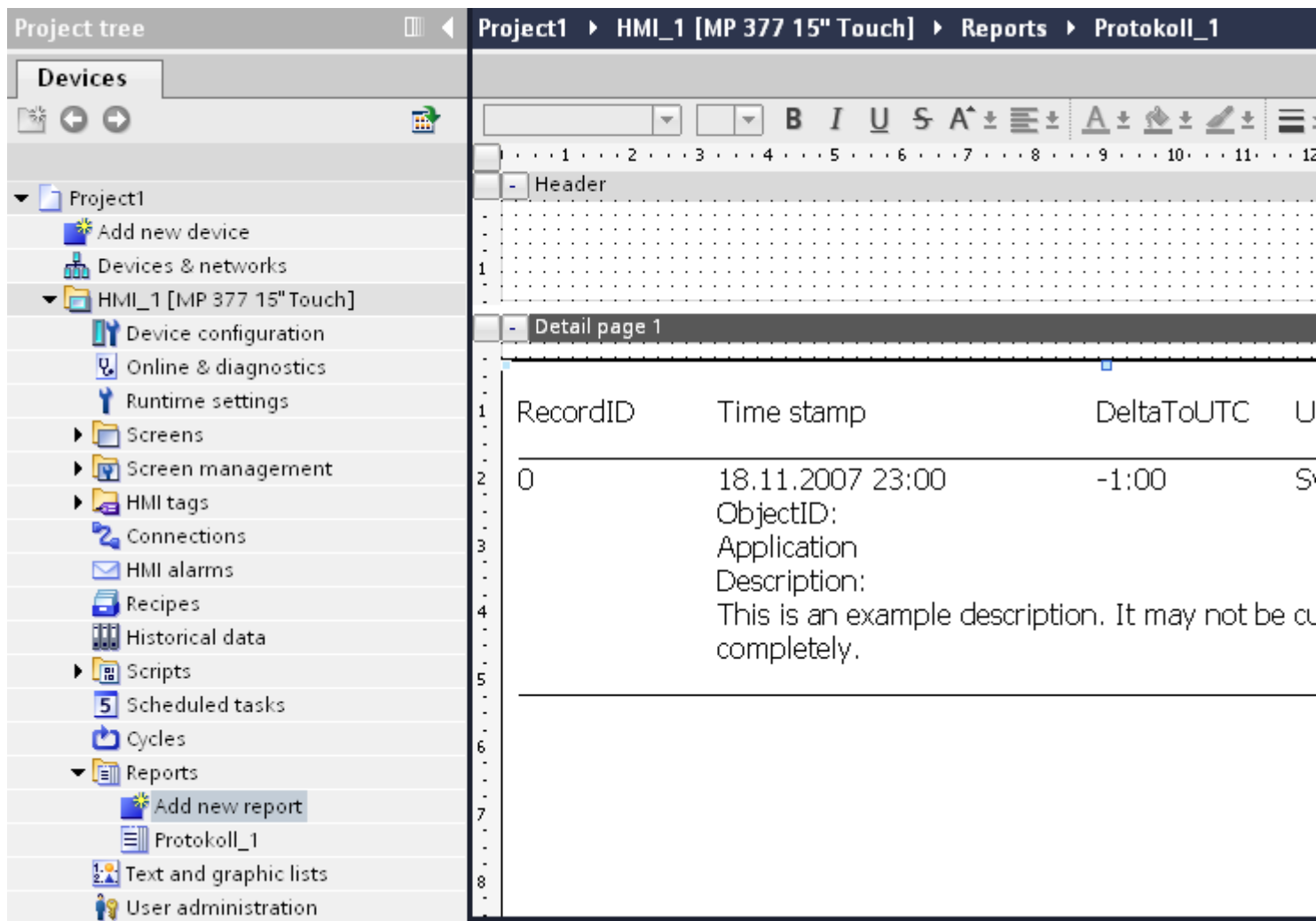

- 4. Click on the "Audit trail report" object.
- 5. Change the object properties of the "Audit trail report" object in the inspector window.

**Result**

You have created a report for the printout Audit Trail.

**Parameters for the audit trail report**

**Introduction**

The "Audit trail report" parameters can be edited in the inspector window.

## Inspector window appearance

Click on the "Audit trail report" object.

Change the appearance of the "Audit trail report" object in the appearance area of the Inspector window under "Properties > Properties > Layout".

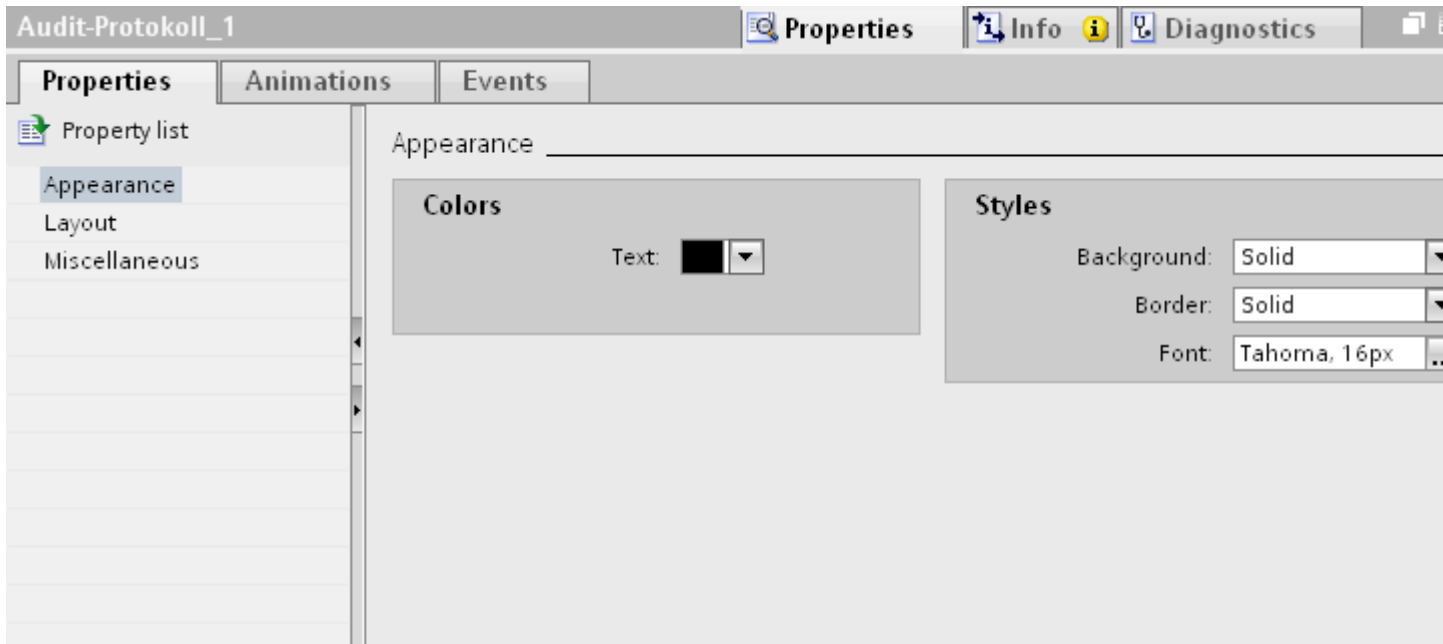

You can configure the foreground color, the background color, the style, and the font settings.

It is recommended to set a font size of 16 px for the output.

## Inspector window layout

Click on the "Audit trail report" object.

Change the position and size of the "Audit trail report" object in the appearance area of the Inspector window under "Properties > Properties > Layout".

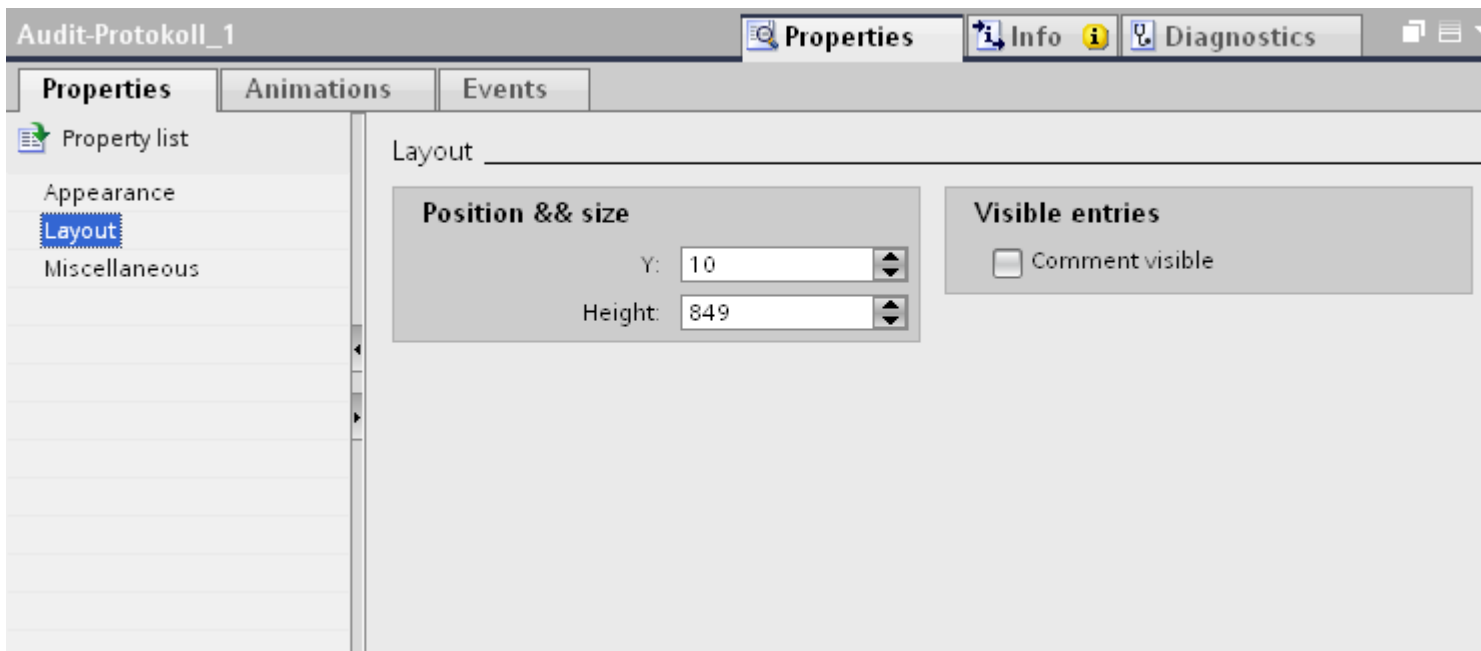

The "Audit trail report" object always fills the space down to the footer on the report page. If you change the height of the object, then you only change the distance of the object to the header. The report printout can involve a large amount of data.

A page break is automatically inserted when the length of the page is exceeded to print out all data.

In the "Visible entries" area, it is determined whether comments are visible on the printed report.

### Inspector window miscellaneous

Click on the "Audit trail report" object.

Change the name and layer position of the "Audit trail report" object in the appearance area in the Inspector window under "Properties > Properties > Miscellaneous".

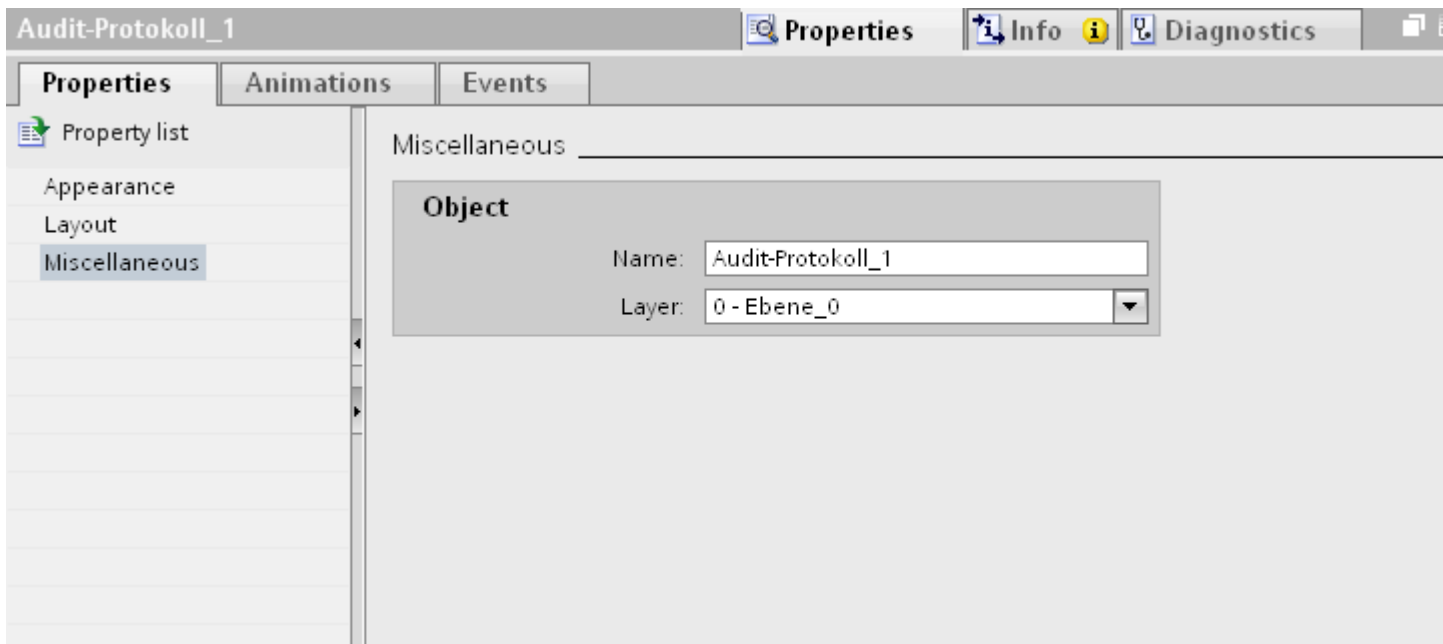

## Printing out an audit trail report

### Introduction

Since logging of the Audit must be stopped in order to print out an Audit Trail, a few details regarding this procedure must be noted.

The following steps must be taken to print out an audit trail in a report file on a printer:

- Stop logging using the "StopLogging" system function.
- Start the printout using the "PrintReport" system function.
- Check if the printing is successfully completed.
- If needed, move or delete the Audit Trail using the system functions "ArchiveLogFile" or "DeleteLog".
- Start the logging of Audit by selecting the "StartLogging" system function.

---

#### Note

Make sure that the Audit Trail has been printed completely before you delete the Audit Trail.

---

### Requirements

- "GMP compliant configuration" has been enabled.
- A report for the printout of an Audit Trail has been configured.
- The screen for the operator control to be configured is open.

## Procedure

1. Add a button to the screen and select "Events > Click" in the Properties window.
2. In the function list, assign the "StopLogging" system function to the "Click" event and select your Audit Trail log.
3. Insert an additional button and assign the "PrintReport" system function to the "Click" event of this button.
4. Configure the "StartLogging" system function in the same function list.
5. Assign unique labels to the buttons.
6. Save the project.

## Result

You have configured the required buttons and system functions. The operator can perform the operating tasks described in the introduction during runtime to print out an Audit Trail report.

---

### Note

You can also insert the report objects for the output of alarms and recipes in the report for the printout of an Audit Trail. However, since GMP-relevant operations and system processes are not recorded while you are printing, you should preferably print the Audit Trail in a separate operation.

---

## Evaluating an audit trail

### Evaluating audit trails

#### Introduction

The Audit Trail has been saved to the memory card of the HMI device and is also read only.

The Audit Trail is protected by a checksum. This checksum ensures that the entry has not been modified at any later time.

There are two possible ways to evaluate the Audit Trail:

- Use the "Audit Viewer":  
You can easily evaluate the Audit Viewer for external analysis on an Office PC with the help of the Audit Trail.
- Use the "HmiCheckLogIntegrity" DOS program:  
The DOS program makes it possible to carry out an automatic check of the Audit Trail using the return values.



## Evaluating Audit Trails in AuditViewer

### Introduction

The Audit Viewer allows you to evaluate all Audit Trail data in a table.

### Requirements

- Audit Viewer is installed
- The Audit Traillog is located on the computer which has Audit Viewer installed.

### Procedure

1. Start the Audit Viewer on the configuration PC:  
"Start > SIMATIC > Audit Viewer > Audit Viewer"  
This path may be different on your operating system version.
2. Click the  button.
3. Load the Audit Trail:

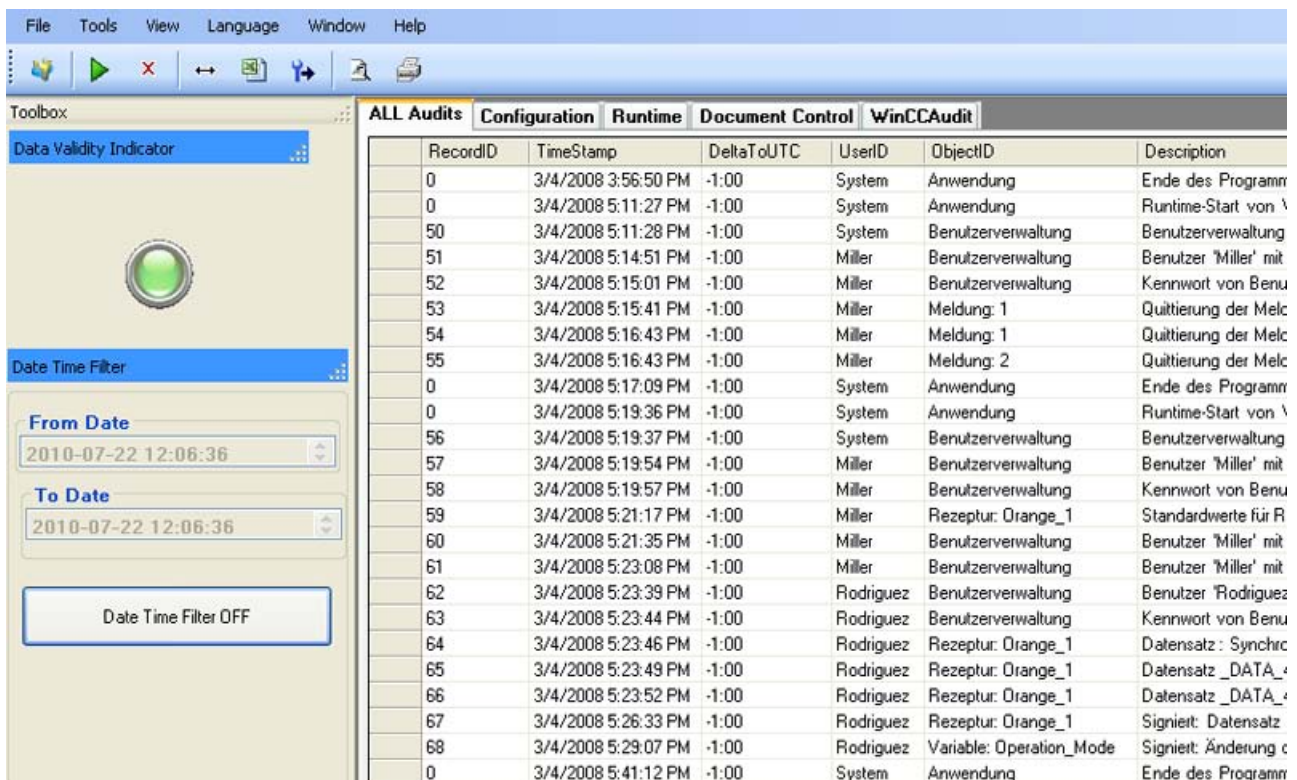

RecordID	TimeStamp	DeltaToUTC	UserID	ObjectID	Description
0	3/4/2008 3:56:50 PM	-1:00	System	Anwendung	Ende des Programr
0	3/4/2008 5:11:27 PM	-1:00	System	Anwendung	Runtime-Start von \
50	3/4/2008 5:11:28 PM	-1:00	System	Benutzerverwaltung	Benutzerverwaltung
51	3/4/2008 5:14:51 PM	-1:00	Miller	Benutzerverwaltung	Benutzer 'Miller' mit
52	3/4/2008 5:15:01 PM	-1:00	Miller	Benutzerverwaltung	Kennwort von Benu
53	3/4/2008 5:15:41 PM	-1:00	Miller	Meldung: 1	Quittierung der Melc
54	3/4/2008 5:16:43 PM	-1:00	Miller	Meldung: 1	Quittierung der Melc
55	3/4/2008 5:16:43 PM	-1:00	Miller	Meldung: 2	Quittierung der Melc
0	3/4/2008 5:17:09 PM	-1:00	System	Anwendung	Ende des Programr
0	3/4/2008 5:19:36 PM	-1:00	System	Anwendung	Runtime-Start von \
56	3/4/2008 5:19:37 PM	-1:00	System	Benutzerverwaltung	Benutzerverwaltung
57	3/4/2008 5:19:54 PM	-1:00	Miller	Benutzerverwaltung	Benutzer 'Miller' mit
58	3/4/2008 5:19:57 PM	-1:00	Miller	Benutzerverwaltung	Kennwort von Benu
59	3/4/2008 5:21:17 PM	-1:00	Miller	Rezeptur: Orange_1	Standardwerte für R
60	3/4/2008 5:21:35 PM	-1:00	Miller	Benutzerverwaltung	Benutzer 'Miller' mit
61	3/4/2008 5:23:08 PM	-1:00	Miller	Benutzerverwaltung	Benutzer 'Miller' mit
62	3/4/2008 5:23:39 PM	-1:00	Rodriguez	Benutzerverwaltung	Benutzer 'Rodriguez
63	3/4/2008 5:23:44 PM	-1:00	Rodriguez	Benutzerverwaltung	Kennwort von Benu
64	3/4/2008 5:23:46 PM	-1:00	Rodriguez	Rezeptur: Orange_1	Datensatz: Synchr
65	3/4/2008 5:23:49 PM	-1:00	Rodriguez	Rezeptur: Orange_1	Datensatz _DATA_
66	3/4/2008 5:23:52 PM	-1:00	Rodriguez	Rezeptur: Orange_1	Datensatz _DATA_
67	3/4/2008 5:26:33 PM	-1:00	Rodriguez	Rezeptur: Orange_1	Signiert: Datensatz
68	3/4/2008 5:29:07 PM	-1:00	Rodriguez	Variable: Operation_Mode	Signiert: Änderung c
0	3/4/2008 5:41:12 PM	-1:00	System	Anwendung	Ende des Programr

The "Data Validity Indicator" is lit up in green to indicate that the loaded Audit Trail has not been manipulated.

Each entry in the Audit Trail is time-stamped to allow precise tracking of operator actions. In addition to system events, such as the attempt to import a password list, the system also records failed logon attempts:

## See also

Evaluating the checksum of log data (Page 3229)

Evaluating the checksum of log data (Page 3317)

## Evaluating Audit Trails with DOS program

### Introduction

Long-term archiving on a server allows an Audit Trail to be checked automatically using return values in a script.

In addition the programmer can integrate the check using the DOS program "HmiCheckLogIntegrity" into the archiving process. "HmiCheckLogIntegrity" then provides the following return values:

- < 0: Different errors, for example, wrong file format or no file exists.
- 1: The checked Audit Trail is valid.
- > 0: The first line that was manipulated will be returned.

Audit Trail logging is only continued if the return value is "1". In both error cases, the administrator or the shift supervisor can be informed.

### HmiCheckLogIntegrity

The "HmiCheckLogIntegrity.exe" DOS program is in the installation directory under:  
"SIEMENS > Automation > WinCC Runtime Advanced"

### Audit trail logging concept

### Format

#### Format - Audit Trail

On an HMI device with "GMP compliant configuration", all events which are relevant to the audit are recorded at runtime in the Audit Trail. You have several format options.

Selection is dependent on the display program and the runtime language used:

- File - CSV (ASCII)  
To view and evaluate a CSV file use, e.g. Microsoft Excel on your PC.

---

**Note**

Double quotation marks or several characters are not permitted as list separators for the storage site "File - CSV (ASCII)". You can find the settings for list separators under "Start > Settings > Control Panel > Regional and Language Options".

---

- File - TXT (Unicode)  
This file format supports all characters that can be used in WinCC. For editing, you will need software that can save files in Unicode, such as Notepad.

---

**Note**

Use "File - TXT (Unicode)" to log Asian languages.

---

### Audit Trail with checksum

The following files are generated under special circumstances:

- \*.keep
  - If a log is started without checksum and will be continued with a checksum.
  - If you update WinCC with a service pack or a new version and the Audit Trail or the log is continued with the checksum.
  - The content of the keep file will remain the same when compared with the original csv file or txt file.

---

**Note**

Before you update WinCC with a Service Pack or a new version, exit and save the Audit Trail or the logs using checksum. After WinCC is updated, the audit trail or logs will be continued with new files using checksum.

---

- \*.bak
  - If runtime has determined a serious, irregular problem in the file.

## Storage location and medium

### Storage location and medium

Depending on the hardware configuration of the HMI device, the data may be logged locally (on the hard disk of a PC or on the storage card of a panel) or, if present, on a network drive.

---

#### Note

##### Logging on network drives

We do not recommend that you log audit trails directly on a network drive. Power supply can be interrupted at any time. This means there is no guarantee for a reliable operation of logs and audit trails.

We recommend you save the logs on your local hard drive, or on a storage medium of the HMI device. Use the system function "ArchiveLogFile" to save the logs long-term on a network drive.

---

A "GMP compliant configuration" cannot be operated at runtime to the full extent unless it is possible to save all user actions which are relevant to the audit to the Audit Trail. It must be ensured that sufficient storage space is available for the Audit Trail and that the connection to the storage location for the Audit Trail is not disturbed.

### Error-handling with insufficient free storage space

If there is insufficient storage space, your project can be configured so that the administrator has an option of continuing the process without logging in the audit trail (forcing).

### Error-handling if there is no storage medium or the connection to the server is interrupted

All audit-relevant user actions are blocked if insufficient storage space is available for the Audit Trail, e.g. due to missing storage medium.

Blocking is canceled as soon as the storage location for the Audit Trail is available again. The block can be skipped by "forcing".

### Error-handling with long-term logging

If the audit trail must be moved to a server for long-term logging and the connection to the server is interrupted at this time, the following error-handling is required:

The system closes the audit trail and renames it. The system attempts to send the renamed audit trail to the server again in the background.

If disruption in the connection to the server persists, you receive a system alarm telling you that the connection is down. Then the system attempts to send the renamed audit trail every 300 seconds.

The attempt to transmit the data is repeated until successfully completed. The data is also transmitted after a restart of the HMI device.

## "Forcing"

If the storage space for the audit trail is insufficient, for example if there is no storage medium or it is full, all audit-relevant user actions are automatically blocked.

In this case the audit trail logging can be configured to give an administrator the option of continuing to operate the system without logging the audit trail (forcing).

The administrator can also be given the option of running the system quickly out of a critical state in case of emergency. In this case the administrator can operate the system without the requirement to input the required electronic signatures or comments.

If the administrator uses the "forcing" function, this is logged as the last entry in the audit trail.

After the end of forcing, the audit trail must be restarted with the system function "StartLogging".

## Protection mechanisms

### Protective mechanisms to prevent changes to audit trail data

The audit trail data are protected against deliberate or accidental changes:

- The directory in which the audit trail is saved can only be accessed with special rights.
- The audit trail files are write-protected.
- Each data record contains a checksum that can be used to detect a change of its contents. This checksum also ensures that the number of lines has not changed in the audit trail file.

Use the "HmiCheckLogIntegrity" tool, included in the audit option, to check whether an audit trail has been changed:

Evaluating Audit Trails with DOS program

## WinCC upgrade

### WinCC upgrade

Before you update WinCC with a Service Pack or a new version, you will have to exit and save the Audit Trail or the logs with checksum. After WinCC is updated, the audit trail or logs with checksum will be continued with new files.

Make sure that the logs are started at a defined state with the new version.

## Audit trail behavior in runtime

### Effects in runtime

The configuration in Audit Trail has the following effects in runtime, depending on the configuration:

- Audit relevant user actions (such as tag changes and recipe changes) are recorded in an audit trail.
- "Enable logging at runtime start" check box enabled:  
The audit trail is started with runtime.
- "Forcing" group, "Allowed if storage space has been exhausted" check box enabled:  
A user with administrator rights can use "forcing" to run operations on the plant even though the audit trail can no longer be logged because of storage space limitations. Interrupting the audit trail prevents the process from being stopped.  
If the check box "Signing may be bypassed" is enabled, the administrator is not required to input electronic signatures, acknowledgments or comments for operator actions that would normally require signing, acknowledgment or comment.
- If the storage space available for the Audit Trail is less than the configured "Minimum storage space in MB", the function list configured for the "Low free storage space" event will be processed.
- If there is insufficient storage space for the audit trail because of hardware limits, the function list configured for the "Free space critically low" event will be processed.

### 10.16.1.4 Configuring audit functions

#### Logging tag value changes

#### Tag value change

#### Changes to tag values

User actions in runtime are recorded in a Audit Trail once "GMP compliant configuration" has been enabled.

When you configure a GMP compliant project, you specify which tags must meet the requirements of Good Manufacturing Practice (GMP).

---

If the user changes the value of a GMP-relevant tag in runtime, the value change action is logged in the Audit Trail .

---

**Note**

The action of changing the value of GMP-relevant tags made by the PLC, or a system function, is not logged in the Audit Trail.

The system functions used to change the values of GMP-relevant tags which are assigned to events that identify a direct user action will be logged.

In addition, configure the "NotifyUserAction" system function to make a manual entry in the Audit Trail or to prompt the user for an electronic signature, an acknowledgment, or a comment.

With the "NotifyUserAction" system function only the value changes that are directly triggered by the event to which the system function is configured are entered in the Audit Trail. For example, if additional tags are changed by changing the value of one tag, the additional value changes are not logged in the Audit Trail.

---

## Logging tag value changes

### Requirement

- "GMP compliant configuration" has been enabled.
- The tags for which you want to configure the GMP settings are created.
- The property view is open.

## Procedure

1. Open the HMI tags editor and select the tag for which you want to make GMP settings.

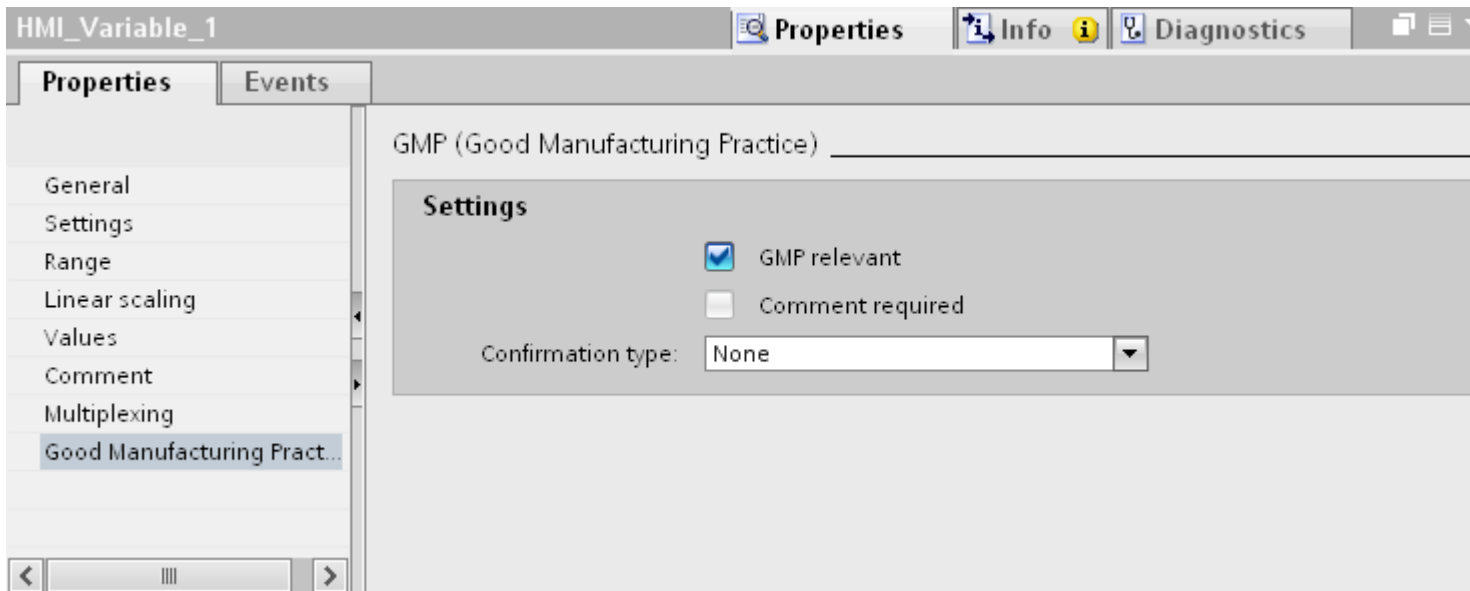

2. Click "GMP relevant" under "Properties > Properties > GMP" in the Inspector window.
3. Specify how the user must confirm a value change in the "Confirmation type" selection field:
  - "Electronic signature"  
If the user's electronic signature is required.
  - "None"  
If the value change is to be logged in the Audit Trail without user confirmation.
  - "Acknowledgment"  
If user acknowledgement of the value change is required.
4. Enable the "Comment required" check box if the user is required to input a comment as well as an electronic signature or acknowledgment.  
This check box is only enabled if "Electronic signature" or "Acknowledgment" is specified under "Type of confirmation".

## Result

If the user changes the value of a GMP-relevant tag in runtime, the value change is entered in the Audit Trail.



## Effects of tag change

### Effects in runtime

The configuration has the following effects in runtime depending on the properties of the GMP-relevant tags:

- If the user changes the value of a GMP-relevant tag in runtime, the value change is entered in the Audit Trail.
- Electronic signature  
If "Electronic signature" is specified as the "Type of confirmation", the user must log every user-related value change of the tags using an electronic signature. Otherwise the value change will be rejected.  
The user name used to sign the change is logged in the audit trail.
- Acknowledgement  
If "Acknowledgment" is specified as the "Type of confirmation", the user must acknowledge every user-related value change of the tags. Otherwise the value change will be rejected.  
The acknowledgement is logged in the Audit Trail.
- Comments  
If the "Comment required" check box is enabled, the user must also comment every user-related value change of the tags, in addition to acknowledgment or input of the electronic signature. Otherwise the value change will be rejected.  
The entered comment is logged in the Audit Trail.

## Logging recipe data record changes

### Recipe data changes

#### Changes to recipe data

User actions in runtime that are relevant to the quality of the process, such as changes of tag values or recipe values, are recorded in an Audit Trail once "GMP compliant configuration" has been enabled.

You specify during configuration which recipes must meet the requirements of "Good Manufacturing Practice" (GMP).

For GMP-relevant recipes, the following operations during runtime are recorded in the Audit Trail:

### 10.16 Options

- Storing after changing and creating recipe data records
- Transfer of recipe data records to the PLC and from the PLC
- For recipe tags: Changing the setting for the synchronization of the tag values with the PLC ("offline"/"online") if the recipe tags are configured as "GMP-relevant".

---

#### Note

##### Differences in the Audit Trail with recipe display and recipe screen

If you use a recipe screen to save recipe data, enable the "GMP-relevant" property for the recipe tags. If the user changes the value of a GMP-relevant recipe tag in runtime, the changed value is recorded in the Audit Trail. You can also configure for the tag to require the user to confirm the value change with an electronic signature and enter a comment.

If you use a recipe display to edit data records of a GMP-relevant recipe, the Audit Trail includes a record of which recipe data records were saved or sent to the PLC. The value changes to the recipe tags are not logged in the Audit Trail. Use the "ExportDataRecords" system function to save the value change to data records in a csv file.

If you want to make changes to recipe data records in conformance to the FDA, disable "Enable edit mode" in the recipe view. Use the recipe screen and "GMP relevant" recipe tags.

---

If you export recipe data records in a regulated project, you can assign the recipe data with a checksum. When you later import the recipe data back, you can use the checksum to determine if the recipe data has changed. The following system functions are available for exporting and importing recipe data with a checksum:

- "ExportDataRecordsWithChecksum"
- "ImportDataRecordsWithChecksum"

## Logging recipe data changes

### Requirement

- "GMP compliant configuration" has been enabled.
- The recipes for which you want to configure the GMP settings are created.
- The property view is open.

## Procedure

1. Open the recipe editor and select the recipe for which you want to make GMP settings.

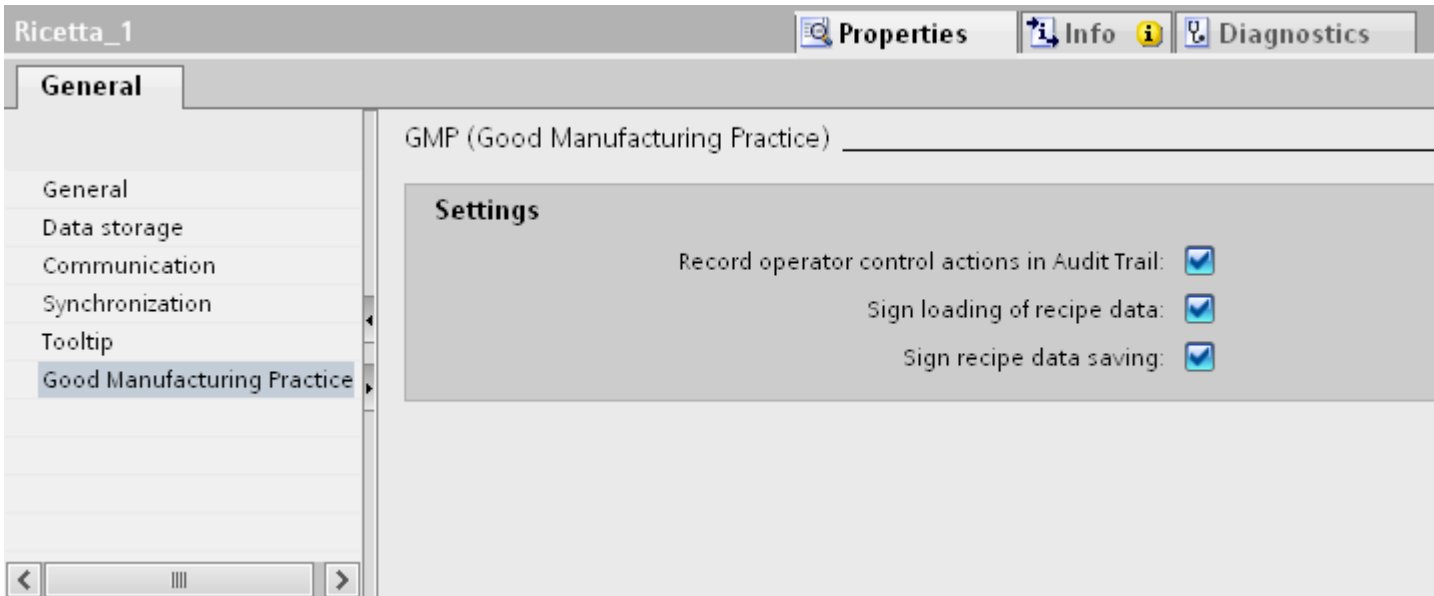

2. Click "GMP relevant" under "Properties > Properties > GMP" in the Inspector window.
3. Under "Settings", select the following:
  - "Record operations in audit trail:"  
If all user actions in runtime that affect this recipe are to be recorded in the Audit Trail.
  - "Sign loading of recipe data":  
If the user is required to confirm the transfer of recipe data records to or from the PLC using an electronic signature.
  - "Signature for saving recipe data: "  
If the user is required to confirm recipe data record saving with an electronic signature.

## Result

If the user works with the GMP-relevant recipe in runtime, the change is entered in the Audit Trail.

## Effects of recipe data change

### Effects in runtime

The configuration has the following effects in runtime depending on the properties of the GMP-relevant recipes:

## Entries in the Audit Trail

Entries are made in the following cases:

- You create and save new recipe data records of a GMP-relevant recipe at runtime.
- You edit recipe data records of a GMP-relevant recipe and save your changes at runtime.
- Recipe data records are transferred to the PLC or recipe data are read from the PLC.
- The "SetRecipeTags" system function is used to change the setting for synchronization of the tag values with the PLC.  
This concerns the following changes:
  - "offline" to "online"
  - "online" to "offline"

## Electronic signature

The user must enter an electronic signature in the following cases depending on the configuration:

- The "Sign loading of recipe data" check box is set:  
Signature for the transfer of recipe data records to the PLC. Signing is always required if the transfer is triggered with the recipe display functions and even if it is triggered with "SetDataRecordToPLC" system functions.
- The "Sign saving of recipe data" check box is set:  
Sign saving of recipe data records. The signature is always required if the save is triggered with the system functions of the recipe display, and even if it is triggered with the "SetDataRecordToPLC" or "SaveDataRecord" system function.
- The user name used to sign the change is logged in the audit trail.

---

### Note

The triggering of the "ImportDataRecords" system function is entered in the Audit Trail but does not require a signature or a comment. In addition, call the "NotifyUserAction" system function to request an electronic signature with or without user comment.

---

## Logging user actions

### User actions with GMP-compliant configuration

#### Introduction

In GMP compliant configuration, user actions and system operations in runtime that are relevant for the quality of the process are recorded in an Audit Trail .

For example, a user logon to the system or the change of a tag value are saved in the log.

In runtime, user actions are saved in an Audit Trail under the following conditions:

- "GMP compliant configuration" has been enabled
- A user is logged on to the system

## Logging modes

### Automatic logging of user actions

The following user actions are recorded in runtime without the need for additional configuration steps if "GMP compliant configuration" is enabled:

- User Administration
  - Logon and logoff of users
  - Import of user administration
- Alarm system
  - All alarms that are acknowledged by the user.  
If an alarm from an alarm group is acknowledged, an entry is made in the Audit Trail indicating that all other alarms of this group have been acknowledged.
  - All acknowledgment attempts of the user

---

**Note****Logging alarm text**

To log alarm texts, select the "Log alarm texts in Audit Trail" option in the Audit Trail editor.

---

- Log operations
  - Starting and stopping a log
  - Opening and closing all logs
  - Deleting a log
  - Starting a sequence log
  - Copying a log
  - Long-term logging of a log

## Configuration-dependent logging

The following processes are logged depending on the configuration of the recipes and the tags of the project:

- Change values of GMP-relevant tags by the user
- for GMP-relevant recipes
  - You create and save new recipe data records of a GMP-relevant recipe at runtime.
  - You edit recipe data records of a GMP-relevant recipe and save your changes at runtime.
  - Transfer of recipe data records to the PLC and from the PLC
  - For recipe tags: Changing the setting for the synchronization of the tag values with the PLC ("offline"/"online")

In addition to logging user actions you can configure tags and recipes to require the user to confirm or acknowledge specific actions with an electronic signature or add a comment to the change.

## Manual logging by means of "NotifyUserAction" system function

This system function is used to record actions in the Audit Trail that are not automatically entered in the Audit Trail. This system function is also used to request the user to enter an electronic signature for the action.

## Configuring the "NotifyUserAction" system function

### Introduction

This system function is used to log user actions that are not entered automatically entered in the Audit Trail. This system function can also used to request an acknowledgment, or an electronic signature for the user's action.

In this example, the system function is assigned to a button. All operations with this button are logged to the Audit Trail.

### Requirements

- "GMP-compliant configuration" has been enabled.
- You created the object that is to be assigned the system function.  
A button is used in this example.
- The properties window is open.

### Procedure

1. Click the button.
2. Click on "Events" in the Inspector window.
3. Assign the "NotifyUserAction" system function to the "Click" event.

## GMP-compliant user administration

### SIMATIC Logon

To run a central user and user group administration for several applications or HMI devices, activate SIMATIC Logon.

For more information on user administration and SIMATIC Logon, refer to the following chapter:

Managing users on the server (Page 3511)

## Logging system functions

### Introduction

If system functions are triggered in runtime, this is recorded in the Audit Trail for some system functions. If specific system functions are used on a GMP-relevant object, the user must confirm the triggering.

Some system functions are not supported when using Audit. If you use these system functions in your project, you are solely responsible for them.

The following table shows which system functions are Audit-relevant and whether the user's signature is required:

### System functions and Audit

Function (call in script)	Effect of /Audit
StartLogging (StartLogging)	entered in Audit Trail
StopLogging (StopLogging)	entered in Audit Trail
ClearLog (ClearLog)	entered in Audit Trail
StartNextLog (StartNextLog)	entered in Audit Trail
CloseAllLogs (CloseAllLogs)	entered in Audit Trail
OpenAllLogs (OpenAllLogs)	entered in Audit Trail
LogTag (---)	---
CopyLog (CopyLog)	entered in Audit Trail
ActivateScreen (ActivateScreen)	---
ActivateScreenByNumber (ActivateScreenByNumber)	---
ActivatePreviousScreen (ActivatePreviousScreen)	---
SetBitInTag (SetBitInTag)	entered in Audit Trail when tag is GMP-relevant Signature is mandatory, depending on the tag configuration
ResetBitInTag (ResetBitInTag)	entered in Audit Trail when tag is GMP-relevant Signature is mandatory, depending on the tag configuration

Function (call in script)	Effect of /Audit
InvertBitInTag (InvertBitInTag)	entered in Audit Trail when tag is GMP-relevant Signature is mandatory, depending on the tag configuration
SetBit (SetBit)	entered in Audit Trail when tag is GMP-relevant Signature is mandatory, depending on the tag configuration
ResetBit (ResetBit)	entered in Audit Trail when tag is GMP-relevant Signature is mandatory, depending on the tag configuration
InvertBit (InvertBit)	entered in Audit Trail when tag is GMP-relevant System function must not be applied to tags that require signing or comment.
SetBitWhileKeyPressed (---)	entered in Audit Trail when tag is GMP-relevant Signature is mandatory, depending on the tag configuration
SetDataRecordToPLC (SetDataRecordToPLC)	entered in Audit Trail if the recipe is GMP-relevant Signing required depending on recipe configuration
GetDataRecordTagsFromPLC (GetDataRecordFromPLC)	entered in Audit Trail if the recipe is GMP-relevant
ImportDataRecords (ImportDataRecords)	entered in Audit Trail if the recipe is GMP-relevant
ImportDataRecordsWithChecksum (ImportDataRecordsWithChecksum)	entered in Audit Trail if the recipe is GMP-relevant
ExportDataRecords (ExportDataRecords)	---
ExportDataRecordsWithChecksum (ExportDataRecordsWithChecksum)	---
LoadDataRecord (LoadDataRecord)	entered in Audit Trail if the recipe is GMP-relevant Signing required depending on recipe configuration
SaveDataRecord (SaveDataRecord)	entered in Audit Trail if the recipe is GMP-relevant Signing required depending on recipe configuration
SetDataRecordTagsToPLC (SetDataRecordTagsToPLC)	entered in Audit Trail if the recipe is GMP-relevant Signing required depending on recipe configuration
GetDataRecordTagsFromPLC (GetDataRecordTagsFromPLC)	entered in Audit Trail if the recipe is GMP-relevant



Function (call in script)	Effect of /Audit
SetRecipeTags (SetRecipeTags)	entered in Audit Trail if the recipe is GMP-relevant
GetDataRecordName (GetDataRecordName)	---
ClearDataRecordMemory (ClearDataRecordMemory)	Not supported
ClearDataRecord (ClearDataRecord)	entered in Audit Trail if the recipe is GMP-relevant
PrintScreen (PrintScreen)	---
PrintReport (PrintReport)	---
RecipeViewSaveDataRecord (---)	entered in Audit Trail if the recipe is GMP-relevant Signing required depending on recipe configuration
RecipeViewSaveAsDataRecord (---)	entered in Audit Trail if the recipe is GMP-relevant Signing required depending on recipe configuration
RecipeViewNewDataRecord (---)	---
RecipeViewClearDataRecord (---)	entered in Audit Trail if the recipe is GMP-relevant
RecipeViewGetDataRecordFromPLC (---)	entered in Audit Trail if the recipe is GMP-relevant
RecipeViewSetDataRecordToPLC (---)	entered in Audit Trail if the recipe is GMP-relevant Signing required depending on recipe configuration
RecipeViewSynchronizeDataRecordWithTags (---)	entered in Audit Trail if the recipe is GMP-relevant Signing required depending on recipe configuration
RecipeViewRenameDataRecord (---)	entered in Audit Trail if the recipe is GMP-relevant
RecipeViewBack (---)	---
RecipeViewOpen (---)	---
RecipeViewMenu (---)	---
TrendViewScrollForward (---)	---
TrendViewScrollBack (---)	---
TrendViewExtend (---)	---
TrendViewCompress (---)	---
TrendViewBackToBeginning (---)	---
TrendViewStartStop (---)	---
TrendViewSetRulerMode (---)	---
TrendViewBackToBeginning (---)	---
StatusForceGetValues (---)	Not supported
StatusForceSetValues (---)	Not supported
AlarmViewAcknowledgeAlarm (---)	entered in Audit Trail
AlarmViewEditAlarm (---)	---

10.16 Options

Function (call in script)	Effect of /Audit
AlarmViewShowOperatorNotes (---)	---
HTMLBrowserBack (---)	Not supported
HTMLBrowserForward (---)	Not supported
HTMLBrowserRefresh (---)	Not supported
HTMLBrowserStop (---)	Not supported
ScreenObjectCursorUp (---)	---
ScreenObjectCursorDown (---)	---
ScreenObjectPageUp (---)	---
ScreenObjectPageDown (---)	---
PressButton (---)	---
ReleaseButton (---)	---
SmartClientViewConnect (---)	Not supported
SmartClientViewDisconnect (---)	Not supported
SmartClientViewReadOnlyOn (---)	Not supported
SmartClientViewReadOnlyOff (---)	Not supported
SmartClientViewRefresh (---)	Not supported
SmartClientViewLeave (---)	Not supported
ShowAlarmWindow (ShowAlarmWindow)	---
ClearAlarmBuffer (ClearAlarmBuffer)	---
ShowSystemAlarm (ShowSystemAlarm)	---
SetAlarmReportMode (SetAlarmReportMode)	---
Logoff (Logoff)	entered in Audit Trail
GetPassword (GetPassword)	---
GetGroupNumber (GetGroupNumber)	---
ExportImportUserAdministration (ExportImportUserAdministration)	Import of user administration is entered in Audit Trail Export is not entered in Audit Trail
Logon (Logon)	entered in Audit Trail
GetUserName (GetUserName)	---
TraceUserChange (---)	---
ShowLogOnDialog (---)	---
LinearScaling (LinearScaling)	entered in Audit Trail when tag is GMP- relevant Signature is mandatory, depending on the tag configuration
InverseLinearScaling (InverseLinearScaling)	entered in Audit Trail when tag is GMP- relevant Signature is mandatory, depending on the tag configuration
IncreaseFocusedValue (---)	---
DecreaseFocusedValue (---)	---
OpenCommandPrompt (OpenCommandPrompt)	Not supported
OpenControlPanel (OpenControlPanel)	Not supported
ActivateCleanScreen (---)	---

Function (call in script)	Effect of /Audit
AdjustContrast (---)	---
CalibrateTouchScreen (CalibrateTouchScreen)	---
OpenScreenKeyboard (OpenScreenKeyboard)	---
OpenTaskManager (OpenTaskManager)	Not supported
BackupRAMFileSystem (BackupRAMFileSystem)	Not supported
SetAcousticSignal (SetAcousticSignal)	---
ShowOperatorNotes (ShowOperatorNotes)	---
AcknowledgeAlarm (AcknowledgeAlarm)	entered in Audit Trail
GoToHome (GoToHome)	---
GoToEnd (GoToEnd)	---
EditAlarm (EditAlarm)	---
DirectKeyScreenNumber (---)	Not supported
DirectKey (---)	Not supported
SetDeviceMode (SetDeviceMode)	entered in Audit Trail
SetDisplayMode (SetDisplayMode)	---
SetConnectionMode (SetConnectionMode)	entered in Audit Trail
SetScreenKeyboardMode (SetScreenKeyboardMode)	---
ChangeConnection (ChangeConnection)	Not supported
SetLanguage (SetLanguage)	---
SetWebAccess (---)	Not supported
StartProgram (StartProgram)	Not supported
ShowSoftwareVersion (ShowSoftwareVersion)	---
SimulateTag (---)	Not supported
StopRuntime (StopRuntime)	entered in Audit Trail
ControlWebServer (ControlWebServer)	Not supported
ControlSmartServer (ControlSmartServer)	Not supported
OpenInternetExplorer (OpenInternetExplorer)	---
SendEMail (SendEMail)	---
UpdateTag (---)	---
ClearAlarmBufferProTool (ClearAlarmBufferProtoolLegacy)	Not supported
Encoding(Encode)	entered in Audit Trail when tag is GMP-relevant Signature is mandatory, depending on the tag configuration
EncodeEx(Encode)	entered in Audit Trail when tag is GMP-relevant Signature is mandatory, depending on the tag configuration

### 10.16.1.5 Performance features of GMP relevant configuration

#### Supported HMI devices

#### Supported HMI devices

The qualification "GMP relevant configuration" can be configured for the following HMI devices:

- TP 277
- OP 277
- MP 277
- Mobile Panels 277
- MP 377
- Comfort Panels
- Panel PCs with WinCC RT Advanced
- WinCC RT Advanced

---

#### Note

The qualification "GMP" is not supported by WinCC RT Professional.

---

#### Restrictions

#### Restrictions

The following functions and configurations cannot be used simultaneously with the qualification "GMP relevant configuration":

- "Status/Force" object
- PN direct keys
- DP DirectKey
- Option /Sm@rtServer
- /Sinumerik option
- The functional scope of the HMI devices is only available to a restricted degree in some circumstances because of the limited storage space

- **Events of screen objects**  
You can set mandatory acknowledgement of important user actions in runtime, such as changing tag values. If you assign an event which has to be acknowledged to a screen object, you may not assign any other events to this graphic object.  
When the event of a screen object is assigned actions which open a user dialog (such as change of a tag value with mandatory acknowledgement), you may not be able to execute these actions at other events.
- **Controlling GMP-relevant tags using a slider**  
The slider is not suitable for controlling GMP-relevant tags. Any operation of the slider will continuously change the tag value. If this is a GMP-relevant tag, a flood of entries will be generated in the AuditTrail.

## 10.16.2 Sm@rt Options

### 10.16.2.1 Basics

#### Sm@rt Options

##### Introduction

Using the Sm@rt Options from WinCC, you can communicate between HMI-systems or to an HMI-System by means of TCP/IP-connections (e.g.LAN).

##### Use of the Sm@rt Options

- Distributed operator stations with Sm@rtClients for controlling large machines or machines that are spread out over a large area.
- Operator stations with system-wide access to current process data via the communication driver "SIMATIC HTTP Protocol".
- Local servicing solution for the central archiving, analysis and additional processing of process data.
- Provision of current process data for higher-level systems (SCADA, production management systems, office applications).
- Remote control of an HMI-System by means of Internet, Intranet and LAN.
- Sending of E-Mails on the basis of messages and events
- Provisioning of Standard-HTML-Pages in HMI-system with service-and maintenance information as well as diagnostic functions.

User benefits:

- Flexible solution for access to HMI systems and process data from any location
- Reduction of load on the field bus:  
For example, the combination of WinCC Runtime and SIMATIC panels enables a factory control system to have access to process data. No load is placed by the factory level on the sensitive field level with respect to the necessary communication requirements. These requirements are handled by HMI Runtime along with the SIMATIC-panels.
- Expensive on-site service visits to be avoided by using the remote control. Unplanned non-operation periods are reduced and the system productivity is increased.

**Note**

The default password for the Sm@rtServer and for the integrated web server is "100". This password should be changed for security reasons.

**Application scenarios**

**E-Mailing and remote diagnostics**

A factory has a service contract with an external service company. The HMI device and the service technician's PC are linked together over a TCP/IP-ready network. E-mail delivery of certain alarms to the service technician was configured in the project. The service technician accesses the HMI device via the Internet and executes remote diagnostics.

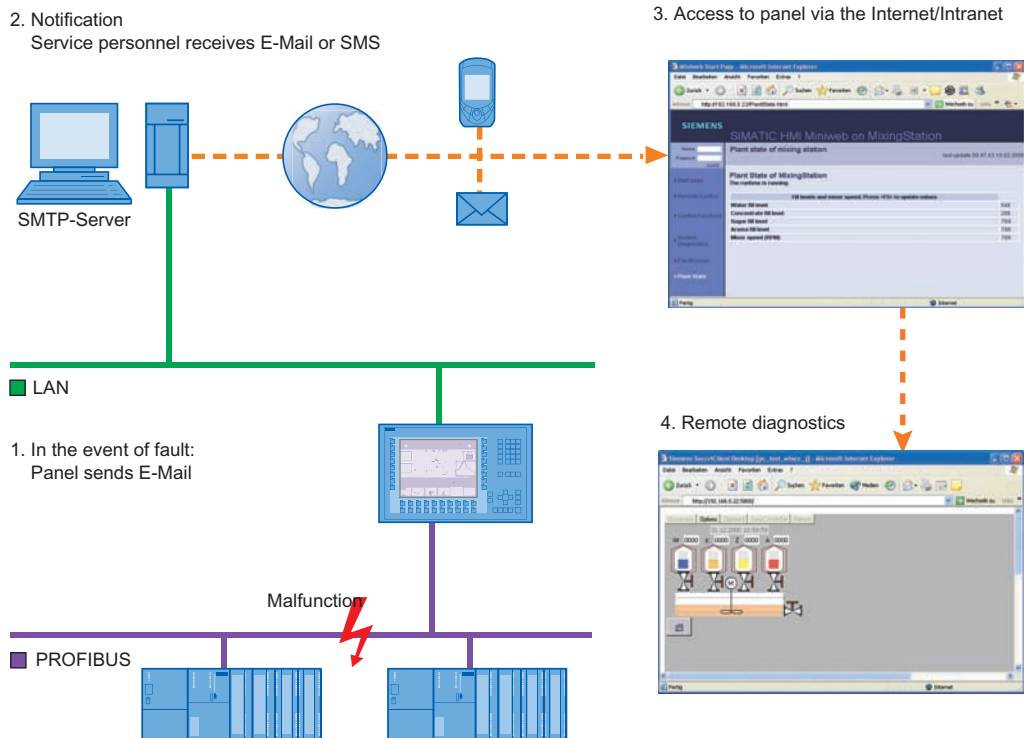

**Application example:**

Amongst other things, flow rates are measured in the process control of a cooling unit. Contamination in a feed line reduces the flow of coolant. When the flow rate drops below the configured threshold value, the operating device displays a warning. In addition, this warning is also dispatched as an e-mail to the assigned service technician.

The service technician then establishes a connection with the remote device and takes the appropriate actions.

Advantage: An alarm that reaches the service technician in a timely manner helps to minimize unplanned downtime.

**Distributed operator stations**

Distributed operator systems, the Sm@rtClients are used for controlling large machines or machines that are spread out over a large area.

The Client-HMI device connects to Sm@rtServer via the Sm@rtClient-Display.

The operator can operate and monitor the system from various locations. The operator sees the same image at each operator station, whereby only one station can be operated at one point of time.

The type of operation is also named as a coordinated operation. Then you must change the configuration only at Sm@rtServer.

**Access to the tags via SIMATIC HMI HTTP Protocol****Operator stations with system-wide access**

For use of the SIMATIC HMI HTTP Protocol, you can provide tags of HMI-device (HTTP-Server) to another device (HTTP-Client).

Thus the local as well as centrally used HMI-systems have access to the tags of other stations. Cell-concepts or line-concepts can be simply implemented. De-centrally obtained information is available centrally.

This concept also permits the setting of cost-effective and small central servicing. There are additional options for archiving, analysis and additional processing of registered process data, if a PC is used for that.

**Remote monitoring and remote control- servicing solution**

If you connect the use of the SIMATIC HMI HTTP Protocol and the Sm@rtServer with each other, you can implement a complex servicing solution.

For this, display the interested tags of the HMI-devices on the Service-PC. If necessary, use the PC for the remote monitoring and remote control of a specific HMI-device.

The locally used HMI-devices are connected with each other and the total process is controlled comprehensively.

The concept of the remote servicing is possible by using the Sm@rtClient-Display in the servicing HMI-Application. The operator has access to the respectively desired local HMI-device through flexible configuration of the Sm@rtClient-Display.

### Connection to the Office-world

The possibility of data exchange exists between HMI-device and office-applications, e.g. MS Excel, with help of VBA-Macro.

For this, the HMI-device must support the Web-Service(SOAP). A script or macro is called in the external application, which has only read or write access to the concerned tags according to provided syntax.

### HMI devices suitable for use

#### HMI devices suitable for use

The following table shows the HMI-devices that are suitable for the use of Sm@rt Options.

The number of the connections based on "SIMATIC HMI HTTP Protocol" and the number of maximum connected Sm@rtClients depends on the HMI-device. For additional information see the "Performance features" documentation and in the technical manual of your HMI-device.

Technical data subject to change.

HMI device	Sm@rt Options
270 series	Yes
370 series	Yes
OP 177B, TP 177B	Yes
Mobile Panel 177 PN, Mobile Panel 277	Yes
In view mode only: <ul style="list-style-type: none"> <li>• Mobile Panel 277 IWLAN</li> <li>• Mobile Panel 277 IWLAN V2</li> <li>• Mobile Panel 277F IWLAN (RFID Tag)</li> </ul>	Yes
Comfort Panels	Yes
WinCC Runtime Advanced	Yes

### Combining options on panels

The following table shows which options and functions on the panels can be combined with each other.

Technical data subject to change.



	SIMATIC HMI HTTP Protocol	Sm@rt Options	HTML browser	WinAC/ MP
SIMATIC HMI HTTP Protocol	--	Yes	Yes	Yes
Sm@rtServer	Yes	--	No	No
HTML browser	Yes	No	--	No
WinAC/ MP	Yes	No	No	--

## Settings for Sm@rt Options

### Configuration in WinCC

#### Introduction

In the "Runtime-Settings" Editor, configure the requirements for using the Sm@rt Options.

As an alternative, configure the settings in the Control Panel of the HMI-device.

Note that the settings on the control unit have a higher priority than the settings in the WinCC-project.

## Open

Double-click on the "Runtime-settings" entry in the project tree. In the "Runtime-settings" editor, click on the "Services".

**Services**

**Remote control**

Start Sm@rtServer

**Read/write tags**

Operate as OPC server

HTTP channel server

Web service SOAP

**Diagnostics**

HTML pages

**SMTP Communication**

Server name:

Name of sender:

E-mail address:

Login:

Password:

Secure connection required (SSL)

## Work area

Enter the settings for the selected HMI device in the work area:

- "Remote control" Group.
  - Sm@rtServer  
Configures the HMI-device as Sm@rtServer.
- "Read/write tags" Group.
  - SIMATIC HMI HTTP Server  
Configures the HMI device as HTTP-Server.
  - Web-service SOAP  
Activates the tags-access via SOAP.

- "Diagnostics" Group
  - HTML pages  
Activates Service-pages of the HMI device.
- "SMTP-Communication" Group
  - Server name  
Enter the name of SMTP server, through which you want to send E-mails.
  - Name of the sender  
Enter the sender name. The recipient sees in the E-Mail from which device the E-mail originates, e.g. "HMI device Production line 2". If the function is not supported by the SMTP-Server, delete the entry. You can obtain more detailed information for this from your service provider.
  - E-mail address  
If you use an SMTP server that requires a valid e-mail address for authentication, enter it here, for example, "John.Doe@gmx.net."
  - User name  
If you use an SMTP server that requires a user name for authentication, enter it here. You can obtain the user name from your service provider.
  - Password  
If you are using an SMTP server that requires a password for authentication, enter this password. You can obtain the user name from your service provider.
  - The server requires a secure connection (SSL).  
The data are sent via an SSL connection. Your service provider can tell you if your mail server supports an SSL connection.

## Configurations on the HMI device

### Settings on the HMI device

#### Introduction

The Sm@rt Options settings in the HMI device are configured in the dialog box "WinCC Runtime Advanced Internet".

Additional tabs may be included in the dialog "WinCC Runtime Advanced Internet". This depends on which options are activated for the network operation in the project.

Note that the settings on the control unit have a higher priority than the settings in the WinCC-project.

#### Tabs

You have opened the dialog "WinCC Runtime Advanced Internet" with the symbol "WinCC Runtime Advanced Internet" .

The "WinCC Runtime Advanced Internet" dialog of the control panel can contain the following tabs:

- WinCC Runtime Advanced Internet, "Email" tab (Page 5806)
- WinCC Runtime Advanced Internet, "Proxy" tab (Page 5807)
- WinCC Runtime Advanced Internet, "Web Server" tab (Page 5808)
- WinCC Runtime Advanced Internet, "Remote" tab (Page 5809)

## Input area plan

At Sm@rtServer and Sm@rtClient, the same input area plan must be set.

The Sm@rtServer uses the Standard-Input area plan of the operating system: (Start>Settings>Control Panel> Country settings>Tab "Entry"). These changes become effective after system restart.

At Sm@rtClient, the same input area plan must be set like at Sm@rtServer. No restart is necessary after the switchover of input area plan at Sm@rtClient.

## WinCC Runtime Advanced Internet, "Email" tab

### Purpose of the dialog box

Specifies the settings for the E-Mailing.

### Settings

- SMTP server
  - Enter the SMTP-server name.
  - Use the default of project file  
The SMTP-Server name from the WinCC-Project is used.
- Name
  - Name of sender  
Enter the sender name. The receipt sees in the E-Mail, from which device the E-mail originates, e.g. "HMI-device Production line 2".  
If the function is not supported by the SMTP-Server, delete the entry. You can obtain more detailed information for this from your service provider.
  - eMail Adress of sender  
If you use an SMTP server that requires a valid e-mail address for authentication, enter it here, for example, "John.Doe@gmx.net."

### Dialog "Advanced Email Settings"

- Authentication
  - Use the default of project file  
The user name and the password from the WinCc-Project are used.
  - Disable authentication  
Authentication is not required.
  - Use panel settings for authentication  
The settings of the HMI-device are used. Enter the user name under "Login" and the password under "Password". You can obtain the user name and the password from your service provider.
- Encryption
  - Use the default of project file  
The setting from the WinCC-Project is used.
  - Enable SSL  
The user information and e-mail are encrypted for transmission.
  - Disable SSL  
The user data and e-mail are sent un-encrypted.

### See also

Settings on the HMI device (Page 5803)

### WinCC Runtime Advanced Internet, "Proxy" tab

#### Purpose of the dialog box

Settings for utilizing the Proxy-Server.

---

#### Note

Enter the Proxy-Server in "Internet Options" at PC.

---

### Settings

- Use proxy server  
Activate the "Use Proxy Server" if access is given in your network via Proxy-server.
- Proxy  
Enter the name or the address of the proxy-server.
- Port  
Enter the port of the proxy-server.

## WinCC Runtime Advanced Internet, "Web Server" tab

### Purpose of the dialog box

The following is configured:

- The utilization of the integrated web server and of the HTTP-Server
- User and user web authorizations

### Settings

#### Tag access

Governs the access to tags via the "SIMATIC HMI HTTP protocol":

- "Read/write": Read/write access
- "Read only": read access only

#### Tag authenticate

Governs the authentication in case of access to variables via the SIMATIC HMI HTTP Protocol":

- "No authentication": No authentication is required for access.
- "Authentication required": An authentication is required for access.  
Specify the user name and password when configuring the communication driver "SIMATIC HMI HTTP Protocol".

#### Enable Remote-Transfer for Projects

This setting enables remote transfer of project files.

#### Start automatically after booting

(on panel only)

The web server is automatically started after the HMI device boots. As a result, the web server is utilized independent of the runtime.

---

#### Note

##### Start web server automatically on PC

Add a link with the program "Miniweb.exe" in the Autostart-Organizer in order to start the web server automatically after the PC starts. The program is located in the installation index of runtime.

---

#### Close with Runtime

The web server is closed along with Runtime.

#### User Administration

After entering the password "100", the "UserDatabase-Edit". dialog opens. The "UserDatabase-Edit" dialog is the user administration of the web server.

#### Start Webserver

Starts the web server.

**Close Webserver**

Ends the web server.

**WinCC Runtime Advanced Internet, "Remote" tab**

**Purpose of the dialog box**

Settings for the Sm@rtServer

**Settings**

**Start automatically after booting**

The Sm@rtServer is automatically started after the HMI device boots. Otherwise the Sm@rtServer starts together with the Runtime.

**Close with runtime**

The Sm@rtServer is closed together with Runtime.

**Change settings**

Opens the "Sm@rtServer: Current User Properties" dialog for specifying the passwords, authorizations, the screen update mechanism and the behavior when connections are disconnected.

---

**Note**

This dialog is titled "Sm@rtServer: Default Local System Properties" on the panel.

---

The dialog contains the following tabs:

- "Server" tab (Page 5810)
- "Polling" tab (Page 5811)
- "Display" tab (Page 5812)
- "Query" tab (Page 5813)
- "Administration" tab (Page 5813)

**Start Remoting**

Starts the Sm@rt Server explicitly.

**Stop Remoting**

Ends the Sm@rt Server explicitly.

## "Sm@rtServer Dialog: Current User Properties"

### "Server" tab

#### Purpose of the dialog

Specifying passwords, web authorizations and the disconnection.

#### Incoming connections

Settings for handling an attempt to establish a connection.

- **Accept socket connections**  
This setting enables the connection to the HMI device. It is a basic requirement for using the Sm@rtServers from the outside.  
If this check box is deactivated, no remote monitoring and no remote control is possible.
- **Password 1**  
First password for remote access. "View only" is disabled as default.
- **Password 2**  
Second password for remote access. "View only" is selected by default.  
This password can be provided as a reserve password for third-party users (such as service technicians); it can be modified when necessary without significant effort within the organization.
- **View only**  
If this check box is enabled, read access (monitoring mode) is the only access available when the corresponding password is entered.  
Default: Enabled

---

#### Note

Both key words are preset with "100". Change this password during commissioning according to your requirements.

---

#### Enable network packets queuing (slower)

This setting enables splitting of data into multiple data packets, which are sent separately over the network. It is useful when multiple clients are connected.

#### Display or port numbers to use

Here, you select the TCP/IP port in the network where the Sm@rtServer waits for attempts to establish a connection.

- **"Auto"**: The Sm@rtServer automatically searches for the appropriate port by itself.
- **"Display"**: The server uses port 5900 plus display number. For HTTP, the server utilizes Port 5800 plus display number.
- **"Ports"**: You enter the port numbers for the "main" and "HTTP" yourself.



### No local input during client session

The keyboard and mouse on the server-HMI device are disabled as long as connections are active.

For example, this setting is useful when an HMI device is being administered from outside.

### Remove desktop wallpaper (on PC only)

This setting removes the screen background on the PC, thus saving transmission effort.

Default: Enabled

### When last client disconnects (on PC only)

This setting governs the behavior after disconnection of the last client connection:

- "Do nothing": no response.
- "Lock workstation": Server PC is locked.
- "Logoff workstation": Server PC is logged off.

The latter two settings are only useful if the Sm@rtServer is running as a service.

### "Polling" tab

#### Purpose of the dialog

Specifying the screen update and the use of virtual graphics driver.

#### Polling modes(on PC only)

The settings govern the screen update.

Most changes are recognized automatically by the server. In case of problems, you can enter additional settings here.

The update method cannot be set on the panel. The settings is always "Poll Full Screen".

- Poll foreground window (On PC only)  
Updates the current window.  
It increases the load on the server.
- Poll window under cursor (On PC only)  
Updates the window that is located under the mouse cursor. The window is updated when a change occurs in the operator control element under the mouse cursor.  
Default: Enabled
- Poll full screen (On PC only)  
This setting specifies an update each time the screen changes. This setting provides you the lowest display error but places a maximum load on the server.
- Polling cycle  
Determine the suitable setting for your configuration. Make sure that the selected update cycle is not too short, since it affects the computer load.

### Window polling

- Poll console windows Only (On PC only)  
This setting specifies an additional update when changes occur in a console window (MS input requirement).
- Poll on event received only (Only on the PC)  
This setting specifies an additional update each time an entry is made.  
Default: Enabled
- Mirror driver status  
(Only on the PC with a mirror driver installed)  
Provides information about the status of the virtual graphics driver.

### Mirror driver options (only on a PC with installed mirror driver)

Enable direct access to display driver's mirror screen

The shared-memory area of the virtual graphics driver is used for the display. The setting improves the performance.

### Troubleshooting (on PC only)

- Don't use VNCHooks.DLL while polling full screen  
VNCHooks.dll is used by default for the screen update. If VNCHooks.dll causes problems when using other program, select this setting.
- Don't use mirror display driver even if available  
(Only on the PC with a mirror driver installed)  
Use this setting only for troubleshooting.

### "Display" tab

#### Purpose of the dialog

Setting of the screen display.

#### Sharing area(on PC only)

- Full desktop  
The entire desktop of the server is accessed.
- Primary display  
The main screen of the multi-monitor configuration is displayed.

#### Downscale to(on PC only)

Scales the screen to be transferred according your inputs. Servers with Windows CE ignore this setting.

## "Query" tab

### Purpose of the dialog

Settings for incoming connection attempts.

---

#### Note

This dialog is titled "Default Local System Advanced" on the panel.

---

### Query settings

These settings govern acceptance of incoming attempts to establish a connection.

- Query console on incoming connections  
The Sm@rtServer registers the incoming attempts to establish a connection and displays a dialog on the screen in which the connection attempt is accepted or rejected.
- Query timeout  
Set the waiting time.
- Default action  
Select the response to an attempt to establish a connection once the waiting time expires:
  - "Refuse": Reject attempt (operator control mode - single mode)
  - "Accept": Accept attempt (operator control mode – shared mode)

### Allow option to accept without authentication

The dialog for handling attempts to establish connections also contains the button "Accept without password" . This gives you the option to accept an attempt to establish connection without a password.

## "Administration" tab

### Purpose of the dialog

Specifications for session management.

---

#### Note

This dialog is titled "Default Local System Advanced" on the panel.

---

## Administration

- **Disable empty passwords**  
Select this check box in order to allow an empty "Password 1".  
Default: Enabled
- **Allow loopback connections**  
This setting allows connections to your own HMI device. It is useful and necessary when security software is used for secure (encoded) connections.
- **Allow only loopback**  
This setting allows only connections to your own HMI device.

## Logging

- **Log info to SmartServer.log**  
(On the panel: Log information to file)  
This setting writes information to the server logbook.
- **Log detailed debugging information**  
This setting writes expanded information to the server logbook (for locating errors).

With HMI devices operating with Windows CE, the log is only created when the MMC card is inserted. If the MMC card is inserted, the log is created directly on the card.

The log files are created in the following path on a PC: C:\Documents and Settings\All Users\Application Data\Siemens\HmiRTm

### Forced write access

This setting governs forced access in an emergency contrary to normal session management.

- Password needed  
If this check box is not selected, every operator can force access in emergencies as follows:
  - Pressing the <Shift> key four times
  - Clicking four times
  - Touching the screen four times

If this check box is enabled, to force access an attempt must be made to gain access and a password must also be entered.

In this case, enter the applicable password in the input field underneath. If a password is not entered, it is not possible to force access in an emergency.

Default: Enabled

---

#### Note

On the server, access can only be forced by pressing the <Shift> key four times, clicking four times, or touching the screen four times.

---

### HTTP-Server

- Enable built-in HTTP server  
If this check box is activated, the Java-Applet is automatically downloaded on the PC when the connection is first established.  
The Java applet accesses the Java VM that is installed on the client and enables remote monitoring and remote control using Internet Explorer.  
Default: Enabled
- Enable applet params in URLs  
Forwards all parameters of the URL to the Sm@rtClient application.

### Connection priority

These settings govern handling of attempts to establish a connection by non-shared clients.

- Disconnect existing connections  
When an attempt is made to establish a connection by a non-shared client, the attempt is accepted; the existing connections are disconnected (single mode).
- Automatic shared sessions  
When an attempt is made to establish a connection by a non-shared client, the attempt is accepted; the prior existing connections are retained. Access is controlled using session management in shared mode.  
Default: Enabled

## 10.16 Options

- **Active user timeout**  
For shared mode, enter the time that must elapse without any actions on the active HMI device before access can be changed.  
Default setting: 10 seconds
- **Refuse concurrent connections**  
If a non-shared client is already connected to the server, attempts to establish a connection by other non-shared clients are rejected.

### See also

Remote control by means of Internet Explorer (Page 5830)

## User administration for web server

### Introduction

Different web authorizations for the operation and monitoring are allocated to the users in the user administration.

### Requirement

- The "WinCC Runtime Advanced Internet" dialog is open.
- The "Web Server" tab is displayed.

### Entries and settings

Click "User Administration" in the "Web Server" tab and enter the password.

---

#### Note

By default, the password is set to "100" and all web authorizations are granted to users with "Administrator" rights. Change this password during commissioning according to your requirements.

---

The "UserDatabase-Edit" dialog is opened.

The "UserDatabase-Edit" dialog has three tabs:

- **Tab "User Manager"**  
User administration for creation or deletion of users.  
Create a new user using "New"; Delete a user using "Remove". The recreation and deletion become effective using "Apply".
- **Tab "Description"**  
You can store a description of or comments on the users selected on the "User Manager" tab.
- **Tab "Authorizations"**  
Specify the web authorizations for the users selected on the "User Manager" tab. You use "Add" to activate a web authorization and "Remove" to deactivate one.  
By default, the password is initially preset to "100" and all web authorizations are granted to users with "Administrator" rights.  
For read and write access to the file browser, the user must possess the web authorizations "FileBrowserAdministrator" and "FileBrowserUser".

---

**Note**

In principle, every user who has access to the control panel can manage users and web authorizations. If necessary, protect the control panel from unwanted access.

---

### List of web authorizations

The following web authorizations exist:

Web authorization	Authorized for:
UserData	Import and export of recipes
UserAdministrator	Import and export of password lists
RuntimeAccess	Starting and stopping of runtime
Engineering	HTTP transfer from ES to the target device
FileBrowserUser	Read access to the file browser
FileBrowserAdministrator	Read/write access to the file browser
RTCommunication	Utilization of the SIMATIC HMI HTTP server
SoapUser	Read/write access via web service (SOAP)

## Settings for remote control

### Session management for remote control

#### Introduction

WinCC enables remote monitoring and remote control of HMI devices over a TCP/IP-ready network such as a LAN or the Internet. Remote monitoring and remote control is implemented in different ways:

- Remote control by means of Internet Explorer
- Remote control by means of the Sm@rtClient-application
- Remote control by means of the Sm@rtClient-display in

Only one device can ever have access to the HMI-device. Which device is permitted access is determined by the session management.

#### Session management options

Session management is used to control access. The client-server connection can be in one of two modes:

- Monitoring mode
- Control mode

#### Monitoring mode

If the client accesses the server in monitoring mode, the operator can see the current screen of the HMI device and track all changes. He can monitor the server but cannot operate.

In the monitoring mode, all the keys on the client retain their standard functions.

If remote control was started from the Sm@rtClient display, the operator uses the <Tab> key or the cursor keys to go to the next object in the current screen of the client project.

#### Control mode

If the client accesses the server in operator control mode, the operator can use the mouse and the keyboard to control the server from the client. If an access attempt is made from another client, the assignment of operating permission depends on the settings at the server and at the clients.

In operator control mode, the client keys act on the server screen. Thus, the operator uses the <Tab> key to go to the next object in the current screen of the project running on the server.

If remote control was started from the Sm@rtClient display, the operator can only go to another object or screen in the project on the client by using an additionally configured function or an additional menu command. The operator to this menu command as follows:



- On the Touch-device, in which he touches the screen longer than 1 sec.
- On the keyboard =device, in which he masks on the menu with <Shift+Control> and operates it with <Alt> and the keyboard.

In both operating modes, the Sm@rtServer is set so that the operator at the remotely controlled device, the server, can be prevented from performing any activities.

In an emergency, the operator can exact the user rights on a remotely controlled HMI device as well as on an inactive HMI device. If no password is specified, he must click the user interface four times consecutively, touch the screen four times consecutively, or press the <Shift> key four times consecutively. If a password is specified, he must click once or press a key on the client and then enter the specified password.

## Settings for session management

You make settings for session management on the server and on the client in the Control Panel "WinCC Internet Settings".

## Configuring Sm@rtServer for remote control

### Introduction

The Sm@rtServer has an internal security concept based on passwords and special settings for session management.

### Security concept for the Sm@rtServer

Remote monitoring and remote control of the Sm@rtServer at the Sm@rtClient is protected by two passwords. The second password is used as a further password for additional access, for example, as a service password. Both key words are preset with "100". The key word can be easily changed, if required.

### Settings on the Sm@rtServer

The settings on the server govern which remote operators can access the runtime of the server.

The passwords for access are set on the server. Open "WinCC Runtime Advanced Internet" in the control panel. On the "Remote" tab, click "Change Settings". On the following Server tab of the subsequent dialog, enter the passwords of the Sm@rtClient. For both passwords, you can use "View only" to set the monitoring mode and to exclude operator control mode.

On the panel, this dialog is called "Sm@rtServer: Default Local System Properties" and contains fewer dialog elements than the dialog on the PC.

### Control mode

To enable operator control mode, the "View only" check box must be cleared.

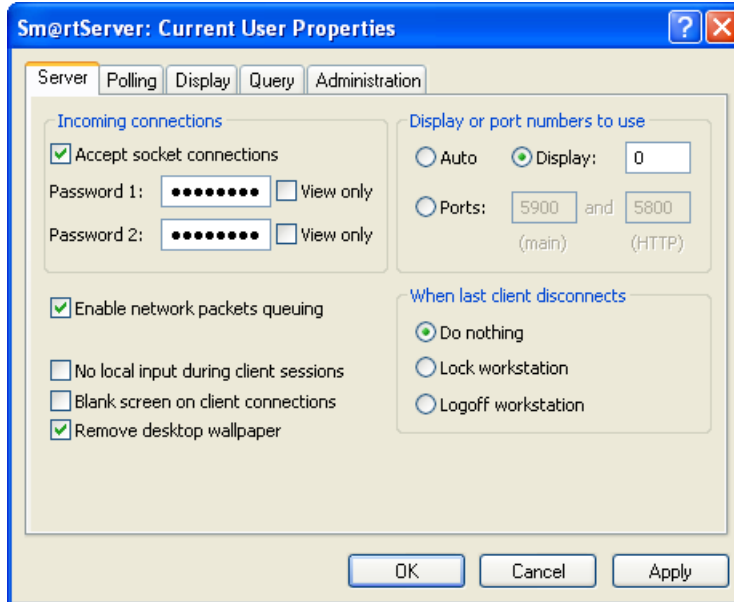

The manner in which the individual remote control station can access the server is set on the "Administration" tab.

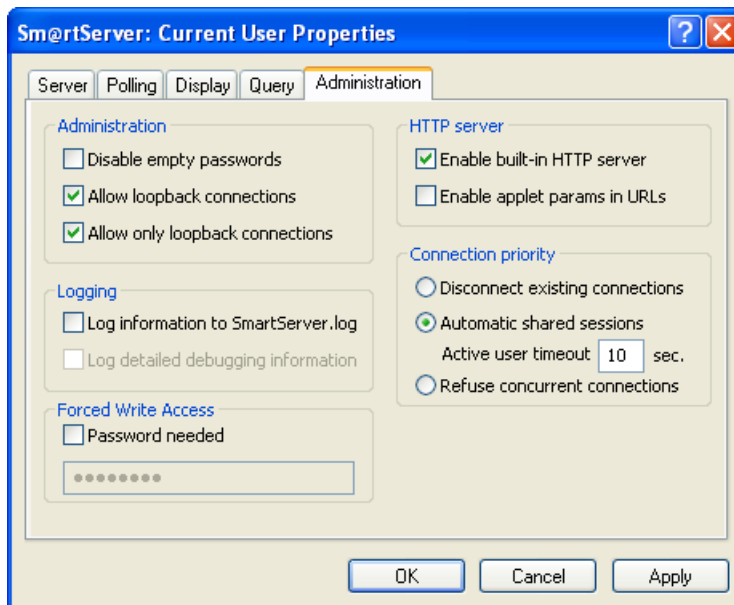

- "Disconnect existing connections"  
When an access attempt is made by a non-shared client, the previous connection is automatically disconnected and control is transferred to the new client.  
When an attempt is made to access by a shared client, the behavior is the same as described for "Automatic shared sessions".
- "Automatic shared sessions"  
When an access attempt is made, control is transferred to the new client.  
The condition for transferring control is that no action has been undertaken by the previously active client for a period of time (in seconds) as specified in the "Active user timeout" setting.
- "Refuse concurrent connections"  
When an attempt is made to access by a non-shared client, this access attempt is rejected so long as the operator station that currently has access is still connected to the server.  
When an attempt is made to access by a shared client, the behavior is the same as described for "Automatic shared sessions".

### Disabling local operator control of the server

To do so, open the "WinCC Internet Settings" in the Control Panel. On the "Remote" tab, click "Change Settings". On the "Server" tab in the subsequent dialog, select "No local input during client session".

### Password for forced access

A password can be specified in "Forced Write Access" for forced access in an emergency.

### Sm@rtServer as a service

You can let the Sm@rtServer run as a service. The operator can then also access the service-HMI device from the client-HMI device, for example, the screen saver is active with a password.

Select the check box "Start automatically after booting" in "WinCC Runtime Advanced Internet" on the "Remote" tab.

### Sm@rtServer as service in Windows 7

The Sm@rtServer always runs as a service under Windows 7. You cannot stop the Sm@rtServer in Runtime with the Notification Area in the taskbar. You have the following options for stopping the Sm@rtServer:

### 10.16 Options

- Stop using the "ControlSmartServer" system function  
Configure the "ControlSmartServer" system function to a button, for example. Select the "Stop" mode at the system function. You can stop the Sm@rtServer in Runtime by clicking the button.
- Stopping the Sm@rtServer in the Control Panel:  
Open "WinCC Runtime Advanced Internet" in the control panel and select the "Remote" tab. Click on the "Stop" button. Sm@rtServer is stopped.
- Stopping Sm@rtServer by stopping Runtime:  
Open "WinCC Runtime Advanced Internet" in the control panel and select the "Remote" tab. Activate the "Close with Runtime" option. The Sm@rtServer is stopped at the stop of Runtime.

## Configure Sm@rtClient for remote control

### Settings on the client PC

- Monitoring mode  
At the client-PC you limit the connection to observation mode, if required. This allows you to prevent unintended control operations.
  - If connection is via the Sm@rtClient application  
In the following "Sm@rtClient Connection" of Sm@rtClient-application, click "Options..." button. In the "Sm@rtclient Options" dialog, select the setting "View only (inputs ignored)".
  - If connection is via Internet Explorer  
Click on the button "Options..." and select "View only" in the subsequent dialog.
- Layout  
You can also specify whether or not the HMI-device is to be displayed with the same layout in the Sm@rtClient application. This is useful if you access from a PC on a touch device. In order to suppress the layout, select the "Sm@rtclient Options" setting in the "Suppress Device Layout" dialog.  
In addition, you can use "Scale by" to zoom in or out of the layout. To use "Scale by", the Suppress Device Layout setting must be selected or the HMI-device must not supply any layout. Otherwise, the desktop is always displayed with a zoom setting of 100%.

---

#### Note

If you scale the display, the performance may be impaired in some situations:

- Strong scaling, for example from 1600 x 1200 px to 640 x 480 px.
  - Scaling with non-matching scaling factors, for example from a 4:3 resolution to 16:10 resolution.
- 

## Configuring of the Sm@rtClient-display

You can configure the Sm@rtClient display in different ways, and thereby set certain inputs: The server name, the password for accessing Sm@rtServer or the restriction to the monitoring mode.

## Sm@rtClient-Application

### Dialog "New Sm@rtServer: Connection"

#### Introduction

This dialog opens when you click the "Sm@rtClient" button in the taskbar.

#### Purpose of the dialog box

This dialog is used for selecting the server and the connection method.

##### **Sm@rtServer:**

Enter the address of the server to which the connection is to be established. The various options for entering the address can be found in "Remote control by means of the Sm@rtClient application (Page 5830)".

##### **Connection profil**

Select the type of connection to the server according to the network you are using.

##### **Listening mode**

If you enable this function, the Sm@rtClient application is minimized and appears as a button in the Windows taskbar. The Sm@rtClient waits for the Sm@rtServer to establish a connection. To establish the connection, click the "Sm@rtServer" button in the Windows taskbar of the server. Select "Add new client" in the context menu.

##### **Options**

The "Sm@rtClient Options" dialog containing the technical settings for the Sm@rtClient-application is displayed.

#### See also

"Options" dialog, "Globals" tab (Page 5825)

"Options" dialog, "Connections" tab (Page 5823)

### "Options" dialog, "Connections" tab

#### Purpose of the dialog box

Technical settings for the Sm@rtClient-application are specified in this dialog box.

Only change the settings here in special cases.

---

##### **Note**

You can also specify these settings in the Java Applet. Note that some of the dialog elements are named differently there.

---

### Format and encodings

Settings for compressing (encoding) the screen data of the server.

- Use encoding  
Preassigned based on the selection under "Connection profile".  
Select the desired compression or "Raw" (no compression).
- User 8-bit color  
(Only in the Java-Applet): Reduces the color depth at the client to 8 bits (256 colors). The data are then transferred faster. However, incorrect colors may result.
- Custom Compression level  
Allows individual customizing of the compression level in the "Level" input field:  
1 = least compression (faster); 9 = maximum compression (slower).
- Allow JPEG compression  
Allows the use of JPEG compression (involves losses).  
Enter the "Screen quality" in the input field underneath:  
1 = least compression (faster); 9 = maximum compression (slower).
- Allow CopyRect encoding  
(In the Java-Applet: Use CopyRect. Encoding)  
Allows compression while using "similar rectangles".

### Restrictions

- Viewonly (inputs ignored)  
Sets the view mode for this client irrespective of the settings on the server.
- Disable clipboard transfer  
Disables the clipboard that is used to transfer data from one PC to another. Applies only to the copying and pasting of texts.  
This functionality is not available at a Windows CE server.

### Display

Settings for the screen display

- Scale by  
Zooms in or zooms out the desktop to be displayed. To use "Scale by", the Suppress Device Layout setting must be selected or the HMI-device must not supply any layout. Otherwise, the desktop is displayed with a zoom setting of 100%.
- Fullscreen Mode  
Displays the desktop to be shown in full-screen mode. If the server screen is larger than the screen of the client, it is scrolled automatically by the mouse movement.
- Suppress Device Layout  
In the Sm@rtClient application window, the entire layout of remote HMI-device is not shown.
- Use CTRL + Cursor Key for Scrolling  
The key combinations <CTRL> + cursor key are used to scroll within the local screen. They are no longer transferred to the server.

### Mouse

(In the Java-Applet: Mouse buttons 2 and 3)

Settings for the evaluation of mouse actions

- Emulate 3 Buttons (with 2-button click)  
Emulation of a three-button mouse by a two-button mouse.
- Swap mouse buttons 2 and 3  
(In the Java-Applet: reversed/normal)  
Mouse buttons 2 and 3 are swapped.

**Mouse cursor**

(In the Java-Applet: Cursor shape updates)

Settings for the display of the cursor

Select the type of transfer of the mouse actions:

- Track remote cursor locally  
The information on the location of the cursor is transferred separately from the screen information. This speeds up the transfer of the cursor. (JavaApplet: Enabled)
- Let remote server deal with mouse cursor  
Tracks the server cursor to the client cursor. This allows more accurate cursor positioning. (YES: Ignore)
- Don't show remote cursor  
The cursor at the server is not included in the transfer. (YES: Disable)

**Request shared session**

(In the Java-Applet: Share desktop)

Declares this client to be a non-exclusive client.

**See also**

Dialog "New Sm@rtServer: Connection" (Page 5821)

**"Options" dialog, "Globals" tab****Purpose of the dialog box**

Technical settings for the Sm@rtClient-application are carried out in this dialog box.

Only change the settings here in special cases.

---

**Note**

You can also carry out these settings in the Java Applet. Note that some of the dialog elements are named differently there.

---

**Interface options**

- Show toolbars by default  
Displays the toolbar.
- Warn at switching to the full-screen mode  
Outputs a message before the full-screen mode is activated.

10.16 Options

- **Enable Onscreen keyboard**  
Enables the display of the on-screen keyboard
- **Number of connection to remember**  
The client creates a list of the recently used connections. This setting specifies the number of connections listed.
- **Clear the list of saved connections**  
The list is cleared.

**Local cursor shape**

Specifies the appearance of the local cursor. This allows you to better differentiate between the local cursor and remote cursor.

**Listening mode**

- **Accept reverse VNC connections on TCP port**  
Specifies the TCP port number. The Sm@rtClient waits for the Sm@rtServer to establish the connection over this TCP port number.

**Logging**

- **Write log to a file**  
Writes information in the logbook of the Sm@rtClient-application.
- **Verbosity level**  
Writes expanded information to the server logbook of the Sm@rtClient-application (for locating faults). The amount of detail in the information is dependent on the verbosity level setting.

**Remote control of key devices**

**Mapping of the function keys**

HMI devices are equipped with a variety of function keys.

Example:

From the PC keyboard, you want to remotely control key F20 on the "MP 377 key" of HMI-device.

You can control the F20 key with the PC-keyboard shortcut <SHIFT + F8>.

The table provides you with an overview for controlling the keys.

xP177/277	xP377	PC keyboard shortcut
F13	F13	SHIFT + F1
F14	F14	SHIFT + F2
F15	F15	SHIFT + F3
F16	F16	SHIFT + F4
F17	F17	SHIFT + F5
F18	F18	SHIFT + F6
F19	F19	SHIFT + F7
F20	F20	SHIFT + F8



xP177/277	xP377	PC keyboard shortcut
K1	S1	SHIFT + F9
K2	S2	SHIFT + F10
K3	S3	SHIFT + F11
K4	S4	SHIFT + F12
K5	S5	CTRL + F1
K6	S6	CTRL + F2
K7	S7	CTRL + F3
K8	S8	CTRL + F4
K9	S9	CTRL + F5
K10	S10	CTRL + F6
K11	S11	CTRL + F7
K12	S12	CTRL + F8
K13	S13	CTRL + F9
K14	S14	CTRL + F10
K15	S15	CTRL + F11
K16	S16	CTRL + F12
HELP	HELP	ALT + H
ACK	ACK	ALT + F1

## Use and restrictions of Sm@rt Options

### Use restrictions

While using the Sm@rt Options, observe the following instructions:

- HMI devices suitable for use  
For additional information, refer to "Usable HMI devices".
- Sm@rtServer and Sm@rtClient
  - If a PC is used as a Sm@rtServer, select the highest-performance platform available.
  - Use only simple projects.
  - Avoid photographs and color gradients in screens.
  - Avoid heavy background loads during operation, for example, those from user-defined functions or logs.
  - The number of the maximum connected Sm@rt Clients depends on the Server-HMI device. For additional information, see the "Performance features" documentation.
  - To improve the performance of the Sm@rtServer, you can disable hardware acceleration of the graphics card .
  - You inevitably loose performance at the HMI when you access the HMI-device using the Sm@rtClient functionality.

### 10.16 Options

- SIMATIC HMI HTTP Protocol
  - Tag exchange via the SIMATIC HMI HTTP Protocol is not suitable for exchanging bulk data.
  - The maximum number of connections depends on the HMI device: For additional information, see the "Performance features" documentation
- Access protection

To protect access to an HMI-device using different passwords, you must use the first password for the protected, and the second password for the unprotected access e.g. remote control with a password, remote monitoring without password.
- Port

The web server connects to the network at the port 80. To run it without problems, make sure port 80 is not in use by any other application, such as IIS World Wide Web Publishing Service.
- Integrated HTML-pages
  - The size of the HTML pages must not exceed 100 Kb in case of Windows CE. In case of exceeding of the given value, these pages are spooled on external storage media.
  - If you display tags on HTML-pages using the entry type "Cyclic on use", it can lead to data-inconsistency.
- E-mailing

The E-mailing function is not suitable for the mass dispatch of E-Mails. It is meant for sending important messages.
- Timeout

If the connection between server and client is interrupted, the server will register this disconnection only with a certain delay. The delay is based on the Windows standard configuration of TCP/IP Timeout.

### Use-requirements in the company network

In order to implement the mentioned scenario, the accesses to the company network must be enabled. If the company network is protected by a Firewall, the system administrator must release the appropriate ports for that.

- Access to the integrated HTML-pages

The web server connects to the network at the port 80.
- Access to Sm@rtServer for downloading the Java-Applet using the Internet Explorer

The Sm@rtServer is connected to the network at the Port 5800 for downloading the Java-applet.
- Access to the Sm@rtServer using the Internet Explorer for remote monitoring and remote control

The Sm@rtServer is connected to the network at the port 5900.

---

#### Note

If you change the ports of the Sm@rtServer you must customize the links in the used Html-pages accordingly. Additional information to modify the Html-pages is provided in "Example: "Configure integrated webserver".

---

## 10.16.2.2 Remote control via Sm@rtServer

### Types of the remote control

#### Remote control and remote monitoring by means of Sm@rtServer

##### Introduction

The Sm@rtOptions of WinCC enable the access from HMI device or PC to a remote HMI device via Ethernet.

##### Requirement

- The License Key "Sm@rtServer" is available at the Server-HMI device.

---

**Note**

The 14-day license is not supported by Windows CE devices.

---

- Both devices are linked via a TCP/IP-ready network, that is via a LAN or the Internet.
- "Sm@rtServer" is activated in the WinCC-Project of the Server-HMI device for the "Services in Runtime".
- Additional requirements must be satisfied according to the type of implementation.

##### Implementing remote access

The Sm@rtServer supports remote monitoring or remote control on the remote device (server).

Remote monitoring or remote control can be implemented on the local device (client) in various ways:

- By means of Internet Explorer
- By means of the Sm@rtClient-application

##### Access via HTML pages

The Sm@rt Options enable access for remote control with Microsoft Internet Explorer and by means of integrated HTML pages of the server.

 **CAUTION****Ethernet communication**

In Ethernet-based communication, such as PROFINET IO, HTTP, Sm@rt Options and OPC, it is the end user who is responsible for the security of his data network. The proper functioning of the device cannot be guaranteed in all circumstances; targeted attacks, for example, can lead to an overloading of the device.

## Remote control by means of Internet Explorer

### Introduction

On the client HMI device, the connection to the remote HMI device is established by means of Internet Explorer.

The window of the Internet Explorer displays only the screen of the remote HMI device, of the server HMI device. If task switching is not disabled at the server HMI device, you can access the complete desktop.

### Requirement

- The Client-HMI device is a PC.
- Internet Explorer from V6.0 SP1 is installed.
- The Client-and Server-certificates are installed to ensure the data security when transferred via internet.
- The Java-Applet is installed. The Java applet accesses the Java runtime environment that is installed on the client.

---

#### Note

You achieve the best results in Internet Explorer by installing the current Java Runtime Environment (JRETM) of Sun Microsystems. Go to [www.java.com](http://www.java.com) to download this program.

---

### Process flow

Enter the address of the remote device in Internet Explorer. The address consists of the server name and the HTTP port number that is set on the server. The default setting is: 5800.

Examples of addressing: "http://MyPanel:5800" or "http://192.168.168.1:5800".

### Restrictions

The "Force write access with password" function cannot be implemented using the Java applet.

### See also

"Administration" tab (Page 5811)

## Remote control by means of the Sm@rtClient application

### Introduction

The Sm@rtClient application provides the connection to the remote HMI device on the remote HMI device.

## Requirement

- The Client-and Server-certificates are installed to ensure the data security when transferred via internet.
- The Client-HMI device is a PC.

## Process flow

The remote control via the Sm@rtClient-application works as follows:

- Start Sm@rtClient application
- Establish connection
- Password input
- Perform operator control or monitoring on the HMI device

## Start Sm@rtClient application

You can access the Sm@rtClient application, the program "SmartClient.exe", in various ways:

- By installing WinCC Runtime on the client device you have automatically installed the Sm@rtClient application.
- You have several options if WinCC Runtime is not installed on the client device:
  - Copy the Sm@rtClient application from the WinCC product-DVD from the folder "Support \SmartClient".
  - Copy the Sm@rtClient application from the "...Siemens\Automation\WinCC RT Advanced" folder of another PC using a floppy disk or the Intranet.

## Establish connection

In order to establish the connection to the remote HMI device, call the Sm@rtClient application and enter the IP address of the server.

- IP address or server name:port number
- IP address or server name:display number

Example: "192.168.0.1::5800"

You can also start the Sm@rtClient application with the command line input: "smartclient.exe 192.168.0.1". The logon dialog box opens.

You can include the password in the command line entry to start the Sm@rtClient application: "smartclient.exe 192.168.0.1 /password 100".

---

**Note**

If the Sm@rtServer at the server HMI device does not run as a service, the connection established with the Sm@rtClient application is interrupted automatically as soon as the keyboard shortcut CTRL+ALT+DEL is pressed at the server HMI device or the screen saver is activated. In order for the Sm@rtServer to run as a service, the "Start automatically after booting" check box in the "Remote" tab in the "WinCC Runtime Advanced Internet Settings" dialog must be activated.

---

## Password input

### Password input at the Sm@rtServer

Instead of the on-screen keyboard, the following message is displayed on the Sm@rtClient if you enter the password directly at the Sm@rtServer: "Remote access by Sm@rt Options is in Progress. Please wait until the input of values has been ended." This measure prevents keyboard input for entering the password from being displayed on the Sm@rtClient.

### Password input at the Sm@rtClient

The on-screen keyboard is hidden on the Sm@rtServer due to the actions carried out on the Sm@rtClient. Use the local on-screen keyboard for entries at the Sm@rtClient.

The local on-screen keyboard will be displayed automatically on the Sm@rtClient or in the Sm@rtClient view.

Close the on-screen keyboard manually. Select "Input > Hide Input Panel" to hide the local on-screen keyboard.

---

**Note**

The entries with full-screen keyboard are not protected on HMI devices with a screen size of  $\leq 6$ ".

Entries in Control Panel Applets which do not use the full-screen keyboard are protected.

---

**Note**

Hidden password input is not supported by the on-screen keyboards of third-party products.

---

**Note**

You cannot enter special characters with the keyboard shortcut Alt Gr.

---

## Perform operator control or monitoring on the HMI device

In the Sm@rtClient application window, the entire layout of the remote HMI device is shown. Depending on the configuration, you can specify monitoring only or operator control of all keys, including the function keys, with the mouse. In addition, the entire desktop can be accessed in the case of a PC.

For operator control via the keyboard, the following is available:

Keyboard shortcut	Function
<ALT+CTRL+SHIFT+O>	Opens the "Sm@rtClient Options" dialog
<ALT+CTRL+SHIFT+F>	Switches over to full screen mode
<ALT+CTRL+SHIFT+R>	Updates the display
<ALT+CTRL+SHIFT+N>	Opens the "New Sm@rtServer Connection" dialog
<ALT+CTRL+SHIFT+S>	Save as
<ALT+CTRL+SHIFT+T>	Displays and hides the toolbar

## Remote control via the Sm@rtClient display during runtime

### Introduction

The Sm@rt options of WinCC enables access from the HMI device or PC to a remote HMI device via Ethernet.

### Requirement

- The License Key "Sm@rtServer" is available at the Server-HMI device.
- Both devices are linked via a TCP/IP-ready network, that is, via a LAN or the Internet.
- HMI-device is configured as Sm@rtServer. For detailed instructions on this, refer to "Configure Sm@rtServer (Page 5837)".
- The Sm@rtClient-Display in an image is added in the client-HMI device project. For detailed information on this, refer to "Project Sm@rtClient (Page 5839)".

### Implementing remote access

The Sm@rtServer supports remote monitoring or remote control on the remote device (server).

On the client HMI device, the connection to the Sm@rtServer is made during runtime by means of the Sm@rtClient display.

On the HMI device only the screen of the server, and not the soft keys, is displayed.

The form of the cursor is not a part of the screen and is therefore not transmitted. Only the coordinates of the cursor are transmitted.

---

**Note**

If a soft-key is activated on the client HMI device, then observe the following:

This signal is transferred to the Server-HMI device and becomes effective there, only if no function was configured at the soft-key.

Otherwise, the function projected on the client-HMI device is executed.

---

### Use of direct keys for remote access

You can only operate direct keys locally on the server. Although the key for the direct key can be operated on the Sm@rtClient, no bit is set in the I/O range of the PLC.

 **CAUTION**

**Ethernet communication**

In Ethernet-based communication, such as PROFINET IO, HTTP, Sm@rt Options and OPC, it is the end user who is responsible for the security of his data network. The proper functioning of the device cannot be guaranteed in all circumstances; targeted attacks, for example, can lead to an overloading of the device.

### Password input

#### Password input at the Sm@rtServer

Instead of the on-screen keyboard, the following message is displayed on the Sm@rtClient if you enter the password directly at the Sm@rtServer: "Remote access by Sm@rt Options is in Progress. Please wait until the input of values has been ended." This measure prevents keyboard input for entering the password from being displayed on the Sm@rtClient.

#### Password input at the Sm@rtClient

The on-screen keyboard is hidden on the Sm@rtServer due to the actions carried out on the Sm@rtClient. Use the local on-screen keyboard for entries at the Sm@rtClient. The local on-screen keyboard will be displayed automatically on the Sm@rtClient or in the Sm@rtClient view.



---

Close the local on-screen keyboard manually. Select "Input > Hide Input Panel" to hide the local on-screen keyboard.

---

**Note**

The entries with full-screen keyboard are not protected on HMI devices with a screen size of  $\leq 6"$ .

Entries in Control Panel Applets which do not use the full-screen keyboard are protected.

---

**Note**

Hidden password input is not supported by the on-screen keyboards of third-party products.

---

**Note**

You cannot enter special characters with the keyboard shortcut Alt Gr.

---

## Distributed operator stations

### Configuration

### Configuration

Multiple HMI devices are used as decentralized, coordinated operator stations that have access to a centralized HMI device connected to the PLC.

The HMI devices are linked via a TCP/IP-network, (LAN or Intranet /Internet).

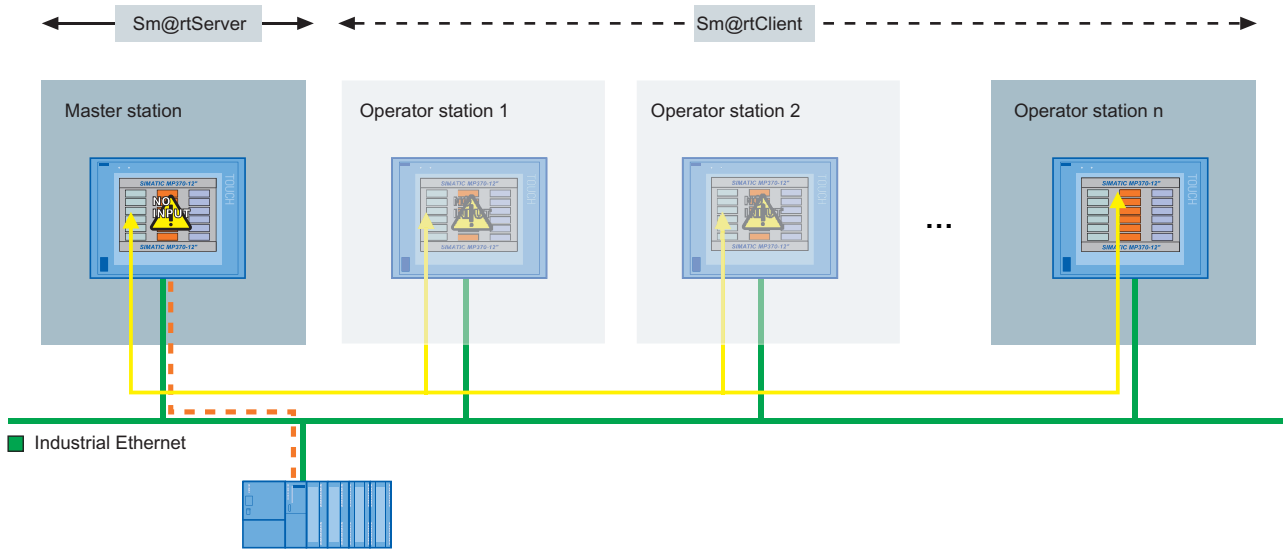

Figure 10-14 Distributed HMI

Only one HMI device, the Sm@rtServer contains the configuration data. The Sm@rtServer is controlled from the HMI devices.

The decentralized operator stations are the Sm@rtClients. These operator stations display the same process screen of the server. A Sm@rtClient-Display is configured in the process screen for the operation and monitoring.

All devices have the same screen resolution.

The operator stations are in shared mode. As soon as a defined period of time elapses without any action on an operator station, another operator station can become active. If Sm@rtClient display is configured accordingly, the user can also log off directly.

## Advantages

- Operator control and monitoring can be performed from various locations without significant efforts.  
The project only has to run on one HMI device configured as a server. The same client project runs on all other HMI devices; the Sm@rtClient display object is contained in a screen on these devices. The screen of the server is displayed via the Sm@rtClient display.
- The server is situated remotely from the machine and is thus not exposed to the environmental conditions of the machinery room.
- Coordinated operation is provided by the Sm@rtServer. Additional PLC investments are not required. For example, the load on the field bus is also reduced – the communication load on the bus is removed due to the interlocking mechanisms on the PLC side.

## Configure distributed operator stations

### Introduction

Operator control of an extensive printing machine need to have the option to exercise control, when necessary, at multiple locations along the machinery. Depending on his current location, the operator must be able to access the process from an operator station in the vicinity.

### Requirement

- The HMI-device with the configuration data is connected with the control.
- The server-HMI device and the Client-HMI devices are networked with each other via TCP/IP-Network.
- The License Key "Sm@rtServer" is available.

### Configuration steps

The following basic steps are necessary for configuring the distributed operator stations:

Step	
1	Configuring Sm@rtServer (Page 5837)
2	Setting WinCC Runtime Advanced Internet (Page 5838)
3	Project Sm@rtClient (Page 5839)

## Configure Sm@rtServer

### Configuring Sm@rtServer

#### Requirement

- The WinCC-Project for the Server-HMI device is configured.

#### Procedure

Proceed as follows to configure the Sm@rtServer in WinCC:

1. Double-click on the "Runtime-settings" entry in the project tree.
2. In the "Runtime-settings" editor, click on the "Services".
3. Enable "Sm@rtServer" in the group "RemoteControl".
4. Transfer the compiled WinCC-project to the Server-HMI-device.

## Result

The Server-HMI device is configured as Sm@rtServer .

## Setting WinCC Runtime Advanced Internet

### Requirement

- The "Control Panel" opens.
- The "WinCC Runtime Advanced Internet" dialog is open.
- The "Remote" tab is displayed.

### Procedure

Proceed as follows to change the "WinCC Runtime Advanced Internet" settings on the Sm@rtServer:

1. On the "Remote" tab, select Start automatically after booting".
2. Click on the button "Change settings". The dialogue "Sm@rtServer: Current User Properties" is opened.

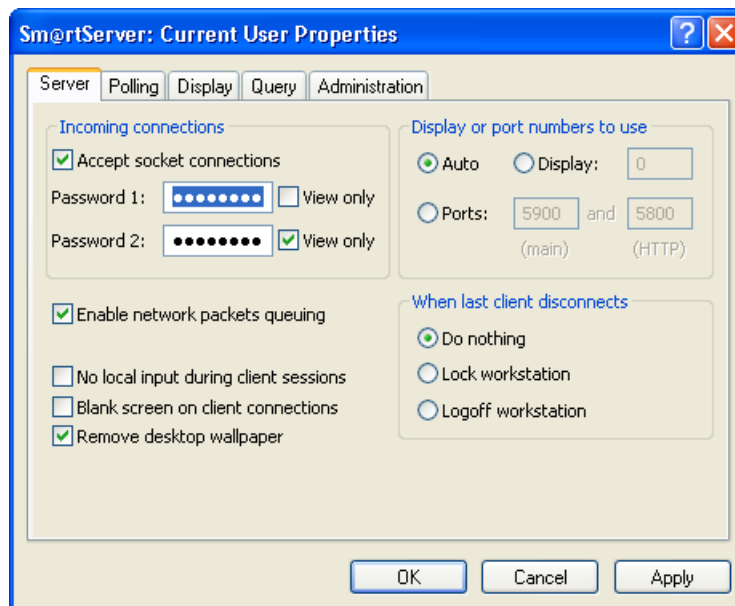

3. On the "Server" tab, select "Accept socket connections".
4. Enter a password for "Password 1 "and "Password 2". Click "Apply".

- Click on the "Administration" tab.

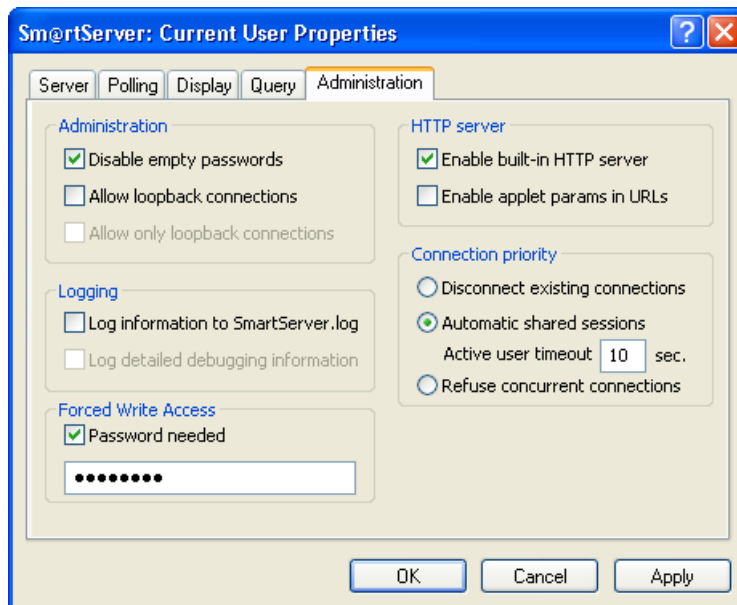

- In the area "Connection priority", select "Automatic shared sessions". For "Active user timeout" enter time that must elapse without any actions on the active HMI device before access can be changed.
- Under the "Forced write access", clear "Password needed" for the forced access to the HMI device. Click on "Apply". Click "OK" to close all opened dialogs.

## Result

The settings were changed. The changes will be effective after restarting the Sm@rtServer.

## See also

Project Sm@rtClient (Page 5839)

## Project Sm@rtClient

## Requirement

- The WinCC-Project for the Client-HMI device is configured.
- The "Screens" editor is open.
- The Inspector window is shown.
- The "Tools" task card is open.

## Procedure

Proceed as follows to configure the Sm@rtClient:

1. Insert the Sm@rtClient display in the start screen.
2. In the Inspector window, click "Properties > Properties > General".
3. Enter the IP-address or the name of Server-HMI device in the "Machine name" field.
4. Enter "Password 1" configured on server in the "Password" field.
5. Activate the setting "Allow Menu".  
This provides the operator the option to log off using the menu.
6. Transfer the compiled project to all operator stations.

## Result

The Sm@rtClient-display was added in start screen in WinCC-Project of Sm@rtClient.

After the Sm@rtServer and operator stations are started, the operator sees the current process screen of the central HMI device at each operator station.

In order to control the server from an operator station, the operator must wait a specified amount of time following the last action on another HMI device.

If the operator uses the menu of the Sm@rtClient display to log off at the previously used HMI device, he can immediately control the server at the next HMI device.

## See also

Remote control via the Sm@rtClient display during runtime (Page 5831)

"Server" tab (Page 5808)

Setting WinCC Runtime Advanced Internet (Page 5836)

### 10.16.2.3 E-mail notification from runtime

## Process flow

## Introduction

WinCC Runtime Advanced with the Sm@rtService offers the option of sending messages automatically via email.

The automatic e-mailing feature ensures that all people affected by the machine status (for example, shift engineer and sales manager) are informed in a timely manner.

## Contents and triggers for e-mailing

The following events can trigger an e-mail to be sent:

- Alarm of a certain alarm class
- Event in which a standard function has been configured, such as a tag value change, etc.

Such an e-mail can have the following contents:

- Alarm text with process tags (maximum of 256 characters)
- Date/time
- E-mail address for replies

If you use e-mail gateways or SMS gateways, you receive access to standard networks, which requires external service providers. If configured accordingly, in critical situations the operator station sends an SMS to your mobile phone.

## Enabling e-mailing and SMS

The HMI device can send e-mails to an SMTP server only. The server sends the e-mails to the addresses configured in the server.

Nothing else is required to send e-mails to addresses in the company network. However, an external service provider is required to access standard networks.

If an SMS communication is to be sent to service personnel, an SMS gateway is required as well.

## Settings on the HMI device

The settings for emailing on the HMI device are made in the "Email" tab under "WinCC Runtime Advanced Internet" on the control panel.

The "Sender" entry field is assigned the default value "Automation HMI device." A change is useful if you want the recipient to be able to identify the device from which the e-mail originated, e.g. "HMI device on production line 2"

You can also use an SMTP server that support authentication to send e-mail.

The following authentication modes can be configured:

- Authentication by means of a valid e-mail address
- Authentication by means of user name and password

Data can also be encrypted and sent via an SSL connection. This means the data cannot be manipulated or read.

## Specify trigger for E-Mailing

### Requirement

- You have to create WinCC project.

### Procedure

Proceed as follows to send a message when an alarm is triggered:

1. Double-click on the "HMI-Alarms" entry in the project tree.
2. Click the "Alarm classes" tab in the "HMI-Alarms" editor.
3. Select the alarm class, e.g. "Errors".
4. Enter the E-Mail-Address in the inspector window under "Properties > Properties > General".
5. Create an analog or discrete message with this alarm class.

### Result

The trigger to send a message was configured. A message is automatically sent when a message of this alarm class is triggered.

## Configure secure e-mail notification from Runtime

### Introduction

If you send e-mail via the SMTP protocol, the sender is not verified. To ensure secure transmission of e-mails, you can use SMTP servers that support SMTP AUTH (authentication).

You must log on to the SMTP server to send e-mails. The following authentication modes can be configured:

- Authentication by means of a valid e-mail address
- Authentication by means of user name and password

The data can also be sent via an SSL connection. SSL (Secure Socket Layer) encrypts e-mails and user data for transmission. This means the e-mail cannot be manipulated or read during transmission.

### Requirement

- The SMTP server supports SMTP AUTH and STARTTLS. You can obtain more detailed information from your service provider.
- User name and password or a valid e-mail address for logon to the SMTP Server. You can obtain this data from your service provider.
- The SMTP server is available.



- The e-mail address of the service technician is entered in the alarm class.
- An analog or discrete alarm has been created for this alarm class.

## Setting up secure e-mailing

### Procedure in the WinCC-Project

1. Double-click on the "Runtime-settings" entry in the project tree.
2. In the "Runtime-settings" editor, click on the "Services".
3. Enter the sender name to be shown in e-mail under "Sender name". If the SMTP-Server does not support the function, delete the entry.
4. Enter the authentication data.
  - Authentication by means of user name and password:  
Enter the user name and click on  at the "Password" input field. Enter the password in the "Enter password" box in the next dialog. Enter the password again in the "Confirm password" box. Close the dialog.
  - Authentication by means of a valid e-mail address  
Type in the e-mail address required for SMTP authentication in the "E-mail address" input field.
5. Enable "The server requires a secure connection (SSL)".

### Procedure on the HMI device

---

#### Note

Note that the settings on the HMI device have a higher priority than the settings in the WinCC project.

---

1. Open the "WinCC Runtime Advanced Internet " dialog in the control panel of the HMI device.
2. Click on the "E-mail" tab.
3. Specify the SMTP server.
  - Select "Use the default project file" if you want to use the SMTP server defined in the project.
  - Deactivate "Use the default project file" if you do not want to use the SMTP server defined in the project. Specify the required SMTP server. For HMI devices with Windows CE, specify the computer name or the FQDN (Fully Qualified Domain Name).
4. Enter the sender name given in the e-mail under "Name of the sender". If the SMTP-Server does not support the function, delete the entry
5. Enter the authentication data.
6. Enter a valid e-mail address at "eMail adress of sender" if required for authentication.
  - Click "Advanced" if you need a user name and password for authentication. The "Advanced Email Settings" dialog opens.

## 10.16 Options

7. Type in the user name and password in the "Advanced Email Settings" dialog.
  - Enable "Use the default of the project file" to use default user data you have defined in the project.
  - Select "Use panel settings for authentication" if you do not want to use the user data defined in the project. Enter the user name and password.
8. Enable transmission via SSL.
  - To use the project settings, enable "Use the default of project file" and SSL in WinCC.

### Result

If a tag such as a mixer speed exceeds configured limits, a corresponding alarm is displayed on the HMI device. The data is sent to the SMTP server via SSL connection. The e-mail is sent to the field service technician after successful logon.

### 10.16.2.4 Display integrated Service-Pages

#### Integrated Webserver

##### Introduction

The operator can display and navigate between web pages during runtime using the web server integrated in the HMI device.

The integrated web server displays the integrated service-pages. Depending on the configuration, own configured HTML-pages or Service-pages of a server accessible over Ethernet are displayed.

##### Requirement

- "HTML-Pages" is activated in the WinCC-Project of the Server-HMI device for the "Services in Runtime".

---

##### Note

It is always possible on a PC to access HTML-pages in runtime, although the option "HTML-pages" is cleared. Setup always installs the standard pages of the Web Server on the PC. Assign an administrator password to prevent unauthorized access to the pages.

---

##### Purpose of the web server

The integrated web server permits HTML pages to be displayed during runtime over one of the following routes:

- Internet Explorer
- HTML browser screen object during runtime (not on Windows CE devices)

The following are displayed:

- internal Service-Pages available by default on the HMI-device
- Other pages that you configure
- Other Internet pages

An operator or service technician can access service-critical information via the HTML pages. The standard HTML pages provide the following options:

- Remote control (if the HMI device is configured as a Sm@rtServer)
- Remote control using Microsoft Internet Explorer
- Starting and stopping of runtime
- Remote access to recipe data records and password lists
- Display of system information
- File management using a file browser
- Downloading of configuration data
- A "DATETIME" tag always returns a date within the range from 1.1.1970 00:00:00 to 31.12.2037 23:59:59.
- The "Export recipes" function requires the following authorizations:
  - PC: "UserData"
  - other HMI devices: "UserData" and "FileBrowserUser"

## HTML browser for HTML pages

The HTML-pages are also displayed using the configured "HTML browser" screen object (not on Windows-CE devices).

You can also arrange for input or activation of an Internet address. As soon as the operator enters or activates an address, the HTML browser opens the relevant page.

The appearance and functionality of the HTML browser screen object depends on the HMI device type. On PCs, the HTML browser corresponds to the Internet Explorer installed.

---

### Note

Note that the HTML browser options during runtime are restricted due to operating device capacities and options.

---

## Service-pages of the web server

### Introduction

The operator can use Internet Explorer or the HTML browser screen object during runtime to display service-pages without any additional configuration.

You can also create own service-pages. For detailed information, refer to "Configure In-house service-pages".

## Requirement

- "HTML-Pages" is activated in the WinCC-Project of the Server-HMI device for the "Services in Runtime".

---

### Note

It is always possible on a PC to access HTML-pages in runtime, although the option "HTML-pages" is cleared. Setup always installs the standard pages of the Web Server on the PC. Assign an administrator password to prevent unauthorized access to the pages.

---

## Service-pages

WINCC Runtime has the following service-pages:

- start.html: Home page
- RemoteControl.html: Remote control (only for Internet Explorer)
- Control.html: Control functions
- StatusDetails.html: System diagnostics
- Browse.html: File browser (only for Internet Explorer)

## Home page: Start.html

The start page contains the links to all other pages and displays current information about the project: Mode, software versions, device data, etc.

## "Remote control": RemoteControl.html

The "Remote control" page enables operator control of the HMI device for which a page is to be displayed. This page can only be displayed by using the Internet Explorer.

**"Control functions": Control.html**

The "Control functions" page enables the following options on the HMI device for which a page is to be displayed:

- Starting and stopping of HMI runtime

---

**Note**

The transfer mode must be set in the Loader-menu on the HMI-device.

---

- Exporting and importing of recipes

---

**Note**

After importing recipes with Sm@rtService (HTML pages), restart Runtime. The imported recipes only become active the next time Runtime is started.

---

- Exporting and importing of password lists

---

**Note**

The password list must be named "pdata.pwl." It is exported to the following directory:

On Windows CE-devices: In the "\\Flash\\simatic\\" target directory

On PCs: the folder that was set in the file "HMIloader.exe".

The password list is exported and becomes active the next time Runtime is started.

---

**"System diagnostics": StatusDetails.html**

The "System diagnostics" page contains system alarms from the alarm buffer.

**"File Browser" – Browse.html**

The "File Browser" page is used to administer directories and files on the remote device. This page can be displayed with any Internet browser.

**Installing the client and server certificates for SSL****Introduction**

To ensure data security, data are encoded for transmission over the Internet. Encoding and decoding is performed by appropriate software – the certificates for SSL (Secure Sockets Layer).

- The client certificate for SSL must be installed on devices that are to be used to control a remote device.
- The server certificate for SSL must be installed on HMI devices that are to allow remote control.

## Configure access to service-pages

## Configure integrated web server

## Configure WinCC-Project

### Requirement

- The WinCC-Project of the server-HMI-device is configured.

### Procedure

Proceed as follows to configure the HMI device in such a way that other HMI devices or PCs can be connected to it:

1. Double-click on the "Runtime-settings" entry in the project tree.
2. In the "Runtime-settings" editor, click on the "Services".
3. Enable the "HTML-Pages" in the "Diagnostics" group.
4. Transfer the compiled WinCC-project to the Server-HMI-device.

### Result

The Server-HMI-device is configured as web server.

## Setting WinCC Runtime Advanced Internet

### Requirement

- The "WinCC Runtime Advanced Internet" dialog is open.
- The "Web Server" tab is displayed.

### Procedure

Proceed as follows to change the "WinCC Runtime Advanced Internet" settings on the HMI device:

1. Click "User Administration" in the "Web Server" tab. Enter "100" as password. The "UserDatabase-Edit" dialog is opened.
2. Click "Add" in the "User manager" tab to create a new user. Enter a user name and specify a password. Click on "Apply".
3. Click the "Authorizations" tab.
4. Specify on the "Authorizations" tab, which functions can the user carry out on the HTML-pages of an HMI-device. See the chapter "User administration for web server (Page 5814)" for additional details.

5. Close the "UserDatabase-Edit" dialog.
6. On the "Remote" tab, select the "Start automatically after booting" check box.
7. Click "Change settings" and enable in the "Sm@rtServer dialog: Current User Properties", select the checkbox "Enable connections".
8. Specify a password for "Password2" so that the HMI device can be remotely controlled by the service technician.

## Result

A user was created on the HMI-device in the user administration of the web server and configured for the remote control.

The service technician can be connected to the HMI-device by means of the Internet Explorer and the Sm@rtClient Application. After disconnecting the connection, the HMI-device can be operated from his PC.

## See also

WinCC Runtime Advanced Internet, "Web Server" tab (Page 5806)

"Server" tab (Page 5808)

## Display and remote-control Service-Pages

## Requirement

- A user is created on the HMI-device in the user administration for the web server.
- The web server is started.
- The Client-and Server-certificates are installed to ensure the data security when transferred via internet.

## Procedure

To display and control the service-pages, follow these steps:

1. Start the Internet Explorer on the configuration-PC and connect with the "Homepage" of the HMI-device.

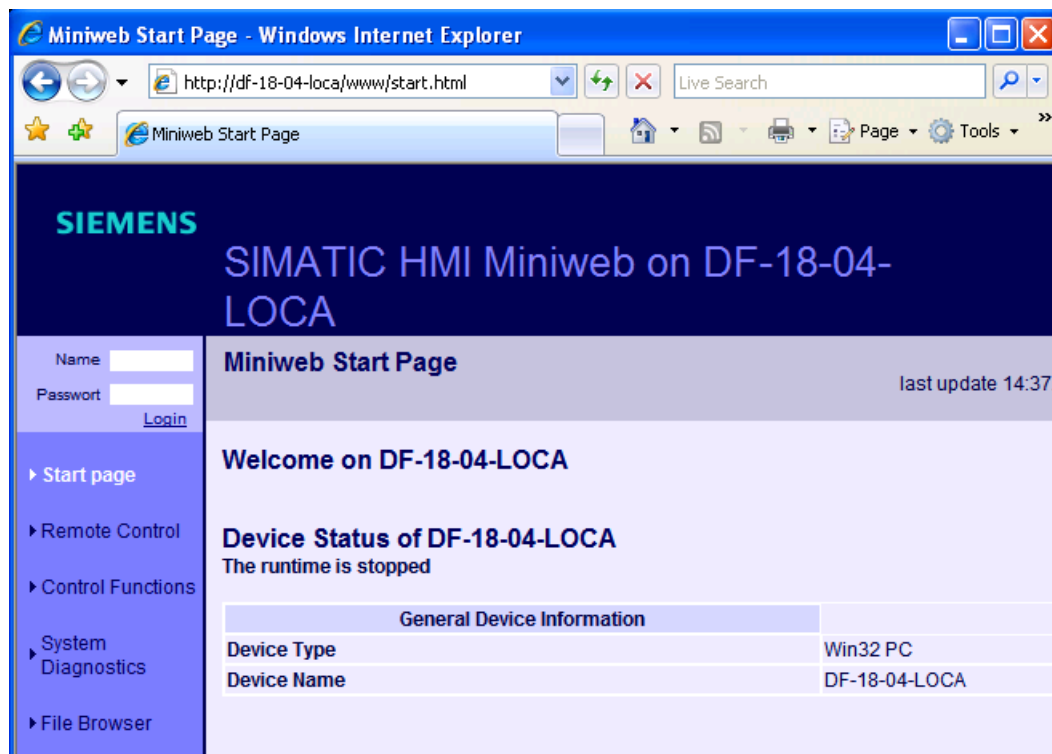

2. For "Name" and for "Password", enter the data of the user configured in the user administration of the web server. Click "Login".
3. Click "System Diagnostics". The system alarms from the alarm buffer are displayed on this page.
4. Click "Remote Control" to remotely control the HMI-device.

## Result

The service-pages are displayed. The HMI-device can be operated or monitored via the service-pages.

A keyboard units cannot be operated completely in the Internet Explorer, since only the screen content is displayed. Use the Sm@rtClient-Application to remotely control the keys of HMI-device. The Sm@rtClient-Application can be located under "Start > Program > Siemens Automation > Runtime Systems > WinCC Runtime Advanced > Sm@rtClient"



## Create own Service-pages

### Basics

#### Introduction

The basic framework of the service-pages corresponds to a normal HTML-file.

- Declaration of the document type
- Header with data for the title
- Body - content to be displayed.

#### Variable parameters in Service-pages

You can specify variable parameters in HTML documents. As soon as a page with variable parameters is opened, the parameters are replaced by specific values.

```
<BODY > Welcome on <MWSL><!-- write(GetVar("[Parameter]")); --></MWSL></BODY>
```

#### Available variable parameter

Parameters	Meaning
ProgramMemoryComplete	CE only: Total program memory
ProgramMemoryFree	CE only: Program memory available
ProgramMemoryUsed	CE only: Program memory utilized
FlashComplete	CE only: Total flash memory
ObjStrComplete	CE only: Total available flash memory
ObjStrFree	CE only: Volatile memory available
ObjStrUsed	CE only: Volatile memory utilized
DeviceType	Type of target device as specified in the control panel.
BtLdVer	CE only: Bootloader-version, as specified in the control panel.
BtLdRelDate	CE only: Bootloader release date
ImageVersion	CE only: Image version as it appears on the loader
DramSize	CE only: Size of DRAM
HostName	The name by which the device is logged on/identified in the network.
RtState	Indicates whether Runtime is running on the target device.
SystemMessageTable	Outputs a table containing the current system events.

In the example below, the "HostName" parameter is replaced by the network-name of the device.

```
<BODY > Welcome on <MWSL><!-- write(GetVar("[HostName]")); --></MWSL></BODY>
```

## Process tag

Process tag values can also be displayed in HTML pages. The syntax is the same as for device tags. Use the tag name as a placeholder for the tag value, , e.g. Tag\_1.

```
<BODY > Welcome on <MWSL><!-- write(GetVar("[Tag_1"]); --></MWSL></BODY>
```



### CAUTION

#### Data inconsistency caused by HTML pages

Note the information below if the "Cyclic in operation" acquisition mode is set at tag:

1. If this tag is not displayed on the HMI device, the HTML page displays the incorrect tag value in the following situations:
  - The HTML page display a "0" value at its first call. The HTML page only displays the correct value after it is called again or updated.
  - The last value is displayed if the connection to the PLC goes down.
2. The HTML page also displays the correct tag value if the tag is displayed on the HMI device.

Situation 1 is based on standard behavior: If a tag is currently not in use currently and its value is not acquired in "Cyclic continuous" mode, the tag is loaded with its initial value in Runtime. Instead of reading the values from the PLC, however, the HTML page receives these from Runtime.

## Link own Service-pages

If a user connects to an HMI device, he is automatically forwarded to the start page `http://<Device name>/www/start.html`. This page represents the starting point for the HTML-pages of the web server. Every standard page is accessible from the start page via a link. For this reason, you insert a link for each of your HTML pages in the start page.

### Note

When inserting links in the HTML page, you must differentiate between relative and absolute links. Make sure that absolute links start with `"/www"` to ensure that the document will be searched for in the correct directory. Example: `"/www/MyDocument.HTML"`.

## Storage location of the service-pages

If files are to be located during a transfer, they must be in a specific directory:

- on a PC with Windows 7: "C:\ProgramData\Siemens\CoRtHmiRTm\MiniWeb11.x.x\WebContent"
- on a PC with Windows XP: "C:\Documents and Settings\All Users\Application Data\Siemens\CoRtHmiRTm\MiniWeb11.x.x\WebContent"
- On xP 177B: "<ES-Installationspath>\Transfer\11.0\XP177B\WebContent.zip"
- On xP 277: "<ES-Installationspath>\Transfer\11.0\XP277\WebContent.zip"
- On MP 177: "<ES-Installationspath>\Transfer\11.0\MP177\WebContent.zip"

- On MP 377: "<ES-Installationspath>\Transfer\11.0\MP377\WebContent.zip"
- on Mobile Panel 177 PN: "<ES-Installationspath>\Transfer\11.0\XP177B\WebContent.zip"
- On Mobile Panel 277: "<ES-Installationspath>\Transfer\11.0\XP277\WebContent.zip"
- On the Mobile Panel 277 (F) IWLAN: "<ES-Installationspath>\Transfer\11.0\XP277\_W\WebContent.zip"
- On the Mobile Panel 277 (F) IWLAN V2: "<ES-Installationspath>\Transfer\11.0\XP277\_W2\WebContent.zip"

## Create service-page for displaying process values

### Requirement

The Ta\_1 and Tag\_2 tags are created in the WinCc-Project.

### Procedure

To create an own Service-page, follow these steps:

1. Copy the "WebContents" ZIP-file in a random work directory on your Configuration-PC and un-zip the ZIP-file.
2. Create a copy of start.html and rename the copy in "tag.html".
3. Open the "tag.html" in a text editor, e.g. Notepad.
4. Replace the existing table with a new table, in which the process values of "Tag\_1" and "Tag\_2" tags are displayed. Save the file "tag.html".

```
<font class="ad_headline2">Device Status of <MWSL><!-- write(GetVar("HostName")); --></MWSL></font><br>
<b>The runtime is <MWSL><!-- write(GetVar("RtState")); --></MWSL></b><br><br>
<table border="1" class="sph_table" cellspacing="0" width="600">
<tr><th class="sph_th"><b>Display of process tags </b></th></tr>
<tr><td class="sph_td"><b> "Tags1" </b></td><td class="sph_td"><MWSL><!-- write(GetVar("Tag_1")); --></MWSL>&nbsp;</td></tr>
<tr><td class="sph_td"><b>"Tags2" </b></td><td class="sph_td"><MWSL><!-- write(GetVar("Tag_2")); --></MWSL>&nbsp;</td></tr>
</table>
```

5. Open the "start.html" file and add a hyperlink to page "tag.html". Expand the available navigation bar, in which you supplement the existing table by an entry.

```
<tr>
<td width="8"></td>
<td width="7"></td>
<td width="101" class="ad_nav_link"><a href="tag.html" class="ad_nav_link">Process value</a></td>
</tr>
```

6. Save start.html.

### Result

You have created the service-page "tag.html". You have added a hyperlink on the start page in order to navigate to the service-page from the start-page.

## Transfer Service-pages

### Transfer files using the standard-path (Active Sync/CF- card)

Proceed as follows to transfer files via the standard-path:

1. Copy the changed HTML pages and pictures according to "\Flash\Simatic\WebContent".  
Access then takes place with "http://<device>/www/<HTML page>".

### Transfer files via the project transfer

Proceed as follows to transfer the files via the project transfer:

1. Add the changed files to the ZIP-file "WebContents". This file must contain all HTML pages and associated pictures.  
Make sure to provide the correct path information because the files are unpacked in the directories specified in the zip file. Incorrect path information results in errors in direct addressing or due to links.
2. In order to transfer the ZIP-file "WebContents", copy this in a certain directory, e.g. for the transfer to an MP377 "<ES-Installationspath>\Transfer\1.3\MP377\WebContent.zip".
3. Transfer the project to the HMI device.  
The ZIP-file "WebContents" is transferred to the Windows CE device where it is unzipped.

### Transfer files using the File Browser

Proceed as follows in order to transfer files using the file transfer:

1. Start the Internet Explorer on the configuration-PC and connect with the "Homepage" of the HMI-device.
2. Log-on to the internal Web Server to work with the File Browser.  
For read and write access to the file browser, the user must possess the web authorizations "FileBrowserAdministrator" and "FileBrowserUser" .
3. Click on "Browse" in the File Browser . The file selection dialog opens.

- Navigate to the file storage location by means of this dialog. Select the desired file and click "Open."

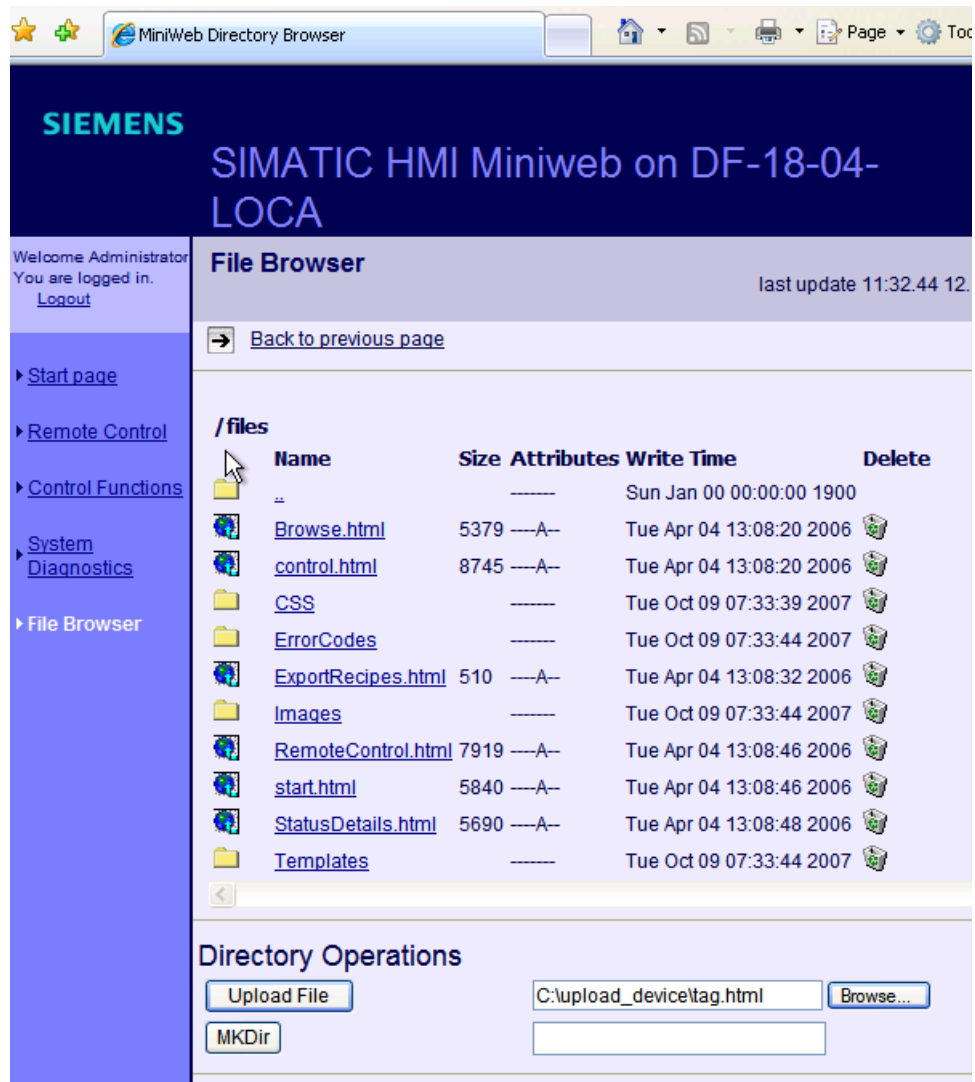

- Click "Upload File". The file is copied in the directory of the internal web server.

### See also

Basics (Page 5849)

### 10.16.2.5 Access via SIMATIC HMI HTTP Protocol

#### Configuration

#### Configuration

During the communication via SIMATIC HMI HTTP Protocol, an HMI-device accesses the tags of a different HMI-device. The access is "read-only" or "read and write" depending on the configuration of the concerned HMI-device.

The HMI device providing the tags is the HTTP-server; the other HMI-device is the HTTP-client. However, access to tags functions in both directions.

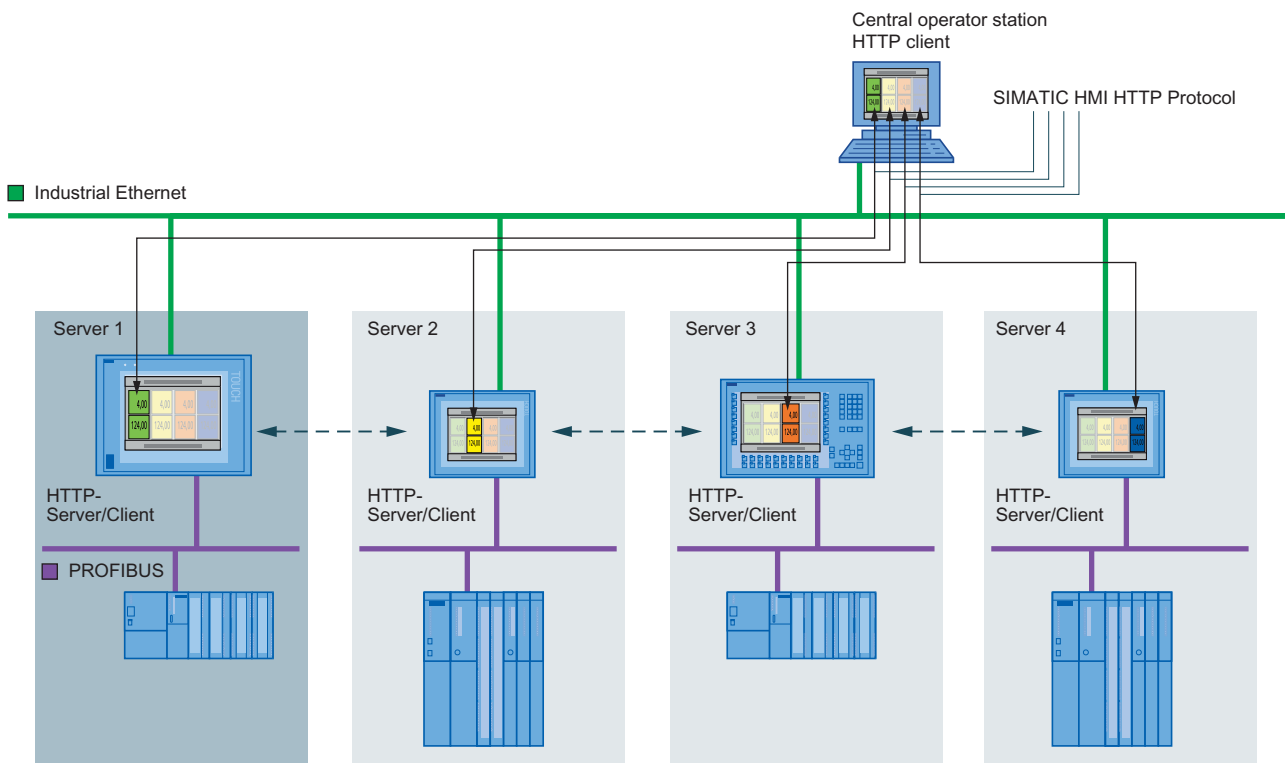

#### Configure access via SIMATIC HTTP Protocol

#### Introduction

The tags in service-application should be illustrated in an overview for a configuration from multiple HMI-devices.

The panels in the machine level are used as tag server. The service-application illustrating tags of machines in an overview image runs on a PC.

**Requirement**

- The HMI-devices are networked via a TCP/IP-network with each other.

**Configuration steps**

The following basic steps are required to configure the access via "SIMATIC HMI Protocol".

Step	
1	Configure WinCC-Project (Page 5858)
2	Setting WinCC Runtime Advanced Internet (Page 5858)
3	Configuring HTTP connections in the client (Page 5859)
4	Configure the HTTP-Client tags (Page 5861)

**Permissible data types (SIMATIC HMI HTTP protocol)****Permitted data types**

When configuring tags, the data types listed below can be used.

Data types in the HTTP Protocol	Length	Signs	Range of values
Bool	0	No	true (-1) or false (0)
Char	1 byte	Yes	-128 to 127
Byte	1 byte	No	0 to 255
Int	2 bytes	Yes	-32768 to 32767
UInt	2 bytes	No	0 to 65535
Long	4 bytes	Yes	-2,147,483,648 to 2,147,483,647
ULong	4 bytes	No	0 to 4,294,967,295
Float	4 bytes	Yes	-3.402823E38 to -1.401298E-45 for negative values and 1.401298E-45 to 3.402823E38 for positive values
Double	8 bytes	Yes	-1.79769313486231E308 to -4.94065645841247E-324 for negative values and 4.94065645841247E-324 to 1.79769313486232E308 for positive values
String	1 to 255 byte	—	
DateTime	8 bytes	—	1.1.1970 00:00:00 up to 31.12.2037 23:59:59

Please note that data types may be defined in external controllers which have different names in WinCC. To ensure correct assignment, please observe the tag definition in the external controllers.

---

**Note**

It is not possible to access array tags from an HTTP client.

---

**See also**

Configure WinCC-Project (Page 5858)

**Configure HTTP server**

**Configure WinCC-Project**

**Requirement**

- The WinCC-Project for the Server-HMI device is configured.

**Procedure**

Proceed as follows to configure the HTTP-Server:

1. Double-click on the "Runtime-settings" entry in the project tree.
2. In the "Runtime-settings" editor, click on the "Services".
3. Select "SIMATIC HMI HTTP Server" in the group "Read/write tags".
4. Check the data types of the tags. The HTTP-client can access only those tags, whose data type is supported by communication driver "SIMATIC HMI HTTP Protocol". For additional information, refer to "Permissible data types (SIMATIC HMI HTTP Protocol) (Page 5855)".
5. Transfer the compiled WinCC-project to the Server-HMI-device.

**Result**

The HMI-device is HTTP-server configured.

**Setting WinCC Runtime Advanced Internet**

**Requirement**

- The "Control Panel" opens.
- The "WinCC Runtime Advanced Internet " dialog is open.
- The "Web Server" tab is displayed.



## Procedure

Proceed as follows to change the "WinCC Runtime Advanced Internet" settings on the HTTP server:

1. Specify the access to tags in case of "Tag access".
  - "Read/write": read and write access
  - "Read only": read access
2. Specify the authentication for access in case of "Tag authenticate":
  - "No authentication": No authentication required.
  - "Authentication required": A password is required for the access. Specify the password for configuring the connection via the SIMATIC HMI HTTP Protocol .
3. Click "User Administration" in the "Web Server" tab. Enter "100" as password. The "UserDatabase-Edit" dialog is opened. For detail instructions, refer to "User administration for Webserver (Page 5814) ".
4. Click "Add" in the "User manager" tab to create a new user. Enter a user name and specify a password. Click on "Apply".
5. Click the "Authorizations" tab.
6. Specify the web-authorizations on the tab "Authorizations". The user must have the Web-authorization "RTCommunication" for utilizing the SIMATIC HTTP Server.
7. Close all open dialog boxes.

## Result

The settings were changed. The changes will be effective after the restart of the WebServer.

## See also

Settings on the HMI device (Page 5803)

WinCC Runtime Advanced Internet, "Web Server" tab (Page 5806)

User administration for web server (Page 5814)

## Configuring HTTP clients

### Configuring HTTP connections in the client

## Requirement

The communication driver "SIMATIC HMI HTTP Protocol" is installed.

## Procedure

Proceed as follows to create an HTTP-connection:

1. Double-click on the "Connections" entry in the project tree. The "Connections" editor opens.
2. Create a connection. Select "SIMATIC HMI HTTP Protocol" for "Communication driver".

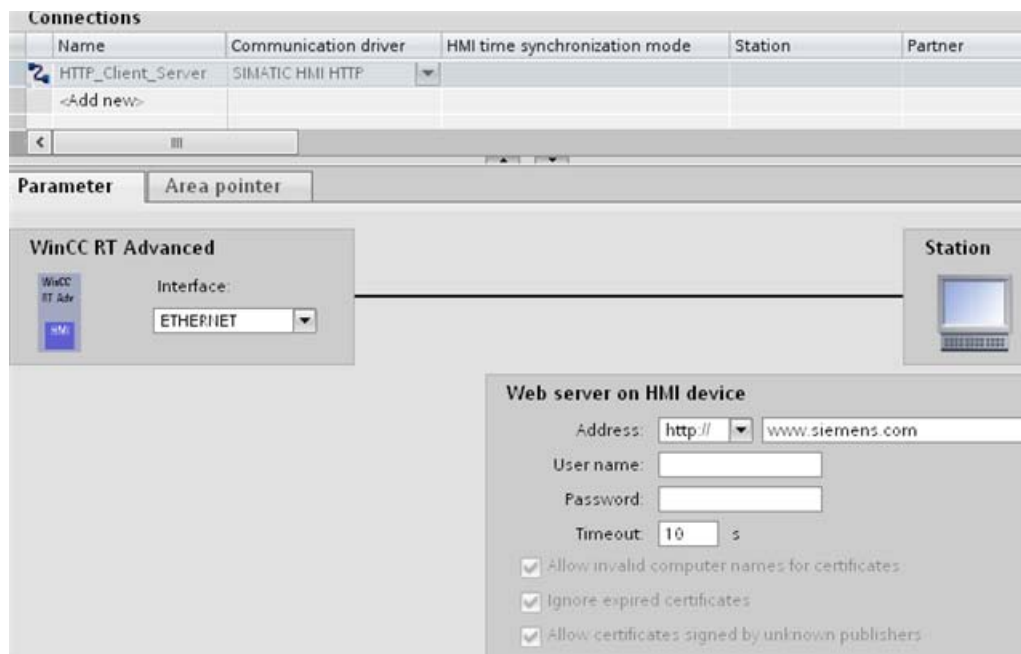

3. Select "Ethernet" for "Interface". Select the protocol type "http://" or "https://" for address.
4. Enter the name of the HTTP-server or its IP address.  
Ask your network administrator for the specific name or parameters of your network.  
If the server has already been commissioned, you can read out the IP address on the server as well:
  - Panel  
Click "Start > Programs > Command Prompt" on the server and enter the "ipconfig" command using the screen keyboard. Press <Enter> to display the IP-address.
  - For PC/Panel PC  
Click on the server on "Start > Run", enter "Cmd", and press <Enter>. The command interpreter is displayed. Enter the "ipconfig" command. Press <Enter> to display the IP-address.
5. If the "HTTPS" protocol type is selected, you can establish how the HTTPS-client verifies the properties of the server-certificate and how it should react in the event of error:
  - "Allow invalid computer names for certificates"
  - "Allow expired certificates"
  - "Allow certificates signed by unknown publishers"
6. If the "Authentication required" option is selected on the HTTP-server, enter the user name and the password.
7. Enter the time for "Timeout" after which disconnection is identified.

## Result

A connection was created in the WinCC-Project of the HTTP-Client. For detail information for HTTPS-connection, refer to "Commissioning an HTTP- connection (Page 5862)".

## Configure the HTTP-Client tags

### Requirement

- An HTTP-connection was created in the WinCC-Project of the HTTP-Client.
- A tag is created in the WinCC-Project of the HTTP-Server. The data type of the tags is supported by SIMATIC HMI HTTP Protocols .

### Procedure

To create tags on the HTTP-client, proceed as follows:

1. Open the "HMI- tags" folder in the project tree and double-click the entry "Standard-tag table". The "Tags" editor opens.
2. Enter a clear tag-name for "Name" in the Inspector window under "Properties > Properties > General".
3. Select the HTTP-connection for "Connection".
4. Select the data type for "data type".  
The client does not check any verification of the tag name and the data type. Pay attention that the selected data type here matches the data type of the tags in the HTTP-server. For additional information, refer to "Permissible data types (SIMATIC HMI HTTP Protocol)". Array tags are not permitted.
5. Enter the exact name of the tag that is to be communicated with on the HTTP-server in the "Address" field.  
If the tag to be addressed is in a sub-folder, the complete path along with tag name must be given as address, e.g.[folder name]\[Tag name].

## Result

A tag was created in the WinCC-Project of the Client-HMI-device. The tag has access to the HTTP-server tag via an HTTP-connection. You can use an "E/A-Field" in an image to display the process value of this tag.

## Commissioning an HTTP- connection

### Introduction

To establish an HTTP connection, you must perform the following actions:

- In the "Connections" editor of WinCC ES, configure the connection as an "https://" protocol type and define how the HTTPS client should verify the properties of the server certificate and respond to errors.
- Install a valid certificate on the HTTPS client.  
Certificates are necessary for server authentication. Using certificates you can ensure that the server with which the connection is to be developed is actually the server for which it is outputting.

### Principle of an HTTPS connection

After runtime start, the HTTPS client establishes a connection to the HTTPS server. The HTTPS server presents its certificate, which the client verifies for authenticity. The session code that can only be read by the HTTPS server is then transmitted. The session code is now available on both sides and enables a symmetrical data encryption.

---

#### Note

The certificate contains the current time. The current time can lead to problems if the time zones of the server and client are different. For example, a certificate generated on a server with an Asian time zone only becomes valid on a client with European time zone in the future (8 hours).

---

### Preparation for installing a certificate on the client

With the first HTTPS client access, the HTTPS server generates the certificate itself and then saves it in the "Cert.cer" memory. The file is stored in the following directory:

- On a PC / Panel PC (with Windows XP) in the directory "<Runtime-Verzeichnis>\SystemRoot\SSL"
- On Windows CE-based devices in the directory "Flash\Simatic\SystemRoot\SSL"

The certificate must be stored on the HTTPS client on a storage medium from which it can be launched with a double click. You can select from the following transfer options:

Server	Client	Possible file transfer
with Windows XP (PC, Panel PC)	with Windows XP (PC, Panel PC)	<ul style="list-style-type: none"> <li>• Diskette</li> <li>• USB stick</li> <li>• LAN (Ethernet)</li> <li>• Internet Explorer (via TCP/IP if service is already running)</li> </ul>
with Windows CE ( xP 277, MP 377, xP 177B, Mobile Panel 177 PN, Mobile Panel 277, Comfort Panels)	with Windows XP (PC, Panel PC)	<ul style="list-style-type: none"> <li>• Memory card</li> <li>• ActiveSync (serial)</li> </ul>
with Windows XP (PC, Panel PC)	with Windows CE ( xP 277, MP 377, xP 177B, Mobile Panel 177 PN, Mobile Panel 277, Comfort Panels)	
with Windows CE ( xP 277, MP 377, xP 177B, Mobile Panel 177 PN, Mobile Panel 277, Comfort Panels)	with Windows CE ( xP 277, MP 377, xP 177B, Mobile Panel 177 PN, Mobile Panel 277, Comfort Panels)	<ul style="list-style-type: none"> <li>• Memory card</li> </ul>

### Installing a certificate on a client with Windows XP

Insert the storage medium on which you have saved the "Cert.cer" file into the HTTPS client or open the directory in which the file is located. Double click on the file and follow the instructions in the Windows dialog.

Tip: The Internet Explorer provides an easy way to install a certificate. Connect to this device via HTTPS (e.g.: <https://<my device>>). The browser establishes if a certificate has not yet been imported. In this case, the browser asks if you want to install the certificate. Any faults in the certificate are displayed.

### Installing a certificate on a client with Windows CE

Insert the memory card on which you have saved the converted "Cert.cer" file into the HTTPS client. WinCC includes the "InstallCert.exe" tool for importing certificates with Windows CE.

You can implement the installation as follows:

- In Explorer:  
Double click the "Cert.cer" file to install the certificate.
- At the command prompt:  
Enter "InstallCert /[command parameter] [filename]".
  - command parameters:  
Parameter /r must be specified because the certificate used in WinCC Runtime Advanced is a root certificate.  
A root certificate is the main certificate and is used to verify the authenticity of all other certificates transferred.
  - filename  
You must specify the certificate file with its complete path (e.g. "\\Storage Card\Cert.cer")

A status alarm is output when you completed the installation. Runtime has to be restarted after the installation of a certificate on Windows CE- HMI devices with HTTPS clients. It is necessary to restart Runtime so that an HTTPS connection can be established.

**The file "Cert.cer" cannot be opened.**

The "Cert.cer" file generated at the HTTPS server cannot be opened on HMI devices based on Windows CE 5.0 by double-clicking the client.

1. Open the Control Panel.
2. Select "Certificates > My Certificates".
3. Click the "Import" button.  
A dialog box opens.
4. Select the "From a File" menu in the file browser and select the "Cert.cer" file.

**10.16.2.6 Connection to the Office-world**

**Configuration**

**Data access via web service (SOAP)**

WinCC provides options for utilization of web-service (SOAP). Web service (SOAP) is based on the Simple Object Access Protocol. Use of this protocol enables an external application to

access tags of an HMI device via Ethernet. If the company network is protected by a Firewall, the system administrator must release the appropriate ports.

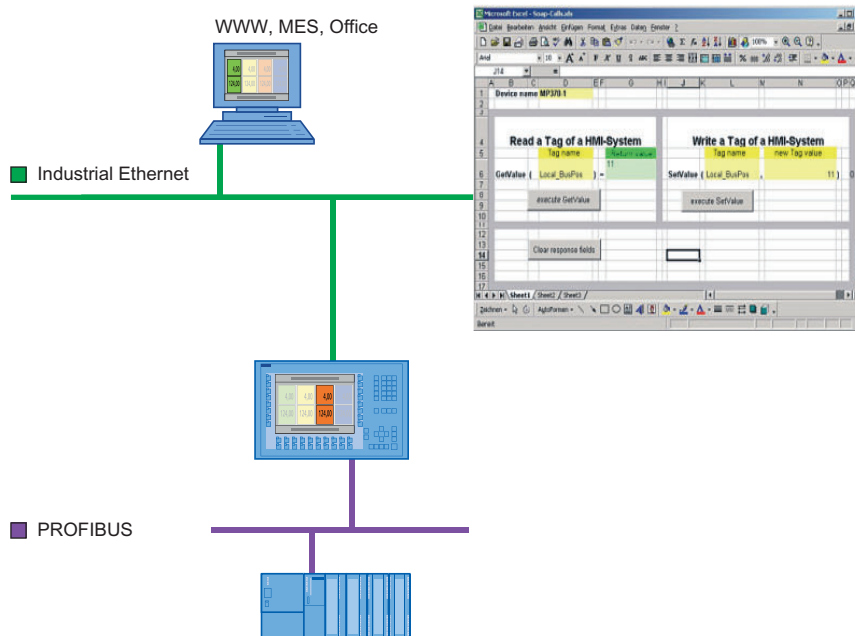

Figure 10-15 Communication with other applications

For example, a device is accessing two HMI devices. The operator sees the values of certain tags and can modify them.

You can use Microsoft Excel, for example, to display tags. You will require the latest version of "MS SOAP Toolkit V2.0" for this purpose. This version is available from Microsoft as a download.

The data access via SOAP is not supported by Windows 7. Use OPC to display the tags in MS Excel. For more information, refer to "Configuring OPC clients (Page 5897)".

### Data access to Windows CE HMI-devices

The data access via the Web-service(SOAP) on Windows CE-HMI-devices functions using only the device name and not via the IP-address.

Enter the device name of the HMI-device with the appropriate IP-address in the hosts-file. The hosts-file is given in the directory "%windir%\system32\drivers\etc", z. B. C:\WINNT\system32\drivers\etc.

The device name, e.g. DEVICEMP377, must be set in the control panel on the HMI device under "System > Device Name". Please change the default device name to ensure that the device name is unique for the network.

### Example for the entry in the hosts-file:

192.168.56.198 DEVICEMP377

Replace the IP-address by the device name in the SOAP-client:

objRuntime.mssoapinit http://DEVICEMP377/soap/RuntimeAccess?wsdl

### Data access with GetValue, SetValue

Access to a tag in SOAP using GetValue or SetValue functions require a special syntax.

- GetValue: "Sinus\_1"
- SetValue: Sinus\_1

The tag name must be given in inverted commas for GetValue. The message "Runtime is offline" will otherwise be output when runtime is accessed.

---

#### Note

Note that the tag name entry is case-sensitive.

---

## Create VBA-Marko in MS Excel

### Introduction

Data access over the network via web service (SOAP) is to be used to permit certain tags of an HMI device to be displayed and reset.

For this purpose, macros are written in Excel, which: 1) obtain the relevant tags on the PC over the network and display them, and 2) transfer reset values back to the HMI device.

The task can be solved using VBA macros "ReadTagValue" and "WriteTagValue," which obtain and display the relevant tags in Excel over an appropriate interface and return them to the HMI device over the network. Note that the tag name entry is case-sensitive.

### Requirement

- The SOAP toolkit is installed.
- "Web-Service (SOAP)" is selected in the WinCC-Project under "Services in Runtime".

### Procedure

1. Insert the "Control element toolbox" toolbar in your workbook in Microsoft Excel.
2. Create a command button. Label the button "ReadTagValue" and name it "Read value".
3. Double-click this command button.  
The macro editor is displayed. The "Click" event is already preset.
4. Write the "ReadTagValue" macro ("intVarTag\_1" designates the actual tag value):



```

'-----
Private Sub ReadTagValue_Click()

Dim objRuntime
Dim intVarTag_1
Dim objWorksheet

Set objWorksheet = Excel.Worksheets("Sheet1")
Set objRuntime = CreateObject("MSSOAP.SoapClient")
objRuntime.mssoapinit "HTTP://servername/soap/RuntimeAccess?wsdl"
objRuntime.ConnectorProperty("AuthUser") = "Administrator"
objRuntime.ConnectorProperty("AuthPassword") = "100"
Var = objWorksheet.Cells(1, 3)
intVarTag_1 = objRuntime.GetValue(Var)
objWorksheet.Cells(1, 1) = intVarTag_1

End Sub
'-----

```

1. Insert a command button. Label the command button "WriteTagValue" and name it "Write value".
2. Double-click this button.
3. Write the "WriteTagValue" macro ("intVarTag\_1" designates the return value of the operation):

```

'-----
Private Sub WriteTagValue()

Dim objRuntime
Dim intVarTag_1
Dim objWorksheet

Set objWorksheet = Excel.Worksheets("Sheet1")
Set objRuntime = CreateObject("MSSOAP.SoapClient")
objRuntime.mssoapinit "HTTP://servername/soap/RuntimeAccess?wsdl"
objRuntime.ConnectorProperty("AuthUser") = "Administrator"
objRuntime.ConnectorProperty("AuthPassword") = "100"
Var = objWorksheet.Cells(2,3)
Value = objWorksheet.Cells(2,5)
intVarTag_1 = objRuntime.SetValue(Var,Value)
objWorksheet.Cells(2,8) = intVarTag_1

End Sub
'-----

```

## Result

As soon as you call "ReadTagValue\_Click" macro by clicking the button "Read-value", the specified intVarTag\_1 tag is obtained from the HMI device using the specified device address and displayed in the cell (1,1).

As soon as you call Macro "WriteTagValue" by clicking the "Write value" button, the tag name is read from the cell (2,3), and the tag value is transferred from cell (2,5) to the HMI device.

**See also**

Configuration in WinCC (Page 5801)

## **10.17 Interfaces**

### **10.17.1 Customer controls**

#### **10.17.1.1 Overview**

##### **Introduction**

User-specific controls are used to create and standardize complex, frequently used screen objects. The WinCC Control Development add-on is required to develop controls. Programming is carried out in Visual Studio 2008 or Visual Studio 2010.

You can, for example, place several motors of a similar type in a plant. In a customer control, you can summarize motor data such as operating mode, setpoint, actual value, rotational speed, operational status, frequency.

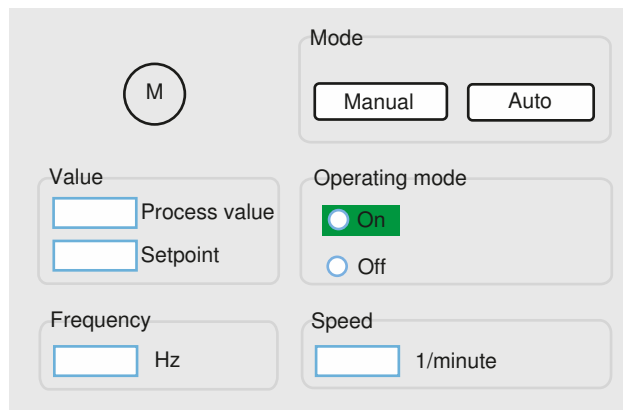

When the customer control is finished, you can integrate it an unlimited number of times into WinCC screens, as well as in other applications.

Central changes to the customer control are automatically adopted at all usage locations. In this way, you can later expand a customer control with additional functionality. The changes are effective on all customer controls of this type used in WinCC screens that are already configured.

### Target group of this documentation

This documentation is aimed at configuration engineers with knowledge of VB.net or C#.

### Service & Support on the Internet

In addition to our documentation, we offer a comprehensive knowledge base on the Internet at: [www.siemens.com/automation/service&support](http://www.siemens.com/automation/service&support)

## 10.17.1.2 Interfaces

### Introduction

To access the WinCC tag value, WinCC makes interfaces available for access to the WinCC data provider. The connection to the WinCC data provider is established or disconnected using methods. Methods are also used to read or write tag values synchronously or asynchronously.

- Synchronous:  
The customer control sends a request to the data provider for which a reply is expected immediately. The customer control waits until a reply comes from the data provider.
- Asynchronous:  
The customer control sends a request to the data provider for which a reply is not expected immediately. Sending the request and receiving the reply occur at separate times.

### Interfaces

- ITag  
The ITag object supports the following methods:

Method	Description
Register	Registers the customer control as a consumer at the data provider. The consumer receives a cookie from the data provider. The cookie is used to assign a request from the data provider to a consumer.
ReadTag	Reads the value of one or more tags at the same time
ReadTagAsync	Reads the tag value asynchronously
ReadTagCyclic	Cyclic reading of the tag values. The update cycle is used to determine how often the value is updated.
RemoveCyclicTag	Removes one or more tags
Cancel	Cancel the cyclic reading of the tag values

Method	Description
WriteTag	Writes values to one or more tags synchronously
WriteTagAsync	Writes values to one or more tags asynchronously
Unregister	Removes the consumer

- ITagSink  
The ITagSink object reacts to specific events using methods.

Method	Description
OnCanceled	Occurs when the ITag method "Cancel" has ended.
OnDataChanged	Occurs when a tag value is changed by the following ITag methods: <ul style="list-style-type: none"> <li>• ReadTagAsync</li> <li>• ReadTagCyclic</li> </ul>
OnError	Occurs as an event of an error with the following methods: <ul style="list-style-type: none"> <li>• ReadTagAsync</li> <li>• ReadTagCyclic</li> <li>• WriteTagAsync</li> <li>• OnDataChanged</li> <li>• OnWriteComplete</li> </ul>
OnRemoved	Occurs when the ITag method "RemoveCyclicTag" has ended.
OnWriteComplete	Occurs when the ITag method "WriteTagAsync" has finished.

## Requirement

- This documentation is aimed at configuration engineers with knowledge of VB.net or C#.
- The "Siemens.Runtime.ControlDev.dll" reference is set. For further details, refer to "Setting the reference "Siemens.Runtime.ControlDev.dll".  
Storage of file:
  - WinCC Runtime Professional: ...\\Siemens\\WinCC\\bin
  - WinCC Runtime Advanced: ...\\WinCC Runtime Advanced

## Basic procedure

1. Create an ITag object to connect to the data provider.
2. The "Register" method is used to register the customer control as a consumer of the data provider. The consumer receives a cookie from the data provider. The cookie is used to identify the access by the consumer to the data provider.
3. When the connection is established, you can access the tag values using the methods of the ITag object.

**See also**

Cancel (Page 5886)  
ReadTag (Page 5883)  
ReadTagAsync (Page 5884)  
ReadTagCyclic (Page 5885)  
Register (Page 5883)  
RemoveCyclicTag (Page 5885)  
Unregister (Page 5888)  
WriteTag (Page 5886)  
WriteTagAsync (Page 5887)  
OnCanceled (Page 5888)  
OnDataChanged (Page 5889)  
OnError (Page 5890)  
OnRemoved (Page 5890)  
OnWriteComplete (Page 5891)  
Check the reference "Siemens.Runtime.ControlDev.dll" (Page 5874)

**10.17.1.3 Demo project****Requirement**

- You need WinCC RT Professional or WinCC RT Advanced in order to test the demo projects.
- Correspondingly installed configuration software (Visual Studio 2008 or Visual Studio 2010) is required to open the demo projects.

**Demo project "CCITagTestLibrary"**

In the directory "%Program Files%\Siemens\Automation search for the folder "samples". The demo projects "CCITagTestLibrary" are contained there. The various methods of iTag-Interfaces are used in these demo projects.

- "VB90\CCITagTest\CCITagTestLibrary" is the demo project for Visual Studio 2008.
- "VB100\CCITagTest\ CCITagTestLibrary" is the demo project for Visual Studio 2010.

Use the demo project as a template for your own customer controls. This demo project includes the interface to the data provider of WinCC.

To use the demo project, proceed as follows:

1. Copy the entire "CCITagTestLibrary" folder to a local destination directory.
2. Double-click on the "CCITagTestLibrary.sln" file.

## See also

Creating and testing customer controls (Page 5874)

### 10.17.1.4 Creating and testing customer controls

## Creating and testing customer controls

### Introduction

This section shows the basic procedure for creating and testing a customer control in VB.net.

To follow the configuration steps, use a VB.net project that uses the provided "CCITagTestLibrary" demo project as a template.

### Requirement

- Visual Studio 2008 or Visual Studio 2010
- WinCC RT Advanced or WinCC RT Professional
- WinCC project for WinCC RT Professional or WinCC RT Advanced has been created. For additional information, refer to "Editing a project".

### Basic procedure

To create and test the "ITagUserControl" customer control, proceed as follows:

1. Check the reference "Siemens.Runtime.ControlDev.dll" (Page 5874)
2. Create a user interface (Page 5876).
3. Create the program code (Page 5877).
4. Create customer controls (Page 5878).
5. Test customer controls in Visual Studio (Page 5879).
6. Test customer controls in WinCC (Page 5881).

## See also

Demo project (Page 5871)

Creating a WinCC project (Page 5879)

## Check the reference "Siemens.Runtime.ControlDev.dll"

### Introduction

To access the data provider of WinCC, the VB.net project is linked to the "Siemens.Runtime.ControlDev.dll" library.



## Requirement

- Visual Studio 2008 or Visual Studio 2010 is installed.
- A VB.net project is open. The VB.net project uses the demo project as a template.

## Procedure

Proceed as follows to verify the reference:

1. In Solution-Explorer, double-click the "CCITagTestLibrary > My Project" item.



The Project Designer opens.

2. Click on "References" in the Project Designer.

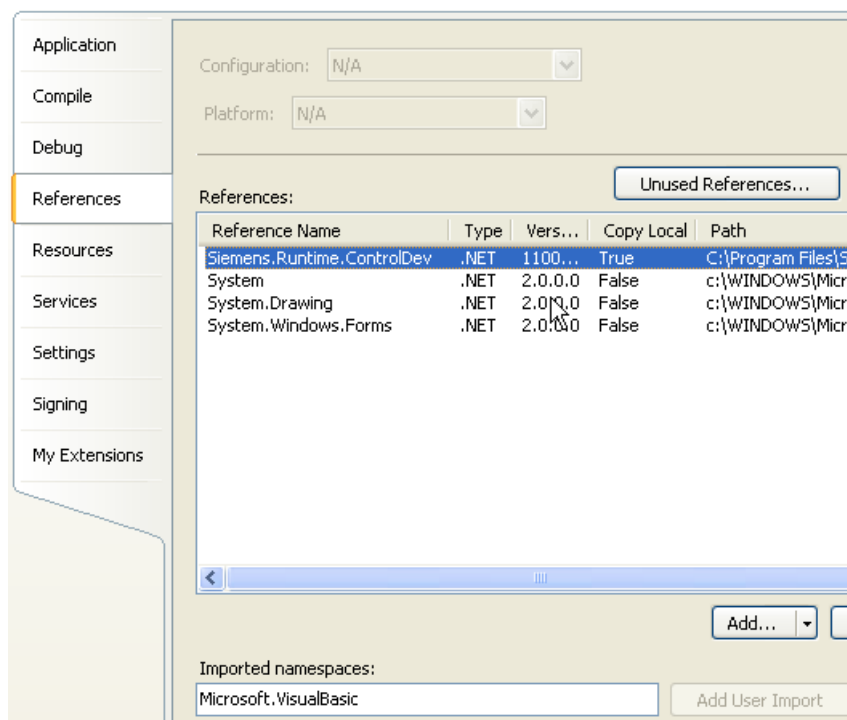

3. If the reference is not set, click on "Add...". In the "Add Reference" dialog, click "Browse".
4. In WinCC Runtime Professional, navigate to the directory "...\\Siemens\\WinCC\\bin". In WinCC Runtime Advanced, navigate to the directory "...\\WinCC Runtime Advanced".
5. Select the entry "Siemens.Runtime.ControlDev.dll". Click "OK".





**See also**

Interfaces (Page 5869)

**Creating a user interface**

**Settings**

For the configuration you require objects with the following settings:

Object	Quantity	Property	Setting
 GroupBox	1	Text	ReadTag
 Label	2	Text Text	TagName Value
 Textbox	2	(Name)	txtReadTagTagName
		(Name) ReadOnly	txtReadTagValue True
 Button	1	Text (Name)	Read btnReadTagStart

**Requirement**

- A VB.net project is open. The VB.net project uses the demo project as a template.
- The toolbox is displayed.
- The properties window is displayed.

**Procedure**

To create the user interface, follow these steps:

1. In Solution-Explorer, double-click the "CCITagTestLibrary > ITagUserControl.vb" item. The Form Designer opens.
2. Insert a GroupBox into the form from the tool window. Configure the GroupBox with the settings described above.
3. Insert two text box objects into the form from the tool window. Configure the objects with the settings described above.
4. Add two labels to the form. Configure the labels with the settings described above.
5. Add a button to the form. Configure the button with the settings described above.

## Result

The user interface for the "ITagUserControl" customer control has been created.



## Creating program code

### Introduction

To use customer control to access the WinCC tag values, implement the access to the ITag interface.

### Procedure

To create the program code, proceed as follows:

1. For access to the ITag interface, enter the following:

```
' ITag interface
Dim m_ITag As ITag ' get the Tagset Object from the container
m_ITag = Site.GetService(GetType(ITag))
' Connect to server
m_RegisterCookie = m_ITag.Register(Me)
```

1. Double-click the "btnReadTagStart" button in the Form Designer. The code window with the "btnReadTagStart\_click" subprocedure opens automatically.
2. Insert the following code between "Sub btnReadTagStart\_Click" and "End Sub".

```
Private Sub btnReadTagStart_Click(ByVal sender As Object, ByVal e As EventArgs)
    _Handles btnReadTagStart.Click
    Try
        Dim TagName As Object = "Tag_Test" ' name of the tag, e.g. coming from TextBox
        Dim Values As Object = m_ITag.ReadTag(m_RegisterCookie, TagName)
        Dim Value
```

```
Dim strResult
For Each Value In Values
    strResult = CStr(Value) ' the result of the ReadTag could be written in a TextBox
    (Enabled = False)
Next
Catch ex As Exception
    MsgBox("ReadTag:" & vbCrLf & ex.Message)
End Try
End Sub
```

## Result

Access to the ITag interface is implemented and the code for the button "btnReadTagStart" is created.

To access the ITag interface from Visual Studio, the ProgID of the data provider must be transferred.

- ProgID for WinCC Runtime Professional: CCITagControl.ITagControl.1
- ProgID for WinCC Runtime Advanced: FwTagDataProvider.FwTagDataProvider

Example:

```
' Create the TagServer Object
Dim oTagServer As Object = CreateObject("CCITagControl.ITagControl.1")
' Set the Tagset Object
m_ITag = oTagServer
```

You can find the full program code in the demo project "CCITagTestLibrary".

## Creating customer controls

### Procedure

To create the customer control, proceed as follows.

1. Double-click the "My Project" entry in the project folder explorer. The Project Designer opens.
2. Click on the "Compile" button in the Project Designer. Specify the destination directory for the DLL file for "Build output path".
3. Save the change in the VB.net project "CCITagTestLibrary".
4. Select the "CCITagTestLibrary" entry in the project folder explorer. Select the "Build" command in the shortcut menu.

## Result

The "ITagUserControl.dll" file is now located in the destination directory. The customer control "ITagUserControl" will be displayed in the toolbox.

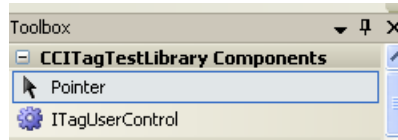

## Testing customer controls in Visual Studio

### Creating a WinCC project

#### Introduction

To test the "ITagUserControl" customer control, you will have to create the "HMI\_Variable\_1" tag and the "CC\_ITagUserControl" screen in WinCC.

#### Requirement

- WinCC project for WinCC RT Professional or WinCC RT Advanced has been created.
- The "CC\_ITagUserControl" screen has been created and opened.
- The internal tag "HMI\_Variable\_1" has been created.

#### Procedure

To create the WinCC project for the test, proceed as follows:

1. Add an I/O field in the "CC\_ITagUserControl" screen. Link the I/O field to the "HMI\_Variable\_1" tag.
2. Add a slider to the screen. Link the slider to the "HMI\_Variable\_1" tag.
3. Configure the "SetTag" system function at the "Change" event with the following settings.

Parameter	Setting
Tag (output)	HMI_Variable_1
Value	HMI_Variable_1

## Result

The "CC\_ITagUserControl" screen has been created. The tag value in the I/O field will be displayed when you use the slider in Runtime.

## Creating a test form

### Introduction

You cannot test the "ITagUserControl" customer control in the Visual Studio Form Designer. You need a test form to test the customer control.

### Requirement

"ITagUserControl" customer control has been created.

### Procedure

Proceed as follows to create a test form:

1. In Solution-Explorer " select the project folder "CCITagTestLibrary". Select "Add > New Project..." in the shortcut menu. The "Add new project" dialog opens.
2. In the left window "Project types" under "Other languages > Visual Basic", select the entry "Windows". In the right window "Templates" select the entry "Windows Forms Application".
3. Enter "TestCustomControl" as the "Name". Click "OK".
4. A test form opens. Insert the "ITagUserControl" control into the test form.
5. Double-click the "TestCustomControl > My Project" entry in the project folder explorer. The Project Designer opens.
6. Click on "References" in the Project Designer. Verify that the reference to "Siemens.Runtime.ControlDev.dll" has been set.  
Storage of file:
  - WinCC Runtime Professional: ...\\Siemens\\WinCC\\bin
  - WinCC Runtime Advanced: ...\\WinCC Runtime Advanced
7. Save the project

### Result

You have created the test form for testing the "ITagUserControl" customer control.

## Testing customer controls in Visual Studio

### Requirement

- WinCC runtime is started.
- Test form is created.

## Procedure

To test the customer control in Visual Studio, proceed as follows:

1. Start the test of the customer control with <F5>. The "Form1" form opens.
2. Enter "TK\_Test5" in the "TagName" field. Click "Read".

## Result

The tag value "TK\_Test5" will be displayed in the "Value" field. Move the slider to change the tag value in WinCC. The current tag value will be displayed in the I/O field. Click on "Read" to update the tag value in the customer control.

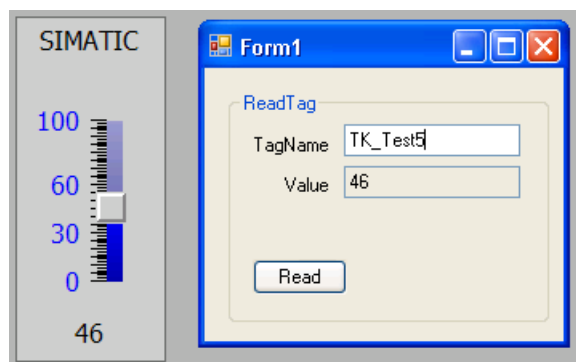

An error message will appear if you enter an incorrect tag name in the "TagName" field.

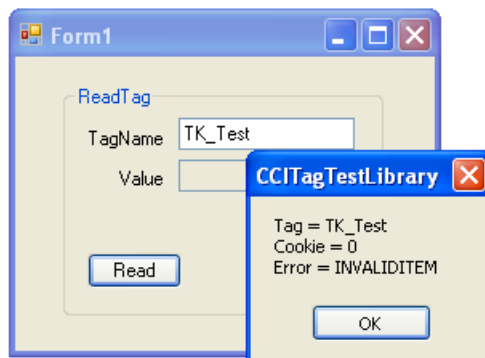

## Testing customer controls in WinCC

## Adding customer control in WinCC

## Introduction

To use customer controls in WinCC, you need to add them to the "My Controls" palette.

## Procedure

To add customer controls, proceed as follows:

1. Open a screen.
2. Select the "Select object" command in the shortcut menu of the "Tools" task card.
3. Click "Specific .Net Controls" in the "Select control" dialog. Navigate to the desired customer control, for example "ITagUserControl", in the "Select assembly" field.
4. Select the "ITagUserControl" customer control.
5. Click "OK".

## Result

The "ITagUserControl" customer control is displayed in the "My Controls" palette.

## Testing customer controls in WinCC

### Requirement

- The "CC\_ITagUserControl" screen has been created and opened.

## Procedure

To test the "ITagUserControl" customer control, proceed as follows:

1. Add a "ITagUserControl" to the screen.
2. Start WinCC Runtime with the start screen "CC\_ITagUserControl".
3. Move the slider. The new value is displayed in the I/O field.
4. Enter "TK\_Test5" in the "TagName" field.
5. Click on the button "Read".

## Result

The "ITagUserControl" customer control has been added. If you activate WinCC Runtime, the tag value is displayed in the "Value" field.



### 10.17.1.5 Reference

#### ITag methods

#### Register

#### Description

Registers the customer control as a consumer at the data provider. The consumer receives a cookie from the data provider. The cookie is used to assign a request from the data provider to a consumer.

#### Syntax

RegisterCookie Object.**Register** (CustomerControl)

#### Parameter

##### Object

Name of the ITag object

##### Customer Control

Name of the customer controls

#### Return value

##### RegisterCookie

Cookie to identify the consumer

#### ReadTag

#### Description

Reads the value of one or more tags at the same time.

#### Syntax

Values Object.**ReadTag**(RegisterCookie, TagNames)

#### Parameter

##### Object

Name of the ITag object

**RegisterCookie**

Cookie to identify the consumer

**TagNames**

Tag name

**Return value**

**Values**

Tag value

**ReadTagAsync**

**Description**

Reads the value of one or more tags asynchronously.

**Syntax**

Object.**ReadTagAsync** (RegisterCookie, TagNames, ClientCookies, CacheDevice)

**Parameter**

**Object**

Name of the ITag object

**RegisterCookie**

Cookie to identify the consumer

**TagNames**

Tag name

**ClientCookies**

Cookie for identification of tags

**CacheDevice**

This parameter is only evaluated by WinCC RT Professional.

0 = The tag value is read from the process image (cache).

1 = The tag value is read directly from the AS.

**See also**

OnDataChanged (Page 5889)

OnError (Page 5890)

## ReadTagCyclic

### Description

Cyclic reading of the tag values. The update cycle is used to determine how often the value is updated.

### Syntax

Object.**ReadTagCyclic** (RegisterCookie, TagNames, UpdateRates, ClientCookies, ServerCookies)

### Parameter

#### Object

Name of the ITag object

#### RegisterCookie

Cookie to identify the consumer

#### TagNames

Tag name

#### UpdateRates

Update cycle of the tags. The value is entered in milliseconds.

#### ClientCookies

Cookie for identification of tags

### Return value

#### ServerCookies

Cookie for identification of tags The return value is used by the ITag method "RemoveCyclicTag (Page 5885)".

### See also

OnDataChanged (Page 5889)

OnError (Page 5890)

## RemoveCyclicTag

### Description

Removes one or more tags.

## Syntax

Object.**RemoveCyclicTag** (RegisterCookie, ServerCookies)

## Parameter

### Object

Name of the ITag object.

### ServerCookies

Cookie for identification of tags

## See also

ReadTagCyclic (Page 5883)

OnRemoved (Page 5890)

## Cancel

## Description

Cancels the cyclic reading of the tag values.

## Syntax

Object.**Cancel** (RegisterCookie)

## Parameter

### Object

Name of the ITag object

### RegisterCookie

Cookie to identify the consumer

## See also

OnCanceled (Page 5888)

## WriteTag

## Description

Writes values to one or more tags at the same time.

## Syntax

Object.**WriteTag**(RegisterCookie, TagNames, Values)

## Parameter

### Object

Name of the ITag object

### RegisterCookie

Cookie to identify the consumer

### TagNames

Tag name

### Values

Values written to the tags

## WriteTagAsync

## Description

Writes values to one or more tags asynchronously.

## Syntax

Object.**WriteTagAsync**(RegisterCookie, TagNames, ClientCookies, Values)

## Parameter

### Object

Name of the ITag object

### RegisterCookie

Cookie to identify the consumer

### TagNames

Tag name

### ClientCookies

Cookie for identification of tags

### Values

Values written to the tags

### See also

OnError (Page 5890)

### Unregister

#### Description

Removes the consumer.

#### Syntax

Object.**Unregister** (RegisterCookie)

#### Parameter

##### Object

Name of the ITag object

##### RegisterCookie

Cookie to identify the consumer

### ITag methods

#### OnCanceled

#### Description

Occurs when the ITag method "Cancel (Page 5884)" has ended.

#### Syntax

Object.**OnCanceled** (RegisterCookie)

#### Parameter

##### Object

Name of the ITagSink object

##### RegisterCookie

Cookie to identify the consumer

## OnDataChanged

### Description

Occurs when a tag is changed by the following ITag methods.

- ReadTagAsync (Page 5882)
- ReadTagCyclic (Page 5883)

### Syntax

Object.**OnDataChanged** (RegisterCookie, TagNames, Values, Qualities, VarStates, TimeStamps, ClientCookies)

### Parameter

#### Object

Name of the ITagSink object

#### RegisterCookie

Cookie to identify the consumer

#### TagNames

Tag names

#### Qualities

Quality code of the tags

#### VarStates

Tag status of the tags

#### TimeStamps

Time stamp

#### ClientCookies

Cookie for identification of tags

### See also

OnError (Page 5890)

## OnError

### Description

Occurs as an event of an error with the following methods:

- ReadTagAsync (Page 5882)
- ReadTagCyclic (Page 5883)
- WriteTagAsync (Page 5885)
- OnDataChanged (Page 5887)
- OnWriteComplete (Page 5891)

### Syntax

Object.**OnError** (RegisterCookie, TagNames, ClientCookies, Errors)

#### Object

Name of the ITagSink object

#### RegisterCookie

Cookie to identify the consumer

#### TagNames

Tag names

#### ClientCookies

Cookie for identification of tags

#### Errors

Error code

## OnRemoved

### Description

Occurs when the ITag method "RemoveCyclicTag (Page 5883)" has ended.

### Syntax

Object.**Remove**(RegisterCookie, ClientCookies)

### Parameter

#### Object

Name of the ITagSink object



**RegisterCookie**

Cookie to identify the consumer

**ClientCookies**

Cookie for identification of tags

**OnWriteComplete**

**Description**

Occurs when the ITag method "WriteTagAsync (Page 5885)" has finished.

**Syntax**

Object.**OnWriteComplete**(RegisterCookies, TagNames, ClientCookies)

**Parameter**

**Object**

Name of the ITagSink object

**RegisterCookie**

Cookie to identify the consumer

**TagNames**

Tag names

**ClientCookies**

Cookie for identification of tags

**See also**

OnError (Page 5888)

## 10.17.2 OPC

### 10.17.2.1 Basics

#### OPC

##### Introduction

OPC refers to standardized manufacturer-specific software interfaces for data exchange in automation engineering.

The OPC interfaces provide a standardized environment in which devices and applications from various manufacturers can be linked.

OPC is based on the Windows technology COM (Component Object Model) and DCOM (Distributed Component Object Model).

OPC UA (Unified Architecture) is the technology succeeding OPC. OPC UA is platform-independent and can use different reports as a communication medium.

##### Principle of operation

In WinCC, you can configure HMI devices as OPC servers or OPC clients. The particular HMI device determines which OPC servers and OPC clients are available.

##### OPC Specifications

OPC specifies interfaces to gain access to the following objects in WinCC:

- Process values (OPC Data Access 1.0, 2.05a)
- Process values (DataAccess ClientFacet (OPC UA))
- Process values (OPC XML-Data Access 1.01)

You can find additional information about the individual OPC specifications in the Internet at the website of OPC Foundation:

- [www.opcfoundation.org](http://www.opcfoundation.org) ([www.opcfoundation.org](http://www.opcfoundation.org))

##### See also

Supported OPC UA services of the OPC UA client (Page 5904)

##### Compatibility

Support of the mentioned specifications is checked regularly by the "Compliance Test Tool" (CTT) of the OPC Foundation. Interoperability with OPC products of other manufacturers is ensured through the participation in "OPC Interoperability Workshops".

The test results submitted are published on the website of the OPC Foundation. The results can be called up from there using the search term "OPC Self-Certified Products".

## Using OPC in WinCC

### Configuration option

HMI devices configured with WinCC feature an OPC interface for data communication between automation devices or automation systems using the OPC communication driver.

You can use an HMI device as an OPC server and/or as an OPC client. As an OPC client, the HMI device can be connected to a maximum of eight OPC servers.

The software ensures up to eight client HTTP connections for an OPC XML DA server on a Multi Panel. For the exchange of data via an XML connection, some OPC XML DA clients create several HTTP connections to the OPC XML DA server.

HMI device	Data exchange over	Operating system	OPC server	OPC client
PC, Panel PC (with WinCC Runtime Advanced)	DCOM or OPC UA binary (TCP/IP)	Windows XP / 7	OPC DA server	OPC DA client OPC UA Client
MP 277, MP 377 Mobile Panel 277	SOAP	Windows CE	OPC XML DA Server	-
Comfort Panel	SOAP or OPC UA binary (TCP/IP)	Windows CE	OPC XML DA Server	OPC UA Client

\*: The OPC UA client exchanges data via TCP/IP.

A communication via DCOM is only possible between HMI devices of the "PC" or the "Panel PC" type. In order for a control room PC to display the process values of Windows CE HMI devices in the plant, for example, install "OPC-XML-Gateway" on the control room PC using the WinCC Runtime Advanced Setup. The "OPC-XML-Gateway" supports the communication within the SIMATIC HMI devices family between an OPC DA client and an OPC XML DA server.

The area pointer is supported by any OPC connection.

### OPC server accessibility

The following table lists the available OPC servers and how you can access them:

OPC server	OPC server name
OPC DA server	OPC.SimaticHMI.CoRtHmiRTm (ProgID)
OPC XML DA Server	http://<xxx>/soap/OpcXml (URL) <sup>1</sup> <xxx>: IP address or DNS name of the HMI device
OPC DA server	OPC.Siemens.XML (ProgID) for accessing the OPC XML DA server via the OPC XML gateway from an OPC DA client

<sup>1</sup>: For the access of an external OPC DA XML client.

### HMI device as OPC client

To use an HMI device as an OPC client, create an "OPC" connection in the WinCC project. The OPC client accesses the tags of the OPC server over this connection. You need a separate connection for each OPC server.

The following exception applies here:

If you want to connect your OPC DA client to multiple panels, you only need one OPC connection to the OPC XML gateway in your project. The multiplexing of the connection to multiple OPC XML connections to individual panels takes place in the OPC XML62 gateway. You configure the connections to the panels using the OPC XML Manager.

The following figure shows the use of an HMI device as a central operator control and monitoring device:

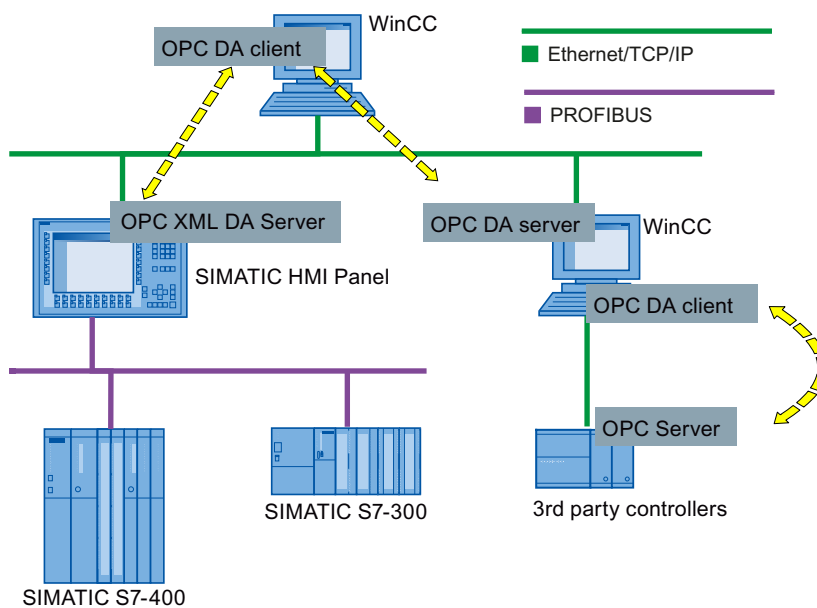

### HMI device as OPC server

An HMI device as OPC server makes the data available to other applications. The applications can run on the same HMI device or on HMI devices in the connected network environment.

The following schematic diagram shows the use of MS Excel as an OPC client that displays process values of the OPC server:

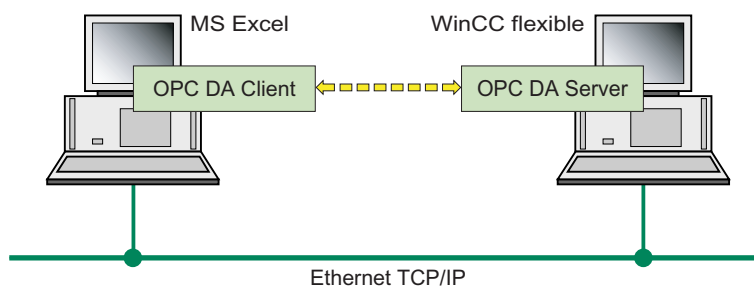

**See also**

Configuring an HMI device as OPC DA server (Page 5895)

Creating a connection to a WinCC OPC DA server (Page 5897)

OPC XML Gateway (Page 5900)

**10.17.2.2 Configuring an OPC server****Configuring an HMI device as OPC DA server****Introduction**

Which OPC server is used depends on the HMI device:

- For HMI devices with Windows XP / 7, the OPC DA server is used.
- For HMI devices with Windows CE, the OPC XML DA server is used

The following figure shows the two methods of accessing an OPC server:

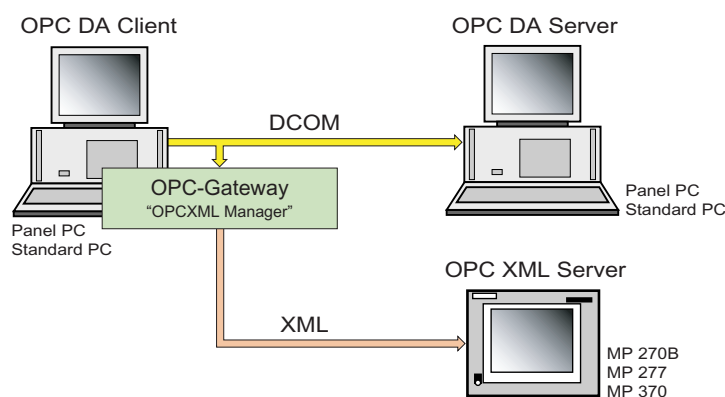
**Procedure**

To configure an HMI device as an OPC server, proceed as follows:

1. Open the "Runtime settings" of the HMI device in the project tree.
2. Select the "Operate as OPC server" option in the "Runtime settings" under "Services > Write/read tags".
3. Save the project.
4. Download the project to the HMI device.
5. Start runtime on the HMI device.

## Result

The OPC server is accessible. If an OPC client connects to the OPC server, the OPC server on the HMI device is started.

## See also

Loading a project (Page 5602)

Starting Runtime Advanced and Panels (Page 5614)

Using OPC in WinCC (Page 5891)

Creating a connection to a WinCC OPC DA server (Page 5897)

## Configuring DCOM user permissions in Windows

### Introduction

The OPC DA client and OPC DA server are DCOM applications, whose security settings must be set in compliance with the DCOM security mechanisms:

- The OPC client needs launch/activation rights and access rights for the OPC DA server.
- The OPC DA server only needs access rights for the OPC DA client

The following must be known on the PCs of the OPC DA server and the OPC DA client respectively:

- The user account for which the OPC DA client is executed

### Requirement

You have administrator rights.

### Procedure

The procedure for configuring DCOM user rights is described in the document (<http://www.opcfoundation.org/DownloadFile.aspx?CM=3&RI=326&CN=KEY&CI=282&CU=14>) of the OPC-Foundation.

For additional information on granting user rights, refer to the documentation for Windows XP, Windows Vista, or Windows 7.

### 10.17.2.3 Configuring an OPC client

#### Creating a connection to a WinCC OPC DA server

##### Introduction

For an HMI device to access the OPC server data of another HMI device, you need to create a connection to this OPC server in the WinCC project. Depending on the target HMI device used, either an OPC DA server or an OPC XML DA server is employed.

The following figure shows the two methods for accessing the OPC servers of the HMI devices:

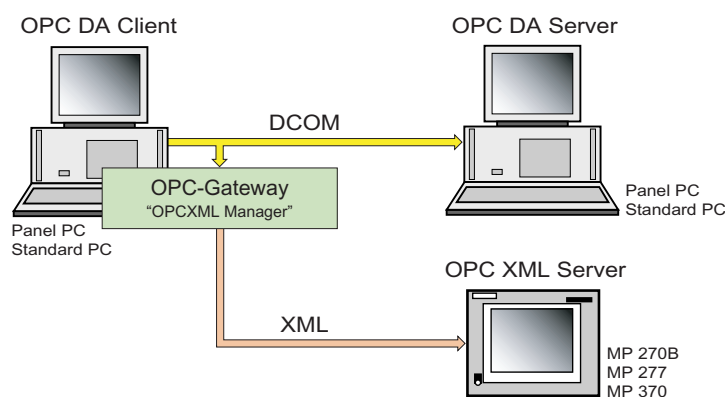

If a connection to one or more OPC XML DA servers is created using an OPC XML gateway, also enter the OPC XML DA servers in the "OPC XML Manager".

##### Requirement

- An HMI device is configured as an OPC server.
- The project on the HMI device is in runtime.
- For connections to a OPC XML DA server: "OPC-XML-Gateway" is installed on the configuration PC and the HMI device with the OPC client.

##### Procedure

To create a connection to an OPC server of an HMI device, follow these steps:

1. Open the "Connections" editor on the configuration PC in the WinCC project of the OPC client.
2. Create a new connection and enter a meaningful name.

3. Select the entry "OPC" as the "Communication driver".
4. Enter the communication partner under "Parameters > OPC server" in the work area:
  - If the connection communicates directly with the OPC server or with the OPC server on a PC-based HMI device, select the "OPC.SimaticHMI.CoRtHmiRTm" item from the list.
  - If the connection communicates directly with the OPC server of a Windows CE HMI device, select "OPC.Siemens.XML" from the list.
  - If the OPC server is installed on a remote computer, enter the computer's IP address or name under "Remote computer name".

## Result

The OPC connection is configured. To access the data on the WinCC OPC DA server, create tags.

## See also

Using OPC in WinCC (Page 5891)

Configuring an HMI device as OPC DA server (Page 5893)

OPC XML Gateway (Page 5900)

Configuring an OPC XML Manager (Page 5901)

## Creating a connection to an OPC UA server

### Introduction

The OPC UA client can access process data in the hierarchical name space of an OPC UA server.

For the OPC UA client to access the process values of an OPC UA server, the OPC UA server and the OPC UA client authorize each other by exchanging certificates. In addition, you can encode the data transfer.

The OPC UA client usually classifies each certificate of an OPC UA server as a "trustworthy". How an OPC UA server responds to a connection request of the OPC UA client depends on the configuration of the OPC UA server.

In order to establish communication to an OPC UA server, inform yourself from the OPC UA server operator about the following:

- URL of the OPC UA server
- Security settings
- Required certificates

### Requirement

URL and security settings of the OPC UA server are known.



## Procedure

To create a connection to an OPC UA server, proceed as follows:

1. Open the "Connections" editor on the HMI device.
2. Create a new connection and enter a meaningful name.
3. Select the entry "OPC UA" as the "Communication driver".
4. In the work area, under "Parameters", configure the "OPC server":
  - Specify the "Discovery URL" of the OPC UA server or select the OPC UA server from the list.
  - Select the "Security policy"
  - Select the "Message security mode"

## Result

The OPC UA connection is configured. You create tags to access data from the OPC UA server.

## See also

Supported OPC UA services of the OPC UA client (Page 5904)

## Accessing process values of an OPC server

### Requirement

- The OPC server to be addressed is ready-to-operate and in the "running" status
- A connection to the OPC-Server is created

## Procedure

To access process values of an OPC-Server via the OPC connection, follow these steps:

1. On the configuration PC in the project navigation, open the "HMI tags" editor under the HMI device that you use as an OPC client.
2. Create a tag with the same data type as the tag on the OPC server.
3. Select the OPC connection for "Connection".
4. Enter the "Address", or select the desired tag on the OPC server via the object list.

## Result

If you launch Runtime on the HMI device, the process value from the OPC server will be written to the tag on the HMI device via the OPC connection.

## See also

Permitted data types (OPC) (Page 5902)

Access to tags with OPC (Page 5903)

## OPC XML Gateway

### Usage

The OPC DA client uses the "OPC XML Gateway" so that the OPC DA client can communicate with the OPC XML DA server. The "OPC XML Gateway" compiles the data in the respective "language" of the corresponding standard. The "OPC XML Gateway" communicates exclusively with the OPC XML DA server which runs on an SIMATIC HMI device.

### Installation

To install "OPC XML Gateway", activate the "OPC XML Gateway" entry during installation of WinCC runtime advanced in the component selection. To install "OPC XML Gateway" afterwards, re-execute the setup of WinCC Runtime Advanced.

### Proxy setting for the OPC XML Gateway

The configuration settings for the OPC XML Gateway can be found in the "SOPCSRVR.ini" file in the section "[Configuration]". The OPC XML Gateway is configured by default on the PC as the HMI device, so that a proxy server configured in the Internet settings of Internet Explorer is ignored:

NOPROXY=1

If this entry is set to "0", the OPC XML Gateway uses a configured proxy server for HTTP connections.

You can find the "SOPCSRVR.ini" file in the folder "C:\Program Files\Siemens\Automation\WinCC RT Advanced".

---

#### Note

When data is requested from an HMI device that cannot be accessed over the configured proxy server, the OPC XML Gateway uses a direct connection after a Timeout. The direct connection is set up again on every request for data and slows down OPC communication significantly.

---

## See also

Configuring an OPC XML Manager (Page 5901)

Using OPC in WinCC (Page 5891)

## Configuring an OPC XML Manager

### Introduction

The OPC XML DA server, to which the OPC DA client has access, is administered in the "OPC XML Manager". The OPC XML Manager can be found in the Windows Start menu under "SIMATIC > OPC-XML-Gateway > OPC XML Manager".

To enter an OPC server, you need the following information:

- Server prefix  
Any string that is used in the name of the OPC tag. Use an abbreviation of the server, for example. You can find the characters permitted for tag names in the reference.
- Name or IP address of the OPC XML DA server

### Requirement

"OPC XML Manager" is open.

### Procedure

To configure the OPC XML Manager, proceed as follows:

1. To enter a new OPC XML DA server, click on the button "Add".  
The "Add/Edit Webservice" dialog is opened.
2. Enter the server prefix and the name or IP address of the OPC XML DA server.
3. Close the two dialogs with "OK".

### Result

The OPC XML DA server is entered. The OPC DA client can now access the data of the OPC XML DA server via the "OPC XML Gateway".

### Editing or removing an OPC server

To edit or delete a configured OPC XML DA server, select the required OPC XML DA server. Then click either "Edit" or "Remove" .

### See also

OPC XML Gateway (Page 5898)

### 10.17.2.4 Reference

#### Permitted data types (OPC)

##### Permitted data types

The following table lists the data types supported by the WinCC OPC servers:

OPC data type	WinCC data type
VT_BOOL	BOOL
VT_I1	CHAR
VT_UI1	BYTE
VT_I2	SHORT
VT_UI2	WORD
VT_UI4	DWORD
VT_I4	LONG
VT_R4	FLOAT
VT_R8	DOUBLE
VT_DATE	DATE
VT_BSTR	STRING

The following table lists the ranges of values of the OPC data types:

OPC data type	Range of values
VT_BOOL	0 or -1
VT_I1	-128 to 127
VT_UI1	0 to 255
VT_I2	-32768 to 32767
VT_UI2	0 to 65535
VT_I4	-2147483648 to 2147483647
VT_UI4	0 to 4294967295
VT_R4	3.402823466 e-38 through 3.402823466 e+38
VT_R8	1.7976931486231e-308 to 1.7976931486231e+308
VT_Date	1 January 100 to 31 December 9999

#### Special features in communication with the OPC-DA server

The array tag in the OPC-DA server belonging to the area pointer must be of the data type SHORT (VT\_I2).

#### Special features in communication with the OPC-XML server

Array tags are not supported by OPC-XML servers.

## Access to tags with OPC

### Introduction

When accessing tags with OPC, note the following when configuring tags:

- Permitted characters in tag names
- Permitted cycle times (OPC XML)
- Special features of the data type "STRING" (OPC XML)
- Special features of the data type "Date/Time" (OPC XML)

The OPC XML DA server is tested and enabled for eight connections, each with 2 groups and consisting of 35 tags.

### Permitted characters in tag names

Only use the following characters in tag names:

- Letters from "a" to "z" (no umlauts)
- Numbers from "0" to "9"
- Special characters: "-" and "\_"

### Permitted cycle times (OPC XML)

OPC XML connections are designed for the exchange of small volumes of data:

- For this reason use cycle times that are greater than one second
- In general, only request a small number of tags; a maximum of 30 per screen

### Special features of the data type "STRING" (OPC XML)

Only valid ASCII values from 0x20hex to 0x7Fhex are supported in the data type "STRING".

### Special features of the data type "Date/Time" (OPC XML)

Values of the data type "Date/Time" are always expected as UTC (Universal Time Coordinated) by the OPC-Gateway. If a tag of the type "Date/Time" is read by the OPC client, the returned value is a time in UTC. If a value is written to the tag, the value is treated as UTC. The time including the time zone and daylight saving time are shown as "local time" on an HMI device.

Example:

The time zone GMT+1 and daylight saving time is set on the HMI device.

OPC DA client (UTC time): 01.01.2005 16:00

Display on the HMI device (OPC server): 01.01.2005 18:00

## Supported OPC UA services of the OPC UA client

### OPC UA Services support

The OPC UA client supports the following OPC UA services:

- SecurityPolicy - Basic128Rsa15
- SecurityPolicy - Basic256
- SecurityPolicy - None
- DataAccess ClientFacet

You can additional information about OPC UA services in the "OPC UA Part 3 - Address Space Model 1.01 Specification" document under "§5.6".

### Explanation of the security settings

The following table lists the security settings supported by the OPC UA client:

SecurityPolicy	Message Security Mode		
None <sup>1</sup>	None		
Basic128Rsa15 <sup>2</sup>	None <sup>4</sup>	Sign <sup>5</sup>	SignAndEncrypt <sup>6</sup>
Basic256 <sup>3</sup>	None	Sign	SignAndEncrypt
1: The certificate exchange is disabled. Every OPC UA client can log on to the WinCC OPC UA server. This setting can be disabled on each OPC UA server.			
2: Certificate exchange with depth of encryption of 128 bit.			
3: Certificate exchange with depth of encryption of 256 bit.			
4: The data packages are exchanged after certificate check unsecured between client and server.			
5: The data packages are signed with the certificates, but not encoded			
6: The data packages are signed with the certificates and encoded			

---

#### Note

##### Unsecured communication between client and server possible

Use the "none" setting only for test and diagnostics purposes.

For a secure communication between client and server, use in operating mode at least the following settings:

- SecurityPolicy: Basic128Rsa15
  - Message Security Mode: Sign
- 

### See also

Creating a connection to an OPC UA server (Page 5896)

## 10.18 Migration to WinCC V12

### 10.18.1 Overview of migration to WinCC V12

#### Overview of the section "Migration to WinCC V12"

SIMATIC WinCC V12 offers a number of functional changes. Some functions differ from the functions that you know from familiar environments such as WinCC V7 or WinCC flexible.

This document provides an overview of the special functions and procedures in SIMATIC WinCC V12.

These functions and procedures are fundamentally different from the WinCC V7 and WinCC flexible version, or have a different name.

### 10.18.2 WinCC flexible

#### 10.18.2.1 Libraries

##### Libraries in WinCC flexible

Libraries are a collection of pre-configured screen objects. They expand the number of available screen objects and increase engineering efficiency, because library objects are always available for reuse; there is no need to reconfigure them.

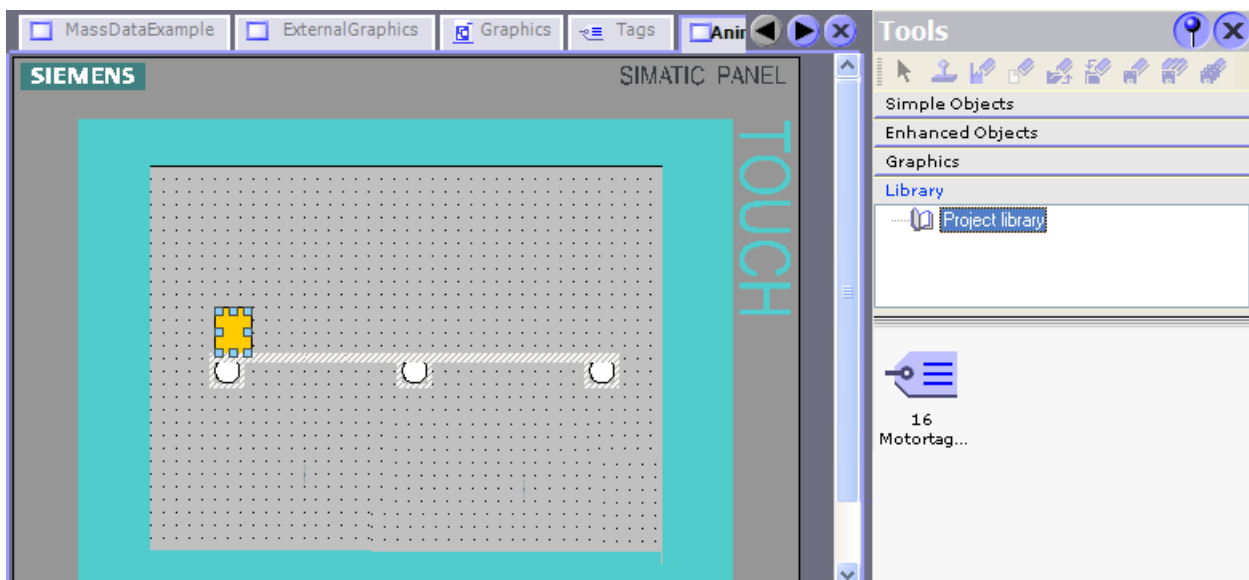

WinCC flexible enables you to create two library types:

- Project library
- Global library

A library can contain all the WinCC flexible objects, such as screens, tags, graphic objects, or alarms.

### How do I configure libraries in WinCC V12?

In WinCC V12, you also configure the "Project library" and the "Global library".

You can no longer store any system functions in libraries, as was the case in WinCC flexible.

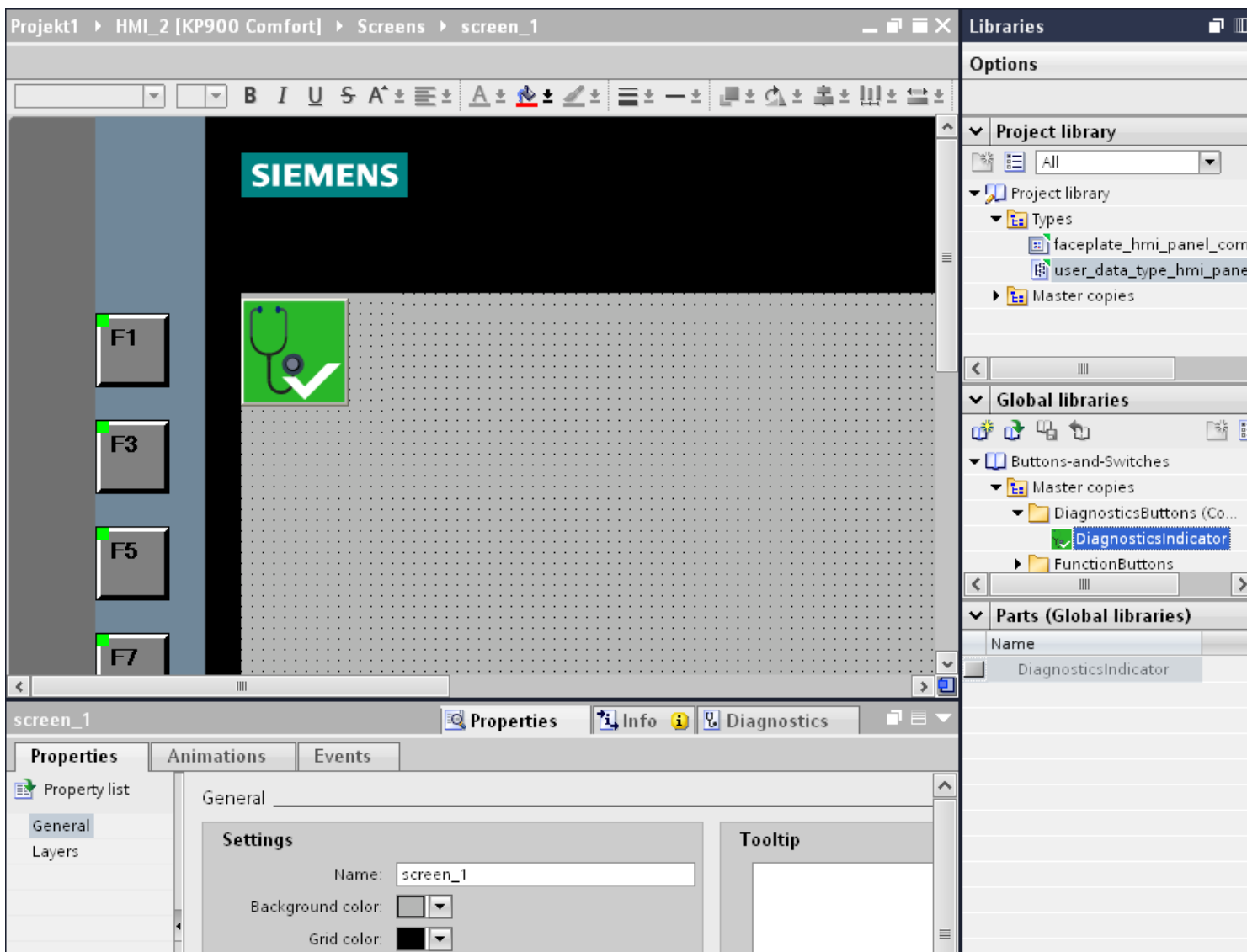

Both the "Project library" and the "Global library" contain the two folders, "Copy templates" and "Types". You can create or use the library objects as a copy template, or as a type.



- **Copy templates**  
Use copy templates to create independent copies of the library object.
- **Types**  
Create instances of objects of the "Types" folder and use the instances in your project. The instances are bound to their respective type. Changes to an instance also change all other instances. Types are marked by a green triangle in the "Libraries" task card.
- **Managing the library objects**  
You can only copy and move library objects within the same library.

For more detailed information, see:

Libraries in WinCC (Page 5491)

### 10.18.2.2 Screens and templates

#### Screens and templates in WinCC flexible

In WinCC flexible, you create screens that an operator can use to control and monitor machines and plants. When you create your screens, the object templates provided support you in visualizing your plant, displaying processes and defining process values.

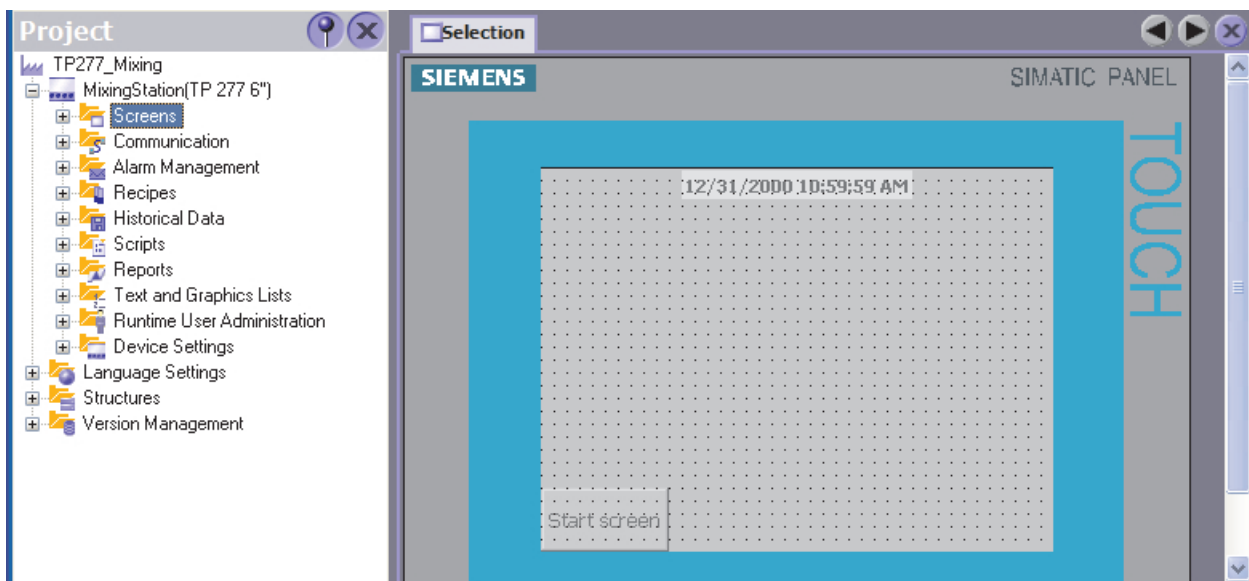

The project has a template for every HMI device. You can centrally configure the function keys and objects for your project in these templates.

Every screen based on this template will contain the function keys and objects that you configured in the template. Changes to an object or of a function key assignment in the template are applied to the object in all the screens, which are based on this template.

#### How do I configure screens and templates in WinCC V12?

In WinCC V12, you also configure "Templates" and a "Global screen" along with the "Screens".

You determine functions and objects in the template which then apply to all screens based on this template. You can create multiple templates in WinCC.

In the "Global screen", define the elements which are independent of the template used for all screens of an HMI device. The "Alarm window" and "Alarm indicator" objects are available for use as global objects. For HMI devices with function keys, configure the function keys in the "Global Screen" editor.

You can also configure a "System Diagnostic Window" in the global screen of Comfort Panels.

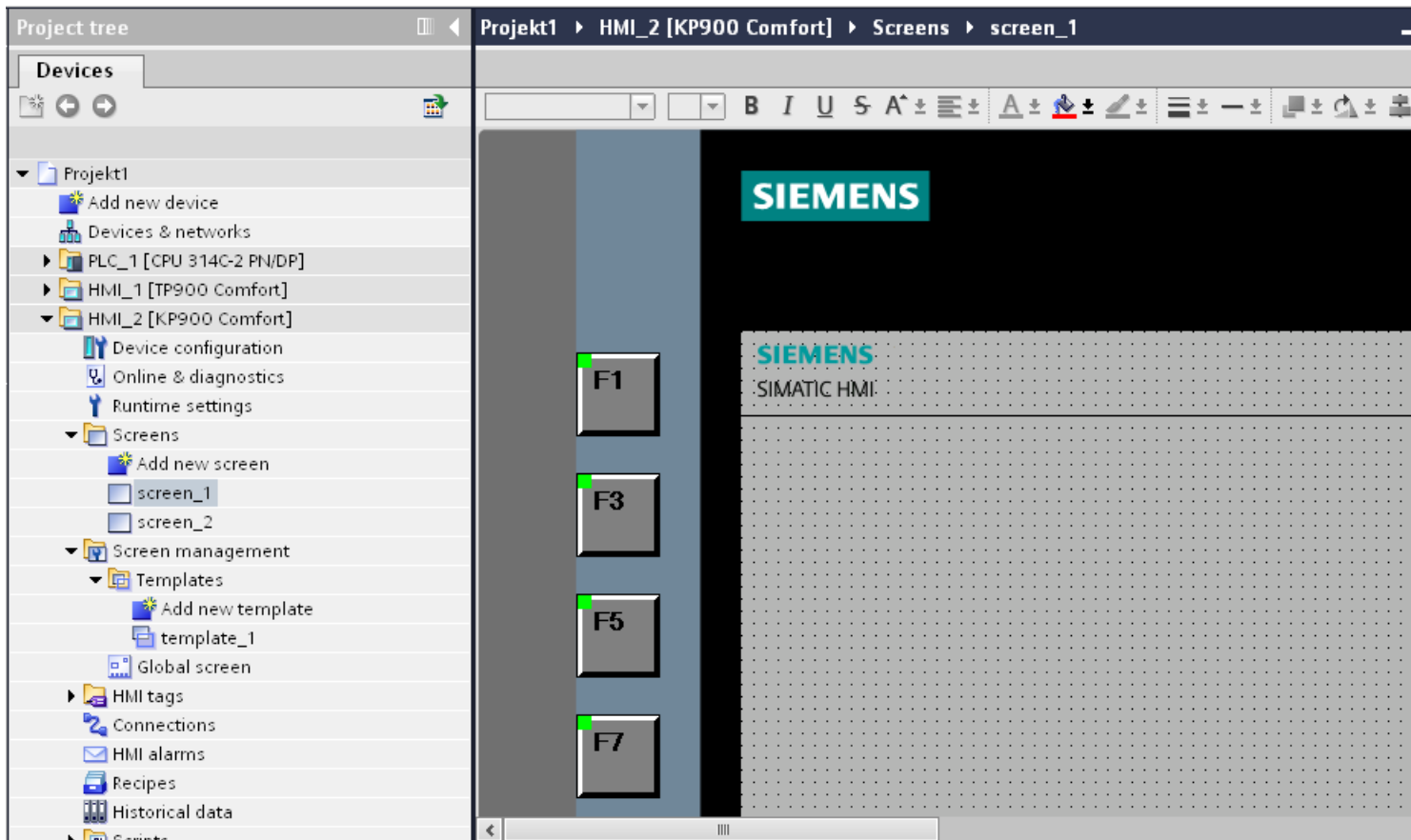

Excluding the controls, the screens are displayed in runtime in the following order:

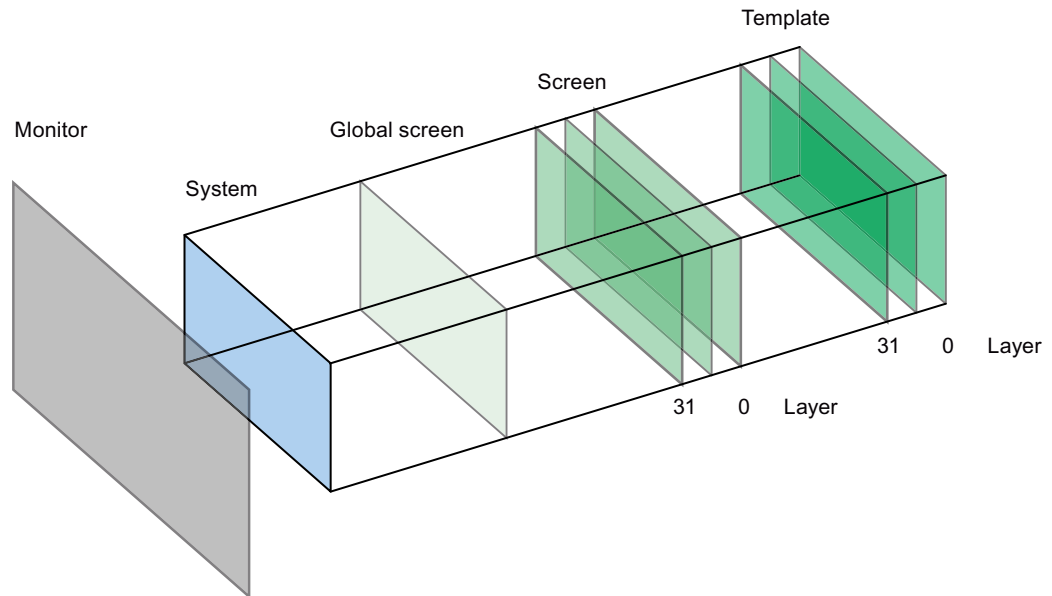

For more detailed information, see:  
Screen basics (Page 2931)

### 10.18.2.3 Scripts in faceplates

#### Scripts in faceplates in WinCC flexible

You configure a script in the "Scripts" tab of the "Faceplate configuration" dialog. These scripts are only available within the faceplate.

Interconnect the script directly to the events of the objects contained in the faceplate, for example, with the "Click" event of a button. If you use the faceplate in a screen, a faceplate instance is generated.

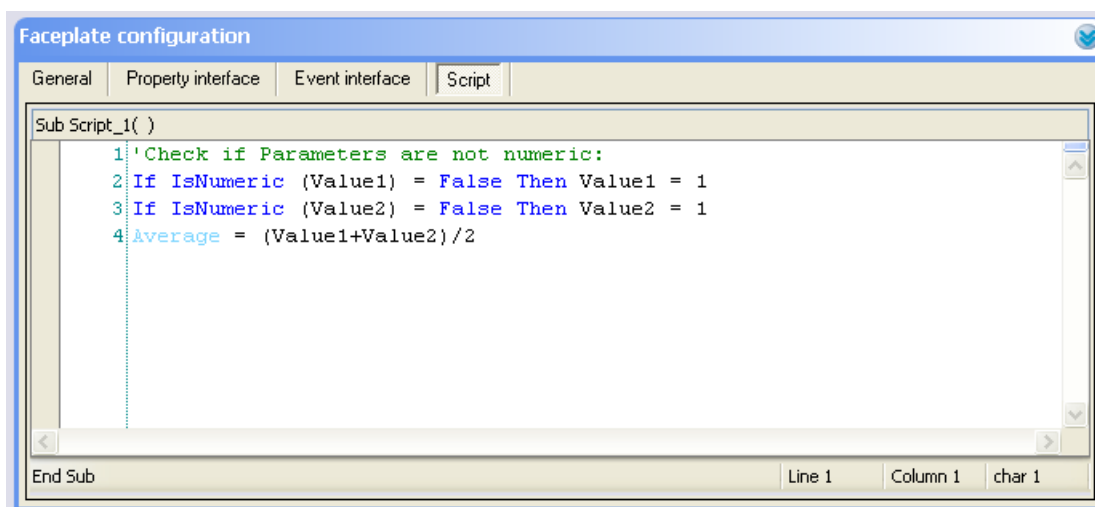

### How do I configure scripts in faceplates in WinCC V12?

In the configuration area of the "Faceplates" editor, you create scripts that you only use within a faceplate type.

In contrast to WinCC flexible, WinCC V12 allows you to configure several scripts for a faceplate.

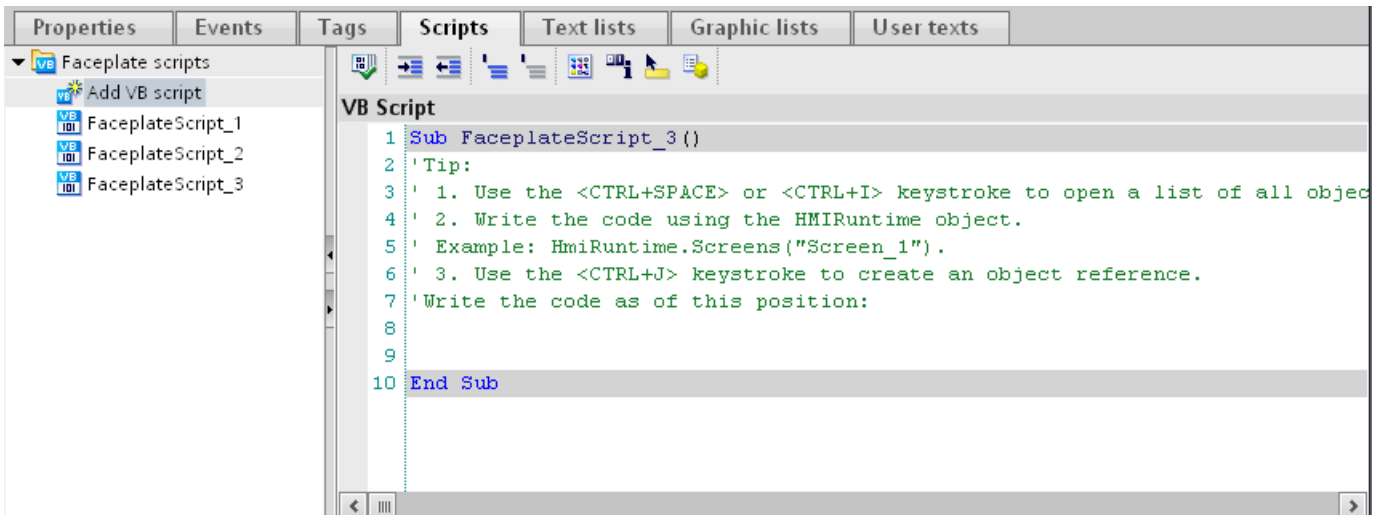

For more detailed information, see:

Example: Creating a script in the faceplate type (Page 3073)

### 10.18.2.4 Synchronization of recipes

#### How do I configure the synchronization of recipes in WinCC V12?

You configure the synchronization of recipes in the "Recipes" editor in WinCC V12. A few terms have changed in WinCC V12 compared to WinCC flexible.

#### Synchronization for Panels and RT Advanced

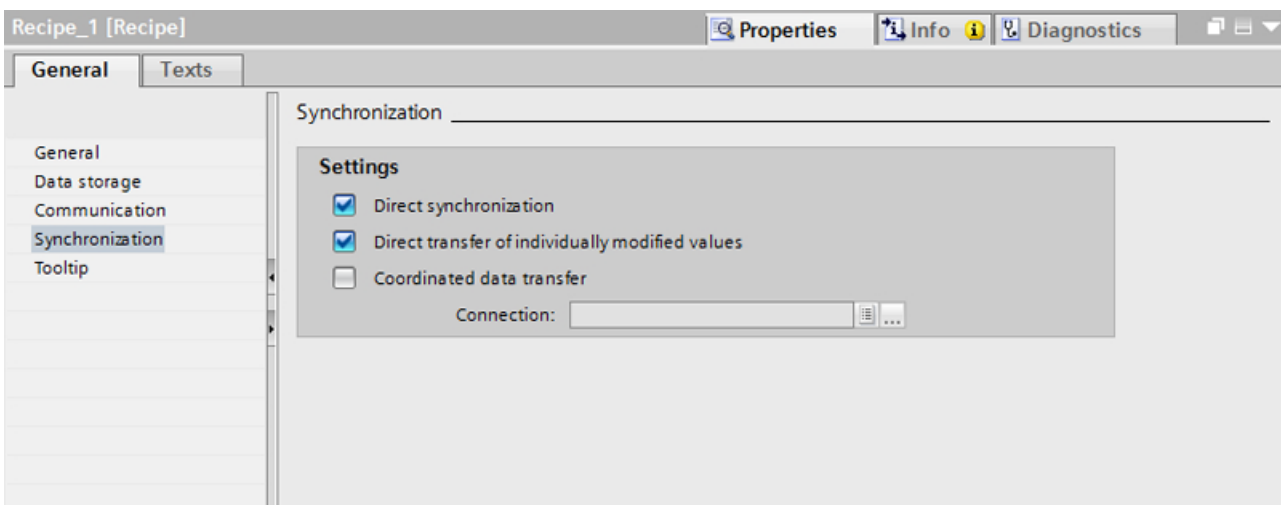

- To synchronize recipe tags that are configured in I/O fields with the recipe view, activate "Direct synchronization".
- Disable "Direct transfer of individually modified values" to specify that the recipe tags are automatically transferred to the controller when you edit the I/O fields.
- Activate "Coordinated data transfer" to monitor the transfer of recipe data in runtime using area pointers.

For more detailed information, see:

Synchronization of recipe data records with the PLC (Page 3403)



## Using technology functions

### 11.1 PID control

#### 11.1.1 Principles for control

##### 11.1.1.1 Controlled system and actuators

#### Controlled system

Room temperature control by means of a heating system is a simple example of a controlled system. A sensor measures the room temperature and transfers the value to a controller. The controller compares the current room temperature with a setpoint and calculates an output value (manipulated variable) for heating control.

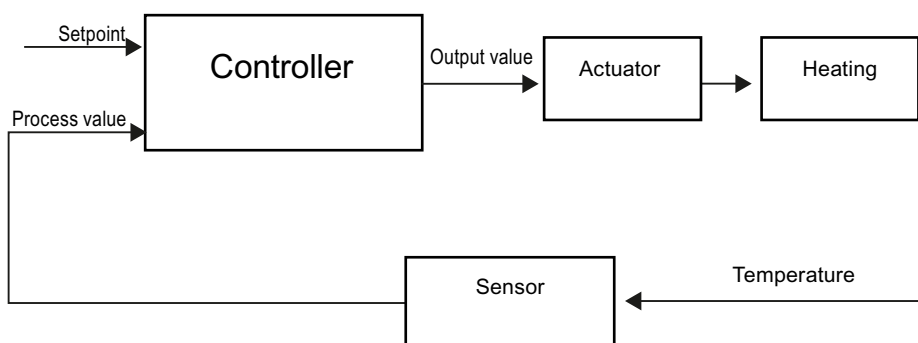

A properly set PID controller reaches this setpoint as quickly as possible and then holds it a constant value. After a change in the output value, the process value often changes only with a time delay. The controller has to compensate for this response.

#### Actuators

The actuator is an element of the controlled system and is influenced by the controller. Its function modifies mass and energy flows.

The table below provides an overview of actuator applications.

Application	Actuator
Liquid and gaseous mass flow	Valve, shutter, gate valve
Solid mass flow, e.g., bulk material	Articulated baffle, conveyor, vibrator channel
Flow of electrical power	Switching contact, contactor, relay, thyristor
	Variable resistor, variable transformer, transistor

Actuators are distinguished as follows:

- Proportional actuators with constant actuating signal  
These elements set degrees of opening, angular positions or positions in proportion to the output value. The output value has an analog effect on the process within the control range. Actuators in this group include spring-loaded pneumatic drives, as well as motorized drives with position feedback for which a position control system is formed.  
An continuous controller, such as PID\_Compact, generates the output value.
- Proportional actuators with pulse-width modulated signal  
These actuators are used to generate the output of pulses with a length proportional to the output value within the sampling time intervals. The actuator - e.g. a heating resistor or cooling apparatus - is switched on in isochronous mode for durations that differ depending on the output value.  
The actuating signal can assume unipolar "On" or "Off" states, or represent bipolar states such as "open/close", "forward/backward", "accelerate/brake".  
The output value is generated by a two-step controller such as PID\_Compact with pulse-width modulation.
- Actuators with integral action and three-step actuating signal  
Actuators are frequently operated by motors with an on period that is proportional to the actuator travel of the choke element. This includes elements such as valves, shutters, and gate valves. In spite of their different design, all of these actuators follow the effect of an integral action at the input of the controlled system.  
A step controller, such as PID\_3Step, generates the output value.

### 11.1.1.2 Controlled systems

The properties of a controlled system can hardly be influenced as these are determined by the technical requirements of the process and machinery. Acceptable control results can only be achieved by selecting a suitable controller type for the specific controlled system and adapting the controller to the time response of the controlled system. Therefore, it is indispensable for the configuration of the proportional, integral and derivative actions of the controller to have precise knowledge of the type and parameters of the controlled system.

### Controlled system types

Controlled systems are classified based on their time response to step changes of the output value.

We distinguish between the following controlled systems:

- Self-regulating controlled systems
  - Proportional-action controlled systems
  - PT1 controlled systems
  - PT2 controlled systems
- Non-self-regulating controlled systems
- Controlled systems with and without dead time



## Self-regulating controlled systems

### Proportional-action controlled systems

In proportional-action controlled systems, the process value follows the output value almost immediately. The ratio between the process value and output value is defined by the proportional Gain of the controlled system.

Examples:

- Gate valve in a piping system
- Voltage dividers
- Step-down function in hydraulic systems

### PT1 controlled systems

In a PT1 controlled system, the process value initially changes in proportion to the change of the output value. The rate of change of the process value is reduced as a function of the time until the end value is reached, i.e., it is delayed.

Examples:

- Spring damping system
- Charge of RC elements
- Water container that is heated with steam.

The time constants are often identical for heating and cooling processes, or for charging and discharge characteristics. With different time constants, controlling is clearly more complex.

### PT2 controlled systems

In a PT2 controlled system, the process value does not immediately follow a step change of the output value, i.e., it increases in proportion to the positive rate of rise and then approaches the setpoint at a decreasing rate of rise. The controlled system shows a proportional response characteristic with second order delay element.

Examples:

- Pressure control
- Flow rate control
- Temperature control

## Non-self-regulating controlled systems

Non-self-regulating controlled systems have an integral response. The process value approaches an infinite maximum value.

Example:

- Liquid flow into a container

## Controlled systems with dead time

A dead time always represents the runtime or transport time that has to expire before a change to the system input can be measured at the system output.

In controlled systems with dead time, the process value change is delayed by the amount of the dead time.

Example:

Conveyor

### 11.1.1.3 Characteristic values of the control section

#### Determining the time response from the step response

Time response of the controlled system can be determined based on the time characteristic of process value  $x$  following a step change of output value  $y$ . Most controlled systems are self-regulating controlled systems.

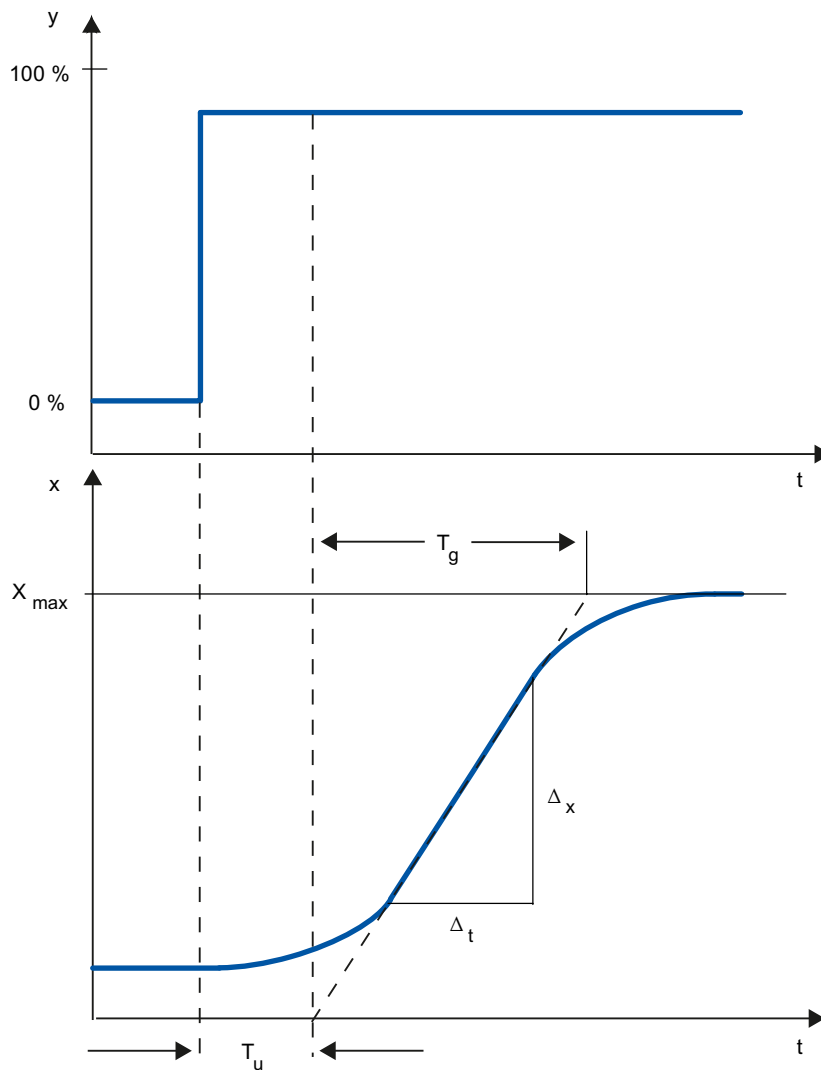

The time response can be determined by approximation using the variables Delay time  $T_u$ , Recovery time  $T_g$  and Maximum value  $X_{max}$ . The variables are determined by applying tangents

to the maximum value and the inflection point of the step response. In many situations, it is not possible to record the response characteristic up to the maximum value because the process value cannot exceed specific values. In this case, the rate of rise  $v_{\max}$  is used to identify the controlled system ( $v_{\max} = \Delta_x/\Delta_t$ ).

The controllability of the controlled system can be estimated based on the ratio  $T_u/T_g$ , or  $T_u \times v_{\max}/X_{\max}$ . Rule:

Process type	$T_u / T_g$	Suitability of the controlled system for controlling
I	< 0,1	can be controlled well
II	0.1 to 0.3	can still be controlled
III	> 0,3	difficult to control

### Influence of the dead time on the controllability of a controlled system

A controlled system with dead time and recovery reacts as follows to a jump of the output value.

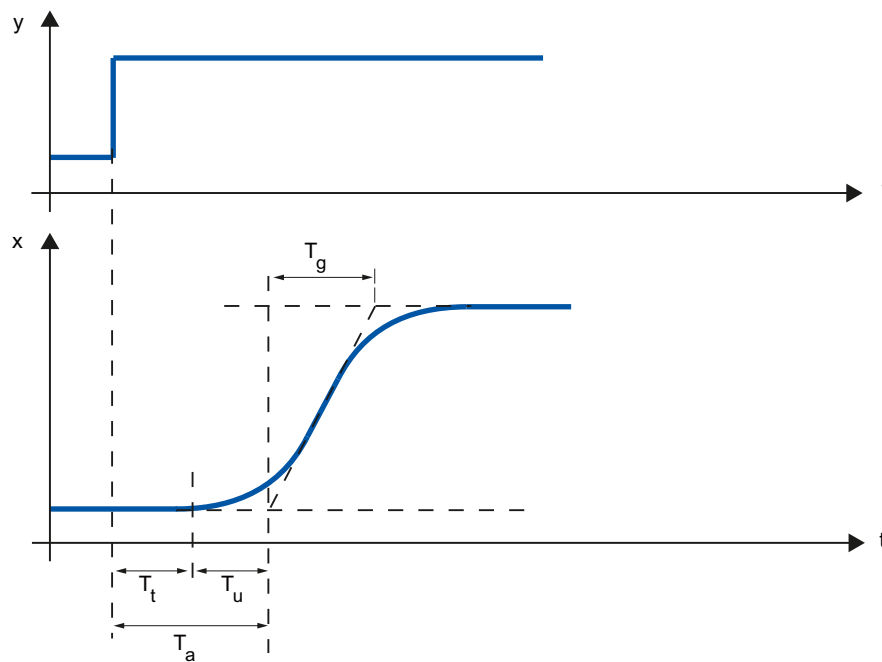

$T_t$	Dead time
$T_u$	Delay time
$T_g$	Recovery time
$y$	Output value
$x$	Process value

The controllability of a self-regulating controlled system with dead time is determined by the ratio of  $T_t$  to  $T_g$ .  $T_t$  must be small compared to  $T_g$ . Rule:

$$T_t/T_g \leq 1$$

### Response rate of controlled systems

Controlled systems can be judged on the basis of the following values:

$T_u < 0.5$  min,  $T_g < 5$  min = fast controlled system

$T_u > 0.5$  min,  $T_g > 5$  min = slow controlled system

### Parameters of certain controlled systems

Physical quantity	Controlled system	Delay time $T_u$	Recovery time $T_g$	Rate of rise $v_{max}$
Temperature	Small electrically heated furnace	0.5 to 1 min	5 to 15 min	Up to 60 K/min.
	Large electrically heated annealing furnace	1 to 5 min	10 to 20 min	Up to 20 K/min.
	Large gas-heated annealing furnace	0.2 to 5 min	3 to 60 min	1 to 30 K/min
	Distillation tower	1 to 7 min	40 to 60 min	0.1 to 0.5° C/s
	Autoclaves (2.5 m <sup>3</sup> )	0.5 to 0.7 min	10 to 20 min	Not specified
	High-pressure autoclaves	12 to 15 min	200 to 300 min	Not specified
	Steam superheater	30 s to 2.5 min	1 to 4 min	2° C/s
	Injection molding machines	0.5 to 3 min	3 to 30 min	5 to 20 K/min
	Extruders	1 to 6 min	5 to 60 min	
	Packaging machines	0.5 to 4 min	3 to 40 min	2 to 35 K/min
	Room heating	1 to 5 min	10 to 60 min	1° C/min
Flow rate	Pipeline with gas	0 to 5 s	0.2 to 10 s	Not relevant
	Pipeline with liquid	None	None	
Pressure	Gas pipeline	None	0.1 s	Not relevant
	Drum boiler with gas or oil firing	None	150 s	Not relevant
	Drum boiler with impact grinding mills	1 to 2 min	2 to 5 min	Not relevant
Vessel level	Drum boiler	0.6 to 1 min	Not specified	0.1 to 0.3 cm/s
Speed	Small electric drive	None	0.2 to 10 s	Not relevant
	Large electric drive	None	5 to 40 s	Not relevant
	Steam turbine	None	Not specified	50 min <sup>-1</sup>
Voltage	Small generators	None	1 to 5 s	Not relevant
	Large generators	None	5 to 10 s	Not relevant

#### 11.1.1.4 Pulse controller

##### Two-step controllers without feedback

Two-step controllers have the state "ON" and "OFF" as the switching function. This corresponds to 100% or 0% output. This behavior generates a sustained oscillation of process value  $x$  around setpoint  $w$ .

The amplitude and duration of the oscillation increase in proportion to the ratio between the delay time  $T_u$  and recovery time  $T_g$  of the controlled system. These controllers are used mainly

for simple temperature control systems (such as electrically directly heated furnaces) or as limit-value signaling units.

The following diagram shows the characteristic of a two-step controller

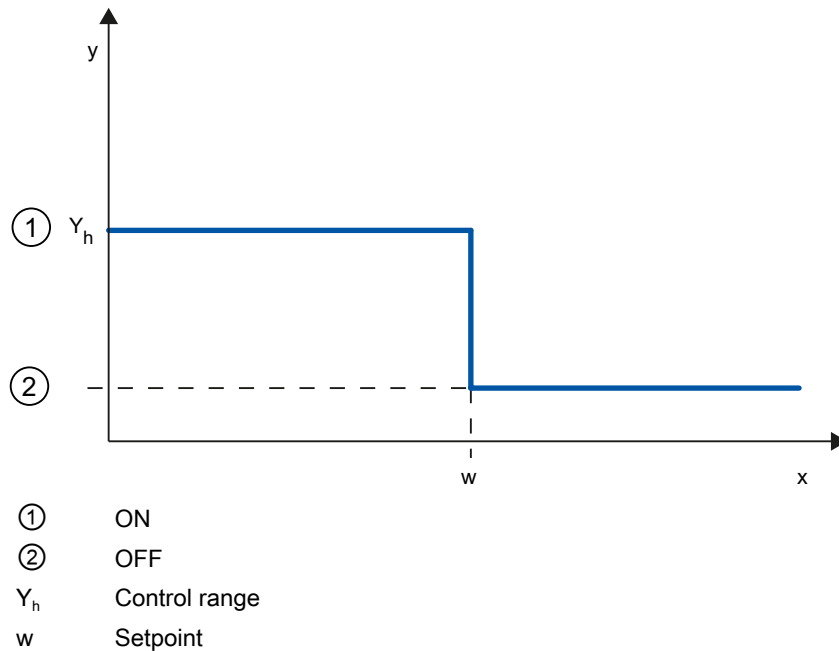

The following diagram shows the control function of a two-step controller

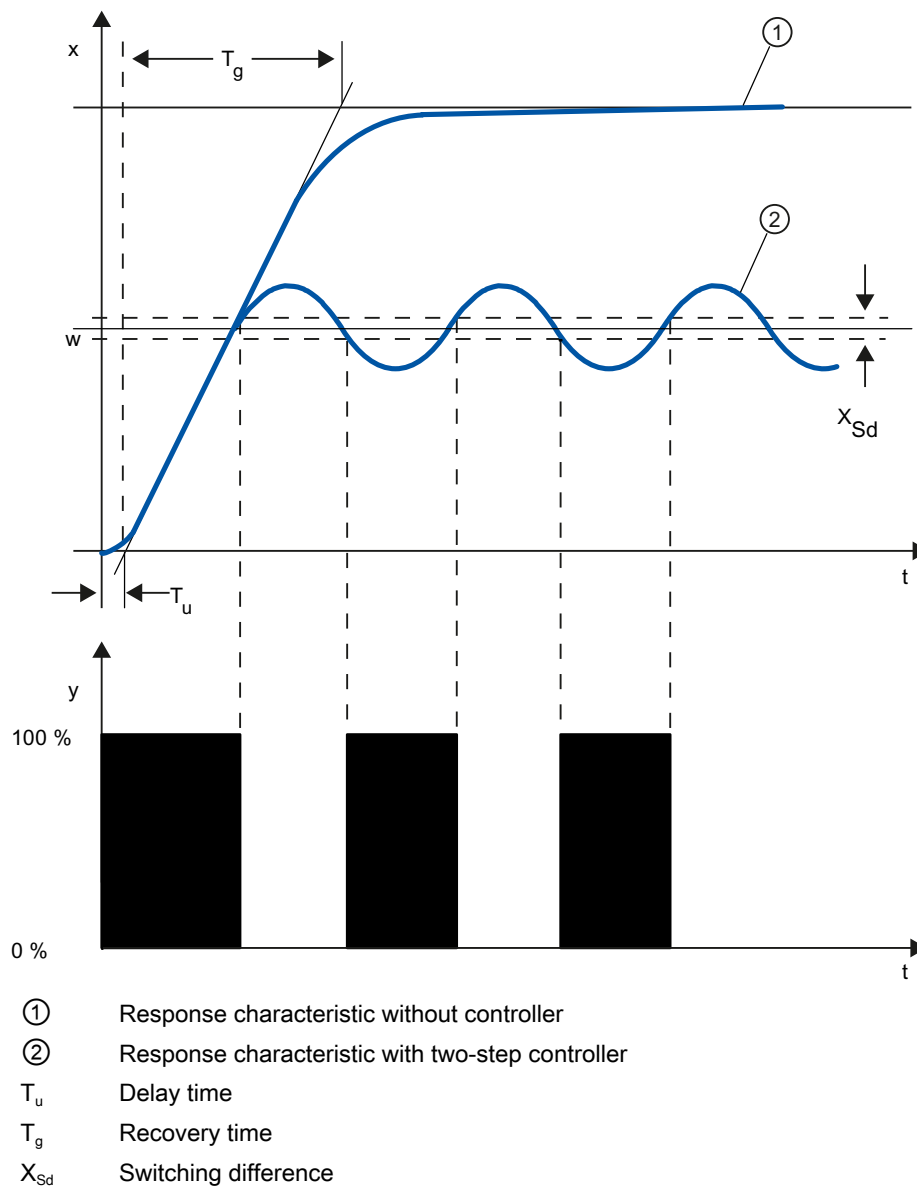

### Two-step controllers with feedback

The behavior of two-step controllers in the case of controlled systems with larger delay times, such as furnaces where the functional space is separated from the heating, can be improved by the use of electronic feedback.

The feedback is used to increase the switching frequency of the controller, which reduces the amplitude of the process value. In addition, the control-action results can be improved substantially in dynamic operation. The limit for the switching frequency is set by the output level. It should not exceed 1 to 5 switches per minute at mechanical actuators, such as relays and contactors. In the case of voltage and current outputs with downstream thyristor or Triac controllers high switching frequencies can be selected that exceed the limit frequency of the controlled system by far.

Since the switching pulses can no longer be determined at the output of the controlled system, results comparable with those of continuous controllers are obtained.

The output value is generated by pulse-width modulation of the output value of a continuous controller.

Two-step controllers with feedback are used for temperature control in furnaces, at processing machines in the plastics, textile, paper, rubber and foodstuff industries as well as for heating and cooling devices.

### Three-step controllers

Three-step controllers are used for heating / cooling. These controllers have two switching points as their output. The control-action results are optimized through electronic feedback structures. Fields of applications for such controllers are heating, low-temperature, climatic chambers and tool heating units for plastic-processing machines.

The following diagram shows the characteristic of a three-step controller

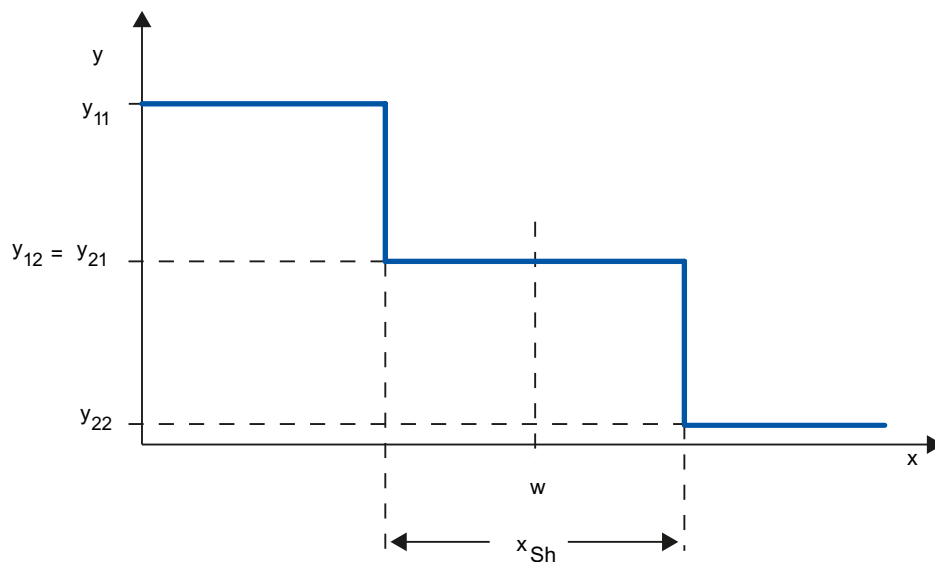

y	Output value, e.g. y11 = 100% heating y12 = 0% heating y21 = 0% cooling y22 = 100% cooling
x	Physical quantity of the process value, e.g., temperature in °C
w	Setpoint
$x_{Sh}$	Distance between Switching Point 1 and Switching Point 2

### 11.1.1.5 Response to setpoint changes and disturbances

#### Response to setpoint changes

The process value should follow a setpoint change as quickly as possible. The response to setpoint changes is improved by minimizing fluctuation of the process value and the time required to reach the new setpoint.

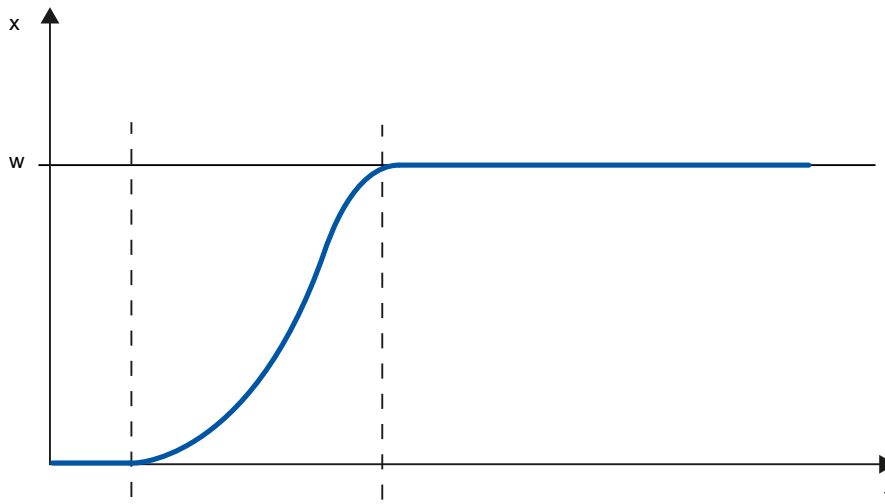

x	Process value
w	Setpoint

#### Response to disturbances

The setpoint is influenced by disturbance variables. The controller has to eliminate the resulting control deviations in the shortest time possible. The response to disturbances is improved by minimizing fluctuation of the process value and the time required to reach the new setpoint.

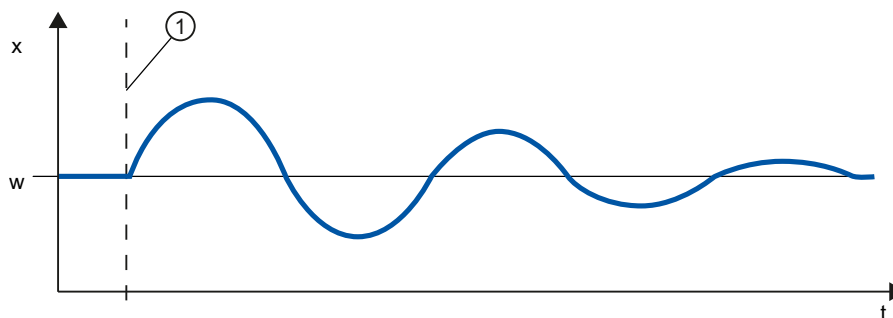

x	Process value
w	Setpoint
①	Influencing a disturbance variable



Disturbance variables are corrected by a controller with integral action. A persistent disturbance variable does not reduce control quality because the control deviation is relatively constant. Dynamic disturbance variables have a more significant impact on control quality because of control deviation fluctuation. The control deviation is eliminated again only by means of the slow acting integral action.

A measurable disturbance variable can be included in the controlled system. This inclusion would significantly accelerated the response of the controller.

### **11.1.1.6 Control Response at Different Feedback Structures**

#### **Control behavior of controllers**

A precise adaptation of the controller to the time response of the controlled system is decisive for the controller's precise settling to the setpoint and optimum response to disturbance variables.

The feedback circuit can have a proportional action (P), proportional-derivative action (PD), proportional-integral action (PI), or proportional-integral-derivative action (PID).

If step functions are to be triggered by control deviations, the step responses of the controllers differ depending on their type.

### Step response of a proportional action controller

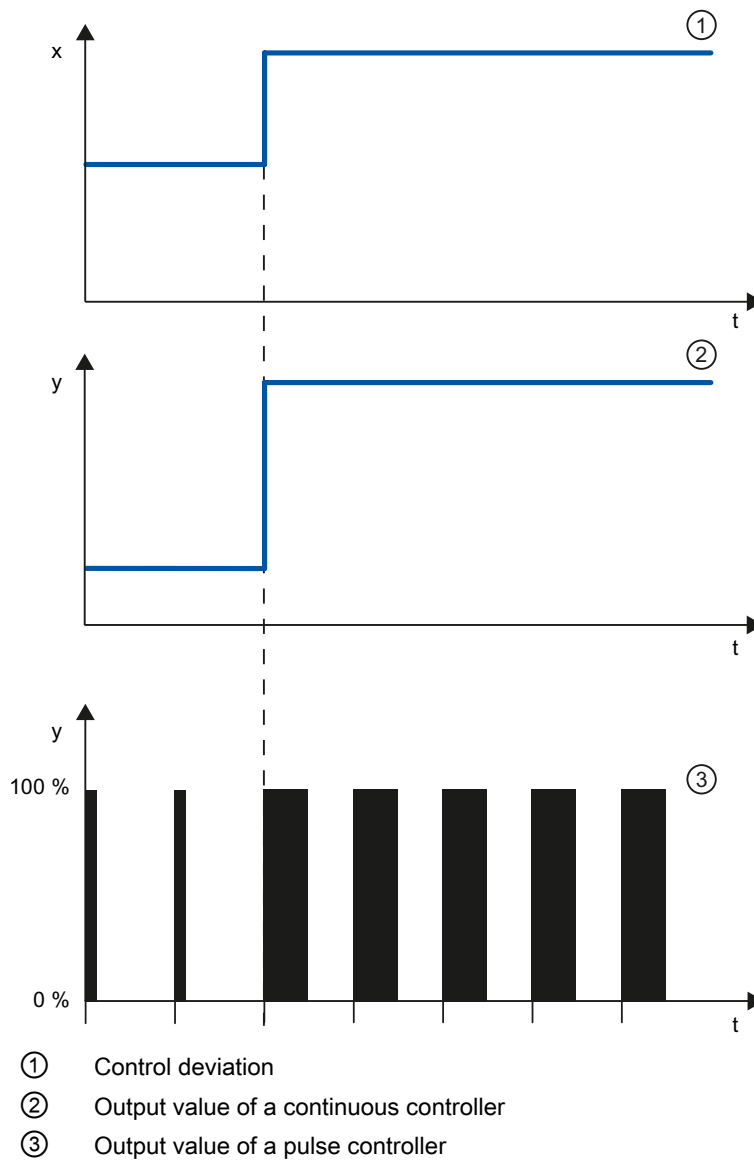

#### Equation for proportional action controller

Output value and control deviation are directly proportional, meaning:

Output value = proportional gain × control deviation

$$y = \text{GAIN} \times x$$

## Step response of a PD-action controller

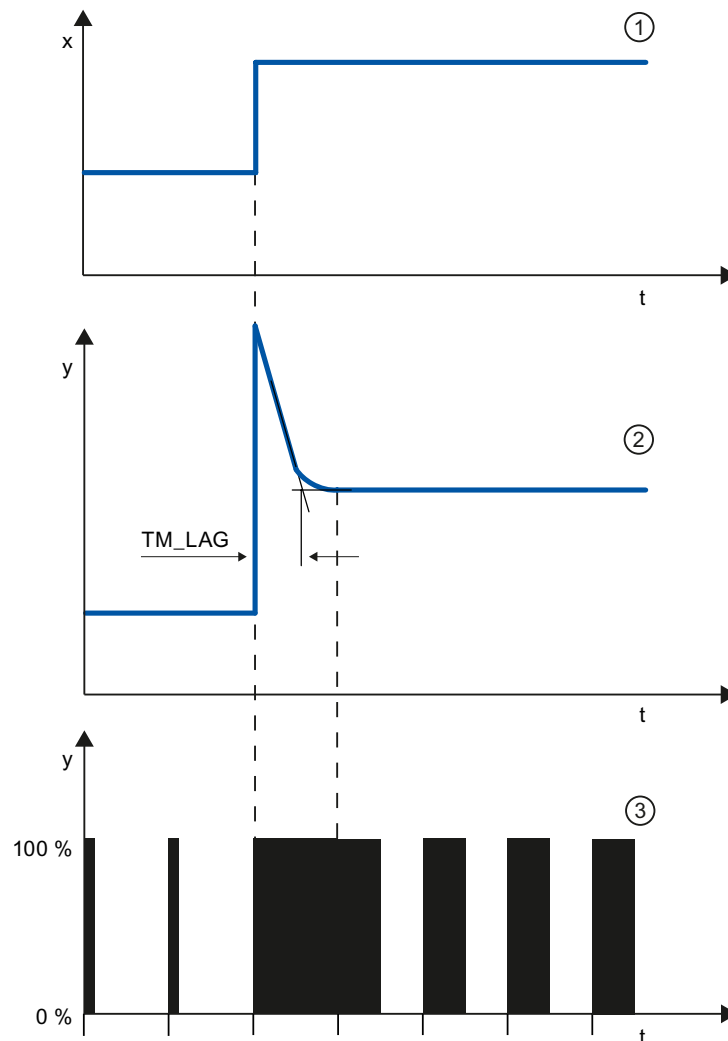

- ① Control deviation  
 ② Output value of a continuous controller  
 ③ Output value of a pulse controller  
 TM\_LAG Delay of the Derivative action

## Equation for PD-action controller

The following applies for the step response of the PD-action controller in the time range:

$$y = \text{GAIN} \cdot X_W \cdot \left( 1 + \frac{\text{TD}}{\text{TM\_LAG}} \cdot e^{-\frac{t}{\text{TM\_LAG}}} \right)$$

t = time interval since the step of the control deviation

The derivative action generates a output value as a function of the rate of change of the process value. A derivative action by itself is not suitable for controlling because the output value only

*11.1 PID control*

follows a step of the process value. As long as the process value remains constant, the output value will no longer change.

The response to disturbances of the derivative action is improved in combination with a proportional action. Disturbances are not corrected completely. The good dynamic response is advantageous. A well attenuated, non-oscillating response is achieved during approach and setpoint change.

A controller with derivative action is not appropriate if a controlled system has pulsing measured quantities, for example, in the case of pressure or flow control systems.

## Step response of a PI-action controller

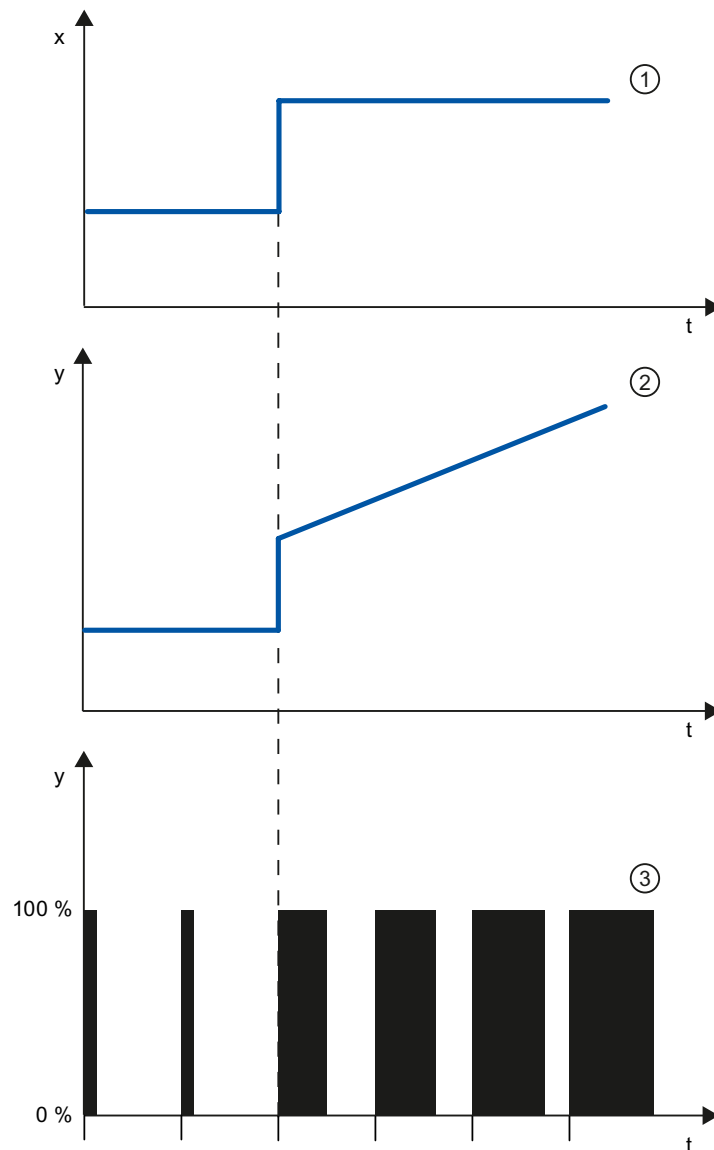

- ① Control deviation
- ② Output value of a continuous controller
- ③ Output value of a pulse controller

An integral action in the controller adds the control deviation as a function of the time. This means that the controller corrects the system until the control deviation is eliminated. A sustained control deviation is generated at controllers with proportional action only. This effect can be eliminated by means of an integral action in the controller.

In practical experience, a combination of the proportional, integral and derivative actions is ideal, depending on the requirements placed on the control response. The time response of the individual components can be described by the controller parameters proportional gain GAIN, integral action time TI (integral action), and derivative action time TD (derivative action).

## Equation for PI-action controller

The following applies for the step response of the PI-action controller in the time range:

$$y = \text{GAIN} \cdot X_W \cdot \left( 1 + \frac{1}{\text{TI} \cdot t} \right)$$

t = time interval since the step of the control deviation

## Step response of a PID controller

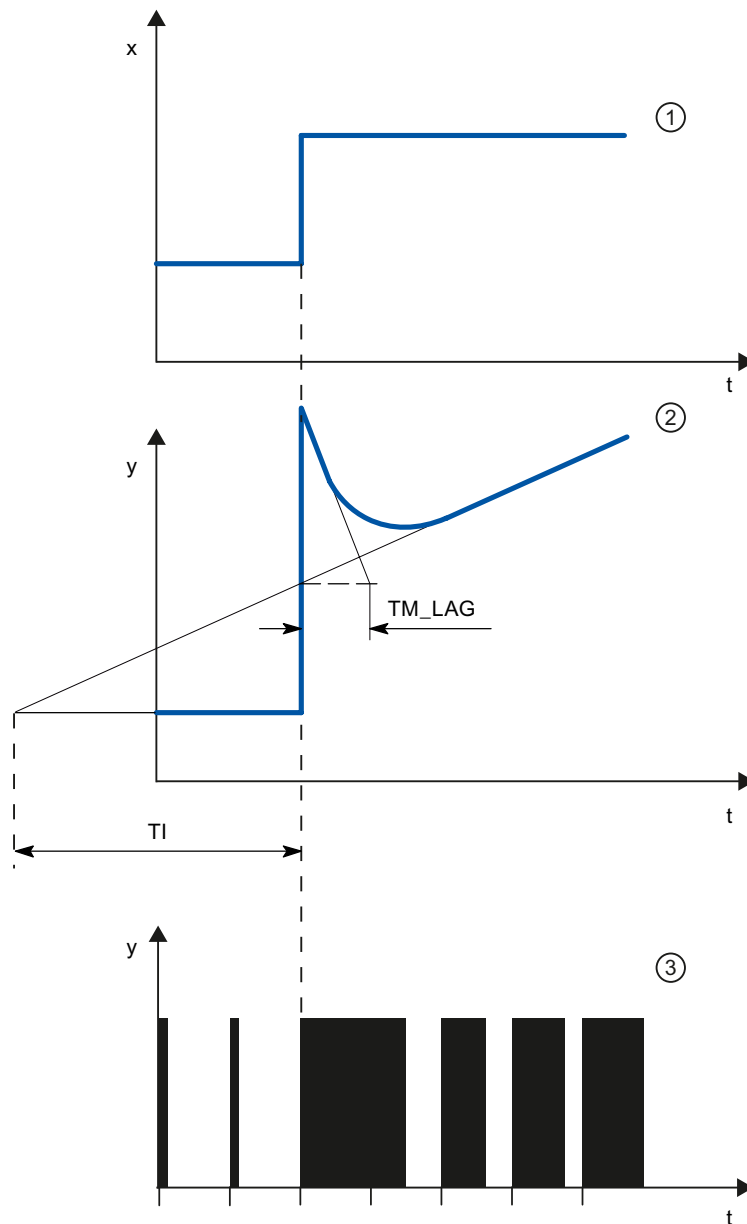

- ① Control deviation
- ② Output value of a continuous controller
- ③ Output value of a pulse controller
- $TM\_LAG$  Delay of the Derivative action
- $T_i$  Integral action time

**Equation for PID controller**

The following applies for the step response of the PID controller in the time range:

$$y = \text{GAIN} \cdot X_w \cdot \left( 1 + \frac{1}{\text{TI} \cdot t} + \frac{\text{TD}}{\text{TM\_LAG}} \cdot e^{-\frac{t}{\text{TM\_LAG}}} \right)$$

t = time interval since the step of the control deviation

### Response of a controlled system with different controller structures

Most of the controller systems occurring in process engineering can be controlled by means of a controller with PI-action response. In the case of slow controlled system with a large dead time, for example temperature control systems, the control result can be improved by means of a controller with PID action.

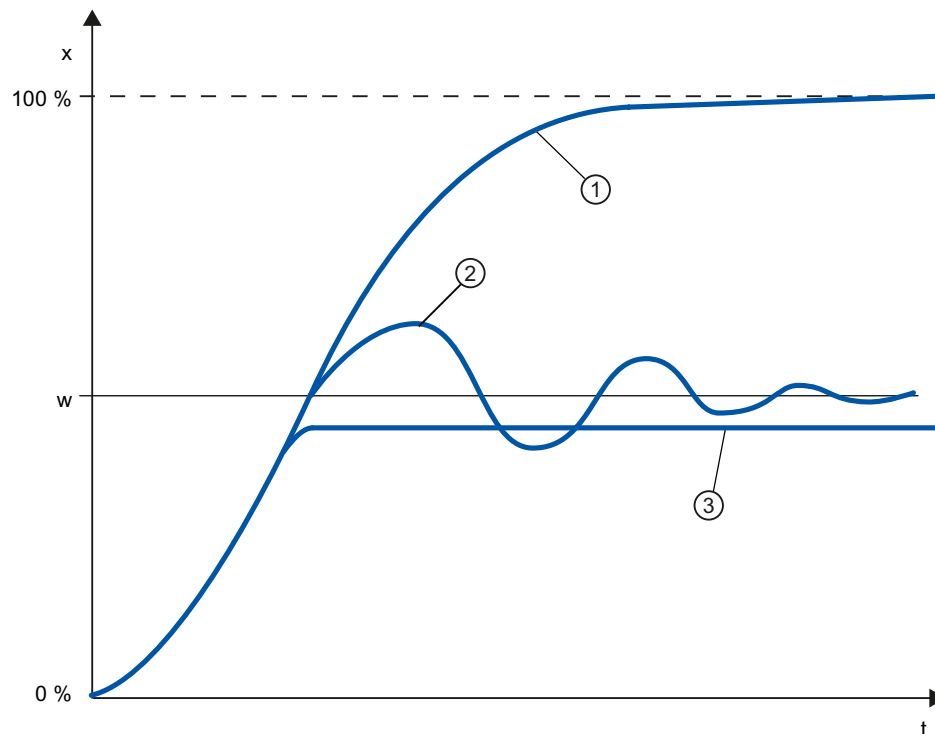

- ① No controller
- ② PID controller
- ③ PD-action controller
- w Setpoint
- x Process value

Controllers with PI and PID action have the advantage that the process value does not have any deviation from the setpoint value after settling. The process value oscillates over the setpoint during approach.







### 11.1.1.7 Selection of the controller structure for specified controlled systems

#### Selection of the Suitable Controller Structures

To achieve optimum control results, select a controller structure that is suitable for the controlled system and that you can adapt to the controlled system within specific limits.

The table below provides an overview of suitable combinations of a controller structure and controlled system.

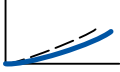
Controlled system		Controller structure			
		P	PD	PI	PID
	With dead time only	Unsuitable	Unsuitable	Suitable	Unsuitable
	PT1 with dead time	Unsuitable	Unsuitable	Well suited	Well suited
	PT2 with dead time	Unsuitable	Suited conditionally	Well suited	Well suited
	Higher order	Unsuitable	Unsuitable	Suited conditionally	Well suited
	Not self-regulating	Well suited	Well suited	Well suited	Well suited

The table below provides an overview of suitable combinations of a controller structure and physical quantity.

Physical quantity	Controller structure			
	P	PD	PI	PID
	Sustained control deviation		No sustained control deviation	
Temperature	For low performance requirements and proportional action controlled systems with $T_u/T_g < 0,1$	Well suited	The most suitable controller structures for high performance requirements (except for specially adapted special controllers)	
Pressure	Suitable, if the delay time is inconsiderable	Unsuitable	The most suitable controller structures for high performance requirements (except for specially adapted special controllers)	
Flow rate	Unsuitable, because required GAIN range is usually too large	Unsuitable	Suitable, but integral action controller alone often better	Hardly required

### 11.1.1.8 PID parameter settings

#### Rule of Thumb for the Parameter Setting

Controller structure	Setting
P	$GAIN \approx v_{max} \times T_u [^{\circ} C]$
PI	$GAIN \approx 1.2 \times v_{max} \times T_u [^{\circ} C]$
PD	$GAIN \approx 0.83 \times v_{max} \times T_u [^{\circ} C]$ $TD \approx 0.25 \times v_{max} \times T_u [min]$ $TM\_LAG \approx 0.5 \times TD [min]$
PID	$GAIN \approx 0.83 \times v_{max} \times T_u [^{\circ} C]$ $TI \approx 2 \times T_u [min]$ $TD \approx 0.4 \times T_u [min]$ $TM\_LAG \approx 0.5 \times TD [min]$
PD/PID	$GAIN \approx 0.4 \times v_{max} \times T_u [^{\circ} C]$ $TI \approx 2 \times T_u [min]$ $TD \approx 0.4 \times T_u [min]$ $TM\_LAG \approx 0.5 \times TD [min]$

Instead of  $v_{max} = \Delta_x / \Delta_t$ , you can use  $X_{max} / T_g$ .

In the case of controllers with PID structure the setting of the integral action time and differential-action time is usually coupled with each other.

The ratio  $TI / TD$  lies between 4 and 5 and is optimal for most controlled systems.

Non-observance of the differential-action time  $TD$  is uncritical at PD controllers.

In the case of PI and PID controllers, control oscillations occur if the integral action time  $TI$  has been select by more than half too small.

An integral action time that is too large slows down the settling times of disturbances. One cannot expect that the control loops operate "optimally" after the first parameter settings. Experience shows that adjusting is always necessary, when a system exists that is "difficult to control" with  $T_u / T_g > 0.3$ .

## 11.1.2 Configuring a software controller

### 11.1.2.1 Overview of software controller

For the configuration of a software controller, you need an instruction with the control algorithm and a technology object. The technology object for a software controller corresponds with the instance DB of the instruction. The configuration of the controller is saved in the technology object. In contrast to the instance DBs of other instructions, technology objects are not stored for the program resources, but rather under CPU > Technology objects.

## Technology objects and instructions

CPU	Library	Instruction	Technology object	Description
S7-1200	Compact PID	PID_Compact V1.X	PID_Compact V1.X	Universal PID controller with integrated tuning
S7-1200		PID_3Step V1.X	PID_3Step V1.X	PID controller with integrated tuning for valves
S7-1500 S7-1200 V4.x		PID_Compact V2.X	PID_Compact V2.X	Universal PID controller with integrated tuning
S7-1500 S7-1200 V4.x		PID_3Step V2.X	PID_3Step V2.X	PID controller with integrated tuning for valves
S7-1500/300/400	PID basic functions	CONT_C	CONT_C	Continuous controller
S7-1500/300/400		CONT_S	CONT_S	Step controller for actuators with integrating behavior
S7-1500/300/400		PULSEGEN	-	Pulse generator for actuators with proportional behavior
S7-1500/300/400		TCONT_CP	TCONT_CP	Continuous temperature controller with pulse generator
S7-1500/300/400		TCONT_S	TCONT_S	Temperature controller for actuators with integrating behavior
S7-300/400	PID Self Tuner	TUN_EC	TUN_EC	Optimization of a continuous controller
S7-300/400		TUN_ES	TUN_ES	Optimization of a step controller
S7-300/400	Standard PID Control (PID Professional optional package)	PID_CP	PID_CP	Continuous controller with pulse generator
S7-300/400		PID_ES	PID_ES	Step controller for actuators with integrating behavior
S7-300/400		LP_SCHED	-	Distribute controller calls
S7-300/400	Modular PID Control (PID Professional optional package)	A_DEAD_B	-	Filter interfering signal from control deviation
S7-300/400		CRP_IN	-	Scale analog input signal
S7-300/400		CRP_OUT	-	Scale analog output signal
S7-300/400		DEAD_T	-	Delay output of input signal
S7-300/400		DEADBAND	-	Suppress small fluctuations to the process value
S7-300/400		DIF	-	Differentiate input signals over time
S7-300/400		ERR_MON	-	Monitor control deviation
S7-300/400		INTEG	-	Integrate input signals over time
S7-300/400		LAG1ST	-	First-order delay element
S7-300/400		LAG2ND	-	Second-order delay element
S7-300/400		LIMALARM	-	Report limit values
S7-300/400		LIMITER	-	Limiting the manipulated variable
S7-300/400		LMNGEN_C	-	Determine manipulated variable for continuous controller
S7-300/400		LMNGEN_S	-	Determine manipulated variable for step controller
S7-300/400		NONLIN	-	Linearize encoder signal
S7-300/400		NORM	-	Scale process value physically

CPU	Library	Instruction	Technology object	Description
S7-300/400		OVERRIDE	-	Switch manipulated variable from 2 PID controllers to 1 actuator
S7-300/400		PARA_CTL	-	Switch parameter sets
S7-300/400		PID	-	PID aAlgorithm
S7-300/400		PUSLEGEN_M	-	Generate pulse for proportional actuators
S7-300/400		RMP_SOAK	-	Specify setpoint according to ramp / soak
S7-300/400		ROC_LIM	-	Limit rate of change
S7-300/400		SCALE_M	-	Scale process value
S7-300/400		SP_GEN	-	Specify setpoint manually
S7-300/400		SPLT_RAN	-	Split manipulated variable range
S7-300/400		SWITCH	-	Switch analog values
S7-300/400		LP_SCHED_M	-	Distribute controller calls

### 11.1.2.2 Steps for the configuration of a software controller

All SW-controllers are configured according to the same scheme:

Step	Description
1	Add technology object (Page 5934)
2	Configure technology object (Page 5935)
3	Call instruction in the user program (Page 5936)
4	Download technology object to device (Page 5937)
5	Commission software controller (Page 5938)
6	Save optimized PID parameters in the project (Page 5939)
7	Comparing values (Page 5940)
8	Display instances of a technology object (Page 5942)

### 11.1.2.3 Add technology objects

#### Add technology object in the project navigator

When a technology object is added, an instance DB is created for the instruction of this technology object. The configuration of the technology object is stored in this instance DB.

#### Requirement

A project with a CPU has been created.

## Procedure

To add a technology object, proceed as follows:

1. Open the CPU folder in the project tree.
2. Open the "Technology objects" folder.
3. Double-click "Add new object".  
The "Add new object" dialog box opens.
4. Click on the "PID" button.  
All available PID-controllers for this CPU are displayed.
5. Select the instruction for the technology object, for example, PID\_Compact.
6. Enter an individual name for the technology object in the "Name" input field.
7. Select the "Manual" option if you want to change the suggested data block number of the instance DB.
8. Click "Further information" if you want to add own information to the technology object.
9. Confirm with "OK".

## Result

The new technology object has been created and stored in the project tree in the "Technology objects" folder. The technology object is used if the instruction for this technology object is called in a cyclic interrupt OB.

---

### Note

You can select the "Add new and open" check box at the bottom of the dialog box. This opens the configuration of the technology object after adding has been completed.

---

### 11.1.2.4 Configure technology objects

The properties of a technology object on a S7-1200 CPU can be configured in two ways.

- In the Inspector window of the programming editor
- In the configuration editor

The properties of a technology object on a S7-300/400 CPU can only be configured in the configuration editor.

### Inspector window of the programming editor

In the Inspector window of the programming editor you can only configure the parameters required for operation.

The offline values of the parameters are also shown in online mode. You can only change the online values in the commissioning window.

To open the Inspector window of the technology object, follow these steps:

1. Open the "Program blocks" folder in the project tree.
2. Double click the block (cyclic interrupt OB) in which you open the instruction of the SW-controller.  
The block is opened in the work area.
3. Click on the instruction of the SW-controller.
4. In the Inspector window, select the "Properties" and "Configuration" tabs consecutively.

### Configuration window



For each technology object, there is a specific configuration window in which you can configure all properties.

To open the configuration window of the technology object, follow these steps:

1. Open the "Technology objects" folder in the project tree.
2. Open the technology object in the project tree.
3. Double-click the "Configuration" object.

### Symbols

Icons in the area navigation of the configuration and in the Inspector window show additional details about the completeness of the configuration:

	<b>The configuration contains default values and is complete.</b> The configuration exclusively contains default values. With these default values the use of the technology object is possible without further changes.
	<b>The configuration contains values defined by the user and is complete</b> All input fields of the configuration contain valid values and at least one default setting was changed.
	<b>The configuration is incomplete or faulty</b> At least one input field or a collapsible list contains no or one invalid value. The corresponding field or the drop-down list box has a red background. When clicked the roll-out error message indicates the cause of the error.

The properties of a technology object are described in detail in the chapter for the technology object.

#### 11.1.2.5 Call instruction in the user program

The instruction of the software controller must be called in a cyclic interrupt OB. The sampling time of the software controller is determined by the interval between the calls in the cyclic interrupt OB.

### Requirement

The cyclic interrupt OB is created and the cycle time of the cyclic interrupt OB is correctly configured.

## Procedure

Proceed as follows to call the instruction in the user program:

1. Open the CPU folder in the project tree.
2. Open the "Program blocks" folder.
3. Double-click the cyclic interrupt OB.  
The block is opened in the work area.
4. Open the "Technology" group in the "Instructions" window and the "PID Control" folder.  
The folder contains all instructions for software controllers that can be configured on the CPU.
5. Select the instruction and drag it to your cyclic interrupt OB.  
The "Call options" dialog box opens.
6. Select a technology object or type the name for a new technology object from the "Name" list.

## Result

If the technology object does not exist yet, it is added. The instruction is added in the cyclic interrupt OB. The technology object is assigned to this call of the instruction.

### 11.1.2.6 Downloading technology objects to device

A new or modified configuration of the technology object must be downloaded to the CPU for the online mode. The following characteristics apply when downloading retentive data:

- **Software (changes only)**
  - S7-1200, S7-1500:  
Retentive data is retained.
  - S7-300/400:  
Retentive data is updated immediately. CPU does not change to Stop.
- **Download PLC program to device and reset**
  - S7-1200, S7-1500:  
Retentive data is updated at the next change from Stop to RUN. The PLC program can only be downloaded completely.
  - S7-300/400:  
Retentive data is updated at the next change from Stop to RUN.

## Downloading retentive data to an S7-1200 or S7-1500 CPU

---

### Note

The download and reset of the PLC program during ongoing system operation can result in serious damages or injuries in the case of malfunctions or program errors.

Make sure that dangerous states cannot occur before you download and reset the PLC program.

---

Proceed as follows to download the retentive data:

1. Select the entry of the CPU in the project tree.
2. Select the command "Download and reset PLC program" from the "Online" menu.
  - If you have not established an online connection yet, the "Extended download" dialog opens. In this case, set all required parameters for the connection and click "Download".
  - If the online connection has been defined, the project data is compiled, if necessary, and the dialog "Load preview" opens. This dialog displays messages and recommends actions necessary for download.
3. Check the messages.  
As soon as download is possible, the "Download" button becomes active.
4. Click on "Download".  
The complete PLC program is downloaded and the "Load results" dialog opens. This dialog displays the status and the actions after the download.
5. If the modules are to restart immediately after the download, select the check box "Start all".
6. Close the dialog "Download results" with "Finish".

### Result

The complete PLC program is downloaded to the device. Blocks that only exist online in the device are deleted. By downloading all affected blocks and by deleting any blocks in the device that are not required, you avoid inconsistencies between the blocks in the user program.

The messages under "Info > General" in the Inspector window indicate whether the download was successful.

### 11.1.2.7 Commissioning software controller

#### Procedure

To open the "Commissioning" work area of the technology object, follow these steps:

1. Open the "Technology objects" folder in the project tree.
2. Open the technology object in the project tree.
3. Double-click the "Commissioning" object.

The commissioning functions are specific for each controller and are described there.



### 11.1.2.8 Save optimized PID parameter in the project

The software controller is optimized in the CPU. Through this, the values in the instance-DB on the CPU no longer agree with those in the project.

To update the PID parameter in the project with the optimized PID parameters, proceed as follows:

#### Requirement

- An online connection to the CPU is established and the CPU is in "RUN" mode.
- The functions of the commissioning window have been enabled by means of the "Start" button.

#### Procedure

1. Open the CPU folder in the project tree.
2. Open the "Technology objects" folder.
3. Open a technology object.
4. Double click on "Commissioning".
5. Click on the  icon "Upload PID parameters".
6. Save the project.

#### Result

The currently active PID parameters are stored in the project data. When reloading the project data in the CPU, the optimized parameters are used.

### 11.1.2.9 Comparing values







#### Comparison display and boundary conditions

The "Compare values" function provides the following options:

- Comparison of configured start values of the project with the start values in the CPU and the actual values
- Direct editing of actual values and the start values of the project
- Immediate detection and display of input errors with suggested corrections
- Backup of actual values in the project
- Transfer of start values of the project to the CPU as actual values

### Icons and operator controls

The following icons and operator controls are available:

Icon	Function
	Start value in CPU matches the configured Start value in the project
	Start value in CPU does not match the configured Start value in the project
	The comparison of the Start value in CPU with the configured Start value in the project cannot be performed
	Backs up the actual values in the project
	Transfers updated start values in the project to the CPU (initialize setting values)
	Opens the "Compare values" dialog

### Boundary conditions

The "Compare values" function is available for S7-1200 and S7-1500 without limitations.

The following limitation applies to S7-300 and S7-400:

In monitoring mode, an S7-300/S7-400 cannot transfer the start values to the CPU. These values cannot be displayed online with "Compare values".

The actual values of the technology object are displayed and can be changed directly.

### Comparing values

The procedure is shown in the following using "PID Parameters" as an example.

### Requirements

- A project with a software controller is configured.
- The project is downloaded to the CPU.
- The configuration dialog is open in the project navigator.

### Procedure

1. Open the desired software controller in the project navigation.
2. Double-click the "Configuration" object.
3. Navigate within the configuration window to the "PID Parameters" dialog.
4. Click the  icon to activate monitoring mode.  
The icons and operator controls (Page 5937) of the "Compare values" function are shown behind the parameters.

5. Click the desired parameter in the input box and change the parameter values manually by entering them directly.
  - If the background of the input box is gray, this value is a read-only value and cannot be changed.
  - To change the values in the "PID Parameters" dialog, enable manual entry by selecting the "Enable manual entry" check box beforehand.
6. Click the  icon to open the dialog for the start values. This dialog indicates two values of the parameter:
  - Start value in CPU: The start value in the CPU is shown in the top part.
  - Start value in the project: The configured start value in the project is shown in the bottom part.
7. Enter the desired value in the input box for the project.

## Error detection

The input of incorrect values is detected. Corrections are suggested in this case.

If you enter a value with incorrect syntax, a rollout containing the corresponding error message opens below the parameter. The incorrect value is not applied.

If you enter a value that is incorrect for the process, a dialog opens containing the error message and a suggested correction:

- Click "No" to accept this suggested correction and correct your input.
- Click "OK" to apply the incorrect value.

<b>NOTICE</b>
<b>Malfunctions of the controller</b>
Values incorrect for the process can result in controller malfunctions.

## Backing up actual values

Click the  icon to transfer the actual controller values to the start values of your configured project.

## Transferring project values to the CPU

Click the  icon to transfer the configured values of your project to the CPU.

 <b>CAUTION</b>
<b>Prevent personal injury and property damage!</b>
Downloading and resetting of the user program while the plant is operating may result in significant property damage and severe personal injuries in the event of malfunctions or program errors.
Make sure that dangerous states cannot occur before you download and reset the user program.

### 11.1.2.10 Display instance DB of a technology object.

An instance DB, in which the parameter and static variables are saved, is created for each technology object.

#### Procedure

To display the instance DB of a technology object, proceed as follows:

1. Open the CPU folder in the project tree.
2. Open the "Technology objects" folder.
3. Highlight a technology object.
4. Select the command "Open DB editor" in the shortcut menu.

## 11.1.3 Using PID\_Compact

### 11.1.3.1 Technology object PID\_Compact

The "PID\_Compact" technology object provides a continuous PID controller with integrated tuning. You can alternatively configure a pulse controller. Both manual and automatic mode are possible.

The PID controller of a controlled system continuously acquires the measured process value and compares it with the desired setpoint. From the resulting control deviation, the instruction PID\_Compact calculates an output value through which the process value is compared with as quickly and stable as possible with the setpoint. The output value for the PID controller consists of three actions:

- **P action**  
The proportional action of the output value increases in proportion to the control deviation.
- **I action**  
The integral action of the output value increases until the control deviation has been balanced.
- **D action**  
The derivative action increases with the rate of change of control deviation. The process value is corrected to the setpoint as quickly as possible. The derivative action will be reduced again if the rate of change of control deviation drops.

The instruction PID\_Compact calculates the proportional, integral and derivative parameters for your controlled system during "pretuning". "Fine tuning" can be used to tune the parameters further. You do not need to manually determine the parameters.

### Additional information

- Overview of software controller (Page 5930)
- Add technology objects (Page 5932)
- Configure technology objects (Page 5933)
- Configuring PID\_Compact V2 (Page 5943)
- Configuring PID\_Compact V1 (Page 5959)

### 11.1.3.2 PID\_Compact V2

#### Configuring PID\_Compact V2

#### Basic settings

#### Introduction

Configure the following properties of the "PID\_Compact" technology object under "Basic settings" in the Inspector window or in the configuration window:

- Physical quantity
- Control logic
- Start-up behavior after reset
- Setpoint (only in the Inspector window)
- Process value (only in the Inspector window)
- Output value (only in the Inspector window)

## Setpoint, process value and output value

You can only configure the setpoint, process value and output value in the Inspector window of the programming editor. Select the source for each value:

- Instance DB  
The value saved in the instance DB is used.  
Value must be updated in the instance DB by the user program.  
There should be no value at the instruction.  
Change via HMI possible.
- Instruction  
The value connected to the instruction is used.  
The value is written to the instance DB each time the instruction is called.  
No change via HMI possible.

## Controller type

### Physical quantity

Select the physical quantity and unit of measurement for setpoint, process value, and disturbance variable in the "Controller type" group. Setpoint, process value, and disturbance variable is displayed in this unit of measurement.

## Control logic

An increase of the output value is generally intended to cause an increase in the process value. This is referred to as a normal control logic.

PID\_Compact does not work with negative proportional gain. Select the check box "Invert control logic" to reduce the process value with a higher output value.

Examples

- Opening the drain valve will reduce the level of a container's contents.
- Increasing cooling will reduce the temperature.

## Startup characteristics

1. To switch to "Inactive" mode after CPU restart, clear the "Activate Mode after CPU restart" check box.  
To switch to the operating mode saved in the Mode parameter after CPU restart, select the "Activate Mode after CPU restart" check box.
2. In the "Set Mode to" drop-down list, select the mode that is to be enabled after a complete download to the device.  
After a complete download to the device, PID\_Compact starts in the selected operating mode. With each additional restart, PID\_Compact starts in the mode that was last saved in Mode.

Example

You have selected the "Activate Mode after CPU restart" check box and the entry "Pretuning" in the "Set Mode to" list. After a complete download to the device, PID\_Compact starts in the

"Pretuning" mode. If pretuning is still active, PID\_Compact starts in "Pretuning" mode again after restart of the CPU. If pretuning was successfully completed and automatic mode is active, PID\_Compact starts in "Automatic mode" after restart of the CPU.

## Setpoint

### Procedure

Proceed as follows to define a fixed setpoint:

1. Select "Instance DB".
2. Enter a setpoint, e.g. 80° C.
3. Delete any entry in the instruction.

Proceed as follows to define a variable setpoint:

1. Select "Instruction".
2. Enter the name of the REAL variable in which the setpoint is saved.  
Program-controlled assignment of various values to the REAL variable is possible, for example for the time controlled change of the setpoint.

## Process value

PID\_Compact will scale the value of the analog input to the physical quantity if you use the analog input value directly.

You will need to write a program for processing if you wish first to process the analog input value. The process value is, for example, not directly proportional to the value at the analog input. The processed process value must be in floating point format.

### Procedure

Proceed as follows to use the analog input value without processing:

1. Select the entry "Input\_PER" in the drop-down list "Input".
2. Select "Instruction" as source.
3. Enter the address of the analog input.

Proceed as follows to use the processed process value in floating point format:

1. Select the entry "Input" in the drop-down list "Input".
2. Select "Instruction" as source.
3. Enter the name of the variable in which the processed process value is saved.

## Output value

PID\_Compact offers three output values. Your actuator will determine which output value you use.

- **Output\_PER**  
The actuator is triggered via an analog output and controlled with a continuous signal, e.g. 0...10V, 4...20mA.
- **Output**  
The output value needs to be processed by the user program, for example because of nonlinear actuator response.
- **Output\_PWM**  
The actuator is controlled via a digital output. Pulse width modulation creates minimum ON and minimum OFF times.

## Procedure

Proceed as follows to use the analog output value:

1. Select the entry "Output\_PER (analog)" in the drop-down list "Output".
2. Select "Instruction".
3. Enter the address of the analog output.

Proceed as follows to process the output value using the user program:

1. Select the entry "Output" in the drop-down list "Output".
2. Select "Instance DB".  
The calculated output value is saved in the instance data block.
3. For the preparation of the output value, use the output parameter Output.
4. Transfer the processed output value to the actuator via a digital or analog CPU output.

Proceed as follows to use the digital output value:

1. Select the entry "Output\_PWM" in the drop-down list "Output".
2. Select "Instruction".
3. Enter the address of the digital output.

## Process value settings

### Scaling the process value

If you have configured the use of Input\_PER in the basic setting, you must convert the value of the analog input to the physical quantity of the process value. The current configuration is displayed in the Input\_PER display.

Input\_PER will be scaled using a low and high value pair if the process value is directly proportional to the value of the analog input.



## Procedure

To scale the process value, follow these steps:

1. Enter the low pair of values in the "Scaled low process value" and "Low" input fields.
2. Enter the high pair of values in the "Scaled high process value" and "High" input boxes.

Default settings for the value pairs are stored in the hardware configuration. To use the value pairs from the hardware configuration, follow these steps:

1. Select the PID\_Compact instruction in the programming editor.
2. Interconnect Input\_PER with an analog input in the basic settings.
3. Click the "Automatic setting" button in the process value settings.

The existing values will be overwritten with the values from the hardware configuration.

## Process value limits

You must specify an appropriate absolute high limit and low limit for the process value as limit values for your controlled system. As soon as the process value violates these limits, an error occurs (ErrorBits = 0001h). Tuning is canceled when the process value limits are violated. You can configure how PID\_Compact reacts to an error in automatic mode in the output value settings.

## Advanced settings

### Monitoring process value

Configure a warning high and low limit for the process value in the "Process value monitoring" configuration window. If one of the warning limits is exceeded or undershot during operation, a warning will be displayed at the PID\_Compact instruction:

- At the InputWarning\_H output parameter if the warning high limit has been exceeded
- At the InputWarning\_L output parameter if the warning low limit has been undershot

The warning limits must be within the process value high and low limits.

The process value high and low limits will be used if you do not enter values.

## Example

Process value high limit = 98 °C; warning high limit = 90 °C

Warning low limit = 10 °C; process value low limit = 0 °C

PID\_Compact will respond as follows:

Process value	InputWarning_H	InputWarning_L	ErrorBits	Operating mode
> 98 °C	TRUE	FALSE	0001h	Inactive or Substitute output value with error monitoring
≤ 98 °C and > 90 °C	TRUE	FALSE	0000h	Automatic mode
≤ 90 °C and ≥ 10 °C	FALSE	FALSE	0000h	Automatic mode
< 10 °C and ≥ 0 °C	FALSE	TRUE	0000h	Automatic mode
< 0 °C	FALSE	TRUE	0001h	Inactive or Substitute output value with error monitoring

In the output value settings, you can specify the reaction of PID\_Compact when the process value high limit or low limit is violated.

**See also**

Parameters State and Mode V2 (Page 2610)

**PWM limits**

The value at the output parameter Output is transformed into a pulse sequence that is output at output parameter Output\_PWM by means of a pulse width modulation. Output is calculated in the PID algorithm sampling time, Output\_PWM is output in the PID\_Compact sampling time.

The PID algorithm sampling time is determined during pretuning or fine tuning. If manually setting the PID parameters, you will also need to configure the PID algorithm sampling time. The PID\_Compact sampling time is equivalent to the cycle time of the calling OB.

The pulse duration is proportional to the value at Output and is always an integer multiple of the PID\_Compact sampling time.

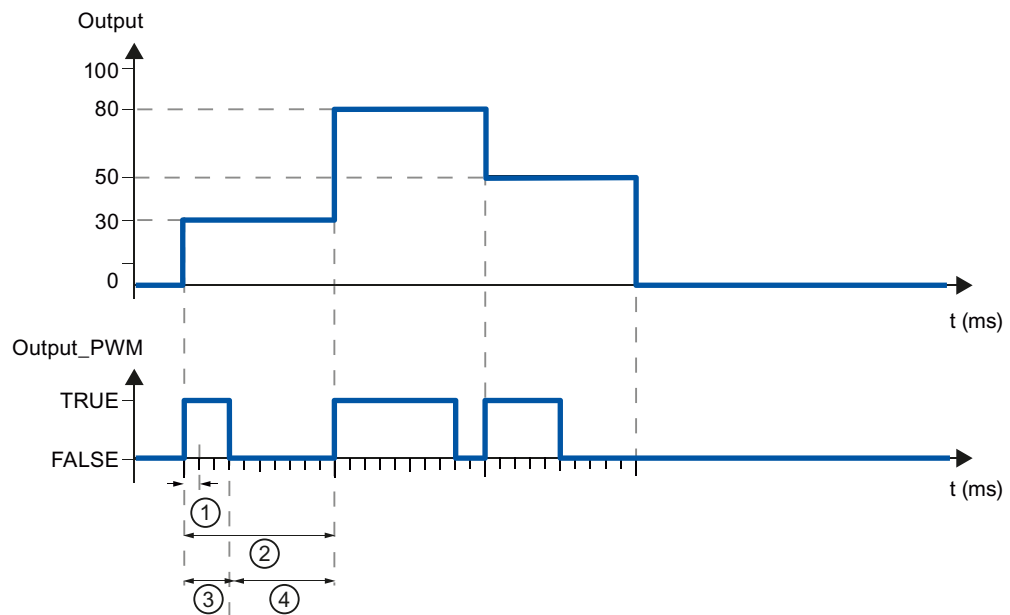

- ① PID\_Compact sampling time
- ② PID algorithm sampling time
- ③ Pulse duration
- ④ Break time

The "Minimum ON time" and the "Minimum OFF time" are rounded to an integer multiple of the PID\_Compact sampling time.

A pulse or a break is never shorter than the minimum ON or OFF time. The inaccuracies this causes are added up and compensated in the next cycle.

### Example

PID\_Compact sampling time = 100 ms

PID algorithm sampling time = 1000 ms

Minimum ON time = 200 ms

Output is a constant 15%. The smallest pulse that PID\_Compact can output is 20%. In the first cycle, no pulse is output. In the second cycle, the pulse not output in the first cycle is added to the pulse of the second cycle.

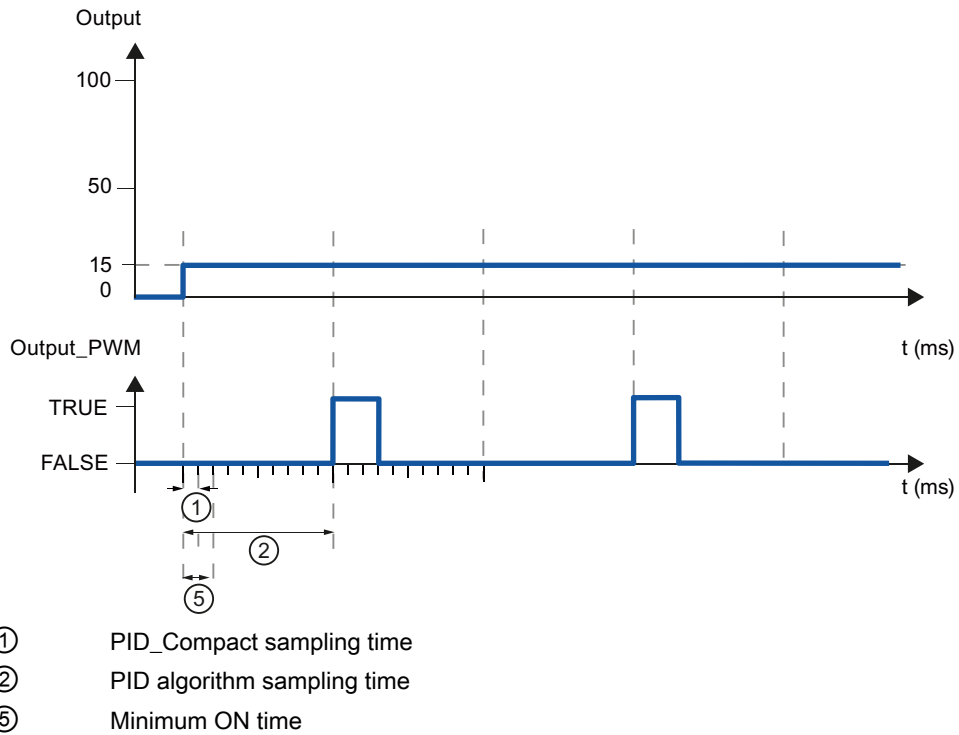

In order to minimize operation frequency and conserve the actuator, extend the minimum ON and OFF times.

If you are using "Output" or "Output\_PER", you must configure the value 0.0 for the minimum ON and OFF times.

**Note**

The minimum ON and OFF times only affect the output parameter Output\_PWM and are not used for any pulse generators integrated in the CPU.

**Output value**

**Output value limits**

In the "Output value limits" configuration window, configure the absolute limits of your output value in percent. Absolute output value limits are not violated in neither manual mode nor automatic mode. If an output value outside the limits is specified in manual mode, the effective value is limited in the CPU to the configured limits.

The output value limits must match the control logic.

The valid output value limit values depend on the Output used.

Output	-100.0 to 100.0%
Output_PER	-100.0 to 100.0%
Output_PWM	0.0 to 100.0%

## Reaction to error

### NOTICE

#### **Your system may be damaged.**

If you output "Current value while error pending " or "Substitute output value while error pending" in the event of an error, PID\_Compact remains in automatic mode. This may cause a violation of the process value limits and damage your system.

It is essential to configure how your controlled system reacts in the event of an error to protect your system from damage.

PID\_Compact is preset so that the controller stays active in most cases in the event of an error. If errors occur frequently in controller mode, this default reaction has a negative effect on the control response. In this case, check the Errorbits parameter and eliminate the cause of the error.

PID\_Compact generates a programmable output value in response to an error:

## 11.1 PID control

- Zero (inactive)  
PID\_Compact outputs 0.0 as output value for all errors and switches to "Inactive" mode. The controller is only reactivated by a falling edge at Reset or a rising edge at ModeActivate.
- Current value while error is pending  
If the following errors occur in **automatic mode**, PID\_Compact returns to automatic mode as soon as the errors are no longer pending.  
If one or more of the following errors occur, PID\_Compact stays in automatic mode:
  - 0001h: The "Input" parameter is outside the process value limits.
  - 0800h: Sampling time error
  - 40000h: Invalid value at Disturbance parameter.  
If one or more of the following errors occur in **automatic mode**, PID\_Compact switches to "Substitute output value with error monitoring" mode and outputs the last valid output value:
  - 0002h: Invalid value at Input\_PER parameter.
  - 0200h: Invalid value at Input parameter.
  - 0400h: Calculation of output value failed.
  - 1000h: Invalid value at Setpoint parameter.  
If an error occurs in **manual mode**, PID\_Compact continues using the manual value as the output value. If the manual value is invalid, the substitute output value is used. If the manual value and substitute output value are invalid, the output value low limit is used.  
If the following error occurs during a **pretuning or fine tuning**, PID\_Compact remains in active mode:
  - 0020h: Pretuning is not permitted during fine tuning.  
When any other error occurs, PID\_Compact cancels the tuning and switches to the mode from which tuning was started.  
As soon as no errors are pending, PID\_Compact returns to automatic mode.
- Substitute output value while error is pending  
PID\_Compact outputs the substitute output value.  
If the following error occurs, PID\_Compact stays in "Substitute output value with error monitoring" mode and outputs the output value low limit:
  - 20000h: Invalid value at SubstituteOutput tag.  
For all other errors, PID\_Compact reacts as described for "Current value while error is pending".

### See also

Parameters State and Mode V2 (Page 2610)

### PID parameters

The PID parameters are displayed in the "PID Parameters" configuration window. The PID parameters will be adapted to your controlled system during controller tuning. You do not need to enter the PID parameters manually.

The PID algorithm operates according to the following equation:

$$y = K_p \left[ (b \cdot w - x) + \frac{1}{T_i \cdot s} (w - x) + \frac{T_D \cdot s}{a \cdot T_D \cdot s + 1} (c \cdot w - x) \right]$$

Symbol	Description
y	Output value of the PID algorithm
$K_p$	Proportional gain
s	Laplace operator
b	Proportional action weighting
w	Setpoint
x	Process value
$T_i$	Integral action time
a	Derivative delay coefficient (derivative delay $T_1 = a \times T_D$ )
$T_D$	Derivative action time
c	Derivative action weighting

The diagram below illustrates the integration of the parameters into the PID algorithm:

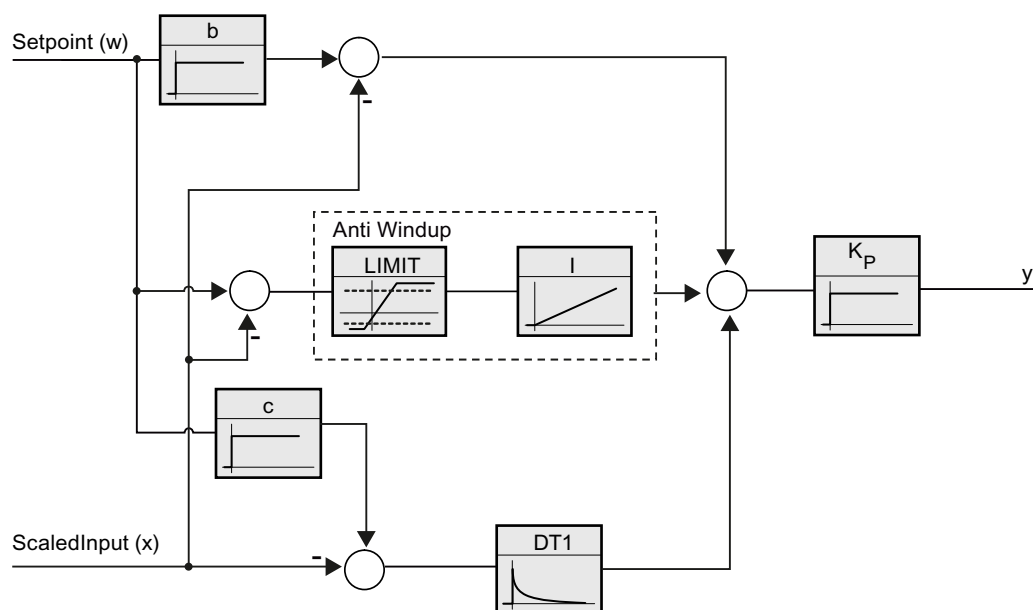

All PID parameters are retentive. If you enter the PID parameters manually, you must completely download PID\_Compact.

Downloading technology objects to device (Page 5935)

## Proportional gain

The value specifies the proportional gain of the controller. PID\_Compact does not work with a negative proportional gain. Control logic is inverted under Basic settings > Controller type.

### Integral action time

The integral action time determines the time behavior of the integral action. The integral action is deactivated with integral action time = 0.0.

### Derivative action time

The derivative action time determines the time behavior of the derivative action. Derivative action is deactivated with derivative action time = 0.0.

### Derivative delay coefficient

The derivative delay coefficient delays the effect of the derivative action.

Derivative delay = derivative action time × derivative delay coefficient

- 0.0: Derivative action is effective for one cycle only and therefore almost not effective.
- 0.5: This value has proved useful in practice for controlled systems with **one** dominant time constant.
- > 1.0: The greater the coefficient, the longer the effect of the derivative action is delayed.

### Proportional action weighting

The proportional action may weaken with changes to the setpoint.

Values from 0.0 to 1.0 are applicable.

- 1.0: Proportional action for setpoint change is fully effective
- 0.0: Proportional action for setpoint change is not effective

The proportional action is always fully effective when the process value is changed.

### Derivative action weighting

The derivative action may weaken with changes to the setpoint.

Values from 0.0 to 1.0 are applicable.

- 1.0: Derivative action is fully effective upon setpoint change
- 0.0: Derivative action is not effective upon setpoint change

The derivative action is always fully effective when the process value is changed.

### PID algorithm sampling time

The controlled system needs a certain amount of time to respond to changes in the output value. It is therefore not advisable to calculate the output value in every cycle. The sampling time of the PID algorithm represents the time between two calculations of the output value. It is calculated during tuning and rounded to a multiple of the cycle time. All other functions of PID\_Compact are executed at every call.

If you use Output\_PWM, the accuracy of the output signal is determined by the ratio of the PID algorithm sampling time to the cycle time of the OB. The PID algorithm sampling time



corresponds to the time period of the pulse width modulation. The cycle time should be at least 10 times the PID algorithm sampling time.

## Rule for tuning

Select whether PI or PID parameters are to be calculated in the "Controller structure" drop-down list.

- **PID**  
Calculates PID parameters during pretuning and fine tuning.
- **PI**  
Calculates PI parameters during pretuning and fine tuning.
- **User-defined**  
The drop-down list displays "User-defined" if you have configured different controller structures for pretuning and fine tuning via a user program.

## Commissioning PID\_Compact V2

### Pretuning

The pretuning determines the process response to a jump change of the output value and searches for the point of inflection. The PID parameters are calculated from the maximum rate of rise and dead time of the controlled system. You obtain the best PID parameters when you perform pretuning and fine tuning.

The more stable the process value is, the easier it is to calculate the PID parameters and the more precise the result will be. Noise on the process value can be tolerated as long as the rate of rise of the process value is significantly higher compared to the noise. This is most likely the case in operating modes "Inactive" and "manual mode". The PID parameters are backed up before being recalculated.

### Requirement

- The "PID\_Compact" instruction is called in a cyclic interrupt OB.
- ManualEnable = FALSE
- Reset = FALSE
- PID\_Compact is in one of the following modes: "Inactive", "Manual mode", or "Automatic mode".
- The setpoint and the process value lie within the configured limits (see "Process value monitoring" configuration).
- The difference between setpoint and process value is greater than 30% of the difference between process value high limit and process value low limit.
- The distance between the setpoint and the process value is > 50% of the setpoint.

## Procedure

To perform pretuning, follow these steps:

1. Double-click the "PID\_Compact > Commissioning" entry in the project tree.
2. Select the entry "Pretuning" in the "Tuning mode" drop-down list.
3. Click the "Start" icon.
  - An online connection will be established.
  - Value recording is started.
  - Pretuning is started.
  - The "Status" field displays the current steps and any errors that may have occurred. The progress bar indicates the progress of the current step.

---

### Note

Click the "Stop" icon when the progress bar has reached 100% and it can be assumed the controller tuning function is blocked. Check the configuration of the technology object and, if necessary, restart controller tuning.

---

## Result

If pretuning was performed without an error message, the PID parameters have been tuned. PID\_Compact switches to automatic mode and uses the tuned parameters. The tuned PID parameters will be retained during power OFF and a restart of the CPU.

If pretuning is not possible, PID\_Compact responds with the configured reaction to errors.

## See also

Parameters State and Mode V2 (Page 2610)

## Fine tuning

Fine tuning generates a constant, limited oscillation of the process value. The PID parameters are tuned for the operating point from the amplitude and frequency of this oscillation. All PID parameters are recalculated from the results. PID parameters from fine tuning usually have better master control and disturbance characteristics than PID parameters from pretuning. You obtain the best PID parameters when you perform pretuning and fine tuning.

PID\_Compact automatically attempts to generate an oscillation greater than the noise of the process value. Fine tuning is only minimally influenced by the stability of the process value. The PID parameters are backed up before being recalculated.

## Requirement

- The PID\_Compact instruction is called in a cyclic interrupt OB.
- ManualEnable = FALSE
- Reset = FALSE

- The setpoint and the process value lie within the configured limits.
- The control loop has stabilized at the operating point. The operating point is reached when the process value corresponds to the setpoint.
- No disturbances are expected.
- PID\_Compact is in one of the following operating modes: Inactive, automatic mode, or manual mode.

### Process depends on initial situation

Fine tuning can be started from the following operating modes: "Inactive", "automatic mode", or "manual mode". Fine tuning proceeds as follows when started from:

- Automatic mode  
Start fine tuning from automatic mode if you wish to improve the existing PID parameters through tuning.  
PID\_Compact controls the system using the existing PID parameters until the control loop has stabilized and the requirements for fine tuning have been met. Only then will fine tuning start.
- Inactive or manual mode  
If the requirements for pretuning are met, pretuning is started. The determined PID parameters will be used for control until the control loop has stabilized and the requirements for fine tuning have been met. Only then will fine tuning start. If pretuning is not possible, PID\_Compact responds with the configured reaction to errors.  
An attempt is made to reach the setpoint with the minimum or maximum output value if the process value for pretuning is already too near the setpoint. This can produce increased overshoot.

### Procedure

To perform fine tuning, follow these steps:

1. Select the entry "Fine tuning" in the "Tuning mode" drop-down list.
2. Click the "Start" icon.
  - An online connection will be established.
  - Value recording is started.
  - The process of fine tuning is started.
  - The "Status" field displays the current steps and any errors that may have occurred. The progress bar indicates the progress of the current step.

---

#### Note

Click the "Stop" icon in the "Tuning mode" group when the progress bar has reached 100% and it is to be assumed that tuning is blocked. Check the configuration of the technology object and, if necessary, restart controller tuning.

---

## Result

If no errors occurred during fine tuning, the PID parameters have been tuned. PID\_Compact switches to automatic mode and uses the tuned parameters. The tuned PID parameters will be retained during power OFF and a restart of the CPU.

If errors occurred during "fine tuning", PID\_Compact responds with the configured response to errors.

## See also

Parameters State and Mode V2 (Page 2610)

## "Manual" mode

The following section describes how you can use the "manual mode" operating mode in the commissioning window of the "PID\_Compact" technology object. Manual mode is also possible when an error is pending.

## Requirement

- The "PID\_Compact" instruction is called in a cyclic interrupt OB.
- An online connection to the CPU has been established and the CPU is in the "RUN" mode.

## Procedure

Use "Manual mode" in the commissioning window if you want to test the controlled system by specifying a manual value. To define a manual value, follow these steps:

1. Click the "Start" icon.
2. Select the "Manual mode" check box in the "Online status of controller" area. PID\_Compact operates in manual mode. The most recent current output value remains in effect.
3. Enter the manual value in the "Output" field as a % value.
4. Click the  icon.

## Result

The manual value is written to the CPU and immediately goes into effect.

Clear the "Manual mode" check box if the output value is to be specified again by the PID controller. The switchover to automatic mode is bumpless.

## See also

Parameters State and Mode V2 (Page 2610)

### 11.1.3.3 PID\_Compact V1

## Configuring PID\_Compact V1

### Basic settings

#### Introduction

Configure the following properties of the "PID\_Compact" technology object under "Basic settings" in the Inspector window or in the configuration window:

- Physical quantity
- Control logic
- Start-up behavior after reset
- Setpoint (only in the Inspector window)
- Process value (only in the Inspector window)
- Output value (only in the Inspector window)

#### Setpoint, process value and output value

You can only configure the setpoint, process value and output value in the Inspector window of the programming editor. Select the source for each value:

- Instance DB  
The value saved in the instance DB is used.  
Value must be updated in the instance DB by the user program.  
There should be no value at the instruction.  
Change via HMI possible.
- Instruction  
The value connected to the instruction is used.  
The value is written to the instance DB each time the instruction is called.  
No change via HMI possible.

#### Controller type

#### Physical quantity

Select the unit of measurement and physical quantity for the setpoint and process value in the "Controller type" group. The setpoint and process value will be displayed in this unit.

#### Control logic

An increase of the output value is generally intended to cause an increase in the process value. This is referred to as a normal control logic.

## 11.1 PID control

PID\_Compact does not work with negative proportional gain. Select the check box "Invert control logic" to reduce the process value with a higher output value.

Examples

- Opening the drain valve will reduce the level of a container's contents.
- Increasing cooling will reduce the temperature.

### Start-up behavior after reset

To change straight to the last active mode after restarting the CPU, select the "Enable last mode after CPU restart" check box.

PID\_Compact will remain in "Inactive" mode if the check box is cleared.

### Setpoint

#### Procedure

Proceed as follows to define a fixed setpoint:

1. Select "Instance DB".
2. Enter a setpoint, e.g. 80° C.
3. Delete any entry in the instruction.

Proceed as follows to define a variable setpoint:

1. Select "Instruction".
2. Enter the name of the REAL variable in which the setpoint is saved.  
Program-controlled assignment of various values to the REAL variable is possible, for example for the time controlled change of the setpoint.

### Process value

PID\_Compact will scale the value of the analog input to the physical quantity if you use the analog input value directly.

You will need to write a program for processing if you wish first to process the analog input value. The process value is, for example, not directly proportional to the value at the analog input. The processed process value must be in floating point format.

#### Procedure

Proceed as follows to use the analog input value without processing:

1. Select the entry "Input\_PER" in the drop-down list "Input".
2. Select "Instruction" as source.
3. Enter the address of the analog input.

Proceed as follows to use the processed process value in floating point format:

1. Select the entry "Input" in the drop-down list "Input".
2. Select "Instruction" as source.
3. Enter the name of the variable in which the processed process value is saved.

## Output value

PID\_Compact offers three output values. Your actuator will determine which output value you use.

- Output\_PER  
The actuator is triggered via an analog output and controlled with a continuous signal, e.g. 0...10V, 4...20mA.
- Output  
The output value needs to be processed by the user program, for example because of nonlinear actuator response.
- Output\_PWM  
The actuator is controlled via a digital output. Pulse width modulation creates minimum ON and minimum OFF times.

## Procedure

Proceed as follows to use the analog output value:

1. Select the entry "Output\_PER (analog)" in the drop-down list "Output".
2. Select "Instruction".
3. Enter the address of the analog output.

Proceed as follows to process the output value using the user program:

1. Select the entry "Output" in the drop-down list "Output".
2. Select "Instance DB".  
The calculated output value is saved in the instance data block.
3. For the preparation of the output value, use the output parameter Output.
4. Transfer the processed output value to the actuator via a digital or analog CPU output.

Proceed as follows to use the digital output value:

1. Select the entry "Output\_PWM" in the drop-down list "Output".
2. Select "Instruction".
3. Enter the address of the digital output.

## Process value settings

Configure the scaling of your process value and specify the process value absolute limits in the "Process value settings" configuration window.

## Scaling the process value

If you have configured the use of Input\_PER in the basic settings, you will need to convert the value of the analog input into the physical quantity of the process value. The current configuration will be displayed in the Input\_PER display.

Input\_PER will be scaled using a low and high value pair if the process value is directly proportional to the value of the analog input.

1. Enter the low pair of values in the "Scaled low process value" and "Low" input fields.
2. Enter the high pair of values in the "Scaled high process value" and "High" input boxes.

Default settings for the value pairs are saved in the hardware configuration. Proceed as follows to use the value pairs from the hardware configuration:

1. Select the instruction PID\_Compact in the programming editor.
2. Connect Input\_PER with an analog input in the basic settings.
3. Click on the "Automatic setting" button in the process value settings.

The existing values will be overwritten with the values from the hardware configuration.

## Monitoring process value

Specify the absolute high and low limit of the process value. As soon as these limits are violated during operation, the controller switches off and the output value is set to 0%. You must enter reasonable limits for your controlled system. Reasonable limits are important during optimization to obtain optimal PID parameters.

The default for the "High limit process value" is 120 %. At the I/O input, the process value can be a maximum of 18% higher than the standard range (overrange). An error is no longer reported for a violation of the "High limit process value". Only a wire-break and a short-circuit are recognized and the PID\_Compact switches to "Inactive" mode.

### WARNING

If you set very high process value limits (for example  $-3.4 \cdot 10^{38} \dots +3.4 \cdot 10^{38}$ ), process value monitoring will be disabled. Your system may then be damaged if an error occurs.

## See also

Monitoring process value (Page 5963)

PWM limits (Page 5963)

Output value limits (Page 5965)

PID parameters (Page 5966)



## Advanced settings

### Monitoring process value

Configure a warning high and low limit for the process value in the "Process value monitoring" configuration window. If one of the warning limits is exceeded or undershot during operation, a warning will be displayed at the PID\_Compact instruction:

- At the InputWarning\_H output parameter if the warning high limit has been exceeded
- At the InputWarning\_L output parameter if the warning low limit has been undershot

The warning limits must be within the process value high and low limits.

The process value high and low limits will be used if you do not enter values.

### Example

Process value high limit = 98° C; warning high limit = 90° C

Warning low limit = 10° C; process value low limit = 0° C

PID\_Compact will respond as follows:

Process value	InputWarning_H	InputWarning_L	Operating mode
> 98° C	TRUE	FALSE	Inactive
≤ 98° C and > 90° C	TRUE	FALSE	Automatic mode
≤ 90° C and ≥ 10° C	FALSE	FALSE	Automatic mode
< 10° C and ≥ 0° C	FALSE	TRUE	Automatic mode
< 0° C	FALSE	TRUE	Inactive

### See also

Process value settings (Page 5959)

PWM limits (Page 5963)

Output value limits (Page 5965)

PID parameters (Page 5966)

### PWM limits

The value at the output parameter Output is transformed into a pulse sequence that is output at output parameter Output\_PWM by means of a pulse width modulation. Output is calculated in the PID algorithm sampling time, Output\_PWM is output in the PID\_Compact sampling time.

The PID algorithm sampling time is determined during pretuning or fine tuning. If manually setting the PID parameters, you will also need to configure the PID algorithm sampling time. The PID\_Compact sampling time is equivalent to the cycle time of the calling OB.

The pulse duration is proportional to the value at Output and is always an integer multiple of the PID\_Compact sampling time.

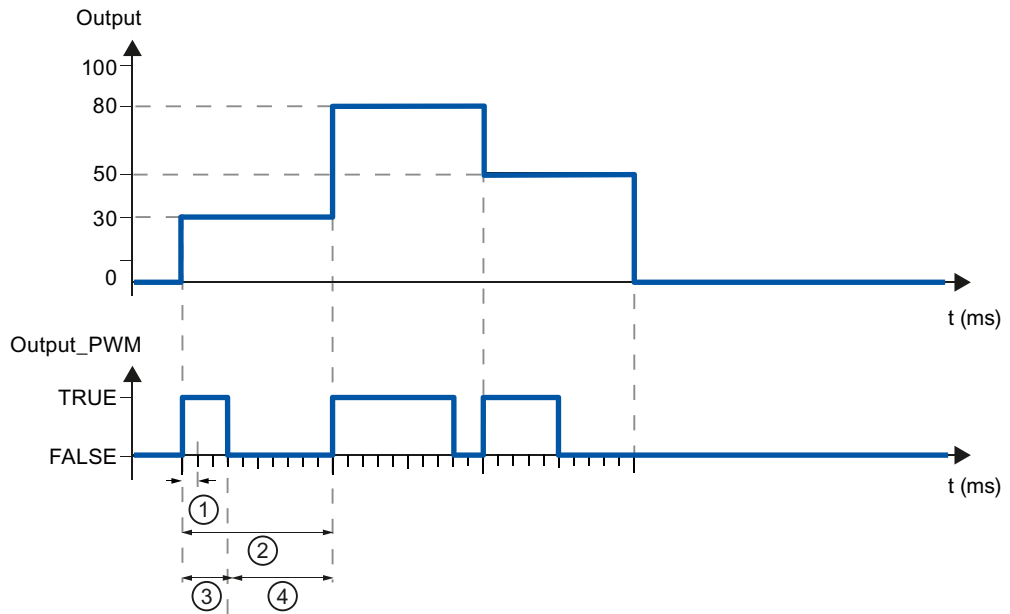

- ① PID\_Compact sampling time
- ② PID algorithm sampling time
- ③ Pulse duration
- ④ Break time

The "Minimum ON time" and the "Minimum OFF time" are rounded to an integer multiple of the PID\_Compact sampling time.

A pulse or a break is never shorter than the minimum ON or OFF time. The inaccuracies this causes are added up and compensated in the next cycle.

**Example**

PID\_Compact sampling time = 100 ms

PID algorithm sampling time = 1000 ms

Minimum ON time = 200 ms

Output is a constant 15%. The smallest pulse that PID\_Compact can output is 20%. In the first cycle, no pulse is output. In the second cycle, the pulse not output in the first cycle is added to the pulse of the second cycle.

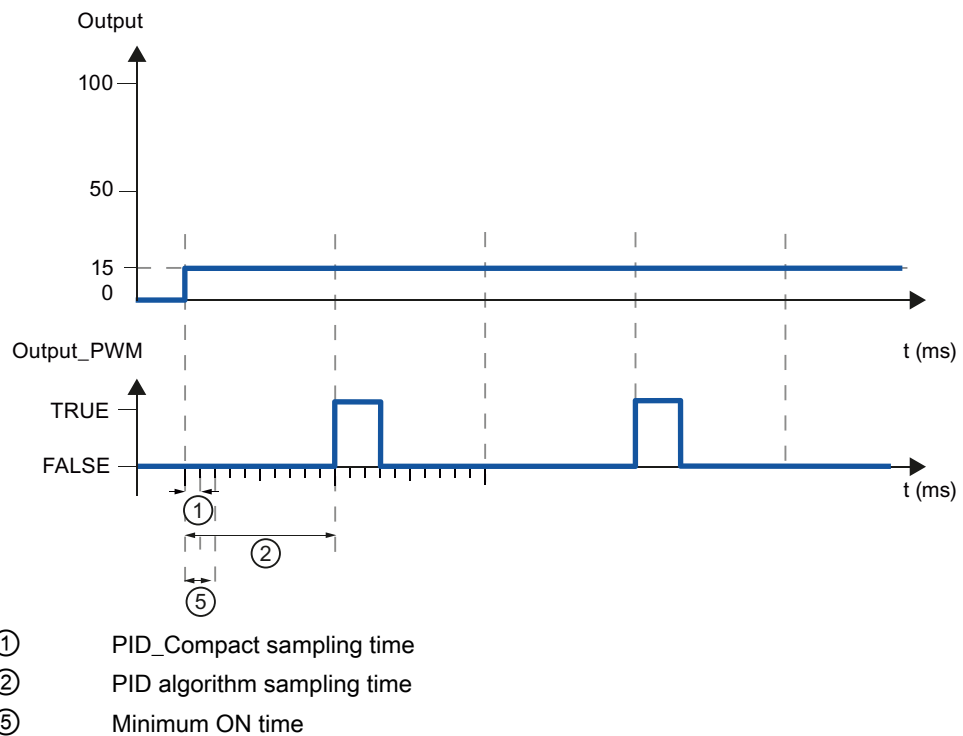

In order to minimize operation frequency and conserve the actuator, extend the minimum ON and OFF times.

If you are using "Output" or "Output\_PER", you must configure the value 0.0 for the minimum ON and OFF times.

#### Note

The minimum ON and OFF times only affect the output parameter Output\_PWM and are not used for any pulse generators integrated in the CPU.

#### See also

[Process value settings \(Page 5959\)](#)

[Monitoring process value \(Page 5961\)](#)

[Output value limits \(Page 5965\)](#)

[PID parameters \(Page 5966\)](#)

#### Output value limits

In the "Output value limits" configuration window, configure the absolute limits of your output value in percent. Absolute output value limits are not violated in neither manual mode nor in automatic mode. If a output value outside the limits is specified in manual mode, the effective value is limited in the CPU to the configured limits.

The valid output value limit values depend on the Output used.

11.1 PID control

Output	-100.0 to 100.0
Output_PER	-100.0 to 100.0
Output_PWM	0.0 to 100.0

PID\_Compact sets the output value to 0.0 if an error occurs. 0.0 must therefore always be within the output value limits. You will need to add an offset to Output and Output\_PER in the user program if you want an output value low limit of greater than 0.0.

**See also**

Process value settings (Page 5959)

Monitoring process value (Page 5961)

PWM limits (Page 5961)

PID parameters (Page 5966)

**PID parameters**

The PID parameters are displayed in the "PID Parameters" configuration window. The PID parameters will be adapted to your controlled system during controller tuning. You do not need to enter the PID parameters manually.

The PID algorithm operates according to the following equation:

$$y = K_p \left[ (b \cdot w - x) + \frac{1}{T_i \cdot s} (w - x) + \frac{T_d \cdot s}{a \cdot T_d \cdot s + 1} (c \cdot w - x) \right]$$

Symbol	Description
y	Output value of the PID algorithm
K <sub>p</sub>	Proportional gain
s	Laplace operator
b	Proportional action weighting
w	Setpoint
x	Process value
T <sub>i</sub>	Integral action time
a	Derivative delay coefficient (derivative delay T1 = a × T <sub>D</sub> )
T <sub>D</sub>	Derivative action time
c	Derivative action weighting

The diagram below illustrates the integration of the parameters into the PID algorithm:

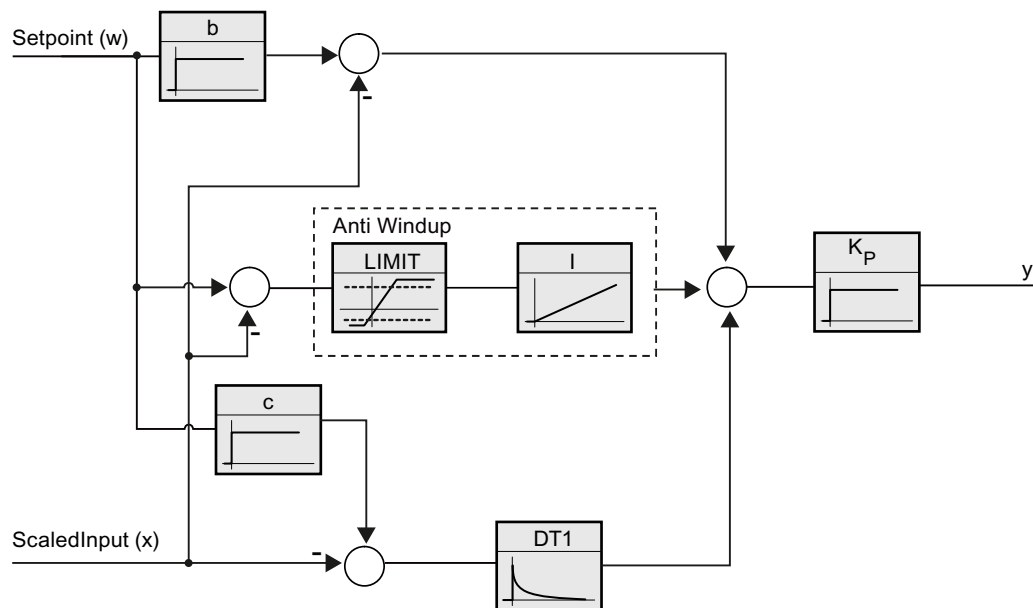

All PID parameters are retentive. If you enter the PID parameters manually, you must completely download PID\_Compact.

Auto-Hotspot

### Proportional gain

The value specifies the proportional gain of the controller. PID\_Compact does not work with a negative proportional gain. Control logic is inverted under Basic settings > Controller type.

### Integral action time

The integral action time determines the time behavior of the integral action. The integral action is deactivated with integral action time = 0.0.

### Derivative action time

The derivative action time determines the time behavior of the derivative action. Derivative action is deactivated with derivative action time = 0.0.

### Derivative delay coefficient

The derivative delay coefficient delays the effect of the derivative action.

Derivative delay = derivative action time × derivative delay coefficient

- 0.0: Derivative action is effective for one cycle only and therefore almost not effective.
- 0.5: This value has proved useful in practice for controlled systems with **one** dominant time constant.
- > 1.0: The greater the coefficient, the longer the effect of the derivative action is delayed.

### Proportional action weighting

The proportional action may weaken with changes to the setpoint.

Values from 0.0 to 1.0 are applicable.

- 1.0: Proportional action for setpoint change is fully effective
- 0.0: Proportional action for setpoint change is not effective

The proportional action is always fully effective when the process value is changed.

### Derivative action weighting

The derivative action may weaken with changes to the setpoint.

Values from 0.0 to 1.0 are applicable.

- 1.0: Derivative action is fully effective upon setpoint change
- 0.0: Derivative action is not effective upon setpoint change

The derivative action is always fully effective when the process value is changed.

### PID algorithm sampling time

The controlled system needs a certain amount of time to respond to changes in the output value. It is therefore not advisable to calculate the output value in every cycle. The sampling time of the PID algorithm represents the time between two calculations of the output value. It is calculated during tuning and rounded to a multiple of the cycle time. All other functions of PID\_Compact are executed at every call.

If you use Output\_PWM, the accuracy of the output signal is determined by the ratio of the PID algorithm sampling time to the cycle time of the OB. The PID algorithm sampling time corresponds to the time period of the pulse width modulation. The cycle time should be at least 10 times the PID algorithm sampling time.

### Rule for tuning

Select whether PI or PID parameters are to be calculated in the "Controller structure" drop-down list.

- **PID**  
Calculates PID parameters during pretuning and fine tuning.
- **PI**  
Calculates PI parameters during pretuning and fine tuning.
- **User-defined**  
The drop-down list displays "User-defined" if you have configured different controller structures for pretuning and fine tuning via a user program.

### See also

Downloading technology objects to device (Page 5935)

## Commissioning PID\_Compact V1

### Commissioning

The commissioning window helps you commission the PID controller. You can monitor the values for the setpoint, process value and output value along the time axis in the trend view. The following functions are supported in the commissioning window:

- Controller pretuning
- Controller fine tuning  
Use fine tuning for fine adjustments to the PID parameters.
- Monitoring the current closed-loop control in the trend view
- Testing the controlled system by specifying a manual output value

All functions require an online connection to the CPU to have been established.

### Basic handling

- Select the desired sampling time in the "Sampling time" drop-down list.  
All values in the commissioning window are updated in the selected update time.
- Click the "Start" icon in the measuring group if you want to use the commissioning functions.  
Value recording is started. The current values for the setpoint, process value and output value are entered in the trend view. Operation of the commissioning window is enabled.
- Click the "Stop" icon if you want to end the commissioning functions.  
The values recorded in the trend view can continue to be analyzed.

Closing the commissioning window will terminate recording in the trend view and delete the recorded values.

### See also

Pretuning (Page 5969)

Fine tuning (Page 5971)

"Manual" mode (Page 5973)

### Pretuning

The pretuning determines the process response to a jump change of the output value and searches for the point of inflection. The tuned PID parameters are calculated as a function of the maximum slope and dead time of the controlled system.

The more stable the process value is, the easier it is to calculate the PID parameters and the more precise the result will be. Noise on the process value can be tolerated as long as the rate of rise of the process value is significantly higher compared to the noise. The PID parameters are backed up before being recalculated.

## Requirement

- The "PID\_Compact" instruction is called in a cyclic interrupt OB.
- ManualEnable = FALSE
- PID\_Compact is in "inactive" or "manual" mode.
- The setpoint may not be changed during controller tuning. PID\_Compact will otherwise be deactivated.
- The setpoint and the process value lie within the configured limits (see "Process value monitoring" configuration).
- The difference between setpoint and process value is greater than 30% of the difference between process value high limit and process value low limit.
- The distance between the setpoint and the process value is > 50% of the setpoint.

## Procedure

To perform pretuning, follow these steps:

1. Double-click the "PID\_Compact > Commissioning" entry in the project tree.
2. Select the entry "Pretuning" in the "Tuning mode" drop-down list.
3. Click the "Start" icon.
  - An online connection will be established.
  - Value recording is started.
  - Pretuning is started.
  - The "Status" field displays the current steps and any errors that may have occurred. The progress bar indicates the progress of the current step.

---

### Note

Click the "Stop" icon when the progress bar has reached 100% and it is to be assumed the controller tuning function is blocked. Check the configuration of the technology object and, if necessary, restart controller tuning.

---

## Result

If pretuning was performed without an error message, the PID parameters have been tuned. PID\_Compact switches to automatic mode and uses the tuned parameters. The tuned PID parameters will be retained during power OFF and a restart of the CPU.

If pretuning is not possible, PID\_Compact will change to "Inactive" mode.



**See also**

Parameters State and sRet.i\_Mode V1 (Page 2628)

Commissioning (Page 5967)

Fine tuning (Page 5971)

"Manual" mode (Page 5973)

**Fine tuning**

Fine tuning generates a constant, limited oscillation of the process value. The PID parameters are optimized for the operating point from the amplitude and frequency of this oscillation. All PID parameters are recalculated on the basis of the findings. PID parameters from fine tuning usually have better master control and disturbance behavior than PID parameters from pretuning.

PID\_Compact automatically attempts to generate an oscillation greater than the noise of the process value. Fine tuning is only minimally influenced by the stability of the process value. The PID parameters are backed up before being recalculated.

**Requirement**

- The PID\_Compact instruction is called in a cyclic interrupt OB.
- ManualEnable = FALSE
- The setpoint and the process value lie within the configured limits (see "Process value monitoring" configuration).
- The control loop has stabilized at the operating point. The operating point is reached when the process value corresponds to the setpoint.
- No disturbances are expected.
- The setpoint may not be changed during controller tuning.
- PID\_Compact is in inactive mode, automatic mode or manual mode.

### Process depends on initial situation

Fine tuning can be started in "inactive", "automatic" or "manual" mode. Fine tuning proceeds as follows when started in:

- **Automatic mode**  
Start fine tuning in automatic mode if you wish to improve the existing PID parameters using controller tuning.  
PID\_Compact will regulate using the existing PID parameters until the control loop has stabilized and the requirements for fine tuning have been met. Only then will fine tuning start.
- **Inactive or manual mode**  
If the requirements for pretuning are met, pretuning is started. The PID parameters established will be used for adjustment until the control loop has stabilized and the requirements for fine tuning have been met. Only then will fine tuning start. If pretuning is not possible, PID\_Compact will change to "Inactive" mode.  
An attempt is made to reach the setpoint with a minimum or maximum output value if the process value for pretuning is already too near the setpoint. This can produce increased overshoot.

### Procedure

Proceed as follows to carry out "fine tuning":

1. Select the entry "Fine tuning" in the "Tuning mode" drop-down list.
2. Click the "Start" icon.
  - An online connection will be established.
  - Value recording is started.
  - The process of fine tuning is started.
  - The "Status" field displays the current steps and any errors that may have occurred. The progress bar indicates the progress of the current step.

---

#### Note

Click the "Stop" icon in the "Tuning mode" group when the progress bar has reached 100% and it is to be assumed the controller tuning function is blocked. Check the configuration of the technology object and, if necessary, restart controller tuning.

---

### Result

The PID parameters will have been optimized if fine tuning has been executed without errors. PID\_Compact changes to automatic mode and uses the optimized parameters. The optimized PID parameters will be retained during power OFF and a restart of the CPU.

If errors occurred during "fine tuning", PID\_Compact will change to "inactive" mode.

## See also

Parameters State and sRet.i\_Mode V1 (Page 2628)

Commissioning (Page 5967)

Pretuning (Page 5967)

"Manual" mode (Page 5973)

## "Manual" mode

The following section describes how you can use the "Manual" operating mode in the commissioning window of the "PID Compact" technology object.

## Requirement

- The "PID\_Compact" instruction is called in a cyclic interrupt OB.
- An online connection to the CPU has been established and the CPU is in the "RUN" mode.
- The functions of the commissioning window have been enabled via the "Start" icon.

## Procedure

Use "Manual mode" in the commissioning window if you want to test the process by specifying a manual value. To define a manual value, proceed as follows:

1. Select the check box "Manual mode" in the "Online status of the controller" area. PID\_Compact operates in manual mode. The most recent current output value remains in effect.
2. Enter the manual value in the "Output" field as a % value.
3. Click the control icon .

## Result

The manual value is written to the CPU and immediately goes into effect.

---

### Note

PID\_Compact continues to monitor the process value. If the process value limits are exceeded, PID\_Compact is deactivated.

---

Clear the "Manual mode" check box if the output value is to be specified again by the PID controller. The change to automatic mode is bumpless.

## See also

Parameters State and sRet.i\_Mode V1 (Page 2628)

Commissioning (Page 5967)

Pretuning (Page 5967)

Fine tuning (Page 5969)

## 11.1.4 Using PID\_3Step

### 11.1.4.1 Technology object PID\_3Step

The technology object PID\_3Step provides a PID controller with tuning for valves or actuators with integral response.

You can configure the following controllers:

- Three-point step controller with position feedback
- Three-point step controller without position feedback
- Valve controller with analog output value

PID\_3Step continuously acquires the measured process value within a control loop and compares it with the setpoint. From the resulting control deviation, PID\_3Step calculates an output value through which the process value reaches the setpoint as quickly and steadily as possible. The output value for the PID controller consists of three actions:

- **P** action  
The proportional action of the output value increases in proportion to the control deviation.
- **I** action  
The integral action of the output value increases until the control deviation has been balanced.
- **D** action  
The derivative action increases with the rate of change of control deviation. The process value is corrected to the setpoint as quickly as possible. The derivative action will be reduced again if the rate of change of control deviation drops.

The instruction PID\_3Step calculates the proportional, integral and derivative parameters for your controlled system during pretuning. Fine tuning can be used to tune the parameters further. You do not need to manually determine the parameters.

## Additional information

- Overview of software controller (Page 5930)
- Add technology objects (Page 5932)
- Configure technology objects (Page 5933)
- Configuring PID\_3Step V2 (Page 5975)
- Configuring PID\_3Step V1 (Page 5991)

## 11.1.4.2 PID\_3Step V2

### Configuring PID\_3Step V2

#### Basic settings

##### Introduction

Configure the following properties of the "PID\_3Step" technology object under "Basic settings" in the Inspector window or in the configuration window:

- Physical quantity
- Control logic
- Start-up behavior after reset
- Setpoint (only in the Inspector window)
- Process value (only in the Inspector window)
- Output value (only in the Inspector window)
- Position feedback (only in the Inspector window)

#### Setpoint, process value, output value and position feedback

You can only configure the setpoint, process value, output value and position feedback in the Inspector window of the programming editor. Select the source for each value:

- Instance DB  
The value saved in the instance DB is used.  
Value must be updated in the instance DB by the user program.  
There should be no value at the instruction.  
Change via HMI possible.
- Instruction  
The value connected to the instruction is used.  
The value is written to the instance DB each time the instruction is called.  
No change via HMI possible.

#### Controller type

##### Physical quantity

Select the physical quantity and unit of measurement for setpoint, process value, and disturbance variable in the "Controller type" group. Setpoint, process value, and disturbance variable is displayed in this unit of measurement.

## Control logic

An increase of the output value is generally intended to cause an increase in the process value. This is referred to as a normal control logic.

PID\_3Step does not work with negative proportional gain. Select the check box "Invert control logic" to reduce the process value with a higher output value.

Examples

- Opening the drain valve will reduce the level of a container's contents.
- Increasing cooling will reduce the temperature.

## Startup characteristics

1. To switch to "Inactive" mode after CPU restart, clear the "Activate Mode after CPU restart" check box.  
To switch to the operating mode saved in the Mode parameter after CPU restart, select the "Activate Mode after CPU restart" check box.
2. In the "Set Mode to" drop-down list, select the mode that is to be enabled after a complete download to the device.  
After a complete download to the device, PID\_3Step starts in the selected operating mode.  
With each additional restart, PID\_3Step starts in the mode that was last saved in Mode.

Example

You have selected the "Activate Mode after CPU restart" check box and the entry "Pretuning" in the "Set Mode to" list. After a complete download to the device, PID\_3Step starts in the "Pretuning" mode. If pretuning is still active, PID\_3Step starts in "Pretuning" mode again after restart of the CPU. If pretuning was successfully completed and automatic mode is active, PID\_3Step starts in "Automatic mode" after restart of the CPU.

## Setpoint

### Procedure

Proceed as follows to define a fixed setpoint:

1. Select "Instance DB".
2. Enter a setpoint, e.g. 80° C.
3. Delete any entry in the instruction.

Proceed as follows to define a variable setpoint:

1. Select "Instruction".
2. Enter the name of the REAL variable in which the setpoint is saved.  
Program-controlled assignment of various values to the REAL variable is possible, for example for the time controlled change of the setpoint.

## Process value

PID\_3Step will scale the value of the analog input to the physical quantity if you use the analog input value directly.

You will need to write a program for processing if you wish first to process the analog input value. The process value is, for example, not directly proportional to the value at the analog input. The processed process value must be in floating point format.

## Procedure

Proceed as follows to use the analog input value without processing:

1. Select the entry "Input\_PER" in the drop-down list "Input".
2. Select "Instruction" as source.
3. Enter the address of the analog input.

Proceed as follows to use the processed process value in floating point format:

1. Select the entry "Input" in the drop-down list "Input".
2. Select "Instruction" as source.
3. Enter the name of the variable in which the processed process value is saved.

## Position feedback

Position feedback configuration depends upon the actuator used.

- Actuator without position feedback
- Actuator with digital endstop signals
- Actuator with analog position feedback
- Actuator with analog position feedback and endstop signals

## Actuator without position feedback

Proceed as follows to configure PID\_3Step for an actuator without position feedback:

1. Select the entry "No Feedback" in the drop-down list "Feedback".

## Actuator with digital endstop signals

Proceed as follows to configure PID\_3Step for an actuator with endstop signals:

1. Select the entry "No Feedback" in the drop-down list "Feedback".
2. Activate the "Actuator endstop signals" check box.
3. Select "Instruction" as source for Actuator\_H and Actuator\_L.
4. Enter the addresses of the digital inputs for Actuator\_H and Actuator\_L.

### Actuator with analog position feedback

Proceed as follows to configure PID\_3Step for an actuator with analog position feedback:

1. Select the entry "Feedback" or "Feedback\_PER" in the drop-down list "Feedback".
  - Use the analog input value for Feedback\_PER. Configure Feedback\_PER scaling in the actuator settings.
  - Process the analog input value for Feedback using your user program.
2. Select "Instruction" as source.
3. Enter the address of the analog input or the variable of your user program.

### Actuator with analog position feedback and endstop signals

Proceed as follows to configure PID\_3Step for an actuator with analog position feedback and endstop signals:

1. Select the entry "Feedback" or "Feedback\_PER" in the drop-down list "Feedback".
2. Select "Instruction" as source.
3. Enter the address of the analog input or the variable of your user program.
4. Activate the "Actuator endstop signals" check box.
5. Select "Instruction" as source for Actuator\_H and Actuator\_L.
6. Enter the addresses of the digital inputs for Actuator\_H and Actuator\_L.

### Output value

PID\_3Step offers an analog output value (Output\_PER) and digital output values (Output\_UP, Output\_DN). Your actuator will determine which output value you use.

- Output\_PER  
The actuator is triggered via an analog output and controlled with a continuous signal, e.g. 0...10V, 4...20mA.
- Output\_UP, Output\_DN  
The actuator is controlled via two digital outputs.

### Procedure

Proceed as follows to use the analog output value:

1. Select the entry "Output (analog)" in the drop-down list "Output".
2. Select "Instruction".
3. Enter the address of the analog output.

Proceed as follows to use the digital output value:

1. Select the entry "Output (digital)" in the drop-down list "Output".
2. Select "Instruction" for Output\_UP and Output\_DN.
3. Enter the addresses of the digital outputs.



Proceed as follows to process the output value using the user program:

1. Select the entry corresponding to the actuator in the drop-down list "Output".
2. Select "Instruction".
3. Enter the name of the variable you are using to process the output value.
4. Transfer the processed output value to the actuator by means of an analog or digital CPU output.

## Process value settings

### Scaling the process value

If you have configured the use of Input\_PER in the basic setting, you must convert the value of the analog input to the physical quantity of the process value. The current configuration is displayed in the Input\_PER display.

Input\_PER will be scaled using a low and high value pair if the process value is directly proportional to the value of the analog input.

### Procedure

To scale the process value, follow these steps:

1. Enter the low pair of values in the "Scaled low process value" and "Low" text boxes.
2. Enter the high pair of values in the "Scaled high process value" and "High" input boxes.

Default settings for the value pairs are stored in the hardware configuration. To use the value pairs from the hardware configuration, follow these steps:

1. Select the PID\_3Step instruction in the programming editor.
2. Interconnect Input\_PER with an analog input in the basic settings.
3. Click the "Automatic setting" button in the process value settings.

The existing values will be overwritten with the values from the hardware configuration.

### Process value limits

You must specify an appropriate absolute high limit and low limit for the process value as limit values for your controlled system. As soon as the process value violates these limits, an error occurs (ErrorBits = 0001h). Tuning is canceled when the process value limits are violated. You can specify how PID\_3Step responds to errors in automatic mode in the actuator settings.

## Actuator settings

### Actuator

#### Actuator-specific times

Configure the motor transition time and the minimum ON and OFF times to prevent damage to the actuator. You can find the specifications in the actuator data sheet.

The motor transition time is the time in seconds the motor requires to move the actuator from the closed to the opened state. You can measure the motor transition time during commissioning.

The motor transition time is retentive. If you enter the motor transition time manually, you must completely download PID\_3Step.

Downloading technology objects to device (Page 5935)

If you are using "Output\_UP" or "Output\_DN", you can reduce the switching frequency with the minimum on and minimum OFF time.

The on or off times calculated are totaled in automatic mode and only become effective when the sum is greater than or equal to the minimum on or OFF time.

Manual\_UP = TRUE or Manual\_DN = TRUE in manual mode operates the actuator for at least the minimum ON or OFF time.

#### Reaction to error

PID\_3Step is preset so that the controller stays active in most cases in the event of an error. If errors occur frequently in controller mode, this default reaction has a negative effect on the control response. In this case, check the Errorbits parameter and eliminate the cause of the error.

<b>NOTICE</b>
<b>Your system may be damaged.</b>
If you output "Current value while error pending" or "Substitute output value while error pending" in the event of an error, PID_3Step remains in automatic mode even if the process value limits are violated. This may damage your system.
It is essential to configure how your controlled system reacts in the event of an error to protect your system from damage.

PID\_3Step generates a programmable output value in response to an error:

- Current value  
PID\_3Step is switched off and no longer modifies the actuator position.
- Current value for error while error is pending  
The controller functions of PID\_3Step are switched off and the position of the actuator is no longer changed.  
If the following errors occur in automatic mode, PID\_3Step returns to automatic mode as soon as the errors are no longer pending.
  - 0002h: Invalid value at Input\_PER parameter.
  - 0200h: Invalid value at Input parameter.
  - 0400h: Calculation of output value failed.
  - 1000h: Invalid value at Setpoint parameter.
  - 2000h: Invalid value at Feedback\_PER parameter.
  - 4000h: Invalid value at Feedback parameter.
  - 8000h: Error during digital position feedback.
  - 20000h: Invalid value at SavePosition tag.

If one or more of the following errors occur, PID\_3Step stays in automatic mode:

- 0001h: The Input parameter is outside the process value limits.
- 0800h: Sampling time error
- 40000h: Invalid value at Disturbance parameter.

PID\_3Step remains in manual mode if an error occurs in manual mode.

If an error occurs during tuning or transition time measurement, PID\_3Step switches to the mode in which tuning or transition time measurement was started. Only in the event of the following error is tuning not aborted:

- 0020h: Pretuning is not permitted during fine tuning.

- Substitute output value  
PID\_3Step moves the actuator to the substitute output value and then switches off.
- Substitute output value while error is pending  
PID\_3Step moves the actuator to the substitute output value. When the substitute output value is reached, PID\_3Step reacts as it does with "Current value for while error is pending".

Enter the substitute output value in "%".

Only substitute output values 0% and 100% can be approached precisely in the case of actuators without analog position feedback. A substitute output value not equal to 0% or 100% is approached via an internally simulated position feedback. This procedure does not, however, allow the exact approach of substitute output value.

All substitute output values can be approached precisely with actuators with analog position feedback.

## Scaling position feedback

### Scaling position feedback

If you have configured the use of Feedback\_PER in the basic settings, you will need to convert the value of the analog input into %. The current configuration will be displayed in the "Feedback" display.

Feedback\_PER is scaled using a low and high value pair.

1. Enter the low pair of values in the "Low endstop" and "Low" input boxes.
2. Enter the high pair of values in the "High endstop" and "High" input boxes.

"Low endstop" must be less than "High endstop"; "Low" must be less than "High".

The valid values for "High endstop" and "Low endstop" depend upon:

- No Feedback, Feedback, Feedback\_PER
- Output (analog), Output (digital)

Output	Feedback	Low endstop	High endstop
Output (digital)	No Feedback	Cannot be set (0.0%)	Cannot be set (100.0%)
Output (digital)	Feedback	-100.0% or 0.0%	0.0% or +100.0%
Output (digital)	Feedback_PER	-100.0% or 0.0%	0.0% or +100.0%
Output (analog)	No Feedback	Cannot be set (0.0%)	Cannot be set (100.0%)
Output (analog)	Feedback	-100.0% or 0.0%	0.0% or +100.0%
Output (analog)	Feedback_PER	-100.0% or 0.0%	0.0% or +100.0%

## Output value limits

### Limiting the output value

You can only exceed or undershoot the output value limits during the transition time measurement. The output value is limited to these values in all other modes.

Enter the absolute output value limits in the "Output value high limit" and "Output value low limit" input boxes. The output value limits must be within "Low endstop" and "High endstop".

If no Feedback is available and Output (digital) is set, you cannot limit the output value. Output\_UP and Output\_DN are then reset at Actuator\_H = TRUE or Actuator\_L = TRUE. If no endstop signals are available, Output\_UP and Output\_DN are reset after a travel time of 150% of the motor actuating time.

## Advanced settings

### Monitoring process value

Configure a warning high and low limit for the process value in the "Process value monitoring" configuration window. If one of the warning limits is exceeded or undershot during operation, a warning will be displayed at the PID\_3Step instruction:

- At the InputWarning\_H output parameter if the warning high limit has been exceeded
- At the InputWarning\_L output parameter if the warning low limit has been undershot

The warning limits must be within the process value high and low limits.

The process value high and low limits will be used if you do not enter values.

### Example

Process value high limit = 98° C; warning high limit = 90° C

Warning low limit = 10° C; process value low limit = 0° C

PID\_3Step will respond as follows:

Process value	InputWarning_H	InputWarning_L	ErrorBits	Operating mode
> 98° C	TRUE	FALSE	0001h	As configured
≤ 98° C and > 90° C	TRUE	FALSE	0000h	Automatic mode
≤ 90° C and ≥ 10° C	FALSE	FALSE	0000h	Automatic mode
< 10° C and ≥ 0° C	FALSE	TRUE	0000h	Automatic mode
< 0° C	FALSE	TRUE	0001h	As configured

In the actuator settings, you can configure the response of PID\_3Step when the process value high limit or low limit is violated.

### PID parameters

The PID parameters are displayed in the "PID Parameters" configuration window. The PID parameters will be adapted to your controlled system during controller tuning. You do not need to enter the PID parameters manually.

The PID algorithm operates according to the following equation:

$$\Delta y = K_p \cdot s \cdot \left[ (b \cdot w - x) + \frac{1}{T_i \cdot s} (w - x) + \frac{T_d \cdot s}{a \cdot T_d \cdot s + 1} (c \cdot w - x) \right]$$

Symbol	Description
$\Delta y$	Output value of the PID algorithm
$K_p$	Proportional gain
s	Laplace operator
b	Proportional action weighting
w	Setpoint
x	Process value
$T_i$	Integral action time
a	Derivative delay coefficient (derivative delay $T_1 = a \times T_D$ )
$T_D$	Derivative action time
c	Derivative action weighting

The diagram below illustrates the integration of the parameters into the PID algorithm:

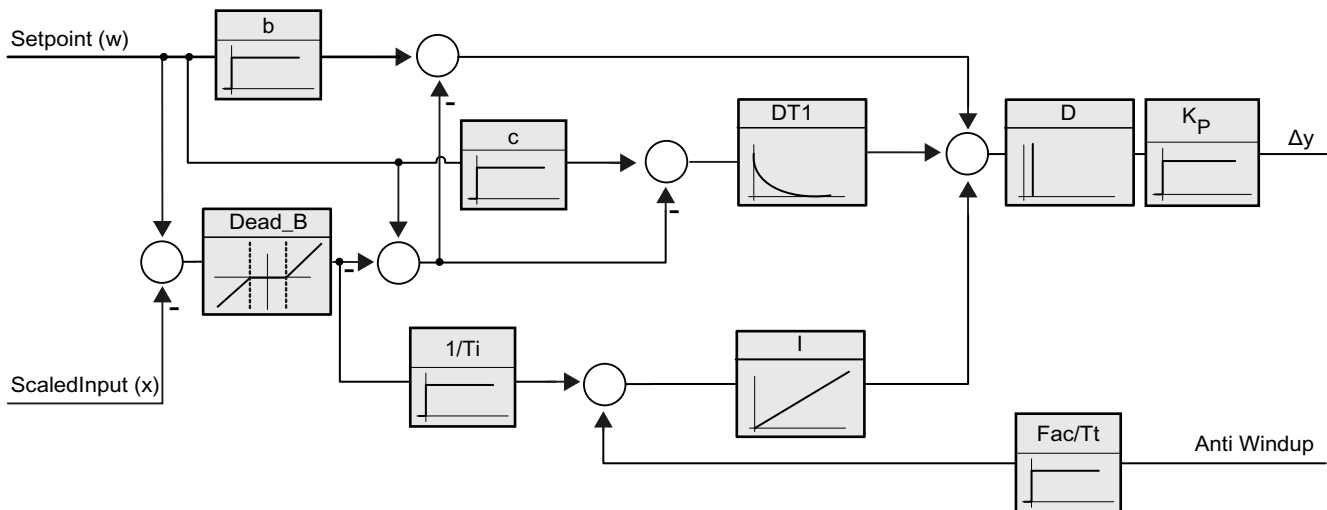

All PID parameters are retentive. If you enter the PID parameters manually, you must completely download PID\_3Step.

Downloading technology objects to device (Page 5935)

### Proportional gain

The value specifies the proportional gain of the controller. PID\_3Step does not work with a negative proportional gain. Control logic is inverted under Basic settings > Controller type.

### Integral action time

The integral action time determines the time behavior of the integral action. The integral action is deactivated with integral action time = 0.0.

### Derivative action time

The derivative action time determines the time behavior of the derivative action. Derivative action is deactivated with derivative action time = 0.0.

### Derivative delay coefficient

The derivative delay coefficient delays the effect of the derivative action.

Derivative delay = derivative action time × derivative delay coefficient

- 0.0: Derivative action is effective for one cycle only and therefore almost not effective.
- 0.5: This value has proved useful in practice for controlled systems with **one** dominant time constant.
- > 1.0: The greater the coefficient, the longer the effect of the derivative action is delayed.

### Proportional action weighting

The proportional action may weaken with changes to the setpoint.

Values from 0.0 to 1.0 are applicable.

- 1.0: Proportional action for setpoint change is fully effective
- 0.0: Proportional action for setpoint change is not effective

The proportional action is always fully effective when the process value is changed.

### Derivative action weighting

The derivative action may weaken with changes to the setpoint.

Values from 0.0 to 1.0 are applicable.

- 1.0: Derivative action is fully effective upon setpoint change
- 0.0: Derivative action is not effective upon setpoint change

The derivative action is always fully effective when the process value is changed.

### PID algorithm sampling time

The controlled system needs a certain amount of time to respond to changes in the output value. It is therefore not advisable to calculate the output value in every cycle. The sampling time of the PID algorithm represents the time between two calculations of the output value. It is calculated during tuning and rounded to a multiple of the PID\_3Step sampling time. All other functions of PID\_3Step are executed at every call.

### Deadband width

The deadband suppresses the noise component in the steady controller state. The deadband width specifies the size of the deadband. The deadband is off if the deadband width is 0.0.

## Commissioning PID\_3Step V2

### Pretuning

The pretuning determines the process response to a pulse of the output value and searches for the point of inflection. The tuned PID parameters are calculated as a function of the maximum slope and dead time of the controlled system. You obtain the best PID parameters when you perform pretuning and fine tuning.

The more stable the process value is, the easier it is to calculate the PID parameters and the more precise the result will be. Noise on the process value can be tolerated as long as the rate of rise of the process value is significantly higher compared to the noise. This is most likely the case in operating modes "Inactive" and "manual mode". The PID parameters are backed up before being recalculated.

The setpoint is frozen during pretuning.

### Requirement

- The PID\_3Step instruction is called in a cyclic interrupt OB.
- ManualEnable = FALSE
- Reset = FALSE
- The motor transition time has been configured or measured.
- PID\_3Step is in one of the following modes: "Inactive", "Manual mode", or "Automatic mode".
- The setpoint and the process value lie within the configured limits (see "Process value settings" configuration).

### Procedure

To perform pretuning, follow these steps:

1. Double-click the "PID\_3Step > Commissioning" entry in the project tree.
2. Select the entry "Pretuning" in the "Tuning mode" drop-down list in the working area "Tuning".
3. Click the "Start" icon.
  - An online connection will be established.
  - Value recording is started.
  - Pretuning is started.
  - The "Status" field displays the current steps and any errors that may have occurred. The progress bar indicates the progress of the current step.

---

#### Note

Click the "Stop" icon when the progress bar has reached 100% and it is to be assumed the controller tuning function is blocked. Check the configuration of the technology object and, if necessary, restart controller tuning.

---



## Result

If pretuning was performed without an error message, the PID parameters have been tuned. PID\_3Step switches to automatic mode and uses the tuned parameters. The tuned PID parameters will be retained during power OFF and a restart of the CPU.

If pretuning is not possible, PID\_3Step responds with the configured reaction to errors.

## Fine tuning

Fine tuning generates a constant, limited oscillation of the process value. The PID parameters are tuned for the operating point from the amplitude and frequency of this oscillation. All PID parameters are recalculated from the results. PID parameters from fine tuning usually have better master control and disturbance characteristics than PID parameters from pretuning. You obtain the best PID parameters when you perform pretuning and fine tuning.

PID\_3Step automatically attempts to generate an oscillation greater than the noise of the process value. Fine tuning is only minimally influenced by the stability of the process value. The PID parameters are backed up before being recalculated.

The setpoint is frozen during fine tuning.

## Requirement

- The PID\_3Step instruction is called in a cyclic interrupt OB.
- ManualEnable = FALSE
- Reset = FALSE
- The motor transition time has been configured or measured.
- The setpoint and the process value lie within the configured limits (see "Process value settings" configuration).
- The control loop has stabilized at the operating point. The operating point is reached when the process value corresponds to the setpoint.
- No disturbances are expected.
- PID\_3Step is in inactive mode, automatic mode or manual mode.

## Process depends on initial situation

Fine tuning proceeds as follows when started from:

- Automatic mode  
Start fine tuning from automatic mode if you wish to improve the existing PID parameters through tuning.  
PID\_3Step controls the system using the existing PID parameters until the control loop has stabilized and the requirements for fine tuning have been met. Only then will fine tuning start.
- Inactive or manual mode  
Pretuning is always started first. The determined PID parameters will be used for control until the control loop has stabilized and the requirements for fine tuning have been met. Only then will fine tuning start.

## Procedure

To perform fine tuning, follow these steps:

1. Select the entry "Fine tuning" in the "Tuning mode" drop-down list.
2. Click the "Start" icon.
  - An online connection will be established.
  - Value recording is started.
  - The process of fine tuning is started.
  - The "Status" field displays the current steps and any errors that may have occurred. The progress bar indicates the progress of the current step.

---

### Note

Click the "Stop" icon in the "Tuning mode" group when the progress bar has reached 100% and it is to be assumed the controller tuning function is blocked. Check the configuration of the technology object and, if necessary, restart controller tuning.

---

## Result

If no errors occurred during fine tuning, the PID parameters have been tuned. PID\_3Step switches to automatic mode and uses the tuned parameters. The tuned PID parameters will be retained during power OFF and a restart of the CPU.

If errors occurred during fine tuning, PID\_3Step responds with the configured response to errors.

## Commissioning with manual PID parameters

### Requirement

- The PID\_3Step instruction is called in a cyclic interrupt OB.
- ManualEnable = FALSE
- Reset = FALSE
- The motor transition time has been configured or measured.
- PID\_3Step is in "inactive" mode.
- The setpoint and the process value lie within the configured limits (see "Process value settings" configuration).

## Procedure

Proceed as follows to commission PID\_3Step with manual PID parameters:

1. Double-click on "PID\_3Step > Configuration" in the project tree.
2. Click on "Advanced settings > PID Parameters" in the configuration window.
3. Select the check box "Enable direct input".
4. Enter the PID parameters.
5. Double-click the "PID\_3Step > Commissioning" entry in the project tree.
6. Establish an online connection to the CPU.
7. Load the PID parameters to the CPU.
8. Click the "Start PID\_3Step" icon.

## Result

PID\_3Step changes to automatic mode and controls using the current PID parameters.

## See also

PID parameters (Page 5981)

## Measuring the motor transition time

### Introduction

PID\_3Step requires the motor transition time to be as accurate as possible for good controller results. The data in the actuator documentation contains average values for this type of actuator. The value for the specific actuator used may differ.

You can measure the motor transition time during commissioning if you are using actuators with position feedback or endstop signals. The output value limits are not taken into consideration during the motor transition time measurement. The actuator can travel to the high or the low endstop.

The motor transition time cannot be measured if neither position feedback nor endstop signals are available.

### Actuators with analog position feedback

Proceed as follows to measure motor transition time with position feedback:

#### Requirement

- Feedback or Feedback\_PER has been selected in the basic settings and the signal has been connected.
- An online connection to the CPU has been established.

1. Select the "Use position feedback" check box.
2. Enter the position to which the actuator is to be moved in the "Target position" input field. The current position feedback (starting position) will be displayed. The difference between "Target position" and "Position feedback" must be at least 50% of the valid output value range.
3. Click the "Start" icon.

## Result

The actuator is moved from the starting position to the target position. Time measurement starts immediately and ends when the actuator reaches the target position. The motor transition time is calculated according to the following equation:

Motor transition time = (output value high limit – output value low limit) × Measuring time / AMOUNT (target position – starting position).

The progress and status of transition time measurement are displayed. The transition time measured is saved in the instance data block on the CPU and displayed in the "Measured transition time" field. When the transition time measurement is ended and ActivateRecoverMode = TRUE, PID\_3Step switches to the operating mode from which the transition time measurement was started. If the transition time measurement is ended and ActivateRecoverMode = FALSE, PID\_3Step changes to "Inactive" mode.

---

### Note

Click on the icon  "Upload measured transition time" to load the motor transition time measured to the project.

---

## Actuators with endstop signals

Proceed as follows to measure the transition time of actuators with endstop signals:

### Requirement

- The "Endstop signals" check box in the basic settings has been selected and Actuator\_H and Actuator\_L are connected.
- An online connection to the CPU has been established.

Proceed as follows to measure motor transition time with endstop signals:

1. Select the "Use actuator endstop signals" check box.
2. Select the direction in which the actuator is to be moved.
  - Open - Close - Open  
The actuator is moved first to the high endstop, then to the low endstop and then back to the high endstop.
  - Close - Open - Close  
The actuator is moved first to the low endstop, then to the high endstop and then back to the low endstop.
3. Click the "Start" icon.

## Result

The actuator is moved in the selected direction. Time measurement will start once the actuator has reached the first endstop and will end when the actuator reaches this endstop for the second time. The motor transition time is equal to the time measured divided by two.

The progress and status of transition time measurement are displayed. The transition time measured is saved in the instance data block on the CPU and displayed in the "Measured transition time" field. When the transition time measurement is ended and `ActivateRecoverMode = TRUE`, `PID_3Step` switches to the operating mode from which the transition time measurement was started. If the transition time measurement is ended and `ActivateRecoverMode = FALSE`, `PID_3Step` changes to "Inactive" mode.

## Cancelling transition time measurement

`PID_3Step` switches to "Inactive" mode if you cancel transition time measurement by pressing the Stop button.

### 11.1.4.3 PID\_3Step V1

## Configuring PID\_3Step V1

### Basic settings

#### Introduction

Configure the following properties of the "PID\_3Step" technology object under "Basic settings" in the Inspector window or in the configuration window:

- Physical quantity
- Control logic
- Start-up behavior after reset
- Setpoint (only in the Inspector window)
- Process value (only in the Inspector window)
- Output value (only in the Inspector window)
- Position feedback (only in the Inspector window)

### Setpoint, process value, output value and position feedback

You can only configure the setpoint, process value, output value and position feedback in the Inspector window of the programming editor. Select the source for each value:

- Instance DB  
The value saved in the instance DB is used.  
Value must be updated in the instance DB by the user program.  
There should be no value at the instruction.  
Change via HMI possible.
- Instruction  
The value connected to the instruction is used.  
The value is written to the instance DB each time the instruction is called.  
No change via HMI possible.

### Controller type

#### Physical quantity

Select the unit of measurement and physical quantity for the setpoint and process value in the "Controller type" group. The setpoint and process value will be displayed in this unit.

### Control logic

An increase of the output value is generally intended to cause an increase in the process value. This is referred to as a normal control logic.

PID\_3Step does not work with negative proportional gain. Select the check box "Invert control logic" to reduce the process value with a higher output value.

Examples

- Opening the drain valve will reduce the level of a container's contents.
- Increasing cooling will reduce the temperature.

### Start-up behavior after reset

To change straight to the last active mode after restarting the CPU, select the "Enable last mode after CPU restart" check box.

PID\_3Step will remain in "Inactive" mode if the check box is cleared.

## Setpoint

### Procedure

Proceed as follows to define a fixed setpoint:

1. Select "Instance DB".
2. Enter a setpoint, e.g. 80° C.
3. Delete any entry in the instruction.

Proceed as follows to define a variable setpoint:

1. Select "Instruction".
2. Enter the name of the REAL variable in which the setpoint is saved.  
Program-controlled assignment of various values to the REAL variable is possible, for example for the time controlled change of the setpoint.

### Process value

PID\_3Step will scale the value of the analog input to the physical quantity if you use the analog input value directly.

You will need to write a program for processing if you wish first to process the analog input value. The process value is, for example, not directly proportional to the value at the analog input. The processed process value must be in floating point format.

### Procedure

Proceed as follows to use the analog input value without processing:

1. Select the entry "Input\_PER" in the drop-down list "Input".
2. Select "Instruction" as source.
3. Enter the address of the analog input.

Proceed as follows to use the processed process value in floating point format:

1. Select the entry "Input" in the drop-down list "Input".
2. Select "Instruction" as source.
3. Enter the name of the variable in which the processed process value is saved.

### Position feedback

Position feedback configuration depends upon the actuator used.

- Actuator without position feedback
- Actuator with digital endstop signals
- Actuator with analog position feedback
- Actuator with analog position feedback and endstop signals

### Actuator without position feedback

Proceed as follows to configure PID\_3Step for an actuator without position feedback:

1. Select the entry "No Feedback" in the drop-down list "Feedback".

### Actuator with digital endstop signals

Proceed as follows to configure PID\_3Step for an actuator with endstop signals:

1. Select the entry "No Feedback" in the drop-down list "Feedback".
2. Activate the "Actuator endstop signals" check box.
3. Select "Instruction" as source for Actuator\_H and Actuator\_L.
4. Enter the addresses of the digital inputs for Actuator\_H and Actuator\_L.

### Actuator with analog position feedback

Proceed as follows to configure PID\_3Step for an actuator with analog position feedback:

1. Select the entry "Feedback" or "Feedback\_PER" in the drop-down list "Feedback".
  - Use the analog input value for Feedback\_PER. Configure Feedback\_PER scaling in the actuator settings.
  - Process the analog input value for Feedback using your user program.
2. Select "Instruction" as source.
3. Enter the address of the analog input or the variable of your user program.

### Actuator with analog position feedback and endstop signals

Proceed as follows to configure PID\_3Step for an actuator with analog position feedback and endstop signals:

1. Select the entry "Feedback" or "Feedback\_PER" in the drop-down list "Feedback".
2. Select "Instruction" as source.
3. Enter the address of the analog input or the variable of your user program.
4. Activate the "Actuator endstop signals" check box.
5. Select "Instruction" as source for Actuator\_H and Actuator\_L.
6. Enter the addresses of the digital inputs for Actuator\_H and Actuator\_L.



## Output value

PID\_3Step offers an analog output value (Output\_PER) and digital output values (Output\_UP, Output\_DN). Your actuator will determine which output value you use.

- Output\_PER  
The actuator is triggered via an analog output and controlled with a continuous signal, e.g. 0...10V, 4...20mA.
- Output\_UP, Output\_DN  
The actuator is controlled via two digital outputs.

## Procedure

Proceed as follows to use the analog output value:

1. Select the entry "Output (analog)" in the drop-down list "Output".
2. Select "Instruction".
3. Enter the address of the analog output.

Proceed as follows to use the digital output value:

1. Select the entry "Output (digital)" in the drop-down list "Output".
2. Select "Instruction" for Output\_UP and Output\_DN.
3. Enter the addresses of the digital outputs.

Proceed as follows to process the output value using the user program:

1. Select the entry corresponding to the actuator in the drop-down list "Output".
2. Select "Instruction".
3. Enter the name of the variable you are using to process the output value.
4. Transfer the processed output value to the actuator by means of an analog or digital CPU output.

## Process value settings

Configure the scaling of your process value and specify the process value absolute limits in the "Process value settings" configuration window.

## Scaling the process value

If you have configured the use of Input\_PER in the basic settings, you will need to convert the value of the analog input into the physical quantity of the process value. The current configuration will be displayed in the Input\_PER display.

Input\_PER will be scaled using a low and high value pair if the process value is directly proportional to the value of the analog input.

1. Enter the low pair of values in the "Scaled low process value" and "Low" input fields.
2. Enter the high pair of values in the "Scaled high process value" and "High" input boxes.

Default settings for the value pairs are saved in the hardware configuration. Proceed as follows to use the value pairs from the hardware configuration:

1. Select the instruction PID\_3Step in the programming editor.
2. Connect Input\_PER to an analog input in the basic settings.
3. Click on the "Automatic setting" button in the process value settings.  
The existing values will be overwritten with the values from the hardware configuration.

### Monitoring process value

Specify the absolute high and low limit of the process value. You must enter reasonable limits for your controlled system. Reasonable limits are important during optimization to obtain optimal PID parameters. The default for the "High limit process value" is 120 %. At the I/O input, the process value can be a maximum of 18% higher than the standard range (overrange). This setting ensures that an error is no longer signaled due to a violation of the "Process value high limit". Only a wire-break and a short-circuit are recognized and PID\_3Step reacts according to the configured reaction to error.

#### NOTICE

**Your system may be damaged.**

If you set very high process value limits (for example  $-3.4 \cdot 10^{38} \dots +3.4 \cdot 10^{38}$ ), process value monitoring will be disabled. Your system may then be damaged if an error occurs. You need to configure useful process value limits for your controlled system.

### Actuator settings

#### Actuator-specific times

Configure the motor transition time and the minimum ON and OFF times to prevent damage to the actuator. You can find the specifications in the actuator data sheet.

The motor transition time is the time in seconds the motor requires to move the actuator from the closed to the opened state. The maximum time that the actuator is moved in one direction is 110% of the motor transition time. You can measure the motor transition time during commissioning.

If you are using "Output\_UP" or "Output\_DN", you can reduce the switching frequency with the minimum on and minimum OFF time.

The on or off times calculated are totaled in automatic mode and only become effective when the sum is greater than or equal to the minimum on or OFF time.

A rising edge at Manual\_UP or Manual\_DN in manual mode will operate the actuator for at least the minimum on or OFF time.

### Reaction to error

PID\_3Step is preset so that the controller stays active in most cases in the event of an error. If errors occur frequently in controller mode, this default reaction has a negative effect on the

control response. In this case, check the Errorbits parameter and eliminate the cause of the error.

PID\_3Step generates a programmable output value in response to an error:

- Current value  
PID\_3Step is switched off and no longer modifies the actuator position.
- Current value for error while error is pending  
The controller functions of PID\_3Step are switched off and the position of the actuator is no longer changed.  
If the following errors occur in automatic mode, PID\_3Step returns to automatic mode as soon as the errors are no longer pending.
  - 0002h: Invalid value at Input\_PER parameter.
  - 0200h: Invalid value at Input parameter.
  - 0800h: Sampling time error
  - 1000h: Invalid value at Setpoint parameter.
  - 2000h: Invalid value at Feedback\_PER parameter.
  - 4000h: Invalid value at Feedback parameter.
  - 8000h: Error during digital position feedback.

If one of these error occurs in manual mode, PID\_3Step remains in manual mode.

If an error occurs during the tuning or transition time measurement, PID\_3Step is switched off.

- Substitute output value  
PID\_3Step moves the actuator to the substitute output value and then switches off.
- Substitute output value while error is pending  
PID\_3Step moves the actuator to the substitute output value. When the substitute output value is reached, PID\_3Step reacts as it does with "Current value for while error is pending".

Enter the substitute output value in "%".

Only substitute output values 0% and 100% can be approached precisely in the case of actuators without analog position feedback. The actuator is moved in one direction at 110% of the motor transition time to ensure the high or low endstop is reached. These endstop signals take priority. A substitute output value not equal to 0% or 100% is approached via an internally simulated position feedback. This procedure does not, however, allow the exact approach of substitute output value.

All substitute output values can be approached precisely with actuators with analog position feedback.

## Scaling position feedback

If you have configured the use of Feedback\_PER in the basic settings, you will need to convert the value of the analog input into %. The current configuration will be displayed in the "Feedback" display.

Feedback\_PER is scaled using a low and high value pair.

1. Enter the low pair of values in the "Low endstop" and "Low" input boxes.
  2. Enter the high pair of values in the "High endstop" and "High" input boxes.
- "Low endstop" must be less than "High endstop"; "Low" must be less than "High".

The valid values for "High endstop" and "Low endstop" depend upon:

- No Feedback, Feedback, Feedback\_PER
- Output (analog), Output (digital)

Output	Feedback	Low endstop	High endstop
Output (digital)	No Feedback	Cannot be set (0.0%)	Cannot be set (100.0%)
Output (digital)	Feedback	-100.0% or 0.0%	0.0% or +100.0%
Output (digital)	Feedback_PER	-100.0% or 0.0%	0.0% or +100.0%
Output (analog)	No Feedback	Cannot be set (0.0%)	Cannot be set (100.0%)
Output (analog)	Feedback	-100.0% or 0.0%	0.0% or +100.0%
Output (analog)	Feedback_PER	-100.0% or 0.0%	0.0% or +100.0%

### Limiting the output value

You can only exceed or undershoot the output value limits during the transition time measurement. The output value is limited to these values in all other modes.

Enter the absolute output value limits in the "Output value high limit" and "Output value low limit" input boxes. The output value limits must be within "Low endstop" and "High endstop".

If no Feedback is available and Output (digital) is set, you cannot limit the output value. The digital outputs are reset with Actuator\_H = TRUE or Actuator\_L = TRUE, or after a travel time amounting to 110% of the motor transition time.

### Advanced settings

#### Monitoring process value

Configure a warning high and low limit for the process value in the "Process value monitoring" configuration window. If one of the warning limits is exceeded or undershot during operation, a warning will be displayed at the PID\_3Step instruction:

- At the InputWarning\_H output parameter if the warning high limit has been exceeded
- At the InputWarning\_L output parameter if the warning low limit has been undershot

The warning limits must be within the process value high and low limits.

The process value high and low limits will be used if you do not enter values.

### Example

Process value high limit = 98° C; warning high limit = 90° C

Warning low limit = 10° C; process value low limit = 0° C

PID\_3Step will respond as follows:

Process value	InputWarning_H	InputWarning_L	Operating mode
> 98° C	TRUE	FALSE	Inactive
≤ 98° C and > 90° C	TRUE	FALSE	Automatic mode
≤ 90° C and ≥ 10° C	FALSE	FALSE	Automatic mode
< 10° C and ≥ 0° C	FALSE	TRUE	Automatic mode
< 0° C	FALSE	TRUE	Inactive

## PID parameters

The PID parameters are displayed in the "PID Parameters" configuration window. The PID parameters will be adapted to your controlled system during controller tuning. You do not need to enter the PID parameters manually.

The PID algorithm operates according to the following equation:

$$\Delta y = K_p \cdot s \cdot \left[ (b \cdot w - x) + \frac{1}{T_i \cdot s} (w - x) + \frac{T_D \cdot s}{a \cdot T_D \cdot s + 1} (c \cdot w - x) \right]$$

Symbol	Description
$\Delta y$	Output value of the PID algorithm
$K_p$	Proportional gain
$s$	Laplace operator
$b$	Proportional action weighting
$w$	Setpoint
$x$	Process value
$T_i$	Integral action time
$a$	Derivative delay coefficient (derivative delay $T_1 = a \times T_D$ )
$T_D$	Derivative action time
$c$	Derivative action weighting

The diagram below illustrates the integration of the parameters into the PID algorithm:

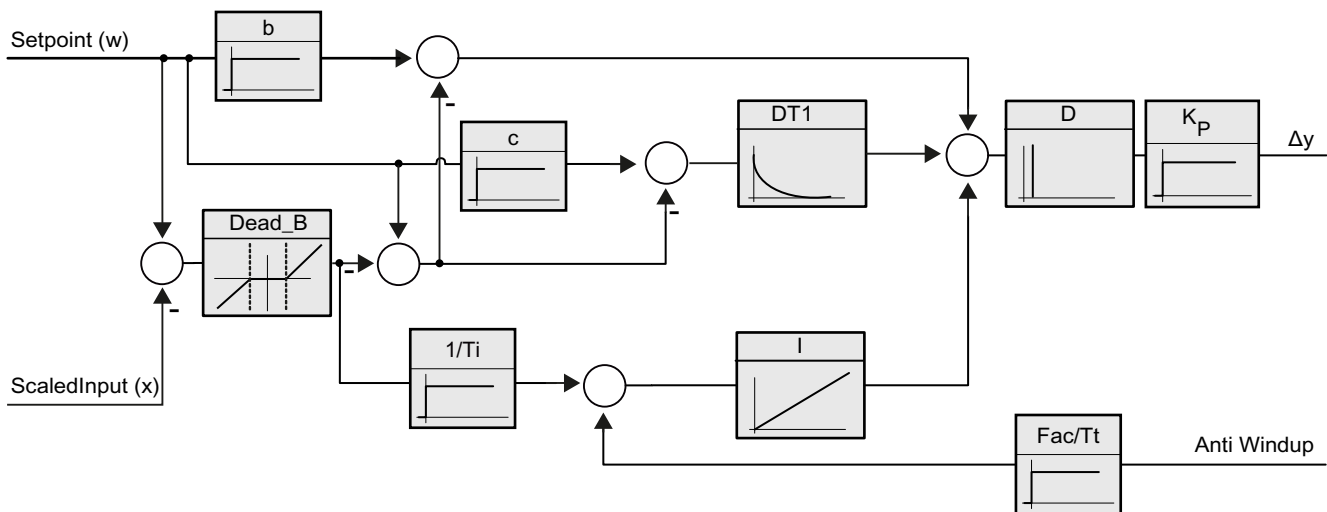

All PID parameters are retentive. If you enter the PID parameters manually, you must completely download PID\_3Step.

Auto-Hotspot

### Proportional gain

The value specifies the proportional gain of the controller. PID\_3Step does not work with a negative proportional gain. Control logic is inverted under Basic settings > Controller type.

### Integral action time

The integral action time determines the time behavior of the integral action. The integral action is deactivated with integral action time = 0.0.

### Derivative action time

The derivative action time determines the time behavior of the derivative action. Derivative action is deactivated with derivative action time = 0.0.

### Derivative delay coefficient

The derivative delay coefficient delays the effect of the derivative action.

Derivative delay = derivative action time × derivative delay coefficient

- 0.0: Derivative action is effective for one cycle only and therefore almost not effective.
- 0.5: This value has proved useful in practice for controlled systems with **one** dominant time constant.
- > 1.0: The greater the coefficient, the longer the effect of the derivative action is delayed.

### Proportional action weighting

The proportional action may weaken with changes to the setpoint.

Values from 0.0 to 1.0 are applicable.

- 1.0: Proportional action for setpoint change is fully effective
- 0.0: Proportional action for setpoint change is not effective

The proportional action is always fully effective when the process value is changed.

### Derivative action weighting

The derivative action may weaken with changes to the setpoint.

Values from 0.0 to 1.0 are applicable.

- 1.0: Derivative action is fully effective upon setpoint change
- 0.0: Derivative action is not effective upon setpoint change

The derivative action is always fully effective when the process value is changed.

### PID algorithm sampling time

The controlled system needs a certain amount of time to respond to changes in the output value. It is therefore not advisable to calculate the output value in every cycle. The sampling time of the PID algorithm represents the time between two calculations of the output value. It is calculated during tuning and rounded to a multiple of the PID\_3Step sampling time. All other functions of PID\_3Step are executed at every call.

### Deadband width

The deadband suppresses the noise component in the steady controller state. The deadband width specifies the size of the deadband. The deadband is off if the deadband width is 0.0.

### See also

Downloading technology objects to device (Page 5935)

### Commissioning PID\_3Step V1

#### Commissioning

You can monitor the setpoint, process value and output value over time in the "Tuning" working area. The following commissioning functions are supported in the curve plotter:

- Controller pretuning
- Controller fine tuning
- Monitoring the current closed-loop control in the trend view

All functions require an online connection to the CPU to have been established.

### Basic handling

- Select the desired sampling time in the "Sampling time" drop-down list. All values in the tuning working area are updated in the selected update time.
- Click the "Start" icon in the measuring group if you want to use the commissioning functions. Value recording is started. The current values for the setpoint, process value and output value are entered in the trend view. Operation of the commissioning window is enabled.
- Click the "Stop" icon if you want to end the commissioning functions. The values recorded in the trend view can continue to be analyzed.
- Closing the commissioning window will terminate recording in the trend view and delete the recorded values.

### Pretuning

The pretuning determines the process response to a pulse of the output value and searches for the point of inflection. The tuned PID parameters are calculated as a function of the maximum slope and dead time of the controlled system.

The more stable the process value is, the easier it is to calculate the PID parameters and the more precise the result will be. Noise on the process value can be tolerated as long as the rate of rise of the process value is significantly higher compared to the noise. The PID parameters are backed up before being recalculated.

The setpoint is frozen during pretuning.

### Requirement

- The PID\_3Step instruction is called in a cyclic interrupt OB.
- ManualEnable = FALSE
- PID\_3Step is in "inactive" or "manual" mode.
- The setpoint and the process value lie within the configured limits (see "Process value settings" configuration).



## Procedure

To perform pretuning, follow these steps:

1. Double-click the "PID\_3Step > Commissioning" entry in the project tree.
2. Select the entry "Pretuning" in the "Tuning mode" drop-down list in the working area "Tuning".
3. Click the "Start" icon.
  - An online connection will be established.
  - Value recording is started.
  - Pretuning is started.
  - The "Status" field displays the current steps and any errors that may have occurred. The progress bar indicates the progress of the current step.

---

### Note

Click the "Stop" icon when the progress bar has reached 100% and it is to be assumed the controller tuning function is blocked. Check the configuration of the technology object and, if necessary, restart controller tuning.

---

## Result

If pretuning was performed without an error message, the PID parameters have been tuned. PID\_3Step switches to automatic mode and uses the tuned parameters. The tuned PID parameters will be retained during power OFF and a restart of the CPU.

If pretuning is not possible, PID\_3Step changes to "Inactive" mode.

## Fine tuning

Fine tuning generates a constant, limited oscillation of the process value. The PID parameters are optimized for the operating point from the amplitude and frequency of this oscillation. All PID parameters are recalculated on the basis of the findings. PID parameters from fine tuning usually have better master control and disturbance behavior than PID parameters from pretuning.

PID\_3Step automatically attempts to generate an oscillation greater than the noise of the process value. Fine tuning is only minimally influenced by the stability of the process value. The PID parameters are backed up before being recalculated.

The setpoint is frozen during fine tuning.

## Requirement

- The PID\_3Step instruction is called in a cyclic interrupt OB.
- ManualEnable = FALSE
- The motor transition time has been configured or measured.
- The setpoint and the process value lie within the configured limits (see "Process value settings" configuration).

## 11.1 PID control

- The control loop has stabilized at the operating point. The operating point is reached when the process value corresponds to the setpoint.
- No disturbances are expected.
- PID\_3Step is in inactive mode, automatic mode or manual mode.

### Process depends on initial situation

Fine tuning proceeds as follows when started in:

- Automatic mode  
Start fine tuning in automatic mode if you wish to improve the existing PID parameters using controller tuning.  
PID\_3Step will regulate using the existing PID parameters until the control loop has stabilized and the requirements for fine tuning have been met. Only then will fine tuning start.
- Inactive or manual mode  
Pretuning is always started first. The PID parameters established will be used for adjustment until the control loop has stabilized and the requirements for fine tuning have been met. Only then will fine tuning start.

### Procedure

Proceed as follows to carry out "fine tuning":

1. Select the entry "Fine tuning" in the "Tuning mode" drop-down list.
2. Click the "Start" icon.
  - An online connection will be established.
  - Value recording is started.
  - The process of fine tuning is started.
  - The "Status" field displays the current steps and any errors that may have occurred. The progress bar indicates the progress of the current step.

---

#### Note

Click the "Stop" icon in the "Tuning mode" group when the progress bar has reached 100% and it is to be assumed the controller tuning function is blocked. Check the configuration of the technology object and, if necessary, restart controller tuning.

---

### Result

The PID parameters will have been optimized if fine tuning has been executed without errors. PID\_3Step changes to automatic mode and uses the optimized parameters. The optimized PID parameters will be retained during power OFF and a restart of the CPU.

If errors occurred during fine tuning, PID\_3Step will change to "inactive" mode.

## Commissioning with manual PID parameters

### Procedure

Proceed as follows to commission PID\_3Step with manual PID parameters:

1. Double-click on "PID\_3Step > Configuration" in the project tree.
2. Click on "Advanced settings > PID Parameters" in the configuration window.
3. Select the check box "Enable direct input".
4. Enter the PID parameters.
5. Double-click on "PID\_3Step > Commissioning" in the project tree.
6. Establish an online connection to the CPU.
7. Load the PID parameters to the CPU.
8. Click on the "Activate controller" icon.

### Result

PID\_3Step changes to automatic mode and controls using the current PID parameters.

## Measuring the motor transition time

### Introduction

PID\_3Step requires the motor transition time to be as accurate as possible for good controller results. The data in the actuator documentation contains average values for this type of actuator. The value for the specific actuator used may differ.

You can measure the motor transition time during commissioning if you are using actuators with position feedback or endstop signals. The output value limits are not taken into consideration during the motor transition time measurement. The actuator can travel to the high or the low endstop.

The motor transition time cannot be measured if neither position feedback nor endstop signals are available.

### Actuators with analog position feedback

Proceed as follows to measure motor transition time with position feedback:

#### Requirement

- Feedback or Feedback\_PER has been selected in the basic settings and the signal has been connected.
- An online connection to the CPU has been established.

1. Select the "Use position feedback" check box.
2. Enter the position to which the actuator is to be moved in the "Target position" input field. The current position feedback (starting position) will be displayed. The difference between "Target position" and "Position feedback" must be at least 50% of the valid output value range.
3. Click the  "Start transition time measurement" icon.

## Result

The actuator is moved from the starting position to the target position. Time measurement starts immediately and ends when the actuator reaches the target position. The motor transition time is calculated according to the following equation:

Motor transition time = (output value high limit – output value low limit) × Measuring time / AMOUNT (target position – starting position).

The progress and status of transition time measurement are displayed. The transition time measured is saved in the instance data block on the CPU and displayed in the "Measured transition time" field. PID\_3Step will change to "Inactive" mode once transition time measurement is complete.

---

### Note

Click on the icon  "Upload measured transition time" to load the motor transition time measured to the project.

---

## Actuators with endstop signals

Proceed as follows to measure the transition time of actuators with endstop signals:

### Requirement

- The "Endstop signals" check box in the basic settings has been selected and Actuator\_H and Actuator\_L are connected.
- An online connection to the CPU has been established.

Proceed as follows to measure motor transition time with endstop signals:

1. Select the "Use actuator endstop signals" check box.
2. Select the direction in which the actuator is to be moved.
  - Open - Close - Open  
The actuator is moved first to the high endstop, then to the low endstop and then back to the high endstop.
  - Close - Open - Close  
The actuator is moved first to the low endstop, then to the high endstop and then back to the low endstop.
3. Click the  "Start transition time measurement" icon.

## **Result**

The actuator is moved in the selected direction. Time measurement will start once the actuator has reached the first endstop and will end when the actuator reaches this endstop for the second time. The motor transition time is equal to the time measured divided by two.

The progress and status of transition time measurement are displayed. The transition time measured is saved in the instance data block on the CPU and displayed in the "Measured transition time" field. PID\_3Step will change to "Inactive" mode once transition time measurement is complete.

## **Cancelling transition time measurement**

PID\_3Step will change to "Inactive" mode immediately if you cancel transition time measurement. The actuator will stop being moved. You can reactive PID-3Step in the curve plotter.

## 11.2 Using S7-1200 Motion Control

### 11.2.1 Introduction

#### 11.2.1.1 Motion functionality of the CPU S7-1200

The TIA Portal, together with the "Motion Control" functionality of the CPU S7-1200, supports you in controlling stepper motors and servo motors with pulse interface:

- In the TIA Portal, you configure the "Axis" and "Command table" technology objects. The CPU S7-1200 controls the pulse and direction outputs for control of the drives using these technology objects.
- In the user program you control the axis by means of motion control instructions and initiate motion commands of your drive.

You can find a multi-media introduction on the Internet (<http://www.automation.siemens.com/mcms/topics/en/simatic/simatic-technology/integrated-functions/simatic-s7-1200/Pages/Default.aspx>).

#### See also

Hardware components for motion control (Page 6009)

Integration of the axis technology object (Page 6022)

Use of the command table technology object (Page 6050)

Command table technology object tools (Page 6050)

### 11.2.1.2 Hardware components for motion control

The representation below shows the basic hardware configuration for a motion control application with the CPU S7-1200.

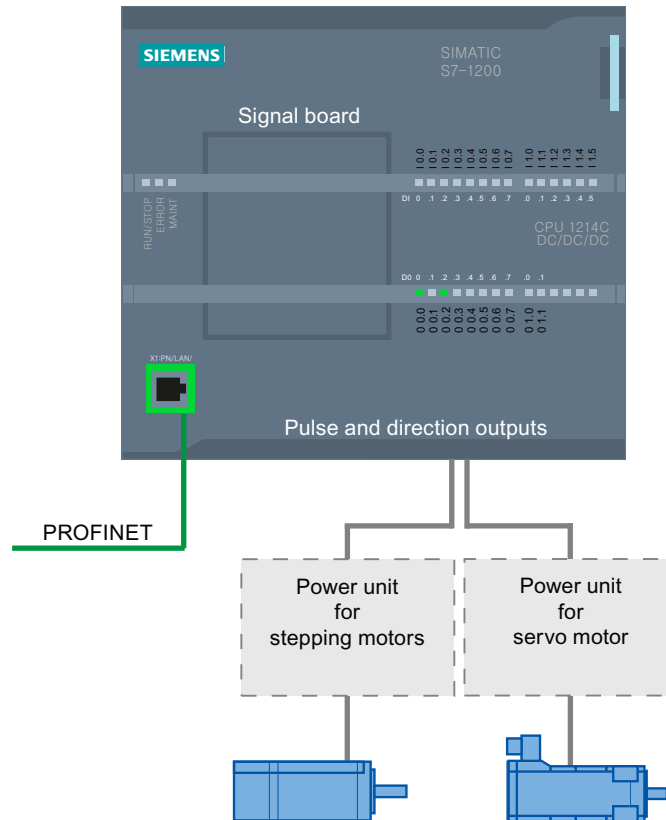

#### CPU S7-1200:

CPU S7-1200 combines the functionality of a programmable logic controller with motion control functionality for operation of stepper motors and servo motors with pulse interface. The motion control functionality takes over the control and monitoring of the drives.

The DC/DC/DC variants of the CPU S7-1200 have onboard outputs for direct control of drives. The relay variants of the CPU require one of the signal boards described below to control a drive.

#### Signal board

You add further inputs and outputs to the CPU with the signal boards. The digital outputs can be used as pulse and direction outputs for controlling drives as required.

In CPUs with relay outputs, the pulse signal cannot be output on the on-board outputs because the relays do not support the necessary switching frequencies. A signal board with digital outputs must be used to enable you to work with the PTO (Pulse Train Output) on these CPUs.

When a DC/DC/DC variant of the CPU S7-1200 is used together with a signal board, the maximum number of controllable drives is limited to "2/4" (MLFB - order number xxxxxxx-1xx30-xxxx / xxxxxxx-1xx31-xxxx).

## PROFINET

Use the PROFINET interface to establish the online connection between the CPU S7-1200 and the programming device. In addition to the online functions of the CPU, additional commissioning and diagnostic functions are available for motion control.

### Maximum number of controllable drives

The maximum number of controllable drives for the various CPU versions is provided in the following table:

CPU		Signal board					
		without	DI2/DO2 x DC24V 20kHz	DI2/DO2 x DC24V 200kHz	DO4 x DC24V 200kHz	DI2/DO2 x DC5V 200kHz	DO4 x DC5V 200kHz
CPU 1211C, CPU 1212C, CPU 1214C (MLFB - order number xxxxxxx-1xx30-xxxx)	DC/DC/DC	2	2	2	2	2	2
	AC/DC/RLY	-	1	1	2	1	2
	DC/DC/RLY	-	1	1	2	1	2
CPU 1211C (MLFB - order number xxxxxxx-1xx31-xxxx)	DC/DC/DC	2	3	3	4	3	4
	AC/DC/RLY	-	1	1	2	1	2
	DC/DC/RLY	-	1	1	2	1	2
CPU 1212C (MLFB - order number xxxxxxx-1xx31-xxxx)	DC/DC/DC	3	4	4	4	4	4
	AC/DC/RLY	-	1	1	2	1	2
	DC/DC/RLY	-	1	1	2	1	2
CPU 1214C (MLFB - order number xxxxxxx-1xx31-xxxx)	DC/DC/DC	4	4	4	4	4	4
	AC/DC/RLY	-	1	1	2	1	2
	DC/DC/RLY	-	1	1	2	1	2
CPU 1215C	DC/DC/DC	4	4	4	4	4	4
	AC/DC/RLY	-	1	1	2	1	2
	DC/DC/RLY	-	1	1	2	1	2



## Limit frequencies of pulse outputs

The following limit frequencies apply to the pulse outputs:

Pulse output	Limit frequencies for technology object "Axis" V1.0	Limit frequencies for technology object "Axis" V2.0 and higher
On-board (MLFB - order number xxxxxxx-1x30-xxxx)	$2 \text{ Hz} \leq f \leq 100 \text{ kHz}$	$2 \text{ Hz} \leq f \leq 100 \text{ kHz}$
On-board (MLFB - order number xxxxxxx-1x31xxxx)	$2 \text{ Hz} \leq f \leq 100 \text{ kHz}$ (PTO 1+2) $2 \text{ Hz} \leq f \leq 20 \text{ kHz}$ (PTO 3+4)	$2 \text{ Hz} \leq f \leq 100 \text{ kHz}$ (PTO 1+2) $2 \text{ Hz} \leq f \leq 20 \text{ kHz}$ (PTO 3+4)
Signal board DI2/DO2 x DC24V 20kHz	$2 \text{ Hz} \leq f \leq 20 \text{ kHz}$	$2 \text{ Hz} \leq f \leq 20 \text{ kHz}$
Signal board DI2/DO2 x DC24V 200kHz	$2 \text{ Hz} \leq f \leq 100 \text{ kHz}$	$2 \text{ Hz} \leq f \leq 200 \text{ kHz}$
Signal board DO4 x DC24V 200kHz	$2 \text{ Hz} \leq f \leq 100 \text{ kHz}$	$2 \text{ Hz} \leq f \leq 200 \text{ kHz}$
Signal board DI2/DO2 x DC5V 200kHz	$2 \text{ Hz} \leq f \leq 100 \text{ kHz}$	$2 \text{ Hz} \leq f \leq 200 \text{ kHz}$
Signal board DO4 x DC5V 200kHz	$2 \text{ Hz} \leq f \leq 100 \text{ kHz}$	$2 \text{ Hz} \leq f \leq 200 \text{ kHz}$

## Ordering information

The order information listed below applies to the currently installed product phase (without any installed Hardware Support Packages) of the TIA Portal.

Name	MLFB (order no.)
CPU 1211C DC/DC/DC	6ES7211-1Ax3x-0XB0
CPU 1211C AC/DC/RLY	6ES7211-1Bx3x-0XB0
CPU 1211C DC/DC/RLY	6ES7211-1Hx3x-0XB0
CPU 1212C DC/DC/DC	6ES7212-1Ax3x-0XB0
CPU 1212C AC/DC/RLY	6ES7212-1Bx3x-0XB0
CPU 1212C DC/DC/RLY	6ES7212-1Hx3x-0XB0
CPU 1214C DC/DC/DC	6ES7214-1Ax3x-0XB0
CPU 1214C AC/DC/RLY	6ES7214-1Bx3x-0XB0
CPU 1214C DC/DC/RLY	6ES7214-1Hx3x-0XB0
CPU 1215C DC/DC/DC	6ES7215-1AG31-0XB0
CPU 1215C AC/DC/RLY	6ES7215-1BG31-0XB0
CPU 1215C DC/DC/RLY	6ES7215-1HG31-0XB0
Signal board DI2/DO2 x DC24V 20kHz	6ES7223-0BD30-0XB0
Signal board DI2/DO2 x DC24V 200kHz	6ES7223-3BD30-0XB0
Signal board DO4 x DC24V 200kHz	6ES7222-1BD30-0XB0
Signal board DI2/DO2 x DC5V 200kHz	6ES7223-3AD30-0XB0
Signal board DO4 x DC5V 200kHz	6ES7222-1AD30-0XB0

Use a Hardware Support Package (HSP) to install new hardware components. The hardware component will then be available in the hardware catalog.

**See also**

- Motion functionality of the CPU S7-1200 (Page 6006)
- CPU outputs relevant for motion control (Page 6012)

**11.2.2 Basics for working with S7-1200 Motion Control**

**11.2.2.1 CPU outputs relevant for motion control**

**Pulse and direction output**

The CPU provides one pulse output and one direction output for controlling a stepper motor drive or a servo motor drive with pulse interface. The pulse output provides the drive with the pulses required for motor motion. The direction output controls the travel direction of the drive.

Pulse and direction outputs are permanently assigned to one another. Onboard CPU outputs or outputs of a signal board can be used as pulse and direction outputs. You select between onboard CPU outputs and outputs of the signal board during device configuration under Pulse generators (PTO/PWM) on the "Properties" tab.

The following table shows the address assignment of the pulse and direction outputs:

CPU S7-1200:	Without signal board				Signal boards DI2/DO2 *)				Signal boards DO4 **)			
	Outputs PTO1		Outputs PTO2		Outputs PTO1		Outputs PTO2		Outputs PTO1		Outputs PTO2	
	Pls.	Dir.	Pls.	Dir.	Pls.	Dir.	Pls.	Dir.	Pls.	Dir.	Pls.	Dir.
CPU 1211C, CPU 1212C, CPU 1214C (DC/DC/DC)	Ax.0	Ax.1	Ax.2	Ax.3	Ax.0	Ax.1	Ax.2	Ax.3	Ax.0	Ax.1	Ax.2	Ax.3
					Ay.0	Ay.1			Ay.0	Ay.1	Ay.2	Ay.3
CPU 1211C, CPU 1212C, CPU 1214C (AC/DC/RLY)	-	-	-	-	Ay.0	Ay.1	-	-	Ay.0	Ay.1	Ay.2	Ay.3
CPU 1211C, CPU 1212C, CPU 1214C (DC/DC/RLY)	-	-	-	-	Ay.0	Ay.1	-	-	Ay.0	Ay.1	Ay.2	Ay.3

x = Initial byte address of onboard CPU outputs (default value = 0)

y = Initial byte address of signal board outputs (default value = 4)

\* If a DC/DC/DC CPU variant is used together with a DI2/DO2 signal board, the signals of the PTO1 can be generated via the onboard CPU outputs or via the signal board.

\*\* If a DC/DC/DC CPU variant is used together with a DO4 signal board, the signals for PTO1 and PTO2 can be generated via the onboard CPU outputs or via the signal board.

## Drive interface

For motion control, you can optionally parameterize a drive interface for "Drive enabled" and "Drive ready". When using the drive interface the digital output for the drive enable and the digital input for "drive ready" can be freely selected.

---

### Note

The firmware will take control via the corresponding pulse and direction outputs if the PTO (Pulse Train Output) has been selected and assigned to an axis.

With this takeover of the control function, the connection between the process image and I/O output is also disconnected. While the user has the possibility of writing the process image of pulse and direction outputs via the user program or watch table, this is not transferred to the I/O output. Accordingly, it is also not possible to monitor the I/O output via the user program or watch table. The information read reflects the value of the process image and does not match the real status of the I/O output.

For all other CPU outputs that are not used permanently by the CPU firmware, the status of the I/O output can be controlled or monitored via the process image, as usual.

---

## See also

How the pulse interface works (Page 6013)

Relationship between the travel direction and voltage level at the direction output (Page 6015)

Hardware and software limit switches (Page 6016)

Jerk limit (Page 6017)

Homing (Page 6018)

Hardware components for motion control (Page 6007)

Integration of the axis technology object (Page 6022)

Tools of the axis technology object (Page 6024)

### 11.2.2.2 How the pulse interface works

Depending on the settings of the stepper motor, each pulse affects the movement of the stepper motor by a specific angle. If the stepper motor is set to 1000 pulses per revolution, for example, it moves 0.36° per pulse.

The speed of the stepper motor is determined by the number of pulses per time unit.

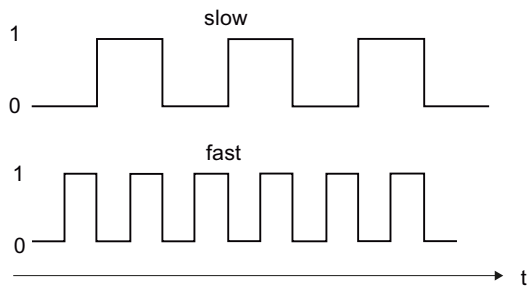

(The statements made here also apply to servo motors with pulse interface.)

### See also

CPU outputs relevant for motion control (Page 6010)

Relationship between the travel direction and voltage level at the direction output (Page 6015)

Hardware and software limit switches (Page 6016)

Jerk limit (Page 6017)

Homing (Page 6018)

Integration of the axis technology object (Page 6022)

Tools of the axis technology object (Page 6024)

### 11.2.2.3 Relationship between the travel direction and voltage level at the direction output

The direction output of the CPU specifies the travel direction of the drive. You configure the direction signal under "Mechanics" in the axis configuration. The relationships between configuration, direction output, and travel direction are presented in the following diagram:

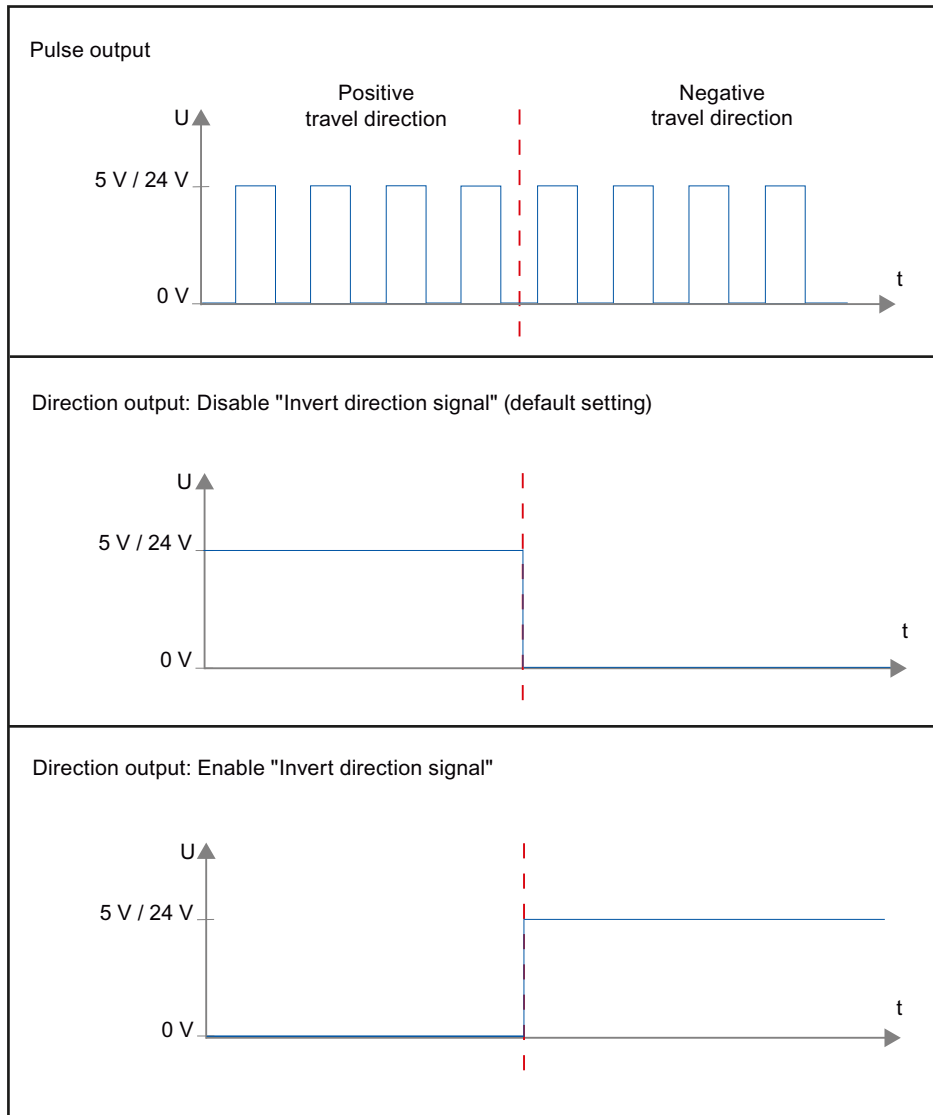

If "Invert direction signal" is deactivated in the configuration, a level of 5 V / 24 V will be output at the direction output for a positive travel direction (the voltage depends on the hardware used). A 0 V level will be output at the direction output for positive travel direction if "Invert direction signal" is activated in the configuration.

**See also**

- CPU outputs relevant for motion control (Page 6010)
- How the pulse interface works (Page 6011)
- Hardware and software limit switches (Page 6016)
- Jerk limit (Page 6017)
- Homing (Page 6018)
- Integration of the axis technology object (Page 6022)
- Tools of the axis technology object (Page 6024)

**11.2.2.4 Hardware and software limit switches**

Use the hardware and software limit switches to limit the "permitted traversing range" and the "working range" of your axis technology object. The relationships are shown in the following diagram:

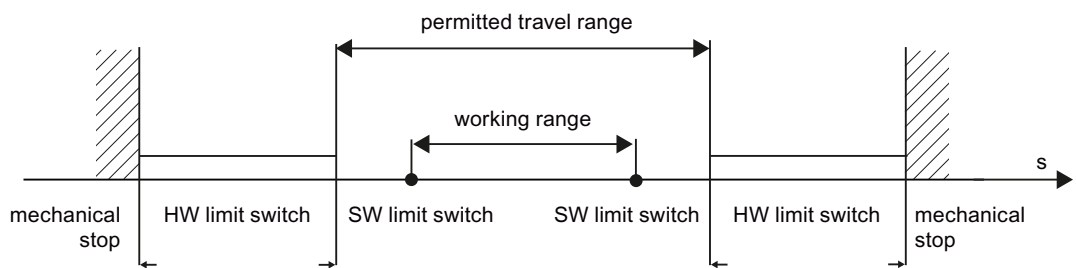

Hardware limit switches are limit switches that limit the maximum "permitted traversing range" of the axis. Hardware limit switches are physical switching elements that must be connected to interrupt-capable inputs of the CPU.

Software limit switches limit the "working range" of the axis. They should fall inside the hardware limit switches relative to the traversing range. Since the positions of the software limit switches can be flexibly set, the working range of the axis can be adapted on an individual basis, depending on the current traversing profile. In contrast to hardware limit switches, software limit switches are implemented exclusively via the software and do not require their own switching elements.

Hardware and software limit switches must be activated prior to use in the configuration or in the user program.. Software limit switches are only active after homing the axis.

## See also

- CPU outputs relevant for motion control (Page 6010)
- How the pulse interface works (Page 6011)
- Relationship between the travel direction and voltage level at the direction output (Page 6013)
- Jerk limit (Page 6017)
- Homing (Page 6018)
- Integration of the axis technology object (Page 6022)
- Tools of the axis technology object (Page 6024)
- Position limits (Page 6032)

### 11.2.2.5 Jerk limit

With the jerk limit you can reduce the stresses on your mechanics during an acceleration and deceleration ramp. The acceleration and deceleration value is not changed abruptly when the jerk limiter is active; it is gradually increased and decreased. The figure below shows the velocity and acceleration curve without and with jerk limit.

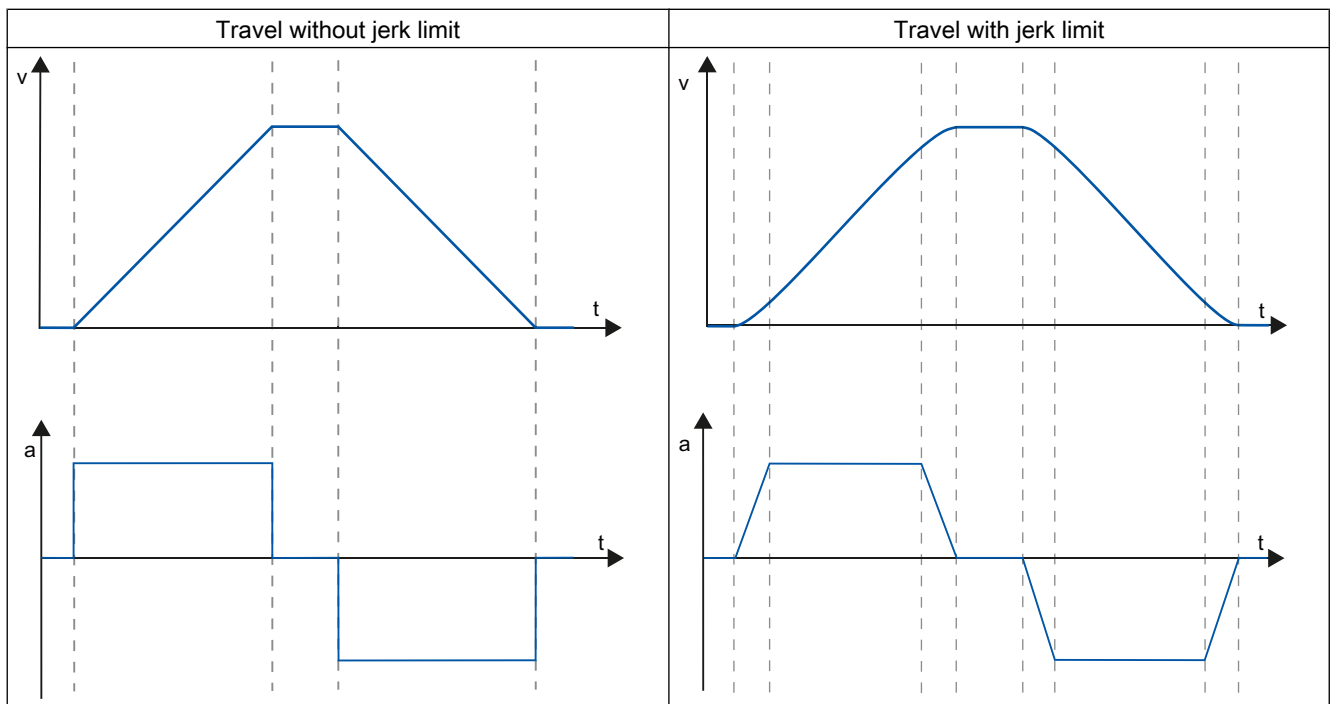

The jerk limit gives a "smoothed" velocity profile of the axis motion. This ensures soft starting and braking of a conveyor belt for example.

## See also

- Behavior of the axis when using the jerk limit (Page 6041)
- CPU outputs relevant for motion control (Page 6010)
- How the pulse interface works (Page 6011)
- Relationship between the travel direction and voltage level at the direction output (Page 6013)
- Hardware and software limit switches (Page 6014)
- Homing (Page 6018)
- Integration of the axis technology object (Page 6022)
- Tools of the axis technology object (Page 6024)

### 11.2.2.6 Homing

Homing means matching the axis coordinates of the technology object to the real, physical location of the drive. For position-controlled axes the entries and displays for the position refer exactly to these axis coordinates. Therefore, agreement between the axis coordinates and the real situation is extremely important. This step is necessary to ensure that the absolute target position of the axis is also achieved exactly with the drive.

In the S7-1200 CPU, axis homing is implemented with the motion control instruction, "MC\_Home". The following homing modes exist:

#### Homing modes

- **Active homing**  
In active homing mode, the motion control instruction "MC\_Home" performs the required reference point approach. When the homing switch is detected, the axis is homed according to the configuration. Active traversing motions are aborted.
- **Passive homing**  
During passive homing, the motion control instruction "MC\_Home" does not carry out any homing motion. The traversing motion required for this step must be implemented by the user via other motion control instructions. When the homing switch is detected, the axis is homed according to the configuration. Active traversing motions are not aborted upon start of passive homing.
- **Direct homing absolute**  
The axis position is set regardless of the homing switch. Active traversing motions are not aborted. The value of input parameter "Position" of motion control instruction "MC\_Home" is set immediately as the reference point of the axis.
- **Direct homing relative**  
The axis position is set regardless of the homing switch. Active traversing motions are not aborted. The following statement applies to the axis position after homing:  
New axis position = current axis position + value of parameter "Position" of instruction "MC\_Home".



## See also

CPU outputs relevant for motion control (Page 6010)  
How the pulse interface works (Page 6011)  
Relationship between the travel direction and voltage level at the direction output (Page 6013)  
Hardware and software limit switches (Page 6014)  
Jerk limit (Page 6015)  
Integration of the axis technology object (Page 6022)  
Tools of the axis technology object (Page 6024)  
Homing (technology object "Axis" as of V2.0) (Page 6043)

### 11.2.3 Guidelines on use of motion control

The guidelines described here present the basic procedure for using motion control with the CPU S7-1200.

#### Requirements

To use the "Axis" technology object, you must create a project with a CPU S7-1200.

#### Procedure

Follow the steps below in the order given to use motion control with the CPU S7-1200. Use the following links for this purpose:

1. Add technological object Axis (Page 6026)
2. Working with the configuration dialog (Page 6027)
3. Download to CPU (Page 6068)
4. Function test of the axis in the commissioning window (Page 6069)
5. Programming (Page 6072)
6. Diagnostics of the axis control (Page 6091)

### 11.2.4 Overview of versions

The relationship between the relevant versions for S7-1200 Motion Control can be found in the following table:

### Technology version

You can check the technology version currently selected in Task Card Instructions > Technology > Motion Control > S7-1200 Motion Control and in the "Add new object" dialog. Select the technology version in Task Card Instructions > Technology > Motion Control > S7-1200 Motion Control. If a technology object with an alternative version is added in the "Add new object" dialog, the technology version will also be changed.

---

#### Note

The selection of an alternative technology version will also affect the Motion Control Instructions version (task card). The technology objects and Motion Control instructions will only be converted to the selected version upon compilation or "Load to device".

---

### Version of the technology object

The version of a technology object can be checked in the inspector window under "Properties > General > Information" in the "Version" field.

To change the version, select the relevant version in the task card under Instructions > Technology and then the menu command Edit > Compile. If a technology object with an alternative version is added in the "Add new object" dialog, the technology object version will also be changed.

Deal with the causes of any errors if error information is displayed during compilation. Repeat compilation until it can be completed without errors.

Check the configuration of the technology objects once you have done so.

### Motion Control instruction version

Proceed as follows to check the version of a Motion Control instruction:

1. Open the Program blocks > System blocks > Program resources folders in the navigator and select the required Motion Control instruction.
2. Select the Edit > Properties menu command.
3. You will find the Motion Control instruction version in the Version field of the Information tab.

If the Motion Control instruction version used is not in line with the following compatibility list, the relevant Motion Control instructions will be highlighted in the program editor.

## Compatibility list

Technology		CPU	Technology object	Motion Control Instruction
V1.0		V1.0, V2.0, V2.1, V2.2	Axis V1.0	MC_Power V1.0 MC_Reset V1.0 MC_Home V1.0 MC_Halt V1.0 MC_MoveAbsolute V1.0 MC_MoveRelative V1.0 MC_MoveVelocity V1.0 MC_MoveJog V1.0
V2.0	Innovations: <ul style="list-style-type: none"> <li>• Jerk control</li> <li>• Command table</li> <li>• MC_ChangeDynamic</li> </ul>	V2.1, V2.2	Axis V2.0, Command table V2.0	MC_Power V2.0 MC_Reset V2.0 MC_Home V2.0 MC_Halt V2.0 MC_MoveAbsolute V2.0 MC_MoveRelative V2.0 MC_MoveVelocity V2.0 MC_MoveJog V2.0 MC_CommandTable V2.0 MC_ChangeDynamic V2.0
V3.0	Innovation: Load in RUN operating mode	V2.2	Axis V3.0, Command table V3.0	MC_Power V3.0 MC_Reset V3.0 MC_Home V3.0 MC_Stop V3.0 MC_MoveAbsolute V3.0 MC_MoveRelative V3.0 MC_MoveVelocity V3.0 MC_MoveJog V3.0 MC_CommandTable V3.0 MC_ChangeDynamic V3.0

### 11.2.5 Technology object axis

#### 11.2.5.1 Integration of the axis technology object

The following representation shows the relations between the hardware and software components which are implemented when using the "Axis" technology object:

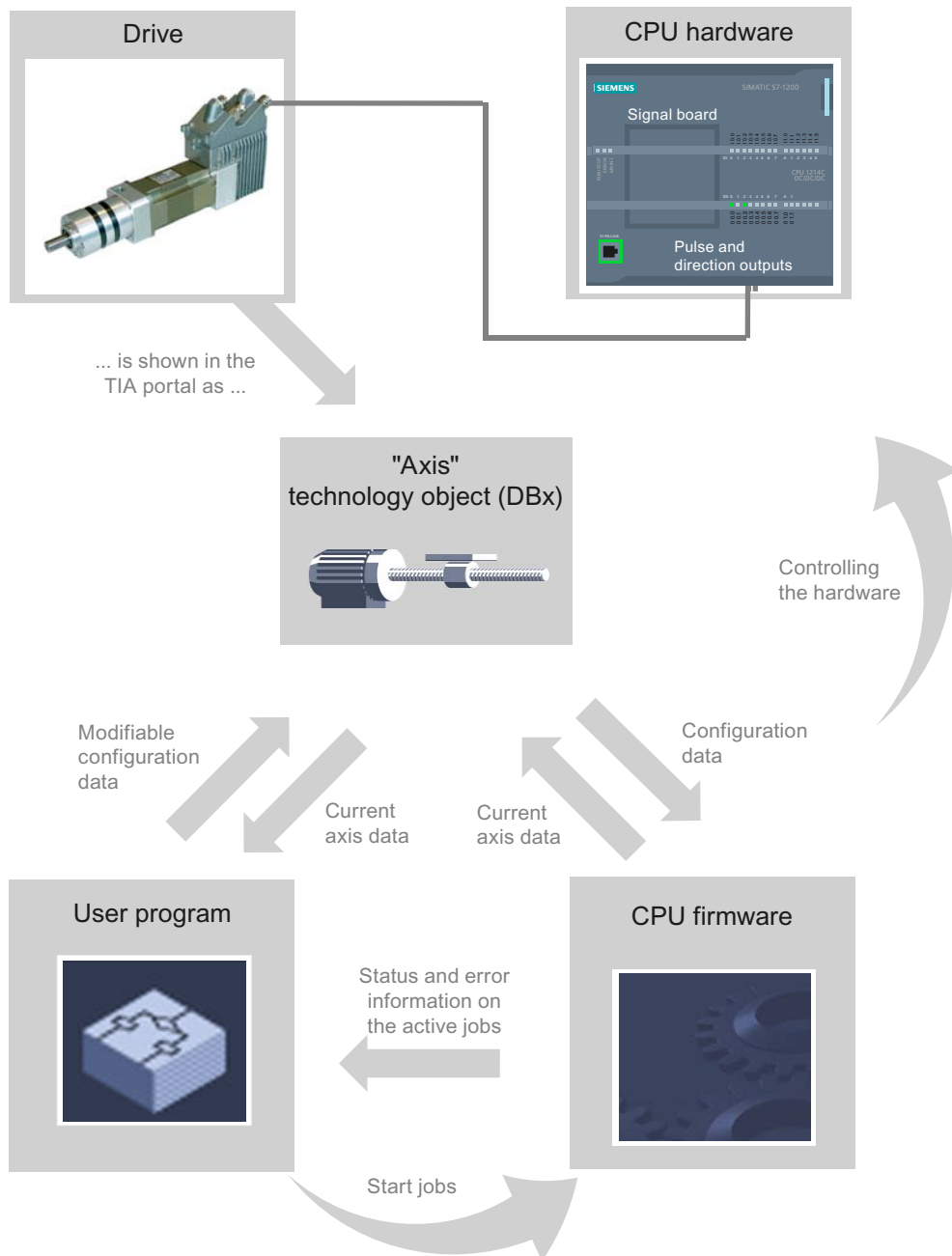

## CPU hardware

The physical drive is controlled and monitored by the CPU hardware.

## Drive

The drive represents the unit of power unit and motor. Stepper motors or servo motors with a pulse interface may be used.

## Technology object "Axis"

The physical drive including mechanics is mapped in the TIA Portal as an "axis" technology object. Configure the "Axis" technology object with the following parameters for this:

- Selection of the PTOs (Pulse Train Output) to be used and configuration of the drive interface
- Parameter for mechanics and gear transmission of the drive (or the machine or system)
- Parameter for position monitoring, for dynamic parameters and for homing

The configuration of the "Axis" technology object is saved in the technology object (data block). This data block also forms the interface between the user program and the CPU firmware. The current axis data is saved in the data block of the technology object at the runtime of the user program.

## User program

You start motion control instructions jobs in the CPU firmware with the user program. The following jobs for controlling the axis are possible:

- Position axis absolutely
- Position axis relatively
- Move axis with velocity set point
- Run axis jobs as movement sequence (as of technology V2.0)
- Move axis in jog mode
- Stop axis
- Reference axis; set reference point
- Acknowledge error

You determine the command parameters with the input parameters of the Motion Control instructions and the axis configuration. The output parameters of the instruction give you up to date information about the status and any errors of the command.

Before starting a command for the axis, you must enable the axis with the motion control instruction "MC\_Power".

You can read out configuration data and current axis data with the tags of the technology object. You can change single, changeable tags of the technology object (e.g. the current acceleration) from the user program.

## CPU firmware

The motion control jobs started in the user program are processed in the CPU firmware. When using the axis control table, Motion Control jobs are triggered by operating the axis control table. The CPU firmware performs the following jobs depending on the configuration:

- Calculate the exact motion profile for motion jobs and emergency stop situations
- Control the drive enable and the pulse and direction signal
- Monitor the drive and the hardware and software limit switches
- Up to date feedback of status and error information to the motion control instructions in the user program
- Writing of current axis data into the data block of the technology object

## See also

CPU outputs relevant for motion control (Page 6010)

Relationship between the travel direction and voltage level at the direction output (Page 6013)

Tools of the axis technology object (Page 6024)

Hardware and software limit switches (Page 6014)

Homing (Page 6016)

Tag of the Axis technology object (Page 6118)

### 11.2.5.2 Tools of the axis technology object

The TIA Portal provides the "Configuration", "Commissioning", and "Diagnostics" tools for the "Axis" technology object. The following representation shows the interaction of the three tools with the technology object and the drive:

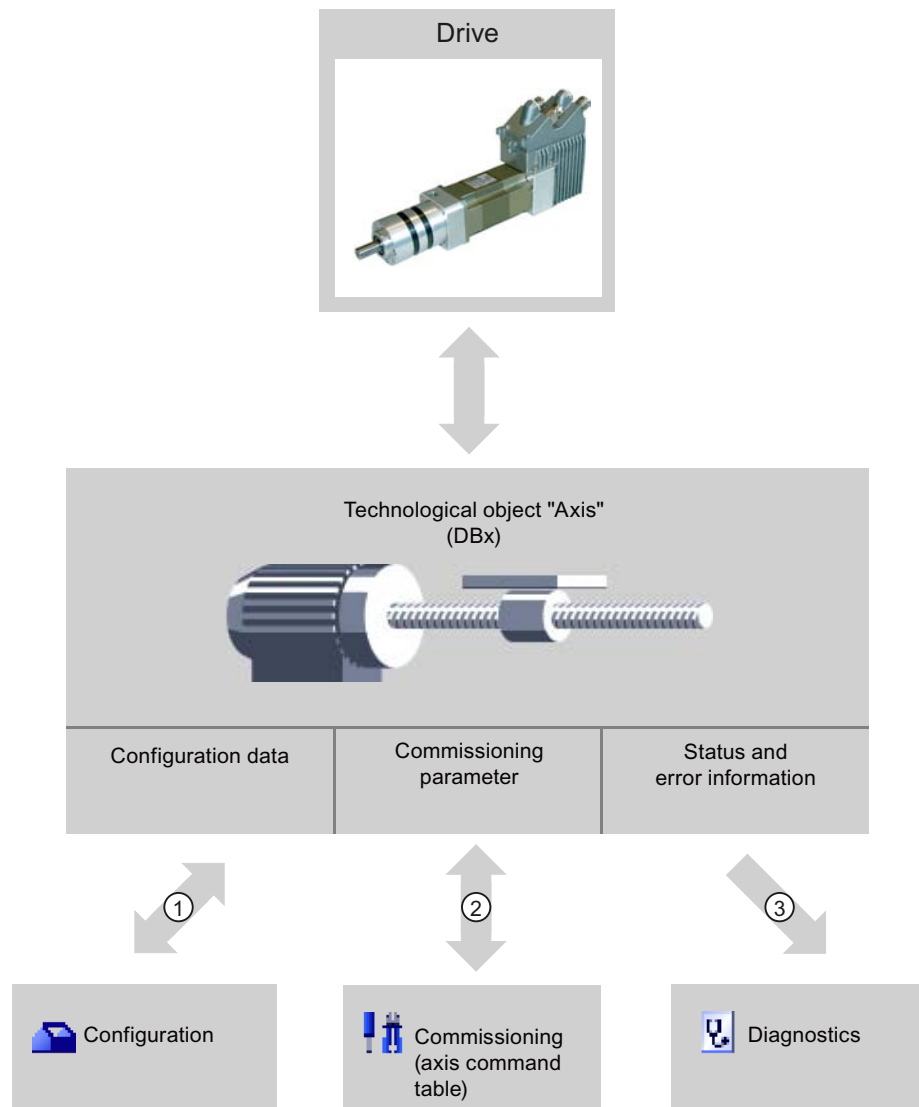

①	Reading and writing of configuration data of the technology object;
②	Drive control via the technology object; Reading axis status for display on the control panel
③	Readout of the current status and error information of the technology object.

## Configuration

Use the "Configuration" tool to configure the following properties of the "Axis" technology object:

- Selection of the PTO to be used and configuration of the drive interface
- Properties of the mechanics and the transmission ratio of the drive (or machine or system)
- Properties for position monitoring, dynamics, and homing

Save the configuration in the data block of the technology object.

## Commissioning

Use the "Commissioning" tool to test the function of your axis without having to create a user program. When the tool is started, the axis control table will be displayed. The following commands are available on the axis control table:

- Releasing and blocking the axis
- Move axis in jog mode
- Position axis in absolute and relative terms
- Home axis
- Acknowledge errors

The dynamic values can be adjusted accordingly for the motion commands. The axis control table also shows the current axis status.

## Diagnostics

Use the "Diagnostics" tool to keep track of the current status and error information for the axis and drive.

## See also

CPU outputs relevant for motion control (Page 6010)

Relationship between the travel direction and voltage level at the direction output (Page 6013)

Integration of the axis technology object (Page 6020)

Hardware and software limit switches (Page 6014)

Homing (Page 6016)

Configuring the axis technology object (Page 6027)

Commissioning the axis - Axis control panel (Page 6069)

Axis - Diagnostics (Page 6091)

### 11.2.5.3 Add technological object Axis

Proceed as follows to add an "Axis" technology object in the project tree:

## Requirements

A project with a CPU S7-1200 has been created.

## Procedure

1. Open the CPU folder in the project tree.
2. Open the technology objects folder.



3. Double-click "Add new object".  
The "Add new object" dialog opens.
4. Select the "Motion" technology.
5. Open the "Motion Control" folder.
6. Open the "S7-1200 Motion Control" folder.
7. Click on the version and select an alternative version of the technology if you want to add an axis from an older version.
8. Select the "TO\_Axis\_PTO" object.
9. Change the name of the axis in the "Name" input field to suit your needs.
10. Select the "Manual" option if you want to change the suggested data block number.
11. Click "More information" if you want to supplement user information for the technology object.
12. Click "OK" to add the technology object.  
Click "Cancel" to discard your entries.

## Result

The new technology object is created and saved to the "Technology objects" folder in the project tree.

## See also

Guidelines on use of motion control (Page 6017)

### 11.2.5.4 Configuring the axis technology object

#### Working with the configuration dialog

You configure the properties of the technology object in the configuration window. Proceed as follows to open the configuration window of the technology object:





1. Open the group of the required technology object in the project tree.
2. Double-click the "Configuration" object.

The configuration is divided into the following categories:

- **Basic parameters**  
The basic parameters contain all the parameters which must be configured for a functioning axis.
- **Extended parameters**  
The advanced parameters include parameters to adapt to your drive or your plant.

### Icons of the configuration window

Icons in the area navigation of the configuration show additional details about the status of the configuration:

	<b>The configuration contains default values and is complete.</b> The configuration contains only default values. With these default values you can use the technology object without additional changes.
	<b>The configuration contains values set by the user and is complete.</b> All input fields of the configuration contain valid values and at least one preset value has changed.
	<b>The configuration is incomplete or incorrect</b> At least one input field or drop-down list contains an invalid value. The corresponding field or the drop-down list is displayed on a red background. Click the roll-out error message to indicate the cause of error.
	<b>The configuration is valid but contains warnings</b> Only one hardware limit switch is configured. Depending on the plant, the lacking configuration of a hardware limit switch may result in a hazard. The corresponding field or the drop-down list is displayed on a yellow background.

### See also

- Guidelines on use of motion control (Page 6017)
- Basic parameters (Page 6028)
- Extended parameters (Page 6030)

### Basic parameters

#### Configuration - General

Configure the basic properties of the "Axis" technology object in the "General" configuration window.

#### Axis name:

Define the name of the axis or the name of the "Axis" technology object in this box. The technology object is listed under this name in the project navigation.

#### Hardware interface

The pulses are output to the power unit of the drive by fixed assigned digital outputs.

In CPUs with relay outputs, the pulse signal cannot be output on these outputs because the relays do not support the necessary switching frequencies. A signal board with digital outputs must be used to enable you to work with the PTO (Pulse Train Output) on these CPUs.

### Note

The PTO requires the functionality of a fast counter (HSC) internally. The corresponding fast counter can therefore not be used elsewhere. The count can not be evaluated from its input address.

The assignment between PTO and HSC is fixed. When the user activates PTO1, it is connected to the HSC1. If the PTO2 is activated, this is connected with the HSC2.

In the drop-down list "Pulse generator selection", select the PTO (Pulse Train Output) which are to provide the pulses for controlling the stepper motors or servo motors with a pulse interface. If the pulse generators and high-speed counters are not used elsewhere in the device configuration, the hardware interface can be configured automatically. In this case, the PTO selected in the drop-down list is displayed with a white background. The interfaces used will be listed in the "Output source", "Pulse output", "Direction output" and "Assigned fast counter" output fields.

Proceed as follows if you wish to change the interfaces or if the PTO could not be automatically configured (entry in the "Pulse generator selection" drop-down list is highlighted in red):

1. Click on the "Device configuration" button.  
The pulse generator device configuration opens.  
Enlarge the property window of the device configuration if the configuration of the pulse generator is not visible.

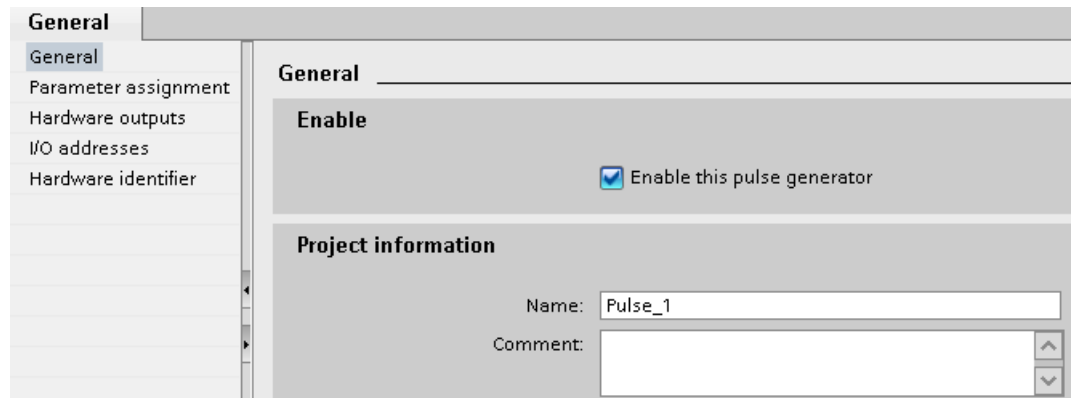

2. Select the "Enable this pulse generator" check box.

3. Select the "Parameter assignment" entry in the block navigator.  
The "Parameter assignment" opens.

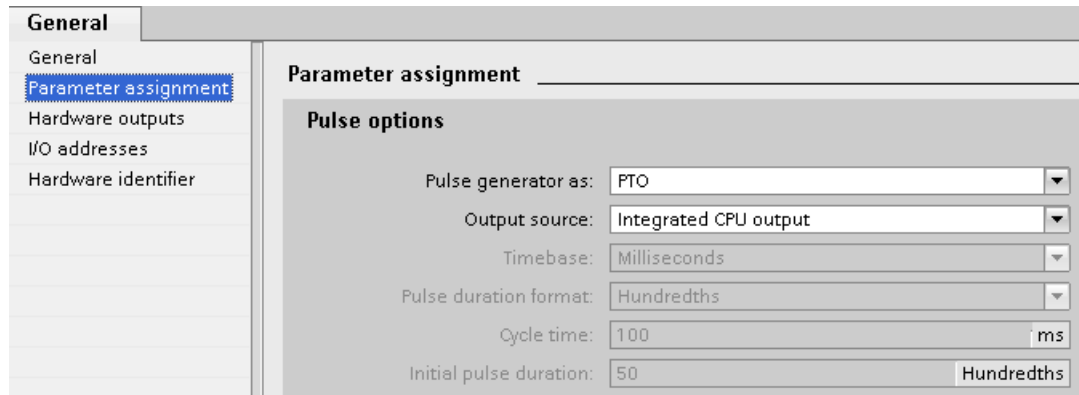

4. In the "Pulse generator as:" dropdown list select the "PTO" entry.
5. In the "Output source:" dropdown list select the "Integrated CPU output" or "Signal board output" entry. The "Signal board output" entry can only be selected for PTO1 or for PTO1 and PTO2 depending on the plugged signal board. For more detailed information, see chapter: CPU outputs relevant for motion control (Page 6010)
6. Go back to the axis configuration.  
Unless the corresponding fast counter has already been used elsewhere, the PTO boxes of the "General" axis configuration are not shaded red. Correct the configuration based on the error messages if this is not the case.

## User unit

Select the desired unit for the dimension system of the axis in the dropdown list. The selected unit is used for the further configuration of the "Axis" technology object and for the display of the current axis data.

The values at the input parameters (Position, Distance, Velocity, ...) of the Motion Control instructions also refer to this unit.

---

### Note

Later changing of the dimension system may not be converted correctly in all the configuration windows of the technology object. In this case check the configuration of all axis parameters.

The values of the input parameters of the Motion Control instructions may have to be adapted to the new unit of measurement in the user program.

---

## Extended parameters

### Configuration - Drive interface

Configure the output for drive enable and the input for the "Drive ready" feedback signal of the drive in the "Drive signals" configuration window.

Drive enable is controlled by Motion Control instruction "MC\_Power" and enables power to the drive. The signal is provided to the drive via the output to be configured.

The drive signals "Drive ready" to the CPU if it is ready to start executing travel after receipt of drive enable. The "Drive ready" signal is reported back to the CPU via the input to be configured.

If the drive does not have any interfaces of this type, you will not have to configure the parameters. In this case, select the value TRUE for the ready input.

## See also

Configuration - Mechanics (Page 6031)

Position limits (Page 6032)

Dynamics (Page 6036)

Homing (technology object "Axis" as of V2.0) (Page 6043)

## Configuration - Mechanics

Configure the mechanical properties of the drive in the "Mechanics" configuration window.

### Increments per motor revolution

Configure the number of pulses required for one revolution of the motor in this field.

Limits (independent of the selected unit of measurement):

- $0 < \text{Pulse per motor revolution} \leq 2147483647$

### Load distance per motor revolution

In this field, configure the load distance per motor revolution covered by the mechanical system of your unit.

Limits (independent of the selected unit of measurement):

- $0.0 < \text{Load distance per motor revolution} \leq 1.0e12$

### Invert direction signal

You can adjust the direction output to the direction logic of the drive using the "Invert direction signal" check box.

- **Invert direction signal: deactivated**
  - 0 V level = negative travel direction
  - 5 V / 24 V level = positive travel direction (the actual voltage depends on the hardware used)
- **Invert direction signal: activated**
  - 0 V level = positive travel direction
  - 5 V / 24 V level = negative travel direction (the actual voltage depends on the hardware used)

### See also

Configuration - Drive interface (Page 6028)

Position limits (Page 6032)

Dynamics (Page 6036)

Homing (technology object "Axis" as of V2.0) (Page 6043)

Relationship between the travel direction and voltage level at the direction output (Page 6013)

### Position limits

#### Requirements for hardware limit switches

Use only hardware limit switches that remain permanently switched after being approached. This switching status may only be revoked after a return to the valid travel range.

### See also

Configuration - Position limits (Page 6032)

Behavior of axis when position limits is tripped (Page 6033)

Changing the position limits configuration in the user program (Page 6035)

#### Configuration - Position limits

Configure the hardware and software limit switches of the axis in the "Position limits" configuration window.

#### Enable hardware limit switch

Activate the function of the low and high hardware limit switch with this check box. The hardware limit switches can be used for purposes of direction reversal during a reference point approach. For details, refer to the configuration description for homing.

#### Low / high HW limit switch input

Select the digital input for the low or high hardware limit switch from the drop-down list. The input must be interrupt-capable. The digital onboard CPU inputs and the digital inputs of a plugged signal board can be selected as inputs for the HW limit switches.



#### CAUTION

The digital inputs are set to a filter time of 6.4 ms by default. If these are used as hardware limit switches, undesired decelerations may occur. If this occurs, reduce the filter time for the relevant digital inputs.

The filter time can be set under "Input filter" in the device configuration of the digital inputs.

### Active level

In the drop-down list, select the signal level available at the CPU when the hardware limit switch is approached.

- "Low level" selected  
0 V (FALSE) at CPU input corresponds to hardware limit switch approached
- "High level" selected  
5 V / 24 V (TRUE) at the CPU input = hardware limit switch approached (the actual voltage depends on the hardware used)

### Enable software limit switch

Activate the function of the low and high software limit switch with this check box.

---

#### Note

The enabled software limit switch only affects a homed axis.

---

### High and low software limit switch

Enter the position value of the low and high software limit switch in these boxes.

Limits (independent of the selected unit of measurement):

- $-1.0e12 \leq \text{low software limit switch} \leq 1.0e12$
- $-1.0e12 \leq \text{high software limit switch} \leq 1.0e12$

The value of the high software limit switch must be greater than or equal to the value of the low software limit switch.

### See also

Requirements for hardware limit switches (Page 6030)

Behavior of axis when position limits is tripped (Page 6033)

Changing the position limits configuration in the user program (Page 6035)

Configuration - Homing - Active (Page 6045)

### Behavior of axis when position limits is tripped

### Behavior of axis when hardware limit switches are approached

When the hardware limit switches are approached, the axis brakes to a standstill at the configured emergency stop deceleration. The specified emergency stop deceleration must be

sufficient to reliably stop the axis before the mechanical stop. The following diagram presents the behavior of the axis after it approaches the hardware limit switches:

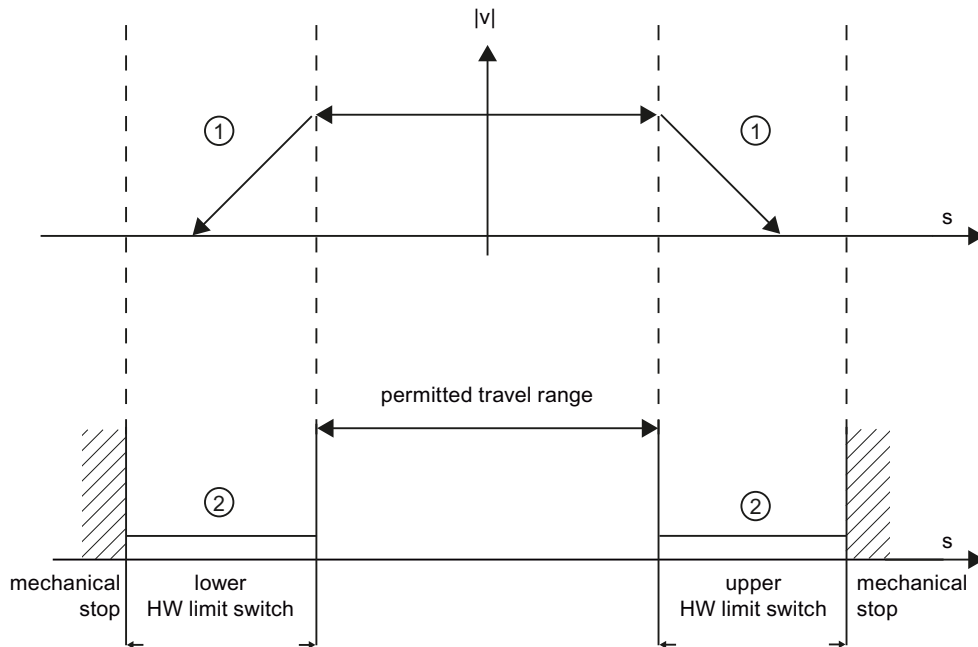

①	The axis brakes to a standstill at the configured emergency stop deceleration.
②	Range in which the HW limit switches signal the status "approached".

The "HW limit switch approached" error is displayed in the motion control instruction to be initiated, in "MC\_Power", and in the technology object tags. Instructions for eliminating errors can be found in the Appendix under "List of ErrorIDs and ErrorInfos".

### Behavior of axis when software limit switches are reached

If software limit switches are activated, an active motion is stopped at the position of the software limit switch. The axis is braked at the configured deceleration.

The following diagram presents the behavior of the axis until it reaches the software limit switches:



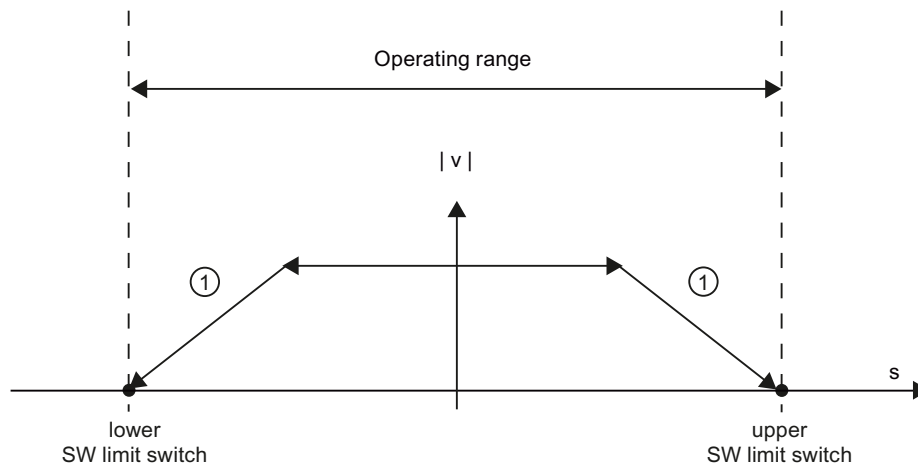

① The axis brakes to a standstill at the configured deceleration.

The "SW limit switch reached" error is displayed in the motion control instruction to be initiated, in "MC\_Power", and in the technology object tags. Instructions for eliminating errors can be found in the Appendix under "List of ErrorIDs and ErrorInfos".

The circumstances under which the "SW limit switch exceeded" error is displayed can be obtained in the topics "Software limit switches in conjunction with a homing operation (Page 6102)" and "Software limit switches in conjunction with dynamic changes (Page 6107)".

Use additional hardware limit switches if a mechanical endstop is located after the software limit switches and there is a risk of mechanical damage.

### See also

Requirements for hardware limit switches (Page 6030)

Configuration - Position limits (Page 6030)

Changing the position limits configuration in the user program (Page 6035)

### Changing the position limits configuration in the user program

You can change the following configuration parameters during user program runtime in the CPU:

### Hardware limit switches

You can also activate and deactivate the hardware limit switches during runtime of the user program. Use the following technology object tag for this purpose:

- <Axis name>.Config.PositionLimits\_HW.Active

Please refer to the description of the technology object tags in the Appendix for information on when changes to the configuration parameter become effective.

### Software limit switches

You can also activate and deactivate the software limit switches and change their position values during runtime of the user program. Use the following technology object tags for this purpose:

- <Axis name>.Config.PositionLimits\_SW.Active  
for activating and deactivating the software limit switches
- <Axis name>.Config.PositionLimits\_SW.MinPosition  
for changing the position of the low software limit switch
- <Axis name>.Config.PositionLimits\_SW.MaxPosition  
for changing the position of the high software limit switch

Refer to the description of technology object tags in the Appendix for information on when changes to the configuration parameters take effect.

### See also

MC\_ChangeDynamic: Changing the dynamic settings for the axis (as of technology object "Axis" V2.0) (Page 2586)

Requirements for hardware limit switches (Page 6030)

Configuration - Position limits (Page 6030)

Behavior of axis when position limits is tripped (Page 6031)

### Dynamics

#### Configuration - General dynamics

Configure the maximum velocity, the start/stop velocity, the acceleration and deceleration and the jerk limit (as of technology object "Axis" V2.0) in the "General dynamics" configuration window.

#### Velocity limiting unit

Select the unit of measurement with which you want to set the velocity limits in the dropdown list. The unit set here depends on the unit of measurement set under "Configuration - General" and serves only for easier input.

### Maximum velocity / Start/stop velocity

Define the maximum permissible velocity and the start/stop velocity of the axis in these boxes. The start/stop velocity is the minimum permissible velocity of the axis.

Limit values:

The limits indicated below refer to the "Pulses/s" unit of measurement:

- **Technology object Axis V2.0**

- $2 \leq \text{start/stop velocity} \leq 20000$  (signal board 20kHz)
- $2 \leq \text{start/stop velocity} \leq 200000$  (signal board 200kHz)
- $2 \leq \text{start/stop velocity} \leq 100000$  (on-board CPU outputs)
- $2 \leq \text{maximum velocity} \leq 20000$  (signal board 20kHz)
- $2 \leq \text{maximum velocity} \leq 200000$  (signal board 200kHz)
- $2 \leq \text{maximum velocity} \leq 100000$  (on-board CPU outputs)

- **Technology object Axis V1.0**

- $2 \leq \text{start/stop velocity} \leq 20000$  (signal board 20kHz)
- $2 \leq \text{start/stop velocity} \leq 100000$  (signal board 200kHz)
- $2 \leq \text{start/stop velocity} \leq 100000$  (on-board CPU outputs)
- $2 \leq \text{maximum velocity} \leq 20000$  (signal board 20kHz)
- $2 \leq \text{maximum velocity} \leq 100000$  (signal board 200kHz)
- $2 \leq \text{maximum velocity} \leq 100000$  (on-board CPU outputs)

The value of the maximum velocity must be greater or equal to the value of the start/stop velocity.

The limit values for other units of measurement must be converted by the user to conform to the given mechanics.

### Acceleration / Delay - Ramp-up time / Ramp-down time

Set the desired acceleration in the "Ramp-up time" or "Acceleration" boxes. The desired deceleration can be set in the "Deceleration time" or "Deceleration" boxes.

The relation between the ramp-up time and acceleration and the deceleration time and deceleration is shown in the following equations:

$$\text{Rampup time} = \frac{\text{Maximum velocity} - \text{Start/stop velocity}}{\text{Acceleration}}$$

$$\text{Deceleration time} = \frac{\text{Maximum velocity} - \text{Start/stop velocity}}{\text{Deceleration}}$$

Motion jobs started in the user program are performed with the selected acceleration / deceleration.

Limit values:

The limits indicated below refer to the "Pulses/s<sup>2</sup>" units of measurement:

- $0.28 \leq \text{acceleration} \leq 9.5e9$
- $0.28 \leq \text{deceleration} \leq 9.5e9$

The limits for other units of measurement must be converted to conform to the given mechanics.

---

**Note**

Changes to the velocity limits ("start/stop velocity" and "maximum velocity") influence the acceleration and deceleration values of the axis. The ramp-up and deceleration times are retained.

---

**Activate jerk limit (as of technology object Axis V2.0)**

Activate the jerk limit with this check box.

---

**Note**

If an error occurs, the axis decelerates with the configured emergency stop deceleration. An activated jerk limit is not considered here.

---

**Smoothing time/jerk (as of technology object "Axis" V2.0)**

You can input the parameters of the jerk limit in the "Smoothing time" field or alternatively in the "Jerk" field.

- Set the desired jerk for acceleration and deceleration ramp in the "Jerk" field.
  - Set the desired smoothing time for the acceleration ramp in the "Rounding time" field.
- 

**Note**

The set smoothing time visible in the configuration only applies to the acceleration ramp.

If the values for acceleration and deceleration differ, the smoothing time of the deceleration ramp is calculated according to the jerk of the acceleration ramp and used. (See also Behavior of the axis when using the jerk limit (Page 6041))

The smoothing time of the deceleration is adapted as follows:

- **Acceleration > deceleration**  
The smoothing time used for the deceleration ramp is shorter than that for the acceleration ramp.
  - **Acceleration < deceleration**  
The smoothing time used for the deceleration ramp is shorter than that for the acceleration ramp.
  - **Acceleration = deceleration**  
The smoothing times of the acceleration and deceleration ramp are equal.
- 

The relation between smoothing times and jerk is shown in the following equation:

$$\text{Rounding off time (acceleration ramp)} = \frac{\text{Acceleration}}{\text{Step}}$$

$$\text{Rounding off time (deceleration ramp)} = \frac{\text{Deceleration}}{\text{Step}}$$

Motion jobs started in the user program are performed with the selected jerk.

Limit values:

The limits indicated below refer to the Pulses/s<sup>3</sup> units of measurement:

- $0.04 \leq \text{jerk} \leq 1.5e8$

The limits for other units of measurement must be converted to conform to the given mechanics.

## See also

Behavior of the axis when using the jerk limit (Page 6041)

Configuration - Dynamics emergency stop (Page 6039)

Changing the configuration of dynamics in the user program (Page 6042)

## Configuration - Dynamics emergency stop

Configure the emergency stop deceleration of the axis in the "Dynamics emergency stop" configuration window. When an error occurs and when the axis is disabled with motion control instruction "MC\_Power" (input parameter StopMode = 0), the axis is brought to a standstill with this deceleration.

## Velocity limits

The velocity values configured in the "General dynamics" configuration window are once again displayed in this information area.

## Deceleration

Set the deceleration value for emergency stop in the "Emergency stop deceleration" or "Emergency stop ramp-down time" field.

The relation between emergency stop deceleration time and emergency stop deceleration is shown in the following equation:

$$\text{Emergency stop deceleration time} = \frac{\text{Maximum velocity} - \text{Start/stop velocity}}{\text{Emergency stop deceleration}}$$

The specified emergency stop deceleration must be sufficient to bring the axis to a standstill in a timely manner in the event of an emergency (for example, when the hardware limit switch is approached prior to reaching the mechanical endstop).

The configured maximum velocity of the axis must be used as a basis for selecting the emergency stop deceleration.

Limit values:

The limits indicated below refer to the "Pulses/s<sup>2</sup>" units of measurement:

- $0.28 \leq \text{emergency stop deceleration} \leq 9.5e9$

The limits for other units of measurement must be converted to conform to the given mechanics.

### **See also**

Configuration - General dynamics (Page 6034)

Changing the configuration of dynamics in the user program (Page 6042)

### Behavior of the axis when using the jerk limit

Axis acceleration and deceleration is not stopped abruptly when the jerk limit is activated; it is adjusted gently according to the set step or rounding off time. The diagram below details the behavior of the axis with and without activated jerk limit:

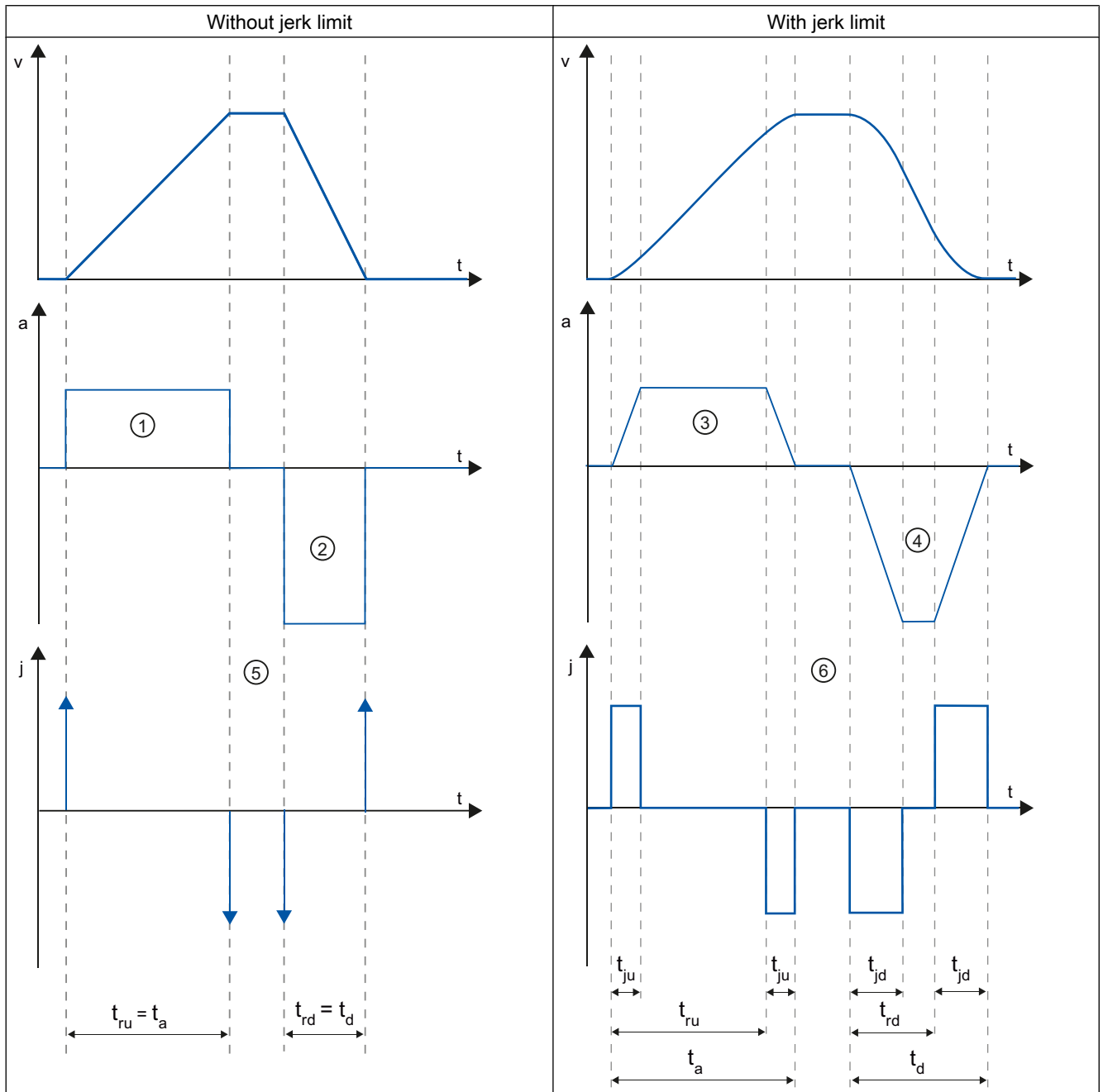

t	Time axis
v	Velocity
a	Acceleration

j	Step
t <sub>ru</sub>	Rampup time
t <sub>a</sub>	Time taken for the axis to accelerate
t <sub>rd</sub>	Deceleration time
t <sub>d</sub>	Time taken for the axis to decelerate
t <sub>ju</sub>	Smoothing time of the acceleration ramp
t <sub>jd</sub>	Smoothing time of the deceleration ramp

The example shows travel in which the deceleration value ② is twice the acceleration value ①. The resulting ramp-down time t<sub>rd</sub> is therefore only half the length of the ramp-up time t<sub>ru</sub>.

Acceleration ① and deceleration ② change abruptly without a jerk limit. Acceleration ① and deceleration ② change gradually with activated jerk limiter. As the jerk applies to entire motion, the rate is the same for the increase and decrease in acceleration and deceleration.

The step value j becomes infinitely high ⑤ as soon as the change is made without jerk limit. The step is limited to the configured value ⑥ when the jerk limit is activated.

The smoothing time t<sub>ju</sub> given in the configuration applies to the acceleration ramp. The deceleration ramp smoothing time t<sub>jd</sub> is calculated using the configured jerk value and the configured deceleration.

## See also

Configuration - General dynamics (Page 6034)

## Changing the configuration of dynamics in the user program

You can change the following configuration parameters during user program runtime in the CPU:

### Acceleration and deceleration

You can also change the values for acceleration and deceleration during runtime of the user program. Use the following technology object tags for this purpose:

- <Axis name>.Config.DynamicDefaults.Acceleration  
for changing acceleration
- <Axis name>.Config.DynamicDefaults.Deceleration  
for changing deceleration

Refer to the description of technology object tags in the Appendix for information on when changes to the configuration parameters take effect.



## Emergency stop deceleration

You can also change the value for the emergency stop deceleration during runtime of the user program. Use the following technology object tag for this purpose:

- <Axis name>.Config.DynamicDefaults.EmergencyDeceleration

Please refer to the description of the technology object tags in the Appendix for information on when changes to the configuration parameter become effective.



### **WARNING**

After changes to this parameter, it may be necessary to adapt the positions of the hardware limit switches and other safety-relevant settings.

## Jerk limit (as of technology object "Axis" V2.0)

You can also activate and deactivate the jerk limit at runtime of the user program and change the value for the jerk. Use the following technology object tag for this purpose:

- <Axis name>.Config.DynamicDefaults.JerkActive  
for activating and deactivating the jerk limit
- <Axis name>.Config.DynamicDefaults.Jerk  
for changing the jerk

Please refer to the description of the technology object tags in the Appendix for information on when changes to the configuration parameter become effective.

## See also

MC\_ChangeDynamic: Changing the dynamic settings for the axis (as of technology object "Axis" V2.0) (Page 2586)

Configuration - General dynamics (Page 6034)

Configuration - Dynamics emergency stop (Page 6037)

## Homing (technology object "Axis" as of V2.0)

### Configuration - Homing - General

Configure the reference point switch input for active and passive homing in the "Homing - General" configuration window.

### Reference point switch input

Select the digital input for the reference point switch from the drop-down list box. The input must be able to generate an interrupt. The onboard CPU inputs and inputs of an inserted signal board can be selected as inputs for the reference point switch.

---

#### Note

The digital inputs are set to a filter time of 6.4 ms by default.

When the digital inputs are used as a reference point switch, this can result in undesired decelerations and thus inaccuracies. Depending on the homing velocity and extent of the reference point switch, the reference point may not be detected. The filter time can be set under "Input filter" in the device configuration of the digital inputs.

The specified filter time must be less than the duration of the input signal at the reference point switch.

---

### See also

Sequence - Active homing (Page 6048)

### Configuration - Homing - Passive

Configure the necessary parameters for passive homing in the "Homing - Passive" configuration window.

The movement for passive homing must be triggered by the user (e.g. using an axis motion command). Passive homing is started using Motion Control instruction "MC\_Home" with input parameter "Mode" = 2.

### Side of the homing switch

This is where you select whether the axis is to be homed on the low or high side of the homing switch.

### Home position

The position configured in the Motion Control instruction "MC\_Home" is used as the home position.

---

#### Note

If passive homing is carried out without an axis motion command (axis at a standstill), homing will be executed upon the next rising or falling edge at the homing switch.

---

## Configuration - Homing - Active

Configure the necessary parameters for active homing in the "Active homing" configuration window. Active homing is started using Motion Control instruction "MC\_Home" with input parameter "Mode" = 3.

### Permit auto reverse at the hardware limit switch

Activate the check box to use the hardware limit switch as a reversing cam for the home position approach. The hardware limit switches must be enabled for the reversal of direction (at least the hardware limit switch in the direction of approach must be configured).

If the hardware limit switch is reached during active homing, the axis brakes at the configured deceleration (not with the emergency stop deceleration) and reverses direction. The homing switch is then sensed in reverse direction.

If the direction reversal is not active and the axis reaches the hardware limit switch during active homing, the home position approach is aborted with an error and the axis is braked at the emergency stop deceleration.

---

#### Note

If possible, use one of the following measures to ensure that the machine does not travel to a mechanical endstop in the event of a direction reversal:

- Keep the approach velocity low
  - Increase the configured acceleration/deceleration
  - Increase the distance between hardware limit switch and mechanical stop
- 

### Approach/homing direction

With the direction selection, you determine the approach direction used during active homing to search for the homing switch, as well as the homing direction. The homing direction specifies the travel direction the axis uses to approach the configured side of the homing switch to carry out the homing operation.

### Side of the homing switch

This is where you select whether the axis is to be homed on the low or high side of the homing switch.

### Velocity

In this field, specify the velocity at which the homing switch is to be searched for during the home position approach.

Limits (independent of the selected unit of measurement):

- Start/stop velocity  $\leq$  approach velocity  $\leq$  maximum velocity

### Homing velocity

Specify in this field the velocity at which the homing switch is to be approached for homing.

Limits (independent of the selected unit of measurement):

- Start/stop velocity  $\leq$  Homing velocity  $\leq$  Maximum velocity

### Home position offset

If the desired home position deviates from the position of the homing switch, the home position offset can be specified in this field.

If the value does not equal 0, the axis executes the following actions following homing at the homing switch:

1. Move the axis at the homing velocity by the value of the home position offset
2. Upon reaching the "Home position offset", the axis is at the home position that was specified in input parameter "Position" of the "MC\_Home" Motion Control instruction.

Limits (independent of the selected unit of measurement):

- $-1.0e12 \leq$  home position offset  $\leq 1.0e12$

### Home position

The position configured in the Motion Control instruction "MC\_Home" is used as the home position.

### Sequence - Passive homing

Passive homing is started with Motion Control instruction "MC\_Home" (input parameter Mode = 2). Input parameter "Position" specifies the absolute reference point position.

The diagram below shows an example of a characteristic curve for passive homing with the following configuration parameters:

- "Reference point switch side" = "High side"

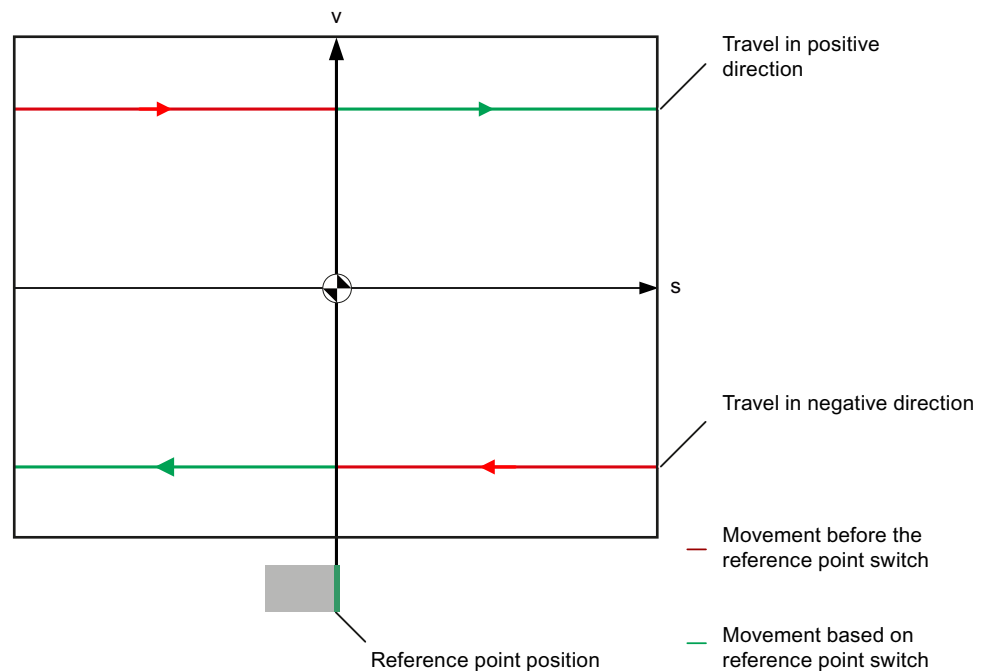

### Movement towards reference point switch (red section of curve)

The Motion Control instruction "MC\_Home" does not itself carry out any homing motion when passive homing is started. The travel required for reaching the reference point switch must be implemented by the user via other motion control instructions such as "MC\_MoveRelative". The tag <axis name>.StatusBits.HomingDone remains TRUE during passive homing if the axis has already been homed.

### Axis homing (transition from red to green section of curve)

The axis is homed when the configured side of the reference point switch is reached. The current position of the axis is set to the reference point position. This is specified at the "Position" parameter of the "MC\_Home" Motion Control instruction. The variable <axis name>.StatusBits.HomingDone will be set to "TRUE" if the axis has not been homed before. The travel previously started is not cancelled.

### Movement beyond reference point switch (green section of curve)

Following homing at the reference point switch, the axis continues and completes the previously started travel with the corrected axis position.

### Sequence - Active homing

You start active homing with motion control instruction "MC\_Home" (input parameter Mode = 3). The "Position" input parameter specifies the absolute home position. Alternatively, you can start active homing on the axis command table for test purposes.

The diagram below shows an example of a characteristic curve for an active reference point approach with the following configuration parameters:

- "Approach/homing direction" = "Positive direction"
- "Side of the homing switch" = "Top side"
- Value of "home position offset" > 0

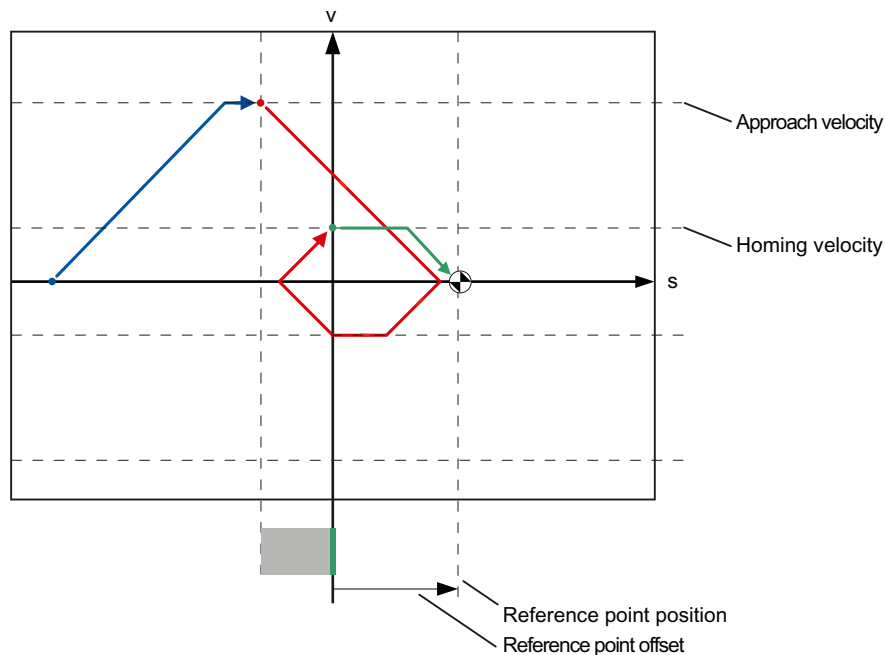

#### Search for homing switch (blue curve section)

When active homing starts, the axis accelerates to the configured "approach velocity" and searches at this velocity for the homing switch. The tag <axis name>.StatusBits.HomingDone is set to FALSE.

#### Reference point approach (red curve section)

When the homing switch is detected, the axis in this example brakes and reverses, to be homed to the configured side of the homing switch at the configured homing velocity. Homing causes the tag <axis name>.StatusBits.HomingDone to change to TRUE.

#### Travel to home position offset (green curve segment)

After homing, the axis moves at the homing velocity along the path to the home position offset. There the axis is at the homing point position that was specified in input parameter "Position" of the "MC\_Home" Motion Control instruction.

## See also

Configuration - Homing - General (Page 6041)

## Changing the homing configuration in the user program

You can change the following configuration parameters in the CPU during user program runtime as of technology object "Axis" V2.0:

### Passive homing

You can change the side of the homing switch for passive homing during the user program runtime. Use the following technology object tag for this purpose:

- <Axis name>.Config.Homing.SidePassiveHoming  
for changing the side of the homing switch

Please refer to the description of the technology object tags in the Appendix for information on when changes to the configuration parameter become effective.

### Active homing

You can change the direction of approach, the side of the homing switch, the approach velocity, the homing velocity, and the home position offset for active homing during the program runtime of the user program. Use the following technology object tags for this purpose:

- <Axis name>.Config.Homing.AutoReversal  
for changing "auto reverse at the HW limit switch"
- <Axis name>.Config.Homing.Direction  
for changing "approach / homing direction"
- <Axis name>.Config.Homing.SideActiveHoming  
for changing the "side of the homing switch"
- <Axis name>.Config.Homing.FastVelocity  
for changing the "velocity"
- <Axis name>.Config.Homing.SlowVelocity  
for changing the "homing velocity"
- <Axis name>.Config.Homing.Offset  
for changing "home position offset"

Please refer to the description of the technology object tags in the Appendix for information on when changes to the configuration parameter become effective.

## See also

MC\_ChangeDynamic: Changing the dynamic settings for the axis (as of technology object "Axis" V2.0) (Page 2586)

## 11.2.6 Technology object command table

### 11.2.6.1 Use of the command table technology object

The Motion Control instruction "Command table" allows you to combine multiple individual axis control jobs in one movement sequence. The technology object can be used for technology as of Version V2.0.

You configure the movement sequence as a table in a configuration dialog.

The motion profile of the movement sequences can be checked on a graph before the project is loaded to the CPU. The command tables created are then linked to an axis and used in the user program with the "MC\_CommandTable" Motion Control instruction. You can process part or all of the command table.

### 11.2.6.2 Command table technology object tools

The "Configuration" tool is provided in the TIA Portal for the "Command Table" technology object. The representation below shows the interaction of the tool with the technology object:

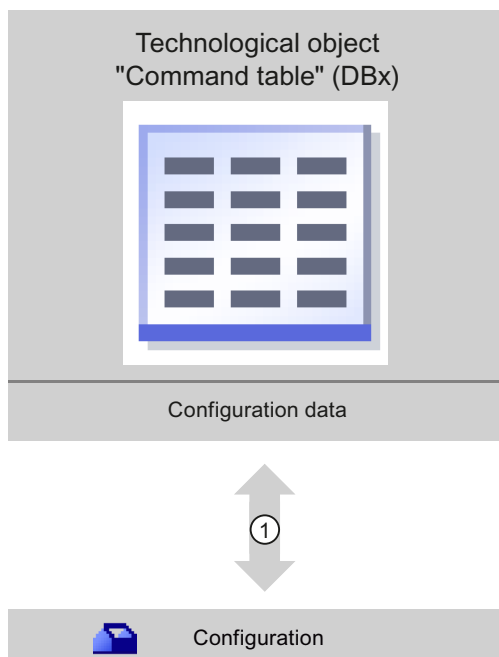

① Writing and reading the configuration of the technology object



## Configuration

Configure the following properties of the "Command Table" technology object with the "Configuration" tool:

- You can create one or more movement sequences by configuring individual jobs.
- You can configure the graphic display to check your movement sequence using an axis already configured or a configurable default axis.

The movement sequence data are saved in the data block of the technology object.

### 11.2.6.3 Adding the technological object command table

Proceed as follows to add a "Command table" technology object in the project tree:

#### Prerequisites

- A project with a CPU S7-1200 has been created.
- The CPU firmware version is V2.1 or higher

#### Procedure

1. Open the CPU folder in the project tree.
2. Open the technology objects folder.
3. Double-click "Add new object".  
The "Add new object" dialog opens.
4. Select the "Motion" technology.
5. Open the "Motion Control" folder.
6. Open the "S7-1200 Motion Control" folder
7. Select the version "V2.0" of the "S7-1200 Motion Control" folder (click on the entry for the version).
8. Select the "TO\_CommandTable" object.
9. Change the name of the command table in the "Name" input field to suit your needs.
10. Select the "Manual" option if you want to change the suggested data block number.
11. Click "More information" if you want to supplement user information for the technology object.
12. Click "OK" to add the technology object.  
Click "Cancel" to discard your entries.

#### Result

The new technology object is created and saved to the "Technology objects" folder in the project tree.

### 11.2.6.4 Configuring the command table technology object

#### Working with the configuration dialog

You configure the properties of the technology object in the configuration window. Proceed as follows to open the configuration window of the technology object:





1. Open the group of the required technology object in the project tree.
2. Double-click the "Configuration" object.

The configuration is divided into the following categories:

- **Basic parameters**  
The basic parameters contain all parameters which must be configured for a functional command table.
- **Extended parameters**  
The extended parameters contain the parameters of the default axis or display the parameter values of the axis selected.

#### Icons of the configuration window

Icons in the area navigation of the configuration show additional details about the status of the configuration:

	<p><b>The configuration contains default values and is complete.</b> The configuration contains only default values. With these default values, you can use the technology object without additional changes.</p>
	<p><b>The configuration contains values set by the user and is complete.</b> All input fields of the configuration contain valid values and at least one preset value has changed.</p>
	<p><b>The configuration is incomplete or incorrect</b> At least one input field or drop-down list contains an invalid value. The corresponding field or the drop-down list is displayed on a red background. Click the roll-out error message to display the cause of the error.</p>
	<p><b>The configuration contains mutually incompatible parameter values</b> The configuration contains parameter values that contradict each other either in size or logic. The corresponding field or the drop-down list is displayed on a yellow background.</p>

#### See also

- Guidelines on use of motion control (Page 6017)
- Basic parameters (Page 6052)
- Extended parameters (Page 6065)

#### Basic parameters

#### Configuration - General

Configure the name of the technology object in the "General" configuration window.

### Name

Define the name of the command table or the name of the "Command table" technology object in this field. The technology object will be listed under this name in the project tree.

### See also

Configuration - Command table (Page 6053)

Shortcut menu commands - Command table (Page 6056)

Working with the trend diagram (Page 6058)

Shortcut menu commands - Curve chart (Page 6062)

Transition from "Complete command" to "Blend motion" (Page 6063)

Changing the command table configuration in the user program (Page 6064)

### Configuration - Command table

Create the desired movement sequence in the "Command Table" configuration window and check the result against the graphic view in the trend diagram.

---

#### Note

Small deviations are possible between the time behavior and position in the trend shown and the real movement of the axis. Movements in response to software limit switches being reached are not shown.

---

### Activate warnings

Activate the display of warnings in the command table with this checkbox.

### Use axis parameters of

From the drop-down list, select which axis parameters are to be used for selecting the graphic view of and checking the movement sequence. Select "Default axis" if you have yet to add an axis to the "Technology object" folder or wish to use value which have not been configured in any of the available axes. You configure the properties of the default axis under "Advanced parameters".

The axis parameters of the axis selected at the "Axis" parameter are used to process the command table in the user program.

### Column: Step

Shows the step number of the command.

### Column: Command type

In this column, select the command types which are to be used for processing the command table. Up to 32 commands can be entered. The commands will be processed in sequence. You can choose between the following entries and command types:

- **Empty**  
The entry serves as a placeholder for any commands to be added. The empty entry is ignored when the command table is processed.
- **Halt**  
Stop axis  
(the command only takes effect after a "Velocity set point" command)
- **Positioning Relative**  
Position axis relatively
- **Positioning Absolute**  
Position axis absolutely
- **Velocity set point**  
Move axis at set velocity
- **Wait**  
Waits until the given period is over. Wait does not stop an active traversing motion.
- **Separator**  
Adds a Separator line above the selected line. The Separator line acts as a range limit for the graphic display of the trend view.  
Use the Separator lines if you wish to process parts of the command table.

### Column: Position

Enter the position or travel path for the selected command in this column:

- **Command "Positioning Relative"**  
The command will move the axis by the the given travel path.
- **Command "Positioning Absolute"**  
The command will move the axis by the the given position.
- **Separator**  
The value given specifies the start position for the graphic display.

Limit values (independent of the selected user unit):

- $-1.0e12 \leq \text{position / distance} \leq -1.0e-12$
- $1.0e-12 \leq \text{position / distance} \leq 1.0e12$
- Position / travel path = 0.0

### Column: Velocity

In this column, you enter the velocity for the selected command:

- **Command "Positioning Relative"**  
The command will move the axis at the the given velocity.  
The given velocity will not be reached if the travel path selected is not large enough.
- **Command "Positioning Absolute"**  
The command will move the axis at the the given velocity.  
The given velocity will not be reached if the target position is too close to the starting position.
- **Command " Velocity set point"**  
The command will move the axis at the the given velocity.  
The given velocity will not be reached during the command if too short a runtime is selected.

Limit values (independent of the selected user unit):

- For the commands: "Positioning Relative" and "Positioning Absolute"
  - $1.0e-12 \leq \text{velocity} \leq 1.0e12$
- For the command: "Velocity set point"
  - $-1.0e12 \leq \text{velocity} \leq -1.0e-12$
  - $1.0e-12 \leq \text{velocity} \leq 1.0e12$
  - Velocity = 0.0

### Column: Duration

Enter the duration of the selected command in this column:

- **Command " Velocity set point"**  
The command will move the axis for the specified duration. The duration includes both the acceleration phase and the constant travel phase. The next command will be processed once the duration is over.
- **Command "Wait"**  
Waits until the given duration is over.

Limit values (independent of the selected user unit):

- $0.001s \leq \text{duration} \leq 64800s$

#### Column: Next step

Select the mode of transition to the next step from the drop-down list:

- **Complete command**  
The command will be completed. The next command will be processed immediately.
- **Blend motion**  
The motion of the current command will be blended with the motion of the following command. The transition mode "Blend motion" is available with command types "Positioning Relative" and "Positioning Absolute".  
Motion will be blended with motions of the following command types:
  - Positioning Relative
  - Positioning Absolute
  - Velocity set point

No blending occurs with other command types.

For the exact behavior of the axis when a command is appended or overlapped, see: Transition from "Complete command" to "Blend motion" (Page 6063)

#### Column: Step code

Enter a numerical value / bit pattern in this column which is to be output at the "StepCode" output parameter of the "MC\_CommandTable" Motion Control instruction while the command is being processed.

Limit values:

- $0 \leq \text{code number} \leq 65535$

#### See also

Configuration - General (Page 6050)

Shortcut menu commands - Command table (Page 6056)

Working with the trend diagram (Page 6058)

Shortcut menu commands - Curve chart (Page 6062)

Transition from "Complete command" to "Blend motion" (Page 6063)

Changing the command table configuration in the user program (Page 6064)

#### Shortcut menu commands - Command table

The following shortcut menu commands are available in the command table:

### **Insert empty line**

Adds an empty line above the selected line.

This shortcut menu command can only be executed if there are enough empty lines at the end of the command table.

### **Add empty line**

Adds an empty line below the selected line.

This shortcut menu command can only be executed if there are enough empty lines at the end of the command table.

### **Insert separator line**

Adds a separator line above the selected line.

You cannot have two consecutive separator lines.

### **Add separator line**

Adds a separator line below the selected line.

You cannot have two consecutive separator lines, nor can you add a separator line at the end of the command table.

### **Cut**

Removes the selected lines or content of the selected cell and saves them/it in the clipboard. Selected lines will be deleted and the subsequent lines of the command table shifted up.

### **Copy**

Copies the selected lines or content of the selected cell and saves them/it in the clipboard.

### **Paste**

- Selected lines:  
Pastes the lines from the clipboard into the table above the selected line.
- Selected cell:  
Pastes the content of the clipboard into the selected line.

This shortcut menu command can only be executed if there are enough empty lines at the end of the command table.

### **Replace**

Replaces the selected lines with the lines in the clipboard.

**Delete**

Deletes the selected lines. The lines below in the command table shift up.

**See also**

- Configuration - General (Page 6050)
- Configuration - Command table (Page 6051)
- Working with the trend diagram (Page 6058)
- Shortcut menu commands - Curve chart (Page 6062)
- Transition from "Complete command" to "Blend motion" (Page 6063)
- Changing the command table configuration in the user program (Page 6064)

**Working with the trend diagram**

**Trend view and components**

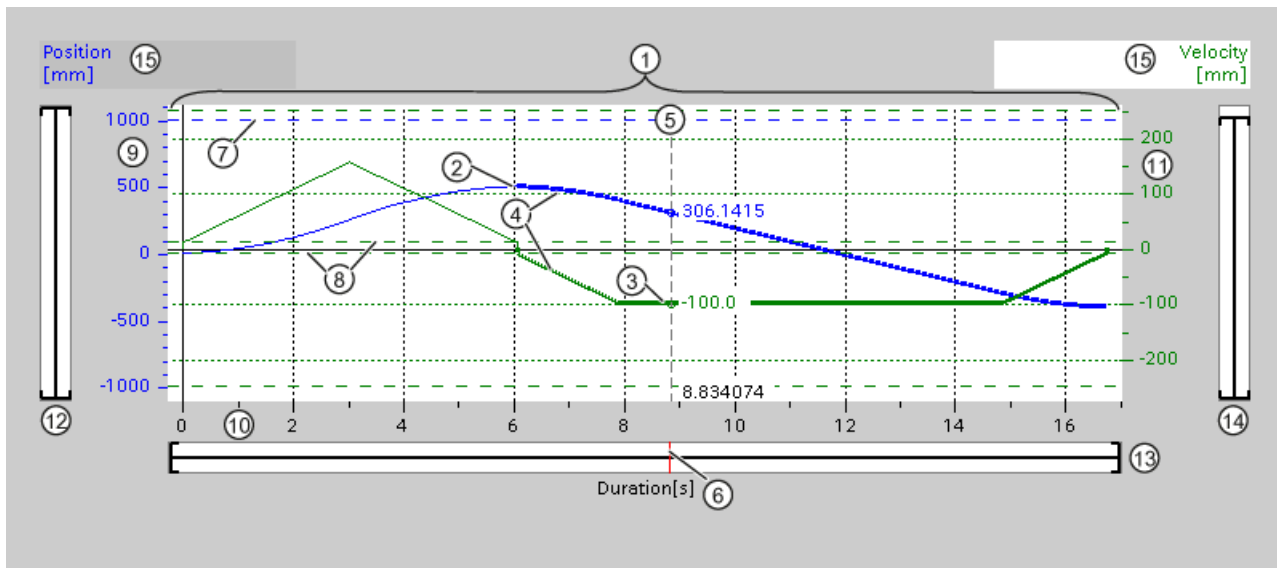

①	Trend view
②	Position curve
③	Velocity curve



④	Curve section of a selected command
⑤	Ruler
⑥	Ruler position marking
⑦	Software limit switch position
⑧	Start/stop velocity
⑨	Position axis scale range
⑩	Time axis scale range
⑪	Velocity axis scale range
⑫	Scroll bar, position axis
⑬	Scroll bar time axis
⑭	Scroll bar, velocity axis
⑮	Selecting the grid

### Selecting separator sections

If the command table consists of multiple sections separated by separators, you can select these sections in the trend view by selecting a command in the section.

### Selecting commands

Commands can be selected in the trend view and in the command table:

- Click on a point on the velocity or position curve in the trend view. The corresponding command will be highlighted in the command table.
- Select a command in the command table.  
The corresponding section of curve will be highlighted.

### Selecting the visible range of the trend view

Follow the steps below to adjust the section of the trend view to be displayed:



Select the scaling in the shortcut menu:

- Scale to curves:  
Scales the axes so the position and velocity curves are visible.
- Scale to curves and limits:  
Scales the axes so the position and velocity curves, the positions of the activated software limit switches and the minimum and maximum velocity limits are visible.

The view selected will be marked in the shortcut menu with a tick.

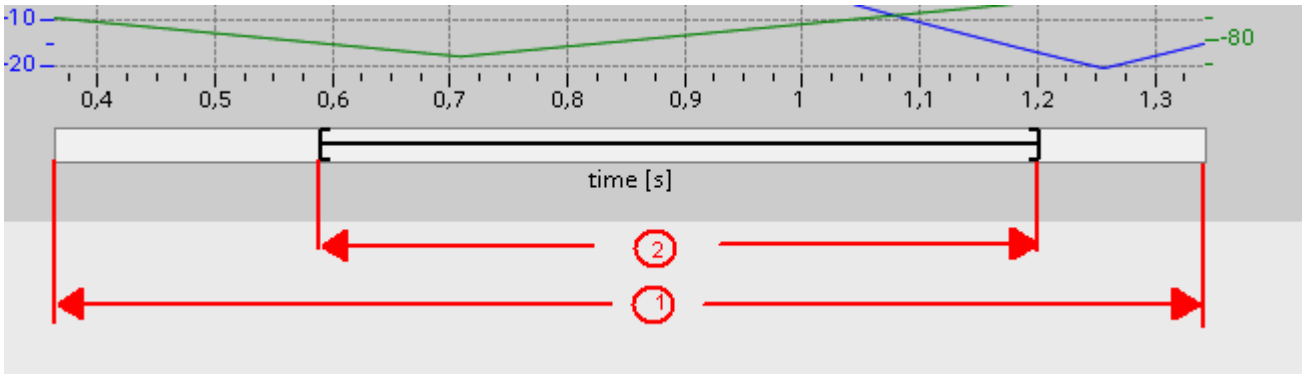
Selecting the section to be shown within the range:

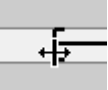

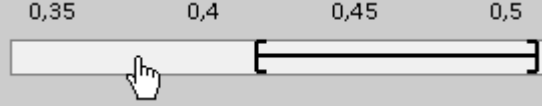
①	Range which the curve values and / or limits are within. (see Selecting in the shortcut menu)
②	<p>Selected range to be shown in the trend window.                  You set the range with the margin cursor at the right-hand and left-hand margin.</p>  <p>You set the position within range ① with the drag cursor.</p>  <p>You can also define the position by clicking in range ①.</p> 

Selecting the section to be shown with the mouse:

Drag a section of the trend view by clicking and dragging with the mouse. The section of curve selected will be enlarged once you release the mouse.

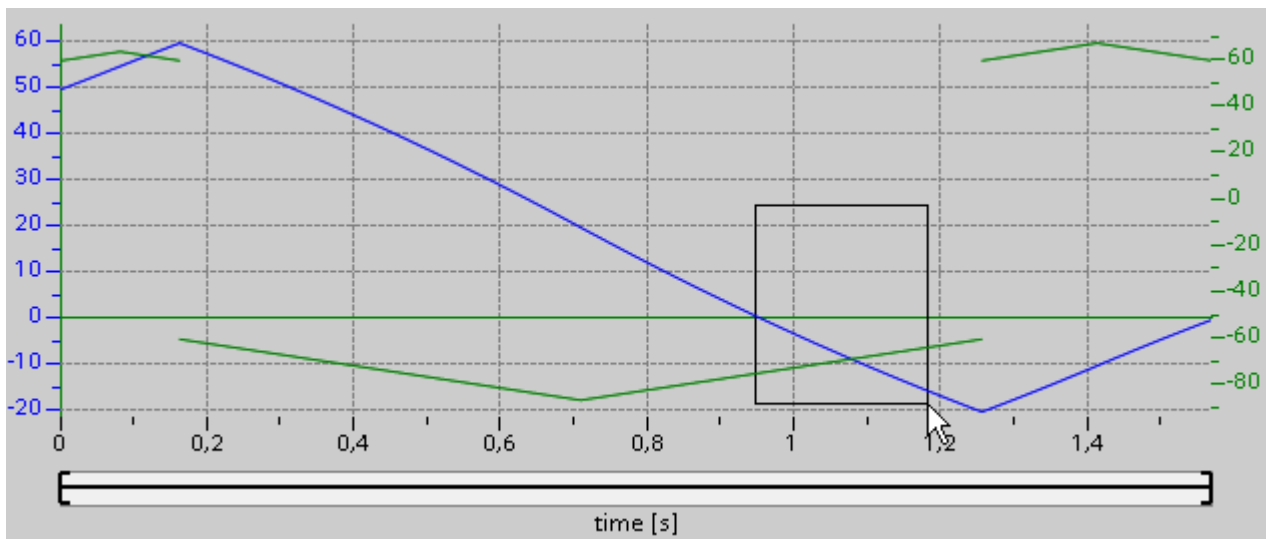

Undoing the last change to the section:

Select the shortcut command "Undo zoom" to undo the last change to the section.

### Synchronizing the grid

Click on the axis scales to select whether the grid is to be synchronized with the position axis or velocity axis.

### Reading off curve values from the ruler

Activate the ruler using the shortcut menu command "Show ruler".

You can move the ruler to any point on the curves using the ruler cursor.

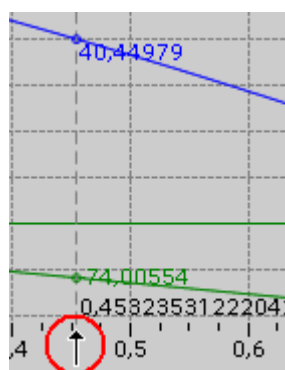

## See also

Configuration - General (Page 6050)

Configuration - Command table (Page 6051)

Shortcut menu commands - Command table (Page 6054)

Shortcut menu commands - Curve chart (Page 6062)

Transition from "Complete command" to "Blend motion" (Page 6063)

Changing the command table configuration in the user program (Page 6064)

## Shortcut menu commands - Curve chart

The following shortcut menu commands are available in the curve window:

### Zoom 100%

Selects a zoom factor which will show 100% of the curve values and / or limits.

### Undo zoom

Undoes the last zoom change.

### Scale to curves

Scales the axes so the position and velocity curves are visible.

### Scale to curves and limits

Scales the axes so the position and velocity curves, the positions of the activated software limit switches and the minimum and maximum velocity limits are visible.

### Show velocity limits

Shows the lines of the velocity limits.

### Show software limit switches

Shows the lines of the software limit switches.

### Show ruler

Fades the ruler in / out

Use the ruler when you want to see the individual values of the curves.

**See also**



- Configuration - General (Page 6050)
- Configuration - Command table (Page 6051)
- Shortcut menu commands - Command table (Page 6054)
- Working with the trend diagram (Page 6056)
- Transition from "Complete command" to "Blend motion" (Page 6063)
- Changing the command table configuration in the user program (Page 6064)

**Transition from "Complete command" to "Blend motion"**

The charts below show the transition between movements in various different transition modes in the "Next step" column:



**Motion transition with preceding positioning jobs**

Complete job	Blend motion
<p style="text-align: center;"><b>Transition from lower to higher velocity</b></p> <p>A job with high velocity is appended to a previous positioning job. The positioning job terminates at its target position at velocity "0". The second job starts from standstill.</p>	<p style="text-align: center;"><b>Transition from lower to higher velocity</b></p> <p>A job with high velocity is overlapped with a previous positioning job. The first positioning job terminates without standstill at its target position. The second job starts with the new velocity.</p>
<p style="text-align: center;"><b>Transition from higher to lower velocity</b></p> <p>A job with low velocity is appended to a previous positioning job. The positioning job terminates at its target position at velocity "0". The second job starts from standstill.</p>	<p style="text-align: center;"><b>Transition from higher to lower velocity</b></p> <p>A job with low velocity is overlapped with a previous positioning job. The first positioning job terminates without standstill at its target position. The first job starts with the new velocity.</p>

	1. Job "Positioning Relative" or "Positioning Absolute"
	2. Job "Velocity set point"
	2. Job "Positioning Relative" or "Positioning Absolute"

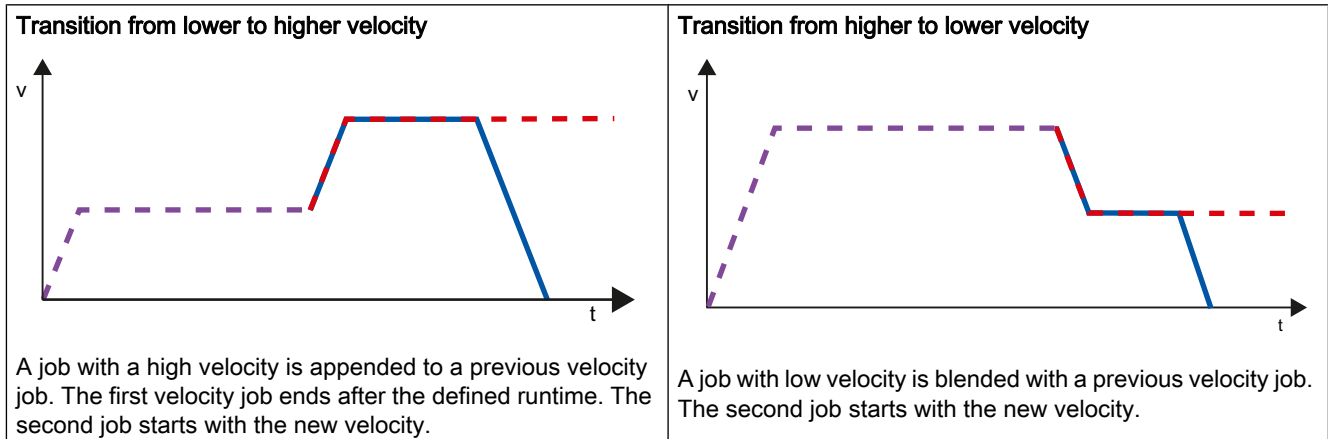
**Motion transition with preceding velocity jobs**



	1. Job "Velocity set point"
	2. Job "Velocity set point"
	2. Job "Positioning Relative" or "Positioning Absolute"

**See also**

- Configuration - General (Page 6050)
- Configuration - Command table (Page 6051)
- Shortcut menu commands - Command table (Page 6054)
- Working with the trend diagram (Page 6056)
- Shortcut menu commands - Curve chart (Page 6060)
- Changing the command table configuration in the user program (Page 6064)

**Changing the command table configuration in the user program**

You can change the following configuration parameters during user program runtime in the CPU:

## Jobs and corresponding values

You can also change the parameters of the command table during the runtime of the user program. Use the following technology object variables for this purpose:

- <Table name>.Config.Commands[1..32].Command  
for changing the command type
- <Table name>.Config.Commands[1..32].Position  
for changing the position / travel path
- <Table name>.Config.Commands[1..32].Velocity  
for changing the velocity
- <Table name>.Config.Commands[1..32].Duration  
for changing the duration
- <Table name>.Config.Commands[1..32].BufferMode  
for changing the parameter "Next step"
- <Table name>.Config.Commands[1..32].Code  
for changing the step code

Refer to the description of technology object variables in the Appendix for information on when changes to the configuration parameters take effect.

## See also

Configuration - General (Page 6050)

Configuration - Command table (Page 6051)

Shortcut menu commands - Command table (Page 6054)

Working with the trend diagram (Page 6056)

Shortcut menu commands - Curve chart (Page 6060)

Transition from "Complete command" to "Blend motion" (Page 6061)

## Extended parameters

### Chart parameters

#### Configuration - General

Configure the basic properties of the chart view of the "Command table" technology object in the "General" configuration window.

---

#### Note

If the default axis has been selected under "Use axis parameters of", the unit of measurement can be edited. If a configured axis has been selected, the unit of measurement for this axis will be displayed.

---

### Use axis parameters of

From the drop-down list, select which axis parameters are to be used for selecting the graphic view of and checking the movement sequence. Select "Default axis" if you have yet to add an axis to the "Technology object" folder or wish to use values which have not been configured in any of the available axes.

The axis parameters of the axis selected at the "Axis" parameter will be used to process the command table in the user program.

### Unit of measurement

Enter the unit of measurement for the default axis in this field. If a preconfigured axis has been selected under "Use axis parameters of", the unit of measurement configured in these parameter will be displayed.

### Configuration - Dynamics

Configure the acceleration and deceleration and the jerk limit for the default axis in the "Dynamics" configuration window.

---

#### Note

If the default axis has been selected under "Use axis parameters of", the following fields can be edited. If a configured axis has been selected, the values of this axis will be displayed.

---

### Acceleration / deceleration

Set the desired acceleration of the default axis in the "Acceleration" field. The desired deceleration can be set in the "Deceleration" field.

Motion jobs configured in the command table will be calculated with the selected acceleration / deceleration.

Limit values:

- $1.0e-12 \leq \text{acceleration} \leq 1.0e12$
- $1.0e-12 \leq \text{deceleration} \leq 1.0e12$

### Activate jerk limit

Activate the jerk limit with this checkbox.

### Step

Set the desired step for ramping up and ramping down in the "Step" field.

Motion jobs configured in the command table will be calculated with the selected step.

Limit values:



- $1.0e-12 \leq \text{jerk} \leq 1.0e12$

### Configuration - Limit values

Configure the maximum velocity, the start/stop velocity and the software limit switches of the default axis in the "Limits" configuration window.

---

#### Note

If the default axis has been selected under "Use axis parameters of", the following fields can be edited. If a configured axis has been selected, the values of this axis will be displayed.

---

### Maximum velocity / Start/stop velocity

Define the maximum permissible velocity and the start/stop velocity of the default axis in these fields. The start/stop velocity is the minimum permissible velocity of the default axis.

Limit values:

- $1.0e-12 \leq \text{start/stop velocity} \leq 1.0e12$   
Start/stop velocity = 0.0
- $1.0e-12 \leq \text{maximum velocity} \leq 1.0e12$   
Maximum velocity = 0.0

The value of the maximum velocity must be greater or equal to the value of the start/stop velocity.

### Enable software limit switches

Activate the function of the low and high software limit switch with this checkbox. Movements in response to software limit switches being reached are not shown in the trend view.

### Low / high software limit switch

Enter the position value of the low and high software limit switches in these fields.

Limits:

- $-1.0e12 \leq \text{low software limit switch} \leq -1.0e-12$   
 $1.0e-12 \leq \text{low software limit switch} \leq 1.0e12$   
Low software limit switch = 0.0
- $-1.0e12 \leq \text{high software limit switch} \leq -1.0e-12$   
 $1.0e-12 \leq \text{high software limit switch} \leq 1.0e12$   
High software limit switch = 0.0

The value of the high software limit switch must be greater than or equal to the value of the low software limit switch.

### 11.2.7 Download to CPU

When loading to the CPU S7-1200 always ensure that the project files are consistent after the online and offline loading. It is not possible to load single blocks. When selecting single blocks, all new and modified blocks are always loaded.

The following object groups can be loaded to the CPU:

Context menu command "Download to device"	Description
All	Download all new and modified blocks and a new or modified hardware configuration
Hardware configuration	Download a new or modified hardware configuration
Software	Download all new and modified blocks
Software (all blocks)	Download all blocks

The data of the Motion Control technology objects are saved in the data blocks. The conditions for downloading of "blocks" thus apply when loading a new or modified technology object.

 <b>CAUTION</b>
<p><b>Possible malfunctions of the axis when loading without hardware configuration</b></p> <p>The hardware configuration is modified when the following modifications are made to the axis configuration:</p> <ul style="list-style-type: none"> <li>• Modification of the pulse generator (PTO)</li> <li>• Modification of the HW limit switch address</li> <li>• Modification of the homing switch address</li> </ul> <p>If the modified configuration of the axis is loaded with the context menu commands "Software" or "Software (all blocks)" without downloading the hardware configuration, this can lead to malfunctions of the axis.</p> <p>Ensure that the current hardware configuration is downloaded to the CPU under the conditions listed below.</p>

#### Download in CPU S7-1200 RUN operating mode (from firmware version V2.2)

For CPU S7-1200 from firmware version V2.2, when loading in CPU RUN operating mode it is checked whether it is possible to load without stopping the CPU.

The following conditions apply when loading data blocks in RUN operating mode:

	Download to load memory	Download to work memory
Data block modified values	Yes	No
Data block modified structure	No	No
New data block	Yes	Yes
Data block deleted	Yes	Yes

From technology version V3.0, Motion Control technology objects (data blocks) can also be downloaded in CPU RUN operating mode.

Technology objects after V3.0 cannot be downloaded in CPU RUN operating mode.

Select one of the actions described below to download the modified version of a Motion Control technology object (from version V3.0) to the work memory:

- **Technology object axis and command table**  
Change the CPU operating mode from STOP to RUN.
- **Technology object axis**  
Disable the axis and execute a "Restart" using the Motion Control instruction "MC\_Reset".
- **Technology object command table**  
Ensure that the command table is not being used. Download the data block of the command table to the work memory using the extended instruction "READ\_DBL".

---

**Note**

In contrast to downloading in STOP operating mode, no actual parameters are overwritten in RUN operating mode. Modifications to the actual parameters only take place at the next change of operating mode from STOP to RUN.

---

**See also**

Guidelines on use of motion control (Page 6017)

MC\_Reset: Acknowledge error (Page 2561)

### 11.2.8 Commissioning the axis - Axis control panel

Use the axis command table to move the axis in manual mode, to optimize the axis settings, and to test your system.

The axis control table can only be used if an online connection to the CPU is established.

---

**Note****Response times of the axis control panel**

The response time during axis control table operation depends on the communication load of the CPU. Close all other online windows of the TIA Portal to minimize the response time.

---

**"Manual control" button**

Click "Manual control" to move the axis in manual control mode. Start by disabling the axis in the user program using motion control instruction "MC\_Power". In "Manual control" mode, the

axis control table takes over control priority for the axis functions. The user program has no influence on the axis functions until manual control is ended.



**WARNING**

The Manual control is active for one axis only. A second axis could be moved in Automatic mode, but this would bring about a dangerous situation.

In this case, set the second axis out of operation.

**"Automatic mode" button**

Click "Automatic mode" to end the "Manual control" mode. The axis control table passes back the control priority and the axis can be controlled by the user program again. The axis must be re-enabled in the user program and homed, if required.

Complete all active traversing motions before switching to automatic control; otherwise, the axis will be braked with the emergency stop deceleration.

**"Enable" button**

Click "Enable" to enable the axis in "Manual control" mode. When the axis is enabled, the axis control panel functions can be used.

If the axis cannot be enabled because certain conditions are not met, note the error message in the "Error message" field. Information on eliminating errors is available in the Appendix under "List of ErrorIDs and ErrorInfos". After the error has been corrected, enable the axis again.

**"Disable" button**

Click "Disable" if you want to temporarily disable the axis in "Manual control" mode.

## "Command" area

Operation in the "Command" area is only possible if the axis is enabled. You can select one of the following command inputs:

- **Jogging**  
This command is equivalent to motion control command "MC\_MoveJog" in the user program.
- **Positioning**  
This command is equivalent to the motion control jobs "MC\_MoveAbsolute" and "MC\_MoveRelative" in the user program. The axis must be homed for absolute positioning.
- **Homing**  
This command is equivalent to motion control command "MC\_Home" in the user program.
  - The "Set reference point" button corresponds to Mode = 0 (direct homing absolute)
  - The "Active homing" button corresponds to Mode = 3 (active homing)For active homing, the homing switch must be configured in the axis configuration. The values for approach velocity, homing velocity, and reference position offset are taken from the axis configuration unchanged.

Depending on the selection, the relevant fields for entry of setpoints and the buttons for starting the command are displayed.

## "Axis status" area

If "Manual control" mode is activated, the current axis status and drive status are shown in the "Axis status" area. The current position and velocity of the axis are displayed at "Process values".

Click "Acknowledge" to acknowledge all cleared errors.

The "Info message" field displays advanced information about the status of the axis.

## Error message

The "Error message" field shows the current error. In "Manual control" mode, the error entry can be deleted by pressing the "Acknowledge" button once the error is eliminated.

---

### Note

#### Initial values for velocity, acceleration / deceleration and jerk

For safety reasons, the "Velocity", "Acceleration/deceleration" and "Jerk" parameters are initialized with values equivalent to only 10% of the configured values when the axis command table is activated. The "Jerk" parameter is only used for technology object "Axis" V2.0 and higher.

The values in the configuration view displayed when you select "Extended parameters > Dynamics > General" are used for initialization.

The "Velocity" parameter on the control panel is derived from the "Maximum velocity" and the "Acceleration/deceleration" parameters from "Acceleration" in the configuration.

The "Velocity", "Acceleration/deceleration" and "Jerk" parameters can be changed in the axis command table; this does not affect the values in the configuration.

---

## See also

Guidelines on use of motion control (Page 6017)

Working with watch tables (Page 6094)

## 11.2.9 Programming

### 11.2.9.1 Overview of the Motion Control statements

You control the axis with the user program using motion control instructions. The instructions start Motion Control jobs that execute the desired functions.

The status of the motion control jobs and any errors that occur during their execution can be obtained from the output parameters of the Motion Control instructions. The following Motion Control instructions are available:

- MC\_Power: Enable, disable axis (Page 2556)
- MC\_Reset: Acknowledge error (Page 2561)
- MC\_Home: Home axes, set home position (Page 2562)
- MC\_Halt: Halt axis (Page 2566)
- MC\_MoveAbsolute: Absolute positioning of axes (Page 2569)
- MC\_MoveRelative: Relative positioning of axes (Page 2572)

- MC\_MoveVelocity: Move axes at preset rotational speed (Page 2576)
- MC\_MoveJog: Move axes in jogging mode (Page 2580)
- MC\_CommandTable: Run axis jobs as movement sequence (as of technology object "Axis" V2.0) (Page 2584)
- MC\_ChangeDynamic: Changing the dynamic settings for the axis (as of technology object "Axis" V2.0) (Page 2586)

## See also

Creating a user program (Page 6073)

Programming notes (Page 6076)

Behavior of the Motion Control commands after POWER OFF and restart (Page 6078)

Monitoring active commands (Page 6078)

Error displays of the Motion Control statements (Page 6090)

### 11.2.9.2 Creating a user program

In the section below you learn how to create a user program with the basic configuration for controlling your axis. All available axis functions are controlled using the Motion Control instructions to be inserted.

## Requirement

- The technology object has been created and configured without errors.

Before creating and testing the user program, it is advisable to test the function of the axis and the corresponding parts of the system with the axis command table.

## Procedure

Proceed as follows to create the user program in accordance with the principles described below:

1. In the project tree, double-click your code block (the code block must be called in the cyclic program).  
The code block is opened in the programming editor and all available instructions are displayed.
2. Open the "Technology" category and the "Motion Control" and "S7-1200 Motion Control" folders.
3. Use a drag-and-drop operation to move the "MC\_Power" instruction to the desired network of the code block.  
The dialog box for defining the instance DB opens.

- In the next dialog box, select from the following alternatives:  
**Single instance**  
Click "Single instance" and select whether you want to define the name and number of the instance DB automatically or manually.  
**Multi-instance**  
Click "Multi-instance" and select whether you want to define the name of the multi-instance automatically or manually.
- Click "OK".  
The Motion Control instruction "MC\_Power" is inserted into the network.

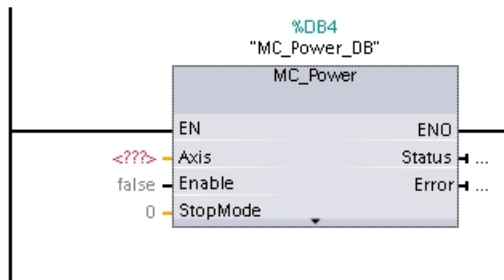

Parameters marked with "<???" must be initialized; all other parameters are assigned default values.

Parameters displayed in black are required for use of the Motion Control instruction.



6. Select technology object in the project tree and drag-and-drop it on <???.>

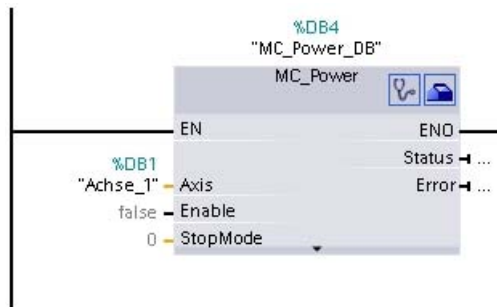

Following selection of the technology object data block, the following buttons are available:



Click the stethoscope icon if you want to open the diagnostics dialog for the technology object.



Click the toolbox icon if you want to open the configuration view of the technology object.

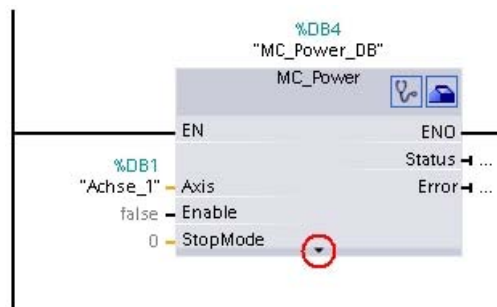

Click the arrow down icon to view additional parameters of the Motion Control instruction.

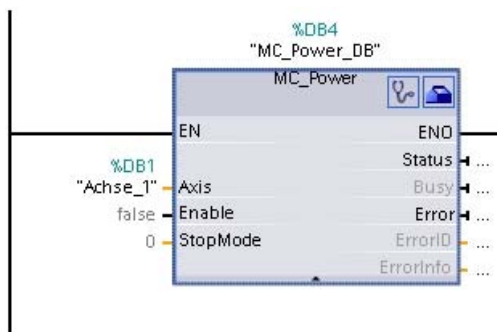

The grayed-out parameters now visible can be used optionally.

7. Add your choice of Motion Control instructions in accordance with steps 3 to 6.

## Result

You have created the basic configuration for axis control in the user program.

Initialize the input parameters of Motion Control instructions in other parts of the user program to initiate the desired jobs for the "Axis" technology object.

Evaluate the output parameters of the Motion Control instructions and the tags of the data block to track the initiated jobs and the status of the axis.

Refer to the detailed description for details on the parameters of Motion Control instructions.

### See also

Overview of the Motion Control statements (Page 6070)

Programming notes (Page 6076)

Behavior of the Motion Control commands after POWER OFF and restart (Page 6078)

Monitoring active commands (Page 6078)

Error displays of the Motion Control statements (Page 6090)

### 11.2.9.3 Programming notes

When creating your user program, note the following information:

- **Cyclic call of utilized motion control instructions**  
The current status of command execution is available via the output parameters of the motion control instruction. The status is updated with every call of the motion control instruction. Therefore, make sure that the utilized motion control instructions are called cyclically.
- **Transfer of parameter values of a motion control instruction**  
The parameter values pending for the input parameters are transferred with a positive edge at input parameter "Execute" when the block is called.  
The motion control command is started with these parameter values. Parameter values that are subsequently changed for the motion control instruction are not transferred until the next start of the motion control command.  
Exceptions to this are input parameters "StopMode" of motion control instruction "MC\_Power" and "Velocity" of motion control instruction "MC\_MoveJog". A change in the input parameter is also applied when "Enable" = TRUE, or "JogForward" and "JogBackward". .

- **Programming under consideration of the status information**

In a stepwise execution of motion control jobs, make sure to wait for the active command to finish before starting a new command. Use the status messages of the motion control instruction and the "StatusBits" tag of the technology object to check for completion of the active command.

In the examples below, observe the indicated sequence. Failure to observe the sequence will display an axis or command error.

  - **Axis enable with motion control instruction "MC\_Power"**

You must enable the axis before it can take on motion jobs. Use an AND operation of tag <Axis name>.StatusBits.Enable = TRUE with output parameter Status = TRUE of motion control instruction "MC\_Power" to verify that the axis is enabled.
  - **Acknowledge error with motion control instruction "MC\_Reset"**

Prior to starting a motion control command, errors requiring acknowledgement must be acknowledged with "MC\_Reset". Eliminate the cause of the error and acknowledge the error with motion control instruction "MC\_Reset". Verify that the error has been successfully acknowledged before initiating a new command. For this purpose, use an AND operation of tag <Axis name>.StatusBits.Error = FALSE with output parameter Done = TRUE of motion control instruction "MC\_Reset".
  - **Home axis with motion control instruction "MC\_Home"**

Before you can start an MC\_MoveAbsolute command, the axis must be homed. Use an AND operation of tag <Axis name>.StatusBits.HomingDone = TRUE with output parameter Done = TRUE of motion control instruction "MC\_Home" to verify that the axis has been homed.
- **Override of motion control command processing**

Motion control jobs for moving an axis can also be executed as overriding jobs. If a new motion control command is started for an axis while another motion control command is active, the active command is overridden by the new command before the existing command is completely executed. The overridden command signals this using CommandAborted = TRUE in the motion control instruction. It is possible to override an active MC\_MoveRelative command with a MC\_MoveAbsolute command.
- **Avoiding multiple use of the same instance**

All relevant information of a motion control command is stored in its instance. Do not start a new command using this instance, if you want to track the status of the current command. Use different instances if you want to track the commands separately. If the same instance is used for multiple motion control commands, the status and error information of the individual commands will overwrite each other.
- **Call of motion control instructions in different priority classes (run levels)**

Motion Control instructions with the same instance may not be called in different priority classes without interlocking. To learn how to call locked motion control instructions, refer to "Tracking commands from higher priority classes (run levels) (Page 6100)".

### See also

- Overview of the Motion Control statements (Page 6070)
- Creating a user program (Page 6071)
- Behavior of the Motion Control commands after POWER OFF and restart (Page 6078)
- Monitoring active commands (Page 6078)
- Error displays of the Motion Control statements (Page 6090)
- Tracking jobs from higher priority classes (execution levels) (Page 6100)

#### 11.2.9.4 Behavior of the Motion Control commands after POWER OFF and restart

A POWER OFF or CPU-STOP aborts all active motion control jobs. All CPU outputs, including pulse and direction outputs, are reset.

After a subsequent POWER ON or CPU restart (CPU RUN), the technology objects and the motion control jobs will be reinitialized.

All actual data of the technology objects as well as all status and error information of the previously active motion control jobs are reset to their initial values.

Before the axis can be reused, it must be enabled again using the Motion Control instruction "MC\_Power". If homing is required, the axis must be homed again with Motion Control instruction "MC\_Home".

### See also

- Overview of the Motion Control statements (Page 6070)
- Creating a user program (Page 6071)
- Programming notes (Page 6074)
- Monitoring active commands (Page 6078)
- Error displays of the Motion Control statements (Page 6090)

#### 11.2.9.5 Monitoring active commands

##### Monitoring active commands

There are three typical groups for tracking active motion control jobs:

- **Motion control instructions with output parameter "Done"**
- **Motion control instruction "MC\_MoveVelocity"**
- **Motion control instruction "MC\_MoveJog"**

## Motion control instructions with "Done" output parameter

Motion control instructions with the output parameter "Done" are started via input parameter "Execute" and have a defined conclusion (for example, with Motion Control instruction "MC\_Home": Homing was successful). The command is complete and the axis is at a standstill.

The commands of the following Motion Control instructions have a defined conclusion:

- MC\_Reset
- MC\_Home
- MC\_Halt
- MC\_MoveAbsolute
- MC\_MoveRelative
- MC\_CommandTable (as of technology object V2.0)
- MC\_ChangeDynamic (as of technology object V2.0)

The output parameter "Done" indicates the value TRUE, if the command has been successfully completed.

The output parameters "Busy", "CommandAborted", and "Error" signal that the command is still being processed, has been aborted or an error is pending. The Motion Control instruction "MC\_Reset" cannot be aborted and thus has no "CommandAborted" output parameter. The Motion Control instruction "MC\_ChangeDynamic" is completed immediately and therefore has no "Busy" or "CommandAborted" output parameters.

During processing of the motion control command, the output parameter "Busy" indicates the value TRUE. If the command has been completed, aborted, or stopped by an error, the output parameter "Busy" changes its value to FALSE. This change occurs regardless of the signal at input parameter "Execute".

Output parameters "Done", "CommandAborted", and "Error" indicate the value TRUE for at least one cycle. These status messages are latched while input parameter "Execute" is set to TRUE.

The behavior of the status bits is presented below for various example situations:

### Complete execution of command

If the motion control command has been completely executed by the time of its conclusion, this is indicated by the value TRUE in output parameter "Done". The signal status of input parameter "Execute" influences the display duration in the output parameter "Done":

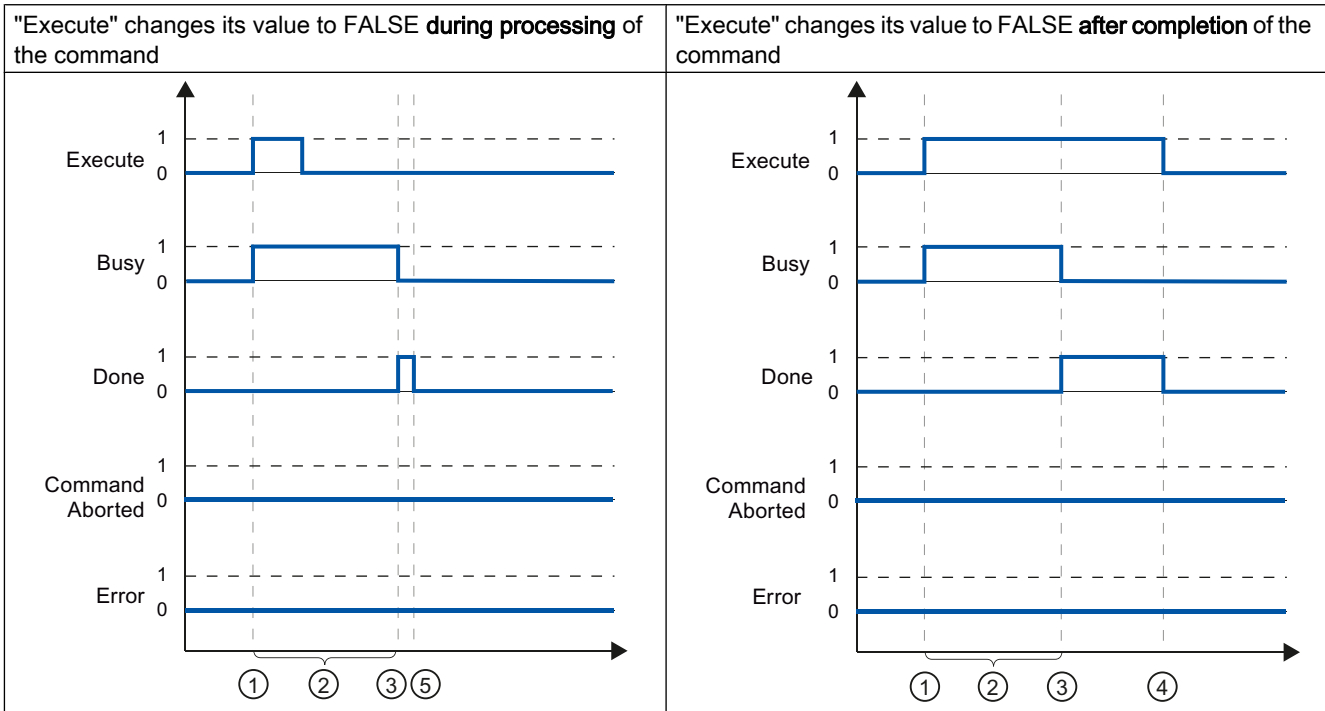

①	The command is started with a positive edge at the input parameter "Execute". Depending on the programming, "Execute" can still be reset to the value FALSE during the command, or the value TRUE can be retained until after completion of the command.
②	While the command is active, the output parameter "Busy" indicates the value TRUE.
③	With conclusion of the command (for example, for Motion Control instruction "MC_Home": Homing was successful), output parameter "Busy" changes to FALSE and "Done" to TRUE.
④	If "Execute" retains the value TRUE until after completion of the command, then "Done" also remains TRUE and changes its value to FALSE together with "Execute".
⑤	If "Execute" has been set to FALSE before the command is complete, "Done" indicates the value TRUE for only one execution cycle.

## Abort command

If the motion control command is aborted during execution, this is indicated by the value TRUE in output parameter "CommandAborted". The signal status of the input parameter "Execute" influences the display duration in the output parameter "CommandAborted":

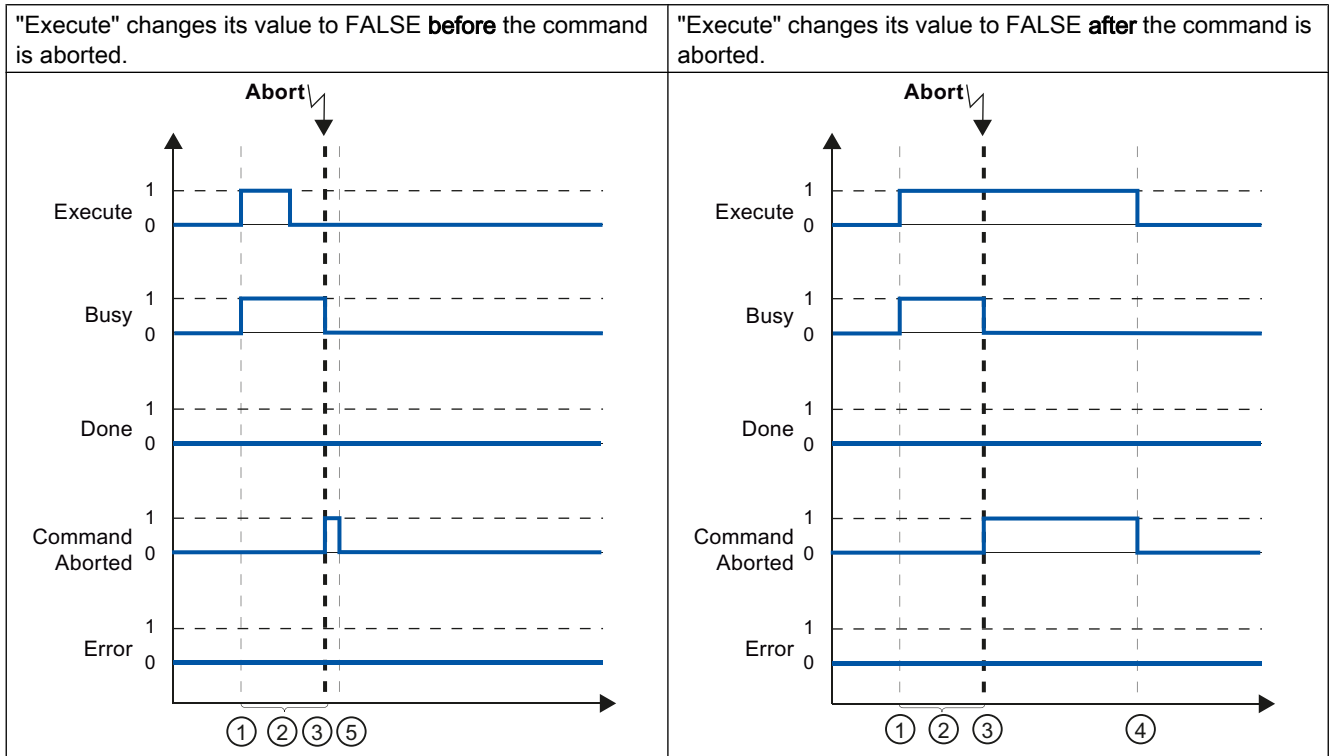

①	The command is started with a positive edge at the input parameter "Execute". Depending on the programming, "Execute" can still be reset to the value FALSE during the command, or the value TRUE can be retained until after completion of the command.
②	While the command is active, the output parameter "Busy" indicates the value TRUE.
③	During command execution, the command is aborted by another motion control command. If the command is aborted, output parameter "Busy" changes to FALSE and "CommandAborted" to TRUE.
④	If "Execute" retains the value TRUE until after the command is aborted, then "CommandAborted" also remains TRUE and changes its value to FALSE together with "Execute".
⑤	If "Execute" has been set to FALSE before the command is aborted, "CommandAborted" indicates the value TRUE for only one execution cycle.

### Error during command execution

If an error occurs during execution of the motion control command, this is indicated by the value TRUE in the output parameter "Error". The signal status of the input parameter "Execute" influences the display duration in the output parameter "Error":

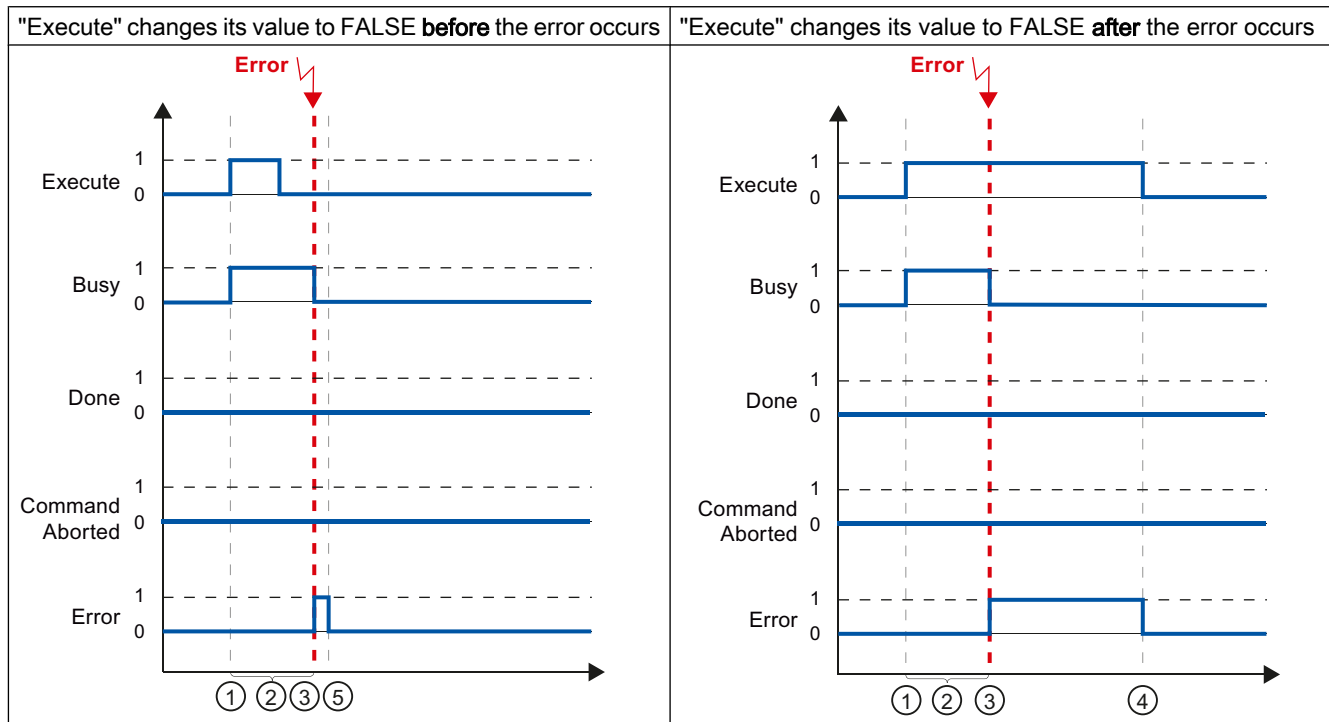

- |   |  |
|---|--|
| ① | The command is started with a positive edge at the input parameter "Execute". Depending on the programming, "Execute" can still be reset to the value FALSE during the command, or the value TRUE can be retained until after completion of the command. |
| ② | While the command is active, the output parameter "Busy" indicates the value TRUE.   |
| ③ | An error occurred during command execution. When the error occurs, the output parameter "Busy" changes to FALSE and "Error" to TRUE.   |
| ④ | If "Execute" retains the value TRUE until after the error occurs, then "Error" also remains TRUE and only changes its value to FALSE together with "Execute".  |
| ⑤ | If "Execute" has been set to FALSE before the error occurs, "Error" indicates the value TRUE for only one execution cycle.   |

### Motion control instruction MC\_MoveVelocity

The jobs of Motion Control instruction "MC\_MoveVelocity" do not have a defined end. The job objective is fulfilled when the parameterized velocity is reached for the first time and the axis travels at constant velocity. When the parameterized velocity is reached, this is indicated by the value TRUE in output parameter "InVelocity".

The job is complete when the parameterized velocity has been reached and input parameter "Execute" has been set to the value FALSE. However, the axis motion is not yet complete



upon completion of the job. For example, the axis motion can be stopped with motion control job "MC\_Halt".

The output parameters "Busy", "CommandAborted", and "Error" signal that the job is still being processed, has been aborted or an error is pending.

During execution of the motion control job, output parameter "Busy" indicates the value TRUE. If the job has been completed, aborted, or stopped by an error, the output parameter "Busy" changes its value to FALSE. This change occurs regardless of the signal at input parameter "Execute".

The output parameters "InVelocity", "CommandAborted", and "Error" indicate the value TRUE for at least one cycle, when their conditions are met. These status messages are latched while input parameter "Execute" is set to TRUE.

The behavior of the status bits is presented below for various example situations:

### The parameterized velocity is reached

If the motion control job has been executed by the time the parameterized velocity is reached, this is indicated by the value TRUE in output parameter "InVelocity".

The signal status of the input parameter "Execute" influences the display duration in the output parameter "InVelocity":

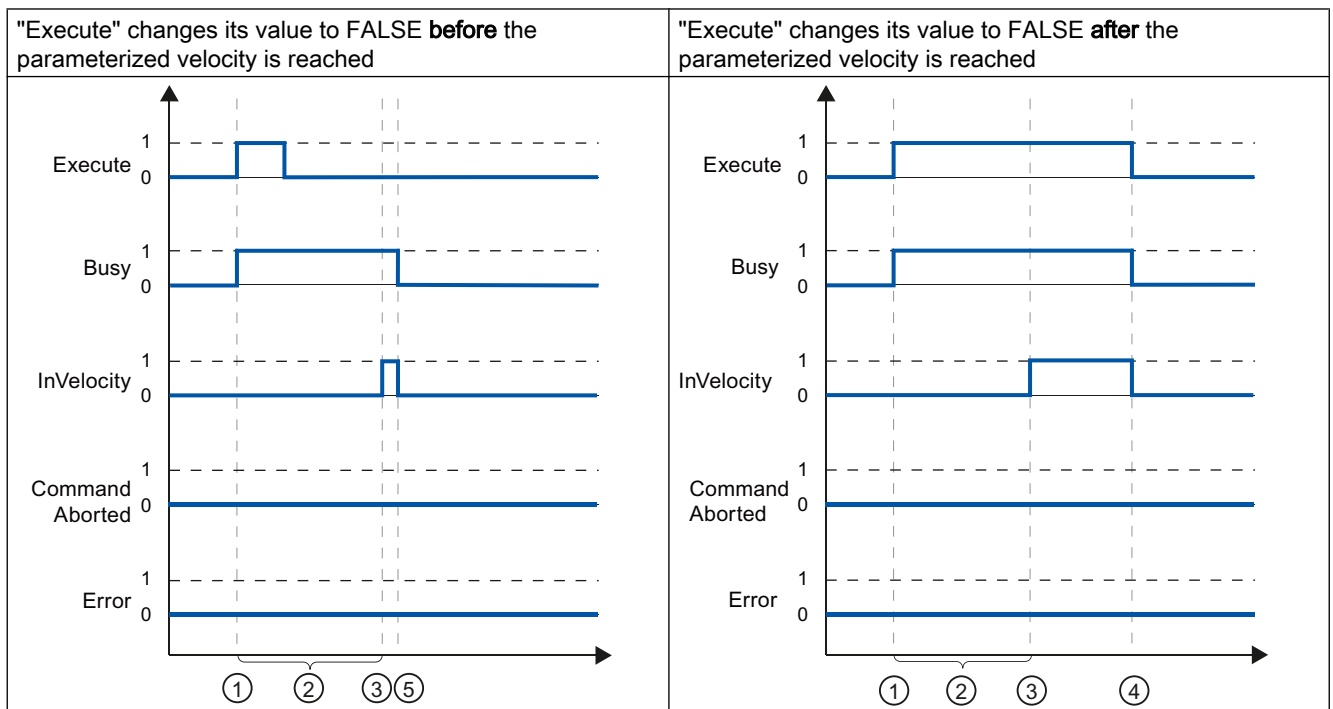

①	The job is started with a positive edge at the input parameter "Execute". Depending on the programming, "Execute" can be reset to the value FALSE event before the parameterized velocity is reached, or alternatively only after it has been reached.
②	While the job is active, the output parameter "Busy" indicates the value TRUE.
③	When the parameterized velocity is reached, the output parameter "InVelocity" changes to TRUE.
④	If "Execute" retains the value TRUE even after the parameterized velocity has been reached, the job remains active. "InVelocity" and "Busy" retain the value TRUE and only change their status to FALSE together with "Execute".
⑤	If "Execute" has been reset to FALSE before the parameterized velocity is reached, the job is complete when the parameterized velocity is reached. "InVelocity" indicates the value TRUE for one execution cycle and changes to FALSE together with "Busy".

**The job is aborted prior to reaching the parameterized velocity**

If the motion control job is aborted before the parameterized velocity is reached, this is indicated by the value TRUE in output parameter "CommandAborted". The signal status of input parameter "Execute" influences the display duration in output parameter "CommandAborted".

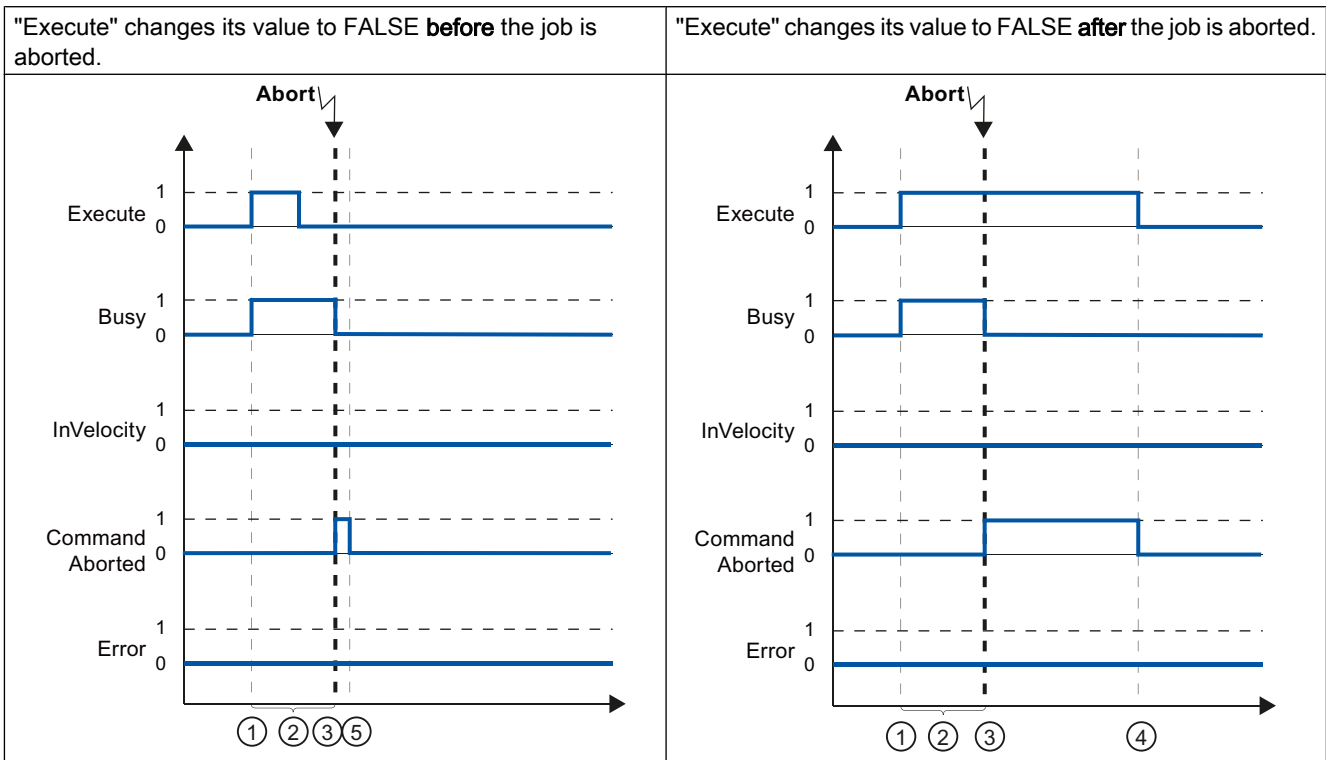

①	The job is started with a positive edge at the input parameter "Execute". Depending on the programming, "Execute" can still be reset to the value FALSE during the job, or the value TRUE can be retained until after the job is aborted.
②	While the job is active, the output parameter "Busy" indicates the value TRUE.
③	During job execution, the job is aborted by another motion control job. If the job is aborted, output parameter "Busy" changes to FALSE and "CommandAborted" to TRUE.

④	If "Execute" retains the value TRUE until after the job is aborted, then "CommandAborted" also remains TRUE and changes its status to FALSE together with "Execute".
⑤	If "Execute" has been reset to FALSE before the job is aborted, "CommandAborted" indicates the value TRUE for only one execution cycle.

**Note**

Under the following conditions, an abort is not indicated in output parameter "CommandAborted":

The parameterized velocity has been reached, input parameter "Execute" has the value FALSE, and a new motion control job is initiated.

When the parameterized velocity is reached and input parameter "Execute" has the value FALSE, the job is complete. Therefore, the start of a new job is not indicated as an abort.

**An error has occurred prior to reaching the parameterized velocity**

If an error occurs during execution of the motion control job before the parameterized velocity has been reached, this is indicated by the value TRUE in the output parameter "Error". The signal status of the input parameter "Execute" influences the display duration in the output parameter "Error":

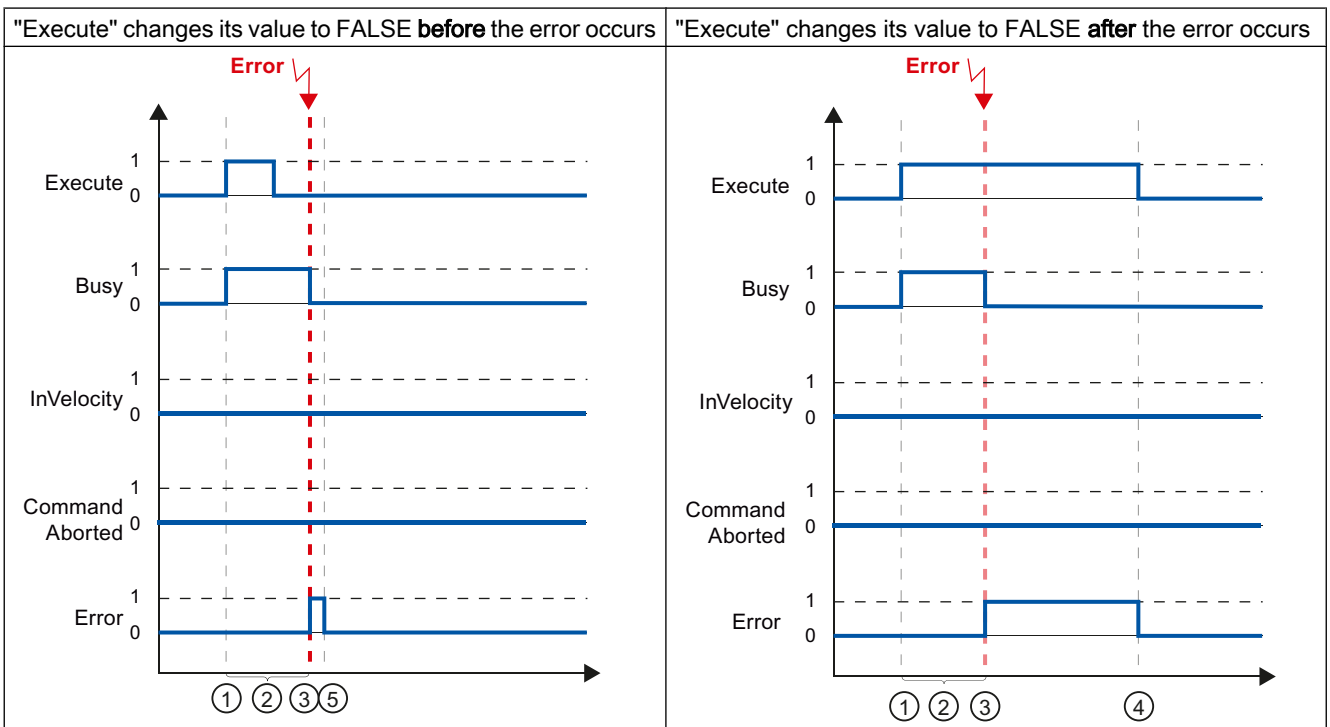

①	The job is started with a positive edge at the input parameter "Execute". Depending on the programming, "Execute" can still be reset to the value FALSE during the job, or the value TRUE can be retained until after the error has occurred.
②	While the job is active, the output parameter "Busy" indicates the value TRUE.
③	An error occurred during job execution. When the error occurs, the output parameter "Busy" changes to FALSE and "Error" to TRUE.
④	If "Execute" retains the value TRUE until after the error has occurred, then "Error" also remains TRUE and only changes its status to FALSE together with "Execute".
⑤	If "Execute" has been reset to FALSE before the error occurs, "Error" indicates the value TRUE for only one execution cycle.

**Note**

Under the following conditions, an error is not indicated in output parameter "Error":

The parameterized velocity has been reached, input parameter "Execute" has the value FALSE, and an axis error occurs (software limit switch is approached, for example).

When the parameterized velocity is reached and input parameter "Execute" has the value FALSE, the job is complete. After completion of the job, the axis error is only indicated in the Motion Control instruction "MC\_Power".

**Motion control instruction MC\_MoveJog**

The commands of Motion Control instruction "MC\_MoveJog" implement a jog operation.

The motion control commands "MC\_MoveJog" do not have a defined end. The command objective is fulfilled when the parameterized velocity is reached for the first time and the axis travels at constant velocity. When the parameterized velocity is reached, this is indicated by the value TRUE in output parameter "InVelocity".

The order is complete when input parameter "JogForward" or "JogBackward" has been set to the value FALSE and the axis has come to a standstill.

The output parameters "Busy", "CommandAborted", and "Error" signal that the command is still being processed, has been aborted or an error is pending.

During processing of the motion control command, the output parameter "Busy" indicates the value TRUE. If the command has been completed, aborted, or stopped by an error, the output parameter "Busy" changes its value to FALSE.

The output parameter "InVelocity" indicates the status TRUE, as long as the axis is moving at the parameterized velocity. The output parameters "CommandAborted" and "Error" indicate the status for at least one cycle. These status messages are latched as long as either input parameter "JogForward" or "JogBackward" is set to TRUE.

The behavior of the status bits is presented below for various example situations:

### The parameterized velocity is reached and maintained

If the motion control command has been executed by the time the parameterized velocity is reached, this is indicated by the value TRUE in output parameter "InVelocity".

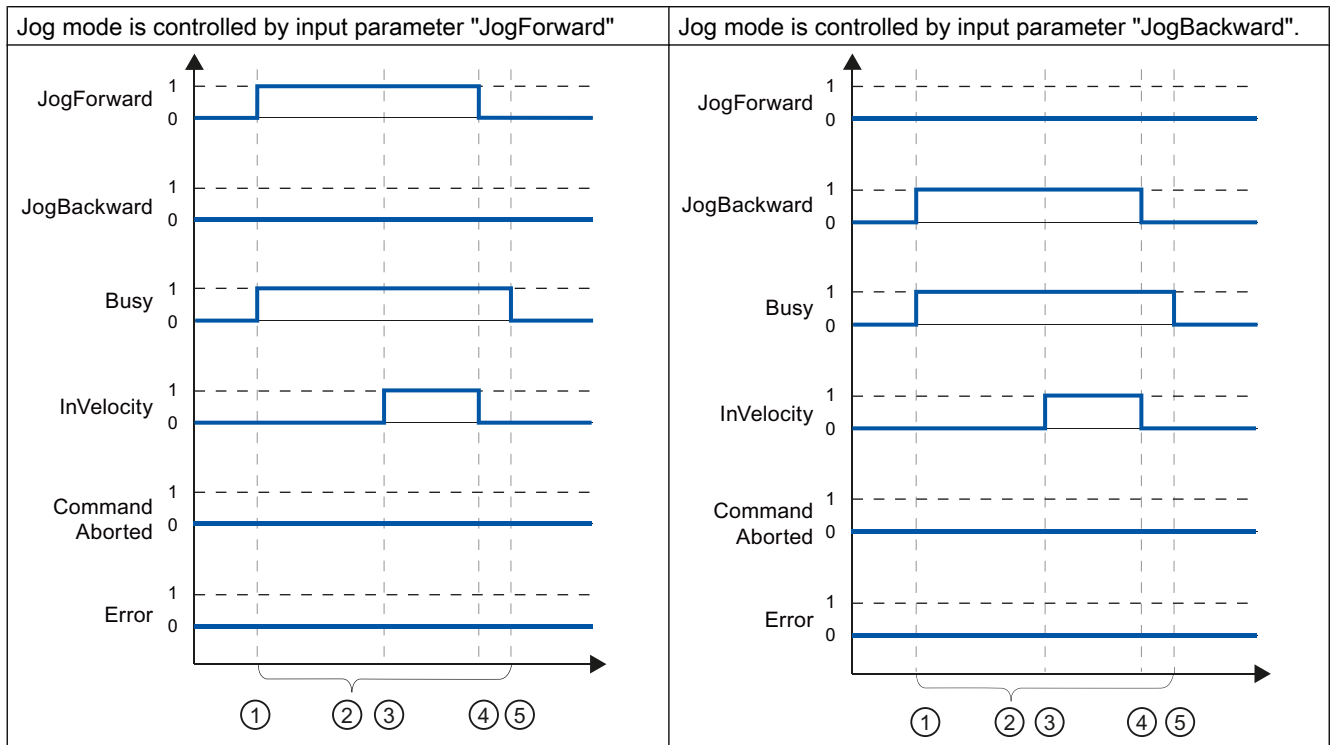

①	The command is started with a positive edge at the input parameter "JogForward" or "JogBackward".
②	While the command is active, the output parameter "Busy" indicates the value TRUE.
③	When the parameterized velocity is reached, the output parameter "InVelocity" changes to TRUE.
④	When the input parameter "JogForward" or "JogBackward" is reset to the value FALSE, the axis motion ends. The axis starts to decelerate. As a result, the axis no longer moves at constant velocity and the output parameter "InVelocity" changes its status to FALSE.
⑤	If the axis has come to a standstill, the motion control command is complete and the output parameter "Busy" changes its value to FALSE.

**The command is aborted during execution**

If the motion control command is aborted during execution, this is indicated by the value TRUE in output parameter "CommandAborted". The behavior is independent of whether or not the parameterized velocity has been reached.

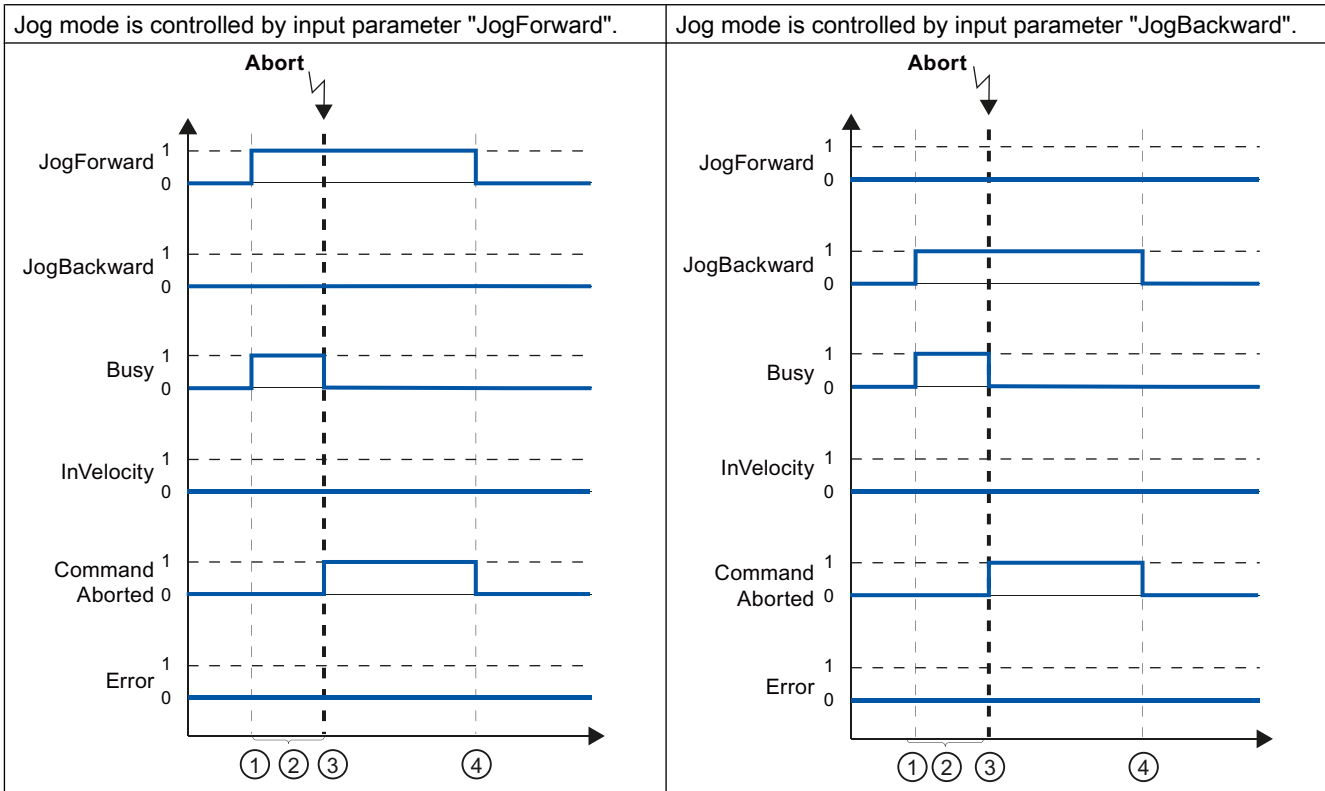

①	The command is started with a positive edge at the input parameter "JogForward" or "JogBackward".
②	While the command is active, the output parameter "Busy" indicates the value TRUE.
③	During command execution, the command is aborted by another motion control command. If the command is aborted, output parameter "Busy" changes to FALSE and "CommandAborted" to TRUE.
④	When the input parameter "JogForward" or "JogBackward" is reset to the value FALSE, the output parameter "CommandAborted" changes its value to FALSE.

**Note**

The command abort is indicated in the output parameter "CommandAborted" for only one execution cycle, if all conditions below are met:

The input parameters "JogForward" and "JogBackward" have the value FALSE (but the axis is still decelerating) and a new motion control command is initiated.

### An error has occurred during command execution

If an error occurs during execution of the motion control command, this is indicated by the value TRUE in output parameter "Error". The behavior is independent of whether or not the parameterized velocity has been reached.

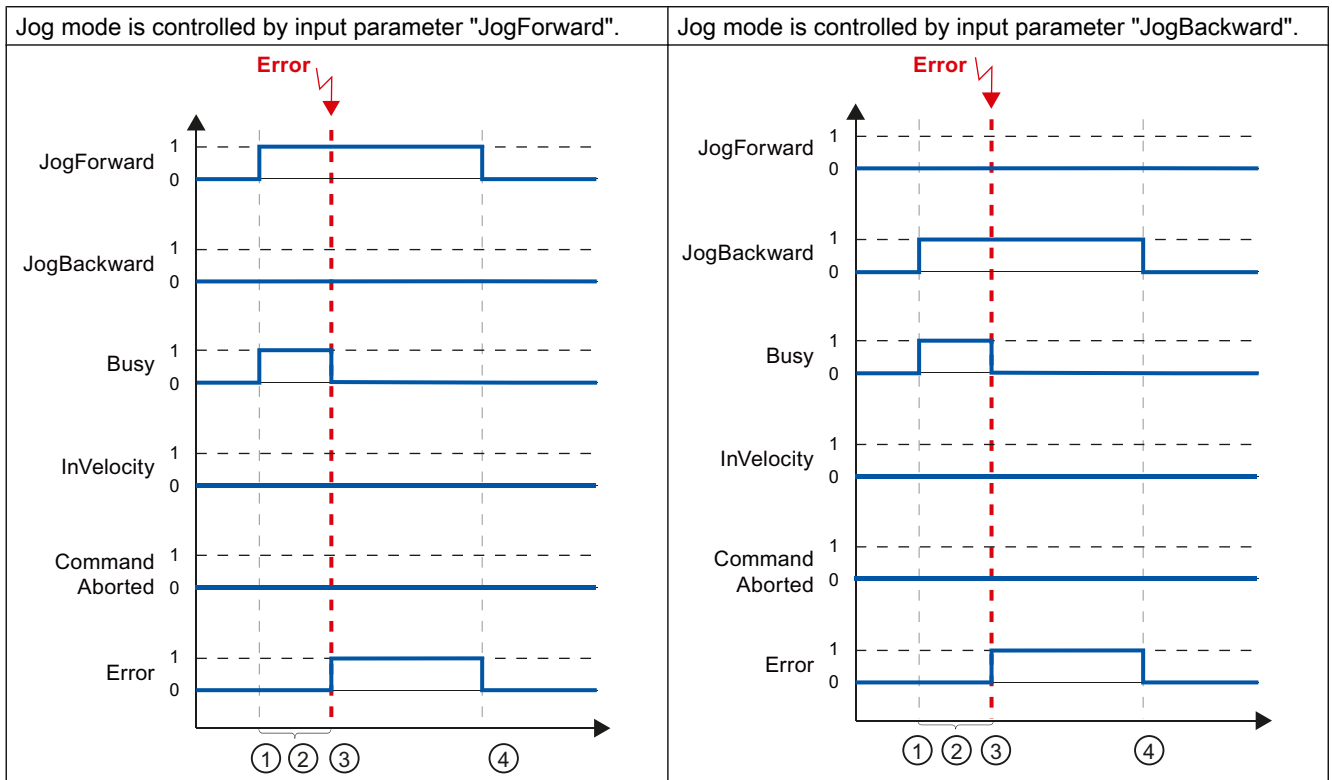

①	The command is started with a positive edge at the input parameter "JogForward" or "JogBackward".
②	While the command is active, the output parameter "Busy" indicates the value TRUE.
③	An error occurred during command execution. When the error occurs, the output parameter "Busy" changes to FALSE and "Error" to TRUE.
④	When the input parameter "JogForward" or "JogBackward" is reset to the value FALSE, the output parameter "Error" changes its value to FALSE.

#### Note

An error occurrence is indicated in the output parameter "Error" for only one execution cycle, if all the conditions below are met:

The input parameters "JogForward" and "JogBackward" have the value FALSE (but the axis is still decelerating) and a new error occurs (software limit switch is approached, for example).

### 11.2.9.6 Error displays of the Motion Control statements

The Motion Control instructions indicate any errors in motion control commands and the technology object at the output parameters "Error", "ErrorID" and "ErrorInfo" of the Motion Control instructions.

#### Error display at output parameters "Error", "ErrorID" and "ErrorInfo"

If the output parameter "Error" indicates the value TRUE, the complete command, or portions thereof, could not be executed. The cause of the error is indicated by the value in output parameter "ErrorID". Detailed information about the cause of the error is returned by the value in output parameter ErrorInfo. We distinguish between the following error classes for error indication:

- **Operating error with axis stop (for example, "HW limit switch was approached")**  
Operating errors with axis stop are errors that occur during runtime of the user program. If the axis is in motion, it is stopped with the configured deceleration or emergency stop deceleration, depending on the error. The errors are indicated in the error-triggering Motion Control instruction and in the Motion Control instruction "MC\_Power".
- **Operating error without axis stop (for example, "Axis is not homed")**  
Operating errors without axis stop are errors that occur during runtime of the user program. If the axis is in motion, the motion is continued. The errors are only indicated in the Motion Control instruction which triggers the error.
- **Parameterization error of Motion Control instruction " (for example, "Incorrect value in parameter "Velocity"")**  
Parameterization errors occur when incorrect information is specified in the input parameters of Motion Control instructions. If the axis is in motion, the motion is continued. The errors are only indicated in the Motion Control instruction which triggers the error.
- **Configuration error on technology object "Axis" (for example, "Value for "Acceleration" is invalid")**  
A configuration error exists if one or more parameters are incorrectly configured in the axis configuration or if editable configuration data have been modified incorrectly during runtime of the program. An axis in motion is stopped with the configured emergency stop deceleration. The error is indicated in the error-triggering Motion Control instruction and in Motion Control instruction "MC\_Power".
- **Configuration error on technology object "Command table" (for example "Value for "Velocity" is invalid")**  
There is a configuration error if one or more parameters are incorrectly set in the axis command table or if programmable configuration data have been modified incorrectly during runtime of the program. If the axis is in motion, the motion is continued. The errors are only indicated in the "MC\_CommandTable" Motion Control instruction.
- **Internal error**  
When an internal error occurs, the axis is stopped. The errors are indicated in the error-triggering Motion Control instruction and, in some cases, in the Motion Control instruction "MC\_Power".

A detailed description of the ErrorIDs and ErrorInfos, as well as their remedies, is available in the Appendix.



**See also**

Overview of the Motion Control statements (Page 6070)

Creating a user program (Page 6071)

Programming notes (Page 6074)

Behavior of the Motion Control commands after POWER OFF and restart (Page 6076)

Monitoring active commands (Page 6076)

**11.2.10 Axis - Diagnostics****11.2.10.1 Status and error bits**

You use the "Status and error bits" diagnostic function to monitor the most important status and error messages for the axis in the TIA Portal. The diagnostic function display is available in online mode in "Manual control" mode and in "Automatic control" when the axis is active. The status error messages have the following meaning:

**Status of the axis**

Status	Description
Enabled	The axis is enabled and ready to be controlled via motion control commands. (Tag of technology object: <Axis name>.StatusBits.Enable)
Homed	The axis is homed and is capable of executing absolute positioning commands of Motion Control instruction "MC_MoveAbsolute". The axis does not have to be homed for relative homing. Special situations: <ul style="list-style-type: none"> <li>• During active homing, the status is FALSE.</li> <li>• If a homed axis undergoes passive homing, the status is set to TRUE during passive homing.</li> </ul> (Tag of technology object: <Axis name>.StatusBits.HomingDone)
Axis error	An error has occurred in the "Axis" technology object. More information about the error is available in automatic control at the ErrorID and ErrorInfo parameters of the Motion Control instructions. In manual mode, the "Error message" field of the axis command table displays detailed information about the cause of error. (Tag of technology object: <Axis name>.StatusBits.Error)
Axis command table enabled	The "Manual control" mode was enabled in the axis command table. The axis command table has control priority over the "Axis" technology object. The axis cannot be controlled from the user program. (Tag of technology object: <Axis name>.StatusBits.ControlPanelActive)
Restart necessary	A modified configuration of the axis was downloaded to the load memory in CPU RUN operating mode. To download the modified configuration to the work memory, you need to restart the axis. Use the Motion Control instruction MC_Reset to do this.

### Drive status

Status	Description
Drive ready	The drive is ready for operation. (Tag of technology object: <Axis name>.StatusBits.DriveReady)
Drive error	The drive has reported an error after failure of its "Drive ready" signal. (Tag of technology object: <Axis name>.ErrorBits.DriveFault)

### Status of the axis motion

Status	Description
Standstill	The axis is at a standstill. (Tag of technology object: <Axis name>.StatusBits.StandStill)
Accelerating	The axis accelerates. (Tag of technology object: <Axis name>.StatusBits.Acceleration)
Constant velocity	The axis travels at constant velocity. (Tag of technology object: <Axis name>.StatusBits.ConstantVelocity)
Decelerating	The axis decelerates (slows down). (Tag of technology object: <Axis name>.StatusBits.Deceleration)

### Status of the motion mode

Status	Description
Positioning	The axis executes a positioning command of the Motion Control instruction "MC_MoveAbsolute" or "MC_MoveRelative" or of the axis command table. (Tag of technology object: <Axis name>.StatusBits.PositioningCommand)
Travel with velocity specification	The axis executes a command with the velocity specification of the Motion Control instruction "MC_MoveVelocity" or "MC_MoveJog" or of the axis command table. (Tag of technology object: <Axis name>.StatusBits.SpeedCommand)
Homing	The axis executes a homing command of the Motion Control instruction "MC_Home" or the axis command table. (Tag of technology object: <Axis name>.StatusBits.Homing)
Command table active (as of technology object Axis V2.0)	The axis is controlled by Motion Control instruction "MC_CommandTable". (Tag of technology object: <Axis name>.StatusBits.CommandTableActive)

## Error messages

Error	Description
Low software limit switch has been reached	The low software limit switch has been reached. (Tag of technology object: <Axis name>.ErrorBits.SwLimitMinReached)
Low software limit switch has been exceeded	The low software limit switch has been exceeded. (Tag of technology object: <Axis name>.ErrorBits.SwLimitMinExceeded)
High software limit switch has been reached	The high software limit switch has been reached. (Tag of technology object: <Axis name>.ErrorBits.SwLimitMaxReached)
High software limit switch has been exceeded	The high software limit switch has been exceeded. (Tag of technology object: <Axis name>.ErrorBits.SwLimitMaxExceeded)
Low hardware limit switch was approached	The low hardware limit switch has been approached. (Tag of technology object: <Axis name>.ErrorBits.HwLimitMin)
High hardware limit switch was approached	The high hardware limit switch has been approached. (Tag of technology object: <Axis name>.ErrorBits.HwLimitMax)
PTO and HSC already in use	A second axis is using the same PTO (Pulse Train Output) and HSC (High Speed Counter) and is enabled with "MC_Power". (Tag of technology object: <Axis name>.ErrorBits.HwUsed)
Configuration error	The "Axis" technology object was incorrectly configured or editable configuration data were modified incorrectly during runtime of the user program. (Tag of technology object: <Axis name>.ErrorBits.ConfigFault)
Internal error	An internal error has occurred. (Tag of technology object: <Axis name>.ErrorBits.SystemFault)

## See also

Motion status (Page 6093)

StatusBits. tag (Page 6128)

ErrorBits. tag (Page 6130)

### 11.2.10.2 Motion status

Use the "Motion status" diagnostic function to monitor the motion status of the axis in the TIA Portal. The diagnostic function display is available in online mode in "Manual control" mode and in "Automatic control" when the axis is active. The displayed status information has the following meaning:

Status	Description
Position	The "Position" field indicates the current axis position. If the axis is not homed, the value indicates the position value relative to the enable position of the axis. (Tag of technology object: <Axis name>.MotionStatus.Position)
Velocity	The "Velocity" field indicates the current axis velocity. (Tag of technology object: <Axis name>.MotionStatus.Velocity)

Status	Description
Target position	The "Target position" field indicates the current target position of an active positioning job or of the axis command table. The value of the "Target position" is only valid during execution of a positioning job. (Tag of technology object: <Axis name>.MotionStatus.TargetPosition)
Remaining traversing distance	The "Remaining traversing distance" field indicates the traversing distance currently remaining for an active positioning job or the axis command table. The "Remaining traversing distance" value is only valid during execution of a positioning job. (Tag of technology object: <Axis name>.MotionStatus.Distance)

**See also**

Status and error bits (Page 6089)

MotionStatus. tag (Page 6127)

**11.2.10.3 Dynamics settings**

Use the "Dynamics settings" diagnostic function to monitor the dynamic limit values of the axis in the TIA Portal. The diagnostic function display is available in online mode in "Manual control" mode and in "Automatic control" when the axis is active. The status information displayed has the following meaning:

Dynamic limit	Description
Acceleration	The "Acceleration" field indicates the currently configured acceleration of the axis. (Technology object variable: <Axis name>.Config.DynamicDefaults.Acceleration)
Deceleration	The "Deceleration" field indicates the currently configured deceleration of the axis. (Technology object variable: <Axis name>.Config.DynamicDefaults.Deceleration)
Emergency stop deceleration	The "Emergency stop deceleration" field indicates the currently configured emergency stop deceleration of the axis. (Technology object variable: <Axis name>.Config.DynamicDefaults.EmergencyDeceleration)
Step (as of technology object Axis V2.0)	The "Velocity" field indicates the current axis step velocity configured. (Technology object variable: <Axis name>.Config.DynamicDefaults.Jerk)

**11.2.11 Working with watch tables**

Use watch tables if you want to monitor and modify tags of motion control instructions or the "Axis" technology object during commissioning.

To monitor and modify tags, you must specify the complete name of the tag, including object name and all structure names in a watch table.

Example: <Axis name>.Config.DynamicDefaults.Acceleration)

**Tip:**

You can use a copy & paste operation to avoid entering long tag names.

## Procedure

To insert the tag names, follow the steps described below:

1. In the project tree, select the instance data block or the technology object of the axis.

2. **Parameters of the motion control instruction**

- Right-click and select the **Open** command in the shortcut menu.

**Tags of the technology object**

- Right-click and select the **Open in editor** command in the shortcut menu.

3. **Parameters of the motion control instruction**

- Select the lines of the tags in the Input or Output area

**Tags of the technology object**

- In the Static area, open the relevant structures and select the lines of the tags

4. Select the **Edit > Copy** menu command.

5. Double-click to open the watch table.

6. Select the line starting at which the tags are to be inserted

7. Select the **Edit > Paste** menu command.

Insert the tags with their complete names in the watch table.



**WARNING**

The watch table also gives you write access to tags whose use is blocked for safety reasons in the user program. Modifying these tags can result in damage to the current axis configuration and to undefined responses of the axis. Only modify those tags whose access is marked with "RW" in the tag list of the technology object.

## See also

Commissioning the axis - Axis control panel (Page 6067)

## 11.2.12 Appendix

### 11.2.12.1 Using multiple axes with the same PTO

Use the motion control functionality of the CPU S7-1200 to run multiple "Axis" technology objects with the same PTO (Pulse Train Output) and thus with the same CPU outputs. This is appropriate, for example, if different axis configurations are to be used for different production sequences via one PTO. As described below, it is possible to switch between these axis

configurations as often as necessary. The following diagram presents the basic functional relationships:

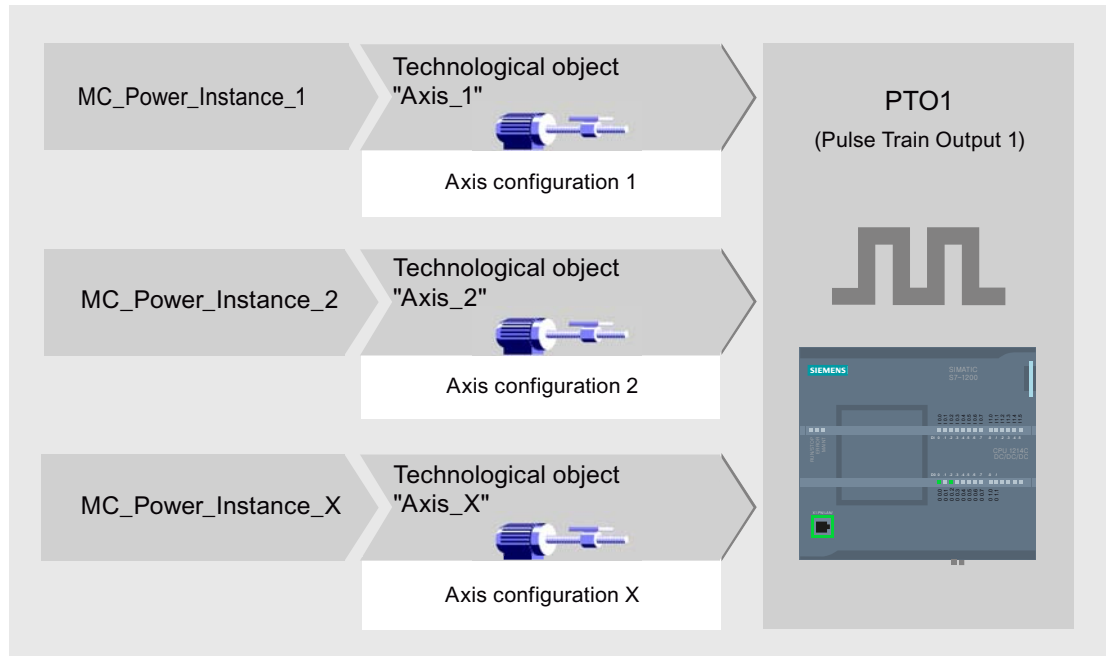

In this example, more than one "Axis" technology object, each with its own axis configuration, uses the same PTO. Each "Axis" must be called in the user program with a separate call of Motion Control instruction "MC\_Power" with a separate instance data block. Only one "Axis" at a time may use the PTO. The axis that is currently using the PTO indicates this with tag <Axis name>.StatusBits.Activated = TRUE.

### Switching between "Axis" technology objects

The program scheme described below shows you how to switch between different technology objects and, thus, between different axis configurations. To use the same PTO with multiple axes without error indications, only the Motion Control instructions of the axis currently being used may be called.

The following diagram presents this principle using Motion Control instruction "MC\_Power" as an example:

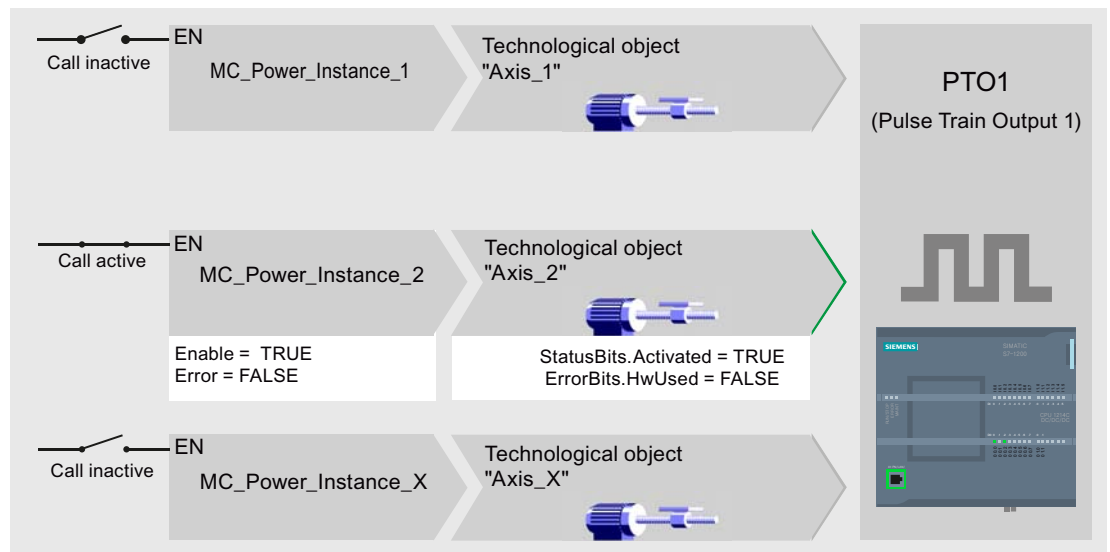

The tags of the activated axis ("Axis\_2" here) show the following typical indicators in the user program:

- <Axis name>.StatusBits.Activated = TRUE
- <Axis name>.ErrorBits.HwUsed = FALSE

To switch to the "Axis" technology object, follow the steps described below. In the example, a switch is made from "Axis\_2" to "Axis\_1":

1. End any active traversing motions of activated "Axis\_2"
2. Disable "Axis\_2" with the associated Motion Control instruction "MC\_Power" using input parameter Enable = FALSE
3. To verify that "Axis\_2" has been disabled, use an AND operation of output parameter Status = FALSE of Motion Control instruction "MC\_Power" and technology object tag <Axis name>.StatusBits.Enable = FALSE.
4. Deactivate the conditional call of the Motion Control instructions for "Axis\_2".
5. Activate the conditional call of the Motion Control instructions for "Axis\_1". On the first call of the corresponding Motion Control instruction "MC\_Power", "Axis\_2" becomes deactivated and "Axis\_1" becomes activated.
6. Enable "Axis\_1" with Motion Control instruction "MC\_Power" using the input parameter Enable = TRUE
7. To verify that "Axis\_1" has been enabled, use an AND operation of output parameter Status = TRUE of Motion Control instruction "MC\_Power" and technology object tag <Axis name>.StatusBits.Enable = TRUE.

It is also always possible to cyclically call all Motion Control instructions of all axes working with a single PTO.

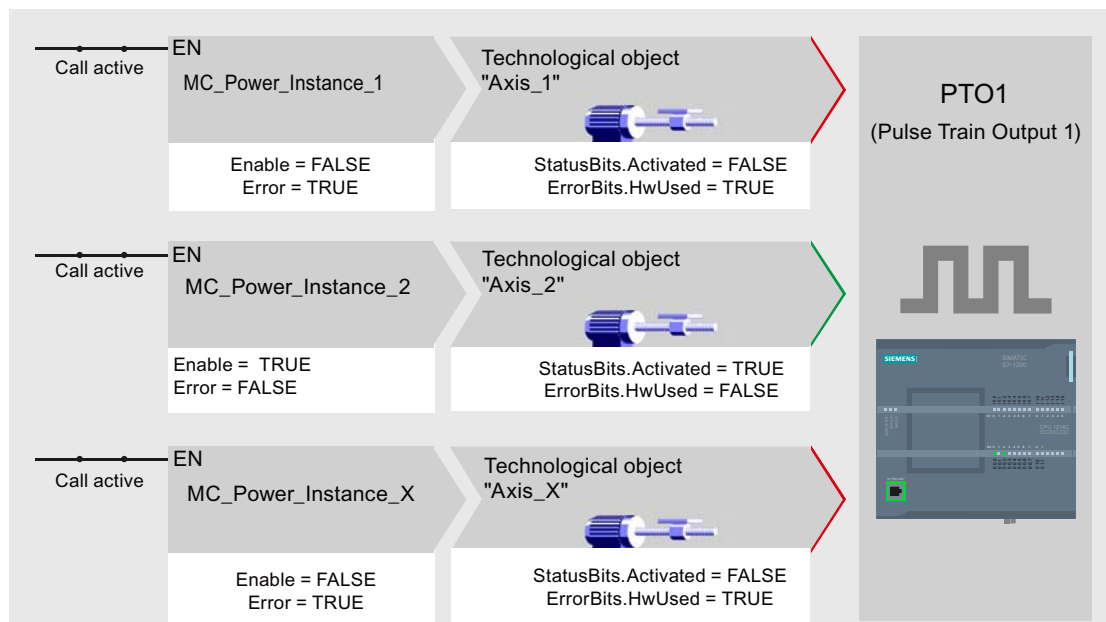

When an axis is enabled (here "Axis\_2"), this axis becomes active.

In contrast to the conditional call, the Motion Control instructions of the deactivated axes (here "Axis\_1" and "Axis\_x") will indicate errors. The tags of these axes indicate the status `<Axis name>.StatusBits.Activated = FALSE` and `<Axis name>.ErrorBits.HwUsed = TRUE`.

Use the conditional call of the Motion Control instructions if you want to implement the user program without error indicators.

## See also

Using multiple drives with the same PTO (Page 6099)

Tracking jobs from higher priority classes (execution levels) (Page 6100)

Special cases for use of software limit switches (Page 6102)

List of ErrorIDs and ErrorInfos (technology objects as of V2.0) (Page 6109)

Tag of the Axis technology object (Page 6118)



### 11.2.12.2 Using multiple drives with the same PTO

If multiple drives are to be used, they can be run with a common PTO (Pulse Train Output) using changeover. The following diagram represents the basic circuit design:

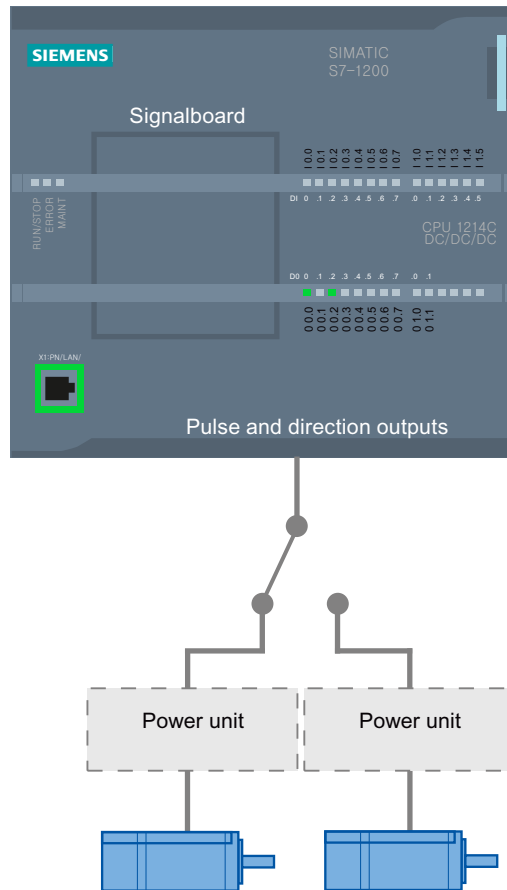

The changeover between drives can be controlled, if required, by the user program via a digital output. If different axis configurations are required for the different drives, a changeover between these configurations is required for the PTO. For additional information on this topic, refer to "Using multiple axes with the same PTO (Page 6093)".

#### See also

Using multiple axes with the same PTO (Page 6093)

Tracking jobs from higher priority classes (execution levels) (Page 6100)

Special cases for use of software limit switches (Page 6102)

List of ErrorIDs and ErrorInfos (technology objects as of V2.0) (Page 6109)

Tag of the Axis technology object (Page 6118)

### **11.2.12.3 Tracking jobs from higher priority classes (execution levels)**

Depending on the application, it may be necessary to start motion control jobs (for example, interrupt-controlled) in a higher priority class (execution level).

The Motion Control instructions must be called at short intervals for status monitoring. Motion Control commands cannot be sufficiently closely monitored if the higher priority Motion Control commands are called only once or at too great an interval. Tracking in such cases can be carried out in the cycle OB. An instance data block that is not currently being utilized must be available for each start of a higher priority motion control command. Refer to the following flow chart to see how you start motion control jobs in a higher priority class (for example, hardware interrupt OB) and continue tracking in the program cycle OB:

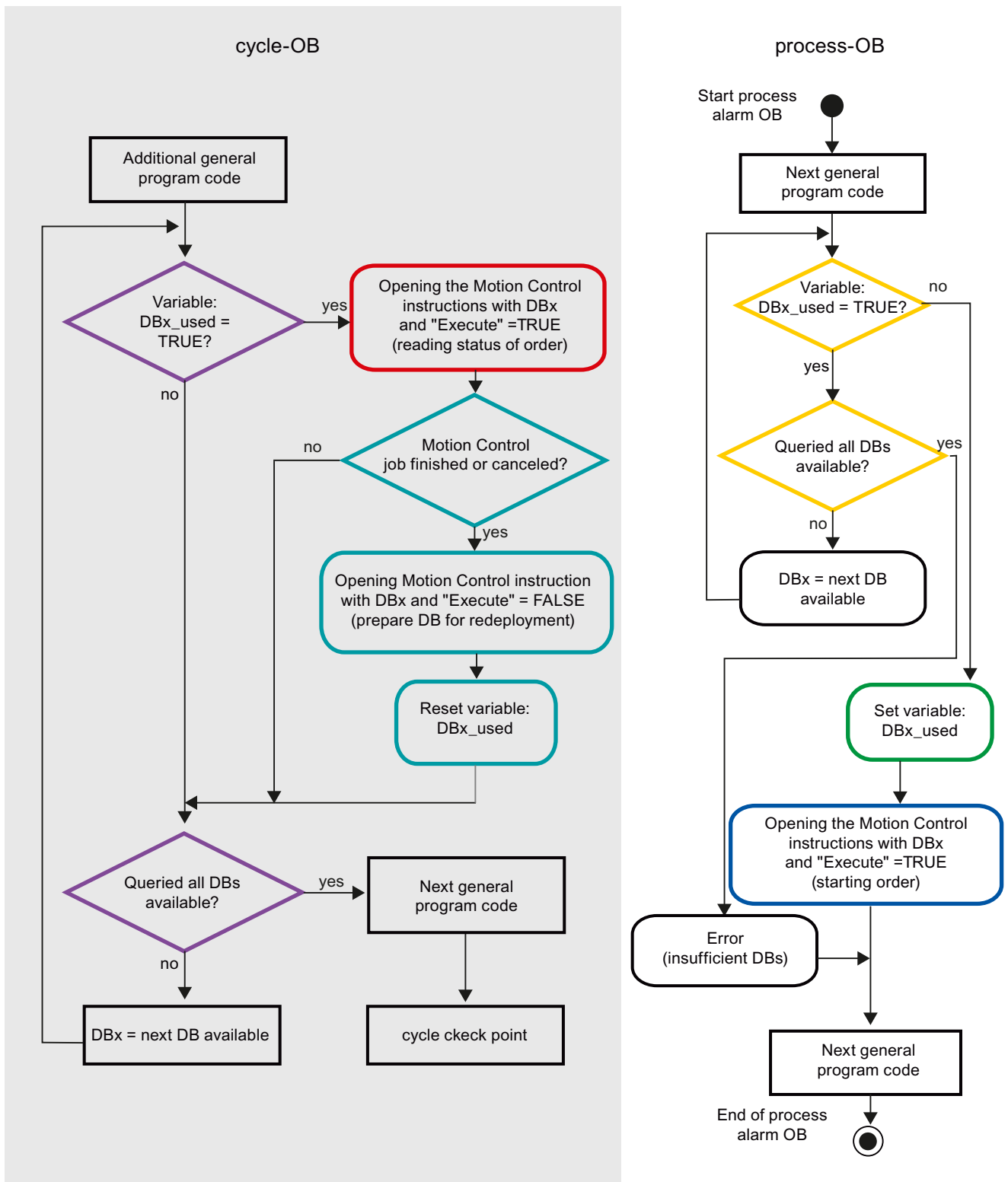

Depending on the frequency of the motion control jobs you want to start, you will have to generate a sufficient number of instance data blocks. Users determine which instance data block is currently used in the DBx\_used tags.

### Start of motion control job in the hardware interrupt OB

Binary queries of the DBx\_used tags (orange) are used to find an instance data block not currently in use. If such an instance data block is found, the utilized instance data block is marked as "used" (green) and the Motion Control job is started with this instance data block.

Any other program sections of the hardware interrupt OB are then executed, followed by a return to the program cycle OB.

### Tracking of started motion control jobs in the program cycle OB

All instance data blocks available in the cycle OB are checked to determine if they are currently in use by means of the DBx\_used tag (violet).

If an instance data block is in use (motion control job is being processed), the motion control instruction with this instance data block and input parameter Execute = TRUE is called to read out the status messages (red).

If the job is complete or has been aborted, the following actions are taken next (blue green):

- Call of motion control instruction with input parameter Execute = FALSE
- Resetting the DBx\_used tag

This completes the job tracking, and the instance data block is now available for use again.

### See also

Using multiple axes with the same PTO (Page 6093)

Using multiple drives with the same PTO (Page 6097)

Special cases for use of software limit switches (Page 6102)

List of ErrorIDs and ErrorInfos (technology objects as of V2.0) (Page 6109)

Tag of the Axis technology object (Page 6118)

#### 11.2.12.4 Special cases for use of software limit switches

### Software limit switches in conjunction with a homing operation

Due to unfavorably parameterized homing jobs, the braking action of the axis may be influenced at the software limit switch. Take the following examples into consideration when developing your program.

**Example 1:**

During a travel command, a homing job (for example, Set reference point) offsets the current axis position in the direction of the software limit switch. It is still possible to bring the axis to a standstill before reaching the software limit switch:

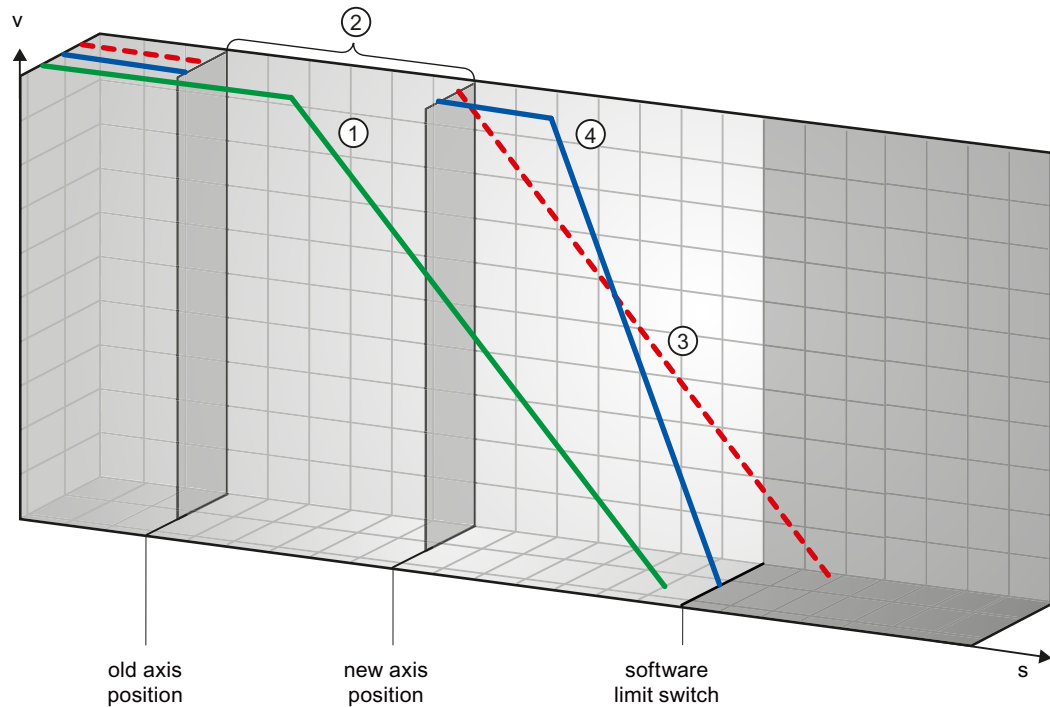

①	The green curve shows the motion <b>without</b> the homing job. The axis brakes at the configured deceleration and comes to a standstill at a position before the software limit switch.
②	A new axis position is set as a result of the homing job. The area between the old and new axis position is thus "skipped".
③	Based on the new axis position, the axis would theoretically be stopped with the configured deceleration at a position after the software limit switch (red curve).
④	Because braking with the configured deceleration is no longer sufficient, the axis actually follows the blue curve. Following a constant motion, the axis brakes at the emergency stop deceleration and comes to a standstill at the position of the software limit switch.

**Example 2:**

During a travel command, a homing job (for example, Set reference point) offsets the current axis position in the direction of the software limit switch. In contrast to example 1, it is no longer

possible to bring the axis to a standstill before reaching the software limit switch. The axis overruns the position of the software limit switch.

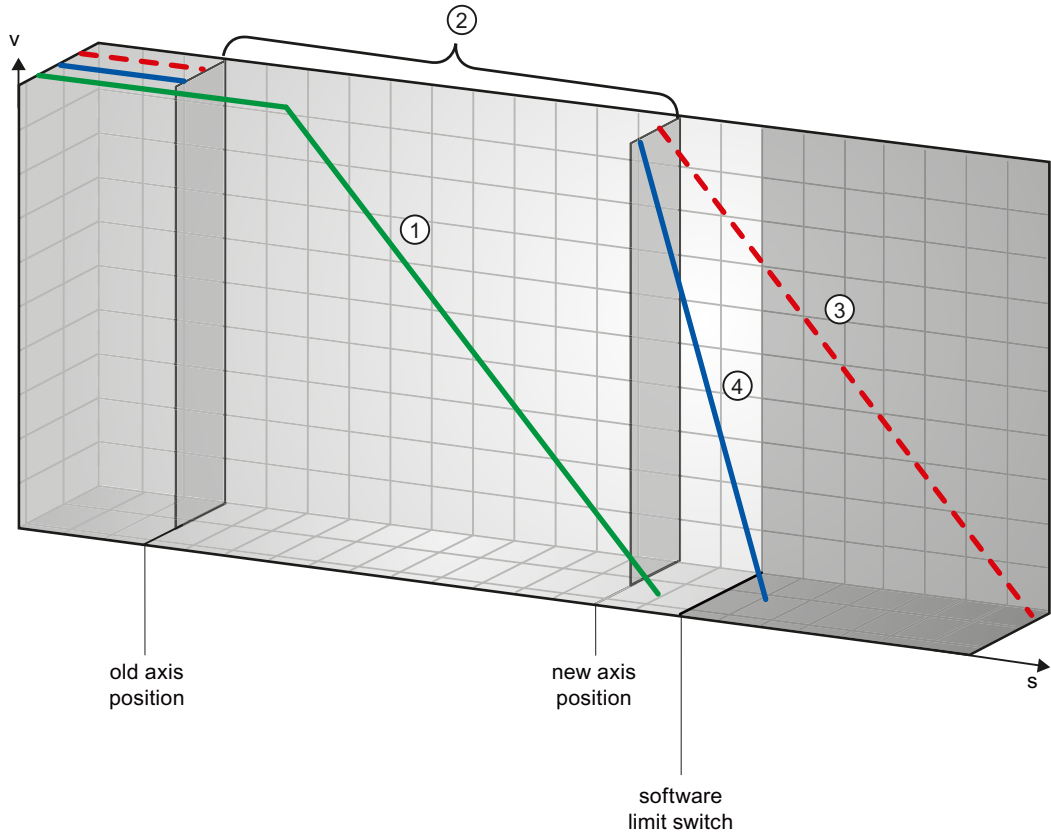

①	The green curve shows the motion <b>without</b> the homing job. The axis brakes at the configured deceleration and comes to a standstill at a position before the software limit switch.
②	A new axis position is set as a result of the homing job. The area between the old and new axis position is thus "skipped".
③	Based on the new axis position, the axis would theoretically be stopped with the configured deceleration at a position well after the software limit switch (red curve).
④	Because braking with the configured deceleration is no longer sufficient, the axis actually follows the blue curve. The axis brakes at the emergency stop deceleration. However, the emergency stop deceleration is not sufficient to stop the axis at the position of the software limit switch. The position of the software limit switch is overrun.

**Example 3:**

During a braking operation, a homing job (for example, Set reference point) offsets the current axis position in the direction of the software limit switch. It is still possible to bring the axis to a standstill before reaching the software limit switch:

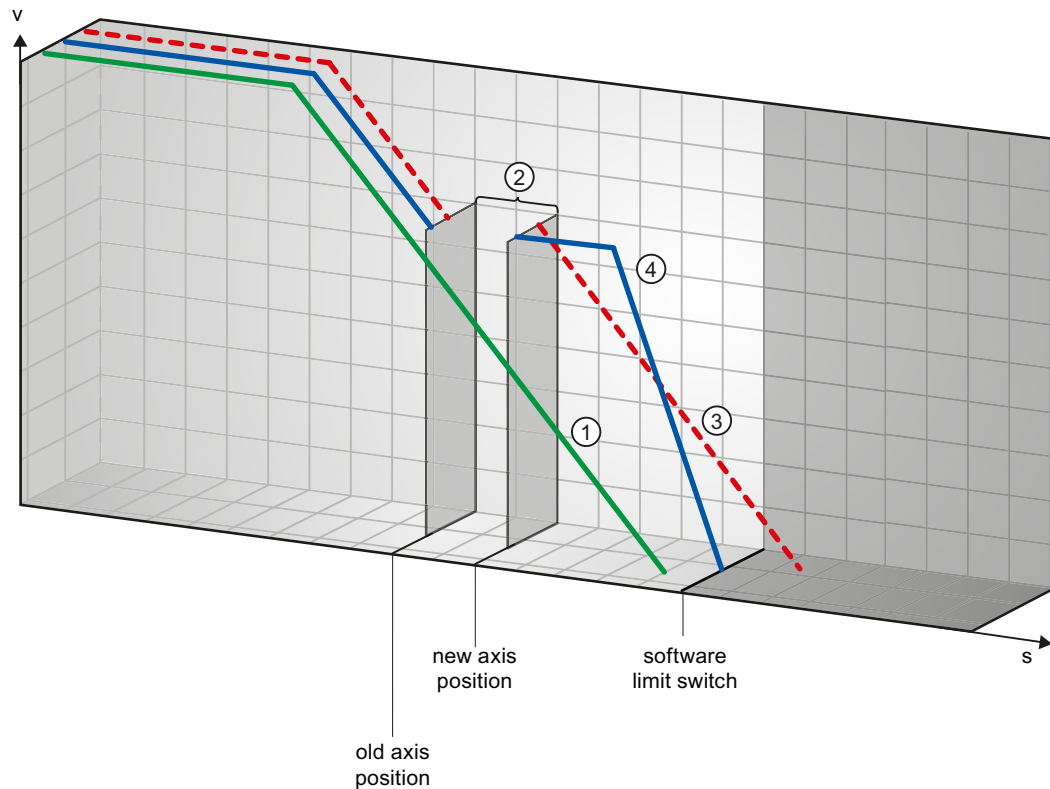

①	The green curve shows the motion <b>without</b> the homing job. The axis brakes at the configured deceleration and comes to a standstill at a position before the software limit switch.
②	A new axis position is set as a result of the homing job. The area between the old and new axis position is thus "skipped".
③	Based on the new axis position, the axis would theoretically be stopped with the configured deceleration at a position after the software limit switch (red curve).
④	Because braking with the configured deceleration is no longer sufficient, the axis actually follows the blue curve. Following a constant motion, the axis brakes at the emergency stop deceleration and comes to a standstill at the position of the software limit switch.

**Example 4:**

During a braking operation, a homing job (for example, Set reference point) offsets the current axis position in the direction of the software limit switch. In contrast to example 3, it is no longer possible to bring the axis to a standstill before reaching the software limit switch. The axis overruns the position of the software limit switch.

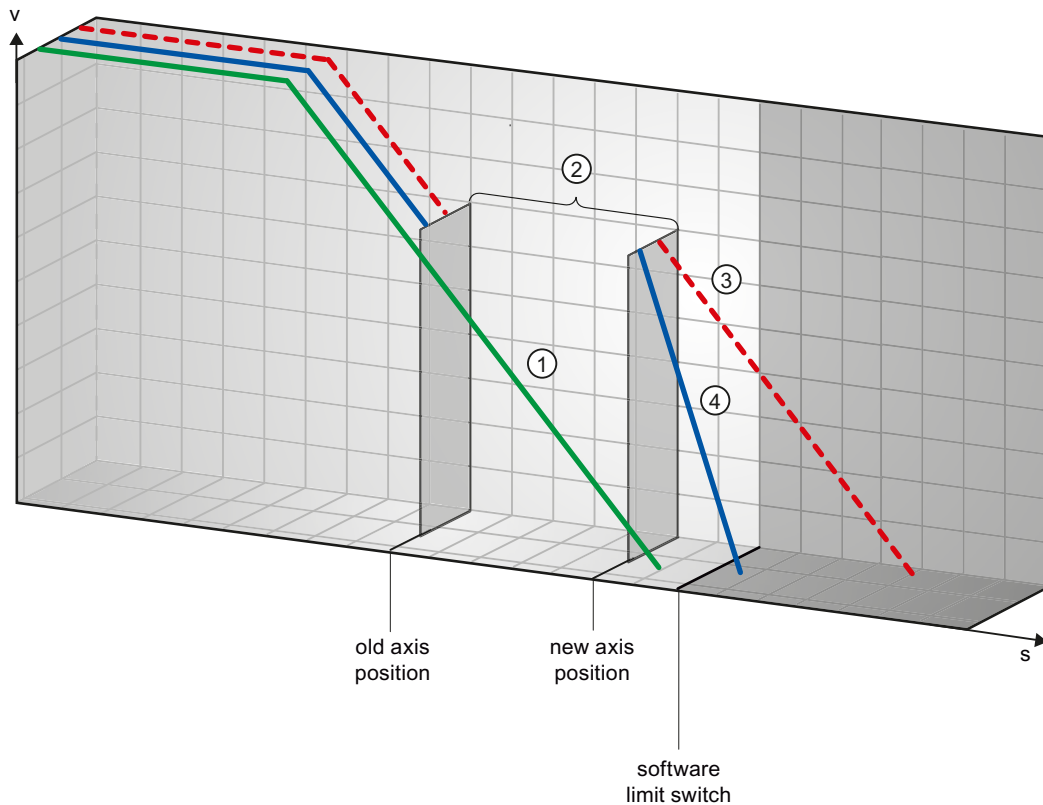

①	The green curve shows the motion <b>without</b> the homing job. The axis brakes at the configured deceleration and comes to a standstill at a position before the software limit switch.
②	A new axis position is set as a result of the homing job. The area between the old and new axis position is thus "skipped".
③	Based on the new axis position, the axis would theoretically be stopped with the configured deceleration at a position well after the software limit switch (red curve).
④	Because braking with the configured deceleration is no longer sufficient, the axis actually follows the blue curve. The axis brakes at the emergency stop deceleration. However, the emergency stop deceleration is not sufficient to stop the axis at the position of the software limit switch. The position of the software limit switch is overrun.

**See also**

Software limit switches and software limit switch position changes. (Page 6106)

Software limit switches in conjunction with dynamic changes (Page 6107)

Behavior of axis when position limits is tripped (Page 6031)

**Software limit switches and software limit switch position changes.**

An incorrect change in the position of the software limit switch during the runtime of the user program can abruptly reduce the distance between the current axis position and the position of the software limit switch.



The axis response is similar to that described in Software limit switches in conjunction with a homing operation (Page 6100).

### See also

Software limit switches in conjunction with a homing operation (Page 6100)

Software limit switches in conjunction with dynamic changes (Page 6107)

Behavior of axis when position limits is tripped (Page 6031)

### Software limit switches in conjunction with dynamic changes

It is possible to influence the deceleration of the axis in the area of the software limit switches in conjunction with overriding motion jobs. This applies when the overriding motion command is started with a lower deceleration (tag <Axis name>.Config.DynamicDefaults.Deceleration). Take the following examples into consideration when developing your program.

#### Example 1:

During axis motion, an active motion job is overridden by another motion job with a lower deceleration:

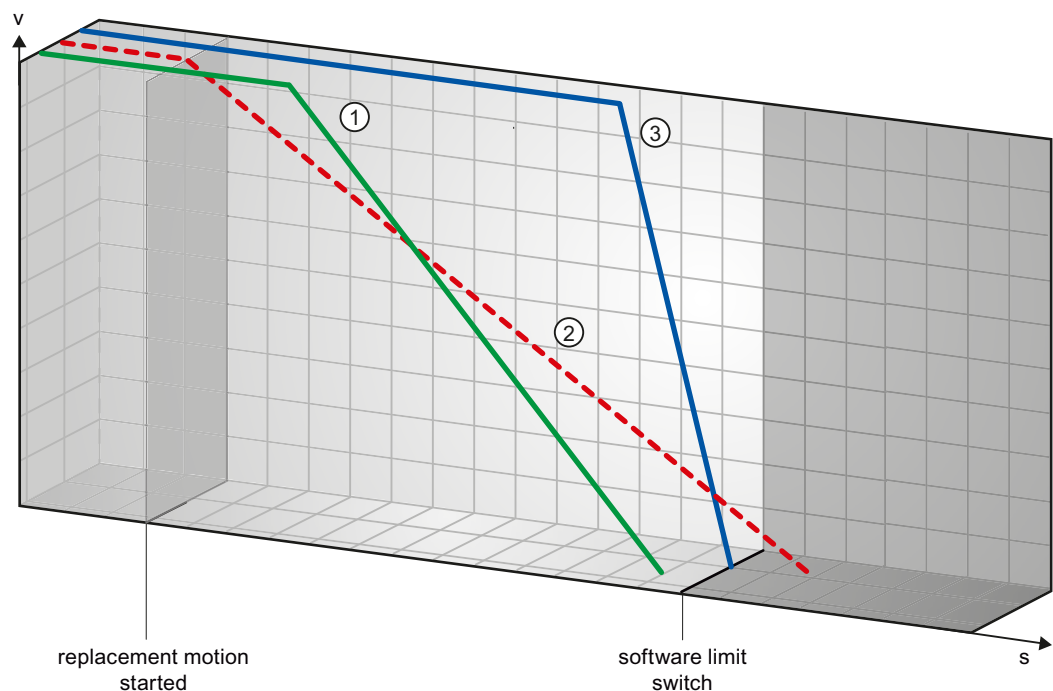

①	The green curve shows the motion of an active job <b>without</b> this job being overridden. The axis brakes at the configured deceleration and comes to a standstill at a position before the software limit switch.
②	Based on the overriding motion job with lower deceleration, the axis would theoretically be stopped with the configured deceleration at a position after the software limit switch (red curve).
③	Because braking with the configured deceleration of the overriding motion job is no longer sufficient, the axis actually follows the blue curve. Following a constant motion, the axis brakes at the emergency stop deceleration and comes to a standstill at the position of the software limit switch.

**Example 2:**

During braking of the axis, an active motion job is overridden by another motion job with a lower deceleration:

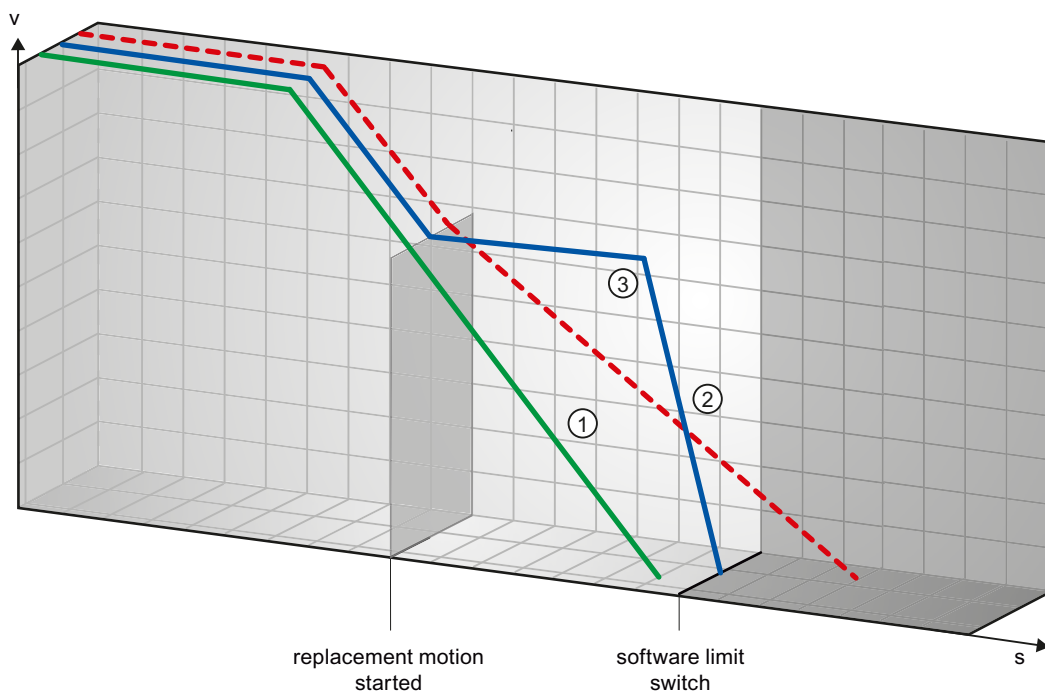

①	The green curve shows the motion of an active job <b>without</b> this job being overridden. The axis brakes at the configured deceleration and comes to a standstill at a position before the software limit switch.
②	Based on the overriding motion job with lower deceleration, the axis would theoretically be stopped at a position well after the software limit switch (red curve).
③	Because braking with the configured deceleration of the overriding motion job is no longer sufficient, the axis actually follows the blue curve. Following a constant motion, the axis brakes at the emergency stop deceleration and comes to a standstill at the position of the software limit switch.

**See also**

Software limit switches in conjunction with a homing operation (Page 6100)

Software limit switches and software limit switch position changes. (Page 6104)

Behavior of axis when position limits is tripped (Page 6031)

**11.2.12.5 Reducing velocity for a short positioning duration**

The CPU can reduce the velocity of a positioning command when the planned positioning duration is  $< 2$  ms.

The velocity of command execution will then be reduced for the entire duration. The reduced velocity (pulses per s) is calculated as follows:

- Reduced velocity = Number of pulses to be output \* 500Hz

Velocity is **not** reduced if the planned positioning duration is  $\geq 2$  ms.

**11.2.12.6 Dynamic adjustment of start/stop velocity**

The configuration of your velocity limits (start/stop velocity and maximum velocity), the dynamic values (acceleration, deceleration and jerk) and the target speed of the traversing command may under certain circumstances result in the start/stop velocity being dynamically adjusted by the CPU.

This is for example the case when, due to a low configured start/stop velocity, the time required for the first pulses would be longer than that possible for the entire acceleration. The first pulse is in these cases output at a greater velocity than the configured start/stop velocity. The subsequent pulses are also dynamically adjusted to ensure the acceleration process can be completed in the specified time.

Ensure in the event of any pulse loss that the hardware (drive) you use is adjusted to this situation, or change the dynamic settings of your axis to avoid dynamic adjustment of the start/stop velocity.

**11.2.12.7 List of ErrorIDs and ErrorInfos (technology objects as of V2.0)**

The following table lists all ErrorIDs and ErrorInfos that can be indicated in Motion Control instructions. In addition to the cause of the error, remedies for eliminating the error are also listed:

**Operating error with stop of the axis**

ErrorID	ErrorInfo	Description	Remedy
16#8000		Drive error, "Drive ready" failure	
	16#0001	-	Acknowledge error with instruction "MC_Reset"; provide drive signal; possibly restart command
16#8001		Low software limit switch has been tripped	

ErrorID	ErrorInfo	Description	Remedy
	16#000E	The position of the low software limit switch was reached with the currently configured deceleration	Acknowledge the error with instruction "MC_Reset"; use a motion command to move the axis in the positive direction out of the range of the software limit switch
	16#000F	The position of the low software limit switch was reached with the emergency stop deceleration	
	16#0010	The position of the low software limit switch was exceeded with the emergency stop deceleration	
<b>16#8002</b>		<b>High software limit switch has been tripped</b>	
	16#000E	The position of the high software limit switch was reached with the currently configured deceleration	Acknowledge the error with instruction "MC_Reset"; use a motion command to move the axis in the negative direction out of the range of the software limit switch
	16#000F	The position of the high software limit switch was reached with the emergency stop deceleration	
	16#0010	The position of the high software limit switch was exceeded with the emergency stop deceleration	
<b>16#8003</b>		<b>Low hardware limit switch was approached</b>	
	16#000E	The low hardware limit switch was approached. The axis was stopped with the emergency stop deceleration. (During an active home position approach, the homing switch was not found)	Acknowledge the error for a released axis with instruction "MC_Reset"; use a motion command to move the axis in the positive direction out of the range of the hardware limit switch.
<b>16#8004</b>		<b>High hardware limit switch was approached</b>	
	16#000E	The high hardware limit switch was approached. The axis was stopped with the emergency stop deceleration. (During an active home position approach, the homing switch was not found)	Acknowledge the error for a released axis with instruction "MC_Reset"; use a motion command to move the axis in the negative direction out of the range of the hardware limit switch.
<b>16#8005</b>		<b>PTO/HSC are already being used by another axis</b>	
	16#0001	-	<b>The axis was configured incorrectly:</b> Correct the configuration of the PTO (Pulse Train Output) / HSC (High Speed Counter) and download it to the controller  <b>More than one axis is to run with one PTO:</b> Another axis is using the PTO/HSC. If the current axis is to assume the control, the other axis must be disabled with "MC_Power" Enable = FALSE. (see also Using multiple axes with the same PTO (Page 6093))
<b>16#8006</b>		<b>A communication error in the control panel has occurred</b>	
	16#0012	A timeout has occurred	Check the cable connection and press the "Manual control" button again.
<b>16#8007</b>		<b>It is not possible to release the axis</b>	
	16#0025	Restarting	Wait until the axis restart is complete.
	16#0026	Executing loading process in RUN mode	Wait until the loading process is complete.

## Operating error without stop of the axis

ErrorID	ErrorInfo	Description	Remedy
<b>16#8200</b>		<b>Axis is not released</b>	
	16#0001	-	Release the axis; restart the command
<b>16#8201</b>		<b>Axis has already been released by another "MC_Power" instance</b>	
	16#0001	-	Release the axis with only one "MC_Power" instance
<b>16#8202</b>		<b>The maximum number of simultaneously active motion control commands has been exceeded (maximum of 200 commands for all motion control technology objects)</b>	
	16#0001	-	Reduce the number of simultaneously active commands; restart the command A command is active if parameter "Busy" = TRUE in the Motion Control instruction.
<b>16#8203</b>		<b>Axis is currently operated in "Manual control" (axis command table)</b>	
	16#0001	-	Exit "Manual control"; restart the command
<b>16#8204</b>		<b>Axis is not homed</b>	
	16#0001	-	Home the axis with instruction "MC_Home"; restart the command
<b>16#8205</b>		<b>The axis is currently controlled by the user program (the error is only displayed in the axis command table)</b>	
	16#0013	The axis is released in the user program.	Disable axis with instruction "MC_Power" and select "Manual control" again in the axis command table
<b>16#8206</b>		<b>Technology object not activated yet</b>	
	16#0001	-	Release the axis with instruction "MC_Power" Enable = TRUE or release the axis in the axis command table.
<b>16#8207</b>		<b>Command rejected</b>	
	16#0016	Active homing is running; another homing method cannot be started.	Wait for active homing to finish or abort the active homing with a motion command, for example, "MC_Halt".
	16#0018	The axis cannot be moved with a command table whilst it is being directly or passively homed.	Wait until direct or passive homing is complete.
	16#0019	The axis cannot be directly or passively homed whilst a command table is being processed.	Wait for command table to finish or abort the command table with a motion command, for example, "MC_Halt".
<b>16#8208</b>		<b>Difference between maximum and start/stop velocity is invalid</b>	
	16#0002	Number format of value is invalid	Correct the value; restart the command
	16#000A	Value is less than or equal to 0	
<b>16#8209</b>		<b>Invalid acceleration for technology object "Axis"</b>	
	16#0002	Number format of value is invalid	Correct the value; restart the command
	16#000A	Value is less than or equal to 0	
<b>16#820A</b>		<b>It is not possible to restart the axis</b>	
	16#0013	The axis is released in the user program.	Disable the axis with the "MC_Power" instruction; restart again

ErrorID	ErrorInfo	Description	Remedy
	16#0027	The axis is currently being operated in "Manual control" (axis control panel)	Exit "Manual control"; restart again
<b>16#820B</b>		<b>It is not possible to execute the command table</b>	
	16#0026	Executing loading process in RUN mode	Wait until the loading process is complete.

## Block parameter error

ErrorID	ErrorInfo	Description	Remedy
<b>16#8400</b>		<b>Invalid value at parameter "Position" of the Motion Control instruction</b>	
	16#0002	Number format of value is invalid	Correct the value; restart the command
	16#0005	The value is outside the number range (greater than $1e^{12}$ )	
	16#0006	The value is outside the number range (less than $-1e^{12}$ )	
<b>16#8401</b>		<b>Invalid value at parameter "Distance" of the Motion Control instruction</b>	
	16#0002	Number format of value is invalid	Correct the value; restart the command
	16#0005	The value is outside the number range (greater than $1e^{12}$ )	
	16#0006	The value is outside the number range (less than $-1e^{12}$ )	
<b>16#8402</b>		<b>Invalid value at parameter "Velocity" of the Motion Control instruction</b>	
	16#0002	Number format of value is invalid	Correct the value; restart the command
	16#0008	Value is greater than the configured maximum velocity	
	16#0009	Value is less than the configured start/stop velocity	
	16#0024	Value is less than 0	
<b>16#8403</b>		<b>Invalid value at parameter "Direction" of the Motion Control instruction</b>	
	16#0011	The selection value is invalid	Correct the selection value; restart the command
<b>16#8404</b>		<b>Invalid value at parameter "Mode" of the Motion Control instruction</b>	
	16#0011	The selection value is invalid	Correct the selection value; restart the command
	16#0015	Active/passive homing is not configured	Correct the configuration and download it to the controller; release the axis and restart the command
	16#0017	The direction reversal is activated at the hardware limit switch, despite the fact that the hardware limit switches are disabled	<ul style="list-style-type: none"> <li>• Activate the hardware limit switch using the tag <code>&lt;Axis&gt;.Config.PositionLimits_HW.Active = TRUE</code>, restart the command</li> <li>• Correct the configuration and download it to the controller; release the axis and restart the command</li> </ul>
<b>16#8405</b>		<b>Invalid value at parameter "StopMode" of the Motion Control instruction</b>	
	16#0011	The selection value is invalid	Correct the selection value; release the axis again
<b>16#8406</b>		<b>Simultaneous forward and backward jogging is not allowed</b>	

ErrorID	ErrorInfo	Description	Remedy
	16#0001	-	Take steps to ensure that parameters "JogForward" and "JogBackward" do not have signal status TRUE simultaneously; restart the command.
<b>16#8407</b>		<b>Switching to another axis with instruction "MC_Power" is only permitted after disabling the active axis.</b>	
	16#0001	-	Disable the active axis; it is then possible to switch to the other axis and release it.
<b>16#8408</b>		<b>Invalid value at parameter "Axis" of the Motion Control instruction</b>	
	16#001A	The specified value does not match the required technology object version	Correct the value; restart the command
	16#001B	The specified value does not match the required technology object type	
	16#001C	The specified value is not a Motion Control technology data block	
<b>16#8409</b>		<b>Invalid value at parameter "CommandTable" of the Motion Control instruction</b>	
	16#001A	The specified value does not match the required technology object version	Correct the value; restart the command
	16#001B	The specified value does not match the required technology object type	
	16#001C	The specified value is not a Motion Control technology data block	
<b>16#840A</b>		<b>Invalid value at parameter "StartStep" of the Motion Control instruction</b>	
	16#000A	Value is less than or equal to 0	Correct the value; restart the command
	16#001D	The start step is greater than the end step	
	16#001E	Value is greater than 32	
<b>16#840B</b>		<b>Invalid value at parameter "EndStep" of the Motion Control instruction</b>	
	16#000A	Value is less than or equal to 0	Correct the value; restart the command
	16#001E	Value is greater than 32	
<b>16#840C</b>		<b>Invalid value at parameter "RampUpTime" of the Motion Control instruction</b>	
	16#0002	Number format of value is invalid	Correct the value; restart the command
	16#000A	Value is less than or equal to 0	
<b>16#840D</b>		<b>Invalid value at parameter "RampDownTime" of the Motion Control instruction</b>	
	16#0002	Number format of value is invalid	Correct the value; restart the command
	16#000A	Value is less than or equal to 0	
<b>16#840E</b>		<b>Invalid value at parameter "EmergencyRampTime" of the Motion Control instruction</b>	
	16#0002	Number format of value is invalid	Correct the value; restart the command
	16#000A	Value is less than or equal to 0	
<b>16#840F</b>		<b>Invalid value at parameter "JerkTime" of the Motion Control instruction</b>	
	16#0002	Number format of value is invalid	Correct the value; restart the command
	16#000A	Value is less than or equal to 0	

## Configuration error of the axis

ErrorID	ErrorInfo	Description	Remedy
<b>16#8600</b>		<b>Parameter assignment of pulse generator (PTO is invalid)</b>	
	16#000B	The address is invalid	<ul style="list-style-type: none"> <li>Download error-free configuration to the controller; release the axis again with instruction "MC_Power"</li> </ul>
	16#0014	The selected hardware is used by another application	
<b>16#8601</b>		<b>Parameterization of the high-speed counter (HSC) is invalid</b>	
	16#000B	The address is invalid	<ul style="list-style-type: none"> <li>Download error-free configuration to the controller; release the axis again with instruction "MC_Power"</li> </ul>
	16#0014	The selected hardware is used by another application	
<b>16#8602</b>		<b>Invalid parameter assignment of "Enable output"</b>	
	16#000B	The address is invalid	<ul style="list-style-type: none"> <li>Download error-free configuration to the controller; release the axis again with instruction "MC_Power"</li> </ul>
<b>16#8603</b>		<b>Invalid parameter assignment of "Ready input"</b>	
	16#000B	The address is invalid	<ul style="list-style-type: none"> <li>Download error-free configuration to the controller; release the axis again with instruction "MC_Power"</li> </ul>
<b>16#8604</b>		<b>Invalid "Pulses per motor revolution" value</b>	
	16#000A	Value is less than or equal to zero	<ul style="list-style-type: none"> <li>Download error-free configuration to the controller; release the axis again with instruction "MC_Power"</li> </ul>
<b>16#8605</b>		<b>Invalid "Load distance per motor revolution" value</b>	
	16#0002	Number format of value is invalid	<ul style="list-style-type: none"> <li>Download error-free configuration to the controller; release the axis again with instruction "MC_Power"</li> </ul>
	16#0005	The value is outside the number range (greater than $1e^{12}$ )	
	16#000A	Value is less than or equal to zero	
<b>16#8606</b>		<b>Invalid "Start / stop velocity" value</b>	
	16#0002	Number format of value is invalid	<ul style="list-style-type: none"> <li>Download error-free configuration to the controller; release the axis again with instruction "MC_Power"</li> </ul>
	16#0003	Value exceeds the high hardware limit	
	16#0004	Value is less than the low hardware limit	
	16#0007	The start/stop velocity is greater than the maximum velocity	
<b>16#8607</b>		<b>Invalid "maximum velocity" value</b>	
	16#0002	Number format of value is invalid	<ul style="list-style-type: none"> <li>Download error-free configuration to the controller; release the axis again with instruction "MC_Power"</li> </ul>
	16#0003	Value exceeds the high hardware limit	
	16#0004	Value is less than the low hardware limit	
<b>16#8608</b>		<b>Invalid "Acceleration" value</b>	
	16#0002	Number format of value is invalid	<ul style="list-style-type: none"> <li>Download error-free configuration to the controller; release the axis again with instruction "MC_Power"</li> </ul>
	16#0003	Value exceeds the high hardware limit	
	16#0004	Value is less than the low hardware limit	
<b>16#8609</b>		<b>Invalid "Deceleration" value</b>	<ul style="list-style-type: none"> <li>Correct the incorrect value online; acknowledge error with instruction "MC_Reset" and if necessary restart the command</li> </ul>



ErrorID	ErrorInfo	Description	Remedy
	16#0002	Number format of value is invalid	<ul style="list-style-type: none"> <li>Download error-free configuration to the controller; release the axis again with instruction "MC_Power"</li> <li>Correct the incorrect value online; acknowledge error with instruction "MC_Reset" and if necessary restart the command</li> </ul>
	16#0003	Value exceeds the high hardware limit	
	16#0004	Value is less than the low hardware limit	
<b>16#860A</b>		<b>Invalid "Emergency stop deceleration" value</b>	
	16#0002	Number format of value is invalid	<ul style="list-style-type: none"> <li>Download error-free configuration to the controller; release the axis again with instruction "MC_Power"</li> <li>Correct the incorrect value online; acknowledge error with instruction "MC_Reset" and if necessary restart the command</li> </ul>
	16#0003	Value exceeds the high hardware limit	
	16#0004	Value is less than the low hardware limit	
<b>16#860B</b>		<b>Value for position of the low SW limit switch is invalid</b>	
	16#0002	Number format of value is invalid	<ul style="list-style-type: none"> <li>Download error-free configuration to the controller; release the axis again with instruction "MC_Power"</li> <li>Correct the incorrect value online; acknowledge error with instruction "MC_Reset" and if necessary restart the command</li> </ul>
	16#0005	The value is outside the number range (greater than $1e^{12}$ )	
	16#0006	The value is outside the number range (less than $-1e^{12}$ )	
	16#0007	The position value of the low software limit switch is greater than that of the high software limit switch	
<b>16#860C</b>		<b>Value for position of the high SW limit switch is invalid</b>	
	16#0002	Number format of value is invalid	<ul style="list-style-type: none"> <li>Download error-free configuration to the controller; release the axis again with instruction "MC_Power"</li> <li>Correct the incorrect value online; acknowledge error with instruction "MC_Reset" and if necessary restart the command</li> </ul>
	16#0005	The value is outside the number range (greater than $1e^{12}$ )	
	16#0006	The value is outside the number range (less than $-1e^{12}$ )	
<b>16#860D</b>		<b>Invalid address of the low HW limit switch</b>	
	16#000C	The address of the falling edge is invalid	<ul style="list-style-type: none"> <li>Download error-free configuration to the controller; release the axis again with instruction "MC_Power"</li> </ul>
	16#000D	The address of the rising edge is invalid	
<b>16#860E</b>		<b>Invalid address of the high HW limit switch</b>	
	16#000C	The address of the falling edge is invalid	<ul style="list-style-type: none"> <li>Download error-free configuration to the controller; release the axis again with instruction "MC_Power"</li> </ul>
	16#000D	The address of the rising edge is invalid	
<b>16#860F</b>		<b>Invalid "home position offset" value</b>	
	16#0002	Number format of value is invalid	<ul style="list-style-type: none"> <li>Download error-free configuration to the controller; release the axis again with instruction "MC_Power"</li> <li>Correct the incorrect value online; acknowledge error with instruction "MC_Reset" and if necessary restart the command</li> </ul>
	16#0005	The value is outside the number range (greater than $1e^{12}$ )	
	16#0006	The value is outside the number range (less than $-1e^{12}$ )	
<b>16#8610</b>		<b>Invalid "approach velocity" value</b>	

ErrorID	ErrorInfo	Description	Remedy
	16#0002	Number format of value is invalid	<ul style="list-style-type: none"> <li>Download error-free configuration to the controller; release the axis again with instruction "MC_Power"</li> <li>Correct the incorrect value online; acknowledge error with instruction "MC_Reset" and if necessary restart the command</li> </ul>
	16#0008	The velocity is greater than the maximum velocity	
	16#0009	The velocity is less than the start/stop velocity	
<b>16#8611</b>		<b>Invalid "Homing velocity" value</b>	
	16#0002	Number format of value is invalid	<ul style="list-style-type: none"> <li>Download error-free configuration to the controller; release the axis again with instruction "MC_Power"</li> <li>Correct the incorrect value online; acknowledge error with instruction "MC_Reset" and if necessary restart the command</li> </ul>
	16#0008	The velocity is greater than the maximum velocity	
	16#0009	The velocity is less than the start/stop velocity	
<b>16#8612</b>		<b>Invalid address of the homing switch</b>	
	16#000C	The address of the falling edge is invalid	<ul style="list-style-type: none"> <li>Download error-free configuration to the controller; release the axis again with instruction "MC_Power"</li> </ul>
	16#000D	The address of the rising edge is invalid	
<b>16#8613</b>		<b>During active homing, direction reversal at the hardware limit switch is activated although the hardware limit switches are not configured</b>	
	16#0001	-	<ul style="list-style-type: none"> <li>Download error-free configuration to the controller; release the axis again with instruction "MC_Power"</li> <li>Correct the incorrect value online; acknowledge error with instruction "MC_Reset" and if necessary restart the command</li> </ul>
<b>16#8614</b>		<b>Invalid "Jerk" value</b>	
	16#0002	Number format of value is invalid	<ul style="list-style-type: none"> <li>Download error-free configuration to the controller; release the axis again with instruction "MC_Power"</li> <li>Correct the incorrect value online; acknowledge error with instruction "MC_Reset" and if necessary restart the command</li> </ul>
	16#001F	Value is greater than the maximum jerk	
	16#0020	Value is less than the minimum jerk	
<b>16#8615</b>		<b>Value for "Unit of measurement" is invalid</b>	
	16#0011	The selection value is invalid	Download error-free configuration to the controller; release the axis again with instruction "MC_Power"

### Configuration error of the command table

ErrorID	ErrorInfo	Description	Remedy
<b>16#8700</b>		<b>Value for "Command type" in the command table is invalid</b>	
	16#0001	-	<ul style="list-style-type: none"> <li>Download error-free configuration to the controller; release the axis again with instruction "MC_Power"</li> <li>Correct the incorrect value online and if necessary restart the command</li> </ul>
<b>16#8701</b>		<b>Value for "Position / travel path" in the command table is invalid</b>	

ErrorID	ErrorInfo	Description	Remedy
	16#0002	Number format of value is invalid	<ul style="list-style-type: none"> <li>Download error-free configuration to the controller; release the axis again with instruction "MC_Power"</li> <li>Correct the incorrect value online and if necessary restart the command</li> </ul>
	16#0005	The value is outside the number range (greater than $1e^{12}$ )	
	16#0006	The value is outside the number range (less than $-1e^{12}$ )	
<b>16#8702</b>		<b>Value for "Velocity" in the command table is invalid</b>	
	16#0002	Number format of value is invalid	<ul style="list-style-type: none"> <li>Download error-free configuration to the controller; release the axis again with instruction "MC_Power"</li> <li>Correct the incorrect value online and if necessary restart the command</li> </ul>
	16#0008	Value is greater than the configured maximum velocity	
	16#0009	Value is less than the configured start/stop velocity	
<b>16#8703</b>		<b>Value for "Duration" in the command table is invalid</b>	
	16#0002	Number format of value is invalid	<ul style="list-style-type: none"> <li>Download error-free configuration to the controller; release the axis again with instruction "MC_Power"</li> <li>Correct the incorrect value online and if necessary restart the command</li> </ul>
	16#0021	Value is greater than 64800 s	
	16#0022	Value is less than 0.001 s	
<b>16#8704</b>		<b>Value for "Next step" in the command table is invalid</b>	
	16#0011	The selection value is invalid	<ul style="list-style-type: none"> <li>Download error-free configuration to the controller; release the axis again with instruction "MC_Power"</li> <li>Correct the incorrect value online and if necessary restart the command</li> </ul>
	16#0023	The command transition is not permitted for this command	

### Internal errors

ErrorID	ErrorInfo	Description	Remedy
<b>16#8FFF</b>		<b>Internal error</b>	
	16#F0**	-	<p>POWER OFF and POWER ON the CPU</p> <p>If this does not work, contact Customer Support. Have the following information ready:</p> <ul style="list-style-type: none"> <li>ErrorID</li> <li>ErrorInfo</li> <li>Diagnostic buffer entries</li> </ul>

**See also**

- Using multiple axes with the same PTO (Page 6093)
- Using multiple drives with the same PTO (Page 6097)
- Tracking jobs from higher priority classes (execution levels) (Page 6098)
- Special cases for use of software limit switches (Page 6100)
- Tag of the Axis technology object (Page 6118)

**11.2.12.8 Tag of the Axis technology object**

**Config. tag**

**Config.General. tag**

**Legend**

<b>Data type</b>	Data type of the tag
<b>Start value</b>	Start value of tag The initial value can be overwritten by the axis configuration.
<b>Access</b>	Access to the tag in the user program:
	RW The tag can be read and written in the user program.
	R The tag can be read in the user program.
	- The tag cannot be used in the user program.
<b>Effective</b>	Specifies when a change in the tag takes effect.
<b>HMI</b>	The tag can be used in an HMI system.

<b>&lt;Axis name&gt;.Config.General.PTO</b>				
Tag cannot be evaluated in the user program.				
<b>Data type</b>	<b>Start value</b>	<b>Access</b>	<b>Effective</b>	<b>HMI</b>
DWORD	DW#16#00000000	-	-	-

<b>&lt;Axis name&gt;.Config.General.HSC</b>				
Tag cannot be evaluated in the user program.				
<b>Data type</b>	<b>Start value</b>	<b>Access</b>	<b>Effective</b>	<b>HMI</b>
DWORD	DW#16#00000000	-	-	-

<b>&lt;Axis name&gt;.Config.General.LengthUnit ("Axis" technology object as of V2.0)</b>				
The unit of measurement for the parameter selected in the configuration:				
<ul style="list-style-type: none"> <li>• 1013 = "mm"</li> <li>• 1010 =: "m"</li> <li>• 1019 = "in"</li> <li>• 1018 = "ft"</li> <li>• 1005 = "°" (degrees)</li> <li>• -1 = "Pulse"</li> </ul>				
Data type	Start value	Access	Effective	HMI
Int	1013	R	-	X

**Config.DriveInterface. tag****Legend**

<b>Data type</b>	Data type of the tag
<b>Start value</b>	Start value of tag The initial value can be overwritten by the axis configuration.
<b>Access</b>	Access to the tag in the user program:
	RW The tag can be read and written in the user program.
	R The tag can be read in the user program.
	- The tag cannot be used in the user program.
<b>Effective</b>	Specifies when a change in the tag takes effect.
<b>HMI</b>	The tag can be used in an HMI system.

<b>&lt;Axis name&gt;.Config.DriveInterface.EnableOutput...</b>				
Tags cannot be evaluated in the user program.				
Data type	Start value	Access	Effective	HMI
-	-	-	-	-

<b>&lt;Axis name&gt;.Config.DriveInterface.ReadyInput...</b>				
Tags cannot be evaluated in the user program.				
Data type	Start value	Access	Effective	HMI
-	-	-	-	-

**Config.Mechanics. tag**

**Legend**

<b>Data type</b>	Data type of the tag
<b>Start value</b>	Start value of tag The initial value can be overwritten by the axis configuration.
<b>Access</b>	Access to the tag in the user program:
	RW   The tag can be read and written in the user program.
	R   The tag can be read in the user program.
-	The tag cannot be used in the user program.
<b>Effective</b>	Specifies when a change in the tag takes effect.
<b>HMI</b>	The tag can be used in an HMI system.

<b>&lt;Axis name&gt;.Config.Mechanics.PulsesPerDriveRevolution)</b>				
Increments per motor revolution				
<b>Data type</b>	<b>Start value</b>	<b>Access</b>	<b>Effective</b>	<b>HMI</b>
DInt	L#1000	R	-	X

<b>&lt;Axis name&gt;.Config.Mechanics.LeadScrew</b>				
Load distance per motor revolution (specified in the configured unit of measurement)				
<b>Data type</b>	<b>Start value</b>	<b>Access</b>	<b>Effective</b>	<b>HMI</b>
Real	1.0E+001	R	-	X

<b>&lt;Axis name&gt;.Config.Mechanics.InverseDirection</b>				
Invert direction signal				
<b>Data type</b>	<b>Start value</b>	<b>Access</b>	<b>Effective</b>	<b>HMI</b>
Bool	FALSE	R	-	X

**Config.DynamicLimits. tag**

**Legend**

<b>Data type</b>	Data type of the tag
<b>Start value</b>	Start value of tag The initial value can be overwritten by the axis configuration.
<b>Access</b>	Access to the tag in the user program:
	RW   The tag can be read and written in the user program.
	R   The tag can be read in the user program.
-	The tag cannot be used in the user program.
<b>Effective</b>	Specifies when a change in the tag takes effect.
<b>HMI</b>	The tag can be used in an HMI system.

<b>&lt;Axis name&gt;.Config.DynamicLimits.MinVelocity</b>				
Start/stop velocity of axis (specified in the configured unit of measurement)				
Data type	Start value	Access	Effective	HMI
Real	1.0E+001	R	-	X

<b>&lt;Axis name&gt;.Config.DynamicLimits.MaxVelocity</b>				
Maximum velocity of axis (specified in the configured unit of measurement)				
Data type	Start value	Access	Effective	HMI
Real	2.5E+002	R	-	X

### Config.DynamicDefaults. tag

#### Legend

<b>Data type</b>	Data type of the tag
<b>Start value</b>	Start value of tag The initial value can be overwritten by the axis configuration.
<b>Access</b>	Access to the tag in the user program: <ul style="list-style-type: none"> <li>RW The tag can be read and written in the user program.</li> <li>R The tag can be read in the user program.</li> <li>- The tag cannot be used in the user program.</li> </ul>
<b>Effective</b>	Specifies when a change in the tag takes effect. <ul style="list-style-type: none"> <li>1 When axis is activated (tag &lt;Axis name&gt;.StatusBits.Activated changes from FALSE -&gt; TRUE), blocked or released</li> <li>2 When axis is enabled</li> <li>5 The next time an MC_MoveAbsolute, MC_MoveRelative, MC_MoveVelocity, MC_MoveJog, MC_Halt, MC_CommandTable or active MC_Home command is started (Mode = 3).</li> <li>6 When a MC_MoveJog command is stopped</li> </ul>
<b>HMI</b>	The tag can be used in an HMI system.

<b>&lt;Axis name&gt;.Config.DynamicDefaults.Acceleration</b>					
Acceleration of axis (specified in the configured dimension unit)					
Data type	Start value	Access	Effective	HMI	
Real	4.8E+001	RW	5	CPU Firmware V1.0	X
			1, 5, 6	CPU firmware as of V2.0	

<b>&lt;Axis name&gt;.Config.DynamicDefaults.Deceleration</b>				
Deceleration of axis (specified in the configured dimension unit)				
Data type	Start value	Access	Effective	HMI

<Axis name>.Config.DynamicDefaults.Deceleration					
Real	4.8E+001	RW	5, 6	CPU Firmware V1.0	X
			1, 5, 6	CPU firmware as of V2.0	

<Axis name>.Config.DynamicDefaults.EmergencyDeceleration					
Emergency stop deceleration of axis (specified in the configured dimension unit)					
Data type	Start value	Access	Effective		HMI
Real	1.2E+002	RW	2, 5, 6	CPU Firmware V1.0	X
			1, 5, 6	CPU firmware as of V2.0	

<Axis name>.Config.DynamicDefaults.JerkActive ("Axis" technology object as of V2.0)					
TRUE = the jerk limit is activated					
Data type	Start value	Access	Effective		HMI
Bool	FALSE	RW	1, 5		X

<Axis name>.Config.DynamicDefaults.Jerk ("Axis" technology object as of V2.0)					
Jerk during axis acceleration and deceleration ramp (specified in the configured unit of measurement)					
Data type	Start value	Access	Effective		HMI
Real	1.92E+002	RW	1, 5		X

**Config.PositionLimits\_SW. tag**

**Legend**

<b>Data type</b>	Data type of the tag				
<b>Start value</b>	Start value of tag The initial value can be overwritten by the axis configuration.				
<b>Access</b>	Access to the tag in the user program:				
	RW	The tag can be read and written in the user program.			
	R	The tag can be read in the user program.			
	-	The tag cannot be used in the user program.			
<b>Effective</b>	Specifies when a change in the tag takes effect.				
	1	When axis is activated (tag <Axis name>.StatusBits.Activated changes from FALSE -> TRUE), blocked or released			
	4	Upon the next start of a Motion Control command after a standstill of the axis. The axis standstill can be checked with tag <Axis name>. StatusBits.Standstill.			



	5	The next time an MC_MoveAbsolute, MC_MoveRelative, MC_MoveVelocity, MC_MoveJog, MC_Halt, MC_CommandTable or active MC_Home command is started (Mode = 3).
<b>HMI</b>	The tag can be used in an HMI system.	

<b>&lt;Axis name&gt;.Config.PositionLimits_SW.Active</b>					
TRUE = The software limit switches are activated					
Data type	Start value	Access	Effective		HMI
Bool	FALSE	RW	4	CPU Firmware V1.0	X
			1,	CPU firmware as of V2.0	
			5,		
			6		

<b>&lt;Axis name&gt;.Config.PositionLimits_SW.MinPosition</b>					
Position of low software limit switch (specified in the configured unit of measurement)					
Data type	Start value	Access	Effective		HMI
Real	-1.0E+004	RW	4	CPU Firmware V1.0	X
			1,	CPU firmware as of V2.0	
			5,		
			6		

<b>&lt;Axis name&gt;.Config.PositionLimits_SW.MaxPosition</b>					
Position of high software limit switch (specified in the configured unit of measurement)					
Data type	Start value	Access	Effective		HMI
Real	1.0E+004	RW	4	CPU Firmware V1.0	X
			1,	CPU firmware as of V2.0	
			5,		
			6		

### Config.PositionLimits\_HW. tag

#### Legend

<b>Data type</b>	Data type of the tag
<b>Start value</b>	Start value of tag The initial value can be overwritten by the axis configuration.
<b>Access</b>	Access to the tag in the user program:
	RW The tag can be read and written in the user program.
	R The tag can be read in the user program.
	- The tag cannot be used in the user program.
<b>Effective</b>	Specifies when a change in the tag takes effect.
	1 When axis is activated (tag <Axis name>.StatusBits.Activated changes from FALSE -> TRUE), blocked or released
	3 After axis enable (the axis must have previously been at a standstill). The axis standstill can be checked with tag <Axis name>. StatusBits.Standstill.

Using technology functions

11.2 Using S7-1200 Motion Control

	4	Upon the next start of a Motion Control command after a standstill of the axis. The axis standstill can be checked with tag <Axis name>. StatusBits.Standstill.
	5	The next time aMC_MoveAbsolute, MC_MoveRelative, MC_MoveVelocity, MC_MoveJog, MC_Halt, MC_CommandTable or active MC_Home command is started (Mode = 3).
<b>HMI</b>	The tag can be used in an HMI system.	

<b>&lt;Axis name&gt;.Config.PositionLimits_HW.Active</b>					
TRUE = The hardware limit switches are active.					
<b>Data type</b>	<b>Start value</b>	<b>Access</b>	<b>Effective</b>		<b>HMI</b>
Bool	FALSE	RW	3, 4	CPU Firmware V1.0	X
			1, 5, 6	CPU firmware as of V2.0	

<b>&lt;Axis name&gt;.Config.PositionLimits_HW.MinSwitchedLevel</b>				
TRUE = 24 V at CPU input corresponds to low hardware limit switch approached FALSE = 0 V at CPU input corresponds to low hardware limit switch approached				
<b>Data type</b>	<b>Start value</b>	<b>Access</b>	<b>Effective</b>	<b>HMI</b>
Bool	FALSE	R	-	X

<b>&lt;Axis name&gt;.Config.PositionLimits_HW.MinFallingEvent</b>				
Tag cannot be evaluated in the user program.				
<b>Data type</b>	<b>Start value</b>	<b>Access</b>	<b>Effective</b>	<b>HMI</b>
DWord	DW#16#00000000	-	-	-

<b>&lt;Axis name&gt;.Config.PositionLimits_HW.MinRisingEvent</b>				
Tag cannot be evaluated in the user program.				
<b>Data type</b>	<b>Start value</b>	<b>Access</b>	<b>Effective</b>	<b>HMI</b>
DWord	DW#16#00000000	-	-	-

<b>&lt;Axis name&gt;.Config.PositionLimits_HW.MaxSwitchedLevel</b>				
TRUE = 24 V at CPU input corresponds to high hardware limit switch approached FALSE = 0 V at CPU input corresponds to high hardware limit switch approached				
<b>Data type</b>	<b>Start value</b>	<b>Access</b>	<b>Effective</b>	<b>HMI</b>
Bool	FALSE	R	-	X

<b>&lt;Axis name&gt;.Config.PositionLimits_HW.MaxFallingEvent</b>				
Tag cannot be evaluated in the user program.				
<b>Data type</b>	<b>Start value</b>	<b>Access</b>	<b>Effective</b>	<b>HMI</b>
DWord	DW#16#00000000	-	-	-

<b>&lt;Axis name&gt;.Config.PositionLimits_HW.MaxRisingEvent</b>				
Tag cannot be evaluated in the user program.				
Data type	Start value	Access	Effective	HMI
DWord	DW#16#00000000	-	-	-

**Config.Homing. tag****Legend**

<b>Data type</b>	Data type of the tag
<b>Start value</b>	Start value of tag The initial value can be overwritten by the axis configuration.
<b>Access</b>	Access to the tag in the user program:
	RW The tag can be read and written in the user program.
	R The tag can be read in the user program.
	- The tag cannot be used in the user program.
<b>Effective</b>	Specifies when a change in the tag takes effect.
	1 When axis is activated (tag <Axis name>.StatusBits.Activated changes from FALSE -> TRUE), blocked or released
	7 When a passive homing command is started
	8 When an active homing command is started
<b>HMI</b>	The tag can be used in an HMI system.

<b>&lt;Axis name&gt;.Config.Homing.AutoReversal</b>					
TRUE = Direction reversal at hardware limit switch enabled (active homing)					
FALSE = Direction reversal at hardware limit switch disabled (active homing)					
Data type	Start value	Access	effective	HMI	
Bool	TRUE	R	-	Technology object "Axis" V1.0	X
		RW	1, 8	Technology object "Axis" V2.0	

<b>&lt;Axis name&gt;.Config.Homing.Direction</b>					
TRUE = Positive approach direction to search for homing switch and positive homing direction (active homing)					
FALSE = Negative approach direction to search for homing switch and positive homing direction (active homing)					
Data type	Start value	Access	effective	HMI	
Bool	TRUE	R	-	Technology object "Axis" V1.0	X
		RW	1, 8	Technology object "Axis" V2.0	

<b>&lt;Axis name&gt;.Config.Homing.SideActiveHoming ("Axis" technology object as of V2.0)</b>				
TRUE = Homing on high side of the homing switch (active homing)				
TRUE = Homing on lower side of the homing switch (active homing)				
Data type	Start value	Access	Effective	HMI
Bool	TRUE	RW	1, 8	X

<b>&lt;Axis name&gt;.Config.Homing.SidePassiveHoming ("Axis" technology object as of V2.0)</b>				
TRUE = Homing on high side of the homing switch (passive homing)				
TRUE = Homing on lower side of the homing switch (passive homing)				
Data type	Start value	Access	Effective	HMI
Bool	TRUE	RW	1, 7	X

<b>&lt;Axis name&gt;.Config.Homing.RisingEdge (as of technology object "Axis" V1.0)</b>				
TRUE = Homing with negative signal edge of the homing switch (active homing)				
FALSE = Homing with positive signal edge of the homing switch (active homing)				
For information on the effect of the tag on passive homing, refer to the description in "Configuration - Homing".				
Data type	Start value	Access	Effective	HMI
Bool	FALSE	R	-	X

<b>&lt;Axis name&gt;.Config.Homing.Offset</b>				
Home position offset /specified in the configured unit of measurement (active homing)				
Data type	Start value	Access	Effective	HMI
Real	0.0	R	-	Technology object "Axis" V1.0
		RW	1, 8	
				X

<b>&lt;Axis name&gt;.Config.Homing.FastVelocity</b>				
Approach velocity / specified in the configured unit of measurement (active homing)				
Data type	Start value	Access	Effective	HMI
Real	2.0E+002	R	-	Technology object "Axis" V1.0
		RW	1, 8	
				X

<b>&lt;Axis name&gt;.Config.Homing.SlowVelocity</b>				
Homing velocity / specified in the configured unit of measurement (active homing)				
Data type	Start value	Access	Effective	HMI
Real	4.0E+001	R	-	Technology object "Axis" V1.0
		RW	1, 8	
				X

<Axis name>.Config.Homing.FallingEvent				
Tag cannot be evaluated in the user program.				
Data type	Start value	Access	Effective	HMI
DWord	DW#16#00000000	-	-	-

<Axis name>.Config.Homing.RisingEvent				
Tag cannot be evaluated in the user program.				
Data type	Start value	Access	effective	HMI
DWord	DW#16#00000000	-	-	

**MotionStatus. tag****Legend**

<b>Data type</b>	Data type of the tag
<b>Start value</b>	Start value of tag
<b>Access</b>	Access to the tag in the user program:
	RW The tag can be read and written in the user program.
	R The tag can be read in the user program.
	- The tag cannot be used in the user program.
<b>Effective</b>	Specifies when a change in the tag takes effect.
<b>HMI</b>	The tag can be used in an HMI system.

<Axis name>.MotionStatus.Position				
Current position of the axis (specified in the configured unit of measurement) If the axis is not homed, the tag indicates the position value relative to the enable position of the axis.				
Data type	Start value	Access	Effective	HMI
Real	0.0	R	-	X

<Axis name>.MotionStatus.Velocity				
Current velocity of the axis (specified in the configured unit of measurement)				
Data type	Start value	Access	Effective	HMI
Real	0.0	R	-	X

<Axis name>.MotionStatus.Distance				
Current distance to the target position of the axis (specified in the configured unit of measurement) The value of the tag is only valid during execution of a positioning command with "MC_MoveAbsolute" or "MC_MoveRelative" or of the axis command table.				
Data type	Start value	Access	Effective	HMI
Real	0.0	R	-	X

<b>&lt;Axis name&gt;.MotionStatus.TargetPosition</b>				
Target position of axis (specified in the configured unit of measurement) The value of the tag is only valid during execution of a positioning command with "MC_MoveAbsolute" or "MC_MoveRelative" or of the axis command table.				
Data type	Start value	Access	Effective	HMI
Real	0.0	R	-	X

**See also**

Motion status (Page 6091)

**StatusBits. tag**

**Legend**

<b>Data type</b>	Data type of the tag
<b>Start value</b>	Start value of tag
<b>Access</b>	Access to the tag in the user program:
	RW   The tag can be read and written in the user program.
	R   The tag can be read in the user program.
	-   The tag cannot be used in the user program.
<b>Effective</b>	Specifies when a change in the tag takes effect.
<b>HMI</b>	The tag can be used in an HMI system.

<b>&lt;Axis name&gt;.StatusBits.Activated</b>				
TRUE = The axis is activated. It is connected to the assigned PTO (Pulse Train Output). The data of the technology data block will be updated cyclically.				
Data type	Start value	Access	Effective	HMI
Bool	FALSE	R	-	X

<b>&lt;Axis name&gt;.StatusBits.Enable</b>				
TRUE = The axis is enabled and ready to take on Motion Control commands.				
Data type	Start value	Access	Effective	HMI
Bool	FALSE	R	-	X

<b>&lt;Axis name&gt;.StatusBits.HomingDone</b>				
TRUE = The axis is homed and is capable of executing absolute positioning commands. The axis does not have to be homed for relative homing.				
The status is FALSE during active homing. The status will remain TRUE during passive homing if the axis has already been homed.				
Data type	Start value	Access	Effective	HMI
Bool	FALSE	R	-	X

<b>&lt;Axis name&gt;.StatusBits.Done</b>				
TRUE = No Motion Control command is active on the axis.				
Data type	Start value	Access	Effective	HMI
Bool	FALSE	R	-	X

<b>&lt;Axis name&gt;.StatusBits.Error</b>				
TRUE = An error occurred in the axis technology object. Detailed information about the error is available in automatic mode in the "ErrorID" and "ErrorInfo" parameters of the motion control instructions. In manual mode, the "Error message" field of the axis command table displays detailed information about the cause of error.				
Data type	Start value	Access	Effective	HMI
Bool	FALSE	R	-	X

<b>&lt;Axis name&gt;.StatusBits.StandStill</b>				
TRUE = The axis is at a standstill.				
Data type	Start value	Access	Effective	HMI
Bool	FALSE	R	-	X

<b>&lt;Axis name&gt;.StatusBits.PositioningCommand</b>				
TRUE = The axis is executing a positioning command.				
Data type	Start value	Access	Effective	HMI
Bool	FALSE	R	-	X

<b>&lt;Axis name&gt;.StatusBits.SpeedCommand</b>				
TRUE = The axis is executing a travel command at predefined velocity.				
Data type	Start value	Access	Effective	HMI
Bool	FALSE	R	-	X

<b>&lt;Axis name&gt;.StatusBits.Homing</b>				
TRUE = The axis is executing a homing command of the "MC_Home" Motion Control instruction or axis command table.				
Data type	Start value	Access	Effective	HMI
Bool	FALSE	R	-	X

<b>&lt;Axis name&gt;.StatusBits.CommandTableActive</b>				
TRUE = The axis is controlled by Motion Control instruction "MC_CommandTable".				
Data type	Start value	Access	Effective	HMI
Bool	FALSE	R	-	X

<b>&lt;Axis name&gt;.StatusBits.ConstantVelocity</b>				
TRUE = The axis travels at constant velocity.				
Data type	Start value	Access	Effective	HMI
Bool	FALSE	R	-	X

<b>&lt;Axis name&gt;.StatusBits.Acceleration</b>				
TRUE = The axis accelerates.				
Data type	Start value	Access	Effective	HMI
Bool	FALSE	R	-	X

<b>&lt;Axis name&gt;.StatusBits.Deceleration</b>				
TRUE = The axis decelerates (slows down).				
Data type	Start value	Access	Effective	HMI
Bool	FALSE	R	-	X

<b>&lt;Axis name&gt;.StatusBits.ControlPanelActive</b>				
TRUE = The "Manual control" mode has been enabled in the axis command table. The axis command table has control priority over the "Axis" technology object. The axis cannot be controlled from the user program.				
Data type	Start value	Access	Effective	HMI
Bool	FALSE	R	-	X

<b>&lt;Axis name&gt;.StatusBits.DriveReady</b>				
TRUE = The drive is ready.				
Data type	Start value	Access	Effective	HMI
Bool	FALSE	R	-	X

<b>&lt;Axis name&gt;.StatusBits.RestartRequired</b>				
TRUE = Values were modified in the load memory.				
To download the values in the CPU RUN operating mode to the work memory, you need to restart the axis. Use the Motion Control instruction MC_Reset to do this.				
Data type	Start value	Access	Effective	HMI
Bool	FALSE	R	-	X

**See also**

Status and error bits (Page 6089)

**ErrorBits. tag**

**Legend**

<b>Data type</b>	Data type of the tag			
<b>Start value</b>	Start value of tag			
<b>Access</b>	Access to the tag in the user program:			
	RW	The tag can be read and written in the user program.		
	R	The tag can be read in the user program.		
	-	The tag cannot be used in the user program.		



<b>Effective</b>	Specifies when a change in the tag takes effect.
<b>HMI</b>	The tag can be used in an HMI system.

<b>&lt;Axis name&gt;.ErrorBits.SystemFault</b>				
TRUE = Internal system error.				
<b>Data type</b>	<b>Start value</b>	<b>Access</b>	<b>Effective</b>	<b>HMI</b>
Bool	FALSE	R	-	X

<b>&lt;Axis name&gt;.ErrorBits.ConfigFault</b>				
TRUE = Incorrect configuration of axis.				
<b>Data type</b>	<b>Start value</b>	<b>Access</b>	<b>Effective</b>	<b>HMI</b>
Bool	FALSE	R	-	X

<b>&lt;Axis name&gt;.ErrorBits.DriveFault</b>				
TRUE = The drive has reported an error after failure of its "Drive ready" signal.				
<b>Data type</b>	<b>Start value</b>	<b>Access</b>	<b>Effective</b>	<b>HMI</b>
Bool	FALSE	R	-	X

<b>&lt;Axis name&gt;.ErrorBits.SwLimitMinReached</b>				
TRUE = The low software limit switch has been reached.				
<b>Data type</b>	<b>Start value</b>	<b>Access</b>	<b>Effective</b>	<b>HMI</b>
Bool	FALSE	R	-	X

<b>&lt;Axis name&gt;.ErrorBits.SwLimitMinExceeded</b>				
TRUE = The low software limit switch has been exceeded.				
<b>Data type</b>	<b>Start value</b>	<b>Access</b>	<b>Effective</b>	<b>HMI</b>
Bool	FALSE	R	-	X

<b>&lt;Axis name&gt;.ErrorBits.SwLimitMaxReached</b>				
TRUE = The high software limit switch has been reached.				
<b>Data type</b>	<b>Start value</b>	<b>Access</b>	<b>Effective</b>	<b>HMI</b>
Bool	FALSE	R	-	X

<b>&lt;Axis name&gt;.ErrorBits.SwLimitMaxExceeded</b>				
TRUE = The high software limit switch has been exceeded.				
<b>Data type</b>	<b>Start value</b>	<b>Access</b>	<b>Effective</b>	<b>HMI</b>
Bool	FALSE	R	-	X

<b>&lt;Axis name&gt;.ErrorBits.HwLimitMin</b>				
TRUE = The low hardware limit switch has been approached.				
Data type	Start value	Access	Effective	HMI
Bool	FALSE	R	-	X

<b>&lt;Axis name&gt;.ErrorBits.HwLimitMax</b>				
TRUE = The high hardware limit switch has been approached.				
Data type	Start value	Access	Effective	HMI
Bool	FALSE	R	-	X

<b>&lt;Axis name&gt;.ErrorBits.HwUsed</b>				
TRUE = A second axis is using the same PTO (Pulse Train Output) and is enabled with "MC_Power".				
Data type	Start value	Access	Effective	HMI
Bool	FALSE	R	-	X

**See also**

Status and error bits (Page 6089)

**Internal. tag**

The "Internal" tags contain no user-relevant data; these tags cannot be accessed in the user program.

**ControlPanel tag**

The "ControlPanel" tags contain no user-relevant data; these tags cannot be accessed in the user program.

**Update of the technology object tags**

The status and error information of the axis indicated in the technology object tags is updated at each cycle control point.

The change in values of editable configuration tags does not take effect immediately. For information on the conditions under which a change takes effect, refer to the detailed description of the relevant tag.

### 11.2.12.9 Command table technology object tag

#### Config.Command.Command[1 ... 32] tag

##### Legend

<b>Data type</b>	Data type of the tag
<b>Start value</b>	Start value of tag The start value can be overwritten by the configuration of the command table.
<b>Access</b>	Access to the tag in the user program:
	RW   The tag can be read and written in the user program.
	R   The tag can be read in the user program.
	-   The tag cannot be used in the user program.
<b>Effective</b>	Specifies when a change in the tag takes effect.
<b>HMI</b>	The tag can be used in an HMI system.

<b>&lt;Axis name&gt;.Config.Command.Command[x].Type</b>				
Command type				
<ul style="list-style-type: none"> <li>• 0 = "Empty" command</li> <li>• 2 = "Hold" command</li> <li>• 5 = "Relative positioning" command</li> <li>• 6 = "Absolute positioning" command</li> <li>• 7 = "Velocity setpoint" command</li> <li>• 151 = "Wait" command</li> </ul>				
<b>Data type</b>	<b>Start value</b>	<b>Access</b>	<b>Effective</b>	<b>HMI</b>
Int	0	RW	-	X

<b>&lt;Axis name&gt;. Config.Command.Command[x].Position</b>				
Command target position / travel path				
<b>Data type</b>	<b>Start value</b>	<b>Access</b>	<b>Effective</b>	<b>HMI</b>
Real		RW	-	X

<b>&lt;Axis name&gt;. Config.Command.Command[x].Velocity</b>				
Command velocity				
<b>Data type</b>	<b>Start value</b>	<b>Access</b>	<b>Effective</b>	<b>HMI</b>
Real	0.0	RW	-	X

<b>&lt;Axis name&gt;. Config.Command.Command[x].Duration</b>				
Command duration				
<b>Data type</b>	<b>Start value</b>	<b>Access</b>	<b>Effective</b>	<b>HMI</b>
Real	0.0	RW	-	X

<Axis name>. Config.Command.Command[x].BufferMode				
Value for command "Next step"				
<ul style="list-style-type: none"> <li>• 0 = "Complete command"</li> <li>• 1 = "Blend movement"</li> </ul>				
Data type	Start value	Access	Effective	HMI
Int	0	RW	-	X

<Axis name>. Config.Command.Command[x].StepCode				
Command step code				
Data type	Start value	Access	Effective	HMI
Word	0	RW	-	X

### 11.2.12.1 Documentation for functions from previous versions

0

#### Configuration - Homing (technology object "Axis" V1.0)

Configure the parameters for active and passive homing in the "Homing" configuration window. The homing method is set using the "Mode" input parameter of the motion control instruction. Here, Mode = 2 means passive homing and Mode = 3 means active homing.

#### Homing switch input

Select the digital input for the homing switch from the drop-down list. The input must be interrupt-capable. The onboard CPU inputs and the inputs of an inserted signal board can be selected as inputs for the homing switch.

---

#### Note

The digital inputs are set to a filter time of 6.4 ms by default.

When the digital inputs are used as a homing switch, this can result in undesired decelerations and thus inaccuracies. Depending on the homing velocity and extent of the homing switch, the home position may not be detected. The filter time can be set under "Input filter" in the device configuration of the digital inputs.

The specified filter time must be less than the duration of the input signal at the homing switch.

---

#### Permitting direction reversal after reaching the HW limit switch (active homing only)

Activate the check box to use the hardware limit switch as a reversing cam for the home position approach. The hardware limit switches must be activated for direction reversal. If the CPU firmware V1.0 is used, both hardware limit switches must be configured. If CPU firmware as of V2.0 is used, only the hardware limit switches in the approach direction must be configured.

If the hardware limit switch is reached during active homing, the axis brakes at the configured deceleration (not with the emergency stop deceleration) and reverses direction. The homing switch is then sensed in reverse direction.

If the direction reversal is not active and the axis reaches the hardware limit switch during active homing, the home position approach is aborted with an error and the axis is braked at the emergency stop deceleration.

---

**Note**

Use one of the following measures to ensure that the machine does not travel to a mechanical endstop in the event of a direction reversal:

- Keep the approach velocity low
  - Increase the configured acceleration/deceleration
  - Increase the distance between hardware limit switch and mechanical stop
- 

### Approach / homing direction (active and passive homing)

With the direction selection, you determine the "approach direction" used during active homing to search for the homing switch, as well as the homing direction. The homing direction specifies the travel direction the axis uses to approach the configured side of the homing switch to carry out the homing operation.

Refer to the table under "Homing switches" for the effect of the approach direction setting on passive homing.

### Side of the homing switch (active and passive homing)

- **Active homing**

This is where you select whether the axis is homed on the low or high side of the homing switch.

---

**Note**

Depending on the start position of the axis and the configuration of the homing parameters, the home position approach sequence can differ from the diagram in the configuration window.

---

- **Passive homing**

With passive homing, the traversing motions for purposes of homing must be implemented by the user via motion commands. The side of the homing switch on which homing occurs depends on the following factors:

- "Approach direction" configuration
- "Homing switch" configuration
- Current travel direction during passive homing

The table below presents details on the effect of factors:

Influencing factors:			Result:
Configuration Approach direction	Configuration Homing switch	Current travel direction	Homing on Homing switch
Positive	"Bottom side"	Positive direction	<b>Top side</b>
		Negative direction	<b>Bottom side</b>
Positive	"Top side"	Positive direction	<b>Bottom side</b>
		Negative direction	<b>Top side</b>
Negative	"Bottom side"	Positive direction	<b>Bottom side</b>
		Negative direction	<b>Top side</b>
Negative	"Top side"	Positive direction	<b>Top side</b>
		Negative direction	<b>Bottom side</b>

### Velocity (active homing only)

In this field, specify the velocity at which the homing switch is to be searched for during the home position approach.

Limits (independent of the selected unit of measurement):

- Start/stop velocity ≤ approach velocity ≤ maximum velocity

### Homing velocity (active homing only)

In this field, specify the velocity at which the axis approaches the homing switch for homing.

Limits (independent of the selected unit of measurement):

- Start/stop velocity ≤ Homing velocity ≤ Maximum velocity

### Home position offset (active homing only)

If the desired home position deviates from the position of the homing switch, the home position offset can be specified in this field.

If the value does not equal 0, the axis executes the following actions following homing at the homing switch:

1. Move the axis at the homing velocity by the value of the home position offset
2. Upon reaching the "home position offset", the axis is at the home position that was specified in input parameter "Position" of the "MC\_Home" Motion Control instruction.

Limits (independent of the selected unit of measurement):

- $-1.0e12 \leq \text{home position offset} \leq 1.0e12$

### Home position

The position configured in the Motion Control instruction "MC\_Home" is used as the home position.

### List of ErrorIDs and ErrorInfos (technology objects V1.0)

The following table lists all ErrorIDs and ErrorInfos that can be indicated in motion control instructions. In addition to the cause of the error, remedies for eliminating the error are also listed:

#### Operating error with stop of the axis

ErrorID	ErrorInfo	Description	Remedy
<b>16#8000</b>		<b>Drive error, "Drive ready" failure</b>	
	16#0001	-	Acknowledge error with instruction "MC_Reset"; provide drive signal; possibly restart command
<b>16#8001</b>		<b>Low software limit switch has been tripped</b>	
	16#000E	The position of the low software limit switch was reached with the currently configured deceleration	Acknowledge the error with instruction "MC_Reset"; use a motion command to move the axis in the positive direction out of the range of the software limit switch
	16#000F	The position of the low software limit switch was reached with the emergency stop deceleration	
	16#0010	The position of the low software limit switch was exceeded with the emergency stop deceleration	
<b>16#8002</b>		<b>High software limit switch has been tripped</b>	
	16#000E	The position of the high software limit switch was reached with the currently configured deceleration	Acknowledge the error with instruction "MC_Reset"; use a motion command to move the axis in the negative direction out of the range of the software limit switch
	16#000F	The position of the high software limit switch was reached with the emergency stop deceleration	
	16#0010	The position of the high software limit switch was exceeded with the emergency stop deceleration	
<b>16#8003</b>		<b>Low hardware limit switch was approached</b>	
	16#000E	The low hardware limit switch was approached. The axis was stopped with the emergency stop deceleration. (During an active home position approach, the homing switch was not found)	Acknowledge the error for a released axis with instruction "MC_Reset"; use a motion command to move the axis in the positive direction out of the range of the hardware limit switch.
<b>16#8004</b>		<b>High hardware limit switch was approached</b>	
	16#000E	The high hardware limit switch was approached. The axis was stopped with the emergency stop deceleration. (During an active home position approach, the homing switch was not found)	Acknowledge the error for a released axis with instruction "MC_Reset"; use a motion command to move the axis in the negative direction out of the range of the hardware limit switch.
<b>16#8005</b>		<b>PTO/HSC are already being used by another axis</b>	

ErrorID	ErrorInfo	Description	Remedy
	16#0001	-	<p><b>The axis was configured incorrectly:</b> Correct the configuration of the PTO (Pulse Train Output) / HSC (High Speed Counter) and download it to the controller</p> <p><b>More than one axis is to run with one PTO:</b> Another axis is using the PTO/HSC. If the current axis is to assume the control, the other axis must be disabled with "MC_Power" Enable = FALSE. (see also Using multiple axes with the same PTO (Page 6093))</p>

### Operating error without stop of the axis

ErrorID	ErrorInfo	Description	Remedy
<b>16#8200</b>		<b>Axis is not released</b>	
	16#0001	-	Release the axis; restart the command
<b>16#8201</b>		<b>Axis has already been released by another "MC_Power" instance</b>	
	16#0001	-	Enable the axis with only one "MC_Power" instruction
<b>16#8202</b>		<b>The maximum number of simultaneously active motion control commands was exceeded (maximum of 200 commands for all motion control technology objects)</b>	
	16#0001	-	Reduce the number of simultaneously active commands; restart the command A command is active if parameter "Busy" = TRUE in the motion control instruction.
<b>16#8203</b>		<b>Axis is currently operated in "Manual control" (axis command table)</b>	
	16#0001	-	Exit "Manual control"; restart the command
<b>16#8204</b>		<b>Axis is not homed</b>	
	16#0001	-	Home the axis with instruction "MC_Home"; restart the command
<b>16#8205</b>		<b>The axis is currently controlled by the user program (the error is only displayed in the axis command table)</b>	
	16#0001	-	Disable axis with instruction "MC_Power" and select "Manual control" again in the axis command table
<b>16#8206</b>		<b>Technology object Axis not yet enabled</b>	
	16#0001	-	Release the axis with instruction "MC_Power" Enable = TRUE or enable the axis in the axis command table.
<b>16#8207</b>		<b>Command rejected</b>	
	16#0016	Active homing is running; another homing method cannot be started.	Wait for active homing to finish or abort the active homing with a motion command, for example, "MC_Halt". The other homing type can then be started.



## Block parameter error

ErrorID	ErrorInfo	Description	Remedy
<b>16#8400</b>		<b>Invalid value at parameter "Position" of the Motion Control instruction</b>	
	16#0002	Number format of value is invalid	Correct the "position" value; restart the command
	16#0005	The value is outside the number range (greater than $1e^{12}$ )	
	16#0006	The value is outside the number range (less than $-1e^{12}$ )	
<b>16#8401</b>		<b>Invalid value at parameter "Distance" of the Motion Control instruction</b>	
	16#0002	Number format of value is invalid	Correct the "Distance" value; restart the command
	16#0005	The value is outside the number range (greater than $1e^{12}$ )	
	16#0006	The value is outside the number range (less than $-1e^{12}$ )	
<b>16#8402</b>		<b>Invalid value at parameter "Velocity" of the Motion Control instruction</b>	
	16#0002	Number format of value is invalid	Correct the "Velocity" value; restart the command
	16#0008	Velocity is greater than the maximum velocity	
	16#0009	Velocity is less than the start/stop velocity	
<b>16#8403</b>		<b>Invalid value at parameter "Direction" of the Motion Control instruction</b>	
	16#0011	Invalid selection value	Correct the selection value; restart the command
<b>16#8404</b>		<b>Invalid value at parameter "Mode" of the Motion Control instruction</b>	
	16#0011	Invalid selection value	Correct the selection value; restart the command
	16#0015	Active/passive homing is not configured	Correct the configuration and download it to the controller; release the axis and restart the command
	16#0017	Axis reversal is activated at the HW limit switch, despite the fact that the hardware limit switches are disabled	<ul style="list-style-type: none"> <li>• Activate the hardware limit switch using the tag &lt;Axis&gt;.Config.PositionLimits_HW.Active = TRUE, restart the command</li> <li>• Correct the configuration and download it to the controller; release the axis and restart the command</li> </ul>
<b>16#8405</b>		<b>Invalid value at parameter "StopMode" of the Motion Control instruction</b>	
	16#0011	Invalid selection value	Correct the selection value; release the axis again
<b>16#8406</b>		<b>Simultaneous forward and backward jogging is not allowed</b>	
	16#0001	-	Take steps to ensure that parameters "JogForward" and "JogBackward" do not have signal status TRUE simultaneously; restart the command.
<b>16#8407</b>		<b>Switching the axis with Motion Control instruction "MC_Power" is only permitted after disabling the axis.</b>	
	16#0001	-	Disable the active axis; it is then possible to switch to the other axis and release it.

## Configuration error

ErrorID	ErrorInfo	Description	Remedy
<b>16#8600</b>		<b>Parameter assignment of pulse generator (PTO is invalid)</b>	
	16#000B	Address is invalid	Correct the configuration of the PTO (Pulse Train Output) and download it to the controller
<b>16#8601</b>		<b>Parameterization of the high-speed counter (HSC) is invalid</b>	
	16#000B	Address is invalid	Correct the configuration of the HSC (High Speed Counter) and download it to the controller
<b>16#8602</b>		<b>Invalid parameter assignment of "Enable output"</b>	
	16#000D	Address is invalid	Correct the configuration and download it to the controller
<b>16#8603</b>		<b>Invalid parameter assignment of "Ready input"</b>	
	16#000D	Address is invalid	Correct the configuration and download it to the controller
<b>16#8604</b>		<b>Invalid "Pulses per motor revolution" value</b>	
	16#000A	Value is less than or equal to zero	Correct the configuration and download it to the controller
<b>16#8605</b>		<b>Invalid "Load distance per motor revolution" value</b>	
	16#0002	Number format of value is invalid	Correct the configuration and download it to the controller
	16#000A	Value is less than or equal to zero	
<b>16#8606</b>		<b>Invalid "Start / stop velocity" value</b>	
	16#0002	Number format of value is invalid	Correct the configuration and download it to the controller
	16#0003	Value exceeds the hardware limit	
	16#0004	Value is less than the hardware limit	
	16#0007	The start/stop velocity is greater than the maximum velocity	
<b>16#8607</b>		<b>Invalid "Maximum velocity" value</b>	
	16#0002	Number format of value is invalid	Correct the configuration and download it to the controller
	16#0003	Value exceeds the hardware limit	
	16#0004	Value is less than the hardware limit	
<b>16#8608</b>		<b>Invalid "Acceleration" value</b>	
	16#0002	Number format of value is invalid	<ul style="list-style-type: none"> <li>Download error-free configuration to the controller; release the axis again with instruction "MC_Power"</li> <li>Correct the incorrect value online; acknowledge error with instruction "MC_Reset" and restart the command, if necessary</li> </ul>
	16#0003	Value exceeds the hardware limit	
	16#0004	Value is less than the hardware limit	
<b>16#8609</b>		<b>Invalid "Deceleration" value</b>	
	16#0002	Number format of value is invalid	<ul style="list-style-type: none"> <li>Download error-free configuration to the controller; release the axis again with instruction "MC_Power"</li> <li>Correct the incorrect value online; acknowledge error with instruction "MC_Reset" and restart the command, if necessary</li> </ul>
	16#0003	Value exceeds the hardware limit	
	16#0004	Value is less than the hardware limit	
<b>16#860A</b>		<b>Invalid "Emergency stop deceleration" value</b>	

ErrorID	ErrorInfo	Description	Remedy
	16#0002	Number format of value is invalid	<ul style="list-style-type: none"> <li>Download error-free configuration to the controller; release the axis again with instruction "MC_Power"</li> <li>Correct the incorrect value online; acknowledge error with instruction "MC_Reset" and restart the command, if necessary</li> </ul>
	16#0003	Value exceeds the hardware limit	
	16#0004	Value is less than the hardware limit	
<b>16#860B</b>		<b>Value for position of the low SW limit switch is invalid</b>	
	16#0002	Number format of value is invalid	<ul style="list-style-type: none"> <li>Download error-free configuration to the controller; release the axis again with instruction "MC_Power"</li> <li>Correct the incorrect value online; acknowledge error with instruction "MC_Reset" and restart the command, if necessary</li> </ul>
	16#0005	The value is outside the number range (greater than $1e^{12}$ )	
	16#0006	The value is outside the number range (less than $-1e^{12}$ )	
	16#0007	The position value of the low SW limit switch is greater than that of the high SW limit switch	
<b>16#860C</b>		<b>Value for position of the high SW limit switch is invalid</b>	
	16#0002	Number format of value is invalid	<ul style="list-style-type: none"> <li>Download error-free configuration to the controller; release the axis again with instruction "MC_Power"</li> <li>Correct the incorrect value online; acknowledge error with instruction "MC_Reset" and restart the command, if necessary</li> </ul>
	16#0005	The value is outside the number range (greater than $1e^{12}$ )	
	16#0006	The value is outside the number range (less than $-1e^{12}$ )	
<b>16#860D</b>		<b>Invalid address of the low HW limit switch</b>	
	16#000C	Address of falling edge is invalid	Correct the configuration and download it to the controller
	16#000D	Address of rising edge is invalid	
<b>16#860E</b>		<b>Invalid address of the high HW limit switch</b>	
	16#000C	Address of falling edge is invalid	Correct the configuration and download it to the controller
	16#000D	Address of rising edge is invalid	
<b>16#860F</b>		<b>Invalid "home position offset" value</b>	
	16#0002	Number format of value is invalid	Correct the configuration and download it to the controller
	16#0005	The value is outside the number range (greater than $1e^{12}$ )	
	16#0006	The value is outside the number range (less than $-1e^{12}$ )	
<b>16#8610</b>		<b>Invalid "approach velocity" value</b>	
	16#0002	Number format of value is invalid	Correct the configuration and download it to the controller
	16#0008	Velocity is greater than the maximum velocity	
	16#0009	Velocity is less than the start/stop velocity	
<b>16#8611</b>		<b>Invalid "Homing velocity" value</b>	
	16#0002	Number format of value is invalid	Correct the configuration and download it to the controller
	16#0008	Velocity is greater than the maximum velocity	
	16#0009	Velocity is less than the start/stop velocity	
<b>16#8612</b>		<b>Invalid address of the homing switch</b>	
	16#000C	Address of falling edge is invalid	Correct the configuration and download it to the controller
	16#000D	Address of rising edge is invalid	

ErrorID	ErrorInfo	Description	Remedy
16#8613		During active homing, direction reversal at the hardware limit switch is activated although the hardware limit switches are not configured	
	16#0001	-	Correct the configuration and download it to the controller

**Internal errors**

ErrorID	ErrorInfo	Description	Remedy
16#8FFF		Internal error	
	16#F0**	-	POWER OFF and POWER ON the CPU If this does not work, contact Customer Support. Have the following information ready: <ul style="list-style-type: none"><li>• ErrorID</li><li>• ErrorInfo</li><li>• Diagnostic buffer entries</li></ul>

**See also**

Using multiple axes with the same PTO (Page 6093)

## Using online and diagnostics functions

### 12.1 Displaying accessible devices

#### Accessible devices

Accessible devices are all devices connected to an interface of the programming device / PC and that are turned on. Devices that allow only restricted configuration using the currently installed products or that cannot be configured at all can also be displayed.

#### Displaying accessible devices on an interface of the programming device / PC in the project tree

To display accessible devices on a single interface of the programming device / PC, follow these steps:

1. Open the "Online access" folder in the project tree.
2. Click on the arrow to the left of the interface to show all the objects arranged below the interface.
3. Double-click on the "Update accessible devices" command below the interface.  
All devices that are accessible over this interface are displayed in the project tree. When there is a large number of connected devices, the update process may take some time. You can see the progress of the update in the status bar. If you have found the desired device before the update is completed, you can cancel the update of accessible devices. To do this, click on the cross to the right of the progress bar.

#### Displaying accessible devices in a list

To display the accessible devices on all available interfaces in an overview list, follow these steps:

1. Select the "Accessible devices" command in the "Online" menu.  
The "Accessible devices" dialog is displayed.
2. Select the type of interface from the "Type of the PG/PC interface" drop-down list. The "PG/PC interface" drop-down list then shows only the interfaces of the programming device / PC that match the selected interface type.
3. Select the required interface of the programming device / PC from the "PG/PC interface" drop-down list, for example an Industrial Ethernet adapter.  
If no devices are available on an interface, an unbroken connecting line is displayed between the programming device / PC and the device. If devices are accessible, an unbroken connecting line is shown and the devices accessible on the selected interface of the programming device / PC are displayed in a list.

*12.1 Displaying accessible devices*

4. If you have connected a new device in the meantime, click the "Refresh" button to refresh the list of accessible devices.
5. To go to a device in the project tree, select the device from the list of accessible devices and click the "Show" button.  
The interface to which the selected device is connected is shown as selected in the project tree.

**Displaying additional information about the accessible devices in the project tree**

To display additional information on the accessible devices in the project tree, follow these steps:

1. Click on the arrow to the left of one of the accessible devices in the project tree.  
All data available online, for example blocks and system data, is displayed for known devices. Objects that you cannot edit directly at this point are grayed out. If additional editing options are available for a device, for example, downloading using the shortcut menu, the device is shown in black text.

**See also**

Changing the device configuration online (Page 6145)

## 12.2 Changing the device configuration online

You can assign parameters to some devices, preferably in small hardware setups, directly online. You do not need to create a project or have offline data to do this. In this way, you can quickly and easily change the device configuration. You do not need to compile the hardware configuration or perform a download. Depending on the device, either all changes become active immediately or they are written to the device only after confirmation.

### Requirement

- The device must support online parameter assignment. You can learn whether or not your specific devices support this function in the device manual.
- The device must be connected to the PG/PC and available in the list of accessible devices.

### Procedure

To change the device configuration online, follow these steps:

1. Show the accessible devices on the interface via which the device is connected. To learn how to show the accessible devices, see the previous chapter "Showing accessible devices (Page 6141)".
2. Expand the device to display the lower-level elements.
3. Double-click the "Parametrize device" item.  
A configuration page for the device opens in the work area.
4. Make all required settings.  
With some devices, the new settings take effect immediately.
5. Optionally, depending on the device: Click on the "Upload to device" button.  
The settings are transferred to the device.

## 12.3 Connecting devices online

### 12.3.1 General information about online mode

#### Online mode

In online mode, there is an online connection between your programming device / PC and one or more devices.

An online connection between the programming device/PC and the device is required, for example, for the following tasks:

- Testing user programs
- Displaying and changing the operating mode of the CPU
- Displaying and setting the date and time of day of the CPU
- Displaying module information
- Comparing blocks
- Hardware diagnostics

Before you can establish an online connection, the programming device/PC and the device must be physically or remotely connected. As an alternative, some devices support a simulation mode. In this case, a connection to the device is simulated via the PLCSIM virtual interface.

After establishing a connection, you can use the Online and Diagnostics view or the "Online tools" task card to access the data on the device. The current online status of a device is indicated by an icon to the right of the device in the project tree. You will find the meaning of the individual status icons in the relevant tooltip.

---

#### Note

Some online functions depend on the scope of the installed software or whether a project is open.

---

#### Standby or hibernation of the programming device / PC

If the programming device / PC is changed to the standby or hibernation mode when there is an online connection, all online connections are terminated. When the programming device / PC wakes up from hibernation, the online connections are not automatically re-established.

Note that suddenly terminating an online connection can lead to loss of data or a connected device may interrupt program execution.

#### Performing an LED flash test

In many online dialogs you can perform an LED flash test, if the device connected online supports this feature. If you select the "Flash LED" check box, an LED flashes on the currently



selected device. This feature is useful, for example, when you are not sure which device in the hardware configuration corresponds to the station currently selected in the software.

Read any additional information and learn about the possible limitations to the LED flash test in the respective device documentation.

## See also

View in online mode (Page 6147)

## 12.3.2 View in online mode

### Online displays

After the online connection has been established successfully, the user interface changes. If a device is unavailable, this is indicated by a symbol. The following figure shows a device connected online and the corresponding user interface:

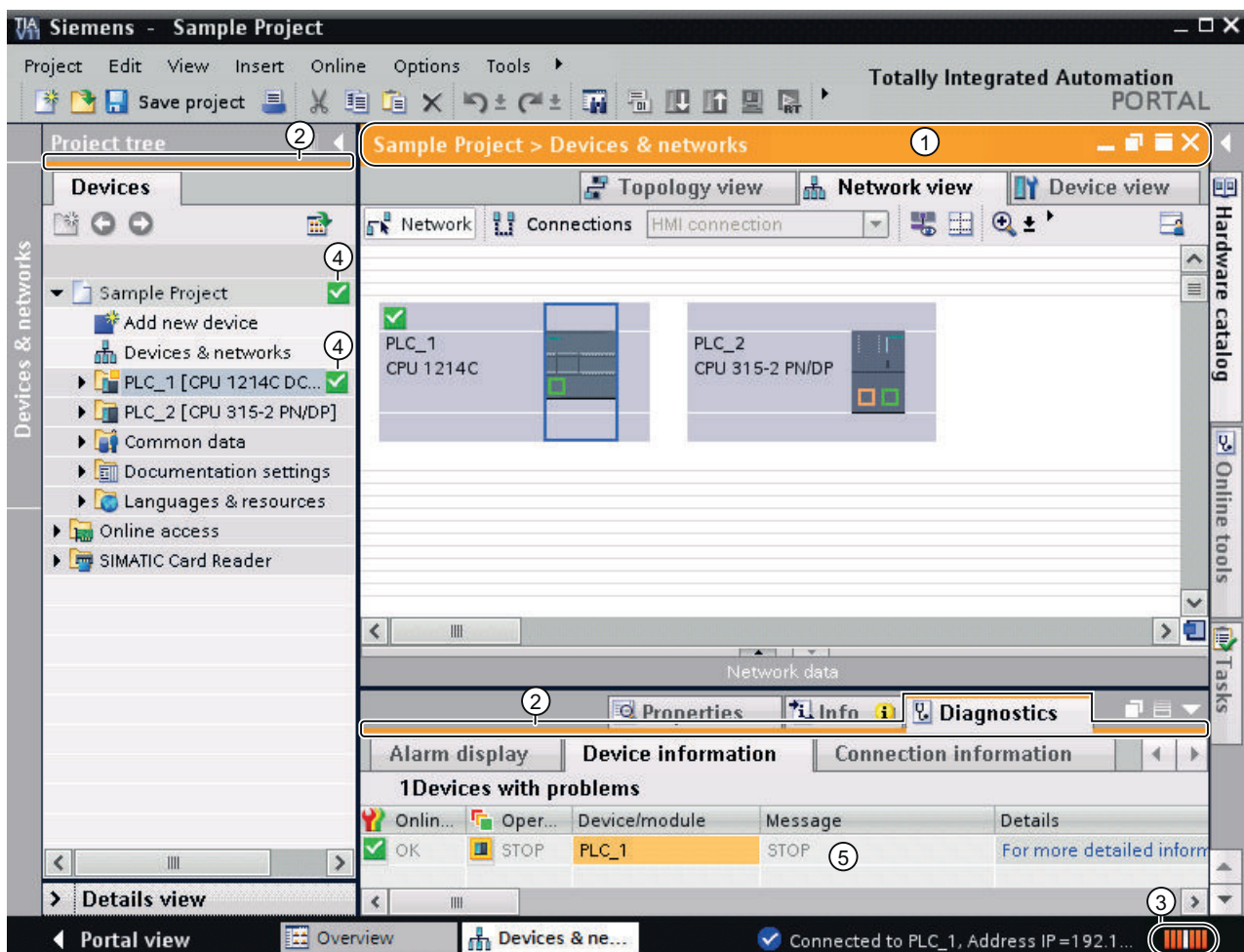

### 12.3 Connecting devices online

- ① The title bar of the active window gets an orange background as soon as at least one of the devices currently displayed in the editor has been successfully connected online. If one or more devices are unavailable, a symbol for a broken connection appears in the title bar of the editor.
- ② The title bars of inactive windows for the relevant station now have an orange line below them.
- ③ An orange, pulsing bar appears at the right-hand edge of the status bar. If the connection has been established but is functioning incorrectly, an icon for an interrupted connection is displayed instead of the bar. You will find more information on the error in "Diagnostics" in the Inspector window.
- ④ Operating mode symbols or diagnostics symbols for the stations connected online and their underlying objects are shown in the project tree. A comparison of the online and offline status is also made automatically. Differences between online and offline objects are also displayed in the form of symbols.
- ⑤ The "Diagnostics > Device information" area is brought to the foreground in the Inspector window.

#### Online connection abort

The online mode and its display are retained as long as at least one device is connected online. If the online connection to one or more devices aborts, the TIA Portal remains in online mode. The display of the TIA Portal changes to offline mode only when there is no longer an online connection to any device.

#### See also

General information about online mode (Page 6144)

Basics of project data comparison (Page 286)

### 12.3.3 Establishing and canceling an online connection

#### Requirement

At least one PG/PC interface is installed and is physically connected to a device, for example with an Ethernet cable. As an alternative, it is also possible to establish a virtual connection using PLCSIM.

## Go online

To establish an online connection, follow these steps:

1. In the project tree, select one or more devices to which you want an online connection to be established.
2. Select the "Go online" command in the "Online" menu.  
If the device was already connected to a specific PG/PC interface, the online connection is automatically established to the previous PG/PC interface. In this case, you can ignore the following steps. If there was no previous connection, the "Go online" dialog opens.
3. Select the type of interface from the "Type of the PG/PC interface" drop-down list. The "PG/PC interface" drop-down list then shows only the interfaces of the programming device / PC that match the selected interface type.
4. Select the required interface of the programming device / PC from the "PG/PC interface" drop-down list, for example an Industrial Ethernet adapter.
5. In the "Connection to subnet" drop-down list, select the interface via which the device is connected to the programming device or PC. In this case, a direct connection is established to the device, without a network node, for example, an interposed switch. Alternatively, select the appropriate subnet for the connection to the programming device or PC if the device can be accessed via a network node. If you do not know how the device is connected to the programming device or PC, choose the "Try all interfaces" entry.  
If you selected an MPI or PROFIBUS subnet, the bus parameters configured in the programming device/PC interface are applied at this point.
6. If the device is accessible via a gateway, select the gateway that connects the two subnets involved in the "1st gateway" drop-down list.  
If no devices are available on the interface, a broken connecting line is displayed between the programming device / PC and the device. If devices are accessible, an unbroken connecting line is shown and the devices accessible on the selected interface of the programming device/PC are displayed in the "Compatible devices in target subnet" list.
7. Optional: Click the "Update" button to update the "Compatible devices in target subnet" list.
8. Optional: Select the "Flash LED" check box to the left of the graphic to run an LED flash test. With this function, you can check that you have selected the correct device. The LED flash test is not supported by all devices.
9. Select your device in the "Compatible devices in target subnet" table, and confirm your selection with "Go online".  
The online connection to the selected target device is established.

## Result

After the online connection has been established, the title bars of the editors change to orange. An orange activity bar is also shown in the title bar of an editor and in the status bar. In the project tree, status symbols show the difference between online and offline objects.

### 12.3 Connecting devices online

The connection path is stored for future connection attempts. It is no longer necessary to open the "Go online" dialog unless you want to select a new connection path.

---

#### Note

If no accessible device is displayed, select a different network access for the PG/PC interface or check the settings of the interface.

---

### Canceling an online connection

To disconnect the existing online connection, follow these steps:

1. Select the device you want to disconnect from in the project tree.
2. Select the "Go offline" command in the "Online" menu.

### See also

Connecting online with several devices (Page 6150)

View in online mode (Page 6145)

Assigning a temporary IP address (Page 6161)

Influence of user rights (Page 244)

## 12.3.4 Connecting online with several devices

You can establish an online connection to several devices at the same time without needing to select individual devices previously in the network view.

### Requirement

- No device must be selected
- At least one PG/PC interface is installed and is physically connected to a device, for example with an Ethernet cable. As an alternative, it is also possible to establish a virtual online connection using PLCSIM or a remote connection.

### Procedure

To establish an online connection to several devices at the same time, follow these steps:

1. Select the project in the project tree.
2. Select the "Go online" command in the "Online" menu.  
The "Select devices" dialog opens with a table of all available devices.
3. Select the devices to which you want to establish an online connection in the "Go online" column.
4. Click the "Go online" button.

## Result

Without any further prompt for confirmation, a connection is established to all selected devices if a connection was already established to the selected devices at least once. If there was no previous online connection, the "Go online" dialog opens. In this case, first configure the online connection as described in the section "Go online and disconnect online connection (Page 6146)".

## See also

Establishing and canceling an online connection (Page 6146)

Assigning a temporary IP address (Page 6161)

### 12.3.5 Disconnecting online connections of multiple devices

You can disconnect the online connections to multiple devices at one time without needing to select individual devices beforehand in the network view.

## Requirement

- No device is selected.
- There is currently an online connection to at least one device.

## Procedure

To terminate the online connections to multiple devices at one time, follow these steps:

1. Select the "Go offline" command in the "Online" menu.  
The "Select devices" dialog opens with a table of all available devices.
2. Select the device for which you want to terminate the online connection in the "Go offline" column.
3. Click the "Go offline" button.

## Result

The online connection to the all the selected devices is terminated.

## 12.4 Backing up the software and hardware configuration of a device

### 12.4.1 Creating a backup of a device

#### Backing up the software and hardware configuration of an S7-300/400 CPU

If you have already downloaded a configuration to an S7-300/400 CPU, it is advisable to make a backup. You may have modified the configuration and want to test the new configuration. Before you download the new configuration to the CPU, you can create a backup of the current device state and then restore the current configuration at a later date. The backup is performed with the current values of the CPU. In the case of S7-400 CPUs with fail-safe function, the initial values are backed up.

You can create as many backups as you want and store a variety of configurations for a CPU. The backups are named with the name of the CPU and the time and date of the backup. You can find the backup in the project tree under the CPU in the "Online backups" folder.

The following figure shows an S7-319 CPU for which two backups were created:

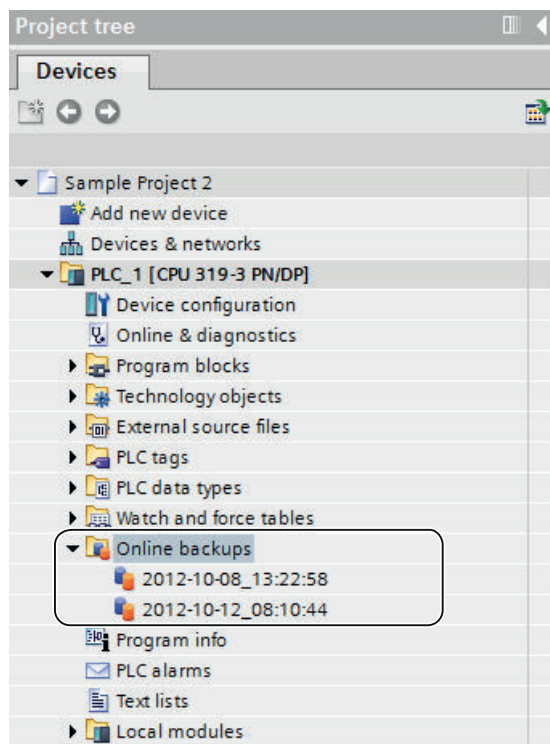

#### See also

Restoring the software and hardware configuration of a device (Page 6153)

Backing up a device configuration (Page 6153)

General information on loading (Page 281)

## 12.4.2 Backing up a device configuration

You can back up the configuration of a S7-300/400 CPU in the TIA Portal. So you can download and test a new configuration to a device without any risk. If needed, you can restore the initial configuration of the CPU.

### Requirement

- The CPU must already be created in the project.
- It must be an S7-300/400 CPU.
- With S7-400 CPUs, a Flash EPROM Memory Card must be plugged.
- The CPU must be online. If there is no online connection, an online connection is established during the backup.

### Procedure

To create a backup of the current configuration of a CPU, follow these steps:

1. Select the CPU in the project tree.
2. Select the "Backup from online device" command in the "Online" menu.

### Result:

A backup of the entire hardware configuration and software is created. The backup is stored in the project tree in the "Name of the CPU > Online backups" folder. The backup is assigned the name of the CPU with the time and date of the backup. You can rename the backup, but you cannot make any changes to the contents of the backup.

### See also

Establishing and canceling an online connection (Page 6146)

Restoring the software and hardware configuration of a device (Page 6153)

Creating a backup of a device (Page 6150)

## 12.4.3 Restoring the software and hardware configuration of a device

If you have backed up the configuration of a device at an earlier point in time, you can transfer the backup back to the device. The saved configuration is then restored on the device.

### Requirement

You must have previously configured the device and stored a backup of the device in the project.

## Procedure

To restore older software and hardware state on a device, follow these steps:

1. Open up the folder of the device in the project tree to display the lower-level objects.
2. Open the "Online backups" folder.
3. Select the backup you want to restore.
4. In the "Online" menu, select the "Download to device" command.
  - If you had previously established an online connection, the "Load preview" dialog opens. This dialog displays messages and proposes actions necessary for downloading.
  - If you had not previously established an online connection, the "Extended download to device" dialog opens, and you must first select the interfaces via which you want to establish the online connection to the device.  
See also: Establishing and terminating an online connection (Page 6146)
5. Check the messages in the "Load preview" dialog, and select the actions in the "Action" column, if necessary.

---

### Note

Performing the proposed actions while the plant is in operation can cause serious bodily injury and property damage in the event of malfunctions or program errors.

---

6. As soon as loading becomes possible, the "Load" button is enabled.
7. Click the "Load" button.  
The backup is transferred to the device and device is restored. The "Load results" dialog then opens. In this dialog, you can check whether or not the loading operation was successful and take any further action that may be necessary.
8. Click the "Finish" button.

## See also

Creating a backup of a device (Page 6150)



## 12.5 Configuring the PG/PC interface

### 12.5.1 Online access

#### Online access of the project

In the "Online access" folder of the project tree, you will find all active interfaces of your programming device/PC. Each interface icon provides you with information on the status of the interface. You can also display the accessible devices and display and edit the properties of an interface using the shortcut menu.

The following figure shows the "Online access" folder in the project tree.

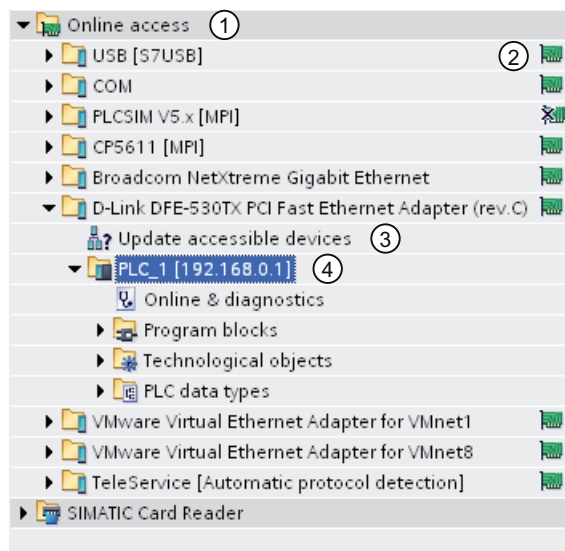

- ① "Online access" folder in the project tree  
All interfaces installed in the programming device/PC are displayed in the "Online access" folder.
- ② Status display for the interfaces  
The current status of an interface is indicated by an icon to the right of the name. You can see the meaning of the icon in the tooltip.
- ③ Updating the list of accessible devices.  
This function is available for each hardware interface of the programming device/PC. Software interfaces, such as a remote connection, do not offer this function.
- ④ Devices connected via the respective interface with the programming device/PC  
The type of the respective device and its status are displayed by the preceding icon.

### Displaying or updating accessible devices







You have the following options if you want to display all devices accessible online on your programming device/PC:

- Display of the accessible devices on a single interface of the programming device / PC in the project tree. In the project tree, you can also display additional information about the individual accessible devices.
- Display of the accessible devices of all interfaces in a list.

See also: Displaying accessible devices

### Overview of icons for accessible devices

The accessible devices are identified with an icon according to their type and status. The following is an overview of all icons and their meaning.

	<p>Icon for unidentified modules</p> <p>This icon is displayed whenever the identification of a module is not yet complete or when the identification of a module was not successful, for example, because the required online data could not be read.</p>
	<p>Icon for the following device types:</p> <ul style="list-style-type: none"> <li>• PLCs</li> <li>• SIMOCODE pro devices</li> <li>• IE/PB links</li> <li>• CPs of PC systems</li> <li>• SCALANCE head modules</li> <li>• S7-300 and S7-400 CPs</li> <li>• PROFINET IO devices and PROFINET CPs</li> <li>• SCALANCE modules and gateways that could not be identified</li> </ul>
	<p>PROFINET IO devices, encoders, switchgear, sensors and identification systems that were replaced by similar devices because these could not be identified</p>
	<p>Icon for the following device types:</p> <ul style="list-style-type: none"> <li>• HMI devices</li> <li>• PROFINET IO devices of the HMI type if these could not be identified and were therefore replaced by a similar device</li> </ul>
	<p>PROFINET IO devices of the drive type that could not be identified and were therefore replaced by a similar device</p>
	<p>PROFINET IO devices of the development kit and network components type that could not be identified and were therefore replaced by a similar device</p>
	<p>PROFINET IO devices of the Teleservice adapter type that could not be identified and were therefore replaced by a similar device</p>

### See also

Displaying and modifying interface properties (Page 6157)

## 12.5.2 Basics of assigning parameters for the PG/PC interface

### Options for connecting to target systems

If the devices of the project are connected via different subnets, you assign a suitable network access to each PG/PC interface to be able to establish online connections to the target systems. The following interfaces are automatically supported:

- MPI
- PROFIBUS
- Industrial Ethernet (ISO and TCP/IP)

You can make various settings for the interfaces. The following sections explain the parameter settings you can make.

---

#### Note

Note that changes to interface parameters have a direct influence on the operating system and the programming device / PC. Remember that some parameter settings can only be changed if you have adequate user rights.

---

### See also

Setting parameters for the Industrial Ethernet interface (Page 6158)

Setting parameters for the MPI and PROFIBUS interfaces (Page 6163)

## 12.5.3 Displaying and modifying interface properties

### Introduction

For each interface, you can display and, in some cases, modify properties, for example the network type, address, and status.

### Procedure

To open the properties, follow these steps:

1. Right-click on the required interface below "Online access" in the project tree.
2. Select the "Properties" command from the shortcut menu.  
A dialog containing the properties of the interface opens. On the left of the dialog, you will see the area navigation. You can view the current parameter settings in the individual entries in the area navigation and, if necessary, change them.

## 12.5.4 Adding interfaces

You have the option of installing additional interfaces after installation of the TIA Portal.

### Procedure

To install an interface at a later time and add it to the TIA Portal, follow these steps:

1. Install or update the drivers in the operating system once you have installed the interface hardware.
2. Close the TIA Portal if it is still open.
3. Open the Windows control panel.
4. Open the entry "Setting the PG/PC Interface" in the Control Panel.  
The "Setting the PG/PC Interface" dialog opens.
5. Make any necessary changes to the interface configuration and confirm them with "OK".  
You have to click "OK", even if you have not made any changes.
6. Restart the TIA Portal.

### Result

The newly installed interface is now displayed in the project tree under the "Online access" folder.

## 12.5.5 Setting parameters for the Ethernet interface

### 12.5.5.1 Setting parameters for the Industrial Ethernet interface

#### Options in the parameter settings for the Industrial Ethernet interface

When setting parameters for the Industrial Ethernet interface, you have the following options:

- Parameters dependent on the operating system  
The Industrial Ethernet interface has parameters that are set in the operating system and are valid for all connected devices. These parameter settings are only displayed here, they can, however, be changed in the network settings of the operating system.
- Parameters that can be set in the software

---

#### Note

Note that changes to interface parameters have a direct influence on the operating system and the programming device / PC. Remember that some parameter settings can only be changed if you have adequate user rights.

---

## Parameters for the Industrial Ethernet interface

The following table contains an overview of the parameters of the Industrial Ethernet interface that are set by the operating system and can be changed by the user.

Parameter settings that cannot be changed	Parameters that can be set
MAC address	Fast acknowledge at the IE-PG access and for TCP/IP
DHCP server activated/deactivated	Timeout at the IE-PG access and for TCP/IP
APIPA activated/deactivated	LLDP
IP address	Additional, dynamic IP addresses for the network adapter
Subnet mask	-
DNS addresses	-
DHCP addresses	-

### See also

Basics of assigning parameters for the PG/PC interface (Page 6155)

Displaying operating system parameters (Page 6159)

Connecting the PG/PC interface to a subnet (Page 6160)

Setting parameters for the Ethernet interface (Page 6160)

Assigning a temporary IP address (Page 6161)

Managing temporary IP addresses (Page 6162)

Influence of user rights (Page 244)

### 12.5.5.2 Displaying operating system parameters

The Ethernet interface is part of the operating system. All parameters of the network adapter can therefore be adapted in the network settings of the operating system.

You can display the following parameters in the software:

- Physical address of the network adapter
- Assignment of the IP address by a DHCP server activated or deactivated
- Assignment of a private IP address by the operating system activated or deactivated
- Current static IP address
- Assigned subnet mask
- DNS addresses
- DHCP addresses

If you want to modify the parameter settings, please refer to the documentation of the operating system or the network adapter.

### Displaying current parameters of the Ethernet interface

To display the current parameters of the Ethernet interface, follow these steps:

1. Select the Ethernet interface in the project tree in "Online access".
2. Select the "Properties" command in the shortcut menu of the interface.  
The dialog for configuring the interface opens.
3. Select "Configurations > Industrial Ethernet" in the area navigation.

### See also

Setting parameters for the Ethernet interface (Page 6160)

### 12.5.5.3 Connecting the PG/PC interface to a subnet

If you have created several subnets, you can specify the subnet to which the Ethernet interface is connected.

### Procedure

To select the subnet to which the Ethernet interface is connected, follow these steps:

1. Select the Ethernet interface in the project tree in "Online access".
2. Select the "Properties" command in the shortcut menu of the interface.  
The dialog for configuring the interface opens.
3. Go to "General > Assignment" and select the subnet to which you want to connect the Ethernet interface of the programming device / PC in the "Connection to subnet" drop-down list.
4. Close the dialog with "OK".

### 12.5.5.4 Setting parameters for the Ethernet interface

You can adapt some parameter settings relating to the network protocol directly in the software.

### Requirement

You must have adequate user rights.

See also: Influence of user rights (Page 244).

### Procedure

To change parameter settings relating to the network protocol, follow these steps:

1. Select the Ethernet interface in the project tree in "Online access".
2. Select the "Properties" command in the shortcut menu of the interface.  
The dialog for configuring the interface opens.

3. Select "Configurations > IE-PG access" to adapt the protocol settings relevant to network management.
  - Select the "Fast acknowledge" check box to achieve faster reaction times with smaller network packets.
  - From the "Timeout" drop-down list, select the maximum time that can elapse before a network node is detected.
4. To activate the LLDP protocol and discover the network topology more accurately, set the "LLDP active" check box in "Configurations > LLDP".
5. Select "Configurations > TCP/IP" to adapt the TCP/IP protocol for network traffic during runtime.
  - Select the "Fast acknowledge" check box to achieve faster reaction times with smaller network packets.
  - From the "Timeout" drop-down list, select the maximum time that can elapse before there is a timeout during communication with a network node.

### See also

Influence of user rights (Page 244)

Displaying operating system parameters (Page 6157)

### 12.5.5.5 Assigning a temporary IP address

#### Adding a dynamic IP address

If the IP address of a device is located in a different subnet from the IP address of the network adapter, you will first need to assign an additional IP address with the same subnet address as the device. Only then is communication between the device and the programming device / PC possible.

The assignment of an additional temporary IP address is also proposed automatically if you want to perform an online action and the current IP address of the programming device/PC is not yet in the correct subnet.

A temporarily assigned IP address remains valid until the next time the programming device/PC is restarted or until you delete it manually.

---

#### Note

You require adequate permissions to be able to assign a temporary IP address.

See also: Influence of user rights (Page 244)

---

### See also

Managing temporary IP addresses (Page 6162)

### 12.5.5.6 Managing temporary IP addresses

If the IP address of a device is located in a different subnet from the current static IP address of the network adapter, the network adapter temporarily assigns a suitable IP address from the subnet of the device.

You can display all temporarily assigned addresses and delete them. Note that IP addresses that you manually assigned in the operating system are not displayed in the TIA Portal.

#### Requirement

To delete, you require adequate permissions.

#### Procedure

To display and delete temporarily assigned addresses, follow these steps:

1. Select the Ethernet interface in the project tree in "Online access".
2. Select the "Properties" command in the shortcut menu of the interface.  
The dialog for configuring the interface opens.
3. Select "Configurations > IE-PG access".  
A table with the assigned IP addresses is displayed.
4. Click the "Delete project-specific IP addresses" button to delete all the IP addresses at one time.

#### See also

Influence of user rights (Page 244)

### 12.5.5.7 Resetting the TCP/IP configuration

If you have changed the TCP/IP protocol settings, you can reset them to the defaults.

#### Procedure

To restore the TCP/IP configuration to the default settings, follow these steps:

1. Select the Ethernet interface in the project tree in "Online access".
2. Select the "Properties" command in the shortcut menu of the interface.  
The dialog for configuring the interface opens.
3. Select "Configurations > TCP/IP".
4. Click the "Standard" button to reset all the settings.



## 12.5.6 Setting parameters for the MPI and PROFIBUS interfaces

### 12.5.6.1 Setting parameters for the MPI and PROFIBUS interfaces

#### Possible parameter settings for the MPI and PROFIBUS interfaces

The following parameter settings can be made for the MPI and PROFIBUS interfaces:

- Automatic configuration: You can use automatic detection functions to find out whether a device is connected to the PG/PC interface over PROFIBUS or MPI.
- Selecting a default configuration for PROFIBUS or MPI that can be adapted later.

#### Device- and network-related settings for MPI and PROFIBUS

You can set device- and network-related parameters for MPI and PROFIBUS interfaces. Device-related parameters are local settings for the interface. Network-related parameters, on the other hand, must match up on all devices.

#### MPI interface parameters you can modify

You can adapt the following default parameters for the MPI interface:

Device-related parameters	Network-related parameters
Is the only master	Highest address
Own address	Transmission rate
Timeout	

#### PROFIBUS interface parameters you can modify

You can adapt the following default parameters for the PROFIBUS interface:

Device-related parameters	Network-related parameters
Is the only master	Highest address
Own address	Transmission rate
Timeout	Profile
	Bus parameters
	Number of masters on bus
	Number of slaves on bus

#### See also

Basics of assigning parameters for the PG/PC interface (Page 6155)

### 12.5.6.2 Setting MPI or PROFIBUS interface parameters automatically

#### Setting up automatic bus parameter detection

If you select an interface with automatic detection of the bus parameters (for example CP 5611 (Auto)), you can connect the programming device or PC to MPI or PROFIBUS without needing to set bus parameters. At a transmission speed lower than 187.5 Kbps, you may, however, have waiting times of up to one minute.

#### Requirement

- Masters that distribute bus parameters cyclically are connected to the bus.
- In PROFIBUS networks, the cyclic distribution of the bus parameters must be enabled.

#### Procedure

To enable automatic bus parameter detection, follow these steps:

1. Select the interface in the project tree.
2. Select the "Properties" command in the shortcut menu of the interface.  
The dialog for configuring the interface opens.
3. Go to "General > Configurations > Active configuration" and select the setting "Automatic protocol detection".
4. Go to "Configurations > Auto configuration > Local settings" and select the address of the PG/PC interface in the "Own address" drop-down list.
5. If you then want to display the current bus settings, click the "Network detection" button.

#### See also

Setting parameters for the MPI interface (Page 6164)

Setting parameters for the PROFIBUS interface (Page 6166)

### 12.5.6.3 Setting parameters for the MPI interface

#### Changing the parameter settings of the MPI interface

The network-related parameters and bus parameters for the MPI network can be adapted. You should first select a default setting and then adapt this to the specific situation.

## Setting defaults for the MPI interface

To adapt the parameters of the MPI interface, follow these steps:

1. Select the interface in the project tree.
2. Select the "Properties" command in the shortcut menu of the interface.  
The dialog for configuring the interface opens.
3. Go to "General > Assignment" and select the subnet with which you want to connect the interface in the "Connection to subnet" drop-down list.
4. Under "General > Configuration", select a default for the device and network-related parameters. The defaults are suitable for most configurations. Select one of the following settings:
  - Automatic protocol detection  
You can connect the programming device to MPI or PROFIBUS without having to set bus parameters. At a transmission speed lower than 187.5 Kbps, you may, however, have waiting times of up to one minute. Prerequisite for the automatic detection is a connection to the bus master, which distributes the bus parameters cyclically. With PROFIBUS subnets, cyclic distribution of bus parameters may not be deactivated (default PROFIBUS network setting).
  - MPI  
The "MPI" transmission protocol is selected. Typical parameters are set that are adequate for most configurations. You can change the parameters to your needs, however.
  - PROFIBUS  
The "PROFIBUS" transmission protocol is selected. Typical parameters are set that are adequate for most configurations. You can change the parameters to your needs, however.

## Changing the default parameter settings

To adapt the default settings to your requirements, change the parameter setting where necessary in "Configurations > MPI".

You can set the following device-related parameters:

- **Is only master**  
An additional verification function to prevent bus disruptions when connecting the PG/PC to the network is disabled because the programming device or PC is the only master on the bus.
  - Do not enable this option unless you have only connected slaves to your programming device or PC.
  - If the "Is only master" check box is enabled, it is not possible to identify the directly connected device in the "Accessible devices" window.
- **Own address**  
This setting relates to the programming device or PC on which you call up the parameter settings of the interface. Set the local device address of your programming device or PC here.
  - This address must be unique throughout the network.
  - The programming device or PC is addressed using this address in the MPI network.
- **Check**  
This enables an additional safety function to prevent bus disruptions when connecting the PG/PC to the network. The driver checks whether the local address is already being used by another station. Active as well as passive stations are taken into consideration in this case. The driver monitors this on the PROFIBUS. The connection of the PG/PC to the network will take longer with the automatic check. To use the check, the driver must support the function. Furthermore, the "Is only master" option must not be selected.
- **Timeout**  
Set a higher timeout value if, for example, you have problems with long response times on the network.

You can set the following network-related parameters:

- **Highest address:**  
Select the configured highest device address. Make sure that the same highest device address is set for all devices of a PROFIBUS or MPI network.
- **Transfer rate:**  
Here, you select the transmission speed to be used on the MPI network.

## See also

Setting MPI or PROFIBUS interface parameters automatically (Page 6162)

### 12.5.6.4 Setting parameters for the PROFIBUS interface

#### Changing the parameter settings of the PROFIBUS interface

The network-related parameters and bus parameters for the PROFIBUS network can be adapted more precisely. You should first select a default setting and then adapt this to the specific situation.

## Setting defaults for the PROFIBUS interface

To adapt the parameters of the PROFIBUS interface, follow these steps:

1. Select the interface in the project tree.
2. Select the "Properties" command in the shortcut menu of the interface.  
The dialog for configuring the interface opens.
3. Go to "General > Assignment" and select the subnet with which you want to connect the interface in the "Connection to subnet" drop-down list.
4. Under "General > Configuration", select a default for the device and network-related parameters. The defaults are suitable for most configurations. Select one of the following settings:
  - Automatic protocol detection  
You can connect the programming device to MPI or PROFIBUS without having to set bus parameters. At a transmission speed lower than 187.5 Kbps, you may, however, have waiting times of up to one minute. Prerequisite for the automatic detection is a connection to the bus master, which distributes the bus parameters cyclically. With PROFIBUS subnets, cyclic distribution of bus parameters may not be deactivated (default PROFIBUS network setting).
  - MPI  
The "MPI" transmission protocol is selected. Typical parameters are set that are adequate for most configurations. You can change the parameters to your needs, however.
  - PROFIBUS  
The "PROFIBUS" transmission protocol is selected. Typical parameters are set that are adequate for most configurations. You can change the parameters to your needs, however.

## Changing the default parameter settings

To adapt the default settings to your requirements, change the parameter setting where necessary in "Configurations > PROFIBUS".

You can set the following device-related parameters:

- Is only master  
An additional verification function to prevent bus disruptions when connecting the PG/PC to the network is disabled because the programming device or PC is the only master on the bus.
  - Do not enable this option unless you have only connected slaves to your programming device or PC.
  - If the "Is only master" check box is enabled, it is not possible to identify the directly connected device in the "Accessible devices" window.
- Own address  
This setting relates to the programming device or PC on which you call up the parameter settings of the interface. Set the local device address of your programming device or PC here.
  - This address must be unique throughout the network.
  - The programming device or PC is addressed using this address in the PROFIBUS network.
- Check  
This enables an additional safety function to prevent bus disruptions when connecting the PG/PC to the network. The driver checks whether the local address is already being used by another station. Active as well as passive stations are taken into consideration in this case. The driver monitors this on the PROFIBUS. The connection of the PG/PC to the network will take longer with the automatic check. To use the check, the driver must support the function. Furthermore, the "Is only master" option must not be selected.
- Timeout  
Set a higher timeout value if, for example, you have problems with long response times on the network.

You can set the following network-related parameters:

- Highest address:  
Select the configured highest device address. Make sure that the same highest station address is set for all devices of a PROFIBUS network.
- Transfer rate:  
Here, you select the transmission speed to be used on the PROFIBUS network.
- Profile:  
You have a choice of four alternatives for the PROFIBUS settings. "DP", "Standard" and "Universal (DP/FMS)" are predefined settings that you cannot change. If you select "User-defined", you can adapt the bus parameters yourself.
  - If you have selected "User-defined", go to "Configurations > PROFIBUS > Bus parameters" in area navigation.
  - If you have selected one of the defaults (DP, Standard or Universal (DP/FMS)), you should select the "Include" check box in "Configurations > PROFIBUS > Bus parameters > Additional parameters". You can then set the number of masters and slaves on the bus. This allows a more precise calculation of the bus parameters and potential bus disruptions can be prevented. The option cannot be selected with a user-defined profile.

## See also

Overview of the bus parameters for PROFIBUS (Page 6169)

Setting MPI or PROFIBUS interface parameters automatically (Page 6162)

### 12.5.6.5 Overview of the bus parameters for PROFIBUS

#### Introduction

The PROFIBUS subnet will only function problem-free if the parameters for the bus profile are matched to one another. You should therefore only change the default values if you are familiar with how to configure the bus profile for PROFIBUS.

It may be possible for the bus parameters to be adjusted depending on the bus profile. The offline values of the bus parameters are always shown even if you are online and linked to the target system.

The displayed parameters are valid for the entire PROFIBUS subnet.

#### Meaning of the individual parameters

- **Tslot: Wait-to-receive time (slot time)**  
The wait-to-receive time (slot time) defines the maximum time the sender will wait to receive a response from the addressed partner.
- **Max. Tsd: Maximum protocol processing time (max. station delay responder)**  
The maximum protocol processing time defines the time after which the responding device must have processed the protocol.
- **Min. Tsd: Minimum protocol processing time (min. station delay responder)**  
The minimum protocol processing time specifies the minimum time required by the responding device to process the protocol.
- **Tset: Trigger time (setup time)**  
The trigger time is the time that may lapse between the reception of a data frame frame and the reaction to it.
- **Tqui: Quiet time for modulator**  
The quiet time for modulator specifies the time required to change from sending to receiving.
- **GAP factor: GAP update factor (GAP factor)**  
The GAP factor specifies the number of token rotations before a new device is included in the token ring.
- **Retry limit: Maximum number of repeated call attempts (retry limit)**  
This parameter defines the maximum number of attempts made to reach a device.
- **Trdy: Ready time**  
The ready time is the time for an acknowledgment or response.
- **Tid1: Idle time 1**  
Idle time 1 specifies the delay time after receiving a response.
- **Tid2: Idle time 2**  
Idle time 2 specifies the delay time after sending a call without a response.

- **Ttr: Target rotation time**  
The target rotation time is the maximum time made available for a token rotation. During this time, all active devices (masters) receive the token once. The difference between the desired token round-trip time and the actual token round-trip time decides how much time is left for masters to send data frames to the slaves.  
As the minimum target rotation time (Ttr), select a value = 5000 times the HSA (Highest Station Address).
- **Watchdog: Watchdog**  
The watchdog time specifies the time after which a device must be addressed.  
As the minimum watchdog time, select a value = 6250 times the HSA.

---

**Note**

If you want to create a user-defined bus profile, please note that the minimum target rotation time (Ttr) should be 5000 times the HSA (highest PROFIBUS address). The minimum watchdog time should also be 6250 times the HSA.

---

**See also**

Setting parameters for the PROFIBUS interface (Page 6164)

### 12.5.6.6 Resetting the MPI or PROFIBUS configuration

If you have changed the MPI or PROFIBUS protocol settings, you can reset them to the defaults.

**Procedure**

To restore the MPI or PROFIBUS configuration to the default settings, follow these steps:

1. Select the MPI/PROFIBUS interface in the project tree in "Online access".
2. Select the "Properties" command in the shortcut menu of the interface.  
The dialog for configuring the interface opens.
3. Select "Configurations > MPI" or "Configurations > PROFIBUS", depending on the interface properties you want to reset.
4. Click the "Standard" button to reset all the settings.



## 12.6 Using the trace and logic analyzer function

### Preface

#### Purpose of the documentation

The diagnostics options available with the trace and logic analyzer function are described in this documentation. Depending on the device used, the recording options can vary.

#### Required basic knowledge

In order to understand this documentation, the following knowledge is required:

- General knowledge in the field of automation
- Knowledge about the use of Windows-based computers
- S7-1200/1500 CPUs
  - Knowledge of working with the SIMATIC industrial automation system
  - Knowledge of working with STEP 7 >= V12.0
- SINAMICS G120
  - Knowledge of working with the drive

#### Validity of the documentation

This documentation applies to all products of the S7-1200, S7-1500 and SINAMICS G120 product family.

#### Conventions

This documentation contains pictures of the devices described. The pictures may differ slightly from the devices supplied.

Please also observe notes marked as follows:

---

#### Note

A note contains important information on the product described in the documentation, on the handling of the product and on the section of the documentation to which particular attention should be paid.

---

## Further support

- The range of technical documentation for the individual SIMATIC products and systems is available on the Internet (<http://www.siemens.com/simatic-tech-doku-portal>).
- The online catalog and the online ordering system is available on the Internet (<http://mall.automation.siemens.com>).

## 12.6.1 Description

### 12.6.1.1 Supported hardware

The following devices (Page 6197) support the trace and logic analyzer function:

- SIMATIC S7-1200 CPUs (as of firmware version V4.x)
- SIMATIC S7-1500 CPUs
- SINAMICS G120

### 12.6.1.2 Recording of measured values with the trace function

#### Introduction

The trace and logic analyzer function can be called in the device folder in the project navigator under the name "Traces" (Page 6175).

You record device tags and evaluate the recordings with the trace and logic analyzer function. Tags are, for example, drive parameters or system and user tags of a CPU. The maximum recording duration is limited by the memory size. How much memory is available for the recording depends on the hardware used.

The recordings are saved on the device and, when required, can be read out with the engineering system (ES) and saved permanently. The trace and logic analyzer function is therefore suitable for monitoring highly dynamic processes. The recorded values are overwritten when "Installed traces" is activated again.

Depending on the device (Page 6197) used, the recording options can vary.

A quick start (Page 6185) for working with the trace and logic analyzer function can be found in the Operation section.

The following figure shows the method of operation of the "Traces":

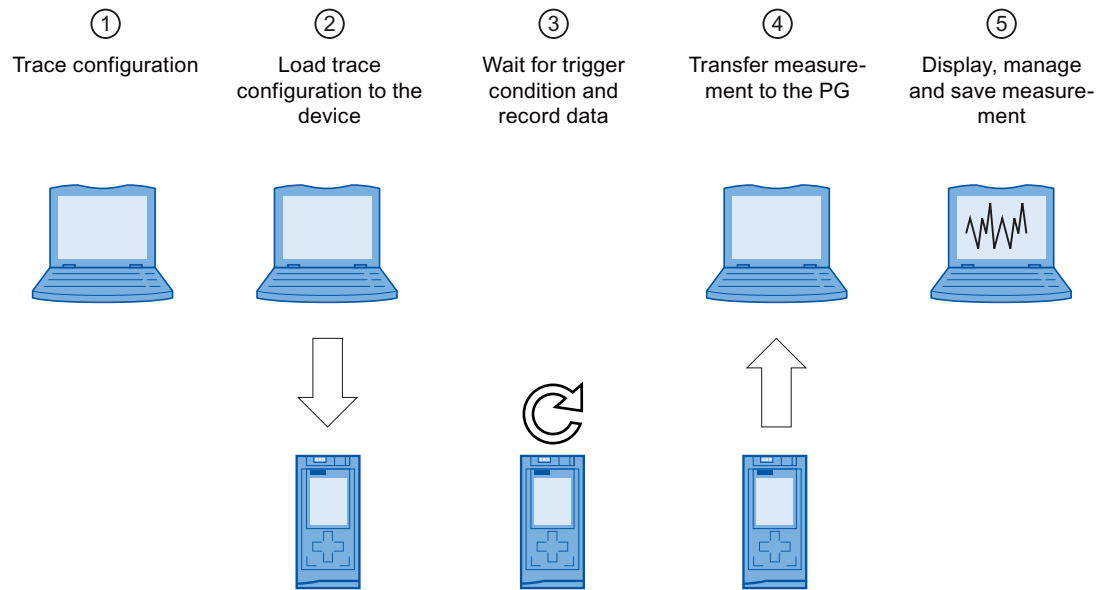

#### ① Trace configuration on the programming device (PG) in the TIA Portal

You can specify the signals to be recorded, the duration of the recording and the trigger condition in the trace configuration. The trace configuration depends on the device and is described at the respective device (Page 6197).

#### ② Transferring the trace configuration from the PG to the device

You can transfer the complete trace configuration (Page 6192) to the device when an online connection is established.

#### ③ Waiting for the recording

If the installed trace configuration is activated (Page 6192), then the recording is performed independently of the PG. The recording is started as soon as the trigger condition is satisfied.

#### ④ Transferring the measurement from the device to the PG

The saving of the measurement in the project (Page 6194) stores the measurement in the opened project of the TIA Portal.

#### ⑤ Evaluating, managing and saving the measurement

Numerous options are available for the evaluation of the measurement in the curve diagram and in the signal table (Page 6193). Various display types are possible, for example, a bit representation for binary signals.

Measurements can also be exported and imported as a file.

With the saving of the project (Page 6194) in the TIA Portal, the measurements transferred to the project are also saved.

### 12.6.1.3 Trace configuration, recording and measurement

This section explains the meaning of the terms: trace configuration, recording and measurement.

## Trace configuration

You can make the following settings in the trace configuration :

- Signals to be recorded
- Trigger condition
- Duration of the recording

## Recording

A recording is performed in the device. There is only one recording for each installed trace configuration. When a new recording is started, the old recording is overwritten.

An installed recording is not retentive (it is lost when the device is switched off/on) and can be saved permanently in the project as a measurement.

## Installed traces

An installed trace  consists of a trace configuration and optionally a recording. The maximum number of installed traces depends on the device.

The status of an installed trace can be viewed online.

## Measurement

A measurement  always consists of a trace configuration with an associated recording. If an installed trace contains a recording, it can be saved in the project as a measurement.

The recording of a measurement can be viewed offline.

### 12.6.1.4 Data storage

The trace handling and the curve diagram also enable the transfer of the trace configuration and the viewing of the recording.

The following figure is a schematic diagram of the data storage:

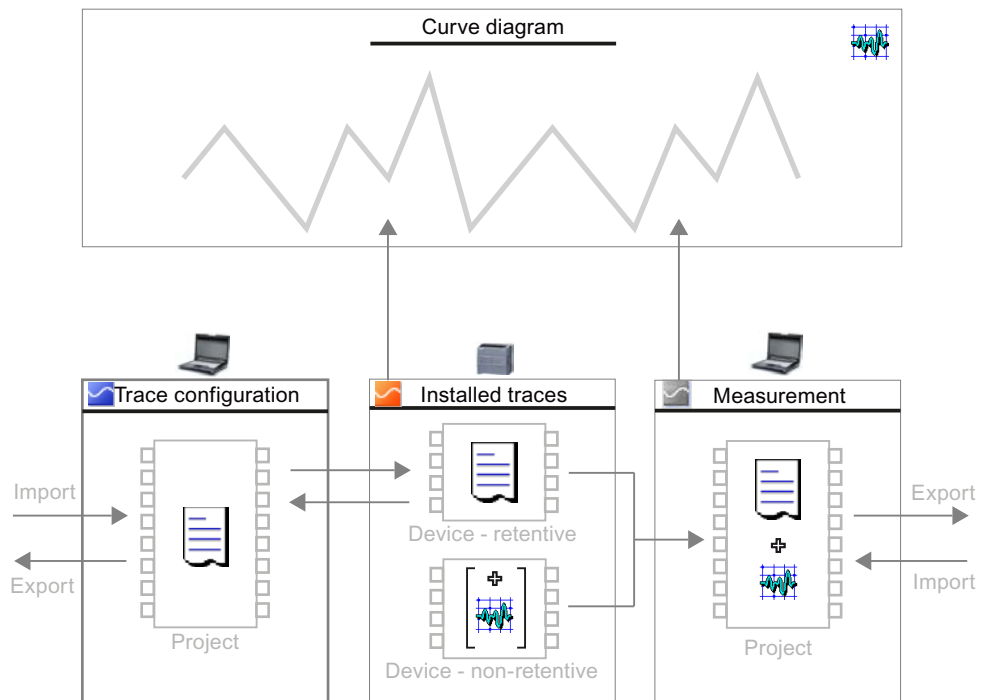

#### Note

##### Saving the trace configuration and measurement

You save the trace configuration and measurement with the project in the TIA Portal.

If you close the project without saving, the trace configurations and the measurements transferred to the project are discarded. The trace editor can be closed and reopened without loss of data until the project is closed.

## 12.6.2 Software user interface

### Display areas

The user interface of the trace and logic analyzer function consists of several areas.

The example in the figure below shows the division of the user interface in the TIA Portal:

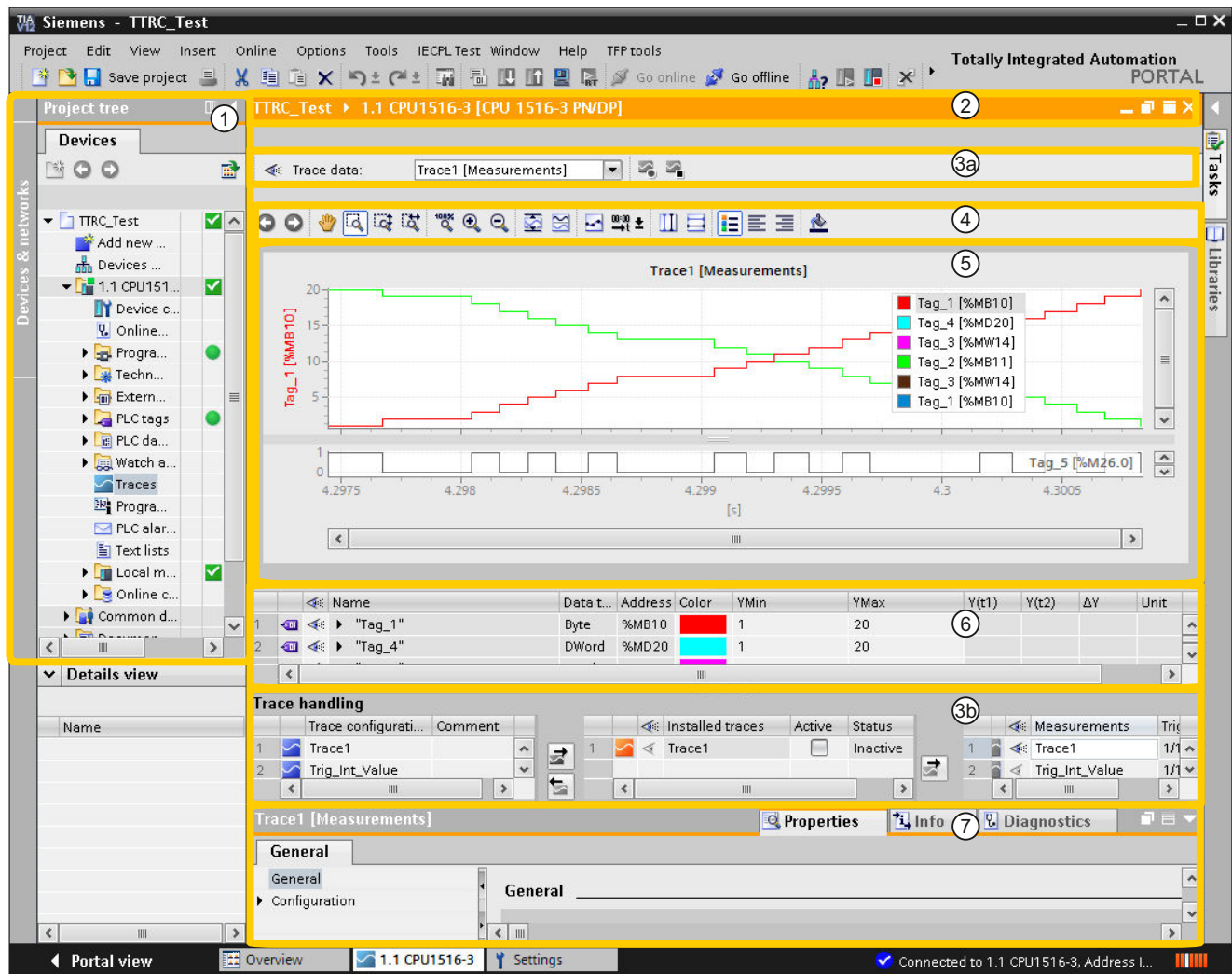

1	Project navigator
	Working area
2	Title bar of the working area Shows the device to which the current display belongs.
3a	Toolbar of the trace handling (Page 6180) Selection of recordings for display in the curve diagram and buttons for activation/ deactivation of installed traces.
4	Toolbar of the curve diagram (Page 6177) Tools for editing the measurement and for adapting the display in the curve diagram
5	Curve diagram (Page 6177) Display of the recorded values
6	Signal table (Page 6179) Signals of the measurement
3b	Trace handling (Page 6180) Creation of new trace configurations and the handling of the measurements.

	Device-specific area (see Devices (Page 6197))
7	Properties area in the Inspector window Configuration dialog boxes for the recording duration, trigger condition and signal selection.

### 12.6.2.1 Project navigator

If a device supports the trace and logic analyzer function,  "Traces" is offered for selection in the project navigator below the device.

Double-clicking  "Traces" opens the trace editor.

### 12.6.2.2 Working area

#### User interface - curve diagram

The curve diagram displays the selected signals of a recording. Bits are shown in the lower diagram as a bit track. Adjust the display of the signals in the signal table (Page 6179) and with the aid of the toolbar of the curve diagram.

#### Setting options and displays in the curve diagram

The following figure shows an example of the display in the TIA Portal:

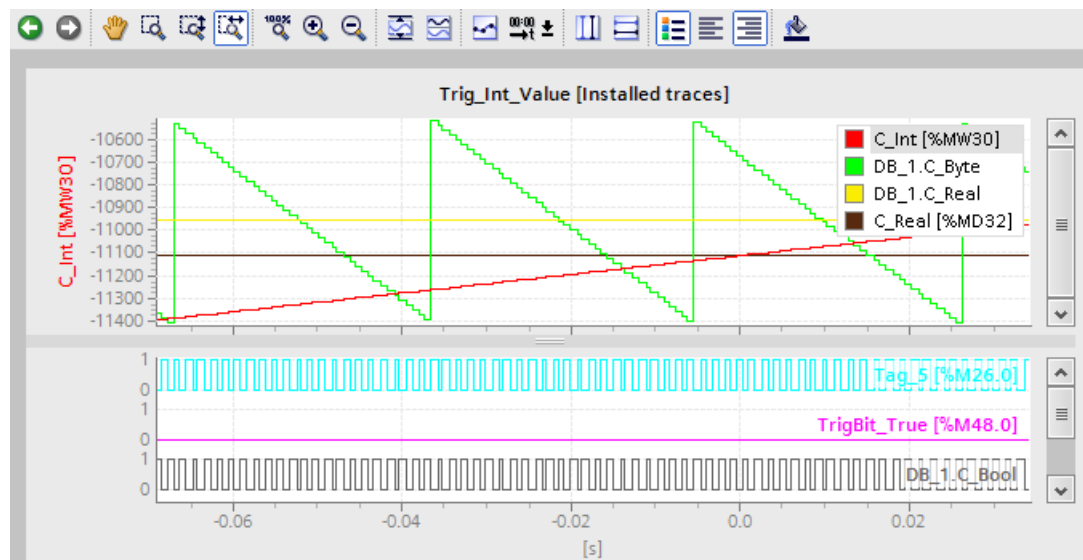

The scale in the diagram applies to the selected (highlighted in gray) signal in the legend. The legend can be moved laterally with the mouse.

### Shortcut menu commands













The following table shows the shortcut menu commands in the curve diagram:

Shortcut menu command	Description
"Save diagram as image"	Exports the current display as a bitmap.
"Copy image to clipboard"	Copies the current display to the clipboard.
"Center measurement cursors"	Positions the activated measurement cursors at a central point in the current display.







### Toolbar of the curve diagram

Tools are available for adapting the display via buttons.

The following table shows the functions of the buttons:

Icon	Function	Description
	Undo zoom	Undoes the zoom function executed last. If several zoom functions have been executed, they can be undone step-by-step.
	Redo zoom	Redoes the last undone zoom function. If several zoom functions have been undone, they can be redone step-by-step.
	Move view	Moves the display with the mouse button pressed.
	Zoom selection	Selection of an arbitrary range with the mouse button pressed. The display is scaled to the range selection.
	Vertical zoom selection	Selection of a vertical range with the mouse button pressed. The display is scaled to the range selection.
	Horizontal zoom selection	Selection of a horizontal range with the mouse button pressed. The display is scaled to the range selection.
	Display all	Scaling of the display so that the entire time range and all values are displayed.
	Zoom in	Enlargement of the display. The ranges of the time axis and value axis are reduced every time the button is clicked. The curves are displayed larger.
	Zoom out	Reduction of the display. The ranges of the time axis and value axis are increased every time the button is clicked. The curves are displayed smaller.
	Scale automatically	Scaling of the display so that all values are displayed for the currently displayed time range.
	Arrange in tracks	Arranges signals one beneath the other without overlaps.
	Display samples	The samples are displayed as small circles on the curves.
	Unit changeover of the time axis	Changeover of the unit between time and cycles.









Icon	Function	Description
	Display vertical measurement cursors	Display of the vertical measurement cursors. The vertical position of the two measurement cursors can be moved with the mouse. The associated measured values and the difference of the measurement cursors corresponding to the position are shown in the signal table.
	Display horizontal measurement cursors	Display of the horizontal measurement cursors.
	Display chart legend	Display of the chart legend in the curve diagram.
	Align the chart legend to the left	Display of the chart legend on the left side of the curve diagram.
	Align the chart legend to the right	Display of the chart legend on the right side of the curve diagram.
	Change background color	Changeover between various background colors.

### User interface - signal table



The signal table lists the signals of the selected measurement and provides setting options for some properties. If recording data of "Installed traces" is displayed and the settings are changed in the signal table, these settings are retained until there is a change to the offline mode.

### Setting options and displays in the signal table

The following figure shows an example of the display in the TIA Portal:

		Name	Data type	Address	Color	YMin	YMax	Y(t1)	Y(t2)	ΔY	Unit	Comment
1		▶ "C_Int"	Int	%MW30		-11410	-10513	-11257	-11113	144		
2		"Tag_5"	Bool	%M26.0		0	1	1	1	0		
3		"TrigBit_True"	Bool	%M48.0		0	1	0	0	0		

The following table shows the settings and displays of the recorded signals:

Column	Description
	Static display of the signal icon
	Selection for the display in the curve diagram
"Name"	Display of the signal name A click on the name of a displayed signal updates the scale in the curve diagram.

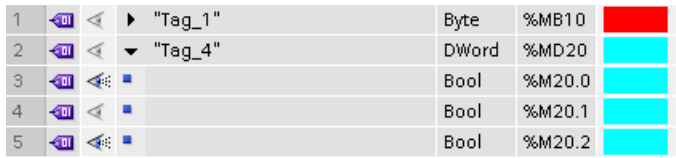
Column	Description
▶	<p>Open bit selection</p> <p>Individual bits can also be selected for the following data types for display as a bit track in the lower curve diagram.</p> <ul style="list-style-type: none"> <li>• Byte, Word, DWord, LWord</li> <li>• SInt, USInt, Int, UInt, DInt, UDInt, LInt, ULInt</li> </ul> <p>Example of an opened bit selection for the DWORD data type:</p>  <p>Select or deselect the relevant bit for display by clicking the ◀ icon.</p>
"Data type"	Display of the data type
"Address"	Display of the address (not for symbolic tags)
"Color"	Display and setting option for the color of the signal
"YMin"	Enter the minimum value for the scaling of the signal
"YMax"	Enter the maximum value for the scaling of the signal
"Y(t1)"	Display of the value at the position of the first measurement cursor
"Y(t2)"	Display of the value at the position of the second measurement cursor
"ΔY"	Display of the value difference between the first and the second measurement cursor
"Unit"	Display of the unit (e.g. for technology objects)
"Comment"	Display and input option for a comment about the signal

### Shortcut menu commands

The following table shows the shortcut menu commands of the signal table:

Shortcut menu command	Description
"Cut"	Cannot be selected.
"Copy"	Copies the contents of the selected lines to the clipboard.
"Paste"	Cannot be selected.
"Show/hide signal"	Shows/hides the signal in the curve diagram.
"Bring to foreground"	Displays the selected signal in the foreground. The other signals are hidden.

### User interface - trace management

The trace handling enables the configuration and handling of trace configurations.

### Setting options and displays in the trace handling

The following figure shows an example of the display in the TIA Portal:

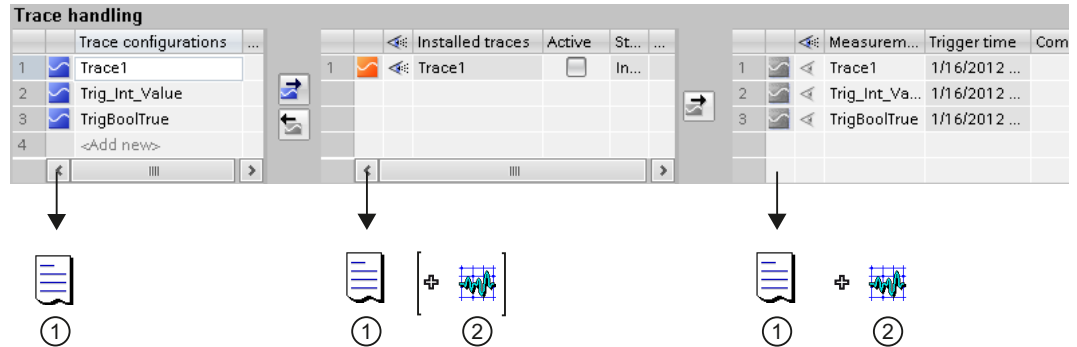

- ① Trace configuration
- ② Recording (recorded values)

### Toolbar of the trace handling

A recording can be selected for display via a drop-down list and buttons, and activated or deactivated.

The example in the figure below shows the toolbar of the trace handling

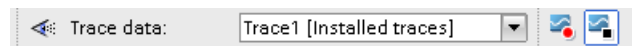

The following table describes the functions of the buttons:



Icon	Description
	Selection for the display in the curve diagram A click on the icon shows/hides the recording in the curve diagram.
	Selection of an "Installed trace" or a "Measurement" for display in the curve diagram
	Activation of the recording The button is available for "Installed traces".
	Deactivation of the recording The button is available for "Installed traces".

### "Trace configurations" table

The table contains all the trace configurations of the project that can be transferred to the device. Each trace configuration contains the tags to be recorded and the required recording settings. The data is displayed in offline and online mode.

The following table shows the settings and displays:

12.6 Using the trace and logic analyzer function

Column	Icon	Description
-	 	Display of the icon for the trace configuration Incorrect trace configurations are shown with an additional red icon and cannot be transferred to the device. Check the device-specific configuration in the Inspector window. Double-clicking the icon brings the Inspector window with the device-specific properties to the foreground.
"Trace configuration"	-	Name of the trace configuration. The name can be changed after double-clicking the field.
"Comment"	-	Input field for a comment.

**Shortcut menu commands**





The following table shows the shortcut menu commands of the "Trace configurations" table:

Shortcut menu command	Description
"Cut"	Removes the selected lines and moves them to the clipboard.
"Copy"	Copies the contents of the selected lines to the clipboard.
"Paste"	Pastes the contents of the clipboard to the selected line. The existing contents are overwritten.
"Delete"	Deletes the selected lines from the table.
"Rename"	Switches the selected cell to the editing mode.
"Transfer trace configuration to device"	Transfers the trace configuration selected in the "Trace configurations" table to the device. The button is active when all the required settings in the device-specific configuration have been configured correctly in the Inspector window and there is an online connection.
"Export trace configuration"	Exports a trace configuration as a file with the ".ttcfg" file extension.
"Import trace configuration"	Imports a trace configuration from a file.
"Properties"	Brings the Inspector window with the device-specific properties to the foreground.

**"Installed traces" table**

The table contains the trace configurations already transferred to the device and their current operating mode. The data is displayed in the online mode.

The following table shows the settings and displays:

Column	Icon	Description
-		Static display of the online icon Double-clicking the icon brings the Inspector window with the device-specific properties to the foreground.
		Selection for the display in the curve diagram A click on the icon shows/hides the recording in the curve diagram.
"Installed traces"	-	Name of the trace configuration.
"Active"	 	Activation of the recording and feedback of the status. The checkbox is reset at the end of the recording.

Column	Icon	Description
"Status"	-	Status display of the trace configuration The following states are possible: <ul style="list-style-type: none"> <li>• "Installing"</li> <li>• "Waiting for trigger"</li> <li>• "Recording"</li> <li>• "Recording finished"</li> <li>• "Aborted"</li> <li>• "Fault"</li> </ul>
"Comment"	-	Display of the trace configuration comment

### Shortcut menu commands

The following table shows the shortcut menu commands of the "Installed traces" table:



Shortcut menu command	Description
"Cut"	Removes the selected lines and moves them to the clipboard.
"Copy"	Copies the contents of the selected lines to the clipboard.
"Paste"	Cannot be selected.
"Delete"	Deletes the selected lines from the table.
"Rename"	Cannot be selected.
"Add to trace configurations"	Transfers the installed trace configuration to the "Trace configurations" table.
"Add to measurements"	Adds the selected "Installed trace" to the "Measurements" table.
"Activate"	Activates the recording and shows the state in the table
"Show/hide in curve diagram"	Shows/hides the recording in the curve diagram.
"Properties"	Brings the Inspector window with the device-specific properties to the foreground.

### "Measurements" table

The table contains the trace configurations with recordings. The data is displayed in offline and online mode.

Measurements can also be exported and imported, see Exporting and importing measurements (Page 6194).

The following table shows the settings and displays:

Column	Icon	Description
-		Static display of the icon for a measurement Double-clicking the icon brings the Inspector window with the device-specific properties to the foreground.
		Selection for the display in the curve diagram A click on the icon shows/hides the recording in the curve diagram.
"Measurements"	-	Name of the measurement The name can be changed after double-clicking the field.

Column	Icon	Description
"Trigger time"	-	The meaning of the trigger time depends on the device Examples: <ul style="list-style-type: none"> <li>• SIMATIC S7-1200/1500 CPUs The absolute time of the controller is entered at the start of the recording.</li> <li>• SINAMICS G120 The transfer time is entered with the transfer of the trace configuration to the device.</li> </ul>
"Comment"	-	Input field for a comment.



### Shortcut menu commands

The following table shows the shortcut menu commands of the "Measurements" table:

Shortcut menu command	Description
"Cut"	Removes the selected lines and moves them to the clipboard.
"Copy"	Copies the contents of the selected lines to the clipboard.
"Paste"	Cannot be selected.
"Delete"	Deletes the selected lines from the table.
"Rename"	Switches the selected cell to the editing mode.
"Add to trace configurations"	Transfers the trace configuration of the measurement to the "Trace configurations" table.
"Show/hide in curve diagram"	Shows/hides the recording in the curve diagram.
"Export measurement"	Exports a measurement as a file with the "*.ttrec" or "*.csv" file extension.
"Import measurement"	Imports a measurement from a file with the "*.ttrec" file extension.
"Properties"	Brings the Inspector window with the device-specific properties to the foreground.

### Buttons

The following table shows the functions available via buttons:

Icon	Description
	Button to transfer a selected trace configuration to the device The selected trace configuration in the "Trace configurations" table is transferred to the device. The button is active when all the required settings in the device-specific configuration have been correctly configured in the Inspector window and there is an online connection.
	Button to transfer a selected trace configuration from the device The trace configuration selected in the "Installed traces" table is transferred from the device to the "Trace configurations" table.
	Button to transfer a selected measurement from the device to the project. The selection in the "Installed traces" table is added to the "Measurements" table.

### 12.6.2.3 Device-specific area

The device-specific area enables the trace configuration.

The signals to be recorded and the trigger condition are specified here. These and other configuration options are described in the device-specific part (Page 6197) for the individual devices.

## 12.6.3 Operation

### 12.6.3.1 Quick start

This description shows the steps for a recording of the S7-1500 CPU as an example. The displayed settings can differ depending on the device.

### Requirement

A device is configured that supports the trace and logic analyzer function.

### Calling the trace editor

The following figure shows the project navigator with "Traces" below the device:

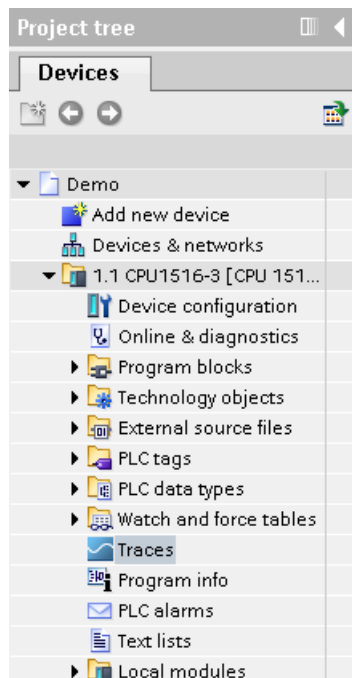

Procedure:

1. Open the trace editor by double-clicking the "Traces" entry.

### Creating a trace configuration

The following figure shows the "Trace configurations" table:

	Trace configurations	Comment
1	Machine1	
2	<Add new>	

Procedure:

1. Enter the name of the trace configuration in the "Trace configurations" table.

### Selecting signals

The following figure shows the configuration of the signals:

	Name	Data type	Address	Color	Comment
1	"Tag_1"	Byte	%MB10	Red	
2	"Tag_2"	Byte	%MB11	Cyan	
3	"Tag_3"	Word	%MW14	Magenta	
4	<Add new>				
	"Tag_2"	Byte	%MB11		
	"Tag_3"	Word	%MW14		
	"Tag_4"	DWord	%MD20		
	"Tag_5"	Bool	%M26.0		
	"Tag_6"	Bool	%M26.5		
	"Trig_Int_Value_Merker"	Bool	%M300.1		
	"TrigBit_False"	Bool	%M52.0		
	"TrigBit_False_Merker"	Bool	%M52.1		

Procedure:



1. Select the signals to be recorded in the "Signals" area of the Inspector window.

### Configuring the recording cycle

The following figure shows the configuration of the sampling:

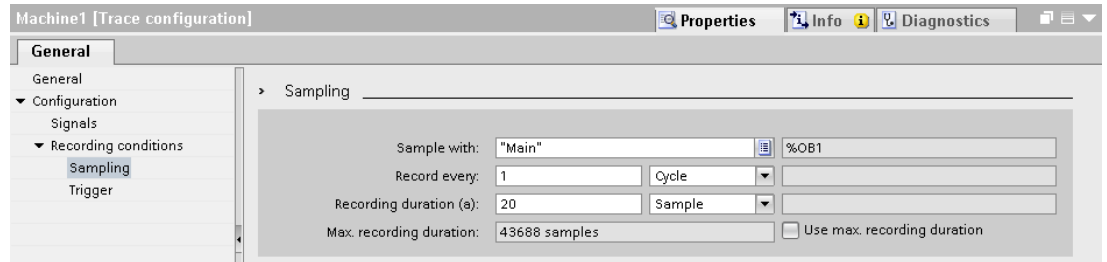

Procedure:

1. Configure the sampling.

### Configuring the trigger

The following figure shows the configuration of the trigger:

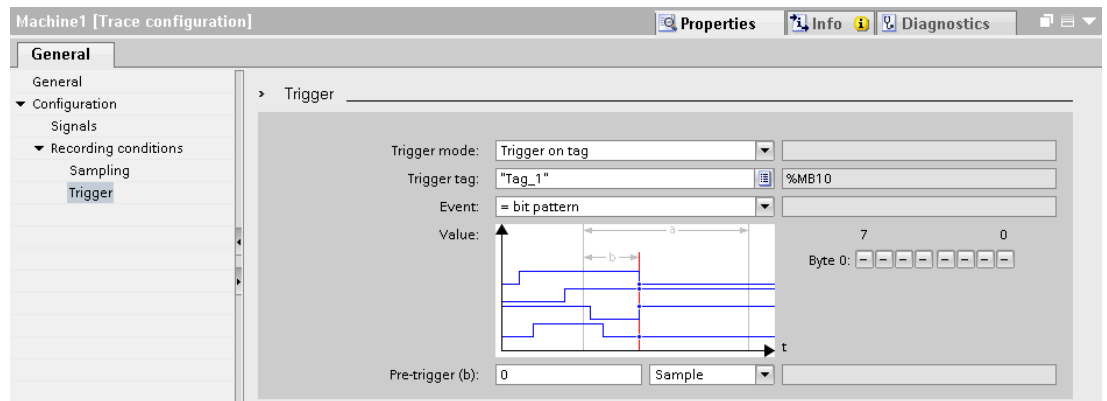

Procedure:

1. Configure the trigger mode and the condition for the selected trigger.

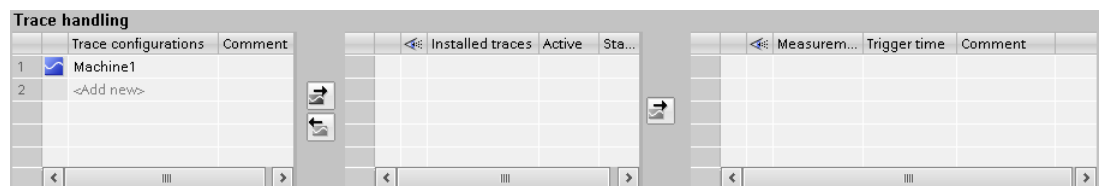

### Transferring the trace configuration to the device

The following figure shows the trace handling in online mode:



Procedure:

12.6 Using the trace and logic analyzer function

1. Check whether the configuration is correct based on the icon in the "Trace configurations" table.  
The  icon indicates a correct trace configuration.  
The  icon indicates a faulty trace configuration.  
Only correct trace configurations can be transferred to the device.
2. Establish an online connection to the device.
3. Select the trace configuration in the "Trace configurations" table and transfer it to the device with the  button.

Activating a recording

The following figure shows the trace handling with an installed trace configuration:

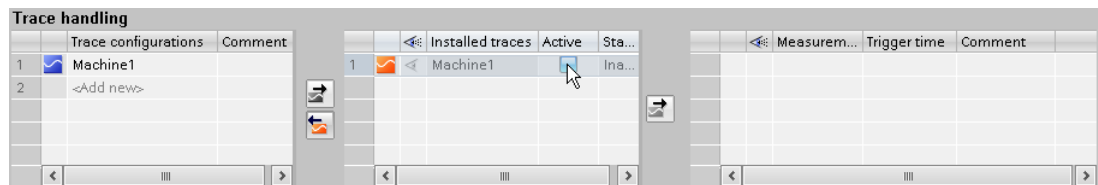

Procedure:



1. Click the checkbox in the "Active" column in the "Installed traces" table.

## Displaying the recording

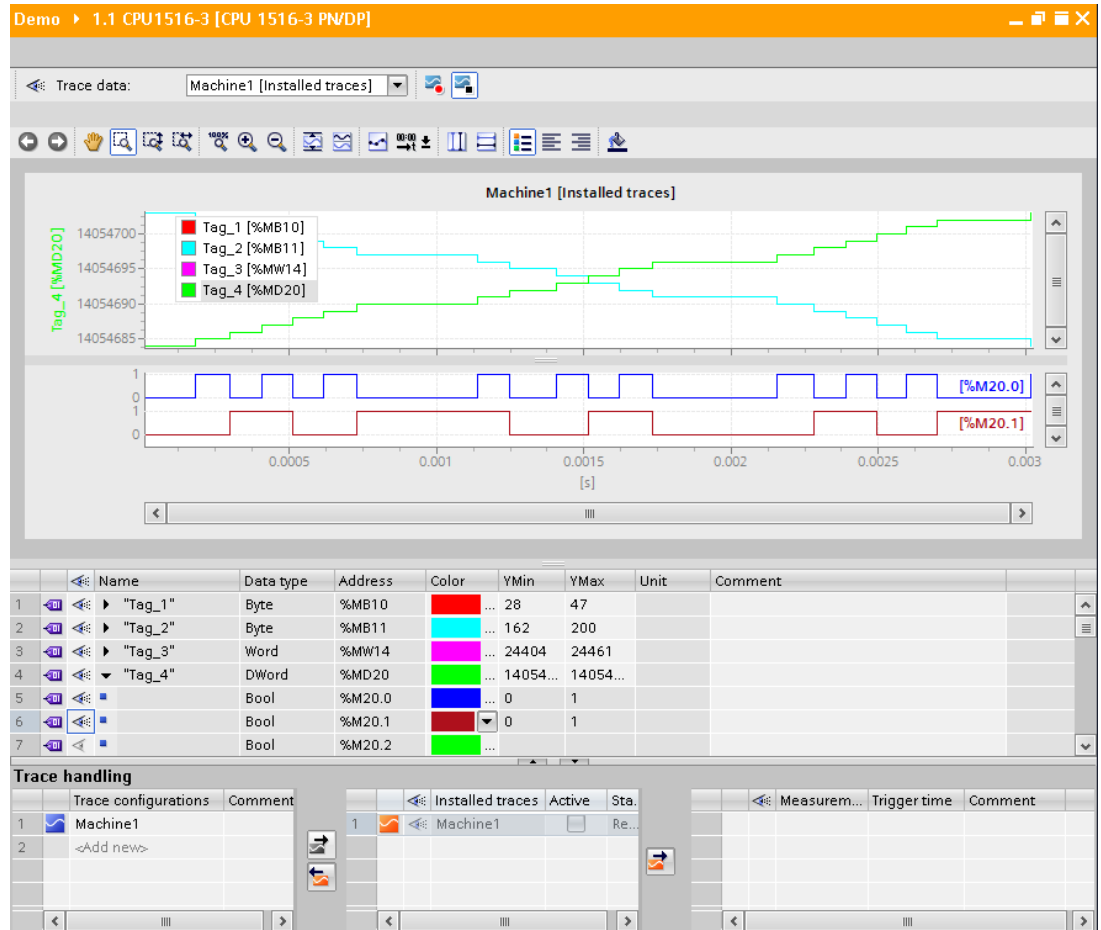
The following figure shows the curve diagram with the recording of the "Installed trace":



Procedure:

1. Wait until the "Recording" or "Recording completed" status is displayed in the "Installed traces" table.
2. Click the  icon in the "Installed traces" table to display the recording in the curve diagram.
3. Click the  icon of a signal in the signal table.  
The individual bits of the signal are offered for display as a bit track.
4. In the signal table, select or deselect the individual signals and bits for display with the  icon.

### Saving the measurement in the project

The following figure shows the measurement saved in the project:

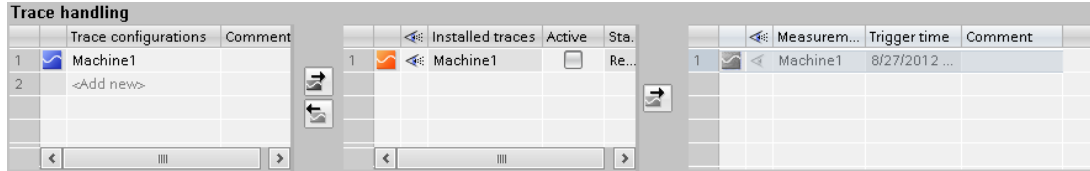

Procedure:

1. Select the measurement in the "Installed traces" table and transfer it to the project with the  button.

### 12.6.3.2 Using the trace function - overview

#### Requirement

A device is configured in the TIA Portal that supports the trace and logic analyzer function and to which an online connection has been established.

#### Procedure

The following table shows a procedural overview with typical steps when working with the trace and logic analyzer function.

Step	Description
1	Calling the trace editor (Page 6190)
2	Configuring the trace (Page 6191)
3	Transferring the trace configuration to the device (Page 6192)
4	Activating/deactivating an installed trace (Page 6192)
5	Monitoring the recording (Page 6193)
6	Saving measurements in the project (Page 6194)
7	Displaying the recording (Page 6193)

### 12.6.3.3 Calling the trace editor

A trace editor can be opened for each device in the project navigator.

The following instructions describe how you call the trace editor in the work area of the TIA Portal.

#### Requirement

A device is configured that supports the trace and logic analyzer function.

## Procedure

To call the trace editor, proceed as follows:

1. In the project navigator, double-click the device.  
The device folder opens.
2. Double-click "Traces".

### 12.6.3.4 Trace handling

## Configuring the trace

### Requirement

The trace editor is open.

### Creating and deleting the trace configuration

To create a new trace configuration, proceed as follows:

1. Click the "<Add>" entry in the "Trace configurations" table in the Trace handling (Page 6178).
2. Enter the name for the trace configuration.  
The new trace configuration is created.

To delete a trace configuration, proceed as follows:

1. Right-click a trace configuration in the "Trace configurations" table and select the shortcut menu command "Delete".  
The trace configuration is deleted.

## Configuring the trace

In the configuration, you specify the recording and trigger conditions and select the signals to be recorded.

See Section "Configuration" below the respective device (Page 6197).

---

### Note

#### Saving the trace configuration

You save the trace configuration with the project in the TIA Portal.

If you close the project without saving, the configuration is discarded. The trace editor can be closed and reopened without loss of data until the project is closed.

---



## Transferring the trace configuration to the device

### Requirement

- A valid trace configuration  is located in the "Trace configurations" table.
- The maximum number of "Installed traces" has not been reached yet.
- There is an online connection to the device.

### Procedure

To transfer a trace configuration to the device, proceed as follows:

1. Select a trace configuration  in the "Trace configurations" table.
2. Click the  button to transfer the trace configuration to the device.

### Result

The trace configuration is transferred to the device and displayed in the "Installed traces" table.

## Activating/deactivating an installed trace

### Requirement

A trace configuration is installed and there is an online connection to the device.

## Activating an installed trace

To activate the recording for an installed trace, proceed as follows:

1. Activate the checkbox of the "Active" column in the "Installed traces" table.  
The installed trace is activated and starts the recording according to the configured trigger condition. The trigger condition is device-specific and described in Section "Configuration" below the respective device (Page 6197).

---

### Note

When a recording is restarted, the previously recorded values are lost.

To save the recorded values, save the measurement in the project (Page 6194) before you activate the recording again.

---

## Deactivating an installed trace

To deactivate an activated installed trace, proceed as follows:

1. Deactivate the checkbox of the "Active" column in the "Installed traces" table.  
The installed trace is deactivated.

## Displaying the recording

### Requirement

A trace configuration with recording is in the device and there is an online connection to the device or there is an entry in the "Measurements" table.

### Procedure

To display the recording, proceed as follows:

1. Select an entry in the "Installed traces" table.
2. Click  in the column for the selected entry.

Or:

1. Select an entry in the "Measurements" table.
2. Click  in the column for the selected entry.

### Result

The recording is displayed in the curve diagram and the signal table.

## Saving measurements in the project

### Requirement

A trace configuration with recording is installed and there is an online connection to the device.

### Procedure

To save a recording in the project, proceed as follows:

1. Click an entry in the "Installed traces" table in the trace handling.
2. Click the  button to transfer the selected entry.  
The selected entry in the "Installed traces" table is added to the "Measurements" table.
3. Save the project in the TIA Portal.

## Exporting and importing measurements

### Requirement

There is at least one measurement in the "Measurements" table.

### Exporting measurements

To export a measurement, proceed as follows:

1. Right-click an entry in the "Measurements" table and select the shortcut menu command "Export measurement".
2. Select a folder, a file name and a data type to save the measurement.
3. Click the "Save" button.

### Importing measurements

To import a measurement, proceed as follows:

1. Right-click in the "Measurements" table and select the shortcut menu command "Import measurement".
2. Select the file of the "\*.ttrec" file type with the measurement to be imported.
3. Click the "Open" button.  
The imported measurement is displayed with the file name in the "Measurements" table.

## Transferring the trace configuration from the device to the project

### Requirement

A trace configuration is installed and there is an online connection to the device.



## Procedure

To transfer a trace configuration to the project, proceed as follows:

1. Select an entry in the "Installed traces" table.
2. Click the  button to transfer the trace configuration from the device.

## Result

The configuration of the "installed trace" is transferred to the "Trace configurations" table.

## Deleting installed traces

### Requirement

A trace is installed and there is an online connection to the device.

### Deleting an installed trace

To delete an installed trace, proceed as follows:

1. Select one or more lines to be deleted in the "Installed traces" table.
2. Press <Del> to delete the "Installed traces".

## 12.6.3.5 Signal table

### Use of the signal table

The signal table shows the recorded values of an installed trace or a measurement. You can show or hide individual signals for the display in the table and adapt the properties for the display.

Individual bits can be selected for some data types and displayed as a bit track.

The following operating instructions describe the operation of the signal table.

### Requirement

- An entry is selected in the  column in the "Installed traces" or "Measurements" table.
- For the display of individual bits as a bit track:  
At least one recorded signal supports the display as a bit track.



### Selecting individual signals in the signal table and changing the format

To adapt the display to suit your requirements, proceed as follows:

1. Click the icon of the respective signal in the  column to select or deselect it for the display.
2. Click in the "Color" column for the respective signal to change the default color of the signal.
3. Click the "Bring to foreground" entry in the shortcut menu of a signal to display it in the foreground.

### Selecting individual bits in the signal table for display as a bit track

To display individual bits as a bit track in the lower curve diagram, proceed as follows:

1. Click the  icon of a signal in the signal table.
2. Click the  icon in the opened bit selection of the signal to select or deselect individual bits for the display.

## 12.6.3.6 Curve diagram

### Use of the curve diagram

The curve diagram shows the signals of a recording selected in the signal table. Select the recording in the "Installed traces" or "Measurements" table of the trace handling.

The display area can be zoomed as required. Measurement cursors can be used to select individual values for display in the signal table.

The following operating instructions describe the use of the measurement cursors.

### Requirement

A recording has been selected for display.

### Evaluation of a certain instant of a recording

To display the values for a specific sample, proceed as follows:

1. Display the vertical measurement cursors via the  button.
2. Move a measurement cursor with the mouse to the required position in the recording. The values of the signals are displayed in the signal table. The time or sample for the measurement cursors is displayed in the lower area of the curve diagram.

### Evaluation of the difference between two samples

To display the difference, proceed as follows:

1. Display the vertical measurement cursors via the  button.
2. Move both measurement cursors with the mouse to the required samples in the recording. The values of the signals and the difference are displayed in the signal table. The time or sample for the measurement cursors is displayed in the lower area of the curve diagram.

## Using horizontal measurement cursors

To check whether a certain value has been reached, proceed as follows:

1. Display the horizontal measurement cursors via the  button.
2. Move a measurement cursor with the mouse to the required value of the recording.  
The values of the measurement cursor for the selected signal are displayed in the lower area of the curve diagram.

## Printing a recording

The curve diagram supports the saving of the display as a bitmap and the copying of the display to the clipboard. Also use these functions (Page 6175) for printing.

## 12.6.4 Devices

### 12.6.4.1 S7-1200/1500 CPUs

#### Recordable variables

#### Device-dependent recording of tags

The following list shows the operand areas from which tags can be recorded:

- Process image input
- Process image output
- Bit memory
- Data blocks

#### Data types

All elementary data types can be recorded.

The following table lists the elementary data types:

Data types	Note
<b>Binary numbers</b>	
BOOL	-
<b>Bit strings</b>	
BYTE	-
WORD	-
DWORD	-
LWORD	Symbolic name required
<b>Integers</b>	

Data types	Note
SINT	-
USINT	-
INT	-
UINT	-
DINT	-
UDINT	-
LINT	Symbolic name required
ULINT	Symbolic name required
<b>Floating-point numbers</b>	
REAL	-
LREAL	Symbolic name required

### Lifetime of the installed trace configuration and recorded values

Installed trace configurations are retained after POWER OFF. The recording is activated again after the restart of the CPU.

Recorded values are lost during the restart.

### Recording levels

The following list shows the execution levels that can be selected for the recording cycle:

- Program cycle - OB 1
- Time-of-day interrupt - OB 1x
- Time-delay interrupt - OB 2x
- Watchdog interrupt - OB 3x
- Synchronized processing cycles - OB 6x, not OB 60
- Servo task - OB 91 (S7-1500)
- IPO - OB 92 (S7-1500)

---

#### Note

The measured values are recorded at the end of the OB after the processing of the user program.

---

## Quantity structure

The following table shows the maximum quantity structure that can be recorded with the trace and logic analyzer function:

Device	Maximum number of "Installed traces"	Maximum number of signals per trace configuration
S7-1200 (as of firmware version V4.x)	2	16
S7-1500	4	16

## CPU load through trace recording

A trace recording increases the runtime of the respective recording level that can result in an execution level overflow with high utilization of the CPU.

### Remedy

- **Change the trace configuration**
  - 1) Configure fewer tags and signals.
  - 2) Then increase the number of tags and signals up to the maximum number of signals step-by-step without an execution level overflow.
- **Select a slower recording level**

## Software user interface of the device-specific area

### Structure of the user interface

## Display areas in the Properties window of the Inspector

The settings options differ depending on the configured device.

The following figure shows an example of the display in the TIA Portal:

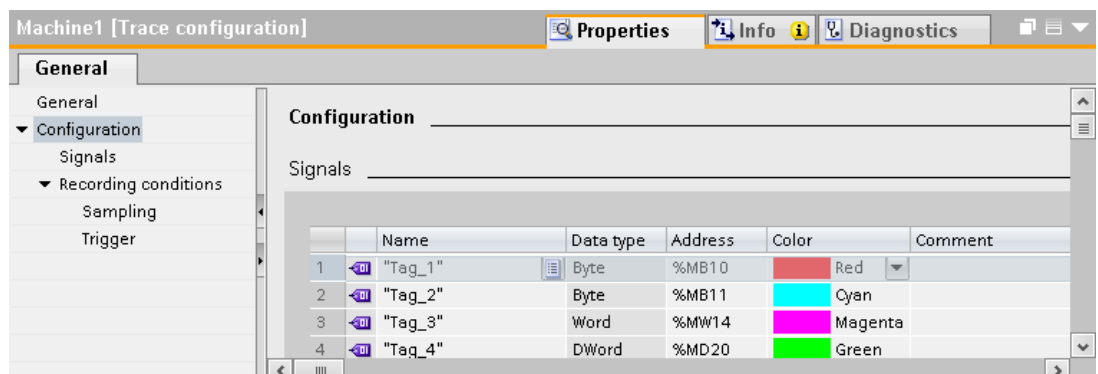

The area navigation provides the following entries for selection:

- General
- Configuration
  - Signals (Page 6200)
  - Recording conditions (Page 6202)

### Display of the properties of a trace configuration

The trace configuration is selected in the trace handling:

- Selection in the "Trace configurations" table  
The properties are displayed in the Inspector window and can be changed.
- Selection in the the "Installed traces" table or "Measurements" table  
The properties are displayed write-protected in the Inspector window.

### User interface - General

The "General" area shows the name of the trace configuration and input fields for the author and a comment.

### Input options and displays in General

The following figure shows an example of the display in the TIA Portal:

The screenshot shows a window titled "General" with a light gray background. On the left side, there are three labels: "Name:", "Author:", and "Comment:". To the right of each label is an input field. The "Name" field contains the text "Machine1". The "Author" field is empty. The "Comment" field is a larger text area, also empty.

The following table shows the input fields and displays:

Column	Icon	Description
"Name"	-	Name of the trace configuration
"Author"	-	Author of the trace configuration
"Comment"	-	Input field for a comment

### User interface - Signals

The "Signals" area shows a table in which the signals to be recorded are configured for the selected trace configuration.

## Setting options and displays in "Signals"

The following figure shows an example of the display in the TIA Portal:

	Name	Data type	Address	Color	Comment
1	"Tag_1"	Byte	%MB10	Red	
2	"Tag_2"	Byte	%MB11	Cyan	
3	"Tag_3"	Word	%MW14	Magenta	
4	"Tag_4"	DWord	%MD20	Green	

The following table shows the settings and displays:

Column	Icon	Description
		Display of the signal icon for a selected signal.
"Name"	-	Input field for the name or address of the signal. <b>Examples:</b> <ul style="list-style-type: none"> <li>• M0.0</li> <li>• DB1.DBW3</li> <li>• "Data_block_1".pressure</li> </ul>
-		Button to open the signal selection table. The button is displayed when the table line is selected. Clicking the icon opens a table which offers possible signals for selection. The selected signal is displayed in the input field.
"Data type"	-	Text field with display of the data type for the signal.
"Address"	-	Input field for the address of the signal. With purely symbolic signals the field remains empty.
"Color"	-	Text field for display and selection of the color. Click the selected field to display the signal color. Click the signal color to open the color selection dialog.
"Comment"	-	Input field for a comment.

## Shortcut menu commands

The following table shows the shortcut menu commands of the table:

Shortcut menu command	Description
"Cut"	Removes the selected lines and moves them to the clipboard.
"Copy"	Copies the contents of the selected lines to the clipboard.
"Paste"	Pastes the contents of the clipboard to the selected line. The existing contents are overwritten.
"Delete"	Deletes the selected lines from the table.
"Rename"	Switches the selected cell to the editing mode.

## Recording conditions

### Supported data types

The following table shows the supported data types for the trigger tag:

Memory requirement and format of the number	Data type
1 byte	BOOL
8-bit integers	SINT, USINT, BYTE
16-bit integers	INT, UINT, WORD
32-bit integers	DINT, UDINT, DWORD
64-bit integers	LINT, ULINT, LWORD
32-bit floating-point numbers	REAL
64-bit floating-point numbers	LREAL

### User interface - Recording conditions

The "Recording conditions" area shows the trigger condition for the selected trace configuration and in which cycle, how fast and how long the recording is made. The configuration is only possible if the trace configuration has been selected in the "Trace configurations" table of the trace handling.



## Setting options and displays in "Recording conditions"

The following figure shows an example of the display in the TIA Portal:

Recording conditions \_\_\_\_\_

> Sampling \_\_\_\_\_

Sample with: "Main"  %OB1

Record every: 1  Cycle

Recording duration (a): 20  Sample

Max. recording duration: 32766 samples   Use max. recording duration

> Trigger \_\_\_\_\_

Trigger mode: Trigger on tag

Trigger tag: "C\_Int"  %MW30

Event: Rising signal

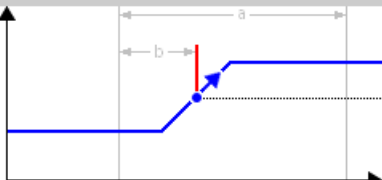
Value:  = 0

Pre-trigger (b): 0  Sample

Setting/display	Description
<b>"Recording time"</b>	
Drop-down list	Selection of the recording time. See Recording levels (Page 6196)
Text field	Detailed information on the selected recording time.
<b>"Record every"</b>	
Input field	Input of the reduction in relation to the cycles.
Drop-down list	Selection of the reduction factor. The following settings are possible: <ul style="list-style-type: none"> <li>• "Cycle"</li> </ul>
Text field	Display of the sampling time, taking into account the configured reduction.
<b>"Recording duration"</b>	
Input field	Input of the recording duration in relation to the samples. If the "Recording duration = max. recording duration" checkbox is activated, entries are overwritten by the value displayed in "Max. recording duration".
Drop-down list	Select the time unit for the recording duration. The following settings are possible: <ul style="list-style-type: none"> <li>• "Samples"</li> </ul>
Text field	Displays the calculated recording duration

Setting/display	Description
"Max. recording duration"	
Text field	Displays the calculated maximum recording duration The "Max. recording duration" depends on how many signals are recorded and the data type of these signals.
"Use max. recording duration"	Set the recording duration to the maximum value. When the checkbox is activated, the recording duration is set to the maximum possible recording duration. The set reduction in the "Record every" input field is taken into account. The recording duration is also adapted when additional signals are added.
"Trigger mode"	Selection of the trigger mode.
Drop-down list	The following settings are possible: <ul style="list-style-type: none"> <li>"Record immediately" The recording is made immediately after the device is activated.</li> <li>"Trigger on tag" The recording is made as soon as the installed trace is activated and the configured trigger condition is fulfilled.</li> </ul>
Text field	Display of the trigger type.
"Trigger tag"	The "Trigger tag" specifies a signal that is used to trigger the recording.
Input field	Enter a signal. <b>Examples:</b> <ul style="list-style-type: none"> <li>M0.0</li> <li>DB1.DBW3</li> <li>"DataBlock_1".Temperature</li> </ul>
	Opens the signal selection table. Clicking the icon opens a table which offers possible signals for selection as trigger tag. The selected signal is displayed in the input field.
Text field	Display of the trigger tag address.
"Event"	The events that can be used on this trigger tag are offered for selection according to the data type of the trigger tag. The event can only be configured when a valid signal has been entered as trigger tag.
Drop-down list	Event selection for which the trigger tag is checked. The entries in the drop-down list are described in Section Trigger event (Page 6205).
Text field	Display of the comparison type.
"Value"	Configuration of the selected event. The configuration options differ depending on the format of the trigger tag and the selected event. See Trigger event (Page 6205).

Setting/display	Description
"Pre-trigger"	<p>"Pre-trigger" defines the time during which the signals are already recorded before the actual trigger condition is fulfilled.</p> <p>If the trigger event occurs immediately or shortly after the activation of the recording, this may result in a shorter recording duration.</p> <p>Example of "recording duration" = 20 samples and "pre-trigger" = 5 samples:</p> <ul style="list-style-type: none"> <li>• Trigger event occurs 50 samples after activation of the recording Actual recording duration = 20 samples</li> <li>• Trigger event occurs 2 samples after activation of the recording Actual recording duration = 17 samples</li> </ul>
Input field	Input of the duration in relation to the selection in the drop-down list.
Drop-down list	<p>Select the time unit</p> <p>The following settings are possible:</p> <ul style="list-style-type: none"> <li>• "Samples"</li> </ul>
Text field	Displays the calculated "pre-trigger" period

## Trigger event

Depending on the selection in the drop-down list box, the further settings differ for the "event".

The individual events are described below.

### "=TRUE"

Supported data types: Bit (Page 6200)

The recording starts when the state of the trigger is TRUE.

### "=FALSE"

Supported data types: Bit (Page 6200)

The recording starts when the state of the trigger is FALSE.

### "Rising edge"

Supported data types: Bit (Page 6200)

The recording is started when the trigger state changes from FALSE to TRUE.  
After activation of the installed trace, at least two cycles are required to identify the edge.

### "Rising signal"

Supported data types: Integers and floating-point numbers (Page 6200)

The recording is started when the rising value of the trigger reaches or exceeds the value configured for this event.

After activation of the installed trace, at least two cycles are required to identify the edge.

### "Falling edge"

Supported data types: Bit (Page 6200)

The recording is started when the trigger state changes from TRUE to FALSE.  
After activation of the installed trace, at least two cycles are required to identify the edge.

### "Falling signal"

Supported data types: Integers and floating-point numbers (Page 6200)

The recording is started when the falling value of the trigger reaches or falls below the value configured for this event.  
After activation of the installed trace, at least two cycles are required to identify the edge.

### "In the range"

Supported data types: Integers and floating-point numbers (Page 6200)

The recording starts as soon as the value of the trigger is in the value range configured for this event.

### "Outside of the range"

Supported data types: Integers and floating-point numbers (Page 6200)

The recording starts as soon as the value of the trigger is outside the value range configured for this event.

### "= value"

Supported data types: Integers (Page 6200)

The recording starts when the value of the trigger is equal to the value configured for this event.

### "<> value"

Supported data types: Integers (Page 6200)

The recording starts when the value of the trigger is not equal to the value configured for this event.

### "= bit pattern"

Supported data types: Integers (Page 6200)

The recording starts when the value of the trigger matches the bit pattern configured for this event.

The following figure shows the setting options for a "bit pattern":

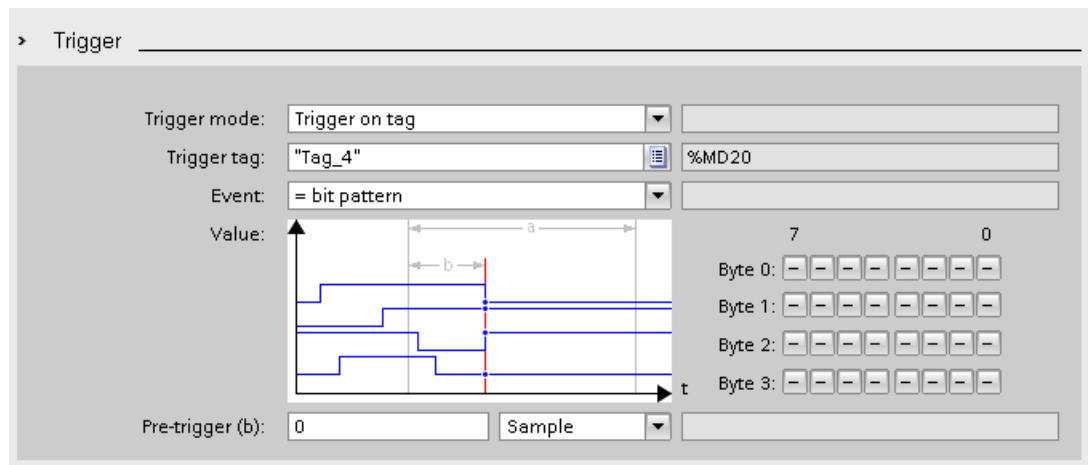

It is possible to switch between the icons by clicking the respective button.

The following table shows the icons:

Icon	Description
<input type="checkbox"/>	Bit is not evaluated
<input type="checkbox"/> 0	Bit is checked for FALSE
<input type="checkbox"/> 1	Bit is checked for TRUE

### "<> bit pattern"

Supported data types: Integers (Page 6200)

The recording starts when the value of the trigger does not match the bit pattern configured for this event.

### See also

Configuring the trigger conditions (Page 6209)

### Configuration

#### Trace configuration - overview

The configuration of the recording conditions and the signals to be recorded is device-specific.

### Requirement

A trace configuration has been created and selected in the "Trace configurations" table of the trace handling.

## Procedure

The following table shows the procedure for configuring.

Step	Description
1	Documentation of the configuration (optional) Enter a comment and an author for the configuration.
2	Selecting signals (Page 6208) Select the signals to be recorded in the "Signals" area.
3	Configuring the recording cycle and duration Select a recording time, a cycle and the duration in the "Recording conditions" area.
4	Configuring the trigger conditions (Page 6209) In the "Recording conditions" area, select whether the recording is to be performed immediately or depending on a trigger condition.

## Selecting signals

### Requirement

- A trace configuration has been created and selected in the "Trace configurations" table of the trace handling.
- The "Signals" area is open in the Inspector window.

### Procedure

To configure the signals to be recorded, proceed as follows:

1. Click in the first empty line of the table.
2. Click in the first empty line of the "Name" column
3. Select a signal. The following options are available:
  - In the "Name" column, click the  button and select a tag.
  - Enter the symbolic tag name in the cell in the "Name" column.
  - Enter the address directly in the "Address" column.
4. Click in the "Display color" column and select a color for the display of the signal.
5. Click in the "Comment" column and enter a comment for the signal.
6. Repeat the procedure from step 1 until all the signals to be recorded have been entered in the table.

## Configuring the recording cycle and duration

### Requirement

- A trace configuration has been created and selected in the "Trace configurations" table of the trace handling.
- The "Recording conditions" area is open in the Inspector window.

### Procedure

To configure the cycle and the duration of a recording, proceed as follows:

1. Click the  button for the recording time.
2. Select an OB for the recording time (Page 6196).
3. Select a unit for the reduction factor in the drop-down list box for "Record every".
4. Enter the factor for the reduction in the input field for "Record every".
5. Select a unit in the drop-down list box for "Recording duration".
6. Specify the recording duration.  
The following options are available:
  - Enter a value for the duration in the input field for "Recording duration".
  - Activate the "Use max. recording duration" checkbox.

## Configuring the trigger conditions

### Requirement

- A trace configuration has been created and selected in the "Trace configurations" table of the trace handling.
- The "Recording conditions" area is open in the Inspector window.

### "Record immediately" trigger condition

To start the recording immediately, proceed as follows:

1. Select the "Record immediately" entry in the drop-down list for "Trigger mode".  
The input fields for the trigger tag are hidden.

### "Trigger on tag" trigger condition

To start the recording depending on a condition, proceed as follows:

1. Select the "Trigger on tag" entry in the drop-down list for "Trigger mode".
2. Select a trigger tag. The following options are available:
  - Click the  button for the trigger tag and select a tag.
  - Enter the address or the symbolic name of the tag directly in the input field for the trigger tag.

A drop-down list with events and input fields is displayed. The display depends on the data type of the tag.
3. Configure the event.
4. Select a unit for the pre-trigger in the drop-down list for "Pre-trigger".
5. In order to record a period before the trigger event, enter a value greater than 0 in the input field for the pre-trigger.

---

#### Note

The trigger condition is checked in every cycle irrespective of the setting in "Record every".  
To reliably identify the trigger, the trigger signal must be present for at least one full cycle.

---



## 12.7 Establishing a remote connection with TeleService

### 12.7.1 Basics of working with TeleService

#### 12.7.1.1 Introduction to TeleService

##### Introduction

TeleService gives your controller telecommunication capability. You can manage, control and monitor distributed plants centrally by means of remote connections.

##### Scope of functions

TeleService allows you to use the range of TIA portal functions via a telephone network or an Internet connection by establishing a remote connection to a remote plant. The online connection allows you to edit a remote plant as usual with the TIA Portal.

##### Advantages

Using TeleService offers the following advantages:

- You can easily access even remote sections of plants and include them in a complete system.
- You can offer rapid help and support in the event of faults in a remote system without having to go there yourself.
- You can employ your resources effectively.
- It significantly reduces costs.
- It can significantly reduce plant downtimes.
- It improves the efficiency of your plant.

##### See also

TeleService functionality (Page 6212)

## 12.7.1.2 TeleService functionality

### TeleService fields of application

TeleService offers the following the fields of application:

- **Access to remote systems (remote maintenance):**  
You can manage, control, and monitor remote systems centrally by means of remote connections.  
This is possible with an S7-300/400 CPU, an S7-1200 CPU and an S7-1500 CPU and a TS Adapter MPI or a TS Adapter IE.
- **Establishing connections from and to remote systems (PG-AS remote link):**  
You can use PRODAVE MPI V5.0 and newer to establish a remote connection to a remote system, and the communications instruction "PG\_DIAL" to establish a remote connection from a remote system.  
This is possible with an S7-300/400 CPU and a TS Adapter MPI.
- **Data exchange between systems (AS-AS remote link):**  
The communications instruction "AS\_DIAL" allows two automation systems to exchange process data over the telephone network.  
This is possible with an S7-300/400 CPU and a TS Adapter MPI.
- **Sending an text message from a system:**  
An automation system can send a message (SMS) via a GSM wireless modem using the communications instruction "SMS\_SEND" .  
This is possible with an S7-300/400 CPU and a TS Adapter MPI.
- **Sending an email from a system**  
An automation system can also send an email with the following communications instructions and a TS Adapter IE .
  - S7-300/400 CPUs (CPU S7-31x-2PN/DP or CPU 41x-3PN/D) use the instruction "AS\_MAIL"
  - S7-1200 CPUs use the instruction "TM\_MAIL"
  - S7-1500 CPUs use the instruction "TMAIL\_C"

## 12.7.1.3 Telephone book at TeleService

### Introduction

By double clicking the "phone book" folder in the project tree you open the phone book editor displaying the TeleService phone book.

Each version of the TIA Portal has its own "global phone book". If a global phone book from an earlier version of the TIA Portal is found in a more recent version of the TIA Portal, you will be asked once if you want to import this phone book.

This gives you the advantage of being able to import the system data from the previous version into the more recent version of the TIA Portal.

## Global phone book properties

The global phone book is used in TeleService to manage specific system data that are required to establish a remote connection.

When you open the phone book for the first time, you will see an empty phone book with all available columns; in all other cases, the last phone book edited is displayed.

You can enter any number of systems in a phone book. Systems contain the data required for establishing a remote connection, for example, the name and location of the device and the phone number to be dialed, along with all country-specific details. With VPN connections, you can enter an IP address or a DNS name instead of the phone number.

The TS adapters used for establishing the connection are distinguished by color, depending on whether a TS Adapter MPI or a TS Adapter IE is used for establishing the connection.

## See also

Working with the phone book (Page 6213)

## 12.7.2 Working with the phone book

### 12.7.2.1 Basics on working with the phone book

#### Working with the phone book

You have the following options when working with a phone book:

- Open phone book
- Save phone book
- Import phone book data
- Export phone book data
- Printing the phone book
- Use phone book data to establish a remote connection

You can implement these functions simply and easily by using the buttons in the phone book toolbar.

---

#### Note

##### Access to phone books

The phonebook is user specific in TeleService. However, it is not possible to access the global phone book with more than one instance of the TIA portal at the same time.

---

**See also**

- Open phone book (Page 6215)
- Saving phone book (Page 6216)
- Exporting phone book data (Page 6218)
- Printing the phone book (Page 6219)
- Structure of the phone book (Page 6214)

**12.7.2.2 Structure of the phone book**

**Introduction**

A global phone book in TeleService is used to manage the data you require for establishing a remote connection. Once you have created the connection data and saved it in the phone book, you can access it each time you want to establish a remote connection.

**Structure of the phone book**

The integrated global phone book in TeleService contains the following columns:

Column name	Meaning
System name	Enter a name for your system.
Adapter type	Select the TS Adapter type used in the drop-down list: TS Adapter MPI or TS Adapter IE.
Connection type	Select the required connection type: Dial-up connection or VPN connection.
Area code	Enter the required area code. This column is only active with dial-up connections. This column cannot be edited for VPN connections.
Phone number/remote address	Enter the required connection data for establishing the remote connection. For dial-up connections, this can be a phone number, and for VPN connections a DNS name or an IP address.
Fingerprint	Enter the corresponding fingerprint for establishing a VPN connection to the TS Adapter IE Advanced.
Country	Enter the country code. This column is only active with dial-up connections. This column cannot be edited for VPN connections.
User name	Enter the user name you have logged on under.
Password	Enter the password for this user name.
Group	Enter the group if you have carried out grouping.
Company	Enter the company to be contacted.
Department	Enter the relevant department.
Street	Enter the street.
Town/City	Enter the town or city to which the remote connection is to be established.
Comment	Enter a comment if required.











## Showing or hiding columns

You can show or hide the individual columns. To do so, select the required column header and open the shortcut menu with the right mouse button.

### 12.7.2.3 Symbols in the phone book

#### Meaning of the TeleService icons

The following table shows the meaning of the TeleService icons:

Symbol	Meaning
	Open the global phone book
	Imports a phone book
	Exports a phone book
	Establishes a remote connection
	Terminates the active remote connection
	Establishes a remote connection or terminates it
	Displays the connection to a TS Adapter IE in the phone book
	Displays the connection to a TS Adapter MPI in the phone book
	Adds a new row to the phone book
	Inserts a new row in the phone book

### 12.7.2.4 Manage phone book

#### Open phone book

#### Opening phone books

To open the phone book, follow these steps:

1. In the project tree, double-click on the "Phone book" folder under "Online access" > "TeleService".
2. The phone book opens so that you can enter or edit the required system data.

## **Inserting rows in the phone book**

### **Inserting rows in the phone book**

To insert a new row in the phone book, follow these steps:

1. Select the row in front of which you want to insert a new row.
2. Click the "Insert row" button in the toolbar.

### **Result**

A new row is inserted in the phone book above the selected row.

## **Showing and hiding columns in the phone book**

### **Showing and hiding columns**

To show or hide columns in the phone book, follow these steps:

1. Click a column header.
2. In the shortcut menu, select the "Show/hide columns" command.  
The selection of available columns is displayed.
3. To show a column, select the column's check box.
4. To hide a column, clear the column's check box.

### **Result**

The respective columns are shown or hidden when displaying the phone book.

## **Saving phone book**

### **Saving phone books**

When you exit the phone book editor or leave the TIA portal, you are asked whether you want to save the global phone book.

Click "Yes" to save the phone book.

## **Importing phone book data**

### **Introduction**

It is possible to import the phone book data from an external file or from an older version of the TIA Portal.

## Requirement

You have already created an import-capable phone book file.

You have already created a phone book with an older version of the TIA Portal.

## Importing phone book data from a phone book file

To import phone book data from a phone book file, follow these steps:

1. Open the "TeleService" folder under "Online access" in the project tree.
2. Double-click on the "Phone book" folder.
3. Click the "Import" button in the toolbar.
4. Confirm the prompt asking if you want to save the current state of the phone book with "Yes", if applicable, and specify the location for storing the phone book in the dialog that follows.
5. If you do not want to save the current state of the phone book, answer the prompt with "No". In the subsequent dialog, select the phone book file to which the current phone book should be stored.
6. Close the dialog box with "OK".

## Result

The imported phone book data is displayed in the global phone book.

---

### Note

#### Defining dialing rules

Dialing rules must be defined before the "area code" and "country" columns in the imported phone book can be edited for dial-up connections.

To define dialing rules, follow the link in the history.

---

## Importing phone book data from an older version of the TIA Portal

To import phone book data from an older version of the TIA Portal, follow these steps:

1. Open the "TeleService" folder under "Online access" in the project tree.
2. Double-click on the "Phone book" folder.
3. Click the "Import" button in the toolbar.
4. Confirm the prompt asking if you want to save the current state of the phone book with "Yes", if applicable, and specify the location for storing the phone book in the dialog that follows.
5. If you do not want to save the current state of the phone book, answer the prompt with "No".

### 12.7 Establishing a remote connection with TeleService

6. Enter the following path in the dialog that follows: "%appdata%\siemens\automation\TeleService\GlobalTeleServicePhoneBook.tel".
7. Close the dialog box with "OK".

#### Result

The phone book data imported from the older version of the TIA Portal is displayed in the global phone book.

---

#### Note

##### Defining dialing rules

Dialing rules must be defined before the "area code" and "country" columns in the imported phone book can be edited for dial-up connections.

To define dialing rules, follow the link in the history.

---

#### See also

Defining dialing rules (Page 6219)

#### Exporting phone book data

##### Introduction

It is possible to export phone book data to an external file.

##### Requirement

You have already created a phone book under TeleService with the corresponding system data.

##### Procedure

Proceed as follows to export the phone book data:

1. Open the "TeleService" folder in project tree.
2. Double-click on the "Phone book" folder.
3. Click the "Export" button in the toolbar.
4. In the next dialog box, select where the current phone book is to be exported.
5. Close the dialog box with "OK".



## Result

The exported phone book data are saved in the specified export file.

## Printing the phone book

### Printing phone books

You can print out all or some of the data in a phone book.

### Proceed as follows:

1. Open the phone book.
2. Select the **Phone book > Print** menu command or click on the appropriate button in the toolbar. The "Print" dialog will open.
3. Specify whether you wish to print the complete phone book or just part of it and set all other options.
4. Start the print job with "OK".

## Result

The phone book data is printed on the default printer. If the printout is more than one page long, an identifier is printed after the page number at the bottom right corner of the page to indicate that there is another page. The last page does not have this symbol, indicating that no more pages are to follow.

## Defining dialing rules

### Procedure

To define location-specific dialing rules, follow these steps:

1. Open the folder "Online access" in the TIA portal and select the "TeleService" folder.
2. Use the shortcut menu to access the "TeleService" properties.
3. In the dialog that follows, open the "Advanced settings" tab and activate the "Use dialing rules" option.
4. Click the "Adapt" button.
5. In the dialog that follows, enter the required location information for connection establishment.
  - For new locations, enter the country or region and the corresponding area code.
  - If required, set the correct destination code and pre-dial line for local/long-distance calls.
  - Select your chosen dialing mode for the location.

12.7 Establishing a remote connection with TeleService

6. Exit the dialog by clicking "OK".
7. In the next dialog, select the location from which you wish to dial, and click "OK".
8. In the TeleService dialog that follows, check that the correct location appears under "Location".
9. Confirm your entries by clicking "OK".

---

**Note**

**Modem operation on a local loop or extension**

You do not need to specify a pre-dial line if you operate your modem on a local loop (main telephone line). The fields for the pre-dial lines for local calls and long-distance calls must be empty.

If you operate your modem on an extension, you should enter the pre-dial lines which need to be called to access a local loop.

---

**Example of the use of dialing rules**

The following example illustrates the use of location-specific dialing rules for the city of Karlsruhe in Germany.

- In the TeleService phone book, you enter the phone number "1234567", without the area code and without the country code.

**Result:**

The phone number "1234567" is always dialed, irrespective of the location of the caller.

- In addition to the phone number "1234567", you enter the location-specific dial parameters for the Karlsruhe area code "0721" and the country code "+49" for Germany in the TeleService phone book.

**Result:**

"1234567" is dialed from Karlsruhe.

"07211234567" is dialed from other towns in Germany.

"00497211234567" is dialed from other countries.

---

**Note**

**Display in the phone book**

The "area code" and "country" columns in the TeleService phone book can only be edited once you have defined the dialing rules as detailed above.

---

## 12.7.3 Remote connections as dial-up connections

### 12.7.3.1 Basics for establishing a dial-up connection

#### Using a TS Adapter for dial-up connections

A TS Adapter is needed for establishing a remote dial-up connection using TeleService.

The TS Adapter is used to prepare an automation system for use with TeleService by connecting it to a telephone network via a modem. The TS Adapter has an integrated parameter memory in which a parameter set for TeleService operation is stored.

With the function "export adapter parameter", different parameter sets can be saved in external files, and reloaded in the TS Adapter via the function "import adapter parameter".

#### Establishing a remote dial-up connection

You can choose between a number of different TS Adapters, each of which offers a different functionality and different connection options.

The figure below shows two possible configurations for establishing a dial-up connection to a system with the TS Adapter IE.

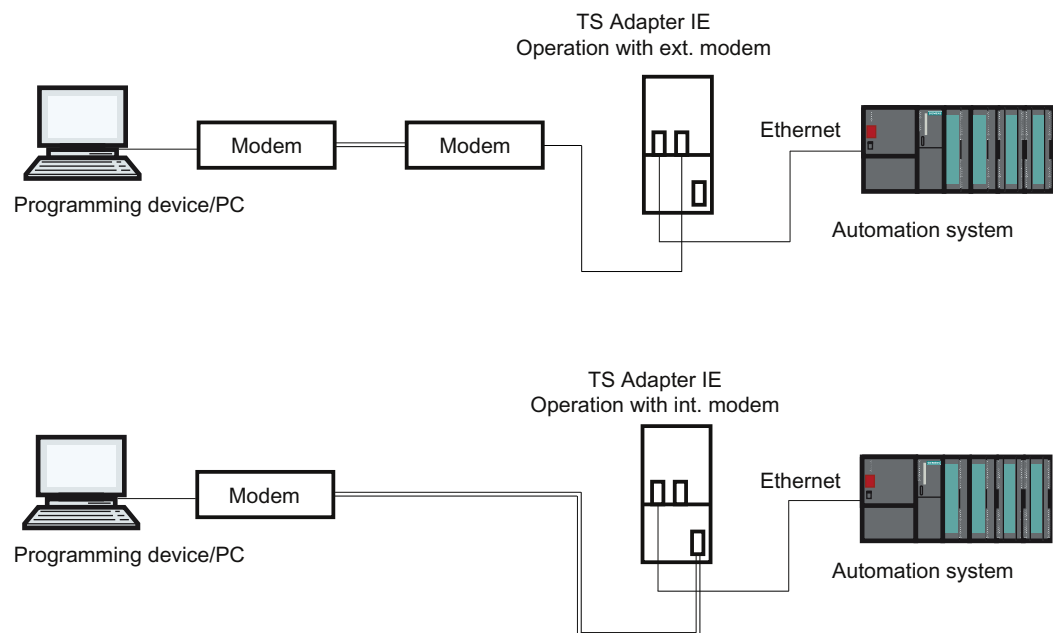

### Overview of possible TS Adapter:

The TS Adapter comes in the following versions:

- TS Adapter II (also designated "TS Adapter MPI")
- TS Adapter IE Standard (also designated "TS Adapter IE")
- TS Adapter IE Basic (also designated "TS Adapter IE")

### Designation "TS Adapter"

In the following pages, the designation "TS Adapter" stands for all versions. The relevant product designation is listed beside information which only applies to a specific version, for example, "TS Adapter II" or "TS Adapter IE Standard".

---

#### Note

For more detailed information on your TS Adapter, please refer to the documentation supplied with the TS Adapter.

---

### See also

Short description of the TS adapter MPI (Page 6230)

Short description of the TS adapter IE (Page 6237)

Exporting adapter parameters (Page 6236)

Importing adapter parameters (Page 6237)

## 12.7.3.2 Telephone networks and modems

### Supported telephone networks and modems

#### Telephone networks which can be used

TeleService can be used with digital networks (ISDN), analog networks and wireless networks (with GSM technology). This version supports a remote connection to a TS Adapter.

#### Modem support

TeleService has been implemented to be independent of the modem. This means that all standard modems which can be installed in the Windows Control Panel and are visible as modems can also be used by TeleService.

The choice of modem type is determined primarily by the existing hardware of the programming device/PC and the telephone network to be used.

**The following modem types/media are supported:**

- Modems (external modems at the COM interface, internal modems and PCMCIA cards)
- External ISDN adapter at the COM interface or USB interface
- Internal ISDN adapter with virtual COM interface (for example AVM CAPI port)
- External ISDN modems (ISDN adapter with integrated analog modem functionality) at the COM interface or USB interface
- Radio network modems with GSM technology, PCMCIA adapter card or data cable and mobile phone

**Gateways**

Gateways between the various telephone networks are in principle possible. Remote connections from an ISDN adapter to an analog modem and vice versa only function with special ISDN telephone adapters.

**Performance in telephone networks**

The data throughput of a remote connection depends on the modem and telephone network used and the quality of the telephone line.

**Installing the local modem**

**Introduction**

If you have already installed a modem for data transfer in your operating system, this modem can also be used for TeleService.

If a modem has not yet been installed for your operating system, one must be installed before you can establish a remote connection with TeleService.

**Procedure**

Proceed as follows:

1. Make sure your programming device/PC and the modem are switched off.
2. Physically connect the external modem to a COM or USB interface on your programming device/PC. You can also install an internal modem or a PCMCIA card in accordance with the manufacturer's specifications.
3. Now switch on the modem and then the programming device or the PC.

## Result

Plug-and-play modems are recognized and installed automatically by the operating system. Dialogs will take you through the installation procedure.

---

### Note

#### Modems without plug-and-play

If your modem is not recognized automatically when switched on, you will have to install it yourself using the Control Panel.

Please refer to the information in the documentation supplied with your modem.

---

## Connecting and configuring the remote modem

### Introduction

A modem must also be connected to the remote system before you can work with TeleService. This modem is designated the "remote modem".

### Configuring the remote modem

The modem receives all parameters required for operation from the TS Adapter connected. These include data for initializing the modem and settings for serial transmission between the TS Adapter and the modem.

The data required for the remote modem is specified during the configuration of the TS Adapter. The modem may be internal or external depending on the TS Adapter used.

### How to connect a TS Adapter with an internal modem

1. Switch off the TS Adapter.
2. Connect the TS Adapter to the automation system.
3. Connect the TS Adapter to the telephone line.
4. Switch on the TS Adapter.

### How to connect a TS Adapter with an external modem

1. Switch off the modem.
2. Connect the TS Adapter to the automation system.
3. Connect the TS Adapter to the modem using a modem cable.
4. Connect the modem to the telephone line.
5. Switch on the modem.
6. Switch on the TS Adapter.

---

**Note**

**Please note the following information on configuring the remote modem:**

- The default parameters for the modem and the serial port set in the TS Adapter should in most cases ensure successful operation; changes in the parameter assignment will only be needed in rare cases.
  - You need only change the parameter assignment of the TS Adapter if a modem connection is not established or if factory settings are to be adapted or optimized.
  - TS Adapter parameter assignment can be changed via either a direct or a remote connection.
- 

### 12.7.3.3 Access protection for dial-up connections

#### Access protection information

##### Introduction

When you assign the parameters for your TS adapter, you can restrict access to the parameters of the TS adapter and access to remote systems.

##### Scope of access protection

Access protection only exists for remote connections; TS adapter parameter assignment can be accessed at any time in direct connection mode.

Access protection also exists in direct connection for the TS adapter IE.

##### Access protection information

The TS Adapter MPI is not delivered with access protection activated. There is a default password for the TS adapter IE.

The first user who assigns the parameters for this adapter can therefore activate access protection by defining the password for a user and/or a callback number.

This is a multi-level access protection with several users, each with or without administrator rights. For the TS adapter MPI there is only one administrator and no more than two users.

For a modem connection, only an administrator can define the two users and change and, if necessary, delete their settings. Those logged in as users can only change their own passwords and their own callback numbers. However, with the TS adapter MP you can access the process of assigning parameters of the TS adapter in direct connection, without restriction.

## Advantages

Access protection offers the following advantages:

- Unauthorized access by persons outside the system is almost impossible.
- The plant operator bears most of the telephone costs.

## TeleService callback options

### Callback variants

The costs of a telephone connection are normally borne by the caller who establishes the dial-up connection.

TeleService can, however, be used so that after a short initial connection the modem connection is established again in the opposite direction, in other words initiated by the TS Adapter (callback). In this case, the plant operator bears the costs of the callback.

### There are two callback variants in TeleService:

1. Callback to a number specified during connection establishment.
2. Callback to a number stored on the TS Adapter.

## Levels of protection

### Introduction

You can set up one of two possible levels of access protection for TeleService access to the TS Adapter. Different options are available with each protection level.

### Access protection options

#### Access protection level 1:

The TS Adapter is protected by the user name and password. You can access the TS Adapter via any telephone line and specify any callback number during connection establishment.

#### Access protection level 2:

The TS Adapter is protected by the user name, password, and the callback number. You can only access the TS Adapter from one telephone connection per user.

The table below sets out the above conditions for the various protection levels:

Level of access protection	Administrator/User password	Callback number
1	enter	do not enter
2	enter	enter



## Logging on to TS Adapter

When you log on to the TS Adapter and after you have set up access protection, enter your user name, the corresponding password and, if desired, a callback number:

Level of access protection	Administrator/User password	Callback number
1	enter	do not enter or enter any callback number
2	enter	do not enter

If you have entered a callback number during connection establishment (access protection level 1) or stored a callback number in the TS Adapter (access protection level 2), the modem connection will be terminated and the TS Adapter will call back the given number.

## Setting up access protection and callback number for the TS adapter

### Introduction

During the parameter assignment for the TS adapter MPI in TeleService, you can set up access protection and a callback number for the parameter assignment of the adapter and connection to the remote system. The following describes the parameter assignment for a TS adapter MPI. The parameter assignment of a TS adapter IE is carried out in analog. The specific method is described in the web help of this adapter.

### Requirement

A TS Adapter MPI is connected to your computer and is displayed in the project tree under "Accessible nodes".

### Procedure

To set up access protection for the TS adapter, proceed as follows:

1. Click on the command "Assign TS Adapter MPI parameters" in the project tree.
2. Open the "Access security" tab.
3. Enter a password for your user name and/or number that you want the modem to call back following logon.
  - If you are an administrator, you can change all the settings for administrators and users, and delete or create users.
  - If you are logged on as a user, you can only change your own settings (password and callback number).
4. Confirm all entries before exiting the dialog with "OK".
5. Click the "Yes" button to confirm the following query.

## Result

The parameter assignment for the access protection and the callback number is saved in the non-volatile memory of the TS adapter MPI.

---

### Note

#### Important points to note when setting up access protection:

- The settings in the "Modem" tab must correspond to the conditions at the plant if callback functionality is to be guaranteed.
  - Entering an incorrect callback number in the role of "ADMIN" user will mean you are no longer able to access the TS Adapter MPI over a remote connection!
  - Test the callback number before you enter it as the "ADMIN" user by calling the given callback number during connection establishment (access protection level 1).
- 

## Complete a callback in TeleService

### Callback options

Two different callback variants can be set up in TeleService.

The following callback options are available:

- Callback to a number specified during connection establishment.
- Callback to a number stored on the TS Adapter

### Callback to a number specified during connection establishment

1. In the project tree of the TIA portal, open the "Online access" folder.
2. Click on the "TeleService" folder it contains.
3. Double-click the "Set up/close remote connection" entry. The "Set up remote connection to the remote system" dialog opens.
4. In the "Adapter type" drop-down list, select the adapter type used.
5. Select the "dial-up connection" under "Connection type" if it is not already selected.
6. Select the modem you are using under "Local Settings".
7. Enter the phone number to be dialed in the appropriate box or open the phone book by clicking on the button behind it and take the desired phone number from the phone book.
8. Enter your user name and associated password of the TS adapter.
9. If you want a "Connection setup with callback", select the appropriate option button.

10. Click the "Connect" button to establish the required remote connection. This button only becomes active when you have entered all the parameters needed to establish a remote connection. Any remote connection is displayed under "Status".
11. Enter the desired callback number in the dialog that follows.

## Result

The remote connection to the desired system is made with callback.

The connected system is shown with the corresponding icon in the project tree.

---

### Note

This procedure is useful if the costs of the modem connection are to be borne by the plant operator and if the actual callback number is not fixed, i.e. callback is not always to the same receiver. It is particularly useful for mobile users.

---

## Callback to a number stored on the TS Adapter

1. Assign the parameters for the desired callback number in the TS adapter.
2. Establish a connection to the TS adapter as described above, and observe the following features:
  - Enter the user name and password for which the callback number parameters are assigned in the TS adapter.
  - The check box "Establish a connection with callback" does not have to be selected, since the callback number is already known by the TS adapter.

## Result

Callback to a number stored on the TS adapter has been established. If a remote connection is established, the callback occurs from the remote system.

---

### Note

This procedure offers the highest level of access protection. However, it does pose a risk: if the callback number stored on the TS Adapter is not correct, it will no longer be possible to access the TS Adapter over a modem connection. The device can in such a case only be put back into operation by changing the parameter settings on site.

---

### 12.7.3.4 TS adapter MPI

#### Short description of the TS adapter MPI

##### TS Adapter MPI:

The designation "TS Adapter MPI" is a collective term for all TS Adapter with an MPI/DP interface.

The TS Adapter MPI comes in the following versions:

- As TS Adapter I (parameters cannot be assigned via the TIA Portal)
- as TS Adapter II

The table below provides a short description of the functionalities. For detailed information on your TS Adapter, please refer to the documentation supplied with your TS Adapter.

TS Adapter II:	
Direct connection	Connection via the Universal Serial Bus (USB). The firmware can be replaced.  The modem is integrated or can also be connected as external modem. The TS Adapter II switches automatically between the modems. As long as no external modem is connected, the adapter will use the internal modem.
There are two variants	<ul style="list-style-type: none"><li>• With internal analog modem. An external modem can also be connected to the RS232 port.</li><li>• With internal ISDN adapter. An external modem can also be connected to the RS232 port.</li></ul>

#### Use of the designation "TS Adapter"

For TeleService the designation "TS Adapter" is the generalization for all versions. The relevant product designation is listed beside information which only applies to a specific version of a TS Adapter, for example, "TS Adapter II", "TS Adapter IE Standard" or "TS Adapter IE Basic".

#### How the TS adapter MPI works

##### How the TS Adapter MPI Works

In line with the configuration, the TS Adapter MPI connects the serial port or USB port of your programming device/personal computer (direct connection) or the serial port of a modem (modem connection) to the MPI/PROFIBUS network of your automation system.

The TS Adapter MPI has a non-volatile memory. Parameters for the following functions are stored in this memory:

- The MPI/PROFIBUS network (network parameters)
- The mode of the modem used

- The serial port to the modem
- Access protection

### Default parameter assignment

The TS Adapter comes with default parameter assignment. The parameters can be set and saved to the non-volatile memory of the TS adapter in a parameter assignment session.

When "Direct connection" is configured, the TS Adapter will only use the network parameters for access to the MPI/PROFIBUS network.

In the "Modem connection" configuration, all the parameters stored on the TS Adapter will be activated.

---

#### Note

For more detailed information on the configuration of your TS Adapter, please refer to the documentation supplied with it.

---

## Operating a TS adapter MPI in direct connection mode

### Direct connection with TS Adapter MPI

The direct connection is used to assign the parameters of the TS Adapter MPI. The same configuration also allows you to go online in the TIA Portal and thereby check the configured MPI/PROFIBUS parameters for bus compatibility. This means that (as with a PC adapter) SIMATIC S7/C7 systems can be accessed via the MPI/DP interface without an MPI/PROFIBUS module occupying a slot for a programming device/PC.

Access protection for the TS Adapter is not active in direct connection configuration. This means that the parameter assignment of the TS Adapter can be changed without any problems, for example by importing adapter parameters.

---

#### Note

##### Display of the TS Adapter MPI in the TIA Portal

As soon as you have connected a TS Adapter MPI with the PG/PC using the USB port, the "TS Adapter" folder is displayed in the project tree of the TIA Portal.

When you open the folder, you can assign the parameters of the connected TS Adapter MPI via the following dialog.

---

## Establishing the direct connection for TS Adapter MPI

Direct connection mode means there is a direct connection via the TS Adapter MPI between the programming device/personal computer on which TeleService is installed and the automation system. No modem is required.

The figure below shows the configuration of the TS Adapter MPI with a direct connection.

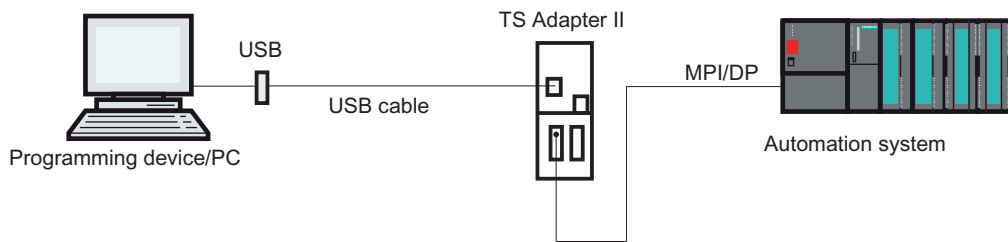

### Operating a TS adapter MPI in modem connection mode

#### Introduction to the modem connection with TS Adapter MPI

This configuration allows you to dial into a remote system. To do this, you establish a remote connection to a remote system using TeleService on a telephone network. Over the established modem connection, you can then work with the selected plant as usual with the TIA Portal.

#### Establishing a modem connection with TS Adapter MPI

This connection between the programming device or PC on which TeleService is installed and the automation system in which the TS Adapter MPI is inserted in the MPI/DP interface is made through a modem route.

The configuration therefore includes the programming device or PC via the telephone network and the TS Adapter MPI on the MPI/DP interface of the automation system.

The figure below shows the structure of the modem connection.

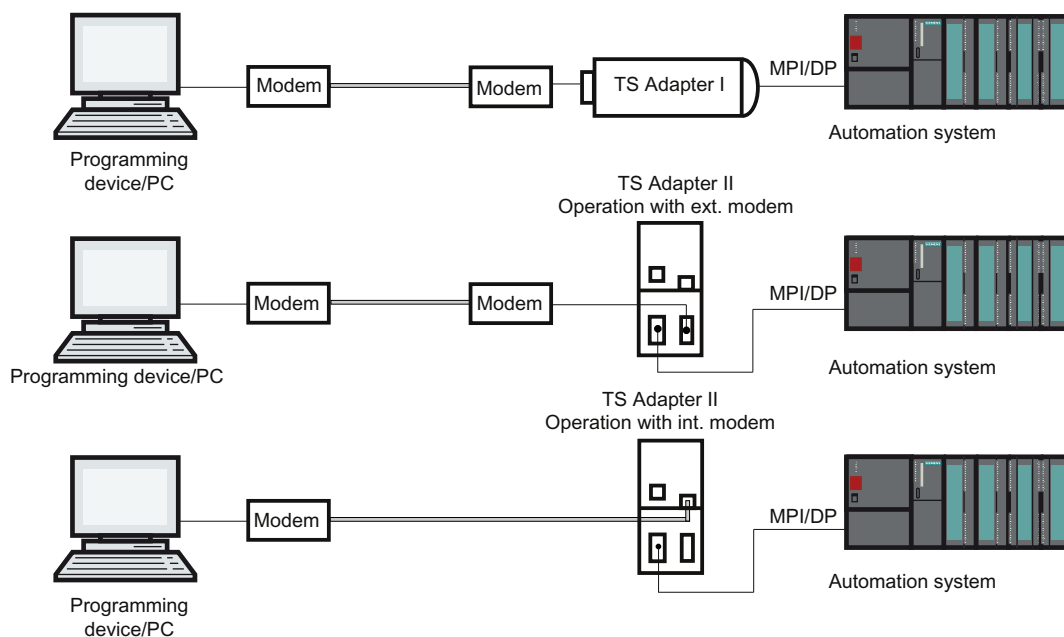

---

### Note

#### Parallel operation between direct and modem connection

The TS Adapter II has two connections for communication with PG/PC, both of which can be connected at the same time. At the same time, connect the USB interface with the PG/PC and the modem interface with the telephone network.

In this configuration you can either use the direct or the modem connection.

A parallel operation is **not** possible!

---

## TS adapter MPI configuration options

### Useful information on configuring the TS Adapter MPI

The TS Adapter MPI can be configured in both direct connection mode and via an existing remote connection.

The following parameter assignment options are available:

- Reconfiguration (Page 6234)
- Restoring default parameter assignment (Page 6235)
- Importing adapter parameters (Page 6237)
- Exporting adapter parameters (Page 6236)
- Setting up access protection (Page 6225)

## Parameter assignment

Configure your TS Adapter in accordance with the documentation supplied with the TS Adapter. It will detail the exact procedure for parameter assignment.

---

### Note

#### Please note the following when configuring the TS Adapter MPI

- If you change the current parameter settings when there is an established remote connection, there is a risk it will not subsequently be possible to establish a modem connection with the modified parameters. The TS Adapter MPI can in this case only be configured in direct connection mode.
  - This means that either parameter assignment must be carried out with a programming device/personal computer at the plant location or the TS Adapter MPI must be brought to the location of the local programming device/personal computer in order to be configured.
- 

## Positive acknowledgement

During parameter assignment, the data is written to the non-volatile memory of the TS Adapter MPI. The parameter assignment process is not acknowledged positively until all precautions have been taken to ensure that parameter changes have been carried out correctly and will thus survive a power failure.

## Changes become effective for the TS Adapter MPI as follows:

- The serial parameters, the modem parameters and the parameters for access protection are activated once the remote connection has been terminated.
- The modified network parameters are activated immediately.

## Configuring TS adapter MPI

### Introduction

The TS Adapter MPI can be configured in both direct connection mode and via an existing remote connection in modem connection mode.

The following describes the method for assigning parameters.

### Requirement

A TS Adapter MPI is connected to your computer and the folder "TS Adapter" is displayed in the project tree under "Online access".



## Procedure

To assign the parameters for the TS Adapter MPI im Direktanschluss please proceed as follows:

1. Double-click the "Online access" folder in the project tree.
2. Open the required folder:
  - The "TS Adapter" folder for a direct connection.
  - For an existing remote connection, the "TeleService" folder followed by the folder with the required system name.
3. Select the command "Assign TS Adapter MPI parameters". The "Assign TS Adapter MPI parameters" dialog opens.
4. Set the required parameters in the individual tabs of the dialog.
5. Confirm your entries with "OK".

## Result

The configured parameters are saved in the non-volatile memory of the TS Adapter MPI. Parameter assignment is then complete.

## Restoring default parameter assignment for TS adapter MPI

### Introduction

You can restore the default, factory state parameters of the TS Adapter MPI.

### Requirement

A TS Adapter MPI is connected to your computer and is displayed in the project tree under "Online access" in the "TeleService" folder.

## Procedure

Proceed as follows to restore default parameters for the TS Adapter MPI:

1. Open the "TeleService" folder in project tree.
2. Double-click the "TS Adapter MPI" folder.
3. Select the command "Assign TS Adapter MPI parameters". The "Assign TS Adapter MPI parameters" dialog opens.
4. Click the "Reset" button under "General".
5. Confirm your entries with "OK".

## **Result**

The TS Adapter MPI default parameters set on delivery are restored.

## **See also**

TS adapter MPI configuration options (Page 6231)

## **Exporting adapter parameters**

### **Introduction**

You can export the configuration of a TS Adapter MPI to an external file. The configuration saved in this file can be imported in turn into any number of TS Adapter MPI.

This can for example be useful if you want to assign identical parameters to multiple TS Adapter MPI or if you want save, document or distribute the parameter set.

### **Requirement**

A TS Adapter MPI is connected to your computer and is displayed in the project tree under "Online access" in the "TeleService" folder.

### **Procedure**

To export the adapter parameters of a TS Adapter MPI:

1. Open the "TeleService" folder in project tree.
2. Double-click the "TS Adapter MPI" folder.
3. Select the command "Assign TS Adapter MPI parameters". The "Assign TS Adapter MPI parameters" dialog opens.
4. Click the "Export" button.
5. A window will open in which you can select the file to which you wish to export the configuration of the TS Adapter MPI.
6. Confirm with "Save".

### **Result**

The parameters of the TS Adapter MPI are saved in the specified file (\*.tap). The export of the adapter parameters is now complete.

## Importing adapter parameters

### Introduction

You can import the configuration of a TS Adapter MPI from a previously created export file (\*.tap).

The configuration saved in this file can be imported into any number of TS Adapter. This can for example be useful if you want to assign identical parameters to multiple TS Adapter MPI.

You can import parameters locally in direct connection mode or via an existing remote connection in modem connection mode.

### Requirement

A TS Adapter MPI is connected to your computer and is displayed in the project tree under "Online access" in the "TeleService" folder.

### Procedure

To import the adapter parameters of a TS Adapter MPI:

1. Open the "TeleService" folder in project tree.
2. Double-click the "TS Adapter MPI" folder.
3. Select the command "Assign TS Adapter MPI parameters". The "Assign TS Adapter MPI parameters" dialog opens.
4. Click the "Import" button.
5. A dialog will open in which you can select the file to which you wish to import the configuration of the TS Adapter MPI.
6. Confirm the next dialog with "Yes".

### Result

The parameters selected are saved in the non-volatile memory of the TS Adapter MPI. Adapter parameter import is then complete.

#### 12.7.3.5 TS adapter IE

### Short description of the TS adapter IE

#### TS Adapter IE

The designation "TS Adapter IE" is a collective term for all TS Adapter with an Ethernet port.

The TS Adapter IE comes in the following versions:

12.7 Establishing a remote connection with TeleService

- as TS Adapter IE Standard
- as TS Adapter IE Basic

The tables below provide a short description of the functionalities. For detailed information on your TS Adapter, please refer to the documentation supplied with it.

<b>TS Adapter IE Standard:</b>
Direct connection by means of Industrial Ethernet (IE). Firmware update possible. Modem integrated or external. The TS Adapter IE cannot automatically switch between modems like the TS Adapter II. Parameters are assigned via a Web interface.
<b>There are 2 variants:</b>
<ul style="list-style-type: none"><li>• With internal analog modem. An external modem can also be connected to the RS232 port.</li><li>• With internal ISDN adapter. An external modem can also be connected to the RS232 port.</li></ul>

<b>TS Adapter IE Basic:</b>
Direct connection by means of Industrial Ethernet (IE). Firmware update possible. Plug-in modules. Parameters are assigned via a Web interface.
<b>There are 4 variants:</b>
<ul style="list-style-type: none"><li>• TS Adapter IE Basic MODEM: Basic device TS Adapter IE Basic with TS Module MODEM for operation on the analog telephone network.</li><li>• TS Adapter IE Basic ISDN: Basic device TS Adapter IE Basic with TS Module ISDN for operation on ISDN telephone systems.</li><li>• TS Adapter IE Basic GSM: Basic device TS Adapter IE Basic with TS Module GSM for operation on the GSM radio network.</li><li>• TS Adapter IE Basic RS232: Basic device TS Adapter IE Basic with TS Module RS232 for connecting an external modem.</li></ul>

### Use of the designation "TS Adapter"

"TS Adapter" is used in the TeleService online help as a general designation for all versions. The relevant product designation is listed beside information which only applies to a specific version of a TS Adapter, e.g. "TS Adapter I", "TS Adapter II", "TS Adapter IE Standard" or "TS Adapter IE Basic".

### How the TS adapter IE works

#### How the TS Adapter IE works

The TS Adapter IE connects the telephone network or the serial port of a modem with the Industrial Ethernet of your automation system.

The TS Adapter IE has a non-volatile memory. Parameters for the following functions are stored in this memory:

- The mode of the modem used
- The serial port to the modem
- Access protection

### Default parameter assignment

The TS Adapter IE comes with default parameter assignment. The parameters can be set and saved to the non-volatile memory of the TS adapter in a parameter assignment session.

---

#### Note

For more detailed information on the configuration of your TS Adapter, please refer to the documentation supplied with it.

---

## Connection Types

### Connection types of the TS Adapter IE Basic

The following diagrams show the connection types possible with the TS Adapter IE Basic.

#### Direct connection

In the direct connection to the PG/PC, you can set the TS Adapter IE Basic through Ethernet.

---

#### Note

The operation of the TS Adapter IE Basic without a TS module is not permitted.

---

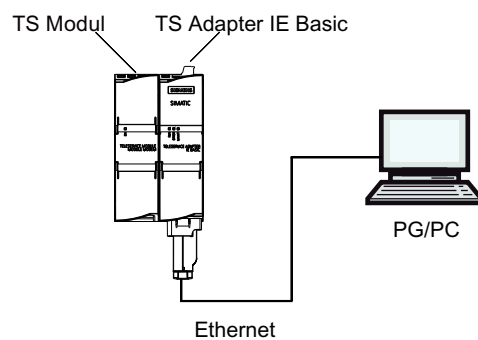

Figure 12-1 Direct connection

### Connection to the telephone network

In order to have a direct connection to the telephone network, you must connect the TS Adapter IE Basic together with one of the following TS modules:

- TS Module Modem
- TS Module ISDN

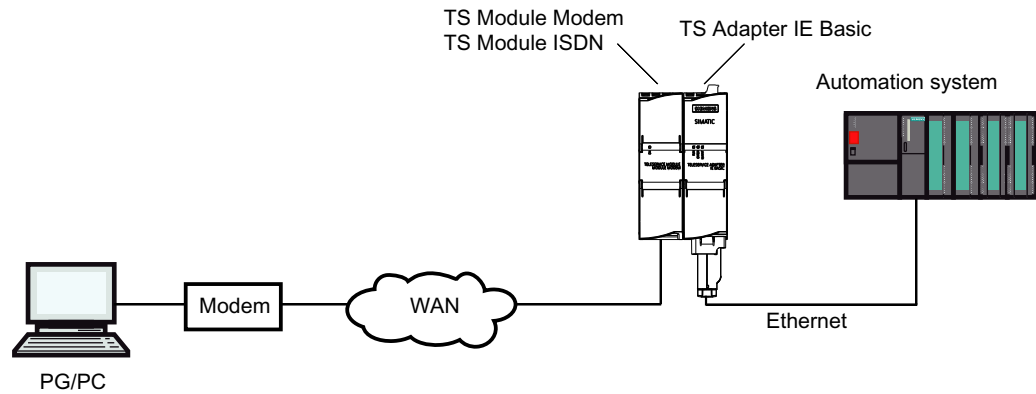

Figure 12-2 Direct connection to the telephone network

More information about the TS modules can be found in the *TS Adapter modular* manual.

### Connection to the GSM network

In order to connect to the GSM network, you must operate the TS Adapter IE Basic together with this TS module:

- TS Module GSM

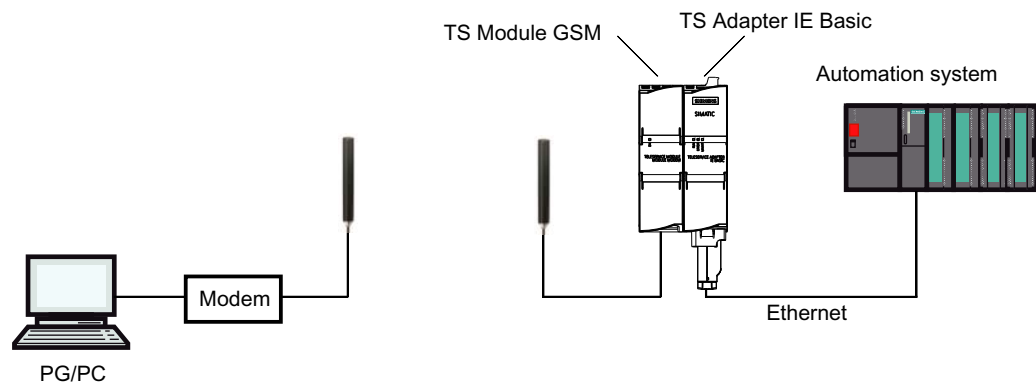

Figure 12-3 Connection to the GSM network

More information about the TS modules can be found in the *TS Adapter modular* manual.

## Connection to the telephone network through an external modem

For the connection to an external modem, you must operate the TS Adapter IE Basic together with this module:

- TS Module RS232

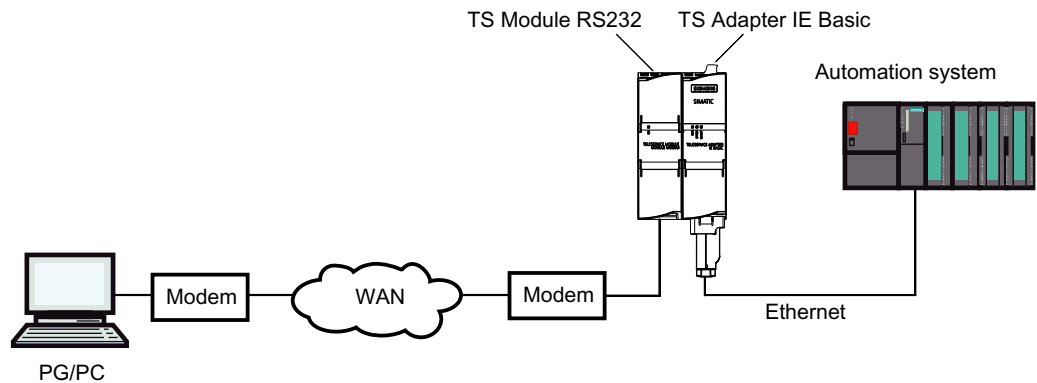

Figure 12-4 Connection to an external modem

More information about the TS modules can be found in the *TS Adapter modular* manual.

## TS Adapter IE parameter assignment options

### Useful information for configuring the TS Adapter IE

The TS Adapter IE is configured via a Web interface.

Web help associated with the parameter assignment interface is made available for the configuring the TS Adapter IE.

The following parameter assignment options are available:

- Reconfiguration
- Restoring default parameter assignment
- Importing adapter parameters
- Exporting adapter parameters

---

#### Note

##### Parameter assignment

Configure your TS Adapter in accordance with the documentation supplied with the TS Adapter. It will detail the exact procedure for parameter assignments.

---

## Parameter assignment for TS Adapter IE

### Introduction

The TS Adapter IE can be configured in both direct connection mode and via an existing remote connection in modem connection mode.

Both parameter assignment options are described below.

Specific details for assigning parameters of the TS Adapter IE can be obtained from the TS Adapter IE documentation.

### Parameter assignment of the TS Adapter IE in direct connection

#### Requirement

There is a LAN connection to your TS Adapter IE .

The TS Adapter IE Basic is connected to the power supply.

#### Procedure

To assign the parameters for the TS Adapter IE , proceed as follows:

1. In the project tree of the TIA portal, open the "Online access" folder.
2. Double-click on the Ethernet port of your computer.
3. Double-click on the "Display accessible nodes" command. The TS Adapter IE is then displayed.
4. Double-click on the <TS Adapter IE> folder and then on "Online and diagnostic", and assign the desired IP address to the TS Adapter IE in the following dialogs. Please note that the IP address of the PG/PC interface card is located in the same subnet as the IP address that you issue for the TS Adapter IE.
5. Update the view in the project tree for the "Accessible nodes", so that the TS Adapter IE is displayed with the newly allocated IP address.
6. Open the folder <TS Adapter IE> in the device list.
7. Double-click the command "Assign TS Adapter IE parameters". The allocated web interface opens for assigning the TS Adapters IE parameters.
8. Complete the "logon" for the web interface.
9. Set the required parameters in the individual tabs of the dialog.
10. Confirm your entries with "Save settings".

#### Result

The configured parameters are saved in the non-volatile memory of the TS Adapter IE. Parameter assignment is then complete.



## Parameter assignment of the TS Adapter IE using a remote connection

### Requirement

There is an established remote connection to a TS Adapter IE .

### Procedure

1. In the project tree of the TIA portal, open the "Online access" folder.
2. Open the "TeleService" folder followed by the required system folder.
3. Double-click the command "Assign TS Adapter IE parameters". The associated web interface for assignment of the TS Adapter IE parameters opens. The "logon" for the web interface takes place automatically with the login data of the remote connection.
4. Set the required parameters in the individual tabs of the dialog.
5. Confirm your entries with "Save settings".

### Result

The configured parameters are saved in the non-volatile memory of the TS Adapter IE. Parameter assignment is then complete.

## 12.7.3.6 Establishing a dial-up connection to a remote system

### Establishing a dial-up connection

#### Introduction to establishing a remote dial-up connection

A dial-up connection is established when you use TeleService to dial into a remote system via a telephone network. The programming device/personal computer is connected to the telephone network with TeleService via a modem. At the other end, the automation system is connected to the telephone line via a configured TS Adapter and a modem.

#### Requirements

A local modem is installed and configured.

The TS Adapter is located in the remote system.

A remote modem is installed and parameters have been assigned.

**Proceed as follows:**

1. In the project tree of the TIA portal, open the "Online access" folder.
2. Click on the "TeleService" folder it contains.
3. Double-click the "Set up/close remote connection" entry. The "Set up remote connection to the remote system" dialog opens.
4. In the "Adapter type" drop-down list, select the adapter type used.
5. Under "Connection type", select "Dial-up connection".
6. Select the modem you are using under "Local settings".
7. Enter the phone number to be dialed in the appropriate box or open the phone book by clicking on the button behind it and take the desired phone number from the phone book.
8. Enter your user name and the corresponding password.
9. If you want a "Connection setup with callback", select the appropriate option button.
10. Click the "Connect" button to establish the required remote connection. This button only becomes active when you have entered all the parameters needed to establish a remote connection. Any remote connection is displayed under "Status".

**Result**

The dial-up connection to the desired system is established.

The dialog closes as soon as the dial-up connection is established. The following message appears in the TIA Portal status bar: "Remote connection is established". You can now use the remote connection with TIA Portal and communicate with the automation system.

**Connection cannot be established**

If the connection cannot be established, try to find the cause using the "Notes on troubleshooting".

**Terminating the connection**

Once you have finished editing the remote system, exit the remote connection in the project tree by double-clicking on the entry "Establish/disconnect remote connection".

By exiting the TIA Portal you are also terminating the remote connection.

## Terminating a dial-up connection

### Terminating an active dial-up connection

---

#### Note

##### Terminating the dial-up connection

You should go offline in the TIA Portal before you terminate the remote connection.

---

#### Proceed as follows:

1. Double-click the "Set up/close remote connection" entry in the TIA portal.
2. Confirm the prompt in the dialog that follows with "Yes".

#### Result

The connection is terminated.

## 12.7.4 Remote VPN connections

### 12.7.4.1 Basics for establishing a VPN connection

#### Using a TS Adapter IE Advanced for VPN connections

A TS Adapter IE Advanced is required to establish a VPN connection using TeleService.

#### VPN definition

VPN stands for "Virtual Private Network". This is a private network of computers based on a public network infrastructure.

VPN is used to create a connection that is as secure as possible between devices in a private network at different locations and the gateway of another network.

A VPN device has direct access to the gateway in the other network over an encrypted connection.

## VPN connections

When a VPN connection is established with TeleService, a CA certificate and a unique fingerprint generated from it are used for the unique identification of the TS Adapter IE Advanced. The VPN connection allows a communication that is secure from tapping and manipulation between the remote PC and the TS Adapter.

If you want to establish a VPN connection to multiple remote networks, you will require a separate TS Adapter IE Advanced as an interface for each network. The networks connected by the TS Adapter can use identical IP addresses internally. Only the external IP addresses (WAN) of the TS Adapters need to be different.

Only one VPN connection to a TS Adapter is possible at any one time.

---

### Note

#### Authentication

Please note that the CA certificate exclusively authenticates the TS Adapter IE Advanced.

As in the case of dial-up connections, users are authenticated via the login (user name and password).

Therefore, use only a secure password for the login.

---

## See also

- Establishing VPN connections (Page 6251)
- Terminating VPN connections (Page 6253)

### 12.7.4.2 Basics of CA certificates

#### Introduction

To establish a secure VPN connection with TeleService, you need to generate a CA certificate with a unique fingerprint when you configure the TS Adapter IE Advanced.

You can install this CA certificate as follows on each PC which is to access the TS Adapter IE Advanced:

- Using the automatic download in the TeleService connection dialog, by entering the fingerprint for the CA certificate
- Manually by using the Microsoft® Management Console.

#### Definition of CA certificate

A CA certificate is a digital certificate issued by a "certificate authority" or "certification authority", hereinafter referred to as "CA". In the case of the TS Adapter IE Advanced, self-signed certificates are used; the certification authority in this case is the TS Adapter IE Advanced itself.

Certificates for "SSTP" (Secure Socket Tunneling Protocol) and "HTTPS" (Hypertext Transfer Protocol Secure) are derived from the CA certificate.

CA certificates contain a "key" and additional information used for authentication and for encrypting and decrypting confidential data. Additional information includes the validity period, references to certificate revocation lists, etc. which are included in the certificate by the CA.

## Using CA certificates with TeleService

A CA certificate with a unique fingerprint is generated by the TS Adapter to uniquely identify the TS Adapter IE Advanced as connection partner for the remote PC.

This CA certificate must be saved in the Windows certificate store of your programming device/ PC before you can establish a VPN connection. When you access the Web server using a direct connection, a security warning will appear if no CA certificate exists. In such cases, however, you can choose to ignore the warning and allow the connection.

---

### Note

#### Handling CA certificates

Specialist knowledge of the operating system is required for handling CA certificates. CA certificates should only be managed by trained personnel!

You require administrator rights to manage CA certificates.

---

## Definition of fingerprint

The fingerprint is a 20-byte hexadecimal expression. It provides a unique value for a CA certificate and is used to identify a specific CA certificate.

A fingerprint is calculated dynamically using the SHA-1 algorithm and is not physically contained in the CA certificate.

## Use of fingerprints with TeleService

The CA certificate is used to uniquely identify the TS Adapter IE Advanced as connection partner. A unique 20-byte fingerprint of this certificate is generated each time a CA certificate is generated by the TS Adapter IE Advanced. It is calculated automatically by the TS Adapter IE Advanced when the certificate is generated. Each certificate has a specific, unique fingerprint. This fingerprint must be transferred securely to your computer, for example by phone or in an encrypted e-mail. You need to enter this fingerprint in the connection dialog when establishing a VPN connection with TeleService, unless the CA certificate is already saved on your PC in the Windows certificate store.

You will find the fingerprint for your TS Adapter IE Advanced in the Web interface for the TS Adapter IE Advanced. To open the Web interface, double-click the command "Assign TS Adapter IE Advanced parameters" in the device list in the TIA portal. Carry out the Web login to view the fingerprint in the "Security > Certificates" tab.

### CA certificate download during connection establishment

When the connection is established, TeleService checks whether a suitable CA certificate is installed in the Windows certificate store of your programming device/PC. If an appropriate certificate is found, the VPN connection is established as an SSTP connection (Secure Socket Tunneling Protocol).

If no appropriate CA certificate is found, the CA certificate is first loaded by the corresponding TS Adapter IE Advanced. The TS Adapter IE Advanced is called by the remote address entered in the connection dialog. If this download of the CA certificate is successful, the fingerprint of the downloaded CA certificate is calculated and compared with the fingerprint entered in the connection dialog. If the two fingerprints match, a dialog opens and you are prompted to save the CA certificate in the Windows certificate store of your programming device/PC. You require administrator rights to save the CA certificate.

The VPN connection is then established.

#### See also

- Installing CA certificates for VPN connections (Page 6248)
- Deleting CA certificates for VPN connections (Page 6251)

### 12.7.4.3 Installing CA certificates for VPN connections

#### Installing CA certificates

To establish a secure VPN connection between your programming device/PC and a remote system with TeleService, you require a valid CA certificate generated by the TS Adapter IE Advanced. This must be saved in the Windows certificate store of your programming device/PC.

A CA certificate can be installed manually or using an automatic download.

CA certificates are managed with the Microsoft® Management Console.

---

#### Note

##### Handling CA certificates

Specialist knowledge of the operating system is required for handling CA certificates. CA certificates should only be managed by trained personnel!

You require administrator rights to manage CA certificates!

---

#### Requirement

A CA certificate has yet to be installed in the Windows certificate store on your computer.

## Installing CA certificates using the automatic download

Proceed as follows:

1. Log on to the system as administrator.
2. Transfer the fingerprint for the CA certificate from the TS Adapter IE Advanced to your computer using a "secure route", for example by phone or in an encrypted e-mail.  
You will find the fingerprint for your TS Adapter IE Advanced in the Web interface for the TS Adapter IE Advanced. To open the Web interface, double-click the command "Assign TS Adapter IE Advanced parameters" in the device list in the TIA portal. Perform the Web login to view the fingerprint in the "Security > Certificates" tab.
3. In the project tree of the TIA portal, open the "Online access" folder.
4. Click on the "TeleService" folder it contains.
5. Double-click the "Set up/close remote connection" entry. The "Set up remote connection to the remote system" dialog opens.
6. Select the "TS Adapter IE Advanced" as Adapter type from the drop-down list.
7. Under "Connection type", select "VPN".
8. In the relevant input box, enter the IP address / DNS name for the TS Adapter IE Advanced to be contacted. Alternatively, you can apply any existing data from the phone book by clicking the corresponding button.
9. Enter your user name and the corresponding password.
10. Copy the fingerprint displayed in the Web interface for the TS Adapter IE Advanced to the "Fingerprint" column.
11. Click the "Connect" button to establish the required remote connection. This button only becomes active when you have entered all the parameters needed to establish a remote connection.
12. No valid CA certificate is found, because no CA certificate has been installed on your PC yet.  
A "normal" connection (not a VPN connection) is therefore established and the certificate required is downloaded from the TS Adapter IE Advanced to the working memory of your computer. The fingerprint is then calculated (SHA-1 algorithm) and compared with the fingerprint entered in the connection dialog. If the two fingerprints match, a dialog opens and you are prompted to save the CA certificate in the Windows certificate store of your programming device/PC.
13. Confirm that you want to save the CA certificate.

## Result

The VPN connection to the required TS Adapter IE Advanced is established. The dialog closes once the connection is established.

### Manual installation of CA certificates

Proceed as follows:

1. Log on to the system as administrator.
2. Open the Windows Certificate Manager on your programming device/PC with the Microsoft® Management Console.  
Click "Start", enter "mmc" in the search field and press ENTER.  
The console will open.
3. Open the "File" menu and click "Add/remove snap-in...".  
The "Add/remove snap-in..." dialog will open.
4. Double-click "Certificates" in the "Snap-in" list and select "Computer account" in the dialog that opens.
5. Select "Local computer" in the next dialog and click "Finish" and "OK".  
The console root opens and the "Certificates (local computer)" folder appears.
6. Open the displayed "Certificates (local computer)" folder and click "Trusted certification authorities".
7. Click the "Certificates" folder and use the shortcut menu to access the command "All tasks" > "Import...".
8. Note the information that appears in the "Certificate - Import wizard" dialog and click "Next".
9. In the dialog that follows, click "Browse ..." and select the required CA certificate.
10. Then click "Next" twice and subsequently "Finish" to install the CA certificate.

### Result

The selected CA certificate is installed at the specified location in the Windows certificate memory.

---

#### Note

##### Additional information ...

... on installing CA certificates can be found using the "F1" button in the online help of your operating system.

---



#### 12.7.4.4 Deleting CA certificates for VPN connections

##### Deleting CA certificates

Proceed as follows:

1. Log on to the system as administrator.
2. Open the Windows Certificate Manager on your programming device/PC with the Microsoft® Management Console.  
Click "Start", enter "mmc" in the search field and press the ENTER KEY.  
The console will open.
3. Open the "File" menu and click "Add/remove snap-in...".  
The snap-in selection dialog will open.
4. Double-click "Certificates" in the "Snap-in" list and select "Computer account" in the dialog that opens.
5. Select "Local computer" in the next dialog and click "Finish" and "OK".  
The console root opens and the "Certificates (local computer)" folder appears.
6. Open the displayed "Certificates (local computer)" folder and click "Trusted certification authorities".
7. Open the "Certificates" folder, select the required CA certificate and click "Delete" in the shortcut menu.
8. Confirm the next prompt with "Yes".

##### Result

The selected CA certificate is deleted from the list of available certificates.

#### 12.7.4.5 Establishing a VPN connection to a remote system

##### Establishing VPN connections

##### Introduction to establishing VPN connections

A VPN connection is established when you use TeleService to connect to a remote system over the Internet.

To do this, your programming device/PC with installed TIA Portal is connected to the Internet at one end. At the other end, the automation system is connected to the Internet via the WAN (Wide Area Network) interface of the configured TS Adapter IE Advanced.

##### Requirement

Your programming device/PC is connected to the Internet.

There is a TS Adapter IE Advanced in the remote system.

### 12.7 Establishing a remote connection with TeleService

The TS Adapter IE Advanced has been configured and is connected to the Internet.

The CA certificate required for identifying the TS Adapter has been generated and installed in the Windows certificate store of your programming device/PC.

#### Proceed as follows:

1. In the project tree of the TIA portal, open the "Online access" folder.
2. Click on the "TeleService" folder it contains.
3. Double-click the "Set up/close remote connection" entry. The "Set up remote connection to the remote system" dialog opens.
4. Select the "TS Adapter IE Advanced" as "Adapter type" from the drop-down list.
5. Enter "VPN" as "connection type".
6. Enter the IP address / DNS name for the TS Adapter IE Advanced to be contacted in the relevant field. Alternatively, you can apply any existing data from the phone book by clicking the corresponding button.
7. Enter your user name and the corresponding password.
8. Click the "Establish" button to establish the required VPN connection. This button only becomes active once you have entered all the parameters needed for establishing the remote connection.

#### Result

The VPN connection to the required system is established. "Status" indicates the progress in establishing the connection. The dialog closes once the VPN connection is established. The following message appears in the TIA Portal status bar: "Remote connection is established". You can now use the remote connection with TIA Portal and communicate with the automation system.

#### Connection cannot be established

If the connection cannot be established, try to find the cause using the "Notes on troubleshooting".

---

#### Note

##### Rules for IP addresses

- Only use IP addresses which have not yet been assigned in the system network.
  - If the IP address configured for the TS Adapter IE Advanced has already been assigned in the system network, the TS Adapter IE Advanced can only be addressed by its MAC address.
-

## See also

Installing CA certificates for VPN connections (Page 6246)

## Terminating VPN connections

### Terminating an active VPN connection

---

#### Note

#### Terminating the VPN connection

You should go offline in the TIA portal before you terminate the VPN connection.

---

### Proceed as follows:

1. Double-click the "Set up/close remote connection" entry in the TIA portal.
2. Confirm the prompt in the dialog that follows with "Yes".

### Result

The VPN connection is terminated.

## 12.7.4.6 TS Adapter IE Advanced

### Short description of the TS Adapter IE Advanced

#### TS Adapter IE Advanced

The TS Adapter IE Advanced has the following properties:

- Direct connection over Industrial Ethernet (IE), 2 ports
- WAN (Wide Area Network) interface for VPN connections
- Firmware update supported
- Plug-in modules
- Parameters are assigned via a Web interface.

**Note**

**Further information on the TS Adapter IE Advanced**

For detailed information on your TS Adapter, please refer to the documentation supplied with your TS Adapter.

---

**Connection types**

**TS Adapter IE Advanced connection types**

The following diagrams show the types of connection possible with the TS Adapter IE Advanced.

**Direct connection**

In the direct connection to the programming device/PC, you can set the TS Adapter IE Advanced parameters over the Ethernet.

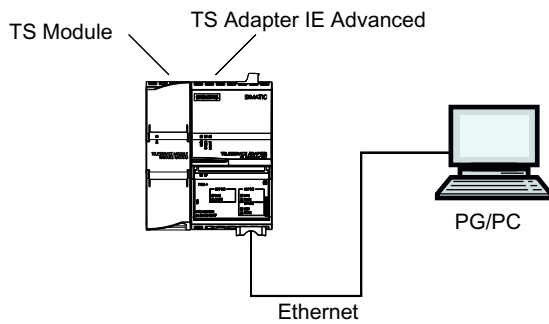

Figure 12-5 TS Adapter IE Advanced - direct connection

### Connection to the Internet (DSL modem/router)

In order to connect to the Internet, you must operate the DSL modem/router at the WAN connection of the TS Adapter IE Advanced.

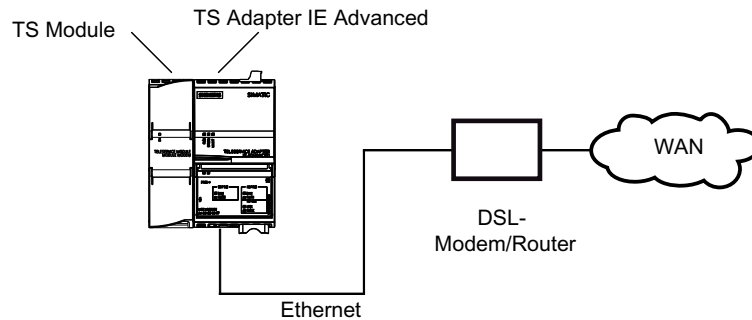

Figure 12-6 TS Adapter IE Advanced - connection to the Internet

### Connection to the company network (Intranet)

In order to connect to the Intranet, you must operate system network (Ethernet) at one of the two LAN connections of the TS Adapter IE Advanced.

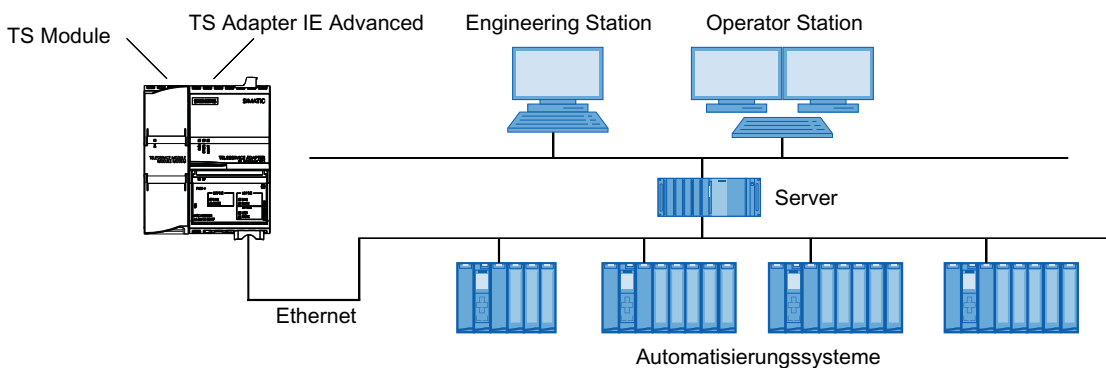

Figure 12-7 TS Adapter IE Advanced - connection to company network (Intranet)

### Additional information

For more detailed information on the TS modules, please refer to the documentation supplied with your TS Adapter IE Advanced.

### TS Adapter IE Advanced parameter assignment options

#### Basics on configuring the TS Adapter IE

The TS Adapter IE Advanced is configured via a Web interface.

Web help in the Web interface is available for assigning TS Adapter IE Advanced parameters.

Parameter assignment options include:

- Reconfiguration
- Restoring default parameter assignment
- Importing adapter parameters
- Exporting adapter parameters

---

**Note**

**Parameter assignment**

Configure your TS Adapter IE Advanced in accordance with the documentation supplied. This details the exact procedure for parameter assignment.

---

## Parameter assignment for TS Adapter IE Advanced

### Introduction

The TS Adapter IE Advanced can be configured in both direct connection mode and via an existing remote connection.

Both parameter assignment options are described below.

Specific details on assigning parameters for the TS Adapter IE Advanced are available in the TS Adapter IE Advanced documentation.

### Assigning parameters for the TS Adapter IE Advanced in direct connection

#### Requirement

There is a LAN connection to your TS Adapter IE Advanced.

#### Procedure

To assign the parameters for the TS Adapter IE Advanced, proceed as follows:

1. In the project tree of the TIA portal, open the "Online access" folder.
2. Double-click on the Ethernet port of your computer.
3. Double-click on the "Display accessible nodes" command. The TS Adapter IE Advanced is then displayed.
4. Double-click on the <TS Adapter IE Advanced> folder and then on "Online and diagnostics", and assign the desired IP address to the TS Adapter in the dialogs that follow. Please note that the IP address of the programming device/PC interface card must be located in the same subnet as the IP address that you assign for the TS Adapter IE Advanced.
5. Update the view in the project tree for the "Accessible nodes", so that the TS Adapter IE Advanced is displayed with the newly assigned IP address.

6. Open the folder <TS Adapter IE Advanced> in the device list.
7. Double-click the command "Assign TS Adapter IE Advanced parameters". The corresponding Web interface opens for assigning TS Adapter IE Advanced parameters.
8. Complete the "logon" for the web interface.
9. Set the required parameters in the individual tabs of the dialog.
10. Confirm your entries with "Save settings".

## Result

The configured parameters are saved in the non-volatile memory of the TS Adapter IE Advanced. Parameter assignment is then complete.

## Assigning parameters for the TS Adapter IE Advanced using a remote connection

### Requirement

There is an established remote connection to a TS Adapter IE Advanced..

### Procedure

1. In the project tree of the TIA Portal, open the "Online access" folder.
2. Open the "TeleService" folder followed by the required plant folder.
3. Double-click the command "Assign TS Adapter IE Advanced parameters". The associated web interface for assignment of the TS Adapter IE parameters opens. The "logon" for the web interface takes place automatically with the login data of the remote connection.
4. Set the required parameters in the individual tabs of the dialog.
5. Confirm your entries with "Save settings".

## Result

The configured parameters are saved in the non-volatile memory of the TS Adapter IE Advanced. Parameter assignment is then complete.

## 12.7.5 CPU controlled TeleService remote connections

### 12.7.5.1 Overview of CPU controlled remote connections

#### Introduction

TeleService offers a range of options for establishing remote connections; these differ according to the CPU used. The initiative for establishing a connection starts from the CPU. The communications instructions given below are used for the individual connection options.

#### Connection establishment with S7-300/400 CPUs

The following communications instructions are available:

- Communications instruction "PG\_DIAL": Establish remote connection to programming device/PC
- Communications instruction "SMS\_SEND": Send text message (SMS)
- Communications instruction "AS\_DIAL": Establish remote connection to AS
- Communications instruction "AS\_MAIL": Transfer email

#### Connection establishment with S7-1200 CPUs

The following communications instruction is available:

- Communications instruction "TM\_MAIL": Transfer email

#### Connection establishment with S7-1500 CPUs

The following communications instruction is available:

- Communications instruction "TMAIL\_C": Transfer email

---

#### Note

##### Description of individual communications instructions

More detailed information on the available communications instructions can be found in the information system of the TIA Portal in the directory "References > Communication > TeleService".

---

#### See also

TS Adapter IE parameter assignment options (Page 6239)



### 12.7.5.2 Establishing a connection from and to remote systems (PG-AS-remote coupling)

#### Remote plant access to a programming device/personal computer

##### Introduction

You can establish a remote connection to and communicate with a remote system using the application TeleService and a TS Adapter MPI. The initiative for establishing the remote connection comes from the programming device/personal computer.

However, events which require rapid intervention often occur at a remote system. In such cases, the automation system can initiate a remote connection to a programming device/personal computer if an asynchronous event occurs.

The graphic below shows the components which are required for establishing a connection from a plant to a programming device/personal computer.

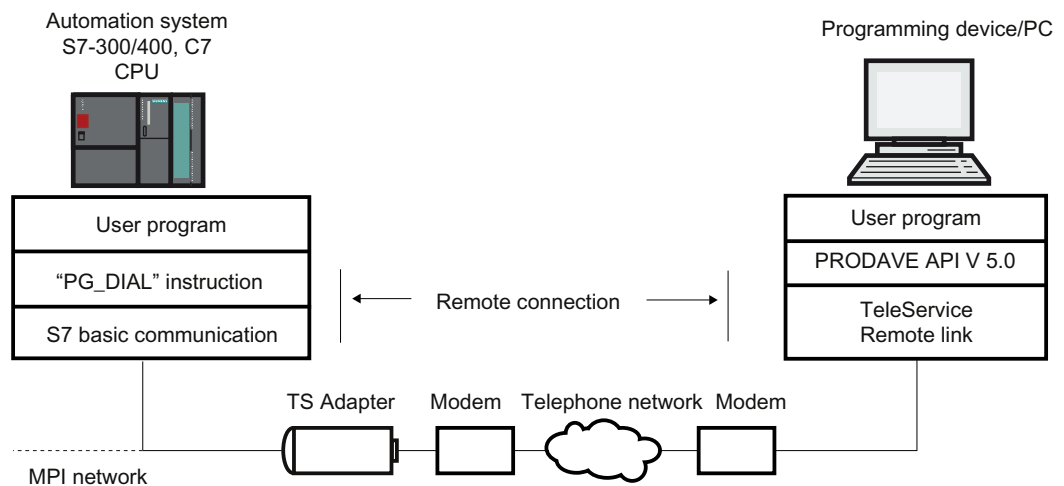

Figure 12-8 How the "PG\_DIAL" communications instruction works

#### Requirements for establishing a connection

##### Introduction

Certain hardware and software requirements must be fulfilled if a remote system is to establish a remote connection to a programming device/personal computer. These requirements are detailed below.

##### Hardware requirements:

The only hardware required for establishing a remote connection from a remote system to a programming device/personal computer is that needed for accessing the remote system from the programming device/personal computer.

## 12.7 Establishing a remote connection with TeleService

Your user program calls the communication instruction "PG\_DIAL" to establish the connection. This can only be executed on an S7-300 or S7-400 CPU on which S7 basic communication is implemented.

A TS Adapter I , version 5.0 or later, or a TS Adapter II must be used.

### Software requirements at the plant end:

Communication instruction "PG\_DIAL" is included in the TeleService scope of delivery and is installed when the TIA portal is installed. You will find the communication instructions installed in the "Communication > TeleService" folder of the block editor task card.

If a remote system is to establish a remote connection to a programming device/personal computer, the plant user program must call the "PG\_DIAL" function block.

### Software requirements for the programming device/personal computer

You require a software product in the programming device/personal computer which, with TeleService, waits for a call from a remote system, recognizes this call and informs your user program.

## 12.7.5.3 Data exchange between remote systems (AS-AS-remote coupling)

### AS-AS remote link basics

#### Introduction

The AS-AS remote link allows two automation systems to exchange process data via the telephone network.

#### Requirement

Communication instruction "AS\_DIAL" is available if you use a CPU from the S7-300/400 family.

#### Definition: Local and remote automation system

- The automation system from which the initiative to establish the remote connection originates is described as **local**.
- The automation system to which the remote connection is to be established is described as **remote**.

#### Data exchange over the AS-AS remote link

Data exchange is carried out using specific communication instructions for non-configured S7 connections. Use the communication instruction "AS\_DIAL" to establish a remote connection to the automation system.

More detailed information on establishing the connection can be found in the information system in the directory "References > Communication > TeleService".

The following graphic shows the components required for establishing a connection from a local to a remote automation system.

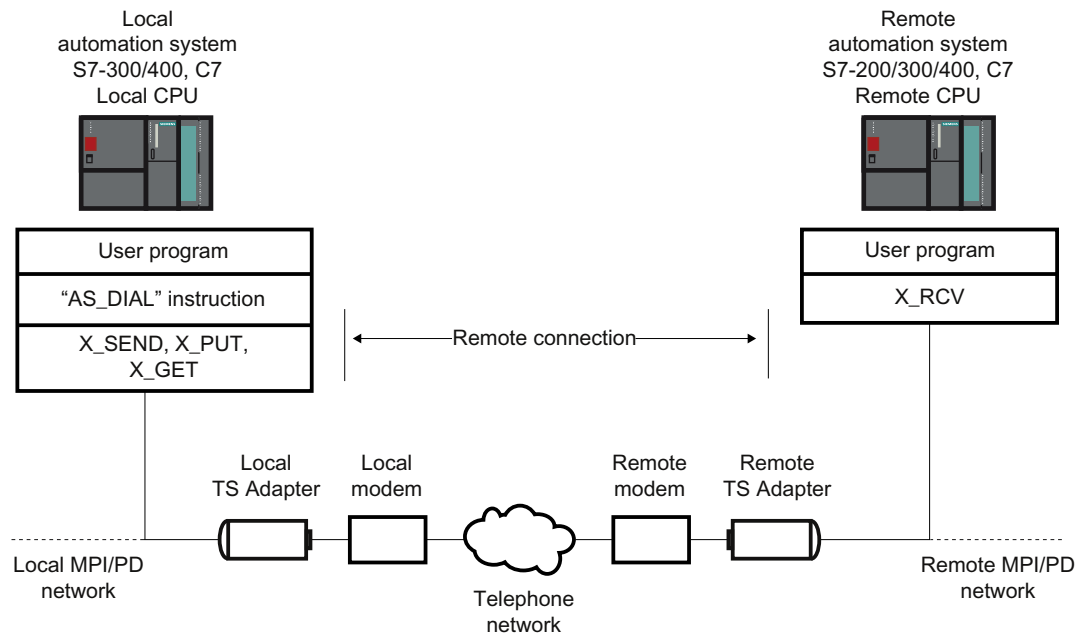

Figure 12-9 Data exchange over the AS-AS remote link

## Hardware and software requirements for AS-AS remote link

### Introduction

Certain hardware and software requirements must be fulfilled before a local automation system can establish a remote connection to a remote automation system. These requirements are detailed below.

### Hardware requirements

The only hardware you need for transferring process data from a local to a remote automation system is that also needed for accessing the respective automation system from the programming device/personal computer.

To establish and terminate the remote connection, the TIA Portal user program of the local CPU calls a communication instruction. This communication instruction can be executed on an S7-300/400 CPU or a C7 CPU. The communication instruction requires S7 basic communication to be implemented on the CPU. The remote CPU must also support S7 basic communication.

A TS Adapter I, version V5.1 or later, or a TS Adapter II must be used.

### Software requirements

The "AS\_DIAL" communication instruction is included in the product package of TeleService, and is integrated into the library of the TIA Portal during the installation in the communication instructions folder of the Task Card under TeleService. In order to establish and terminate a remote connection to a remote automation system from a local automation system, call the communication instruction "AS\_DIAL" in the TIA Portal user program of the local CPU.

AS-AS remote link

Automation system  
S7 300/400, C7

Automation system  
S7 300/400, C7

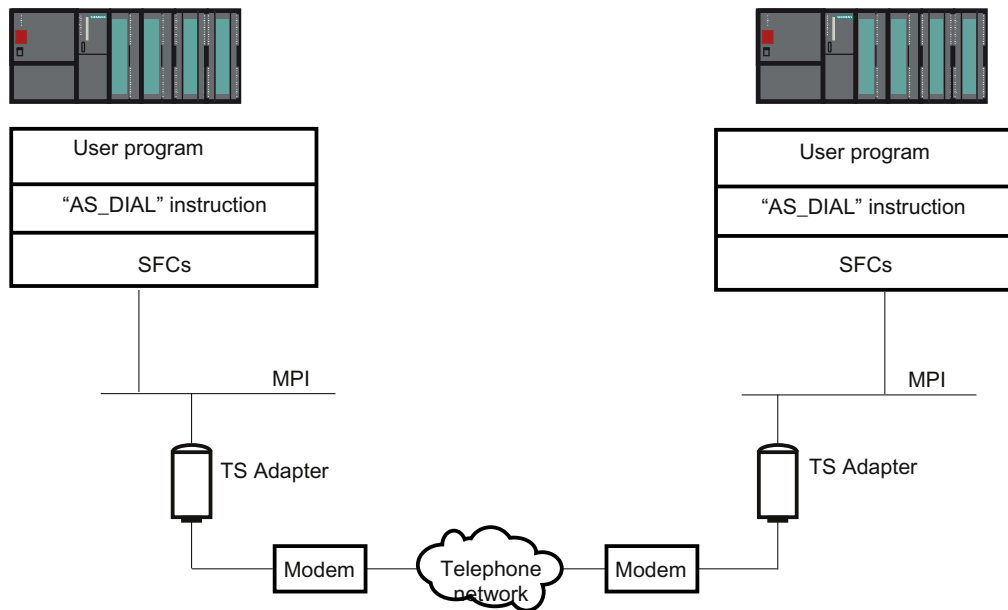

Figure 12-10 Hardware and software requirements for AS-AS remote link

#### 12.7.5.4 Send SMS from a system

### Requirements for sending an SMS

#### Introduction

Certain hardware and software requirements must be fulfilled before a system can send an SMS. These requirements are detailed below.

#### Hardware requirements

To send an SMS from a system, you will require a GSM wireless modem and a TS Adapter MPI.

A TS Adapter I, version V5.2 or later, or a TS Adapter II must be used.

## Software requirements at the system end

The "SMS\_SEND" communications instruction is included in the scope of delivery of TeleService, and is integrated into the library of the TIA Portal during the installation in the communications instructions folder of the Task Card under TeleService. If a system is to send an SMS, the user program of the system must call the communications instruction "SMS\_SEND".

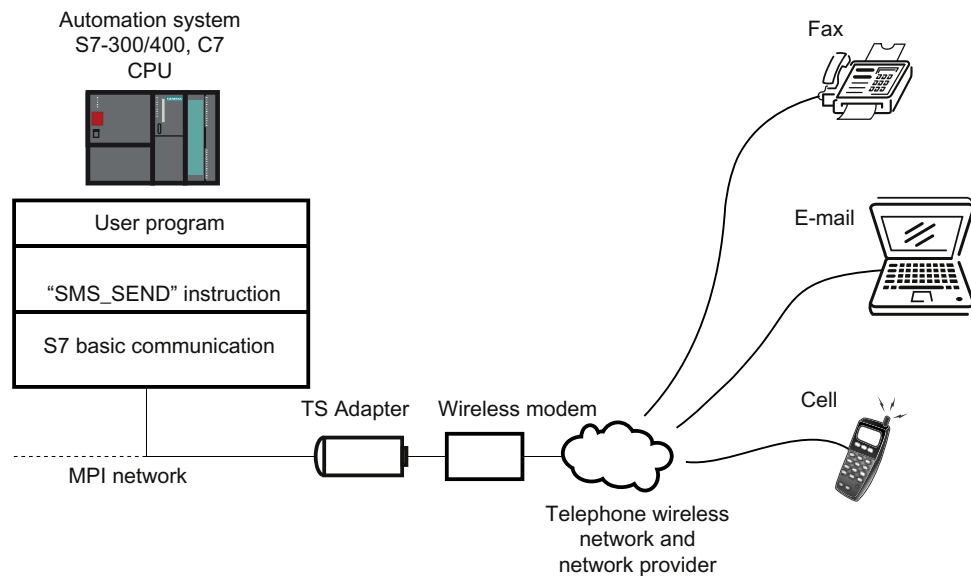

Figure 12-11 How the "SMS\_SEND" communications instruction works

### Note

You may be able to send an SMS not only to a cell phone but also to an email address or a fax device by using additional services offered by the cell phone service provider.

## 12.7.5.5 Send an email from a system

### Requirements for sending e-mails

#### Introduction

The following hardware and software requirements must be fulfilled if a system is to send an email:

### **Hardware requirements**

You need a TS Adapter IE to send an email from a system and one of the CPUs listed below:

- a CPU 31x2 PN/DP as of firmware version V2.5
- a CPU 41x-3 PN/DP
- a CPU of the S7-1200 series with Ethernet connection
- a CPU of the S7-1500 series

### **Software requirements at the system end**

Different communications instructions are included in the scope of delivery of TeleService depending on the CPU that are integrated into the library of the TIA Portal during the installation in the communications instructions folder of the Task Card under TeleService.

If a system is to send an email, the user program of the system must call the corresponding communications instruction for the CPU.

The following communications instructions are available for sending an email:

- S7-300/400 CPUs: use the communications instruction "AS\_MAIL": Transfer email
- S7-1200 CPUs: use the communications instruction "TM\_MAIL": Transfer email
- S7-1500 CPUs: use the communications instruction "TMAIL\_C": Transfer email

The respective communications instruction transfers an email from a CPU to a mail server by means of the Simple Mail Transfer Protocol (SMTP) with the "LOGIN" authentication method. The data is transferred unencrypted with this SMTP process.

The figure below shows an example with the communications instruction "AS\_MAIL":

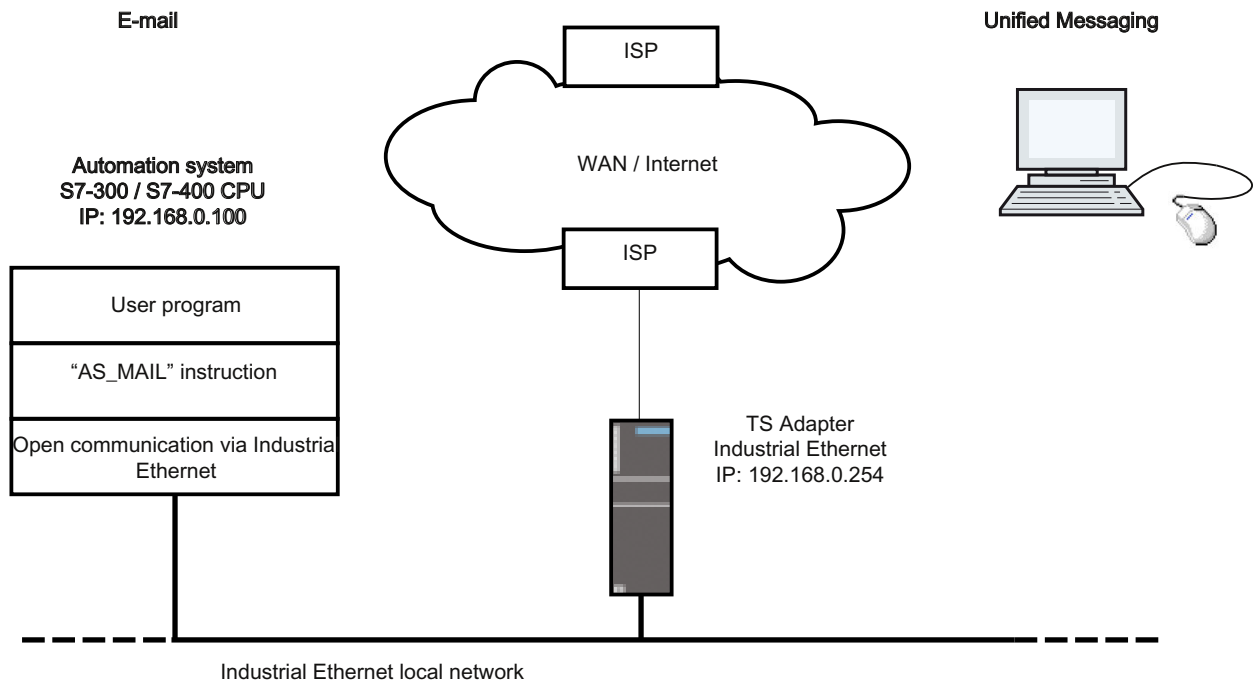

The "Use gateway/router" property must also be set for the Ethernet interface in the configuration of the CPU on which the communications instruction "AS\_MAIL" runs. (available in the device configuration under Ethernet addresses and there under IP protocol) The IP address of the Ethernet interface of the TS Adapter IE is to be specified as "Address".

---

#### Note

You can find further information in the task card in the "Communications instructions" folder under TeleService.

---

## 12.7.6 Notes on troubleshooting

### 12.7.6.1 General information on troubleshooting for modem problems

#### Introduction

The information below should help you establish and eliminate the causes of any modem problems.

1. Enable "Record log file" for data traffic between PG/PC and modem. The entries in this file can provide valuable information for determining the cause of errors.
2. Switch on the loudspeaker on your local modem. Select a volume loud enough to be clearly heard.  
You can then hear whether:
  - there is a dial tone at the connection
  - the modem called is busy
  - the modem called accepts the call.

#### Common modem problems

Modem connection problems are among the most common modem problems:

- Modem connection is not established
- Modem connection is interrupted

The topics below contain tables detailing possible causes and providing information on eliminating the error in question.

#### See also

Dial-up connection to the TS Adapter is not established (Page 6267)

Dial-up connection from the TS Adapter is not established (Page 6268)

Modem connection is interrupted (Page 6269)

Modem alarms (Page 6270)

Recording a log file for the modem (Page 6266)

### 12.7.6.2 Recording a log file for the modem

#### Introduction

It is advisable to record a log file as this makes it easier to find the causes of faults in a modem.



**Procedure:**

Proceed as follows:

1. Activate the properties dialog of the modem used via the "Phone and modem options" option in the Control Panel.
2. Check the settings of the "Log" option in the "Diagnostics" tab and if necessary change the log file settings so that the file is recorded.

**Result:**

Activity between the programming device/personal computer and the modem are entered in the log file. If there are problems establishing the connection, you can evaluate the data recorded in the log file to determine the cause of the error.

**12.7.6.3 Dial-up connection to the TS Adapter is not established****Dial-up connection to TS Adapter is not established**

The table below sets out possible causes and how to eliminate them if no remote connection to the TS Adapter can be established.

Possible cause	Check/Remedy
Cabling faulty	<ul style="list-style-type: none"> <li>• Are all the connecting cables connected correctly?</li> <li>• Are the connectors loose?</li> </ul>
Dial parameters for main telephone line and extension incorrectly set	<ul style="list-style-type: none"> <li>• Do the properties and dial parameters of your modem match the phone connection to main phone line or extension?</li> <li>• Do not specify a dial-out code in the "Dial parameters" dialog if you operate your modem on a local loop (main telephone line). The fields for the dial-out code for local calls and long-distance calls must be empty.</li> </ul>
Dialing mode incorrectly set	<ul style="list-style-type: none"> <li>• Is the correct dialing mode (tone/pulse) set in the dialog for the dial parameters of your modem?</li> <li>• Use a connected telephone to check the connection on which you want to operate the modem. You should hear crackling noises on the telephone during pulse dialing and tones of varying pitches during tone dialing. Set the corresponding dialing mode in the modem dial parameters.</li> </ul>

12.7 Establishing a remote connection with TeleService

Possible cause	Check/Remedy
Dial disable active	<ul style="list-style-type: none"> <li>The dial disable function is a country-specific modem property which, depending on the modem, becomes effective after one or more unsuccessful attempts to establish a connection.</li> <li>If your modem still does not respond after several attempts to dial, the dial disable function may be active. Characters are still sent to the modem after the dial command but the modem does not start the dialing process. The driver receives a general error message.</li> <li>Refer to the modem documentation for information on how the dial disable function is implemented for your modem.</li> <li>Create a log file (Page 6264) (modemlog.txt) in which the activities between the programming device/personal computer and modem are recorded. Then check whether the file contains an entry caused by dial disable (e.g. DELAYED).</li> </ul>
Phone connection defective or busy	<ul style="list-style-type: none"> <li>Connect a phone and check whether a dial tone can be heard on this connection.</li> <li>Any analog phone connected on the same connection must be hung up. You cannot establish an additional modem connection on this connection if there is an existing phone connection.</li> </ul>
Serial parameters set incorrectly	<ul style="list-style-type: none"> <li>Are the correct values entered in the "Settings" tab for modem properties (8 data bits, no parity, 1 stop bit)?</li> <li>Is the correct COM interface set in the "General" tab for the modem properties?</li> </ul>
Initialization string of the TS Adapter is not suitable for the modem.	<ul style="list-style-type: none"> <li>Familiarize yourself with the modem initialization string requirements and set the string accordingly.</li> <li>Procedure for configuring the TS Adapter IE (Page 6236)</li> </ul>
Settings for error correction between the modem at the TS Adapter and the modem at the PC/programming device are not compatible.	<ul style="list-style-type: none"> <li>Adapt the modem settings.</li> <li>Useful information on configuring the TS Adapter MPI (Page 6231)</li> <li>Restoring the default parameter assignment of a TS Adapter MPI (Page 6233)</li> <li>Procedure for configuring the TS Adapter IE (Page 6232)</li> </ul>

12.7.6.4 Dial-up connection from the TS Adapter is not established

No callback from TS Adapter

The table below sets out possible causes and how to eliminate them if there is no callback from the TS Adapter.

Possible cause	Check/Remedy
Errors in the location or call settings in the TS Adapter	<p>Check the TS Adapter parameter assignment:</p> <ul style="list-style-type: none"> <li>Are the dialing mode and dial-out code set correctly for your phone connection?</li> <li>Does the modem at the TS Adapter support the characters configured for the dial-out code?</li> <li>Is "Wait for dial tone before dialing" deactivated for an extension?</li> </ul>
Initialization of modem insufficient	<p>Check the string for modem initialization:</p> <ul style="list-style-type: none"> <li>The modem may require a further initialization in order to establish a remote connection.</li> <li>Properties of the modem initialization string for the TS Adapter MPI</li> </ul>
Callback number is incorrect	<p>Check the configuration of the callback number you assigned.</p>

## No call from TS Adapter MPI

The table below sets out possible causes and how to remedy them if there is no call from the TS Adapter MPI.

Possible cause	Check/Remedy
Phone number is incorrect	Is the required number being transferred to the communication instruction "PG_DIAL" ?
TS Adapter MPI parameter assignment incorrect	Check the TS Adapter MPI parameter assignment: <ul style="list-style-type: none"> <li>• Are the dialing mode and dial-out code set correctly for your phone connection?</li> <li>• Does the modem at the TS Adapter MPI support the characters configured for the dial-out code?</li> <li>• Is "Wait for dial tone before dialing" deactivated for an extension?</li> </ul>

### 12.7.6.5 Modem connection is interrupted

#### Modem connection is interrupted

The table below sets out possible causes and how to remedy them if the modem connection is interrupted.

Possible cause:	Check / Remedy:
Metering pulses in the line	Metering pulses will be generated if you have applied to the phone company for a metering clock. This may mean that the modem no longer recognizes the carrier signal and switches off. <ul style="list-style-type: none"> <li>• Set a longer waiting or switch-off time at the modem.</li> <li>• Have the metering pulse deactivated by the phone company.</li> </ul>
Shielding	<ul style="list-style-type: none"> <li>• Are the connection cables used shielded sufficiently?</li> <li>• Make sure that the modem cables do not run next to power cables and that they are as far as possible from power supply units and monitors.</li> </ul>
Protocol timeout	<ul style="list-style-type: none"> <li>• Set fixed monitoring times.</li> </ul>
Automatic connection termination	<ul style="list-style-type: none"> <li>• Deactivate the option that terminates an existing connection automatically after a specified time without data transfer ("Terminate after idle of ...").</li> </ul>
Data flow control deactivated	<ul style="list-style-type: none"> <li>• Click on the "Extended" button in the "Settings" tab of the modem properties and activate the following options in the dialog displayed (if available and not yet set):               <ul style="list-style-type: none"> <li>– Data flow control</li> <li>– Hardware (RTS/CTS)</li> <li>– Data compression</li> <li>– Error control</li> </ul> </li> </ul>
Initialization string of the TS Adapter is not suitable for the modem	<ul style="list-style-type: none"> <li>• Set the modem initialization string in accordance with the following requirements. See also: TS Adapter IE parameter assignment options (Page 6239)</li> </ul>

#### See also

TS adapter MPI configuration options (Page 6231)

### 12.7.6.6 Checklist for troubleshooting the modem

#### Introduction

The following list should help you establish the potential cause of any problems with the modem. The help topics below set out how and in which dialogs you define the relevant settings.

#### Modem connection cannot be established:

- Check the cabling and the connections.
- Check whether the correct dialing mode (tone/pulse) is set.
- If your modem does not react after several attempts to dial, a dial disable function may be active. Familiarize yourself with dial disable on your modem.
- Are you operating your modem on a main telephone line or on an extension line? Configure the properties and dialing parameters of the modem accordingly.
- Enable the log file option in the advanced properties. The next attempt to establish a connection will then be recorded in a file in the Windows directory.
- Ensure that the ISDN TAs used work with the same B and D channel protocol.

#### The modem connection is terminated:

- Metering pulses can have a negative affect on a connection. Have the pulses deactivated by your telephone company.
- Set fixed monitoring times.
- Deactivate the option that terminates an existing connection automatically after a specified time without data transfer (idle).
- Make sure that you have activated RTS/CTS for data flow control.

### 12.7.6.7 Modem alarms

#### Information in the log file

The modem alarms are entered in a log file if you have activated the recording function.

The log file contains the following information:

Alarm:	Possible cause:	Remedy:
NO DIALTONE	A phone call may currently be being carried out on this line.	<ul style="list-style-type: none"><li>• Repeat the process once the phone call is over.</li></ul>
NO CARRIER	The device dialed is not ready, is not a modem or cannot establish a connection in the set operating mode.	<ul style="list-style-type: none"><li>• Check the numbers and the settings.</li></ul>

Alarm:	Possible cause:	Remedy:
BUSY	The device dialed is busy.	<ul style="list-style-type: none"> <li>• Try again later.</li> </ul>
DELAYED: ...	Dial disable	<ul style="list-style-type: none"> <li>• Refer to the modem documentation for information on how the dial disable function is implemented for your modem and if necessary remove it.</li> </ul>

### 12.7.6.8 Possible error messages with VPN connections

#### VPN connection to TS Adapter IE Advanced is not established

The table below sets out possible errors and how to eliminate them if no VPN connection to the TS Adapter IE Advanced can be established.

Possible errors	Check/Remedy
The error message "The webpage cannot be displayed" appears when the Web interface is accessed.	<ul style="list-style-type: none"> <li>• Note: This problem occurs when the Windows certificate store contains a CA certificate with the same name as the CA certificate which has just been generated.</li> <li>• If a CA certificate for this TS Adapter is already installed in the Windows certificate store and you have generated a new CA certificate on the TS Adapter, you need to remove the old CA certificate from the Windows certificate store and install the newly generated CA certificate.</li> <li>• See also: Installing CA certificates for VPN connections (Page 6246)</li> <li>• See also: Deleting CA certificates for VPN connections (Page 6249)</li> </ul>
"Error during connection establishment" error message.	<ul style="list-style-type: none"> <li>• Check whether other users have been saved in the TS Adapter IE Advanced user database.</li> <li>• Check which user is attempting to establish a remote connection. You cannot establish a remote connection if you are logged on as "Administrator".</li> </ul>
"No matching CA certificate found in Windows certificate store" error message.	<ul style="list-style-type: none"> <li>• Use the automatic certificate download. Enter the fingerprint in the corresponding field in the connection dialog.</li> <li>• See also: Establishing VPN connections (Page 6249)</li> <li>• Or</li> <li>• Export the CA certificate from the Web interface of the TS Adapter IE Advanced and install it manually in the Windows certificate store.</li> <li>• See also: Installing CA certificates for VPN connections (Page 6246)</li> </ul>
Error message: "The remote address specified does not correspond to the remote address of the TS Adapter".	<ul style="list-style-type: none"> <li>• You must use the remote address which you specified in the TS Adapter IE Advanced to establish the connection.</li> <li>• You cannot use the IP address if you have entered the DNS name (and vice versa).</li> </ul>
Error message: "The signature of the certificate could not be verified".	<ul style="list-style-type: none"> <li>• If you have generated a new CA certificate on the TS Adapter IE Advanced, you need to delete the old CA certificate from the Windows certificate store and install the new one.</li> <li>• See also: Deleting CA certificates for VPN connections (Page 6249)</li> <li>• See also: Installing CA certificates for VPN connections (Page 6246)</li> </ul>
An e-mail cannot be sent.	<ul style="list-style-type: none"> <li>• Check whether there is a network/Internet connection at the WAN port.</li> <li>• Check whether the mail server is accessible.</li> <li>• Check whether the outgoing connections in the TS Adapter IE Advanced are valid.</li> <li>• Check whether the SMTP port in the firewall is open for outgoing connections.</li> </ul>



## Hardware documentation

### 13.1 General information on the hardware documentation

#### Additional information on the available hardware

The TIA Portal can be used to configure a wide variety of hardware, depending on the installed products. You can find the available hardware in the hardware catalog. You can find all the current manuals, operating instructions and FAQs as well as updates for your devices in the Service and Support section (<https://support.automation.siemens.com/>) of the Siemens Website.

To help you locate the appropriate documents for your hardware in the Service and Support area, the following sections list all modules and module families that are available in the current scope of the installation of the TIA Portal. You will find a link for each module that takes you directly to the relevant manuals and operating instructions in the Service and Support area.

## 13.2 HMI

### 13.2.1 Basic Panels

#### 13.2.1.1 Basic Panels

Information about Basic Panels is available here (<http://support.automation.siemens.com/WW/view/en/28426379/133300>).

### 13.2.2 Panels

#### 13.2.2.1 Panels of the 70 series

Information about Basic Panels of the 70 series is available here ([http://support.automation.siemens.com/WW/llisapi.dll?aktprim=0&lang=en&referer=%2fWW%2f&func=cslib\\_csinfo&siteid=csius&groupid=4000002&extranet=standard&viewreg=WW&nodeid=15271786&objaction=csopen](http://support.automation.siemens.com/WW/llisapi.dll?aktprim=0&lang=en&referer=%2fWW%2f&func=cslib_csinfo&siteid=csius&groupid=4000002&extranet=standard&viewreg=WW&nodeid=15271786&objaction=csopen)).

#### 13.2.2.2 Panels of the 170 series

Information about panels of the 170 series is available here (<http://support.automation.siemens.com/WW/view/en/10805566/133300>).

#### 13.2.2.3 Panels of the 270 series

Information about panels of the 270 series is available here (<http://support.automation.siemens.com/WW/view/en/10805567/133300>).

### 13.2.3 Comfort Panels

#### 13.2.3.1 Comfort Panels

Information about Comfort Panels is available here (<http://support.automation.siemens.com/WW/view/en/47182890/133300>).



## 13.2.4 Multi Panels

### 13.2.4.1 170 series

Information about Multi Panels of the 170 series is available here. (<http://support.automation.siemens.com/WW/view/en/28421795/133300>)

### 13.2.4.2 270 series

Information about Multi Panels of the 270 series is available here (<http://support.automation.siemens.com/WW/view/en/10805569/133300>).

### 13.2.4.3 370 series

Information about Multi Panels of the 370 series is available here (<http://support.automation.siemens.com/WW/view/en/10805570/133300>).

## 13.2.5 Mobile Panels

### 13.2.5.1 170 series

Information about Mobile Panels of the 170 series is available here (<http://support.automation.siemens.com/WW/view/en/26268543/133300>).

### 13.2.5.2 270 series

Information about Mobile Panels of the 270 series is available here (<http://support.automation.siemens.com/WW/view/en/22584001/133300>).

## 13.2.6 Key Panels

### 13.2.6.1 Key Panels

Information about Key Panels is available here (<http://support.automation.siemens.com/WW/view/de/47416561/0/en>).

### 13.2.6.2 Push Button Panels

Information about Push Button Panels is available here (<http://support.automation.siemens.com/WW/view/en/19860219/133300>).

## 13.2.7 WinAC for Multi Panels

### 13.2.7.1 WinAC for Multi Panels

Information about WinAC MP is available here (<http://support.automation.siemens.com/WW/view/en/10997567/130000>).

## 13.3 PLC

### 13.3.1 SIMATIC S7-1200

#### 13.3.1.1 CPU

##### CPU 1211C (6ES7 211-1xxx-0XB0)

Information on CPUs 1211C AC/DC/Rly, 1211C DC/DC/DC and 1211C DC/DC/Rly is available here (<http://support.automation.siemens.com/WW/llisapi.dll?func=cslib.csinfo&lang=en&objid=6ES72111BD300XB0&objaction=csviewmlfbbeitraege&subtype=133300&caller=view>).

##### CPU 1212C (6ES7 212-1xxx-0XB0)

Information on CPUs 1212C AC/DC/Rly, 1212C DC/DC/DC and 1212C DC/DC/Rly is available here (<http://support.automation.siemens.com/WW/llisapi.dll?func=cslib.csinfo&lang=en&objid=6ES72121BD300XB0&objaction=csviewmlfbbeitraege&subtype=133300&caller=view>).

##### CPU 1214C (6ES7 214-1xxx-0XB0)

Information on CPUs 1214C AC/DC/Rly, 1214C DC/DC/DC and 1214C DC/DC/Rly is available here (<http://support.automation.siemens.com/WW/llisapi.dll?func=cslib.csinfo&lang=en&objid=6ES72141BE300XB0&objaction=csviewmlfbbeitraege&subtype=133300&caller=view>).

##### CPU 1215C (6ES7 215-1xxx-0XB0)

Information on CPUs 1215C DC/DC/DC, 1215C AC/DC/Rly and 1215C DC/DC/Rly is available here (<http://support.automation.siemens.com/WW/llisapi.dll?func=cslib.csinfo&lang=en&objid=6ES72151HG400XB0&objaction=csviewmlfbbeitraege&subtype=133300&caller=view>).

### CPU 1217C (6ES7 217-1xxx-0XB0)

Information on the 1217C DC/DC/DC CPU is available here (<http://support.automation.siemens.com/WW/llisapi.dll?func=cslib.csinfo&lang=en&objid=6ES72171AG400XB0&objaction=csviewmlfbbeitraege&sbtype=133300&caller=view>).

#### 13.3.1.2 Signal boards (6ES7 2xx-xxx30-0XB0)

Information on signal boards for S7-1200 is available here (<http://support.automation.siemens.com/WW/llisapi.dll?func=cslib.csinfo&lang=en&objid=6ES72213BD300XB0&objaction=csviewmlfbbeitraege&sbtype=133300&caller=view>).

#### 13.3.1.3 CB 1241 (6ES7 241-1CH30-1XB0)

Information on the CB 1241 communication board is available here (<http://support.automation.siemens.com/WW/llisapi.dll?func=cslib.csinfo&lang=en&objid=6ES72411CH301XB0&objaction=csviewmlfbbeitraege&sbtype=133300&caller=view>).

#### 13.3.1.4 BB 1297 (6ES7 297-0AX30-0XA0)

Information on the CB 1241 communication board is available here (<http://support.automation.siemens.com/WW/llisapi.dll?aktprim=100&lang=en&referer=%2fWW>

[%2f&func=cslib.cssearch&nodeid0=41886045&viewreg=WW&siteid=csius&extranet=standard&groupid=4000002&objaction=cssearch&content=adsearch%2Fadsearch%2EaspX\).](#)

### 13.3.1.5 Digital input modules (6ES7 221-1Bx30-0XB0)

Information on digital input modules DI8 x 24VDC and DI16 x 24VDC is available here (<http://support.automation.siemens.com/WW/llisapi.dll?func=cslib.csinfo&lang=en&objid=6ES72211BF300XB0&objaction=csviewmlfbbeitraege&subtype=133300&caller=view>).

### 13.3.1.6 Digital output modules (6ES7 222-1xx30-0XB0)

Information on the following digital output modules is available here (<http://support.automation.siemens.com/WW/llisapi.dll?func=cslib.csinfo&lang=en&objid=6ES72221BF300XB0&objaction=csviewmlfbbeitraege&subtype=133300&caller=view>):

- DQ8 x 24VDC
- DQ16 x 24VDC
- DQ16 x relay
- DQ8 x relay
- DQ8 x NO/NC relay

### 13.3.1.7 Digital input and output modules (6ES7 223-1xx30-0XB0)

Information on the following digital input and output modules is available here (<http://support.automation.siemens.com/WW/llisapi.dll?func=cslib.csinfo&lang=en&objid=6ES72231BH300XB0&objaction=csviewmlfbbeitraege&subtype=133300&caller=view>):

- DI8/DQ8 x 24VDC
- DI16/DQ16 x 24VDC
- DI8 x 24VDC / DQ8 x relay
- DI16 x 24VDC / DQ16 x relay
- DI8 x 120VDC / DQ8 x relay

### 13.3.1.8 Analog input modules (6ES7 231-xxx30-0XB0)

Information on the following analog input modules is available here (<http://support.automation.siemens.com/WW/llisapi.dll?func=cslib.csinfo&lang=en&objid=6ES72314HD300XB0&objaction=csviewmlfbbeitraege&subtype=133300&caller=view>):

- AI4 x 13Bit
- AI4 x 16Bit
- AI8 x 13Bit
- AI4 x RTD
- AI8 x RTD
- AI4 x TC
- AI8 x TC

### 13.3.1.9 Analog output modules (6ES7 234-4Hx30-0XB0)

Information on analog output modules AQ2 x 14Bits and AQ4 x 14Bits is available here (<http://support.automation.siemens.com/WW/llisapi.dll?func=cslib.csinfo&lang=en&objid=6ES72324HB300XB0&objaction=csviewmlfbbeitraege&subtype=133300&caller=view>).

### 13.3.1.10 Analog input and output module (6ES7 234-4HE30-0XB0)

Information on the analog input and output modules AI4 x 13Bits / AQ2 x 14Bits is available here (<http://support.automation.siemens.com/WW/llisapi.dll?func=cslib.csinfo&lang=en&objid=6ES72324HB300XB0&objaction=csviewmlfbbeitraege&subtype=133300&caller=view>).

### 13.3.1.11 Communications modules

#### Industrial Remote Control

##### CP 1242-7 (6GK7 242-7KX30-0XE0)

Information on the CP 1242-7 Telecontrol communication module is available here (<http://support.automation.siemens.com/WW/llisapi.dll?func=cslib.csinfo&lang=en&objid=6GK72427KX300XE0&objaction=csviewmlfbbeitraege&subtype=133300&caller=view>).

##### CP 1243-1 (6GK7 243-1JX30-0XE0)

Information on the CP 1243-1 Ethernet communication module is available here (<http://support.automation.siemens.com/WW/llisapi.dll?func=cslib.csinfo&lang=en&objid=6GK72431JX300XE0&objaction=csviewmlfbbeitraege&subtype=133300&caller=view>).

#### PROFIBUS

##### CM 1242-5 (6GK7 242-5DX3x-0XE0)

Information on the CM 1242-5 PROFIBUS communication module is available here (<http://support.automation.siemens.com/WW/llisapi.dll?func=cslib.csinfo&lang=en&objid=6GK72425DX300XE0&objaction=csviewmlfbbeitraege&subtype=133300&caller=view>).

##### CM 1243-5 (6GK7 243-5DX3x-0XE0)

Information on the CM 1243-5 PROFIBUS communication module is available here (<http://support.automation.siemens.com/WW/llisapi.dll?func=cslib.csinfo&lang=en&objid=6GK72435DX300XE0&objaction=csviewmlfbbeitraege&subtype=133300&caller=view>).

#### Point-to-point

##### CM 1241 RS232 (6ES7 241-1AH30-0XB0)

Information on the CM 1241 (RS232) communication module for point-to-point connections is available here (<http://support.automation.siemens.com/WW/llisapi.dll>).

[func=cslib.csinfo&lang=en&objid=6ES72411AH300XB0&objaction=csviewmlfbbeitraege&sbtype=133300&caller=view](https://support.automation.siemens.com/WW/llisapi.dll?func=cslib.csinfo&lang=en&objid=6ES72411AH300XB0&objaction=csviewmlfbbeitraege&sbtype=133300&caller=view)).

#### CM 1241 RS232 (6ES7 241-1AH32-0XB0)

Information on the CM 1241 (RS232) communication module for point-to-point connections is available here (<https://support.automation.siemens.com/WW/llisapi.dll?func=cslib.csinfo&lang=en&objid=6ES72411AH320XB0&objaction=csviewmlfbbeitraege&sbtype=133300&caller=view>).

#### CM 1241 RS485 (6ES7 241-1CH30-0XB0)

Information on the CM 1241 (RS485) communication module for point-to-point connections is available here (<http://support.automation.siemens.com/WW/llisapi.dll?func=cslib.csinfo&lang=en&objid=6ES72411CH300XB0&objaction=csviewmlfbbeitraege&sbtype=133300&caller=view>).

#### CM 1241 RS422/485 (6ES7 241-1CH31-0XB0)

Information on the CM 1241 (RS422/485) communication module for point-to-point connections is available here (<http://support.automation.siemens.com/WW/llisapi.dll?func=cslib.csinfo&lang=en&objid=6ES72411CH310XB0&objaction=csviewmlfbbeitraege&sbtype=133300&caller=view>).

#### CM 1241 RS422/485 (6ES7 241-1CH32-0XB0)

Information on the CM 1241 (RS422/485) communication module for point-to-point connections is available here (<https://support.automation.siemens.com/WW/llisapi.dll?func=cslib.csinfo&lang=en&objid=6ES72411CH320XB0&objaction=csviewmlfbbeitraege&sbtype=133300&caller=view>).

### AS-Interface

#### AS-Interface CM 1243-2 (3RK7243-2AA30-0XB0)

Information on the CM 1243-2 AS-i communication module is available here (<http://support.automation.siemens.com/WW/llisapi.dll?func=cslib.csinfo&lang=en&objid=3RK72432AA300XB0&objaction=csviewmlfbbeitraege&sbtype=133300&caller=view>).



### 13.3.1.12 Technology modules

#### SIWAREX WP231 (7MH4960-2AA01)

Information on the SIWAREX WP231 weighing module is available here (<https://support.automation.siemens.com/WW/llisapi.dll?func=cslib.csinfo&lang=en&objid=7MH4960-2AA01&objaction=csviewmlfbbeitraege&subtype=133300&caller=view>).

#### 4SI IO-Link (6ES7 278-4BD32-0XB0)

Information on the 4SI IO-Link IO-Link Master technology module is available here (<https://support.automation.siemens.com/WW/llisapi.dll?func=cslib.csinfo&lang=en&objid=6ES72784BD320XB0&objaction=csviewmlfbbeitraege&subtype=133300&caller=view>).

## 13.4 Distributed I/O

### 13.4.1 ET 200MP

#### 13.4.1.1 Interface modules

##### PROFINET

#### IM 155-5 PN ST (6ES7 155-5AA00-0AB0)

Information on the distributed I/O module IM 155-5 PN ST is available here (<http://support.automation.siemens.com/WW/llisapi.dll?func=cslib.csinfo&lang=en&objid=6ES71555AA000AB0&objaction=csviewmlfbbeitraege&sbtype=133300&caller=view>).

### 13.4.2 ET 200SP

#### 13.4.2.1 Interface modules

##### PROFINET

#### IM 155-6 PN ST (6ES7155-6AU00-0BN0)

You can find information on the interface module IM 155-6 PN ST here (<https://support.automation.siemens.com/WW/llisapi.dll?func=cslib.csinfo&lang=en&objid=6ES71556AU000BN0&objaction=csviewmlfbbeitraege&sbtype=133300&caller=view>).

#### IM 155-6 PN ST V1.1 (6ES7 155-6AU00-0BN0)

Information on the interface module IM 155-6 PN ST V1.1 is available here (<https://support.automation.siemens.com/WW/llisapi.dll?func=cslib.csinfo&lang=en&objid=6ES71556AU000BN0&objaction=csviewmlfbbeitraege&sbtype=133300&caller=view>).

**IM 155-6 PN HS (6ES7155-6AU00-0NN0)**

You can find information on the interface module IM 155-6 PN HS here (<https://support.automation.siemens.com/WW/llisapi.dll?func=cslib.csinfo&lang=en&objid=6ES71556AU000NN0&objaction=csviewmlfbbeitraege&subtype=133300&caller=view>).

**IM 155-6 PN HF (6ES7155-6AU00-0CN0)**

You can find information on the interface module IM 155-6 PN HF here (<https://support.automation.siemens.com/WW/llisapi.dll?func=cslib.csinfo&lang=en&objid=6ES71556AU000CN0&objaction=csviewmlfbbeitraege&subtype=133300&caller=view>).

**IM 155-6 PN HF V2.0 (6ES7 155-6AU00-0CN0)**

Information on the IM 155-6 PN HF V2.0 interface module is available here (<https://support.automation.siemens.com/WW/llisapi.dll?func=cslib.csinfo&lang=en&objid=6ES71556AU000CN0&objaction=csviewmlfbbeitraege&subtype=133300&caller=view>).

**BusAdapter****BusAdapter BA 2xRJ45 (6ES7 193-6AR00-0AA0)**

Information on the BusAdapter BA 2xRJ45 is available here (<https://support.automation.siemens.com/WW/llisapi.dll?func=cslib.csinfo&lang=en&objid=6ES71936AR000AA0&objaction=csviewmlfbbeitraege&subtype=133300&caller=view>).

**BusAdapter FC (6ES7 193-6AF00-0AA0)**

Information on the BusAdapter FC is available here (<https://support.automation.siemens.com/WW/llisapi.dll?func=cslib.csinfo&lang=en&objid=6ES71936AF000AA0&objaction=csviewmlfbbeitraege&subtype=133300&caller=view>).

## PROFIBUS

### IM 155-6 DP ST (6ES7155-6BA00-0BN0)

You can find information on the interface module IM 155-6 DP ST here (<https://support.automation.siemens.com/WW/llisapi.dll?func=cslib.csinfo&lang=en&objid=6ES71556BA000BN0&objaction=csviewmlfbbeitraege&sbtype=133300&caller=view>).

## Point-to-point

### CM PtP (6ES7137-6AA00-0BA0)

Information on the communication module CM PtP is available here (<https://support.automation.siemens.com/WW/llisapi.dll?func=cslib.csinfo&lang=en&objid=6ES71376AA000BA0&objaction=csviewmlfbbeitraege&sbtype=133300&caller=view>).

## Other fieldbuses

### IM 155-6 Receive (6ES7155-6DU00-0BN0)

You can find information on the interface module IM 155-6 Receive here (<https://support.automation.siemens.com/WW/llisapi.dll?func=cslib.csinfo&lang=en&objid=6ES71386AA000BA0&objaction=csviewmlfbbeitraege&sbtype=133300&caller=view>).

## BusAdapter

### BusAdapter Send (6ES7 193-6AS00-0AA0)

Information on the BusAdapter Send is available here (<https://support.automation.siemens.com/WW/llisapi.dll?func=cslib.csinfo&lang=en&objid=6ES71936AS000AA0&objaction=csviewmlfbbeitraege&sbtype=133300&caller=view>).

### BusAdapter Receive (6ES7 193-6AE00-0AA0)

Information on the BusAdapter Receive is available here (<https://support.automation.siemens.com/WW/llisapi.dll>).

[func=cslib.csinfo&lang=en&objid=6ES71936AE000AA0&objaction=csviewmlfbbeitraege&subtype=133300&caller=view](https://support.automation.siemens.com/WW/llisapi.dll?func=cslib.csinfo&lang=en&objid=6ES71936AE000AA0&objaction=csviewmlfbbeitraege&subtype=133300&caller=view)).

### 13.4.2.2 Digital input modules

#### DI 8x24VDC ST (6ES7 131-6BF00-0BA0)

Information on the digital input module DI 8x24VDC ST is available here (<https://support.automation.siemens.com/WW/llisapi.dll?func=cslib.csinfo&lang=en&objid=6ES71316BF000BA0&objaction=csviewmlfbbeitraege&subtype=133300&caller=view>).

#### DI 8x24VDC HF (6ES7 131-6BF00-0CA0)

Information on the digital input module DI 8x24VDC HF is available here (<https://support.automation.siemens.com/WW/llisapi.dll?func=cslib.csinfo&lang=en&objid=6ES71316BF000CA0&objaction=csviewmlfbbeitraege&subtype=133300&caller=view>).

#### DI 8x24VDC HF V2.0 (6ES7 131-6BF00-0CA0)

Information on the digital input module DI 8x24VDC HF is available here (<https://support.automation.siemens.com/WW/llisapi.dll?func=cslib.csinfo&lang=en&objid=6ES71316BF000CA0&objaction=csviewmlfbbeitraege&subtype=133300&caller=view>).

#### DI 8xNAMUR (6ES7 131-6TF00-0CA0)

Information on the digital input module DI 8x24VDC HF is available here (<https://support.automation.siemens.com/WW/llisapi.dll?func=cslib.csinfo&lang=en&objid=6ES71316TF000CA0&objaction=csviewmlfbbeitraege&subtype=133300&caller=view>).

#### DI 16x24VDC ST (6ES7 131-6BH00-0BA0)

Information on the digital input module DI 16x24VDC ST is available here (<https://support.automation.siemens.com/WW/llisapi.dll?func=cslib.csinfo&lang=en&objid=6ES71316BH000BA0&objaction=csviewmlfbbeitraege&subtype=133300&caller=view>).

### 13.4.2.3 Digital output modules

#### DQ 16x24VDC/0.5A ST (6ES7 132-6BH00-0BA0)

Information on the digital output module DQ 16x24VDC/0.5A ST is available here (<https://support.automation.siemens.com/WW/llisapi.dll?func=cslib.csinfo&lang=en&objid=6ES71326BH000BA0&objaction=csviewmlfbbeitraege&subtype=133300&caller=view>).

#### RQ 4x24VDC..230VAC/5A NO (6ES7 132-6HD00-0BB0)

Information on the relay output module RQ 4x24VUC...230VUC/5A is available here (<https://support.automation.siemens.com/WW/llisapi.dll?func=cslib.csinfo&lang=en&objid=6ES71326HD000BB0&objaction=csviewmlfbbeitraege&subtype=133300&caller=view>).

#### DQ 4x24VDC/2A ST (6ES7 132-6BD20-0BA0)

Information on the digital output module DQ 4x24VDC/2A ST is available here (<https://support.automation.siemens.com/WW/llisapi.dll?func=cslib.csinfo&lang=en&objid=6ES71326BD200BA0&objaction=csviewmlfbbeitraege&subtype=133300&caller=view>).

#### DQ 8x24VDC/0.5A ST (6ES7 132-6BF00-0BA0)

Information on the digital output module DQ 8x24VDC/0.5A ST is available here (<https://support.automation.siemens.com/WW/llisapi.dll?func=cslib.csinfo&lang=en&objid=6ES71326BF000BA0&objaction=csviewmlfbbeitraege&subtype=133300&caller=view>).

#### DQ 8x24VDC/0.5A HF (6ES7 132-6BF00-0CA0)

Information on the digital output module DQ 8x24VDC/0.5A HF is available here (<https://support.automation.siemens.com/WW/llisapi.dll?func=cslib.csinfo&lang=en&objid=6ES71326BF000CA0&objaction=csviewmlfbbeitraege&subtype=133300&caller=view>).

#### DQ 8x24VDC/0.5A HF V2.0 (6ES7 132-6BF00-0CA0)

Information on the digital output module DQ 8x24VDC/0.5A HF V2.0 is available here (<https://support.automation.siemens.com/WW/llisapi.dll>).

[func=cslib.csinfo&lang=en&objid=6ES71326BF000CA0&objaction=csviewmlfbbeitraege&subtype=133300&caller=view](https://support.automation.siemens.com/WW/llisapi.dll?func=cslib.csinfo&lang=en&objid=6ES71326BF000CA0&objaction=csviewmlfbbeitraege&subtype=133300&caller=view)).

#### 13.4.2.4 Analog input modules

##### AI 4xRTD/TC 2-/3-/4-wire HF (6ES7 134-6JD00-0CA1)

Information on the analog input module AI 4xRTD/TC 2-/3-/4-wire HF is available here (<https://support.automation.siemens.com/WW/llisapi.dll?func=cslib.csinfo&lang=en&objid=6ES71346JD000CA1&objaction=csviewmlfbbeitraege&subtype=133300&caller=view>).

##### AI 4xRTD/TC 2-/3-/4-wire HF V2.0 (6ES7 134-6JD00-0CA1)

Information on the analog input module AI 4xRTD/TC 2-/3-/4-wire HF V2.0 is available here (<https://support.automation.siemens.com/WW/llisapi.dll?func=cslib.csinfo&lang=en&objid=6ES71346JD000CA1&objaction=csviewmlfbbeitraege&subtype=133300&caller=view>).

##### AI 4xU/I 2-wire ST (6ES7 134-6HD00-0BA1)

Information on the analog input module AI 4xU/I 2-wire ST is available here (<https://support.automation.siemens.com/WW/llisapi.dll?func=cslib.csinfo&lang=en&objid=6ES71346HD000BA1&objaction=csviewmlfbbeitraege&subtype=133300&caller=view>).

##### AI 4xI 2-/4-wire ST (6ES7 134-6GD00-0BA1)

Information on the analog input module AI 4xI 2-/4-wire ST is available here (<https://support.automation.siemens.com/WW/llisapi.dll?func=cslib.csinfo&lang=en&objid=6ES71346GD000BA1&objaction=csviewmlfbbeitraege&subtype=133300&caller=view>).

##### AI 3x400VAC/1-5A ST (6ES7 134-6PA00-0BD0)

Information on the analog input module AI 3x400VAC/1-5A ST is available here (<https://support.automation.siemens.com/WW/llisapi.dll?func=cslib.csinfo&lang=en&objid=6ES71346PA000BD0&objaction=csviewmlfbbeitraege&subtype=133300&caller=view>).

### AI 2xU/I 2-/4-wire HS (6ES7 134-6HB00-0DA0)

Information on the analog input module AI 2xU/I 2-/4-wire HS is available here (<https://support.automation.siemens.com/WW/llisapi.dll?func=cslib.csinfo&lang=en&objid=6ES7134-6HB00-0DA1&objaction=csviewmlfbbeitraege&subtype=133300&caller=view>).

### AI 2xU/I HS (6ES7 134-6HB00-0DA1)

Information on the analog input module AI 2xU/I HS is available here (<https://support.automation.siemens.com/WW/llisapi.dll?func=cslib.csinfo&lang=en&objid=6ES71346HB000DA1&objaction=csviewmlfbbeitraege&subtype=133300&caller=view>).

## 13.4.2.5 Analog output modules

### AQ 2xU/I HS (6ES7 135-6HB00-0DA1)

Information on the analog output module AQ 2xU/I HS is available here (<https://support.automation.siemens.com/WW/llisapi.dll?func=cslib.csinfo&lang=en&objid=6ES71356HB000DA1&objaction=csviewmlfbbeitraege&subtype=133300&caller=view>).

### AQ 4xU/I ST (6ES7 135-6HD00-0BA1)

Information on the analog output module AQ 4xU/I ST is available here (<https://support.automation.siemens.com/WW/llisapi.dll?func=cslib.csinfo&lang=en&objid=6ES71356HD000BA1&objaction=csviewmlfbbeitraege&subtype=133300&caller=view>).

### AQ 2xU/I HS (6ES7 135-6HB00-0DA1)

Information on the analog output module AQ 2xU/I HS is available here (<https://support.automation.siemens.com/WW/llisapi.dll?func=cslib.csinfo&lang=en&objid=6ES71356HB000DA1&objaction=csviewmlfbbeitraege&subtype=133300&caller=view>).



### 13.4.2.6 Communication modules

#### CM PtP (6ES7 137-6AA00-0BA0)

Information on the CM PtP communication module is available here (<https://support.automation.siemens.com/WW/llisapi.dll?func=cslib.csinfo&lang=en&objid=6ES71376AA000BA0&objaction=csviewmlfbbeitraege&sbtype=133300&caller=view>).

### 13.4.2.7 Special modules

#### Server module (6ES7 193-6PA00-0AA0)

Information on the server module is available here (<https://support.automation.siemens.com/WW/llisapi.dll?func=cslib.csinfo&lang=en&objid=6ES71936PA000AA0&objaction=csviewmlfbbeitraege&sbtype=133300&caller=view>).

#### Server module V2.0 (6ES7 193-6PA00-0AA0)

Information on the server module is available here (<https://support.automation.siemens.com/WW/llisapi.dll?func=cslib.csinfo&lang=en&objid=6ES71936PA000AA0&objaction=csviewmlfbbeitraege&sbtype=133300&caller=view>).

### 13.4.2.8 Technology modules

#### TM Count 1x24V (6ES7 138-6AA00-0BA0)

Information on the relay output module TMCount 1x24V is available here (<https://support.automation.siemens.com/WW/llisapi.dll?func=cslib.csinfo&lang=en&objid=6ES71386AA000BA0&objaction=csviewmlfbbeitraege&sbtype=133300&caller=view>).

#### TM PosInput 1 (6ES7 138-6BA00-0BA0)

Information on the positioning module TM PosInput 1 is available here (<https://support.automation.siemens.com/WW/llisapi.dll?func=cslib.csinfo&lang=en&objid=6ES71386BA000BA0&objaction=csviewmlfbbeitraege&sbtype=133300&caller=view>).

### AI Energy Meter (6ES7 134-6PA00-0BD0)

Information on the relay output module AI Energy Meter is available here (<https://support.automation.siemens.com/WW/llisapi.dll?func=cslib.csinfo&lang=en&objid=6ES71346PA000BD0&objaction=csviewmlfbbeitraege&sbtype=133300&caller=view>).

### IO-Link Master Module (6ES7 137-6BD00-0BA0)

Information on the relay output module IO-Link Master Module is available here (<https://support.automation.siemens.com/WW/llisapi.dll?func=cslib.csinfo&lang=en&objid=6ES71376BD000BA0&objaction=csviewmlfbbeitraege&sbtype=133300&caller=view>).

# Index

-

-, 1342

- add external graphic , 5547
- add graphic to graphics library, 5546
- 6ES7 155-6DU00-0BN0, 6284
- 6ES7 155-6AU00-0CN0, 6283
- AboveUpperLimitColor property (VBS), 4145
- Absolute value, 1694, 1949
- Alarm report
  - Layout in reports, 3490
- Autocompletion, 3550
- BelowLowerLimitColor property (VBS), 4194
- Compiling
  - Project, 5599
- Connection configuration
  - General, 473
- Create
  - Report (overview), 3464
- Creating
  - Report (overview), 3464
- External source file
  - Editing, 1422
  - Opening, 1422
- Logging method
  - Segmented circular log, 3215
- Module
  - Inserting, 422
- Page number
  - Use in reports, 3493
- Quality code, 950
- Recipe report
  - Layout in reports, 3492
- SetBacklightColor, 3712
- SIMATIC PC station
  - Load, 76
- SortByTimeDirection property (VBS), 4538
- STARTUP
  - Warm restart, 837
- TrendWindowRulerLayer property (VBS), 4658
- User-defined function
  - Autocompletion, 3550
- Zoom in/out, (See Zoom)

"

- "Pack&Go" file
  - Download to HMI device, 5608
- "WWW" instruction, 663

&

&, 1346, 1347

\*

- \*, 1342
- \*\* , 1342
- \*.bmp, 2975
- \*.cer, 598
- \*.dat, 598
- \*.emf, 2975
- \*.gif, 2975
- \*.ico, 2975
- \*.jpeg, 2975
- \*.jpg, 2975
- \*.p12, 535, 598
- \*.tif, 2975
- \*.wmf, 2975

.

- .Net control
  - Add, 2973
  - Remove, 2974
- .Net service packs, 35
- .Net versions, 35

/

/, 1342

:

- :=, 1347, 1348
- :Displays
  - Log contents, 3306
- :P, 848

:PROFIBUS DP  
 Direct key, 5260

'

'XAxisEndValue property (VBS), 4721  
 'YAxisEndValue property (VBS), 4734

**+**  
 +, 1342

**<**  
 <, 1344  
 <=, 1344  
 <>, 1344, 1347

**=**  
 =, 1344  
 ==, 1347

**>**  
 >, 1344  
 >=, 1344

**3**  
 32-bit down counter, 916  
 3D border style property (VBS), 4213  
 3DES, 578  
 3RK7243-2AA30-0XB0, 6281

**6**  
 6AV2124-0GC01-0AX0, 6273  
 6AV2124-0JC01-0AX0, 6273  
 6AV2124-0MC01-0AX0, 6273  
 6AV2124-0QC02-0AX0, 6273  
 6AV2124-0UC02-0AX0, 6273  
 6AV2124-0XC02-0AX0, 6273  
 6AV2124-1DC01-0AX0, 6273  
 6AV2124-1GC01-0AX0, 6273  
 6AV2124-1JC01-0AX0, 6273  
 6AV2124-1MC01-0AX0, 6273  
 6AV3688-3AF37-0AX0, 6274  
 6AV3688-3AY36-0AX0, 6274  
 6AV3688-3EH47-0AX0, 6274  
 6AV3688-4CX07-0AA0, 6274  
 6AV3688-4EY06-0AA0, 6274  
 6AV3688-4EY07-0AA0, 6274  
 6AV6545-0CC10-0AX0, 6272, 6273  
 6AV6591-1DC20-0AB0, 6273  
 6AV6641-0AA11-0AX0, 6272  
 6AV6641-0BA11-0AX0, 6272  
 6AV6641-0CA01-0AX0, 6272  
 6AV6642-0AA11-0AX0, 6272  
 6AV6642-0AA11-0AX1, 6272  
 6AV6642-0BA01-1AX0, 6272  
 6AV6642-0BA01-1AX1, 6272  
 6AV6642-0BC01-1AX0, 6272  
 6AV6642-0BC01-1AX1, 6272  
 6AV6642-0BD01-3AX0, 6272  
 6AV6642-0DA01-1AX0, 6272  
 6AV6642-0DA01-1AX1, 6272  
 6AV6642-0DC01-1AX0, 6272  
 6AV6642-0DC01-1AX1, 6272  
 6AV6642-0EA01-3AX0, 6273  
 6AV6642-8BA10-0AA0, 6272  
 6AV6643-0AA01-1AX0, 6272  
 6AV6643-0CB01-1AX0, 6273  
 6AV6643-0CB01-1AX1, 6273  
 6AV6643-0CD01-1AX0, 6273  
 6AV6643-0CD01-1AX1, 6273  
 6AV6643-0DB01-1AX0, 6273  
 6AV6643-0DB01-1AX1, 6273  
 6AV6643-0DD01-1AX0, 6273  
 6AV6643-0DD01-1AX1, 6273  
 6AV6643-0ED01-2AX0, 6273  
 6AV6643-8AD10-0AA0, 6273  
 6AV6644-0AA01-2AX0, 6273  
 6AV6644-0AC01-2AX0, 6273  
 6AV6644-0AC01-2AX1, 6273  
 6AV6644-0BA01-2AX0, 6273  
 6AV6644-0BA01-2AX1, 6273  
 6AV6644-2AB01-2AX0, 6273  
 6AV6645-0AA01-0AX0, 6273  
 6AV6645-0AB01-0AX0, 6273  
 6AV6645-0AC01-0AX0, 6273  
 6AV6645-0BA01-0AX0, 6273  
 6AV6645-0BB01-0AX0, 6273  
 6AV6645-0BC01-0AX0, 6273  
 6AV6645-0BE02-0AX0, 6273  
 6AV6645-0CA01-0AX0, 6273  
 6AV6645-0CB01-0AX0, 6273  
 6AV6645-0CC01-0AX0, 6273  
 6AV6645-0DD01-0AX1, 6273  
 6AV6645-0DE01-0AX1, 6273  
 6AV6645-0EB01-0AX1, 6273

6AV6645-0EC01-0AX1, 6273  
 6AV6645-0EF01-0AX1, 6273  
 6AV6645-0FD01-0AX1, 6273  
 6AV6645-0FE01-0AX1, 6273  
 6AV6645-0GB01-0AX1, 6273  
 6AV6645-0GC01-0AX1, 6273  
 6AV6645-0GF01-0AX1, 6273  
 6AV6647-0AA11-3AX0, 6272  
 6AV6647-0AB11-3AX0, 6272  
 6AV6647-0AC11-3AX0, 6272  
 6AV6647-0AD11-3AX0, 6272  
 6AV6647-0AE11-3AX0, 6272  
 6AV6647-0AF11-3AX0, 6272  
 6AV6647-0AG11-3AX0, 6272  
 6AV6647-0AH11-3AX0, 6272  
 6AV6647-0AJ11-3AX0, 6272  
 6AV6647-0AK11-3AX0, 6272  
 6AV6651-1AA01-0AA0, 6272  
 6AV6651-1BA01-0AA0, 6272  
 6AV6651-2AA01-0AA0, 6272  
 6AV6691-1DA01-0AA1, 6272  
 6AV6691-1DG01-0AA1, 6272  
 6AV6691-1DJ01-0AA0, 6273  
 6AV6691-1DJ01-0AB0, 6273  
 6AV6691-1DJ01-0AC0, 6273  
 6AV6691-1DJ01-0AD0, 6273  
 6AV6691-1DJ01-0AE0, 6273  
 6AV6691-1DR01-0AB0, 6273  
 6ES7 131-6BF00-0BA0, 6285  
 6ES7 131-6BF00-0CA0, 6285  
 6ES7 131-6BH00-0BA0, 6285  
 6ES7 132-6BD20-0BA0, 6286  
 6ES7 132-6BF00-0BA0, 6286  
 6ES7 132-6BF00-0CA0, 6286, 6287  
 6ES7 132-6BH00-0BA0, 6286  
 6ES7 132-6HD00-0BB0, 6286, 6290  
 6ES7 134-6GD00-0BA1, 6287  
 6ES7 134-6HB00-0DA1, 6288  
 6ES7 134-6HD00-0BA1, 6287  
 6ES7 134-6JD00-0CA1, 6287  
 6ES7 134-6PA00-0BD0, 6287  
 6ES7 135-6HB00-0DA1, 6288  
 6ES7 135-6HD00-0BA1, 6288  
 6ES7 137-6AA00-0BA0, 6289  
 6ES7 137-6BD00-0BA0, 6290  
 6ES7 138-6AA00-0BA0, 6289  
 6ES7 138-6BA00-0BA0, 6290  
 6ES7 155-5AA00-0AB0, 6282  
 6ES7 155-6AU00-0BN0, 6282  
 6ES7 155-6AU00-0CN0, 6283  
 6ES7 155-6AU00-0NN0, 6283  
 6ES7 155-6BA00-0BN0, 6284  
 6ES7 193-6AE00-0AA0, 6285  
 6ES7 193-6AF00-0AA0, 6283  
 6ES7 193-6AR00-0AA0, 6283  
 6ES7 193-6AS00-0AA0, 6284  
 6ES7 193-6PA00-0AA0, 6289  
 6ES7 211-1AD30-0XB0, 6275  
 6ES7 211-1AE31-0XB0, 6275  
 6ES7 211-1AE40-0XB0, 6275  
 6ES7 211-1BD30-0XB0, 6275  
 6ES7 211-1BE31-0XB0, 6275  
 6ES7 211-1BE40-0XB0, 6275  
 6ES7 211-1HD30-0XB0, 6275  
 6ES7 211-1HE31-0XB0, 6275  
 6ES7 211-1HE40-0XB0, 6275  
 6ES7 212-1AD30-0XB0, 6275  
 6ES7 212-1AE31-0XB0, 6275  
 6ES7 212-1AE40-0XB0, 6275  
 6ES7 212-1BD30-0XB0, 6275  
 6ES7 212-1BE31-0XB0, 6275  
 6ES7 212-1BE40-0XB0, 6275  
 6ES7 212-1HD30-0XB0, 6275  
 6ES7 212-1HE31-0XB0, 6275  
 6ES7 212-1HE40-0XB0, 6275  
 6ES7 214-1AE30-0XB0, 6275  
 6ES7 214-1AG31-0XB0, 6275  
 6ES7 214-1AG40-0XB0, 6275  
 6ES7 214-1BE30-0XB0, 6275  
 6ES7 214-1BG31-0XB0, 6275  
 6ES7 214-1BG40-0XB0, 6275  
 6ES7 214-1HE30-0XB0, 6275  
 6ES7 214-1HG31-0XB0, 6275  
 6ES7 214-1HG40-0XB0, 6275  
 6ES7 215-1AG31-0XB0, 6276  
 6ES7 215-1AG40-0XB0, 6276  
 6ES7 215-1BG31-0XB0, 6276  
 6ES7 215-1BG40-0XB0, 6276  
 6ES7 215-1HG31-0XB0, 6276  
 6ES7 215-1HG40-0XB0, 6276  
 6ES7 217-1AG40-0XB0, 6276  
 6ES7 221-1BF30-0XB0, 6277  
 6ES7 221-1BF32-0XB0, 6277  
 6ES7 221-1BH30-0XB0, 6277  
 6ES7 221-1BH32-0XB0, 6277  
 6ES7 221-3AD30-0XB0, 6276  
 6ES7 221-3BD30-0XB0, 6276  
 6ES7 222-1AD30-0XB0, 6276  
 6ES7 222-1BD30-0XB0, 6276  
 6ES7 222-1BF30-0XB0, 6277  
 6ES7 222-1BF32-0XB0, 6277  
 6ES7 222-1BH30-0XB0, 6277  
 6ES7 222-1BH32-0XB0, 6277  
 6ES7 222-1HF30-0XB0, 6277

6ES7 222-1HF32-0XB0, 6277  
 6ES7 222-1HH30-0XB0, 6277  
 6ES7 222-1HH32-0XB0, 6277  
 6ES7 222-1XF30-0XB0, 6277  
 6ES7 222-1XF32-0XB0, 6277  
 6ES7 223-0BD30-0XB0, 6276  
 6ES7 223-1BH30-0XB0, 6278  
 6ES7 223-1BH32-0XB0, 6278  
 6ES7 223-1BL30-0XB0, 6278  
 6ES7 223-1BL32-0XB0, 6278  
 6ES7 223-1PH30-0XB0, 6278  
 6ES7 223-1PH32-0XB0, 6278  
 6ES7 223-1PL30-0XB0, 6278  
 6ES7 223-1PL32-0XB0, 6278  
 6ES7 223-1QH30-0XB0, 6278  
 6ES7 223-1QH32-0XB0, 6278  
 6ES7 223-3AD30-0XB0, 6276  
 6ES7 223-3BD30-0XB0, 6276  
 6ES7 231-4HA30-0XB0, 6276  
 6ES7 231-4HD30-0XB0, 6278  
 6ES7 231-4HD32-0XB0, 6278  
 6ES7 231-4HF30-0XB0, 6278  
 6ES7 231-4HF32-0XB0, 6278  
 6ES7 231-5ND30-0XB0, 6278  
 6ES7 231-5ND32-0XB0, 6278  
 6ES7 231-5PA30-0XB0, 6276  
 6ES7 231-5PD30-0XB0, 6278  
 6ES7 231-5PD32-0XB0, 6278  
 6ES7 231-5PF30-0XB0, 6278  
 6ES7 231-5PF32-0XB0, 6278  
 6ES7 231-5QA30-0XB0, 6276  
 6ES7 231-5QD30-0XB0, 6278  
 6ES7 231-5QD32-0XB0, 6278  
 6ES7 231-5QF30-0XB0, 6278  
 6ES7 231-5QF32-0XB0, 6278  
 6ES7 232-4HA30-0XB0, 6276  
 6ES7 232-4HB30-0XB0, 6278  
 6ES7 232-4HB32-0XB0, 6278  
 6ES7 232-4HD30-0XB0, 6278  
 6ES7 232-4HD32-0XB0, 6278  
 6ES7 234-4HE30-0XB0, 6279  
 6ES7 234-4HE32-0XB0, 6279  
 6ES7 241-1AH30-0XB0, 6280  
 6ES7 241-1AH32-0XB0, 6280  
 6ES7 241-1CH30-0XB0, 6280  
 6ES7 241-1CH30-1XB0, 6276, 6277  
 6ES7 241-1CH31-0XB0, 6280  
 6ES7 241-1CH32-0XB0, 6280  
 6ES7 278-4BD32-0XB0, 6281  
 6ES7137-6AA00-0BA0, 6284  
 6ES7671-4EE00-0YA0, 6274  
 6ES7671-5EF01-0YA0, 6274

6GK7 242-5DX30-0XE0, 6279  
 6GK7 242-5DX31-0XE0, 6279  
 6GK7 242-7KX30-0XE0, 6279  
 6GK7 243-1JX30-0XE0, 6279  
 6GK7 243-5DX30-0XE0, 6279  
 6GK7 243-5DX31-0XE0, 6279

## 7

7MH4960-2AA01, 6281

## A

Ability to read back connection parameters, 495  
 ABS, 1694, 1949, 2138  
 Absolute Addressing  
     of a tag, 3170, 4949  
 Absolute value, 2138  
 Access  
     HMI tag, 3552  
     Local tag, 3552  
 Access point, 4891  
 Access Point, 4862, 4891  
 Access protection, 3531  
     Access protection level 1, 6224  
     Access protection level 2, 6224  
     Advantages, 6224  
     Configuring, 3535  
     Factory state, 6223  
     User administration, 3529, 3530  
     Validity, 6223  
 Access to operands, 1057, 1058, 1059, 1061, 1062,  
 1064, 1065, 1076  
 Accessible devices, 819, 4996, 5066, 5138  
 ACK, 5681  
     Key, 5699  
 acknowledge  
     Key, 5699  
 Acknowledge, 3252, 3793  
     Alarm, 5687  
     Error alarm, 5687  
 Acknowledge alarm  
     Alarm group, 3258  
 AcknowledgeAlarm, 3688, 3797  
 Acknowledgement  
     Audit Trail, 5785  
 Acknowledgment, 3256  
     Configuring, 3300, 3301, 3302  
 Acknowledgment concept  
     Alarm with simple acknowledgment, 3258  
     Alarm without acknowledgment, 3258

- Acknowledgment model, 3258
- ACOS, 1711, 1966, 2155
- Acquisition cycle
  - Area pointer, 4954
  - Tag, 3186, 3200, 3212
- Acquisition mode
  - Tag, 3186
- ACT\_TINT, 2450
- Actions
  - Basics of redoing actions, 324
  - Basics of undoing, 324
  - Redoing, 327
  - Undoing, 326
- activate, 3786
- Activate
  - Project language, 5535
- Activate method, 4742
- Activate property (VBS), 4147
- ActivateCleanScreen, 3621
- ActivateDynamic, 4745
- ActivatePreviousScreen, 3622, 3797
- ActivateScreen, 3619, 3798
- ActivateScreenByNumber, 3620, 3799
- ActivateSystemDiagnosticsView, 3739, 3800
- Activating ENO, 44
- Active
  - Area pointer, 4954
- Active bus module (ET 200M), 948
- Active nodes, 581
- Active property (VBS), 4148
- ActiveScreen property (VBS), 4150
- ActiveScreenItem object, 4151
- ActiveX-Control
  - Add, 2973
  - Remove, 2974
- ActualPointLeft property (VBS), 4152
- ActualPointTop property (VBS), 4153
- Acylic triggers, 4898
- AdaptBorder property (VBS), 4154
- AdaptFontSizeToLineHeight property (VBS), 4154
- Adapting a project
  - For a different HMI device, 5635
- AdaptPicture property (VBS), 4155
- AdaptScreenToWindow property (VBS), 4155
- AdaptSize property (VBS), 4155
- AdaptWindowtoScreen property (VBS), 4155
- Add, 1685, 1938
  - .Net control, 2973
  - ActiveX control, 2973
  - Objects to the group, 2982
- ADD, 1685, 1938
- Add empty line, 6055
- Add separator line, 6055
- Adding
  - Adding times with T\_ADD, 2282
- Additional field devices (PROFIBUS and PROFINET), 794, 821
- Add-on
  - Installing, 98
  - Removing, 98
- Address
  - Area pointer, 4954
  - Mitsubishi, 5374
  - Omron Host Link, 5436
- address conversion
  - Instructions for, 2542
- Address multiplexing
  - with absolute addresses, 3190
  - with symbolic addresses, 3191
- Address overview, 430
- Address packing, 786
- Address property (VBS), 4156
- Address range, 558
  - Changing, 638
- Address register, 1073, 1074
- Addresses
  - Assigning, 640
  - Determining a module with GEO\_LOG, 2549
  - Interrupt with packed, 792
  - Pack, 786
  - Read station address with GetStationInfo, 2490
  - Unpack, 787
- Addressing, 848
  - Addressing tags indirectly, 3197, 3198
  - Allen-Bradley, 5334, 5352
  - Allen-Bradley Ethernet IP, 5330
  - Changing, 638
  - Ethernet/IP, 5334, 5352
  - General, 637
  - MPI, 5165
  - Multiplexing, 3197
- Addressing operands, 1057, 1058, 1059, 1061, 1062, 1064, 1065, 1067, 1068, 1069, 1070, 1072, 1073, 1074, 1076
- AdjustBorder3DWithStyle property (VBS), 4156
- AdjustContrast, 3623
- AdjustRulerWindow property (VBS), 4157
- Admin, 5723
- Administrator, 537
- Advanced Encryption Standard (AES), 578
- Advanced mode
  - Global firewall rules, 544
- Advanced recipe view, 3126, 3412
  - Configuring, 3126

- AES, 578
- AES-128, 625, 635
- Aggressive mode, 577
- Aging time, 743
- Alarm
  - acknowledge, 3327, 3330
  - Acknowledge, 5687
  - Calling the infotext, 3331
  - Components, 3260
  - Configuring, 3270, 3281
  - Display, 3112
  - Editing, 3328, 5688
  - Event, 3335
  - Exporting, 5510
  - Importing, 5511
  - in Runtime, 5679
  - In Runtime, 3321, 3323
  - Inspector window, 62
  - Sequence is not adhered to, 3575
  - System function, 3334
- Alarm buffer, 3303
  - in Runtime, 5680
  - In Runtime, 3322, 3324
  - Memory size, 3303
- Alarm buffer overflow, 3303, 3793
- Alarm class, 3260
  - Diagnostics, 3290
  - Identifying, 3116
  - in Runtime, 5679
  - In Runtime, 3322, 3324
  - Layout, 3325, 3329, 5683, 5684
- Alarm classes, 3254, 3255
  - Common, 3255
  - Custom, 3254, 3255
  - Name change through migration, 147
  - Predefined, 3254, 3255
  - Use, 3254, 3255
- Alarm display, 829
  - "Active alarms" view, 832
  - Acknowledging an alarm, 833
  - Archive view, 830
  - Clear archive, 832
  - Export archive, 831
  - Ignoring alarms, 833
  - Layout of the alarms in the "Active alarms" view, 832
  - Layout of the alarms in the archive view, 830
  - Receiving alarms, 831
  - Using the keyboard, 834
- Alarm event
  - Acknowledge, 3252
  - Incoming, 3252
  - Outgoing, 3252
- Alarm group, 3259, 3261
  - Acknowledge alarm, 3258
  - Configuring, 3268
  - Creating, 3268
  - Migration, 146
- Alarm indicator, 62, 3120, 3285, 3331, 5682
  - Alarm classes, 3120
  - Application, 3331
  - Configuring, 3292
  - Events, 3120
  - in Runtime, 5681
  - In Runtime, 3323, 3325
  - Layout, 3120, 3331
  - Operation, 3331
  - Operation using the mouse, 3332
- Alarm line, 3113
- Alarm log, 3304, 3388
  - Configuring, 3309
  - Configuring an alarm view, 3297
  - Creating, 3304, 3309
  - Displaying contents, 3297
  - in Runtime, 5680
  - In Runtime, 3324
  - Migrating, 153
- Alarm logging, 3246
  - Memory medium, 3306
- Alarm message
  - Acknowledgment by the PLC, 5027, 5102, 5183, 5225, 5237, 5361, 5391, 5423, 5442
  - Acknowledgment on the HMI device, 5027, 5103, 5184, 5226, 5238, 5361, 5392, 5423, 5443
  - Configure acknowledgment, 5026, 5102, 5183, 5225, 5237, 5361, 5391, 5423, 5442
- Alarm number, 3259, 3260
- Alarm object, 3912
- Alarm property (VBS), 4157
- Alarm report
  - Configuring, 5773
  - Use in reports, 3489
- Alarm status, 3260
  - Acknowledged, 3252
  - Incoming, 3252
  - Outgoing, 3252
- Alarm system, 3245
- Alarm text, 3261
  - Formatting, 3273
  - Output fields, 68
  - Removing format settings, 3274
  - Special characters, 68
- Alarm types, 3248



- Alarm view, 62, 3112, 3117, 3284, 3325, 3330, 5682, 5685
  - Configuring the display of S7 diagnostic alarms, 3290
  - ~ configuring for logged alarms, 3291, 3314
  - Alarm line, 3113
  - Alarm text window, 3330, 5685
  - Application, 3325
  - Column, 3115
  - Complex alarm view, 3112
  - Configuring, 3287
  - Configuring the layout, 3289
  - Control element, 3114, 3326, 5683
  - Enable sorting, 3115
  - Filter display, 3295
  - Identifying an alarm class, 3116
  - Layout, 3325, 3329, 5683, 5685
  - Operation, 3326, 3330, 5683, 5685
  - Operation using the keyboard, 3327
  - Operation using the mouse, 3327
  - Simple Alarm view, 3113
  - Use, 5682
- Alarm window, 62, 3284, 3325, 5682
  - Application, 3325
  - Configuring, 3292
  - Control element, 3326, 5683
  - in Runtime, 5681
  - In Runtime, 3323, 3325
  - Operation, 3326, 5683
  - Operation using the keyboard, 3327
  - Operation using the mouse, 3327
  - Use, 5682
- Alarm with simple acknowledgment, 3258
- Alarm without acknowledgment, 3258
- AlarmColor property (VBS), 4158
- AlarmControl object, 3947
- AlarmFilter property (VBS), 4158
- AlarmHigh property (VBS), 4159
- AlarmID property, 4159
- AlarmLogs object, 3915
- AlarmLow property (VBS), 4160
- AlarmLowerLimit property (VBS), 4161
- AlarmLowerLimitColor property (VBS), 4161
- AlarmLowerLimitEnabled property (VBS), 4162
- AlarmLowerLimitRelative property (VBS), 4162
- Alarms
  - Configuring, 5025, 5101, 5182, 5224, 5236
  - Data types, 5025, 5101, 5182, 5224, 5236
  - Modicon Modbus, 5422
  - Non-integrated connection, 5422
  - Output of a tag value, 3274
  - Output of texts from a text list, 3275
  - Restriction, 5391
- Alarms object (list), 3913
- AlarmUpperLimit property (VBS), 4163
- AlarmUpperLimitColor property (VBS), 4164
- AlarmUpperLimitEnabled property (VBS), 4164
- AlarmUpperLimitRelative property (VBS), 4165
- AlarmView object, 3958
- AlarmViewAcknowledgeAlarm, 3680
- AlarmViewEditAlarm, 3679
- AlarmViewShowOperatorNotes, 3681
- AlarmViewUpdate, 3679
- Align
  - Object flush, 2960, 3480
- Alignment property (VBS), 4165
- AlignmentLeft property (VBS), 4166
- AlignmentTop property (VBS), 4166
- Allen-Bradley, 5320, 5342, 5343
  - Allen-Bradley DF1 communication driver, 5342, 5343
  - Analog alarm, 5360
  - Basic Panel, 4958
  - Comfort Panel, 4965
  - Communication drivers, 5323
  - Data type, 5358, 5360
  - DF1, 5323
  - EtherNet/IP, 5323
  - Mitsubishi, 5390
  - Mobile Panel, 4971
  - Multi Panel, 4969
  - Panel, 4961
  - WinCC Runtime, 4975
- Allen-Bradley
  - Area pointer, 5355
- Allen-Bradley DF1
  - Configuring a connection, 5338
  - Connection, 5338, 5341
  - Connection parameters, 5339
  - CPU type, 5352
  - KF2 module, 5342, 5343
  - KF3 module, 5342, 5343
  - Migrating data types, 161
  - Valid data type, 5350
- Allen-Bradley DH485
  - Migrating data types, 162
- Allen-Bradley Ethernet IP
  - Address multiplexing, 5334
  - Addressing, 5330
  - Addressing type, 5332
  - Migrating data types, 162
- Allen-Bradley EtherNet/IP
  - Configuring a connection, 5324
  - Connection, 5324, 5327

- Connection parameters, 5325
  - Data type, 5328
- AllowMenu property (VBS), 4167
- AllowPersistence property (VBS), 4167
- Alphanumeric key assignment, 5699
- Alphanumerical screen keyboard, 5695
- Alphanumerical value
  - Changing, 5695, 5702
  - Entering, 5695, 5702
- ALT
  - Key, 5699
- Analog alarm, 3248, 3249
  - Allen-Bradley, 5360
  - Configuring, 3270, 3282
  - Mitsubishi, 5390
  - Omron, 5441
- Analog alarm types, 3248, 3249
- Analog alarms
  - Configuring, 3261, 3262
- Analog module
  - Resetting to factory settings, 1003
- Analog property (VBS), 4168
- AND, 1346, 1347, 1791, 1835, 1836, 2048
- AngleMax property (VBS), 4168
- AngleMin property (VBS), 4169
- Animation, 3011
  - Configuring, 3012, 3411
  - Diagonal movement, 3016
  - Direct movement, 3017
  - Green arrow in Overview, 3013
  - Horizontal movement, 3015
  - Multiple selection, 3023
  - Object group, 3022, 3023
  - Overview, 3013
  - Tag binding, 3020
  - Vertical movement, 3016
- Antivirus programs, 39, 90, 94
- ANY, 1113
- Appearance
  - Dynamization of an object, 3014
- Applet, 539
- Application, 823
  - Alarm indicator, 3331
  - Alarm view, 3325
  - Alarm window, 3325
  - Date/time field, 3485
  - Key switch, 3133
  - Recipe view, 3128, 3442
  - Simple alarm view, 3328
  - simple alarm window, 3328
- Application example
  - Entering recipe data offline , 3455
  - Recipe with manual production sequence, 3456
- ApplicationWindow object, 4080
- ApplyProjectSettings property (VBS), 4170
- Arccosine, 1711, 1966, 2155
- ArchiveLogFile, 3625, 3801
- Archiving projects, 274, 275
- Arcsine, 1710, 1965, 2153
- Arctangent, 2156
- Arctangent value, 1713, 1968
- Area of unplugged modules, 416
- Area pointer, 4976, 5009, 5082, 5165, 5208, 5444
  - Acquisition cycle, 4954
  - Active, 4954
  - Address, 4954
  - Allen-Bradley, 5355
  - Availability, 4976
  - Basic Panel, 4961
  - Comment, 4954
  - Connection, 4953, 4957
  - Connections editor, 4954
  - Coordination, 5449
  - Data record, 3404, 5018, 5092, 5173, 5215, 5453
  - Date/time, 71
  - Date/time PLC, 71
  - Job mailbox, 5015, 5090, 5171, 5213, 5450
  - Length, 4954
  - Migration, 143
  - Mobile Panel, 4974
  - PLC tag, 4954
  - Pointer name, 4954
  - Project ID, 5015, 5089, 5170, 5212, 5450
  - Screen number, 5010, 5088, 5166, 5208, 5446
  - Tab, 4954
  - Trends, 5023, 5099, 5180, 5222, 5234, 5356, 5387, 5419, 5439
- Area pointers, 4952
  - Configuring, 4956
  - Coordination, 5014, 5086, 5169, 5211
  - Creating, 4956
  - Date/time, 5011, 5083, 5084, 5167, 5209, 5447
  - Date/time PLC, 5012, 5168, 5210, 5448
  - Length, 4956
  - Mitsubishi, 5387
  - Modicon Modbus, 5418
  - Omron, 5438
- Arrange
  - Object in the screen, 2953
- Arrangement of byte sequence, 1993, 2169
- Array, 67, 192, 1105, 1106, 3201, 3203
  - Creating, 3203
  - Indirect addressing, 3197
  - see ARRAY, 1246, 1390

- ARRAY, 1070
  - Addressing, 1062
  - Declaration in global data blocks, 1390
  - Declaration in PLC data types, 1412
  - Declaration in the block interface, 1246
  - Example, 1108, 1109
  - Format, 1105, 1106
- Array data block, 1739, 1740, 1742, 1744, 1995, 1997, 1998, 2000, 2170, 2172, 2173, 2175, 2207
- ARRAY data block, 1024, 1027, 1059, 1062, 1199, 1383, 1386, 1405
- Array element
  - Location of use of HMI tag, 67
  - Name, 67
- ARRAY limits, 1349
- Array tag, 3201
  - Char, 67
- AS interface, 796
- ASCII code table, 497
- ASCII TSAP, 497
- Asian operating system, 5533
- ASIN, 1710, 1965, 2153
- AskOperationMotive property (VBS), 4171
- Assembling manuals, 255
- Assign
  - Object of a layer, 3044
- Assigning
  - a function to a function key, 3035
  - a graphic to a function key, 3037
  - Function key, 3030, 3032, 3034
- Assigning an IP address
  - Basics, 995
  - from the project context, 996
  - Using "Accessible devices", 995
- Assigning global data blocks , 49
- Assigning parameters
  - Hardware, 409
- Assigning symbol, 640
- Assigning tag, 640
- Assignment, 1348, 1590, 1842
  - Negate, 1591, 1843
- Assignment list
  - Enabling the display of retentive bit memories, 1469
- Assignment list
  - Meaning of symbols, 1464
  - Defining filter, 1467
  - Delete filter, 1467
  - Displaying, 1465
  - Example for displaying bit memory, 1463
  - Example for displaying inputs and outputs, 1463
  - Filter options, 1466
  - Filtering, 1468
  - Introduction, 1462
  - Setting view options, 1466
  - Structure, 1463
- Assignments property (VBS), 4171
- AssumeOnExit property (VBS), 4172
- AssumeOnFull property (VBS), 4172
- Asynchronous
  - Transferring data, 5018, 5093, 5174, 5220, 5453
- Asynchronous error event
  - Delaying with DIS\_AIRT, 2469
  - Disabling with DIS\_IRT, 2466
  - Enabling with EN\_AIRT, 2469
  - Enabling with EN\_IRT, 2467
- AT , 1065
- ATAN, 1713, 1968, 2156
- ATH, 2304
- ATTACH, 852, 2441
- AttachDB, 4748
- ATTR\_DB, 2539
- Audit
  - Configuration, 5796
  - Enhancements in the ES, 5757
  - Forcing, 5781
  - Functional scope, 5756
  - Logging concept, 5757
  - Scope of logging, 5758
  - Screen object, 5797
  - Supported HMI devices, 5796
- Audit log, 593, 595
- Audit Trail
  - Acknowledgement, 5785
  - Checksum, 3217, 3230, 3317, 5779
  - Comments, 5785
  - CSV file, 5778
  - Editor, 5761
  - Effects in runtime, 5782
  - Electronic signature, 5785
  - File format, 5778
  - Log tag value change, 5782
  - Logging recipe data changes, 5785
  - Logging system functions, 5791
  - Logging user actions, 5788
  - Memory medium, 5780
  - Printing, 5770
  - Protection against change, 5781
  - Reporting, 5770
  - Storage location, 5780
  - Troubleshooting, 5780
- Audit trail editor, 5761
- Authentication, 701, 764
- Authentication methods, 576, 577

- Authorization, 5706
  - Assignment, 3507, 3537
  - Changing the name, 3511
  - Configuring, 3528
  - Creating, 3505, 3534
  - Deleting, 3511
  - Managing, 3510
- Authorization property (VBS), 4173
- AutoCompleteColumns property (VBS), 4175
- AutoCompleteRows property (VBS), 4175
- Autocompletion
  - Function, 1236
  - Insert tag, 1236, 1237
  - Inserting an instruction, 1237
- Automatic
  - Reporting, 3273
- Automation License Manager, 5483
- Automation system, 4910, 4934
  - Local, 6258
  - Remote, 6258
  - Setting up, 4910
- Autonegotiation, 818
  - Disabled, 4995, 5065, 5137
- AutoScroll property (VBS), 4176
- AutoSelectionColors property (VBS), 4176
- AutoSelectionRectColors property (VBS), 4177
- Availability
  - Object for Basic Panels, 3077
  - Object for Comfort Panel, 3080
  - Object for Mobile Panels, 3083
  - Object for Panels, 3078
  - Object for WinCC Runtime Advanced, 3084
  - Objects for Multi Panels, 3081
- Availability for specific devices
  - Screen, 2933
- Available system functions
  - Basic Panels, 3583
  - Comfort Panels, 3602
  - Mobile panels, 3608
  - Multi Panels, 3596
  - Panels, 3590
  - WinCC Runtime, 3614
- Average property (VBS), 4178
- AWP command, 651, 652
- AWP\_In\_Variable, 655
- AWP\_Out\_Variable, 653
- Axis technology object: Active homing, 6046
- Axis technology object: Add new object, 6025
- Axis technology object: Axis name configuration, 6026
- Axis technology object: Basic parameters, 6025
- Axis technology object: Changing the configuration parameters for dynamics in the user program, 6040
- Axis technology object: Changing the configuration parameters for homing in the user program, 6047
- Axis technology object: Commissioning overview, 6024
- Axis technology object: Config.DriveInterface. tag, 6117
- Axis technology object: Config.DynamicDefaults tag, 6119
- Axis technology object: Config.DynamicLimits tag, 6119
- Axis technology object: Config.General. tag, 6116
- Axis technology object: Config.Homing tag, 6123
- Axis technology object: Config.Mechanics tag, 6118
- Axis technology object: Config.PositionLimits\_HW tag, 6122
- Axis technology object: Config.PositionLimits\_SW tag, 6121
- Axis technology object: Configuration overview, 6023
- Axis technology object: Configuration window icons, 6026
- Axis technology object: Configuring acceleration, 6035
- Axis technology object: Configuring active homing, 6043
- Axis technology object: Configuring approach/homing direction, 6043
- Axis technology object: Configuring deceleration, 6035
- Axis technology object: Configuring distance per motor revolution, 6029
- Axis technology object: Configuring home position, 6042, 6044
- Axis technology object: Configuring home position offset, 6044
- Axis technology object: Configuring invert direction signal, 6029
- Axis technology object: Configuring jerk limiter, 6036
- Axis technology object: Configuring maximum velocity / start/stop velocity, 6035
- Axis technology object: Configuring passive homing, 6042
- Axis technology object: Configuring permit auto reverse at the hardware limit switch, 6043
- Axis technology object: Configuring pulses per motor revolution, 6029
- Axis technology object: Configuring ramp-down time, 6035
- Axis technology object: Configuring ramp-up time, 6035

- Axis technology object: Configuring smoothing time, 6036
  - Axis technology object: Configuring the homing speed, 6044
  - Axis technology object: Configuring the reference point switch input, 6042
  - Axis technology object: Configuring the side of the homing switch, 6042, 6043
  - Axis technology object: Configuring the velocity limiting unit configuration, 6034
  - Axis technology object: Diagnosis overview, 6024
  - Axis technology object: Drive enable configuration, 6029
  - Axis technology object: Drive ready configuration, 6029
  - Axis technology object: Drive signal configuration, 6028
  - Axis technology object: Emergency stop deceleration configuration, 6037
  - Axis technology object: ErrorBits tag, 6129
  - Axis technology object: Extended parameters, 6025
  - Axis technology object: General dynamics configuration, 6034
  - Axis technology object: Hardware and software components, 6020
  - Axis technology object: Hardware interface configuration, 6026
  - Axis technology object: Mechanics configuration, 6029
  - Axis technology object: MotionStatus tag, 6125
  - Axis technology object: Passive homing, 6044
  - Axis technology object: PTO and HSC configuration, 6027
  - Axis technology object: Response when jerk limiter is activated, 6039
  - Axis technology object: StatusBits tag, 6126
  - Axis technology object: Tools, 6022
  - Axis technology object: Updating the tags, 6130
  - Axis technology object: User unit configuration, 6028
- B**
- Back page
    - Report, 3462
  - Back up RAM file system, 3724, 3802
  - BackColor color property (VBS), 4181
  - BackColor property (VBS), 4179
  - BackColorBottom property (VBS), 4182
  - BackColorTop property (VBS), 4182
  - BackFillStyle property (VBS), 4183, 4184
  - BackFillStyleReadOnlySpecial property (VBS), 4185
  - BackFlashingColorOff property (VBS), 4186
  - BackFlashingColorOn property (VBS), 4186
  - BackFlashingEnabled property (VBS), 4187
  - BackFlashingRate property (VBS), 4188
  - Background color
    - Dynamization, 3014
  - Backing up, 5647, 5707
    - Using WinCC flexible, 5647
  - BACKSPACE key, 5698
  - Backup
    - Data of the HMI device, 5624, 5626
    - Deleting, 5591
    - Rename, 5591
  - Backup from online device, 6151
  - BackupRAMFileSystem, 3724, 3802
  - Bar, 3086
    - Color transition, 3086
    - Display limit lines, 3087
  - Bar object, 3962
  - Bar segment
    - Defining, 3087
  - BarBackColor property (VBS), 4189
  - BarBackFillStyle property (VBS), 4189
  - BarColor property (VBS), 4191
  - BarStartValue property (VBS), 4192
  - BaseScreenName property (VBS), 4193
  - Basic Comfort
    - Omron, 4965
  - Basic mode, 1500
  - Basic Panel
    - Area pointer, 4961
    - Communication drivers, 4958
    - Display and operating element, 3077
    - ETHERNET, 4960
    - HTTP protocol, 4958
    - IF1B, 4960
    - Interface, 4960
    - Mitsubishi, 4958
    - Modicon Modbus, 4958
    - Omron, 4958
    - OPC, 4958
    - S7 1200, 4958
    - S7 200, 4958
    - S7 300, 4958
    - S7 400, 4958
  - Basic Panels
    - Available system functions, 3583
  - Basics
    - HMI HTTP protocol, 5278
    - Migration, 127
  - Battery object, 3967
  - BCDCPL, 1833, 2091, 2278
  - BeginTime(i) property (VBS), 4194

- Behavior
  - Simple recipe view, 3437, 5673
- Benefits of using TeleService, 6209
- Bit (0, 1)
  - Graphics list, 3004
  - Text list, 2996
- Bit field
  - Reset, 1846
  - Resetting, 1595
  - Set, 1845
  - Setting, 1594
- Bit logic operations
  - AND, 1835, 1836
  - EXCLUSIVE OR, 1839
  - Insert input, 1840
  - OR, 1837, 1838
- Bit mask, 1824, 2082, 2269
- Bit memories
  - Enabling the display of retentive bit memories, 1469
- Bit number (0 - 31)
  - Graphics list , 3006
  - Text list, 2997
- Bit string, 1082, 1083
  - 64-bit, 1084
- BitNumber property (VBS), 4195
- Bits
  - Count, 1834, 2280
  - Counting, 2092
- BITSUM, 1834, 2092, 2280
- Bit-triggered trends, 5023, 5099, 5180, 5222, 5234, 5356, 5387, 5419, 5439
- BlinkColor property (VBS), 4195
- BlinkMode property (VBS), 4196
- BlinkSpeed property (VBS), 4197
- BLKMOV, 1746, 2002, 2187
- Block
  - Block, 2002
  - Changing passwords for know-how protected blocks, 1459
  - Closing, 1215
  - Comparing, 1428
  - Comparing code blocks, 1425
  - Comparing data blocks, 1426
  - Comparison, 1423
  - Compile, 1438
  - Compiling in the program editor, 1441
  - Compiling in the project tree, 1440
  - Consistency check, 1438, 1475, 1480, 1481
  - Consistency check in the call structure, 1475
  - Copying, 1202, 1205
  - Deleting offline, 1217
  - Deleting online, 1217
  - Displaying properties, 1213
  - Downloading blocks to a memory card, 1451
  - Downloading to device, 1442
  - Downloading to device in RUN operating mode, 1445
  - Editing properties, 1213
  - Entering a comment, 1207
  - Entering a title, 1206
  - exporting to an external source file, 1420
  - Fill, 1733, 1751, 1989, 2007, 2165, 2192
  - Fill uninterruptible, 1735, 1991, 2167
  - Find and open, 1214
  - Inserting, 1202
  - Know-how protection, 1453
  - Leave, 2227
  - Load to device, 1446
  - Move, 1981, 2158, 2187
  - Move uninterruptible, 1731, 1749, 1987, 2005, 2163, 2189
  - Moving, 1726, 1746
  - Opening, 1214
  - Opening know-how protected blocks, 1457
  - Optimized access, 1027, 1029
  - Pasting, 1206
  - Printing know-how protected blocks, 1458
  - Properties, 1208
  - Removing copy protection, 1455
  - Renaming, 1216
  - Saving, 1215
  - Setting up copy protection, 1455
  - Time stamp, 1211
  - Types, 1021
  - Uploading blocks from a memory card, 1452
  - Uploading blocks from device, 1450
  - Uploading from device, 1442
  - Using a library, 1200
- BLOCK, 1117
- Block access
  - Data block, 1395
- Block call
  - Basics, 1032
  - Calling as single instance or multiple instance, 1034
  - Correcting the call type, 1281, 1322
  - Inserting, 1278, 1319, 1364, 1365, 1367, 1368, 1369, 1370
  - Multi-instance, 1035
  - Nesting depth, 1033
  - Single instance, 1035
  - Updating, 1280, 1321, 1371

- Block comment
  - Hiding, 1228
  - Showing, 1228
- Block comparison
  - Basics, 1423
  - Changing the block, 1433
  - Comparing code blocks, 1425
  - Comparing data blocks, 1426
  - Detailed comparison, 1429
  - Execute action, 297
  - Navigation, 1432
  - Representation of the detailed comparison, 1430
  - Synchronize scrolling, 1433
  - Updating comparison results, 294, 1434
- Block consistency
  - Checking, 1475
  - Checking in the dependency structure, 1481
- Block folder, 1196
- Block interface
  - Declaring ARRAY, 1246
  - Declaring PLC data type, 1248
  - Declaring STRUCT, 1247
  - Declaring tags, 1244, 1245, 1249
  - Hiding, 1228
  - Importing and exporting tags, 1259
  - Multi-instance, 1250
  - Purpose of tag declaration, 1239
  - Retentivity, 1254
  - Showing, 1228
  - Structure, 1240
  - Tag properties, 1253, 1255
  - Updating, 1250
  - Valid data types, 1243
- Block parameters, 1037, 1039, 1041, 1043, 1045, 1046, 1047, 1048
  - Basics, 897
  - Block interface, 1240
- Block property
  - Displaying, 1213
  - Editing, 1213
  - Function, 1208
  - Overview, 1208
- Bookmarks
  - Deleting, 1356
  - Function, 1354
  - Navigating, 1356
  - Setting, 1355
- BOOL, 1081, 1126, 1142
- BOOL\_TO\_, 1142
- Border color property (VBS), 4201
- BorderBackColor property (VBS), 4197
- BorderBrightColor3D property (VBS), 4198, 4199
- BorderColor property (VBS), 4200
- BorderEndStyle property (VBS), 4203
- BorderFlashingColorOff property (VBS), 4204
- BorderFlashingColorOn property (VBS), 4205
- BorderFlashingEnable property (VBS), 4206
- BorderFlashingRate property (VBS), 4207
- BorderInnerStyle3D property (VBS), 4208
- BorderInnerWidth3D property (VBS), 4208
- BorderOuterStyle3D property (VBS), 4209
- BorderOuterWidth3D property (VBS), 4209
- Borders
  - Placeholder for document information, 313
  - Specifying the print area, 312
- BorderShadeColor3D property (VBS), 4210, 4211
- BorderStyle property (VBS), 4211
- BorderStyle3D property (VBS), 4213
- BorderWidth property (VBS), 4214, 4215
- BorderWidth3D property (VBS), 4216
- Boundaries, 819, 4996, 5066, 5138
- Boundary reached, 3793
- Branch, 2214, 2216
  - Closing, 1297
  - Definition, 1295, 1336
  - Deleting, 1297, 1337
  - Inserting, 1296, 1337
  - Rules, 1296
  - Rules , 1336
- BRCV, 2841
- Broadcast, 558, 565, 745
- BrowserView object, 4019
- BSEND, 2839
- Button, 3130
  - Adding a system diagnostics indicator, 3383
  - Configuring, 3535
  - Configuring access protection, 3531
  - Define hotkey, 3131
  - Graphic, 3130
  - HTML Browser, 3102
  - Mode, 3130
  - Status/Force, 3140
  - Text, 3130
- Button object, 3968
- ButtonCommand property (VBS), 4218
- Buttons and Switches
  - Library, 5491
- BYTE, 1082, 1126, 1143
- BYTE\_TO\_, 1143
- Bytes
  - Swap, 2169
  - Swap, 1737, 1993

- C**
- CA certificate, 531, 534, 6244
- CA group certificate, 534
- Cabling rules (PROFINET), 818, 4995, 5065, 5137
- CALC, 1682, 1935
- Calculate, 1281, 1322, 1682, 1935
- CALCULATE, 1281, 1322
- CalculateStatistic, 4749
- CalibrateTouchScreen, 3657, 3803
- Calibrating, 1000
  - Overview, 1000
- Call hierarchy, 1033
- Call structure, 1470
  - Meaning of symbols, 1472
  - Displaying, 1473
  - Introduction, 1470
  - Setting view options, 1474
  - Structure, 1473
- Callback to a number specified during connection establishment, 6226
- CAN\_DINT, 2454
- CAN\_TINT, 2449
- Cancel
  - Connection to the faceplate type, 3068
- Canceling a calibration, 1002
- Canceling printing, 319
- Caption property (VBS), 4219
- CaptionBackColor property (VBS), 4220
- CaptionColor property (VBS), 4221, 4222
- CaptionText property (VBS), 4222
- CaptionTop property (VBS), 4223
- Cascaded counting function, 916
- CASE, 2216
- CD, 1665, 1919
- CEIL, 1756, 2013, 2197
- CellCut property (VBS), 4223
- CellSpaceBottom property (VBS), 4224
- CellSpaceLeft property (VBS), 4225
- CellSpaceRight property (VBS), 4225
- CellSpaceTop property (VBS), 4226
- CenterColor property (VBS), 4226
- CenterSize property (VBS), 4227
- CentrePoint property (VBS), 4227
- CentrePointLeft property (VBS), 4228
- CentrePointTop property (VBS), 4228
- Certificate, 531, 576, 5290, 5860
  - Exporting, 531
  - Importing, 531
  - Importing on HTTP client, 5290, 5860
  - Installing on devices, 5290, 5860
  - Installing under Windows XP, 5290, 5860
  - Renewing, 533
  - Replace, 534
  - Replacing, 534
  - self-signed, 533
  - signed by certificate authority, 533
- Certificate authority, 531, 532
- Certificate manager, 531
- change
  - Recipe data record in Runtime, 3446
- Change, 3786
- Change word order
  - Modicon MODBUS TCP/IP, 5398
- ChangeConnection, 3746, 3804
- ChangeMouseCursor property (VBS), 4229
- Changeover contact, 951
- Changeover contact sensor type, 951
- Changing
  - Displayed name of user group, 3510
  - Logoff time in runtime, 3522, 3524
  - Name of the user, 3521, 3523
  - Object property, 3576
  - Object size, 2959, 3476
  - Password, 3509
  - Password in runtime, 3522
  - User group in runtime, 3522, 3524
  - Users, 5719, 5721
- Changing a port interconnection
  - Graphic view, 518
- Changing and displaying operating mode (example), 3581
- Changing the configuration online, 6143
- Changing the device configuration online, 6143
- Changing the name
  - Authorization, 3511
  - User group, 3510
  - Users, 3509
- Changing the PROFIBUS connection
  - Operating mode, 5240
- Changing the PROFINET connection
  - Operating mode, 5240
- ChannelDiagnose object, 3973
- Char
  - Array tag, 67
- CHAR, 1103, 1140, 1165
- CHAR\_TO\_, 1165
- Character, 1103
- Character string, 1103
  - Combining character strings with CONCAT, 2309
  - Comparing string tags with S\_COMP, 2295
  - Converting from a hexadecimal number with HTA, 2306



- Converting number to character string with VAL\_STRG, 2299
- Converting numeric character string with STRG\_VAL, 2297
- Converting to a hexadecimal number with ATH, 2304
- Converting with S\_CONV, 2296
- Copy character string to characters with Strg\_TO\_Chars, 2302
- Copying characters to character string with Chars\_TO\_Strg, 2303
- Deleting characters with DELETE, 2311
- Determine maximum length with MAX\_LEN, 2303
- Determining length with LEN, 2308
- Finding a character with FIND, 2314
- Inserting characters with INSERT, 2312
- Moving/copying with S\_CONV, 2294
- Reading out left character with LEFT, 2309
- Reading out middle character with MID, 2311
- Reading out right character with RIGHT, 2310
- Replacing character with REPLACE, 2313
- Charging condition, 3106
  - Operation, 3106
- Chars\_TO\_Strg, 2303
- CheckBox object, 3974
- Checking
  - Device version, 5588
- Checking the connection, 2909
- Checklist for troubleshooting the modem, 6268
- CheckMarkAlignment property (VBS), 4231
- CheckMarkCount property (VBS), 4231
- Checksum, 3305, 5781
  - Audit Trail, 3230, 3317, 5779
  - Log, 3217, 3230, 3317, 5779
  - Updating WinCC , 3230, 3317
- Circle, 3103
  - Radius, 3103
- Circle object, 3977
- CircleSegment object, 3979
- Circular log, 3305
  - Select size, 3223, 3320
- CircularArc object, 3982
- CJ1, 5435
- CJ2, 5435
- Class of Service, 714
- ClearAlarmBuffer, 3677, 3805
- ClearAlarmBufferProTool, 3678, 3806
- ClearAlarmBufferProtoolLegacy, 3678, 3806
- ClearDataRecord, 3675, 3807
- ClearDataRecordMemory, 3676, 3808
- cleared, 3785
- ClearLog, 3674, 3809
- ClearOnError property (VBS), 4232
- ClearOnFocus property (VBS), 4233
- Click, 3791
- Click when flashing, 3792
- Client
  - Configuring, 5282
  - Parameters, 5283
  - Tags, 5286
- Clock, 3151
  - Display, 3151
  - Display dial, 3151
  - Length of the pointer, 3151
  - Width of hands, 3151
- Clock memory, 856, 877
- Clock object, 3984
- Closable property (VBS), 4234
- CloseAllLogs, 3701, 3810
- CMP <, 1676, 1929
- CMP <=, 1672, 1926
- CMP <>, 1668, 1922
- CMP ==, 1666, 1920
- CMP >, 1674, 1928
- CMP >=, 1670, 1924
- Code templates
  - inserting in user-defined functions, 3551
- Coil, 1590
  - Negate, 1591
- Color
  - Diagnostics of Ethernet cables, 968
  - Diagnostics of ports, 968
- Color of individual ranges
  - Gauge, 3160
- Color property (VBS), 4234, 4235
- Color transition
  - Bar, 3086
- ColorChangeHysteresis property (VBS), 4236
- ColorChangeHysteresisEnabled property (VBS), 4237
- Column
  - Alarm view, 3115
- ColumnColor(i) property (VBS), 4239
- ColumnDisplayName(i) property (VBS), 4240
- ColumnResize property (VBS), 4240
- ColumnScrollbar property (VBS), 4242
- ColumnSizingEnable property (VBS), 4241
- ColumnTitle property (VBS), 4243
- ColumnTitleAlign property (VBS), 4242
- ColumnUpdateEnabled(i) property (VBS), 4243
- Comfort Panel
  - Area pointer, 4968
  - Communication drivers, 4965
  - Deleting HMI device images, 5593

- Display and operating element, 3080
- HTTP protocol, 4965
- Interface, 4966
- Mitsubishi, 4965
- Modicon Modbus, 4965
- OPC, 4965
- S7 1200, 4965
- S7 200, 4965
- S7 300, 4965
- S7 400, 4965
- S7-1200, 76
- Comfort Panels
  - Available system functions, 3602
- Command property (VBS), 4244
- Comment
  - Area pointer, 4954
- Comments
  - Audit Trail, 5785
  - Electronic signature, 5785
  - Inserting in SCL program, 1373
- Commissioning
  - HMI device, 5638
- Common alarm classes, 3255
- CommonTimeAxisColor property (VBS), 4245
- Communication, 882, 4909, 5468
  - Basics, 4910
  - between HMI devices, 5280
  - Configuring, 5302
  - Definition, 4909
  - OPC, 5294
  - Routing, 5298, 5300, 5302
  - Runtime settings, 5281
  - S7 1200, 5045
  - S7 1500, 4978
  - S7 200, 5198
  - S7 300, 5118
  - S7 400, 5118
  - SIMATIC LOGO!, 5228
  - Third-party drivers, 5320
  - using area pointers, 4916
  - WinAC MP, 5465
- Communication drivers, 4916
  - Allen-Bradley, 5323
  - Basic Panel, 4958
  - Comfort Panel, 4965
  - Mitsubishi, 5363
  - Mobile Panel, 4971
  - Modicon Modbus, 5393
  - Multi Panel, 4969
  - Omron, 5425
  - Panel, 4961
  - WinCC Runtime, 4975
- Communication load, 856
- Communication network, 4934
  - PROFINET, 4935
- Communication partners
  - HMI device, 4909
  - Networking, 4938
  - PLC, 4909
  - SIMATIC S7, 5036, 5115, 5195, 5204, 5207
- Communication types
  - Allen-Bradley, 5327
  - Connectable PLCs, 5401, 5412
  - Enabled, 5368, 5381, 5400, 5411, 5430
  - Ethernet/IP, 5327
  - Restriction, 5400, 5411
- Communication via PUT/GET instructions
  - Basic information on PUT/GET instructions, 500
  - Creating and assigning parameters to a connection, 505
  - Deleting an interconnection, 506
  - Overview of connection configuration, 501
  - Requirements, 500
  - Starting connection parameter assignment, 504
- Communications
  - Cycle load, 860
- Communications instruction
  - "AS\_DIAL", 6258, 6259
  - "AS\_MAIL", 6261
  - "PG\_DIAL", 6257, 6258
  - "SMS\_SEND", 6260
- Communications load, 860
- Communications module (CM), 2764
- Communications modules, 868
  - Properties, 868
- Communications parameters
  - Ethernet, 5471, 5472
  - PROFIBUS DP, 5475, 5476
  - ProSave, 5471, 5475
  - WinCC, 5472, 5476
- Communications port
  - Configuring, 869
- Communications protocol
  - Area pointer, 4976
  - Defining, 872
  - Overview, 871
- Compact, 5403, 5416
- CompactLogix, 5330
- Comparator operations
  - Time tags, 2281
- Compare
  - Bit mask, 1824, 2082, 2269
  - Character strings with S\_COMP, 2295
  - Equal, 1666, 1920

- Greater or equal, 1670, 1924
- Greater than, 1674, 1928
- Less or equal, 1672, 1926
- Less than, 1676, 1929
- Not equal, 1668, 1922
- Compare editor
  - Changing the view, 298
  - Filtering the view, 293
  - Overview, 289
  - Specifying actions, 296
- Compare offline/online
  - Automatic device assignment, 521
- Compare scan matrix, 1826, 2084, 2271
- Comparing library objects, 339
- Compatibility, 44, 5890
  - Backward compatibility of projects, 261
  - Projects from newer program versions, 261
  - Projects from older program versions, 261
  - Projects with add-on software, 262
  - WinCC version, 5584
- Compatibility (firmware versions), 905
- Compile
  - Block, 1440
  - Blocks, 1438
  - Consistency check, 1438
- Compiling
  - Address parameters, 76
  - Correcting compilation errors, 1442
  - Migrated project, 131
- Complex alarm view, 3112
- Complex user view
  - Configuring, 3088
- Components
  - Alarm, 3260
  - Commissioning, 5336, 5354, 5375, 5385, 5405, 5417, 5437
- CONCAT, 2309
- Configuration
  - Downloading to device, 827
  - DP slave, 782
  - DP slave, simple, 773
  - Hardware, 409
  - Tag, 3179
  - Uploading to programming device/PC, 828
- Configuration control, 930
- Configuration mode, 691
- Configuration PC
  - Ethernet, 5469
  - HMI device , 5469, 5474
  - PROFIBUS DP, 5474
  - Starting Runtime, 5613
  - WinCC Runtime, 4983, 5001
- Configuration phase, 5637
- Configuration rights, 538
- Configure a PROFIBUS subnet
  - Matching parameters to one another, 442
  - Setting bus parameters, 442
- Configure acknowledgment
  - Alarm message, 5026, 5102, 5183, 5225, 5237, 5361, 5391, 5423, 5442
- Configure alarms
  - Allen-Bradley, 5359
  - Data types, 5390
  - Non-integrated connection, 5390
  - Special considerations, 5390
- Configured
  - Loop-in-alarm, 3279
- ConfigureTimeAxis(i) property (VBS), 4245
- Configuring, 3270, 3283, 3432
  - Access protection, 3535
  - Alarm acknowledgment, 3300, 3301, 3302
  - Alarm group, 3268
  - Alarm log, 3309
  - Alarm view, 3287
  - Alarm view for logged alarms, 3291, 3314
  - Alarms, 5025, 5101, 5224, 5236
  - Analog alarm, 3270, 3282
  - Analog alarms, 3261, 3262
  - Animation, 3411
  - Authorization, 3528
  - Connections, 5030, 5031, 5037, 5186, 5187, 5189, 5198, 5229
  - Controller alarms, 3261, 3262
  - Discrete alarm, 3268, 3281
  - Discrete alarms, 3261, 3262
  - Display of S7 diagnostic alarms, 3290
  - Event, 3410, 3415
  - Event-driven tasks, 3273
  - Function list, 3547
  - HART variable, 949
  - HMI connection, 4983, 4986, 5051, 5053, 5124, 5126
  - HMI device as OPC DA Server, 5893
  - I-slave, 783
  - Layout of the alarm view, 3289
  - Logging tag, 3234
  - Multiple tags, 3179
  - OPC XML DA server in the OPC XML Manager, 5899
  - Project-wide alarm class, 3265
  - Recipe screen, 3432
  - Recipe view, 3427, 3430
  - Rectangle, 2988
  - Server, 5281

- System events, 3261, 3262
- Trend view for logging, 3242
- Trend view for values from the PLC, 3236, 3240
- User-defined VB function, 3558
- WinCC OPC Client, 5897
- Configuring a connection
  - Allen-Bradley DF1, 5338
  - Allen-Bradley EtherNet/IP, 5324
  - Mitsubishi FX, 5376
  - Mitsubishi MC TCP/IP, 5364
  - Modicon Modbus RTU, 5406
  - Modicon Modbus TCP, 5394
  - Omron Host Link, 5426
  - OPC, 5294
- Configuring a filter
  - for fixed character string, 3295
- Configuring a PROFIBUS subnet
  - Meaning of the bus parameters, 443
- Configuring a tag
  - HTTP client, 5284
  - HTTP server, 5282
- Configuring internal subnets manually, 611
- Configuring IP network nodes manually, 610
- Configuring MAC network nodes manually, 611
- Configuring the Control Panel
  - PROFIBUS DP, 5469
- Configuring the network with Ethernet, 447, 5060, 5134
  - Creating private subnets, 449, 5061, 5135
  - Linking networks, 449, 5061, 5135
  - Relationship between IP address and subnet mask, 448, 5060, 5134
  - Setting the IP address, 448, 5060, 5134
  - Setting the subnet mask, 448, 5060, 5134
- Configuring the remote modem, 6222
- Connecting
  - PLC, 5327, 5367, 5380, 5399, 5430
- Connecting a TS Adapter with an external modem, 6222
- Connecting a TS Adapter with an internal modem, 6222
- Connecting cable
  - 6XV1440 - 2P for Mitsubishi PG protocol, 5381
  - Allen-Bradley cable 1784-CP10, 5347
  - Mitsubishi FX, 5380
- Connecting cable 9-pole
  - Sub D, RS 422, 5346
- Connecting cables
  - Point-to-point cable 1,
  - Point-to-point cable 2, 5414
- Connection, 450, 463, 4915
  - Address details, 1016
  - Allen-Bradley DF1, 5338, 5341
  - Allen-Bradley EtherNet/IP, 5324
  - Area pointer, 4953, 4957
  - Change after migration, 142
  - Configuring, 4939, 4943, 5324, 5338, 5364, 5376, 5394, 5406, 5426
  - Configuring a connection when there is no or no clear network assignment, 455
  - Creating, 482, 4939, 4943
  - Deleting, 485
  - Highlighting, 4941
  - Integrated, 4939
  - integrated connection, 3170, 4949
  - Mitsubishi MC TCP/IP, 5364
  - Modicon, 5410
  - Modicon Modbus RTU, 5406
  - Modicon Modbus TCP, 5394
  - offline, 5015, 5089, 5170, 5213
  - Omron communication drivers, 5438
  - Omron Host Link, 5426
  - Parameters, 5325, 5339, 5365, 5378, 5396, 5408, 5428
  - Password, 4992, 5009, 5063, 5081
  - S7 200, 5198, 5229
  - Table, 4938
- Connection cable
  - Allen-Bradley cable 1747-CP3, 5348
  - Allen-Bradley cable 1761-CBL-PM02, 5349
  - Modicon, 5410
  - Multipoint cable 1:MP/TP/PC, 5432
  - Multipoint cable 2:RS422, MP/TP/PC, 5433
  - Omron Host Link, 5430
  - Point-to-point cable PP2 for Omron, 5433, 5434
- Connection configuration
  - Connection parameters, 478
  - Overview, 475
  - Starting, 481
- Connection description
  - Changing parameter values, 494
  - Data block , 488, 491, 492
  - Structure, 488, 491, 492
- Connection details, 1016
- Connection diagnostics
  - Detailed, 1014
  - Overview, 1012
- Connection information, 1014
  - Diagnostics, 4923
- Connection mechanisms, 882
- Connection modes, 675
- Connection parameter assignment of PUT/GET instructions, 504

- Connection parameters
  - Allen-Bradley DF1, 5339
  - Allen-Bradley EtherNet/IP, 5325
  - Mitsubishi FX, 5378
  - Mitsubishi MC TCP/IP, 5365
  - Modicon Modbus RTU, 5408
  - Modicon Modbus TCP, 5396
  - Omron Host Link, 5428
- Connection parameters of PUT/GET instructions, 503
- Connection resource, 450, 463
  - SIMATIC S7 1200, 73
- Connection resources
  - Online, 1014, 1015
- Connection rules, 621, 632
- Connection status
  - Displaying using icons, 1013
- Connections
  - Allen-Bradley DF1, 5342, 5343
  - Configuring, 5030, 5031, 5037, 5186, 5187, 5189, 5198, 5229
  - Editor, 5030, 5031, 5037, 5186, 5187, 5189
- ConnectionType property (VBS), 4246
- Connector object, 3986
- ConnectTrendWindows property (VBS), 4246
- Consistency
  - Slot rules, 411
- Consistency check, 607, 1475, 1480, 1481
  - Introduction, 1475, 1480
  - local, 530
  - project-wide, 530
- Constant
  - Basics, 1051
  - Declaring, 1188
  - Entering, 1076
  - PLC tag table, 1173
  - Properties, 1191
  - Rules, 1187
- Context filter, 411
- ContinousChange property (VBS), 4247
- CONTINUE, 2223
- Control element
  - Alarm view, 3114, 3118, 3326, 5683
  - Alarm window, 3326, 5683
  - f(x) trend view, 3095
  - HTML Browser, 3102
  - Media Player, 3111
  - Recipe view, 3127
  - Simple alarm view, 3329, 5685
  - Status/Force, 3139
  - Trend view, 3104
- Control panel
  - assigning parameters, 5474
  - Transferring data, 5469, 5470
- Controller alarm, 3249, 3250
  - System-defined, 3252
- Controller alarms
  - Configuring, 3261, 3262
  - System-defined, 3249
- ControlLogix, 5330
- Controls
  - WinCC MediaControl, 4030
- ControlSmartServer, 3736, 3811
- Control-timer alarm, 1817, 1820, 2075, 2078, 2262, 2266
- ControlWebServer, 3736, 3811
- Conversion, 1123
  - Explicit, 1142, 1143, 1148, 1150, 1151, 1153, 1155, 1157, 1158, 1160, 1161, 1162, 1163, 1164, 1165, 1166
  - Explicit , 1144, 1146
  - Implicit, 1126, 1127, 1128, 1129, 1130, 1131, 1132, 1133, 1134, 1135, 1136, 1137, 1138, 1139, 1140, 1141
- Conversion operations
  - Converting times with T\_CONV, 2282
- Convert, 1753, 2010, 2195
- CONVERT, 1753, 2010, 2195
- Convert VARIANT to DB\_ANY, 2206
- Converted name (PROFINET), 805
- Converting
  - A character string to a hexadecimal number with ATH, 2304
  - Character strings with S\_CONV, 2296
  - Converting number to numeric character string with VAL\_STRG, 2299
  - Converting numeric character string to number with STRG\_VAL, 2297
  - Converting times with T\_CONV, 2282
  - Copy numerical character string to characters with Strg\_TO\_Chars , 2302
  - Copying characters to numerical character string with Chars\_TO\_Strg, 2303
  - Hexadecimal number to character string with HTA, 2306
- Converting an unspecified CPU, 178
- Cookie, 656
- Coordinated transfer, 3404
  - With PLC, 3404
- Coordination, 4916
- Copy
  - Recipe data record in runtime, 3445
  - Screen, 2939

- Tag, 3178
- Template, 2943
- Copy protection, 1455
- Copy template
  - Library, 5490
- Copying
  - Adjusting screen size, 5577
  - Alarm indicator, 62
  - Alarm view, 62
  - Alarm window, 62
  - Color, 5576
  - Excel format, 5505
  - Font, 5576
  - Function key, 5577
  - Hardware component, 425
  - HMI device, 55
  - Invalid object, 5576
  - Linked objects, 5578, 5579
  - Principle, 5574, 5575
  - Screen, 5577
  - User-defined folders, 5575
- CopyRows, 4749
- Corner points, 3123
- Corners, 3121
- CornerStyle property (VBS), 4248
- CoS, 714
  - Queue, 714
- COS, 1708, 1962, 2151
- Cosine, 1708, 1962, 2151
- Count
  - Down, 1652, 1661, 1665, 1905, 1919, 2127, 2134
  - Up, 1649, 1659, 1664, 1902, 2124, 2132
  - Up and down, 1654, 1657, 1907, 2129, 2136
  - Up and Down, 1910
- Count (8 DI NAMUR), 914
- Count property (VBS), 4249
- CountDivisions property (VBS), 4250
- COUNTER, 1117, 1657, 2136
- Counter input, 864
- Counter mode, 864
- Counter operations
  - Control high-speed counters, 2588
  - High-speed counters, 2588
- Counter, high-speed, 863
- Counting
  - Down, 1914
  - Up, 1912, 1917
- CountSubDivisions property (VBS), 4250
- CountValueColumns property (VBS), 4251
- CountVisibleItems property (VBS), 4251
- Cover page
  - Placeholder for document information, 313
- CP 1242-7, 47
- CP 1613, 37
- CP 1623, 37
- CP 343-2, 46
- CP1, 5435
- CPM, 5435
- CPU
  - Displaying the current LED status, 978
  - Fill level of all types of memory, 979, 980
  - Inserting a signal board, 642
  - Properties, 854
  - Reading date and time-of-day with RD\_SYS\_T, 2287
  - Reading out a diagnostics buffer, 982
  - Selecting from the hardware catalog, 417
  - Setting time-of-day with WR\_SYS\_T, 2286
  - Switching operating mode, 988
- CPU control panel
  - Display area, 979
- CPU data block
  - Definition, 1026
  - Deleting, 1218
- CPU firmware, 905
- CPU load through trace, 6197
- CPU memory area
  - Displaying, 1484
- CPU properties, 856
- CPU type
  - Allen-Bradley DF1, 5352
  - Allen-Bradley EtherNet/IP, 5330
  - FX3 series, 5373
  - Mitsubishi FX, 5383
  - Mitsubishi MC TCP/IP, 5373
  - Modicon Modbus RTU, 5416
  - Modicon Modbus TCP, 5403
  - Omron Host Link, 5435
- Create
  - Connection, 5047
  - Faceplate type, 3054
  - Global library, 5492
  - Group, 2980
  - Recipe data record on the HMI device, 3445
  - Report, 3466
  - Template, 2944
- Create script
  - Faceplate type, 3073
- CREATE\_DB, 2533
- CreateTagSet-Method, 4751
- Creating, 3420
  - Alarm group, 3268

- Alarm log, 3304
- Alarm log , 3309
- Array, 3203
- Connection, 4939, 4943, 4980, 5120
- Connection to an OPC UA Server, 5897
- Connection to OPC DA server, 5895
- Customer control, 5876
- Cycle, 3213
- Data log, 3220
- External tag, 3173
- Infotext, 3270, 3273
- Internal tag, 3175
- Program code for customer control, 5875
- Project-wide alarm class, 3265
- Recipe, 3420
- Recipe data record, 5660, 5661, 5674
- Recipe data record on the HMI device, 3440, 3441
- Screen, 2938
- Test form, 5878
- User group, 3506, 3537
- User interface, 5874
- User-defined VB function, 3558
- Users, 3507, 3538, 5710, 5713, 5714, 5716, 5717
- Users in runtime, 3519
- Creating a print preview, 314
- Creating a route, 604
- Creating a type
  - Screen, 5503
  - Script, 5502
- Creating a watch table, 1503
- Creating custom documentation, 255
- Creating labels, 319
- Crossing
  - Definition, 1298
  - Deleting, 1300
  - Inserting, 1298
  - rearranging, 1299
- Cross-reference
  - Inspector window, 62
- Cross-reference list, (See cross-references), (See cross-references)
  - Displaying, 1488, 5527
  - Overview, 1488, 5527
  - Settings, 1486, 5528
  - Sorting columns, 1486, 5528
  - Structure, 1486, 5528
  - Views, 1486, 5528
- Cross-references
  - Displaying, 1488, 5527, 5530
  - Introduction, 1486, 5527
  - Uses, 1486, 5527
- CS1, 5435
- csv file
  - Example, 3243, 3336
  - Layout, 3243, 3336
- CSV file, 5506, 5508, 5517
  - Audit Trail, 5778
- CTD, 1652, 1905, 2127
- CTRL
  - Key, 5699
- CTRL\_HSC, 2588
- CTRL\_PWM, 2506
- CTU, 1649, 1902, 2124
- CTUD, 1654, 1907, 2129
- CU, 1664, 1917
- Cu10 sensor, 938
- CurrentColumnIndex property (VBS), 4252
- CurrentCurveIndex property (VBS), 4253
- Cursor key, 5698
- CursorControl property (VBS), 4254
- CurveColor(i) property (VBS), 4254
- CurveLineWidth(i) property (VBS), 4255
- CurvesCount property (VBS), 4255
- CurveUpdateEnabled(i) property (VBS), 4256
- Custom alarm classes, 3254, 3255
- Customer control, 5867
  - Creating, 5876
  - Creating program code, 5875
  - Setting a reference, 5872
- Customer controls
  - testing, 5878
- Customized VB function
  - Rename, 3561
- CutRows, 4751
- Cycle
  - Creating, 3213
- Cycle load, 860
- Cycle monitoring time, 2232
- Cycle time, 856, 859
  - display configured, 972
  - display measured, 977
- Cyclic
  - Continuous, 3187
  - In operation, 3187
- Cyclic interrupt, 890
- Cyclic interrupt OB
  - Assigning parameters, 899
  - Description, 890
  - Querying parameters with QRY\_CINT, 2445
  - Setting parameters with SET\_CINT, 2443
- Cyclic operation, 5197, 5207, 5233

Cyclic program execution  
 Options for interrupting, 883  
 Programming, 883  
 Cyclic triggers, 4897, 4906

**D**

D\_ACT\_DP, 2353  
 DangerRangeColor property (VBS), 4257  
 DangerRangeStart property (VBS), 4257  
 DangerRangeVisible property (VBS), 4258  
 Data areas  
 Area pointer, 4955, 5446  
 Reading, 4955, 5446  
 Writing, 4955, 5446  
 Data backup, 102  
 HMI device , 5624  
 Data bit (DBX), 843  
 Data block  
 Adjusting data values during commissioning,  
 1394, 1405, 1406, 1408  
 ARRAY data block, 1024, 1027, 1059, 1062, 1199,  
 1383, 1386, 1405  
 Based on a PLC data type , 1392  
 CPU data block, 1026  
 Creating, 1199, 1386  
 Creating with CREATE\_DB, 2533  
 Declaration table, 1384  
 Declaring ARRAY, 1390  
 Declaring STRUCT, 1391  
 Default value, 1392  
 Deleting with DELETE\_DB, 2540  
 Displaying values, 1404  
 Global data block, 1024, 1383  
 Importing and exporting tags, 1403  
 Instance data block, 1025, 1383  
 Loading block changes without reinitialization,  
 1388  
 Monitoring data values online, 1404  
 Optimized access, 1027, 1029  
 Programming, 1383, 1389  
 Reading attributes with ATTR\_DB, 2539  
 Reading from load memory with READ\_DBL,  
 2535  
 Retentive behavior, 1395, 1396  
 Start value, 1392, 1393  
 Tag properties, 1397, 1399, 1400  
 Updating, 1387  
 Using setting values, 1394, 1405, 1406, 1408  
 Writing to load memory with WRIT\_DBL, 2537  
 Data byte (DBB), 843  
 Data consistency, 2826

Data double word (DBD), 843  
 Data Encryption Standard (DES), 578  
 Data exchange, 4909  
 DP slave, 773  
 I-slave - DP master, 774  
 Tags, 4915  
 Trends, 5023, 5099, 5180, 5222, 5234, 5356,  
 5387, 5419, 5439  
 using area pointers, 4916  
 Data exchange over the AS-AS remote link  
 Communication instruction "AS\_DIAL", 6258  
 Data flow, 5652  
 Data Flow, 3397  
 Data flow control, 870  
 Data log, 647, 3388  
 Acquisition cycle, 3215  
 Closing with DataLogClose, 2526  
 Creating, 3220  
 Creating with DataLogCreate, 2515  
 Creating with DataLogNewFile, 2529  
 Creating with DataLogTypedNewFile, 2531  
 Deleting with DataLogDelete, 2528  
 Empty with DataLogClear, 2522  
 Logging cycle, 3215  
 Name, 3221  
 Opening with DataLogOpen, 2519  
 Opening with DataLogTypedOpen, 2520  
 Output of the tag value, 3239  
 Tags, 3218, 3224  
 Tolerance band, 3224  
 Writing with DataLogWrite, 2524  
 Data logging, 3214, 3215  
 Application, 3214  
 Memory medium, 3216  
 Data mailbox  
 For recipes, 3404  
 Data record, 4916  
 Asynchronously reading data record of a module  
 with RD\_DPARA, 2436  
 Exporting, 3449  
 Importing, 3449  
 Making available on I-device with PRVREC, 2370  
 Reading, 3441, 3447  
 Reading from configured system data with  
 RD\_DPARM, 2438  
 Reading of a module with RD\_DPAR, 2433  
 Reading with RD\_REC, 2358  
 Reading with RDREC, 2321  
 Receiving on I-device with RCVREC, 2367  
 Transfer, 3442, 3448  
 Transferring with WRREC, 2323  
 Writing and reading data records, 2431



- Writing predefined parameters with WR\_DPARM, 2439
- Writing with WR\_REC, 2362
- Data record list, 3408, 5654
- Data transfer settings, 5474
- Data type
  - Convert explicit, 2010
  - Convert explicitly, 2195
  - Explicit conversion, 1753
  - Allen-Bradley, 5358, 5360
  - Allen-Bradley EtherNet/IP, 5328
  - ANY, 1113
  - ARRAY, 1105, 1106
  - BOOL, 1081, 1126, 1142
  - BYTE, 1082, 1126, 1143
  - CHAR, 1103, 1140, 1165
  - Conversion, 1123, 1128, 1137, 1138, 1139
  - DATE, 1099, 1139, 1162
  - DINT, 1089, 1133, 1155
  - Discrete alarm, 5360, 5390, 5441
  - DT, 1100
  - DTL, 1102, 1138, 1164
  - DWORD, 1083, 1128, 1146
  - Explicit conversion, 1142, 1143, 1144, 1146, 1148, 1150, 1151, 1153, 1155, 1157, 1158, 1160, 1161, 1162, 1163, 1164, 1165, 1166
  - Implicit conversion, 1126, 1127, 1129, 1130, 1131, 1132, 1133, 1134, 1135, 1136, 1138, 1140, 1141
  - INT, 1087, 1131, 1151
  - Internal tag, 3172, 4952
  - LDT, 1101
  - LINT, 1090
  - LREAL, 1094, 1136, 1160
  - LTIME, 1098
  - LTIME\_OF\_DAY, 1100
  - LWORD, 1084
  - Mitsubishi, 5390
  - Mitsubishi FX, 5382
  - Mitsubishi MC TCP/IP, 5372
  - Modicon Modbus RTU, 5415
  - Modicon Modbus TCP, 5402
  - Omron, 5440, 5441
  - Omron Host Link, 5434
  - PLC data type, 1118, 1409
  - POINTER, 1111
  - REAL, 1093, 1135, 1158
  - S5TIME, 1096
  - SCL instruction, 1360, 1361
  - SINT, 1085, 1129, 1148
  - STRING, 1103, 1141, 1166
  - STRUCT, 1110
  - TIME, 1098, 1137, 1161
  - TIME\_OF\_DAY, 1099
  - TOD, 1138, 1163
  - Trend, 5358
  - UDINT, 1089, 1134, 1157
  - UINT, 1088, 1132, 1153
  - ULINT, 1092
  - USINT, 1086, 1130, 1150
  - Valid, 5328, 5372, 5382, 5402, 5415, 5434
  - Validity, 1077
  - VARIANT, 1115
  - WORD, 1083, 1127, 1144
- Data types, 184
  - Migration, 160
  - Mitsubishi FX, 5389
  - Mitsubishi MC TCP/IP, 5389
  - Modicon Modbus RTU, 5421
  - Modicon Modbus TCP/IP, 5421
  - OPC DA, 5296
  - OPC UA, 5297
  - OPC XML DA, 5297
  - S7 1500, 5029
  - S7 200, 5227
  - S7 300/400, 5185
  - SIMATIC LOGO!, 5239
  - Trends, 5025, 5101, 5182, 5224, 5236
  - Valid, 5029, 5185, 5227, 5239, 5296, 5297
- Data word (DBW), 843
- DataIndex(i) property (VBS), 4259
- DataItem object, 3916
- DataLogClear, 2522
- DataLogClose, 2526
- DataLogCreate, 2515
- DataLogDelete, 2528
- DataLogNewFile, 2529
- DataLogOpen, 2519
- DataLogs object, 3918
- DataLogTag property (VBS), 4260
- DataLogTypedNewFile, 2531
- DataLogTypedOpen, 2520
- DataLogWrite, 2524
- DataSet object (list), 3919
- DataX(i) property (VBS), 4261
- DataXY(i) property (VBS), 4261
- DataY(i) property (VBS), 4262
- Date, 1099, 1100, 1101, 1102
- DATE, 1099, 1139, 1162
- Date/time, 4916
  - Area pointers, 5083
- Date/time field, 3089
  - Application, 3485
  - Display system time, 3089

- Format, 3090
  - Layout in reports, 3486
  - Using tags, 3090
- Date/time PLC, 4916
- DATE\_AND\_LTIME, 1101
- DATE\_AND\_TIME, 1100
- DATE\_TO\_, 1162
- DateTimeField object, 3989
- DB variable
  - Definition, 1050
- DCAT, 1817, 2075, 2262
- DCP (Primary Setup Tool), 551
- DCP server, 690
- Deactivate, 3789
- Dead peer detection (DPD), 584
- Deadband
  - Setting, 3272
- Debugger
  - Closing, 3572
  - Error types, 3566
  - Starting, 3572, 5622
  - Windows, 3564
  - Windows CE, 3564
- DEC, 1693, 1948
- Decimal place, 5694
- Decimal places, 38, 1714, 1969, 2157
- DECO, 1797, 2054, 2243
- Decode, 1797, 2054, 2243
- DecreaseFocusedValue, 3745
- DecreaseTag, 3745, 3813
- Decrement, 1693, 1948
- Default font, 5554
- Defective devices, 961
- Defective license, 88, 103
- Define
  - Reference object, 2970, 3478
- Define hotkey, 3131
- Defining, 3319
  - For the assignment list, 1467
- Delay time
  - Setting, 3272
- Delete
  - Recipe data record, 5665
  - Template, 2943
  - Users, 5722, 5724
- DELETE, 2311
- Delete key, 5698
- DELETE\_DB, 2540
- DeleteDataRecord, 3675, 3807
- DeleteDataRecordMemory, 3676, 3808
- DeleteDate(i) property (VBS), 4262
- DeleteEnable property (VBS), 4263

- DeleteRows, 4754
- Deleting
  - Report page, 3468
  - Authorization, 3511
  - Filter in the assignment list, 1467
  - Hardware component, 424
  - Object, 2956, 3471
  - OPC XML DA server in the OPC XML Manager, 5899
  - Recipe data record, 5676
  - Recipe data record in runtime, 3446
  - Screen, 2939
  - Tag, 3178
  - User group, 3511
  - Users, 3510, 5723
- Deleting a category
  - Faceplate type, 3058
- Deleting a connection, 182
- Deleting a property
  - Faceplate type, 3058
- Deleting CA certificates, 6249
- Demultiplex, 1804, 2061, 2249
- DEMUX, 1804, 2061, 2249
- Dependencies of rights, 540
- Dependency structure, 1476
  - Introduction, 1476
  - Meaning of symbols, 1478
  - Setting view options, 1479
  - Structure, 1477
- Dependency structure
  - Displaying, 1479
- DES, 578, 625, 635
- Designation
  - TS Adapter, 6220, 6228, 6236
- Designing a background, 2966
- Designing a frame, 2966
- Destruction of license keys, 86
- DETACH, 2442
- DetachDB, 4754
- Detail page
  - Adding to report, 3467
  - remove from report, 3468
  - Report, 3463
  - Sorting, 3468
- Detailed comparison, 294
- Details view, 225
- Determine diagnostics status, 981
- Determining time of day, 989
- Device
  - Adding to a hardware configuration , 419
  - Copying, 55, 425
  - Defective devices, 961

- Deleting, 424
- Inserting, 4911
- Moving, 427
- Renaming, 521
- Device address, 637
- Device dependency
  - S7-1200 V1, 5104
  - S7-1200 V2, 5104
  - S7-1200 V3, 5104
  - S7-1200 V4, 5104
  - SIMATIC S7-1500 V1.0, 5029
- Device information, 304, 961
  - Diagnostics, 4923
- Device name, 800, 802, 805
- Device number, 801
- Device overview
  - Address range, 637
- Device replacement without exchangeable medium, 819
- Device Tool, 824, 826
- Device type
  - Changing, 5467
- Device version, 5629
  - Checking, 5588
  - Switching, 5587
- Device view
  - Area of unplugged modules, 416
  - Edit parameters, 428
  - Edit properties, 428
  - Hardware and network editor, 394, 4925
  - Inserting a signal board, 641
  - Inserting module, 422
  - Racks, 413
- Device wizard, 5484, 5485
- Devices
  - Connecting, 4915
  - Networking, 4914, 4938
- Devices & Networks, 4914, 4938
- Devices and networks, 4914, 4938
  - Connections, 4939
  - HMI connections, 4939
- DeviceStates, 2493
- DHCP
  - Client, 698
  - Server configuration, 605
- DHCP server, 606
- Diagnose repeater, 1009
- Diagnostic data
  - Reading out with GET\_DIAG, 2501
- Diagnostic error interrupt, 893
- Diagnostic interrupt OB, 893
- Diagnostics, 587, 925
  - Alarm class, 3290
  - Connection, 4923
  - Connection information, 4923
  - Device, 4923
  - Device information, 4923
  - DP slave, reading diagnostic data with DPNRM\_DG, 2378
  - Diagnostics buffer
    - Basics, 847, 1003
    - Organization, 1003
  - Diagnostics status
    - Determine and display online, 962
  - Diagnostics user, 537
  - Diagonal movement
    - Animation, 3016
  - DialColor property (VBS), 4263
  - DialFillStyle property (VBS), 4264
  - Dialing rules in phone books, 6217
  - Dialog fonts
    - Runtime settings, 5643
  - DialSize property (VBS), 4265
  - dial-up connection
    - Establishing, 6241
    - Terminating, 6243
  - Diffie-Hellman key agreement, 577
  - DINT, 1089, 1133
  - DINT , 1155
  - DINT\_TO\_, 1155
  - Direct access to the I/O, 848
  - Direct key, 5239, 5246, 5263, 5691
    - Assigning the inputs/outputs, 5246, 5263
    - configuring, 3039, 5241
    - KP 1500 Comfort, 5259, 5277
    - KP1200 Comfort, 5259, 5277
    - KP700 Comfort, 5257, 5275
    - KP900 Comfort, 5258, 5276
    - KTP400 Comfort, 5256, 5274
    - Mobile Panel 177, 5253, 5271
    - Mobile Panel 277, 5254, 5272
    - Mobile Panel 277 IWLAN V2 , 5255, 5273
    - Multi Panel 277 , 5251, 5269
    - Multi Panel 377, 5252, 5270
    - Multi Panel 177 , 5249, 5267
    - OP 277, 5248, 5266
    - OP 177B, 5247, 5265
    - OP 77B, 5264
    - PROFIBUS DP, 5260, 5261, 5262
    - PROFINET IO, 5243, 5244, 5245
    - TP 177, 5248, 5266
    - TP 277, 5249, 5267
    - TP1200 Comfort, 5259, 5277
    - TP1500 Comfort, 5260, 5278

- TP1900 Comfort, 5260, 5278
- TP2200 Comfort, 5260, 5278
- TP700 Comfort, 5257, 5275
- TP900 Comfort, 5258, 5276
- Direction output and travel direction: relation, 6013
- Direction property (VBS), 4265
- DirectKey, 3633
- DirectKeyScreenNumber, 3635
- DIS\_AIRT, 2469
- DIS\_IRT, 2466
- Disabling
  - Project language, 5535
- Disabling program switching
  - Runtime settings, 5643
- Discrete alarm, 3248, 3249, 3250
  - Allen-Bradley, 5360
  - Configuring, 3268, 3281
  - Mitsubishi, 5390
  - Omron, 5441
- Discrete alarm types, 3248, 3249
- Discrete alarms
  - Configuring, 3261, 3262
- DiskSpaceView object, 3991
- display
  - Infotext, 5696, 5699, 5703
- Display
  - HMI backup, 5589
- Display Caption property (VBS), 4220
- Display classes, 3252
- Display dial, 3151
- Display format, 5693, 5701
- Display number, 3127
- Display object
  - Availability for Basic Panels, 3077
  - Availability for Comfort Panels, 3080
  - Availability for Mobile Panels, 3083
  - Availability for Multi Panels, 3081
  - Availability for Panels, 3078
  - Availability for WinCC Runtime Advanced, 3084
- Display on the PLC
  - Runtime settings, 5642
- Display PDF files, 84
- Display peak value
  - Gauge, 3159
- Display peak value pointer property (VBS), 4522
- Display system time, 3089
- Display Welcome Tour, 84
- Displaying
  - Call structure, 1473
  - Assignment list , 1465
  - CPU memory area, 1484
  - Cross-reference, 5530
  - Cross-references, 1488, 5527
  - Dependency structure , 1479
  - Load memory, 1485
  - Maximum load memory available, 1485
  - Program information, 1461
- Displaying a force table, 1529
- Displaying alarms, 829
- Displaying memory types of a CPU, 979, 980
- Displaying or hiding tag information, 1294, 1335
- Displaying the online status, 6147
- Displaying values
  - As a trend, 3235
- DisplayName(i) property (VBS), 4266
- DisplayOptions property (VBS), 4266
- Distribute
  - Objects evenly, 2961, 3480
- Distributed I/O, 771, 923
- Distributed operator stations
  - Configure SmartClient, 5835
  - Configure SmartServer, 5835
  - configuring, 5835
- DIV, 1689, 1943
- Divide, 1689, 1943
- DMSK\_FLT, 2464
- Documentation editor
  - Structure, 309
- Documentation settings
  - Using frames and cover pages, 307
- Double word, 1083
- double-click, 3789
- DoubleClickAction property (VBS), 4267
- Download, (See Downloading to device)
  - "Pack&Go" file to HMI device, 5608
  - Error messages, 5633
  - HMI device, 5607
  - HMI device , 5622, 5623
  - Project, 5604, 5606, 5637
  - via USB, 5609
- Downloading
  - Isochronous applications, 827
  - to the device, 827
- Downloading data to the PLC
  - Error message, 76
- DP, 5080, 5152
- DP interface, 776
- DP master, 636, 909
  - Add DP master system, 779
  - Devices and modules, 776
  - Disconnection from DP master system, 779
  - Display on DP slave, 778
  - DP interface, 776

- DP master system
    - Add DP slave, 781
    - Creating, 771, 774, 776
    - Determining topology with DP\_TOPOL, 2381
    - Disconnect DP slave, 781
    - Disconnection from subnet, 779
    - Edit properties, 780
    - Highlight, 778
    - Node disconnection, 779
  - DP slave, 636
    - Activating and deactivating with D\_ACT\_DP, 2353
    - Add to DP master system, 781
    - Assign DP master system, 781
    - configuring, 782
    - Configuring, 773
    - Data exchange, 773
    - Disconnect from DP master system, 781
    - DP master display, 778
    - Hardware catalog, 772
    - Intelligent, (See I-slave)
    - Networking, 774
    - Reading diagnostic data with DPNRM\_DG, 2378
    - Synchronizing groups with DP\_SYC\_FR, 2372
    - Types, 780
    - With preprocessing, (See I-slave)
  - DP standard slave, 794
  - DP standard slaves
    - Reading a portion of the inputs with GETIO\_PART, 2326
    - Reading all inputs with GETIO, 2325
    - Reading consistent data with DPRD\_DAT, 2363
    - Writing a part of the outputs with SETIO\_PART, 2327
    - Writing all outputs with SETIO, 2325
    - Writing consistent data with DPWR\_DAT, 2365
  - DP/DP coupler, 772
  - DP\_TOPOL, 2381
  - DPNRM\_DG, 2378
  - DPRD\_DAT, 2363
  - DPSYC\_FR, 2372
  - DPV1
    - Configuring an ET 200S, 792
  - DPWR\_DAT, 2365
  - DrawAlwaysInsideFrame property (VBS), 4267
  - DrawEnhancedHTMLBrowser property (VBS), 4268
  - DrawInsideFrame property (VBS), 4268
  - DrawStylishButton property (VBS), 4270
  - Drive property (VBS), 4270
  - Drive signals, 6011
  - DRUM, 1814, 2072, 2259
  - DSCP, 714
  - DT, 1100
  - DTL, 1102, 1138, 1164
  - DTL data type
    - Restriction, 71
  - DTL\_TO\_, 1164
  - Duration, 1096
  - DWORD, 1083, 1128, 1146
  - DWORD\_TO\_, 1146
  - Dynamic control
    - Object property, 3007
  - Dynamic reference temperature, 945
  - Dynamization
    - Color of an object, 3014
    - Control enable state of an object, 3018
    - Flashing, 3014
    - Object, 3007
  - Dynamize
    - Appearance of an object, 3014
    - Direct movement, 3017
    - Faceplate, 3069
    - Faceplate type, 3069
    - Green arrow in Overview, 3013
    - Movement of an object, 3015
    - Object appearance, 3383
    - Property list, 3010
    - Tag binding, 3020
- ## E
- EC31-RTX, 46
  - Edge
    - Negative, 1599, 1602, 1604, 1851, 1853, 1856, 2094
    - Positive, 1598, 1601, 1603, 1850, 1852, 1854, 2093
  - EdgeStyle property (VBS), 4271, 4272
  - Edit, 4755
    - Object within a group, 2984
  - Edit networking
    - Disconnecting from a network, 439
  - Editable(i) property (VBS), 4273
  - EditAlarm, 3627, 3814
  - EditEnabled property (VBS), 4274
  - Editing
    - Alarm, 5688
    - Folder link, 2976
    - Function list, 3549
    - OPC XML DA server in the OPC XML Manager, 5899
    - Recipe data record, 5663, 5664, 5675
    - System event, 3276
  - Editing a version of a type in testing, 369

- Editing language, 266, 5531
  - Selecting, 5535
- Editing networking
  - Copying a subnet, 439
  - Copying subnets and devices, 440
- EditOnFocus property (VBS), 4274
- Editor
  - Connection, 4943
  - Connections, 5030, 5031, 5037, 5186, 5187, 5189
  - Devices and networks, 4941
  - Graphics, 5545
- Effective range, 4862, 4875, 4878, 4880
  - Calculating signal quality, 3156
  - Configure effective range object, 4886
  - Configuring, 4884
  - Configuring logoff, 4885
  - Configuring logon, 4885
  - Logoff, 3153
  - Logon, 3152
  - Override function, 3156
  - Principle of Operation, 4863
  - Runtime, 4878
  - Work area, 4876
- Effective range (RFID), 4878
  - Configuring, 4887
  - Configuring logoff, 4888
  - Configuring logon, 4888
  - Overview, 4886
  - Runtime, 4880
  - Work area, 4878
- Effective range name, 3152
- Effective range name (RFID), 3154
- Effective range signal, 3156
- Effective range (RFID)
  - Logoff, 3155
  - Logon, 3155
- Effective ranges editor, 4875, 4878
- Effects in runtime
  - Audit Trail, 5782
- Effects in Runtime
  - Recipe data change, 5787
  - Value changes to GMP-relevant tags, 5785
- Electronic signature, 5756
- Element list, 3408, 5654
- Ellipse
  - Horizontal radius, 3093
  - Vertical radius, 3093
- Ellipse , 3092
- Ellipse object, 3993
- EllipseSegment object, 3995
- EllipticalArc object, 3998
- ELSE, 2216
- E-mail
  - Transferring e-mail with TM\_MAIL, 2922
  - Transferring e-mail with TMAIL\_C, 2866
- E-Mail
  - Setting at the HMI-device, 5804
- E-mail notification, 3285, 5838
  - configuring, 5840
  - Setting up the trigger, 5840
- Empty box
  - Inserting a LAD element, 1273
  - Inserting an FBD element, 1314
- EN/ENO mechanism
  - Basics, 1167
  - FBD example, 1170
  - LAD example, 1169
  - SCL example, 1170
  - STL example, 1171
- EN\_AIRT, 2469
- EN\_IRT, 2467
- Enable autonegation, 817, 4994, 5064, 5136
- Enable output ENO, 188
- Enable sorting
  - Alarm view, 3115
- Enabled property (VBS), 4275, 4277
- Enabling
  - Reporting, 3299
  - S7 diagnostic alarm, 3278
- Enabling the firewall
  - SCALANCE S, 601, 602
- Enabling tunneled communication
  - CP x43-1 Adv., 614
  - SCALANCE S, 601, 602
- ENCO, 1798, 2055, 2244
- Encode, 1798, 2055, 2244, 3631, 3814
- EncodeEx, 3632, 3815
- Encryption, 526
- Encryption software, 90, 94
- END key, 5698
- End of discovery of accessible devices, 819, 4996, 5066, 5138
- End of sync domain, 819, 4996, 5066, 5138
- End of topology discovery, 819, 4996, 5066, 5138
- EndAngle property (VBS), 4278
- ENDIS\_PW, 1778, 2035, 2228
- EndPoint property (VBS), 4279
- EndPointLeft property (VBS), 4279
- EndPointTop property (VBS), 4280
- EndStyle property (VBS), 4281
- EndTime(i) property (VBS), 4282
- Energy-saving mode, 4890

- Engineering station
  - Starting Runtime, 5613
- Engineering system
  - Performance features, 5725
- Enhanced Recipe View, 5653
- ENO, 44, 188
- ENTER key, 5698
- Entering
  - Alphanumeric value, 5695, 5702
  - Input field, 5692
  - Numerical value, 5694, 5701
  - Parameters in user-defined functions, 3550
- Entry on the HMI device
  - By means of function key, 5700
- Enumeration types, 658
- Enumerations
  - Web server, 660
- Error
  - Logical error, 3566
  - Runtime error, 3566
- Error alarm
  - Acknowledge, 5687
- Error analysis with RET\_VAL, 1584
- Error handling, 1382
  - Basics, 1378
  - GetError, 1783, 2040, 2234
  - GetErrorID, 1787, 2044, 2237
  - Local error handling, 1380
- Error information, 1380, 1584, 1783, 1787, 2040, 2044, 2234, 2237
- Error message
  - Downloading data to the PLC, 76
- Error messages
  - Download, 5633
- ESC key, 5698
- ESP protocol, 578
- Establishing a connection from a remote system ("PG\_DIAL"), 6257
- Establishing a remote connection, 6241
  - Procedure, 6242
- ET 200eco, 907
- ET 200eco PN, 907, 923
- ET 200iSP, 907
- ET 200iSP distributed I/O station
  - Definition, 909
- ET 200L, 907
- ET 200M, 907, 948
  - Definition, 948
- ET 200MP, 940
- ET 200pro, 907
- ET 200R, 907
- ET 200S, 907
  - DPV1 mode, 792
  - Option handling, 788, 791
  - Positioning module, 45
  - Reference junctions, 784
  - Slot rules, 784
- ET 200S COMPACT, 907
- ET 200SP, 929
  - Application area, 929
- ET 200M distributed IO device, 948
- Ethernet
  - Parameters, 5036, 5112, 5193, 5202, 5232
- ETHERNET
  - Basic Panel, 4960
- Ethernet interface
  - Displaying parameters, 6158
- Ethernet module
  - Removal/insertion, 43
- Ethernet non IP frames, 543
- Event
  - Acknowledge, 3793
  - activate, 3786
  - Alarm buffer overflow, 3793
  - Assigning organization block (OB) with ATTACH, 2441
  - Boundary reached, 3793
  - Canceling assignment to organization block (OB) with DETACH, 2442
  - Change, 3786
  - cleared, 3785
  - Click, 3791
  - Click when flashing, 3792
  - Configuring, 3410, 3415
  - Deactivate, 3789
  - double-click, 3789
  - Dynamize, 3012
  - Execute, 3787
  - For function lists, 3199
  - Free space critically low, 3796, 5770
  - Incoming, 3791
  - Input finished, 3790
  - Inspector window, 62
  - Loop-In-Alarm, 3792
  - Low free storage space, 3796, 5769
  - Outgoing, 3791
  - Overflow, 3226, 3795
  - Press, 3790
  - Press ESC twice, 3790
  - Press key, 3794
  - release, 3792
  - Release key, 3794
  - Runtime Stop, 3794
  - Screen change, 3788

- Selection changed, 3787
- Switch OFF, 3795
- Switch ON, 3795
- Tags, 3199
- Time expired, 3796
- Toggle, 3795
- User change, 3788
- Value change, 3796
- When dialog is closed, 3788
- When dialog is opened, 3788
- When high limit is exceeded, 3787
- When low limit is undershot, 3787
- Event name, 900
- Event trigger, 4897, 4901, 4904
- Event-driven output
  - Report, 3468
- Event-driven tasks
  - Configuring:event-driven tasks, 3270
- Events
  - Configuration, 695
  - Severity filter, 697
- Example
  - Application for alarm classes, 3254, 3255
  - Calculating an equation, 1571
  - Changing and displaying operating mode, 3581
  - Communication, 5300
  - Controlling a conveyor belt, 1552, 1566, 1576
  - Controlling room temperature, 1557, 1564
  - Detecting the direction of a conveyor belt, 1553, 1560, 1568, 1578
  - Detecting the fill level of a storage area, 1554, 1561, 1569, 1579
  - For displaying bit memory in the assignment list, 1463
  - For displaying inputs and outputs in the assignment list, 1463
  - For entering force values in the force table, 1532
  - Heating an oven, 1572
  - Modify values in the watch table, 1507
  - System alarm, 3251
  - User-defined function for temperature conversion, 3577
- Example:
  - Discrete alarm, 3250
  - System event, 3251
- Examples
  - Controlling a conveyor belt, 1559
- Exchangeable medium, 819
- EXCLUSIVE OR, 1838, 1839
  - Bit logic operations, 1838
- Execute, 3787
- Executing
  - User-defined functions in Runtime, 3574
- Exit
  - User program, 1783, 2040, 2233
- EXIT, 2224
- EXP, 1705, 1960, 2149
- Expanded mode, 1500
- Expanding and collapsing sections of code, 1354
- Exponential value, 1705, 1960
- Exponentiate, 1715, 1970
- Export, 4755
  - Alarm, 5510
  - Excel format, 5505
  - Project texts, 5542
  - Recipe, 3642, 3818, 5506
  - Tag, 5517
  - Text list, 5523
  - User administration, 3525
- Export of labels, 320
- ExportDataRecords, 3640, 3816
- ExportDataRecordsWithChecksum, 3642, 3818
- ExportDirectoryChangeable property (VBS), 4284
- ExportDirectoryname property (VBS), 4284
- ExportFileExtension property (VBS), 4285
- ExportFilename property (VBS), 4286
- ExportFilenameChangeable property (VBS), 4286
- ExportFormatGuide property (VBS), 4287
- ExportFormatName property (VBS), 4287
- ExportImportUserAdministration, 3645, 3821
- Exporting
  - Recipe, 3449
  - Recipe data record, 3399, 3449, 5657
- Exporting an NTP server, 570
- ExportParameters property (VBS), 4288
- ExportSelection property (VBS), 4288
- ExportShowDialog property (VBS), 4289
- Expression
  - Basics, 1341
  - Logical expression, 1346
  - Relational expressions, 1344
- Expression
  - Arithmetic expression, 1342
- EXPT, 1715, 1970
- Extended download to device, 76
- Extended status information, 1349
- External graphic
  - Edit folder, 2975
  - Link folder, 2976
  - Removing the folder link, 2975
  - Rename folder, 2975
- External image file
  - add to graphics library, 5547



- Managing, 2954
- Storing in the image browser, 2977
- External source file
  - Basics, 1418
  - Exporting blocks, 1420
  - inserting, 1421
  - Linking file types to an editor, 1422
  - Rules for programming, 1419
- External tags
  - Data exchange, 4915
- ExtraSpaceForLabelDisplay property (VBS), 4291

## F

- f(x) trend view, 3093
  - Toolbar, 3095
- F\_TRIG, 1606, 1858, 2094
- Faceplate, 3049
  - Cancel connection to faceplate type, 3068
  - Controlling properties dynamically, 3069
  - Create, 3071
  - Dynamically controlling included objects, 3075
  - Dynamize, 3069
  - Example, 3070
  - Faceplate type, 3049
  - Instance of the faceplate, 3049
  - Response to sizing, 3066
- Faceplate type, 3049
  - Deleting a property connection, 3057
  - Cancel connection, 3068
  - Create, 3054
  - Creating a tag, 3072
  - Defining properties, 3072
  - Deleting a category, 3058
  - Deleting a connection, 3057
  - Deleting a property, 3058
  - Dynamic control, 3069
  - Editing, 3066
  - Enable, 3066
  - Event, 3053
  - Faceplate, 3067
  - Graphics list, 3054
  - Properties, 3053
  - Response to resizing, 3066
  - Script, 3053
  - Tag, 3053
  - Text list, 3053
  - Updating, 3065
  - Use, 3067
  - User text, 3054
- Facility, 563
- Factory settings
  - Resetting to, 992, 993
- FAQs, 405, 4933
- Fault monitoring
  - Connection status change, 709
  - Power supply, 708
  - Redundancy, 709
- Favorites
  - Adding, 1276, 1317, 1362
  - Hiding, 1228
  - Removing, 1278, 1319, 1363
  - Showing, 1228
  - Using, 1277, 1318, 1363
- FB, 1023
- FBD, 1302, 1559, 1560, 1561
- FBD element
  - Copying, 1327
  - Cutting, 1327
  - Deleting, 1332
  - Inserting, 1313, 1314
  - Inserting an operand , 1333
  - pasting from the clipboard, 1328
  - Replacing, 1329
  - Rules for inserting, 1312
  - Selecting, 1326
- FBD network
  - Branch, 1336
  - Deleting a branch, 1337
  - Inserting a block call, 1278, 1319
  - Inserting a branch, 1337
  - Program status display, 1497
  - Rules for branches, 1336
- FC, 1022
- FDA, 5755
- Feedback
  - Optical, 5690
- FETCH/WRITE, 882
- Field device, 794, 821
- FieldLengthReadOnlySpecial property (VBS), 4291
- FieldRead, 1722, 1977
- FieldWrite, 1724, 1979
- File Browser, 647
- File format
  - Audit Trail, 5778
- Fill
  - Block, 1733, 1751, 1989, 2007, 2165, 2192
  - Block uninterruptible, 1735, 1991, 2167
- FILL, 1751, 2007, 2192
- Fill style, 3141
- FILL\_BLK, 1733, 1989, 2165
- FillColorMode property (VBS), 4293
- FillPatternColor property (VBS), 4294

- FillStyle property (VBS), 4295
- Filter
  - Defining for the assignment list, 1467
  - Delete, 1467
  - Hardware catalog, 411
  - In the assignment list, 1466
  - Selecting, 1468
- Filter property (VBS), 4296
- Filtering
  - the alarm view, 3295
- Filters
  - Assignment list , 1468
- FIND, 2314
- Find and replace, 328
  - Additional options for searching, 328
  - Replacing search keys, 329
  - Start search, 329
  - Using the search function, 328
- Firewall
  - Creating service groups, 549, 551
  - Defining ICMP services, 548
  - Firewall rules, 543
  - Managing service groups, 549, 552
- Firmware, 905
- Firmware update, 990
- Firmware update memory card, 841
- Firmware version V4, 35
- FirstConnectedObjectIndex property (VBS), 4296
- FirstConnectedObjectName property (VBS), 4297
- Fixed aspect ratio, 3141
- Fixed reference temperature, 945
- FixedAspectRatio property (VBS), 4297
- Flash test, 1008
- Flashing, 2966, 3014
- FlashingColorOff property (VBS), 4298
- FlashingColorOn property (VBS), 4300
- FlashingEnable property (VBS), 4301
- FlashingRate property (VBS), 4302
- FlashTransparentColor property (VBS), 4305
- Flip, 3141
  - Object, 2953
- Flip property (VBS), 4306
- Flip-flop
  - Reset/set, 1597, 1848
  - Set/reset, 1596, 1847
- Floating-point number, 1093, 1094
  - Check invalidity, 1681, 1934
  - Check validity, 1680, 1933
- Floating-point numbers, 1095
  - Invalid , 1095
- FLOOR, 1758, 2014, 2198
- Flutter monitoring, 951
- FocusColor property (VBS), 4306, 4307
- FocusWidth property (VBS), 4308
- Folder link
  - Editing, 2976
  - Removing, 2976
  - Renaming, 2976
- Font property (VBS), 4309
- Font settings
  - Migrate, 140
- FontBold property (VBS), 4311
- FontItalic property (VBS), 4312
- FontName property (VBS), 4313
- FontSize property (VBS), 4314
- FontUnderline property (VBS), 4315
- Footer
  - Report, 3463
- FOR, 2218
- Force
  - Force all, 1544
  - Stop forcing, 1546, 1547
- Force job
  - On SD card, 36
- Force table
  - Meaning of the icons, 1528
  - "Monitor once and now" command for tags, 1538
  - Basic mode, 1527
  - Display, 1529
  - Expanded mode, 1527
  - Functionality, 1524
  - Layout, 1526
  - Meaning of the columns, 1526
  - Monitoring and modifying modes, 1513
  - Opening, 1529
  - Overview of the display formats, 1533
  - Overview of the test options, 1524
  - Permitted operands, 1531
  - Permitted operands for force values, 1532
  - Saving, 1530
  - Switching between basic mode and expanded mode, 1527
  - Syntax check, 1530
  - Test options, 1524
- Force value
  - Permitted operands, 1532
- Forcing
  - Audit, 5781
- Forcing tags, 51
  - Safety precautions, 1526, 1540
- Forcing tags for direct I/O access, 51
- ForeColor property (VBS), 4316, 4317
- Foreground color
  - Dynamization, 3014

- Form exponential value, 2149
  - Format, 3090
  - FormatPattern property (VBS), 4318
  - FormatPatternReadOnlySpecial property (VBS), 4319
  - Formatting
    - Alarm text, 3273
  - FormatType property (VBS), 4319
  - Forward Delay, 729
  - FRAC, 1714, 1969, 2157
  - Fragment, 660, 666
  - Free property (VBS), 4320
  - Free space critically low, 3796, 5770
  - Free-form comments
    - Deleting, 1285, 1325
    - Editing, 1283, 1324
    - Inserting, 1283, 1324
    - Introduction, 1282, 1323
  - FreePercent property (VBS), 4320
  - FreezeProviderConnections property (VBS), 4321
  - Frequency meter, 920, 923
  - FTP, 539, 540, 882, 2699
  - FTP\_CMD, 2699
  - FTPS, 2699
  - FTPS certificates, 531
  - Function, 3541
    - Assigning to a function key, 3035
    - Function list , 3551
  - Function (FC)
    - Creating, 1198
    - Definition, 1022
    - exporting to an external source file, 1420
  - Function block (FB)
    - Creating, 1198
    - Definition, 1023
    - exporting to an external source file, 1420
    - Instance data block, 1023
  - Function Block Diagram, 1302
  - Function key, 3030
    - Assigning a function, 3035
    - Assigning a graphic, 3037
    - Global assignment, 3032
    - Global screen, 2942
    - Local assignment, 2942, 3034
    - protect with password, 3036
    - Replacing devices, 5561
    - Use global assignment, 2942
    - used for screen navigation, 3041
  - Function keys
    - Global assignment, 5700
    - Local assignment, 5700
  - Function list, 3199, 3545, 4895
  - Asynchronous execution, 3573
  - Configuring, 3547
  - Editing, 3549
  - Execution in Runtime, 3573
  - Synchronous execution, 3573
  - Functional scope
    - ProSave, 5624
  - Functionality of the force table, 1524
  - Functions
    - Updating tag value, 3169, 4949
  - FunctionTrendControl object, 4004
  - FX1 series, 5383
  - FX2 series, 5383
  - FX3
    - PLC, 5369
  - FX3 series, 5373
- ## G
- GADR\_LGC, 2553
  - Gauge, 3158
    - Color of individual ranges, 3160
    - Display peak value, 3159
    - GMP-relevant tag, 3158
    - Maximum value, 3159
    - Minimum value, 3159
    - Normal range visible , 3160
  - Gauge object, 4008
  - GE Fanuc SNP
    - Migrating data types, 163
  - GEN\_DIAG, 2499
  - General information on troubleshooting, 6264
  - General rules, 1038
  - Generating diagnostics information, 2499
  - Generation of packed addresses, 787
  - GEO\_LOG, 2549
  - GEO2LOG, 2543
  - Geographic coordinates, 693
  - GET, 2831
  - Get\_AlarmState, 2472
  - GET\_DIAG, 50, 2501
  - GET\_NAME, 2488
  - GetBrightness, 3670, 3821
  - GetColumn, 4756, 4775, 4776, 4835, 4836, 4853, 4854
  - GetColumnCollection, 4757
  - GetDataRecordFromPLC, 3666, 3822
  - GetDataRecordName, 3667, 3668, 3824
  - GetDataRecordTagsFromPLC, 3669, 3825
  - GetError, 1381, 1382, 1783, 2040, 2234
  - GetError , 1380
  - GetErrorID, 1380, 1381, 1382, 1787, 2044, 2237

- GetGroupNumber, 3670, 3826
- GetHitlistColumn, 4759
- GetHitlisteColumnCollection, 4758
- GETIO, 2325
- GETIO\_PART, 2326
- GetMessageBlock, 4760
- GetMessageBlockCollection, 4761
- GetMessageColumn, 4763
- GetMessageColumnCollection, 4768
- GetMessageColumnCollection , 4765
- GetOperatorMessage, 4764
- GetOperatorMessageCollection, 4766
- GetPassword, 3671, 3827
- GetPLCMode, 69
- GetRow, 4767
- GetRulerBlock, 4769
- GetRulerBlockCollection, 4770
- GetRulerColumn, 4772
- GetRulerColumnCollection, 4773
- GetRulerData, 4774
- GetSelectionText property (VBS), 4321
- GetStationInfo, 2490
- GetStatisticAreaColumn, 4777
- GetStatisticAreaColumnCollection, 4779
- GetStatisticResultColumn, 4780
- GetStatisticResultColumnCollection, 4781
- GetStatusBarElement, 4782
- GetStatusBarElementCollection, 4783
- GetTimeAxis, 4784
- GetTimeAxisCollection, 4786
- GetTimeColumn, 4787
- GetTimeColumnCollection, 4788
- GetToolBarButton, 4790
- GetToolBarButtonCollection, 4791
- GetTrend, 4792
- GetTrendCollection, 4793
- GetTrendWindow, 4795
- GetTrendWindowCollection, 4796
- GetUserName, 3665, 3827
- GetValue, 5864
- GetValueAxis, 4797
- GetValueAxisCollection, 4798
- GetValueColumn, 4799
- GetValueColumnCollection, 4800
- GetXAxis, 4802
- GetXAxisCollection, 4803
- GetYAxis, 4804
- GetYAxisCollection, 4805
- Gigabit address, 534
- Global assignment
  - Of a function key, 3030, 3032
- Global data block, 1024
- Configuring, 4956
- Creating, 4956
- Retentive behavior, 1396
- Global firewall rules, 544
  - Assigning, 545
- Global libraries, 338
  - Archiving, 355
  - Retrieving, 356
- Global library, 5486
  - Adding types, 376
  - Archiving, 355
  - Cleaning up, 384
  - Closing, 353
  - Create, 5492
  - Creating, 348
  - Creating folders, 357
  - Deleting, 354
  - Displaying logs, 352, 5495
  - Migrating, 152
  - Open, 5494
  - Opening, 349
  - Save, 5493
  - Saving, 352
  - Showing properties, 351
  - Updating the project, 379
  - Using filter view, 359
  - Using the element view, 342
  - Using types, 378
- Global packet filter rules, 545
- Global screen, 2942
  - Function key, 2942
  - Template, 2943
- Global softkey, 3032
- Global tag, (See PLC tag)
- GlobalColorScheme property (VBS), 4672
- GlobalShadow property (VBS), 4674
- GMP, 5755
- GMP settings, 5783, 5787
- GMP-relevant tag, 5783
  - Gauge, 3158
- GMRP, 744
- Go online, 1006
  - connecting several devices, 6148, 6149
- Going offline, 1008
- Going online
  - Multiple TIA Portal instances, 43
- Good Manufacturing Process, 5755
- GOTO, 2225
- GoToEnd, 3646, 3828
- GoToHome, 3646, 3828
- GPRS, 674
- Gradation property (VBS), 4321

- GraphDirection property (VBS), 4322
  - Graphic
    - add to graphics library, 5546
    - Assigning to a function key, 3037
    - Button, 3130
    - Graphic view, 3096, 3488
    - Inserting, 2954, 3469
    - managing, 2975
    - Stretching, 3096, 3098, 3488
    - Using from the graphic browser, 2974
    - With transparent background, 2975
  - Graphic browser, 2974
  - Graphic browser , 5547
  - Graphic I/O field, 3097
    - Output graphics list, 3007
    - Use in reports, 3489
  - Graphic view, 3096, 3488
    - transparent color, 3097
  - GraphicIOField object, 4011
  - Graphics, 2977
    - Editor, 5545
  - Graphics list
    - Application, 2999
    - Bit (0, 1), 3004
    - Bit number (0 - 31), 3006
    - Creating, 3000
    - Graphic I/O field, 3007
    - Outputting configuration data, 3006
    - Range (0 - 31), 3001
    - Range (... - ...), 3003
  - GraphicView object, 4014
  - GridBackColor property (VBS), 4323
  - GridlineColor property (VBS), 4323
  - GridLineWidth property (VBS), 4324
  - group
    - Cancel, 2981
    - Edit, 2980
    - Ungroup, 2981
  - Group
    - Adding objects, 2982
    - Cancel, 2981
    - Creating, 2980
    - Editing, 2980
    - Removing an object, 2983
    - Ungroup, 2981
  - Group acknowledgment, 5699
  - Group name, 547, 550
  - Group object, 4017
  - Group properties, 577
  - GSD files
    - Configuring devices (PROFIBUS), 794
    - GSD revisions (PROFIBUS), 793
    - Installation, 794
  - GSD files (PROFINET), 820
    - Changing revision, 822
    - Installation, 821
  - GSDML, (See GSD files (PROFINET))
  - GSM network, 674
- ## H
- Handshaking, 871
  - Handwheel, 3099
    - Tag, 3099
  - Hardware
    - Configuring and assign parameters, 409
    - Detection, 46
    - Edit parameters, 428
    - Edit properties, 428
  - Hardware acceleration
    - SmartServer, 5825
  - Hardware and network editor
    - Device view, 394, 4925
    - Network view, 391, 4919
    - Topology view, 397, 4927
  - Hardware and software limit switches: Function, 6014
  - Hardware catalog
    - Adding device, 419
    - Browsing, 411
    - DP slave, 772
    - DP/DP coupler, 772
    - I slave, 772
    - Selecting the hardware component, 417
    - Task card, 403, 4931
  - Hardware configuration
    - Adding device, 419
    - Adding module, 422
  - Hardware configuration for Motion Control S7-1200, 6007
  - Hardware data types, 1121
  - Hardware detection, 421
  - Hardware diagnostics, 960
  - Hardware documentation, 6271
  - Hardware editor
    - Components, 389, 4917
    - Function, 389, 4917
    - Hardware catalog, 403, 4931
    - Inspector window , 402, 4929
  - Hardware identifier, 637, 2718, 2721, 2724, 2728, 2733, 2734, 2735, 2736
    - Determining with LOG2MOD, 2546
  - Hardware interrupt, 891
    - How it works, 852

- Hardware interrupt OB
  - Description, 891
  - Parameter assignment, 900
- Hardware requirements, 89
  - Communications instruction "AS\_MAIL", 6262
  - Communications instruction "PG\_DIAL", 6257
  - Communications instruction "SMS\_SEND", 6260
- Hardware requirements for AS-AS remote link
  - Communication instruction "AS\_DIAL", 6259
- Hardware support package
  - Installing, 109
- Hardware-controlled data flow control, 870
- Harmonizing
  - Object size, 2959, 3477
- HART, 911
- HART variables
  - Configuring, 949
  - Quality code, 950
  - Structure, 950
- Header
  - Report, 3463
- Height property (VBS), 4325
- Help
  - Browsing, 250
  - Call topic from favorites, 251
  - Delete topic from favorites, 252
  - Find keywords, 250
  - Full-text search, 250
  - Identification of Help topics, 248
  - Open, 250
  - Open tooltip cascades automatically, 253
  - Printing help topics, 252
  - Save topics in favorites, 251
  - Use index, 250
- Help indicator, 3100
- HelpText property (VBS), 4328
- Hibernate, 37
- Hidden input, 3092
- Hidden parameters, 1294, 1334
- HiddenInput property (VBS), 4329
- HideAlarm, 4807
- HideTagNames property (VBS), 4329
- Hiding
  - Report sections, 3468
- Highlighting
  - Connection, 4941
- HighLimitColor property (VBS), 4330
- High-speed counter
  - Configuring, 866
  - General, 863
  - How it works, 863
- HitlistColumnAdd property (VBS), 4330
- HitlistColumnCount property (VBS), 4331
- HitlistColumnIndex property (VBS), 4331
- HitlistColumnName property (VBS), 4332
- HitlistColumnRemove property (VBS), 4332
- HitlistColumnRepos property (VBS), 4332, 4409
- HitlistColumnSort property (VBS), 4333
- HitlistColumnSortIndex property (VBS), 4333
- HitlistColumnVisible property (VBS), 4334, 4410
- HitlistDefaultSort property (VBS), 4334
- HitlistMaxSourceItems property (VBS), 4335
- HitlistMaxSourceItemsWarning property (VBS), 4335
- HitlistRelativeTimeFactor property (VBS), 4336
- HitlistRelativeTimeFactorType property (VBS), 4336
- HitlistRelTime property (VBS), 4337
- HMI backup
  - Deleting, 5591
  - Display, 5589
  - Rename, 5591
- HMI connection, 179, 463, 882, 4915
  - Configuring, 4983, 4986, 5051, 5053, 5124, 5126
  - Creating, 4980, 5047, 5120
  - MPI, 5153, 5157, 5158
  - MPI parameters, 5160
  - Password, 4992, 5009, 5063, 5081
  - PC, 4983, 5001, 5053, 5073, 5126, 5143, 5158
  - PROFIBUS, 4998, 5001, 5002, 5071, 5073, 5140, 5143
  - PROFIBUS parameters, 5004, 5075, 5147
  - PROFINET, 4979, 4980, 4981, 4983, 4986, 5046, 5047, 5049, 5051, 5053, 5119, 5120, 5122, 5124, 5126
  - PROFINET parameters, 4987, 5055, 5128
  - S7 1200, 5047
  - S7 1500, 4980
  - S7 300/400, 5120
  - SIMATIC PC, 4986, 5002, 5051, 5071, 5124, 5157
  - WinCC RT Advanced, 4981, 5001, 5049, 5071, 5073, 5122, 5143, 5157, 5158
  - WinCC RT Professional, 4981, 5001, 5002
  - WinCC Runtime, 4981, 5049, 5122
  - WinCC RT Advanced, 5002
- HMI connections
  - Devices & Networks, 4939
- HMI device, 100
  - as OPC client, 5892
  - as OPC server, 5892
  - available area pointers, 4976
  - Changing the device type, 5635
  - Commissioning, 5638
  - Configuration, 5587
  - Data backup, 5626

- Download, 5607
  - MPI parameters, 5162
  - Performance features, 5727, 5730, 5734, 5739, 5742, 5747
  - PROFIBUS parameters, 5006, 5077, 5149
  - PROFINET parameters, 4989, 5057, 5130
  - Recommissioning, 5638
  - Replacing, 5572
  - Reset to factory settings, 5629
  - Restoring data, 5626
  - Server, 5281
  - System limits, 5727, 5730, 5734, 5739, 5742
  - Transferring authorization, 5483
  - Transferring license key, 5630
  - Updating the operating system (Windows CE), 5629
  - WinAC MP, 5468, 5478
  - HMI device
    - Data backup, 5622, 5623, 5624
    - Download, 5622, 5623
    - Image, 5622, 5623
    - Restoring data, 5624
    - Software, 5622, 5623
  - HMI device configuration, 5587
  - HMI device dependency
    - System function, 3555
  - HMI device image
    - Deleting, 5593
  - HMI device licensing
    - Non-PC-based, 100
  - HMI device on a PLC
    - Commissioning, 5336, 5354, 5375, 5385, 5405, 5417, 5437
  - HMI device replacement, 55
    - by the migration, 137
  - HMI device type
    - Changing, 5635
  - HMI device version, 5572, 5587, 5588, (Device version), (Device version)
  - HMI device wizard, 5484, 5485
  - HMI HTTP protocol, 5278
    - Basics, 5278
  - HMI tag
    - Access to user-defined VB functions, 3552
  - HMIRuntime, 3903
  - HMIRuntime object, 3903, 3922
  - HOME key, 5698
  - Homing: Homing modes, 6016
  - Horizontal radius, 3093
  - HorizontalAlignment property (VBS), 4338, 4339
  - HorizontalGridLines property (VBS), 4339
  - HourNeedleHeight property (VBS), 4340
  - HourNeedleWidth property (VBS), 4341
  - How the frequency meter works, 921
  - HSC, 863
  - HSP, (See Support package)
  - HTA, 2306
  - HTML Browser, 3101
    - Button, 3102
    - Connection to the FTP server, 3101
    - File explorer, 3101
  - HTML page
    - Displaying data type DATETIME, 5843
  - HTMLBrowserBack, 3649
  - HTMLBrowserForward, 3649
  - HTMLBrowserRefresh, 3648
  - HTMLBrowserStop, 3648
  - HTTP, 547, 5278
  - HTTP client, 5858
    - Configure HTTP-Connection, 5858
    - Configuring a tag, 5284
    - Configuring tags, 5859
    - Configuring the SIMATIC HMI HTTP protocol, 5858
    - Importing certificates, 5290, 5860
  - HTTP connection
    - Client, 5282
  - HTTP protocol
    - Basic Panel, 4958
    - Comfort Panel, 4965
    - Mobile Panel, 4971
    - Multi Panel, 4969
    - Panel, 4961
    - Timeout, 5283
    - WinCC Runtime, 4975
  - HTTP server
    - Configure WinCC-Project , 5856
    - Configuring a tag, 5282
    - Setting at the HMI-device, 5856
    - Setting up the WinCC Internet connections, 5287
  - HTTPS, 601, 646, 5278, 5280
  - HTTPS server only, 690
  - HW ID
    - See Hardware identifier, 637
- I**
- I address, 637
  - I slave
    - Hardware catalog, 772
  - I/O
    - Direct access to, 848
  - I/O access error, 846
  - I/O address, 637, 848

- I/O field, 3090
  - application in reports, 3486
  - Data format, 3091
  - Decimal format, 64
  - Display format in reports, 3487
  - Format, 64
  - Hidden input, 3092
  - Mode, 3091
- I/O input, 843
- I/O output, 843
- I/Os, 1058
- ICMP, 553
- Icon
  - For comparison, 966
  - For comparison status, 1013
  - for connection status, 1013
  - For hardware diagnostics, 965
  - for operating mode, 967
  - For software diagnostics, 966
  - For value comparison, 5937
  - Overlay icon, 967
- Icons
  - in TeleService, 6213
- Icons in the force table, 1528
- Icons in the watch table, 1502
- IconSpace property (VBS), 4342
- Identifying
  - Alarm class, 3116
- I-device, 808
- IE/AS-i link PN IO, 796
- IEC check, 1123
  - Setting, 1125
- IEC counters, 187
- IEC timer, 1098
- IEC timers, 187
- IEEE 802.3, 543
- IEEE tag, 910
- IF, 2214
- IF1B
  - Basic Panel, 4960
- IGMP, 743
- IKE settings, 577
- Illuminated pushbutton, 3106
  - Tag, 3107
- Image, 5587
  - HMI device , 5622, 5623
- Image file
  - Storing in the image browser, 2977
  - Storing in the image browser , 5547
- IMC, 1824, 2082, 2269
- Import
  - Alarm, 5511
  - Analog alarm structure, 5512
  - Project texts, 5544
  - Recipe, 5508
  - Structure of discrete alarms, 5515
  - Structure of recipe data, 5509
  - Tag, 5519
  - Text list, 5524
  - User administration, 3526
- ImportDataRecords, 3650, 3829
- ImportDataRecordsWithChecksum, 3652, 3831
- Importing
  - Recipe, 3449
  - Recipe data record, 3399, 3449, 5657
- Importing a recipe
  - Structure for the import, 5509
- Importing analog alarms
  - Structure for the import, 5512
- Importing discrete alarms
  - Structure for the import, 5515
- Importing NTP servers, 570
- in the screen
  - Arrange object, 2962, 3475
- IN\_RANGE, 1678, 1931
- INC, 1692, 1947
- Incoming, 3252, 3791
- IncreaseFocusedValue, 3639
- IncreaseTag, 3639, 3832
- Increment, 1692, 1947
- Indenting and outdenting
  - Lines, 1353
- Index property (VBS), 4342
- Index tag, 3197, 3198
- Indirect addressing, 185, 1067, 1068, 1069, 1070, 1072, 1073
- Indirect addressing , 3197
- Industrial Ethernet, 4934
- Information system
  - Components of the information system, 247
  - Roll-out, 248
  - Tooltip, 248
- Infotext, 3261
  - Creating, 3270, 3273
  - display, 5696, 5699, 5703
  - Key, 5699
- Infotext
  - Display, 3328
- INIT\_RD, 1789, 2046, 2239
- Initialization (user-defined web pages), 649
- Initialize all retain data, 1789, 2046, 2239
- InnerBackColorOff property (VBS), 4343
- InnerBackColorOn property (VBS), 4344



- Input
  - Inserting, 1289, 1840
  - remove, 1290, 1330
- Input (I), 843
- Input area plan
  - SmartClient, 5804
  - SmartServer, 5804
  - SmartService, 5804
- Input byte (IB), 843
- Input field, 5692
  - Character mode, 5698
  - Standard mode, 5698
- Input finished, 3790
- Input word (IW), 843
- INSERT, 2312
- Insert empty line, 6055
- Insert input, 1329
- Insert separator line, 6055
- InsertData(i) property (VBS), 4345
- InsertEnable property (VBS), 4345
- Inserting
  - Code template in user-defined functions, 3551
  - Graphic, 2954, 3469
  - Library object, 5501
  - Object, 2953, 2954, 3469
  - Rectangle, 2990
- Inserting a comment section, 2227
- Inspector window
  - Cross-reference, 62
  - Event, 62
  - Layout, 219
  - Reducing automatically, 214
- Inspector window
  - Diagnostics tab, 961
  - Hardware and network editor, 402, 4929
- Installation
  - Displaying software, 110
  - Licenses, 83
  - Log, 106
  - Modifying products, 111
  - ProSave, 75
  - Repairing products, 113
  - Smartdrive, 57
  - Starting, 107
  - Support package, 109
  - System requirements, 84
  - Target directory, 39
  - Updating products, 111
- Installing, 98
  - Add-on, 98
  - Option, 5632
  - Powerpack, 105
- Installing CA certificate, 6246
- Installing license keys, 86
- Installing support packages, 109
- Installing the communications driver (WinAC MP), 5467
- Installing the local modem, 6221
- Instance data block
  - Creating, 1025
  - Definition, 1025
  - Modifying the data types of IEC timers and IEC counters, 1361
  - Retentive behavior, 1395
- Instruction
  - Copying, 1375
  - Cutting, 1375
  - Deleting, 1375
  - Inserting, 1375
  - Rules, 1357
  - Specify data type, 1274, 1275, 1315, 1316
  - Versions, 1230
- Instruction profile
  - Activating and deactivating, 1234
  - Basics, 1231
  - Creating, 1232
  - Deleting, 1235
  - Editing, 1233
  - Opening, 1233
- Instructions
  - Function list, 3551
- Instructions for configuring a remote modem, 6223
- INT, 1087, 1131, 1151
- INT\_TO\_, 1151
- Integer, 1759, 2015, 2200
  - 16-bit, 1087, 1088
  - 32-bit, 1089
  - 64-bit, 1090, 1092
  - 8-bit, 1085, 1086
- IntegerDigits property (VBS), 4346
- Integrated
  - Connection, 4939, 4943
- Integrated connection, 3170, 4949
- Integrated project
  - Converting an unspecified CPU, 178
  - Creating an integrated HMI connection, 179
  - Deleting an unspecified connection, 182
  - Linking HMI tags, 181
  - Migrating, 157, 175
  - Post-editing, 177
- Intelligent DP slave, (See I-slave)
- Interconnecting ports
  - Graphic view, 517, 519
  - Table view, 519, 520

- Interface, (See block interface)
  - Adding, 6156
  - Basic Panel, 4960
  - Comfort Panel, 4966
  - Displaying, 973
  - Mobile Panel, 4973
  - Multi Panel, 4970
  - Panel, 4963
  - Renaming, 521
  - WinCC RT Advanced, 4975
  - WinCC RT Professional, 4975
  - WinCC Runtime Advanced, 4975
  - WinCC Runtime Professional, 4975
- Interface properties, 973
- Interference frequency suppression, 943
- Internal
  - Ethernet port, 5372
- Internal Ethernet port
  - Open settings, 5372
- Internal network nodes
  - Configuring, 582
  - Diagnostics, 592
- Internal reference junction, 945
- Internal tags
  - Data exchange, 4915
- Internet Key Exchange (IKE), 577
- Interrupt event
  - Delaying with DIS\_AIRT, 2469
  - Disabling with DIS\_IRT, 2466
  - Enabling with EN\_AIRT, 2469
  - Enabling with EN\_IRT, 2467
- Interrupts
  - Activating time-of-day interrupt with ACT\_TINT, 2450
  - Canceling time-delay interrupt with CAN\_DINT, 2454
  - Canceling time-of-day interrupt with CAN\_TINT, 2449
  - Querying time-delay interrupt with QRY\_DINT, 2455
  - Querying time-of-day interrupt with QRY\_TINT, 2451
  - Receiving from I/O module with RALRM, 2328
  - Setting time-of-day interrupt with SET\_TINT, 2446
  - Setting time-of-day interrupt with SET\_TINTL, 2448
  - Starting time-delay interrupt with SRT\_DINT, 2453
  - With packed addresses, 792
- Interval property (VBS), 4346
- Intrusion Detection System (IDS), 90, 94
- INV, 1796, 2053
- Invalid license
  - With a time zone change, 87, 103
- InverseLinearScaling, 3655, 3833
- Invert, 1590, 1796, 1841, 2053
- InvertBit, 3653, 3834
- InvertBitInTag, 3654, 3835
- InvertLinearScaling, 3655, 3833
- IO device
  - Networking, 811
  - Update time, 814
  - Watchdog time, 815
- IO system, 811
  - Creating, 811
- IO2MOD, 2547
- IOField object, 4021
- IO-Link, 825
- IP access control list, 539
- IP address, 37, 800
  - Reading out, 5284
- IP address parameters, 801, 808
- IP configuration
  - Change parameters from the user program, 2914
- IP packet filter rules, 553
- IP parameters, 973
- IP protocol, 5058
- IP rule sets, 544
- IP services, 547
- IPsec settings, 577
- IPv4 addresses, 558
- IPv6
  - Notation, 687
- IPv6 addresses, 558
- IQ sense, 952
- iQ series, 5373
- IRT (Isochronous Realtime Ethernet), 5305
- ISAKMP, 586
- I-slave, 773, 782
  - Configuring, 783
  - Data access, 783
  - Data exchange, 774
- ISO protocol, 609
- Isochronous mode, 827
- ISO-on-TCP
  - Characteristics, 487
  - TSAP, 496
- ITag, 5869
- ITag method
  - Cancel, 5884
  - ReadTag, 5881
  - ReadTagAsync, 5882
  - ReadTagCyclic, 5883

- Register, 5881
- RemoveCyclicTag, 5883
- Unregister, 5886
- WriteTag, 5884
- WriteTagAsync, 5885
- ITagSink, 5869
- ITagSink methods
  - OnCanceled, 5886
  - OnError, 5888
  - OnRemove, 5888
  - OnUpdate, 5887
  - WriteTagAsync, 5889
- Item methods, 4808
- Item object, 3924
- ItemBorderStyle property (VBS), 4347

## J

- Jerk limiter: Function, 6015
- JMP, 1769, 2026
- JMP\_LIST, 1772, 2029
- JMPN, 1770, 2027
- Job mailbox, 4916
  - Transferring data, 5020, 5096, 5177, 5217, 5456
- Jump, 1769, 1770, 1771, 1772, 1774, 1777, 2026, 2027, 2028, 2029, 2030, 2033
- Jump distributor, 1774, 2030
- Jump label, 1771, 2028, 2225
- Jump list, 1772, 2029
- JumpToLimitsAfterMouseClicked property (VBS), 4348

## K

- Key
  - Backspace, 5698
  - Cursor, 5698
  - Delete, 5698
  - END, 5698
  - ENTER, 5698
  - ESC, 5698
  - HOME, 5698
  - Infotext, 5699
  - Scrolling back, 5698
  - Scrolling up, 5698
  - TAB, 5698
- Key assignment
  - Replacing devices, 5561
- Key operation, 5697, 5700
- Key switch
  - Application, 3133
  - Layout, 3133

- Tag, 3133
- Keyboard operation, 406
  - Basic functions of the TIA Portal, 234
  - Customizing editors, 239
  - Editing objects, 240
  - Editing texts, 241
  - Navigation in the TIA Portal, 237
  - Online functions, 243
  - Project editing, 236
  - Selecting objects, 240
  - Tables, 242
  - Window, 236
- Keyword highlighting, 1349
- Keywords, 1052
- K-key
  - Replacing devices, 5562
- Know-how protection
  - Changing a password, 1459, 3564
  - Converting blocks from V10.5, 49
  - Introduction, 1453
  - opening a user-defined function, 3563
  - Opening blocks, 1457
  - Printing block, 1458
  - remove, 1459, 3563
  - Setting up, 1456, 3562

## L

- LABEL, 1771, 2028
- LabelColor property (VBS), 4348
- LACP, 735
- LAD, 1259, 1553
- LAD element
  - Copying, 1286
  - Cutting, 1287
  - Deleting, 1292
  - Inserting, 1272, 1273
  - Inserting an operand, 1292
  - pasting from the clipboard, 1287
  - Replacing, 1288
  - Rules for inserting, 1270
  - Selecting, 1285
- LAD network
  - Branch, 1295
  - Closing a branch, 1297
  - Crossing, 1298
  - Deleting a branch, 1297
  - Deleting a crossing, 1300
  - Insert crossing, 1298
  - Inserting a block call, 1278, 1319
  - Inserting a branch, 1296
  - Program status display, 1496

- Prohibited interconnections, 1272
- Rearranging a crossing, 1299
- Rules for simultaneous branches, 1296
- Ladder Logic, 1259
- Language
  - Activate project language, 5535
  - Asian languages, 5533
  - Asian operating system, 5533
  - Disabling the project language, 5535
  - Editing language, 5535
  - Language support, 5533
  - Language-dependent format, 5532
  - Language-specific graphic, 5545
  - Log, 3231, 3318, 5555
  - multilingual project , 5537
  - Reference language, 5535
  - Regional format of the date, time, currency, and numbers, 5532
- Language abbreviation, 670
- Language behavior
  - On-screen keyboard, 77
- Language property (VBS), 4349
- Language switching, 670, 5549
  - In Runtime, 3577
  - Log, 3231, 3318, 5555
  - Runtime language, 5552
- Languages
  - Migrating, 150
- LargeTicksBold property (VBS), 4350
- LargeTicksSize property (VBS), 4350
- LastConnectedObjectIndex property (VBS), 4351
- LastConnectedObjectName property (VBS), 4351
- Layer
  - Assigning objects to a layer, 3044
- Layer 2, 543
- Layer 3, 543
- Layer object, 3924
- Layers object (list), 3926
- Layout
  - Alarm report , 3490
  - Recipe report , 3492
  - Alarm indicator, 3120, 3331
  - Alarm line, 3113
  - Alarm view, 3114, 3118, 3325, 3329, 5683, 5685
  - Bar, 3086
  - Button, 3130
  - Charging condition, 3106
  - Circle, 3103
  - Clock, 3151
  - Date/time field, 3089
  - Date/time field in reports, 3486
  - Effective range name, 3152
  - Effective range name (RFID), 3154
  - Effective range signal, 3156
  - Ellipse, 3092
  - f(x) trend view, 3094
  - Gauge, 3159
  - Graphic I/O field, 3097
  - Graphic I/O field in reports , 3489
  - Graphic view, 3096, 3488
  - Handwheel, 3099
  - HTML Browser, 3101
  - I/O field, 3091
  - I/O field in reports, 3487
  - Illuminated pushbutton, 3107
  - Key switch , 3133
  - Line, 3110
  - Media Player , 3111
  - Page number in reports, 3493
  - Polygon, 3121
  - Polyline, 3123
  - Recipe view, 3126
  - Rectangle, 3125
  - Simple Alarm view, 3113
  - Simple recipe view, 3436, 5672
  - Simple user view, 5709
  - Slider, 3132
  - Sm@rtClient view, 3136
  - Status/Force, 3139
  - Switch, 3129
  - Symbol library, 3140
  - Symbolic I/O field, 3142
  - Symbolic I/O field in reports, 3494
  - Text field, 3150, 3495
  - Trend view, 3104
  - User view, 3088, 5707
  - WLAN reception, 3157
  - Zone name, 3160
  - Zone signal, 3161
- Layout of the force table, 1526
- LDT, 1101
- Lead and lag algorithm, 1828, 2086, 2274
- LEAD\_LAG, 1828, 2086, 2274
- Learning functionality, 582
- Learning mode, 608
- LeaveMarginForBorder property (VBS), 4363
- LeaveMarginForMarkers property (VBS), 4364
- LED, 2484
  - Assignment, 5028, 5104, 5184, 5227, 5362, 5393, 5424, 5443
  - Function, 5028, 5104, 5184, 5227, 5362, 5393, 5424, 5443
  - Image, 5028, 5104, 5184, 5227, 5362, 5393, 5424, 5443

- LED ACK, 5681
- LED control, 5644
- LED status
  - Reading out with LED, 2484
- LEFT, 2309
- Left property (VBS), 4364
- LEN, 2308
- Length
  - Area pointer, 4954
  - Area pointers, 4956
- LG GLOFA GM
  - Migrating data types, 163
- LGC\_GADR, 2555
- Library, 5486
  - Adding a master copy, 359
  - Adding and using a block, 1200
  - Basics, 338
  - Buttons and Switches, 5491
  - Cleaning up, 384
  - Comparing library elements, 385
  - Copy template, 5490
  - Copying a library object, 5490
  - Copying types to the clipboard, 380
  - Creating folders, 357
  - Cutting library elements, 380
  - Cutting master copies, 380
  - Cutting types, 380
  - Deleting instances, 381
  - Deleting types and versions, 381
  - Displaying the properties of a type, 365
  - Harmonizing names and path structure, 383
  - Master copies, 338
  - Moving library elements, 381
  - Open, 5494
  - Opening a released type version, 364
  - Pasting master copies from the clipboard, 381
  - Pasting types from the clipboard, 380
  - PLC data types generated by the system, 49
  - Released type version, 363
  - Save, 5493
  - Storing an object, 5500
  - System diagnostics indicator, 3379
  - Task card, 339
  - Type, 5490
  - Type version in progress, 362
  - Type version in testing, 363
  - Types, 338
  - Using filter view, 359
  - Using master copies, 357, 360
  - Using the element view, 342
  - Using types, 361
  - Versioning of types, 361
- Library management
  - Opening, 348
  - Overview, 346
- Library object, 5486, 5488
  - Inserting, 5501
- Library view
  - Exit, 346
  - Opening, 345
  - Overview, 343, 5488
- License
  - Defective, 88, 103
  - Defective license, 88, 103
  - Managing, 5630
  - Starting without valid license, 85, 99
- License key, 87, 102
  - Handling license keys, 87
  - Working with license keys, 102
- License Keys, 5630
- License Manager Panel plug-in, 100
- License key
  - Transfer to an HMI device, 5630
- Licenses, 83
- Licensing
  - General information, 5642
- Life of certificates, 575
- Light emitting diode
  - acknowledge, 5699
  - Toggle, 5699
- LIMIT, 1700, 1954, 2144
- Limit and enable password legitimation, 1778, 2035, 2228
- Limit frequencies of pulse outputs, 6009
- Limit test, 5693, 5701
- Limit value, 935, 1700, 1954, 2144, 3261
  - Tag, 3184
- Limit values
  - Tag, 3183
- Limit4LowerLimit property (VBS), 4367
- Limit4LowerLimitColor property (VBS), 4368
- Limit4LowerLimitEnabled property (VBS), 4368
- Limit4LowerLimitRelative property (VBS), 4369
- Limit4UpperLimit property (VBS), 4369
- Limit4UpperLimitColor property (VBS), 4370
- Limit4UpperLimitEnabled property (VBS), 4371
- Limit4UpperLimitRelative property (VBS), 4371
- Limit5LowerLimit property (VBS), 4372
- Limit5LowerLimitColor property (VBS), 4372
- Limit5LowerLimitEnabled property (VBS), 4373
- Limit5LowerLimitRelative property (VBS), 4374
- Limit5UpperLimit property (VBS), 4374
- Limit5UpperLimitColor property (VBS), 4375
- Limit5UpperLimitRelative property (VBS), 4376

- Line, 3110
  - design, 2966
  - Line end, 2966, 3110
  - Line start, 3110
- Line break, 926
- Line end
  - Line, 3110
  - Polyline, 3123
- Line object, 4025
- Line start
  - Line, 3110
  - Polyline, 3123
- Linear programming, 1020
- LinearScaling, 3672, 3836
- LineWidth property (VBS), 4379, 4380
- Link folder
  - External graphic, 2976
- Linked objects
  - Copying, 5578, 5579
- Linking HMI tags, 181
- LINT, 1090
- Listbox, 4027
- Lists, 3945
- Lists in VBS
  - Alarms object (list), 3913
- Lists:DataSet, 3919
- Lists:Layers, 3926
- Lists:Tags Object (List), 3944
- LLDP, 539, 540
- LLDP (Link Layer Discovery Protocol), 819, 4996, 5066, 5138
- LN, 1704, 1959, 2148
- load
  - Recipe data record in Runtime, 3446
- Load
  - Extended download to device, 76
  - In programming device/PC, 828
  - Loading blocks to device, 1446, 1447
  - SIMATIC PC station, 76
- Load memory, 843, 1481
  - Displaying, 1485
- Load window layout
  - Loading additional window layouts, 231
  - Loading via quick access, 231
- LoadDataImmediately property (VBS), 4381
- LoadDataRecord, 3664, 3837
- Loading
  - Blocks to the device, 1445
  - Downloading blocks to a memory card, 1450
  - Downloading project data to the device, 282
  - Downloading to a memory card, 283
  - from a device, 43, 48, 284
  - General information, 281
  - in RUN operating mode, 1445
  - to the device, 43
  - Uploading blocks from a memory card, 1452
  - USB, 5610
- Loading projects
  - with connected HMI device, 5601
  - without connected HMI device, 5602
- Local assignment
  - Of a function key, 3030, 3034
- Local data bit (L), 843
- Local data byte (LB), 843
- Local data double word (LD), 843
- Local data word (LW), 843
- Local error handling, 1380
  - Error information, 1380
  - Instructions, 1380
  - Priorities, 1381
- Local logging, 587
- Local script, 3541
- Local tag, 1239
  - Access to user-defined VB functions, 3552
- Local time, 856
  - Calculating with SET\_TIMEZONE, 2290
  - Reading out with RD\_LOC\_T, 2288
  - Writing with WR\_LOC\_T, 2288
- LocalCursor property (VBS), 4382
- Localizable property (VBS), 4382
- LockAlarm, 4810
- LockSquaredExtent property (VBS), 4383
- Log
  - Alarm log, 3388
  - Automatic entries, 3390
  - Characters which may be used in tag names, 3221
  - Checksum, 3217, 3230, 3317
  - Data log, 3388
  - Language switching, 3231, 3318, 5555
  - Level-dependent management, 3223, 3320
  - Runtime language, 3231, 3318, 5555
  - Storage on network, 5641
- Log behavior
  - Control with system function, 3226
  - Level-dependent management, 3223, 3320
  - Managing upon system start, 3222, 3319
- Log contents
  - Display, 3216, 3306
- Log data
  - Migrating, 153
- Log database
  - Direct access with ODBC, 3232, 3244, 3314
- Log entries, 3390

- Log file
  - Modem alarms , 6268
- Log language, 3231, 3318, 5555
- Log tag value change
  - Audit Trail, 5782
- Log type, 3305
- Log with level-dependent execution of system functions, 3305
- Log with level-dependent system alarm, 3305
- LOG\_GEO, 2551
- LOG2GEO, 2545
- LOG2MOD, 2546
- Logarithm, 1704, 1959, 2148
- Logging, 587
  - Change to a recipe data record in Audit Trail, 5785
  - Circular log, 3215
  - CP x43-1 Adv., 614
  - Log type, 3215, 3305
  - SCALANCE S, 601, 602
  - Segmented circular log, 3215
  - System functions in Audit Trail, 5791
  - Tag value, 3214
  - Tag value change in Audit Trail, 5782
  - Tags, 3218, 3224
  - Tolerance band, 3224
  - User actions in audit trail, 5788
  - Within/outside the limit values, 3224
- Logging concept
  - Audit , 5757
- Logging cycle, 3224
  - Tag, 3212
- Logging method
  - Circular log, 3215
  - Level-dependent, 3215
- Logging object, 3927
- Logging recipe data changes
  - Audit Trail, 5785
- Logging system functions
  - Audit Trail, 5791
- Logging tag
  - Configuring, 3234
- Logging user actions
  - Audit Trail, 5788
- Logic analyzer function, 6170
- Logic operation
  - AND, 1791, 2048
  - EXCLUSIVE OR, 1794, 2051
  - OR, 1793, 2050
- Logic path
  - Deleting, 1340
  - Inserting, 1339
  - Use, 1338
- Logical address
  - Determining a module with GADR\_LGC, 2553
  - Determining a module with RD\_LGADR, 2552
  - Determining associated slot with LGC\_GADR, 2555
  - Determining associated slot with LOG\_GEO, 2551
- Logical error, 3566
- Logoff, 3618, 3838
  - Configuring on the effective range, 4885
  - Configuring to effective range (RFID), 4888
  - Effective range, 3153
  - Effective range (RFID) , 3155
  - Users, 5712
- LogOff, 3618, 3838
- Logoff time, 5706
  - Changing, 3509
  - Changing in runtime, 3522, 3524
- Logon, 3624, 3839
  - Configuring on the effective range, 4885
  - Configuring to effective range (RFID), 4888
  - Effective range, 3152
  - Effective range (RFID), 3155
  - Logon failed, 3528
  - Reporting, 3532
  - User, 3527
  - Users, 5711
- Logon dialog
  - Configuring access protection, 3531
- Logon for web server, 644
- Logon web server, 644
- LogOperation property (VBS), 4384
- LogTag, 3627
- Long word, 1084
- LookupText, 3742, 3839
- Loop, 2214, 2218, 2220, 2222, 2223, 2224
- Loop-in alarm
  - trigger, 3331
- LoopInAlarm, 4810
- Loop-in-alarm
  - Configured, 3279
- Loop-In-Alarm, 3792
- Low free storage space, 3796, 5769
- LowerLimit property (VBS), 4386
- LowerLimitColor(i) property (VBS), 4386
- LowerLimitValue(i) property (VBS), 4387
- LowLimitColor property (VBS), 4388
- LREAL, 1094, 1136, 1160
- LREAL\_TO\_, 1160
- LTIME, 1098
- LTOD, 1100

LWORD, 1084

## M

MAC packet filter rules, 556

MAC rule sets, 544

MAC services, 550

MachineName property (VBS), 4389

Main, 883

Main mode, 577

managing

    Graphic, 2975

Managing

    License, 5630

    User group, 3510

    Users, 3509

    Users in runtime, 3521, 3523

Manual fragment, 666

Manuals, 405, 4933

MarginToBorder property (VBS), 4389

Math functions

    CALCULATE, 1281, 1322

MAX, 1698, 1952, 2142

MAX\_LEN, 2303

Maximum, 1698, 1952, 2142

Maximum cycle time, 840, 859, 860, 1782, 2039

Maximum length

    Tag, 77

Maximum load memory available

    Displaying, 1485

Maximum number of controllable drives, 6008

MaximumValue property (VBS), 4390, 4391

MB\_CLIENT, 2790, 2808

MB\_COMM\_LOAD, 2774

MB\_MASTER, 2777

MB\_SERVER, 2798, 2819

MB\_SLAVE, 2785

MC\_ChangeDynamic: Instruction, 2586

MC\_ChangeDynamic: Parameter, 2586

MC\_CommandTable: Instruction, 2584

MC\_CommandTable: Parameter, 2585

MC\_Halt: Function chart, 2568

MC\_Halt: Instruction, 2566

MC\_Halt: Parameter, 2566

MC\_Home: Instruction, 2562

MC\_Home: Parameter, 2564

MC\_MoveAbsolute: Function chart, 2571

MC\_MoveAbsolute: Instruction, 2569

MC\_MoveAbsolute: Parameter, 2570

MC\_MoveJog: Function chart, 2583

MC\_MoveJog: Instruction, 2580

MC\_MoveJog: Parameter, 2581

MC\_MoveRelative: Function chart, 2575

MC\_MoveRelative: Instruction, 2572

MC\_MoveRelative: Parameter, 2573

MC\_MoveVelocity: Function chart, 2579

MC\_MoveVelocity: Instruction, 2576

MC\_Power: Function chart, 2560

MC\_Power: Instruction, 2556

MC\_Power: Parameter, 2557

MC\_Reset: Instruction, 2561

MC\_Reset: Parameter, 2561

MCAT, 1820, 2078, 2266

MD5, 578, 625, 635

MDM, 255

Meaning of the columns in the force table, 1526

Measure program runtime, 2241

Measuring window (GATE), 923

Media Player , 3111

Media redundancy (MRP), 5313, 5314, 5315, 5318

MediaControl, 4030

Memory area

    Load memory, 843

    Retentive memory areas, 845

    Work memory, 843

Memory bit (M), 843

Memory byte (MB), 843

Memory card, 841, (See Memory Card)

    Accessing, 336

    Adding a card reader, 335

    Formatting, 994

    Introduction, 335

    Removal/insertion, 43

    Showing properties, 337

Memory cards, 38

Memory double word (MD), 843

Memory medium, 3306

    Audit Trail, 5780

Memory requirements

    Recipe, 5752, 5753

Memory reserve, 49

Memory reset, 841

    Making, 989

Memory size

    Alarm buffer, 3303

Memory space warning, 37

Memory word (MW), 843

Menu command

    Simple recipe view, 3437, 5673

Message

    Sending, 874

    Specifying the end, 875

    Specifying the start, 874

MessageBlockAlign property (VBS), 4395



- MessageBlockAutoPrecisions property (VBS), 4395
- MessageBlockCaption property (VBS), 4396
- MessageBlockCount property (VBS), 4396, 4400
- MessageBlockDateFormat property (VBS), 4397
- MessageBlockExponentialFormat property (VBS), 4397
- MessageBlockFlashOn property (VBS), 4398
- MessageBlockHideText property (VBS), 4398
- MessageBlockHideTitleText property (VBS), 4399
- MessageBlockID property (VBS), 4399
- MessageBlockLeadingZeros property (VBS), 4400
- MessageBlockLength property (VBS), 4401
- MessageBlockName property (VBS), 4401
- MessageBlockPrecisions property (VBS), 4402
- MessageBlockSelected property (VBS), 4402
- MessageBlockShowDate property (VBS), 4403
- MessageBlockShowIcon property (VBS), 4403
- MessageBlockShowTitleIcon property (VBS), 4404
- MessageBlockTextID property (VBS), 4404
- MessageBlockTimeFormat property (VBS), 4405
- MessageBlockType property (VBS), 4405
- MessageColumnAdd property (VBS), 4406
- MessageColumnCount property (VBS), 4407
- MessageColumnIndex property (VBS), 4407
- MessageColumnName property (VBS), 4408
- MessageColumnRemove property (VBS), 4408
- MessageColumnRepos property (VBS), 4332, 4409
- MessageColumnSort property (VBS), 4409
- MessageColumnSortIndex property (VBS), 4410
- MessageColumnVisible property (VBS), 4334, 4410
- MessageListType property (VBS), 4410
- Methods, 4745, 4748, 4749, 4751, 4754, 4755, 4756, 4757, 4758, 4759, 4760, 4761, 4763, 4764, 4765, 4766, 4767, 4768, 4769, 4770, 4772, 4773, 4774, 4775, 4776, 4777, 4779, 4780, 4781, 4782, 4783, 4784, 4786, 4787, 4788, 4790, 4791, 4792, 4793, 4795, 4796, 4797, 4798, 4799, 4800, 4802, 4803, 4804, 4805, 4807, 4810, 4811, 4812, 4813, 4814, 4815, 4816, 4817, 4818, 4819, 4820, 4821, 4822, 4835, 4836, 4837, 4838, 4839, 4840, 4841, 4842, 4843, 4844, 4845, 4846, 4847, 4848, 4849, 4850, 4851, 4852, 4853, 4854, 4858, 4859, 4860, 4861
- Methods (VBS), 4742, 4751
  - Activate, 4742
  - CreateTagSet, 4751
  - Item, 4808
  - Stop, 4851
  - Trace, 4852
- Methods in VBS
  - Create, 4750
  - DeactivateDynamic, 4752
- Methods:Add, 4747
- Methods:Read, 4823
- Methods:Refresh, 4826
- Methods:Remove, 4827
- Methods:RemoveAll, 4831
- Methods:Restore, 4832
- Methods:Write, 4855
- MIB, 539
- Micro, 5403
- MicroLogix, 5330, 5352
- MID, 2311
- Migrated project
  - Compiling, 131
- Migrating projects
  - Procedure, 123
  - Requirements, 123
- Migration, 37
  - Adaptations beforehand, 134
  - Alarm groups, 146
  - Allen-Bradley DF1 data types, 161
  - Allen-Bradley DH485 data types, 162
  - Allen-Bradley Ethernet IP data types, 162
  - Area pointer, 143
  - Basics, 127
  - Data types Modicon Modbus, 165
  - Data types Modicon Modbus TCP/IP, 166
  - Data types Omron Hostlink/Multilink, 166
  - Data types OPC, 167
  - Data types SIMATIC 500/505 DP, 168
  - Data types SIMATIC 500/505 serial, 168
  - Data types SIMATIC HMI HTTP Protocol, 169
  - Data types SIMATIC S5 AS511, 169
  - Data types SIMATIC S5 DP, 170
  - Data types SIMATIC S7 200, 171
  - Data types SIMATIC S7 300/400, 171
  - Data types Telemecanique Uni-Telway, 174
  - Displaying a log file, 125
  - Displaying history, 125
  - Font settings, 140
  - GE Fanuc SNP data types, 163
  - Global library, 152
  - HMI device replacement, 137
  - Including the hardware configuration, 120
  - Integrated project, 175
  - Introduction, 126
  - Introduction to migration, 119
  - LG GLOFA GM data types, 163
  - Migrating an integrated project, 157, 175
  - Migrating projects, 130, 158
  - Mitsubishi FX data types, 164
  - Mitsubishi Protocol 4 data types, 165
  - of external tags, 160
  - of languages, 150

- of log data, 153
- of project text, 150
- Project library, 152
- Recipe data, 153
- Reconfigure connection, 142
- Runtime data, 153
- Script, 149
- Supported HMI devices, 132
- Supported products, 119
- Text, 150
- The migration process, 119
- User administration, 153
- VB-script, 149
- WinCC V7.0 SP3, 60
- Migration tool, 128
  - Creating a migration file, 122
  - Distribution and sources, 117
  - Including the hardware configuration, 121
  - Removing, 118
  - System requirements, 117
  - Using the migration tool, 120
- MIN, 1696, 1950, 2140
- Mini USB, 5610
- Minimum, 1696, 1950, 2140
- Minimum cycle time, 840, 859
- MinimumValue property (VBS), 4411, 4412
- MinuteNeedleHeight property (VBS), 4412
- MinuteNeedleWidth property (VBS), 4413
- Mirroring, 722
- Missing supply voltage, 935, 942
- Mitsubishi, 5320
  - Address, 5374
  - Analog alarm, 5390
  - Basic Panel, 4958
  - Comfort Panel, 4965
  - Communication drivers, 5363
  - Connection interruption, 71
  - FX, 5363
  - Mobile Panel, 4971
  - Multi Panel, 4969
  - Panel, 4961
  - TCP/IP, 5363
  - WinCC Runtime, 4975
- Mitsubishi FX
  - Address areas, 5383
  - Configuring a connection, 5376
  - Connection, 5376, 5380
  - Connection parameters, 5378
  - CPU type, 5383
  - Data type, 5382
  - Migrating data types, 164
  - Mitsubishi MC TCP/IP, 5368, 5381
- Mitsubishi MC TCP/IP
  - Configuring a connection, 5364
  - Connection, 5364, 5367
  - Connection parameters, 5365
  - CPU type, 5373
  - Data type, 5372
- Mitsubishi Protocol 4
  - Migrating data types, 165
- Mixed mode, 579
- Mobile Panel
  - Area pointer, 4974
  - Communication drivers, 4971
  - Display and operating element, 3083
  - HTTP protocol, 4971
  - Interface, 4973
  - Mitsubishi, 4971
  - Modicon Modbus, 4971
  - OPC, 4971, 5891
  - S7 1200, 4971
  - S7 200, 4971
  - S7 300, 4971
  - S7 400, 4971
- Mobile panels
  - Available system functions, 3608
- Mobile Wireless, 4876, 4878
  - Work area, 4876
  - Zone ID / connection point ID, 4891
- Mobile Wireless (RFID)
  - Work area, 4878
- Mobile Wireless V2, 4878
- MOD, 1342, 1690, 1944
- Modbus communication
  - as a slave with MB\_SLAVE, 2785
  - as Modbus master with MB\_MASTER, 2777
  - Configuring a port with MB\_COMM\_LOAD, 2774
- Mode, 3130
  - Graphic I/O field, 3098
  - I/O field, 3091
- Mode property (VBS), 4413
- Modem
  - Local, 6221
  - Problem, 6264
  - Remote, 6222
- Modem alarms
  - Log file, 6268
- Modem connection cannot be established, 6268
- Modem connection is closed, 6268
- Modem connection is interrupted, 6267
  - Causes and solutions, 6267
- Modems without plug-and-play, 6222

- Modicon
  - Approved communication with Modbus RTU, 5411
  - Connection, 5410
  - Connection cable, 5410
  - Restrictions with Modbus RTU, 5411
- Modicon M340, 5403
- Modicon Modbus, 5320
  - Basic Panel, 4958
  - Comfort Panel, 4965
  - Communication drivers, 5393
  - Migrating data types, 165
  - Mobile Panel, 4971
  - Multi Panel, 4969
  - Panel, 4961
  - RTU, 5393
  - TCP, 5393
  - WinCC Runtime, 4975
- Modicon Modbus connection
  - Data types, 5422
- Modicon Modbus RTU, 5416
  - Configuring a connection, 5406
  - Connection, 5406
  - Connection parameters, 5408
  - Data type, 5415
- Modicon Modbus TCP, 5403
  - Configuring a connection, 5394
  - Connection, 5394, 5399
  - Connection parameters, 5396
  - Data type, 5402
- Modicon MODBUS TCP/IP
  - Change word order, 5398
- Modicon Modbus TCP/IP
  - Migrating data types, 166
- Modify
  - High-speed counters, 2588
- Modify value
  - Permitted operands, 1507
- Modifying mode, 1513
- Modifying recipe structures, 3450
- Module
  - Addressing, 637
  - Asynchronously reading data record with RD\_DPARA, 2436
  - Communication Status, 591
  - Configuring and assigning, 43
  - Copying, 425
  - Deleting, 424
  - Determine diagnostics status, 981
  - Determining logical address of the slot with LOG\_GEO, 2551
  - Determining logical address with GADR\_LGC, 2553
  - Determining logical addresses with RD\_LGADR, 2552
  - Determining slot of a logical address with LGC\_GADR, 2555
  - Determining start address with GEO\_LOG, 2549
  - Inserting, 43, 423
  - Moving, 427
  - Reading data record with RD\_DPAR, 2433
  - Removing, 43
  - Replacing, 427
  - Select, 414
  - Time of day on a module, 989
- Module addressing, 847
- Module arrangement, 411
- Module replacement, 178
- Module rights, 539
- Module titles, 413
- Module version
  - Updating, 431
- ModuleStates, 2496
- Momentum, 5403, 5416
- Monitor, 817, 4994, 5064, 5136
- Monitoring
  - "Monitor all" command, 1515, 1537
  - "Monitor now" command, 1538
  - "Monitor once and now" command, 1516
- Monitoring and modifying modes, 1513
- Monitoring mode, 1513, 5816
- Monitoring window, 951
- Mono-master system, 773
- Motion Control CPU S7-1200
  - Guidelines, 6017
- Movable property (VBS), 4414
- Move
  - Block, 1726, 1746, 1981, 2002, 2158, 2187
  - Block uninterruptible, 1731, 1749, 1987, 2005, 2163, 2189
  - Screen, 2939
  - Value, 1717, 1972
- MOVE, 190, 1717, 1972
- Move block, 1728, 1983, 2160
- Move view
  - Keyboard operation, 407
  - Overview navigation, 392, 395, 398, 4920, 4926, 4928
- MOVE\_BLK, 1726, 1981, 2158
- MOVE\_BLK\_VARIANT, 2160
- MOVE\_BLK\_VARIANT:, 1728, 1983
- MoveAxis, 4811
- MoveToFirst, 4811

- MoveToFirstLine, 4812
- MoveToFirstPage, 4812
- MoveToLast, 4813
- MoveToLastLine, 4813
- MoveToLastPage, 4814
- MoveToNext, 4814
- MoveToNextPage, 4815
- MoveToPrevious, 4816
- MoveToPreviousLine, 4816
- MoveToPreviousPage, 4817
- Moving
  - Hardware components, 427
- MPI, 4934
  - Addressing, 5165
  - Connection, 5189
  - HMI connection, 5153, 5157, 5158
  - Network, 4936
  - Network architecture, 4936
  - Parameters, 5160, 5162, 5163
  - S7 200, 5196, 5205
  - S7 300/400, 5153, 5155, 5157, 5158
  - WinCC RT Advanced, 5155
- MPI address
  - S7 300, 5165
  - S7 400, 5165
- MPI communication
  - S7 300/400, 5153, 5155
- MPI parameters
  - S7 300/400, 5160, 5162, 5163
- MRP (Media Redundancy Protocol), 5313, 5314
- MRP domain, 976, 5315, 5318
- MRP domain properties, 976
- MsgFilterSQL property (VBS), 4415
- MSK\_FLT, 2463
- MSTP, 732
  - Port, 729
- MUL, 1688, 1941
- Multi Panel
  - Area pointer, 4970
  - Communication drivers, 4969
  - Display and operating element, 3081
  - HTTP protocol, 4969
  - Interface, 4970
  - Mitsubishi, 4969
  - Modicon Modbus, 4969
  - OPC, 4969, 5891
  - S7 1200, 4969
  - S7 200, 4969
  - S7 300, 4969
  - S7 400, 4969
- Multi Panel
  - Omron, 4969, 4971

- Multi Panels
  - Available system functions, 3596
- Multicast, 565, 742
- Multi-instance
  - Declaring, 1250
  - Definition, 1035
- Multi-key operation, 80
- MultiLineEdit, 4032
- Multiple instance, 1061
  - Correcting the call type, 1281, 1322
- Multiple selection, 414, 2969, 3477
- Multiple Spanning Tree, 729, 732
- Multiplex, 1801, 2058, 2247
- Multiplex/synchronous mode, 956
- Multiplexing, 3197
  - Address multiplexing, 3190
  - Address multiplexing Allen-Bradley Ethernet IP, 5334
    - with absolute addresses, 3190
    - with symbolic addresses, 3191
- Multiply, 1688, 1941
- Multi-point connection
  - Allen-Bradley DF1, 5345, 5346
- MUX, 1801, 2058, 2247
- My Documentation Manager, 255

## N

- N, 1599, 1602, 1851, 1853
- N\_TRIG, 1604, 1856
- Name
  - Array element, 67
- Names of alarm classes
  - Change through migration, 147
- NAT/NAPT
  - Routing, 564
- NeedleBorderColor property (VBS), 4418
- NeedleColor property (VBS), 4418
- NeedleFillStyle property (VBS), 4419
- NEG, 1691, 1945
- Negate, 1691, 1945
- Negotiation, 706
- Nesting depth, 1033
- Network, 4909
  - Closing, 1266, 1308
  - Copying, 1265, 1307
  - Deleting, 1266, 1307
  - Entering a comment, 1268, 1310
  - Entering a title, 1267, 1309
  - Ethernet, 4935
  - Inserting, 1263, 1265, 1305, 1307
  - MPI, 4936

- Navigating blocks, 1269, 1311
    - Opening, 1266, 1308
    - PPI, 4937
    - PROFIBUS, 4935
    - PROFINET, 4935
    - Selecting, 1264, 1306
    - Using, 1263, 1305
  - Network access
    - Opening the properties, 6155
  - Network adapter, 613
  - Network architecture
    - PPI, 4937
  - Network comments
    - Hiding, 1228
    - Showing, 1228
  - Network drive, 38
    - Storing logs, 5641
  - Network editor
    - Components, 389, 4917
    - Function, 389, 4917
    - Hardware catalog, 403, 4931
    - Inspector window , 402, 4929
  - Network ID, 605
  - Network overview
    - Basic functions, 436
    - Basic functions for editing the network overview table, 436
  - Network Syslog, 587
  - Network view, 4938
    - Adding device, 419
    - Hardware and network editor, 391, 4919
  - Networking
    - Communication partners, 4938
    - Devices, 4938
  - Networking devices
    - Basics of configuring networks, 432
    - Editing interface parameters, 438
    - Editing network parameters, 438
    - Networking several interfaces at the same time, 434
    - Networking with an existing subnet, 435
    - Networking without an existing subnet, 433
    - Networks within a project, 432
    - Requirements, 437
    - Types of communication, 432
  - Networking in the device view
    - Networking options, 436
    - Procedure, 437
  - New data types, 184
  - NextColumn, 4817
  - NextTrend, 4818
  - Nodes with an unknown IP address, 580
  - Non-integrated
    - Connection, 4943
  - Non-licensed mode
    - Engineering system, 99
    - ES, 85
    - HMI devices, 101
    - Runtime, 100
  - NORM\_X, 1763, 2019, 2204
  - Normal range visible, 3160
  - Normalize, 1763, 2019, 2204
  - Normally closed contact, 1589
  - Normally open contact, 1588
  - NormalRangeColor property (VBS), 4420
  - NormalRangeVisible property (VBS), 4420
  - NOT, 1346, 1347, 1590
  - NOT\_OK, 1681, 1934
  - NotifyUserAction, 3637, 3840, 5790
  - NTP, 742
  - NTP (secure), 570
  - NTP server, 570
  - NumberOfValues(i) property (VBS), 4421
  - Numerical
    - Screen keyboard, 5693
  - Numerical key assignment, 5699
  - Numerical value
    - Changing, 5694, 5701
    - Decimal places, 5694
    - Display format, 5693, 5701
    - Entering, 5694, 5701
    - Limit test, 5693, 5701
- O**
- O, 6144
  - OB
    - Events and OBs, 848
    - Overview, 848
  - OB 1, 883
  - OB 80, 892
  - OB 82, 893
  - OB for manufacturer-specific interrupt, 888
  - OB for profile-specific interrupt, 888
  - OB 83, 895
  - object
    - Group, 2980
    - Paste, 2967, 3472
    - Rotate, 2963, 3481
  - Object
    - Arrange, 2953, 2962, 3475
    - Assigning to a layer, 3044
    - Availability for Basic Panels, 3077
    - Availability for Comfort Panels, 3080

- Availability for Mobile Panels, 3083
- Availability for Multi Panels, 3081
- Availability for Panels, 3078
- Availability for WinCC Runtime Advanced, 3084
- Creating a new OLE object, 2954
- Creating an OLE object from a file, 2954
- Deleting, 2956, 3471
- Design, 2966
- Dynamization, 3007
- Dynamization of the appearance, 3014
- Dynamize direct movement, 3017
- editing within a group, 2984
- Evenly distributing, 2961, 3480
- Flashing, 2966
- Flip, 2953
- Flush alignment, 2960, 3480
- Grouping, 2980
- Inserting, 2953, 2954, 3469
- Inserting of the same type, 2953
- Inserting several times, 2967, 3472
- Multiplying, 2967, 3472
- outside the area, 2963
- Referencing, 3554
- Repositioning and resizing multiple objects, 2954, 2971, 3479
- Repositioning objects, 2957, 3473
- Resize, 2959, 3476
- Rotate, 2953, 2963, 3481
- Select multiple objects, 2969, 3477
- Selecting multiple objects, 2954
- Storing in a library, 5500
- Tab sequence, 2953
- Object group
  - Animation, 3022, 3023
  - Editing an object within a group, 2984
  - Removing an object, 2983
- Object list
  - Tag, 3174
- Object names
  - Renaming upon migration, 127
  - Uniqueness, 127
- Object properties
  - Dynamization, 3007
- Object size
  - Harmonizing, 2959, 3477
- ObjectName property (VBS), 4422
- Objects
  - Page number , 3493
  - Alarm report, 3489
  - Recipe report, 3492
- Objects (VBS)
  - ActiveScreenItem, 4151
  - AlarmControl object, 3947
  - AlarmView, 3958
  - ApplicationWindow, 4080
  - Bar, 3962
  - Battery, 3967
  - BrowserView, 4019
  - Button, 3968
  - ChannelDiagnose, 3973
  - CheckBox, 3974
  - Circle, 3977
  - CircleSegment, 3979
  - CircularArc, 3982
  - Clock, 3984
  - Connector, 3986
  - DateTimeField, 3989
  - DiskSpaceView, 3991
  - Ellipse object, 3993
  - EllipseSegment, 3995
  - EllipticalArc, 3998
  - FunctionTrendControl, 4004
  - Gauge, 4008
  - GraphicIOField, 4011
  - GraphicView, 4014
  - Group object, 4017
  - HMIRuntime, 3903
  - IOField object, 4021
  - Line, 4025
  - Listbox, 4027
  - MultiLineEdit, 4032
  - OLEView object, 4035
  - OnlineTrend Control, 4045
  - OptionGroup, 4054
  - Polygon, 4057
  - Polyline, 4060
  - ProjectName object, 4062
  - ProtectedAreaName, 4064
  - RangeLabelView, 4065
  - RangeQualityView, 4067
  - Rectangle, 4074
  - RoundButton, 4074
  - Screen, 3905, 3930
  - Screen object (list), 3904
  - ScreenItem, 3906, 3932
  - ScreenItems (list), 3908, 3934
  - ScreenWindow, 4078
  - Slider, 4084
  - SmartClientView object, 4085
  - SmartTag, 3911, 3938
  - SmartTags (list), 3910, 3940
  - StatusForce, 4087
  - Switch, 4089
  - SymbolicIOField, 4093

- SymbolLibrary, 4098
- SystemDiagnoseView, 4100
- SystemDiagnoseWindow, 4104
- TableView object, 4037
- TextField, 4107
- TrendRulerControl, 4110
- TrendView, 4118
- TubeArcObject, 4121
- TubeDoubleTeeObject, 4123
- TubePolyline, 4125
- TubeTeeObject, 4128
- UserArchiveControl object, 4130
- UserView, 4137
- WindowSlider, 4140
- WLanQualityView, 4142
- ZoneLabelView, 4143
- ZoneQualityView, 4144
- Objects in VBS
  - Alarm object, 3912
- Objects:AlarmLogs, 3915
- Objects:Dataltem, 3916
- Objects:DataLogs, 3918
- Objects:HMIRuntime, 3922
- Objects:Item, 3924
- Objects:Layer, 3924
- Objects:Logging, 3927
- Objects:Tag, 3941
- Obtaining user rights
  - Logging on to the operating system with administrator privileges, 245
  - With Windows user account control, 245
- OCXState property (VBS), 4426
- OF, 2216
- Off delay, 1612, 1621, 1639, 1648, 1864, 1890, 1900, 2102, 2122
- Offline, 526
  - Recipe tag, 5656
- OK, 1680, 1933
- OLE object
  - create from a file, 2954
  - Recreate, 2954
  - Save in Graphics, 2977
  - Storing in the image browser , 5547
- OLEView object, 4035
- Omron, 5320
  - Analog alarm, 5441
  - Basic Panel, 4958
  - Comfort Panel, 4965
  - Communication drivers, 5425
  - Data type, 5440
  - Host Link, 5425
  - Mobile Panel, 4971
  - Multi Panel, 4969
  - Panel, 4961
  - Trend, 5440
  - WinCC Runtime, 4975
- Omron Host Link, 5435
  - Address, 5436
  - Configuring a connection, 5426
  - Connection, 5426, 5430
  - Connection cable, 5430
  - Connection parameters, 5428
  - Data type, 5434
- Omron Hostlink/Multilink
  - Migrating data types, 166
- On delay, 1610, 1619, 1634, 1645, 1862, 1885, 1896, 2099, 2117
  - Retentive, 1637, 1646, 1888, 1898, 2119
- On demand, 3187
- Ones complement, 1796, 2053
- OneToOneView, 4818
- Online, 526
  - Hardware detection, 421
  - Recipe tag, 3401, 5656
- Online access, 6153
- Online and Diagnostics view, 960
- Online connection, 6144
  - Multiple TIA Portal instances, 43
- Online diagnostics, 588
- Online displays
  - Orange color, 969
- Online mode, 6144
  - Canceling an online connection, 6148
  - Display of the online mode, 6145
  - Displaying accessible devices on an interface, 6141
  - Displaying all accessible devices as a list, 6141
  - Go online, 6147
  - Standby or hibernation of the programming device / PC, 6144
- Online operation, 35, 43
- Online property (VBS), 4426
- Online Tools, 960, 970
- OnlineTrendControl, 4045
- OP 177B mono
  - Symbol library, 3141
- OP 73
  - Baud rate on PROFIBUS, 5034, 5113, 5194, 5196, 5203, 5205, 5206
- OP 77A
  - Baud rate on PROFIBUS, 5034, 5113, 5194, 5196, 5203, 5205, 5206
- OP 77A and TP 177A
  - Differences in the recipe, 3402

- OP73
  - Loading a project, 76
- OP77A
  - Loading a project, 76
- OPC, 5294, 5890
  - Accessing tags, 5901
  - Basic Panel, 4958
  - Basics, 5294
  - Comfort Panel, 4965
  - Communication, 5294
  - Compatibility, 5890
  - Configuring a connection, 5294
  - DCOM user rights, 5894
  - HMI device as OPC client, 5892
  - HMI device as OPC server, 5892
  - HTTP connection, 5891
  - Migrating data types, 167
  - Mobile Panel, 4971, 5891
  - Multi Panel, 4969, 5891
  - OPC XML DA Server, 5891
  - Panel, 4961
  - Permitted characters in tag names, 5901
  - Permitted data type, 5900
  - Specifications, 5890
  - WinCC Runtime, 4975
- OPC DA
  - Data types, 5296
- OPC DA server
  - Creating a connection, 5895
  - ProgID, 5891
- OPC DA Server
  - Configuring HMI device as ~, 5893
- OPC Gateway
  - Proxy setting, 5898
- OPC server
  - Accessibility, 5891
- OPC UA
  - Data types, 5297
- OPC UA Server
  - Creating a connection, 5897
- OPC XML
  - "Date/Time" data type, 5901
  - "STRING" data type, 5901
  - Configuring server, 5899
  - Permitted cycle time, 5901
- OPC XML DA
  - Data types, 5297
  - Deleting a server, 5899
  - Editing a server, 5899
- OPC XML DA Client, 5891
- OPC XML DA Server
  - URL, 5891
- Open
  - Global library, 5494
  - Selection list, 5698
- Open a project, 260
- Open log file
  - Packet filter events, 594, 596
  - Security events, 593, 595
  - System events, 593, 595
- Open User Communication
  - Changing parameter values, 494
  - Ability to read back, 495
  - Changing IP configuration parameters with T\_CONFIG, 2914
  - Connection configuration, 473, 475
  - Connection description, 488, 491, 492
  - Connection establishment, 473
  - Connection parameters, 478
  - Creating a connection, 482
  - Deleting an interconnection, 485
  - Establishing a communication connection with TCON, 2877, 2880
  - Establishing a connection and reading data with TRCV\_C, 2854, 2859
  - Establishing a connection and sending data with TSEND\_C, 2843, 2847
  - General, 472
  - Instructions, 473
  - Port numbers, 494
  - Protocols used, 486
  - Receiving data via UDP with TURCV, 2904
  - Receiving data with TRCV, 2892, 2896
  - Sending data via UDP with TUSEND, 2901
  - Sending data with TSEND, 2886, 2889
  - Starting connection parameter assignment, 481
  - TCON\_IP\_RFC, 492
  - TCON\_IP\_v4, 491
  - TCON\_Param, 488
  - Terminating a communications connection with TDISCON, 2884
  - TSAP, 496
- OpenAllLogs, 3682, 3842
- OpenCommandPrompt, 3685, 3842
- OpenControlPanel, 3687
- OpenControlPanelDialog, 3684, 3843
- OpenFileBrowser, 3683
- Opening a force table, 1529
- Opening a watch table, 1504
- Opening for the first time, 35
- Opening phone books, 6213
- OpenInternetExplorer, 3686, 3844
- OpenScreenKeyboard, 3683, 3845
- OpenTaskManager, 3688, 3845



- Operability
  - Dynamization, 3018
- Operand, 1049, 1051, 1052, 1057, 1058, 1059, 1061, 1062, 1064, 1065, 1076
  - Inserting, 1292, 1333
- Operand area, 843
- Operate recipe
  - Change recipe data record, 3446
- Operating
  - Key, 5700
  - Runtime using the keyboard, 5704
  - Runtime with mouse, 5705
- Operating behavior
  - Enabling system memory, 876
  - Using clock memory, 877
  - Using time-of-day functions, 862
- Operating element
  - Availability for Basic Panels, 3077
  - Availability for Comfort Panels, 3080
  - Availability for Mobile Panels, 3083
  - Availability for Multi Panels, 3081
  - Availability for Panels, 3078
  - Availability for WinCC Runtime Advanced, 3084
  - operation, 5698
  - Recipe view, 3443, 5659
- Operating mode, 613
  - , 5240
  - Introduction, 834
  - RUN, 840
  - STARTUP, 836
  - STOP, 840
  - Transitions, 835
- Operating recipes
  - Change recipe data record, 3446
  - Copying a recipe data record, 3445
  - Creating a recipe data record, 3440
  - Creating recipe data records, 3440, 3441, 3445
  - Delete recipe data record, 3446
  - Load recipe data record, 3446
  - Modifying the recipe structure, 3450
  - Read recipe data record, 3441, 3447
  - Transfer data record, 3442, 3448
- Operating system
  - Asian language setting, 5533
  - Setting to Western, 5533
- Operating system , 1019
- operation
  - Key, 5697
  - Operating element, 5698
- Operation
  - Alarm indicator, 3331
  - Alarm view, 3326, 5683
  - Alarm window, 3326, 5683
  - Feedback, 5690
  - Recipe view, 3443, 5659
  - Simple alarm view, 3329, 5685
  - Simple recipe view, 3436, 5672
  - Simple user view, 5710
- Operation feedback, 5690
- Operation in runtime
  - Multi-key operation, 80
- Operation using the keyboard
  - Alarm view, 3327
  - Alarm window, 3327
  - Simple alarm view, 3330
- Operation using the mouse
  - Alarm indicator, 3332
  - Alarm view, 3327
  - Alarm window, 3327
  - Simple alarm view, 3330
- Operation with the keyboard
  - Recipe view, 3444, 5660
- Operation with the mouse
  - Recipe view, 3444, 5660
- OperationSteps property (VBS), 4427
- Operator input in the recipe view
  - Transferring data, 5095, 5176, 5216, 5455
- OperatorMessageID property (VBS), 4428
- OperatorMessageIndex property (VBS), 4428
- OperatorMessageName property (VBS), 4429
- OperatorMessageNumber property (VBS), 4430
- OperatorMessageSelected property (VBS), 4430
- OperatorMessageSource1 property (VBS), 4430
- OperatorMessageSource10 property (VBS), 4435
- OperatorMessageSource2 property (VBS), 4431
- OperatorMessageSource3 property (VBS), 4431
- OperatorMessageSource4 property (VBS), 4432
- OperatorMessageSource5 property (VBS), 4432
- OperatorMessageSource6 property (VBS), 4433
- OperatorMessageSource7 property (VBS), 4434
- OperatorMessageSource8 property (VBS), 4434
- OperatorMessageSource9 property (VBS), 4435
- OperatorMessageType1 property (VBS), 4435
- OperatorMessageType10 property (VBS), 4440
- OperatorMessageType2 property (VBS), 4436
- OperatorMessageType3 property (VBS), 4436
- OperatorMessageType4 property (VBS), 4437
- OperatorMessageType5 property (VBS), 4437
- OperatorMessageType6 property (VBS), 4438
- OperatorMessageType7 property (VBS), 4438
- OperatorMessageType8 property (VBS), 4439
- OperatorMessageType9 property (VBS), 4439
- Optical feedback, 5690
- Optimized access, 1027, 1029

- Optimized block access, 183
- Optimizing the configuration
  - Allen-Bradley DF1, 5337, 5354, 5375, 5386, 5405, 5417, 5437
- Option
  - Installing, 5632
  - Uninstalling, 5632
- Option handling, 788, 791, (See Configuration control (ET 200SP))
- OptionGroup object, 4054
- OR, 1347, 1793, 1837, 1838, 2050
- Organization block (OB)
  - Assigning event with ATTACH, 2441
  - Canceling event assignment with DETACH, 2442
  - Creating, 1197
  - Cyclic interrupt OB, querying parameters with QRY\_CINT, 2445
  - Cyclic interrupt OB, setting parameters with SET\_CINT, 2443
  - exporting to an external source file, 1420
  - Function, 1022
  - Reading start information with RD\_SINFO, 2475
  - Start information, 1022
- Orientation property (VBS), 4440
- OSPF
  - Area range, 758
  - Areas, 757
  - Configuration, 756
  - Interfaces, 759
  - Virtual Links, 761
- Other PLCs
  - Addressing, 5321
  - Data types, 5321
  - Special features, 5321
- OUT\_RANGE, 1679, 1932
- Outgoing, 3252, 3791
- Output
  - Inserting, 1289, 1329
  - remove, 1290, 1330
- Output (O), 843
- Output byte (QB), 843
- Output double word (QD), 843
- Output fields
  - Multiplex tag, 68
- Output word (QW), 843
- Overflow, 927, 935, 3795
- Overlay icon, 967
- Overlaying
  - Tag, 1065
- Overlaying tags, 1249
- Override function, 3156

- Overview
  - using the display formats in the force table, 1533
  - via the display formats in the watch table, 1509
- Overview navigation, 392, 395, 398, 4920, 4926, 4928
- Overview of the cross-reference list, 1488
- Overview of TS Adapters that can be used, 6220
- Overview window, 56, 226
  - Comparing objects, 228
  - Display all blocks, 229
  - Showing and hiding columns, 229
  - Sorting details view, 229

## P

- P, 1598, 1601, 1850, 1852
- P\_TRIG, 1603, 1854
- Pack&Go file, 5607
- Packet filter log, 594, 596
- Page
  - Deleting report page, 3468
  - Sorting report page, 3468
  - Adding to report, 3467
  - Maximum number of configurable in report, 3465
- Page number
  - Layout in reports, 3493
- PageDown, 3704, 3846
- PageMode property (VBS), 4442
- PageModeMessageNumber property (VBS), 4442
- PageUp, 3705, 3846
- Pane mode, 223
- Panel
  - Area pointer, 4964
  - Communication drivers, 4961
  - Display and operating element, 3078
  - HTTP protocol, 4961
  - Interface, 4963
  - Mitsubishi, 4961
  - Modicon Modbus, 4961
  - Omron, 4961
  - OPC, 4961
  - S7 1200, 4961
  - S7 200, 4961
  - S7 300, 4961
  - S7 400, 4961
- Panels
  - Available system functions, 3590
- Panning, (See move view)
- Parallel communication
  - Communication drivers, 4977, 5321
- Parameter
  - For CPU, 856

- Hidden parameters, 1294, 1334
  - Predefined - writing with WR\_DPARM, 2439
  - SIMATIC LOGO!, 5230
- Parameter assignment, 1038
- Parameter transfer, 1037, 1039, 1041, 1043, 1045, 1046, 1047, 1048
  - User-defined function, 3556
- Parameter types, 1117
- Parameters
  - Client, 5283
  - Connection, 5325, 5339, 5365, 5378, 5396, 5408, 5428
  - MPI, 5160, 5162, 5163
  - PROFIBUS, 5004, 5006, 5007, 5075, 5077, 5078, 5147, 5149, 5150
  - S7 1200, 5110
  - S7 1500, 5033
  - S7 200, 5191, 5196, 5200, 5205, 5206
  - Tags, 5286
- Parent property (VBS), 4443
- Password, 5706
  - Backing up, 5707
  - Changing, 3509
  - Changing in runtime, 3522
  - For CPU access protection, 856
  - for function key, 3036
  - Hierarchy level, 3501, 3503
  - HMI connection, 4992, 5009, 5063, 5081
  - Password aging, 3502
  - Password complexity, 3502, 3504
  - Restoring, 5707
  - SmartServer, 5826
- Password legitimation, 1778, 2035, 2228
- Password list, 5706
- Password property (VBS), 4445
- Password protection, 644, 856, 878, 879
  - Protection concept, 298
  - Revoking access rights, 299
- PasteRows, 4819
- Pasting
  - Adjusting screen size, 5577
  - Color, 5576
  - Font, 5576
  - Function key, 5577
  - Invalid object, 5576
  - Principle, 5574
- PC
  - HMI connection, 4983, 5001, 5053, 5073, 5126, 5143, 5158
  - S7 1500, 4983
  - S7 300/400, 5126
  - WinCC RT Professional, 4983, 5001
  - WinCC RT Advanced, 4983, 5001
- PC CP, 525
- PE\_CMD, 2397
- PE\_DS3\_Write\_ET200S, 2402
- PE\_End\_RSP, 2421
- PE\_Error\_RSP, 2419
- PE\_Get\_Mode\_RSP, 2424
- PE\_I\_DEV, 2415
- PE\_List\_Modes\_RSP, 2423
- PE\_Measurement\_List\_RSP, 2429
- PE\_Measurement\_Value\_RSP, 2430
- PE\_PEM\_Status\_RSP, 2426
- PE\_Start\_End, 2393
- PE\_Start\_RSP, 2420
- PEEK, 2177
  - Read memory address, 2177
- PEEK\_BOOL, 2179
  - Read memory bit, 2179
- Perfect Forward Secrecy, 578
- Performance, 183
- Performance features
  - Engineering system, 5725
  - HMI device, 5727, 5730, 5734, 5739, 5742, 5747
  - WinCC Runtime, 5747
- Permanent connection, 675
- Permanent station, 675
- Permanent window, 2945
- Permit access with PUT/GET communication from remote partners, 882
- Permitted characters
  - User view, 77
- Permitted data type
  - OPC, 5900
  - SIMATIC HMI HTTP Protocol, 5855
- Permitted data types
  - Trends, 5025, 5101, 5182, 5224, 5236
- Permitted operands for the force table, 1531
- Permitted operands for the watch table, 1506
- PersistentRTAuthorization property (VBS), 4446
- PersistentRTCAuthorization property (VBS), 4446
- PersistentRuntime property (VBS), 4447
- PersistentRuntimeAuthorization property (VBS), 4448
- PersistentToDownload property (VBS), 4448
- PersistentToDownloadAuthorization property (VBS), 4449
- PG/PC interface
  - Go online, 6147
  - Modifiable MPI interface parameters, 6161
  - Modifiable PROFIBUS interface parameters, 6161
- Picture property (VBS), 4451

- PictureDeactivated property (VBS), 4452
- PictureOff property (VBS), 4453
- PictureOn property (VBS), 4453
- PID\_3Step
  - In/out parameters, 2650
  - Input parameters, 2646, 2677
  - Instruction, 2637, 2669
  - Output parameters, 2648, 2678
  - Static tags, 2679
- PID\_Compact
  - Input parameters, 2599, 2621
  - In/out parameters, 2601
  - Instruction, 2618
  - Output parameters, 2600
  - Static tags, 2602, 2623
- Pin assignment
  - 6XV1440 - 2P for Mitsubishi PG protocol, 5381
  - Allen-Bradley, 5346
  - Allen-Bradley cable 1747-CP3, 5348
  - Allen-Bradley cable 1761-CBL-PM02, 5349
  - Allen-Bradley cable 1784-CP10, 5347
  - Multipoint cable 1:MP/TP/PC, 5432
  - Multipoint cable 2:RS422, MP/TP/PC, 5433
  - Point-to-point cable 1,
  - Point-to-point cable 2, 5414
  - Point-to-point cable PP1 for Omron, 5433
  - Point-to-point cable PP2 for Omron, 5434
- PLC
  - Connecting, 5327, 5367, 5380, 5399, 5430
  - Enabling system diagnostics, 3379
  - MPI parameters, 5163
  - PROFIBUS parameters, 5007, 5078, 5150
  - PROFINET parameters, 4990, 5058, 5132
  - Reading recipe data record, 5668, 5669, 5678
  - System diagnostics view, 3379
  - Tag, 3190
  - Transferring recipe data record, 5670, 5671, 5677
- PLC data type
  - Addressing, 1063
  - Comparing, 1437
  - Creating, 1411
  - Declaration in data blocks, 1392
  - Declaration in the block interface, 1248
  - Declaration table for PLC data types, 1410
  - Declaring, 1414
  - Declaring ARRAY, 1412
  - Declaring STRUCT, 1413
  - Definition, 1118, 1409
  - Deleting, 1411
  - Offline/offline comparison, 1427
  - PLC data types generated by the system in libraries, 49
  - Programming the structure, 1412
  - Tag properties, 1415
- PLC data types, 184
- PLC tag
  - Importing and exporting, 1549, 1550, 1551
  - Automatically filling in cells, 1195
  - Comparing, 1435
  - Comparing a PLC tag table, 1427
  - Comparison, 1423
  - Copying, 1193
  - Declaring, 1180, 1181, 1184, 1186
  - Definition, 1050
  - Monitor, 1192
  - Offline/offline comparison, 1427
  - Permissible addresses and data types, 1178
  - PLC tag table, 1172, 1173, 1179, 1180
  - Properties, 1189, 1190
  - reconnecting, 3182
  - Retentive behavior, 1182, 1183
  - Rules, 1178
  - Sorting rows, 1194
  - Updating comparison results, 294
- PLC tags, 652, 653, 655
- PLC5, 5352
- PN/PN couplers
  - Grouping, 824
  - Linking Ethernet subnets, 824
- Pointer
  - ANY, 1113
  - POINTER, 1111
  - VARIANT, 1115
- POINTER, 1111
- Pointer name
  - Area pointer, 4954
- PointerColor property (VBS), 4455
- PointsCount property (VBS), 4456
- Point-to-point communication (PtP), 868
  - Freeport protocol, 868
- Point-to-point connection
  - Allen-Bradley DF1, 5344
  - Configuring communication parameters with PORT\_CFG, 2744
  - Configuring receive parameters with RCV\_CFG, 2749
  - Configuring serial transmission parameters with SEND\_CFG, 2747
  - Deleting receive buffer with RCV\_RST, 2759
  - Enable receiving with RCV\_PTP, 2757
  - Initiating data transfer with SEND\_PTP, 2755
  - Querying the signal state with SGN\_GET, 2759

- Setting output signals with SGN\_SET, 2760
- POKE, 2181
  - Write memory address, 2181
- POKE\_BLK, 2184
  - Write memory area, 2184
- POKE\_BOOL, 2183
  - Write memory bit, 2183
- Polygon, 3121
  - Configuring corners, 3121
  - Layout, 3121
  - Radii, 3121
- Polygon object, 4057
- Polyline, 3123
  - Configuring corners, 3123
  - Line end, 3123
  - Line start, 3123
  - Radii, 3123
- Polyline object, 4060
- Port
  - 102 (S7 protocol - TCP), 547
  - 123 (NTP), 565, 569
  - 161 (SNMP), 565
  - 20/21 (FTP), 547
  - 443 (HTTPS), 565
  - 4500 (IPsec), 565
  - 500 (IPsec), 565
  - 500 (ISAKMP - UDP), 586
  - 514 (Syslog), 565
  - 80 (HTTP), 547
  - 8448 (security diagnostics), 628
  - Configuration, 707
  - Interconnecting, 813
  - Port configuration, 706, 708
  - Renaming, 521
- Port configuration, 708
- Port numbers, 494
- Port options, 818, 4995, 5065, 5137
  - Enable autonegation, 817, 4994, 5064, 5136
  - Monitor, 817, 4994, 5064, 5136
  - Transmission medium/duplex, 816
  - Transmission rate / duplex, 4994, 5064, 5136
- PORT\_CFG, 2744
- Portal view, 204
- Position
  - Editing multiple objects, 2971, 3479
  - Of objects, 2957, 3473
  - of objects in the report, 3465
- Possible cause of error
  - Transferring data, 5022, 5098, 5179, 5219, 5458
- Power budget, 941
- Power Management, 4890
- Powerpack, 104, 105
  - Engineering system, 104
  - Installing, 105
  - Runtime, 104
- PPI, 4934
  - Network, 4937
  - Network architecture, 4937
  - S7 200, 5206
- Precision property (VBS), 4457
- Predefined alarm classes, 3254, 3255
- Predefined firewall rules
  - CP 1543-1, 628
  - CP 1628, 617
  - CP x43-1 Adv., 615
  - SCALANCE S, 601, 602
- Premium, 5403
- Prerequisites for establishing a VPN connection, 6249
- Preshared keys, 576
- Press, 3790
- Press ESC twice, 3790
- Press key, 3794
- PressButton, 3698
- Pressed property (VBS), 4457
- PreviousColumn, 4819
- PreviousTrend, 4820
- Print, 4820
- Print alarm
  - Configuring print parameters, 5773
- Print scope, 301
- Print server, 5751
- Printable contents, 301
- PrintConfiguration property (VBS), 4458
- Printing
  - Alarms, 5644
  - Audit Trail, 5770
  - Changing the settings, 302
  - Creating a cover page, 307
  - Creating frames, 306
  - Documentation settings, 299
  - Elements in the library, 305
  - Elements in the project tree, 305
  - Non-printable contents, 301
  - Non-printable objects, 302
  - Print contents, 304
  - Print server, 5751
  - Printing device view, 399
  - Printing network view, 399
  - Process a cover page, 308
  - Process borders, 308
  - Report, 3468, 3484
  - Runtime, 5644
  - Screen, 5644

- Specify layout, 303
- Specify print layout, 303
- Specifying the print area, 312
- Structure of printout, 300
- Use borders, 305
- Use borders and cover pages, 300
- Use cover page, 303
- Printing a project, 318
- Printing labels, 321
  - Determining the correction value for the print shift, 323
- Printing of alarms
  - Configuring:printing of alarms, 3283
- PrintJobName property (VBS), 4458
- PrintReport, 3637, 3847
- PrintScreen, 3636, 3847
- PrintVisibleColumnsOnly property (VBS), 4459
- Priorities
  - Local error handling, 1381
- Process control phase, 5637
- Process data area
  - Module addressing, 847
  - Module start address, 847
- Process image, 848
  - Basics, 845
  - I/O access error, 846
  - Reading inputs with GETIO, 2325
  - Reading the process image area with GETIO\_PART, 2326
  - Synchronizing the inputs with SYNC\_PI, 2318
  - Synchronizing the outputs with SYNC\_PO, 2319
  - Transferring the process image area with SETIO\_PART, 2327
  - Updating, 846
  - Updating inputs with UPDAT\_PI, 2315
  - Updating the outputs with UPDAT\_PO, 2316
  - Writing outputs with SETIO, 2325
- Process value logging, 3215
- ProcessValue
  - Assigning SmartTags, 4461
- Processvalue property (VBS), 4459
- ProcessValue property (VBS), 4461
- Product support, 405, 4933
  - Enabling, 405
- PROFIBUS, 444, 4934, 5080, 5152
  - Connection with PROFINET, 796
  - ET 200S in DPV1 mode, 792
  - HMI connection, 4998, 5001, 5002, 5068, 5071, 5073, 5140, 5143
  - Network, 4935
  - OP 73, 5034, 5113, 5194, 5196, 5203, 5205, 5206
  - OP 77A, 5034, 5113, 5194, 5196, 5203, 5205, 5206
  - Parameters, 5004, 5006, 5007, 5034, 5075, 5077, 5078, 5113, 5147, 5149, 5150, 5194, 5203
  - S7 1200, 5067, 5068, 5069, 5071, 5073
  - S7 1500, 4997, 4999, 5001, 5002
  - S7 300/400, 4998, 5139, 5140, 5141, 5143
  - Standard, 5080, 5152
  - Universal, 5080, 5152
  - WinCC RT Advanced, 4999, 5069, 5141
  - WinCC RT Professional, 4999
- PROFIBUS cable configuration
  - Optical ring, 446
- PROFIBUS communication
  - S7 1200, 5067, 5069
  - S7 1500, 4997, 4999
  - S7 300/400, 5139, 5141
- PROFIBUS DP, 774, 4935
  - Configuring the Control Panel, 5469
  - Connection, 5031, 5187
  - Direct key, 5261
- PROFIBUS parameters
  - S7 1200, 5075, 5077, 5078
  - S7 1500, 5004, 5006, 5007
  - S7 300/400, 5147, 5149, 5150
- PROFIBUS profile, 444, 5080, 5152
  - Different profiles on the same subnet, 444, 5080, 5152
  - Effect on the transmission rate, 444, 5080, 5152
  - Meaning of profiles, 445, 5080, 5152
- PROFIBUS DP
  - DirectKey, 3635
  - Network configuration, 5474
- PROFInergy
  - Control PROFInergy commands in the I-Device, 2415
  - Description, 2391
  - Generate answer to command at end of pause, 2421
  - Generate answer to command at start of pause, 2420
  - Generate list of supported measured values as answer, 2429
  - Generate negative answer to command, 2419
  - Generate PEM status as response, 2426
  - Generate queried energy data as response, 2424
  - Generate queried energy savings modes as answer, 2423
  - Generate queried measured values as answer, 2430
  - Generate supported PROFInergy commands as answer, 2427

- PE\_CMD, 2397
- PE\_DS3\_Write\_ET200S, 2402
- PE\_End\_RSP, 2421
- PE\_Error\_RSP, 2419
- PE\_Get\_Mode\_RSP, 2424
- PE\_I\_DEV, 2415
- PE\_Identify\_RSP, 2427
- PE\_List\_Modes\_RSP, 2423
- PE\_Measurement\_List\_RSP, 2429
- PE\_Measurement\_Value\_RSP, 2430
- PE\_PEM\_Status\_RSP, 2426
- PE\_Start\_End, 2393
- PE\_Start\_RSP, 2420
- Reading out status information, 2397
- Set power module switching behavior, 2402
- Start and exit energy-saving mode, 2393, 2397
- Profile, (See bus profile)
- Profiles, 888
- PROFINET, 609, 4934, 5305, 5315, 5318
  - Connection, 5030, 5186
  - Connection with PROFIBUS, 796
  - Device replacement without exchangeable medium, 819
  - HMI connection, 4979, 4980, 4981, 4983, 4986, 5046, 5047, 5049, 5051, 5119, 5120, 5122, 5124, 5126
  - S7 1200, 5046, 5049
  - S7 1500, 4979, 4981
  - S7 300/400, 5119, 5122
- PROFINET address, 534
- PROFINET device name, 805
- PROFINET interface, 808, 856, 973
- PROFINET IO, 795, 800, 801, 810, 811, 5303
  - Port options, 816, 4994, 5064, 5136
- PROFINET IO device
  - Assigning a name, 997
  - Name assignment from within the project context, 998
  - Name assignment via "Accessible devices", 998
- PROFINET IO devices
  - Reading a portion of the inputs with GETIO\_PART, 2326
  - Reading consistent data with DPRD\_DAT, 2363
  - Writing a part of the outputs with SETIO\_PART, 2327
  - Writing all outputs with SETIO, 2325
  - Writing consistent data with DPWR\_DAT, 2365
- PROFINET IO system, 811
- PROFINET parameters
  - HMI connection, 4987, 5055, 5128
  - HMI device, 4989, 5057, 5130
  - PLC, 4990, 5058, 5132
  - S7 1200, 5055, 5058
  - S7 1500, 4987, 4989, 4990
  - S7 300/400, 5128, 5130, 5132
- PROFINET RT class, 796, 5305
- PROFIsafe address, 4889
- Program alarm
  - generating with Program\_Alarm, 2470
- Program control operations, 1783, 2040, 2233
- Program cycle OB
  - Description, 883
- Program editor
  - "Instructions" task card, 1221
  - Block interface, 1221
  - Enlarging the programming window, 1227
  - Favorites, 1221
  - Function, 1219
  - General settings, 199, 201, 202, 1238
  - Programming window, 1221
  - Structure, 1220
  - Testing task card, 1221
  - Toolbar, 1221
  - Using the keyboard, 1223
- Program execution
  - Cyclic, 883
- Program information
  - Displaying, 1461
  - In the assignment list, 1462
  - In the call structure, 1470
  - In the dependency structure, 1476
  - in the tab , 1481
  - Views, 1461
- Program resources, 1196
- Program status
  - Editing blocks, 1494
  - FBD, 1497
  - Function, 1492
  - LAD, 1496
  - Modify tag, 1495
  - SCL, 1498
  - Switching off, 1493
  - Switching on, 1493
- Program\_Alarm, 2470
- Programming
  - Linear, 1020
  - Structured, 1020
- Programming error, 49
- Programming language
  - Changeover, 1378
  - FBD, 1302
  - LAD, 1259
  - Rules for changing, 1377

- Programming window
  - Customizing, 1352
  - SCL, 1351
- Project
  - Basics, 257
  - Carrying out an online/offline comparison, 287
  - Carrying out offline/offline comparisons, 287
  - Closing, 265
  - Comparing data, 43, 286
  - compile (overview), 5597
  - Compiling , 5599
  - Compiling project data, 281
  - Creating, 259
  - Deleting, 265
  - Detailed comparison, 294
  - Download, 5604, 5606, 5637
  - download (overview), 5597
  - Harmonizing, 383
  - Migrating, 130, 158
  - multilingual, 5537
  - Multiple connections, 5015, 5089, 5170, 5213
  - Saving, 264
  - Showing properties, 264
  - Simulation with a tag simulator, 5617
  - Upgrade, 5586
- Project archives, 274
- Project data
  - Compiling, 281
  - Downloading to a memory card, 283
  - Export alarm, 5510
  - Export text list, 5523
  - Exporting a recipe, 5506
  - Exporting tag, 5517
  - Importing alarms, 5511
  - Information on compiling, 280
  - Information on loading, 281
  - Loading, 282
  - Uploading from a device, 284
- Project ID, 4916
- Project language, 266, 5531
  - Activate, 5535
  - Disabling, 5535
- Project languages
  - Changing the editing language, 269
  - Specifying project languages, 268
  - System texts, 5538
  - Use, 266
  - User texts, 5538
- Project library, 56, 338, 5486
  - Adding types, 365
  - Assigning a common version to types, 373
  - Cleaning up, 384
  - Creating folders, 357
  - Discarding the type version, 371
  - Migrating, 152
  - Performing a consistency check for a type version, 370
  - Release the type version, 371
  - Updating the project, 375
  - Using filter view, 359
  - Using the element view, 342
  - Using types, 366
- Project text
  - Exporting, 5542
- Project texts
  - Application example, 273
  - Changing the text of selected objects, 270
  - Displaying reference text, 270, 5541
  - Exporting all texts, 272
  - Exporting individual texts, 271
  - Importing, 272, 5544
  - Migrating, 150
  - Translating individual texts, 3064, 5539
  - Translating project texts, 269
  - Translation into project languages, 266, 5538
- Project tree
  - Adding device, 419
  - Function, 208
  - Hiding, 1227
  - Reducing automatically, 214
  - Showing, 1227
- Project version
  - Upgrade, 5586
- Project view, 205
- ProjectName object, 4062
- ProjectPath property (VBS), 4462
- Project-wide alarm class
  - Create, 3265
  - Use, 3265
- Properties (CPU), 856
- Properties (VBS)
  - RotationCenterLeft, 4471
  - TrendWindowRulerLayer , 4658
  - AboveUpperLimitColor, 4145
  - AcceptOnExit, 4146
  - AcceptOnFull, 4146
  - AccessPath, 4147
  - ActiveProject, 4149
  - ActiveScreen, 4149, 4150
  - ActualPointIndex, 4152
  - ActualPointLeft, 4152
  - ActualPointTop, 4153
  - AdaptBorder, 4154
  - AdaptFontSizeToLineHeight, 4154



AdaptPicture, 4155  
AdaptScreenToWindow, 4155  
AdaptSize, 4155  
AdaptWindowToScreen, 4155  
Address, 4156  
AdjustBorder3DWithStyle, 4156  
AdjustRulerWindow, 4157  
Alarm, 4157  
AlarmColor, 4158  
AlarmFilter, 4158  
AlarmHigh, 4159  
AlarmID, 4159  
AlarmLow, 4160  
AlarmLowerLimit, 4161  
AlarmLowerLimitColor, 4161  
AlarmLowerLimitEnabled, 4162  
AlarmLowerLimitRelative, 4162  
AlarmUpperLimit, 4163  
AlarmUpperLimitColor, 4164  
AlarmUpperLimitEnabled, 4164  
AlarmUpperLimitRelative, 4165  
Alignment, 4165  
AlignmentLeft, 4166  
AlignmentTop, 4166  
AllowMenu, 4167  
AllowPersistence, 4167  
Analog, 4168  
AngleMax, 4168  
AngleMin, 4169  
ApplyProjectSettings, 4170  
AskOperationMotive, 4171  
Assignments, 4171  
AssumeOnExit, 4172  
AssumeOnFull, 4172  
Authorization, 4173  
AutoCompleteColumns, 4175  
AutoCompleteRows, 4175  
AutoScroll, 4176  
AutoSelectionColors, 4176  
AutoSelectionRectColors, 4177  
Average, 4178  
BackColor, 4179, 4181  
BackColorBottom, 4182  
BackColorTop, 4182  
BackFillStyle, 4183, 4184  
BackFillStyleReadOnlySpecial, 4185  
BackFlashingColorOff, 4186  
BackFlashingColorOn, 4186  
BackFlashingEnabled, 4187  
BackFlashingRate, 4188  
BackPictureAlignment, 4452  
BackPictureName, 4453  
BarBackColor, 4189  
BarBackFillStyle, 4189  
BarColor, 4191  
BarStartValue, 4192  
BaseScreenName, 4193  
BeginTime(i), 4194  
BelowLowerLimitColor, 4194  
BitNumber, 4195  
BlinkColor, 4195  
BlinkMode, 4196  
BlinkSpeed, 4197  
BorderBackColor, 4197  
BorderBrightColor3D, 4198, 4199  
BorderColor, 4200, 4201  
BorderEndStyle, 4203  
BorderFlashingColorOff, 4204  
BorderFlashingColorOn, 4205  
BorderFlashingEnable, 4206  
BorderFlashingRate, 4207  
BorderInnerStyle3D, 4208  
BorderInnerWidth3D, 4208  
BorderOuterStyle3D, 4209  
BorderOuterWidth3D, 4209  
BorderShadeColor3D, 4210, 4211  
BorderStyle, 4211  
BorderStyle3D, 4213  
BorderWidth, 4214, 4215, 4368  
BorderWidth3D, 4216  
ButtonCommand, 4218  
Caption, 4219, 4220  
CaptionBackColor, 4220  
CaptionColor, 4221, 4222  
CaptionText, 4222  
CaptionTop, 4223  
CellCut, 4223  
CellSpaceBottom, 4224  
CellSpaceLeft, 4225  
CellSpaceRight, 4225  
CellSpaceTop, 4226  
CenterColor, 4226  
CenterSize, 4227  
CentrePoint, 4227  
CentrePointLeft, 4228  
CentrePointTop, 4228  
ChangeMouseCursor, 4229  
CheckMarkAlignment, 4231  
CheckMarkCount, 4231  
ClearOnError, 4232  
ClearOnFocus, 4233  
Closable, 4234  
Color, 4234, 4235  
ColorChangeHysteresis, 4236

ColorChangeHysteresisEnabled, 4237  
 ColumnColor(i), 4239  
 ColumnDisplayName(i), 4240  
 ColumnResize, 4240  
 ColumnScrollbar, 4242  
 ColumnSizingEnable, 4241  
 ColumnTitle, 4243  
 ColumnTitleAlign, 4242  
 ColumnUpdateEnabled(i), 4243  
 comma,EdgeStyle, 4272  
 Command, 4244  
 CommonTimeAxisColor, 4245  
 ConfigureTimeAxis(i), 4245  
 ConnectionType, 4246  
 ConnectTrendWindows, 4246  
 ContinousChange, 4247  
 CornerStyle, 4248  
 Count, 4249  
 CountDivisions, 4250  
 CountSubDivisions, 4250  
 CountValueColumns, 4251  
 CountVisibleItems, 4251  
 CurrentColumnIndex, 4252  
 CurrentCurveIndex, 4253  
 CursorControl, 4254  
 CurveColor(i), 4254  
 CurveLineWidth(i) , 4255  
 CurvesCount, 4255  
 CurveUpdateEnabled(i), 4256  
 DangerRangeColor, 4257  
 DangerRangeStart, 4257  
 DangerRangeVisible, 4258  
 DataIndex(i), 4259  
 DataLogTag, 4260  
 DataX(i), 4261  
 DataXY(i), 4261  
 DataY(i), 4262  
 DeleteDate(i), 4262  
 DeleteEnable, 4263  
 DialColor, 4263  
 DialFillStyle, 4264  
 DialSize, 4265  
 Direction , 4265  
 DisplayName(i), 4266  
 DisplayOptions, 4266  
 DoubleClickAction, 4267  
 DrawAlwaysInsideFrame, 4267  
 DrawEnhancedHTMLBrowser, 4268  
 DrawInsideFrame, 4268  
 DrawStylishButton, 4270  
 Drive, 4270  
 EdgeStyle, 4271  
 Editable(i), 4273  
 EditEnabled, 4274  
 EditOnFocus, 4274  
 Enabled, 4275, 4277  
 EndAngle, 4278  
 EndPoint, 4279  
 EndPointLeft, 4279  
 EndPointTop, 4280  
 EndStyle, 4281  
 EndTime(i), 4282  
 ExportDirectoryChangeable , 4284  
 ExportDirectoryname, 4284  
 ExportFileExtension, 4285  
 ExportFilename, 4286  
 ExportFilenameChangeable , 4286  
 ExportFormatGuid, 4287  
 ExportFormatName, 4287  
 ExportParameters, 4288  
 ExportSelection, 4288  
 ExportShowDialog, 4289  
 ExtraSpaceForLabelDisplay, 4291  
 FieldLengthReadOnlySpecial, 4291  
 FillColorMode, 4293  
 FillPatternColor, 4294  
 FillStyle, 4295  
 Filter, 4296  
 FirstConnectedObjectIndex, 4296  
 FirstConnectedObjectName, 4297  
 FixedAspectRatio, 4297  
 FlashingColorOff, 4298  
 FlashingColorOn, 4300  
 FlashingEnable, 4301  
 FlashingRate, 4302  
 FlashTransparentColor, 4305  
 Flip, 4306  
 FocusColor, 4306, 4307  
 FocusWidth, 4308  
 Font , 4309  
 FontBold, 4311  
 FontItalic, 4312  
 FontName, 4313  
 FontSize, 4314  
 FontUnderline, 4315  
 ForeColor, 4316, 4317  
 FormatPattern, 4318  
 FormatPatternReadOnlySpecial, 4319  
 FormatType, 4319  
 Free, 4320  
 FreePercent, 4320  
 FreezeProviderConnections, 4321  
 GetSelectionText, 4321  
 GlobalColorScheme, 4672

GlobalShadow, 4674  
 Gradation, 4321  
 GraphDirection, 4322  
 GridBackColor, 4323  
 GridlineColor, 4323  
 GridLineWidth, 4324  
 Height, 4325  
 Help text, 4328  
 HelpText, 4328  
 HiddenInput, 4329  
 HideTagName, 4329  
 HighLimitColor, 4330  
 HitlistColumnAdd, 4330  
 HitlistColumnCount, 4331  
 HitlistColumnIndex, 4331  
 HitlistColumnName , 4332  
 HitlistColumnRemove , 4332  
 HitlistColumnRepos, 4332, 4409  
 HitlistColumnSort, 4333  
 HitlistColumnSortIndex, 4333  
 HitlistColumnVisible, 4334, 4410  
 HitlistDefaultSort, 4334  
 HitlistMaxSourceItems, 4335  
 HitlistMaxSourceItemsWarning, 4335  
 HitlistRelativeTimeFactor, 4336  
 HitlistRelativeTimeFactorType, 4336  
 HitlistRelTime, 4337  
 HorizontalAlignment, 4338, 4339  
 HorizontalGridLines, 4339  
 HourNeedleHeight, 4340  
 HourNeedleWidth, 4341  
 IconSpace, 4342  
 Index, 4342  
 InnerBackColorOff, 4343  
 InnerBackColorOn, 4344  
 InsertData(i), 4345  
 InsertEnable, 4345  
 IntegerDigits, 4346  
 Interval, 4346  
 ItemBorderStyle, 4347  
 JumpToLimitsAfterMouseClicked, 4348  
 LabelColor, 4348  
 Language, 4349  
 LargeTicksBold, 4350  
 LargeTicksSize, 4350  
 LastConnectedObjectIndex, 4351  
 LastConnectedObjectName, 4351  
 LeaveMarginForBorder, 4363  
 LeaveMarginForMarkers, 4364  
 Left, 4364  
 Limit4LowerLimit, 4367  
 Limit4LowerLimitRelative, 4369  
 Limit4LowrLimitColor , 4368  
 Limit4UpperLimit, 4369  
 Limit4UpperLimitColor, 4370  
 Limit4UpperLimitEnabled, 4371  
 Limit4UpperLimitRelative, 4371  
 Limit5LowerLimit, 4372  
 Limit5LowerLimitColor, 4372  
 Limit5LowerLimitEnabled, 4373  
 Limit5LowerLimitRelative, 4374  
 Limit5UpperLimit, 4374  
 Limit5UpperLimitColor, 4375  
 Limit5UpperLimitEnabled, 4375  
 Limit5UpperLimitRelative, 4376  
 LineWidth, 4379, 4380  
 LoadDataImmediately, 4381  
 LocalCursor, 4382  
 Localizable, 4382  
 LockSquaredExtent, 4383  
 LogOperation, 4384  
 LowerLimit, 4386  
 LowerLimitColor(i), 4386  
 LowerLimitValue(i), 4387  
 LowLimitColor, 4388  
 MachineName , 4389  
 MarginToBorder, 4389  
 MaximumValue, 4390, 4391  
 MessageBlockAlign , 4395  
 MessageBlockAutoPrecisions, 4395  
 MessageBlockCaption, 4396  
 MessageBlockCount, 4396, 4400  
 MessageBlockDateFormat, 4397  
 MessageBlockExponentialFormat, 4397  
 MessageBlockFlashOn, 4398  
 MessageBlockHideText, 4398  
 MessageBlockHideTitleText, 4399  
 MessageBlockID, 4399  
 MessageBlockLeadingZeros, 4400  
 MessageBlockLength, 4401  
 MessageBlockName, 4401  
 MessageBlockPrecisions, 4402  
 MessageBlockSelected, 4402  
 MessageBlockShowDate, 4403  
 MessageBlockShowIcon, 4403  
 MessageBlockShowTitleIcon, 4404  
 MessageBlockTextId, 4404  
 MessageBlockTimeFormat, 4405  
 MessageBlockType, 4405  
 MessageColumnAdd, 4406  
 MessageColumnCount, 4407  
 MessageColumnIndex, 4407  
 MessageColumnName , 4408  
 MessageColumnRemove, 4408

MessageColumnRepos, 4332, 4409  
MessageColumnSort, 4409  
MessageColumnSortIndex, 4410  
MessageColumnVisible, 4334, 4410  
MessageListType, 4410  
MinimumValue, 4411, 4412  
MinuteNeedleHeight, 4412  
MinuteNeedleWidth, 4413  
Mode, 4413  
Movable, 4414  
MsgFilterSQL, 4415  
NeedleBorderColor, 4418  
NeedleColor, 4418  
NeedleFillStyle, 4419  
NormalRangeColor, 4420  
NormalRangeVisible, 4420  
NumberOfValues(i), 4421  
ObjectName, 4422  
Online, 4426  
OperationSteps, 4427  
OperatorMessageID, 4428  
OperatorMessageIndex, 4428  
OperatorMessageName, 4429  
OperatorMessageNumber, 4430  
OperatorMessageSelected, 4430  
OperatorMessageSource1, 4430  
OperatorMessageSource10, 4435  
OperatorMessageSource2, 4431  
OperatorMessageSource3, 4431  
OperatorMessageSource4, 4432  
OperatorMessageSource5, 4432  
OperatorMessageSource6, 4433  
OperatorMessageSource7, 4434  
OperatorMessageSource8, 4434  
OperatorMessageSource9, 4435  
OperatorMessageType1, 4435  
OperatorMessageType10, 4440  
OperatorMessageType2, 4436  
OperatorMessageType3, 4436  
OperatorMessageType4, 4437  
OperatorMessageType5, 4437  
OperatorMessageType6, 4438  
OperatorMessageType7, 4438  
OperatorMessageType8, 4439  
OperatorMessageType9, 4439  
Orientation, 4440  
PageMode, 4442  
PageModeMessageNumber, 4442  
Parent, 4443  
Password, 4445  
PersistentRTAuthorization, 4446  
PersistentRTCSAuthorization, 4446  
PersistentRuntime, 4447  
PersistentRuntimeAuthorization, 4448  
PersistentToDownload, 4448  
PersistentToDownloadAuthorization, 4449  
Picture, 4451  
PictureAlignment, 4452  
PictureDeactivated, 4452  
PictureName, 4453  
PictureOff, 4453  
PictureOn, 4453  
PointerColor, 4455  
PointsCount, 4456  
Precision, 4457  
Pressed, 4457  
PrintConfiguration, 4458  
PrintJobName, 4458  
PrintVisibleColumnsOnly, 4459  
Processvalue, 4459  
ProcessValue, 4461  
ProjectPath, 4462  
RadiusHeight, 4464  
RadiusWidth, 4465  
ReadOnly, 4466  
RecipeName, 4466  
RecipeNumber, 4467  
RecordName, 4467  
RecordNumber, 4467  
RelativeFillLevel, 4468  
Rotation, 4470  
RotationAngle, 4470  
RotationCenterTop, 4472  
RowNumber, 4473  
RowScrollbar, 4473  
RowSizingEnable, 4474  
RTPersistence, 4475  
RTPersistencePasswordLevel, 4475  
RTPersistenceType, 4476  
RulerColor, 4477  
RulerPrecision(i), 4477  
RulerXPrecision(i), 4478  
RulerYPrecision(i), 4478  
ScaleColor, 4479  
ScaleDenominator, 4485  
ScaleGradation, 4480  
ScaleLabelColor, 4481  
ScaleNumerator, 4481  
ScalePosition, 4482  
ScaleTickColor, 4482  
ScaleTickLabelPosition, 4483  
ScaleTickLength, 4483  
ScaleTickPosition, 4484  
ScalingType, 4486

ScreenItems, 4487  
Screens, 4487  
Scrollable, 4488  
SecondNeedleHeight, 4489  
SecondNeedleWidth, 4489  
SegmentColoring, 4490  
SelectBackColor, 4491  
SelectedCellColor, 4491  
SelectedCellForeColor, 4492  
SelectedRowColor, 4493  
SelectedRowForeColor, 4493  
SelectedTitleColor, 4494  
SelectedTitleForeColor, 4495  
SelectForeColor, 4495  
SelectionBackColor, 4496, 4497  
SelectionColoring, 4497  
SelectionForeColor, 4498, 4499  
SelectionMode, 4499, 4500  
SelectionRect, 4500  
SelectionRectColor, 4501  
SelectionRectWidth, 4502  
SeparatorBackColor, 4503  
SeparatorColor, 4503  
SeparatorWidth, 4505  
SeperatorCornerStyle, 4504  
SeperatorStyle, 4504  
ServerNames, 4506  
ServerScale, 4505  
SetpointTrendArchiveStartId(i), 4507  
SetpointTrendColor(i), 4508  
SetpointTrendNumberOfValues(i), 4508  
Shared, 4511  
ShareTimeColumn, 4509  
ShareValueAxis, 4510  
ShareXAxis, 4510  
ShareYAxis, 4511  
ShiftDecimalPointReadOnlySpecial, 4512  
ShortenCellText, 4512  
ShortenColumnHeaderText, 4513  
ShowAlarmsFromDate, 4513  
ShowBar, 4514  
ShowBorder, 4514  
ShowCaption, 4515  
ShowColumn(i), 4516  
ShowCurve(i), 4516  
ShowDecimalPoint, 4517  
ShowFillLevel, 4517  
ShowFocusRectangle, 4518  
ShowInputControls, 4518  
ShowLimitMarkers, 4519  
ShowMainFrame, 4519  
ShowMessagesAtDate, 4520  
ShowOverflowIndicator, 4521  
ShowPeakValuePointer, 4521, 4522  
ShowPosition, 4522  
ShowRowHeaders, 4523  
ShowRuler, 4523, 4524  
ShowRulerInAxis, 4524  
ShowScale, 4525  
ShowScrollbars, 4525  
ShowSetpointTrend(i), 4526  
ShowSortButton, 4526  
ShowSortIcon, 4527, 4528  
ShowStatusBar, 4528  
ShowTableGridlines, 4529  
ShowThumb, 4530  
ShowTickLabels, 4530  
ShowTicks, 4531  
ShowTitle, 4532  
ShowToolBar, 4532  
ShowTrendIcon, 4533  
ShowTrendIndicator, 4534  
ShowVerticalGridlines, 4534  
ShowXValuesExponential(i), 4535  
ShowYValuesExponential(i), 4535  
SkinName, 4536  
SmartTags, 4537  
Sort, 4537  
SortByTimeDirection, 4538  
SortByTimeEnable, 4538  
SortByTimeEnabled, 4539  
SortOnColumnHeaderClick, 4539  
SortSequence, 4540  
SortTimeAscending, 4540  
SortTimeEnable, 4541  
StartAngle, 4541  
StartLeft, 4542  
StartPointTop, 4544  
StartStyle, 4543  
StatusbarBackColor, 4545  
StatusbarElementAdd, 4545  
StatusbarElementAutoSize, 4546  
StatusbarElementCount, 4546  
StatusbarElementIconId, 4547  
StatusbarElementID, 4547  
StatusbarElementIndex, 4548  
StatusbarElementName, 4548  
StatusbarElementRemove, 4549  
StatusbarElementRename, 4549  
StatusbarElements, 4550  
StatusbarElementTooltipText, 4550  
StatusbarElementUserDefined, 4551  
StatusbarElementVisible, 4552  
StatusbarElementWidth, 4552

StatusBarFontColor, 4552  
 StatusBarShowArchiveName, 4553  
 StatusBarShowColumn, 4553  
 StatusBarShowRecord, 4554  
 StatusBarShowRow, 4554  
 StatusBarShowText, 4554  
 StatusBarShowTooltips, 4555  
 StatusBarText, 4556  
 StatusBarUseBackColor, 4556  
 StatusBarVisible, 4557  
 Style, 4558  
 SwapDimensionsWithOrientation, 4559  
 SwapFirstWithLastConnection, 4560  
 TableBackColor, 4560, 4561  
 TableColor, 4562  
 TableColor2, 4562  
 TableFocusOnButtonCommand, 4562  
 TableForeColor, 4563, 4564  
 TableForeColor2, 4564  
 TableGridLineColor, 4565  
 TableHeaderBackColor, 4566  
 TableHeaderForeColor, 4567  
 Text, 4570, 4571  
 TextList, 4571  
 TextOff, 4572  
 TextOn, 4573  
 TextOrientation, 4574  
 ThumbBackColor, 4575, 4576  
 TicksColor, 4576  
 TickStyle, 4577  
 TimeAxisBeginTime(i), 4578  
 TimeAxisEndTime, 4578  
 TimeAxisLabel(i), 4579  
 TimeAxisRange, 4579  
 TimeAxisShowGridLines(i), 4580  
 TimeAxisShowLargeIncrements(i), 4580  
 TimeAxisShowSmallIncrements(i), 4581  
 TimeAxisTimeFormat(i), 4582  
 TimeBase, 4582  
 TimeColumnActualize, 4583, 4589  
 TimeColumnAdd, 4584  
 TimeColumnAlign, 4584  
 TimeColumnAlignment(i), 4585  
 TimeColumnBackColor, 4586  
 TimeColumnBeginTime, 4586  
 TimeColumnCaption, 4586  
 TimeColumnCount, 4587  
 TimeColumnDateFormat, 4587  
 TimeColumnEndTime, 4588  
 TimeColumnForeColor, 4588  
 TimeColumnFormat(i), 4589  
 TimeColumnHideTitleText, 4590  
 TimeColumnIndex, 4590  
 TimeColumnLength, 4591  
 TimeColumnMeasurePoints, 4591  
 TimeColumnName, 4592  
 TimeColumnRangeType, 4592  
 TimeColumnRemove, 4593  
 TimeColumnRename, 4593  
 TimeColumnRepos, 4593  
 TimeColumnShowDate, 4594  
 TimeColumnShowIcon, 4594  
 TimeColumnShowTitleIcon, 4595  
 TimeColumnSort, 4595  
 TimeColumnSortIndex, 4596  
 TimeColumnTimeFormat, 4596  
 TimeColumnTimeRangeBase, 4597  
 TimeColumnTimeRangeFactor, 4598  
 TimeColumnUseValueColumnColors, 4598  
 TimeColumnVisible, 4599  
 TimeJumpColor(i), 4599  
 TimeJumpEnabled(i), 4600  
 TimeOverlapColor(i), 4600  
 TimeOverlapEnabled(i), 4601  
 TimeRangeBase(i), 4601  
 TimeRangeFactor(i), 4602  
 TitleColor, 4604  
 TitleDarkShadowColor, 4605  
 TitleForeColor, 4605  
 TitleGridLineColor, 4605  
 TitleLightShadowColor, 4606  
 TitleSort, 4606  
 TitleStyle, 4607  
 Toggle, 4608  
 Tolerance, 4608  
 ToleranceColor, 4609  
 ToleranceLowerLimit, 4610  
 ToleranceLowerLimitColor, 4610  
 ToleranceLowerLimitEnabled, 4611  
 ToleranceLowerLimitRelative, 4611  
 ToleranceUpperLimit, 4612  
 ToleranceUpperLimitColor, 4612  
 ToleranceUpperLimitEnabled, 4613  
 ToleranceUpperLimitRelative, 4614  
 ToolbarAlignment, 4614  
 ToolbarBackColor, 4615  
 ToolbarButtonActive, 4615  
 ToolbarButtonAdd, 4616  
 ToolbarButtonBeginGroup, 4616  
 ToolbarButtonCount, 4617  
 ToolbarButtonEnabled, 4617  
 ToolbarButtonHotKey, 4618  
 ToolbarButtonID, 4618  
 ToolbarButtonIndex, 4618

ToolBarButtonLocked, 4619  
ToolBarButtonName, 4619  
ToolBarButtonPasswordLevel, 4620  
ToolBarButtonRemove, 4620  
ToolBarButtonRename, 4620  
ToolBarButtonRepos, 4621  
ToolBarButtonTooltipText, 4621, 4639, 4646  
ToolBarButtonUserDefined, 4622, 4642  
ToolBarShowTooltips, 4622  
ToolBarUseBackColor, 4623  
ToolBarUseHotKeys, 4624  
ToolBarVisible, 4624, 4625  
ToolTipText, 4625  
Top, 4627  
Total, 4630  
TransparentColor, 4633  
TransparentColorDeactivatedPicture, 4633  
TransparentColorPictureOff, 4634  
TransparentColorPictureOn, 4634  
TrendActualize, 4635  
TrendBeginTime, 4636  
TrendCount, 4637  
TrendEndTime, 4637  
TrendExtendedColorSet, 4637  
TrendFill, 4638  
TrendIndicatorColor, 4639  
TrendLineStyle, 4640  
TrendLineType, 4641  
TrendLowerLimit, 4642  
TrendLowerLimitColor, 4642  
TrendName, 4643  
TrendPointStyle, 4644  
TrendProvider, 4645  
TrendRangeType, 4645  
TrendSelectTagNameX, 4647  
TrendSelectTagNameY, 4647  
TrendTag, 4648  
TrendTagNameX, 4648  
TrendTagNameY, 4649  
TrendTimeRangeBase, 4649  
TrendTimeRangeFactor, 4650  
TrendUncertainColor, 4650  
TrendUncertainColoring, 4651  
TrendUpperLimit, 4651  
TrendUpperLimitColoring, 4652  
TrendWindowCoarseGrid, 4653  
TrendWindowFineGrid, 4654  
TrendWindowForegroundTrendGrid, 4655  
TrendWindowGridInTrendColor, 4655  
TrendWindowHorizontalGrid, 4656  
TrendWindowIndex, 4657  
TrendWindowRename, 4657  
TrendWindowRulerStyle, 4659  
TrendWindowVerticalGrid, 4660  
Type, 4662  
UncertainStateColor(i), 4664  
UncertainStateEnabled(i), 4664  
UnitColor, 4665  
UnitText, 4666  
UnitTop, 4667  
UpdateEnable, 4668  
UpperLimit, 4668  
UpperLimitColor(i), 4669  
UpperLimitEnabled(i), 4669  
UpperLimitValue(i), 4670  
UseAllServers, 4671  
UseBarBorderConstraints, 4671  
Used, 4686  
UsedPercent, 4686  
UseEffectiveProcessValue, 4676  
UseExponentialFormat, 4676  
UseFlashTransparentColor, 4677  
UseGDI, 4677  
UseMeasurePoints(i), 4678  
UseMessageColor, 4678  
UseMultipleLimits, 4679  
UserArchiveNumberOfValues(i) , 4687  
UserArchiveStartId(i), 4687  
UseScaleConstraints, 4679  
UseScaledBarBorder, 4680  
UseSelectedTitleColor, 4680  
UseSeparateDiagrams, 4681  
UseSimplePrecisionOffset, 4681  
UseTableColor2, 4682  
UseTimeRange(i), 4683  
UseTransparentColor, 4683  
UseTransparentColorDeactivatedPicture, 4684  
UseTransparentColorPictureOff, 4684  
UseTransparentColorPictureOn, 4685  
UseTrendNameAsLabel, 4685  
UsingDesignColorScheme, 4672  
UsingDesignShadowSettings, 4674  
ValidateFormatPattern, 4689  
ValueAxisAutorange(i), 4691  
ValueAxisBegin(i), 4691  
ValueAxisDecimalPrecision(i), 4692  
ValueAxisEnd(i), 4692  
ValueAxisGridLineInterval(i), 4693  
ValueAxisLabel(i), 4693  
ValueAxisLargeIncrementsSize(i), 4694  
ValueAxisScalingType(i), 4694  
ValueAxisShowGridLines(i), 4695  
ValueAxisShowLargeIncrements(i), 4696  
ValueAxisShowSmallIncrements(i), 4696

- ValueAxisSmallIncrementSize(i), 4697
- ValueColumnAlignment(i), 4698
- ValueColumnPrecision(i), 4698
- VerticalAlignment, 4699
- VerticalGridLines, 4700
- ViewOnly, 4701
- Visible, 4701
- Warning, 4704
- WarningColor, 4704
- WarningLowerLimit, 4705
- WarningLowerLimitColor, 4706
- WarningLowerLimitEnabled, 4706
- WarningLowerLimitRelative, 4707
- WarningRangeColor, 4708
- WarningRangeStart, 4708
- WarningRangeVisible, 4709
- WarningUpperLimit, 4710
- WarningUpperLimitColor, 4710
- WarningUpperLimitEnabled, 4711
- WarningUpperLimitRelative, 4711
- Width, 4712
- WindowCloseEnabled, 4714
- WindowSizingEnabled, 4716
- WindowsStyle, 4716
- XAxisAdd, 4717
- XAxisAlign, 4717
- XAxisAutoPrecisions, 4718
- XAxisAutorange(i), 4718
- XAxisBegin(i), 4719
- XAxisBeginValue, 4719
- XAxisCount, 4720
- XAxisDecimalPrecision(i), 4720
- XAxisEnd(i), 4721
- XAxisEndValue, 4721
- XAxisExponentialFormat, 4722
- XAxisGridLineInterval(i), 4722
- XAxisIndex, 4723
- XAxisInTrendColor, 4723
- XAxisLabel(i), 4723
- XAxisLargeIncrementSize(i), 4724
- XAxisMode(i), 4724
- XAxisName, 4725
- XAxisPrecisions , 4725
- XAxisRemove, 4726
- XAxisRepos, 4726
- XAxisScalingType(i), 4727
- XAxisShowGridLines(i), 4727
- XAxisShowLargeIncrements(i), 4728
- XAxisShowSmallIncrements(i), 4728
- XAxisSmallIncrementSize(i), 4729
- XAxisTrendWindow, 4729
- XAxisVisible, 4730
- XDataLogTag(i), 4730
- XOnlineTag(i), 4731
- YAxisAdd, 4731
- YAxisAlign, 4732
- YAxisAutoPrecisions, 4732
- YAxisBeginValue, 4733
- YAxisColor, 4733
- YAxisCount, 4734
- YAxisEndValue, 4734
- YAxisExponentialFormat, 4734
- YAxisIndex, 4735
- YAxisInTrendColor, 4735
- YAxisLabel, 4736
- YAxisName, 4736
- YAxisPrecisions , 4736
- YAxisRemove, 4737
- YAxisRename, 4737
- YAxisRepos, 4737
- YAxisTrendWindow, 4738
- YAxisVisible, 4739
- YDataLogTag(i), 4739
- YOnlineTag(i), 4740
- ZeroPoint, 4740
- Zoomable, 4742
- Properties in VBS
  - Comment, 4245
  - ComputerName, 4245
  - Context, 4247
  - InputValue, 4344
  - Instance, 4346
  - SelIndex, 4493
  - SelText, 4491
  - State, 4544
  - Transparency, 4631
  - UserName, 4688
  - WinCCStyle, 4559, 4714
- Properties in VBS/HorizontalScrollPosition, 4340
- Properties in VBS/ScrollPositionX, 4488
- Properties in VBS/ScrollPositionY, 4489
- Properties in VBS/VerticalScrollPosition, 4701
- Properties in VBS:AngleAlpha, 4168
- Properties in VBS:AngleBeta, 4168
- Properties in VBS:Application, 4170, 4715
- Properties in VBS:Axe, 4178
- Properties in VBS:AxisSection, 4178
- Properties in VBS:BackBorderWidth, 4179
- Properties in VBS:BackColor2, 4181
- Properties in VBS:BackColor3, 4182
- Properties in VBS:BackFlashColorOff, 4185
- Properties in VBS:BackFlashColorOn, 4186
- Properties in VBS:Background, 4189
- Properties in VBS:BarDepth, 4192



- Properties in VBS:BarHeight, 4192
- Properties in VBS:BarWidth, 4193
- Properties in VBS:BaseX, 4193
- Properties in VBS:BaseY, 4193
- Properties in VBS:BorderColorBottom, 4202
- Properties in VBS:BorderColorTop, 4202
- Properties in VBS:BorderFlashColorOff, 4203
- Properties in VBS:BorderFlashColorOn, 4203
- Properties in
  - VBS:BottomConnectedConnectionPointIndex, 4216
- Properties in VBS:BottomConnectedObjectName, 4217
- Properties in VBS:BoxAlignment, 4217
- Properties in VBS:BoxCount, 4217
- Properties in VBS:BoxType, 4217
- Properties in VBS:Button1Width, 4217
- Properties in VBS:Button2Width, 4217
- Properties in VBS:Button3Width, 4218
- Properties in VBS:Button4Width, 4218
- Properties in VBS:ButtonColor, 4218
- Properties in VBS:CheckAlarmHigh, 4230
- Properties in VBS:CheckAlarmLow, 4230
- Properties in VBS:CheckLimitHigh4, 4230
- Properties in VBS:CheckLimitHigh5, 4230
- Properties in VBS:CheckLimitLow4, 4230
- Properties in VBS:CheckLimitLow5, 4231
- Properties in VBS:CheckToleranceHigh, 4232
- Properties in VBS:CheckToleranceLow, 4232
- Properties in VBS:CheckWarningHigh, 4232
- Properties in VBS:CheckWarningLow, 4232
- Properties in VBS:ClearOnNew, 4233
- Properties in VBS:CloseButton, 4234
- Properties in VBS:ColorAlarmHigh, 4236
- Properties in VBS:ColorAlarmLow, 4236
- Properties in VBS:ColorBottom, 4236
- Properties in VBS:ColorChangeType, 4237
- Properties in VBS:ColorLimitHigh4, 4237
- Properties in VBS:ColorLimitHigh5, 4238
- Properties in VBS:ColorLimitLow4, 4238
- Properties in VBS:ColorLimitLow5, 4238
- Properties in VBS:ColorToleranceHigh, 4238
- Properties in VBS:ColorToleranceLow, 4238
- Properties in VBS:ColorTop, 4239
- Properties in VBS:ColorWarningHigh, 4239
- Properties in VBS:ColorWarningLow, 4239
- Properties in VBS:CurrentContext, 4252
- Properties in VBS:DataFormat, 4259
- Properties in VBS>EditAtOnce, 4274
- Properties in VBS:Exponent, 4284
- Properties in VBS:ExtendedOperation, 4290
- Properties in VBS:ExtendedZoomingEnable, 4290
- Properties in VBS:FillColor, 4292
- Properties in VBS:Filling, 4293
- Properties in VBS:FillingIndex, 4293
- Properties in VBS:FillStyle2, 4296
- Properties in VBS:FlashBackColor, 4298
- Properties in VBS:FlashBorderColor, 4298
- Properties in VBS:FlashFlashPicture, 4298
- Properties in VBS:FlashForeColor, 4298
- Properties in VBS:FlashPicReferenced, 4304
- Properties in VBS:FlashPicture, 4304
- Properties in VBS:FlashRate, 4304
- Properties in VBS:FlashRateBackColor, 4304
- Properties in VBS:FlashRateBorderColor, 4304
- Properties in VBS:FlashRateFlashPic, 4305
- Properties in VBS:FlashRateForeColor, 4305
- Properties in VBS:ForeFlashColorOff, 4318
- Properties in VBS:ForeFlashColorOn, 4318
- Properties in VBS:Hotkey, 4340
- Properties in VBS:Hysteresis, 4341
- Properties in VBS:HysteresisRange, 4342
- Properties in VBS:ItemBorderBackColor, 4347
- Properties in VBS:ItemBorderColor, 4347
- Properties in VBS:ItemBorderWidth, 4348
- Properties in VBS:LanguageSwitch, 4350
- Properties in VBS:Layer, 4353
- Properties in VBS:Layer00Checked, 4356
- Properties in VBS:Layer00Color, 4356
- Properties in VBS:Layer00Value, 4356
- Properties in VBS:Layer01Checked, 4356
- Properties in VBS:Layer01Color, 4356
- Properties in VBS:Layer01Value, 4357
- Properties in VBS:Layer02Checked, 4357
- Properties in VBS:Layer02Color, 4357
- Properties in VBS:Layer02Value, 4357
- Properties in VBS:Layer03Checked, 4357
- Properties in VBS:Layer03Color, 4358
- Properties in VBS:Layer03Value, 4358
- Properties in VBS:Layer04Checked, 4358
- Properties in VBS:Layer04Color, 4358
- Properties in VBS:Layer04Value, 4358
- Properties in VBS:Layer05Checked, 4359
- Properties in VBS:Layer05Color, 4359
- Properties in VBS:Layer05Value, 4359
- Properties in VBS:Layer06Checked, 4359
- Properties in VBS:Layer06Color, 4359
- Properties in VBS:Layer06Value, 4360
- Properties in VBS:Layer07Checked, 4360
- Properties in VBS:Layer07Color, 4360
- Properties in VBS:Layer07Value, 4360
- Properties in VBS:Layer08Checked, 4360
- Properties in VBS:Layer08Color, 4361
- Properties in VBS:Layer08Value, 4361
- Properties in VBS:Layer09Checked, 4361

- Properties in VBS:Layer09Color, 4361
- Properties in VBS:Layer09Value, 4361
- Properties in VBS:Layer10Checked, 4362
- Properties in VBS:Layer10Color, 4362
- Properties in VBS:Layer10Value, 4362
- Properties in VBS:LayerDeclutteringEnable, 4362
- Properties in VBS:Layers, 4363
- Properties in VBS:LeftComma, 4367
- Properties in VBS:LeftOffset, 4367
- Properties in VBS:LightEffect, 4367
- Properties in VBS:LimitHigh4, 4376
- Properties in VBS:LimitHigh5, 4376
- Properties in VBS:LimitLow4, 4377
- Properties in VBS:LimitLow5, 4377
- Properties in VBS:LimitMax, 4377
- Properties in VBS:LimitMin, 4377
- Properties in VBS:ListType, 4381
- Properties in VBS:LockStatus, 4383
- Properties in VBS:LockText, 4383
- Properties in VBS:LockTextColor, 4383
- Properties in VBS:Logging, 4384
- Properties in VBS:LongStrokesBold, 4385
- Properties in VBS:LongStrokesOnly, 4385
- Properties in VBS:LongStrokesSize, 4385, 4519
- Properties in VBS:LongStrokesTextEach, 4385
- Properties in VBS:Marker, 4390
- Properties in VBS:Max, 4390
- Properties in VBS:MaximizeButton, 4390, 4715
- Properties in VBS:MCGUBackColorOff, 4391
- Properties in VBS:MCGUBackColorOn, 4391
- Properties in VBS:MCGUBackFlash, 4391
- Properties in VBS:MCGUTextColorOff, 4392
- Properties in VBS:MCGUTextColorOn, 4392
- Properties in VBS:MCGUTextFlash, 4392
- Properties in VBS:MCKOBackColorOff, 4392
- Properties in VBS:MCKOBackColorOn, 4392
- Properties in VBS:MCKOBackFlash, 4392
- Properties in VBS:MCKOTextColorOff, 4393
- Properties in VBS:MCKOTextColorOn, 4393
- Properties in VBS:MCKOTextFlash, 4393
- Properties in VBS:MCKQBackColorOff, 4393
- Properties in VBS:MCKQBackColorOn, 4393
- Properties in VBS:MCKQBackFlash, 4393
- Properties in VBS:MCKQTextColorOff, 4394
- Properties in VBS:MCKQTextColorOn, 4394
- Properties in VBS:MCKQTextFlash, 4394
- Properties in VBS:MCText, 4394
- Properties in VBS:MessageClass, 4406
- Properties in VBS:Min, 4411
- Properties in VBS:Movable, 4715
- Properties in VBS:Name, 4415
- Properties in VBS:NumberLines, 4421
- Properties in VBS:ObjectSizeDeclutteringEnable, 4424
- Properties in VBS:ObjectSizeDeclutteringMax, 4424
- Properties in VBS:ObjectSizeDeclutteringMin, 4425
- Properties in VBS:OnTop, 4427
- Properties in VBS:OperationMessage, 4427
- Properties in VBS:OperationReport, 4427
- Properties in VBS:OutputFormat, 4441
- Properties in VBS:OutputValue, 4442
- Properties in VBS:Path, 4445
- Properties in VBS:PicDeactReferenced, 4450
- Properties in VBS:PicDeactTransparent, 4450
- Properties in VBS:PicDeactUseTransColor, 4450
- Properties in VBS:PicDownReferenced, 4450
- Properties in VBS:PicDownTransparent, 4450
- Properties in VBS:PicDownUseTransColor, 4451
- Properties in VBS:PicReferenced, 4451
- Properties in VBS:PicTransColor, 4451
- Properties in VBS:PictureUp, 4454
- Properties in VBS:PicUpReferenced, 4454
- Properties in VBS:PicUpTransparent, 4454
- Properties in VBS:PicUpUseTransColor, 4455
- Properties in VBS:PicUseTransColor, 4455
- Properties in VBS:PointCount, 4455
- Properties in VBS:Position, 4456
- Properties in VBS:PredefinedAngles, 4457
- Properties in VBS:Process, 4459
- Properties in VBS:QualityCode, 4462
- Properties in VBS:ReferenceRotationLeft, 4468
- Properties in VBS:ReferenceRotationTop, 4468
- Properties in VBS:Relevant, 4469
- Properties in VBS:RightComma, 4469
- Properties in VBS:RoundCornerHeight, 4472
- Properties in VBS:RoundCornerWidth, 4473
- Properties in VBS:SameSize, 4479
- Properties in VBS:ScaleTicks, 4485
- Properties in VBS:Scaling, 4485
- Properties in VBS:ScreenName, 4487
- Properties in VBS:ScrollBars, 4488
- Properties in VBS:SelBGColor, 4490
- Properties in VBS:SelTextColor, 4503
- Properties in VBS:ServerPrefix, 4506
- Properties in VBS:SignificantMask, 4536
- Properties in VBS:Sizeable, 4536
- Properties in VBS:SmallChange, 4537
- Properties in VBS:StartValue, 4544
- Properties in VBS:TagName, 4568
- Properties in VBS:TagPrefix, 4568
- Properties in VBS:Tags, 4569
- Properties in VBS:Template, 4569
- Properties in VBS:TimeStamp, 4603
- Properties in VBS>TitleCut, 4604

- Properties in VBS:Titleline, 4606
  - Properties in VBS:ToleranceHigh, 4609
  - Properties in VBS:ToleranceLow, 4609
  - Properties in
    - VBS:TopConnectedConnectionPointIndex, 4630
    - Properties in VBS:TopConnectedObjectName, 4630
    - Properties in VBS:TopOffset, 4630
    - Properties in VBS:Trend, 4635
    - Properties in VBS:TrendColor, 4636
    - Properties in VBS:TypeAlarmHigh, 4662
    - Properties in VBS:TypeAlarmLow, 4662
    - Properties in VBS:TypeLimitHigh4, 4662
    - Properties in VBS:TypeLimitHigh5, 4662
    - Properties in VBS:TypeLimitLow4, 4663
    - Properties in VBS:TypeLimitLow5, 4663
    - Properties in VBS:TypeToleranceHigh, 4663
    - Properties in VBS:TypeToleranceLow, 4663
    - Properties in VBS:TypeWarningHigh, 4663
    - Properties in VBS:TypeWarningLow, 4663
    - Properties in VBS:UnselBGColor, 4667
    - Properties in VBS:UnselTextColor, 4667
    - Properties in VBS:UpdateCycle, 4668
    - Properties in VBS:UserValue1, 4688
    - Properties in VBS:UserValue2, 4688
    - Properties in VBS:UserValue3, 4689
    - Properties in VBS:UserValue4, 4689
    - Properties in VBS:Value, 4689
    - Properties in VBS:WarningHigh, 4705
    - Properties in VBS:WarningLow, 4705
    - Properties in VBS:WindowBorder, 4202, 4714
    - Properties in VBS:WindowOnTop, 4715
    - Properties in VBS:ZeroPointValue, 4741
    - Properties in VBS:Zoom, 4741
  - Properties of the VPN group, 577
  - Property list
    - Dynamize, 3010
  - ProSave, 5468, 5624
    - Installation, 75
  - Protect
    - Function key with password, 3036
  - ProtectedAreaName object, 4064
  - Protection concept, 879, 882
    - Introduction, 298
    - Revoking access rights, 299
  - Protection level, 878, 879
    - Revoking access rights, 299
  - Protocol, 547
  - PRVREC, 2370
  - PT, 1878
  - PTC resistor, 938
  - PTO, 48
  - Pull/plug interrupt (ET 200M), 948
  - Pull/plug interrupt OB, 895
  - Pulse, 1608, 1617, 1628, 1642, 1859, 1879, 1893, 2096, 2111
    - Extended, 1631, 1643, 1882, 1894, 2114
  - Pulse and direction output, 6010
  - Pulse extension, 934
  - Pulse generator
    - Enabling/disabling with CTRL\_PWM, 2506
  - Pulse interface: Principle, 6012
  - Pulse stretching, 951
  - PUT, 2833
  - PUT / GET, 882
  - PWM, 48
- Q**
- Q
    - PLC, 5370
  - Q address, 637
  - Q series, 5373
  - Q0xUDEH CPU
    - PLC, 5372
  - QRY\_CINT, 2445
  - QRY\_DINT, 2455
  - QRY\_TINT, 2451
  - Quantum, 5403
  - QuitHorn, 4821
  - QuitSelected, 4821
  - QuitVisible, 4822
- R**
- R, 444, 1592, 1843
  - R\_TRIG, 1605, 1857, 2093
  - Rack error OB, 896
  - Rack or station failure, 896
  - Racks, 413
    - Inserting a module, 422
  - Radius, 3103, 3121, 3123
  - RADIUS, 763
  - RadiusHeight property (VBS), 4464, 4465
  - RadiusWidth property (VBS), 4465
  - Range
    - Value outside range, 1679, 1932
    - Value within range, 1678, 1931
  - Range (... - ...)
  - Graphics list, 3003
  - RangeLabelView object, 4065
  - RangeQualityView object, 4067
  - RCV\_CFG, 2749
  - RCV\_PTP, 2757

- RCV\_RST, 2759
- RCVREC, 2367
- RD\_ADDR , 2548
- RD\_DPAR, 2433
- RD\_DPARA, 2436
- RD\_DPARM, 2438
- RD\_LOC\_T, 2288
- RD\_REC, 2358
- RD\_SINFO, 2475
- RDREC, 2321
- RE\_TRIGR, 1782, 2039, 2232
- Read continuously
  - Tag, 3187
- Read field, 1722, 1977
- Read memory address, 2177
- Read memory bit, 2179
- Read system time with TIME\_TCK, 2292
- READ\_DBL, 50, 2535
- READ\_ERR, 2464
- ReadFromArrayDB, 1739, 1995, 2170, 2207
- ReadFromArrayDBL, 1742, 1998, 2173
- Reading
  - A data record with RD\_REC, 2358
  - Asynchronously- data record of a module with RD\_DPARA, 2436
  - Data record of a module with RD\_DPAR, 2433
  - from a data block in load memory with READ\_DBL, 2535
- Reading data
  - From DP standard slaves/PROFINET IO devices with DPRD\_DAT, 2363
  - From remote CPU with GET, 2831
- Reading out
  - IP address, 5284
  - LED status with LED, 2484
  - Local time with RD\_LOC\_T, 2288
  - Recipe data record, 5678
- Reading out a diagnostics buffer, 982
- Reading tags, 653
- Read-only, 878
- ReadOnly property (VBS), 4466
- ReadTags, 4822
- REAL, 1093, 1135, 1158
- REAL\_TO\_, 1158
- Receiving data
  - on I-device with RCVREC, 2367
- Receiving SMS messages, 2727
- Recipe, 647, 3391, 3393, 3394, 5509, 5650
  - Application example: Machine parameter assignment, 3393
  - Application example:Batch production, 3393
  - Basics, 3391, 3393
  - Configuration option, 3400
  - Control, 5651
  - Creating new, 3420
  - Data flow, 5652
  - Data Flow, 3397
  - Data record, 3394, 5651
  - Differences in TP 177A and OP 77A, 3402
  - Entry, 3394
  - Export format, 3642, 3818
  - Exporting, 3449, 5506
  - Exporting to CSV file, 2507
  - GMP settings, 5787
  - Importing, 3449, 5508
  - Importing into data block, 2509
  - Memory requirements, 5752, 5753
  - Recipe screen, 3407, 5653
  - Recipe view, 3407, 5653
  - Synchronizing recipe tag, 3446
  - Synchronizing tags, 5666, 5667
  - Use, 3393
  - Use of text lists, 3406
- Recipe data
  - Migration, 153
- Recipe data record
  - change, 3446
  - Copy, 3445
  - Create on the HMI device, 3440, 3441, 3445
  - Creating, 5674
  - Creating new, 3420
  - Creating on the HMI device, 3440
  - Creating, key operation, 5660
  - Creating, keyboard operation, 5661
  - Creating, mouse operation, 5661
  - Creating, touch operation, 5660
  - Delete, key operation, 5665
  - Delete, keyboard operation, 5665
  - Delete, mouse operation, 5665
  - Deleting, 3446, 5676
  - Deleting, touch operation, 5665
  - Editing, 5675
  - Editing, key operation, 5663
  - Editing, keyboard operation, 5664
  - Editing, mouse operation, 5664
  - Editing, touch operation, 5663
  - Export format, 3642, 3818
  - Exporting, 3449, 5657
  - Importing, 3449, 5657
  - Importing and exporting, 3399
  - load, 3446
  - Reading from PLC, 5668, 5669, 5678
  - Reading, key operation, 5668
  - Reading, keyboard operation, 5669

- Reading, mouse operation, 5669
- Reading, touch operation, 5668
- Synchronize with PLC, 5675
- Synchronizing, 3446
- Synchronizing, key operation, 5666
- Synchronizing, keyboard operation, 5667
- Synchronizing, mouse operation, 5667
- Synchronizing, touch operation, 5666
- Transfer option, 3397
- Transfer, key operation, 5670
- Transfer, keyboard operation, 5671
- Transfer, mouse operation, 5671
- Transfer, touch operation, 5670
- Transferring the project, 80
- Transferring to PLC, 5670, 5671, 5677
- Use of text lists, 3406
- Recipe data record change
  - Effects in Runtime, 5787
- Recipe data record name
  - Writing to a tag, 3409, 3414
- Recipe data record number
  - Writing to a tag, 3409, 3414
- Recipe element
  - Creating new, 3420
- Recipe list, 3408, 5654
- Recipe name
  - Writing to a tag, 3409, 3414
- Recipe number
  - Writing to a tag, 3409, 3414
- Recipe report
  - application in reports, 3492
- Recipe screen, 3417, 5655
  - Automatic transfer, 3417
  - Configuring, 3432
  - Overview, 5655
  - Recipe tag, 3396
  - Synchronizing recipe value, 3417
  - Visual machine simulation, 3417
- Recipe tag
  - Offline, 5656
  - Online, 5656
  - Synchronizing, 3400, 3446, 5656
  - Teach-in mode, 3401
- Recipe value, 3417
  - Automatic transfer in the recipe screen, 3417
  - Synchronizing in the recipe screen, 3417
- Recipe view, 3125, 3407, 3412, 3442, 5653, 5659
  - Advanced recipe view, 3126
  - Application, 3128, 3442
  - Behavior with screen change, 3415
  - Configurable events, 3410, 3415
  - Configuring, 3427, 3430
  - Control element, 3127
  - Display number, 3127
  - Displaying one recipe only, 3413
  - Displaying values only, 3409
  - Dynamic properties, 3411
  - Expanded, 3412, 5653
  - Layout, 3128
  - Operating element, 3443, 5659
  - Operation, 3443, 5659
  - Operation using the function key, 3415
  - Operation with the keyboard, 3444, 5660
  - Operation with the mouse, 3444, 5660
  - Recipe data record, 3395, 3396, 3416
  - Simple, 3408, 5654
  - Simple recipe view, 3126
  - Toolbar, 3128
  - Updating, 3408, 3412
  - Use, 5659
  - Using as a drop-down list, 3414
- RecipeExport, 2507
- RecipeImport, 2509
- RecipeName property (VBS), 4466
- RecipeNumber property (VBS), 4467
- Recipes
  - Export CSV file from ES, 3435
  - Import CSV file into ES, 3433
- RecipeViewBack, 3695
- RecipeViewClearDataRecord, 3690
- RecipeViewGetDataRecordFromPLC, 3689
- RecipeViewMenu, 3690
- RecipeViewNewDataRecord, 3689
- RecipeViewOpen, 3691
- RecipeViewRenameDataRecord, 3694
- RecipeViewSaveAsDataRecord, 3693
- RecipeViewSaveDataRecord, 3692
- RecipeViewSetDataRecordToPLC, 3692
- RecipeViewShowOperatorNotes, 3695
- RecipeViewSynchronizeDataRecordWithTags, 3693
- Recommissioning
  - HMI device, 5638
- Reconnecting
  - Tag, 3182
- Reconnecting a PLC tag, 3182
- Recording a log file for the modem, 6264
- RecordName property (VBS), 4467
- RecordNumber property (VBS), 4467
- Rectangle
  - Configuring, 2988
  - Inserting, 2990
  - Inserting and configuring, 2990
  - Radius corners X, 3125
  - Radius corners Y, 3125

- Rectangle object, 4074
- Redoing actions
  - Basics of redoing actions, 324
  - Redoing actions, 327
- Reference channel, 935
- Reference channel error, 943
- Reference channel of the module, 945
- Reference junction, 785, 912, 927, 935, 944, 945
- Reference language, 266, 5531
  - Selecting, 5535
- Reference object
  - Defining, 2970, 3478
- Reference project
  - Basics, 277
  - Closing, 277
  - Comparing, 278
  - Opening, 277
- Reference temperature, 935, 944, 945
- References, 185
- Referencing
  - Object, 3554
- RelativeFillLevel property (VBS), 4468
- release, 3792
- Release
  - User data type, 3209
- Release key, 3794
- ReleaseButton, 3699
- Remainder of division, 1690, 1944
- Remote access user, 537
- Remote connection
  - as CPU-controlled remote connection, 6256
  - as dial-up connection, 6219
  - As VPN connection, 6243
- Remote connection cannot be established, 6242
- Remote connection from the TS Adapter is not established, 6266
- Remote connection to the TS Adapter is not established, 6265
- Remote control
  - By means of Internet Explorer, 5828
  - By means of SmartClient application, 5828
  - Configure SmartClient, 5820
  - Configure SmartServer, 5817
  - Devices with keys, 5824
  - Direct keys, 5832
  - Monitoring mode, 5816
  - Session Management, 5816
  - Smart Options, 5827
  - SmartClient display, 5831
- Remote desktop, 36
- Remote monitoring
  - Smart Options, 5827
- Remote system access to a programming device/  
personal computer, 6257
- Remove
  - Object from the group, 2983
- Removing, 98
  - Add-on, 98
  - Folder link, 2976
  - Formatting in the alarm text, 3274
- Rename
  - Customized VB function, 3561
  - Screen, 2939
  - Tag, 3178
  - Template, 2943
- Renewing the CA group certificate, 581
- REPEAT, 2222
- Replace
  - HMI device, 5572
- REPLACE, 2313
- Replace modules during operation, 948
- Replacing
  - Module, 427
- Replacing devices
  - Function key, 5561
  - K-key, 5562
  - Limitations on connections, 5559
  - Principle, 5559
- Report
  - Adding a detail page, 3467
  - Back page, 3462
  - Creating, 3466
  - creating (overview), 3464
  - Deleting page, 3468
  - Detail page, 3463
  - Device dependency, 4973
  - Event-driven output, 3468
  - Footer, 3463
  - Header, 3463
  - Maximum configurable number of pages, 3465
  - output to file, 3468
  - print, 3468
  - printing, 3484
  - Showing and hiding sections, 3468
  - Size and position of objects, 3465
  - Sorting pages, 3468
  - Steps for the output configuration, 3469
  - Time-driven output, 3468
  - Title page, 3462
- Reporting
  - Audit Trail, 5770
  - enabling, 3299
- Reports
  - Recipe report , 3492

- Alarm report , 3490
- Date/time field, 3486
- Graphic I/O field, 3489
- I/O field, 3486
- Page number, 3493
- Symbolic I/O field, 3494
- Requirements for establishing a remote connection, 6241
- Requirements for sending an SMS, 6260
- Requirements for sending emails, 6261
- Reset
  - Bit field, 1595, 1846
  - IEC timer, 1625, 2108
  - Operand, 1592, 1597, 1843, 1848
  - To factory settings, 992, 993
- Reset timer, 1876
- Reset to factory settings, 5628
- RESET\_BF, 1595, 1846
- ResetBit, 3696, 3848
- ResetBitInTag, 3697, 3849
- ResetTagToHandWheel , 3743
- Resetting
  - HMI device to factory settings, 5629
- Resetting the connection, 2907
- Resetting the MPI/PROFIBUS settings, 6168
- Resetting the TCP/IP settings, 6160
- Resetting the user interface layout, 233
- Resizing
  - Faceplate, 3066
- Resource
  - SIMATIC S7 1200, 73
- Resources, 1481
  - Code work memory, 1481
  - Data work memory, 1481
  - Introduction, 1481
  - Load memory, 1481
  - Retentive memory, 1481
  - Retentive memory data, 1481
  - Work memory, 1481
- Resources tab
  - Structure, 1483
- Response to resizing
  - Faceplate type, 3066
- Restore process
  - Authorization, 101
  - License key, 101, 102
- Restore window layout, 231
- Restoring, 5648, 5707
  - Data of the HMI device, 5624, 5626
  - Using WinCC flexible, 5648
- Restoring a backup, 6152
- Restoring a device, 6152
- Restoring data
  - HMI device, 5626
  - HMI device , 5624
- Restriction
  - Modicon Modbus RTU, 5419
  - Modicon Modbus TCP/IP, 5419
- Restrictions due to user rights, 244, 245
  - Recognizing, 245
- RET, 1777, 2033
- Retain, 1029
- Retentive behavior
  - Bit memory, timers, counters, 1183
- Retentive bit memories
  - Enabling the display, 1469
- Retentive memory, 1481
- Retentivity, 845, 1027
  - Bit memory, timers, counters, 1182
  - Block interface, 1254
  - Data block, 1395
  - Data block , 1396
  - PLC tag, 1182, 1183
- Retentivity of IP address parameters, 808
- Retrieving projects, 276
- RETURN, 2227
- RFID tag, 4865
- RIGHT, 2310
- Ring port, 5315, 5318
- Ring redundancy, 726
- RLO
  - Invert, 1590, 1841
- ROL, 1812, 2070, 2257
- Role name, 537
- Roles, 536
  - System-defined, 537
  - User-defined, 537
- Root certification authorities, 533
- Root, square, 2147
- ROR, 1810, 2068, 2255
- Rotate
  - Left, 1812, 2070, 2257
  - Object, 2953
  - Right, 1810, 2068, 2255
- Rotation property (VBS), 4470
- RotationAngle property (VBS), 4470
- RotationCenterLeft property (VBS), 4471
- RotationCenterTop property (VBS), 4472
- Round, 1755, 1756, 1758, 1759, 2011, 2013, 2014, 2015, 2196, 2197, 2198
- ROUND, 1755, 2011, 2196
- RoundButton object, 4074
- Router IP address, 605
- Routing, 5461

Routing connection  
     Configuring, 5298  
 Routing mode, 563  
 RowNumber property (VBS), 4473  
 RowScrollbar property (VBS), 4473  
 RowSizingEnable property (VBS), 4474  
 RS, 1597, 1848  
 RS-232/PIP multi-master cable, 872  
 RT, 1625, 1876, 2108  
 RT class, 796, 5305  
 RTPersistence property (VBS), 4475  
 RTPersistencePasswordLevel property (VBS), 4475  
 RTPersistenceType property (VBS), 4476  
 RulerColor property (VBS), 4477  
 RulerPrecision(i) property (VBS), 4477  
 RulerXPrecision(i) property (VBS), 4478  
 RulerYPrecision(i) property (VBS), 4478  
 Rules for configuring MPI networks  
     Rules for assigning the MPI address, 440  
 Rules for network configuration for PROFIBUS networks  
     Assigning device addresses, 440, 441  
 RUN, 840  
 Rung  
     Deleting, 1302  
     Inserting, 1301  
     Use, 1300  
 Runtime, 4878, 4880  
     Changing object property, 3576  
     Effective range, 4878  
     Effective range (RFID), 4880  
     Executing user-defined functions, 3574  
     Execution of the function list, 3573  
     Language switching, 3577  
     Mouse wheel, 78  
     Operation with the keyboard, 5704  
     Operation with the mouse, 5705  
     Start screen, 2940  
     starting on a panel, 5615  
     starting on PC, 5615  
 RUNTIME, 2241  
     Measure program runtime, 2241  
 Runtime data  
     Migration, 153  
 Runtime error, 3566  
 Runtime language, 5531, 5549  
     Font, 5554  
     Log, 3231, 3318, 5555  
     Order for language switching, 5552  
     Selecting, 5550  
 Runtime meters  
     Handling with RTM, 2293

Runtime scripting, 3541  
     Function, 3541  
     System function, 3541  
     User-defined function, 3541  
 Runtime settings, 5801  
     Communication, 5281  
     Dialog fonts, 5643  
     Disabling program switching, 5643  
     Screen saver, 5643  
     User administration, 2940, 3500, 3502, 3515, 3524, 3527  
 Runtime Stop, 3794

## S

S, 1593, 1844  
 S\_AVERZ, 1639  
 S\_CD, 1661, 1914  
 S\_COMP, 2295  
 S\_CONV, 2294, 2296  
 S\_CU, 1659, 1912, 2132  
 S\_CUD, 1910  
 S\_EVERZ, 1634  
 S\_ODT, 1634, 1885, 2117  
 S\_ODTS, 1637, 1888, 2119  
 S\_OFFDT, 1639, 1890, 2122  
 S\_PEXT, 1631, 1882, 2114  
 S\_PULSE, 1628, 1879, 2111  
 S\_SEVERZ, 1637  
 S5TIME, 1096  
 S7 1200  
     Basic Panel, 4958  
     Comfort Panel, 4965  
     Communication, 5045  
     Connection parameters, 5110  
     HMI connection, 5047  
     Mobile Panel, 4971  
     Multi Panel, 4969  
     Panel, 4961  
     Parameters, 5110  
     PROFIBUS, 5067, 5068, 5069, 5071, 5073  
     PROFIBUS parameters, 5075, 5077, 5078  
     PROFINET, 5046, 5049  
     WinCC Runtime, 4975  
 S7 1500  
     Communication, 4978  
     Connection parameters, 5033  
     Data types, 5029  
     HMI connection, 4980  
     Parameters, 5033  
     PC, 4983  
     PROFIBUS, 4997, 4998, 4999, 5001, 5002



- PROFIBUS parameters, 5004, 5006, 5007
- PROFINET, 4979, 4981
- PROFINET parameters, 4987, 4989, 4990
- WinCC Runtime, 4975
- S7 200
  - Communication, 5198
  - Connection, 5198, 5229
  - Connection parameters, 5200
  - Data types, 5227
  - MPI, 5196, 5205
  - Parameters, 5196, 5200, 5205, 5206
  - PPI, 5206
- S7 300
  - Basic Panel, 4958
  - Comfort Panel, 4965
  - Communication, 5118
  - Mobile Panel, 4971
  - MPI address, 5165
  - Multi Panel, 4969
  - Panel, 4961
  - WinCC Runtime, 4975
- S7 300/400
  - Connection parameters, 5191
  - Data types, 5185
  - HMI connection, 5120
  - MPI, 5153, 5155, 5157, 5158
  - MPI parameters, 5160, 5162, 5163
  - Parameters, 5191
  - PC, 5126
  - PROFIBUS, 5139, 5140, 5141, 5143
  - PROFIBUS parameters, 5147, 5149, 5150
  - PROFINET, 5119, 5122
  - PROFINET parameters, 5128, 5130, 5132
- S7 400
  - Basic Panel, 4958
  - Comfort Panel, 4965
  - Communication, 5118
  - Mobile Panel, 4971
  - MPI address, 5165
  - Multi Panel, 4969
  - Panel, 4961
  - WinCC Runtime, 4975
- S7 communication
  - Parameter, 2828
  - Receive data from a remote partner instruction with BRCV, 2841
  - Receive data from a remote partner instruction with URCV, 2837
  - Send and receive parameters, 2829
  - Send data to a remote partner instruction with BSEND, 2839
  - Send data to a remote partner instruction with USEND, 2836
  - User data size, 2830
- S7 connection, 450
  - TSAP, 461
- S7 CPU
  - Work memory, 843
  - Load memory, 843
  - Operand area, 843
- S7 diagnostic alarm
  - enabling, 3278
- S7 diagnostic alarms, 3252
- S7-1200, 45
- S7-1200 modules, 45
- S7-CP, 525
- S7-PCT, 826
- SA lifetime, 578
- SafelyRemoveHardware, 3647, 3850
- Safety guidelines, 253
- Safety instruction
  - Changing the recipe data record in the background, 3408
  - Direct key, 5691
  - Recipe data record in background, 3412, 5654
  - Renamed tag, 5666
  - Switching infotext, 5697, 5703
- Safety precautions when forcing tags, 1526, 1540
- Save
  - Global library, 5493
- Save table layout, 230
- Save user interface
  - Save layout in editors, 230
  - Save window layout, 230
- Save window layout, 230
- SaveDataRecord, 3730, 3851
- Saving a force table, 1530
- Saving a watch table, 1505
- Saving phone books, 6214
- Saving the user interface, 230
- SC, 1663, 1916
- SCALANCE S, 525
- SCALANCE XR500, "Compile"/"Download", 47
- Scale, 1760, 1765, 2017, 2021, 2201, 2209
- SCALE, 1765, 2021, 2209
- SCALE\_X, 1760, 2017, 2201
- ScaleColor property (VBS), 4479
- ScaleDenominator property (VBS), 4485
- ScaleGradation property (VBS), 4480
- ScaleLabelColor property (VBS), 4481
- ScaleNumerator property (VBS), 4481
- ScalePosition property (VBS), 4482
- ScaleTickColor property (VBS), 4482

- ScaleTickLabelPosition property (VBS), 4483
  - ScaleTickLength property (VBS), 4483
  - ScaleTickPosition property (VBS), 4484
  - Scaling
    - Applying linear scaling to a tag, 3187, 3189
  - ScalingType property (VBS), 4486
  - Scan operand for negative signal edge, 1599, 1851
  - Scan operand for positive signal edge, 1598, 1850
  - Scan RLO for negative signal edge, 1604, 1856
  - Scan RLO for positive signal edge, 1603, 1854
  - Scheduler, 4892
    - Acyclic triggers, 4897, 4898
    - Administer task, 4902
    - Cyclic triggers, 4897, 4900, 4906
    - Deactivated task, 4896
    - Event trigger, 4896, 4897, 4901, 4904
    - Function list, 4895
    - Timers for cyclic and acyclic triggers, 4898
    - Triggers, 4896, 4897
    - Work area, 4894
  - SCL, 1340, 1576, 1578
    - Insert comment, 2227
    - Programming window, 1351
  - SCL instruction
    - Changing the data type, 1361
    - Data type basics, 1360
    - Inserting, 1358, 1359
    - Rules, 1357
    - Selecting, 1374
  - SCL program
    - Inserting a block call, 1364, 1365, 1367, 1368, 1369, 1370
    - Inserting an instruction, 1358, 1359
    - Inserting comments, 1373
    - Program status display, 1498
    - Selecting an instruction, 1374
    - Showing and hiding the parameter list, 1372
  - Screen
    - Availability for specific devices, 2933
    - Copy, 2939
    - Copying, 5577
    - Creating, 2938
    - Creating a type, 5503
    - Deleting, 2939
    - Font, 2934
    - Inserting, 2939
    - Library, 5503
    - Move, 2939
    - Printing, 5644
    - Rename, 2939
    - Use template, 2946
    - Working steps in creating, 2937
    - Zooming, 2937
  - Screen change, 3788
    - Displaying the screen on entering a zone, 4881
  - Screen display, 38
  - Screen keyboard, 5691
    - Alphanumerical, 5695
    - Keyboard level, 5695
    - Language behavior, 77
    - Language change, 5695
    - Numerical, 5693
  - Screen number, 4916
  - Screen object, 3905, 3930
    - Dynamic movement, 3015
    - Dynamization of the control enable state, 3018
  - Screen object (list), 3904
  - Screen saver
    - Runtime settings, 5643
  - Screen template, 3032
  - ScreenItem, 4030
    - Control, 4000
  - ScreenItem object, 3906, 3932
  - ScreenItems object (list), 3908, 3934
  - ScreenItems property (VBS), 4487
  - ScreenObjectCursorDown, 3628
  - ScreenObjectCursorUp, 3629
  - ScreenObjectPageDown, 3629
  - ScreenObjectPageUp, 3630
  - Screens property (VBS), 4487
  - ScreenWindow object, 4078
- Script
    - Creating a type, 5502
    - Library, 5502
    - Migrating, 149
    - Updating tag value, 3169, 4949
  - Scrollable property (VBS), 4488
  - Scrolling back key, 5698
  - Scrolling up key, 5698
  - SD, 1643, 1645, 1896
  - SD card
    - Open force job, 36
  - SD cards, 36
  - SE, 1643, 1894
  - Search
    - Hardware catalog, 412
  - SecondNeedleHeight property (VBS), 4489
  - SecondNeedleWidth property (VBS), 4489
  - Security Configuration Tool
    - Configuration views, 526
  - Security events, 593, 595
  - Security module, 525
  - Security program, 90, 94
  - Security settings, 700

- Security system, 5706
- SEG, 1831, 2089, 2277
- Segment diagnostics
  - Graphic display, 1010
  - Icons, 1010
  - Text display, 1010
- SegmentColoring property (VBS), 4490
- Segmented circular log, 3305
- SEL, 1799, 2057, 2245
- Select, 1799, 2057, 2245
  - Multiple objects, 2969, 3477
- SelectBackColor property (VBS), 4491
- SelectedCellColor property (VBS), 4491
- SelectedCellForeColor property (VBS), 4492
- SelectedRowColor property (VBS), 4493
- SelectedRowForeColor property (VBS), 4493
- SelectedStatisticArea, 4836
- SelectedTitleColor property (VBS), 4494
- SelectedTitleForeColor property (VBS), 4495
- SelectForeColore property (VBS), 4495
- Selecting
  - Multiple objects, 2954
- Selection changed, 3787
- Selection list
  - Open, 5698
- SelectionBackColor property (VBS), 4496, 4497
- SelectionColoring property (VBS), 4497
- SelectionForeColor property (VBS), 4498, 4499
- SelectionMode property (VBS), 4499, 4500
- SelectionRect property (VBS), 4500
- SelectionRectColor property (VBS), 4501
- SelectionRectWidth property (VBS), 4502
- Send clock cycle, 814
- SEND\_CFG, 2747
- SEND\_PTP, 2755
- SendEMail, 3705, 3852
- Sending SMS messages, 2723
- SeparatorBackColor property (VBS), 4503
- SeparatorColor property (VBS), 4503
- SeparatorWidth property (VBS), 4505
- SeperatorCornerStyle property (VBS), 4504
- SeperatorStyle property (VBS), 4504
- Sequence of columns, 3139
- Sequencer, 1814, 2072, 2259
- Server
  - Configuring, 5281
  - HMI device, 5281
- ServerExport, 4837
- ServerImport, 4838
- ServerNames property (VBS), 4506
- ServerScale property (VBS), 4505
- Service & Support, 405, 4933
  - Enabling, 405
- Service data
  - Saving, 987
- Service groups, 549, 551
- Service-pages, 5843
  - Create own , 5851
  - Display, 5847
  - remote control, 5847
  - Transfer, 5852
- Servo motor, 6007
- Session Management, 5816
  - Setting, 5817
- Set
  - Bit field, 1594, 1845
  - Counter initial value, 1663
  - Counter start value, 1916
  - Operand, 1593, 1596, 1844, 1847
- Set limit value, 1700, 1954, 2144
- Set operand on negative signal edge, 1602, 1853
- Set operand on positive signal edge, 1601, 1852
- Set tag on negative signal edge, 1606, 1858, 2094
- Set tag on positive signal edge, 1605, 1857, 2093
- Set the services
  - SmartClient, 5801
  - SmartServer, 5801
- SET\_BF, 1594, 1845
- SET\_CINT, 2443
- SET\_TIMEZONE, 2290
- SET\_TINT, 2446
- SET\_TINTL, 2448
- SetAccessModeViaWeb, 3723
- SetAcousticSignal, 3706, 3853
- SetAlarmReportingMode, 3716, 3854
- SetAlarmReportMode, 3716, 3854
- SetAndGetBrightness, 3720, 3854
- SetBacklightColor, 3712
- SetBit, 3709, 3855
- SetBitInTag, 3710, 3856
- SetBitWhileKeyPressed, 3711
- SetBrightness, 3713, 3857
- SetConnectionMode, 3722, 3858
- SetDataRecordTagsToPLC, 3703, 3859
- SetDataRecordToPLC, 3702, 3860
- SetDaylightSavingTime, 3718, 3861
- SetDeviceMode, 3708, 3862
- SetDisplayMode, 3707, 3862
- SETIO, 2325
- SETIO\_PART, 2327
- SetLanguage, 3719, 3863
- SetPLCMode, 69, 3672, 3715
- SetpointTrendArchiveStartId(i) property (VBS), 4507
- SetpointTrendColor(i) property (VBS), 4508

- SetpointTrendNumberOfValues(i) property (VBS), 4508
  - SetRecipeTags, 3717, 3864
  - SetScreenKeyboardMode, 3714, 3865
  - SetStart at boot, 3769, 3877
  - SetTag, 3721, 3866
  - SetTagToHandWheel, 3744
  - Setting
    - Deadband, 3272
    - Delay time, 3272
    - Language, 5649
    - Languages in the operating system, 5532
    - View options for the assignment list, 1466
    - View options for the dependency structure, 1479
  - Setting AS-i network configuration parameters, 449
  - Setting at the HMI-device
    - E-Mail, 5804
    - HTTP server, 5806, 5856
    - SmartServer, 5807
    - Web authorization, 5806
    - Web server, 5806
  - Setting ENO automatically, 1349
  - Setting language, 5649
  - Setting parameters for the Ethernet interface, 6158
    - Adding a dynamic IP address, 6159
    - Connecting to a subnet, 6158
    - Deleting dynamic IP addresses, 6160
    - Modifiable parameters, 6157
    - Options in the parameter settings, 6156
  - Setting the communication load, 447
  - Setting the font, size and color , 1352
  - Setting the Internet Settings
    - HTTP server, 5287
  - Setting the mnemonics, 1229
  - Setting the tab spacing , 1352
  - Setting up
    - DCOM user rights, 5894
  - Setting up DCOM user rights, 5894
  - Settings
    - Changing, 203, 1239, 1263, 1305, 1350
    - FBD, 1262, 1304
    - General, 199, 201, 202, 1238
    - LAD, 1262, 1304
    - SCL, 1349
  - Settings for the PG/PC interface, 6155
    - Automatic bus parameter detection, 6162
    - Setting parameters for the MPI interface, 6162
    - Setting parameters for the PROFIBUS interface, 6164
  - SetValue, 5864
  - SetWebAccess, 3723
  - Seven-segment display, 1831, 2089, 2277
  - Severity, 563
  - SF, 1648, 1900
  - SGN\_GET, 2759
  - SGN\_SET, 2760
  - SHA algorithm, 700
  - SHA1, 578, 625, 635
  - Shared device
    - Associated IO controllers, 975
  - Shared property (VBS), 4511
  - ShareTimeColumn property (VBS), 4509
  - ShareValueAxis property (VBS), 4510
  - ShareXAxis property (VBS), 4510
  - ShareYAxis property (VBS), 4511
  - Shift
    - Left, 1808, 2066, 2253
    - Right, 1806, 2064, 2251
  - SHIFT
    - Key, 5699
  - ShiftDecimalPointReadOnlySpecial property (VBS), 4512
  - SHL, 1808, 2066, 2253
  - Short-circuit to ground, 933
  - Short-circuit to L+, 934
  - ShortenCellText property (VBS), 4512
  - ShortenColumnHeaderText property (VBS), 4513
  - Show
    - Limit lines on the bar, 3087
  - Show line numbers, 1352
  - ShowAlarmsFromDate property (VBS), 4513
  - ShowAlarmWindow, 3749, 3751, 3868, 3871
  - ShowBar property (VBS), 4514
  - ShowBorder property (VBS), 4514
  - ShowCaption property (VBS), 4515
  - ShowColumn(i) property (VBS), 4516
  - ShowColumnSelection, 4838
  - ShowComment, 4839
  - ShowCurve(i) property (VBS), 4516
  - ShowDecimalPoint property (VBS), 4517
  - ShowDisplayOptionsDialog, 4839
  - ShowEmergencyQuitDialog, 4840
  - ShowFillLevel property (VBS), 4517
  - ShowFocusRectangle property (VBS), 4518
  - ShowHelp, 4840
  - ShowHideList, 4841
  - ShowHitList, 4841
- Showing
    - Report sections, 3468
  - Showing and hiding absolute operands, 1352
  - Showing and hiding columns, 1195, 1259, 1403, 1418
  - ShowInputControls property (VBS), 4518
  - ShowLimitMarkers property (VBS), 4519

- ShowLockDialog, 4842
- ShowLockList, 4843
- ShowLogonDialog, 3748
- ShowLongTermArchiveList, 4843
- ShowMainFrame property (VBS), 4519
- ShowMessagesAtDate property (VBS), 4520
- ShowOperatorNotes, 3748, 3869
- ShowOverflowIndicator property (VBS), 4521
- ShowPeakValuePointer property (VBS), 4521
- ShowPercentageAxis, 4844
- ShowPosition property (VBS), 4522
- ShowPropertyDialog, 4845
- ShowRowHeaders property (VBS), 4523
- ShowRuler property (VBS), 4523, 4524
- ShowRulerInAxis property (VBS), 4524
- ShowScale property (VBS), 4525
- ShowScrollbars property (VBS), 4525
- ShowSelectArchive, 4845
- ShowSelection, 4846
- ShowSelectionDialog, 4846
- ShowSelectTimeBase, 4847
- ShowSetpointTrend(i) property (VBS), 4526
- ShowShortTermArchiveList, 4847
- ShowSoftwareVersion, 3750, 3870
- ShowSort, 4848
- ShowSortButton property (VBS), 4526
- ShowSortDialog, 4848
- ShowSortIcon property (VBS), 4527, 4528
- ShowStatusBar property (VBS), 4528
- ShowSystemAlarm, 3751, 3871
- ShowSystemDiagnosticsWindow, 3751, 3871
- ShowTableGridlines property (VBS), 4529
- ShowTagSelection, 4849
- ShowThumb property (VBS), 4530
- ShowTickLabels property (VBS), 4530
- ShowTicks property (VBS), 4531
- ShowTimebaseDialog, 4849
- ShowTimeSelection, 4850
- ShowTitle property (VBS), 4532
- ShowToolBar property (VBS), 4532
- ShowTrendIcon property (VBS), 4533
- ShowTrendIndicator property (VBS), 4534
- ShowTrendSelection, 4850
- ShowVerticalGridlines property (VBS), 4534
- ShowXValuesExponential(i) property (VBS), 4535
- ShowYValuesExponential(i) property (VBS), 4535
- SHR, 1806, 2064, 2251
- Shutting down Windows XP, 37
- SiClock, 551
- Sign, 1694, 1949
- Signal board, 641
  - Inserting, 642
- Signal quality
  - Calculating the effective range, 3156
- signature
  - electronic, 5756
- SIMATIC 500/505 DP
  - Migrating data types, 168
- SIMATIC 500/505 serial
  - Migrating data types, 168
- SIMATIC HMI HTTP protocol
  - Valid data type, 5293
- SIMATIC HMI HTTP Protocol
  - Configuring HTTP clients, 5858
  - Configuring the connection, 5858
  - HTTP Protocol, 5280
  - HTTPS Protocol, 5280
  - Migrating data types, 169
  - Permitted data type, 5855
- SIMATIC ISB driver, 40
- SIMATIC LOGO!
  - Communication, 5228
  - Connection parameters, 5230
  - Data types, 5239
  - Parameter, 5230
- SIMATIC Logon, 3511
- SIMATIC memory card
  - Formatting, 994
- SIMATIC PC
  - HMI connection, 4986, 5002, 5051, 5071, 5124, 5157
  - S7 1500, 4986
  - S7 300/400, 5124
  - WinCC RT Advanced, 5002
  - WinCC RT Professional, 4986, 5002
  - WinCC RT Advanced, 4986
- SIMATIC S5 AS511
  - Migrating data types, 169
- SIMATIC S5 DP
  - Migrating data types, 170
- SIMATIC S7
  - Communication partners, 5036, 5115, 5195, 5204, 5207
- SIMATIC S7 1200
  - Connection resource, 73
  - Resource, 73
- SIMATIC S7 Embedded Controller, 46
- SIMATIC S7 200
  - Migrating data types, 171
- SIMATIC S7 300/400
  - Migrating data types, 171
- simple alarm view, 5684
  - Use, 5684
- Simple alarm view, 3328

- Application, 3328
  - Control element, 3329, 5685
  - Operation, 3329, 5685
  - Operation using the keyboard, 3330
  - Operation using the mouse, 3330
- Simple Alarm view, 3113
- simple alarm window
  - Application, 3328
  - Use, 5684
- Simple recipe view, 3126, 3408, 5654
  - Behavior, 3437, 5673
  - Configuring, 3126
  - Constraints, 3411
  - Layout, 3436, 5672
  - Menu command, 3437, 5672, 5673
  - Operation, 3436, 5672
- Simple user view, 5709
  - Configuring, 3088
  - Layout, 5709
  - Operation, 5710
  - Use, 5709
- Simulate hardware, 388
- Simulate modules, 388
- Simulate software, 388
- SimulateSystemKey, 3725
- SimulateTag, 3726
- Simulating
  - Define temporary start screen, 5619
  - Project with tag simulator, 5617
- Simulating devices, 388
- Simulation, 80
  - PLC connection, 80
- SIN, 1706, 1961, 2150
- Sine, 1706, 1961, 2150
- Single instance
  - Correcting the call type, 1281, 1322
  - Definition, 1035
  - Example, 1035
- SINT, 1085, 1129, 1148
- SINT\_TO\_, 1148
- Size
  - Editing multiple objects, 2971, 3479
  - of objects in the report, 3465
- SkinName property (VBS), 4536
- SLC, 5352
- Slice access, 1064
- Slicing, 185
- Slider, 3131
  - Display bar, 3132
  - Display current value, 3132
  - Maximum value, 3132
  - Minimum value, 3132
- Slider object, 4084
- Slot
  - Determining logical address with LGC\_GADR, 2555
  - Determining logical address with LOG\_GEO, 2551
  - Racks, 413
  - Select, 414
- Slot rules, 410
  - ET 200S, 784
- Sm@rtClient view, 3136
  - Shared use, 3137
  - View only, 3137
- Smart Objects
  - Control, 4000
- Smart Options, 5827
  - HMI devices suitable for use, 5800
  - Remote control, 5827
  - Remote control by means of Internet Explorer, 5828
  - Remote monitoring, 5827
- Smart tags
  - ProcessValue, 4461
- SmartAccess
  - Distributed operator stations, 5835
  - Editing tag values in MS Excel, 5864
- SmartClient
  - Monitoring mode, 5820
  - Password input, 5832
  - SmartClient display, 5820
- SmartClient display, 5831
- SmartClientView object, 4085
- SmartClientViewConnect, 3729
- SmartClientViewDisconnect, 3728
- SmartClientViewLeave, 3730
- SmartClientViewReadOnlyOff, 3727
- SmartClientViewReadOnlyOn, 3728
- SmartClientViewRefresh, 3727
- Smartdrive
  - Installation, 57
- SmartServer, 3736, 3811
  - As a service, 5819
  - Control mode, 5817
  - Forced access, 5819
  - Hardware acceleration, 5825
  - Local operator control, 5819
  - Monitoring mode, 5817
  - Password, 5826
  - Password input, 5832
  - Setting at the HMI-device, 5807
- SmartService
  - E-mail notification, 5838

- Input area plan, 5804
- Remote control by means of the SmartClient application, 5828
- SmartTag object, 3911, 3938
- SmartTags object (list), 3910, 3940
- SmartTags property (VBS), 4537
- SMC, 1826, 2084, 2271
- Smoothing, 926, 943
- SMS text, 2725, 2729, 2735
- SMTP Client, 697
- SNC\_RTCB, 2291
- SNMP, 539, 691, 700
  - Groups, 700
  - SNMP trap, 700
  - Users, 701
- SNMPv1, 625, 635
- SNMPv3, 625, 635
- SOAP
  - Access from Excel, 5863
  - GetValue, 5864
  - SetValue, 5864
  - Windows CE, 5863
- Softbus, 5461
- Softkey, 3030, 3034
  - global, 3032
- SOFTNET Security Client
  - Configuring in the project, 597
  - Creating a configuration file, 597
  - Database, 598
  - Using, 596
- SOFTNET Security Client, 525
- Software
  - HMI device , 5622, 5623
- Software controller
  - Configuring, 5931
- Software requirements at the plant end
  - Communications instruction "PG\_DIAL", 6258
- Software requirements at the system end
  - Communications instruction "AS\_MAIL", 6262
  - Communications instruction "SMS\_SEND", 6261
- Software requirements for AS-AS remote link
  - Communication instruction "AS\_DIAL", 6260
- Software requirements for the programming device/ personal computer
  - Communications instruction "PG\_DIAL", 6258
- Software-controlled data flow control, 871
- Sort property (VBS), 4537
- SortByTimeEnable property (VBS), 4538
- SortByTimeEnabled property (VBS), 4539
- Sorting
  - Report page, 3468
- SortOnColumnHeaderClick property (VBS), 4539
- SortSequence property (VBS), 4540
- SortTimeAscending property (VBS), 4540
- SortTimeEnable property (VBS), 4541
- SP, 1642, 1893
- Special characters
  - Alarm text, 68
- Special considerations
  - Omron Host Link, 5438
- Special tag (web server), 656
- Specific .Net control
  - Add, 2973
  - Remove, 2974
- Speedy Splitter, 391, 394, 397, 406
- SQR, 2146
- SQR , 1702, 1956
- SQRT, 1703, 1958, 2147
- Square, 1702, 1956, 2146
- Square root, 1703, 1958, 2147
- SR, 1596, 1847
- SRT\_DINT, 2453
- SS, 1646, 1898
- SSH server, 690
- SSL certificate, 534
- Stamping, 2967, 3472
- Standard
  - PROFIBUS, 5080, 5152
- Standard device, 820
- Standard router, 604
- Standard slave, 794
- Standard user, 537
- Standby Mode, 37
- Standby module
  - Substitute value, 789
- Start address, 637, 847
- Start information, 1022
- Start off-delay timer, 1872
- Start on-delay timer, 1870
- Start pulse timer, 1868
- Start screen, 2940
- Start the online and diagnostics view, 969
- Start the simulation, 388
- Start value
  - Tag, 3185, 3186
- Start value of danger range
  - Gauge, 3159
- Start value of warning range
  - Gauge, 3159
- StartAngle property (VBS), 4541
- Starting
  - Debugger, 3572, 5622
  - Runtime at Engineering Station, 5613
  - Runtime on a panel, 5615

- Runtime on PC, 5615
  - Runtime on the configuration PC, 5613
  - Starting removal, 115
  - Starting the migration tool, 122
  - Starting the topology view, 510
  - StartLeft property (VBS), 4542
  - StartLogging, 3731, 3872
  - StartNextLog, 3732, 3873
  - StartPointTop property (VBS), 4544
  - StartProgram, 3733, 3873
  - StartSequenceLog, 3732, 3873
  - StartStopUpdate, 4851
  - StartStyle property (VBS), 4543
  - Startup, 883
    - Organization blocks, 883
  - STARTUP
    - Function, 836
    - STARTUP activities, 838
  - Startup language
    - determine:Startup language, 3319
  - Startup OB
    - Description, 883
  - Start-up parameters, 839
  - Startup routine, 883
  - Startup type, 856
  - Stateful packet inspection, 543
  - Station
    - Copying, 425
    - Deleting, 424
    - Moving, 427
    - Read information with GetStationInfo, 2490
    - Renaming, 521
  - Station name, (See device name)
  - Status, 887
    - Module defective, 982
  - Status interrupt, 887
  - Status interrupt OB, 887
  - Status of the online connection, 1006
  - Status/Force
    - Button, 3140
    - Column header, 3140
    - Control element, 3139
    - Sequence of columns, 3139
    - Visible column, 3139
  - StatusbarBackColor property (VBS), 4545
  - StatusbarElementAdd property (VBS), 4545
  - StatusbarElementAutoSize property (VBS), 4546
  - StatusbarElementCount property (VBS), 4546
  - StatusbarElementIconId property (VBS), 4547
  - StatusbarElementId property (VBS), 4547
  - StatusbarElementIndex property (VBS), 4548
  - StatusbarElementName property (VBS), 4548
  - StatusbarElementRemove property (VBS), 4549
  - StatusbarElementRename property (VBS), 4549
  - StatusbarElements property (VBS), 4550
  - StatusbarElementTooltipText property (VBS), 4550
  - StatusbarElementUserDefined property (VBS), 4551
  - StatusbarElementVisible property (VBS), 4552
  - StatusbarElementWidth property (VBS), 4552
  - StatusbarFontColor property (VBS), 4552
  - StatusbarShowArchiveName property (VBS), 4553
  - StatusbarShowColumn property (VBS), 4553
  - StatusbarShowRecord property (VBS), 4554
  - StatusbarShowRow property (VBS), 4554
  - StatusbarShowText property (VBS), 4554
  - StatusbarShowTooltips property (VBS), 4555
  - StatusbarText property (VBS), 4556
  - StatusbarUseBackColor property (VBS), 4556
  - StatusbarVisible property (VBS), 4557
- StatusForce object, 4087
  - StatusForceGetValues, 3735
  - StatusForceSetValues, 3735
  - Stepper motor, 6007
  - STL, 1568
  - STL source
    - Generating blocks, 1422
  - STOP, 840
  - Stop forcing, 1546, 1547
  - Stop method, 4851
  - StopLogging, 3737, 3875
  - Stopping
    - Debugger, 3572
  - StopRuntime, 3738, 3876
  - Storage location, 3306
    - Audit Trail, 5780
  - Storing
    - External graphic, 2977
  - STP, 1783, 2040, 2233
  - Strg\_TO\_Chars, 2302
  - STRG\_VAL, 2297
  - String
    - Comparing tags with S\_COMP, 2295
  - STRING, 1072, 1103, 1141, 1166
    - Addressing, 1063
  - STRING\_TO\_, 1166
  - STRUCT
    - Addressing, 1063
    - Declaration in global data blocks, 1391
    - Declaration in the block interface, 1247
    - Declaring in a PLC data type, 1413
    - Structure, 1110
  - Structure, 929, 941
    - Call structure, 1473
    - of the cross-reference list, 1486, 5528



- Of the dependency structure, 1477
- Resources tab, 1483
- STRUCT, 1110
- Structured programming, 1020
- Style property (VBS), 4558
- SUB, 1687, 1940
- Subnet mask, 801
- Substitute value
  - Standby module, 789
- Subtract, 1687, 1940
- Subtracting
  - Subtracting times with T\_SUB, 2284
- Supply voltage, 935
- SWAP, 1737, 1993, 2169
- Swap bytes, 1737
- SwapDimensionsWithOrientation property (VBS), 4559
- SwapFirstWithLastConnection property (VBS), 4560
- Switch, 3129
  - Type, 3129
- SWITCH, 1774, 2030
- Switch buffer, 5024, 5100, 5181, 5223, 5235, 5357, 5388, 5420, 5439
- Switch object, 4089
- Switch OFF, 3795
- Switch ON, 3795
- Switching between basic mode and expanded mode in the force table, 1527
- Switching between basic mode and expanded mode in the watch table, 1501
- Switching operating mode, 988
- Switchover time, 873
- Switchport, 818, 4995, 5065, 5137
- Symbol
  - Alarm classes, 3285
- Symbol library, 3140
  - Fill style, 3141
  - Fixed aspect ratio, 3141
  - Flip, 3141
  - OP 177B mono, 3141
  - Rotate, 3141
  - TP 177B mono, 3141
- Symbolic addressing, 185
  - of a tag, 3171, 4950
- Symbolic constants, 1051
- Symbolic I/O field, 3142
  - application in reports, 3494
  - Mode, 3142
  - Text list, 2998, 3143
- Symbolic programming
  - Displaying absolute addresses, 1230
- SymbolicIOField object, 4093
- Symbolism, 183
- SymbolLibrary object, 4098
- Symbols
  - In the assignment list, 1464
  - In the call structure, 1472
  - In the dependency structure, 1478
- Sync domain, 819, 975, 4996, 5066, 5138
- Sync domain properties, 975
- SYNC\_PI, 2318
- SYNC\_PO, 2319
- Synchronization
  - From DP slaves with DP\_SYC\_FR, 2372
  - Slave clocks with SNC\_RTCB, 2291
- Synchronization (user-defined web pages), 649
- Synchronizing
  - Object in user-defined functions, 3551
  - Recipe data record, 3446
  - Recipe tag, 3400, 5656, 5666, 5667
  - Recipe view and recipe screen, 3396
  - Tag in user-defined functions, 3551
- Synchronizing user-defined web pages, 2920
- Synchronous
  - Transferring data, 5019, 5093, 5174, 5221, 5454
- Synchronous errors
  - Masking with MSK\_FLT, 2463
  - Querying the error register with READ\_ERR, 2464
  - Unmasking with DMSK\_FLT, 2464
- Syntax
  - Addressing, 5332
- Syntax errors
  - Basics, 1376
  - Finding errors, 1376
- Syntax for AWP commands, 652
- Syntax highlighting
  - User-defined function, 3552
- Syslog Client, 705
- Syslog server, 587
- System
  - General information, 692
  - System configuration, 690
- System alarm, 3251
  - Meaning, 3339, 3341, 3349, 3354, 3357, 3369
- System block
  - System blocks folder, 1196
- System diagnostic view
  - Icon, 3147
- System diagnostics, 3371, 3376
  - Button, 3383
  - Detail view, 3372, 3376
  - Device view, 3372, 3376
  - Diagnostic buffer view, 3372, 3377

- Matrix view, 3375
- Settings in the PLC, 3379
- System diagnostics view, 3371, 3376
- System diagnostics window, 3371, 3382
- System diagnostics indicator
  - Button as system diagnostics indicator, 3383
  - Inserting, 3379
  - System diagnostics window, 3379
- system diagnostics view
  - Layout, 3145
  - Show split view, 3147, 3386
  - Single display, 3147
  - System diagnostics indicator, 3379
- System diagnostics view, 3371
  - Configuring, 3384, 3385, 3386
  - Detail view, 3144
  - Device view, 3144
  - Diagnostic buffer view, 3144
  - Settings in the PLC, 3379
- System diagnostics window, 3371, 3382
  - Configuring, 3382
  - Layout, 3149
- System event, 3248, 3249, 3251
  - Editing, 3276
  - Meaning, 3339, 3340, 3341, 3342, 3345, 3347, 3349, 3350, 3351, 3353, 3354, 3355, 3357, 3358, 3359, 3361, 3362, 3364, 3365, 3370
  - Parameters, 3339
- System events, 593, 595
  - Configuring, 3261, 3262
- System function, 3541, 3764
  - SetStart at boot, 3769, 3877
  - WinACMPUpdateINTFLED, 3759
  - Applications, 3542
  - DirectKeyScreenNumber, 3635
  - HMI device dependency, 3555
  - In a function list, 3542
  - in user-defined functions, 3574
  - In user-defined functions, 3542
  - Language dependency, 3543
  - NotifyUserAction, 5790
  - SafelyRemoveHardware, 3647, 3850
  - Sequence is not adhered to, 3575
  - Usage, 3543
  - WinACMPArchive, 3767
  - WinACMPClearCycleTimeBuffer, 3769
  - WinACMPControl, 3773
  - WinACMPGetStartCharacteristics, 3767
  - WinACMPGetVersion, 3768, 3877
  - WinACMPRestore, 3774
  - WinACMPSetHMIExecutionTime, 3770
  - WinACMPSetKeySwitch, 3770
  - WinACMPSetRestartMethod, 3771
  - WinACMPSetSleeptime, 3771
  - WinACMPSetStartMode, 3772, 3878
  - WinACMPStartHistogram, 3772
  - WinACMPUpdateAverageCycleTime, 3757
  - WinACMPUpdateAverageExecTime, 3756
  - WinACMPUpdateBUSF1LED, 3754
  - WinACMPUpdateBUSF2LED, 3755
  - WinACMPUpdateEXTFLED, 3758
  - WinACMPUpdateKeySwitchSetting, 3753
  - WinACMPUpdateLastCycleTime, 3760
  - WinACMPUpdateMaximumCycleTime, 3761
  - WinACMPUpdateMinimumCycleTime, 3762
  - WinACMPUpdatePowerLED, 3763
  - WinACMPUpdateRUNLED, 3765
  - WinACMPUpdateSleepTime, 3764
  - WinACMPUpdateStartupCharacteristics, 3752
  - WinACMPUpdateSTOPLED, 3766
- System functions
  - AcknowledgeAlarm, 3688, 3797
  - ActivateCleanScreen, 3621
  - ActivatePreviousScreen, 3622, 3797
  - ActivateScreen, 3619, 3798
  - ActivateScreenByNumber, 3620, 3799
  - ActivateSystemDiagnosticsView, 3739, 3800
  - AdjustContrast, 3623
  - AlarmViewAcknowledgeAlarm, 3680
  - AlarmViewEditAlarm, 3679
  - AlarmViewShowOperatorNotes, 3681
  - AlarmViewUpdate, 3679
  - ArchiveLogFile, 3625, 3801
  - Available for WinCC Runtime, 3614
  - Available on Comfort Panels, 3602
  - Available on mobile panels, 3608
  - Available on Multi Panels, 3596
  - Available on Panels, 3590
  - BackupRAMFileSystem, 3724, 3802
  - CalibrateTouchScreen, 3657, 3803
  - ChangeConnection, 3746, 3804
  - ClearAlarmBuffer, 3677, 3805
  - ClearAlarmBufferProTool, 3678, 3806
  - ClearDataRecord, 3675, 3807
  - ClearDataRecordMemory, 3676, 3808
  - ClearLog, 3674, 3809
  - CloseAllLogs, 3701, 3810
  - ControlSmartServer, 3736, 3811
  - ControlWebServer, 3736, 3811
  - DecreaseFocusedValue, 3745
  - DecreaseTag, 3745, 3813
  - DirectKey, 3633
  - EditAlarm, 3627, 3814
  - Encode, 3631, 3814

EncodeEx, 3632, 3815  
ExportDataRecords, 3640, 3816  
ExportDataRecordsWithChecksum, 3642, 3818  
ExportImportUserAdministration, 3645, 3821  
GetBrightness, 3670, 3821  
GetDataRecordFromPLC, 3666, 3822  
GetDataRecordName, 3667, 3824  
GetDataRecordTagsFromPLC, 3669, 3825  
GetGroupNumber, 3670, 3826  
GetPassword, 3671, 3827  
GetUserName, 3665, 3827  
GoToEnd, 3646, 3828  
GoToHome, 3646, 3828  
HTMLBrowserBack, 3649  
HTMLBrowserForward, 3649  
HTMLBrowserRefresh, 3648  
HTMLBrowserStop, 3648  
ImportDataRecords, 3650, 3829  
ImportDataRecordsWithChecksum, 3652, 3831  
IncreaseFocusedValue, 3639  
IncreaseTag, 3639, 3832  
InvertBit, 3653, 3834  
InvertBitInTag, 3654, 3835  
InvertLinearScaling, 3655, 3833  
LinearScaling, 3672, 3836  
LoadDataRecord, 3664, 3837  
Logoff, 3618, 3838  
Logon, 3624, 3839  
LogTag, 3627  
LookupText, 3742, 3839  
NotifyUserAction, 3637, 3840  
OpenAllLogs, 3682, 3842  
OpenCommandPrompt, 3685, 3842  
OpenControlPanel, 3687  
OpenControlPanelDialog, 3684, 3843  
OpenInternetExplorer, 3686, 3844  
OpenScreenKeyboard, 3683, 3845  
OpenTaskManager, 3688, 3845  
PageDown, 3704, 3846  
PageUp, 3705, 3846  
PressButton, 3698  
PrintReport, 3637, 3847  
PrintScreen, 3636, 3847  
RecipeViewBack, 3695  
RecipeViewClearDataRecord, 3690  
RecipeViewGetDataRecordFromPLC, 3689  
RecipeViewMenu, 3690  
RecipeViewNewDataRecord, 3689  
RecipeViewOpen, 3691  
RecipeViewRenameDataRecord, 3694  
RecipeViewSaveAsDataRecord, 3693  
RecipeViewSaveDataRecord, 3692  
RecipeViewSetDataRecordToPLC, 3692  
RecipeViewShowOperatorNotes, 3695  
RecipeViewSynchronizeDataRecordWithTags, 3693  
ReleaseButton, 3699  
ResetBit, 3696, 3848  
ResetBitInTag, 3697, 3849  
ResetTagToHandWheel, 3743  
SaveDataRecord, 3730, 3851  
ScreenObjectCursorDown, 3628  
ScreenObjectCursorUp, 3629  
ScreenObjectPageDown, 3629  
ScreenObjectPageUp, 3630  
SendEmail, 3705, 3852  
SetAcousticSignal, 3706, 3853  
SetAlarmReportMode, 3716, 3854  
SetAndGetBrightness, 3720, 3854  
SetBit, 3709, 3855  
SetBitInTag, 3710, 3856  
SetBitWhileKeyPressed, 3711  
SetBrightness, 3713, 3857  
SetConnectionMode, 3722, 3858  
SetDataRecordTagsToPLC, 3703, 3859  
SetDataRecordToPLC, 3702, 3860  
SetDaylightSavingTime, 3718, 3861  
SetDeviceMode, 3708, 3862  
SetDisplayMode, 3707, 3862  
SetLanguage, 3719, 3863  
SetRecipeTags, 3717, 3864  
SetScreenKeyboardMode, 3714, 3865  
SetTag, 3721, 3866  
SetTagToHandWheel, 3744  
SetWebAccess, 3723  
ShowAlarmWindow, 3749, 3868  
ShowLogonDialog, 3748  
ShowOperatorNotes, 3748, 3869  
ShowSoftwareVersion, 3750, 3870  
ShowSystemAlarm, 3751, 3871  
ShowSystemDiagnosticsWindow, 3751, 3871  
SimulateSystemKey, 3725  
SimulateTag, 3726  
SmartClientViewConnect, 3729  
SmartClientViewDisconnect, 3728  
SmartClientViewLeave, 3730  
SmartClientViewReadOnlyOff, 3727  
SmartClientViewReadOnlyOn, 3728  
SmartClientViewRefresh, 3727  
StartLogging, 3731, 3872  
StartNextLog, 3732, 3873  
StartProgram, 3733, 3873  
StatusForceGetValues, 3735  
StatusForceSetValues, 3735

- StopLogging, 3737, 3875
- StopRuntime, 3738, 3876
- SystemDiagnosticsViewBack, 3742
- SystemDiagnosticsViewDetailView, 3740
- SystemDiagnosticsViewDeviceView, 3741
- SystemDiagnosticsViewDiagnosticsBuffer, 3741
- SystemDiagnosticsViewRefreshPLCBuffer, 3740
- TraceUserChange, 3744
- TrendViewBackToBeginning, 3663
- TrendViewCompress, 3660
- TrendViewExtend, 3660
- TrendViewRulerLeft, 3662
- TrendViewRulerRight, 3661
- TrendViewScrollBack, 3659
- TrendViewScrollForward, 3659
- TrendViewSetRulerMode, 3662
- TrendViewStartStop, 3663
- UpdateTag, 3623
- System limits
  - HMI device, 5727, 5730, 5734, 5739, 5742
- System log, 593, 595
- System memory, 856, 876
  - Diagnostics buffer, 847, 1003
  - Operand areas, 843
  - process image input/output, 845
- System power supply, 941
- System requirement for WinCC Advanced, 91
- System requirements STEP 7 Basic, 88
- System texts, 266
- System Time
  - NTP Client, 703
  - PTP Client, 704
  - SNTP Client, 702
- System-defined controller alarm, 3252
- System-defined controller alarms, 3249
- System-defined role
  - Administrator, 537
  - diagnostics, 537
  - Remote access, 537
  - standard, 537
- System-defined text lists
  - Editing, 333
  - Modifying texts, 334
- SystemDiagnoseView object, 4100
- SystemDiagnoseWindow object, 4104
- SystemDiagnosticsViewBack, 3742
- SystemDiagnosticsViewDetailView, 3740
- SystemDiagnosticsViewDeviceView, 3741
- SystemDiagnosticsViewDiagnosticsBuffer, 3741
- SystemDiagnosticsViewRefreshPLCBuffer, 3740
- System-relevant information
  - Module information, 970

- Vendor information, 970

## T

- T\_ADD, 2282
- T\_COMBINE, 2285
- T\_COMP, 2281
- T\_CONFIG, 49, 2914
- T\_CONV, 2282
- T\_DIAG, 2909
- T\_DIFF, 2285
- T\_RESET, 2907
- T\_SUB, 2284
- TAB key, 5698
- Table
  - Connection, 4938
  - TableBackColor property (VBS), 4560, 4561
  - TableColor property (VBS), 4562
  - TableColor2 property (VBS), 4562
  - TableFocusOnButtonCommand property (VBS), 4562
  - TableForeColor property (VBS), 4563, 4564
  - TableForeColor2 property (VBS), 4564
  - TableGridLineColor property (VBS), 4565
  - TableHeaderBackColor property (VBS), 4566
  - TableHeaderForeColor property (VBS), 4567
  - TableView object, 4037
- Tag
  - absolute addressing, 3170, 4949
  - Acquisition cycle, 3186, 3200, 3212
  - Acquisition mode, 3186
  - Addressing, 3173
  - Changing the PLC, 3190
  - Comment, 3175
  - Configuration, 3179
  - Configuring several tags, 3179
  - Connection to PLC, 3173
  - Copy, 3178
  - Creating external tags, 3173
  - Creating internal tags, 3175
  - Creating the user data type, 3206
  - Data log, 3218, 3224
  - Data type, 3175
  - Deleting, 3178
  - Displaying or hiding tag information, 1294, 1335
  - Displaying values, 3235
  - Event, 3199
  - Exporting, 5517
  - External tag, 3169, 4948
  - Faceplate type, 3072
  - GMP settings, 5783
  - GMP-relevant tag, 5783

- Handwheel, 3099
- Illuminated pushbutton, 3107
- Importing, 5519
- in Runtime, 3186
- Index tag, 3197, 3198
- Indirect addressing, 3197, 3198
- Internal tag, 3172, 4951
- Key switch , 3133
- Length, 3175
- Limit value, 3184
- Limit values, 3183
- Linear scaling, 3187, 3189
- Logging, 3218, 3224
- Logging cycle, 3212
- Maximum length, 77
- Multiplexing, 3197
- Name, 3175
- Negative, 1606, 1858
- Object list, 3174
- Output in alarm, 3274
- Overlaying, 1065
- Overview, 1049
- PLC tag, 1172
- PLC tags and DB tags, 1050
- Positive, 1605, 1857
- Read continuously, 3187
- reconnecting, 3182
- Rename, 3178
- RFID tag, 4862
- Start value, 3185, 3186
- symbolic addressing, 3171, 4950
- Tolerance band, 3218, 3224
- Transponder, 4862
- Update, 3187, 3200
- User data type, 3205
- User data type element, 3205
- Tag array, 3201
- Tag binding
  - Animation, 3020
- Tag data
  - Structure for the import, 5520, 5525
- Tag declaration
  - Automatically filling in cells, 1195, 1258, 1402, 1417
  - Based on a PLC data type, 1392
  - Block interface, 1240
  - Declaring ARRAY, 1246
  - Declaring PLC data type, 1248
  - Declaring STRUCT, 1247
  - Declaring tags, 1244, 1245, 1249
  - Deleting a tag, 1194, 1257, 1402, 1417
  - Importing and exporting tags, 1259, 1403
  - Inserting a table row, 1192, 1257, 1401, 1416
  - Inserting table rows at the end, 1257, 1401, 1416
  - Multi-instance, 1250
  - Overlaying tags, 1249
  - Purpose of tag declaration, 1239
  - Reserved key words, 1052
  - Retentivity, 1254
  - Showing and hiding columns , 1195, 1259, 1403, 1418
  - Sorting rows, 1194
  - Tag properties, 1253, 1255, 1397, 1399, 1400
  - Updating the block interface, 1250
  - Valid data types, 1243
- Tag import
  - Tag data structure, 5520, 5525
- Tag list
  - Indirect addressing, 3197, 3198
- Tag log
  - Migrating, 153
- Tag name
  - Valid names in logs, 3221
- Tag object, 3941
- Tag simulator, 5619
- Tag table
  - Default, 3167, 4947
  - for HMI devices, 3167, 4947
  - user-defined, 3167, 4947
- Tag value
  - Output, 3235, 3239
- Tags, 3944, 3945
  - Basics, 3166, 4946
  - Data exchange, 4915
  - Migration, 160
  - Monitor all, 1515, 1537
  - Monitor now, 1538
  - Monitor once and now, 1516
- Tags object (list), 3945
- Tan, 2152
- TAN, 1709, 1964
- Tangent, 1709, 1964, 2152
- Task, 4893
  - Changing during Runtime, 4904
  - Changing the name, 4902
  - Deactivate, 4896, 4898
  - Deleting, 4902
- Task card, 2935
  - Changing the pane mode, 223
  - Function, 221
  - Hardware catalog, 403, 4931
  - Reducing automatically, 214
- Task Card
  - Online Tools, 970

- Tools, 2947, 2950
- TCI (Tool Calling Interface), 824
- TCON, 2877, 2880
- TCON\_IP\_RFC, 492
- TCON\_IP\_v4, 491
- TCON\_Param, 488
- TCP, 547
  - Characteristics, 487
  - Port numbers, 494
- TDISCON, 2884
- Teach-in mode, 3401
  - Recipe tag, 3401
- Technology object command table: Add new object, 6049
- Technology object command table: Basic parameters, 6050
- Technology object command table: Command table configuration, 6051
- Technology object command table: Configuration window icons, 6050
- Technology object command table: Configuring activate warnings, 6051
- Technology object command table: Configuring duration, 6053
- Technology object command table: Configuring position / travel path, 6052
- Technology object command table: Configuring the command type, 6052
- Technology object command table: Configuring the next step, 6054
- Technology object command table: Configuring the step code, 6054
- Technology object command table: Configuring the use axis parameters of, 6051
- Technology object command table: Configuring velocity, 6053
- Technology object command table: Extended parameters, 6050
- Technology object command table: General configuration, 6050
- Technology object command table: Shortcut menu commands, 6054
- Technology object command table: Tools, 6048
- Technology object command table: Usage, 6048
- Technology object, axis and command table: List of ErrorIDs and ErrorInfo, 6107
- Technology objects
  - PID\_3Step, 5972
  - PID\_Compact, 5940
- Telecontrol server, 674
- TELECONTROL SERVER BASIC, 674
- Telemecanique Uni-Telway
  - Migrating data types, 174
- TeleService
  - Meaning of the icons, 6213
  - Phone book properties, 6211
  - Access to phone books, 6211
  - AS\_DIAL, 6258
  - Callback variants, 6224
  - Communications instruction:"AS\_DIAL", 6210
  - Communications instruction:"AS\_MAIL", 6210
  - Communications instruction:"PG\_DIAL", 6210
  - Communications instruction:"SMS\_SEND", 6210
  - Communications instruction:"TM\_MAIL", 6210
  - Communications instruction:"TMAIL\_C", 6210
  - Connection establishment options:S7-1200 CPUs, 6256
  - Connection establishment options:S7-1500 CPUs, 6256
  - Connection establishment options:S7-300/400 CPUs, 6256
  - Defining dialing rules, 6217
  - Establish connection to AS, 6258
  - Export phone book, 6216
  - Functionality, 6210
  - Gateways, 6221
  - Import phone book, 6214
  - Inserting rows in the phone book, 6214
  - Modem support, 6220
  - Modem types / media, 6221
  - Open phone book, 6213
  - Performance in telephone networks, 6221
  - Phone book, 6210
  - Printing the phone book, 6217
  - Save phone book, 6214
  - Showing or hiding columns in the phone book, 6214
  - Structure of the phone book, 6212
  - Transferring e-mail with TM\_MAIL, 2922
  - Using the TS Adapter IE Advanced, 37
  - Working with the phone book, 6211
- TeleService callback options, 6226
- TeleService phone book, 6210
- TeleService via GPRS, 679
  - Establish connection, 680
- Temperature coefficient, 925, 943
- Temperature compensation, 912
- template
  - Template, 2943
- Template, 3030
  - Copy, 2943
  - Creating, 2944
  - Deleting, 2943

- Global screen, 2943
  - Inserting, 2943
  - Move, 2943
  - Rename, 2943
  - Use in screen, 2946
- temporary, 675
- Temporary connection, 675
- Temporary station, 675
- Tens complement, 1833, 2091, 2278
- Terminal modules and electronic modules, 909
- Terminating the remote connection, 6242
- Test form
  - Creating, 5878
- Test options in the force table, 1524
- testing, 5878
  - Customer controls, 5878
- Testing
  - User-defined function, 3560
- Text
  - Button, 3130
  - Text field, 3150, 3495
- Text field, 3150, 3494
  - Size, 3150, 3495
- Text list
  - Application, 2991
  - Bit (0, 1), 2996
  - Bit number (0 - 31), 2997
  - Creating, 2992
  - Exporting, 5523
  - Importing, 5524
  - Output in alarm, 3275
  - Symbolic I/O field, 2998, 3143
  - Value/Range, 2995
- Text lists
  - Introduction, 331
  - System-defined, 331
  - Use in recipe data records, 3406
  - User-defined, 331
- Text property (VBS), 4570, 4571
- TextField object, 4107
- TextList property (VBS), 4571
- TextOff property (VBS), 4572
- TextOn property (VBS), 4573
- TextOrientation property (VBS), 4574
- Texts
  - Migrating, 150
- TFTP
  - Load/save, 693
- Third-party drivers
  - Communication, 5320
  - Special features, 5321
- ThumbBackColor property (VBS), 4575, 4576, 4577
- TIA Portal
  - Exiting, 199
  - Starting, 199
- TicksColor property (VBS), 4576
- Time, 856, 1096, 1098
  - Converting UTC time to local time with SET\_TIMEZONE, 2290
- TIME, 1098, 1137, 1161
- Time accumulator, 1615, 1866, 1874, 2105
- Time delay, 1790, 2047, 2240
- Time delay interrupt, 889
- Time duration, 1626, 1878, 2109
- Time error interrupt, 892
- Time error OB, 892
- Time expired, 3796
- Time of day
  - Precision Time Protocol, 704
  - Setting the time of day in the Online and Diagnostics view, 989
  - SNTP (Simple Network Time Protocol), 702
  - Time-of-day synchronization, 702
- Time setting, 691
- Time stamp, 3260
- Time stamping, 913
- Time synchronization, 570, 856, 5042, 5115
  - Configuring, 5043, 5044
  - integrated connection, 5043
  - Non-integrated connection, 5044, 5117
  - Restriction, 5042, 5116
  - System limits, 5042, 5116
- TIME\_TCK, 2292
- TIME\_TO\_, 1161
- TimeAxisBeginTime(i) property (VBS), 4578
- TimeAxisEndTime property (VBS), 4578
- TimeAxisLabel(i) property (VBS), 4579
- TimeAxisRange property (VBS), 4579
- TimeAxisShowGridLines(i) property (VBS), 4580
- TimeAxisShowLargeIncrements(i) property (VBS), 4580
- TimeAxisShowSmallIncrements(i) property (VBS), 4581
- TimeAxisTimeFormat(i) property (VBS), 4582
- TimeBase property (VBS), 4582
- TimeColumnActualize property (VBS), 4583, 4589, 4598
- TimeColumnAdd property (VBS), 4584
- TimeColumnAlign property (VBS), 4584
- TimeColumnAlignment(i) property (VBS), 4585
- TimeColumnBackColor property (VBS), 4586
- TimeColumnBeginTime property (VBS), 4586
- TimeColumnCaption property (VBS), 4586
- TimeColumnCount property (VBS), 4587

- TimeColumnDateFormat property (VBS), 4587
- TimeColumnEndTime property (VBS), 4588
- TimeColumnForeColor property (VBS), 4588
- TimeColumnFormat(i) property (VBS), 4589
- TimeColumnHideTitleText property (VBS), 4590
- TimeColumnIndex property (VBS), 4590
- TimeColumnLength property (VBS), 4591
- TimeColumnMeasurePoints property (VBS), 4591
- TimeColumnName property (VBS), 4592
- TimeColumnRangeType property (VBS), 4592
- TimeColumnRemove property (VBS), 4593
- TimeColumnRename property (VBS), 4593
- TimeColumnRepos property (VBS), 4593
- TimeColumnShowDate property (VBS), 4594
- TimeColumnShowIcon property (VBS), 4594
- TimeColumnShowTitleIcon property (VBS), 4595
- TimeColumnSort property (VBS), 4595
- TimeColumnSortIndex property (VBS), 4596
- TimeColumnTimeFormat property (VBS), 4596
- TimeColumnTimeRangeBase property (VBS), 4597
- TimeColumnTimeRangeFactor property (VBS), 4598
- TimeColumnVisible property (VBS), 4599
- Time-delay interrupt
  - Canceling with CAN\_DINT, 2454
  - Instructions, 2452
  - Querying with QRY\_DINT, 2455
  - Starting with SRT\_DINT, 2453
- Time-delay interrupt OB, 889
- Time-driven output
  - Report, 3468
- TimeJumpColor(i) property (VBS), 4599
- TimeJumpEnabled(i) property (VBS), 4600
- Time-of-day, 1099, 1100, 1101, 1102
  - Calculating local time with SET\_TIMEZONE, 2290
  - Reading the system time of the CPU with TIME\_TCK, 2292
  - Reading time-of-day and date of CPU with RD\_SYS\_T, 2287
  - Setting for CPU with WR\_SYS\_T, 2286
- Time-of-day function
  - Basics, 862
  - Clock parameters, 863
  - Reading the time-of-day, 862
  - Setting the time-of-day, 862
  - Time-of-day format, 862
- Time-of-day interrupt
  - Activating with ACT\_TINT, 2450
  - Cancel, 885
  - Canceling with CAN\_TINT, 2449
  - Function, 885
  - Querying with QRY\_TINT, 2451
- Rules, 885
  - Set and activate, 885
  - Setting with SET\_TINT, 2446, 2448
  - Status query, 885
- Time-of-day interrupt OB
  - Parameter assignment, 898
- Timeout
  - HTTP protocol, 5283
- TimeOverlapColor(i) property (VBS), 4600
- TimeOverlapEnabled(i) property (VBS), 4601
- Timer, 1628, 1879, 4898
  - Acyclic triggers, 4898
  - Cyclic triggers, 4898
  - Recording, 1623
- TIMER, 1117
- TimeRangeBase(i) property (VBS), 4601
- TimeRangeFactor(i) property (VBS), 4602
- Timers
  - Combine date and time with T\_COMBINE, 2285
  - Comparing time tags with T\_COMP, 2281
- Times
  - Adding with the instruction T\_ADD, 2282
  - Converting with T\_CONV, 2282
  - Determining difference with T\_DIFF, 2285
  - Subtracting with T\_SUB, 2284
- Time-triggered trends, 5023, 5099, 5180, 5222, 5234, 5356, 5387, 5419, 5439
- Title page
  - Report, 3462
- TitleColor property (VBS), 4604
- TitleDarkShadowColor property (VBS), 4605
- TitleForeColor property (VBS), 4605
- TitleGridLineColor property (VBS), 4605
- TitleLightShadowColor property (VBS), 4606
- TitleSort property (VBS), 4606
- TitleStyle property (VBS), 4607
- TM\_MAIL, 2922
- TMAIL\_C, 2866
- TO\_Axis\_PTO, 6025
- TOD, 1099, 1138, 1163
- TOD\_TO\_, 1163
- TOF, 1612, 1621, 1864, 1872, 2102
- Toggle, 3795
  - Between Runtime languages, 5549
  - Key, 5699
- Toggle property (VBS), 4608
- Tolerance band
  - Tags, 3218, 3224
- Tolerance property (VBS), 4608
- ToleranceColor property (VBS), 4609
- ToleranceLowerLimit property (VBS), 4610
- ToleranceLowerLimitColor property (VBS), 4610



- ToleranceLowerLimitEnabled property (VBS), 4611
- ToleranceLowerLimitRelative property (VBS), 4611
- ToleranceUpperLimit property (VBS), 4612
- ToleranceUpperLimitColor property (VBS), 4612
- ToleranceUpperLimitEnabled property (VBS), 4613
- ToleranceUpperLimitRelative property (VBS), 4614
- TON, 1610, 1619, 1862, 1870, 2099
- TONR, 1615, 1623, 1866, 1874, 2105
- Tool Calling Interface (TCI), 824
- Toolbar, 3095
  - Order, 2953, 2962, 3475
- ToolbarAlignment property (VBS), 4614
- ToolbarBackColor property (VBS), 4615
- ToolbarButtonActive property (VBS), 4615
- ToolbarButtonAdd property (VBS), 4616
- ToolbarButtonBeginGroup property (VBS), 4616
- ToolbarButtonCount property (VBS), 4617
- ToolbarButtonEnabled property (VBS), 4617
- ToolbarButtonHotKey property (VBS), 4618
- ToolbarButtonID property (VBS), 4618
- ToolbarButtonIndex property (VBS), 4618
- ToolbarButtonLocked property (VBS), 4619
- ToolbarButtonName property (VBS), 4619
- ToolbarButtonPasswordLevel property (VBS), 4620
- ToolbarButtonRemove property (VBS), 4620
- ToolbarButtonRename property (VBS), 4620
- ToolbarButtonRepos property (VBS), 4621
- ToolbarButtonTooltipText property (VBS), 4621, 4639, 4646
- ToolbarButtonUserDefined property (VBS), 4622, 4642
- ToolbarShowTooltips property (VBS), 4622
- ToolbarUseBackColor property (VBS), 4623
- ToolbarUseHotKeys property (VBS), 4624
- ToolbarVisible property (VBS), 4624, 4625
- Tools, 2947, 2950
- ToolTipText property (VBS), 4625
- Top property (VBS), 4627
- Topology discovery, 819, 4996, 5066, 5138
- Topology view
  - Adding device, 419
  - Adopt devices identified online, 524
  - Adopt port interconnections identified online, 524
  - Configured topology, 511, 512
  - Diagnostics status in the graphic view, 513
  - Diagnostics status in the table view, 514
  - Differences compared with the network view, 509
  - Functions, 509
  - Hardware and network editor, 397, 4927
  - Interconnecting ports, 516
  - Offline/online comparison, 515
- Total property (VBS), 4630
- TP, 1608, 1617, 1859, 1868, 2096
- TP 177B mono
  - Symbol library, 3141
- TP177A
  - Loading a project, 76
- Trace, 6170
  - Bit track, 6175
  - CPU load, 6197
  - Curve diagram, 6175, 6194
  - Data storage, 6172
  - Installed traces, 6180
  - Lifetime of the values, 6196
  - Measurement, 6172, 6181, 6192
  - Measurement cursor, 6194
  - Pre-trigger, 6203
  - Printing, 6195
  - Project navigator, 6175
  - Quantity structure, 6197
  - Quick start, 6183
  - Recordable tags, 6195
  - Recording, 6172, 6191
  - Recording conditions, 6200, 6203
  - Recording cycle, 6185, 6207
  - Recording duration, 6207
  - Recording levels, 6196
  - Reduction, 6201
  - Sampling, 6185
  - Saving the trace configuration, 6189
  - Signal table, 6177, 6194
  - Signals, 6198, 6206
  - Supported devices, 6170
  - Trace configuration, 6172, 6179, 6189, 6190, 6193, 6206
  - Trace editor, 6188
  - Trace handling, 6178
  - Trigger, 6208
  - Trigger mode, 6202
  - Trigger tag, 6200, 6202
  - Trigger time, 6182
  - User interface, 6173, 6197, 6198
- Trace function, 6170
- Trace methods, 4852
- Trace S7-1200/1500, 6195
- TraceUserChange, 3744
- Transfer card, (See Memory Card)
- Transfer to the HMI device
  - WinAC MP, 5480
- Transferring
  - License key to HMI device, 5630
  - Recipe data record, 5670, 5671, 5677
- Transferring authorization
  - HMI device, 5483

## Transferring data

- Area pointer, 4952, 5009, 5082, 5165, 5208, 5444
- Area pointer screen number, 5010, 5088, 5166, 5208, 5446
- Control panel, 5469, 5470
- Coordination area pointer, 5014, 5086, 5169, 5211, 5449
- Data record are pointer, 5453
- Data record area pointer, 5018, 5092, 5173, 5215
- Date/time area pointer, 5011, 5083, 5084, 5167, 5209, 5447
- Date/time PLC area pointer, 5012, 5168, 5210, 5448
- Job mailbox, 5020, 5096, 5177, 5217, 5456
- Job mailbox area pointer, 5015, 5090, 5171, 5213, 5450
- Operator input in the recipe view, 5095, 5176, 5216, 5455
- Possible cause of error, 5022, 5098, 5179, 5219, 5458
- Project ID area pointer, 5015, 5089, 5170, 5212, 5450
- Triggering by means of a configured function, 5022, 5097, 5178, 5219, 5458
- With synchronization, 5019, 5093, 5174, 5221, 5454
- Without synchronization, 5018, 5093, 5174, 5220, 5453

Transferring the project

- HMI device, 80
- Recipe data record, 80

Translate

- Editor, 5537

Translating texts, 266

Transmission medium/duplex, 816

Transmission rate / duplex, 4994, 5064, 5136

Transparency

- In graphic, 2975

transparent color, 3097

- Display on panels, 3097

TransparentColor property (VBS), 4633

TransparentColorDeactivatedPicture property (VBS), 4633

TransparentColorPictureOff property (VBS), 4634

TransparentColorPictureOn property (VBS), 4634

Transponder, 4863

TRCV, 2892, 2896

TRCV\_C, 49, 2854, 2859

Trend, 3237

- Data type, 5358, 5440

Trend control, 5421

## Trend request

- Trend transfer, 5024, 5100, 5181, 5223, 5235, 5357, 5388, 5420, 5439

Trend request area, 5024, 5100, 5181, 5223, 5235, 5357, 5388, 5420, 5439

Trend transfer area, 5024, 5100, 5181, 5223, 5235, 5357, 5388, 5420, 5439

Trend transfer area 1

- Trend transfer area 2, 5024, 5100, 5181, 5223, 5235, 5357, 5388, 5420, 5439

Trend view, 3104, 3237

- Button, 3104
- Configuring for logging, 3242
- Configuring for values from the PLC, 3236, 3240

TrendActualize property (VBS), 4635

TrendBeginTime property (VBS), 4636

TrendCount property (VBS), 4637

TrendEndTime property (VBS), 4637

TrendExtendedColorSet property (VBS), 4637

TrendFill property (VBS), 4638

TrendIndicatorColor property (VBS), 4639

TrendLineStyle property (VBS), 4640

TrendLineType property (VBS), 4641

TrendLowerLimit property (VBS), 4642

TrendLowerLimitColor property (VBS), 4642

TrendName property (VBS), 4643

TrendPointSize property (VBS), 4644

TrendProvider property (VBS), 4645

TrendRangeType property (VBS), 4645

TrendRulerControl, 4110

TrendSelectTagNameX property (VBS), 4647

TrendSelectTagNameY property (VBS), 4647

TrendTag property (VBS), 4648

TrendTagNameX property (VBS), 4648

TrendTagNameY property (VBS), 4649

TrendTimeRangeBase property (VBS), 4649

TrendTimeRangeFactor property (VBS), 4650

TrendUncertainColor property (VBS), 4650

TrendUncertainColoring property (VBS), 4651

TrendUpperLimit property (VBS), 4651

TrendUpperLimitColoring property (VBS), 4652

TrendView object, 4118

TrendViewBackToBeginning, 3663

TrendViewCompress, 3660

TrendViewExtend, 3660

TrendViewRulerLeft, 3662

TrendViewRulerRight, 3661

TrendViewScrollBack, 3659

TrendViewScrollForward, 3659

TrendViewSetRulerMode, 3662

TrendViewStartStop, 3663

TrendWindowCoarseGrid property (VBS), 4653

- TrendWindowFineGrid property (VBS), 4654
  - TrendWindowForegroundTrendGrid property (VBS), 4655
  - TrendWindowGridInTrendColor property (VBS), 4655
  - TrendWindowHorizontalGrid property (VBS), 4656
  - TrendWindowIndex property (VBS), 4657
  - TrendWindowRename property (VBS), 4657
  - TrendWindowRulerStyle property (VBS), 4659
  - TrendWindowVerticalGrid property (VBS), 4660
  - Trigger tag, 3261
  - Triggering by means of a configured function
    - Transferring data, 5022, 5097, 5178, 5219, 5458
  - Triggers, 4896
    - Acyclic, 4897, 4898
    - Changing, 4902
    - Cyclic, 4897, 4906
    - Event trigger, 4896, 4897, 4901, 4904
    - Standard cycle, 4897
  - TRUNC, 1759, 2015, 2200
  - TS adapter, 80
  - TS Adapter IE Advanced
    - Brief description, 6251
    - Connection types, 6252
    - Parameter assignment, 6254
    - Parameter assignment options, 6253
  - TS Adapter MPI
    - Brief description, 6228
    - Default parameter assignment, 6229
    - Direct connection, 6229
    - Establishing a modem connection, 6230
    - Establishing the direct connection, 6229
    - Exporting adapter parameters, 6234
    - Importing adapter parameters, 6235
    - Modem connection, 6230
    - parameter Assignment, 6232
    - Parameter assignment , 6232
    - Parameter assignment options, 6231
    - Principle of operation, 6228
    - Restoring the default parameter assignments, 6233
    - Setting up access protection, 6225
  - TS Adapter IE
    - Brief description, 6235
    - Default parameter assignment, 6237
    - Parameter assignment, 6240, 6254
    - Principle of operation, 6236
  - TS Adapter IE Basic
    - Connection to the GSM network, 6238
    - Connection to the telephone network, 6238
    - Connection to the telephone network through an external modem, 6239
    - Connection types, 6237
  - TSAP
    - ASCII code table, 497
    - Structure, 461, 496
  - TSAP assignment
    - Examples, 498
  - TSEND, 2886, 2889
  - TSEND\_C, 2843, 2847
  - TubeArcObject, 4121
  - TubeDoubleTeeObject, 4123
  - TubePolyline, 4125
  - TubeTeeObject, 4128
  - TURCV, 2904
  - Turkish, 40
  - Turkish regional and language options, 40
  - TUSEND, 2901
  - Twos complement, 1691, 1945
  - Type
    - Library, 5490
  - Type property (VBS), 4662
  - Types of DP slave, 780
- ## U
- UART data transmission, 867
  - UBLKMOV, 1749, 2005, 2189
  - UDINT, 1089, 1134, 1157
  - UDINT\_TO\_, 1157
  - UDP, 547, 553, 569
    - Characteristics, 488
    - Port numbers, 494
  - UDT, 184, 194
  - UFILL\_BLK, 1735, 1991, 2167
  - UINT, 1088, 1132, 1153
  - UINT\_TO\_, 1153
  - ULINT, 1092
  - UMOVE\_BLK, 1731, 1987, 2163
  - UncertainStateColor(i) property (VBS), 4664
  - UncertainStateEnabled(i) property (VBS), 4664
  - Underflow, 927, 935
  - Undoing actions
    - Basics of undoing, 324
    - Undoing last action, 326
    - Undoing multiple actions, 326
  - UnhideAlarm, 4852
  - Uninstalling
    - Option, 5632
  - Uninstalling license keys, 87
  - Uniqueness
    - of object names, 127
  - UnitColor property (VBS), 4665
  - UnitText property (VBS), 4666

- UnitTop property (VBS), 4667
- Universal
  - PROFIBUS, 5080, 5152
- Universal Serial Interface Protocol, (See USS protocol)
- Universal symbolism, 183
- Unknown peers, 580
- Unlock
  - User, 3524
- UnlockAlarm, 4853
- Unplugged module, 416
- Unscale, 1767, 2023, 2211
- UNSCALE, 1767, 2023, 2211
- Unspecified CPU, 420
- UPDAT\_PI, 2315
- UPDAT\_PO, 2316
- Update, 888
  - Tag, 3187, 3200
- Update cycle, 3212
- Update interrupt, 888
- Update interrupt OB, 888
- Update time, 814
- UpdateEnable property (VBS), 4668
- UpdateTag, 3623
- Updating
  - Faceplate type, 3065
  - Operating system of the HMI device (Windows CE), 5629
- Updating a library, 382, 5496
- Updating the device version, 5627
- Updating the firmware, 5627
- Updating the operating system, 5627
- Updating types to the latest version, 382, 5496
- Upgrade
  - Project, 5586
  - Project version, 5586
- Upgrading a global library, 350
- UpperLimit property (VBS), 4668
- UpperLimitColor(i) property (VBS), 4669
- UpperLimitEnabled(i) property (VBS), 4669
- UpperLimitValue(i) property (VBS), 4670
- URCV, 2837
- USB
  - Download, 5609
  - Loading, 5610, 5611
- USB card readers, 38
- USB driver, 5610, 5611
  - Installation under Windows 7, 5611
  - Installation under Windows XP, 5610
- USB port, 5610, 5611
- Use, 3393
  - Alarm view, 5682
  - Alarm window, 5682
  - Faceplate type, 3067
  - Of recipes, 3393
  - Project-wide alarm class, 3265
  - Recipe view, 5659
  - Screen navigation function keys, 3041
  - simple alarm view, 5684
  - simple alarm window, 5684
  - Simple user view, 5709
  - User view, 5708
  - User view , 5707
- Use global assignment
  - Function key, 2942
- UseAllServers property (VBS), 4671
- UseBarBorderConstraints property (VBS), 4671
- Used property (VBS), 4686
- UsedPercent property (VBS), 4686
- UseEffectiveProcessValue property (VBS), 4676
- UseEyponentialFormat property (VBS), 4676
- UseFlashTransparentColor property (VBS), 4677
- Useful information on configuring the TS Adapter MPI, 6231
- UseGDI property (VBS), 4677
- UseMeasurePoints(i) property (VBS), 4678
- UseMessageColor property (VBS), 4678
- UseMultipleLimits property (VBS), 4679
- USEND, 2836
- User
  - Assigning roles, 538
  - Changing, 3523
  - Creating roles, 537
  - Deleting in runtime, 3524
  - Logon, 3527
  - Setting up, 536
  - Unlock, 3524
- User administration, 3496
  - Central user administration, 3511
  - exporting, 3525
  - importing, 3526
  - Migration, 153
  - Object with access protection, 3529, 3530
  - Runtime settings, 2940, 3500, 3502, 3515, 3524, 3527
  - Setting up, 3533
  - SIMATIC Logon, 3511
- User change, 3788, 4903
- User data
  - Area, 848
  - Backing up, 5707
  - Restoring, 5707
- User data type, 3205
  - Create, 3205, 3206

- Creating a user data type element, 3206
  - Deleting, 3210
  - Editing, 3209
  - Release, 3209
  - Tags, 3205
- User data type element
  - Create, 3206
- User group, 5706
  - Administer authorizations, 3510
  - Assigning, 3538
  - Assigning users, 3508
  - Change displayed name, 3510
  - Changing in runtime, 3522, 3524
  - Changing the name, 3510
  - Creating, 3537
  - Deleting, 3511
  - Managing, 3510
  - Unauthorized, 3528
- User interface
  - "Reference projects" palette, 223
  - Details view, 225
  - Inspector window, 219
  - Maximizing the work area, 213
  - Minimizing the work area, 213
  - Overview window, 226
  - Portal view, 204
  - Project tree, 208
  - Project view, 205
  - Task card, 221
  - Views, 203
  - Work area, 211
- User interface language, 5531
  - Selecting, 5534
- User name, 536
- User program
  - Finding errors, 1376
  - Function, 1019
  - Testing, 1491
- User texts, 266
- User view, 3516, 5707
  - Changing user data, 5708
  - Columns moveable, 3089
  - Complex user view, 3088
  - Complex user view , 3518
  - Configuring, 3519
  - Export user data, 5709
  - Import user data, 5709
  - Layout, 5707
  - Number of lines, 3088
  - Permitted characters, 77
  - Simple user view, 3088, 3516
  - Use, 5707, 5708
- UserArchiveControl object, 4130
- UserArchiveNumberOfValues(i) property (VBS), 4687
- UserArchiveStartId(i) property (VBS), 4687
- User-defined function, 3541
  - Adapting display properties, 3552
  - Applications, 3544
  - Changing object property, 3576
  - Code templates, 3551
  - configuring with VBS, 3558
  - Entering parameters, 3550
  - Executing in Runtime, 3574
  - In a function list, 3544
  - In user-defined functions, 3544
  - Opening know-how protected functions, 3563
  - Parameter transfer, 3556
  - Properties, 3544
  - Return value in VBS, 3557
  - Sequence is not adhered to, 3575
  - Synchronizing object, 3551
  - Synchronizing tag, 3551
  - Syntax highlighting, 3552
  - Temperature conversion, 3577
  - Testing, 3560
  - Usage, 3544
  - Using a system function, 3574
- User-defined roles, 537
- User-defined text lists
  - Creating, 332
  - Editing, 333
  - Editing value ranges and texts, 333
- User-defined web pages, 648, 651, 660, 662, 663
- Users, 5706
  - Admin, 5723
  - Assigning a user group, 3508
  - Changing, 3521
  - Changing the name, 3509
  - Changing, key operation, 5719
  - Changing, touch operation, 5721
  - Creating, 3507, 3538, 5710
  - Creating in runtime, 3519
  - Creating, keyboard operation, 5717
  - Creating, mouse operation, 5716
  - Creating, touch operation, 5710, 5713, 5714
  - Delete, keyboard operation, 5722, 5724
  - Delete, mouse operation, 5722, 5724
  - Deleting, 3510, 5723
  - Deleting in runtime, 3522
  - Logging logons, 3532
  - Logoff, 5712
  - Logon, 5711
  - Logon, keyboard operation, 5711

- Logon, mouse operation, 5711
- Managing, 3509, 3521, 3523
- Updating after change of user, 4903
- UserView object, 4137
- UseScaleConstraints property (VBS), 4679
- UseScaledBarBorder property (VBS), 4680
- UseSelectedTitleColor property (VBS), 4680
- UseSeparateDiagrams property (VBS), 4681
- UseSimplePrecisionOffset property (VBS), 4681
- UseTableColor2 property (VBS), 4682
- UseTimeRange(i) property (VBS), 4683
- UseTransparentColor property (VBS), 4683
- UseTransparentColorDeactivatedPicture property (VBS), 4684
- UseTransparentColorPictureOff property (VBS), 4684
- UseTransparentColorPictureOn property (VBS), 4685
- UseTrendNameAsLabel property (VBS), 4685
- Using a TS Adapter for TeleService, 6219, 6243
- Using frames and cover pages from the library, 307
- Using tags, 3090
- Using the keyboard
  - Editing texts, 1223
  - FBD, 1223
  - GRAPH, 1223
  - LAD, 1223
  - Program editor, 1223
  - SCL, 1223
  - STL, 1223
- Using the on-screen keyboard, 244
- Using UDTs, 194
- UsingDesignColorScheme property (VBS), 4672
- UsingDesignShadowSettings property (VBS), 4674
- USINT, 1086, 1130, 1150
- USINT\_TO\_, 1150
- USS communication
  - Controlling a transmission to a drive with USS\_PORT, 2766
  - Data exchange with drives via USS\_DRIVE, 2767
  - Modifying parameters in the drive with USS\_WPM, 2771
  - Reading parameters from the drive with USS\_RPM, 2770
- USS protocol
  - Instructions, 2762
- USS status codes, 2772
- USS\_DRIVE, 2767
- USS\_PORT, 2766
- USS\_RPM, 2770
- USS\_WPM, 2771

## V

- VAL\_STRG, 2299
- Valid
  - Data type, 5328, 5372, 5382, 5402, 5415, 5434
  - Data types, 5029, 5185, 5227, 5239, 5296, 5297
- Valid data type
  - Allen-Bradley DF1, 5350
  - SIMATIC HMI HTTP protocol, 5293
- ValidateFormatPattern property (VBS), 4689
- Value, 1694, 1949
- Value assignment, 1348
- Value change, 3796
- Value changes to GMP-relevant tags
  - Effects in Runtime, 5785
- Value/Range
  - Text list, 2995
- ValueAxisAutorange(i) property (VBS), 4691
- ValueAxisBegin(i) property (VBS), 4691
- ValueAxisDecimalPrecision(i) property (VBS), 4692
- ValueAxisEnd(i) property (VBS), 4692
- ValueAxisGridLineInterval(i) property (VBS), 4693
- ValueAxisLabel(i) property (VBS), 4693
- ValueAxisLargeIncrementSize(i) property (VBS), 4694
- ValueAxisScalingType(i) property (VBS), 4694
- ValueAxisShowGridLines(i) property (VBS), 4695
- ValueAxisShowLargeIncrements(i) property (VBS), 4696
- ValueAxisShowSmallIncrements(i) property (VBS), 4696, 4697
- ValueColumnAlignment(i) property (VBS), 4698
- ValueColumnPrecision(i) property (VBS), 4698
- Values
  - Comparing, 5937
- Variable index, 192
- VARIANT, 1115
- VARIANT\_TO\_DB\_ANY, 2206
- VBS
  - Object model, 3899
  - Reference, 3899
- VB-script
  - Migrating, 149
- Versioning of types
  - Released version, 363
  - Version in progress, 362
  - Version in testing, 363
- Versions in WinCC, 5583
- Vertical movement
  - Animation, 3016
- Vertical radius, 3093

- VerticalAlignment property (VBS), 4699
  - VerticalGridLines property (VBS), 4700
  - View options
    - For the assignment list, 1466
    - Setting the call structure, 1474
    - Setting the dependency structure, 1479
  - ViewOnly property (VBS), 4701
  - Views of the cross-reference list, 1486, 5528
  - Virtual Machine (VM)
    - Supported virtualization platforms, 90, 93
  - Visible column , 3139
  - Visible property (VBS), 4701
  - VLAN
    - Port VID, 719
    - Priority, 719
    - Tag, 719
  - VLAN operation, 576
  - VLAN tagging, 576
  - VOID, 1117
  - VPN connection
    - Deleting CA certificates, 6249
    - Establishing, 6249
    - Installing CA certificate, 6246
    - Terminating, 6251
  - VPN connection is not established
    - Check and remedy, 6269
  - VPN group, 574
  - VRRP
    - Address overview, 755
    - Configuration, 754
    - Router, 753
- W**
- WAIT, 1790, 2047, 2240
  - Wake-up call, 676
  - Wake-up SMS, 676
  - WAN IP address
    - Specifying, 585
  - Warm restart, 837
  - Warning property (VBS), 4704
  - WarningColor property (VBS), 4704
  - WarningLowerLimit property (VBS), 4705
  - WarningLowerLimitColor property (VBS), 4706
  - WarningLowerLimitEnabled property (VBS), 4706
  - WarningLowerLimitRelative property (VBS), 4707
  - WarningRangeColor property (VBS), 4708
  - WarningRangeStart property (VBS), 4708
  - WarningRangeVisible property (VBS), 4709
  - WarningUpperLimit property (VBS), 4710
  - WarningUpperLimitColor property (VBS), 4710
  - WarningUpperLimitEnabled property (VBS), 4711
  - WarningUpperLimitRelative property (VBS), 4711
  - Watch table
    - Meaning of the icons, 1502
    - "Enable peripheral outputs" function, 51
    - Basic mode, 1500
    - Copying, 1504
    - Creating, 1503
    - Example of filling out a watch table, 1505
    - Expanded mode, 1500
    - Layout, 1500
    - Loading data blocks during an active control job, 51
    - Meaning of the columns, 1500
    - Monitoring and modifying modes, 1513
    - Multiple access to the same CPU, 50
    - Opening, 1504
    - Overview of the display formats, 1509
    - Overview of the test options, 1499
    - Permitted operands, 1506
    - Permitted operands for modify values, 1507
    - Possible applications, 1499
    - Saving, 1505
    - Switching between basic mode and expanded mode, 1501
    - Syntax check, 1505
    - Testing wiring, 1499
  - Watchdog time, 815
  - Web address, 3101
  - Web application, 648
  - Web authorization, 5815
    - Setting at the HMI-device, 5806
  - Web Control DB, 664
  - Web data blocks, 662
  - Web pages in browser, 669
  - Web server, 635, 642, 644, 648, 651, 662, 5842
    - Configure WinCC-Project , 5846
    - Enable, 645
    - Enumerations, 660
    - Fragment, 660
    - HTTPS, 646
    - Service-pages, 5843
    - User administration, 5814
    - Web authorization, 5814, 5815
  - When dialog is closed, 3788
  - When dialog is opened, 3788
  - When high limit is exceeded, 3787
  - When low limit is undershot, 3787
  - WHILE, 2220
  - Width property (VBS), 4712
  - WinAC MP, 5459
    - HMI device, 5478
    - Transfer, 5477

- Transfer to the HMI device, 5480
- Transferring, 5478
- WinACMPArchive, 3767
- WinACMPClearCycleTimeBuffer, 3769
- WinACMPControl, 3773
- WinACMPGetStartCharacteristics, 3767
- WinACMPGetVersion, 3768, 3877
- WinACMPRestore, 3774
- WinACMPSetHMIExecutionTime, 3770
- WinACMPSetKeySwitch, 3770
- WinACMPSetSleeptime, 3771
- WinACMPSetStart at boot, 3769, 3877
- WinACMPSetStartMode, 3772, 3878
- WinACMPStartHistogram, 3772
- WinACMPStopHistogram, 3773
- WinACMPUpdateAverageCycleTime, 3757
- WinACMPUpdateAverageExecTime, 3756
- WinACMPUpdateBUSF1LED, 3754
- WinACMPUpdateBUSF2LED, 3755
- WinACMPUpdateEXTFLED, 3758
- WinACMPUpdateHMIEnableTime, 3759
- WinACMPUpdateINTFLED, 3759
- WinACMPUpdateKeySwitchSetting, 3753
- WinACMPUpdateLastCycleTime, 3760
- WinACMPUpdateMaximumCycleTime, 3761
- WinACMPUpdateMinimumCycleTime, 3762
- WinACMPUpdatePowerLED, 3763
- WinACMPUpdateRUNLED, 3765
- WinACMPUpdateStartupCharacteristics, 3752
- WinACMPUpdateSTOPLED, 3766
- WinACSetStartMode, 3772, 3878
- WinCC
  - WinCC MediaControl, 4030
- WinCC data provider
  - accessing, 5869
- WinCC flexible
  - Configuring, 5465
- WinCC flexible project
  - Migrating, 130, 158
- WinCC OPC Client
  - Configuring, 5897
- WinCC RT Advanced, 5051, 5124
  - HMI connection, 5001, 5071, 5073, 5143, 5157, 5158
  - Interface, 4975
  - MPI, 5155
  - PROFIBUS, 4999, 5069, 5141
  - SIMATIC PC, 5002
- WinCC RT Professional
  - HMI connection, 5001, 5002
  - Interface, 4975
  - PC, 4983, 5001
- PROFIBUS, 4999
- SIMATIC PC, 4986, 5002
- WinCC Runtime
  - Available system functions, 3614
  - Communication drivers, 4975
  - HTTP protocol, 4975
  - Mitsubishi, 4975
  - Modicon Modbus, 4975
  - OPC, 4975
  - S7 1200, 4975
  - S7 1500, 4975
  - S7 200, 4975
  - S7 300, 4975
  - S7 400, 4975
- WinCC Runtime
  - Omron, 4975
- WinCC Runtime Advanced
  - Display and operating element, 3084
  - Interface, 4975
- WinCC Runtime Advanced Internet, 5803
- WinCC Runtime Professional
  - Interface, 4975
- WinCC V7.0 SP3, 60
- WinCC version
  - Compatibility, 5584
- WinCC flexible, 5468
- WinCC RT Advanced, 5053, 5126
  - HMI connection, 5002
  - PC, 4983, 5001
  - SIMATIC PC, 4986
- Window layouts
  - Changing order, 232
  - Deleting window layouts, 232
- WindowCloseEnabled property (VBS), 4714
- Windows Server 2003, 40
- WindowSizingEnabled property (VBS), 4716
- WindowSlider object, 4140
- WindowsStyle property (VBS), 4716
- Wire break, 926, 942
- Wireless LAN/PB link, 796
- Wiring tests, 1499
- Wizard
  - Device wizard, 5484, 5485
- WLAN area, 4862
- WLAN reception, 3157
  - Layout, 3157
- WLANQualityView object, 4142
- WORD, 1083, 1127, 1144
- WORD\_TO\_, 1144
- Work area
  - Effective range, 4876
  - Effective range (RFID), 4878



- Embedding floating elements, 216
- Floating elements, 216
- Function, 211
- Maximizing, 213
- Maximizing elements, 218
- Minimizing, 213
- Minimizing elements, 218
- Mobile Wireless, 4876
- Mobile Wireless (RFID), 4878
- Saving a layout of editors and tables, 232
- Splitting, 215
- Switching between elements, 219
- Using grouped elements, 216
- Zone, 4874
- Work memory, 843, 1481
- Working step
  - to create screens, 2937
- WR\_DPARM, 2439
- WR\_LOC\_T, 2288
- WR\_REC, 2362
- WR\_SYS\_T, 2286
- WRIT\_DBL, 50, 2537
- Write field, 1724, 1979
- Write memory address, 2181
- Write memory area, 2184
- Write memory bit, 2183
- WriteTag, 4858
- WriteToArrayDB, 1740, 1997, 2172
- WriteToArrayDBL, 1744, 2000, 2175
- Writing
  - A data record with WR\_REC, 2362
- Writing data
  - in remote CPU with PUT, 2833
  - To DP standard slaves/PROFINET IO devices with DPWR\_DAT, 2365
- Writing tags, 655
- WRREC, 2323
- WWW (instruction), 663
- WWW Synchronizing user-defined web pages, 2920

## X

- XAxisAdd property (VBS), 4717
- XAxisAlign(VBS), 4717
- XAxisAutoPrecisions property (VBS), 4718
- XAxisAutorange(i) property (VBS), 4718
- XAxisBegin(i) property (VBS), 4719
- XAxisBeginValue property (VBS), 4719
- XAxisCount property (VBS), 4720
- XAxisDecimalPrecision(i) property (VBS), 4720
- XAxisEnd(i) property (VBS), 4721
- XAxisExponentialFormat property (VBS), 4722

- XAxisGridLineInterval(i) property (VBS), 4722
- XAxisIndex property (VBS), 4723
- XAxisInTrendColor property (VBS), 4723
- XAxisLabel(i) property (VBS), 4723
- XAxisLargeIncrementSize(i) property (VBS), 4724
- XAxisMode(i) property (VBS), 4724
- XAxisName property (VBS), 4725
- XAxisPrecisions property (VBS), 4725
- XAxisRemove property (VBS), 4726
- XAxisRepos property (VBS), 4726
- XAxisScalingType(i) property (VBS), 4727
- XAxisShowGridLines(i) property (VBS), 4727
- XAxisShowLargeIncrements(i) property (VBS), 4728
- XAxisShowSmallIncrements(i) property (VBS), 4728
- XAxisSmallIncrementSize(i) property (VBS), 4729
- XAxisTrendWindow property (VBS), 4729
- XDataLogTag(i) property (VBS), 4730
- xlsx file, 5511, 5519, 5523, 5524
- XOnlineTag(i) property (VBS), 4731
- XOR, 1346, 1347, 1794, 1838, 1839, 2051

## Y

- YAxisAdd property (VBS), 4731
- YAxisAlign(VBS), 4732
- YAxisAutoPrecisions property (VBS), 4732
- YAxisBeginValue property (VBS), 4733
- YAxisColor property (VBS), 4733
- YAxisCount property (VBS), 4734
- YAxisExponentialFormat property (VBS), 4734
- YAxisIndex property (VBS), 4735
- YAxisInTrendColor property (VBS), 4735
- YAxisLabel property (VBS), 4736
- YAxisName property (VBS), 4736
- YAxisPrecisions property (VBS), 4736
- YAxisRemove property (VBS), 4737
- YAxisRename property (VBS), 4737
- YAxisRepos property (VBS), 4737
- YAxisTrendWindow property (VBS), 4738
- YDataLogTag(i) property (VBS), 4739
- YOnlineTag(i) property (VBS), 4740

## Z

- ZeroPoint property (VBS), 4740
- Zone, 4863, 4874
  - Calculating quality, 3162
  - Configuring a screen change, 4881
  - Displaying an object in relation to the zone, 4882
  - ID Zone, 4882
  - On entry, 3161

- Work area, 4874
- Zone ID, 3161
- Zone ID / connection point ID, 4891
- Zone name, 3160
- Zone signal, 3161
- ZoneLabelView object, 4143
- ZoneQualityView object, 4144
- Zones editor, 4874
- Zoom
  - Adjusting the zoom setting, 392, 395, 398, 4920, 4926, 4928
  - Keyboard operation, 407
- Zoomable property (VBS), 4742
- ZoomArea, 4858
- Zooming
  - Screen, 2937
- ZoomInOut, 4859
- ZoomInOutTime, 4859
- ZoomInOutValues, 4860
- ZoomInOutX, 4860
- ZoomInOutY, 4861
- ZoomMove, 4861