

Radar Transmitters

SITRANS LR260 (PROFIBUS PA)

Operating Instructions · 12/2013



SITRANS

SIEMENS

Safety Guidelines: Warning notices must be observed to ensure personal safety as well as that of others, and to protect the product and the connected equipment. These warning notices are accompanied by a clarification of the level of caution to be observed.

Qualified Personnel: This device/system may only be set up and operated in conjunction with this manual. Qualified personnel are only authorized to install and operate this equipment in accordance with established safety practices and standards.

Unit Repair and Excluded Liability:

- The user is responsible for all changes and repairs made to the device by the user or the user's agent.
- All new components are to be provided by Siemens Milltronics Process Instruments.
- Restrict repair to faulty components only.
- Do not reuse faulty components.

Warning: Cardboard shipping package provides limited humidity and moisture protection. This product can only function properly and safely if it is correctly transported, stored, installed, set up, operated, and maintained.

This product is intended for use in industrial areas. Operation of this equipment in a residential area may cause interference to several frequency based communications.

Note: Always use product in accordance with specifications.

Copyright Siemens AG 2013. All Rights Reserved

Disclaimer of Liability

This document is available in bound version and in electronic version. We encourage users to purchase authorized bound manuals, or to view electronic versions as designed and authored by Siemens Milltronics Process Instruments. Siemens Milltronics Process Instruments will not be responsible for the contents of partial or whole reproductions of either bound or electronic versions.

While we have verified the contents of this manual for agreement with the instrumentation described, variations remain possible. Thus we cannot guarantee full agreement. The contents of this manual are regularly reviewed and corrections are included in subsequent editions. We welcome all suggestions for improvement.

Technical data subject to change.

MILLTRONICS® is a registered trademark of Siemens Milltronics Process Instruments.

Contact SMPI Technical Publications

at the following address:

Technical Publications
Siemens AG
Siemens Milltronics Process Instruments
1954 Technology Drive, P.O. Box 4225
Peterborough, Ontario, Canada, K9J 7B1
Email: techpubs.smpi@siemens.com

European Authorized Representative

Siemens AG
Industry Sector
76181 Karlsruhe
Deutschland

- For a selection of Siemens Milltronics level measurement manuals, go to: **www.siemens.com/processautomation**. Under Process Instrumentation, select *Level Measurement* and then go to the manual archive listed under the product family.
- For a selection of Siemens Milltronics weighing manuals, go to: **www.siemens.com/processautomation**. Under Weighing Technology, select *Continuous Weighing Systems* and then go to the manual archive listed under the product family.

Table of Contents

Table of Contents	i
Safety Notes	1
Safety marking symbols	1
FCC Conformity	1
The Manual	2
Application Examples	2
Technical Support	2
Abbreviations and Identifications	3
SITRANS LR260 Overview	4
Specifications	5
Dimensions	9
Threaded Horn Antenna with extension	10
Threaded Horn dimensions	11
Installation	13
Mounting location	14
Nozzle design	14
Nozzle location	14
Orientation in a vessel with obstructions	15
Easy Aimer	16
Air Purging System (Optional)	17
Universal Slotted Flange	18
Dust Cap (Optional)	19
Wiring	21
Power	21
Connecting SITRANS LR260	21
Basic PLC configuration with PROFIBUS PA	23
Wiring setup for hazardous area installations	24
Instructions specific to hazardous area installations	26
Quick Start via local operation	27
Activating SITRANS LR260	27
The LCD Display	27
Handheld Programmer	29
Programming SITRANS LR260	30
Quick Start Wizard via the handheld programmer	33
Requesting an Echo Profile	35
Device Address	35
Auto False Echo Suppression	35
Level application example	36
Operating via SIMATIC PDM	37
Functions in SIMATIC PDM	37
Features of SIMATIC PDM Rev. 6.0, SP3 (or higher)	37
Electronic Device Description (EDD)	38

Configuring a new device	38
Quick Start Wizard via SIMATIC PDM	39
Changing parameter settings using SIMATIC PDM	42
Parameter Reference	51
Pull-down menus via SIMATIC PDM	51
Quick Start Wizard	52
Quick Start	52
Setup	54
Device	54
Input.....	54
Output.....	66
Fail-safe	70
Diagnostics.....	72
Fault Reset	72
Echo Profile.....	72
Measured Values (MEAS. VALUES).....	73
Remaining Device Lifetime (REMAIN. DEV. LIFE).....	74
Remaining Sensor Lifetime (REMAIN SENS. LIFE)	77
Condensed Status Setup (COND. STAT. SETUP)	80
Condensed Status	81
Service.....	84
Device Reset.....	84
LCD Fast Mode.....	84
LCD Contrast.....	85
PROFIBUS Ident Number (PROFIBUS IDENT).....	85
Powered Hours	85
Power-on Resets.....	85
Service Interval	85
Calibration Interval (CALIB INTERVAL).....	87
Communication.....	88
Device Address	88
Remote Lockout	88
Security.....	88
Write Locking	88
Language.....	89
Appendix A: Alphabetical Parameter List	91
Appendix B: Troubleshooting	93
Device Status Icons	94
General Fault Codes	95
Operation Troubleshooting	99
Appendix C: Maintenance	101
Unit Repair and Excluded Liability	101
Appendix D: Technical Reference	103
Principles of Operation	103
Echo Processing	103
Process Intelligence	103
Time Varying Threshold (TVT) Curves	104

Echo Lock	104
Echo Position Detection	104
Auto False Echo Suppression	105
Measurement Range	105
Near Range	105
Far Range	106
Measurement Response	106
Damping	106
Loss of Echo (LOE)	106
LOE (Loss of Echo) Timer	107
Fail-safe Mode	107
Fail-safe value	107
Process Pressure/Temperature derating curves	
Horn Antenna	109
Appendix E: Application Example	111
Flour in steel storage vessel, level measurement	111
Appendix F: PROFIBUS PA Profile Structure	113
PROFIBUS Level Device Design	113
Description of the blocks	114
Appendix G: Communications via PROFIBUS PA	119
Device Configuration tool	119
SIMATIC PDM	119
Network Configuration	119
The GSD file	119
Bus Termination	119
Power Demands	120
PROFIBUS address	120
Operating as a Profile Device	120
Configuring a device	121
Configuring PROFIBUS PA with an S7-300/ 400 PLC	121
Cyclic versus Acyclic Data	121
Cyclic Data	121
Status Byte	122
Condensed Status	122
Status Byte	124
Diagnostics	125
Diagnosis reply (available cyclically)	125
Diagnosis Object (available cyclically or acyclically)	125
Extended Mode Diagnosis	126
Condensed Mode Diagnosis	126
Acyclic Extended Diagnostics (General Fault Codes)	127
Acyclic Data	130

Appendix H: Firmware Revision History 133
Glossary 135
Index 139
LCD menu structure 141

Safety Notes

Special attention must be paid to warnings and notes highlighted from the rest of the text by grey boxes.



WARNING: relates to a caution symbol on the product, and means that failure to observe the necessary precautions can result in death, serious injury, and/or considerable material damage.



WARNING¹: means that failure to observe the necessary precautions can result in death, serious injury, and/or considerable material damage.

Note: means important information about the product or that part of the operating manual.

Safety marking symbols

In manual	On product	Description
		Earth (ground) Terminal
		Protective Conductor Terminal
		(Label on product: yellow background.) WARNING: refer to accompanying documents (manual) for details.

FCC Conformity

US Installations only: Federal Communications Commission (FCC) rules



WARNING: Changes or modifications not expressly approved by Siemens Milltronics could void the user's authority to operate the equipment.

Notes:

- This equipment has been tested and found to comply with the limits for a Class A digital device, pursuant to Part 15 of the FCC Rules. These limits are designed to provide reasonable protection against harmful interference when the equipment is operated in a commercial environment.
- This equipment generates, uses, and can radiate radio frequency energy and, if not installed and used in accordance with the instruction manual, may cause harmful interference to radio communications. Operation of this equipment in a residential area is likely to cause harmful interference to radio communications, in which case the user will be required to correct the interference at his own expense.

¹⁾ This symbol is used when there is no corresponding caution symbol on the product.

The Manual

Notes:

- Please follow the installation and operating procedures for a quick, trouble-free installation and to ensure the maximum accuracy and reliability of your SITRANS LR260.
- This manual applies to the SITRANS LR260 (PROFIBUS PA) only.

This manual will help you set up your SITRANS LR260 for optimum performance. We always welcome suggestions and comments about manual content, design, and accessibility. Please direct your comments to techpubs.smpi@siemens.com.

For other Siemens Milltronics level measurement manuals, go to: www.siemens.com/level, and look under **Level Measurement**.

Application Examples

The application examples used in this manual illustrate typical installations using SITRANS LR260. (See *Appendix E: Application Example* on page 111.) Because there is often a range of ways to approach an application, other configurations may also apply.

In all examples, substitute your own application details. If the examples do not apply to your application, check the applicable parameter reference for the available options.

Technical Support

Support is available 24 hours a day.

To find your local Siemens Automation Office address, phone number, and fax number go to:

www.siemens.com/automation/partner

- Click on the tab **Contacts by Product** and then find your product group (**+Process Automation > +Process Instrumentation > +Level Measuring Instruments**).
- Select the team **Technical Support**. Click on **Next**.
- Click on the appropriate continent, then select the country followed by the city. Click on **Next**.

For on-line technical support go to:

www.siemens.com/automation/support-request

- Enter the device name (SITRANS LR260) or order number, then click on **Search**, and select the appropriate product type. Click on **Next**.
- You will be prompted to enter a keyword describing your issue. Then either browse the relevant documentation, or click on **Next** to email a detailed description of your issue to Siemens Technical Support staff.

Siemens A&D Technical Support Center: phone +49 180 50 50 222

fax +49 180 50 50 223

Abbreviations and Identifications

Short form	Long Form	Description	Units
A/D	Analog to digital		
AIFB	Analog Input Function Block		
CE / FM / CSA	Conformité Européene / Factory Mutual / Canadian Standards Association	safety approval	
C _i	Internal capacitance		F
D/A	Digital to analog		
DAC	Digital Analog Converter		
DCS	Distributed Control System	control room apparatus	
dK	dielectric constant		
I _i	Input current		mA
I _o	Output current		mA
IS	Intrinsically Safe	safety approval	
L _i	Internal inductance		mH
LTB	Level Transducer Block		
mH	milliHenry	10 ⁻³	Henry
μF	microFarad	10 ⁻⁶	Farad
μs	microsecond	10 ⁻⁶	Second
PA	Process Automation (PROFIBUS)		
PED	Pressure Equipment Directive	safety approval	
pF	pico Farads	10 ⁻¹²	Farad
ppm	parts per million		
PV	Primary Value ^{a)}	measured value	
SELV	Safety extra low voltage		
SV	Secondary Value ^{a)}	equivalent value	
TVT	Time Varying Threshold	sensitivity threshold	
U _i	Input voltage		V
U _o	Output voltage		V

a) The output from the Level Transducer Block can be called the Primary Value (or Secondary Value). When it becomes the input to the AIFB, it is called the Process Variable.

SITRANS LR260 Overview

SITRANS LR260 is a 2-wire 25 GHz pulse radar level transmitter for continuous monitoring of solids and liquids in storage vessels including extreme levels of dust and high temperatures, to a range of 30 m (98.4 ft).

The instrument consists of an electronic component coupled to a horn antenna with an integral Easy Aimer and flange for quick and easy positioning. A dust cover or air purging are available as options.

SITRANS LR260 supports PROFIBUS PA communication protocol, and SIMATIC PDM software. Signals are processed using Process Intelligence which has been field-proven in over 1,000,000 applications worldwide (ultrasonic and radar). This device supports acyclic communications from both a PROFIBUS Class I and Class II master.

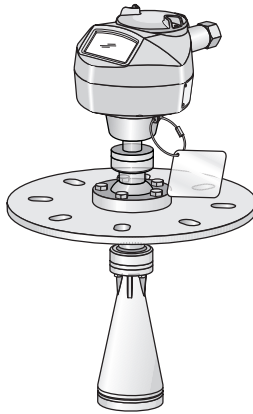

Programming

SITRANS LR260 is very easy to install and configure via a graphical local user interface (LUI). You can modify the built-in parameters either locally via the Siemens infrared handheld programmer, or from a remote location via SIMATIC PDM.

Applications

- cement powder, plastic powder/pellets, grain, flour, coal, and other applications
- solids and liquids bulk storage vessels

Approvals and Certificates

SITRANS LR260 is available with General Purpose approval, or for Hazardous areas. For details, see *Approvals* on page 7.

Specifications

Notes:

- Siemens Milltronics makes every attempt to ensure the accuracy of these specifications but reserves the right to change them at any time.

Power

Bus powered	Per IEC 61158-2 (PROFIBUS PA)
Current consumed	15.0 mA (General Purpose or Intrinsically Safe version)

Performance

Reference operating conditions according to IEC 60770-1

- ambient temperature +15 to +25 °C (+59 to +77 °F)
- humidity 45% to 75% relative humidity
- ambient pressure 860 to 1060 mbar g (86,000 to 106,000 N/m² g)

Measurement Accuracy (measured in accordance with IEC 60770-1)

- Maximum measured error (including hysteresis and non-repeatability)
 - 25 mm (1") from minimum detectable distance up to 300 mm
 - Remainder of range = 10 mm (0.39") or 0.1% of span (whichever is greater)

Frequency K-band (25 GHz nominal)

Max. measurement range¹⁾

- solids
 - 2" horn: 10 m (32.8 ft)
 - 3" horn: 20 m (65.6 ft)
 - 4" horn: 30 m (98.4 ft)
- liquids
 - 2" horn: 20 m (65.6 ft)
 - 3" horn: 30 m (98.4 ft)
 - 4" horn: 30 m (98.4 ft)

Min. detectable distance²⁾ 0.05 m (1.97") from end of horn

Update time³⁾ minimum 2 seconds, depending on **Response Rate (2.2.6.1)** and **LCD Fast Mode (4.2)**

Influence of ambient temperature <0.003% / K (average over full temperature range, referenced to maximum range)

¹⁾ From sensor reference point.

²⁾ See *Dimensions* on page 9.

³⁾ Reference conditions: **Response Rate (2.2.6.1)** set to **FAST** and **LCD Fast Mode (4.2)** set to **ON**

Dielectric constant of material measured

- Minimum dK = 1.6 (depending on antenna and application type)

Memory

- non-volatile EEPROM
- no battery required.

Interface

- PROFIBUS PA
- configuration

Siemens SIMATIC PDM (PC), or
Siemens Milltronics infrared hand-held programmer
(see *Programmer (infrared keypad)* on page 8)

- display (local)¹⁾

graphic LCD, with bar graph (representing level)

Mechanical (Easy Aimer model)

Materials

- flange and horn flange and horn: 304 stainless steel

Process Connections:

- universal flanges²⁾ 2"/50 mm, 3"/80 mm, 4"/100 mm, 6"/150 mm

Horn:

- 2" horn
- 3" horn
- 4" horn

Enclosure

- construction aluminum, polyester powder-coated
- conduit entry 2 x M20x1.5, or 2 x ½" NPT
- ingress protection Type 4X/NEMA 4X, Type 6/NEMA 6, IP67, IP68 (see note below)

Dust cap (optional)

- 2" PTFE, pipe clamp connection, O.D. 50 mm (1.97")
- 3" PTFE, pipe clamp connection, O.D. 75 mm (2.95")
- 4" PTFE, pipe clamp connection, O.D. 100 mm (3.94")

Air Purge Connection

- equipped with female 1/8" NPT fitting

Weight

- standard model < 8.14 kg (17.9 lb) including 4" flange and standard Easy Aimer with 4" horn antenna

¹⁾ Display quality will be degraded in temperatures below -25 °C (-13 °F) and above +65 °C (+149 °F).

²⁾ Universal flange mates with EN 1092-1 (PN16)/ASME B16.5 (150 lb)/JIS 2220 (10K) bolt hole pattern.

Mechanical (Threaded Connection model)

- threaded connection 2" NPT (ASME B1.20.1), R (BSPT, EN 10226-1) or G (BSPP, EN ISO 228-1)
- materials 316L /1.4404 or 316L /1.4435 stainless steel
PTFE emitter

Environmental

- location indoor/ outdoor
- altitude 2000 m (6562 ft) max.
- ambient temperature -40 to $+80$ °C (-40 to $+176$ °F)
- relative humidity suitable for outdoor
Type 4X/NEMA 4X, Type 6/NEMA 6, IP67 enclosure (see note below)
- installation category I
- pollution degree 4

Notes:

- Check *Approvals* on page 7, for the specific configuration you are about to use or install.
- Use appropriate conduit seals to maintain IP or NEMA rating.

Process

- temperature¹⁾ -40 to $+200$ °C (-40 to $+392$ °F)²⁾
(at process connection with FKM O-ring)
- pressure (vessel)¹⁾ Refer to *Process Pressure/Temperature derating curves* on page 108.

Approvals

Note: The device nameplate lists the approvals that apply to your device.

- General CSA_{US/C}, FM, CE
- Radio Europe (R&TTE), FCC, Industry Canada
- Hazardous ATEX II 1GD, 1/2D, 2D Ex ia IIC T4 Ga, Ex ta IIIC T100 °C Da
ATEX II 3G Ex nA IIC T4 Gc
IECEx SIR 11.0153X Ex ia IIC T4 Ga, Ex ta IIIC T100 °C Da
FM/CSA Class I, Div. 1, Groups A, B, C, D, Class II, Div. 1, Groups E, F, G, Class III T4
FM/CSA Class I, Div 2, Groups A, B, C, D T5
SABS ARP0108 Ex ia IIC T4 Ga

¹⁾ The maximum temperature is dependent on the ambient temperature and vessel pressure. For more detail, or for other configurations, see *Process Pressure/Temperature derating curves* on page 108.

²⁾ Pressure rated version for maximum process temperature of 80 °C (176 °F)

INMETRO: DNV 12.0081 X
Ex ia IIC T4 Ga
Ex ta IIIC T100 °C Da
 $-40\text{ °C} \leq T_a \leq +80\text{ °C}$
IP67/IP68
DNV #OCP 0017
ABNT NBR IEC 60079-0:2008
ABNT NBR IEC 60079-11:2009
ABNT NBR IEC 60079-26:2008 e
ABNT NBR IEC 60079-31:2011

Programmer (infrared keypad)

Siemens Milltronics Infrared IS (Intrinsically Safe) Hand Programmer for hazardous and all other locations (battery is non-replaceable)

- approval ATEX II 1GD, Ex ia IIC T4 Ga, Ex iaD 20 T135 °C,
SIRA 01ATEX2147
IECEx SIR 09.0073 Ex ia IIC T4 Ga, Ex iaD 20 T135 °C
FM/CSA: Class I, Div. 1, Groups A, B, C, D
INMETRO: DNV 12.0075
Ex ia IIC T4 Ga
Ex ta IIIC T135 °C Da
DNV #OCP 0017
ABNT NBR IEC 60079-0:2008
ABNT NBR IEC 60079-11:2009
ABNT NBR IEC 60079-26:2008 e IEC 61241-11:2005
- ambient temperature -20 to $+50\text{ °C}$ (-5 to $+122\text{ °F}$)
- interface proprietary infrared pulse signal
- power 3 V lithium battery
- weight 150 g (0.3 lb)
- color black
- Part Number 7ML5830-2AJ

Dimensions

Notes:

- Process temperature and pressure capabilities are dependent upon information on the process device tag.
- Signal amplitude increases with horn diameter, so use the largest practical size.

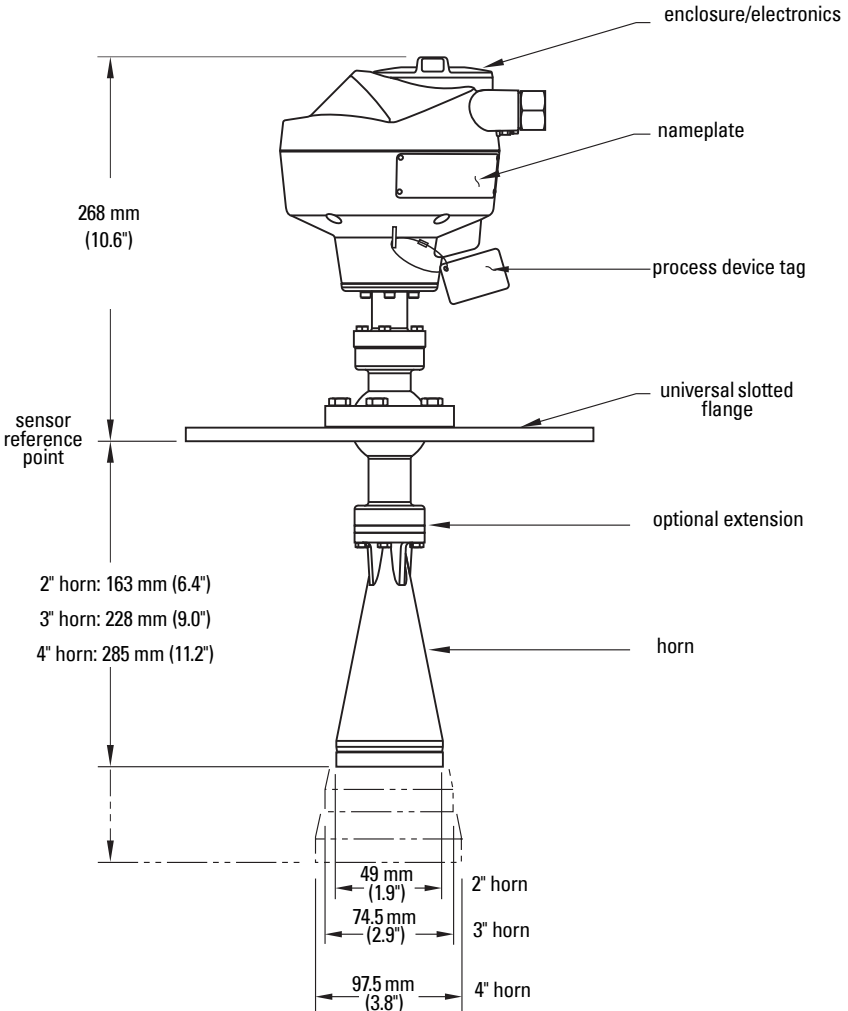

Threaded Horn Antenna with extension

Notes:

- Process temperature and pressure capabilities are dependent upon information on the process connection tag.
- Signal amplitude increases with horn diameter, so use the largest practical size.
- Optional extensions can be installed below the threads.

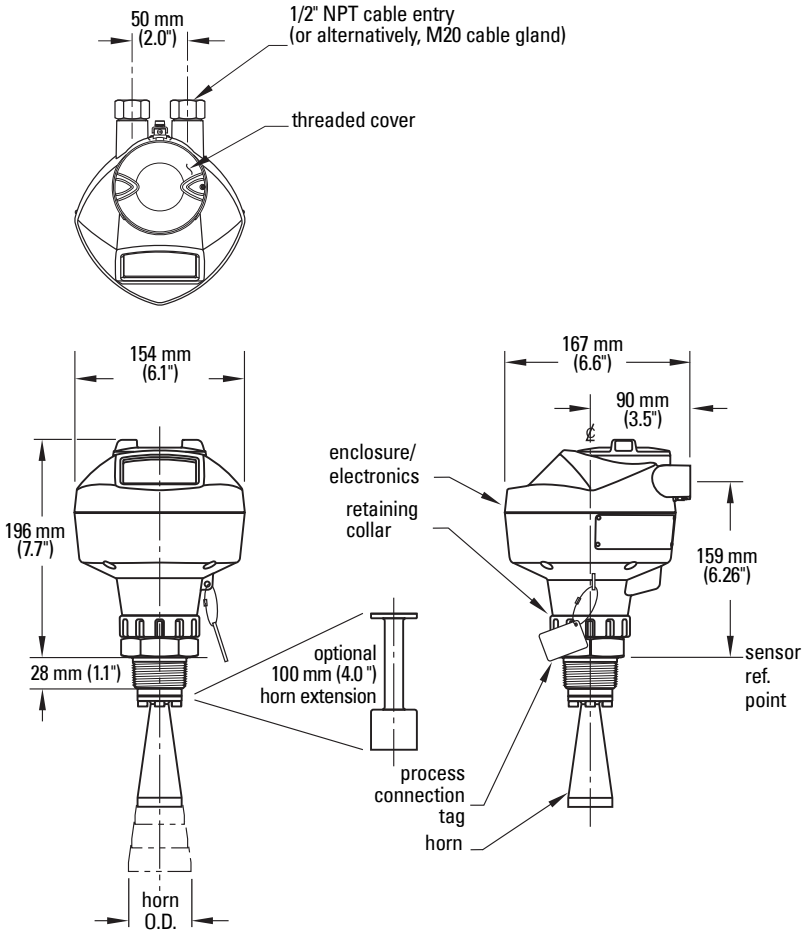

See table under *Threaded Horn dimensions* on page 11 for horn height to sensor reference point.

Threaded Horn dimensions

Antenna Type	Antenna O.D.	Height to sensor reference point ^{a)}			Beam Angle ^{b)}	Measurement Range
		1-1/2" threaded connection	2" threaded connection	3" threaded connection		
2" Horn	47.8mm (1.88")	N/A	166mm (6.55")	180mm (7.09")	15 degrees	20m (65.6 ft)
3" Horn	74.8mm (2.94")	N/A	199mm (7.85")	213mm (8.39")	10 degrees	20m (65.6 ft)
4" Horn	94.8mm (3.73")	N/A	254mm (10")	268mm (10.55")	8 degrees	20m (65.6 ft)

- a) Height from bottom of horn to sensor reference point as shown: see *Threaded Horn Antenna with extension* on page 10.
- b) – 3dB in the direction of the polarization axis (see *Polarization reference point* on page 15 for an illustration).

Notes

Installation



• WARNINGS:

- **Installation shall be performed only by qualified personnel and in accordance with local governing regulations.**
- **SITRANS LR260 is to be used only in the manner outlined in this manual, otherwise protection provided by the device may be impaired.**
- **Never attempt to loosen, remove, or disassemble process connection or instrument housing while vessel contents are under pressure.**
- **This product is designated as a Pressure Accessory per Directive 97/23/EC and is not intended for use as a safety device.**
- **Materials of construction are chosen based on their chemical compatibility (or inertness) for general purposes. For exposure to specific environments, check with chemical compatibility charts before installing.**
- **The user is responsible for the selection of bolting and gasket materials which will fall within the limits of the flange and its intended use and which are suitable for the service conditions.**
- **Improper installation may result in loss of process pressure.**

Notes:

- For European Union and member countries, installation must be according to ETSI EN 302372.
- Refer to the device nameplate for approval information.
- The Process Device Tag shall remain with the process pressure boundary assembly¹. In the event the instrument package is replaced, the Process Device Tag shall be transferred to the replacement unit.
- SITRANS LR260 units are hydrostatically tested, meeting or exceeding the requirements of the ASME Boiler and Pressure Vessel Code and the European Pressure Equipment Directive.
- The serial numbers stamped in each process connection body provide a unique identification number indicating date of manufacture.
Example: MMDDYY – XXX (where MM = month, DD = day, YY = year, and XXX= sequential unit produced)
Further markings (space permitting) indicate flange configuration, size, equivalent pressure class, material, and material heat code.

¹⁾ The process pressure boundary assembly comprises the components that act as a barrier against pressure loss from the process vessel: that is, the combination of process connection body and emitter, but normally excluding the electrical enclosure.

Mounting location

Notes:

- Correct location is key to a successful application.
- Avoid reflective interference from vessel walls and obstructions by following the guidelines below

Nozzle design

- The end of the horn must protrude a minimum of 10 mm (0.4") to avoid false echoes being reflected from the nozzle.
- Optional antenna extensions: 100 mm (3.93"), 200 mm (70.9"), 500 mm (19.69"), 1000 mm (39.4")¹⁾

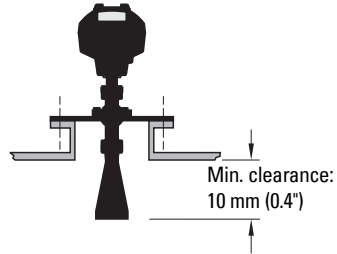

Nozzle location

Notes:

- Beam angle depends on horn size.
- For details on avoiding false echoes, see *Auto False Echo Suppression* on page 105.
- Keep emission cone free of interference from ladders, pipes, I-beams or filling streams.
- Avoid central locations on tall, narrow vessels.
- Align the antenna so that the radar cone is perpendicular to the surface of the monitored material, if possible. (See *Easy Aimer* on page 16.)

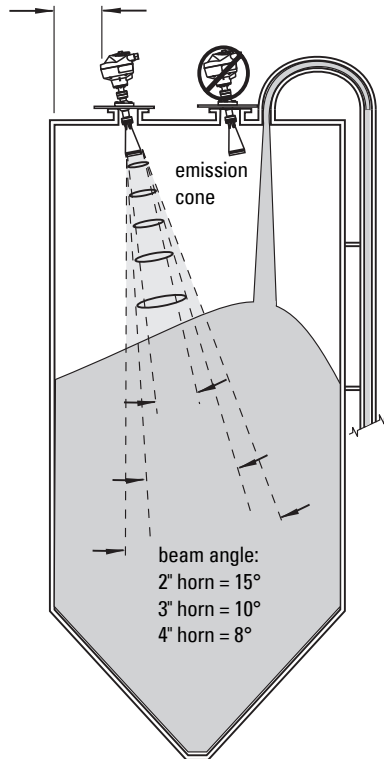

¹⁾ Extensions are not recommended for applications where there may be excessive visible vibration. Please consult the factory for more information.

Nozzle location (continued)

- Provide easy access for viewing the display and programming via the hand programmer.
- Provide an environment suitable to the housing rating and materials of construction.
- Provide a sunshield if the instrument will be mounted in direct sunlight.

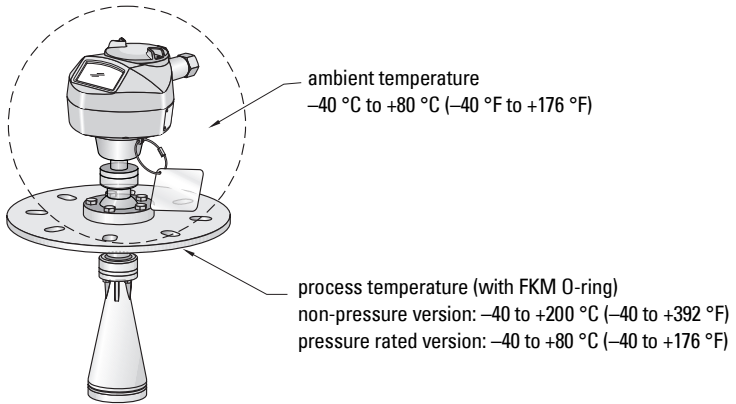

Orientation in a vessel with obstructions

Polarization reference point

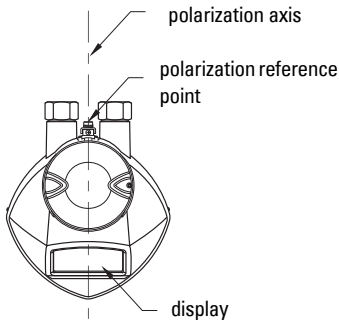

For best results on a vessel with obstructions, orient the front or back of the device toward the obstructions.

Easy Aimer

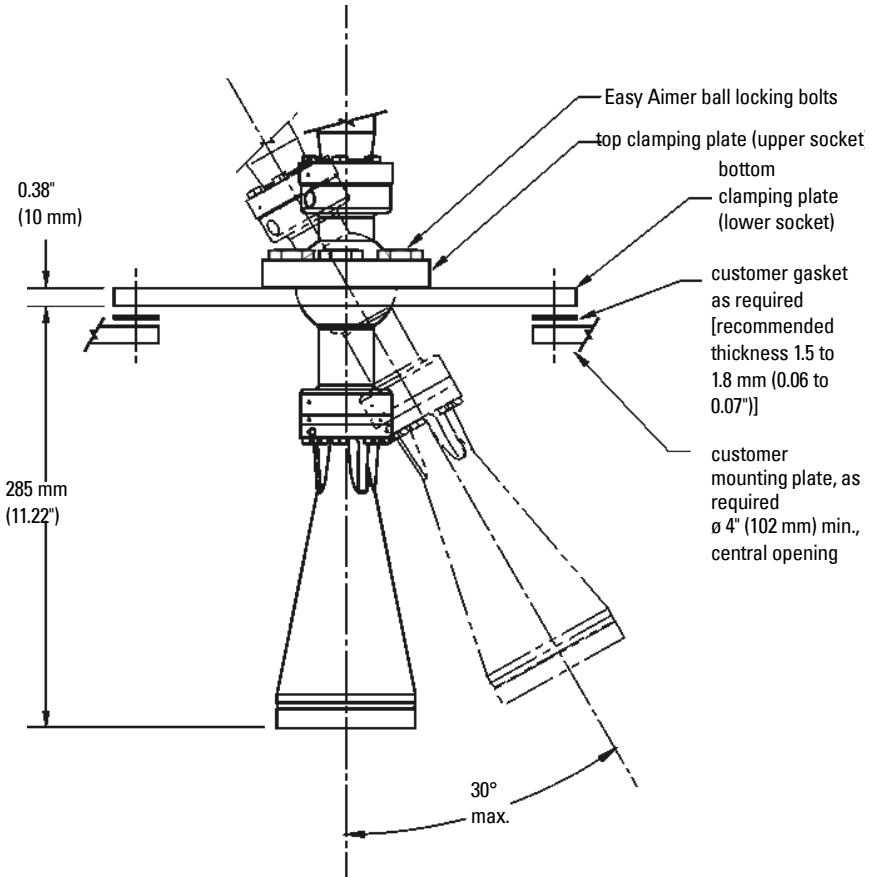

Note: When the Easy Aimer ball is loosened, the device is free to tilt to a maximum of 30°.

1. Holding the electronics enclosure firmly, loosen the Easy Aimer ball locking bolts and gently reposition the enclosure.
2. Direct SITRANS LR260 so the horn antenna is pointed at an angle perpendicular to the material surface, if possible. (As a guide, aim the beam at a point approximately 2/3 of the way across the tank diameter.)
3. When the desired position is reached, re-tighten the 5 bolts to 15-23 Nm (11 to 17 Lbf-ft).

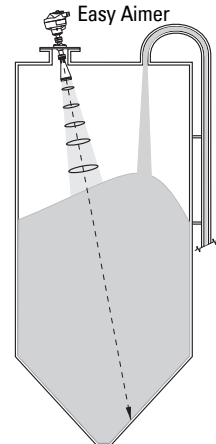

Air Purging System (Optional)

For more frequent cleaning, a purging system can be installed between the flange and the horn antenna. The system provides an 1/8" inlet (female thread) on the flange where cooling air or cleaning fluid passes through the flange and exits the inside of the horn to clean it. The customer will supply the purging medium by a manual or automatic valve system.

This option is only available with the universal flange for purging shown on page 17.

Notes:

- The Air Purge feature should not be activated with a dust cap in place.
- Purge duration, pressure, and interval, will vary with each application. It is the user's responsibility to determine the requirements depending on the application and cleaning required.
- Short duration bursts of high pressure provide more effective cleaning than continuous low pressure air.
- Some dust particles are highly abrasive and can be drawn into the inside of the horn during purge cleaning, damaging the internal PTFE emitter of the antenna. A replacement kit is available from your local Siemens Milltronics representative.
- It is the customer's responsibility to ensure that any vacuum or pressure in the measured vessel is maintained, considering the hole that passes through the process connection and SITRANS LR260 antenna system.

Air Consumption (Flow rate versus applied pressure)

Air Pressure (psi) ²	Approx. inlet volume flow rate
20	5 SCFM
40	6 SCFM
60	8 SCFM
80	9 SCFM
90	10 SCFM
Recommended 90 to 110 psi for effective cleaning with inlet flow of 10 SCFM ¹⁾	

- The purge connection is closed by the manufacturer, using a 1/8" plug.
- When the plug is removed to connect a purging system, the operator is responsible for ensuring that the purging circuit conforms to "Ex" requirements: for example, by fitting an NRV valve.

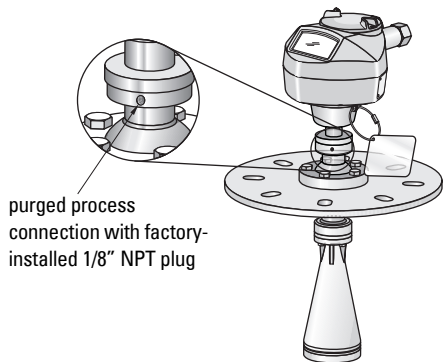

¹⁾ SCFM (standard cubic feet/minute) referenced to 14.7 psia, +68 °F and 36% relative humidity (RH).

²⁾ Air pressure in vessel can affect purge operation.

³⁾ Not for pressure applications

Universal Slotted Flange

! WARNING: The user is responsible for the selection of bolting and gasket materials which will fall within the limits of the flange and its intended use and which are suitable for the service conditions.

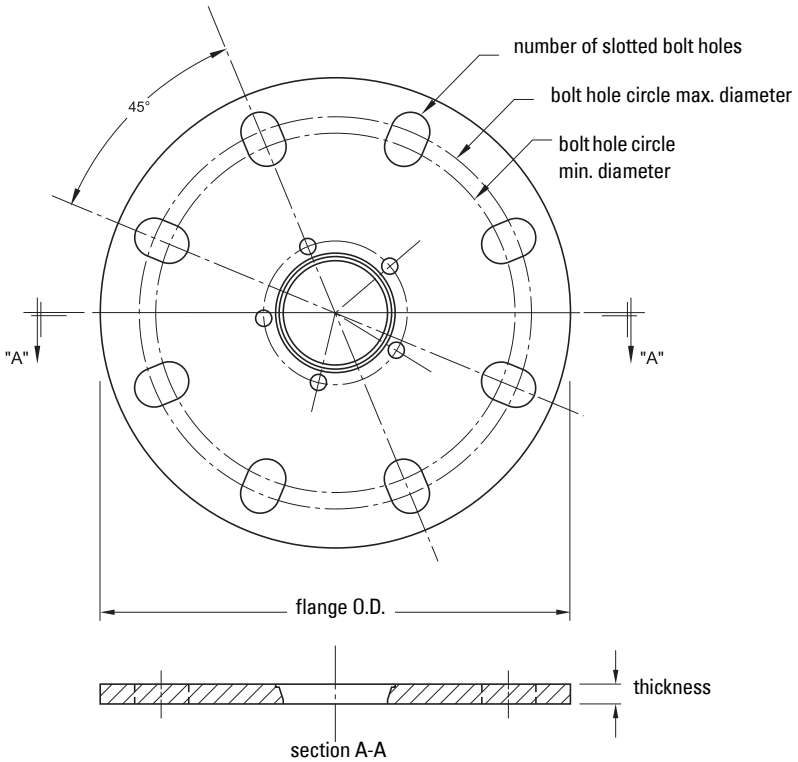

Slotted Flange Dimensions (see above)¹⁾

Pipe Size	Flange O.D.	Thick-ness (s)	Bolt Hole Circle Max Ø	Bolt Hole Circle Min Ø	Bolt Hole radius	No. of Slotted Holes
2" or 50 mm	6.50" (165 mm)	0.38" (9.65 mm)	4.92" (125 mm)	4.72" (120 mm)	0.38" (9.65 mm)	4
3" or 80 mm	7.87" (200 mm)	0.38" (9.65 mm)	6.30" (160 mm)	5.91" (150 mm)	0.38" (9.65 mm)	8
4" or 100 mm	9.00" (229 mm)	0.38" (9.65 mm)	7.52" (191 mm)	6.89" (175 mm)	0.38" (9.65 mm)	8
6" or 150 mm	11.22" (285 mm)	0.38" (9.65 mm)	9.53" (242 mm)	9.45" (240 mm)	0.45" (11.5 mm)	8

Dust Cap (Optional)

Note: The dust cap must be removed before using the Air Purge feature. (See *Air Purging System (Optional)* on page 17).

The dust cap fits onto the end of the horn and prevents the buildup of dust and other process material inside the horn.

- It is particularly useful for applications in areas of high humidity, or with bulk solids with a high moisture content.
- Three sizes are available, to fit the standard 2", 3", and 4" horns.

Installation

1. Thoroughly clean inside the horn. If you remove the horn for easier cleaning, take care not to damage or bend the plastic emitter.

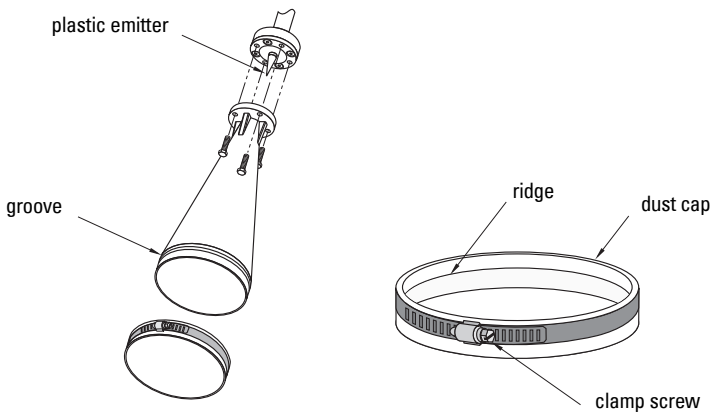

2. Press the cap firmly onto the horn until the ridge inside the cap snaps into position in the groove on the outside of the horn.
3. Hand tighten the adjustable clamp supplied to secure the cap.
4. Use a screwdriver or nut driver to tighten the clamp screw until the clamp provides an air-tight seal.

Note: It is critical to ensure no moisture can be trapped inside.

¹⁾ Universal flange mates with EN 1092-1 (PN16)/ASME B16.5 (150 lb)/JIS 2220 (10K) bolt hole pattern.

Notes

Wiring

Power

WARNINGS:



The DC input terminals shall be supplied from a source providing electrical isolation between the input and output, in order to meet the applicable safety requirements of IEC 61010-1.



All field wiring must have insulation suitable for rated voltages.

Connecting SITRANS LR260



WARNINGS:

- Check the nameplate on your instrument, to verify the approval rating.
- Use appropriate conduit seals to maintain IP or NEMA rating.

Notes:

- Use twisted pair cable: AWG 22 to 14 (0.34 mm² to 2.5 mm²).
- Separate cables and conduits may be required to conform to standard instrumentation wiring practices or electrical codes.

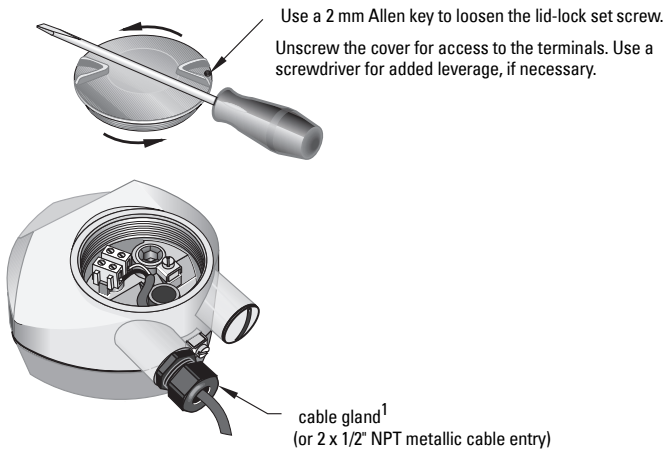

¹⁾ Depending on the approval rating, glands and plugs may be supplied with your instrument.

1. Strip the cable jacket for approximately 70 mm (2.75") from the end of the PROFIBUS PA cable, and thread the wires through the gland¹⁾.
2. Connect the wires to the terminals as shown below (SITRANS LR260 is not polarity sensitive).
3. Ground the instrument according to local regulations.

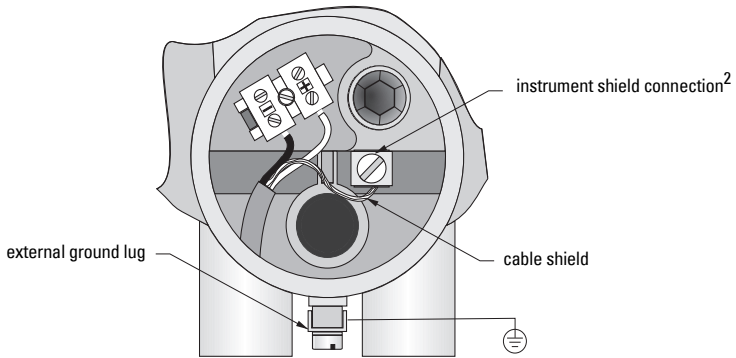

4. Tighten the gland to form a good seal.
5. Close the lid and secure the locking ring before programming and calibration.

Notes:

- PROFIBUS PA must be terminated at both extreme ends of the cable for it to work properly.
- Please refer to the *PROFIBUS PA User and Installation Guidelines* (order number 2.092), available from www.profibus.com, for information on installing PROFIBUS devices.

-
- 1) If cable is routed through conduit, use only approved suitable-size hubs for waterproof applications.
 - 2) The instrument shield connection is internally connected to the external ground lug.

Basic PLC configuration with PROFIBUS PA

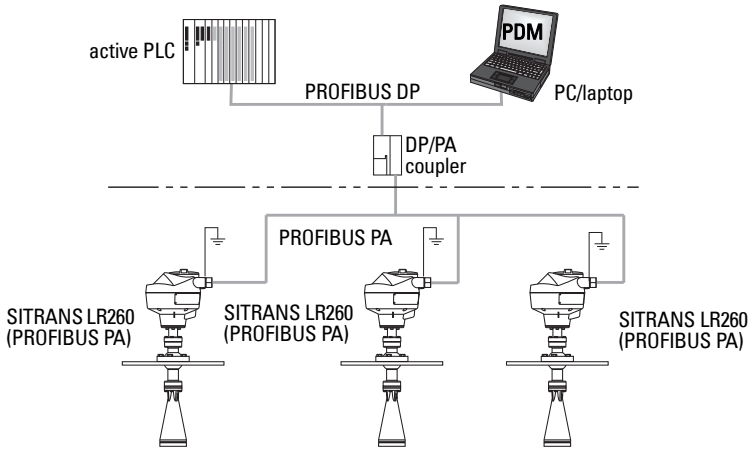

Wiring setup for hazardous area installations

1. Intrinsically Safe wiring

Device nameplate (ATEX/IECEx/INMETRO/C-TICK)

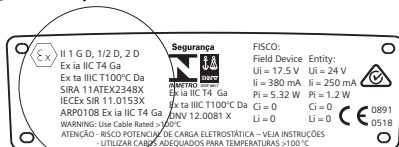
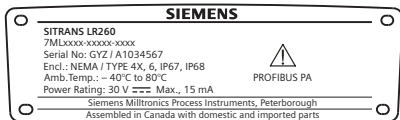

The ATEX certificate listed on the nameplate can be downloaded from the product page of our website at: www.siemens.com/LR260. Go to **Support > Approvals / Certificates**.

The IECEx certificate listed on the nameplate can be viewed on the IECEx website. Go to: <http://iecex.iec.ch> and click on **Ex Equipment Certificates of Conformity** then enter the certificate number IECEx SIR 11.0153X.

Device nameplate (FM/CSA)

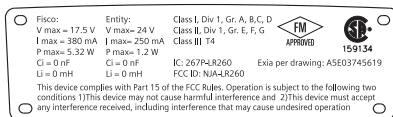
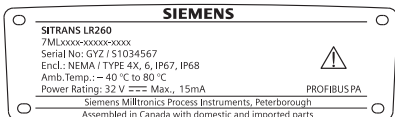

FM/CSA Intrinsically Safe connection drawing

number **A5E03745619** can be downloaded from the product page of our website at: www.siemens.com/LR260. Go to **Support > Installation Drawings > Level Measurement > Continuous - Radar**.

- For wiring requirements: follow local regulations.
- Approved dust-tight and water-tight conduit seals are required for outdoor NEMA 4X / type 4X / NEMA 6, IP67, IP68 locations.
- Refer to *Instructions specific to hazardous area installations* on page 26.

Note: Selecting a suitable PLC input module, power supply, or barrier requires knowledge about Intrinsic Safety and the application. It is the responsibility of the installer to ensure that the intrinsically safe installation complies with both the apparatus approval requirements and the relevant national code of practice.

2. Non-Sparking wiring

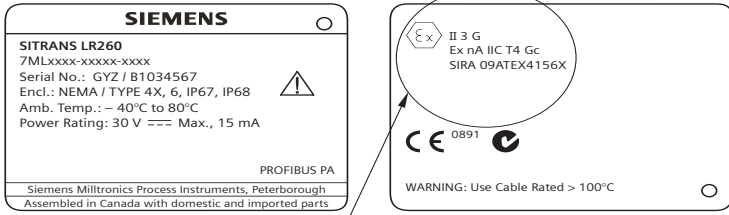

The ATEX certificate listed on the nameplate

can be downloaded from the product page of our website at: www.siemens.com/LR260. Go to **Support > Approvals / Certificates**.

- For wiring requirements: follow local regulations.
- Approved dust-tight and water-tight conduit seals are required for outdoor Type 4X/NEMA 4X, Type 6/NEMA 6, IP67 locations.
- Refer to *Instructions specific to hazardous area installations* on page 26.

3. Non-incendive wiring (US/Canada only)

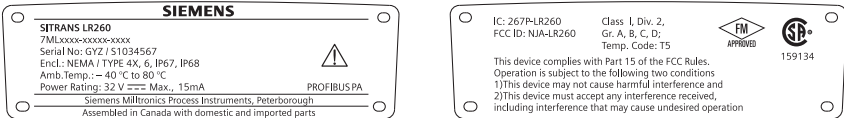

FM/CSA Class 1, Div 2 connection drawing number A5E03745541

can be downloaded from the product page of our website at: www.siemens.com/LR260. Go to **Support > Installation Drawings > Level Measurement > Continuous - Radar**.

Instructions specific to hazardous area installations

(Reference European ATEX Directive 94/9/EC, Annex II, 1/0/6)

The following instructions apply to equipment covered by certificate number SIRA 11ATEX2348X, and SIRA 09ATEX4156X.

- 1) For use and assembly, refer to the main instructions.
- 2) The equipment is certified for use as Category 1GD, 1/2D, 2D equipment per SIRA 11ATEX2348X and Category 3G equipment per SIRA 09ATEX4156X.
- 3) The equipment may be used with flammable gases and vapors with apparatus group IIC, IIB and IIA and temperature classes T1, T2, T3 and T4.
- 4) The equipment has a degree of ingress protection of IP67 and a temperature class of T100°C and may be used with flammable dusts.
- 5) The equipment is certified for use in an ambient temperature range of -40 °C to 80 °C.
- 6) The equipment has not been assessed as a safety related device (as referred to by Directive 94/9/EC Annex II, clause 1.5).
- 7) Installation and inspection of this equipment shall be carried out by suitably trained personnel in accordance with the applicable code of practice (EN 60079-14 and EN 60079-17 in Europe).
- 8) The equipment is non-repairable.
- 9) The certificate numbers have an 'X' suffix, which indicates that special conditions for safe use apply. Those installing or inspecting this equipment must have access to the certificates.
- 10) If the equipment is likely to come into contact with aggressive substances, then it is the responsibility of the user to take suitable precautions that prevent it from being adversely affected, thus ensuring that the type of protection is not compromised.
 - Aggressive substances: for example, acidic liquids or gases that may attack metals, or solvents that may affect polymeric materials.
 - Suitable precautions: for example, establishing from the material's data sheet that it is resistant to specific chemicals.

SPECIAL CONDITIONS FOR SAFE USE

The 'X' suffix to the certificate number relates to the following special condition(s) for safe use:

- Unused cable entries shall be fitted with blanking elements that can only be removed with the aid of a tool.
- Any glands, conduit entry devices or blanking elements fitted to the equipment shall be suitable for use in the presence of combustible dusts and certified as such by a notified body; the installation of these devices shall not compromise the IP6X rating of the equipment enclosure.
- For applications that use the purge facility, the user shall provide a means to ensure that combustible dust from the hazardous area cannot enter the purge supply in such a way as to compromise the area classification.

Quick Start via local operation

SITRANS LR260 carries out its level measurement tasks according to settings made via parameters. The settings can be modified locally via the Local User Interface (LUI) which consists of an LCD display and a handheld programmer.

A Quick Start Wizard provides an easy step-by-step guide to help you configure the device for a simple application. There are two ways to access the wizard:

- 7-step *Quick Start Wizard via the handheld programmer* on page 33
- 4-step *Quick Start Wizard via SIMATIC PDM* on page 39

For more complex setups, see *Appendix E: Application Example* on page 111, and for the complete range of parameters see *Parameter Reference* on page 51.

Activating SITRANS LR260

Power up the instrument. SITRANS LR260 automatically starts up in Measurement mode.

Press **Mode**  to toggle between Measurement and Program Mode.

The LCD Display

Measurement mode

Normal operation

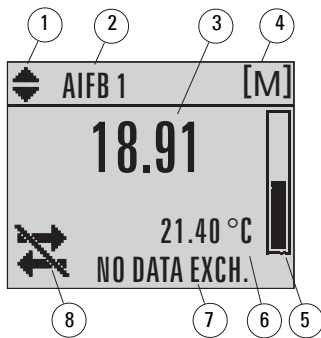

- 1 – toggle indicator for AIFB 1 or AIFB 2
- 2 – identifies which AIFB is source of displayed value
- 3 – measured value (level, space, or distance)
- 4 – units
- 5 – bar graph indicates level
- 6 – secondary region indicates on request¹ electronics temperature, echo confidence, or distance
- 7 – text area displays status messages
- 8 – device status indicator

Fault present



S: 0 LOE

- 7 – text area displays a fault code and an error message
- 8 – service required icon appears

¹⁾ In response to a key press request. For details, see *Key functions in Measurement mode* on page 29.

PROGRAM mode display

Navigation view

- A visible menu bar indicates the menu list is too long to display all items.
- A band halfway down the menu bar indicates the current item is halfway down the list.
- The depth and relative position of the item band on the menu bar indicates the length of the menu list, and approximate position of the current item in the list.
- A deeper band indicates fewer items.

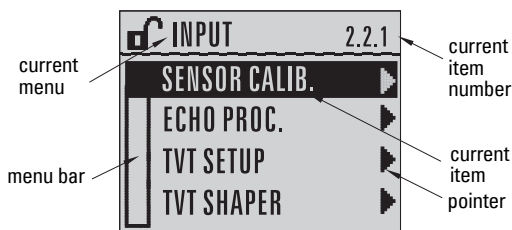

Parameter view

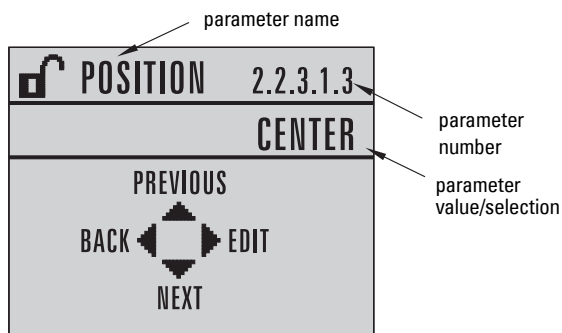

Edit view

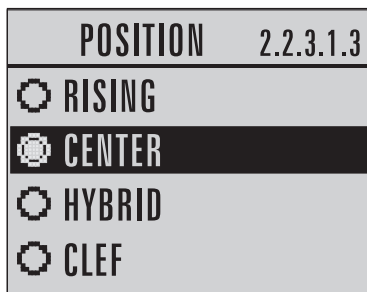

Handheld Programmer

(Part No. 7ML5830-2AJ)

The programmer is ordered separately.



Key functions in Measurement mode

Key	Function	Result
	Updates internal enclosure temperature reading.	New value is displayed in LCD secondary region.
	Updates echo confidence value.	New value is displayed in LCD secondary region.
	Updates distance measurement.	New value is displayed in LCD secondary region.
	Mode opens PROGRAM mode.	Opens the menu level last displayed in this power cycle, unless power has been cycled since exiting PROGRAM mode or more than 30 minutes have elapsed since PROGRAM mode was used. Then top level menu will be displayed.
	RIGHT arrow opens PROGRAM mode.	Opens the top level menu.
	UP or DOWN arrow toggles between AIFB 1 and AIFB 2.	LCD displays measured value in configured Analog Input Function Block outputs.

Programming SITRANS LR260

Note: While the device is in PROGRAM mode the output remains active and continues to respond to changes in the device.

Change parameter settings and set operating conditions to suit your specific application.

- See *Operating via SIMATIC PDM* on page 37 for remote operation.

Programming via the handheld programmer

Notes:

- The Quick Start wizard settings are inter-related and changes apply only after you click on **Apply** at the end of the Quick Start steps.
- Do not use the Quick Start wizard to modify individual parameter: see instead *Parameter Reference* on page 51.
- SITRANS LR260 automatically returns to Measurement mode after a period of inactivity in PROGRAM mode (between 15 seconds and 10 minutes, depending on the menu level).

Parameter menus

Parameters are identified by name and organized into function groups, then arranged in a 5-level menu structure (see *LCD menu structure* on page 141).

Note:

In Navigation mode, **ARROW keys** move to the next menu item in the direction of the arrow.

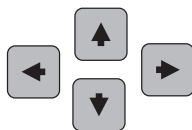



1. QUICK START

2. SETUP

- 2.1. DEVICE
- 2.2. INPUT
 - 2.2.1. SENSOR CALIB.
 - 2.2.8. ECHO PROC.





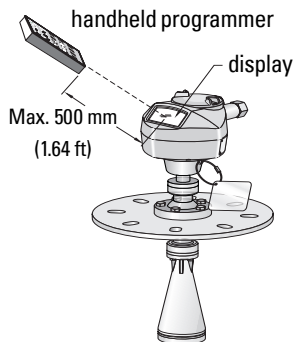

- For the complete list of parameters with instructions, see *Parameter Reference* on page 51.

1. Enter PROGRAM mode

- Point the programmer at the display (from a maximum distance of 500 mm [1.64 ft]).
- **RIGHT arrow**  activates PROGRAM mode and opens menu level 1.
- **Mode**  opens the menu level last displayed in PROGRAM mode within the last 30 minutes, or menu level 1 if power has been cycled since then.





2. Navigating: key functions in Navigation mode

Key	Name	Menu level	Function
 	UP or DOWN arrow	menu or parameter	Scroll to previous or next menu or parameter.
	RIGHT arrow	menu	Go to first parameter in the selected menu, or open next menu.
		parameter	Open Edit mode.
	LEFT arrow	menu or parameter	Open parent menu.
	Mode	menu or parameter	Change to MEASUREMENT mode.
	Home	menu or parameter	Open top level menu: menu 1.



3. Editing in PROGRAM mode

Selecting a listed option

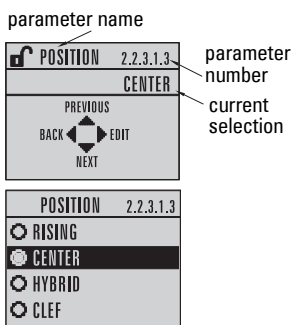
- Navigate to the desired parameter.
- Press **RIGHT arrow**  to open parameter view.
- Press **RIGHT arrow**  again to open **Edit** mode. The current selection is highlighted. Scroll to a new selection.
- Press **RIGHT arrow**  to accept it. The LCD returns to parameter view and displays the new selection.







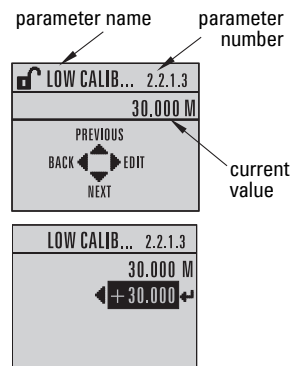

Changing a numeric value

- Navigate to the desired parameter.
- Press **RIGHT arrow**  to open parameter view. The current value is displayed.
- Press **RIGHT arrow**  again to open **Edit** mode. The current value is highlighted.
- Key in a new value.
- Press **RIGHT arrow**  to accept it. The LCD returns to parameter view and displays the new selection.



Key functions in Edit mode







Key	Name	Function	
	UP or DOWN arrow	Selecting options	Scrolls to item.
		Alpha-numeric editing	<ul style="list-style-type: none"> - Increments or decrements digits - Toggles plus and minus sign
	RIGHT arrow	Selecting options	<ul style="list-style-type: none"> - Accepts the data (writes the parameter) - Changes from Edit to Navigation mode
		Numeric editing	<ul style="list-style-type: none"> - Moves cursor one space to the right - or with cursor on Enter sign, accepts the data and changes from Edit to Navigation mode
	LEFT arrow	Selecting options	<ul style="list-style-type: none"> - Cancels Edit mode without changing the parameter
		Numeric editing	<ul style="list-style-type: none"> - Moves cursor to plus/minus sign if this is the first key pressed - or moves cursor one space to the left. - or with cursor on Cancel arrow, cancels the entry
	Clear	Numeric editing	Erases the display.
	Decimal point	Numeric editing	Enters a decimal point.
	Plus or minus sign	Numeric editing	Changes the sign of the entered value.
	Numeral	Numeric editing	Enters the corresponding character.

Quick Start Wizard via the handheld programmer

Notes:

- The Quick Start Wizard is a complete package and the settings are inter-related.
- Do not use the Quick Start wizard to modify individual parameters: see instead *Parameter Reference* on page 51 (perform customization for your application after the quick start has been completed).

1. Quick Start

- Point the programmer at the display (from a maximum distance of 500 mm [1.64 ft]), then press **RIGHT arrow**  to activate PROGRAM mode and open menu level 1.
- Press **RIGHT arrow**  twice to navigate to menu item 1.1 and open parameter view.
- Press **RIGHT arrow**  to open **Edit mode** or **DOWN arrow**  to accept default values and move directly to the next item.
- To change a setting, scroll to the desired item or key in a new value.
- After modifying a value, press **RIGHT arrow**  to accept it and press **DOWN arrow**  to move to the next item.

1.1. Application Type

Options	STEEL	Silo construction
	CONCRETE	
	Default: STEEL	

1.2. Response Rate

Sets the reaction speed of the device to measurement changes in the target range.

Options	SLOW	0.1 m/minute
	MED	1.0 m/minute
	FAST	10.0 m/minute
	Default: FAST	

Use a setting just faster than the maximum filling or emptying rate (whichever is greater).

1.3. Units

Select the units for the Quick Start variables (high and low calibration point, and level, distance, or space)

Options	M, CM, MM, FT, IN
	Default: M

1.4. Operation

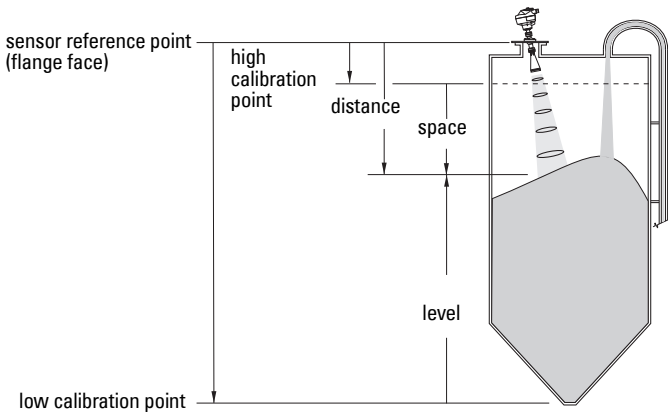

Operation types	NO SERVICE	SITRANS LR260 stops updating measurements. Last valid measurement is displayed.
	LEVEL	Distance to material surface referenced from Low Calibration Point (process empty level).
	SPACE	Distance to material surface referenced from High Calibration Point (process full level).
	DISTANCE	Distance to material surface referenced from Sensor Reference Point.
	Default: DISTANCE	

1.5. Low Calibration Point

Distance from Sensor Reference to Low Calibration Point: usually process empty level. (See 1.4. Operation for an illustration.)

Values	Range: 0.0000 to 30.000 m Default: horn type dependent
---------------	---

1.6. High Calibration Point

Distance from Sensor Reference to High Calibration Point: usually process full level. (See 1.4. Operation for an illustration.)

Values	Range: 0.0000 to 30.000 m Default: 0.0 m
---------------	---

1.7. Apply? (Apply changes)

In order to save the Quick Start settings it is necessary to select Yes to apply changes.

Options	YES, NO, DONE (Display shows DONE when Quick Start is successfully completed)
----------------	---

Press **Mode**  to return to Measurement mode. SITRANS LR260 is now ready to operate.

¹⁾ The point from which High and Low Calibration points are referenced: see *Dimensions* on page 9.

Requesting an Echo Profile



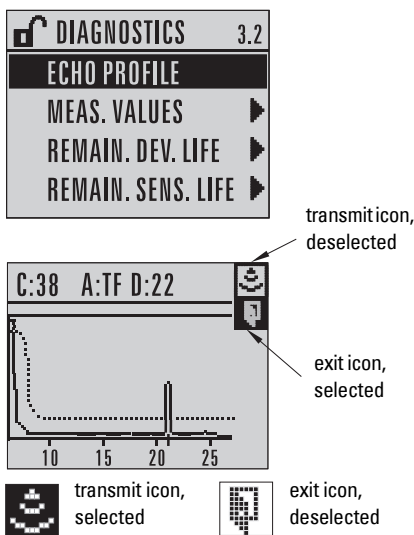

- In PROGRAM mode, navigate to: **LEVEL METER > DIAGNOSTICS > ECHO PROFILE (3.2)**
- Press **RIGHT arrow** to request a profile.
- In the Profile screen, press **UP arrow** to select the **Transmit** icon, and **Right ARROW** to update the profile.
- Press **DOWN arrow** to select the **Exit** icon, then **Right ARROW** to return to previous menu.



Device Address

The unique address of the device on the network (also called PROFIBUS address).

Values	0 - 126. Default: 126
--------	-----------------------

- In PROGRAM mode, navigate to: **Level Meter > Communication > Device Address.**
- Press **RIGHT arrow** , **RIGHT arrow** , to open parameter view and enable Edit mode.
- If required, key in a new value and press **RIGHT arrow**  to accept it. The LCD displays the new value.
- Press **Mode**  to return to Measurement mode.

Auto False Echo Suppression

If SITRANS LR260 displays a false high level, or the reading is fluctuating between the correct level and a false high level, you can use the Auto False Echo Suppression parameters to prevent false echo detection. See **TVT (Auto False Echo Suppression) setup (2.2.4.)** on page 61 for instructions.

Level application example

The application is a steel silo containing flour that takes an average of 3 hours to fill and 3 weeks to empty.

Using the Easy Aimer, the LR260 is oriented so that the emission cone is approximately perpendicular to the material surface.

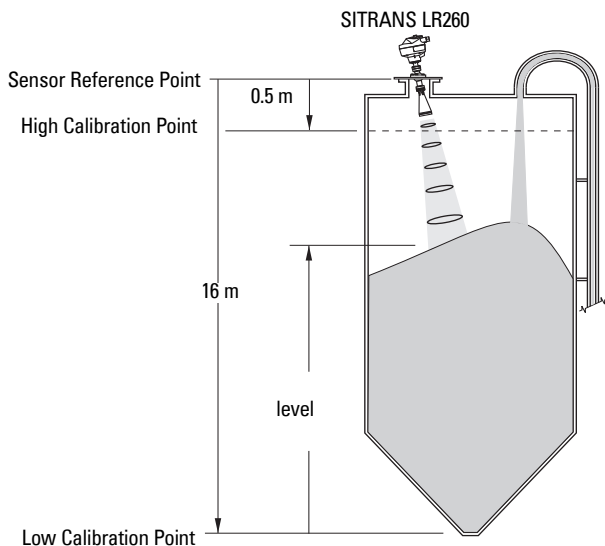

Quick Start Setting	Description	
APPLICATION	STEEL	
RESPONSE RATE	SLOW	Response rate = 0.1 m/minute.
UNITS	m	
OPERATION	LEVEL	Material level referenced from Low Calibration Point.
LOW CALIBRATION POINT	16	Process empty level.
HIGH CALIBRATION POINT	0.5	Process full level.
APPLY? (CHANGES)	YES	Save new settings.

$$\begin{aligned} \text{Fill rate} &= 0.09 \text{ m/minute (Low Cal Pt. minus High Cal Pt.) / fastest fill/empty time} \\ &= (16 \text{ m} - 0.5 \text{ m}) / 180 \text{ min.} \\ &= 15.5 \text{ m} / 180 \text{ min.} = 0.09 \text{ m/min.} \end{aligned}$$

Operating via SIMATIC PDM

Note: For a complete list of parameters with instructions, see *Parameter Reference* starting on page 51.

SIMATIC PDM is a software package used to commission and maintain SITRANS LR260 and other process devices. Please consult the operating instructions or online help for details on using SIMATIC PDM. (You can find more information at www.fielddevices.com: go to **Products and Solutions > Products and Systems > Communications and Software > Process Device Manager**.)

Functions in SIMATIC PDM

Note:

- While the device is in PROGRAM mode, the output remains active and continues to respond to changes in the device.
- Do not use the handheld programmer at the same time as SIMATIC PDM, or erratic operation may result.

SIMATIC PDM monitors the process values, alarms and status signals of the device. It allows you to display, compare, adjust, verify, and simulate process device data.

For information on adjusting parameter values and viewing the results, see *Changing parameter settings using SIMATIC PDM* on page 42 and *Parameters accessed via pull-down menus* on page 42.

Features of SIMATIC PDM Rev. 6.0, SP3 (or higher)

The graphic interface in SITRANS LR260 makes monitoring and adjustments easy:

- The graphic Quick Start Wizard provides an easy 4-step guide to help you configure the device for a simple application. See *Quick Start Wizard via SIMATIC PDM* on page 39 for instructions.
- See *Display* on page 43 to monitor process variables.
- See *Echo profile* on page 43 for easy echo profile comparison.
- See *Trend* on page 46 for Level trend monitoring.
- See *Auto False Echo Suppression* on page 44 and *TVT Shaper* on page 45 on adjusting the TVT curve to avoid false echoes.
- See *Simulation* on page 46 for simulating process values during commissioning/maintenance.









Electronic Device Description (EDD)

Note: SITRANS LR260 requires the EDD for SIMATIC PDM version 6.0 with SP3 or higher.

You can locate the EDD in Device Catalog, under **Sensors/Level/Echo/Siemens Milltronics/SITRANS LR260**. Check the product page of our website at: www.siemens.com/LR260, under **Downloads**, to make sure you have the latest version of SIMATIC PDM, the most recent Service Pack (SP) and the most recent hot fix (HF). If you need to install a new EDD see *Configuring a new device* on page 38

Configuring a new device

Note: Clicking on **Cancel** during an upload from device to SIMATIC PDM will result in some parameters being updated.

1. Check that you have the most recent EDD that applies to your device version, and if necessary download it from the product page listed above. Save the files to your computer, and extract the zipped file to an easily accessed location. Launch **SIMATIC PDM – Manage Device Catalog**, browse to the unzipped EDD file and select it.
2. Set Address via handheld programmer (default for PROFIBUS PA is 126). (See *Device Address* on page 88 to use SIMATIC PDM.)
 - Point the handheld programmer at the display then press **Mode**  to activate **PROGRAM** mode, menu item **1.0**.
 - Press **DOWN arrow** , **RIGHT arrow** , **RIGHT arrow**  to navigate to *5.1.Device Address*.
 - Press **RIGHT arrow**  to open Edit mode: the PROGRAM icon  will flash.
 - If required, key in a new value and press **RIGHT arrow**  to accept it. The LCD displays the new value and the PROGRAM icon disappears.
 - Press **Mode**  to return to Measurement mode.
3. Launch SIMATIC Manager and create a new project for LR260. Application Guides for setting up PROFIBUS PA devices with SIMATIC PDM can be downloaded from the product page of our website at: www.siemens.com/LR260.
4. Open the menu **Device – Device Reset** and click on **Factory Defaults**.
5. After the reset is complete click on **Close**, then upload parameters to the PC/PG.
6. Calibrate the device.

Quick Start Wizard via SIMATIC PDM

The graphic Quick Start Wizard provides an easy 4-step guide to help you configure the device for a simple application.

Please consult the operating instructions or online help for details on using SIMATIC PDM. (Application Guides for setting up Siemens PROFIBUS PA devices with SIMATIC PDM are available on our website: www.siemens.com/processautomation.)

1. If you have not already done so, check that you have the most up-to-date Electronic Device Description (EDD) for your instrument. (See *Configuring a new device* on page 38.)
2. Launch SIMATIC Manager and create a new project for LR260. Application Guides for setting up PROFIBUS PA devices with SIMATIC PDM can be downloaded from the product page of our website at: www.siemens.com/LR260.
3. Upload parameters to the PC/PG.
4. Configure the device via the Quick Start Wizard.

Quick Start Wizard steps

Notes:

- The Quick Start wizard settings are inter-related and changes apply only after you click on **Transfer** at the end of step 4.
- Do not use the Quick Start Wizard to modify individual parameters: see instead *Parameter Reference* on page 51 (perform customization only after the Quick Start has been completed).
- Click on **BACK** to return and revise setting or **Cancel** to exit the Quick Start.

Launch SIMATIC PDM, open the menu **Device – Quick Start**, and follow steps 1 to 4.

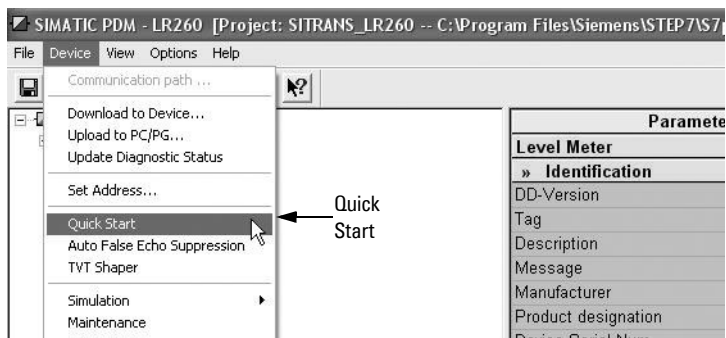

Step 1 – Identification

Note: The layout of the dialog boxes shown may vary according to the resolution setting for your computer monitor.

Click on **NEXT** to accept the default values. (Description, Message, and Installation Date fields can be left blank.)

Quick Start - Step 1 - LR260

Identification

Step 1 → Step 2 → Step 3 → Step 4

Identification → Application Type → Range Setup → Summary

SIEMENS

Identify the device:

Tag:

Description:

Message:

Installation Date:

Order No.:

Select the language for local user interface:

Language:

Load from Device NEXT > Cancel Help

Step 2 – Application Type

Select the application type and the operation, then click on **NEXT**.

Quick Start - Step 2 - LR260

Application Type

Step 1 → Step 2 → Step 3 → Step 4

Identification → Application Type → Range Setup → Summary

SIEMENS

Select the Application Type:

Application Type:

Select the Operation:

Operation:

< BACK NEXT > Cancel Help

Step 3 – Range Setup

Set the parameters, and click on **NEXT**.

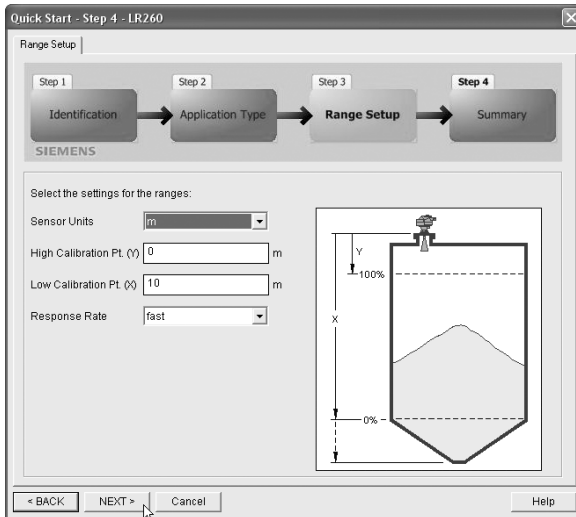

Step 4 – Summary

Check parameter settings, and click on **BACK** to return and revise values, or **TRANSFER** to transfer values to the device.

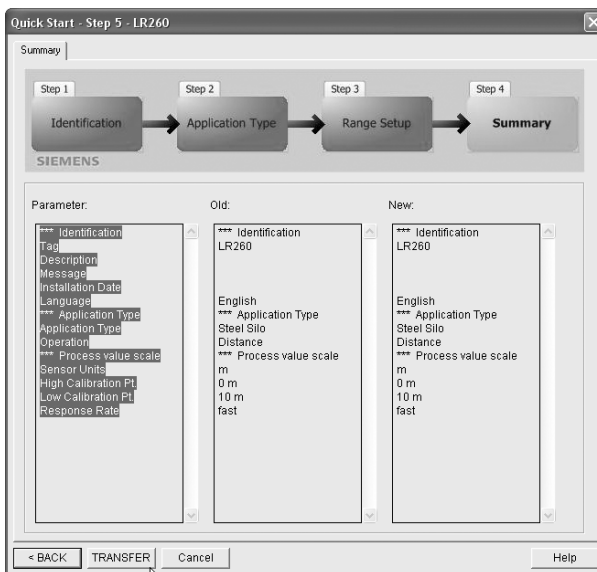

The message **Quick Start was successful** will appear. Click on **OK**, then click on **OK** again to synchronize with the device.

Changing parameter settings using SIMATIC PDM

Notes:

- For a complete list of parameters, see *Parameter Reference* on page 51.
- Clicking on **Cancel** during an upload from device to SIMATIC PDM will result in some parameters being updated.

1. Launch SIMATIC PDM, connect to SITRANS LR260, and upload data from the device.
2. Adjust parameter values in the parameter value field then press **Enter**. The status fields read **Changed**.
3. Open the Device menu, click on **Download to Device**, then use **File – Save**, to save parameter settings. The status fields are cleared.

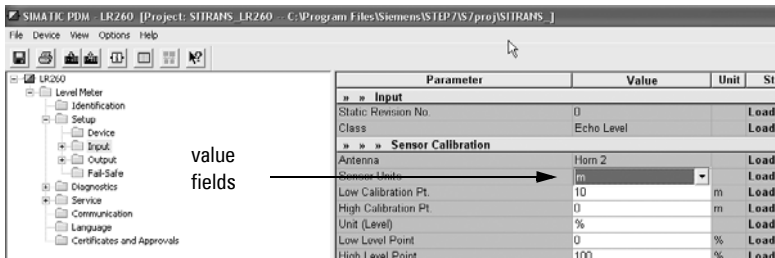

Parameters accessed via pull-down menus

You have access to a number of functions via pull-down menus from the menu bar, under **Device** or **View**.

For a complete list, see *Pull-down menus via SIMATIC PDM* on page 51.

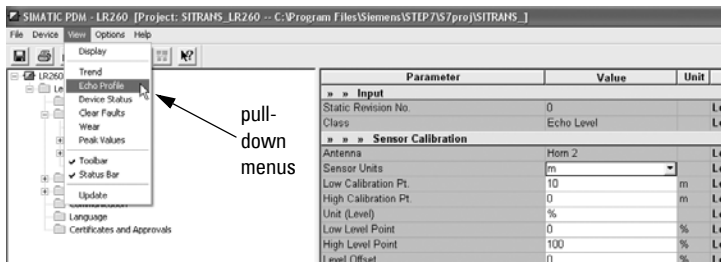

Display

To compare outputs in real time, open the menu **View – Display**.

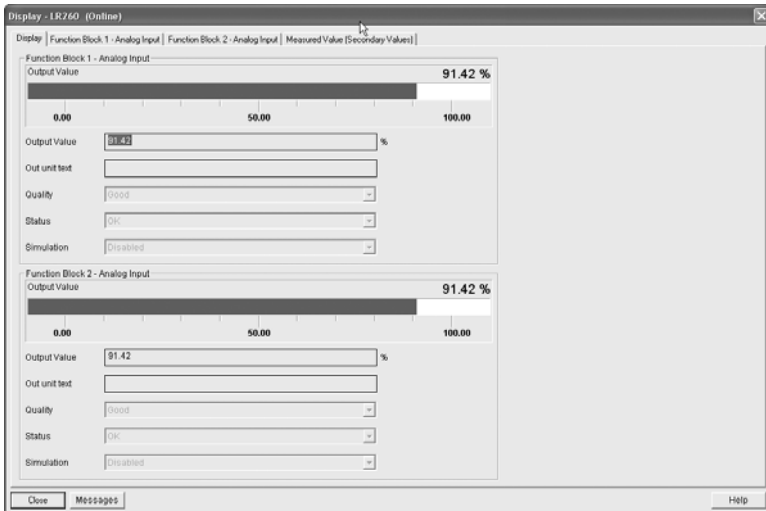

Echo profile

Notes:

- Record the default X-Scale (horizontal axis) and Data Scale (vertical axis) values so that you can restore the default view by resetting to these values.
- You can save a profile or delete a saved profile.
- After saving a profile open menu **View – Show echo profile**.

Open the menu **View - Echo Profile**.

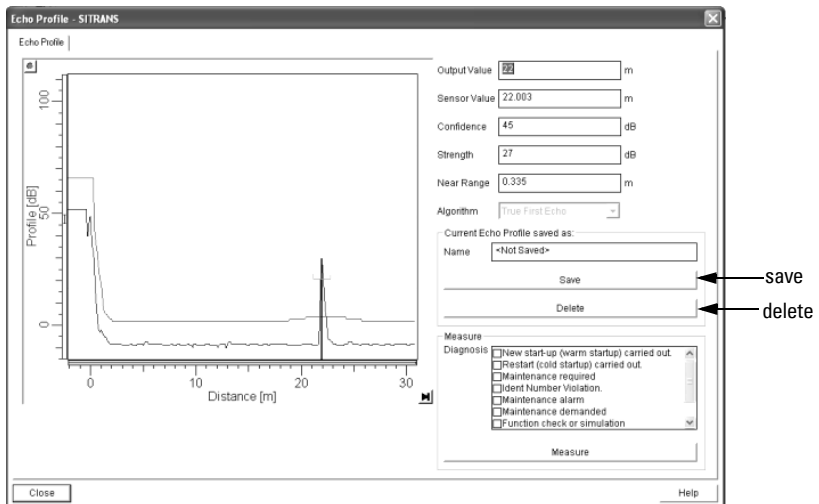

Auto False Echo Suppression

Notes:

- If possible, adjust Auto False Echo Suppression parameters with an empty or almost empty vessel. There should be a minimum distance of 2 meters from the radar instrument to the material.
- Set Auto False Echo Suppression and Auto Suppression Range during installation, if possible.
- Before adjusting these parameters, rotate the instrument for best signal (minimum false-echo amplitude).

SITRANS LR260 first learns the echo profile. Then the learned profile, or part of it, is used to screen out false echoes. (See *Auto False Echo Suppression* on page 105 for a more detailed explanation.)

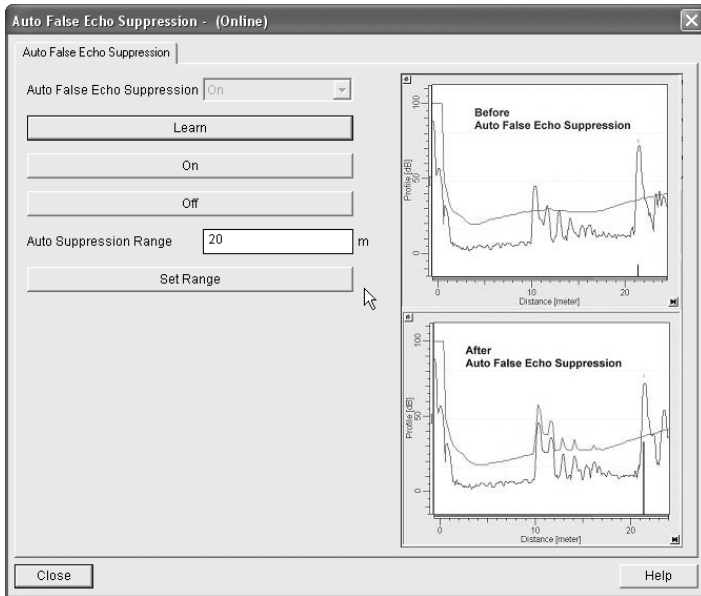

1. Determine **Auto Suppression Range** (the distance within which the learned TVT will replace the default TVT). Measure the actual distance from the antenna reference point to the material surface using a rope or tape measure, and make allowances for the actual location of the LR260. Subtract 2 m (6.56 ft) from this distance, and use the resulting value.
2. Open the menu **Device – Auto False Echo Suppression**.
3. Enter the value for **Auto Suppression Range** and click on **Set Range**.
4. Click on **Learn**. While the new curve is being learned, all buttons are inaccessible. Unless calculation is instantaneous, buttons will disappear until it is complete.
5. When the buttons are visible, click on **Close**. Auto TVT is now on, and the learned TVT curve will be used.
6. To turn Auto False Echo Suppression off or on, re-open menu **Device – Auto False Echo Suppression** and click on **Off** or **On**.

TVT Shaper

Note: Record the default X-Scale (horizontal axis) and Data Scale (vertical axis) values so that you can restore the default view by resetting to these values.

This feature allows you to manually adjust the TVT curve to avoid false echoes caused by obstructions. (For an explanation see *Auto False Echo Suppression* on page 105.)

Open the menu **Device – TVT Shaper**

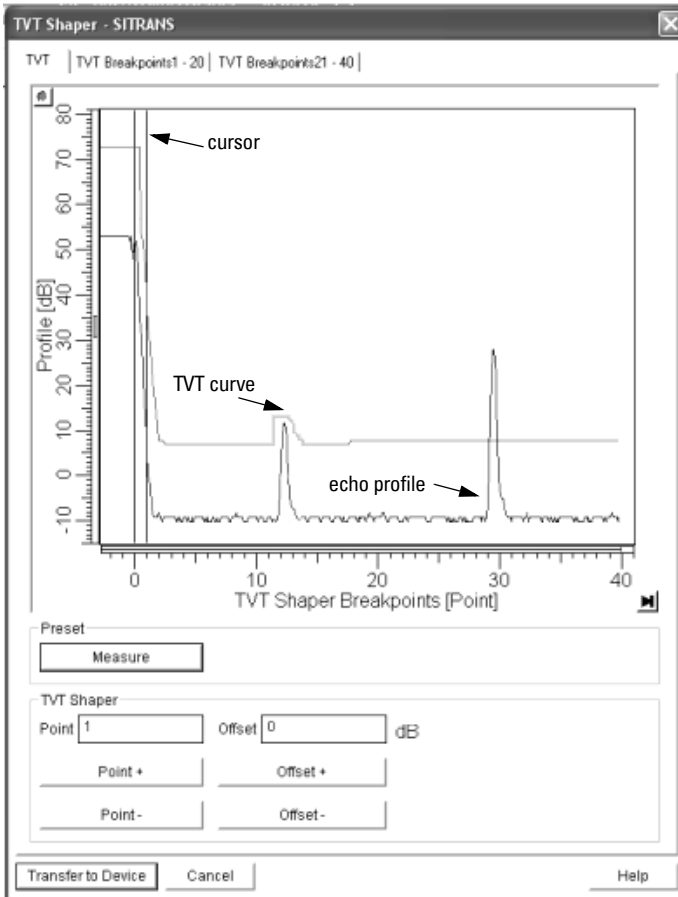

- Press **Measure** to refresh the echo profile and load the current TVT curve from the device.
- Change the position of the cursor on the TVT curve using the **Point+** and **Point-** buttons: raise and lower the curve using **Offset+** and **Offset-** (entered in dB).
- Alternatively, enter values for **Point** and **Offset** directly into the dialog boxes.
- If desired, click on the **TVT breakpoints** tabs to see settings.
- Then press **Transfer to Device**.

Trend

Note: Record the default X-Scale (horizontal axis) and Data Scale (vertical axis) values so that you can restore the default view by resetting to these values.

Open the menu **View – Trend**

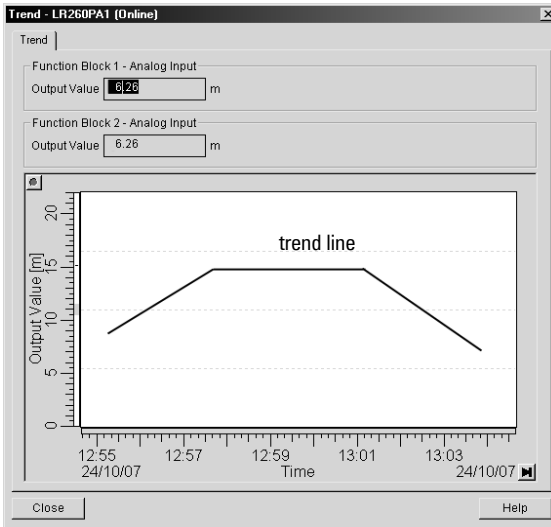

Simulation

Note: The Simulation parameter influences output to the control system.

Simulate Analog Input to AIFB1 or AIFB2

Allows you to input a simulated value in order to test the functioning of the Analog Input Function Blocks.

1. Open the menu **Device – Simulation**, and select the desired function block.
2. Enable simulation. Click on **Transfer**.
3. Enter a value, quality, status, and click on **Transfer**. The LCD displays the substitute value.
4. After simulation is complete, disable simulation.

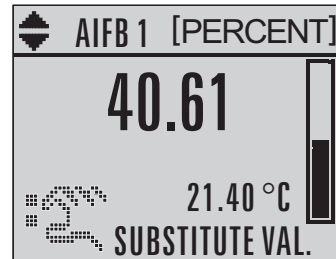

Simulate Input

Allows you to simulate the sensor value which is input to the Level Transducer Block. This tests everything between the Level Transducer Block and Output.

1. Open the menu **Device – Simulation**, and select **Simulation (Input)**.
2. To enable simulation select **Fixed** or **Ramp**.
If you select Ramp, enter the Ramp start and end, step length and number of steps. Click on **Transfer**.
If you select Fixed, enter the simulated value and click on **Transfer**.
3. After simulation is complete, disable simulation.

Device Reset

Reset options	Result
Factory Defaults	Resets all parameters excluding Device Address , Tag, Description, Message, and Installation Date to the manufacturer's default settings.
Standard Defaults	Resets all parameters excluding Device Address, Description, Message, and Installation Date to the PROFIBUS default settings
Informational	Resets parameter Tag
Functional	Resets parameters that control device behavior, such as Low Calibration Pt.
Warm Start	Has the same effect as recycling power to the device
Reset Device Address to 126	<ul style="list-style-type: none">• Resets the PROFIBUS device address to 126• If the address lock was on, will disable the lock.

To perform a reset to Factory Defaults:

1. Open the menu **Device – Device Reset**, and click on **Factory Defaults**.
2. After the reset is complete, click on **Close**, then upload parameters to the PC/PG.
(If you are performing a reset after replacing the device with a different instrument, do not upload parameters to the PC/PG.)

Write Locking

If Write Locking is enabled, the data can be viewed but not modified. See *Write Locking (6.1.)* on page 88 for more details.

To enable/disable Write Locking:

1. Open the menu **Device – Write Locking** and select **On** or **Off**.
2. Click on **Transfer**.

Maintenance

You can set schedules for:

- maintenance of the device based on its projected lifetime
- maintenance of the sensor based on its projected lifetime
- service
- calibration

To set Device/Sensor Maintenance schedules:

1. Open the menu **Device – Maintenance**, and click on the **Remaining Device/Sensor Lifetime** tab.
2. If desired, activate alerts for either or both of **Maintenance Required/Maintenance Demanded**.
3. Modify desired values, and click on **Write**.
4. Click on **Read**, to see the effects of your modification.
5. Click on **Snooze** to add a year to the Total Expected Device Life.

To set Service/Calibration schedules:

1. Open the menu **Device – Maintenance**, and click on the **Service/Calibration Interval** tab.
2. If desired, activate alerts.
3. Modify desired values, and click on **Write**.
4. Click on **Read**, to see the effects of your modification.
5. Click on **Service Performed** to reset the schedule.

Maintenance - LR260 (Changed)

Remaining Device Lifetime | Remaining Sensor Lifetime | **Service Interval** | Calibration Interval

Time Elapsed From Last Service: 0.006 years

Remaining Lifetime: 0.994 years

Maintenance Required Limit: 0.164 years

Maintenance Demanded Limit: 0.019 years

Maintenance Alert Activation: Timer On with limit 1 checked

Total Service Interval: 1.000 years

Units: years

Read

Write

Service Performed

OK Cancel Help

Device Status

Open the menu **View – Device Status** and click on the appropriate tab to monitor maintenance and diagnostics conditions.

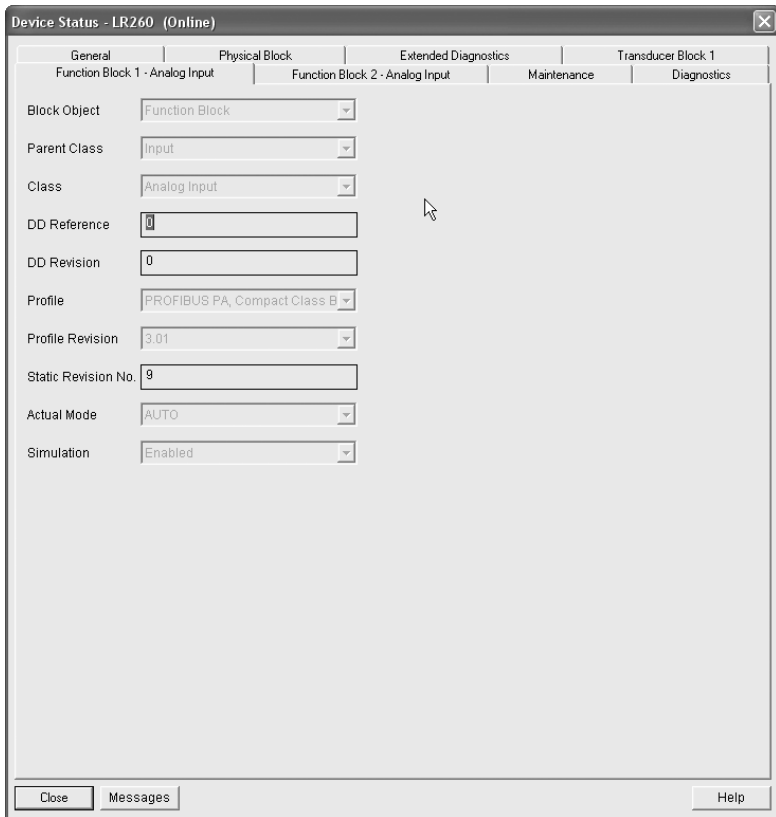

The screenshot shows a software window titled "Device Status - LR260 (Online)". The window has a tabbed interface with the following tabs: "General", "Physical Block", "Extended Diagnostics", and "Transducer Block 1". Under "General", there are sub-tabs for "Function Block 1 - Analog Input", "Function Block 2 - Analog Input", "Maintenance", and "Diagnostics". The "Function Block 1 - Analog Input" sub-tab is active. The main area contains the following fields:

Block Object	Function Block
Parent Class	Input
Class	Analog Input
DD Reference	0
DD Revision	0
Profile	PROFIBUS PA, Compact Class B
Profile Revision	3.01
Static Revision No.	9
Actual Mode	AUTO
Simulation	Enabled

At the bottom of the window, there are buttons for "Close", "Messages", and "Help".

Wear

Open the menu **View – Wear** to view:

- Powered Hours
- Power-on Resets

Peak Values

Open the menu **View – Peak Values** to view:

- Sensor minimum and maximum Measured Values
- Minimum and maximum Output Values for AIFB1 and AIFB2
- Minimum and maximum Internal Temperatures

Notes

Parameter Reference

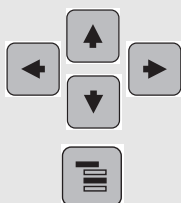

Notes:

- See *Programming via the handheld programmer* on page 30 for detailed instructions.
- In Navigation mode, **ARROW keys** navigate the menu in the direction of the arrow.
- Press **RIGHT Arrow** to open **Edit Mode**, or to save a modification.
- **Mode** key toggles between **PROGRAM** and **Measurement Modes**.

Parameters are identified by name and organized into function groups. Menus arranged on up to five levels give access to associated features and options. (See *LCD menu structure* on page 141 for a chart.)

Parameters accessible via the handheld programmer are preceded by a number. Parameters not preceded by a number are accessible only via SIMATIC PDM.

Some parameters are accessible in SIMATIC PDM via pull-down menus. Where those parameters can also be accessed via the handheld programmer, they are found in the numbered list, and directions for SIMATIC PDM are given below the individual parameter. Page references for further information on using these features via SIMATIC PDM can be found in the table below.

Pull-down menus via SIMATIC PDM

Device menus	page	View menus	page
Communication path	-	Display	-
		Trend	46
		Echo profile	43
Download to device	-	Show Echo profile	-
Upload to PC/PG	-	Device Status	49
Update diagnostic status	-	Clear Faults	-
		Wear	49
		Peak Values	49
Set Address		Tool bar	
		Status bar	
Quick Start	39		
Auto False Echo Suppression	44		
TVT Shaper	45		
Simulation	46	Update	
Maintenance	48		
Device Reset	47		
Write Locking	47		

Quick Start Wizard

The Quick Start wizard groups together all the settings you need to configure for a simple application. You can access it either via SIMATIC PDM, or via the handheld programmer.

- The Quick Start wizard is a complete package and settings are inter-related.
- Do not use the Quick Start wizard to modify individual parameters.
- Perform customization of the device only after the Quick Start is completed.

1. Quick Start

1.1. Application Type

Options	STEEL	Silo construction
	CONCRETE	
	Default: STEEL	

1.2. Response Rate

Sets the reaction speed of the device to measurement changes in the target range.

Options	SLOW	0.1 m/minute
	MED	1.0 m/minute
	FAST	10.0m/minute
	Default: FAST	

Use a setting just faster than the maximum filling or emptying rate (whichever is greater). Slower settings provide higher accuracy, faster settings allow for more level fluctuation.

1.3. Units

Select the units for the Quick Start variables (high and low calibration point, and level, distance, or space).

Options	M, CM, MM, FT, IN Default: M
----------------	---------------------------------

1.4. Operation

Options	NO SERVICE	SITRANS LR260 stops updating measurements. Last valid measurement value is displayed.
	LEVEL	Distance to material surface referenced from Low Calibration Point (process empty level).
	SPACE	Distance to material surface referenced from High Calibration Point (process full level).
	DISTANCE	Distance to material surface referenced from Sensor Reference Point.
	Default: DISTANCE	

Operation types

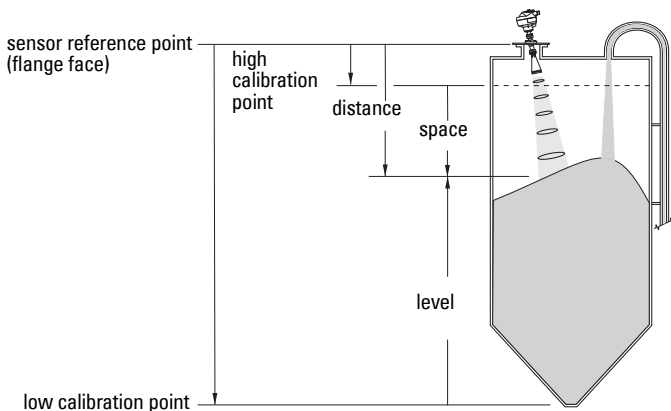

1.5. Low Calibration Point (LOW CALIB. PT.)

Distance from Sensor Reference to Low Calibration Point: usually process empty level.

Values	Range: 0.000 to 30.000 m Default: horn type dependent
---------------	--

1.6. High Calibration Point (HIGH CALIB. PT.)

Distance from Sensor Reference to High Calibration Point: usually process full level.

Values	Range: 0.000 to 30.000 m Default: 0.0 m
---------------	--

1.7. Apply? (Apply changes)

*In order to save the Quick Start settings it is necessary to select **Yes** and apply changes.*

Options	NO, YES, DONE
----------------	---------------

- Display shows **DONE** when Quick Start is successfully completed.
- Press **Mode**  to return to Measurement mode.

2. Setup

Notes:

- See *Programming via the handheld programmer* on page 30 or *Operating via SIMATIC PDM* on page 37 for instructions.
- Default settings in the parameter tables are indicated with an asterisk (*) unless explicitly stated.
- Values shown in the following tables can be entered via the handheld programmer.

2.1. Device

2.1.1. Tag

Text that can be used in any way. A recommended use is as a unique label for a field device in a plant. Limited to 32 ASCII characters. Read only on device, Read/Write using SIMATIC PDM.

2.1.2. Description

Text that can be used in any way. Limited to 32 ASCII characters. No specific recommended use. Read only on device, Read/Write using SIMATIC PDM.

2.1.3. Message

Text that can be used in any way. Limited to 32 ASCII characters. No specific recommended use. Read only on device, Read/Write using SIMATIC PDM.

2.1.4. Firmware Revision (FIRMWARE REV.)

Corresponds to the software or firmware that is embedded in the Field Device. Read only.

2.1.5. Loader Revision (LOADER REV.)

Corresponds to the software used to update the Field Device. Read only.

2.1.6. Hardware Revision (HARDWARE REV.)

Corresponds to the electronics hardware of the Field Device. Read only.

2.2. Input

2.2.1. Sensor Calibration (SENSOR CALIB.)

2.2.1.1. Antenna

Displays antenna type.

Values (view only)	No Horn, Horn 2, Horn 3, Horn 4
	Default is set by factory depending on horn size.

2.2.1.2. Sensor Units

Sets engineering units to be used by the sensor for measurement.

Values	M, CM, MM, FT, IN
	Default: m

2.2.1.3. Low Calibration Pt. (LOW CALIB. PT.)

Distance from Sensor Reference to Low Calibration Point (corresponding to Low Level Point). Unit is defined in Sensor units.¹⁾

Values	Range: 0 to 30 m. Default: 30.000 m (dependent on horn type)
---------------	--

2.2.1.4. High Calibration Pt. (HIGH CALIB. PT.)

Distance from Sensor Reference to High Calibration Point (corresponding to High Level Point). Unit is defined in Sensor units.

Values	Range: 0 to 30 m. Default: 0.000 m
---------------	------------------------------------

2.2.1.5. Limit Sensor Value

When ON, limits sensor value to the range between Low Calibration Point and High Calibration Point.

Options	ON, OFF
	Default: ON

2.2.1.6. Unit (Level)

Select engineering units for Level.

Options	M, CM, MM, FT, IN, Percent
	Default: Percent

2.2.1.7. Low Level Point

The level when the material is at Low Calibration Point. The unit is defined in Level units.

Values	Default: 0%
---------------	-------------

2.2.1.8. High Level Point

The level when the material is at High Calibration Point. The unit is defined in Level units.

Values	Default: 100%
---------------	---------------

2.2.1.9. Level Offset

A constant offset that can be added to Level. The unit is defined in Level units.

Values	Default: 0%
---------------	-------------

¹⁾ The point from which **level** measurement is referenced (see *Dimensions* on page 9).

2.2.1.10. Sensor Offset

A constant offset that can be added to the sensor value to compensate if the sensor has been changed. The units is defined in Sensor Units. (See Transducer block function groups on page 114 and How the LTB works on page 114 for more detail.)

Values	Range: - 999.99 to 999.99 m
	Default: 0 m

2.2.1.11. Temperature Units (TEMP UNITS)

Selects the engineering unit to be displayed with the value representing temperature.

Options		DEG C, DEG F, RANKINE, KELVIN
	*	DEG C

2.2.3. Echo Processing (ECHO PROC)

2.2.3.1. Echo select

2.2.3.1.1. Algorithm

Selects the algorithm to be applied to the echo profile to extract the true echo.

Options		ALF	Area Largest First
		A	Echo Area
		L	Largest Echo
		F	First echo
		AL	Area Largest
		AF	Area First
		LF	Largest First
		BLF	Best of Largest or First echo
		BL	Best Largest
		BF	Best First
		LAST	Last echo
	*	TF	True First

2.2.3.1.2. Echo Threshold

Sets the minimum echo confidence that the echo must meet in order to prevent a Loss of Echo condition and the expiration of the LOE timer. When Echo Confidence (2.2.3.6.1.) exceeds the Echo Threshold (2.2.3.1.2.), the echo is accepted as a valid echo and evaluated.

Values	Range: 0 to 99 dB
	Default: 10 dB
Related Parameters	LOE Timer (2.4.1.)

Use this feature when an incorrect material level is reported.

2.2.3.1.3. Position

Defines where on the echo the distance measurement is determined. (See Echo Position Detection on page 104 for more detail.)

Options		Rising Edge
	*	Center of Mass (COM)
		Hybrid (Center and CLEF)
		CLEF (Constrained Leading Edge Fit)

2.2.3.1.4. Echo Marker

The point on the selected echo from which the measured value is taken.

Values	Range: 5 to 95%
	Default: 70%
Related Parameters	Position (2.2.3.1.3.)

When SITRANS LR260 is using Rising Edge, higher values will cause lower level readings and lower values will cause higher level readings.

2.2.3.2. Sampling

Provides a method of checking the reliability of a new echo before accepting it as the valid reading, based on numbers of samples above or below the currently selected echo.

2.2.3.2.1. Echo Lock

Selects the measurement verification process. See Echo Lock on page 104 for more details.

Options		Lock Off (no verification)
	*	Maximum Verification
		Material Agitator
		Total Lock ^{a)}
Related parameters	Fill Rate (FILL RATE/MIN) (2.2.6.2.) Empty rate (EMPTY RATE/MIN) (2.2.6.3.) Up sampling (UP SAMP) (2.2.3.2.2.) Down sampling (DOWN SAMP) (2.2.3.2.3.) Window (2.2.3.2.4.) Algorithm (2.2.3.1.1.)	

- a) When Echo Lock is set to Total Lock, the Echo Lock Window is preset to 0 for automatic width and cannot be changed.

2.2.3.2.2. Up sampling (UP SAMP.)

Specifies the number of consecutive echoes that must appear above the echo currently selected, before the measurement is accepted as valid.

Values	Range: 1 to 50
	Default: 5

2.2.3.2.3. Down sampling (DOWN SAMP.)

Specifies the number of consecutive echoes that must appear below the echo currently selected, before the measurement is accepted as valid.

Values	Range: 1 to 50
	Default: 5

2.2.3.2.4. Window

A “distance window” centered on the echo¹⁾ is used to derive the reading. When a new measurement is in the window, the window is re-centered and the reading is calculated.

Values	Range: 0 to 31.5 m
	Default: 0 m

When the value is 0, the window is automatically calculated after each measurement.

- For slower Measurement Response values, the window is narrow.
- For faster Measurement Response values, the window becomes progressively wider.

Note: The Echo Lock window is stored as a standard sample, but displayed in sensor units. Any value entered for the Echo Lock window will be rounded to the nearest sample.

2.2.3.3. Filtering

2.2.3.3.1. Shots

The number of echo profile samples averaged to produce a measurement.

Values	Range: 1 to 25
	Default: 10

2.2.3.3.2. Narrow Echo Filter (NARROW ECHO FIL)

Filters out echoes of a specific width

Values	Range: 0 to 255
	0 = OFF
	greater = wider
	Default: 0 (OFF)
Related parameters	2.2.3.3.3. Reform Echo

To remove a false echo from the Echo Profile, take its width in mm and multiply it by 0.013. Enter the result.

For example, to filter out a spike with 500 mm width, enter 6 or 7 (the closest integer product of 500 x 0.013).

When a value is keyed in, the nearest acceptable value is entered.

¹⁾ See *Echo Lock* on page 104 for more detail.

2.2.3.3. Reform Echo

Smooths jagged peaks in the echo profile. Reforms fragmented echoes into one echo.

Values	0 = OFF
	greater = wider Range: 0 to 50 mS Recommended: 5 to 20 mS; higher is not recommended.
Related parameters	2.2.3.1.1. Algorithm 2.2.3.3.2. Narrow Echo Filter (NARROW ECHO FIL.) 2.2.3.1.4. Echo Marker

2.2.3.5. Range

2.2.3.5.1. Near Range

The range in front of the device (measured from the sensor reference point¹⁾) within which any echoes will be ignored. (This is sometimes referred to as "Blanking" or "Dead Zone".) The range is dependent on the horn type and any extensions.

Values	Factory Defaults	
	2" horn	0.21 m (8.43")
	3" horn	0.28 m (10.95")
	4" horn	0.34 m (13.19")
	Range: 0 to 31.5 m	

2.2.3.5.2. Far Range

Note: Far Range can extend beyond the bottom of the vessel.

Maximum distance from the reference point¹⁾, within which an echo should be considered valid.

Values	Range: Min. = Low Calibration Pt. Max. for 2" horn = 13 m (42.65 ft) Max. for 3" horn = 23 m (75.46 ft) Max. for 4" horn = 31.5 m (103.35 ft)
	Default: Value for Low Calibration Pt. + 3 m (9.43 ft)
	Range: 0 to 31.5 m

¹⁾ See *Dimensions* on page 9.

2.2.3.5.3. Min. Sensor Value (MIN. SENSOR VAL.)

The minimum value the device can measure in Sensor units.

2.2.3.5.4. Max. Sensor Value (MAX. SENSOR VAL.)

The maximum value the device can measure in Sensor units.

2.2.3.6. Noise

2.2.3.6.1. Echo Confidence

Indicates echo reliability: higher values represent better echo quality. The display shows the echo confidence of the measurement echo from the last shot. Confidence Threshold defines the minimum criterion for echo confidence.

Values (view only)	0 to 99 dB
Related Parameters	Echo Threshold (2.2.3.1.2.)

In PDM, open the menu **View – Echo Profile**.

2.2.3.6.2. Echo Strength

Displays the absolute strength (in dB referenced to 1 μ V rms) of the echo selected as the measurement echo.

Values (view only)	-20 to 99 dB
---------------------------	---------------------

In PDM, open the menu **View – Echo Profile**.

2.2.4. TVT (Auto False Echo Suppression) setup

First SITRANS LR260 learns the echo profile. Then the learned profile, or part of the learned profile, is used to screen out false echoes. See Before Auto False Echo Suppression on page 63 and After Auto False Echo Suppression on page 63 for examples.

2.2.4.1. TVT Type

Selects the TVT shaping type to be applied to the echo profile to extract the true echo.

Options		Short Curved
		Short Flat
		Long Flat
		Long Smooth Front
		Long Smooth
		Slopes
	*	Long Smooth 2
		Short Curved 2

Note: Changing the TVT type will reset the value of the TVT Hover Level.

2.2.4.2. TVT Hover Level¹⁾

Defines how high the TVT (Time Varying Threshold) curve is placed above the noise floor of the echo profile, as a percentage of the difference between the peak of the largest echo in the profile and the noise floor. When SITRANS LR260 is located in the center of the vessel, the TVT hover level may be lowered to increase the confidence level of the largest echo. (For an illustration of the TVT curve see *Before Auto False Echo Suppression* on page 63.)

Values	Range: 0 to 100%
	Default: 33%

2.2.4.3. Auto False Echo Suppression (AUTO ECHO SUPP)

Enables a 'learned' TVT curve to be used in place of the default TVT curve. (See *Auto False Echo Suppression* on page 105 for an explanation)

Notes:

- If possible adjust Auto False Echo Suppression parameters with an empty or almost empty vessel.
- Set Auto False Echo Suppression and Auto False Echo Range during startup, if possible.
- If the vessel contains an agitator, the agitator should be running.

Options		OFF	Default TVT curve will be used.
	*	ON	'Learned' TVT curve will be used.
		LEARN	'Learn' the TVT curve.

- Determine **Range** (the distance within which the learned TVT will replace the default TVT). Measure the actual distance from the antenna reference point to the material surface using a rope or tape measure, and make allowances for the actual location of the device.
- Subtract 2 m (6.56 ft) from this distance, and use the resulting value.

To use Auto False Echo Suppression via SIMATIC PDM:

- Open the menu **Device – Auto False Echo Suppression** and set Range. For more detail see *Auto False Echo Suppression* on page 44.
- Select **Learn**. The device will automatically revert to On (Use Learned TVT) after a few seconds.

To set Auto False Echo Suppression via the handheld programmer:

- Go to **Auto Suppression Range (AUTO SUPP RANGE)(2.2.4.4.)** and enter new value.
- Go to **Auto False Echo Suppression (AUTO ECHO SUPP)(2.2.4.3.)**. Press **RIGHT ARROW** to open Edit Mode.
- Select **Learn**. The device will automatically revert to On (Use Learned TVT) after a few seconds.

¹⁾ For an illustration, see *Before Auto False Echo Suppression* and *After Auto False Echo Suppression* on page 63.

Before Auto False Echo Suppression

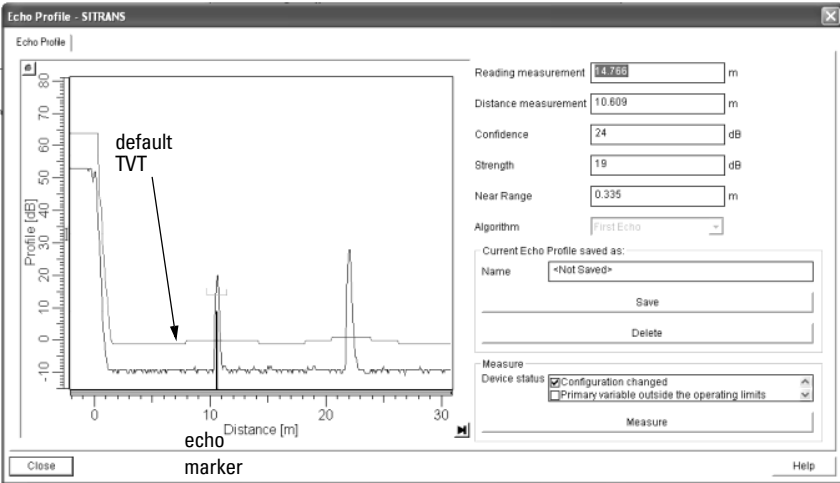

After Auto False Echo Suppression

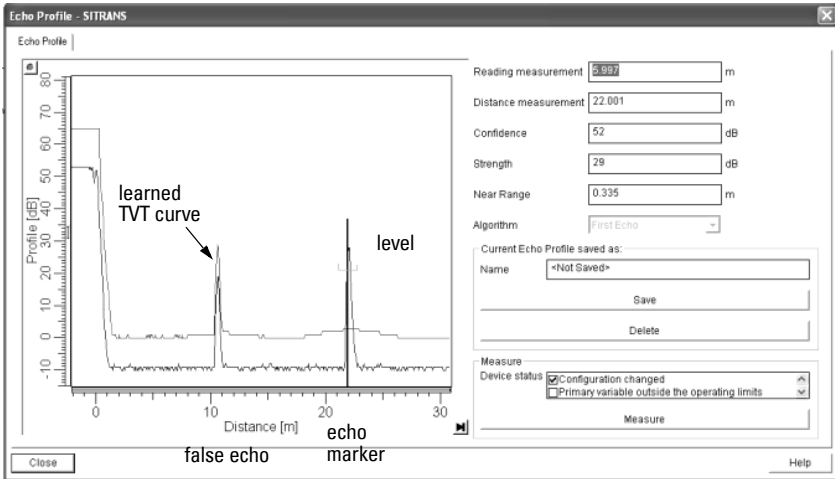

2.2.4.4. Auto Suppression Range (AUTO SUPP RANGE)

Defines the endpoint of the Learned TVT distance. Units are defined in sensor units.

Values	Range: 0.00 to 31.50 m
	Default: 1.00 m

- Press **RIGHT ARROW** to open Edit mode.
- Enter the new value and press **RIGHT ARROW** to accept it.
- Set **Auto False Echo Suppression (AUTO ECHO SUPP)**(2.2.4.3.)

2.2.4.5. Shaper Mode

Enables/disables TVT Shaper(2.2.5.)

Options	OFF*, ON
----------------	----------

2.2.5. TVT Shaper

Note: The range is -100 to 100 bits. With 2 bits per dB, this gives a range of -50 to 50 dB.

A breakpoint on the TVT curve. This allows you to reshape the TVT curve to avoid unwanted echoes. There are 40 breakpoints arranged in 5 groups. (We recommend using SIMATIC PDM to access this feature.)

To use TVT shaper via LUI (local user interface):

- Go to **Shaper Mode(2.2.4.5.)** and select option **ON**.
- In TVT Shaper, go to **Shaper 1-9(2.2.5.1.)**.
- Open Shaper 1 and enter the TVT Offset value (between -100 to 100 bits, inclusive).
- Go to the next Shaper point and repeat step (c) until all desired breakpoint values have been entered.

2.2.5.1. Shaper 1-9

Values	Range: -100 to 100 bits
	Default: 0 bits

2.2.5.2. Shaper 10-18

Values	Range: -100 to 100 bits
	Default: 0 bits

2.2.5.3. Shaper 19-27

Values	Range: -100 to 100 bits
	Default: 0 bits

2.2.5.4. Shaper 28-36

Values	Range: -100 to 100 bits
	Default: 0 bits

2.2.5.5. Shaper 37 - 40

Values	Range: -100 to 100 bits
	Default: 0 bits

To access TVT shaper via SIMATIC PDM:

- Open the menu **Device – TVT shaper**.
- For more details and an illustration see *TVT Shaper* on page 45.

2.2.6. Rate

2.2.6.1. Response Rate

Sets the reaction speed of the device to measurement changes.

Related parameters	Response Rate(2.2.6.1.)	Fill Rate (FILL RATE/MIN)(2.2.6.2.)	Empty rate (EMPTY RATE/MIN)(2.2.6.3.)	Filter Time Constant (FILTER TIME CONST)(2.3.1.4.) ^{a)}	Shots(2.2.3.3.1.)
Options	slow	0.1 m/minute	0.1 m/minute	60 s	25
	medium	1 m/minute	1 m/minute	10 s	10
	* fast	10 m/minute	10 m/minute	0 s	10

a) Numbering depends on AIFB selected.

Note: Changing Response Rate resets Fill Rate, Empty Rate, Filter Time Constant and Shots.

Use a setting just faster than the maximum filling or emptying rate (whichever is greater). Slower settings provide higher accuracy; faster settings allow for more level fluctuation.

2.2.6.2. Fill Rate (FILL RATE/MIN)

Note: Fill Rate is automatically updated whenever **Response Rate(2.2.6.1.)** is altered.

Defines the maximum rate at which the reported sensor value is allowed to increase. Allows you to further adjust the SITRANS LR260 response to increases in the rate at which the vessel fills.

Options	Range: 0 to 999.99 m/min	
	Slow	0.1 m/min.
	Medium	1 m/min.
	* Fast	10 m/min.
Altered by:	Response Rate (2.2.6.1.)	
Related parameters	Unit (Level) (2.2.1.6.)	

Enter a value slightly greater than the maximum vessel-filling rate, in Sensor Units per minute.

2.2.6.3. Empty rate (EMPTY RATE/MIN)

Note: Empty Rate is automatically updated whenever **Response Rate(2.2.6.1.)** is altered

Defines the maximum rate at which the reported sensor value is allowed to decrease. Adjusts the SITRANS LR260 response to decreases in the rate at which the vessel empties.

Options	Range: 0 to 999.99 m/min.		
		Slow	0.1 m/min.
		Medium	1 m/min.
	*	Fast	10 m/min.
Altered by:	Response Rate (2.2.6.1.)		
Related parameters	Unit (Level) (2.2.1.6.)		

Enter a value slightly greater than the vessel's maximum emptying rate, in Sensor Units per minute.

2.2.7. Transducer Block Values (for diagnostic purposes)

2.2.7.1. Main Output (PV– Primary Value)

The value for level/volume. Read Only.

In SIMATIC PDM, open the menu **View – Display**, and select the tab **Measured Value (Secondary Values)**. Refer to **Level/Volume** field.

2.2.7.2. Output, no linearization (SV1 – Secondary Value 1)

The value for level. Read Only.

In SIMATIC PDM, open the menu **View – Display**, and select the tab **Measured Value (Secondary Values)**. Refer to **Level/Volume** field.

2.2.7.3. Output, no level offset (SV2 – Secondary Value 2)

The value for distance. Read Only.

In SIMATIC PDM, open the menu **View – Display**, and select the tab **Measured Value (Secondary Values)**. Refer to **Distance** field.

2.3. Output

2.3.1. AIFB1

Static Revision No.

The revision level of the static data associated with Analog Input Function Block 1. The Static Revision No. is updated whenever a configuration parameter is changed.

2.3.1.1. Target Mode

Used to request an operating mode from the Function Block.

Options	*	Automatic Mode (AUTO)
		Manual Mode (MAN)
		Out of Service (O/S)

Allows you to put the SITRANS LR260 into Out of Service Mode and then reset it to Automatic Mode.

Manual Mode is used in conjunction with Simulation. See *Simulation* on page 46. It should be used only with SIMATIC PDM in order to benefit from all the features available.

2.3.1.2. Label

User defined label

2.3.1.3. Unit

Note: Additional units are available in SIMATIC PDM.

Engineering unit to be displayed with the output value

Options		m, cm, mm, ft, in, percent, Follow out unit (device only) m, cm, mm, ft, in, L, gal, imp gal, percent, Not Used, Unknown, Special, " ", Follow out unit (SIMATIC PDM)
	*	m

2.3.1.4. Filter Time Constant (FILTER TIME CONST)

*The time constant for the damping filter. (See **Damping** on page 106 for more detail.) The engineering unit is always in seconds. (This is an exponential filter: when a change occurs at the input, the output will be at 63.2% of the change in one time constant, and will be at full change after 5 time constants.)*

Values	Range 0 to 1000 s
	Default: 0 s

2.3.1.5. Channel

Used to select between the different Level Transducer Block outputs.

Options		Level/Volume (PV), Level (SV1), Distance (SV2)
	*	Distance (SV2)

When volume is not supported, the Primary Variable (Level/Volume) will have alternate functionality. It is possible to configure the Transducer Block outputs so that PV/SV1 is not always a level output.

2.3.1.6. Batch Information (BATCH INFO)

These 4 parameters are intended to be used in Batch Applications conforming to IEC 61512 Part 1 (ISA S88). Other applications do not require these values, which are only stored in the Function Block.

2.3.1.6.1. Batch ID

Identifies a certain batch to allow assignment of equipment-related information (for example faults, alarms) to the batch.

Values	Range: 0 to 999999 (on unit)
	Default: 0

Although higher batch ID numbers may be entered via PDM, the maximum limit of 999999 should be used.

2.3.1.6.2. Batch Unit

Identifies the active Control Recipe Unit Procedure or the related Unit (for example, reactor, centrifuge, drier).

Values	Range: 0 to 65535
	Default: 0

2.3.1.6.3. Batch operation

Identifies the active Control Recipe Operation.

Values	Range: 0 to 65535
	Default: 0

2.3.1.6.4. Batch Phase

Identifies the active Control Recipe Phase.

Values	Range: 0 to 65535
	Default: 0

2.3.1.7. Process Value Scale (PROC. VALUE SCAL)**2.3.1.7.1. Lower Value**

Defines the operational lower range value of the input value (Process Value Scale) in PV (Level) Units. Process Value Scale normalizes the input value to a customer-defined range.

Values	Range: -999.99 to 999.99 m
	Default: 0 m

2.3.1.7.2. Upper Value

Defines the operational upper range value of the input value (Process Value Scale) in PV (Level) Units. Process Value Scale normalizes the input value to a customer-defined range.

Values	Range: -999.99 to 999.99 m
	Default: 30 m (dependent on horn type)

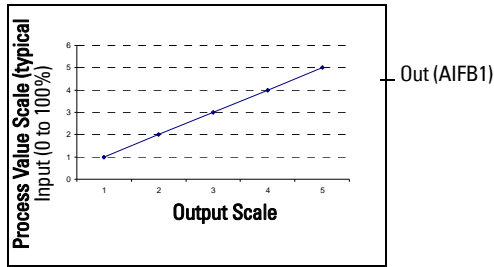

2.3.1.8. Output Scale

Scales the Process Variable. The function block parameter OUT SCALE contains the values of the lower limit and upper limit effective range in AIFB1 units.

2.3.1.8.1. Lower Value

Defines the operational lower range value of the output value in AIFB1 units.

Values	Range: -999.99 to 999.99 m
	Default: 0 m

2.3.1.8.2. Upper Value

Defines the operational upper range value of the output value in AIFB1 units.

Values	Range: -999.99 to 999.99 m
	Default: 30 m (dependent on horn type)

2.3.1.9. Output Limits

2.3.1.9.1. Lower Limit Alarm (LO LIMIT ALARM)

The setting for the lower alarm limit in AIFB1 units.

Values	Range: -999.99 to 999.99 m
	Default: -999.99 m

2.3.1.9.2. Lower Limit Warning (LO LIMIT WARN)

The setting for the lower warning limit in AIFB1 units.

Values	Range: -999.99 to 999.99 m
	Default: -999.99 m

2.3.1.9.3. Upper Limit Warning (HI LIMIT WARN)

The setting for the upper warning limit in AIFB1 units.

Values	Range: -999.99 to 999.99 m
	Default: 999.99 m

2.3.1.9.4. Upper Limit Alarm (HI LIMIT ALARM)

The setting for the upper alarm limit in AIFB1 units

Values	Range: -999.99 to 999.99 m
	Default: 999.99 m

2.3.1.9.5. Limit Hysteresis

Hysteresis is used to adjust the sensitivity of the trigger for alarm messages. It is used to compensate when a process variable fluctuates around the same value as a limit. A high level alarm occurs when a value exceeds an upper limit. The alarm's status remains true until the value drops below the limit minus the alarm hysteresis. The directions are reversed for low limit detection.

Values	Range: -999.99 to 999.99 m
	Default: 0.5% of output scale range

Enter a value for the hysteresis here, to be used for all warnings and alarms. The units are the same as the Output scale, i.e. AIFB1 units.

2.3.1.10. Human Interface

2.3.1.10.1. Decimal Point

The number of digits to display after the decimal point. (The LCD is limited to displaying two decimal places in Measurement mode. In SIMATIC PDM up to seven decimal places may be used to display measured values.)

Options	Range: 0, 1, 2, 3, 4, 5, 6, 7
	Default: 2

2.3.2. AIFB2

(See AIFB1: the parameters for AIFB2 are identical.)

2.4. Fail-safe

2.4.1. LOE Timer

Note: The last valid reading is maintained until the LOE timer expires. After the timer expires, the reading is set based on Fail-safe Value (see below).

Sets the time to elapse in minutes since the last valid reading, before Fail-safe State activates

Values	Range: 0 to 720 min.
	Default: 10.0 min

2.4.2. Fail-safe Mode FB1 (FS MODE FB1)

Fail-safe Mode occurs if the status of the input value is bad, or if the device has been put into Fail-safe mode using Simulation. One of three options can be selected for the material level to be reported when the LOE timer expires.

Options	Material level to be reported
	Substitute value (Default value used as output value).
	* Last value (Store last valid output value).
	Use bad value (Calculated output value is incorrect).

2.4.3. Fail-safe Value FB1 (FS VALUE FB1)

*Accessible in SIMATIC PDM only after **Substitute value** is selected in **Fail-safe Mode FB1 (FS MODE FB1)(2.4.2.)**.*

User-defined default for the Output Value, if sensor or sensor electronic fault is detected. Units are the same as the AIFB1 units.

Values	Range: -999.99 to 999.99 m
	Default: 0 m

2.4.4. Fail-safe Mode FB2 (FS MODE FB2)

Fail-safe Mode occurs if the status of the input value is bad, or if the device has been put into Fail-safe mode using Simulation. One of three options can be selected for the material level to be reported when the LOE timer expires.

Options	Material level to be reported
	Substitute value (Default value used as output value).
	* Last value (Store last valid output value).
	Use bad value (Calculated output value is incorrect).

2.4.5. Fail-safe Value FB2 (FS VALUE FB2)

*Accessible in SIMATIC PDM only after **Substitute value** is selected in **Fail-safe Mode FB2 (FS MODE FB2)(2.4.4.)**.*

User-defined default for the Output Value, if sensor or sensor electronic fault is detected. Units are the same as the AIFB2 units.

Values	Range: -999.99 to 999.99 m
	Default: 0 m

3. Diagnostics

Use these parameters to set up schedules for calibration and maintenance. The device will track itself based on operating hours instead of a calendar-based schedule, and will monitor its predicted lifetime.

The maintenance warnings and alarms are communicated via either the Status or Condensed Status bytes. This information can be integrated into any Asset Management system. We recommend that you use SIMATIC PCS7 Asset Management Software in conjunction with SIMATIC PDM.

3.1. Fault Reset

Clears the following fault (known as **Acknowledge Fault** in PDM.)

To clear a fault using the handheld programmer:

- Enter the fault code number then press **RIGHT Arrow**.

Fault Code	Description
S12	Internal Temperature High

To clear a fault via SIMATIC PDM:

- Open the menu **View – Acknowledge Faults**.
- Select the fault to be cleared from the pull-down menu in Extended Diagnostics.
- Click on **Transfer** to clear the fault.

Fault Code	Description
S3	Device Lifetime Limit 1 (Maintenance Required)
S4	Device Lifetime Limit 2 (Maintenance Demanded)
S6	Sensor Lifetime Limit 1 (Maintenance Required)
S7	Sensor Lifetime Limit 2 (Maintenance Demanded)
S8	Device Service Limit 1 (Maintenance Required)
S9	Device Service Limit 2 (Maintenance Demanded)
S17	Calibration Schedule Limit 1 (Maintenance Required)
S18	Calibration Schedule Limit 2 (Maintenance Demanded)
S25	Internal Error (Maintenance Demanded)

3.2. Echo Profile

You can request the current echo profile either via the handheld programmer (see next page) or via SIMATIC PDM. (For more details see Echo Processing on page 103.)

To request a profile via SIMATIC PDM:

- a. Open the menu **View – Echo Profile**.
- b. If desired, press **Save**.
- c. To view the saved profile, open the menu **View – Show Echo Profile**.

To request a profile via the handheld programmer:

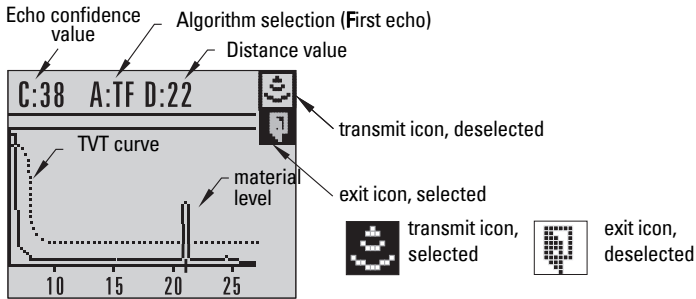

- In PROGRAM mode, navigate to **ECHO PROFILE (3.2)**
- Press **RIGHT arrow** to request a profile.
- In the Profile screen, press **UP arrow** to select the **Transmit** icon, and **Right ARROW** to update the profile.
- Press **DOWN arrow** to select the **Exit** icon, then **Right ARROW** to return to previous menu.

3.3. Measured Values (MEAS. VALUES)

To access the following parameters via SIMATIC PDM, open the menu **View – Peak Values**, and click on the appropriate tab.

3.3.1. Min. Measured Value (MIN. MEAS. VALUE)

The minimum recorded Sensor value, defined in Sensor units.

3.3.2. Max. Measured Value (MAX. MEAS. VALUE)

The maximum recorded Sensor value, defined in Sensor units.

3.3.3. Minimum Output Value - AIFB1 (MIN. OUTPUT FB1)

The minimum recorded Output Value from the Analog Input Function Block 1.

3.3.4. Maximum Output Value - AIFB1 (MAX. OUTPUT FB1)

The maximum recorded Output Value from the Analog Input Function Block 1.

3.3.5. Minimum Output Value - AIFB2 (MIN. OUTPUT FB2)

The minimum recorded Output Value from the Analog Input Function Block 2.

3.3.6. Maximum Output Value - AIFB2 (MAX. OUTPUT FB2)

The maximum recorded Output Value from the Analog Input Function Block 2.

3.3.7. Minimum Internal Temperature (MIN. INTERN. TEMP)

Read only. The minimum recorded electronics temperature of the SITRANS LR260.

3.3.8. Maximum Internal Temperature (MAX. INTERN. TEMP)

Read only. The maximum recorded electronics temperature of the SITRANS LR260.

3.4. Remaining Device Lifetime (REMAIN. DEV. LIFE)

Note: Performing a reset to Factory Defaults will reset all Maintenance parameters to their factory defaults.

The Remaining Device/Sensor Lifetime parameters set up schedules for calibration and maintenance. The device will track itself based on operating hours instead of a calendar-based schedule, and will monitor its predicted lifetime.

The maintenance warnings and alarms are communicated via either the Status or Condensed Status bytes. This information can be integrated into any Asset Management system. We recommend that you use SIMATIC PCS7 Asset Management Software in conjunction with SIMATIC PDM.

- To access these parameters via SIMATIC PDM open the menu **Device – Maintenance** and select the **Remaining Device Lifetime** tab.

The screenshot shows a dialog box titled "Maintenance - LR260" with four tabs: "Remaining Device Lifetime", "Remaining Sensor Lifetime", "Service Interval", and "Calibration Interval". The "Remaining Device Lifetime" tab is selected. The dialog contains the following fields and controls:

- Total Device Operating Time: 0.006 years
- Remaining Lifetime: 9.994 years
- Maintenance Required Limit: 0.164 years
- Maintenance Demanded Limit: 0.019 years
- Maintenance Alert Activation: Off (dropdown menu)
- Total Expected Device Life: 10.000 years
- Units: years (dropdown menu)
- Buttons: Read, Write, Snooze
- Bottom buttons: OK, Cancel, Help

- After modifying values/units as required, click on **Write** to accept the change, and **Read** to view the effect of the change.
- Click on **Snooze** to add a year to the Total Expected Device Life.

3.4.1. Total Device Operating Time (TOTAL OP. TIME)

Read only. Displays the amount of time the device has been operating in selected units.

3.4.2. Remaining Device Lifetime (REMAIN LIFETIME)

Read only. Total Expected Device Life less Total Device Operating Time in selected units.

3.4.3. Maintenance Required Limit (MAINT REQ LIMIT)

If the Total Expected Device Life less Total Device Operating Time is equal to or less than this limit, the device sets Maintenance Required.

Values	Range: 0 to 20 years
	Default: 0.164 years

- Open the menu **Device – Maintenance**, and click on the **Remaining Device/Sensor Lifetime** tab.
- Modify limit values as required.
- Modify desired values, and click on **Write**.
- Click on **Read** to see the effects of your modification.
- Click on **Snooze** to add a year to the Total Expected Device Life.
- See **Maintenance Alert Activation (ALERT ACTIVATION)(3.4.5.)** to set the Alert Activation options.

3.4.4. Maintenance Demanded Limit (MAINT DEM LIMIT)

If the Total Expected Device Life less Total Device Operating Time is equal to or less than this limit, a Maintenance Demanded status is generated.

Values	Range: 0 to 20 years
	Default: 0.019 years

- Open the menu **Device – Maintenance**, and click on the **Remaining Device/Sensor Lifetime** tab.
- Modify limit values as required.
- Modify desired values, and click on **Write**.
- Click on **Read** to see the effects of your modification.
- Click on **Snooze** to add a year to the Total Expected Device Life.
- See **Maintenance Alert Activation (ALERT ACTIVATION)(3.4.5.)** to set the Alert Activation options.

3.4.5. Maintenance Alert Activation (ALERT ACTIVATION)

Select limits to be activated.

Values		Warning Limit 1 (Maintenance Required Limit)
		Warning Limit 2 (Maintenance Demanded Limit)
		Warning Limits 1 and 2 (Maintenance Required and Maintenance Demanded Limits)
	*	OFF

To enable or disable Maintenance Alert Activation via SIMATIC PDM:

- First set the limit values in **Maintenance Required Limit (MAINT REQ LIMIT)(3.4.3.)**/**Maintenance Demanded Limit (MAINT DEM LIMIT)(3.4.4.)**
- Modify desired values, and click on **Write**.
- Click on **Read** to see the effects of your modification.
- Click on **Snooze** to add a year to the Total Expected Device Life.
- Select the desired Alert Activation option.

3.4.6. Total Expected Device Life (TOTAL EXP. LIFE)

The device tries to predict its overall lifetime. The factory default can be reset by the user.

Values	Range: 0 to 20 years
	Default: 10.00 years

To modify the value via SIMATIC PDM:

- Open the menu **Device – Maintenance** and click on **Remaining Device Lifetime**.
- Modify desired values, and click on **Write**.
- Click on **Read** to see the effects of your modification.
- Click on **Snooze** to add a year to the Total Expected Device Life.

3.4.7. Maintenance Status (MAINT STAT)

Displays the status of the Maintenance Alerts.

Options (view only)	Maintenance Required Alert active
	Maintenance Demanded Alert Active

To view via SIMATIC PDM, open the menu **View - Device Status**, click on the **Maintenance** tab, and check the **Device Lifetime Status** window.

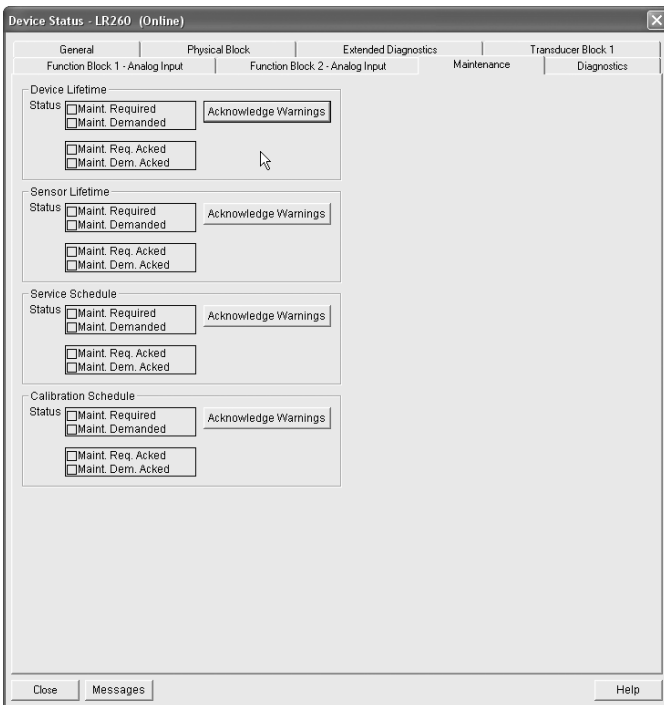

3.4.8. Acknowledge Status (ACK STATUS)

Displays the status of the Maintenance Alerts that have been acknowledged.

Options (view only)	Maintenance Required Alert acknowledged.
	Maintenance Demanded Alert acknowledged.

3.4.9. Acknowledge (ACK)

Allows you to acknowledge either a Maintenance Required or a Maintenance Demanded alert.

To acknowledge an alert via SIMATIC PDM:

- Open the menu **View – Device Status** and click on the **Maintenance** tab.
- In the **Device Lifetime** section, click on **Acknowledge Warnings**.

3.5. Remaining Sensor Lifetime (REMAIN SENS. LIFE)¹⁾

The device monitors the predicted lifetime of the sensor (the components exposed to the vessel environment).

To access these parameters via SIMATIC PDM, open the menu **Device – Maintenance** and select the **Remaining Sensor Lifetime** tab.

The screenshot shows the 'Maintenance - LR260' dialog box with the 'Remaining Sensor Lifetime' tab selected. The parameters are as follows:

Parameter	Value	Unit
Total Sensor Operating Time	0.006	years
Remaining Sensor Lifetime	9.994	years
Maintenance Required Limit	0.164	years
Maintenance Demanded Limit	0.019	years
Maintenance Alert Activation	Off	
Total Expected Sensor Life	10.000	years
Units	years	

Buttons at the bottom: Read, Write, Sensor Replaced, Snooze, OK, Cancel, Help.

3.5.1. Total Sensor Operating Time (SENS OP. TIME)

Read only. Displays the amount of time the sensor has been operating.

Can be reset to zero via the handheld programmer (after performing a service).

¹⁾ In device, Maintenance parameters are displayed in years. In SIMATIC PDM, maintenance parameter units are user selectable.

3.5.2. Remaining Sensor Lifetime (REMAIN LIFETIME)

Read only. The sum of Total Expected Sensor Life less Total Sensor Operating Time.

3.5.3. Maintenance Required Limit (MAINT REQ LIMIT)

If the Total Expected Sensor Life less Total Sensor Operating Time is equal to or less than this limit, a Maintenance Required status is generated.

Values	Range: 0 to 20 years
	Default: 0.164 years

To modify the value via SIMATIC PDM:

- Modify limit values as required.
- Modify desired values, and click on **Write**.
- Click on **Read** to see the effects of your modification.
- Click on **Snooze** to add a year to the Total Expected Device Life.
- Enable **Maintenance Alert Activation (ALERT ACTIVATION)(3.5.5.)** to set the Alert Activation options.

3.5.4. Maintenance Demanded Limit (MAINT. DEM. LIMIT)

If the Total Expected Sensor Life less Total Sensor Operating Time is equal to or less than this limit, a Maintenance Demanded status is generated.

Values	Range: 0 to 20 years
	Default: 0.019 years

To modify the value via SIMATIC PDM:

- Modify limit values as required
- Modify desired values, and click on **Write**.
- Click on **Read** to see the effects of your modification.
- Click on **Snooze** to add a year to the Total Expected Device Life.
- Enable **Maintenance Alert Activation (ALERT ACTIVATION)(3.5.5.)** to set the Alert Activation options.

3.5.5. Maintenance Alert Activation (ALERT ACTIVATION)

Select limits to be activated.

Values	Warning Limit 1 (Maintenance Required Limit)
	Warning Limit 2 (Maintenance Demanded Limit)
	Warning Limits 1 and 2 (Maintenance Required and Maintenance Demanded Limits)
	* OFF

To enable or disable Maintenance Alert Activation via SIMATIC PDM:

- First set the limit values in **Maintenance Required Limit (MAINT REQ LIMIT)(3.5.3.)** and **Maintenance Demanded Limit (MAINT. DEM. LIMIT)(3.5.4.)**.
- Modify desired values, and click on **Write**.
- Click on **Read** to see the effects of your modification.
- Click on **Snooze** to add a year to the Total Expected Device Life.

- e) Select the desired Alert Activation option.

3.5.6. Total Expected Sensor Life (TOTAL EXP. LIFE)

The device tries to predict its overall lifetime. You can reset the factory default.

Values	Range: 0 to 20 years
	Default: 10.00 years

To modify the value via SIMATIC PDM:

- Open the menu **Device – Maintenance** and click on **Remaining Sensor Lifetime**.
- Modify the value/units as desired (or click on **Snooze** to add a year to the current value) then click on **Write** to accept the change.
- Click on **Read** to view the effect of the modification.

3.5.7. Maintenance Status (MAINT STAT)

Displays the status of the Maintenance Alerts.

Options (view only)	Maintenance Required Alert active
	Maintenance Demanded Alert Active

To view via SIMATIC PDM open the menu **View - Device Status**, click on the **Maintenance** tab, and check the **Sensor Lifetime Status** window.

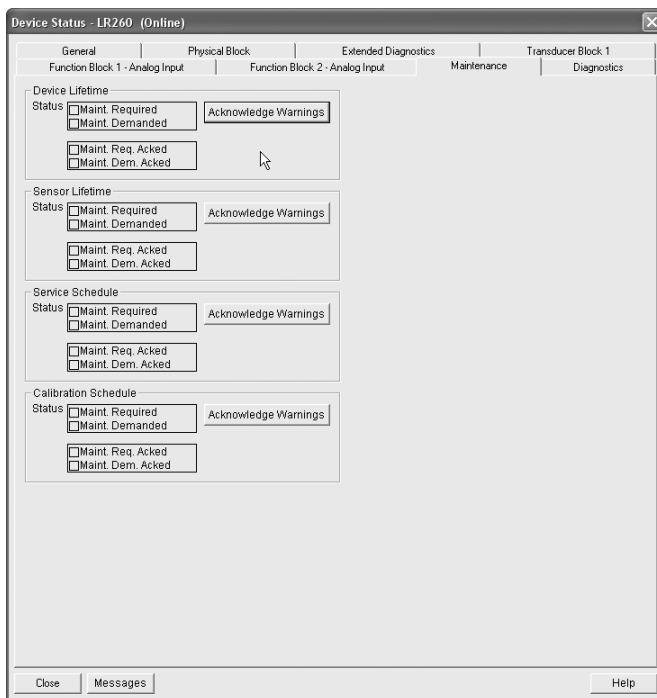

3.5.8. Acknowledge Status (ACK STATUS)

Displays the status of the Maintenance Alerts that have been acknowledged.

Options (view only)	Maintenance Required Alert acknowledged.
	Maintenance Demanded Alert acknowledged.

3.5.9. Acknowledge (ACK)

Allows you to acknowledge either a Maintenance Required or a Maintenance Demanded alert.

To acknowledge an alert via SIMATIC PDM:

- Open the menu **View – Device Status** and click on the **Maintenance** tab.
- In the **Sensor Lifetime** section, click on **Acknowledge Warnings**.

3.6. Condensed Status Setup (COND. STAT. SETUP)

*When **Condensed Status Mode (COND. STAT. MODE)(3.6.1)** is enabled, you can select the level of severity of errors, and tailor a device response appropriate for your particular process.*

- In **Event Index(3.7.1.)**, you can select a particular event or error by means of its index number.
- In **Event Status (EVENT. STAT)(3.7.2.)**, you can assign a status to the selected event.
- In **Event Diagnosis (EVENT DIAG.)(3.7.3.)**, you can assign a diagnosis to the selected event.

3.6.1. Condensed Status Mode (COND. STAT. MODE)

Note: When cyclic communication is in progress, Condensed Status Mode cannot be changed.

Options		No (disabled)
	*	Yes (enabled)

Select **Yes** or **No** to enable/disable Condensed Mode.

3.6.2. Features supported (View only) (FEAT. SUPPORTED)

Features supported are:

- Condensed Diagnostics
- Extended Diagnostics
- Application Relationships

3.6.3. Features enabled (View only) (FEAT. ENABLED)

Lists those features that have been enabled.

3.7. Condensed Status

3.7.1. Event Index

The numeric component of the Event Code for a Condensed Status event. Use the index number to identify a particular event in the list below.

Event Index	Event Code	Event Description ^{a)}
0	S0	Loss of Echo
2	S2	No Tech Power
10	S10	Level Transducer Block (LTB) Scale
11	S11	Internal Temperature Sensor
12	S12	Internal Temperature High
14	S14	AIFB1 PV Range
15	S15	AIFB2 PV Range
25	S25	Internal Device Error
28	S28	Memory RAM
29	S29	EEPROM damaged.
31	S31	Memory Flash
33	S33	Internal Temperature Calibration
34	S34	Velocity Calibration
35	S35	Receiver Init Calibration
36	S36	Receiver Calibration
37	S37	Technology Module Calibration
38	S38	Technology Module Ramp

a) See *General Fault Codes* on page 95 for the meaning of each event.

For example:

Event Code for Loss of Echo = S0
Event Index = 0

To select a particular event via the handheld programmer:

- Go to **Condensed Status Mode (COND. STAT. MODE)(3.6.1.)** and select **Yes** to enable Condensed Mode.
- Go to **Event Index(3.7.1.)** and enter the event index number corresponding to the event.
- Go to **Event Status (EVENT. STAT)(3.7.2.)** and choose a Status option.
- Go to **Event Diagnosis (EVENT DIAG.)(3.7.3.)** and choose a Diagnosis option.

To select a particular event via SIMATIC PDM:

- Go to **Diagnostics > Condensed Status Setup > Condensed Status Mode** and select **Yes** to enable Condensed Mode.
- Go to **Diagnostics > Condensed Status**.
- For each event, you can select either the Status or the Diagnosis line, then choose a Status or Diagnosis option from the associated pull-down menu.

3.7.2. Event Status (EVENT. STAT)

*Event Status allows you to assign one of the status options listed below, to any of the events listed in **Event Index(3.7.1.)**. This allows you to tailor a device response appropriate for your particular process. (Event Status affects Condensed Status¹⁾).*

Event Status Options	
	Good
	Good: maintenance required
	Good: maintenance demanded
	Uncertain: maintenance demanded
*	Bad: maintenance alarm
	Uncertain: process related, no maintenance
	Bad: process related, no maintenance
	Bad: function check, local override
	Good: function check

To assign a status to a particular event via the handheld programmer:

- Go to **Condensed Status Mode (COND. STAT. MODE)(3.6.1.)** and select **Yes** to enable Condensed Mode.
- Go to **Event Index(3.7.1.)** and enter the event index number corresponding to a particular event.
- Go to **Event Status (EVENT. STAT)(3.7.2.)** and choose a Status option from the table above.
- Go to **Event Diagnosis (EVENT DIAG.)(3.7.3.)** and choose a Diagnosis option.

To assign a status to a particular event via SIMATIC PDM:

- Go to **Level Meter > Diagnostics > Condensed Status Setup**, select **Yes** to enable Condensed Status Mode.
- Go to **Level Meter > Diagnostics > Condensed Status**.
- Select the Status line for the selected Event, then choose a Diagnosis option from the associated pull-down menu.

¹⁾ See *Condensed Status* on page 122 for more detail.

3.7.3. Event Diagnosis (EVENT DIAG.)

Allows you to assign one of the diagnostic options listed below to any of the events listed in **Event Index(3.7.1.)**. This allows you to tailor a device response appropriate for your particular process.(Event Diagnosis affects Condensed Acyclic Diagnostics and Cyclic Extended Diagnostics¹⁾).

	Event Diagnosis Options
	Status OK
	Maintenance Required
	Maintenance Demanded
*	Maintenance alarm
	Invalid process condition
	Function check or simulation

To assign a diagnosis to a particular event via the handheld programmer:

- Go to **Condensed Status Mode (COND. STAT. MODE)(3.6.1.)** and select **Yes** to enable Condensed Mode.
- Go to **Event Index(3.7.1.)** and enter the event index number corresponding to a particular event.
- Go to **Event Status (EVENT. STAT)(3.7.2.)** and choose a Status option.
- Go to **Event Diagnosis (EVENT DIAG.)(3.7.3.)** and choose a Diagnosis option from the table above.

To assign a status to a particular event via SIMATIC PDM:

- Go to **Level Meter > Diagnostics > Condensed Status Setup**, and select **Yes** to enable Condensed Status Mode.
- Go to **Level Meter > Diagnostics > Condensed Status**.
- Select the Diagnosis line for the selected Event, then choose a Diagnosis option from the associated pull-down menu.

¹⁾ See *Condensed Mode Diagnosis* on page 126 for more detail.

4. Service

4.1. Device Reset

Note: Following a Factory Reset, some degree of reprogramming may be required, depending on the option chosen below.

Reset Options	Result
Factory Defaults ^{a)}	Resets all parameters to the manufacturer's default settings with the following exceptions: <ul style="list-style-type: none">• device addresses are not reset• Lock and Unlock values are not reset• the learned TVT curve is not lost• Description, Tag, Message, and Installation Date (in SIMATIC PDM) are not reset
Standard Defaults ^{a)}	Resets all parameters excluding device addresses, Description, Message, and Installation Date to the PROFIBUS default settings
Informational	Resets parameter Tag
Functional	Resets parameters that control device behavior and functionality (such as calibration points)
Warm Start	Has the same effect as re-cycling power to the device
Reset Device Address to 126	<ul style="list-style-type: none">• Resets the PROFIBUS device address to 126• If the address lock was on, will disable the lock. (See Resetting the PROFIBUS address to 126: on page 120 for details.)

- a) Differences between Factory Defaults and Standard Defaults:
Factory Reset modifies the functional block outputs to measure distance in meters and to be scaled based on Low Calibration Point.

To access via SIMATIC PDM, open the menu **Device – Device Reset**. For more detail see *Device Reset* on page 47.

To perform a reset via the handheld programmer:

- Press **RIGHT Arrow** to open Edit Mode then scroll down to the desired Reset option and press **RIGHT Arrow** to select it.
- Press **LEFT Arrow** to exit.

4.2. LCD Fast Mode

Note: Affects Measurement mode only: has no effect on Navigation mode.

Enables a faster rate of measurement from the device by disabling most of the display area. Only the bar graph will be refreshed when LCD Fast Mode is set to ON. When Fast Mode is set to ON, there is a delay of 30 minutes with no pressed buttons before actions result.

Values	ON or OFF Default: OFF
---------------	----------------------------------

4.3. LCD Contrast

The factory setting is for optimum visibility at room temperature and in average light conditions. Extremes of temperature will lessen the contrast.

Values	Range: 0 (High contrast) to 20 (Low contrast). Default: Matches factory calibration for best visual contrast.
---------------	--

Adjust the value to improve visibility in different temperatures and luminosity. Change the LCD contrast in small steps to ensure you can continue to read the display and to prevent viewing difficulties.

4.4. PROFIBUS Ident Number (PROFIBUS IDENT)

Identifies the device on the network. The Ident Number must match that in the GSD file (the GSD file provides information on the device to the master).

Options		STD PROFILE	Standard Profile (uses generic GSD for 2 AIFB [ident # = 0x9701])
	*	MANUFACTURER	Manufacturer-specific (uses Siemens EDD and GSD file, which identifies the LR260 [PROFIBUS PA]) [ident # = 0x8162]
		STD – AIFB 1 ONL.	Standard Profile AIFB 1 only (uses generic GSD for 1 AIFB) [ident # = 0x9700]

4.5. Powered Hours

View only. Number of hours the unit has been powered up since manufacture.

To view via SIMATIC PDM, open the menu **View – Wear**.

4.6. Power-on Resets

View only. The number of power cycles that have occurred since manufacture.

To view via SIMATIC PDM, open the menu **View – Wear**.

4.17. Service Interval

Allows for scheduling of service inspections.

To access these parameters via SIMATIC PDM, open the menu **Device – Maintenance** and click on the **Service Schedule** tab.

4.17.1. Time Last Serviced (TIME LAST SERV)

View only. Time elapsed since device was last serviced.

Can be reset to zero via the handheld programmer (after performing a service).

4.17.2. Remaining Lifetime (REMAIN LIFETIME)

View only. The sum of Total Service Interval less Time Last Serviced.

4.17.3. Maintenance Required Limit (MAINT REQ LIMIT)

If Remaining Lifetime is equal to or less than this limit, a Maintenance Required status is generated.

Values	Range: 0 to 20 years
	Default: 0.164 years

4.17.4. Maintenance Demanded Limit (MAINT DEM. LIMIT)

If Remaining Lifetime is equal to or less than this limit, a Maintenance Demanded status is generated.

Values	Range: 0 to 20 years
	Default: 0.019 years

4.17.5. Alert Activation

Select limits to be activated.

Options	*	Timer off
		On - no limits
		On - limit 1
		On - limits 1 - 2
		On - limit 2

4.17.6. Service Interval

Set time between scheduled service inspections.

Values	Range: 0 to 20 years
	Default: 1.0 year

4.17.7. Maintenance Status (MAINT STAT)

Displays the status of the Maintenance Alerts.

Options (view only)	Maintenance Required Alert active
	Maintenance Demanded Alert Active

Open the menu **View – Device Status** and click on the **Maintenance** tab.

4.17.8. Acknowledge Status (ACK STATUS)

Displays the status of the Maintenance Alerts that have been acknowledged.

Options (view only)	Maintenance Required Alert acknowledged
	Maintenance Demanded Alert acknowledged

4.17.9. Acknowledge (ACK)

Allows you to acknowledge either a Maintenance Required or a Maintenance Demanded alert.

In SIMATIC PDM:

- a) Open the menu **View – Device Status** and click on the **Maintenance** tab.
- b) Click on the appropriate **Acknowledge Warnings** button then click on **Close**.

4.18. Calibration Interval (CALIB INTERVAL)

Allows you to schedule calibration.

To access these parameters via SIMATIC PDM, open the menu **Device –Maintenance** and click on the **Calibration Schedule** tab.

4.18.1. Time Last Calibrated (TIME LAST CAL.)

View only: time elapsed since device was last calibrated.

Can be reset to zero via the handheld programmer (after performing a service).

4.18.2. Remaining Lifetime (REMAIN LIFETIME)

View only. The sum of Total Calibration Interval less Time Last Calibrated.

4.18.3. Maintenance Required Limit (MAINT REQ LIMIT)

If Remaining Lifetime is equal to or less than this limit, a Maintenance Required status is generated.

Values	Range: 0 to 20 years
	Default: 0.164 years

4.18.4. Maintenance Demanded Limit (MAINT DEM LIMIT)

If Remaining Lifetime is equal to or less than this limit, a Maintenance Demanded status is generated.

Values	Range: 0 to 20 years
	Default: 0.019 years

4.18.5. Alert Activation

Select limits to be activated.

Options	*	Timer off
		On - no limits
		On - limit 1
		On - limits 1 - 2
		On - limit 2

4.18.6. Total Calibration Interval (TOTAL CALIB. INTRV)

Set time between scheduled calibrations.

Values	Range: 0 to 20 years
	Default: 1.0 year

4.18.7. Maintenance Status (MAINT STAT)

Displays the status of the Maintenance Alerts

Options (view only)	Maintenance Required Alert active
	Maintenance Demanded Alert Active

In SIMATIC PDM, open the menu **View – Device Status** and click on the **Maintenance** tab.

4.18.8. Acknowledge Status (ACK STAT)

Displays the status of the Maintenance Alerts that have been acknowledged.

Options (view only)	Maintenance Required Alert acknowledged
	Maintenance Demanded Alert acknowledged

In SIMATIC PDM, open the menu **View – Device Status** and click on the **Maintenance** tab.

4.18.9. Acknowledge (ACK)

Allows you to acknowledge either a Maintenance Required or a Maintenance Demanded alert.

In SIMATIC PDM:

- Open the menu **View – Device Status** and click on the **Maintenance** tab.
- Click on the appropriate **Acknowledge Warnings** button then click on **Close**.

5. Communication

5.1. Device Address

Note: The address can be changed and locked from a remote master. See *Resetting the PROFIBUS address to 126*: **on page 120** for details on disabling the address lock.

Sets the unique address of the device on the network (also called PROFIBUS address).

Values	0 - 126. Default: 126
---------------	-----------------------

To change Device Address via SIMATIC PDM:

- Open the menu **Device – Set Address**.
- Enter value in **New Address** field and click on **Assign Address** button.

To change Device Address via the handheld programmer:

See *Device Address* on page 35 for details.

5.2. Remote Lockout

Enables or disables programming via the network and PDM.

Options	*	Off (Remote operation enabled)
		On (Remote operation disabled)

6. Security

6.1. Write Locking

Prevents any changes to parameters via PDM or the hand-held programmer.

Hand-held programmer Values	2457 (unlock value)	Off (enables programming)
	any other value	On (disables programming)

In SIMATIC PDM, open the menu **Device – Write Locking**, and select **On** or **Off**.

7. Language

Selects the language to be used on the LCD.

Options	*	English
		German
		French
		Spanish

Notes

Appendix A: Alphabetical Parameter List

Note: Maintenance Parameters are not listed below. See *Remaining Device Lifetime (REMAIN. DEV. LIFE) (3.4.)* on page 74, *Remaining Sensor Lifetime (REMAIN SENS. LIFE) (3.5.)* on page 77, *Service Interval (4.17.)* on page 85, and *Calibration Interval (CALIB INTERVAL) (4.18.)* on page 87 for those parameters.













Parameter Name (Parameter Number)	Page Number
Algorithm (2.2.3.1.1.)	56
Auto False Echo Suppression (AUTO ECHO SUPP) (2.2.4.3.)	62
Auto Suppression Range (AUTO SUPP RANGE) (2.2.4.4.)	63
Echo Confidence (2.2.3.6.1.)	61
Device Address (5.1.)	88
Device Reset (4.1.)	84
Echo Lock (2.2.3.2.1.)	58
Echo Marker (2.2.3.1.4.)	57
Echo Profile (3.2.)	72
Echo Threshold (2.2.3.1.2.)	57
Empty rate (EMPTY RATE/MIN) (2.2.6.3.)	66
Fail-safe Mode FB1 (FS MODE FB1) (2.4.2.)	71
Fail-safe Mode FB2 (FS MODE FB2) (2.4.4.)	71
Fail-safe Value FB1 (FS VALUE FB1) (2.4.3.)	71
Fail-safe Value FB2 (FS VALUE FB2) (2.4.5.)	71
Far Range (2.2.3.5.2.)	60
Fill Rate (FILL RATE/MIN) (2.2.6.2.)	65
Filter Time Constant (FILTER TIME CONST) (2.3.1.4.)	67
Firmware Revision (FIRMWARE REV.) (2.1.4.)	54
Hardware Revision (HARDWARE REV.) (2.1.6.)	54
High Calibration Pt. (HIGH CALIB. PT.) (2.2.1.4.)	55
Language (7.)	89
LCD Contrast (4.3.)	85
LCD Fast Mode (4.2.)	84
Level Offset (2.2.1.9.)	55
Loader Revision (LOADER REV.) (2.1.5.)	54
LOE Timer (2.4.1.)	70
Low Calibration Pt. (LOW CALIB. PT.) (2.2.1.3.)	55
Maximum Internal Temperature (MAX. INTERN. TEMP) (3.3.8.)	73
Minimum Internal Temperature (MIN. INTERN. TEMP) (3.3.7.)	73
Narrow Echo Filter (NARROW ECHO FIL.) (2.2.3.3.2.)	59





Parameter Name (Parameter Number)	Page Number
Near Range (2.2.3.5.1.)	60
Noise (2.2.3.6.)	61
Position (2.2.3.1.3.)	57
Powered Hours (4.5.)	85
Power-on Resets (4.6.)	85
PROFIBUS Ident Number (PROFIBUS IDENT) (4.4.)	85
Remote Lockout (5.2.)	88
Response Rate (2.2.6.1.)	65
Sensor Offset (2.2.1.10.)	56
Sensor Units (2.2.1.2.)	54
Echo Strength (2.2.3.6.2.)	61
Temperature Units (TEMP UNITS) (2.2.1.11.)	56
TVT Hover Level (2.2.4.2.)	62
TVT Type (2.2.4.1.)	61
Unit (Level) (2.2.1.6.)	55
Window (2.2.3.2.4.)	59
Write Locking (6.1.)	88

Appendix B: Troubleshooting

1. Check the following:
 - There is power at the instrument.
 - The LCD shows the relevant data you are expecting.
 - Check whether any fault codes are being displayed (see *Acyclic Extended Diagnostics (General Fault Codes)* on page 127 for a detailed list).
 - The device can be programmed using the hand-held programmer.
2. Verify that the wiring connections are correct.
3. Check the PROFIBUS address and make sure all devices are at unique PROFIBUS addresses.
4. If the device cannot be programmed via the hand-held programmer, make sure **Write Locking (6.1.)** on page 88 is disabled.
5. If you try to set a SITRANS LR260 parameter via remote communications, but the parameter remains unchanged, check the following parameters:
 - **Remote Lockout (5.2.)** on page 88 should be disabled
 - **Write Locking (6.1.)** on page 88 should be disabled
 - **Resetting the PROFIBUS address to 126:** on page 120 on how to disable an address lock
6. If you continue to experience problems, go to our website at www.siemens.com/processautomation, and check the FAQs for SITRANS LR260, or contact your Siemens Milltronics representative.
7. If the PLC value equals the display value, but does not correspond to actual material level, either:
 - scaling in AIFB1 is incorrect, or
 - High Calibration Point is incorrectly entered, or
 - the wrong echo is being selected.
8. If the PLC value is not equal to the displayed value (regardless of actual material level), either:
 - you may not be looking at the right spot in the PLC, or
 - you may have programmed scaling into the PLC, instead of leaving all scaling to be performed in the LR260, or
 - the PLC may not be communicating with the LR260. Check the network to verify that you are communicating.

Device Status Icons





Icon	Priority Level	Meaning
	1	<ul style="list-style-type: none"> • Maintenance alarm • Measurement values are not valid
	2	<ul style="list-style-type: none"> • Maintenance warning: maintenance demanded immediately • Measured signal still valid
	3	<ul style="list-style-type: none"> • Maintenance required • Measured signal still valid
	1	<ul style="list-style-type: none"> • Process value has reached an alarm limit
	2	<ul style="list-style-type: none"> • Process value has reached a warning limit
	3	<ul style="list-style-type: none"> • Process value has reached a tolerance limit
	1	<ul style="list-style-type: none"> • Configuration error • Device will not work because one or more parameters/components is incorrectly configured
	2	<ul style="list-style-type: none"> • Configuration warning • Device can work but one or more parameters/components is incorrectly configured
	3	<ul style="list-style-type: none"> • Configuration changed • Device parameterization not consistent with parameterization in project. Look for info text.
	1	<ul style="list-style-type: none"> • Manual operation (local override) • Communication is good; device is in manual mode.
	2	<ul style="list-style-type: none"> • Simulation or substitute value • Communication is good; device is in simulation mode or works with substitute values.
	3	<ul style="list-style-type: none"> • Out of operation • Communication is good; device is out of action.

Icon	Priority Level	Meaning (cont'd)
		<ul style="list-style-type: none"> Data exchanged
		<ul style="list-style-type: none"> No data exchange
		<ul style="list-style-type: none"> Write access enabled
		<ul style="list-style-type: none"> Write access disabled









General Fault Codes

Notes:









- If more than one fault is present, the device status indicator and text for each fault alternate at 2 second intervals.
- Some faults cause the device to go to Fail-safe mode (Fault 52). These are indicated with an asterisk (*).

General Fault Codes			
Code / Icon		Meaning	Corrective Action
S: 0	*	The device was unable to get a measurement within the Fail-safe LOE Timer period. Possible causes: faulty installation, antenna material buildup, foaming/other adverse process conditions, invalid calibration range.	Ensure installation details are correct. Ensure no antenna material buildup. Clean if necessary. Adjust process conditions to minimize foam or other adverse conditions. Correct range calibration. If fault persists, contact your local Siemens representative.
			
S: 2	*	Unable to collect profile because of a power condition that is outside of the operating range of the device.	Repair required: contact your local Siemens representative.
			
S: 3		Device is nearing its lifetime limit according to the value set in Maintenance Required Limit.	Replacement is recommended.
			
S: 4		Device is nearing its lifetime limit according to the value set in Maintenance Demanded Limit.	Replacement is recommended.
			







General Fault Codes (cont'd) (cont'd)

Code / Icon	Meaning	Corrective Action
S: 6 	Sensor is nearing its lifetime limit according to the value set in Maintenance Required Limit.	Replacement is recommended.
S: 7 	Sensor is nearing its lifetime limit according to the value set in Maintenance Demanded Limit.	Replacement is recommended.
S: 8 	Service interval as defined in Maintenance Required Limit has expired.	Perform service.
S: 9 	Service interval as defined in Maintenance Demanded Limit has expired.	Perform service.
S: 10 	Input parameters High Calibration Point and Low Calibration Point are the same.	Check calibration settings of device. Ensure settings for High Calibration Point and Low Calibration Point are different.
S: 11 	Internal temperature sensor failure.	Repair required: contact your local Siemens representative.
S: 12 	Internal temperature of device has exceeded specifications: it is operating outside its temperature range.	Relocate device and/or lower process temperature enough to cool device. Inspect for heat-related damage and contact your local Siemens representative if repair is required. Fault code will persist until a manual reset is performed using PDM or the LCD interface.
S:14 	Upper and Lower input values (Process Value Scale) for AIFB1 are the same.	Check configuration for AIFB1. Ensure that Upper Value and Lower Value (Process Value Scale) are not the same.

General Fault Codes (cont'd) (cont'd)





Code / Icon	Meaning	Corrective Action
S: 15 	Upper and Lower input values (Process Value Scale) for AIFB2 are the same.	Check configuration for AIFB2. Ensure that Upper Value and Lower Value (Process Value Scale) are not the same.
S: 17 	Calibration interval as defined in Maintenance Required Limit has expired.	Perform calibration.
S: 18 	Calibration interval as defined in Maintenance Demanded Limit has expired.	Perform calibration.
S: 25 	Internal device error.	Reset power. If fault persists, contact your local Siemens representative.
S: 28 	* Internal device failure caused by a RAM memory error.	Repair required: contact your local Siemens representative.
S: 29 	* EEPROM damaged.	Repair required: contact your local Siemens representative.
S: 31 	* Flash error.	Repair required: contact your local Siemens representative.
S: 32 	* IDENT number conflict	Ensure value of the Ident number selector is correct for the network configuration. If it is correct, the device needs to be re-parameterized by the PLC.
S: 33 	* Factory calibration for the internal temperature sensor has been lost.	Repair required: contact your local Siemens representative.

General Fault Codes (cont'd) (cont'd)

Code / Icon	Meaning	Corrective Action
S: 34 	* Factory calibration for the device has been lost.	Repair required: contact your local Siemens representative.
S: 35 	* Factory calibration for the device has been lost.	Repair required: contact your local Siemens representative.
S: 36 	* Unable to start microwave module.	Cycle power. If fault persists, contact your local Siemens representative.
S: 37 	* Measurement hardware problem.	Cycle power. If fault persists, contact your local Siemens representative.
S: 38 	* Microwave module hardware failure: unable to calculate distance measurement.	Cycle power. If fault persists, contact your local Siemens representative: repair required.
S: 43 	* Factory calibration for the radar receiver has been lost.	Repair required: contact your local Siemens representative.
S: 64 	* SPC42 Access Error	Cycle power. If fault persists, contact your local Siemens representative.

Operation Troubleshooting

Operating symptoms, probable causes, and resolutions.

Symptom	Cause	Action
Display shows  S: 0 LOE	level or target is out of range	<ul style="list-style-type: none"> check specifications check Low Calibration Point (LOW CALIB. PT.) (1.5.) increase Echo Confidence (2.2.3.6.1.)
Display shows  S: 0 LOE	material build-up on antenna	<ul style="list-style-type: none"> clean the antenna re-locate SITRANS LR260
Display shows  S: 0 LOE	location or aiming: <ul style="list-style-type: none"> poor installation flange not level 	<ul style="list-style-type: none"> check to ensure nozzle is vertical use Auto False Echo Suppression (AUTO ECHO SUPP) (2.2.4.3.) and check Auto Suppression Range (AUTO SUPP RANGE) (2.2.4.4.) to ensure nozzle protrudes from end of vessel nozzle.
Display shows  S: 0 LOE	antenna malfunction: <ul style="list-style-type: none"> temperature too high physical damage 	<ul style="list-style-type: none"> check Maximum Internal Temperature (MAX. INTERN. TEMP) (3.3.8.) set Algorithm (2.2.3.1.1.) to tF (trueFirst echo) relocate
Reading does not change, but the level does	SITRANS LR260 processing wrong echo, i.e. vessel wall, or structural member	<ul style="list-style-type: none"> re-locate SITRANS LR260 ensure nozzle protrudes 10 mm min. rotate instrument 90° use Auto False Echo Suppression (AUTO ECHO SUPP) (2.2.4.3.) and Auto Suppression Range (AUTO SUPP RANGE) (2.2.4.4.)
Measurement is consistently off by a constant amount	<ul style="list-style-type: none"> setting for Low Calibration Pt. (LOW CALIB. PT.) (2.2.1.3.) not correct setting for Sensor Offset (2.2.1.10.) not correct 	<ul style="list-style-type: none"> check distance from sensor reference point to Low Calibration Pt. (LOW CALIB. PT.) (2.2.1.3.) check Sensor Offset (2.2.1.10.)
Screen blank	power error	<ul style="list-style-type: none"> check nameplate rating against voltage supply check power wiring or source

Symptom	Cause	Action (cont'd)
Reading erratic	echo confidence weak	<ul style="list-style-type: none"> refer to Echo Confidence (2.2.3.6.1) use Auto False Echo Suppression (AUTO ECHO SUPP) (2.2.4.3.) and Auto Suppression Range (AUTO SUPP RANGE) (2.2.4.4.) use foam deflector
	liquid surface vortexed	<ul style="list-style-type: none"> decrease Fill Rate (FILL RATE/MIN) (2.2.6.2.) increase confidence threshold in Echo Threshold (2.2.3.1.2.)
	material filling	<ul style="list-style-type: none"> re-locate SITRANS LR260
Reading response slow	Fill Rate (FILL RATE/MIN) (2.2.6.2.) setting is incorrect	<ul style="list-style-type: none"> increase measurement response if possible
Reads correctly but occasionally reads high when vessel is not full	<ul style="list-style-type: none"> detecting close range echo build up near top of vessel or nozzle nozzle problem 	<ul style="list-style-type: none"> clean the antenna use Auto False Echo Suppression (AUTO ECHO SUPP) (2.2.4.3.) and Auto Suppression Range (AUTO SUPP RANGE) (2.2.4.4.)
Level reading lower than material level	<ul style="list-style-type: none"> material is within Near Range zone multiple echoes processed 	<ul style="list-style-type: none"> decrease Near Range (2.2.3.5.1.) (minimum value depends on antenna type) raise SITRANS LR260 ensure Algorithm (2.2.3.1.1.) is set to tF (trueFirst echo)
	<ul style="list-style-type: none"> vessel near empty and low dK material 	<ul style="list-style-type: none"> set Position (2.2.3.1.3.) to Hybrid

Appendix C: Maintenance

SITRANS LR260 requires no maintenance or cleaning under normal operating conditions.

Under severe operating conditions, the antenna may require periodic cleaning. If cleaning becomes necessary:

- Note the antenna material and the process medium, and select a cleaning solution that will not react adversely with either.
- Remove the instrument from service and wipe the antenna clean using a cloth and suitable cleaning solution.

Unit Repair and Excluded Liability

All changes and repairs must be done by qualified personnel, and applicable safety regulations must be followed. Please note the following:

- The user is responsible for all changes and repairs made to the device.
- All new components must be provided by Siemens Milltronics Process Instruments Inc.
- Restrict repair to faulty components only.
- Do not re-use faulty components.

Notes

Appendix D: Technical Reference

Principles of Operation

SITRANS LR260 is a 2-wire 25 GHz pulse radar level transmitter for continuous monitoring of solids and liquids¹⁾. Radar level measurement uses the time of flight principle to determine distance to a material surface. The device transmits a signal and waits for the return echo. The transit time is directly proportional to the distance from the material.

Pulse radar uses polarized electromagnetic waves. Microwave pulses are emitted from the antenna at a fixed repetition rate, and reflect off the interface between two materials with different dielectric constants (the atmosphere and the material being monitored).

Electromagnetic wave propagation is virtually unaffected by temperature or pressure changes, or by changes in the vapor levels inside a vessel. Electromagnetic waves are not attenuated by dust.

SITRANS LR260 consists of an enclosed electronic circuit coupled to an antenna and process connection. The electronic circuit generates a radar signal (25 GHz) that is directed to the horn.

The signal is emitted from the horn, and the reflected echoes are digitally converted to an echo profile. The profile is analyzed to determine the distance from the material surface to the reference point on the instrument. This distance is used as a basis for the display of material level.

Echo Processing

Process Intelligence

The signal processing technology embedded in Siemens radar level devices is known as **Process Intelligence**.

Process intelligence provides high measurement reliability regardless of the dynamically changing conditions within the vessel being monitored. The embedded Process Intelligence dynamically adjusts to the constantly changing material surfaces within these vessels.

Process Intelligence is able to differentiate between the true microwave reflections from the surface of the material and unwanted reflections being returned from obstructions such as seam welds or supports within a vessel. The result is repeatable, fast and reliable measurement. This technology was developed as result of field data gained over some twenty years from more than 1,000,000 installations in many industries around the world.

¹⁾ The microwave output level is significantly less than that emitted from cellular phones.

Higher order mathematical techniques and algorithms are used to provide intelligent processing of microwave reflection profiles. This “knowledge based” technique produces superior performance and reliability.

Time Varying Threshold (TVT) Curves

A Time Varying Threshold (TVT) curve hovers above the echo profile to screen out unwanted reflections (false echoes).

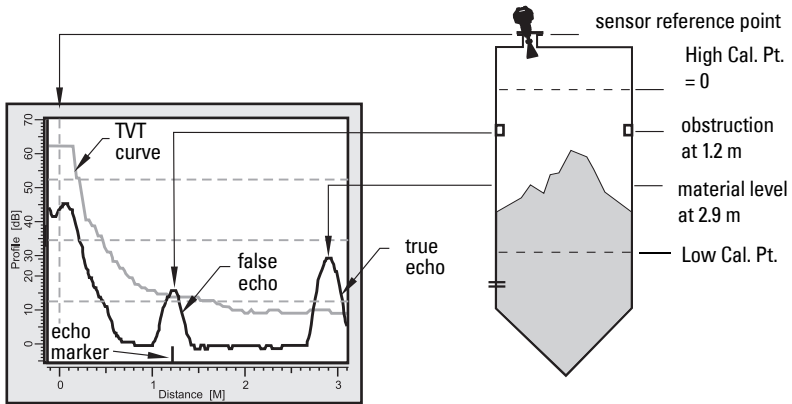

In most cases the material echo is the only one which rises above the default TVT curve. In a vessel with obstructions a large false echo may rise above the default TVT. The Auto False Echo Suppression feature (see below) can be used to screen it out.

The device characterizes all echoes that rise above the TVT as potential good echoes. Each peak is assigned a rating based on its strength, area, height above the TVT, amongst other characteristics.

The true echo is selected based on the setting for the Echo selection algorithm [Algorithm (2.2.3.1.1.)].

Echo Lock

If the echo selected by **Algorithm** is within the Echo Lock window, the window is centered about the echo, which is used to derive the measurement.

- **Echo Lock Off:**
SITRANS LR260 responds immediately to a new selected echo (within the restrictions set by the Maximum Fill / Empty Rate), but measurement reliability is affected.

Echo Position Detection

The echo position algorithm (2.2.3.1.3. *Position*) determines which point on the echo will be used to calculate the precise time of flight, and calculates the range using the calibrated propagation velocity (adjusted by a propagation factor, if necessary).

The options are **Center** or **CLEF** (Constrained Leading Edge Fit), **Hybrid**, or **Rising Edge**. **CLEF** uses the leading edge of the echo. It can be used to compensate for materials with

a low dK value, which may cause the vessel bottom to be reported as the level instead of the actual material level, in low level conditions. **CLEF range** is the level below which the CLEF algorithm will be used: above this level the Center algorithm is used.

Center of Mass selects the center of the echo for evaluation. **Rising Edge** selects the rising edge of the echo. **Hybrid** uses a combination of **Center** and **CLEF** depending on the setting for CLEF range.

Auto False Echo Suppression

If an obstruction is causing a large echo before the material level echo, that echo will rise above the default TVT curve and may be selected as the true echo. Auto False-Echo Suppression modifies the TVT curve so that the false echo will not rise above the TVT curve.

When you use Auto False Echo Suppression, the device first learns the echo profile at that moment¹⁾. A learned TVT curve follows the echo profile and rises above the false echo. You set Auto Suppression Range so that the learned profile replaces the default TVT curve up to a point past the obstruction. From that point on, the default TVT curve is used. The material level echo rises above this, and is selected as the true echo.

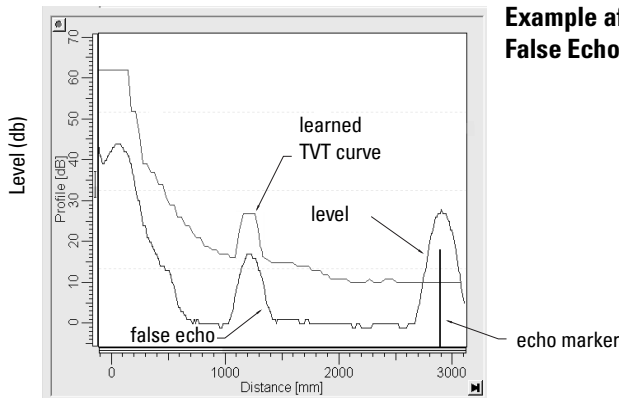

Example after Auto False Echo Suppression

Measurement Range

Near Range

2.2.3.5.1. Near Range programs SITRANS LR260 to ignore the zone in front of the antenna. The default blanking distance is 50 mm (1.97") from end of horn antenna.

Near Range allows you to increase the blanking value from its factory default. But *2.2.4.3. Auto False Echo Suppression (AUTO ECHO SUPP)* is generally recommended in preference to extending the blanking distance from factory values.

¹⁾ Use Auto False Echo Suppression when the material level is substantially lower than process full level (ideally when the tank is empty or almost empty).

Far Range

In applications where the base of the vessel is conical or parabolic, a reliable echo may be available below the vessel empty distance, due to an indirect reflection path. Increasing the range extension to 30% or 40% can provide stable empty vessel readings.

Measurement Response

The measurement response (**Response Rate (1.2.)**) limits the maximum rate at which the display and output respond to changes in the measurement. Once the real process fill/empty rate (m/s) is established, a response rate can be selected that is slightly higher than the application rate. The response rate automatically adjusts the filters that affect the output response rate.

There are three preset options: slow, medium, and fast.

Response Rate (1.2.)	Fill Rate (FILL RATE/ MIN) (2.2.6.2.)/ Empty rate (EMPTY RATE/MIN) (2.2.6.3.)	Filter Time Constant (FILTER TIME CONST) (2.3.1.4.) ^{a)}	Shots (2.2.3.3.1.)
Slow	0.1 m/min	60 s	25
Medium	1 m/min	10 s	10
Fast	* 10 m/min	0 s	10

a) Numbering depends on AIFB selected.

Damping

A damping filter smooths out the response to a sudden change in level. This is an exponential filter and the engineering unit is always in seconds. The setting can be modified in **Filter Time Constant (FILTER TIME CONST) (2.3.1.4.)**.

Damping example

time constant = 2 seconds

input (level) change = 2 m

In 5 time constants the output rises exponentially: from 63.2% of the change in the first time constant, to almost 100% of the change by the end of the 5th time constant.

Level (m)

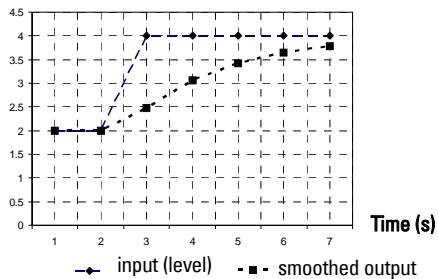

Loss of Echo (LOE)

A loss of echo (LOE) occurs when the calculated measurement is judged to be unreliable because the echo confidence value has dropped below the echo confidence threshold.

If the LOE condition persists beyond the time limit set in *2.4.1. LOE Timer* the LCD displays the Maintenance Alarm icon, and the text region displays the fault code **S: 0** and the text LOE.

If two faults are present at the same time, the fault code, error text, and error icon for each fault are displayed alternately. For example, Loss of Echo and Temperature Sensor Failure.



S: 0 LOE



S: 11 Temp. Sensor Failure

LOE (Loss of Echo) Timer

LOE Timer determines the time to elapse after the last valid reading before a Fail-safe state is activated. Fail-safe Material Level determines the level to be reported when the Fail-safe timer expires. Upon receiving a reliable echo, the loss of echo condition is aborted, the Service Required icon and error message are cleared, and the reading return to the current level.

Fail-safe Mode

The purpose of the Fail-safe setting is to put the process into a safe mode of operation in the event of a fault or failure. The value to be reported in the event of a fault is selected so that a loss of power or loss of signal triggers the same response as an unsafe level.

Fail-safe mode may be triggered by a loss of echo, a bad configuration, or certain device faults. You can select on of three possible values to be reported when a Fail-safe mode is activated.

Options	Material level to be reported	
		Substitute value (Default value used as output value).
	*	Last value (Store last valid output value).
		Use bad value (Calculated output value is incorrect).

Fail-safe value

When the **LOE Timer (2.4.1.)** expires, the material level to be reported is determined by Fail-safe Mode. If the option **Use substitute value** is selected, a user-defined value can be reported.

The two Analog Input Function blocks are set separately. For example, to set a user-defined value for AIFB1:

- Set **Fail-safe Mode FB1 (FS MODE FB1) (2.4.2.)** to **Use substitute value**.
- Go to **Fail-safe Value FB1 (FS VALUE FB1) (2.4.3.)** and enter the desired value.

Process Pressure/Temperature derating curves

Notes:

- The Process Device Tag shall remain with the process pressure boundary assembly¹. In the event the instrument package is replaced, the Process Device Tag shall be transferred to the replacement unit.
- SITRANS LR260 units are hydrostatically tested, meeting or exceeding the requirements of the ASME Boiler and Pressure Vessel Code and the European Pressure Equipment Directive.
- The serial numbers stamped in each process connection body, (flange, threaded, or sanitary), provide a unique identification number indicating date of manufacture. Example: MMDDYY – XXX (where MM = month, DD = day, YY = year, and XXX= sequential unit produced)

Further markings (space permitting) indicate flange configuration, size, equivalent pressure class, material, and material heat code.



WARNINGS:

- **Never attempt to loosen, remove or disassemble process connection or instrument housing while vessel contents are under pressure.**
- **This product is designated as a Pressure Accessory per Directive 97/23/EC and is not intended for use as a safety device.**
- **Materials of construction are chosen based on their chemical compatibility (or inertness) for general purposes. For exposure to specific environments, check with chemical compatibility charts before installing.**
- **The user is responsible for the selection of bolting and gasket materials which will fall within the limits of the flange and its intended use and which are suitable for the service conditions.**
- **Improper installation may result in loss of process pressure and/or release of process fluids and/or gases.**

¹⁾ The process pressure boundary assembly comprises the components that act as a barrier against pressure loss from the process vessel: that is, the combination of process connection body and emitter, but normally excluding the electrical enclosure.

Horn Antenna

**2" (50 mm), 3" (80 mm), 4" (100 mm), and 6" (150 mm)
Flanged Versions**

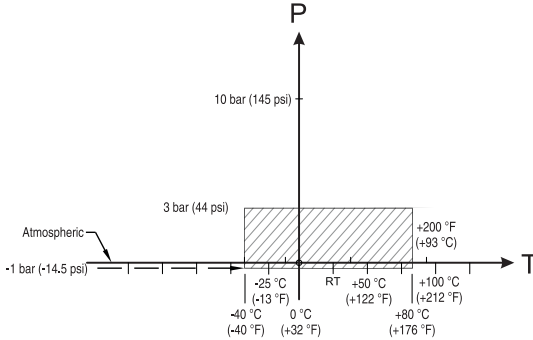

Process Connection Series:

- 51262 or 51263 series flange.
- Ensure your instrument has the process identification Tag showing one of this series, and 25589 stamped on flange.

Pressure/Temperature Curve SITRANS LR260 (7ML5427) Universal Flanged Process Connections

P = Permitted Operating Pressures

T = Permitted Operating Temperature

! WARNING: Never attempt to loosen, remove or disassemble process connection or instrument housing while vessel contents are under pressure.

Notes

Appendix E: Application Example

Note: In the applications illustrated below, values are for example purposes only.

You can use this examples as setup references. Enter the values in the parameter tables to select the corresponding functions.

Configure the basic settings using the Quick Start wizard parameters. (These parameters are inter-related, and changes take effect only after you select **YES** in step 7 (or **Finish and Transfer** in PDM) to apply changes.)

In each example, after performing a Quick Start, navigate to the other required parameters (either via the handheld programmer, or via SIMATIC PDM) and enter the appropriate values.

Flour in steel storage vessel, level measurement

Note: Minimum distance from flange face to target is limited by *Near Range 2.2.3.5.1 on page 60*.

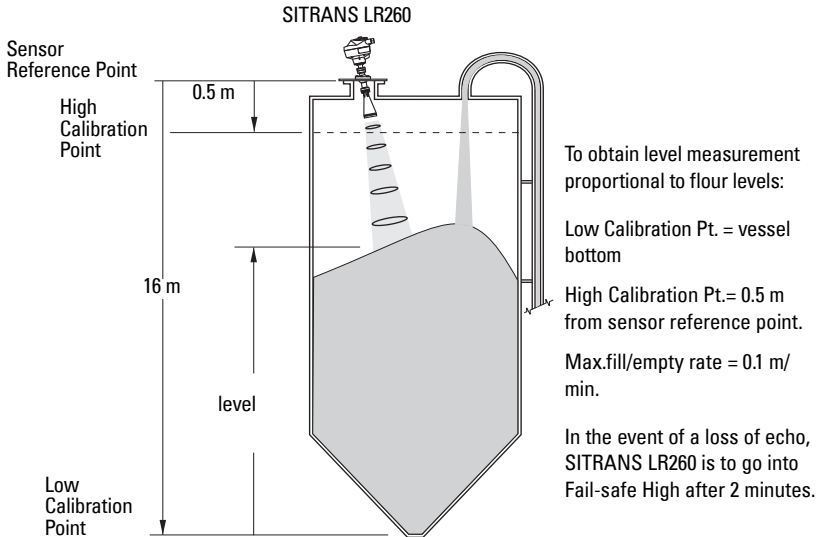

Parameter type	Parameter Name/No.	Options/ Values	Function
Quick Start Wizard parameters	Application Type (1.1.)	STEEL	
	Response Rate (1.2.)	MED	Medium =1 m/minute
	Units (1.3.)	M	meters
	Operation (1.4.)	LEVEL	Level
	Low Calibration Point (LOW CALIB. PT.) (1.5.)	16	16 m
	High Calibration Point (HIGH CALIB. PT.) (1.6.)	0.5	0.5 m
	Apply? (Apply changes) (1.7.)	YES	Transfers Quick Start settings to device.
Independent parameters	LOE Timer (2.4.1.)	2	2 minutes
	Fail-safe Mode FB1 (FS MODE FB1) (2.4.2.)	Substitute value	User-defined value to be used.
	Fail-safe Value FB1 (FS VALUE FB1) (2.4.3.)	4.5	4.5 m

Press **Mode**  to return to **Measurement** mode.

Appendix F: PROFIBUS PA Profile Structure

PROFIBUS Level Device Design

The device follows the profile block model and is implemented as a Profile 3.01, Class B, PA device. Standard profile parameters are used to program the level transducer block.

Block Model for recording and processing measured values

The functions of the device are divided into blocks for different areas of responsibility. They can be parameterized by acyclic data transfer via PDM.

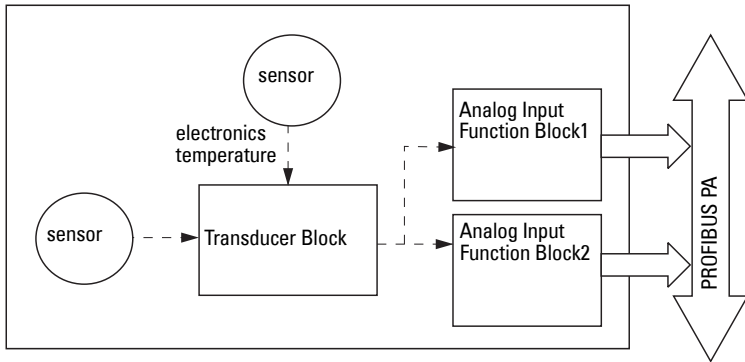

The device is implemented with one Physical Block (PB1), one Level Transducer Block (LTB1), and two Analog Input Function Blocks (AIFB1 and AIFB2).

All data is viewed from the perspective of the DCS or PLC, so information from the sensor is an input.

Transducer Block (TB)

The Level Transducer Block (LTB) carries out adjustments to the sensor, such as level calibration. It supplies the outputs utilized by either or both of the AIFBs.

Analog Input Function Blocks AIFB1 and AIFB2

The two AIFBs are completely independent of each other. They utilize the output from the Level TB, and apply any required quality checks, scaling, and Fail-safe operation selections.

The output of an Analog Input Function Block supplies the measured value and associated status information to PROFIBUS PA, via cyclic data transfer.

Description of the blocks

Transducer block function groups

The figure below shows the signal flow of measured values from the sensor through the Transducer block into the output value:

- Primary Value (PV): Level
- Secondary Value 1 (SV1): Level/Volume
- Secondary Value 2 (SV2): Distance

The Level TB implements all of the basic parameters.

Level Transducer Block

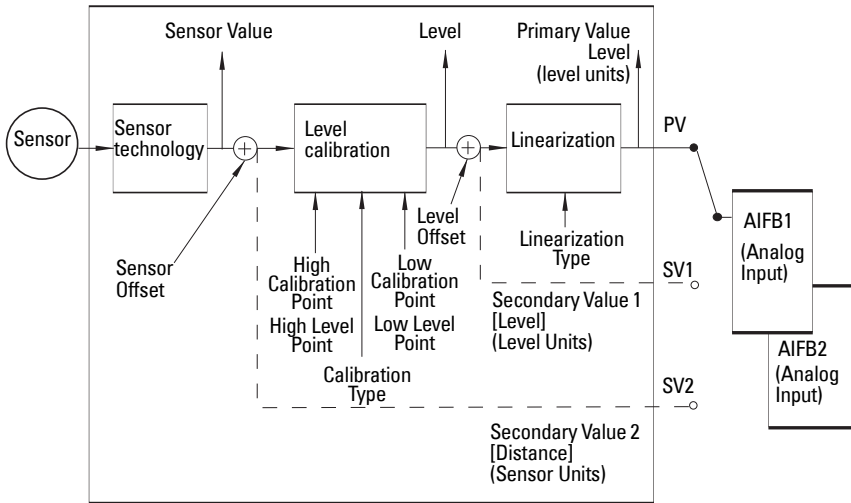

How the LTB works

1. The sensor technology block selects the proper echo. For an explanation of sensor technology, see *Appendix D: Technical Reference*, page 103 onwards.

The sensor value (in sensor units) is checked to see if it is within its measuring limits. If the limit is exceeded, this results in a **Bad** status and the error message **Failure in measurement**. The sensor value is stored in Sensor Value.

The analog signal from the sensor is transformed into a digital signal.

A Sensor Offset (default 0) provides compensation if necessary for changes in the sensor.

2. Level Calibration is a linear transfer function that converts a sensor value to a level value.

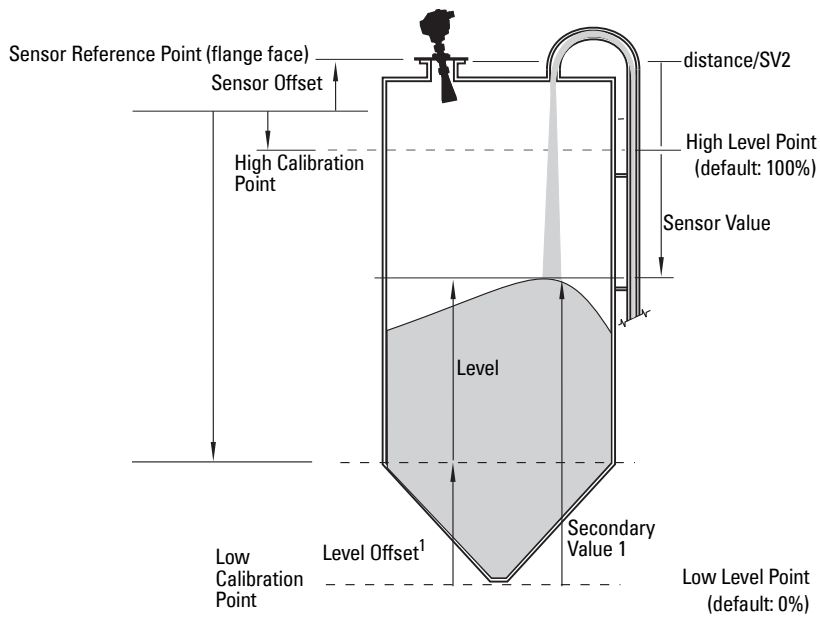
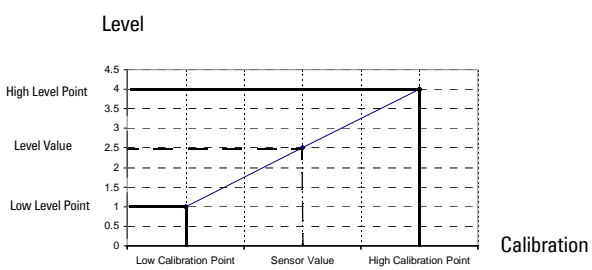

3. The LTB provides four possible outputs
- Primary Value (PV) / Level/Volume
 - Secondary Value 1 (SV1) / Level
 - Secondary Value 2 (SV2) / Distance (sensor units)

Electronics temperature

The transducer block also monitors the internal temperature of the device electronics. If the temperature exceeds permitted limits, it does not change the sensor value, but it does change the status. The permitted limits correspond to those of the permitted ambient temperature.

¹⁾ Level Offset (default 0) can compensate for specific vessel configurations.

If a temperature limit is exceeded, the status changes. Peak indicators¹⁾ allow you to check the maximum and minimum temperatures that have occurred.

Analog Input Function Blocks 1 and 2

The figure below shows how measured values are processed within the two Analog Input Function Blocks (AIFB1 and AIFB2) to produce the device outputs, which are communicated via cyclic transfer to PROFIBUS PA, and displayed on the LCD.

Analog Input Function Block function groups (simulation, mode and status)

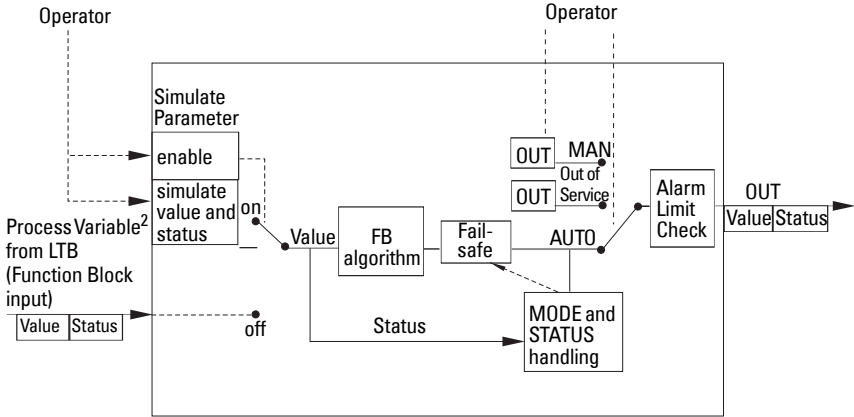

How the AIFBs work

The Analog Input Function Blocks allow you to control modifications to the output value (PROFIBUS cyclic data).

Output Conversion

Values transmitted by the Level TB have a status attached. The decision on what to do with each value is made by the Analog Input Function Block.

Device/ Input Simulation

The input can be a simulated value instead of a TB OUT value. This allows the AI block to be tested independently of the characteristics of the environment.

Fail-safe

If the status of the Primary Value or Simulation Value is **bad**, the fault logic can output either the last usable measured value, or a given substitute value.

1) Open the menu **View – Peak Values**.

2) The output from the Level Transducer Block can be called the Primary Value (or Secondary Value). When it becomes the input to the AIFB, it is called the Process Variable.

Device / Output Simulation

Setting	description	Output value
AUTO	automatic	the automatically-recorded measured value
MAN	manual	a manually-set fixed simulation value
O/S	function block disabled	the preset safety value.

One of three settings can be selected: the result is the output parameter (OUT).

AIFB execution steps:

The AIFBs can provide a linear conversion to any desired units.

1. The input value is normalized (Scaling Input)

Process Variable range applies to any of the four LTB values. (Units of the Process Variable scale are the same as the units used for the LTB output.) Output units together with Process Variable range determine how the LTB output is converted to whatever units the customer wants.

2. The scaling output is applied.

For example:

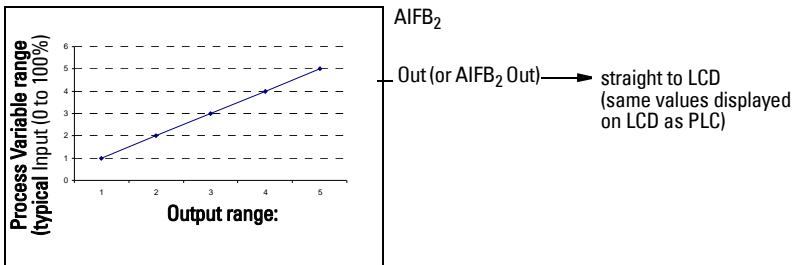

3. This value is filtered using a first order filter based on a time constant provided by the user.
4. The status of the Process Variable (input value) is checked. If the status is Bad, a Fail-safe condition occurs. The output is determined by the Fail-safe Mode of the block.
5. The target mode parameter allows the entire AI block to be overridden by a Manual Out value.
6. The value is checked against the user parameterized warning and alarm limits. (There is an upper and lower warning limit and an upper and lower alarm limit. The unit of the limits corresponds to the unit of the output range. A hysteresis parameter prevents toggling in the Status field of the OUT value.)
7. The OUT VALUE parameter is the value for the cyclic data transfer.

Notes

Appendix G: Communications via PROFIBUS PA

SITRANS LR260 (PROFIBUS PA) is a Profile Version 3.01, Class B, PA device. It supports Class 1 Master for cyclic and acyclic data exchange, and Class 2 for acyclic services. The full range of SITRANS LR260 functions is available only over a PROFIBUS PA network.

PROFIBUS PA is an open industrial protocol. Full details about PROFIBUS PA can be obtained from PROFIBUS International at www.profibus.com.

Device Configuration tool

To use PROFIBUS PA, you will need a PC configuration tool: we recommend SIMATIC PDM. Please consult the operating instructions or online help for details on using SIMATIC PDM. (You can find more information at www.fielddevices.com: go to **Products and Solutions > Products and Systems > Communications and Software > Process Device Manager**.)

SIMATIC PDM

SIMATIC PDM is a software package used to commission and maintain SITRANS LR260 and other process devices. For more detail see *Functions in SIMATIC PDM* on page 37.

Electronic Device Description

In order to use **Process Device Manager (PDM)** with PROFIBUS PA, you will need the Electronic Device Description for SITRANS LR260. For details see *Electronic Device Description (EDD)* on page 38.

Network Configuration

To configure a PROFIBUS PA Class 1 Master (for example, a PLC), you will need a **GSD** file.

The GSD file

The GSD file **SIEM8162.gsd** is available from the SITRANS LR260 product page on our web site. Go to www.siemens.com/LR260 and click on **Downloads**.

Bus Termination

Note: PROFIBUS PA MUST be terminated at both extreme ends of the cable for it to work properly. Please refer to the PROFIBUS PA User and Installation Guidelines (order number 2.092), available from www.profibus.com.

Power Demands

To determine how many devices can be connected to a bus line, calculate the combined maximum current consumption of all the connected devices: 15 mA for SITRANS LR260. Allow a current reserve for safety.

PROFIBUS address

A unique PROFIBUS address identifies each device on the network. To set the PROFIBUS address see **Device Address (5.1.)** on page 88.

Notes:

- It is possible to change the device address via a Class 1 master (for example, a PLC) and lock the device address to prevent further changes.
- If this Address Lock is on, the PA address cannot be changed. This lock can be disabled only by performing an Address Reset.

Resetting the PROFIBUS address to 126:

- Via SIMATIC PDM:
 - a) Open the menu **Device – Device Reset** and click on **Reset Address to 126**.
 - b) Click on **OK**: the address will be reset to 126, and if the address lock was on, it will be disabled.
- Via the handheld programmer:
 - a) Navigate to **Service (4.) > Device Reset (4.1.)**. (You can enter the numeric value instead of navigating via the Arrow keys.)
 - b) Press **RIGHT Arrow** to open Edit Mode then scroll down to **DEV ADDRESS** and press **RIGHT Arrow** to select it. The address will be reset to 126, and if the address lock was on, it will be disabled.
 - c) Press **LEFT Arrow** to exit.

Operating as a Profile Device

Every manufactured PROFIBUS product has a unique PROFIBUS identification number which identifies it to the system. PROFIBUS Profile Standard version 3.01 also defines a Profile Model which can identify a product as a generic profile device on the network.

SITRANS LR260 can be identified in one of three ways:

Device Identification	Profile Model
STD PROFILE	Standard Profile (uses generic GSD for 2 AIFB [ident # = 0x9701])
* MANUFACTURER	Manufacturer-specific (uses Siemens EDD and GSD file, which identifies the LR260 [PROFIBUS PA]) [ident # = 0x8162]
STD – AIFB 1 ONLY	Standard Profile AIFB 1 only (uses generic GSD for 1 AIFB) [ident # = 0x9700]

Defining the device as Profile-specific as opposed to Manufacturer-specific makes it possible to exchange the device for any other device of the same profile type without changing the GSD file.

To set up SITRANS LR260 as a profile device see **PROFIBUS Ident Number (PROFIBUS IDENT) (4.4.)** on page 85.

Configuring a device

See *Configuring a new device* on page 38.

Configuring PROFIBUS PA with an S7-300/ 400 PLC

1. If SITRANS LR260 is not listed in the STEP 7 device catalog, you can download the DeviceInstall file from the Siemens Milltronics Web site and run it from your computer. Go to <https://pia.khe.siemens.com/index.asp?Nr=7427> and click on **Downloads**.
2. Add the SITRANS LR260 "rack": click on and drag the SITRANS LR260 folder from the hardware catalog.
3. Fill the rack with desired modules, by dragging and dropping them from the hardware catalog.
4. After configuring PROFIBUS PA in steps 2 and 3, download it to the PLC.
5. Add code to the PLC program to read data consistently using the SFC14.

Cyclic versus Acyclic Data

When you request data from a device via PROFIBUS PA, you have two choices. Cyclic data is provided at every bus scan: acyclic data is requested and provided as needed.

Input information is always requested at every bus scan and is set up as cyclic data. Configuration information is only needed periodically and is set up as acyclic data.

Cyclic Data

When you configure SITRANS LR260 on the PROFIBUS PA bus, there are two slots available for modules.

Note: Each of the slots has to have a module defined in it.

Slot 0 always transmits **AIFB1** information¹⁾; slot 1 defaults to Free Place, but can be changed to **AIFB2** information. If you do not wish to have data transmitted, then you must use a **Free Place** module in that slot.

Each of the two Analog Input Function Blocks can be set up to return **Level**, or **Distance**. Within the function blocks, the values are scaled according to the user requirements (please see *Analog Input Function Blocks 1 and 2* on page 116 for details).

¹⁾ For more information, please see *Analog Input Function Blocks 1 and 2* on page 116.

AIFB1 and **AIFB2** return 5 bytes of data each:

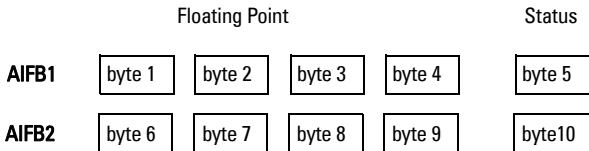

The first 4 bytes are the floating point representation (IEEE) of the variable. The variables are the outputs of the function block. The 5th byte is the status word and the list of possible values is given in the chart below.

The 5 bytes must be read consistently, in a contiguous chunk: they cannot be read byte by byte, and cannot suffer an interrupt. If you are using an S7-300 / 400, you will need to use SFC14 DPRD_DAT: Read Consistent Data of a Standard DP Slave.

Status Byte

In PROFIBUS PA there are two possible types of status byte:

- **status byte:** originally defined in Profile Standard V3.0
- **condensed status:** an alternative status byte defined in Profile Standard V3.01

You can choose which type of status byte will be returned, by enabling or disabling **Condensed Status Mode (COND. STAT. MODE) (3.6.1)**. The default setting is Condensed Status enabled:

Condensed Status

These codes are available when Condensed Status is enabled. See **Condensed Status Setup (COND. STAT. SETUP) (3.6.)** on page 80 for more details.

Condensed Status		
Hex value	Status – GOOD	Description
0x80	GOOD – ok	No error or special condition is associated with this value.
0x84 ...0x87	GOOD – update event	Set if the value is good and the block has an active Update event. (This status remains active for 20 seconds.)
0x89, 0x8A	GOOD – active advisory alarm	Set if the value is good and the block has an active Alarm.
0x8D, 0x8E	GOOD – limit check/ update event	See <i>Status Codes for Good Quality</i> on page 124.
0xA0 ...0xA3	GOOD – initiate fail safe	This fault is not generated by the product, but can be simulated.
0xA4 ...0xA7	GOOD – maintenance required	Value is valid. Maintenance is recommended within a medium-term period.
0xA8 ...0xAB	GOOD – maintenance demanded	Value is valid. Maintenance is demanded within a short-term period.
0xBC ...0xBF	GOOD – function check	Device performs internal function check without influencing the process. Value is valid.

Condensed Status		
Hex value	Status – UNCERTAIN	Description
0x4B	UNCERTAIN – substitute set	Output of Failsafe logic only.
0x4F	UNCERTAIN – initial value	Default value as long as no measured value is available or until a diagnosis is made that affects the value and the status accorded to it.
0x68 ...0x6B	UNCERTAIN – maintenance demanded	Usability of the process value depends on the application. Value is potentially invalid. Cause is a wear ^{a)} detected in the device. Maintenance is demanded within a short-term period.
0x73	UNCERTAIN – simulated value, start	Indicates the start of a simulation. Simulation of a measured value or Input FB mode changes from AUTO to MAN. <ul style="list-style-type: none"> • This status remains active for at least 10 seconds: <ul style="list-style-type: none"> – after enabling simulation – after setting the FB to MAN mode – after a restart (e.g. power down cycle) if the simulation is enabled or the FB is in MAN mode – after passivation is cleared if simulation is enabled or the FB is in MAN mode • In MAN mode the status remains until a subsequent write command overwrites the OUT value after the 10 seconds have expired. • In simulation mode the written status is buffered and appears in the value flow after 10 seconds. However the new written SIMULATE parameter with its status can be read before the 10 seconds have expired.
0x74 ...0x77	UNCERTAIN – simulated value, end	Indicates the end of a simulation. Simulation of a measured value is disabled or Input FB mode changes from MAN to AUTO. This Status remains active for 10 seconds after simulation ends. While this status is active there is no reliable process value. Measured values and their status are updated afterwards.

a) See *Wear* on page 49 for more detail.

Condensed Status		
Hex value	Status BAD	Description
0x00	BAD – non specific	Proxy determines that a device does not communicate.
0x23	BAD – passivated (diagnostics alerts disabled)	Configured failsafe value is used, accompanied by this status.
0x24 ...0x27	BAD – maintenance alarm, more diagnosis available	No measurement available because of a failure.
0x2B	BAD – process related, no maintenance	No measurement available because of invalid process conditions.
0x3C ...0x3F	BAD – function check / local override, value not usable	Occurs during cleaning or calibration process.

Status Byte

When Condensed Status is disabled, Status Byte will be returned, and the following codes will be used.

Status Codes for Good Quality	
Values in hex notation	Description
0x80	Data is GOOD.
0x84...0x87	A parameter in the function block has been changed: status active for 20 s
0x89	Active low warning.
0x8A	Active high warning.
0x8D	Active low alarm.
0x8E	Active high alarm.

Status Codes for Uncertain Quality	
Values in hex notation	Description
0x4B	Value is a substituted value (normally used in Failsafe).
0x4C...0x4F	Initial value.
0x44...0x47	Last usable value.

Status Codes for Bad Quality

Values in hex notation	Description
0x10...0x1C	The LOE timer has expired: this could be caused by LOE or by a sensor malfunction: value is BAD.
0x04...0x07	There is an error in the configuration of the function blocks in PROFIBUS PA ^{a)} .
0x1C...0x1F	The function block, or the transducer block, has been placed out of service.

- a) This could happen when a firmware download has been done, but a system reset has not been done. This could also happen if the function blocks are not configured properly using the handheld programmer, PDM or acyclic services.

Diagnostics

All diagnostic information shown below is viewable via PDM.

Diagnosis reply (available cyclically)

During DPVO data exchange, the PROFIBUS PA slave will notify the Master when a serious error occurs. The Master will then send a Diagnosis request. The reply to this request is normally logged in the PLC and is referred to as the "Hex values."

The reply may contain two parts. The first part is 6 bytes long and is defined by the PROFIBUS standard. If there is a second part, it is called the 'extended cyclic diagnosis' and it is 8 bytes long. The last 4 bytes of the extended diagnostic message give the error code shown. (See *Extended Mode Diagnosis* on page 126 and *Condensed Mode Diagnosis* on page 126.)

The same information is also available acyclically via the Diagnosis Object.

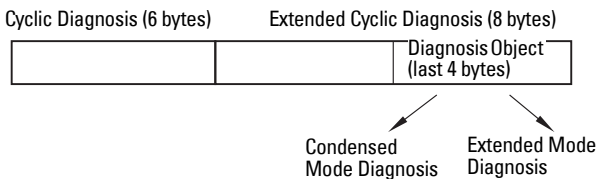

Diagnosis Object (available cyclically or acyclically)

This consists of four bytes.

In PROFIBUS PA there are two possible types of Acyclic Diagnostics:

- **Extended Mode Diagnosis**
- **Condensed Mode Diagnosis**

You can choose which of these will be returned, by enabling or disabling **Condensed Status Mode (COND. STAT. MODE) (3.6.1)** on page 80. The default setting is Condensed Status enabled: **Extended Mode Diagnosis** will be returned, and the following codes will be used.

Extended Mode Diagnosis

Extended Mode Diagnosis				
Hex values	Byte	Bit	Description	Indication class ^{a)}
0x01000000	0	0	Electronics failure	R
0x02000000		1	Mechanical failure	R
0x04000000		2	Motor Temperature too high	R
0x08000000		3	Electronics temperature too high	R
0x10000000		4	Memory error	R
0x20000000		5	Measurement failure	R
0x40000000		6	Device not initialized (no calibration)	R
0x80000000		7	Self calibration failed	R
0x00100000	1	0	Zero point error (limit position)	R
0x00200000		1	Power supply failure (electrical, pneumatic)	R
0x00400000		2	Configuration invalid	R
0x00800000		3	New startup carried out (Warm Start)	A
0x00100000		4	Restart carried out (Cold Start)	A
0x00200000		5	Maintenance required	R
0x00400000		6	Characterization invalid	R
0x00800000		7	Set to 1 (one), if the Ident_Number of the running cyclic data transfer and the value of Physical Block IDENT__NUMBER_SELECTOR parameter are different.	R
	2	0 to 7	Reserved for use within the PNO	
	3	0 to 6	Reserved for use within the PNO	
0x00000080		7	More diagnosis information is available	

- a) **R** indicates the message remains active as long as the reason for the message exists.
A indicates the message will automatically reset after 10 seconds

Values of the DIAGNOSIS bit: **0** = not set; **1** = set

Condensed Mode Diagnosis

Condensed Mode Diagnosis				
Hex values	Byte	Bit	Description	Indication class ^{a)}
0x01000000	0	0	Reserved for use within the PNO	
0x02000000		1	Reserved for use within the PNO	
0x04000000		2	Reserved for use within the PNO	
0x08000000		3	Reserved for use within the PNO	
0x10000000		4	Reserved for use within the PNO	

Condensed Mode Diagnosis (cont'd)				
Hex values	Byte	Bit	Description (cont'd)	Indication class ^{a)} (cont'd)
0x20000000	0 (cont'd)	5	Reserved for use within the PNO	
0x40000000		6	Reserved for use within the PNO	
0x80000000		7	Reserved for use within the PNO	
0x00080000	2	3	New startup carried out (Warm Start)	A
0x00100000		4	Restart carried out (Cold Start)	A
0x00200000		5	Maintenance required	R
0x00400000		6	Reserved for use within the PNO	
0x00800000		7	Set to 1 (one), if the Ident_Number of the running cyclic data transfer and the value of Physical Block IDENT_NUMBER_SELECTOR parameter are different.	R
0x00010000	3	0	Failure of the device or armature	R
0x00020000		1	Maintenance demanded	R
0x00040000		2	Device is in function check mode, or simulation, or under local control e.g. maintenance	R
0x00080000		3	The process conditions do not allow the return of valid values. (Set if a value has the quality Uncertain - Process related, no maintenance or Bad - Process related, no maintenance.)	R
		4 to 7	Reserved for use within the PNO	
	4	0 to 6	Reserved for use within the PNO	
0x80000000		7	0: There is no more information available 1: More diagnosis information is available in DIAGNOSIS_EXTENSION	

- a) **R** indicates the message remains active as long as the reason for the message exists.
A indicates the message will automatically reset after 10 seconds

Acyclic Extended Diagnostics (General Fault Codes)

In addition to the extended diagnostics available by cyclic data exchange (shown above), further extended diagnostics are available via acyclic communications. This consists of six bytes. See *Acyclic Data* on page 130 for information on the location of the **Extended Diagnostics**

Note: Certain fault codes (identified by an asterisk [*] in the table below) will persist until a manual reset has been performed (see **Fault Reset (3.1.)** on page 72).

Acyclic Extended Diagnostics /General Fault Codes					
LCD display	Meaning	Corrective Action	Byte	Bit	
S:0	The device was unable to get a measurement within the LOE Fail-safe Timer period. Possible causes: faulty installation, material buildup, foaming/other adverse process conditions, invalid calibration range.	Ensure installation details are correct. Ensure no material buildup. Clean if necessary. Adjust process conditions to minimize foam or other adverse conditions. Correct range calibration. If fault persists, contact your local Siemens representative.	0		0
S:2	Unable to collect profile because of a low power condition that is outside of the operating range of the device.	Repair required. Contact your local Siemens representative.			2
S:3	Device is nearing its lifetime limit according to the value set in Maintenance Required Limit.	Replacement is recommended.			3
S:4	Device is nearing its lifetime limit according to the value set in Maintenance Demanded Limit.	Replacement is recommended.			4
S:6	Sensor is nearing its lifetime limit according to the value set in Maintenance Required Limit.	Replacement is recommended.			6
S:7	Sensor is nearing its lifetime limit according to the value set in Maintenance Demanded Limit.	Replacement is recommended.			7
S:8	Service interval as defined in Maintenance Required Limit has expired.	Perform service.	1		0
S:9	Service interval as defined in Maintenance Demanded Limit has expired.	Perform service.			1
S:10	Input parameters High Calibration Point and Low Calibration Point are the same.	Check calibration settings of device. Ensure settings for High Calibration Point and Low Calibration Point are different.			2

Acyclic Extended Diagnostics /General Fault Codes (cont'd)

LCD display	Meaning (cont'd)	Corrective Action	Byte (cont'd)	Bit
S:11	Internal temperature sensor failure.	Return the device to the factory.	1 (cont'd)	3
S:12	* Internal temperature of device has exceeded specifications: it is operating outside its temperature range.	Lower the ambient temperature enough to cool the device. Fault code will persist until a manual reset is performed using PDM or the LCD interface.		4
S:14	Upper and lower input values (Process Value Scale) for AIFB1 are the same.	Check configuration for AIFB1. Ensure that Upper Value and Lower Value (Process Value Scale) are not the same.		6
S:15	Upper and lower input values (Process Value Scale) for AIFB2 are the same.	Check configuration for AIFB2. Ensure that Upper Value and Lower Value (Process Value Scale) are not the same.		7
S: 17	Calibration interval as defined in Maintenance Required Limit has expired.	Perform calibration.	2	1
S: 18	Calibration interval as defined in Maintenance Demanded Limit has expired.	Perform calibration.		2
S: 25	Internal device error	Reset power. If error persists, contact your local Siemens representative.	3	1
S:28	Internal device failure caused by a RAM memory error.	Repair required: contact your local Siemens representative.		4
S:29	EEPROM damaged.	Repair required: contact your local Siemens representative.		5
S:31	Flash error.	Repair required: contact your local Siemens representative.		7

Acyclic Extended Diagnostics /General Fault Codes (cont'd)				
LCD display	Meaning (cont'd)	Corrective Action	Byte (cont'd)	Bit
S:32	The IDENT number used in communications, and number selected by the Ident Number Selector do not correspond.	Ensure value of the Ident number selector is correct for the network configuration. If it is correct, the device needs to be re-parameterized by the PLC.	4	0
S:33	Factory calibration for the internal temperature sensor has been lost.	Repair required: contact your local Siemens representative.		1
S:34	Factory calibration for the device has been lost.	Repair required: contact your local Siemens representative.		2
S:35	Factory calibration for the device has been lost.	Repair required: contact your local Siemens representative.		3
S:36	Unable to start microwave module.	Cycle power. If error persists, contact your local Siemens representative.		4
S:37	Measurement hardware problem.	Cycle power. If error persists, contact your local Siemens representative.		5
S:38	Microwave module hardware failure: unable to calculate distance measurement.	Cycle power. If fault persists, contact your local Siemens representative: repair required.		6
S:43	Factory calibration for the radar receiver has been lost.	Repair required: contact your local Siemens representative.	5	3

Acyclic Data

SITRANS LR260 supports up to four simultaneous connections by a Class 2 Master (C2 connection). It supports one connection by a Class 1 Master (C1 connection).

In order for a Class 1 Master to read parameters from an instrument, it needs to know the slot and absolute index of the parameter.

The parameters are all listed in SIMATIC PDM under Help. If you do not have SIMATIC PDM you can download the EDD and reference the HTML help file directly.

(continued on next page)

To find the slot and index numbers via SIMATIC PDM, go to **Help > Help on Device Parameters > Communications**, and select the appropriate block from the list. For each parameter, the slot and the relative index is listed. For example.

AIFB 1		
Index	Parameter	Datatype
1	Static Revision No.	UNSIGNED_INTEGER (2)

Each block has a slot number and an Index Offset value.

Block Name	Slot	Index Offset
Physical block	0	16
Transducer block	0	77
AIFB 1	1	16
AIFB 2	2	16

To get the absolute index for any parameter, add the Index Offset for the appropriate block to the relative index for that parameter. The parameter takes the slot number of the block in which it is located.

For example:

- Parameter **Static Revision Number** has relative index = 1 and is located on AIFB1.
- It has Absolute Index = 17 (relative index 1 + index offset 16).
- It is located at Slot 1 (the slot number for AIFB 1).

Notes

Appendix H: Firmware Revision History

Firm-ware Rev.	EDD Rev.	Date	Changes
1.00.01	1.00.04	Dec. 5, 2007	<ul style="list-style-type: none"><li data-bbox="493 277 653 302">• Initial release

Notes

Glossary

- accuracy:** degree of conformity of a measure to a standard or a true value.
- agitator:** mechanical apparatus for mixing or aerating. A device for creating turbulence.
- algorithm:** a prescribed set of well-defined rules or processes for the solution of a problem in a finite number of steps.
- ambient temperature:** the temperature of the surrounding air that comes in contact with the enclosure of the device.
- antenna:** an aerial which sends out and receives a signal in a specific direction. There are four basic types of antenna in radar level measurement, horn, parabolic, rod, and waveguide.
- attenuation:** a term used to denote a decrease in signal magnitude in transmission from one point to another. Attenuation may be expressed as a scalar ratio of the input magnitude to the output magnitude or in decibels.
- Auto False-Echo Suppression:** a technique used to adjust the level of a TVT curve to avoid the reading of false echoes. (See TVT.)
- Auto False-Echo Suppression Distance:** defines the endpoint of the TVT distance. (See TVT.) This is used in conjunction with auto false echo suppression.
- beam angle:** the angle diametrically subtended by the one-half power limits (-3 dB) of the microwave beam.
- beam spreading:** the divergence of a beam as it travels through a medium.
- blanking:** a blind zone extending away from the reference point plus any additional shield length. The instrument is programmed to ignore this zone.
- capacitance:** the property of a system of conductors and dielectrics that permits the storage of electricity when potential differences exist between the conductors. Its value is expressed as the ratio of a quantity of electricity to a potential difference, and the unit is a Farad.
- confidence:** describes the quality of an echo. Higher values represent higher quality. Confidence threshold defines the minimum value.
- damping:** term applied to the performance of an instrument to denote the manner in which the measurement settles to its steady indication after a change in the value of the level.
- dB (decibel):** a unit used to measure the amplitude of signals.
- derating:** to decrease a rating suitable for normal conditions according to guidelines specified for different conditions.
- dielectric:** a nonconductor of direct electric current.¹⁾

dielectric constant (DK): the ability of a dielectric to store electrical potential energy under the influence of an electric field. Also known as Relative Permittivity. An increase in the dielectric constant is directly proportional to an increase in signal amplitude. The value is usually given relative to a vacuum /dry air: the dielectric constant of air is 1¹.

echo: a signal that has been reflected with sufficient magnitude and delay to be perceived in some manner as a signal distinct from that directly transmitted. Echoes are frequently measured in decibels relative to the directly transmitted signal.

echo confidence: the recognition of the validity of the echo. A measure of echo reliability.

Echo Lock Window: a window centered on an echo in order to locate and display the echo's position and true reading. Echoes outside the window are not immediately processed.

Echo Marker: a marker that points to the processed echo.

Echo Processing: the process by which the radar unit determines echoes.

Echo Strength: describes the strength of the selected echo in dB above 1 μ V rms.

Echo Profile: a graphical display of a processed echo.

false echo: any echo which is not the echo from the desired target. Generally, false echoes are created by vessel obstructions.

frequency: the number of periods occurring per unit time. Frequency may be stated in cycles per second.

hertz (Hz): unit of frequency, one cycle per second. 1 Gigahertz (GHz) is equal to 10⁹ Hz.

horn antenna: a conical, horn-shaped antenna which focuses microwave signals. The larger the horn diameter, the more focused the radar beam.

inductance: the property of an electric circuit by virtue of which a varying current induces an electromotive force in that circuit or in a neighboring circuit. The unit is a Henry.

microwaves: the term for the electromagnetic frequencies occupying the portion of the radio frequency spectrum from 1 GHz to 300 GHz.

multiple echoes: secondary echoes that appear as double, triple, or quadruple echoes in the distance from the target echo.

Near Blanking: see Blanking

nozzle: a length of pipe mounted onto a vessel that supports the flange.

parameters: in programming, variables that are given constant values for specific purposes or processes.

polarization: the property of a radiated electromagnetic wave describing the time-varying direction and amplitude of the electric field vector.

¹⁾ Many conductive liquids/electrolytes exhibit dielectric properties; the relative dielectric constant of water is 80.

polarization error: the error arising from the transmission or reception of an electromagnetic wave having a polarization other than that intended for the system.

PROFIBUS PA: one of the PROFIBUS family of protocols, specifically tailored for the needs of process industries (PA = Process Automation).

propagation factor (pf): where the maximum velocity is 1.0, pf is a value that represents a reduction in propagation velocity as a result of the wave travelling through a pipe or medium.

pulse radar: a radar type that directly measures distance using short microwave pulses. Distance is determined by the return transit time.

radar: radar is an acronym for **RA**dio **D**etection **A**nd **R**anging. A device that radiates electromagnetic waves and utilizes the reflection of such waves from distant objects to determine their existence or position.

range: distance between a transmitter and a target.

range extension: the distance below the zero percent or empty point in a vessel.

relative permittivity: see dielectric constant.

repeatability: the closeness of agreement among repeated measurements of the same variable under the same conditions.

shot: one transmit pulse or measurement.

speed of light: the speed of electromagnetic waves (including microwave and light in free space. Light speed is a constant 299,792,458 meters per second.

two wire radar: a low-energy radar. Can be loop powered, analog, intrinsically safe, or a digital (BUS) transmitter.

TVT (time varying threshold): a time-varying curve that determines the threshold level above which echoes are determined to be valid.

waveguide antenna: a hollow, metallic tube that transmits a microwave signal to the product target.

Notes

Index

A

- abbreviations
 - list 3
- activating SITRANS LR260 27
- acyclic diagnostics
 - fault codes 125
- address 88
- Auto False Echo Suppression
 - explanation 105
 - setup 62
- Auto False-Echo Suppression
 - TVT shaper adjustment 45

B

- beam angle
 - illustration 14
 - values 11
- blanking (see Near Range) 105
- bus address (device address) 120
- bus termination 119

C

- cables
 - requirements 21
- cleaning
 - instructions 101
- conduits
 - requirements 21
- configuration 119
- cyclic data 121
 - versus acyclic 121

D

- device description (DD)
 - PROFIBUS PA 119
- Device Reset
 - factory defaults 84
- diagnosis reply 125
- diagnostics 122
- dimensions table
 - threaded horn 11

E

- echo profile viewing
 - via LUI 33
- edit mode
 - handheld programmer 31
- enclosure
 - opening 21

F

- factory defaults 84
- Far Range
 - explanation 106
- fault codes
 - acyclic diagnostics 125
 - acyclic extended diagnostics 127
- function keys
 - navigation mode 31

G

- GSD file 119

H

- handheld programmer
 - edit mode 31
 - navigation 31
- hazardous area installations
 - wiring requirements 24

I

- identifications and abbreviations
 - list 3
- installation
 - hazardous area requirements 24
 - requirements 13
 - warnings and notes 13

L

- LCD display
 - echo profile viewing 33
 - PROGRAM mode 28
- level trend viewing
 - via PDM 45
- lid-lock set screw 21
- loop voltage vs. loop resistance
 - power supply requirements 24
- Loss of Echo (LOE)
 - explanation 106

M

- maintenance
 - cleaning 101
- maintenance settings 72
- Measurement Response
 - explanation 106
- mounting
 - handheld programmer access 15
 - housing construction 15
 - nozzle design 14
 - nozzle location 14
 - on vessel with obstructions 15
 - sunshield recommended 15

N

- Near Range

explanation 105

O

operating principles 103

P

PDM

- see SIMATIC PDM 37

polarization reference point 15

power consumption 120

power source

- requirements 21

power supply requirements

- loop voltage vs. loop resistance 24

Primary Value 116

Process Variable 116

PROFIBUS address 88

Q

Quick Start

- launching via PDM 39

Quick Start Wizard

- via handheld programmer 30
- via LUI 33

R

range extension

- see Far Range 106

repair

- cautions 101
- excluded liability 101

resets 84

S

safety notes 1

Secondary Value 116

settings

- adjust parameters via LUI 31

SIMATIC PDM

- features of rev. 6.0 37
- overview 37, 119
- Quick Start 39

SITRANS LR260

- operating principles 103
- overview 4

status byte

- status codes 122, 124

status codes 122, 124

Support

- contact information 2

T

temperature de-Rating

- curves 108

terminals

- accessing 21

trend diagram

- level trend viewing 45

troubleshooting

- operation 99

TVT curve 105

TVT Shaper

- manual adjustment via PDM 45

W

wiring

- cables 21
- hazardous areas 24

LCD menu structure

LCD menu structure

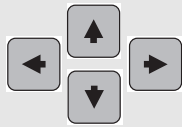

Notes:

- In Navigation mode **ARROW keys** navigate the menu in the direction of the arrow..
- See *Parameter Reference* on page 46 for detailed information and instructions.

1. QUICK START

- 1.1 APPLICATION TYPE
- 1.2 RESPONSE RATE
- 1.3 UNITS
- 1.4 OPERATION
- 1.5 LOW CALIB. PT.
- 1.6 HIGH CALIB. PT.
- 1.7 APPLY?

2. SETUP

- 2.1 DEVICE
 - 2.1.1 TAG
 - 2.1.2 DESCRIPTION
 - 2.1.3 MESSAGE
 - 2.1.4 FIRMWARE REV
 - 2.1.5 LOADER REV
 - 2.1.6 HARDWARE REV
- 2.2 INPUT
 - 2.2.1 SENSOR CALIB.
 - 2.2.1.1 ANTENNA
 - 2.2.1.2 SENSOR UNITS
 - 2.2.1.3 LOW CALIB. PT.
 - 2.2.1.4 HIGH CALIB. PT.
 - 2.2.1.5 LIMIT SENSOR VALUE
 - 2.2.1.6 UNIT (LEVEL)
 - 2.2.1.7 LOW LEVEL POINT
 - 2.2.1.8 HIGH LEVEL POINT
 - 2.2.1.9 LEVEL OFFSET
 - 2.2.1.10 SENSOR OFFSET
 - 2.2.1.11 TEMP UNITS
 - 2.2.3 ECHO PROC.
 - 2.2.3.1 ECHO SELECT
 - 2.2.3.1.1 ALGORITHM
 - 2.2.3.1.2 ECHO THRESHOLD
 - 2.2.3.1.3 POSITION
 - 2.2.3.1.4 ECHO MARKER
 - 2.2.3.2 SAMPLING
 - 2.2.3.2.1 ECHO LOCK
 - 2.2.3.2.2 UP SAMP
 - 2.2.3.2.3 DOWN SAMP
 - 2.2.3.2.4 WINDOW
 - 2.2.3.3 FILTERING
 - 2.2.3.3.1 SHOTS
 - 2.2.3.3.2 NARROW ECHO FIL.
 - 2.2.3.3.3 REFORM ECHO

2. SETUP (cont'd)

- 2.2.3.5 RANGE
 - 2.2.3.5.1 NEAR RANGE
 - 2.2.3.5.2 FAR RANGE
 - 2.2.3.5.3 MIN SENSOR VAL
 - 2.2.3.5.4 MAX SENSOR VAL
- 2.2.3.6 NOISE
 - 2.0.0.0.1 CONFIDENCE
 - 2.0.0.0.2 STRENGTH
- 2.2.4 TVT SETUP
 - 2.2.4.1 TVT TYPE
 - 2.2.4.2 TVT HOVER LEVEL
 - 2.2.4.3 AUTO ECHO SUPP
 - 2.2.4.4 AUTO SUPP RANGE
 - 2.2.4.5 SHAPER MODE
- 2.2.5 TVT SHAPER
 - 2.2.5.1 SHAPER 1-9
 - 2.2.5.2 SHAPER 10-18
 - 2.2.5.3 SHAPER 19-27
 - 2.2.5.4 SHAPER 28-36
 - 2.2.5.5 SHAPER 37-40
- 2.2.6 RATE
 - 2.2.6.1 RESPONSE RATE
 - 2.2.6.2 FILL RATE /MIN
 - 2.2.6.3 EMPTY RATE /MIN
- 2.2.7 TB VALUES
 - 2.2.7.1 MAIN OUTPUT
 - 2.2.7.2 O/P NO LINEAR.
 - 2.2.7.3 O/P NO OFFSETS
- 2.3 OUTPUT
 - 2.3.1 AIFB 1
 - 2.3.1.1 TARGET MODE
 - 2.3.1.2 LABEL
 - 2.3.1.3 UNIT
 - 2.3.1.4 FILTER TIME CONS
 - 2.3.1.5 CHANNEL
 - 2.3.1.6 BATCH INFO
 - 2.3.1.6.1 BATCH ID
 - 2.3.1.6.2 BATCH UNIT
 - 2.3.1.6.3 BATCH OPERATION
 - 2.3.1.6.4 BATCH PHASE
 - 2.3.1.7 PROC VALUE SCAL.
 - 2.3.1.7.1 LOWER VALUE
 - 2.3.1.7.2 UPPER VALUE
 - 2.3.1.8 OUTPUT SCALE
 - 2.3.1.8.1 LOWER VALUE
 - 2.3.1.8.2 UPPER VALUE
 - 2.3.1.9 OUTPUT LIMITS
 - 2.3.1.9.1 LO LIMIT ALARM
 - 2.3.1.9.2 LO LIMIT WARN
 - 2.3.1.9.3 HI LIMIT WARN
 - 2.3.1.9.4 HI LIMIT ALARM
 - 2.3.1.9.5 LIMIT HYSTERESI.
 - 2.3.1.10 HUMAN INTERFAC
 - 2.3.1.10.1 DECIMAL POINT
- 2.3.2 AIFB 2 (AS AIFB 1)

- 2.4 FAIL-SAFE
 - 2.4.1 LOE TIMER
 - 2.4.2 FS MODE FB1
 - 2.4.3 FS VALUE FB1
 - 2.4.4 FS MODE FB2
 - 2.4.5 FS VALUE FB2

3. DIAGNOSTICS

- 3.1 FAULT RESET
- 3.2 ECHO PROFILE
- 3.3 MEAS. VALUES
 - 3.3.1 MIN MEAS. VALUE
 - 3.3.2 MAX MEAS. VALUE
 - 3.3.3 MIN OUTPUT FB1
 - 3.3.4 MAX OUTPUT FB1
 - 3.3.5 MIN OUTPUT FB2
 - 3.3.6 MAX OUTPUT FB2
 - 3.3.7 MIN INTERN TEMP
 - 3.3.8 MAX INTERN TEMP
- 3.4 REMAIN. DEV. LIFE
 - 3.4.1 TOTAL OP-TIME
 - 3.4.2 REMAIN. LIFETIM
 - 3.4.3 MAINT REQ LIMIT
 - 3.4.4 MAINT DEM LIMIT
 - 3.4.5 ALERT ACTIVATIO
 - 3.4.6 TOTAL EXP. LIFE
 - 3.4.7 MAINT STAT
 - 3.4.8 ACK STATUS
 - 3.4.9 ACK
- 3.5 REMAIN. SENS. LIFE
 - 3.5.1 SENSOR OP-TIME
 - 3.5.2 REMAIN. LIFETIME
 - 3.5.3 MAINT REQ LIMIT
 - 3.5.4 MAINT DEM LIMIT
 - 3.5.5 ALERT ACTIVATIO
 - 3.5.6 TOTAL EXP. LIFE
 - 3.5.7 MAINT STAT
 - 3.5.8 ACK STATUS
 - 3.5.9 ACK
- 3.6 COND. STAT SETUI..
 - 3.6.1 COND .STAT MODE
 - 3.6.2 FEAT. SUPPORTED
 - 3.6.3 FEAT. ENABLED
- 3.7 CONDENSED STAT
 - 3.7.1 EVENT INDEX
 - 3.7.2 EVENT STAT
 - 3.7.3 EVENT DIAG.

4. SERVICE

- 4.1 DEVICE RESET
- 4.2 LCD FAST MODE
- 4.3 LCD CONTRAST
- 4.4 PROFIBUS IDENT
- 4.5 POWERED HOURS
- 4.6 POWERON RESETS

(continued on next page)

4. SERVICE (cont'd)

4.17 SERVICE INTERVAL

- 4.17.1 TIME LAST SERV
- 4.17.2 REMAIN LIFETIM.
- 4.17.3 MAINT REQ LIMIT
- 4.17.4 MAINT DEM LIMIT
- 4.17.5 ALERT ACTIVATIO
- 4.17.6 SERVICE INTERVAL
- 4.17.7 MAINT STAT
- 4.17.8 ACK STATUS
- 4.17.9 ACK

4.18 CALIB. INTERVAL

- 4.18.1 TIME LAST CAL.
- 4.18.2 REMAIN LIFETIM.
- 4.18.3 MAINT REQ LIMIT
- 4.18.4 MAINT DEM LIMIT
- 4.18.5 ALERT ACTIVATIO
- 4.18.6 TOTAL CALIB.INT
- 4.18.7 MAINT STAT
- 4.18.8 ACK STATUS
- 4.18.9 ACK

5. COMMUNICATION

- 5.1 DEVICE ADDRESS
- 5.2 REMOTE LOCKOUT

6. SECURITY

- 6.1 WRITE LOCKING

7. LANGUAGE

For more information

www.siemens.com/level

www.siemens.com/continuous-weighing

Siemens AG
Industry Sector
1954 Technology Drive
P.O. Box 4225
Peterborough, ON
Canada K9J 7B1

email: techpubs.smpi@siemens.com

www.siemens.com/processautomation

Subject to change without prior notice
A5E32337685 Rev. AA

© Siemens AG 2013



A 5 E 3 2 3 3 7 6 8 5
Printed in Canada